

BYTE[®]

JUNE 1981 Vol: 6, No. 6
\$2.50 in USA/\$2.95 in Canada

A McGraw-Hill Publication

the small systems journal

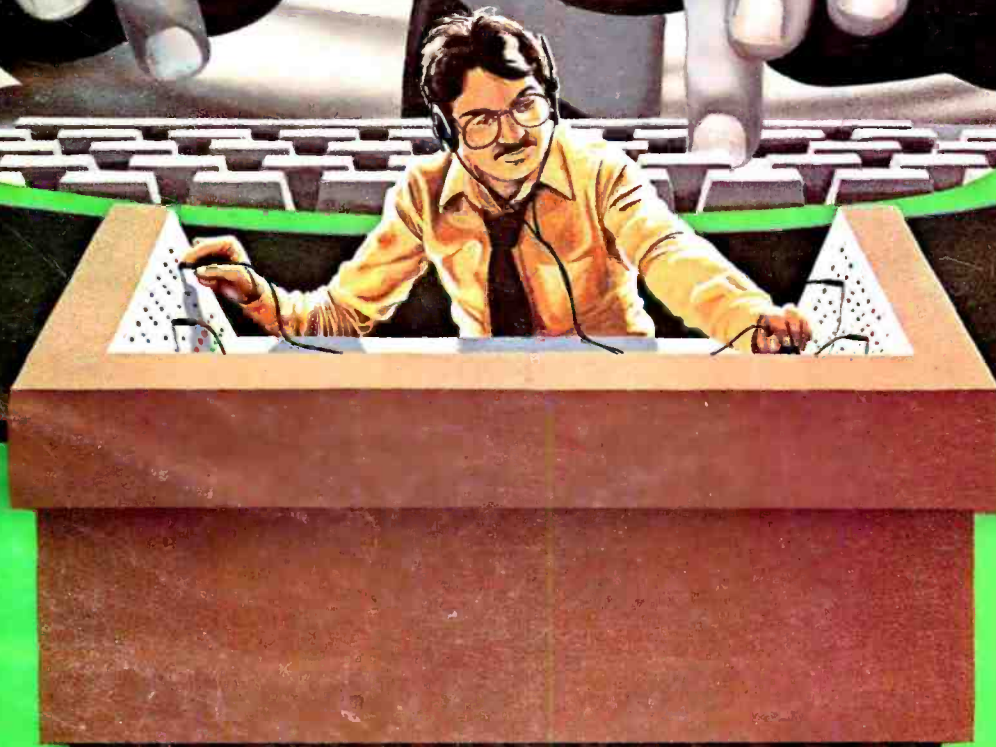

ROBERT
BL. TINNEY

OPERATING SYSTEMS



YOUR CHOICE-smart either way

- Over 140 software driven functions
- 82 x 24 or 82 x 20 screen format – software selectable
- High resolution 7 x 12 matrix characters – P-31 green phosphor
- Upper/lower case character set – plus graphics character set
- 56-key alphanumeric keyboard – plus 12-key cursor, numeric pad
- Internal editing functions – insert, delete, scroll, roll, slide, etc.
- Parallel printer I/O port
- 50 to 38,400 baud operation – programmable
- Cursor type, cursor position, print control characters, protected fields, shift inversion, dual intensity and many other features

8212 – twelve-inch diagonal screen or **8209** – nine-inch diagonal screen



SOUTHWEST TECHNICAL PRODUCTS CORPORATION
219 W. RHAPSODY
SAN ANTONIO, TEXAS 78216 (512) 344-0241

Circle 342 on inquiry card.

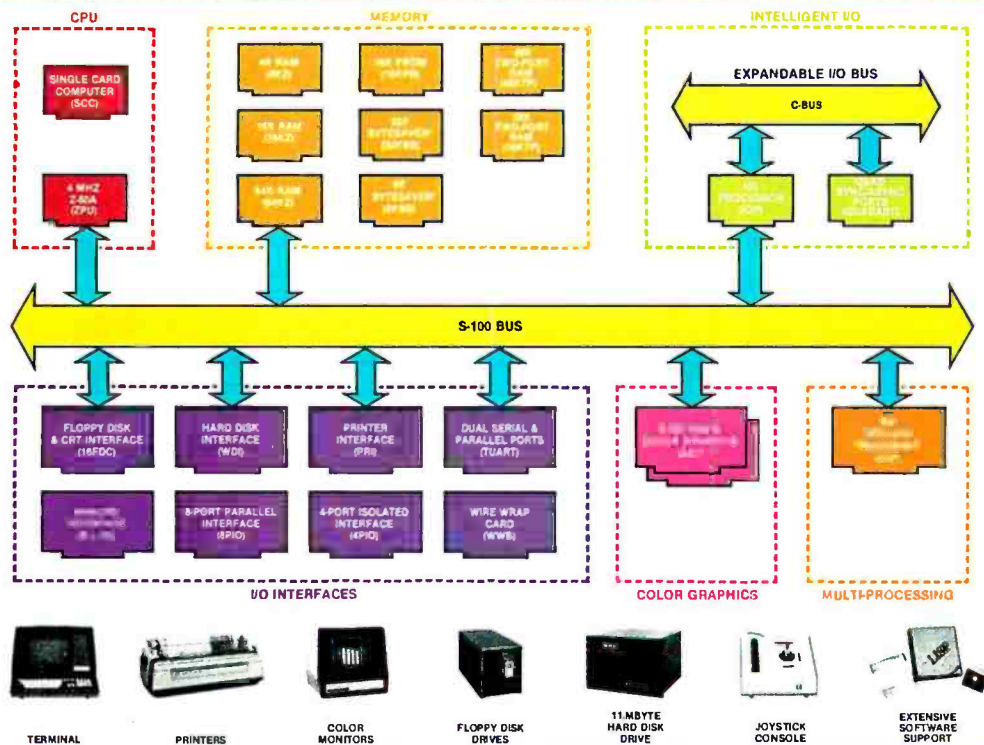

What Cromemco computer card capability can do for you

The above diagram shows in a functional way one of the most complete lines of computer cards in the industry.

Look it over carefully. It could be well worth your while.

These are all cards that plug into our S-100 bus microcomputers.

You can also assemble them into a custom system in convenient Cromemco card cages.

MULTI-PROCESSING AND INTELLIGENT I/O

The range of capabilities and versatility you can draw upon is enormous.

In processors, for example, you have a choice of CPU's including our extremely useful new I/O Processor. This can be used as a satellite processor to do off-line processing, multi-processing, and to form intelligent I/O. It opens the door to a whole new group of applications and tasks. Ask us about it.

HIGH RESOLUTION COLOR GRAPHICS

Again, you can have beautiful high-resolution color graphics with our color graphics interface. You can select from over 4000 colors and have a picture with a resolution at least equal to quality broadcast-TV pictures.



You have an unprecedented selection of memory including our unusual 48K and 16K two-port RAMs which allow high-speed color graphics.

LOTS OF STORAGE

These days you often want lots of disk storage. So you can select from our disk controller card which will operate our 5" and 8" floppy disk drives (up to 1.2 megabytes). Or select our WDI interface to operate our 11-megabyte hard disk drives.

POWERFUL SOFTWARE AND PERIPHERAL SUPPORT

There's much more yet you can do with our cards. And, of course, there's an easy way to put them to work in our 8-, 12-, and 21-slot card cages. Our PS8 power supply makes it simple to get the system into operation.

Finally, Cromemco offers you the strongest software support in the industry

with languages like FORTRAN, C, COBOL, ASSEMBLER, LISP, BASIC and others. There is also a wide choice from independent vendors.

To top it all off, you can draw from a substantial array of peripherals: terminals, printers, color monitors and disk drives.

CONTACT YOUR CROMEMCO REP

There is even more capability than we're able to describe here.

Contact your Cromemco rep now and get this capability working for you.

CROMEMCO COMPUTER CARDS

- **PROCESSORS** — 4 MHz Z-80 A CPU, single card computer, I/O processor
- **MEMORY** — up to 64K including special 48K and 16K two-port RAMS and our very well known BYTESAVERS® with PROM programming capability
- **HIGH RESOLUTION COLOR GRAPHICS** — our SDI offers up to 754 x 482 pixel resolution.
- **GENERAL PURPOSE INTERFACES** — QUADART four-channel serial communications, TU-ART two-channel parallel and two-channel serial, 8PIO 8-port parallel, 4PIO 4-port isolated parallel, D+7A 7-channel D/A and A/D converter, printer interface, floppy disk controller with RS-232 interface and system diagnostics, wire-wrap and extender cards for your development work.



Cromemco™
i n c o r p o r a t e d

280 BERNARDO AVE., MOUNTAIN VIEW, CA 94040 • (415) 964-7400

Tomorrow's computers today

Circle 98 on inquiry card.

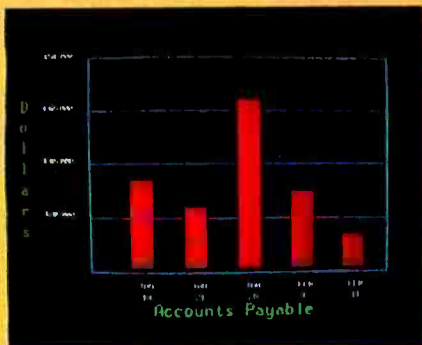

Management Information Display

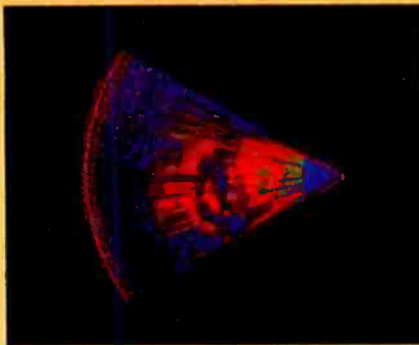

Ultrasonic heart sector scan

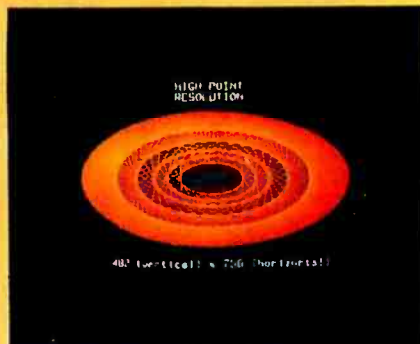

High-resolution display with alphanumerics

Get the professional color display that has **BASIC/FORTRAN** simplicity

LOW-PRICED, TOO

Here's a color display that has everything: professional-level resolution, enormous color range, easy software, NTSC conformance, and low price.

Basically, this new Cromemco Model SDI* is a two-board interface that plugs into any Cromemco computer.

The SDI then maps computer display memory content onto a convenient color monitor to give high-quality, high-resolution displays (756 H x 482 V pixels).

When we say the SDI results in a high-quality professional display, we mean **you can't get higher resolution than this system offers in an NTSC-conforming display.**

The resolution surpasses that of a color TV picture.

BASIC/FORTRAN programming

Besides its high resolution and low price, the new SDI lets you control with optional Cromemco software packages that use simple BASIC- and FORTRAN-like commands.

Pick any of 16 colors (from a 4096-color palette) with instructions like DEFCLR (c, R, G, B). Or obtain a circle of specified size, location, and color with XCIRC (x, y, r, c).

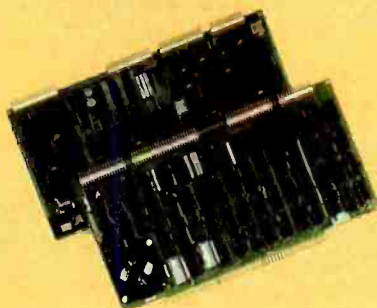

Model SDI High-Resolution Color Graphics Interface



Model SDI plugs into Z-2H 11-megabyte hard disk computer or any Cromemco computer

HIGH RESOLUTION

The SDI's high resolution gives a professional-quality display that strictly meets NTSC requirements. You get 756 pixels on every visible line of the NTSC standard display of 482 image lines. Vertical line spacing is 1 pixel.

To achieve the high-quality display, a separate output signal is produced for each of the three component colors (red, green, blue). This yields a sharper image than is possible using an NTSC-composite video signal and color TV set. Full image quality is readily realized with our high-quality RGB Monitor or any conventional red/green/blue monitor common in TV work.

DISPLAY MEMORY

Along with the SDI we also offer an optional fast and novel **two-port** memory that gives independent high-speed access to the computer memory. The two-port memory stores one full display, permitting fast computer operation even during display.

CONTACT YOUR REP NOW

The Model SDI has been used in scientific work, engineering, business, TV, color graphics, and other areas. It's a good example of how Cromemco keeps computers in the field up to date, since it turns any Cromemco computer into an up-to-date color display computer.

The SDI has still more features that you should be informed about. So contact your Cromemco representative now and see all that the SDI will do for you.

*U.S. Pat. No. 4121283



Cromemco
I n c o r p o r a t e d

280 BERNARDO AVE., MOUNTAIN VIEW, CA 94043 • (415) 964-7400

Tomorrow's computers today

Circle 98 on inquiry card.

Features

36 Logo for Personal Computers by Harold Nelson / A preview of the first small-computer versions of this exciting language.

46 Build a Low-Cost Speech-Synthesizer Interface by Steve Ciarcia / The Digitaiker integrated circuits from National Semiconductor can easily give your computer a limited spoken vocabulary.

72 Mathematical Modeling: A BASIC Program to Simulate Real-World Systems by Randall E Hicks / A Compucolor II BASIC program effectively simulates a physical system through the solution of a system of linear differential equations.

110 A Computer-Based Laboratory Timer by John Gibson / Accurate, repeatable time measurements can be made in rapid succession, and logged for later use.

216 CP/M: A Family of 8- and 16-Bit Operating Systems by Gary Kildall / An overview of Digital Research's operating systems, including a 16-bit operating system.

248 The UNIX Operating System and the XENIX Standard Operating Environment by Robert Greenberg / An inside look at a large-computer operating system implemented for use with microprocessors.

268 The Ins and Outs of CP/M by James Larson / Directly access the I/O and disk access functions of the CP/M operating system.

302 Build a Super Simple Floppy-Disk Interface, Part II by Roger Camp and James Nicholson / A moderate amount of software makes the 10-device circuit into a flexible floppy-disk controller.

378 An Easy-to-Use A/D Converter by Robert Daggit / This analog-to-digital converter features six input channels with accuracy of 8 to 10 bits.

392 The Impossible Dream: Computing e to 116,000 Places with a Personal Computer by Stephen Wozniak / An 8-bit microcomputer is harnessed to the Herculean task of computing the mathematical constant e to 115,925 places.

Reviews

24 RAMCRAM Memory Module for the Atari by Mark Pelczarski

88 Information Unlimited: The Dialog Information Retrieval Service by Stan Miastkowski

176 Four Word Processors for the Apple II by Keith Carlson and Steve Haber

352 Startrek 4.0 and Startrek 3.5 by Scott Mitchell

356 The BDS C Compiler by Christopher Kern

Nucleus

6 Editorial: The New 16-Bit Operating Systems. or, The Search for Benutzerfreundlichkeit

12 Letters

30, 162, 384 Technical Forums: LISP vs FORTRAN: A Fantasy; We Interrupt This Program...; A Votrax Vocabulary Education Forum: Microcomputers in Education: A Concept-Oriented Approach

146 Programming Quickie: Z80 Table Lookup

208 BYTELINES

234 System Notes: LIST — A Source-Listing Program for the C Language

342 Ask BYTE

348 Software Received

350 Books Received

350, 370, 377 BYTE's Bits

364, 374 Book Reviews: Musical Applications of Microprocessors; TEX and METAFONT: New Directions in Typesetting

371 Clubs and Newsletters

372 Event Queue

376 BYTE's Bugs

409 What's New?

462 Unclassified Ads

463 BOMB, BOMB Results

464 Reader Service

BYTE

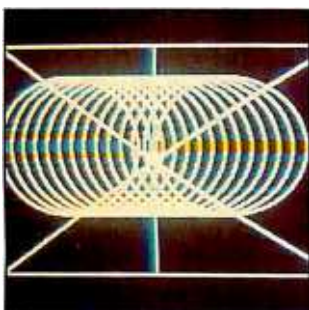

Page 36



Page 46



Page 88



Page 110



Editor in Chief

Christopher Morgan

Managing Editor

Mark Haas

Technical Editors

Gregg Williams, Senior Editor;
Richard S Shuford; Curtis P Feigel;
George Stewart; Stan Miastkowski;
Kevin Cohan; Charles Freiberg,
New Products Editor;
Steve Ciarcia, Mark Dahmke,
Consulting Editors;
Jon Swanson, Draftsman

Copy Editors

Richard Friedman, Chief; Faith Hanson;
Warren Williamson; Anthony J Lockwood;
Ann Graves; Beverly Cronin

Assistants

Faith Ferry; Debe Wheeler;
Karen A Cilley

Production

Nancy Estle, Director; Christine Dixon,
Asst Director; Wai Chiu Li;
Deborah Porter; Jonathan M Graves;
Patrice Scribner; Sherry McCarthy;
Chief Typographer: Debi Fredericks;
Donna Sweeney; Valerie Horn

Advertising

Thomas Harvey, Director; Marlon Gagnon;
Barbara J Greene; Rob Hannings;
Jacqueline Earnshaw,
Reader Service Coordinator

Circulation

Gregory Spitzfaden, Manager;
Andrew Jackson, Asst Manager;
Agnes E Perry; Barbara Varnum;
Louise Menegus; Bill Watson;
James Bingham, Dealer Sales

Marketing

Laura Hanson

Controller's Office

Daniel Rodrigues, Controller; Mary E Fluhr,
Asst Controller; Karen Burgess; Jeanne Cilley;
Mary Beth Ireland

Traffic

N Scott Gagnon; Robert A Fiske;
William Fluhr

Receptionist

Joanne Colburn

Publishers

Virginia Londoner; Gordon R Williamson;
John E Hayes, Associate Publisher;
Cheryl A Hurd, Publisher's Assistant

Officers of McGraw-Hill Publications Company: Paul F McPherson, President; Executive Vice Presidents: James E Boddorf, Gene W Simpson; Group Vice President: Daniel A McMillan; Senior Vice President-Editorial: Ralph R Schulz; Vice Presidents: Kemp Anderson, Business Systems Development; Robert B Doll, Circulation; James E Hackett, Controller; Eric B Herr, Planning and Development; H John Sweger, Marketing.

Officers of the Corporation: Harold W McGraw Jr, President, Chief Executive Officer and Chairman of the Board; Robert F Landes, Senior Vice President and Secretary; Ralph J Webb, Treasurer.



In This Issue

It's the operating systems that turn a hunk of hardware into a clever machine. As Robert Tinney's cover drawing depicts, they are the brains behind the brawn of today's computing systems.

This month two articles analyze the most popular operating system, "CP/M: A Family of 8- and 16-Bit Operating Systems," by Gary Kildall, and James Larson's "The Ins and Outs of CP/M." If you can get by the title of Chris Morgan's editorial — "The New 16-Bit Operating Systems, or, the Search for Benutzerfreundlichkeit" — you'll discover what form the operating systems of the future may take. And Robert Greenberg presents what may be the next popular operating system in his article, "The UNIX Operating System and the XENIX Standard Operating Environment."

BYTE is published monthly by BYTE Publications Inc, 70 Main St, Peterborough NH 03458, phone (603) 924-9281, a wholly-owned subsidiary of McGraw-Hill, Inc. Address subscriptions, change of address, USPS Form 3579, and fulfillment questions to BYTE Subscriptions, POB 590, Martinsville NJ 08836. Controlled circulation postage paid at Waseca, Minnesota 56093 - USPS Publication No. 528890 (ISSN 0360-5280). Canadian second class registration number 9321. Subscriptions are \$19 for one year, \$34 for two years, and \$49 for three years in the USA and its possessions. In Canada and Mexico, \$21 for one year, \$38 for two years, \$55 for three years. \$43 for one year air delivery to Europe. \$35 surface delivery elsewhere. Air delivery to selected areas at additional rates upon request. Single copy price is \$2.50 in the USA and its possessions, \$2.95 in Canada and Mexico, \$4.00 in Europe, and \$4.50 elsewhere. Foreign subscriptions and sales should be remitted in United States funds drawn on a US bank. Printed in United States of America.

Address all editorial correspondence to the editor at BYTE, POB 372, Hancock NH 03449. Unacceptable manuscripts will be returned if accompanied by sufficient first class postage. Not responsible for lost manuscripts or photos. Opinions expressed by the authors are not necessarily those of BYTE. Entire contents copyright © 1981 by BYTE Publications Inc. All rights reserved. Where necessary, permission is granted by the copyright owner for libraries and others registered with the Copyright Clearance Center (CCC) to photocopy any article herein for the base fee of \$1.00 per copy of the article or item plus 25 cents per page. Payment should be sent directly to the CCC, 21 Congress St, Salem MA 01970. Copying done for other than personal or internal reference use without the permission of McGraw-Hill is prohibited. Requests for special permission or bulk orders should be addressed to the publisher.

BYTE® is available in microform from University Microfilms International, 300 N Zeeb Rd, Dept PR, Ann Arbor MI 48106 USA or 18 Bedford Row, Dept PR, London WC1R 4EJ England.



Subscription WATS Line: (800) 258-5485

Office hours: Mon-Thur 8:30 AM - 4:30 PM, Friday 8:30 AM - Noon, Eastern Time

NATIONAL ADVERTISING SALES REPRESENTATIVES:

NORTHEAST (617) 444-3946
Hajar Associates
280 Hillside Ave
Needham Heights MA 02194

MIDWEST (312) 966-0160
Hajar Associates
5225 Old Orchard Dr
Skokie IL 60076

MID ATLANTIC (212) 682-5844
Hajar Associates
521 Fifth Ave
New York NY 10017

NORTHWEST (415) 964-0706
Hajar Associates
1000 Elwell Ct, Suite 227
Palo Alto CA 94303

SOUTHWEST (714) 540-3554
Hajar Associates
3303 Harbor Blvd
Suite K-4
Costa Mesa CA 92626

SOUTHEAST (305) 886-7210
Hajar Associates
1220 Prairie Lane
Apopka FL 32703

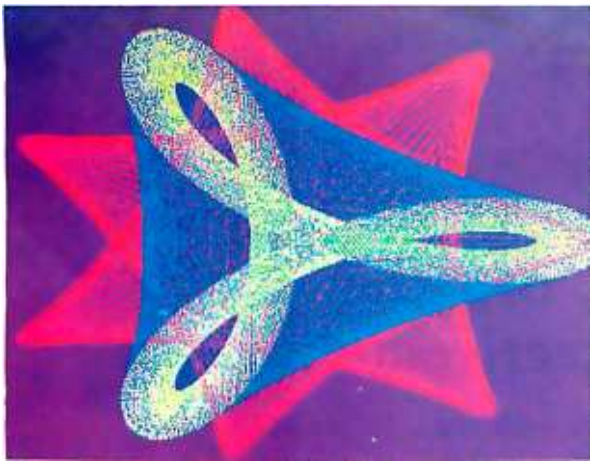

"...stands well above other S-100 graphics displays in its price and performance range."

BYTE, Product Review

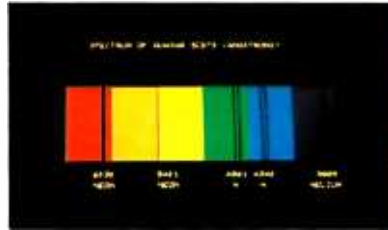

"...better monochromatic display..."

ELECTRONIC DESIGN,
1981 Technology Forecast

MICROANGELO

HIGH RESOLUTION GRAPHICS SINGLE BOARD COMPUTER
512 x 480 resolution black and white and vivid color displays

RS-170 composite or direct drive output

Local or external sync generation

4 Mhz Z80 microprocessor

60 hertz real-time clock

8 level interrupt tie-in

IEEE S100 bus compatible

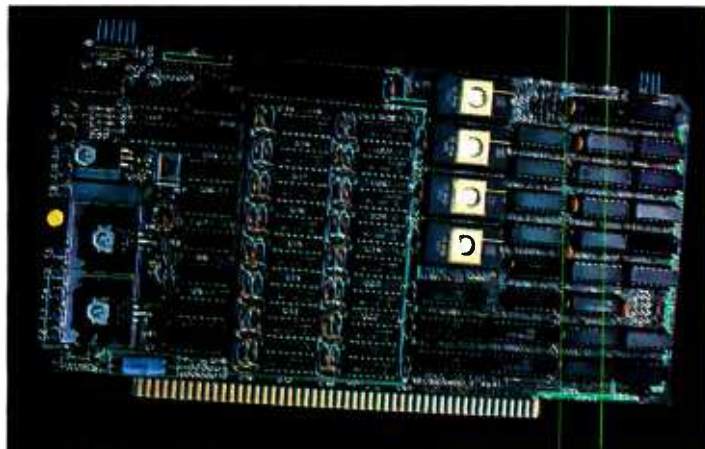

Light pen interface

Time multiplexed refresh

4K resident Screenware™ Pak I operating system

32K RAM isolated from host address space

High speed communications over parallel bus ports

Screenware™ Pak I

A 4K byte operating system resident in PROM on MicroAngelo™. Pak I emulates an 85 character by 40 line graphics terminal and provides over 40 graphics commands. Provisions exist for user defined character sets and directly callable user extensions to Screenware™ Pak I.

Screenware™ Pak II

An optional software superset of Pak I which adds circle generation, polygon flood, programmable split screen for separate graphics and terminal I/O, relative coordinates, faster vector and character plotting, a macro facility, full UCSD Pascal compatibility, and more.

And now...COLOR!!

The new MicroAngelo™ Palette board treats from 2 to 8 MicroAngelos as "bit planes" at a full 512 x 480 resolution. Up to 256 colors may be chosen from 16.8 million through the programmable color lookup table. Overlays, bit plane precedence, fade-in, fade-out, gray levels, blinking bit plane, and a highly visual color editor are standard.

SCION

8455-D Tyco Road • Vienna, Virginia 22180 • TWX: 710-831-9087 • (703) 827-0888

Circle 322 on Inquiry card.

When you're tired of following your friends to the clay pits, do your modeling with **PLAN80**™.

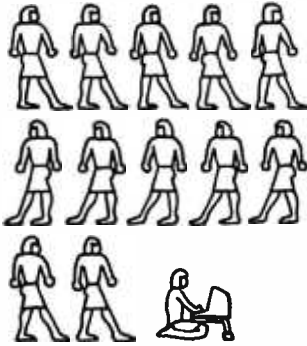

PLAN80 is a financial modeling system that runs on a desk top computer. It's easy to use yet powerful enough to replace most timesharing applications.

PLAN80 lets you tackle any numeric problem that can be defined in worksheet format. It performs complex calculations quickly and precisely and lets you examine "What if?" questions so you can evaluate more planning alternatives in greater detail.

With **PLAN80** you get more than your calculated results...You know **how** you get them, because you define rows and columns with familiar names such as UNITS, PRICE and JANUARY and express calculations in terms such as SALES=UNITS * PRICE. It's easy to review your assumptions and methods with people who have never seen **PLAN80**.

At any point in the **PLAN80** model you may display or print results on your screen, printer or disk, save all or part of the results for use by another model, or play "What if?" by inputting new values, recalculating and displaying or printing results.

Best of all, you can incorporate **PLAN80** results into any report that requires a financial model—using your word processor—to create professional results for a polished business plan.

Anyone can use **PLAN80** to create budgets, project sales or analyze costs—or even build a complex system of interrelated plans.

PLAN80 requires 56K RAM & CP/M. Specify Z80, 8080 or CDOS. Formats: 8" single density IBM soft-sectored, Cromemco CDOS, 5¼" NorthStar DD, Micropolis Mod II, Superbrain 3.0.

Price is \$295. Manual alone—\$30. Add \$7.00 for shipping & handling.

SOFTWARE
SOFTWARE
DIGITAL MARKETING
DIGITAL MARKETING

2670 CHERRY LANE
WALNUT CREEK • CA 94596
(415) 938-2880

CP/M™ trademark Digital Research CDOS™ trademark Cromemco Superbrain™ trademark Interlec Data Systems

Editorial

The New 16-Bit Operating Systems, or, The Search for Benützerfreundlichkeit

by Chris Morgan, Editor in Chief

"Benützerfreundlichkeit: (literally 'user friendliness') The philosophy that a system should be constructed with the interests of the user as the chief concern."

— from The Practical Guide to Structured Systems Design
by Meilir Page-Jones, Yourdon Press, New York, 1980, page 338.

Sam Goldwyn, the "G" of MGM, was famous for his inside-out logic. He once said, "A verbal agreement isn't worth the paper it's written on." This month's topic prompted me to coin a "Goldwynism" of my own: "The best time to talk about the future is before it happens."

In one sense 16-bit microcomputers are definitely here, yet in another they are strangers to us. The personal-computer community still lives in an 8-bit world, straining all 8 bits of every word to perform miracles.

But all that can and must change. Opponents of 16-bit systems cite cost and software conversion problems as the two main justifications for staying with 8 bits. Yet, how can software keep pace with the increased demand for more sophisticated graphics, to name only one area, unless we can address more than 64 K bytes of memory? How will we be able to access the staggering amounts of information in future memory banks without an increase in word size? And then there are the exciting new languages like Smalltalk that demand 16 bits for their operation. Simply put, 16 bits is the only way to go. The 16-bit operating system, therefore, becomes a critical link in the computing chain.

Doing It Right the Second Time

The *operating system* is the "master controller" of the computer: it gets us going when we turn on our computers, keeps track of files, lets programs talk to one another, performs input/output tasks, and so on. Put charitably, most operating systems in the 8-bit world have been afterthoughts or compromises in design. Even CP/M, a de facto standard in our field, has been criticized as being awkward for nontechnical users. But CP/M's ubiquitousness is responsible for the development of a lot of valuable software that would otherwise probably not have been written.

The sin of inefficiency is venial compared to the mortal sin of "user-unfriendliness." I'd buy an operating system any day that takes a long time to run a given program but which makes me more productive by communicating with me in useful ways. Let's face it: most of us don't have to worry about real-time process control and its inherent time constraints. And the cost of a line of code is becoming astronomical.

KEVIN COHAN 1956-1981

Kevin Cohan, BYTE technical editor, died April 22nd when the car he was driving left the road, striking a tree. He was 24 years old. Kevin joined the BYTE staff in November, 1980, after attending Dartmouth College, and was a valuable and well-liked member of our "family." He will be missed.

Percom Mini-Disk Drive Systems for TRS-80* Computers...

Now! Add-On and Add-In Mini-Disk Storage for your Model III.



The industry leader in microcomputer peripherals, Percom not only gives you better design, better quality and first-rate service, but you pay less to boot.

New for the TRS-80* Model III

Patterned after our fast-selling TFD Model I drives. And subjected to the same reliability controls. These new TFD mini-disk systems for the Model III provide more features than Tandy drives, yet cost far less.

- **Flippy Capability:** Both internal (add-in) and external (add-on) drives permit recording on either side of a diskette.
- **Greater Storage Capacity:** Available with either 40- or 80-track drive mechanisms, Percom TFD mini-disk systems store more. A 40-track drive stores up to 180 Kbytes — formatted — on one side of a 5-inch diskette. An 80-track drive stores a whopping 364 Kbytes.
- **1.5 Mbyte On-line:** The Percom drive controller (included with the initial drive) handles up to four drives. With four 80-track mini-disk drives you can access over 1.5 million bytes of on-line file data.
Moreover, the initial drive may be either an internal add-in drive or an external add-on drive. And whichever configuration you get, the initial drive kit comes complete with our advanced 4-drive controller, interconnecting cables, power supplies, installation hardware, a DOS and of course the drive mechanism itself.
- **First Drive Includes DOS:** OS-80™, Percom's fast extendable BASIC-language disk operating system, is included on diskette when you purchase an initial drive kit. Originally called MicroDOS, OS-80 was favorably reviewed in the June 1980 issue of Creative Computing magazine.
- **Works with Model III TRSDOS:** Besides being fully hardware compatible, Percom's Model III 40-track drive systems may be operated with Tandy's Model III TRSDOS — without any modifications whatsoever. And, TRSDOS may be easily upgraded with simple software patches for operating 80-track drives.

Percom TFD add-on drives start at only \$399. Model III Drive kits start at only \$749.95.

Quality Percom products are available at authorized dealers. Call toll free 1-800-527-1592 for the address of your nearest dealer or to order direct from Percom.

Still #1 for Model I

As if greater storage capacities, exceptional quality control measures and lower prices aren't reasons enough to make Percom your first choice for Model I add-on drives, all Percom Model I drives are also rated for double-density operation.

Add our innovative DOUBLER™ adapter to your Model I Expansion Interface, and with Percom drive systems you can enjoy the same double-density storage capability as Model III owners.

The DOUBLER includes a TRSDOS*-like double-density disk operating system called DBLDOS™

We also offer a double-density Model I version of OS-80 as well as DOUBLEZAP programs for modifying NEWDOS/80 and VTOS 4.0† for DOUBLER compatibility.

Of course you don't have to upgrade your computer for double-density operation to use Percom mini-disk drive systems. In single-density operation, our TRS-80* Model I compatible 40-track drives store 102 Kbytes of formatted data on one side of a diskette, and our 80-track drives store 205 Kbytes. By comparison, Tandy's standard drive for the Model I stores just 86 Kbytes.

And like our Model III drives, Model I add-on drives are optionally available with "flippy" storage capability.

System Requirements:

Model III: 16-Kbyte system (min) and Model III BASIC. The second internal drive may be installed after the first internal drive kit is installed, and external drives #2, #3 and #4 may be added if either an internal, or external first-drive kit has been installed. External drives #3 and #4 require an optional interconnecting cable.

Model I: 16-Kbyte system (min), Level II BASIC, Expansion Interface, disk operating system and an interconnecting cable. For double-density storage, a Percom DOUBLER must be installed in the Expansion Interface and DBLDOS (comes with the DOUBLER) or other double-density DOS must be used. For single-density operation, a Percom SEPARATOR™ adapter, installed in the Expansion Interface, will virtually eliminate "CRC ERROR — TRACK LOCKED OUT" read errors. Prices and specifications subject to change without notice.

PERCOM

PERCOM DATA COMPANY, INC.
211 N. KIRBY GARLAND, TEXAS 75042
(214) 272-3421

*Trademark of Tandy Radio Shack Corporation which has no relationship to Percom Data Company.
™DOUBLER, DBLDOS, OS-80 and SEPARATOR are trademarks of Percom Data Company, Inc.

†Trademark of Virtual Technology Corporation.



FOR ANY ϵ
THERE IS A δ^*

WHY LET ONE MAINFRAME DEFINE

OUR WELL-DIFFERENTIATED
ARE CALCULATED
SYSTEMS INTEGRATION

A simple algorithm

We work with the serious systems integrator... on terms that make sense to you. That means giving you a set of products which expand your limits, not reduce them.

We manufacture the most complete family of high quality IEEE/696 S-100 mainframes on the market. Choices include three mainframes in rack-mount or table-top packages with complete board sets, to serve as the building blocks for your 8 or 16 bit system. We also provide other options ranging from complete floppy disk systems right up to our proven Pascal development system.

The \int factor: one source.

No matter which option you choose, you get the benefit of working with completely integrated products... fully assembled and tested... under one warranty and one price structure... leaving you free to concentrate on value-added application development and sales.

Choose from mainframe options...

Select from three packaging options: Rack-mount, table-top or front panel models. All three feature our 20 slot S-100 motherboard with 25 amp power supply and are delivered fully assembled and tested with our Series II™ board sets. Any board configuration you choose works with any DPS-1 version, allowing you to vary your package offering, or develop on one version and market another.

- ◆ Front Panel model — a powerful development and diagnostic tool for Z-80† systems, which can be used for prototyping, servicing, debugging, and software or hardware development. Use its features to set breakpoints, trigger scopes, single step, slow step and more.

- ◆ Front Panelless desk top model—a lower cost option for OEM or other turnkey operations which do not require the extra capability of our Front Panel.

- ◆ Rack Mount version — features a heavy gauge frame designed to fit into standard 19" racks. CVT power supply for brown out immunity is standard.

*In Calculus, a fundamental statement in the definition of limit; interpreted here to imply: "For your integration problem, Intersystems has a solution."

† Registered trademark of Zilog, Inc.

YOUR LIMITS?

OPTIONS
TO SOLVE YOUR
PROBLEMS.

Board level options...

Intersystems mainframe packages, equipped with Series II boards, are operational in both 8 and 16 bit settings and support extended addressing in both I/O and memory space, recognizing 16 bit I/O addresses and 24 bit memory addresses. Just look at these individual features:

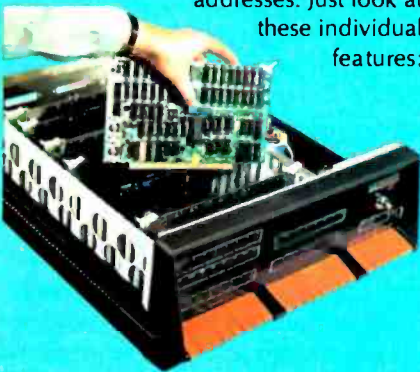

- ◆ MPU-80—uses a Z-80, 8 vectored interrupt lines and two 4K windows to address up to 1 Megabyte of RAM without bank select.
- ◆ 64KDR—sophisticated refresh circuitry allows unlimited DMA and absolutely reliable operation without wait states.

- ◆ 6 SI/O — six individually software-controllable serial I/O ports with optional interrupts. Each can run RS 232 at up to 19,200 BAUD, as can our VI/O board.
- ◆ VI/O—has two serial ports; two 8-bit parallel output and two 8-bit parallel input ports plus 8 individually controllable command lines and 16 levels of vectored interrupts.
- ◆ FDC II—can DMA up to a full track into 16 Megabytes of memory. Optionally generates interrupts and handles up to four 8" floppies.
- ◆ MPU-8000 — available with the non-segmented Z-8002[†], which directly addresses 64K, or the segmented Z-8001[†], which can directly address 8 Megabytes.

Extended systems options...

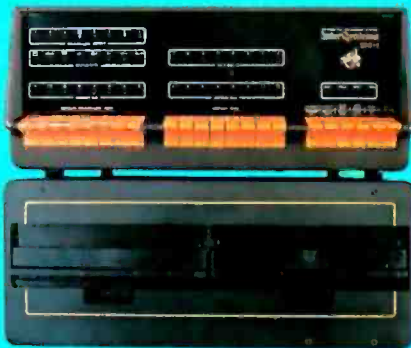

Interfacing disk drives is not a trivial matter, so when your objectives and resources dictate you spend your energy elsewhere, use our resources to perform the service for you. We can add our disk drive package to any Z-80 or Z-8000 configuration we provide... again, fully assembled and tested and covered under one warranty.

Or our complete Pascal Development System.

We use it for our own hardware and software development. It includes either table-top mainframe, two 8" floppy disks, 128K RAM, CP/M[®], and Intersystems Pascal/Z[™] compiler and Cache BIOS[™].

THIS SYSTEM IS FAST! Why? Because our ultra-fast Cache BIOS automatically buffers whole tracks, eliminating most disk accesses. This delivers up to three times the throughput of any other floppy-based system we know and is equal to many small hard disk systems.

The system is versatile, too. SET program allows you to change many BIOS parameters and specify control characters to enable special features such as diagnostic output to trace program execution. It can also provide remote I/O to link your system to almost any other computer, large or small.



And it's reliable. The Cache BIOS System runs continuous memory tests when idle, and verifies with a Read after Write and Read after Read.

And the system also includes our Pascal/Z, a true native compiler producing ROMable and Re-entrant code. It features a minimum of extensions chosen for the development of your scientific and business applications. And it's compatible with our native code Pascal for Z-8000, providing a graceful upward path to 16 bit applications. So what you write now is right later.

One choice you won't have to make...

We don't believe you should ever have to sacrifice good technical support to find a good product. We'll back you to the hilt with services like free technical consultation, board-swapping, diagnostic packages, and documentation that gives you all you need to integrate, operate and maintain your system... right down to schematics of the boards.

Your solution should be clear.

Whether you're integrating for scientific, governmental or commercial applications, Intersystems can provide a Delta for your Epsilon.

Talk to us today.

Ithaca Intersystems Inc.,
Dept. B
1650 Hanshaw Road,
P.O. Box 91
Ithaca, NY 14850

Phone
(607) 257-0190



Intersystems[™]
Ithaca Intersystems Inc.

Micros for bigger ideas.

Circle 183 on Inquiry card.

High Technology

We make our competition obsolete

with Information Master,TM Data Master,TM and Transit.TM

Information Master is clearly the best information management software available for your Apple II,* and it's the easiest to use.

Here are two very useful companions that add even more power to Information Master.

- Data Master — Alter the file layout of existing Information Master files without re-entering data. Add, omit, change fields, subdivide and append files selectively.
- Transit — Convert VisiCalc* files (and almost any other files you may have) into Information Master files.

See your computer dealer today for all the details.

* VisiCalc is a trademark of Personal Software, Inc.

Apple II is a trademark of Apple Computer, Inc.

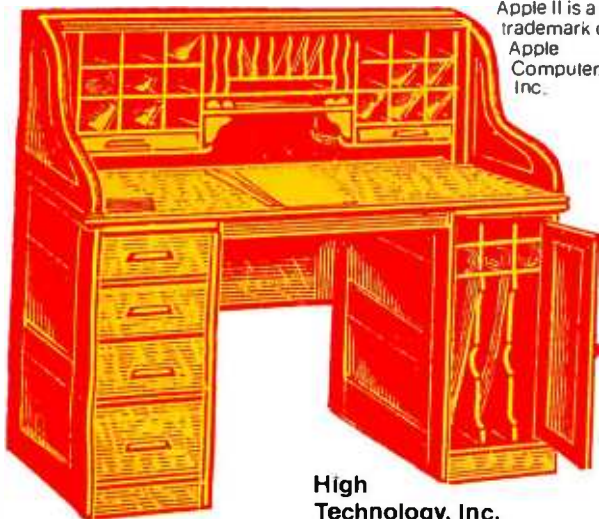

High

Technology, Inc.

Software Products Division
P.O. Box B-14665
8001 N. Classen Blvd.
Oklahoma City, Okla. 73113
405 840-9900

* Apple II is a trade name of Apple Computer, Inc.

Editorial

Now we have a chance to start with a clean slate. Software manufacturers are filling their 16-bit tabula rasas with offsprings of UNIX, an operating system developed at Bell Labs in 1969 by Kenneth Thompson and Dennis Ritchie. (See Robert Greenberg's article, "The UNIX Operating System and the XENIX Standard Operating Environment," page 248.) A software engineer was quoted in a recent issue of *Electronics* magazine (March 24, 1981, page 119) as saying that UNIX is "like sitting behind the wheel of a well-tuned sports car—when you press the gas, it goes, and when you hit the brakes, it stops. It's the ultimate in responsiveness, and yet all the while you are riding in comfort." UNIX deserves such accolades. Its hierarchical file structure lends much needed order to the chaotic approaches found in many personal computer operating systems; it is designed for truly efficient multiuser operation; the elegant idea of the *pipe* allows data to flow from program to program efficiently; and the *shell* program acts as a user-friendly interface to the rest of the operating system. An excellent example of UNIX's versatility, described in Greenberg's article, shows how the user can add a simple spelling correction program to a system, with just one line of code.

New Programs

Several software vendors have taken out licenses to adapt UNIX to 16-bit personal computer systems. These include Microsoft, Whitesmiths, Zilog, and Onyx, the developers of XENIX, Idris, Zeus, and Onix, respectively. Among non-UNIX-related 16-bit operating systems, OASIS, developed by Phase One Systems Inc, has received high marks from many professional programmers. And judging from its past track record with CP/M, Digital Research's new CP/M-86 should also become a major factor in the market. (See "CP/M: A Family of 8- and 16-Bit Operating Systems," by Gary Kildall, page 216.)

Despite the recent relaxation of UNIX licensing fee conditions by Western Electric, the UNIX offspring will not be cheap. Operating system software could sell for more than \$2000. However, Lifeboat Associates' version of XENIX will probably retail for less than \$1000 by the end of the year.

The 8-bit computer is far from dead. There is too much good 8-bit software around for this to happen. And, for many applications, it's hard to beat the price-performance ratio of the 8-bit machine—at least by today's prices. Sixteen-bit and 8-bit machines will coexist for many years to come. I don't believe in the "mutually exclusive" school of computer punditry. Just as no high-level language has ever supplanted another (can readers give me an example of this?), 8-, 16-, 32-, (etc) bit microcomputers will coexist in the future.

In our field, the future becomes the present overnight. You don't need a crystal ball to state emphatically that we have not seen the end of the 8-bit versus 16-bit debate. But the new operating systems do add a welcomed layer of professionalism to personal computing. ■



Apple* I/O Interfaces. SSM Spells Success Three Ways.

SSM helps you get the most from your Apple II* computer. Choose from three general purpose interface boards. With flexibility and prices that translate to big savings. Now, and when you upgrade.

Serial (ASIO™). Our ASIO gives you a full-duplex RS-232 interface. Plus jumper-selectable rates from 110 to 9600 baud. You also get software control, three handshaking lines and two output plugs—so you can connect your Apple to a modem or to a terminal/printer without modifying the cable.

Parallel (APIO™). For parallel interfaces, our APIO offers two 8-bit bidirectional ports. We also include additional interrupt and handshaking lines, plus software control of the interface configuration and data direction. Cables for Centronics and other printers are optional.

Or Both (AIO™). Choose our tried and proven AIO when you

need a sometimes-serial or a sometimes-parallel operation. This single-board solution packs a lot of performance for the price. Thousands are now being used. It even lets you operate both ways—simultaneously—under Pascal, or with special drivers.

All three boards feature powerful firmware so you don't have to write software to use them. The ASIO and AIO include cables.

Whether you're an OEM or end-user, we can supply virtually any quantity you need.

Quickly. Even in kit form. For the latest word on these, see your local computer dealer. Or call us today. You may also want to look into our cost-effective A488™ board which converts your Apple II into an IEEE-488 controller.

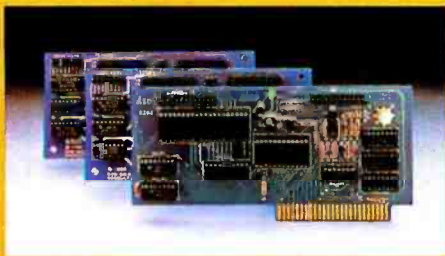

*SSM Microcomputer Products, Inc.,
2190 Paragon Drive, San Jose, CA
95131. (408) 946-7400. (TWX
910-338-2077. Telex 171171.)*

*Apple and Apple II are trademarks of Apple Computers Inc. ASIO, APIO, AIO and A488 are trademarks of SSM Microcomputer Products, Inc.

OSI Still In Personal-Computer Business

As a result of "Ohio Scientific Sold" ("BYTELINES," March 1981 BYTE, page 246), we have had several telephone calls from dealers who were disturbed by BYTE's report that "In all likelihood OSI will move away from personal computing and into the small-business market." This statement is a false and damaging "projection."

When Ohio Scientific was founded in 1975, our first products were designed for, and directed to, the personal-computer market. In 1977, when other small-computer manufacturers were entering the "fun and games" computer market, OSI introduced the Challenger C3B Business Systems, featuring a three-processor system with 74-megabyte Winchester hard-disk storage.

As a pioneer in small business-computer systems, we feel we moved into the small-business market some time ago. Our

first business-system advertisements appeared in BYTE in 1978!

As for our personal-computer systems, now and for the future—in May 1980, we announced an enhanced version of our Challenger C1P and introduced our Challenger C1P Series 2. In total units and dollar volume, we are counting heavily on our personal-computer line to carry a full share of Ohio Scientific's continued success.

W Paul Warren
Coordinator, Marketing Communications
Ohio Scientific
1333 S Chillicothe Rd
Aurora OH 44202

We are sorry for any misinterpretations of Sol Libes's speculation on the future of OSI's marketing strategy. We were not implying that OSI will drop its personal-computer line, but that we feel that there may be a shift in its marketing emphasis.
... MH

BYTELINES Makes Waves

I have always enjoyed reading Sol Libes's "BYTELINES," and consider him to be a good source of information on the personal-computer industry, except for one annoying trait. Because Mr Libes is professionally associated with products that use the S-100 bus, his information is strongly biased toward Intel and S-100 products. For example, I recently counted six issues in a row where he discussed UNIX-like software to be introduced for Intel and S-100 users. At no time did he mention that the Motorola/S-50 users have had UNIX-like systems available for some time. Certainly he has seen the advertisements in BYTE for UNIFLEX for the 6809 by TSC (Technical Systems Consultants). If Mr Libes hasn't heard of the UNIX-like OS-9 by Microware, it is only because he looks at the world through S-100 blinders. Perhaps "BYTELINES" should be expanded to include associate editors who would supply information on other computer buses and the popular "no-bus" systems.

Leo Taylor
18 Ridge Ct W
West Haven CT 06516

Sol Libes Replies:

I am pleased that Leo Taylor enjoys reading my column and considers it "a good source of information." There is no doubt that I have a bias toward S-100-based systems—I guess it's my upbringing. I try to control it and present a balanced picture of the personal-computing field. I feel that I am successful 99% of the time, and that no one can be 100% unbiased.

When I wrote the UNIX items for "BYTELINES" during the spring and summer of 1980, TSC had not yet announced UNIFLEX, so I was not aware that it was coming. Additionally, nowhere in TSC's advertisements is it specifically stated that UNIFLEX is "UNIX-like," although the description sure sounds like it is.

The OS-9 operating system fell into the same category as UNIFLEX. Despite the fact that its advertisements refer to OS-9 as UNIX-like, a product review, in the December 1980 issue of 68' Micro Journal, stated that "the similarity [to UNIX] is mostly superficial."

Mini Power, Micro Price!

New CADO C.A.T. II Desktop Multi-Terminal Business Computer/Word Processor

Do your payables and receivables type letters and print reports... all at the same time! CADO'S Data & Word Processor, TWX & Telex communications, and Just Ask™ Inquiry system do it all. Off-the-shelf software, self-teaching tutorials & Mini-Winchester high capacity disk drives are available, of course. Write now for free color brochure.

CADO SYSTEMS
Cado Systems Corporation
2771 Toledo Street • Torrance, CA 90503 • (213) 320-9660
Please send me a free 12-page color brochure on the new CADO C.A.T. II. file bye

Name _____ Company _____
Address _____ City _____ State _____ Zip _____

The One Printer Solution for the Two Printer Problem.



HIGH SPEED DATA PROCESSING

The new Dual-Mode 200 brings speed and uncompromising print quality to business and professional applications.

Financial statements, inventory reports, labels and more are printed at data processing speeds from 165 cps to 250 cps.

Fully adjustable tractors and a friction feed platen provide precise forms handling for pin-feed and single sheet paper.

Complete "Dot Control" graphics is standard with resolution to 120 x 144 dots per inch.

Interfacing is easy with both E.I.A. RS-232C serial and an ASCII parallel port.

LETTER QUALITY WORD PROCESSING

The Dual-Mode 200 also features letter-perfect print you will be proud to use for business letters and reports. Letter Mode speeds range from 42 cps to 60 cps.

The standard Titan 10 pitch font is complemented by an array of optional fonts including Elite 12 pitch, italics, proportionally spaced, OCR-A, scientific and foreign character sets.

Up to 12 font selections may be stored in the printer and interchanged while printing.

The Dual-Mode 200 accepts standard daisy-wheel print commands for word processing system compatibility.

It's the perfect solution for the two printer problem.

The Dual-Mode 200 Printer for the one printer office.

Call or write today for complete specifications

2301 Townsgate Road, Westlake Village, CA 91361, (805) 496-1990

a subsidiary of Datametrics Corporation

malibu
Electronics Corporation

DOTS DO IT BETTER™

DISCOUNT HARDWARE

IEEE 696/S-100 Standard Boards
Assembled, tested, warranted



STATE OF THE ART CPU BOARDS

DUAL CPU 8/16 bit..... \$349
Z-80 CPU..... \$249

FAST RELIABLE STATIC MEMORY

16K \$299 32K..... \$549
48K \$799 64K..... \$999

SYSTEM AUGMENTATION BOARDS

I/O-I 2-Parallel Ports \$199
I/O-II 3-Serial, 1-Par..... \$199
I/O-III 8-Port \$549
DISK-1 DMA Disk Cont. \$399
MPX Multiplex Channel \$399
SUPPORT-1 Multifunction \$299
 Port, clock, interrupts
 timers, battery back-up
 7 Boards in one

DISCOUNT HARDWARE

Division of System Interface Consultants, Inc.
17440 Revello Drive
Pacific Palisades, CA 90272

Enclosed is \$ _____
Please express the following assembled,
tested, and warranted IEEE 696/S-100
boards:

Name _____
Address _____
Phone () _____

Add \$25 to each order for express shipping, handling
and insurance. California residents add 6% tax. Allow
2 weeks for personal checks. Prices subject to change
without notice.

**CALL FOR INFORMATION AND PRICES ON
Mainframes, terminals, printers, and complete
integrated and tested systems to meet
YOUR UNIQUE REQUIREMENTS.**

(213) 454-2100

DISCOUNT HARDWARE

Division of System Interface Consultants, Inc.
Computer Specialists Established 1969

Letters

Treasure on Disk

I enjoyed the reviews and comments on the Adventure-like games in the December 1980 BYTE, especially Jerry Pournelle's "User's Column." (See "BASIC, Computer Languages, and Computer Adventures," page 222.) I would, however, like to point out for the benefit of BYTE's readers that the original version of Adventure ("The Colossal Cave") has been available from the Heath Users' Group for over two years, for a mere \$10.

This version comes on a 5-inch disk that runs on the Heath H-8 (with disk drive) or the H-89 computers. A minimum of 32 K bytes of memory is required, and the game plays very fast. Unlike other issues, Heath's version (written by Gordon Letwin before he left to join Microsoft) can be easily copied for backup and safe keeping—a distinct plus.

I'd also like to point out that while there are several maps and guides available to the Colossal Cave, none help that much. They may assist in reducing the search for treasures, but they won't help in avoiding some of the more subtle pitfalls, and certainly won't help in the Final Adventure.

D C Shoemaker
2000 A Foxridge
Blacksburg VA 24060

More GOTOs Changing

In David Carew's article "Change Your GOTOS into FOR...NEXT Loops" (January 1981 BYTE, page 334), a better approach to the problem would have been (if step 0 not allowed):

```
510 FOR I = 1 TO 2
520 READ X
530 I = 1
535 IF X = K THEN I = 2
540 NEXT I
```

However, the best way, for systems that allow it, is:

```
510 FOR I = 0 TO -1 STEP -1
520 READ X
530 I = X = K
540 NEXT I
```

For the TRS-80 (and, I think, all Microsoft BASICs), line 530 treats the second equals sign as a logical operation, giving a -1 (true condition) if equal, and a 0 (false condition) if not equal. Some BASICs have a different convention for true and

false (some represent true as 1 and false as 0) so the statement would be FOR I=0 TO 1. Another advantage of this form is that it can be embedded in the middle of a long line as follows:

```
500 ..... : FOR I = 0 TO -1 STEP -1
                  : READ X : I = X = K : NEXT : ....
```

Both of these examples are faster than the published counterparts—always setting I to 1 is faster than the test (even if false), because there are fewer characters to interpret, and the same goes for the other example. Also, both of these examples use less memory for the program.

Carey Tyler Schug
POB 585
Chicago IL 60690

CMOS Is Boss

A few important points need to be made in connection with Larry Malakoff's article "Memory: Making an Intelligent Decision." (See the February 1981 BYTE, page 142.) Mr Malakoff generalizes that dynamic memories are superior in the areas of packing density, power consumption, and cost. Unfortunately, he has overlooked one of the most exciting memory techniques currently available: CMOS (complementary metal-oxide semiconductor) *static* memories.

While we at Hitachi are active in the dynamic memory business (especially the 4816-type 16 K by 1-bit and the 4864-type 64 K by 1-bit devices), we recognize that, for many reasons, static memory is often desirable. This approach is typified by our CMOS 6116-type fully static 2 K by 8-bit memory.

Responding to each of Mr Malakoff's points:

●Density: Using the 6116, a 64 K-byte static memory board is not only feasible, but Godbout Electronics will soon release an S-100-compatible board, called RAM 17. The increased size of the 6116's package (24 pins versus 16 pins for the 4116-type dynamic device) is easily offset by the total lack of "tricky" refresh logic required by dynamic memory.

●Power Consumption: The 6116's power requirements (operating *and* standby) are equal to or less than most 16 K-bit dynamic devices. The power supply to Godbout's 64 K-byte static board is con-

Radio Shack's TRS-80TM Model III is Your Best Buy in Desktop Computers.



\$2495

(Because the "Extras" are Built In!)

With the TRS-80 Model III, you don't pay extra for the features you want. For \$2495, you get a *complete*, ready-to-run desktop computer. Go ahead — judge their extras by our standards.

32K RAM. Expandable to 48K.

Two Double-Density Disk Drives. You get two *built-in* 175K disk drives, and can add up to two more externally.

BASIC in 14K ROM. Our powerful Model III BASIC provides a program line editor, machine language programming, real time clock, and more. Compatible with most Model I Level II BASIC programs, too.

Upper and Lower Case Characters. *With* a special graphics character set, and 64 characters-per-line format.

Built-In Monitor. 12" high-resolution.

12-Key Datapad. As well as repeating keys and keyboard-controlled screen print.

Pa allel Printer Port. Add one of our printers anytime.

RS-232 Serial Interface. For data communications, just add a modem.

Nationwide Support. Backed by 6100 Radio Shack stores and dealers, 130 Computer Centers and 135 service centers throughout the USA.

Available Now. Why pay more? Get a demonstration of our 32K, two-disk TRS-80 Model III computer today. For less

demanding applications (or if you want a personal "starter" system), check out our 16K Model III—only \$999.

Radio Shack[®]
The biggest name in little computersTM
A DIVISION OF TANDY CORPORATION

Read about your best buy in computers. Send for a TRS-80 catalog.

Radio Shack, Dept. 81-A-297
1300 One Tandy Center
Fort Worth, Texas 76102

NAME _____
STREET _____
CITY _____ STATE _____
ZIP _____ PHONE _____

Retail prices may vary at individual stores and dealers. Special order may be required.

servatively overregulated using one 7805 5 V, 1 A voltage regulator.

●Price: Expect the price of Godbout's RAM 17 to be competitive (\$1400) with the \$895 to \$1195 figures quoted by Mr Malakoff.

A few other points:

●Compatibility: The 6116 is easy to interface and is fully compatible with all processors, DMA (direct memory access) controllers, front panels, etc. Boards like those mentioned in the article may not work with faster processors (eg: 6809, 8088) now available for the S-100 bus.

●Versatility: The 6116 is pin-compatible with the 2716 EPROM (erasable programmable read-only memory) and Hitachi's new 48016 EEPROM (electrically erasable PROM), and so the user can configure a board to contain the best combination of memory types for a given application.

●Speed: The 6116 is available for speeds rated as fast as 120 ns (more than fast enough for microprocessor applications). Godbout's board will work with Z80 microprocessors running at 6 MHz with no wait states. I do not believe that there is a dynamic board that can do the same.

●Design Simplicity: No "black art" transparent refresh or special circuitry (eg: DMA, Reset) is needed; consequently, the time and the cost of the design process have been reduced. (For systems with more than 64 K bytes of memory, the best solution is to adopt the IEEE 696 Extended Addressing Standard, not the cumbersome nonstandard bank-select scheme.)

As CMOS manufacturing processes continue to approach NMOS in density, cost, and performance, companies like Hitachi have the capability to bring their CMOS expertise to bear on applications like memory devices and peripheral controllers. As devices become more complex, and applications more demanding, CMOS technology will be required to overcome thermal dissipation problems.

Thomas Cantrell
Microprocessor Product Marketing
Hitachi America Inc
1800 Bering Dr
San Jose CA 95112

Hand-Held Computer Algorithm Improvement

I read with interest Gregg Williams's

Table Rank (N)	Number of Elements in Table (2 ^N)	Williams's Algorithm F(N) = 2 ^N + 2F(N-1)	Modified Algorithm F'(N) = 2 ^N + 2F'(N-1) - 1	Ordinary Lookup N2 ^N
1	2	1	1	2
2	4	6	4 + 2(1) - 1 = 5	8
3	8	20	8 + 2(5) - 1 = 17	24
4	16	56	16 + 2(17) - 1 = 49	64
5	32	144	32 + 2(49) - 1 = 129	160
6	64	352	64 + 2(129) - 1 = 321	384

Table 1

description of the Panasonic and Quasar hand-held computers, especially the data-compression techniques. (See "The Panasonic and Quasar Hand-Held Computers," January 1981 BYTE, page 34.) Reading the text box that describes the mapping algorithm, however, I noticed a possible improvement.

In figure 3, page 41, a permutation of four elements encoded with 6 bits (001010, by rows) is demonstrated. However, according to the text, the first box will always be unswitched. Since it is constant, the first box (or first bit) need not be stored explicitly. This leaves 5 bits instead of 6 to encode the permutation (01010 for the example). The recursive nature of the algorithm should compound the savings significantly for larger permutations. In table 1, I have reproduced Mr Williams's table 2 with an additional column.

Craig R Ewert
400 Raymondale #16
South Pasadena CA 91030

Gregg Williams Replies:

Your analysis of the requirements of the algorithm is completely correct, although this does not necessarily mean that even more space can be saved within the HHC (hand-held computer). I compiled the table of results you referred to based on a description of the algorithm, and I did not realize that the box in the upper-left corner did not need to be encoded. Although I was unable to contact the person who had written the code implementing the algorithm, your interpretation of the algorithm does, in fact, allow permutations to be stored with less memory. My thanks to you (and to Paul E Black, of Oquirrh City, Utah, who wrote a similar letter) for pointing this out.

Thermodynamic Flaws

Richard Hetherington's excellent "Programming Quickie" in the February 1981 BYTE contains one flaw that can cause the user of his routine to arrive at some misleading results. (See "Energy-Saving Cost/Benefit Analysis," page 266.)

Table 2 gave the heat value of various fuels, and as far as I can see, it's correct. Unfortunately, the heat values are theoretical maxima, and to compute cost savings you need to make allowances for inefficiencies in extracting that heat. In practice, efficiencies range from (essentially) 100% for electricity to 20% or less for a fireplace. (A small fire in a large fireplace on a cold night can actually run at negative efficiency—losing more heat up the chimney than it contributes to the house.) Efficiencies tend to vary with the quality of the heating hardware, and (I suspect) with whether they are measured in the laboratory or in a more conventional environment. In general, you would not be wrong to expect 100% for electricity; 60% to 70% for gas or oil heat; 40% to 50% for wood or coal stoves; and something pretty dismal for an unaugmented fireplace.

The conventional means of accounting for this are either to reevaluate the fuel's heat value by the efficiency, or to alter the equation C=Z*Q/H to read C=Z*Q*E/(100*H), where E is the efficiency in percent. In this case, I would modify the routine to use the latter method, because it lets you evaluate the effect of switching to a more efficient heat source.

Anyone seriously planning to tackle his or her home-heating problem should construct a paper-and-pencil thermodynamic model of his or her house. This is nowhere near as difficult as it sounds. Any public library has some books (mostly those dealing with solar heating) that can help.

GUARANTEED RELIABLE FOR 2 FULL YEARS.

Unprecedented product reliability deserves an unprecedented warranty. IMS International provides its dealers with both.

Our commitment is real.

We are so confident that our products are the industry standard in reliability, we stand behind them for *two full years* from date-of-sale to the end user. All IMS manufactured products are covered.

The success of our dealers will insure our continued growth. That's why IMS International

is committed to providing every IMS dealer with these distinct advantages in today's marketplace:

- 2 year warranty
- Low retail cost
- Best margins in the industry
- Protected territories
- Full factory technical support
- Complete system delivery in 30 days
- Comprehensive advertising and promotional support

For more information about IMS International's "Reliables" and our unique dealer plan, call 714/978-6966 or write us:



2800 Lockheed Way
Carson City, NV 89701
Telex: 910-395-6051

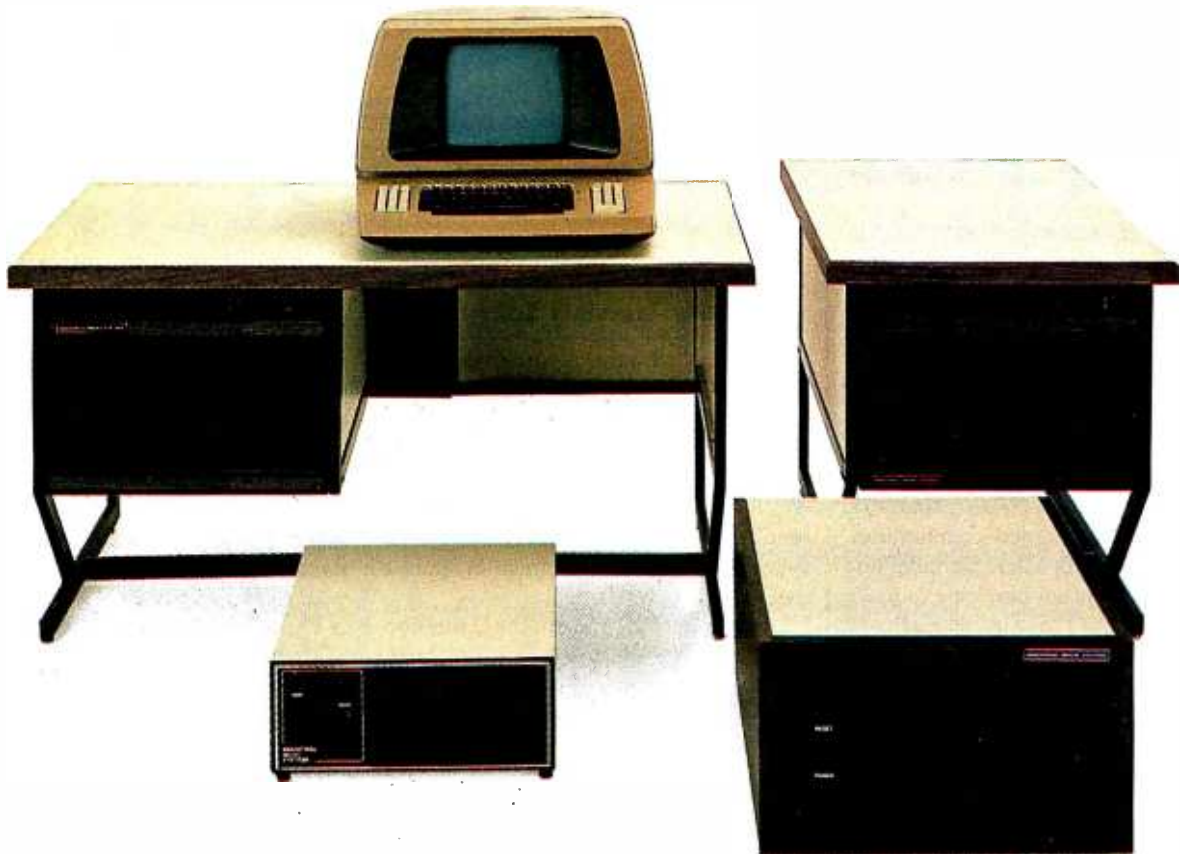

Mr Hetherington's routine is only as good as the data you put into it, and if you don't know how much heat you are putting into your house, and where it is going out, you may not recognize bad data when you use it.

Donald Kenney
291 S Main St
Andover MA 01810

Computers Can Help People

I read Mark Dahmke's editorial and would like to share with BYTE readers an interest of mine. (See "Computer Speech: An Update," February 1981 BYTE, page 6.)

I'm an academic adviser at Michigan State University and work with students in the Lower Division. Among our many academic services, we try to assist students in selecting majors that will help them attain their individual goals in life. I have very realistic concern and at the same time very optimistic hope for one student in particular.

Kelly Watson is a quadriplegic and has a combination of athetoid and spastic cerebral palsy. She is a delightful young lady—bright, pretty, and her sparkling sense of humor helps her overcome frustration. Kelly, although just 20, became a sophomore at the end of this winter term. She has gotten this far in her academic career out of sheer determination, and I'm sure someday she will be the newspaper editor she plans to become.

Kelly uses a joystick-operated electric wheelchair and types with a headstick on an IBM electric typewriter. MSU's Artificial Language Laboratory hopes to be able to provide her with a word-processing system. With financial assistance from concerned communities, technologists such as Mark Dahmke and John Eulenberg will soon be able to make accessible to persons such as Bill Rush and Kelly Watson those opportunities we all enjoy. I foresee a great advancement in human concern.

Jane E Linnell
Michigan State University
Undergraduate University Division
Student Academic Affairs Office
East Lansing MI 48824

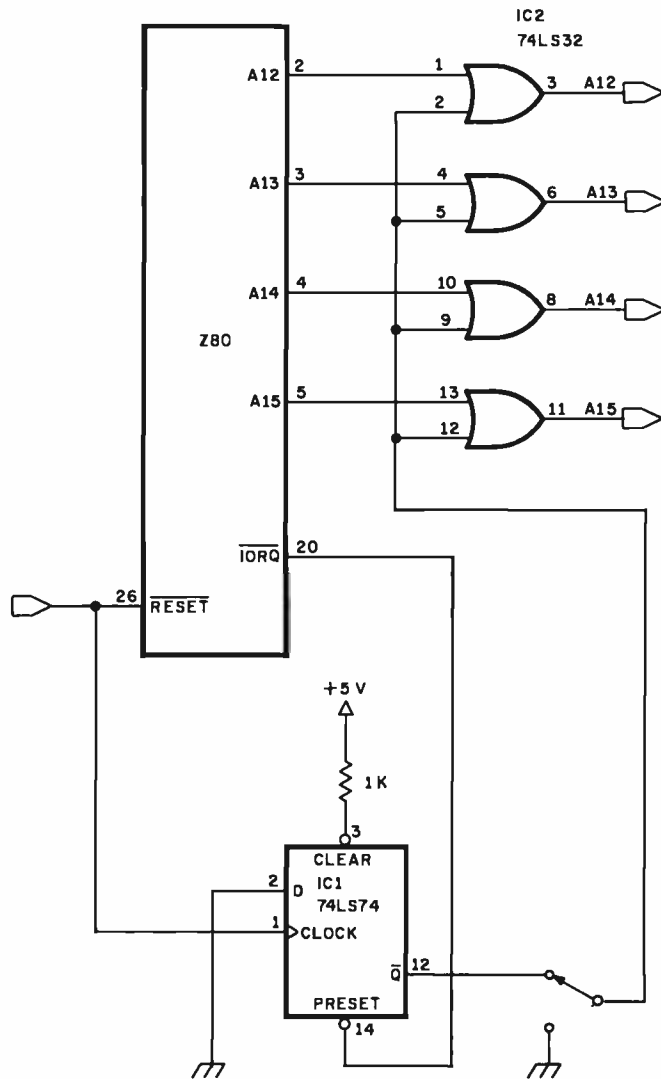

Figure 1

Simpler Starting Solution

Although Randy Soderstrom's approach to the problem of forcing the Z80 starting address was interesting, it is not the simplest solution. (See "Forcing the Z80 Starting Address," February 1981 BYTE, page 288.) His suggestion requires four integrated circuits, and an initial time delay is introduced. The circuit in figure 1 uses only two devices.

Upon reset of the system, the D flip-flop (IC1) is clocked, causing Q̄ to go high. Although the processor's address bus and program counter contain all 0s, the memory addressed is hexadecimal F000. The 74LS32 quad OR gate (IC2) accomplishes this with one input per gate high. The system monitor can be stored at hexadecimal address F000 and can now handle its high-priority housekeeping

without worrying about the address. A JP (jump immediate) to the next instruction will set the program counter correctly. The first OUT or IN instruction will activate the IORQ (input/output request), and then preset the D flip-flop, allowing signals on the address bus to pass freely through the 74LS32, and restoring the system to normal operation. As in Randy's circuit, there is no interference with memory refresh.

This technique is used on MOSTEK's STD Bus-based CPU-1 card. We feel this is the best and most economical approach to take.

Mitchell A Russo
MOSTEK
29 Cummings Pk, Suite 426
Woburn MA 01801

Mountain Computer put it all together for you.

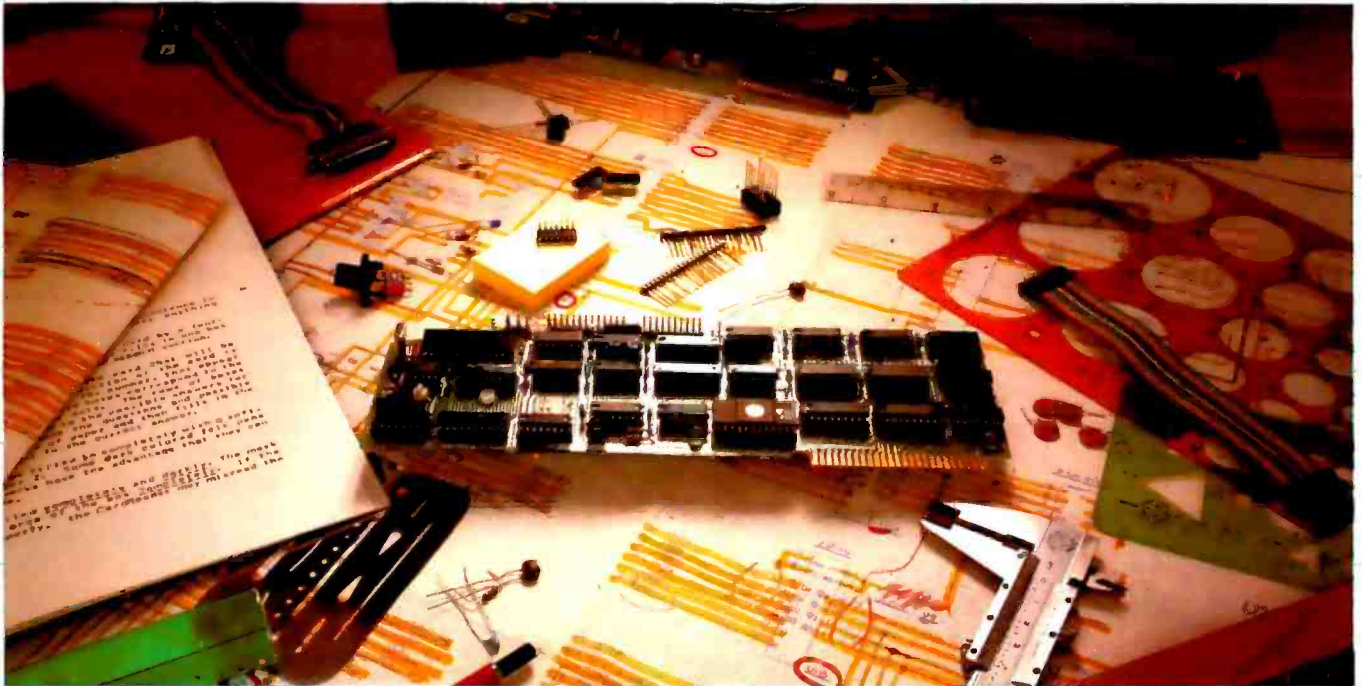

The CPS MultiFunction Card

Three cards in one! The Mountain Computer CPS MultiFunction Card provides all the capabilities of a serial interface, parallel output interface and real-time clock/calendar—all on one card—occupying only one slot in your Apple II®. Serial and Parallel output may be used simultaneously from CPS. CPS is configured from a set-up program on diskette which sets the parameters (such as baud rate, etc.) for all functions contained on the card and is stored in CMOS RAM on the card. Once you have configured your card, you need never set it up again. You may also change parameters from the keyboard with control commands. All function set-ups stored on-board are battery powered for up to two years. "Phantom slot" capability permits assigning each of the functions of CPS to different slots in your Apple without the card actually being in those slots! For example, insert CPS in slot #4 and set it up so that it simulates a parallel interface in slot #1 and a clock in slot #7 and leave the serial port assigned to slot #4. CPS's on-board intelligence lets it function in a wide variety of configurations, thereby providing software compatibility with most existing programs. "We've put it all together for you"—for these reasons and many more! *Drop by your Apple dealer and see for yourself how our CPS MultiFunction Card can expand the capabilities of your Apple and save you a great deal of money as well!*

Calendar/Clock

- One second to 99 years
- Battery backed-up (2 years)
- Two AA standard alkaline batteries for back-up (provided)
- Compatible with MCI Apple Clock™ time access programs

Parallel Output

- Features auto-line feed, Apple tabbing, line length, delay after carriage return, lower to upper case conversion
- Centronics standard—reconfigurable to other standards
- Status bit handshaking

Serial Interface

- Features auto-line feed, transparent terminal mode, Apple tabbing, line length, delay after carriage return, local echo of output characters, simultaneous serial/parallel output, lower to upper case conversion, discarding of extraneous LFs from serial input
- Uses the powerful 2651 serial PCI chip
- 16 selectable internal baud rates—50 to 19.2Kbaud
- Half/Full duplex terminal operation
- I/O interface conforms to RS-232C
- Asynchronous/Synchronous operation



Mountain Computer
INCORPORATED

300 El Pueblo Scotts Valley, CA 95066
(408) 438-6650 TWX: 910 598-4504

Special
Introductory
Price

\$239

BASIC Problems

Samuel Bates's "Rotation Algorithm" was fascinating but frustrating for two reasons. (See the January 1981 BYTE, page 328.) First, there are many terms used from Hewlett-Packard's HP 3000 BASIC that are not common to other versions of BASIC. I can figure out what MAT R=ZER does (it puts 0 in every element of the array R) and duplicate it with a subroutine, and I can determine from context that # means < > (not equal). However, I'm stymied by FILES*, ASSIGN, ENTER, and READ#1,1. Please, BYTE, return to the old policy of inserting a box with explanations of uncommon terms! A flowchart would have been useful, too.

"Whose BASIC Does What?" by Teri Li was also welcome. (See the January 1981 BYTE, page 318.) I hope its idea will be extended both to cover more computers and to be more complete in terms. I hope that BYTE will eventually publish it as a separate reference booklet. There were, however, some errors in the article.

```
10 FILES *
120 ASSIGN A$,1,S
160 ENTER 255,A9,A$
1130 READ #1,1
1140 IF END #1
      THEN 1190
1150 READ #1,B$
```

tells the interpreter that file names will be provided in a later ASSIGN statement
 assigns A\$ as file number 1, a sequential file
 allows 255 seconds for the values A9 and A\$ to be input
 sets the pointer for file number 1 to the first record
 transfers control to statement 1190 if
 end-of-file number 1 is encountered
 reads the next value from file number into the variable B\$

Table 2

For the Commodore PET, the major errors of significance are:

- HOME and CLS should be checked.
- COLOR=n, FRE(x\$), SPC(expr), and RANDOMIZE should not be checked.
- CALL address should have SYS entered.
- TI(expr) should be TI or TI = expr.
- TIS, a different real-time clock function, should be listed.

I don't need to say that BYTE is the best (I read six other journals regularly as

well), so I'll just say "thanks and keep it up."

Frank Chambers
Rock House
Ballyoroy, Westport
County Mayo, Ireland

The Hewlett-Packard 3000 is correctly classified as a minicomputer, so only a small percentage of our readers will have access to a system similar to the one used by Mr Bates. The BASIC statements that may be unfamiliar are defined in table 2. ■

"A pencil, a card, and this low-cost reader... it's the new, fast way to enter data into your microcomputer."

Interfaces to TRS-80, Apple II, PET, and others.

Good news! Now, all you need is a standard #2-pencil, a card, and our new MR-500 mark sense card reader to quickly and easily enter data into your favorite microcomputer.

As Easy as One, Two, Three...

Here's all you have to do. *One* — program the card by marking with the pencil. *Two* — feed the card into the reader slot. *Three* — the reader automatically turns on, the card is fed through, and data is instantly entered into memory. It's the simple low-cost alternative to keyboard data entry.

Interfaces with TRS-80, Apple, PET...

The MR-500 is ready to plug into most popular microcomputers. Interfaces are already available for TRS-80, Apple II and PET. And we're developing others almost daily. So whatever your microcomputer, we'll make it easy to use our mark sense card reader.

For Educators, Small Businessmen, and...

The applications for our low-cost MR-500 are endless. For small businesses, it's ideal for inventory, time cards, labor distribution (just to name a few). Educators will find that the MR-500 streamlines test scoring, attendance records, and grade reporting. Bet you can find a use already.

The Small Reader for the Small Computer

The MR-500 is lightweight — 4 lbs. Compact — a 4½-inch cube. And at \$750, it's the only mark sense card reader that makes sense for the small computer.



Phone or write for details. Or better yet, order yours today.



CHATSWORTH DATA CORPORATION

20710 Lassen Street • Chatsworth, California 91311
 (213) 341-9200

Circle 57 on inquiry card.



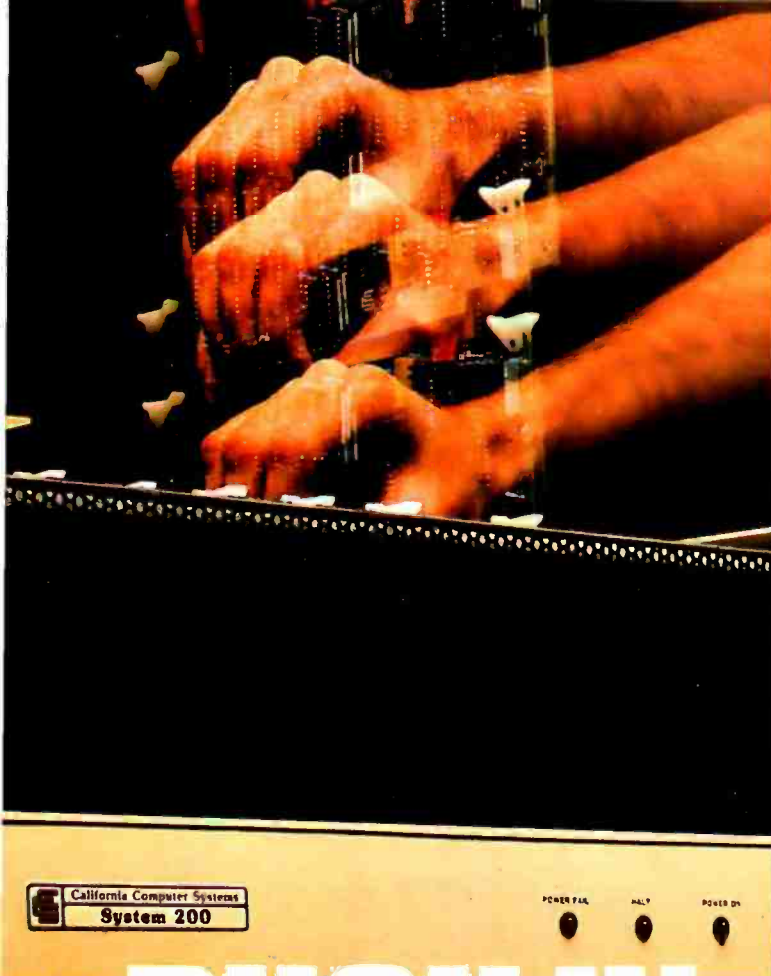

PUSH IN. PUSH ON.

CCS. MAKING MINIS OUT OF MICROS.

Here's the CCS line of board-level computers for system builders on the move. **Push in** the CCS board. And **push on** with your application. CCS board-level systems go together easily, come up quickly, and run reliably, with a proven return rate of less than 1%.

CCS board-level computers offer systems builders the optimal combination of low development cost, low manufacturing cost, and high reliability from proven, tested modules.

A headstart on reliability. CCS modules are designed to industrial performance standards, manufactured to industrial quality standards, fully burned in and tested. You spend more time and energy on your application when you rely on CCS modules instead of reinventing (and rebuilding) standard computer functions.

A full selection of S-100 board-level computers. Whether you want to add capability to another S-100 based system, or build a system from scratch, chances are you'll find solu-

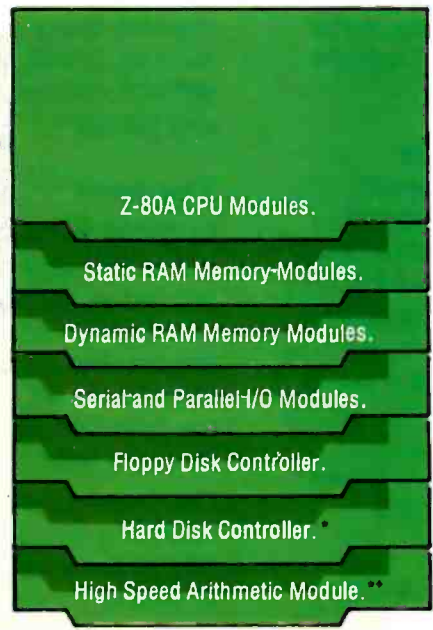

ons for all your system needs in the CCS product line. CCS manufactures a comprehensive selection, so you can tailor a system to your needs with a minimum of components. You buy exactly what you need. But you can easily expand later.

We'd like to tell you more about the CCS line of board-level computers, OEM systems, and computer systems. There's a lot more to tell. Send in the coupon for more information, contact your local computer dealer, or call.

Please have a sales representative call me.

Please send more information on CCS Board-Level Computer Modules.

Name _____

Company _____

Address _____

City/State/Zip _____

Phone () _____

 California Computer Systems
250 Caribbean Drive
Sunnyvale, California 94086
(408) 734-5811

* Available Quarter 2, 1981
* For use with CCS System Models 200, 300, 400.

Circle 47 on inquiry card.

ANNOUNCING

A Major Breakthrough

The

SYSTEM 2800

The System 2800 is the next logical step in the continuing line of innovative products from the Systems Group.

Unbeatable S-100 Memory Boards

First was the development of the DMB6400 series of S-100 Memory boards featuring the innovative Bank Select switching technique. This enables users to software select up to four totally independent memory banks per board.



The 2nd Generation

Then came the 2nd Generation of IEEE S-100 COMPATIBLE Z80 PROCESSORS, FLOPPY DISK CONTROLLERS and SERIAL I/O BOARDS. Each has been designed for single user, multi-user or

network operating systems such as CP/M[®], MP/M[™], CP/Net[™] and OASIS[™].

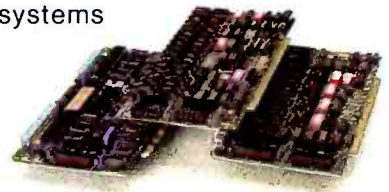

The Next Logical Step ...

We challenged our design team to create an innovative yet competitive system utilizing our existing line of field proven, dependable S-100 boards. The result: a highly reliable, quality built, state of the art microcomputer that gives you the cost/performance edge you need to be a leader in your field.

The System 2800 comes with a choice of operating systems: CP/M with an enhanced CBIOS for single user systems and either MP/M or OASIS for multi-user, multi-tasking systems. MP/M is available with either a standard or

CP/M MP/M and CP/Net are trademarks of Digital Research
OASIS is a trademark of Phase One Systems



enhanced XIOS. The CP/M based System 2800 provides improved diagnostic reporting capability and increased sector sizes of 1024 bytes yielding disk performance throughput increases up to 400% over standard unblocked systems.

The enhanced multi-user, multi-tasking MP/M based System 2800 provides the same advanced features as CP/M. In addition, this interrupt driven implementation can offer performance throughput increases up to 2000% thru extensive disk buffering for applications requiring a large number of disk accesses.

Also available is the OASIS operating system with ISAM files, automatic record locking and multiple-user print spooling.

All operating systems are available in either floppy or hard disk configurations. The disk drive selection includes single or double sided, double density 8-inch floppies with up to 2.52 megabytes of formatted storage per system, expandable to 5.04 megabytes, and an 8-inch 10 megabyte winchester hard disk.

Cost Effective Reliability

Dealers, OEM's and System Integrators share many common needs. Not the least of these is dependable products. That's why we back our System 2800 with our established reputation for high quality products, superior support, prompt and courteous service, and a one-year warranty.

Take the next logical step. See your nearest computer dealer, or contact us for the complete story on our S-100 family of board products and enhanced systems.

Systems Group

A Division of MEASUREMENT systems & controls
incorporated

1601 Orangewood Ave.
Orange, Calif. USA 92668
(714) 633-4460 TWX/TELEX: 678 401 TAB IRIN

For International Sales Inquiries contact: SIGMA INTERNATIONAL, INC., P.O.
Box 1118, Scottsdale, AZ 85252 USA (602) 994-3435 / Telex 165 745 Sigma

Tomorrow's
Software...
Today!

UCSD*

P-SYSTEM

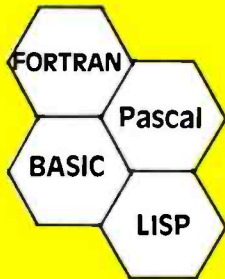

PORTABLE POWERFUL PROFESSIONAL

FOR PROGRAMMERS

- Operating system with interpreter, screen and character editors, filer, assemblers, utilities and compilers.
- PFAS(TM) — Keyed - ISAM in 6K user memory

FOR ENGINEERS, CONTRACTORS

- Milestone(TM) — Organic Software's answer to PERT. Critical path modeling.
- FORTRAN — ANSI '77 Subset

FOR DOCTORS, CLINICS

- MEDOFFICE(TM) — The complete office system for the professional
- DATE BOOK(TM) — Appointment scheduling for your micro.

FOR SMALL BUSINESS

- GL, AR, AP, Payroll Packages
- Word Processing

FOR EDUCATORS, RESEARCHERS

- INTELLECT-UL(TM) — A full range LISP interpreter for A. I. applications
- mINDEX(TM) — Text database system for bibliographies, contracts, abstracts, etc.

And Much More —
READY TO RUN ON
DEC LSI-11‡
TRS-80 Model II§

PCD SYSTEMS
P. O. Box 143
Penn Yan, NY 14527
315-536-3734

‡TM Digital Equipment
§TM of Tandy Corp.
*TM U. of California

Hardware Review

RAMCRAM Memory Module for the Atari

Mark Pelczarski
1206 Kings Circle
West Chicago IL 60185

Axlon Inc has released an alternative for add-on memory for the Atari computers that might save some money for Atari 800 owners. RAMCRAM will also offer more memory for the Atari 400 than you may have thought possible.

For \$320 you can buy a single module that contains 32 K bytes of programmable memory. The unit plugs into the middle memory slot of an Atari 800, and with the 16 K-byte module provided with your system, gives a full 48 K bytes of memory (it will not work with only an 8 K-byte module ahead of it).

In an Atari 400, the module can replace the built-in 8 K bytes of memory to give a 32 K-byte system. The Atari 400 would then be able to use any software for Atari 800 32 K-byte systems, plus it would contain enough memory to handle a DOS (disk operating system) and, therefore, a floppy-disk drive. With RAMCRAM, Personal Software's 17 K-byte VisiCalc will run on the Atari 400.

In an Atari 800, the top 8 K bytes of memory-address space are pre-empted if you have a cartridge in the left slot, such as BASIC, the Editor/Assembler, or Star Raiders. With a left cartridge installed you can use



Photo 1: The Axlon RAMCRAM memory cartridge for the Atari 400 or 800.

only 40 K bytes. Without a cartridge, but with RAMCRAM installed, you have 48 K bytes of memory which can be used for copying disks faster on a one-drive system. (DOS does not require a cartridge, and more programmable memory means swapping disks fewer times while copying.) You also have 48 K bytes for machine-language programs that do not need cartridges, such as VisiCalc, and languages could be loaded from disk without using cartridges.

Axlon also provides its dealers with a memory-diagnostic program that will analyze the memory of an Atari



Turn your Apple into the world's most versatile personal computer.

The SoftCard™ Solution. SoftCard turns your Apple into two computers. A Z-80 and a 6502. By adding a Z-80 microprocessor and CP/M to your Apple, SoftCard turns your Apple into a CP/M based machine. That means you can access the single largest body of microcomputer software in existence. Two computers in one. And, the advantages of both.

Plug and go. The SoftCard system starts with a Z-80 based circuit card. Just plug it into any slot (except 0) of your Apple. No modifications required. SoftCard supports most of your Apple peripherals, and, in 6502-mode, your Apple is still your Apple.

CP/M for your Apple. You get CP/M on disk with the SoftCard package. It's a powerful and simple-to-use operating system. It supports more software than any other microcomputer operating system. And that's the key to the versatility of the SoftCard/Apple.

BASIC included. A powerful tool, BASIC-80 is included in the SoftCard package. Running under CP/M, ANSI Standard BASIC-80 is the most powerful microcomputer BASIC available. It includes extensive disk I/O statements, error trapping, integer variables, 16-digit precision, extensive EDIT commands and string functions, high and low-res Apple graphics, PRINT USING, CHAIN and COMMON, plus many additional commands. And, it's a BASIC you can compile with Microsoft's BASIC Compiler.

More languages. With SoftCard and CP/M, you can add Microsoft's ANSI Standard COBOL, and FORTRAN, or

Basic Compiler and Assembly Language Development System. All, more powerful tools for your Apple.

Seeing is believing. See the SoftCard in operation at your Microsoft or Apple dealer. We think you'll agree that the SoftCard turns your Apple into the world's most versatile personal computer.

Complete information? It's at your dealer's now. Or, we'll send it to you and include a dealer list. Write us. Call us. Or, circle the reader service card number below.

SoftCard is a trademark of Microsoft. Apple I and Apple II Plus are registered trademarks of Apple Computer. Z-80 is a registered trademark of Zilog, Inc. CP/M is a registered trademark of Digital Research, Inc.

MICROSOFT

CONSUMER PRODUCTS

Microsoft Consumer Products, 400 108th Ave. N.E.,
Bellevue, WA 98004. (206) 454-1315

What can you honestly expect from an interactive data terminal that costs only \$369?*



Well, to begin with, color graphics.

RCA's VP-3301 has unique color-locking circuitry that gives you sharp, jitter-free color graphics and rainbow-free characters.

Plus much more: Microprocessor control. Resident and programmable character set. Reverse video. State-of-the-art LSI video control. 20 and 40 character formats. RS232C and 20 mA current loop. Six baud rates. Eight data formats. ASCII encoding. Light-touch flexible-membrane key switches for reliability and long life. CMOS circuitry and a spill-proof, dust-proof keyboard for hostile environments.

The VP-3301 can be used with a 525-line color or monochrome monitor or a standard TV set through an RF modulator.** It serves a wide variety of industrial, educational, business and individual applications including communication with time sharing and data base networks such as those provided by Dow Jones News/Retrieval Service, CompuServe and Source.

All this—for the low price of \$369. And it's made by RCA. So get the whole story about the surprising VP-3301 today. Write RCA MicroComputer Marketing, New Holland Avenue, Lancaster, PA 17604. Order toll-free: 800-233-0094.

Circle 313 on inquiry card.

800, checking that the full 48 K bytes are functional. It performs three tests: the first tries to zero every bit in memory, the second checks for memory uniqueness by turning on bits and testing whether other bits were affected, and the third rolls a 1 bit through each location, checking that every bit can be turned on. The diagnostic program is available to customers for \$15.

If you own an Atari computer and you're the type of person that thinks ahead more than a year, it seems as though RAMCRAM is the way to go for memory expansion. If you own an Atari 400, it gives you memory that you couldn't get otherwise. If you own an Atari 800, it gives you all the memory it can now hold *and* leaves one expansion slot open for future use. Given Axlon's plans for additional Atari-compatible products, that slot may be valuable. ■

At a Glance

Name
RAMCRAM

Use
Increases programmable-memory capacity of Atari computers

Manufacturer
Axlon Inc
170 Wolfe Rd
Sunnyvale CA 94086
(408) 730-0216

Dimensions
7.5 by 15.5 by 1.5 cm (3 by 6 by 5/8 inches)

Price
\$320

Features
Expands Atari 800 to 48 K bytes, replaces existing memory in Atari 400 to give a total of 32 K bytes

Hardware needed
Atari 800 computer with 16 K bytes of programmable memory, or any Atari 400 computer

*Model VP-3303 with built-in RF modulator—\$389.
**Suggested user price. Monitor and modem not included.

Circle 368 on Inquiry card. →

Tiny BASIC MICROCOMPUTER K-8073

The Engineer's Product Development Board Level Computer

**LOW COST
POWERFUL/VERSATILE
ENGLISH-LIKE PROGRAMMING**



1K Byte Local RAM
Ext. Expandable To 9K

ART/RC Master, For Single
Wire Data I/O Of 128 Slave Units

Real Time Clock
W/Ext. Battery Backup
Yr, Mo, Wk, Day, Hour, Sec.

RS-232 For CRT
110-4800 Baud

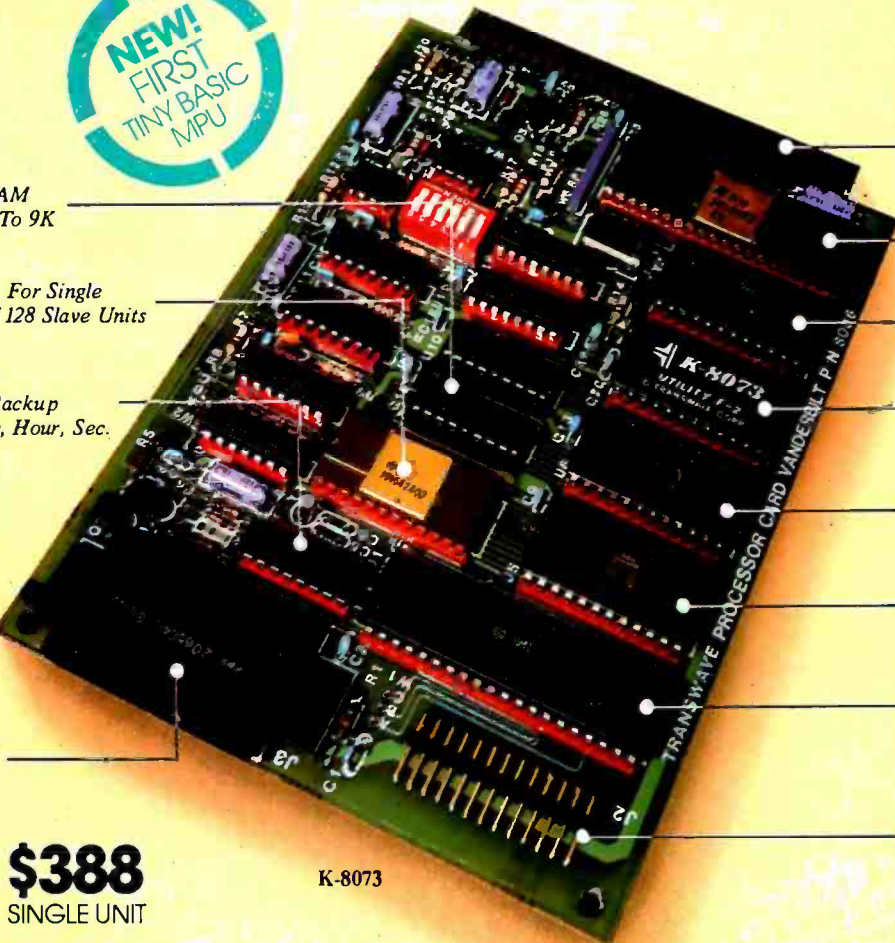

STD (MOD) BUS 4.5 x 6.5 in.
5 Volt Only—Cassette
Tape In/Out—2 Sense—
3 Flags

INS8073 Microinterpreter
Tiny BASIC Processor

Autostart EPROM 2K Byte

Utilities Firmware, For
Software Dev., EPROM 2K

EPROM—2K Byte

EPROM Programmer, 2K
Byte Prm. Decoded—Req.
Ext. 25V Only

PPI, Programmable I/O,
24 Lines

PPI Interface Ribbon
Connector

\$388
SINGLE UNIT

K-8073

THIS IS AN ENGINEER'S COMPUTER.

Simply attach a CRT, connect 5 volts, and you have yourself one each powerful, versatile microcomputer that YOU can program.

If you're fed-up with board level computers that require expensive development systems plus the skills of an Assembly language programmer, then you need the K-8073. With an on-chip microinterpreter and the extra control devices we designed into the board, you can do your own programming in the most simple English-like language available—Tiny BASIC. Sophisticated application designs can be implemented in hours instead of days or weeks because you have eliminated expensive and time consuming hardware and software costs.

IN ADDITION TO ALL THIS, the K-8073 offers advantages unheard of in other board level computers. Among these are an on-board EPROM Programmer, A Real Time Clock, Autostart, 1K Byte local RAM for variables, 8K Byte EPROM, ART/RC and PPI W/24 line I/O.



8K Byte RAM \$232.00



Development Station \$195.00

THE K-8073 IS FOR OEM'S AS WELL AS END USERS.

Whether you manufacture Industrial Process Control, Environmental or Test/Measurement systems, or simply for your own use, you can count on top quality performance. The K-8073 comes complete with all socketed devices including the powerful F-2 Utilities Firmware and a Hardware/Software manual.

In Industry, Education, or New Product Development, the K-8073 provides you with State-of-the-Art technology for microprocessor efficiency and ease. With a full line of support products, the TransWave line takes care of your every need at the most reasonable prices.

To order your K-8073 or for further information, write or call TRANSWAVE CORPORATION, Cedar Valley Building, Vanderbilt, PA 15486, (412) 628-6370.

TRANSWAVE

COMPUTER DIVISION OF UTSC



Introducing 4 new programs from the

These new programs are going to do for you just what our VisiCalc™ program has done: make your computer work harder, so you can work smarter!

They'll enable a personal computer to take over more of those tasks eating up so much of your time. That'll give you more time to concentrate on the tasks where your skills, experience and intuition can do the most good. Things like thinking, planning and managing.

A personal computer can help you do all these things better. And Personal Software™ programs will help you do them best!

VisiDex. The VisiDex™ program makes it a snap for you to remember anything, and everything, you don't want to forget.

It's a free-form personal filing program with nearly unlimited cross referencing.

VisiDex "thinks" and "remembers" just the way you ask it to—so you can access it anyway you want, and find exactly what you want—instantly!

VisiPlot. The VisiPlot™ program makes it easy to see what your numbers really say.

It adds real meaning to financial analysis, forecasting, budgeting and business planning. Because VisiPlot takes hard-to-grasp numbers and automatically turns them into easy-to-comprehend charts and graphs, right before your eyes!

All kinds of charts and graphs, with all kinds of flexibility in titling, shading, and color—all at the touch of a few buttons!

HOW TO WORK SMARTER NOT HARDER



people who brought you VisiCalc!

VisiTrend/VisiPlot. If you want sophisticated trend forecasting and statistical analysis—and you know how hard it is to create them by hand—you'll want to get your hands on the VisiTrend/VisiPlot™ program!

This program will enable you to rapidly perform regressions and time series analysis, plus providing you with comprehensive charting and graphing capabilities.

VisiTerm. The VisiTerm™ program enables you to reach out to the world.

With VisiTerm, you'll be able to use your personal computer to communicate with larger computers, to tap into data networks, to communicate with other personal computers.

VisiTerm gives you all the benefits of a personal computer, plus all the advantages of an intelligent terminal, all in one package.

All of these programs are currently available for the Apple II and II Plus. Besides their many individual benefits, these new programs deliver an even greater total benefit. That's because many of them interact with each other and with our new, enhanced version of VisiCalc.

Together, they give you an unprecedented family of personal computing capabilities; making the computer work harder, so you can work smarter!

PERSONAL SOFTWARE INC.

Or call us at (408) 745-7841 for the name of the Personal Software dealer nearest you. Or write us at 1330 Bordeaux Drive, Sunnyvale, CA 94086.

Circle 291 on inquiry card.

StackWork's

FORTH

A full, extended FORTH interpreter/compiler produces COMPACT, ROMABLE code. As fast as compiled FORTRAN, as easy to use as interactive BASIC.



SELF COMPILING
Includes every line of source necessary to recompile itself.

EXTENSIBLE
Add functions at will.

CP/M* COMPATIBLE

Z80 or 8080 ASSEMBLER included

Single license
Supplied with extensive user manual and tutorial:
\$175.00
Documentation alone: \$25.00

OEM's, we have a deal for you!

CP/M Formats: 8" soft sectored,
5" Northstar, 5" Micropolis Mod II,
Vector MZ, TRS-80 Mod II

Please specify CPU type.
Z80 or 8080

All Orders and General Information:
SUPERSOFT ASSOCIATES
P.O. BOX 1628
CHAMPAIGN, IL 61820
(217) 359-2112
Technical Hot Line: (217) 359-2691
(answered only when technician is available)



SuperSoft
First in Software Technology

*CP/M registered trademark Digital Research

Technical Forum

LISP vs FORTRAN

A Fantasy

Laurie Rocheleau
c/o David Clay
Florida Institute of Technology
Melbourne FL 32901

Editor's Note: *David Clay, an instructor of computer science at the Florida Institute of Technology, sent us an interesting short story written by one of his students. In his cover letter, he wrote:*

"I assigned a short term paper recently on the comparison of two programming languages, LISP and FORTRAN. Most papers were written in an expected style, outline of topics, and format—until I came to Laurie Rocheleau's. I was surprised, entertained, and impressed. After reading it, I felt that others might find it a novel approach to a somewhat mundane academic chore—writing term papers."

We, too, were surprised, entertained, and impressed, so we decided to publish this short story/term paper. We also want to thank Clay for rewarding such creativity: the cover letter of Rocheleau's paper is marked "A++". . . GW

As they wheeled her into the room her hopes began to fade. She had been praying that this place would be different from all the others. The last room had been so cold. Not only in temperature; no one had even attempted a conversation the entire eight months she had been there. This new room seemed to be a copy of the last, and all the others she had been in.

They placed her in a corner, and after plugging in all of her tubes and wires, they left. It was terribly quiet and dark.

Suddenly she began to receive something from someone across the room. She was absolutely ecstatic. Someone was trying to communicate with her. The language was a bit strange, it was some form of output statement:

PRINT*, 'What is your name?'

It was sort of hard to understand yet they were characters, her specialty, and after a bit of interpretation, she decided upon a method of replying. She had no PRINT statement in her memory, but she did have a trick up her circuit board. She sent her interpreter the instruction:

(CONS('My name is LISP. What is yours?))

As the other received her message, she could almost sense a chuckle. Soon she received his reply:

PRINT*, 'My name is FORTRAN. Why must you com-

SOFTWARE FOR SERIOUS INVESTORS

Dow Jones Information Services Software Products Provide Personal Financial Control To Apple, Atari, Commodore And TRS-80™ Owners

In the convenience of your home or office, Dow Jones Information Services portfolio management packages give you on-line access to the in-depth business and investment information Dow Jones continually gathers for The Wall Street Journal, Barron's and the Dow Jones News Service.

Whether you own an Apple, Atari, Commodore, or Radio Shack computer, you can now control the management of your own portfolio in a way never before possible. . . tracking its growth, evaluating possible changes, even creating hypothetical new portfolios.

Imagine being able to call up current stock quotations on over 6,000 listed companies (with only a 15 minute delay) as well as fifty key financial indicators on selected firms. Imagine being able to spot trends, summarize data, and project growth. You can even review news in detail on the companies in your current or future portfolio (as recent as 90 seconds, as far back as 90 days).

What's more, when you make your software package purchase, we'll give you a Dow Jones password absolutely free. . . as well as one hour of free introductory time. Plus, software and usage costs will be tax deductible in many cases (consult your tax advisor for further information). And it's all just a fingertip away!

Find out more about Dow Jones' unique portfolio management packages at your nearest computer store, and be sure to ask for a free demonstration. Or, simply call Dow Jones today.

Call Toll Free
800-257-5114
(In New Jersey call
609-452-1511).

DOW JONES INFORMATION SERVICES

A Division Of Dow Jones & Company, Inc.

Providing Information Through Innovation

municate in such a strange way? Don't you have input and output commands?

She felt a bit embarrassed, yet she knew that she had many advantages over this FORTRAN fellow. She replied:

(CONS('No, I don't have input or output commands. I have to use this CONS instruction with quotes to get something printed out. And I have other instructions to use as input instructions.))

His reply upset her greatly:

PRINT '.Ha, how cumbersome. I bet you can't even handle a simple addition without some complicated function call. Well anyway, I'll grace you with a little knowledge about myself. I was one of the world's first high-level programming languages. And today I am probably the most widely used language for programming of scientific and engineering computations.'

She sat for a few nanoseconds, organizing her cut-down:

(CONS('All right, blowhard, listen to this; I and my various dialects are the primary languages in at least two areas of computer science: symbolic computation and artificial intelligence, which are concerned with programs that perform tasks that humans say require intelligence. Has anyone ever said you have intelligence? I bet not!!!))

PRINT '.Intelligent! How can you even consider your-

self intelligent if you can't deal with numbers. I mean numbers make the world go around. Look, even your insides are numbers—all zeros and ones, and you don't even understand them. I bet you can't deal with decimals, or even take the square root of a number—real or integer. You're useless.'

Quickly she replied:

(CONS('No, I can't take the square root of a number, but I can do quite a bit with numbers. Just take a look at this, these are some more of my functions:

(PLUS $X_1 \dots X_n$) = $X_1 + \dots + X_n$
 (DIFFERENCE X Y) = $X - Y$
 (MINUS X) = $-X$
 (TIMES $X_1 \dots X_n$) = $X_1 \times \dots \times X_n$
 (ADD1 X) = $X + 1$
 (SUB1 X) = $X - 1$
 (QUOTIENT X Y) = $X \div Y$
 (LESSP X Y) = T if $X < Y$ else NIL
 (GREATERP X Y) = T if $X > Y$ else NIL
 (ZEROP X) = T if $X = 0$ else NIL
 (NUMBERP X) = T if X is a number else NIL
 (LENGTH X) = Length of list X

They may not be as simple to understand as your method of manipulating numbers, but remember this: numbers are just a minor part of my abilities. Why, unlike you, I can even distinguish between a character and a number with my NUMBER function.

I realize that you are very graceful when it comes to dealing with numbers, but when it comes to character manipulation, a programmer would be crazy to use you. With me, the programmer can easily deal with characters and do a little with numbers if need be. You see, I'm not quite so one-sided as you are.))

PRINT '.OK Miss LISP, how about subroutines? They're simple. All I have to do after the END statement (I do hope you understand everything so far) of the main body is have the programmer write SUBROUTINE Name (parameter list). Below this all he has to do is write a sub-program that will be executed just like a regular program, when, in the calling program, the instruction CALL Name (argument list) is encountered. When the execution of the subroutine is finished, a RETURN statement returns control to the statement following the CALL statement in the calling program. The parameters in the parameter list are reference parameters, using the chaining, the copying, or the value/result method. Why, my subroutines can even call other subroutines if they want to. . . . I'm waiting for your response!

(CONS('I love the way you quickly changed the subject—away from letters and numbers. But, OK, here's my response: I will add to my argument of input and output while describing my "subroutines," which I call Procedures. I don't need explicit input and output statements

Leverage: Tomorrow's UNIX-Based Mailing List System on Today's CP/M Machines

If you are now using a microcomputer to maintain a mailing list or membership list, then you should consider converting to *Leverage*. *Leverage* is a new information management system which combines full screen data entry, flexible record selection, and general purpose report generation and word processing capabilities in a well-structured, easy to use package. In fact, *Leverage* can outperform, feature for feature, any mailing list program now on the market. What's more, when you buy *Leverage* you get, at no extra charge, a program to convert your current data base to *Leverage*-compatible format. And since *Leverage* is written entirely in "C", the native language of the powerful UNIX operating system, you will be able to take the *Leverage* program and databases with you when you upgrade to the next generation of UNIX-based micros.

For complete details on *Leverage*, including up-to-date information on conversion programs and hardware compatibility, use the reader service card or call us for a brochure and newsletter.

Leverage Program . . . \$185

Manual Alone \$ 15 (Credited to subsequent program purchase)

Leverage Newsletter . . . \$ 10/year (First year included with purchase)

Leverage is a trademark of Urban Software Corp., Unix of Bell Labs, CP/M of Digital Research.

Urban Software Corporation

19 West 34th Street • New York, NY 10001 • (212) 947-3811

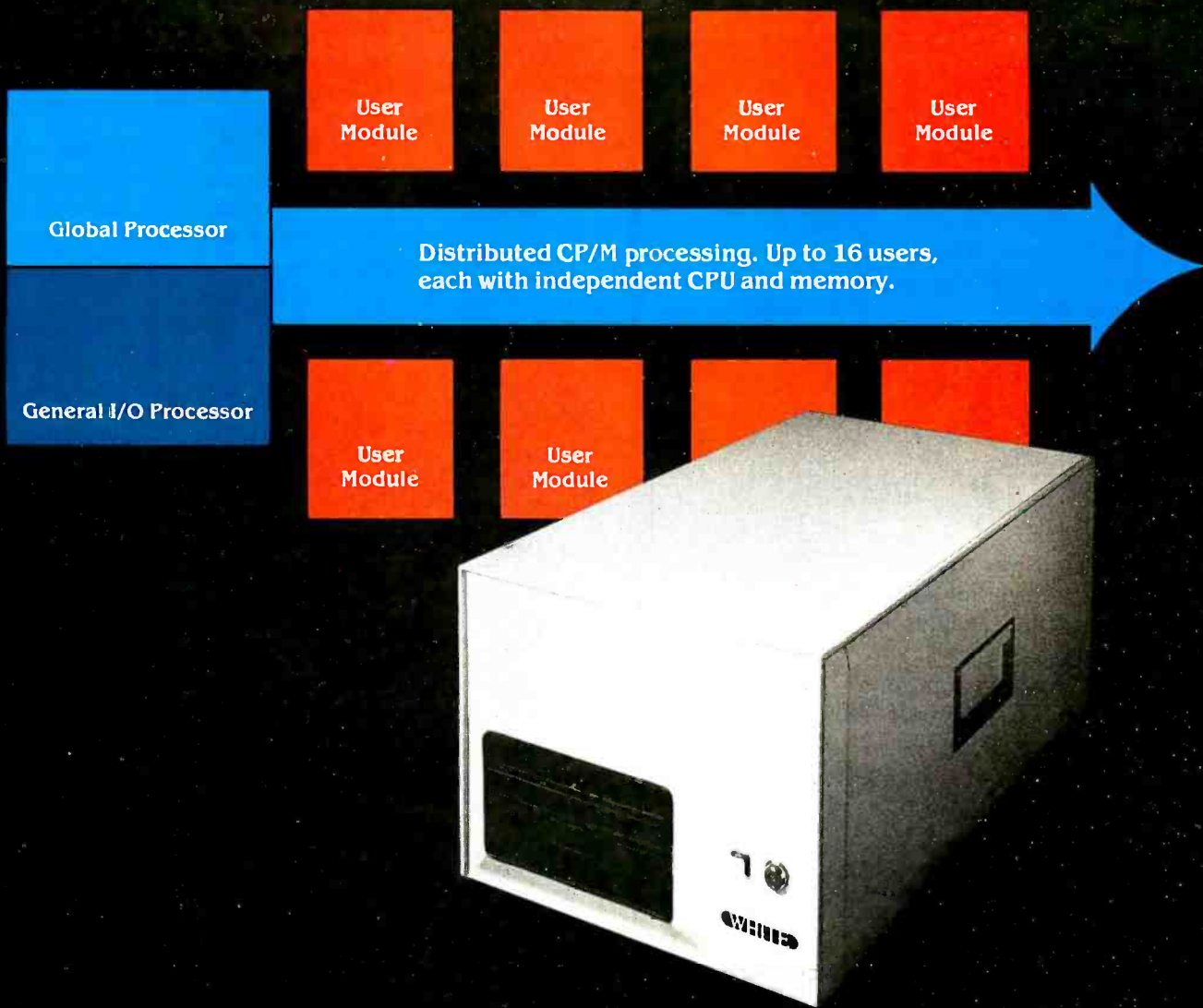

How to tell if it's a White Computer.

(Users 2 through 16 — multiuser expansion with high performance through distributed processing.)

Look for a single user CP/M® system that expands to multiuser configurations economically.

Look for independent 6 MHz Z80B-based User Modules with 64K of RAM memory, each module with a port to the user terminal capable of handling baud rates of up to 38K under program selection. Look for high-speed block data transfers from user modules to the Global Processor for disk storage. That way, CP/M programs run independently for each user. Fast. And each user's station acts just like the fastest standalone system — no delays, no waiting for other users.

Look for a Z80-based Global Processor for disk and tape I/O that transfers data from disk to user modules at the data transfer rate of the peripheral device. And a controller that handles as many as 8

SMD disk drives for up to 528 megabytes of hard disk storage, plus up to four 8" floppies, plus optional streaming tape backup.

And look for a Z80-based General I/O Processor that supports up to eight printers — with 64K bytes of independent buffer memory.

That's part of how you tell if it's a White Computer. There's a lot more. Here's a number and address for more information.

CP/M is a registered trademark of Digital Research. Z80, Z80A, Z80B are registered trademarks of Zilog Corporation.



White Computer Company Δ 1876 Industrial Way
Redwood City, California 94063 Δ 415 364 7570

SOFTWARE SALE

SANDS OF MARS

by Crystalware

Adventure at it's best.

Hi-res graphics, animation and sound effects.

Reg. Price: \$39.95

Cat No.	Description	SALE
3029	ATARI 800, 48K, Disk	\$34.95
3030	Apple II, Applesoft, 48K, Disk	\$34.95
3031	TRS-80 Mod I, L2, 48K, Disk	\$34.95

GALACTIC QUEST

by Crystalware

Barter your way to riches and battle pirates in space. Hi-res graphics, sound and real-time action. Reg. Price: \$29.95

Cat No.	Description	SALE
3026	ATARI 800, 32K, Disk	\$24.95
3027	Apple II, Applesoft, 48K, Disk	\$24.95
3028	TRS-80 Mod I, L2, 32K, Disk	\$24.95

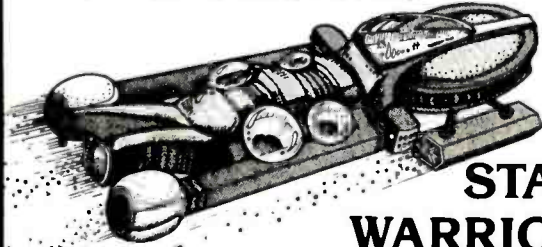

STAR WARRIOR

by Automated Simulations

Be an interstellar avenger. Hi-res graphics and tough opponents. Reg. Price: \$39.95

Cat No.	Description	SALE
3057	Apple, Applesoft ROM, 48K & TRS-80, 32K Cass	\$34.95
3058	Apple, Applesoft ROM, 48K & TRS-80, 32K Disk	\$34.95

UPS Shipping & Handling Included with purchase.

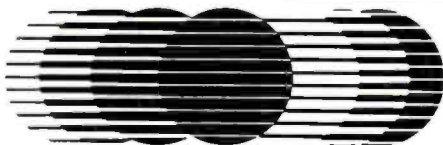

HW ELECTRONICS

(Formerly Hobbyworld Electronics)

Write or phone us for your FREE HW Catalogue.

19511 Business Center Drive, Dept. B6
Northridge, California 91324

TOLL-FREE (OUTSIDE CALIF): (800)423-5387
CALIF & OUTSIDE USA:(213)886-9200

Technical Forum

because "data" is provided in the form of arguments in procedure calls and because the value produced by a procedure called at the top level is automatically output by my interpreter.

I have taken a good look at your basic structure—Blah! At my top level, your main program, I have no need for variable declaration, assignments, loops, tests, etc. This is so because usually the first environment where such things are meaningful is the environment established by a procedure called from my top level.

To show you how I "call" a procedure, I must first say that nearly all of my commands are procedure-related. And all of my procedures return a value—thus, they are function procedures.

First I define a procedure, then I call it—just the opposite of your goofy subroutines. To define a procedure, I merely say:

LISP PROCEDURE Name(parameter list)

Body

where the body is much like the body of your subroutines. It is simply instructions to perform the task of the procedure. Some of the instructions can even be Procedures themselves.

As far as calling goes, I don't even have to say Call. All I have to do is write the name of the procedure along with its parameter list, for in essence my procedures are functions.

Name(parameter list)

This is all that is needed. The parameters are usually values. But I can pass arguments in the unevaluated form—Name Parameters. And my procedures can call themselves; this is called recursion, the all-important function that you can't even handle. You're nothing but an old man that's constantly being updated. They'll soon phase you out. No recursion—ha ha!)))

PRINT*, 'OK, so I am old, but you ain't no spring chicken yourself. I have been doing a bit of research while you were babbling. We were both invented in the late '50s. So don't talk to me about old.

Oh, and there's one little thing you left out—how about Global Variables? You don't even have such a thing. Why, when I call a subroutine, I can have a COMMON statement in both the calling and the called routines, in which there are variables which are global to the called routine. They can be changed if need be by the called routine, or they can just be used in evaluations. These changes, if any, affect the values in the calling routine. Why, I can even name my common statements, like this:

COMMON /Name / variables

This way, different subroutines can have different globals with their calling routines. Can you top that????'

(CONS('I sure can . . .))

Suddenly the lights came on. The humans were back. Oh well, their talk would have to wait. Maybe this place wouldn't be so bad after all. ■

Introducing the COLOR CONNECTION™

Plug A TRS-80* Color Computer into the World of System-50™ Computing.

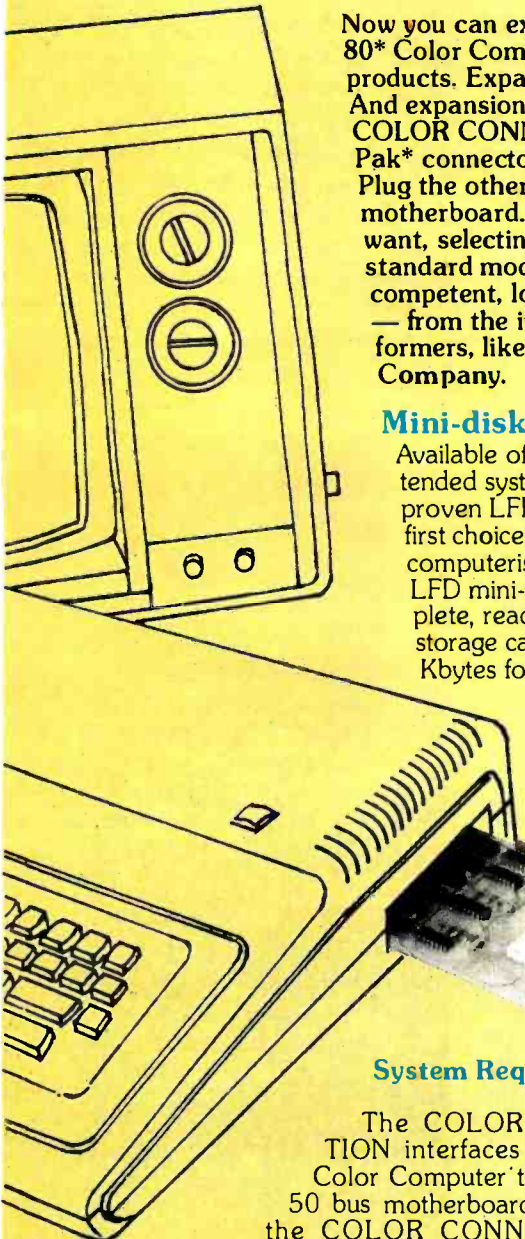

Now you can expand Tandy's exciting new TRS-80* Color Computer using proven System-50 products. Expansion possibilities are limitless. And expansion is easy. Plug one end of the COLOR CONNECTION into the Program Pak* connector of the Color Computer. Plug the other end into a System-50 bus motherboard. Now add the functions you want, selecting from an inventory of standard modules manufactured by competent, long-established firms — from the inventory of solid performers, like Percom Data Company.

Mini-disk storage — today!

Available off-the-shelf for your extended system is Percom's field-proven LFD mini-disk system. The first choice of knowledgeable 680X computerists since 1977, Percom LFD mini-disk systems come complete, ready to plug in and run. File storage capacities range from 102 Kbytes for a one-drive LFD-400™ system to almost 0.6 Mbyte for a three-drive LFD-800™ system.

System Requirements

The COLOR CONNECTION interfaces a TRS-80* Color Computer to a System-50 bus motherboard. Power for the COLOR CONNECTION is obtained from the computer. Power for the extended bus cards must be provided by an external source, such as Percom's System-50 Power Supply. The COLOR CONNECTION provides for disabling the computer internal memory at 8-Kbyte boundaries to prevent contention with external memory.

The COLOR CONNECTION..... \$99.95

Quality Percom products are available at Percom dealers nationwide. Call toll-free, 1-800-527-1592, for the address of your nearest dealer, or to order direct from Percom.

PRICES AND SPECIFICATIONS SUBJECT TO CHANGE WITHOUT NOTICE.
PRICES DO NOT INCLUDE SHIPPING AND HANDLING.

™ trademark of Percom Data Company, Inc.
* trademark of Tandy Radio Shack Corporation which has no relationship to Percom Data Company.

Get serious!

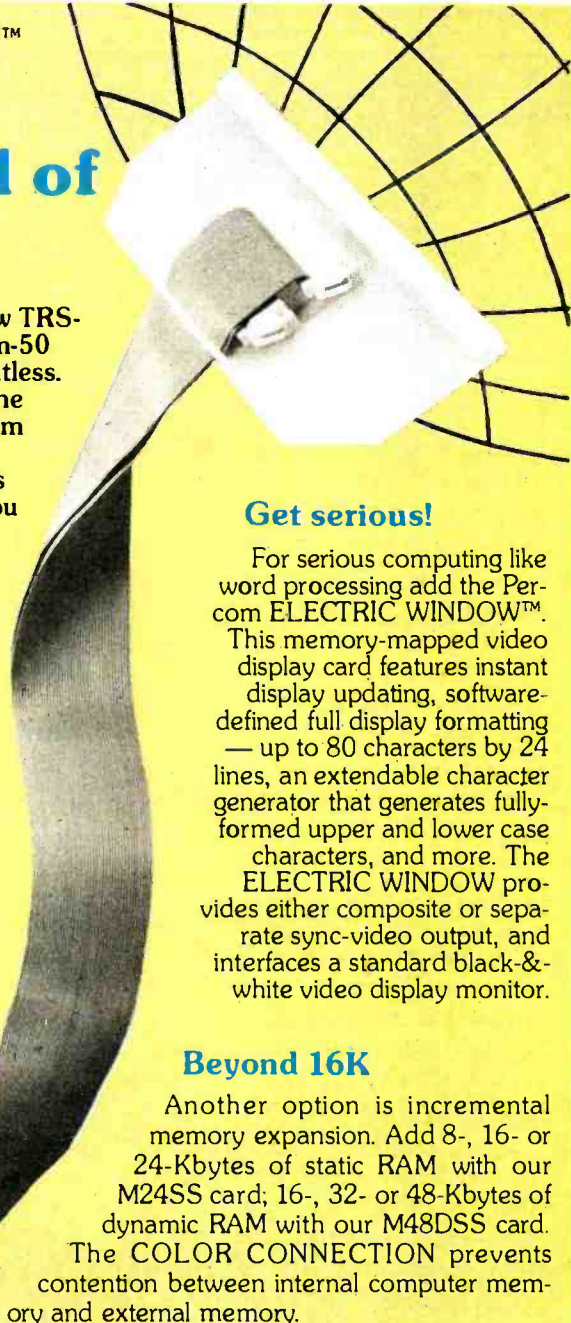

For serious computing like word processing add the Percom ELECTRIC WINDOW™. This memory-mapped video display card features instant display updating, software-defined full display formatting — up to 80 characters by 24 lines, an extendable character generator that generates fully-formed upper and lower case characters, and more. The ELECTRIC WINDOW provides either composite or separate sync-video output, and interfaces a standard black-&-white video display monitor.

Beyond 16K

Another option is incremental memory expansion. Add 8-, 16- or 24-Kbytes of static RAM with our M24SS card; 16-, 32- or 48-Kbytes of dynamic RAM with our M48DSS card. The COLOR CONNECTION prevents contention between internal computer memory and external memory.

The right motherboard

Fast mini-disk storage, full-format alphanumerics and memory add-on are obvious expansion possibilities. The optional Percom System-50 Motherboard allows you to consider the less obvious. This seven-slot motherboard not only can be self-extended, but also can be extended with our 30-pin I/O motherboard. The richness of readily available peripheral interface cards provides an uncommon degree of expansion flexibility.

The System-50 (SS-50) bus community. With a TRS-80* Color Computer and the COLOR CONNECTION, it's your world. Enjoy!



PERCOM DATA COMPANY, INC.
211 N. KIRBY GARLAND, TEXAS 75042
(214) 272-3421

Circle 287 on Inquiry card.

Logo for Personal Computers

Harold Nelson, Technical Editor

The imminent release of not one but *two* versions of the Logo language for personal computers may be one of the most exciting software developments of the year.

The Logo programming language was developed at the Artificial Intelligence Laboratory at MIT (Massachusetts Institute of Technology). According to the Logo Project's originator and driving force, MIT Professor Seymour Papert, "Logo is the name of a philosophy of education in a growing family of computer languages...."

In the same passage, Professor Papert is quick to point out that Logo is not merely a children's language, although since its development over twelve years ago it has always been intended to facilitate discovery learning by young children. In fact, it represents a kind of "Copernican revolution." Rather than the child being programmed by the computer (as with computer-aided instruction), the child learns by *teaching* the computer—and has a good deal of fun in the process. In the past, this has been the overriding purpose of the Logo Project. However, Professor Papert states: "An example of a powerful use of list structure is the representation of Logo procedures themselves as lists of lists so that Logo procedures can construct, modify, and run other Logo procedures." (*Mindstorms: Children, Computers and Powerful Ideas*. New York: Basic Books Inc, 1980, page 217.)

Apple Logo and TI Logo are the first versions of this language that are intended for use with personal computers. TI Logo was developed for the Texas Instruments 99/4 computer, while Apple Logo runs on the Apple II or Apple II Plus computer. Each is a descendant of earlier implementations written in LISP and Pascal for larger computers, and this heritage is

evident in both versions of the language.

TI Logo

The first "draft" of Logo for the TI 99/4 was prepared by the Logo Project at MIT. Texas Instruments modified this draft according to its priorities and has done some impressive code compression in order to increase available memory for the production version of TI Logo.

Hardware for TI Logo

In addition to the TI 99/4 computer and a color monitor, memory expansion (from 16 K bytes up to 48 K bytes) and the language in EPROM (erasable programmable read-only memory) are the only requirements for running the prototype of TI Logo. In the prototype, both memory expansion and the language are contained in an actual black box (see photo 1, inset).

TI Logo has two production versions. The currently available version requires a disk controller, a 5-inch floppy-disk drive, a 32 K-byte memory expansion unit, and a TI Logo command module or ROM (read-only memory) cartridge. The second version, scheduled for release later this year, will require only the memory expansion unit and the command module (see photo 1).

Features

TI Logo can perform arithmetic operations on integers from $-32,768$ thru $32,767$, and can generate random integers from 0 thru 9, perform basic logical operations, and evaluate

logical relationships. It can also assign numerical values to words (values to variables), assign names to numbers (so that something can be called by name instead of number), and it has functions for structuring and modifying lists. In addition, there is a fine program editor for writing and modifying procedures (Logo programs).

Other Logo features in Texas In-



Photo 1: The TI Logo prototype (inset), including memory expansion, is contained in the black box under the monitor and behind the TI 99/4 computer. The final production version of TI Logo, which should be available later this year, will consist of a 32 K-byte memory expansion unit and a solid-state command module. (Photo courtesy of Texas Instruments.)

struments' version include powerful yet easy-to-use graphics capabilities that employ a *turtle* for drawing and thirty *sprites* for creating dynamic displays.

The Turtle

One of the best-known features of Logo is turtle graphics, or the line-drawing turtle—a small triangle on the video display (see photos 2 and 3). A variety of simple instructions move the turtle, tell it to face a certain direction, move it a given distance, and instruct it to draw, not draw, or erase a line.

Early MIT versions of Logo actually controlled a floor robot that resembled a turtle. This floor turtle

had a pen that could be raised or lowered for tracing the path that the turtle was instructed to follow. Originally, the state of the art made use of a mechanical robot easier than computer graphics. When young children were involved, the floor turtle also seemed to facilitate the transition to using the screen turtle. (The significance of turtle graphics has been recognized outside MIT for some time. For example, a subset of Logo, called Turtletalk, has been included in the Smalltalk language designed by Alan Kay for Xerox. Turtlegraphics is also a program in the library of the Apple version of Pascal.)

TI Logo has a screen turtle that can

be controlled by simple primitive instructions (see text box on turtle primitives). These *primitives* can be used for immediate turtle instructions or to create *procedures* (sequential lists of instructions) which define new instructions.

An important feature of TI Logo is that while all primitives can be spelled out in full, many can be abbreviated to two-letter instructions (eg: CS can be used anywhere in place of CLEARSCREEN). Such abbreviations can make Logo more accessible to such nontypists as the very young or the handicapped.

Sprites

The inclusion of thirty sprites and



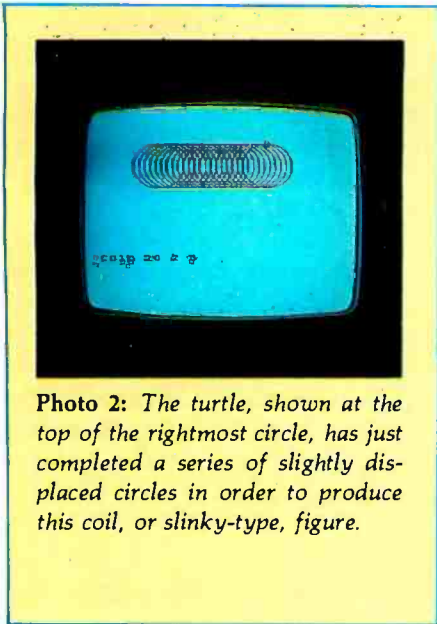

Photo 2: The turtle, shown at the top of the rightmost circle, has just completed a series of slightly displaced circles in order to produce this coil, or slinky-type, figure.

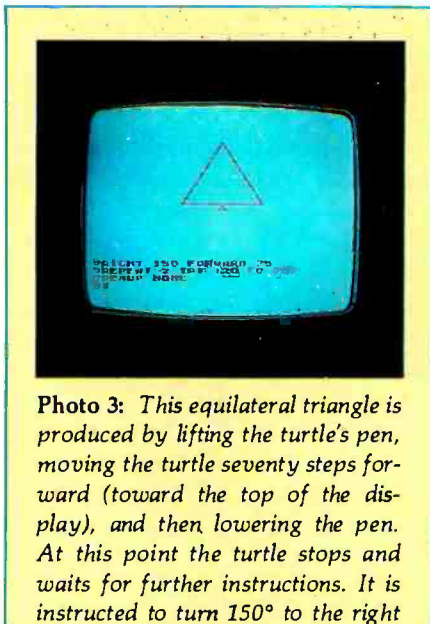

Photo 3: This equilateral triangle is produced by lifting the turtle's pen, moving the turtle seventy steps forward (toward the top of the display), and then lowering the pen. At this point the turtle stops and waits for further instructions. It is instructed to turn 150° to the right and move forward seventy-five steps—this produces the right leg of the triangle. The turtle waits again. It is told to repeat the following sequence twice: turn right 120° and go forward seventy-five steps. This causes the turtle to draw the base and left leg of the triangle. The turtle is then told to raise its pen, return home (to the center of the drawing pad), and put its pen down. Since these instructions are not written in a procedure, it is necessary to reenter the entire sequence each time the triangle is to be reproduced.

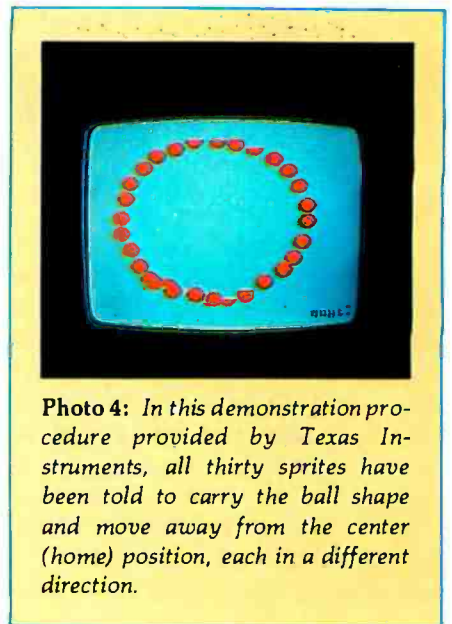

Photo 4: In this demonstration procedure provided by Texas Instruments, all thirty sprites have been told to carry the ball shape and move away from the center (home) position, each in a different direction.

dynamic sprite graphics is unique to TI Logo. As shown in photos 4 and 5a, sprites are TI Logo "beings" (software constructs) that assume various shapes and colors and move in a number of directions at different speeds. (See also listing 1.) Of themselves, sprites possess none of these "physical" characteristics—these must be given to them, once again, by use of simple primitives (see text box on sprite primitives).

Sprites can assume (carry) any one of twenty-eight possible shapes. The first six shapes (turtle, truck, plane, rocket, ball, and box) are predefined in TI Logo (see photo 6). The remaining twenty-two shapes must be user-defined.

A new shape can be created, or an existing one modified (you can change the six predefined shapes), by calling a 16 by 16 square MAKE-SHAPE grid (see photo 5b) and blacking out the desired shape. Each square of the grid represents one pixel (picture element) on the video display. The shape is formed (blacked out) by moving the cursor from square to square within the grid. Once a shape has been defined, any or all of the sprites can carry that shape.

(Displaying sprites seems to be a major capability of Texas Instruments' TMS9918A Video Display Processor. TI has released the TMS9918A, and the unit is beginning to appear in products from indepen-

dent manufacturers. See "Video Display Processor Simulates Three Dimensions," by Karl Gutttag and John Hayn, *Electronics*, November 20, 1980, page 123.)

Characters

TI Logo also allows you to define (or redefine) alphanumeric characters and static designs by using any of the 256 8 by 8 square grids, called *tiles*. Letters, numbers, and other keyboard characters are predefined tiles, but they can be changed. If the predefined keyboard characters are modified (eg: made lowercase), the modified character appears when the appropriate key is typed.

New characters or designs can be defined and placed anywhere on the display screen (see photo 5c). While tiles can be located anywhere on the screen, they cannot move about as

can shapes that are carried by sprites. You can assign colors to tiles and use them in either the turtle or sprite modes to form titles, explanations, or parts of "pictures."

Procedures

Procedures can be considered as either Logo programs or definitions of words that, once defined, can be used like primitives. Procedures are lists of instructions made of primitives and/or the names of previously defined procedures (see photos 7a and 7b, and listings 1, 2, and 3). Resident or defined shapes, colors, and movements can be assigned to sprites in procedures. The turtle can be instructed to draw figures by simply entering the name of a procedure.

It is often easier to define procedures, whether they contain instructions for the turtle, the sprites, or nongraphic operations, rather than enter the individual instructions needed to carry out such tasks. One reason is that several sophisticated programming techniques become quite simple in Logo. It's possible to nest level upon level of procedures by having one procedure call another which, in turn, can call another, and so on. A nested procedure is called by entering its name as an instruction in the procedure being written. *Iteration* is accomplished by merely having the procedure repeat a list of instructions a certain number of times. *Recursion*



Photo 5: The shapes and characters used in the FISHBOWL (photo 5a) were specifically defined (see listing 1 for the procedures). Shapes are defined by blacking out the desired shape on a 16 by 16 square grid (photo 5b). Characters are similarly defined on an 8 by 8 grid (photo 5c).

is a simple matter of using the name of the procedure being defined as an instruction in that procedure—the procedure then calls itself from within itself.

It is also possible to construct a procedure so that it modifies itself. This can be done by having the procedure change the values of local variables and/or by having it define new, or modify already-nested procedures. This type of recursion causes the procedure to produce a different effect at each recursive level—the procedure performs its task, changes itself, performs its modified task, etc. Listing 2 demonstrates how these powerful concepts and techniques become virtual child's play with Logo.

In addition to the ease of writing procedures and all that can be learned in the process, there is another advantage to working with procedures rather than immediate instructions. After entering all of the individual instructions for the turtle or sprites, it would then be necessary to enter the entire sequence each time that activity was to be performed. If the instructions are included in a procedure, it's simply a matter of entering the procedure's name to have the activity performed. In addition, procedures, along with user-defined shapes and characters, can be saved for future recall. In the TI Logo prototype this is done on cassette. In the production

versions it will be possible to do this on disk—a preferable method with regard to both speed and reliability. The production versions of TI Logo have hard-copy capability via a thermal printer. In some settings this can be extremely useful.

The Editor

TI Logo has a full-screen, real-time edit mode that is extremely helpful for writing, modifying, and debugging procedures. While in the edit mode, the cursor can be moved anywhere in the displayed text to

Listing 1: The FISHBOWL procedure turns the video display into a simulated aquarium (see photo 5a) with fish swimming in various directions and bubbles rising to the surface. FISHBOWL first calls TITLE, which places the tiles (see photo 5c) containing the specially designed letters of "Fish Bowl" at the center bottom of the display. The FISHBOWL procedure then tells the background (BG) to set its color (SC) to dark blue (4), and calls the procedures FISHRIGHT, FISHLEFT, BUBBLES, and SHARK. These four procedures assign shapes, colors, and motion to various sprites. For example, FISHLEFT tells three sprites (4, 5, and 6) to carry the shape (7) of a fish swimming to the left (see photo 5b), and sets different colors, headings (SH), and speeds (SS) for each sprite. In BUBBLES, the SETX primitive is used to horizontally fix the two columns of bubbles. The numbers input are the x coordinates of the desired columns.

```
TO FISHBOWL
TITLE
TELL BG SC 4
FISHRIGHT
FISHLEFT
BUBBLES
SHARK
END
```

```
TO TITLE
CS
PUTTILE 12 20 100
PUTTILE 13 20 101
PUTTILE 14 20 102
PUTTILE 15 20 103
PUTTILE 16 20 104
PUTTILE 17 20 105
END
```

```
TO FISHRIGHT
TELL [1 2 3] CARRY 6
TELL 1 SC :RED SH 95 SS 20
TELL 2 SC 8 SH 75 SS 18
```

```
TELL 3 SC :YELLOW SH 105 SS 16
END
```

```
TO FISHLEFT
TELL [4 5 6] CARRY 7
TELL 4 SC :ORANGE SH 273 SS 19
TELL 5 SC :GREEN SH 265 SS 21
TELL 6 SC :LEMON SH 279 SS 17
END
```

```
TO BUBBLES
TELL [7 8 9] CARRY 8
EACH [SC :WHITE SETX -50]
EACH [SH 0 SS 3*YN]
TELL [10 11 12 13] CARRY 8
EACH [SC :WHITE SETX 70]
EACH [SH 0 SS 2*YN]
END
```

```
TO SHARK
TELL 14 CARRY 10
SC :GRAY SH 271 SS 40
END
```

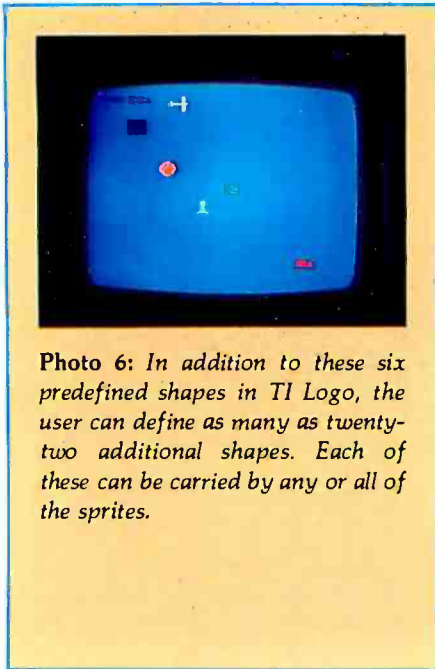

Photo 6: In addition to these six predefined shapes in TI Logo, the user can define as many as twenty-two additional shapes. Each of these can be carried by any or all of the sprites.

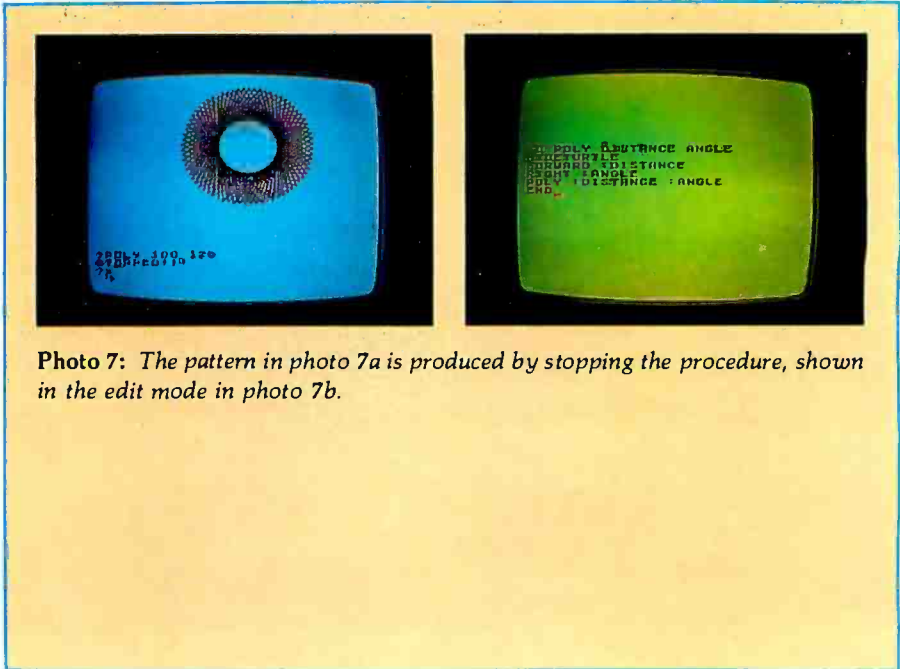

Photo 7: The pattern in photo 7a is produced by stopping the procedure, shown in the edit mode in photo 7b.

Turtle Primitives

The basic turtle primitives are virtually identical in TI and Apple Logo. Differences are noted in parentheses, as are acceptable abbreviations. All primitives can be fully spelled out and most can be entered as two-letter abbreviations.

The turtle mode is entered by the instruction TELL TURTLE (DRAW in Apple Logo). This places the triangular-shaped turtle at the center of the "drawing pad." In TI Logo this position is the origin of a coordinate system whose horizontal (x) axis goes from -128 to 128, whose vertical (y) axis ranges from -96 to 96.

There are four text lines under the pad for entering instructions and receiving messages. The Apple version is almost the same in the split-screen turtle mode (actually the horizontal axis goes from -140 to 138). This is normal turtle mode. Apple Logo, however, also offers a full-screen turtle mode that allows the turtle to draw on the entire pad but eliminates the text lines (see photos 9 and 10a).

Both versions employ the following instructions for moving the turtle:

- | | |
|---|--|
| FORWARD (FD) number }
BACK (BK) number | } { The number represents the number of turtle steps that the turtle is to move. |
| RIGHT (RT) angle }
LEFT (LT) angle | |

It is possible to move the turtle anywhere on the drawing pad and trace virtually any shape with these instructions.

More interesting figures can be obtained by having the turtle draw only part of the time. The following commands, in both versions, control the turtle's pen:

- PENDOWN (PD): Causes the pen to leave a trace of the turtle's path (the pen is down when the turtle mode is entered).
- PENUP (PU): Allows the turtle to move about without leaving a trace.
- PENERASE: Causes the turtle to erase a line it has drawn if the original path is retraced.
- PENREVERSE: Instructs the turtle to draw lines where there are none and erase lines where they are present.

HOME sends the turtle back to the center of the drawing pad. CLEARSCREEN (CS) in TI Logo erases all drawing and text and returns the turtle to the home position. DRAW does almost the same thing in Apple Logo but it does not erase text.

In order to exit the turtle mode, enter the instruction NOTURTLE (NODRAW in Apple Logo). This will return you to the Logo monitor.

change, delete, or insert characters, words, or entire lines. It's also possible to move lines up or down and merge them with other lines.

The editor in the production version of TI Logo is automatically activated for writing procedures. (The prototype does not have this feature.) Several features can be written in the edit mode and all of them entered into memory by exiting the edit mode. One advantage to writing procedures in the edit mode is the ease with which you can change and correct the procedure as it is being written.

You can also use the editor's capabilities as a basic text editor. This is an important feature, since learning to write with a text editor relieves the tedium of making pencil-and-paper corrections and revisions.

Limiting Features

The video hardware of the TI 99/4 does not allow more than four sprites carrying shapes to be displayed on a horizontal row at one time (see photos 8a and 8b). If a fifth sprite is placed on the same row, the first one disappears, and so on. The process is reversible, so as soon as the newcomers move on, the original residents begin to reappear. Once you are aware of this problem, you can work around it.

An annoying occurrence in TI Logo is that the turtle sometimes runs out

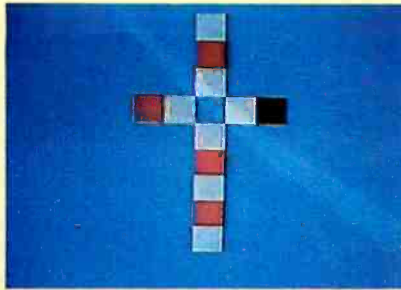
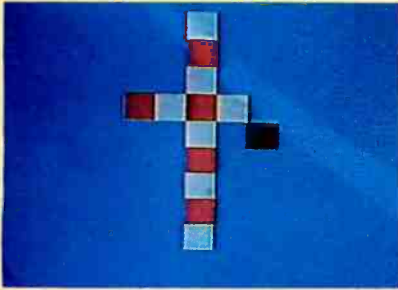

Photo 8: These photos illustrate a slight problem caused by the TI 99/4's video hardware when running Logo. As long as there are no more than four shapes in a horizontal row, there is no difficulty (photo 8a), but as soon as a fifth shape is moved onto a row (the black square in photo 8b), the first shape in that row disappears (the red square that was at the center in photo 8a is gone in photo 8b). The first shape reappears when the fifth shape is moved to another row, so there can never be more than four visible shapes in a row at one time.

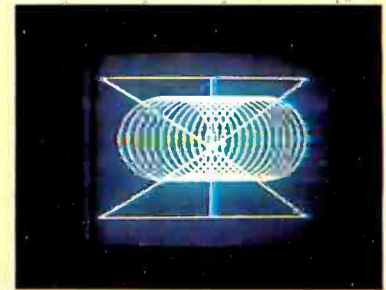

Photo 9: Apple Logo's turtle graphics can produce interesting figures from simple procedures. Straight lines can be drawn by setting the x and y coordinates. The turtle will draw a straight line from its present point to the point you have set. This photo and photo 10a show the full-screen graphics feature of Apple Logo.

of lines. At this point, the turtle stops in its tracks, the procedure halts, and the following message is printed:

NO MORE LINES

Apparently, workspace allocations have to accommodate both sprite and turtle graphics modes. Some tradeoff was necessary, and this message appears to inform you that the workspace (memory) allocated for graphics in the turtle mode has been used up.

Apple Logo

At present, the 5-inch disk version of Logo for the Apple II and Apple II Plus computers is still under development at MIT. (For convenience, we refer to this version as "Apple Logo," as does the Logo Project staff. To our knowledge there is no connection with Apple Computer Inc.) Representatives of MIT and the National Science Foundation, which funded portions of the Logo Project, are involved in discussions concerning distribution rights for Apple Logo. This issue should be resolved soon, and Apple Logo will, it is hoped, be available this summer.

This review is based on a pre-production prototype, and in fact, an updated prototype that will include color is being completed. This feature will allow you to choose the color of

the display background and the lines drawn by the turtle.

Apple Logo has three modes: a nongraphics mode, a graphics (turtle) mode, and an edit mode—but no sprites. However, the Apple version does have much more power in the other modes than TI Logo.

Hardware for Apple Logo

An Apple II or Apple II Plus computer with 48 K bytes of memory,

one disk drive, and an Apple Language Card are all that is needed to run the Apple version of Logo.

Nongraphic Features

Apple Logo can handle *floating-point* as well as integer arithmetic. It also accepts and outputs numbers (when large or small enough), in exponential notation. For example, 2.7E3 can be used in place of $2.7 \times 10^3 = 2700$, and $-4.3N4$ can

Sprite Primitives

Some of the primitives used to instruct the sprites (available only in TI Logo) are as follows:

TELL sprite number(s): Gets the attention of the sprite(s) that you wish to address. You can address one or any combination of sprites from 0 thru 29. To talk to all thirty sprites, the phrase :ALL (read "dots ALL" in Logo jargon) is used in place of a number.

CARRY shape: Tells the sprite(s) which shape to assume. Shapes can be identified either by name or number.

SETCOLOR (SC) color: Identifies, either by name or number, the color of the shape being carried.

SETHEADING (SH) number: Gives the sprite(s) the direction to travel. The number entered corresponds to a compass heading.

SETSPEED (SS) number: Tells the sprite(s) how fast to move.

The displays produced with these five instructions can be amazing, especially when multiple instructions are combined in procedures.

A few other primitives can also be used in interesting ways. HOME causes all active sprites to go to the center of the display screen but, if they have headings and speed, only momentarily. FREEZE stops all active sprites and holds them in place. They will not resume movement until THAW is entered.

Sprites will also respond to the FORWARD (FD), BACK (BK), RIGHT (RT), and LEFT (LT) primitives as used in the turtle mode.

replace $-4.3 \times 10^{-4} = -.00043$.

Apple Logo can also return the sine and cosine of an input in degrees. This means, in effect, that it has full trigonometric capability. The other trigonometric functions can be easily defined in terms of the sine and cosine. Apple Logo can return a random integer in the range of 0 to $n-1$, where n is an integer input by the user. There is, in addition, a randomizing feature to ensure that each sequence of random numbers will be unique.

Apple Logo has features for evaluating logical relationships, assigning values to variables, words to numbers, and working with list structures. The Apple version of Logo also has provisions for going from Logo to the Apple monitor, calling machine-language subroutines, and determining the current amount of free workspace in Logo. (Texas Instruments omitted similar features in order to save memory space.) And it's worth pointing out that the primitives that instruct the turtle are similar in both the Apple and the TI versions of Logo.

Turtle Procedures

The draft of the Apple Logo manual, by MIT Professor Harold Abelson, contains over twenty-five pages of turtle geometry projects of rapidly increasing complexity (see photos 9, 10a, and 10b). This manual also contains some interesting discussions of recursion—in fact, the author suggests a level of recursion that can be used to have the turtle draw a "binary tree" (see listing 3).

The additional mathematical capabilities of Apple Logo, as compared with the TI version, can be used to increase the power of turtle procedures, even though these mathematical features are not graphics features *per se*. That is, the floating-point, trigonometric, and randomizing features can be employed to give straightforward instructions to the turtle that will result in figures otherwise difficult, if not impossible, to produce.

The Editor

The Apple Logo editor functions in



Photo 10: The SPINSLINK figure (photo 10a) is the result of the simple five-line SPINSLINK procedure (shown in the edit mode in photo 10b) that calls the three-line RCIRCLE procedure which, in turn, calls the RCP procedure. Each procedure is nested in the one listed below it. Note the use of floating-point arithmetic in RCP, the use of iteration in RCIRCLE, and the use of recursion in SPINSLINK (it calls itself). (The procedures are taken from the draft of the Apple Logo manual prepared by Harold Abelson.)

essentially the same manner as the production-version TI Logo editor. As soon as you begin to write a procedure, you're automatically in the edit mode. Therefore, all of the editor's features are available whenever procedures are being written. It is also possible, as with TI Logo, to employ these features as a text editor.

There is, however, one confusing sidelight. The command to abort a procedure (rub out what has just been written and exit the edit mode) in Apple Logo is very nearly the same command used in TI Logo to enter the procedure into memory and exit the editor. This could cause considerable confusion if you work with both versions side by side.

An Annoying Feature

If the turtle tries to draw beyond the drawing pad in the turtle mode of Apple Logo, everything stops and you are told that the turtle just went OUT OF BOUNDS. If you are in the process of modifying a procedure to fit onto the pad, this is quite a nuisance. In the TI version, if the turtle leaves his pad he simply wraps around the display, and the procedure continues to execute. This approach seems preferable, because you can visualize the finished product. (In the large-machine versions of Logo you can choose between wrapping and not wrapping—an ideal arrangement.)

Conclusions

Both personal computer versions of Logo are exciting, valuable products. Seymour Papert has said on more than one occasion that Logo provides easy access to very powerful ideas, but the question remained—would this be true of Logo designed for small personal computers? The answer, relative to both versions, is clearly affirmative, whether the user is a young child, a physically handicapped individual, or an adult who discovers computing for the first time.

It's difficult to find anything to criticize in either product. Given their common background of over ten years of development and testing in the Logo Project at MIT, such a situation is not hard to understand. Still, a few items in each version might have been handled differently.

One such example occurs when you attempt to use the Apple and TI Logo nongraphics instructions in the immediate mode. These functions do not simply return a value. For example, in TI Logo:

3+4

returns:

TELL ME WHAT TO DO WITH 7

It will not return just the value 7. Similarly, in Apple Logo:

SIN 30

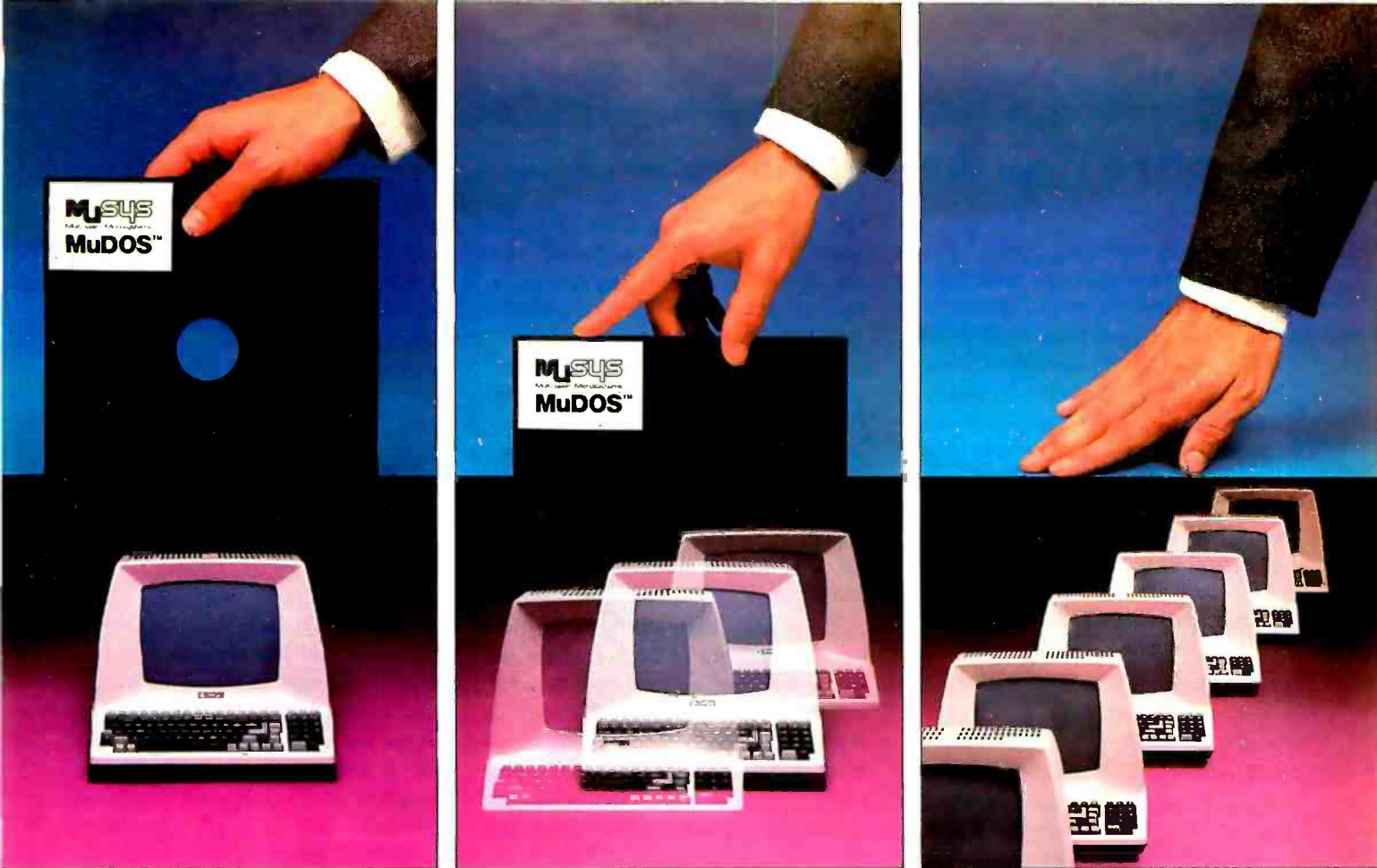

Introducing MuDOS.* The rest of the works for networks.

A CP/M compatible replacement for CP/NET****
 MuDOS multiplies your micro capabilities with higher throughput, increased reliability and extra professional features for both single and multi-user environments. MuDOS works with any Z80-based micro, in place of CP/NET, MP/M**, or CP/M — and, of course, with MuSYS NET/80* and EXP/80* network slaves.

MuDOS works faster — MuDOS makes the most of the Z80's extra registers and instructions. Program loading is up to six times faster; file processing functions average three to five times faster than CP/M.

MuDOS works smarter — A sophisticated buffer manager, a totally re-entrant file manager, multiple print queuing, disk file support to 67MB, drive support to 2000MB and read-after-write verification of disk updates helps you make the most of your multi-user data and word processing pro-

grams. Modular design allows us to tailor the system to your configuration.

Build your network with MuSYS — MuDOS is ideal for use with our NET/80 board (64K RAM, single level interrupt, console port and parallel port for bus communication) and our EXP/80 expansion board (another serial port, Centronics port, priority interrupt control, real time clock, etc.) for S-100 based systems.

This is the year of the network — Make sure you have the works.

Call or write MuSYS Corporation,
 1451 E. Irvine Blvd., Suite 11,
 Tustin, CA 92680 (714)730-5692.
 TWX: 910-595-1967. CABLE: MUSYSTSTN.



MUSYS

CORP

Specialists in Multi-user Microsystems

*MuDOS, NET/80, and EXP/80 are trademarks of MuSYS Corp.

**CP/M, MP/M and CP/NET are trademarks of Digital Research.

returns:

```
YOU DON'T SAY WHAT TO DO  
WITH .5
```

The reason for this, apparently, is that these functions are intended for use in instructions in procedures where the value returned will be used for a variable. It would be useful, however, if these functions could be used immediately, and if they returned only the appropriate values: they could then be used more easily for mathematical or logical evaluations, either in planning procedures or for other purposes.

If you type PRINT in front of the statement to be evaluated, only the value is returned. For example:

```
PRINT 3+4
```

will return only the value 7. Still, it would be useful to obtain this kind of return without typing PRINT, especially when you are not "talking" to sprites or the turtle.

Another inconvenience occurs in TI Logo when you have active sprites on the screen and want to go to the turtle mode. There is no easy way to get the active sprites off the video

display. While you can go from the turtle mode to the sprite mode and remove the turtle with everything it has drawn (by entering NOTURTLE), the reverse is not possible. You can leave the sprites there and work with the turtle, but the moving sprites can be distracting. You can also enter the necessary instructions to remove the colors, shapes, speeds, and headings of the sprites, but this can be time consuming. A third alternative is to leave Logo and then restart it. This is often the quickest solution. In any case, it would be helpful to have a single command that would remove all active sprites from the video screen.

There may be features in the production versions of Logo that are not present in the prototypes—in addition to the possibility of color in Apple Logo, there is discussion of including music capability in both personal computer versions of Logo. Texas Instruments has mentioned this possibility, while the Apple Logo documentation already contains some explanation of how to use the music features, even though they are not present in the prototype.

The prototypes of Apple and TI Logo are currently being used in pre-

school through high school classrooms (see *onComputing*, Summer 1981, for details) on a "pilot project" basis, and evidence of its value to students is growing rapidly. This evidence deals not only with amount of material learned, but also with a heightened self-awareness and self-esteem derived from the student controlling a powerful machine and thus his or her own learning. It seems inevitable that Logo will become a forceful learning tool, both in the school and in the home.

Having acquired at least a passing familiarity with these two Logo implementations, I see them as complementary, rather than competitive. Anyone who is seriously interested in education and learning on any level should examine both versions. TI Logo easily attracts user interest (the sprites are a definite attention-getter) and it encourages fundamental exploration of a variety of significant concepts. Apple Logo provides a somewhat deeper exploration of the same concepts. The development of Logo for other popular personal computers such as the Radio Shack TRS-80 and Atari will probably not be far behind. ■

Listing 2: *The COILGROW procedure has CIRCLEMOVE and CIRCLE nested within it. CIRCLE, in turn, is nested in CIRCLEMOVE. Both COILGROW and CIRCLE employ iteration by repeating the instructions in the brackets. COILGROW is a recursive procedure—it calls itself. COILGROW produces a coil consisting of connected circles of increasing diameter. The procedure is run by entering its name and values for the variables NUMBER, DISTANCE, and ANGLE. (The 360/(:ANGLE) in CIRCLE causes an interesting "bending" of the coil, since it returns an integer that may be slightly more or less than the number of iterations required to produce an exact circle. HIDETURTLE, in the CIRCLE procedure, speeds up drawing since the turtle itself need not be redrawn at each "step." SHOWTURTLE causes the turtle to reappear.)*

```
TO COILGROW :NUMBER :DISTANCE :ANGLE  
REPEAT :NUMBER [CIRCLEMOVE :DISTANCE :ANGLE]  
CIRCLE :DISTANCE :ANGLE  
MAKE "ANGLE :ANGLE - 3  
COILGROW :NUMBER :DISTANCE :ANGLE  
END
```

```
TO CIRCLEMOVE :DISTANCE :ANGLE  
CIRCLE :DISTANCE :ANGLE  
FORWARD :DISTANCE  
END
```

```
TO CIRCLE :DISTANCE :ANGLE  
HIDETURTLE  
REPEAT 360/( :ANGLE) [FORWARD :DISTANCE RIGHT :ANGLE]  
SHOWTURTLE  
END
```

For More Information

To add your name to the Apple Logo mailing list, write: Apple Logo, The Logo Project, 545 Technology Square, Cambridge MA 02139. For \$1 they will also send a bibliography of papers produced in conjunction with the project.

For information on TI Logo, write: TI Logo, Texas Instruments Inc, Corporate Engineering Ctr, 12860 Hillcrest Wing E M/S 376, Dallas TX 75230.

Listing 3: *MYSTERY requires that an integer be input for the variable NUMBER. It then prints the integers 1 thru NUMBER in an unexpected order: the STOP in the recursive procedure produces the MYSTERY effect; when the technique is used in a V-drawing procedure, the turtle can draw a "binary tree."*

```
TO MYSTERY :NUMBER  
IF :NUMBER = 0 STOP  
MYSTERY :NUMBER - 1  
PRINT :NUMBER  
END
```

CRYSTALWARE

At Crystal we are doing our best to provide the finest state-of-the-art graphic adventure software in the world. Our list of credits include the first indoor-outdoor graphic adventure, the first multi-disk graphic adventure, and now for the Atari, the first graphic adventure in the world which includes screen scrolling and animation. The era of the text adventure and games which are simple combinations of static graphics and text is rapidly drawing to a close. We attempt to utilize the full potential of your computer. True, many of our games use up to 48K and we only deal in disk products, but there are a lot of users out there who have worked hard to upgrade their systems to the max and we think they deserve games that will give their computer system a run for its money.

FANTASYLAND 2041

Brand new and available June 1 on Apple and Atari, it has over 520 full screens of graphics and occupies more than 500,000 bytes on disk. Step into the world of tomorrow's fantasy as you enter the Hall of Heroes. Wander through exhibits and equip yourself for your perilous journey through 6 graphic adventures with Crystalsonics and on the Atari, our revolutionary new scrolling techniques written by Mike Potter. Rescue the fair prince(ss) from the depths of Hell and make it back alive. You will need 40K and joysticks on the Atari version.

CONGOLAND: In deep dark Africa search for the lost mine of King Solomon. Treacherous jungle and man-eating tigers stalk you. Battle the fierce gorillas and consult the witch doctor.

ARABIAN ADVENTURE: Lost in the desert you lead a caravan of brave warriors. Graphic sandstorms and deadly cobras dog your path. Hidden in the ruins are priceless treasures and somewhere in the Evil Mountains hides the Black Sorcerer who you must pass to get to.

OLYMPUS: In search of the golden fleece, board your ship the Athena and sail the ancient Aegean Sea. Set your sails with care and beware of typhoons and sea monsters. This adventure alone occupies 80 screens of graphics. You may land on islands and disembark to explore. The Cyclops awaits your coming and Circe the Enchantress may turn you and your crew into swine. You seek the legendary Thera, gateway to Atlantis, and as you anchor you will descend into the depths...

KING ARTHUR: In merry old England in the days of Arthur, you head a party of brave knights. As you embark from Camelot on your quest, you seek the fair prince(ss) and the Holy Grail. The Black Forest conceals Modred the Traitor. In the Emerald Mountains lurk Herman the Dragon and Merlin the White Magician. Beware of the Enchanted Forest and the Sea of Mists.

THE PRIZE! To the bravest of our Adventurers on the Apple and Atari versions of Fantasyland 2041 will go a \$1000.00 cash prize and a trophy which will be awarded in December. Details on this contest are in the game manual. In addition to this supergame we also have many other fine graphic adventures which we haven't room to describe here. If you would like a catalog please send \$3.00 to cover postage and handling to the address below.

HOUSE OF USHER	\$29.95	BENEATH THE PYRAMIDS	\$29.95	WATERLOO II	\$49.95
GALACTIC QUEST	\$29.95	LITTLE CRYSTAL	\$39.95	SANDS OF MARS	\$39.95
WORLD WAR III	\$29.95	IMPERIAL WALKER	\$29.95	FANTASYLAND 2041	\$59.95

CRYSTAL USERS CLUB: If you would like a subscription to our magazine CRYSTAL VISION, a free copy of House of Usher for your system, and quarterly copies of our software bank, please send an original or public domain program to us along with a \$10.00 membership fee.

WE ARE INTERESTED IN YOUR PROGRAMS: With over 800 distributors in 30 countries we can offer you 35% of the gross royalties in exchange for quality business or game software. Sales may range from 10,000 to 50,000 copies. If you are a quality programmer, have written a good game, and would like to retire before 30, give us a call.

It is our intention to provide you with the finest game software available today. We are always open to feedback and are genuinely interested in knowing what you the adventurer expect and desire in a fantasy game. Feel free to call either of us and we or staff will be glad to hear any constructive suggestions you might have.

John Bell *Patty Bell*

You must have a disk drive and an Apple II 48K or Atari 800 40K or Pet 32K or TRS-80 48K to run our adventures.



Our order lines are open 24 hrs. a day 7 days a week.



(408) 683-0696

CRYSTAL COMPUTER

12130 Steffs Ct., San Martin, Calif. 95046

Build a Low-Cost Speech-Synthesizer Interface

Recently I was at a local electronics store looking at DVMs (digital voltmeters). I didn't want to buy one, but, like looking at new cars, I wanted to reestablish the cost-effectiveness of what I already owned.

Most of the meters in the showcase were 3½-digit units with five or more ranges and many ancillary functions. The sales pitch for every one sounded alike.

While not trying to be cute, I stopped the clerk in midsentence and asked if he had any DVMs that "talked." He completely ignored the question. I had to interrupt him twice

Steve Ciarcia
POB 582
Glastonbury CT 06033

to get his attention, and even then, he thought I was being difficult.

Eventually, he said that he had no talking DVMs and never expected to see any. Even though I anticipated his answer, I was testing his response to the idea. Considering that we now have talking toys, talking hand-held DVMs shouldn't sound that strange. In fact, such use would be a relatively minor application of synthesized speech. Someday they will be very common.

While I wouldn't consider this salesman a total loss, there are some

people who have to go to Missouri to believe the state exists. I trust, however, that you have an open mind to new technology.

Cost-Effective Speech Synthesis

Advances in the production of high-density LSI (large-scale integrated) circuits and new techniques to synthesize speech have reduced the cost of voice-output systems dramatically. Attaching a speech synthesizer to your computer is now as reasonable financially as adding any other peripheral device.

The cost of a synthesizer is a function of the number of words the synthesizer can speak. Limited-vocabulary synthesizers, such as the TMS0280 unit in the Texas Instruments Speak & Spell toy or any others that have their vocabulary stored totally in ROM (read-only memory), are generally less expensive. Speech interfaces using phoneme synthesis, such as the Votrax SC-01, usually require the help of a computer program running on an external processor to generate extensive voice output. The added complexity makes this type of synthesizer more expensive. Of course, a phoneme synthesizer can have an unlimited vocabulary by using a text-to-speech program running on the external processor.

This article describes the construction of a cost-effective limited-vocabulary voice-synthesis speech-processor board called the Micromouth. It uses the new Digitalker DT1050 integrated circuit set from National Semiconductor, which has a stored vocab-

Digitalker is a registered trademark of National Semiconductor Corporation.

Copyright © 1981 by Steven A Ciarcia.
All rights reserved.

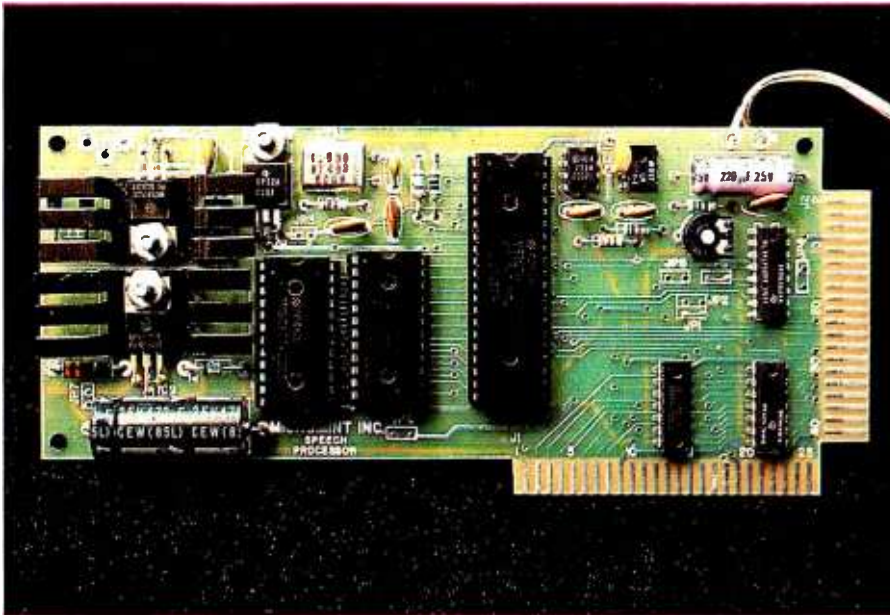

Photo 1: Assembled Micromouth speech-processor board. The 40-pin integrated circuit is the MM54104 speech processor, and the two 24-pin packages are 64 K-bit ROMs, which contain 144 digitized expressions. The 40-pin edge connector on the right is plug-compatible with the Radio Shack TRS-80 Model I, and the 50-pin edge connector on the bottom is plug-compatible with the Apple II. The heat sinks shown in the photo are not generally required but were included on this particular unit for testing.

ulary of 144 expressions. For about \$120, you can build this board and add voice output to monitoring functions, computer games, and calculations. It can say "The time is 6:40 pm" and "Number 4 is set at 6.35 volts"

just as easily as "Control error..." or "Danger...a star is on the left at 8.2 million meters." While a limited-vocabulary synthesizer may never have appealed to you before, I am sure the low price and simple system integra-

tion of this speech interface will spark your interest.

The Micromouth speech-processor board I am presenting is plug-compatible with the Apple II and Radio Shack TRS-80 Model I computers. (It can be used with the TRS-80 Model III with an adapter cable.) It is signal-compatible with other microcomputers, such as the Digital Group product line or the Heath H-8, and can be connected to any computer with an 8-bit parallel I/O (input/output) port, such as a printer port. It requires no external controlling software except a simple BASIC statement to say any expression in its vocabulary. For example, executing OUT 127,120 on the TRS-80 (or POKE -16001,120 on the Apple II) will cause the board to say "Please."

The design and features of the Micromouth speech-processor board are discussed in detail here. But, first, a little background on speech-synthesis techniques, in general, and then details of National Semiconductor's Digitalker system, in particular.

Speech-Synthesis Techniques

Three techniques are presently used to synthesize the human voice: formant synthesis, linear-predictive coding, and waveform digitization. They differ primarily in the number of bits per second of data required to construct a word.

Formant synthesis is essentially a modeling of the natural resonances of the human vocal tract. The bands of resonant frequencies defined are called *formants*. In an electronic synthesizer, these frequencies are generated by excitation sources and are then passed through variable-parameter filters.

One form of the formant technique is called *phoneme synthesis*. In this, the spectral parameters are derived from basic sound units that make up words. A phoneme generator, in turn, reproduces these sounds. In such a circuit, each phoneme has been assigned a code, and the synthesizer module (or chip) utters the corresponding phoneme sound for each code it receives. Creation of continuous speech, therefore, is simply a

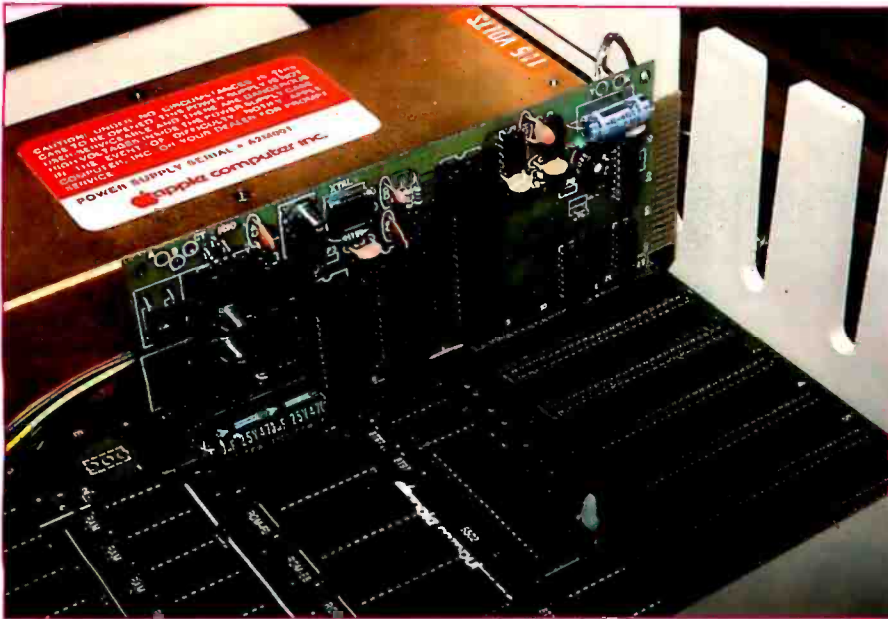

Photo 2: Micromouth speech-processor board shown inserted in peripheral slot 1 of an Apple II computer. Execution of a simple BASIC statement can cause any of the stored vocabulary to be uttered. For example, to make it say "This is Digitalker," a POKE -16001,0 statement would be executed. While the rest of the vocabulary has a male voice, this particular expression has a distinctly female voice.

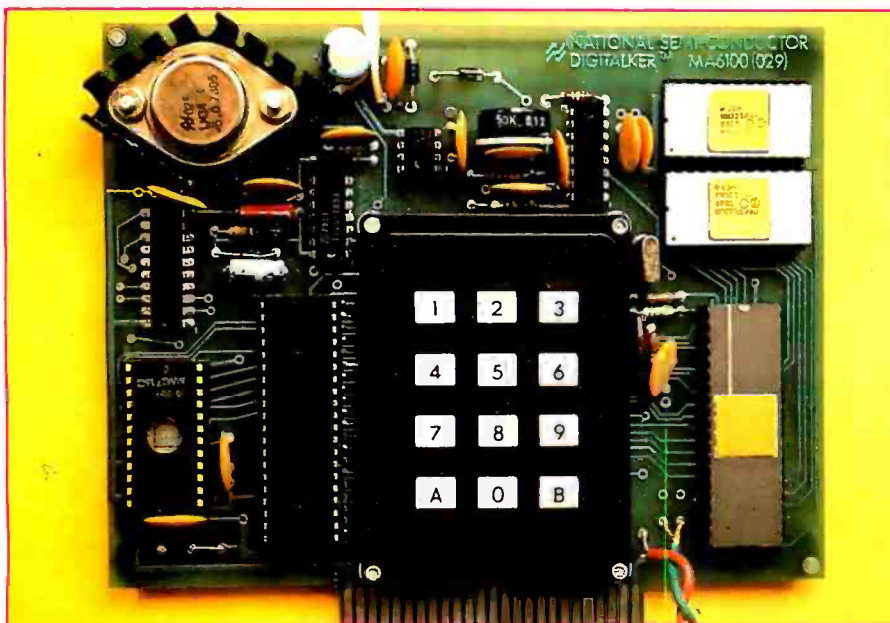

Photo 3: National Semiconductor's DT1000 Speech-Synthesis Evaluation Board. Available from National Semiconductor distributors for \$495, the DT1000 contains a microprocessor equipped with a program that allows a user to hear any single expression or a combination of expressions by entering the appropriate decimal code on the keyboard. While all the I/O lines are available on the Evaluation Board connector and it could be used as a general-purpose speech interface, it is more suitable as a sales tool and demonstration device.

System Log

3:10 P.M. - System Down!

4:45 P.M. - Problem diagnosed using
DIAGNOSTICS II.

Board replaced and
system back on line.

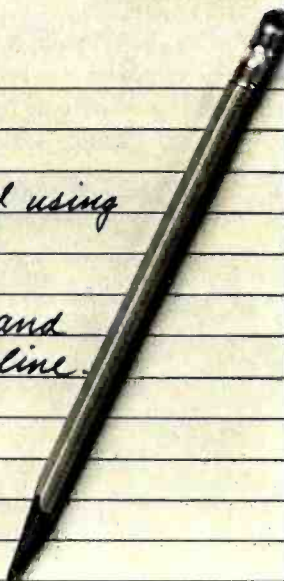

DIAGNOSTICS II

Diagnostics II is SuperSoft's expanded Diagnostic package.

Diagnostics II builds upon the highly acclaimed Diagnostics I. It will test each of the five areas of your system:

Memory Terminal Printer CPU Disk

Every test is expanded.

Every test is "submit"-able. A "submit" file is included in the package which "chains" together the programs in Diagnostics II, achieving an effective acceptance test. All output can be directed to a log file for unattended operation, for example over night testing. Terminal test is now generalized for most crt terminals. A quick-test has been added for quick verification of the working of the system.

The memory test is the best one we have encountered. It has new features, including:

- default to the size of the CP/M Transient Program Area (TPA)
- printout of a graphic memory map
- bank selection option
- burn in test
- memory speed test

Diagnostics-II still includes the only CPU test for 8080/8085/Z80.

A Spinwriter/Diablo/Qume test has been added, which tests for the positioning and control features of the Spinwriter/Diablo/Qume as well as its ASCII printing features. (Serial Interface only)

And, as with all SuperSoft products, a complete online HELP system and user manual is included.

Price: \$100.00 (manual only): \$15.00

Requires: 32K CP/M

CP/M Formats: 8" soft sectored, 5" Northstar, 5" Micropolis
Mod II, Vector MZ, Superbrain DD/QD



All Orders and General Information:
SUPERSOFT ASSOCIATES
P.O. BOX 1628
CHAMPAIGN, IL 61820
(217) 359-2112

Technical Hot Line: (217) 359-2691
(answered only when technician is available)

CP/M REGISTERED TRADEMARK DIGITAL RESEARCH

SuperSoft

First in Software Technology

matter of stringing the phonemes together.

In most cases, the electronic voice generated is quite intelligible, but it may have a mechanical quality about it. Continuous speech using phoneme synthesis can generally be generated with a data rate of less than 400 bps (bits per second). This technique is used by the Votrax Division of Federal Screw Works in the SC-01 Speech Synthesizer Chip and other products.

Linear-predictive coding is similar to formant synthesis. Both techniques are based in the frequency domain and use similar hardware to model

The Digtalker speech processor uses a comprehensive data-compression algorithm.

the vocal tract. Rather than using a simple phoneme code, however, linear-predictive coding stores parameters for filter coefficients, gain, and excitation frequencies. The term "linear-predictive coding" refers to the programmed activities of the multistage lattice filters that produce the desired formants. Adequate-quality speech can generally be achieved with data rates of 1200 to 2400 bps. This synthesis technique is used by Texas Instruments in several products, including the Speak & Spell and the TI 99/4 Text to Speech Translator. It is also used by General Instrument Corporation in its Orator VSM2032 Voice-Synthesis Module.

The third method is *waveform digitization*. This very old technique produces speech by generating a waveform with the time-domain characteristics of voice, in contrast to the previously considered parameter-encoding methods, which represent speech in terms of frequency. The simplest form is uncompressed digital data recording, called PCM, for pulse-code modulation. (In the June 1978 BYTE, my article entitled "Talk to Me: Add a Voice to Your Computer for \$35," page 142, discussed how to build a simple digitized speech interface.)

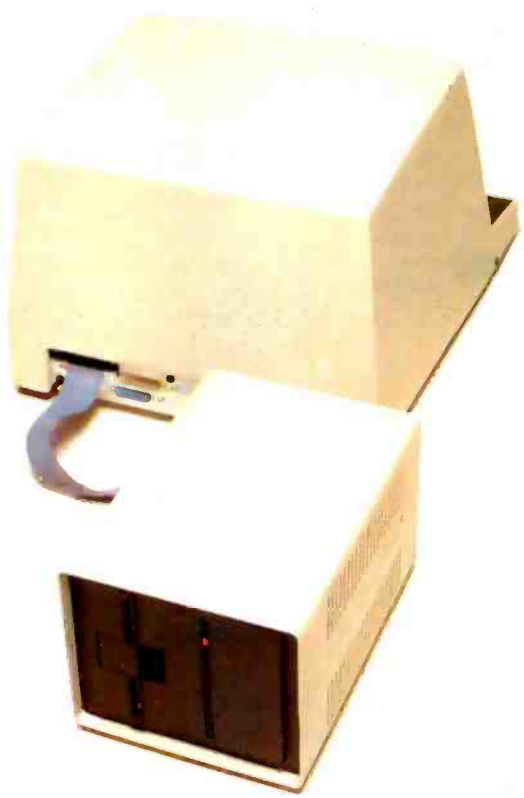

**“And in conclusion,
I’ll only use
my exceptional powers
for the good of mankind.”**

“That’s a vow all we Vector 3005s make. And it’s not one we make lightly.

“After all, being the only product on the market with a Vector 3 terminal, a 5¼” floppy, and a 5¼” Winchester rigid disk drive that provides 5 megabytes of storage is quite a responsibility. It used to take 20 floppies to give you that kind of capacity.

“Our powers don’t stop there, however. Each 3005 also comes with a 32-bit error-correcting code—the first time sophisticated IBM-style technology has been available on a small business system. This lets us detect and correct errors, and almost completely eliminates data loss on disks due to dirt, wear, or damage.

“All this makes us pretty awesome, all right. But there’s more. When coupled with Vector’s MEMORITE III and EXECUPLAN software packages, we give you a 30,000 word dictionary, the ability to create your own phrase library, a teaching manual right on the screen, pass word security, plus a host of other word processing capabilities as well as financial planning, forecasting and basic accounting.

“And we’re reliable. Our powers won’t diminish, our abilities won’t fade, and dedication to mankind won’t weaken.

“For more information and your nearest dealer, call Vector at 800-423-5857. In California, call 800-382-3367. Or write to them at 31364 Via Colinas, Westlake Village, CA 91362.

“Thank you all for coming today. And I hope we’ll have the chance to do business together in the future.”

VECTOR
VECTOR GRAPHIC INC.

COMPUTERS FOR THE ADVANCEMENT OF SOCIETY.

In simple PCM recording, the analog speech waveform is sampled at a rate twice that of the frequency of the highest voice component and converted to digital format through an A/D (analog-to-digital) converter. Once stored, the digital signal can be played back through a D/A (digital-to-analog) converter and a low-pass filter. One major advantage of digitally encoded speech is its human-like quality. Since it is in essence a recorded voice, the reproduced speech retains the inflections and ac-

cents of the original voice. Thus, in addition to male and female voices, it is possible to have a speech synthesizer that reproduces regional or foreign accents. The clarity of the reproduction depends on the speech-compression method used.

Unfortunately, one problem in using PCM alone is that it requires very high data rates. Rates above 100 k bps are not unusual with this method. To reduce the data rate, it is necessary to compress the speech data to remove redundant information.

One compression method is called *delta modulation*. As in PCM, the analog speech waveform is sampled, but this time only the *changes* in amplitude (delta values) between samples are stored. Since speech contains many redundant sounds and silences, these changes are much smaller than the absolute amplitude of the waveform, and fewer bits are required to store the smaller values. Delta modulation, therefore, reduces the amount of memory required to store a list of words.

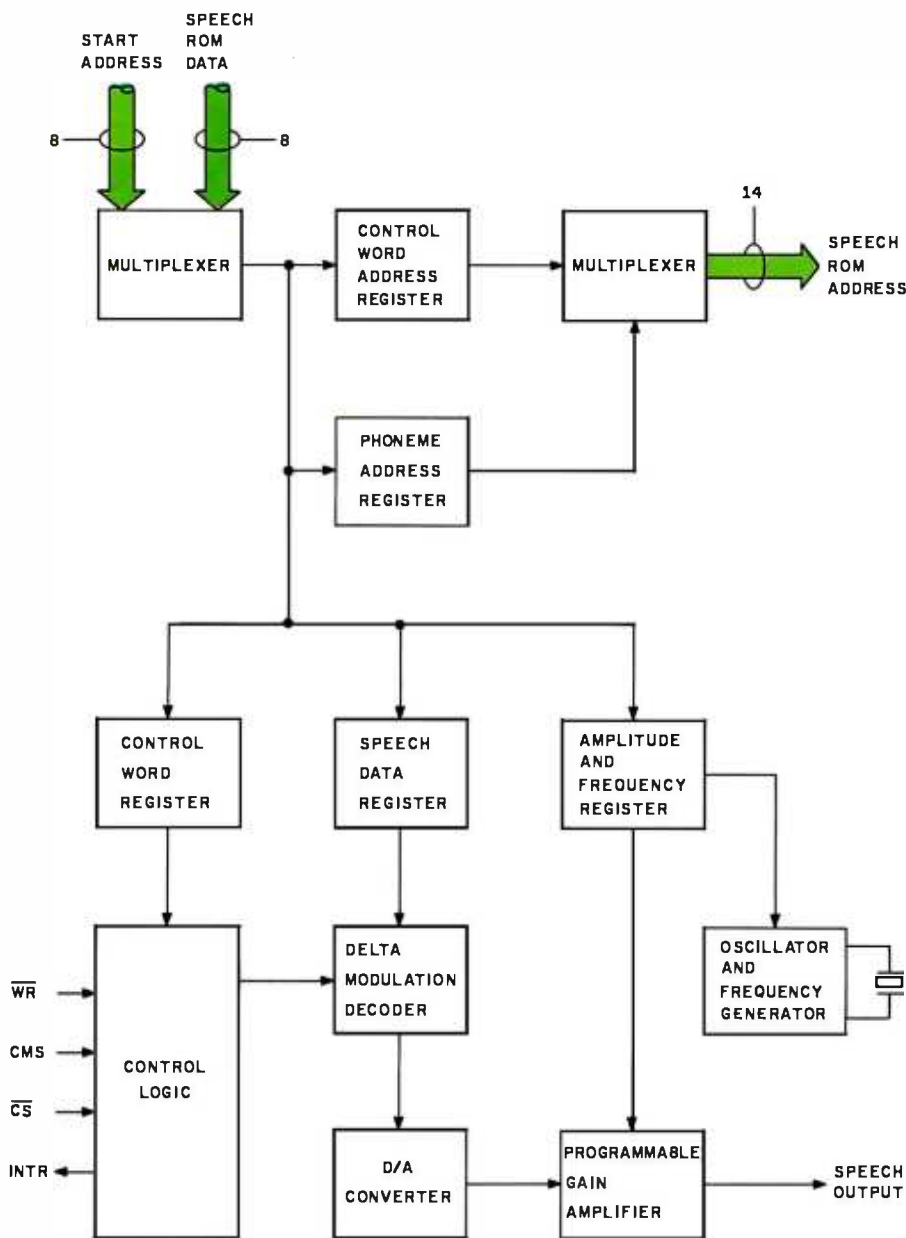

Figure 1a: Block diagram of the National Semiconductor Digitalker MM54104 speech-processor chip. This figure and figure 2 were provided through the courtesy of National Semiconductor Corporation.

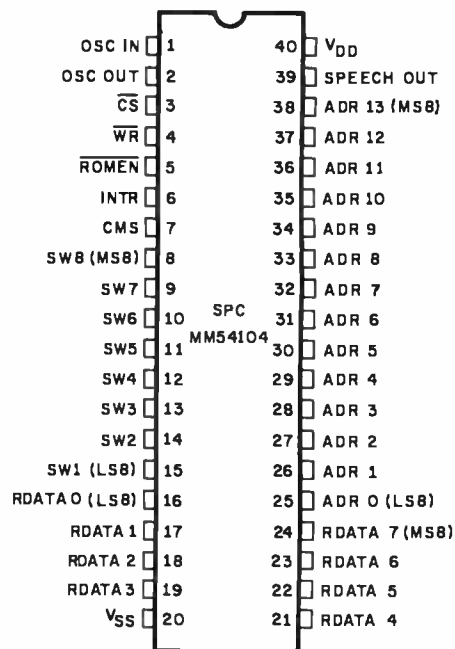
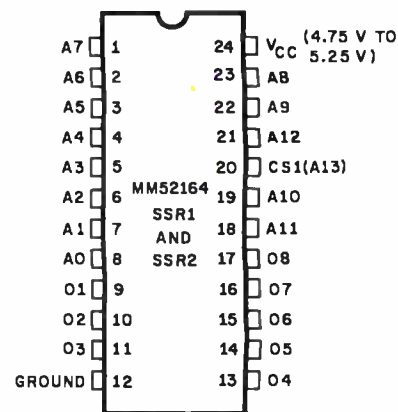

Figure 1b: Pinout specifications of the DT1050 system, which comprises the MM54104 speech-processor chip and the associated MM52164 SSR1 and SSR2 ROMs (read-only memories). The ROMs are designed to be used in sets of two; the chip-select (CS1) signals are set up in complementary fashion.

YOU HAVE 10 DAYS TO DISCOVER THE COMPUTER AGE.

If you've never used a computer, you're missing something. Programming your own computer is more fun than playing backgammon. More challenging than crossword puzzles.

And more practical than about anything else you could do.

Because the fact is, you're living in the age of computers. And now you can discover what it's all about. For 10 days, at no risk and no obligation, you can have your very own Sinclair ZX80 computer. To play with, experiment with, learn with.

ANYONE CAN USE IT.

You'll discover the ZX80 is incredibly easy to use for anyone 10 years or older. You don't have to know anything about computers when you start out. We'll send you a complete 128-page guide that takes you step-by-step into the world of computing. In one day, you'll be writing your own programs!

The ZX80 will absorb you for hours as you find new ways to use it. You can create games. Home budgets. Math lessons for your children. Almost anything, in fact.

THE ZX80 IS YOURS FOR 10 DAYS. THE COMPUTER GUIDE IS YOURS FOREVER.

For your 10-day home trial, just call our toll-free number and order with your Master Charge or VISA. Or send the coupon along with a check or money order for the remarkably low price of \$199.95, plus shipping. (Other personal computers cost two or three times as much!)

And we'll send you the Sinclair ZX80 personal computer. It's yours for 10 days. If you decide you don't want to keep it, then send it back. We'll give you a full refund. Either way, the 128-page guide to computing—a \$5.95 value—is yours to keep as a free gift.

But we have to be honest with you. After you've discovered the fun of owning a ZX80 computer, we don't think you'll send it back.

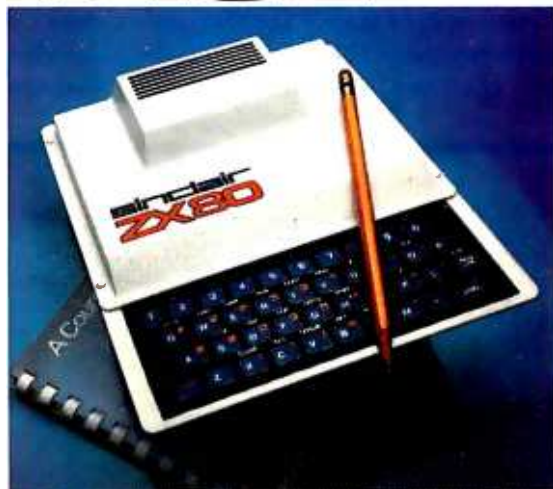

EVERYTHING YOU NEED. For just \$199.95, you get everything you need to operate your ZX80. You just hook it up to your TV (either black & white or color). Then to store your programs, you can use any ordinary cassette tape recorder. We'll also send you a 128-page guide to computing that's yours to keep as a free gift.

\$199.95



For an extra \$49.95, you can also have the Sinclair Computer Learning Lab—a set of 100 experiments and lessons on cassette tapes that make the ZX80 itself your teacher.

10-DAY MONEY-BACK HOME TRIAL CALL TOLL FREE 800-543-3000.

Ask for operator #508. In Ohio call 800-582-1364. Phones open 24 hours a day, 7 days a week.

Mail to: Sinclair Research Ltd.
One Sinclair Plaza, Nashua, N.H. 03061

068Y

Check one:

ZX80 Personal Computer \$199.95
Shipping \$ 4.00

ZX80 Personal Computer \$199.95
Computer Learning Lab \$ 49.95
Shipping \$ 4.00

Total \$203.95*

Total \$253.90*

If I'm not fully satisfied with my purchase I can return it in 10 days for a full refund. The 128-page guide is mine to keep.

Name _____

Address _____

City, State, Zip _____

*U.S. dollars.

sinclair

SINCLAIR RESEARCH LTD., ONE SINCLAIR PLAZA, NASHUA, N.H. 03061

Ultimately, the total amount of memory required for continuous speech becomes a function of exotic compression algorithms. Data rates as low as 2400 bps have been achieved. The Digitalker speech-synthesis chip set uses data-compressed digitized speech.

Digitalker Components

The Micromouth synthesized-speech-processor board is based upon the National Semiconductor

Digitalker DT1050 speech-synthesizer chip set, which consists of a speech processor (SPC) and two 64 K-bit ROMs (read-only memories).

The speech processor uses PCM encoding with a comprehensive data-compression algorithm developed by Forest Mozer at the University of California, Berkeley. The primary compression method employed is delta modulation. As previously described, this concept recognizes that speech waveforms are generally

smooth and continuous. Rather than storing the absolute amplitude of the voice signal, the differences between successive samples are stored instead. During speech reconstruction, successive amplitudes in the output waveform are obtained by adding these delta values to the previous values, allowing us to avoid using large numbers of bits to store large voltages.

The speech processor also uses phase-angle adjustment and half-

Word	Decimal Address	Binary Address	Word	Decimal Address	Binary Address	Word	Decimal Address	Binary Address
This is Digitalker	000	00000000	P	047	00101111	it	097	01100001
one	001	00000001	Q	048	00110000	kilo	098	01100010
two	002	00000010	R	049	00110001	left	099	01100011
three	003	00000011	S	050	00110010	less	100	01100100
four	004	00000100	T	051	00110011	lesser	101	01100101
five	005	00000101	U	052	00110100	limit	102	01100110
six	006	00000110	V	053	00110101	low	103	01100111
seven	007	00000111	W	054	00110110	lower	104	01101000
eight	008	00001000	X	055	00110111	mark	105	01101001
nine	009	00001001	Y	056	00111000	meter	106	01101010
ten	010	00001010	Z	057	00111001	mile	107	01101011
eleven	011	00001011	again	058	00111010	milli	108	01101100
twelve	012	00001100	ampere	059	00111011	minus	109	01101101
thirteen	013	00001101	and	060	00111100	minute	110	01101110
fourteen	014	00001110	at	061	00111101	near	111	01101111
fifteen	015	00001111	cancel	062	00111110	number	112	01110000
sixteen	016	00010000	case	063	00111111	of	113	01110001
seventeen	017	00010001	cent	064	01000000	off	114	01110010
eighteen	018	00010010	400 Hz tone	065	01000001	on	115	01110011
nineteen	019	00010011	80 Hz tone	066	01000010	out	116	01110100
twenty	020	00010100	20 ms silence	067	01000011	over	117	01110101
thirty	021	00010101	40 ms silence	068	01000100	parenthesis	118	01110110
forty	022	00010110	80 ms silence	069	01000101	percent	119	01110111
fifty	023	00010111	160 ms silence	070	01000110	please	120	01111000
sixty	024	00011000	320 ms silence	071	01000111	plus	121	01111001
seventy	025	00011001	centi	072	01001000	point	122	01111010
eighty	026	00011010	check	073	01001001	pound	123	01111011
ninety	027	00011011	comma	074	01001010	pulses	124	01111100
hundred	028	00011100	control	075	01001011	rate	125	01111101
thousand	029	00011101	danger	076	01001100	re	126	01111110
million	030	00011110	degree	077	01001101	ready	127	01111111
zero	031	00011111	dollar	078	01001110	right	128	10000000
A	032	00100000	down	079	01001111	ss	129	10000001
B	033	00100001	equal	080	01010000	second	130	10000010
C	034	00100010	error	081	01010001	set	131	10000011
D	035	00100011	feet	082	01010010	space	132	10000100
E	036	00100100	flow	083	01010011	speed	133	10000101
F	037	00100101	fuel	084	01010100	star	134	10000110
G	038	00100110	gallon	085	01010101	start	135	10000111
H	039	00100111	go	086	01010110	stop	136	10001000
I	040	00101000	gram	087	01010111	than	137	10001001
J	041	00101001	great	088	01011000	the	138	10001010
K	042	00101010	greater	089	01011001	time	139	10001011
L	043	00101011	have	090	01011010	try	140	10001100
M	044	00101100	high	091	01011011	up	141	10001101
N	045	00101101	higher	092	01011100	volt	142	10001110
O	046	00101110	hour	093	01011101	weight	143	10001111
			in	094	01011110			
			inches	095	01011111			
			is	096	01100000			

Table 1: The 144 spoken expressions in the vocabulary of the standard Digitalker system, with word-access codes in decimal and binary. The "ss" expression is a generalized hissing sound provided to make plurals out of other words in the list. If an address greater than 143 is sent to the speech processor, it "executes data" and nonsense sounds are generated.

IT WAS INEVITABLE

Sooner or later, someone had to take all this proven microcomputer hardware and software technology and wrap it up in a portable package at a price that shocks the industry. Adam Osborne decided to do it sooner.

The OSBORNE 1®, from Osborne Computer Corporation. You get full CP/M® disk computer capabilities—Z80A® CPU, 64K bytes of RAM memory, a full business keyboard, a built-in monitor, and two floppy drives with 100K bytes each of storage. You get two interfaces, the IEEE 488 and the RS-232C. Just connect a printer, via either interface.

Software? You get CP/M®, CBASIC-2®, Microsoft BASIC®, the WORDSTAR® word processing system with the MAILMERGE® mailing list feature, and the SUPERCALC® electronic spreadsheet package. All standard. All for \$1795.



And it's portable. When the keyboard is clipped over the display panel, only the weatherproof brushed aluminum case is exposed. (There are even optional modem electronics, couplers, battery packs, and external monitor connections, providing practically unlimited system portability.)

It's all business. The OSBORNE 1 delivers significant productivity at an irresistible price. At \$1795, its immediate and lasting success as a personal business computer is, quite simply, inevitable.



\$1795

OSBORNE

COMPUTER CORPORATION

26500 Corporate Avenue Hayward, California 94545 (415) 887-8080

Orders for the Osborne 1 Computer can be placed over the telephone at (415) 887-8080. Your order will be forwarded by the factory for delivery by your nearest authorized Osborne 1 dealer.

period zeroing compression techniques. Phase-angle adjustment is based on the concept that the intelligibility of speech is not affected by the phase angle of the sine-wave components of the Fourier-transformed waveforms. Therefore, these values can be adjusted to produce a waveform with mirror symmetry; only half the data need be stored.

In half-period zeroing, the low-amplitude portions of a signal are reproduced as silence. For the most part, only the center half of any pitch period needs to be stored since the center half contains most of the energy. The remainder of the wave-

form is relatively insignificant and can be discarded.

The 144-expression Digitalker vocabulary was initially recorded

The Digitalker system introduces low-cost speech output into areas where the expense has not been previously justified.

through a microphone, then differentiated and digitized. A computer program operated on the data to perform

phase-angle adjustment, delta modulation, and half-period zeroing. The redundant pitch periods and phonemes were reduced to individual stored periods and a record of the number of times they are repeated (usually 3 to 8 times). The resulting data containing frequency, amplitude, and control information is stored in the two 64 K-bit speech ROMs.

Figure 1a is a block diagram of the speech-processor chip. Each block of speech data contains a control word specifying the location in ROM of an audible expression, the type of waveform generated, and the number of

Text continued on page 58

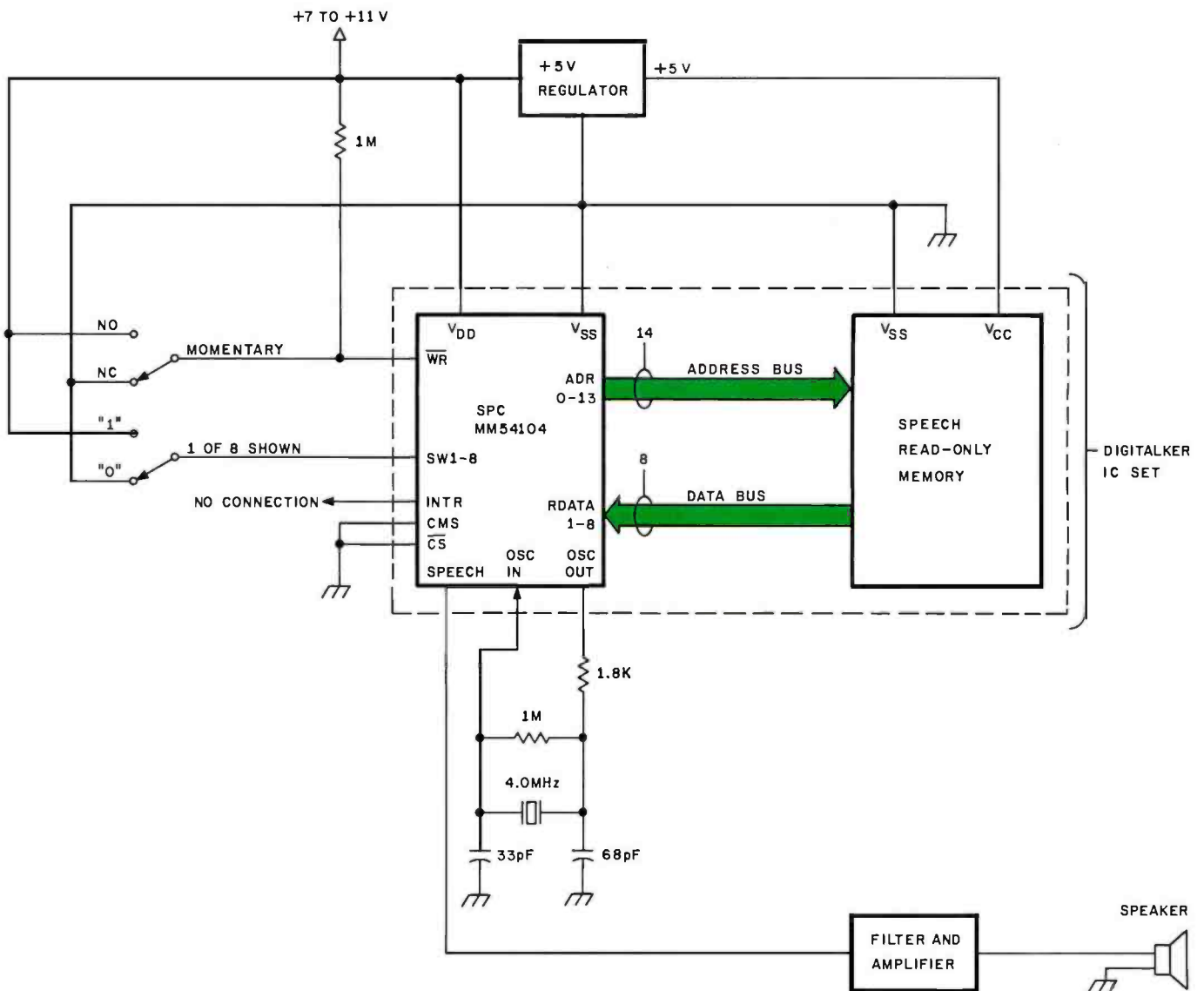
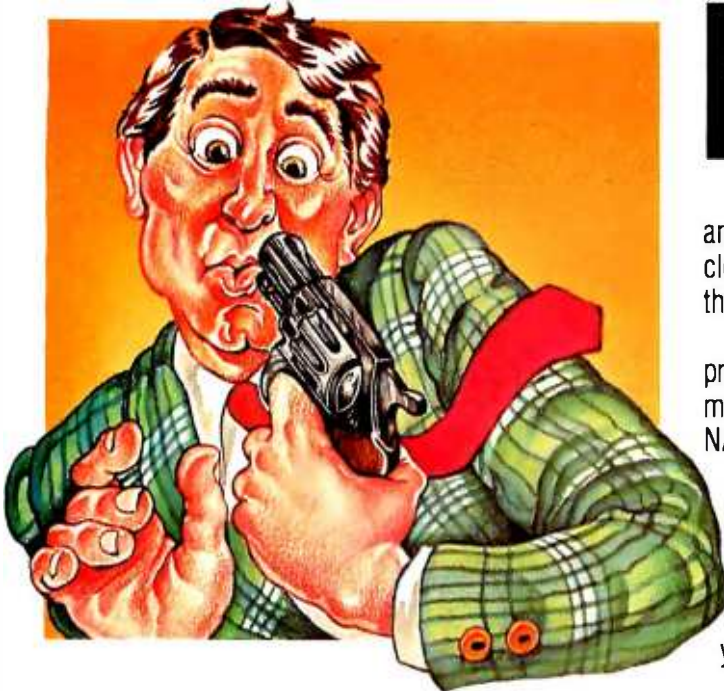

Figure 2: Simplified schematic diagram of a minimum-configuration speech demonstration system, in which mechanical switches are used to set up the desired word. The momentary switch is a single-pole, two-position type. The crystal is a 4.0 MHz Electro Dynamics Corporation HC18 20 pF unit.

STOP STEALING FROM YOUR OWN BUSINESS



Here's the white collar crime of 1981: Let your people labor away for hours at jobs a properly trained computer can do in seconds.

You pay for all those wasted hours.

And you're missing opportunities, because the hours could be spent on new, productive, profitable projects.

We can help you.

If you have a CP/M®-based microcomputer, SSG's Business Productivity Packages will scoop up all those hours you're losing and give you back more productivity, more time, more information, and more success.

ANALYST. \$250. An information storage and retrieval (data base) system that will replace piles of files with information you can USE.

MAGIC WORKSHEET. \$250. SSG's answer to the world's demand for electronic spreadsheet calculation and "what-if" capabilities on CP/M systems. (Available quarter two 1981.)

NAD Name and Address. \$100. A mailing

and addressing system to do all the typing and clerical work on lists—from ten names to ten thousand.

LETTERRIGHT. \$200. A correspondence processing package that speeds letter writing AND merges your letters with names selected from your NAD list.

It takes very few hours at today's salary levels to repay the cost of any of these systems. They'll do you far better than that. SSG's Productivity Software Packages will contribute immediately to the growth and success of your business.

Please act now. Tear out this page. This coupon or a phone call will get you immediate relief from the white collar crime of 1981. We'll send you complete information. Or better still, answer your questions immediately.

Time's a-wasting.
That's a crime.



Please rush me information on the SSG Business Productivity Packages for CP/M-based computers.

Please call me right away.

Name _____

Company _____

Address _____

City State Zip _____

Telephone () _____

CP/M is a registered trademark of Digital Research. NAD, Magic Worksheet are trademarks of SSG.

Structured Systems Group

INCORPORATED

5204 Claremont, Oakland, California 94618 (415) 547 1567

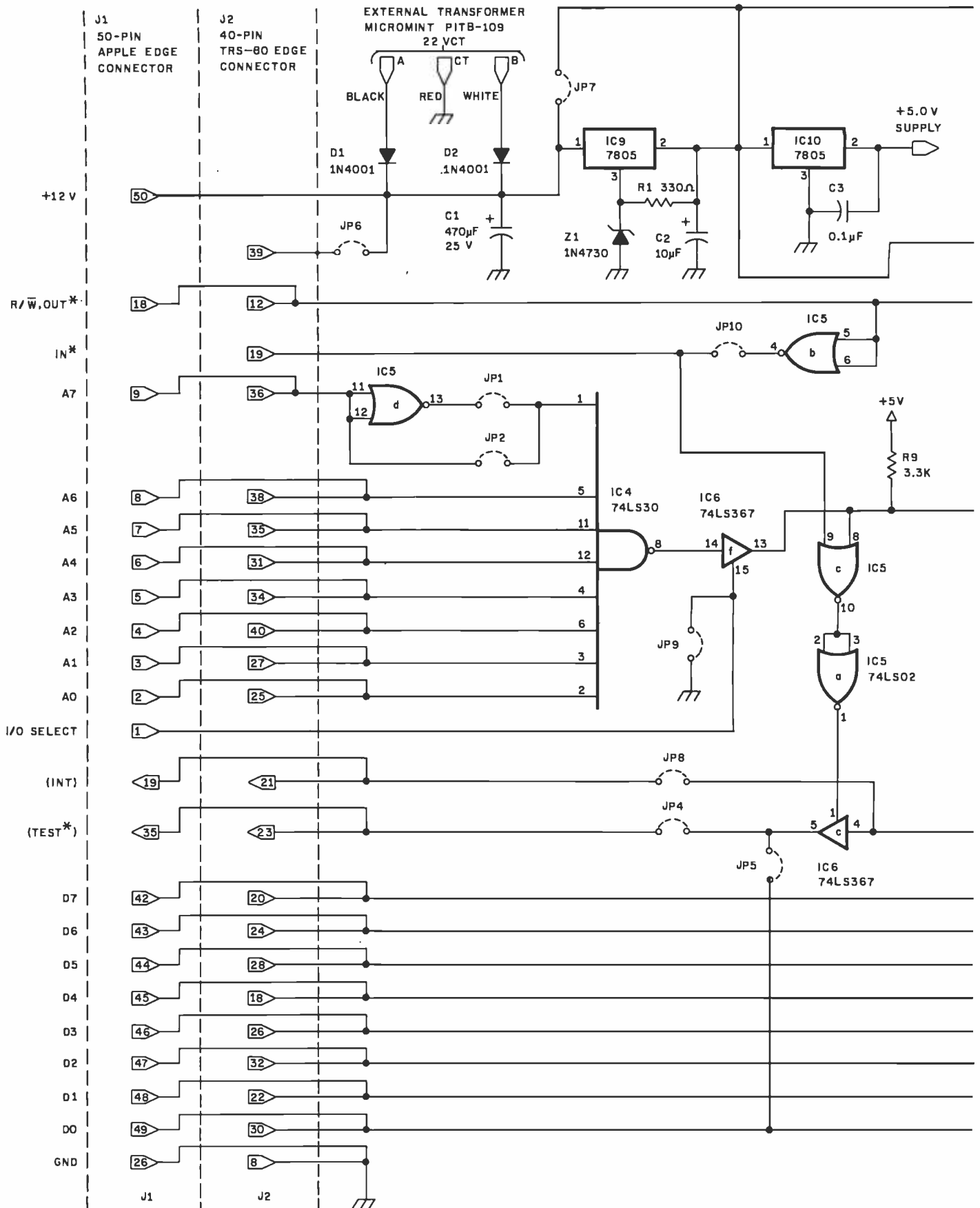
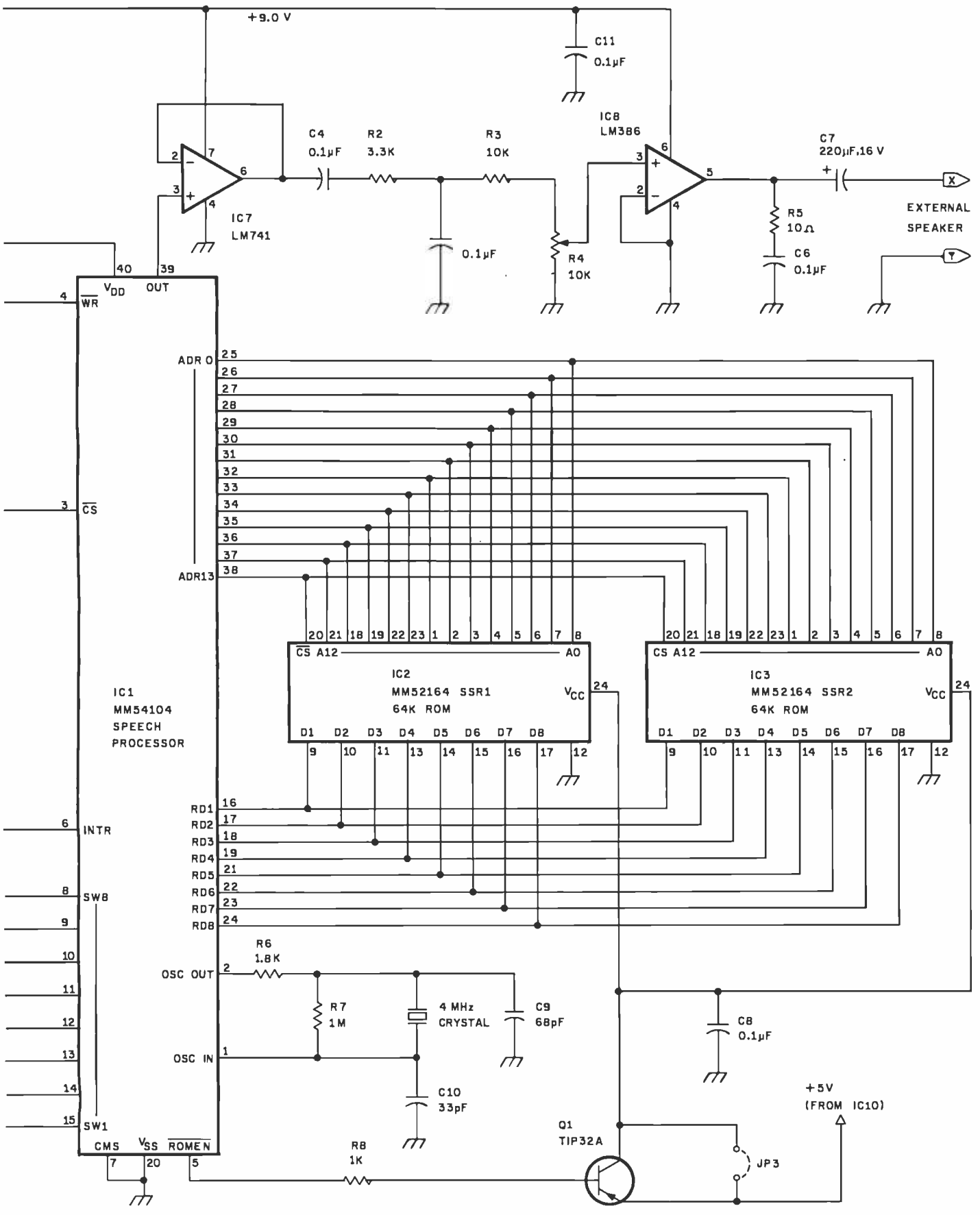

Figure 3: Schematic diagram of the Micromouth speech-processor board. The board is plug-compatible with the Apple II and TRS-80 Model I computers and can be plugged into the TRS-80 Model III with a simple adapter. Several features and options in the circuit are activated by selection of jumper connections; see table 3, on page 58, for a list of jumpers and their purposes. Interface signals are compatible with other microcomputers, including Digital Group, Heath H-8, and S-100-bus systems.



Text continued from page 54:

times it is repeated. Speech data from the ROM is loaded into the speech processor's data register and passed on to the delta-modulator decoder. This produces a 4-bit number that is applied to the D/A converter. Successive and regressive (remember the mirror waveform) digitizations produce a final waveform that is output in real time. Figure 1b shows the pinout specifications of the speech processor and the associated ROMs.

Adding a Digitalker Interface

In general, causing any of the 144

stored expressions to be uttered is done by loading a numeric word code into a register in the speech processor. The code, selected from the list in table 1, is latched when the write-enable and chip-select lines are strobed. The speech processor immediately utters the selected expression.

If the input code is 0, the message "This is Digitalker" is spoken, in about 1.3 seconds. To say a word like "at" takes much less time. If another word-selection address is strobed into the speech processor while it is speaking, it will terminate the current out-

put and begin speaking the newly selected expression. To keep the unit from jamming one word on top of another, a handshaking signal (INTR) goes to a low logic condition when the device is talking.

The simplest Digitalker system can consist of as little as the three speech-system integrated circuits, a 4 MHz oscillator, and an amplifier/filter (as shown in figure 2). Different expressions can be accessed by attaching eight switches to the SW1 thru SW8 input lines and a pushbutton switch to momentarily pulse the write-enable line.

Full use of the Digitalker's capabilities, however, can only be achieved when it is connected to a computer and exercised under program control. Figure 3, on pages 56 and 57, is the schematic diagram of the Micromouth speech-synthesizer interface, which incorporates the Digitalker chips. It is designed to be bus-signal-compatible with a number of computers, and it can be operated through a parallel I/O port. Assembled on the printed-circuit board shown in photo 1, it is plug-compatible with the Apple II and TRS-80 Model I personal computers. The pin numbers listed in the figure for connector J2 correspond to the TRS-80 Model I TRS-BUS edge connector, and pin numbers listed for J1 correspond to the Apple II's I/O card slots. A source for the Micromouth speech-processor assembled unit, blank boards, and components is given in the text box on page 68.

Micromouth Versatility

The Micromouth board is designed to accommodate bidirectional as well as unidirectional data buses. The data-bus lines are normally attached to pins 8 thru 15 of IC1, the speech-processor component. The bus line from the speech processor, INTR, is jumpered (by either jumper connection JP4 or JP5) to meet the requirements of the particular bus being used. For both the TRS-80 and Apple II, which have bidirectional data buses, jumper JP5 is inserted to connect the INTR output to the D0 bus

Text continued on page 62

Peripheral Slot	Address Jumpers			
	JP1		JP2	
	Hexadecimal	Decimal	Hexadecimal	Decimal
1	C17F	- 16001	C1FF	- 15873
2	C27F	- 15745	C2FF	- 15617
3	C37F	- 15489	C3FF	- 15361
4	C47F	- 15233	C4FF	- 15105
5	C57F	- 14977	C5FF	- 14849
6	C67F	- 14721	C6FF	- 14593
7	C77F	- 14465	C7FF	- 14337

Table 2: I/O addresses used by the Apple II in communicating with the Micromouth speech-processor board. These are addresses in the Apple's peripheral-card ROM address space. The driving software can manipulate these registers using memory-reference instructions; in BASIC, PEEK and POKE are used.

Jumper Connection	Purpose
JP1	When connected, sets TRS-80 I/O-port address to decimal 127; mutually exclusive with JP2; see table 2 for Apple II addressing.
JP2	Sets TRS-80 I/O-port address to decimal 255; see table 2 for Apple II addressing.
JP3	To be connected if transistor Q1 is to be omitted and an adequate external power supply is to be used.
JP4	Not for use with either TRS-80 or Apple II computers; provides INTR feedback to computer, gated by the address strobe; see also JP8.
JP5	When connected, enables use of a bidirectional data bus; otherwise a unidirectional bus is assumed.
JP6	Not for use with either TRS-80 or Apple II; when the 40-pin edge connector is used, a +12 V supply may be provided to the board through pin 39.
JP7	May be connected if an external +9 V or +8 V supply is available.
JP8	Not for use with either TRS-80 or Apple II; provides INTR feedback to computer, although not gated as through JP4.
JP9	Must be connected when board is used with a TRS-80; enables I/O commands to be decoded properly.
JP10	Must be connected when board is used with an Apple II; provides proper I/O-command decoding.

Table 3: List of jumper connections in the schematic diagram of figure 3. Various features and options of the Micromouth speech-processor board are activated by connecting different jumpers. Some options are not needed when the board is used with an Apple II or a TRS-80. Experimenters with other computers may use the 40-pin and 50-pin edge connectors in nonstandard ways; therefore some connections have been provided that have no obvious use.

NEVER UNDER\$OLD.

That's right. If you can find a lower price in this magazine **WE WILL BEAT IT! Period.***

S-100 HARDWARE

SO SYSTEMS	
Versa Floppy I kit	\$259
Versa Floppy II kit	\$349
ExpandoRam II kit	\$249
ITHICA INTERSYSTEMS	\$CALL
ALTOS	\$CALL
NORTHSTAR	\$CALL

SUPPLIES

Verbatim Datalife Diskettes	
MD525-01, 10, 16	\$26.50
FD34-9000	\$30.00
FD34-8000	\$44.00

Avery Tabulables	
5,000 3 1/2 X 15/16	\$18.75
3,000 3 1/2 X 15/16	\$14.25
1,000 3 1/2 X 15/16	\$8.15

UARC Paper (prices are FOB S.P.)	
9 1/2 X 11, 15 or 18 Lb.	\$25.95
14 7/8 X 11, 15 or 18 Lb.	\$35.00

SOFTWARE

Microsoft Basic-80	\$299
Microsoft Basic Compiler	\$319
Microsoft Fortran-80	\$399
Magic Wand	\$275
Apple Visicalc	\$113
Pickles and Trout CP/M*	\$175

APPLE HARDWARE

Microsoft Z-80 Softcard	\$259
Microsoft Ramcard	\$170
SSM AIO A&T	\$165
SYMTEC Apple Light Pen	\$219
MOUNTAIN HARDWARE:	
Super Talker	\$270
ROMWRITER	\$157
INTROL/X-10	\$180
ROMPLUS+	\$162
MUSICSYSTEM	\$499
Apple Clock	\$252
Lobo Drive	\$CALL
Videx 80 x 24	\$299
Andromeda	\$170
M & R Sup-R-Term	\$299
Enhancer	\$100
NEC Green Monitor	\$240
Sanyo Green Monitor	\$240
D.C. Hayes Micromodem	\$299
CALIFORNIA COMPUTER SYSTEMS	

See our full page ad in this magazine.

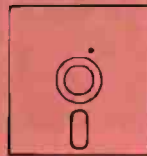

**ALPHA
BYTE
STORES**

PRINTERS

EPSON MX-80	CALL
MX-80 Graphics ROM	CALL
NEW EPSON MX-80 TF	CALL
Okidata Microline 80	\$415
Okidata Microline 82	\$625
Okidata Microline 83	\$899
IDS Paper Tiger 460G	\$1050
Anadex DP-9000, 1	\$1195
Anadex DP-9500, 1	\$1295
Centronics 737	\$689
NEC Spinwriter	\$CALL
NEC w/ Sellum Option	\$CALL
C. Itoh Starwriter 25 cps	\$1440
C. Itoh Starwriter 45 cps	\$1770
Diablo 630	\$2195
Malibu 165	\$1995
Malibu 200	\$CALL
MPI 88G	\$495

TRS-80 HARDWARE

TRS-80's	\$CALL
Micropolis 77 track	\$399
Percom Doubler	\$199
Percom Separator	\$27
Orchestra 80	\$79

5115 Douglas Fir Road • Suite B • Calabasas, CA 91302

*Include \$2.00 shipping and handling on all orders. Visa and Master Card accepted. Never undersold offer applies only to items currently deliverable from other retail vendors at advertised price. All never undersold offers good as supply lasts. Please add \$2.00 for all COD orders. Please call for items not listed. We gladly answer any questions on all of our hardware, software, and supply needs. Quantity discounts available. School purchase orders accepted. Please remember to figure competitors shipping and handling charges when arriving at never undersold price.

(213) 883-8594





BUMPER CROP

8-inch Winchester Multi-User Systems. Now In Volume- \$8,500.

Altos is delivering the cream of the crop with their new 8-inch multi-user Winchester disk systems. They're freshly packed with the quality features you expect from Altos, and at a price you expect from Altos, too—just \$8,500.

Pick from two fully integrated systems, each packaged in our new compact, stylish cabinet suitable for either rack mount or table top applications. You get 10 MBytes of reliable on-line storage in our 8-inch Winchester drives. Then for system back-up storage, you can select from

either 8-inch, single or double-sided floppy drives (ACS8000-10 and -10D) or a 1/4-inch magnetic tape drive (ACS8000-10/MTU). And for powerful performance, all of these Z80A*based systems come complete with 208K of RAM and 6 programmable serial ports, ready to support four users.

Here's the most bountiful selection of systems and capacities in the field from the company that knows how to deliver quality systems in the volumes that OEMs need to stay competitive.

And Altos supports these systems with a broad software selection including the three industry standard operating systems—CP/M, multi-user MP/M** and OASIS†. These operating systems support seven high level programming languages: BASIC, FORTRAN, COBOL, PASCAL, APL, PL/1 and C. Also available are comprehensive communications packages: ASYNC—Altos-to-Altos, BISYNC—Altos-to-mainframe and full networking with CP/NET. All are designed to run on a high speed 800 Kilobaud networking channel—standard with every system.

The ACS8000-10 Winchester systems join our growing family of field-proven products. In just three years, more than 8,000 systems have been shipped to an OEM customer-base.

Get to market fast. Harvest your 8-inch Winchester system direct from the heart of Silicon Valley. Call or write today for specific product information and OEM pricing. Altos Computer Systems, 2360 Bering Drive, San Jose, CA 95131, (408) 946-6700, Telex 171562 ALTOS SNJ.



Packed with Fresh Ideas

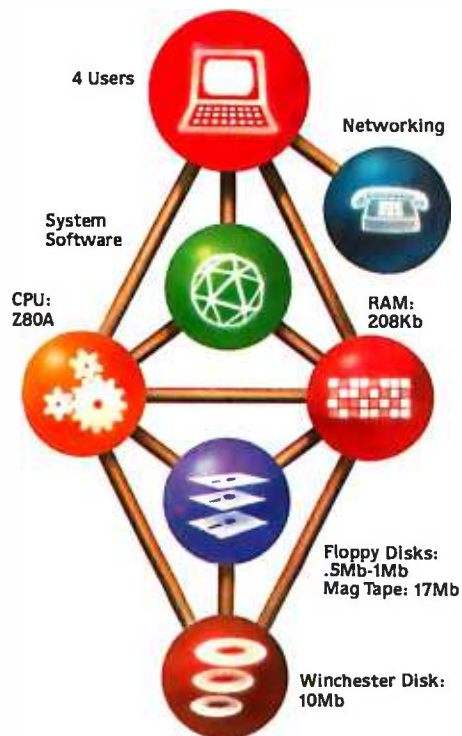

SYSTEMS PICTURED:
ACS8000-10 (10Mb HD + 1 floppy) \$ 8,500
ACS8000-10/MTU (10Mb HD + DEI MagTape) \$10,990

*Z80A is a registered trademark of Zilog, Inc.
**CP/M and MP/M are registered trademarks of Digital Research, Inc.
†OASIS is a registered trademark of Phase One Systems, Inc.
‡datapro is a registered trademark of Datapro Research Corp.
© 1981 Altos Computer Systems

Text continued from page 58:

line. The controlling computer can read the status of this line with an input instruction; only the least-significant bit will be affected. For a unidirectional data bus, as in a Digital Group computer, JP4 would be inserted and pin 5 of IC6 connected to the least-significant bit of the input bus.

The logic gates of IC4, IC5, and IC6 perform address decoding and chip selection. The I/O-port address of the board is set by inserting jumper JP1 or JP2. With JP1 installed, the address is port hexadecimal 7F (decimal 127). With JP2 installed, it is port hexadecimal FF (decimal 255). On the Apple II, the port address depends upon the slot in which the board is inserted. Table 2 is an address map for the Micromouth speech-processor board installed in an Apple II.

The speech-processor chip requires +7 to +11 V for normal operation, while the ROMs and other integrated circuits require only a +5 V supply. To accommodate the different ranges, I used two separate voltage

regulators. IC9, a 7805 regulator, can safely be fed an input-voltage range of +9 to +24 V. When installed in an Apple II it receives a +12 V supply from the I/O bus. When the board is used with the TRS-80, a separate full-wave power supply using a 22 V center-tapped power transformer supplies approximately +15 V RMS. IC9 and associated components regulate the output to the speech processor to about +9 V. IC10, another 7805, in turn, reduces the +9 V to the +5 V required by the rest of the components.

The typical maximum current requirement of the Micromouth speech-processor circuitry is about 250 mA. Most of this is consumed running the two 64 K-bit ROMs, which are used only a few microseconds at a time. A memory-enable signal, ROMEN, can be used with a transistor (Q1) to gate the power on and off to the ROMs. The average current required ends up being about 80 mA.

The final section for consideration is the filter and amplifier, IC7 and

IC8. As in any digitized analog-signal output, a low-pass filter is required. For low-pitched male voices, the cutoff frequency should be about 100 Hz; for high-pitched female or children's voices it should be 300 Hz. The filter in figure 3 has a cutoff frequency around 150 Hz. That limit wasn't set mathematically; I simply chose a pleasant-sounding range. The frequency response of the output speaker and its enclosure can also affect sound quality. In my opinion, the sound output by this circuit is quite human-like. Any additional filtering usually serves only to eliminate background noise.

Using a Parallel Port

The Micromouth board can also be jumpered so that it can be driven by a parallel I/O port. This is accomplished by inserting jumpers JP8 and JP9. With the input lines to IC5 and IC6 left open, a constant chip-select signal will be generated. The 8-bit parallel output from the computer is attached to pins 8 thru 15 on the speech processor. The same signal that latches the bit values into the output port can be used as the WR strobe on IC1 pin 4. The speech-processor-busy status indication is handled by directly reading the INTR line via an input-port line.

Basic Software Simplicity

The best thing about a fixed vocabulary "canned-speech" synthesizer is the low software overhead. Text-to-speech synthesizers, on the other hand, usually require at least an 8 K-byte driver program, which must be integrated into the existing operating system. With the Micromouth speech-processor board, any or all of the 144 expressions can be spoken using a simple BASIC OUT or POKE statement.

For example, to say "twenty" using the board connected to a TRS-80 system, you would execute an OUT 127,20 statement in BASIC. With the Apple II, the appropriate statement would be POKE -16001,20 if the board were installed in slot 1. As you can see, the control information communicated to the board, a decimal 20,

The secret may be our exclusive Agent Code of Standards. Our air-ride van fleet. International agent network. Computerized scheduling.

Or our ability to move whatever or whomever you want. Reliably. Whatever the secret, it's made us America's most experienced movers. Call your local agent.

American RED BALL
World Wide Movers

CALL CALL

ICC MC-6592

datasouth announces... **THE TOTAL PRINTER PACKAGE!**

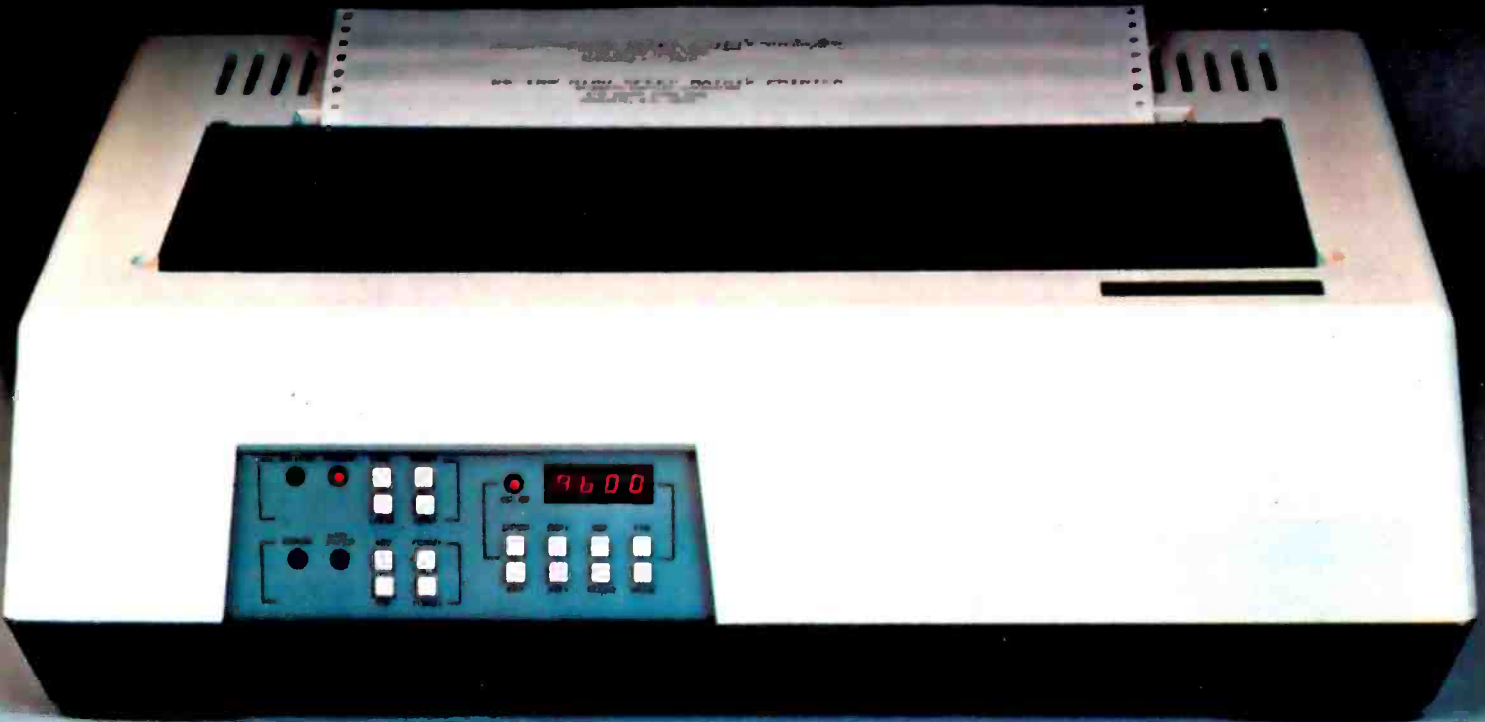

With so many matrix printers on the market today, it may seem tough to find exactly the right one for your application. Some models may offer the speed you need, others the communications flexibility and still others the forms handling capability. But no printer offers all the features you need...until now.

The DS180 matrix printer provides the total package of performance features and reliability required for applications such as CRT slave copy, remote terminal networks and small to mid-range systems. Not a "hobby-grade" printer, the DS180 is a real work-horse designed to handle your most demanding printer requirements. And pricing on the DS180 is hundreds of dollars below competitive units.

High Speed Printing—Bidirectional, logic-seeking printing at 180 cps offers throughput of over 200 lpm on average text. A 9-wire printhead life-tested at 650 million characters generates a 9x7 matrix with true lower case descenders and underlining.

Non-volatile Format Retention—a unique programming keypad featuring a non-volatile memory allows the user to configure the DS180 for virtually any application. Top of form, horizontal and vertical tabs, perforation skipover, communications parameters

and many other features may be programmed and stored from the keypad. When your system is powered down, the format is retained in memory. The DS180 even remembers the line where you stopped printing. There is no need to reset the top of form, margins, baud rate, etc....it's all stored in the memory. If you need to reconfigure for another application, simply load a new format into the memory.

Communications Versatility—The DS180 offers three interfaces including RS232, current loop and 8-bit parallel. Baud rates from 110-9600 may be selected. A 1K buffer and X-on, X-off handshaking ensure optimum throughput.

Forms Handling Flexibility—Adjustable tractors accommodate forms from 3"-15". The adjustable head can print 6-part forms crisply and clearly making the DS180 ideal for printing multipart invoices and shipping documents. Forms can be fed from the front or the bottom.

If you would like more information on how the DS180's low-cost total printer package can fill your application, give us a call at Datasouth. The DS180 is available for 30-day delivery from our sales/service distributors throughout the U.S.

datasouth
computer corporation

Listing 1: A BASIC program for the Radio Shack TRS-80 Model I that will cause the Micromouth speech-processor board to say "At the mark the time is 2:45 pm....beep." A program for the Apple II would use the POKE keyword to achieve the same effect as the OUT statement.

```

100 DIM N(15)
110 DATA 61,138,105,71,138,139,
    96,2,4,5,47,44,71,71,65
120 FOR X=1 TO 15 :READ N(X)
    : NEXT X

150 FOR X=1 TO 15 : OUT 127,N(X)
    : GOSUB 1000 : NEXT X
160 GOTO 1999

1000 IF INP(127)=1 THEN
    GOTO 1000 ELSE RETURN
1999 END

```

is the same even though the keywords differ. (Since my program illustrations consistently use OUT statements directed to port 127, I will not bother to restate the conversion in subsequent examples, but you should recognize the direct relationship.)

Listing 2: A BASIC program that will cause the Micromouth speech-processor board to recite multiplication results for any number between 1 and 10.

```

100 PRINT "MULTIPLICATION TABLE EXERCISER"
110 OUT 127,0:REM Say This is Digi-Talker
120 PRINT:PRINT"Which table do you want to review (1 to 10)";
130 INPUT N
140 FOR X=0 TO 10
150 PRINT X;"X";N;"=";X*N:J=X*N
160 IF X=0 THEN OUT 127,31:GOSUB 290:GOTO 180
170 OUT 127,X:GOSUB 290
180 GOSUB 310:OUT 127,N:GOSUB 290
190 OUT 127,80:GOSUB 290:OUT 127,129:GOSUB 290
200 J1=INT(J/10)
210 IF J=100 THEN OUT 127,1:GOSUB 290:OUT 127,28:GOSUB 290:GOTO 260
220 IF J=0 THEN OUT 127,31:GOSUB 290:GOTO 260
230 IF J<20 THEN OUT 127,J:GOSUB 290:GOTO 260
240 OUT 127,18+J1:GOSUB 290
250 IF J-J1*10>0 THEN OUT 127,J-J1*10:GOSUB 290:GOTO 260
260 NEXT X
270 PRINT:GOTO 120
280 REM
290 IF INP(127)=1 THEN 290 ELSE RETURN:REM check end of word
300 REM
310 OUT 127,139:GOSUB 290:OUT 127,129:GOSUB 290:RETURN
320 REM say TIMES

```

READY

Having the board speak in a series of words can be handled in one of two ways. One way is to use timing loops or other program-execution steps to allow enough time for a word to be spoken before loading the speech processor with the next word

code. The preferred method is to check the busy line (INTR) before loading the next word. In this way, speech can sound continuous regardless of the length of each word. The INTR status bit is read as the least-significant bit of port 127 by the function INP(127). In my examples, while the speech processor is talking, the decimal value returned by INP(127) equals 1; while it is not talking, INP(127) equals 0.

Therefore, saying the number twenty-one, which consists of saying "twenty" and "one" successively, goes as follows:

```

100 OUT 127,20 : GOSUB 1000
    : OUT 127,1
110 STOP
1000 IF INP(127)=1 THEN
    GOTO 1000 ELSE RETURN
1999 END

```

A similar program can be used to demonstrate the entire Digtalker vocabulary:

```

100 FOR N=0 TO 143 : OUT
    127,N : GOSUB 1000
    : NEXT N
110 STOP
1000 IF INP(127)=1 THEN
    GOTO 1000 ELSE RETURN
1999 END

```

Longer utterances are typically

Available right now — and for under \$6000! PrintaColor IS8001, the world's first low-cost color ink jet printer. All the advantages of hard-copy color graphics. And at a price you can afford!

One thin dime — and two minutes time! Fast, quiet and cost efficient. Just 10¢ per copy! Typewriter-size desktop unit uses ordinary fanfold paper. And continuous copy printing, unattended.

What you see

Now—hard copy
in color
for one thin dime

PrintaColor

Reproduced from actual PrintaColor printed

PrintaColor Corporation P.O. Box 52 Norcross, Georgia 30091 404/448-2675

SUPERBRAIN QD™

VS.

SUPERBRAIN™

the two top microcomputer contenders

When you decide to buy a microcomputer system, it usually gets down to one model versus another. Will it be the SuperBrain from Intertec... or one of those other models from Intertec's competitors? Well, there's really not much of a choice in the price/performance competition. The SuperBrain wins hands down! And it's a pretty tough contender if reliability, factory support and nationwide service are important to you. So what do you do? Choose our SuperBrain just because you know it's best? Or keep waiting for someone to announce something better?

WAIT NO LONGER...

It wasn't enough that our SuperBrain had such standard features as twin double-density disk drives with nearly 350,000 bytes of disk storage. A full 64K of dynamic RAM. A CP/M* Disk Operating System which assures compatibility to literally hundreds of application packages. A crisp, 12" non-glare screen with a full 24 line by 80 column display. A full-featured ASCII keyboard with a separate keypad and individual cursor control keys. Twin RS232 serial ports for fast and easy connection to a modem or a printer. Plus, dual Z80 processors which operate at 4 megahertz to insure lightning-fast program execution. No, it wasn't enough. So we changed it. We made it even better!

ANNOUNCING SUPERBRAIN QD...

Our new QD model boasts all the features of our phenomenally popular SuperBrain with the addition of double-sided disk drives. So, for only a modest increase in price, you can order your next SuperBrain with more than twice the disk storage. But, best of all, you can field upgrade the disk capacity of either model to a whopping 10 megabytes! Now how's that for a choice?

HOW DID WE DO IT?

The secret of SuperBrain QD's incredible disk storage lies within our new double-density, double-sided disk drives. Nearly 750,000 bytes of data can be formatted on two specially designed 5¼" drives. More than enough to tackle almost any serious small business application. Plus, SuperBrain QD's 64K of dynamic RAM will handle even your most complicated programming tasks.

Of course, if you really need megabytes instead of kilobytes, just add our 10 megabyte CompuStar™ Disk Storage System. It connects in seconds and gives you the capability to expand your system into a powerful multi-user network with up to 255 CompuStar terminals. You can add users one at a time as you need them. So no matter how much your needs expand, your original investment in computer hardware is always protected.

BUT IS IT RELIABLE?

Our best salesmen are our present customers. Not only have SuperBrain and QD users been impressed with the inherent reliability of the systems, they tell us that no other microcomputers available offer such a unique modular design concept. Just about the only service tool required is a common screwdriver. But of course if you'd rather let us do the service, our total commitment to product and customer support, with service outlets in most major cities, will guarantee your satisfaction for many years to come.



The CompuStar™ Disk Storage System
... Connects in seconds to either model.

THE DECISION IS YOURS...

Whether your next microcomputer is the SuperBrain or our QD model, you'll be purchasing what is becoming one of the world's most popular microcomputer systems. And regardless of which model you choose, you'll probably never outgrow it because you can keep expanding it.

Call or write us today for more information on our full line of microcomputer systems. Ask for our "SuperBrain Buyer's Guide" and read why so many customers like yourself have made the SuperBrain and the SuperBrain QD their top two choices for performance, value and reliability.

 **INTERTEC
DATA
SYSTEMS®**

2300 Broad River Rd., Columbia, S.C., 29210
(803) 798-9100 TWX: 810-666-2115



Listing 3: A BASIC program to demonstrate several different ways of using the speech interface.

```

50 DIM M(20),M(60)
55 DATA 71,138,139,96,71,12,69,93,129,71
60 FOR T=1 TO 19: READ M(T):NEXT T
70 DATA 71,76,71,71,75,81,71,71,105,71,7,20,47,44,71,71
75 DATA 83,125,96,1,26,21,6,85,129,32,110,71,71,104,133
80 DATA 2,12,28,049,047,044,60,131,83,125,2,1,26,10,85
85 DATA 129,32,110,71,71,71,71,71
90 FOR T=1 TO 56:READ M(T):NEXT T
100 REM DIGI-TALKER TEST PROGRAM
110 PRINT "DIGI-TALKER TEST PROGRAM"
120 PRINT: PRINT"1. Say entire vocabulary"
130 PRINT"2. Count from 0 to 20"
140 PRINT"3. Tones"
150 PRINT"4. Speech example A"
160 PRINT"5. Speech example B"
165 PRINT"6. Say 'THIS IS DIGI-TALKER'"
170 PRINT:PRINT"Enter choice (1-5) ":INPUT A
180 IF A=1 THEN GOSUB 250
190 IF A=2 THEN GOSUB 300
200 IF A=3 THEN GOSUB 350
210 IF A=4 THEN GOSUB 400
220 IF A=5 THEN GOSUB 450
225 IF A=6 THEN OUT 127,0:GOSUB 1000
230 GOTO 110
250 REM speak entire word list
260 FOR T=0 TO 143:OUT 127,T:GOSUB 1000
270 NEXT T: RETURN
300 REM speak numbers 0-20
310 OUT 127,31: GOSUB 1000
320 FOR T=1 TO 20: OUT 127,T: GOSUB 1000
330 NEXT T: RETURN
350 REM 80 Hz and 400 Hz tone
360 FOR T=0 TO 5:OUT 127,65:GOSUB 1000
370 OUT 127,66:GOSUB 1000:NEXT T
380 RETURN
400 REM Speak time
410 FOR B=0 TO 5:OUT 127,65:GOSUB 1000
415 FOR C=0 TO 2:OUT 127,71:GOSUB 1000:NEXT C
420 NEXT B
425 FOR T=1 TO 18 :OUT 127,M(T):GOSUB 1000:NEXT T
430 FOR T=0 TO 5:OUT 127,65:FOR S=0 TO 100:NEXT S:NEXT T
440 RETURN
450 REM example of use as error detector and verbal annunciator
460 FOR T=1 TO 55: OUT 127,M(T):GOSUB 1000:NEXT T
470 RETURN
1000 IF INP(127)=1 THEN 1000 ELSE RETURN
1010 IF INP(127)=1 THEN 1010 ELSE RETURN

```

READY

handled by storing all the word codes in an array. Such a technique can be used to say, "At the mark the time is 2:45 pm....beep," using the BASIC statements in listing 1.

I have included a few program examples to demonstrate how the speech-processor board can be used. Listing 2 is a simple program for saying multiplication tables. This program asks the operator to choose a multiplication table for a number between 1 and 10. If 8 were chosen, for example, the program would say:

"Zero times eight equals zero."
 "One times eight equals eight."
 "Two times eight equals sixteen."

and so on to:

"Ten times eight equals eighty."

This is just a rudimentary example. The program could be modified easily to posit questions such as "Six times nine equals..." and wait for a typed response. Appropriate answers would be "Error...Please try again," or "Right."

Listing 3, on page 66, is a menu-driven program that further exercises the interface and demonstrates a few more applications. Speech example A says, "beep... beep... beep... beep..." The time is...twelve hours...seventeen minutes...beep." It is very much

Listing 4: The printed output of the program in listing 3. Due to the limitations of magazine printing, we cannot reproduce the audible output produced by the program.

```

run
DIGI-TALKER TEST PROGRAM

1. Say entire vocabulary
2. Count from 0 to 20
3. Tones
4. Speech example A
5. Speech example B
6. Say 'THIS IS DIGI-TALKER'

```

Enter choice (1-5) ?

like the time message heard over shortwave radio station CHU Canada.

Speech example B from listing 3 illustrates how process-control applications might be handled. It says, "Control error...Mark seven twenty pm...Flow rate is thirty gallons a minute...Lower speed to twelve hundred rpm and set flow rate to one hundred gallons a minute."

In Conclusion

Applications that would be enhanced by speech output are limitless. I have demonstrated just a few examples dealing with process control and time.

Many handicapped persons could benefit from speech output. It would be possible, for example, to attach a speech-output device to the user-terminal keyboard of a personal computer. As the keys are pressed, the corresponding letters are spoken aloud. (A simple ROM containing Digitalker equivalents for ASCII [American Standard Code for Information Interchange] characters could be used to interface the speech-processor board.) A similar connection can be made to the printer output (using the INTR-signal handshaking to slow it down) to allow the operator to hear what would otherwise be printed.

I did not attempt to modify any computer games as illustrations. Computer games could easily be made to talk using a few extra BASIC



The best news since CP M... customizable full screen editing

As a serious computer user you spend much of your time editing, whether it be for program development or word processing. Make the best use of your time with the help of VEDIT, an exceptionally fast and easy to use full screen editor. VEDIT is a highly refined and proven editor which is easy enough for novices to learn and use. Yet its unequalled set of features also makes it the choice of computer professionals. And because VEDIT is user customizable, it adapts to your keyboard, hardware, applications and preferences.

In VEDIT, the screen continuously displays the region of the file being edited, a status line and cursor. Changes are made by first moving the cursor to the text you wish to change. You can then overtype, insert any amount of new text or hit a function key. These changes are immediately reflected on the screen and become the changes to the file.

VEDIT has the features you need, including searching, file handling, text move and macros, plus it has many special features. Like an 'UNDO' key which undoes the changes you mistakenly made to a screen line. The Indent and Undent Keys allow automatic indenting for use with structured programming languages such as Pascal and PL/I. The disk write error recovery lets you delete files or even insert another disk should you run out of disk space during an edit session. And you have the ability to insert a specified line range of another file anywhere in the text. Disk access is very fast and VEDIT uses less than 12K of memory. The extensive 70 page, clearly written manual has sections for both the beginning and experienced user.

Totally User Customizable

Included is a setup program which allows you to easily customize many parameters in VEDIT, including the keyboard

layout for all cursor and function keys, screen size, default tab positions, scrolling methods and much more. This setup program requires no programming knowledge or 'patches', but simply prompts you to press a key or enter a parameter.

The CRT version supports all terminals by allowing you to select during setup which terminal VEDIT will run on. Features such as line insert and delete, reverse scroll, status line and reverse video are used on 'smart' terminals. The memory mapped version supports bank select and a hardware cursor such as on the SSM VB3. Special function keys on terminals such as the H19, Televideo 920C and IBM 3101, and keyboards producing 8 bit codes or escape sequences are also supported.

Ordering

Specify the CRT version, your video board or microcomputer, the 8080/Z80 or Z80 code version, and disk format required. (Call for pricing and delivery on the CP/M-86 version)

Standard Package: Disk and manual \$130
Manual: Price refunded with software purchase \$15

VISA and MASTER CARD Welcomed.
Attractive Dealer Terms.

New CRT Emulation Package

Get the details on our CRT emulation package for S-100 computers, which features the PLICEON V-100, 24x80 video board and our software to give you an exceptionally compatible and high speed alternative to a CRT terminal.

CP/M and MP/M are registered trademarks of Digital Research, Inc. Apple II is a registered trademark of Apple Computer, Inc. SoftCard is a trademark of Microsoft. TRS-80 is a trademark of Tandy Corp.

North Star ● Cromemco ● Heath H8/H89 ● SuperBrain ● Apple II Softcard ● Sorcerer ● TRS-80 Model II & Model I
Most other CP/M Systems with CRT or Memory Mapped Displays ● MP/M ● CP/M-86

CompuView Products Inc.

618 Louise, Ann Arbor, Michigan 48103 ● Telephone (313) 996-1299

Circle 92 on Inquiry card.

statements that are independent of the program flow.

What I'd like to leave you with is an appreciation for the price/performance advantages and ease of use inherent in this speech interface. Soon other Digitalker ROMs will be available, containing specialized vocabularies for medical, aeronautical, or even space-war applications. These other ROMs will be available eventually thru the MicroMint.

[Editor's Note: National Semiconductor Corporation is providing a brief telephone demonstration of the Digitalker speech-synthesis system at (408) 737-3939....RSS]

The invention of Digitalker does not mean the demise of other approaches to computer-generated

speech. Instead, it introduces low-cost speech output into areas that could never have justified the expense previously. Eventually, hand-held talking digital volt-ohmmeters will be mass-produced, and I don't think it will be too far into the future. But that is merely one application. You can expect to see (or rather hear) speech emanating from many commercial products.

Those who work with other speech-synthesis techniques have not been standing still during the development of "canned-speech" chips. Phoneme synthesizers, such as the Votrax SC-01, now accomplish on a single chip what once required a whole circuit board. My investigation of speech synthesis doesn't stop here. In the months ahead I hope to

demonstrate other computer-speech techniques, interfaces, and applications.

Next Month:

Would you think that a computer system capable of running a BASIC interpreter could fit on a 4-inch-square circuit board? Find out how to build one in next month's *Circuit Cellar*. ■

Bibliography

1. Ahrens, Paul; Klaus Skoge; David Vetter; and John Stork. "Speech Chip Timeshares a 2-Pole Section to Create a 12-Pole Filter," *Electronics*, March 10, 1981, page 177.
2. Ciarcia, Steven A. "Talk to Me: Add a Voice to Your Computer for \$35," in *Ciarcia's Circuit Cellar*, Volume 1, BYTE Books, 1979, page 77.
3. Gargagliano, Tim A. and Kathryn Fons. "Text Translator Builds Vocabulary for Speech Chip," *Electronics*, February 10, 1981, page 118.
4. Lin, Kun-Shan; Gene A. Frantz; and Kathy Goudie. "Software Rules Give Personal Computer Real Word Power," *Electronics*, February 10, 1981, page 122.
5. Weinrich, David W. "Speech-Synthesis Chip Borrows Human Intonation," *Electronics*, April 10, 1980, page 113.
6. Wiggins, Richard and Larry Brantingham. "Three-Chip System Synthesizes Human Speech," *Electronics*, August 31, 1978, page 109.

The following items are available postpaid in the United States from:

The MicroMint Inc
917 Midway
Woodmere NY 11598
(800) 645-3479, for orders only
(516) 374-6793, for technical information

Item		Price
Apple II Micromouth speech-processor board	Kit	\$120
	Assembled and Tested	\$150
TRS-80 Model I Micromouth speech-processor module (includes circuit board, power supply, 40-conductor cable, and enclosure; deduct \$10 if you don't want the enclosure)	Kit	\$150
	Assembled and Tested	\$175
TRS-80 Model III Micromouth speech-processor module (includes board, power supply, adapter cable, and enclosure)	Kit	none
	Assembled and Tested	\$200
Blank printed-circuit board for Micromouth speech-processor board (without components)		\$29

The Apple II version of the Micromouth speech-processor board is suitable for use with parallel-I/O-port and other non-plug-compatible computer connections. The assembly/operation instructions include directions for attaching the board to S-100 bus, Digital Group, and Heath H-8 computers.

All printed-circuit boards are solder-masked and silk-screened. They come with assembly instructions and program examples.

The Digitalker integrated circuits are not sold separately by The MicroMint. They can be obtained through National Semiconductor distributors for \$85 per set plus shipping charges.

New York residents please add 7% sales tax.

Editor's Note: Steve often refers to previous *Circuit Cellar* articles as reference material for the articles he presents each month. These articles are available in reprint books from BYTE Books, 70 Main St, Peterborough NH 03458. Ciarcia's *Circuit Cellar* covers articles that appeared in *BYTE* from September 1977 thru November 1978. Ciarcia's *Circuit Cellar*, Volume II presents articles from December 1978 thru June 1980.

To receive a complete list of Ciarcia *Circuit Cellar* kits available from The MicroMint, circle 100 on the inquiry card.

If you write software, write Digital Research.

We can help you bring your products to market.

Independent Software Vendors (ISV's) are the key to solving the software crunch in the 1980's. To help you bring your products to market, Digital Research introduces the ISV Support Plan — designed to assist you in:

- Developing Your Product
- With the fast and powerful PL/I-80™ Programming System
- ISV Seminars covering high level applications programming

Getting Established in Your Market

ISV Seminars cover:

- Designing a marketing strategy
- Advertising
- Writing Manuals
- Assuring software security
- Supporting and updating products

On-Going Support Includes:

- Legal and technical information
- Distribution channels
- Printing facilities
- Free product listing in our Applications Software Catalog

All this plus the world's largest software marketplace — the CP/M® customer base.

So why do it alone? Write Digital Research. We'll send you our free brochure detailing the ISV Support Plan.

 **DIGITAL RESEARCH®**

P.O. Box 579
Pacific Grove, CA 93950
(408) 649-3896
TWX 910 360 5001

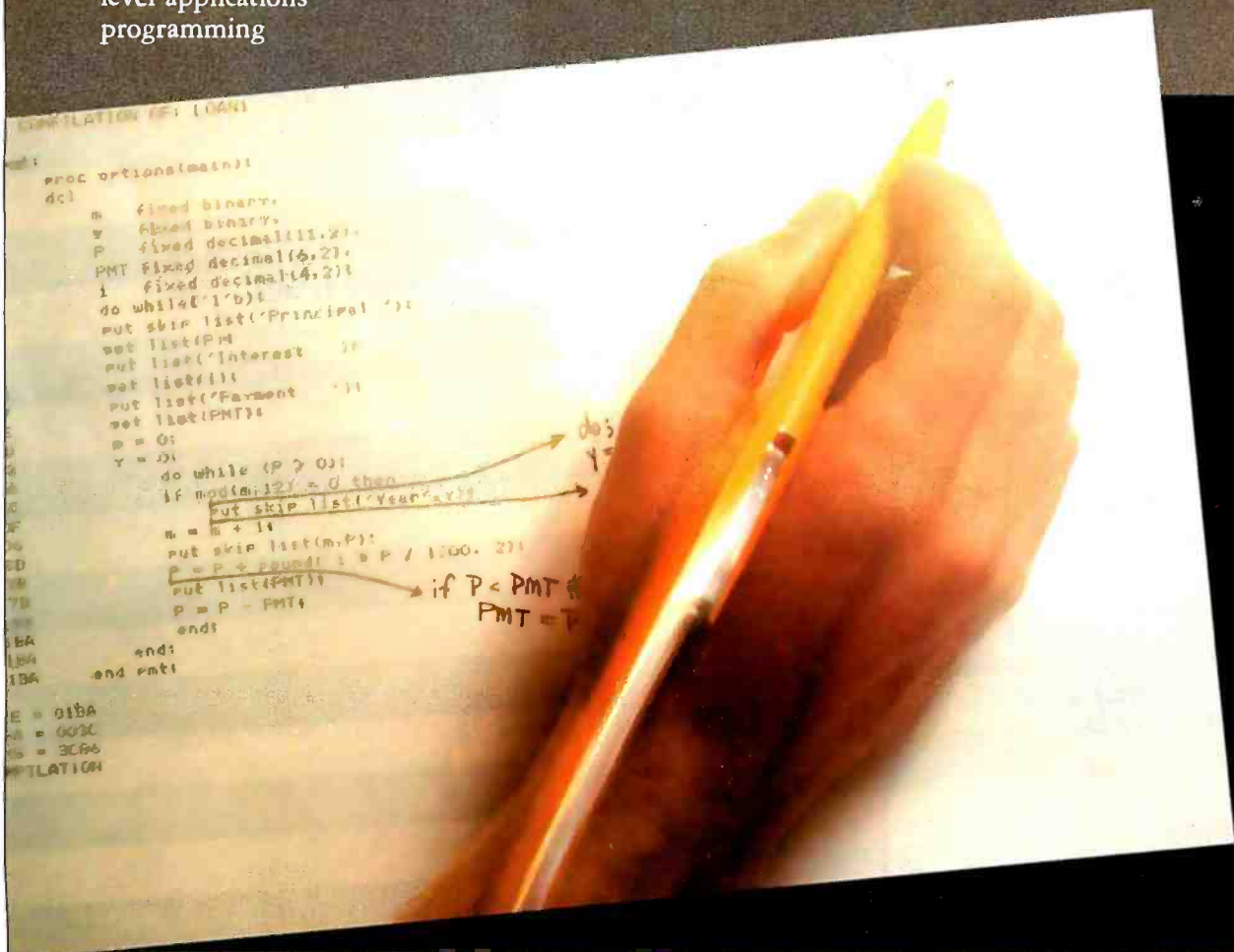

Space Shuttle Columbia is a symbol of the commitment to explore the limits of science and technology.

The Denver Software Company has made a similar commitment: to simplify these breakthroughs for everyday use.

By developing applications software in UCSD Pascal*, the newest microcomputer language, and by using a unique approach to design, The Denver Software Company creates high quality programs for use in business, industry, and the home.

The speed and flexibility of UCSD Pascal enable DSC to manufacture versatile programs, usable on more microcomputers, while at the same time reducing costs to the consumer. In addition, DSC has combined the strength of this language with a new, low-cost portable computer, the Attache from Otrona, to provide the user with even more efficient computer capability.

Pascal-related products now available from The Denver Software Company include:

The PASCAL TUTOR™: Teaches persons at the entry level how to write simple programs. Using the computer as instructor, this self-paced program is the first in a series of Pascal teaching tools. Price \$125

The PASCAL PROGRAMMER™: A programming aid for those familiar with UCSD Pascal. Provides pre-tested modules which reduce programming efforts by approximately 70%. Includes two diskettes with source code and library units, user's manual, complete module documentation, and ideas for modifications. Price: \$125

The FINANCIAL PARTNER™: A one- or two-drive accounting system designed specifically for households or for small businesses with an annual gross of up to \$1,000,000. All necessary "how-to" is contained in a comprehensive user's manual. Price: \$175

PERT/Critical Path Management: Time analysis program which allows critical path supervision. For use in project management, this time-saving system considers manpower and skill levels, and provides for fulltime, fulltime plus overtime, and parttime employment of personnel. Price: \$750

*UCSD Pascal is a trademark of the Regents of the University of California.

All programs available from your local dealer or contact:

THE DENVER SOFTWARE COMPANY

MANUFACTURERS OF MICROCOMPUTER SOFTWARE



36 Steele Street, Suite 19 • Denver, Colorado 80206
Dealer inquiries welcome. 303 321-4551.

..“another giant step”..

“The success of the Columbia mission signifies another giant step in the on-going effort to adapt computer technology for individual use.”

Wally Schina

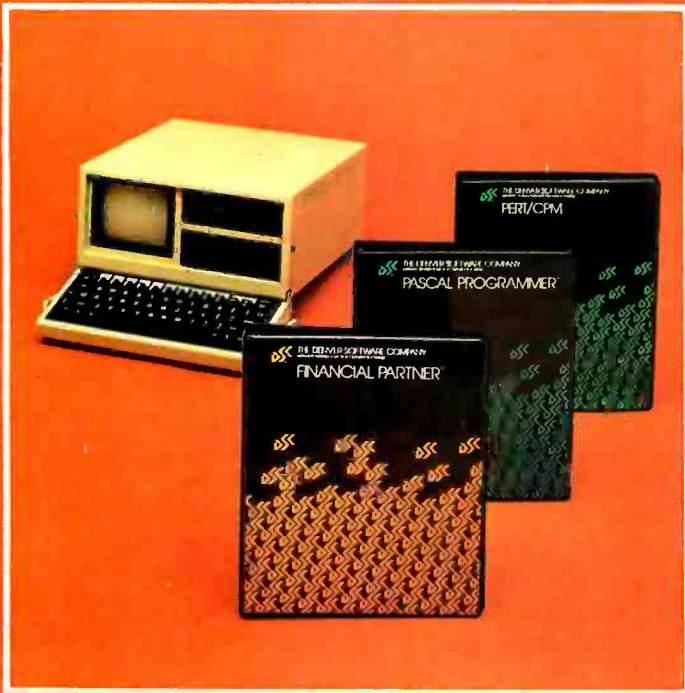

Applications software for business, industry, and home use.
The **FINANCIAL PARTNER™**: accounting for home or small business.
The **PASCAL SERIES**: computer language teaching aids.
PERTCritical Path Management: for efficient project management.

All programs available from your local dealer or contact:

THE DENVER SOFTWARE COMPANY

MANUFACTURERS OF MICROCOMPUTER SOFTWARE



36 Steele Street, Suite 19 • Denver, Colorado 80206
Dealer inquiries welcome. 303 321-4551.

Circle 108 on Inquiry card.

Mathematical Modeling: A BASIC Program to Simulate Real-World Systems

Randall E Hicks
University of Georgia
Marine Institute
Sapelo Island GA 31327

Editor's Note: The subject of this article, simulating systems by solving a system of differential equations, is difficult, but we feel it is useful to many BYTE readers. In fact, only a rudimentary understanding of the principles involved is needed to use the general-purpose BASIC program of listing 2. The involved mathematics at the end of the article presents the theory on which the program is based. . . . GW

Many academic disciplines have used computers for modeling biological, physical, economic, and social systems. Modeling complicated systems once was time-consuming, expensive, and cumbersome. Yet, as computer-related technology advanced, the magnitude of these problems has dwindled, and the potential for less-expensive modeling and simulation tasks in all disciplines has increased.

My purpose is to demonstrate how useful microcomputers can be in mathematical simulations. I will introduce you to modeling the behavior of a system by describing it mathematically with a system of time-invariant linear differential equations. I will show how to solve systems of differential equations by two separate numerical methods. As a framework for the simulation tasks, I will use a simple model as an example for you to follow: a hydrologic model of the forested uplands surrounding Okefenokee swamp in Georgia. (See reference 3.)

The Conceptual Model

To simulate a system, you must be able to conceptualize it into some logical framework. A flow diagram consisting of compartments and connecting flows satisfies this requirement. (See figure 1.) Each compartment in

About the Author

Randall E Hicks is a graduate student at the University of Georgia working toward his PhD in Ecology at the Institute of Ecology. He is employed by Ecology Simulations Inc, Athens, Georgia, as a marine systems modeling consultant.

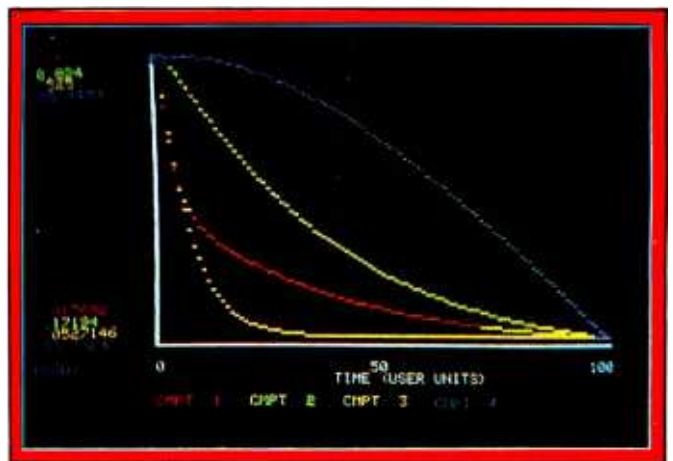

Photo 1: Zero-input response of the Okefenokee swamp hydrologic model simulated with the program in listing 2.

the diagram represents a place for the potential accumulation of energy, matter, or information. A *system* is defined as the collection of compartments that have been outlined and the potential interactions among them. The flows between compartments describe how the system interacts with itself through transfers of the compartmental contents.

The boundaries of the system must also be defined. The *environment* of the system is the area outside the system's periphery. If the system does not interact with its environment, it is called a *closed system*, and the model will not receive inputs from or yield losses to its surroundings. In other words, the system is self-contained. In the Okefenokee swamp uplands hydrologic model, the system is said to be *open* because it interacts with its environment. In the conceptual model (figure 1), this is visualized by an input from the environment to the system and by an output from the system to the environment.

The input to the system (Z) is the sum of the flows to each compartment (f_{i0}) from all environmental inputs. The environment surrounding the system is represented by the numeral 0. In the hydrologic model, there is only

Corvus Lowers the Price of Admission to the Winchester Club.

Here's the price breakthrough you've been waiting for on Winchester disk systems. It's our new 5¼-inch 5-million byte Winchester that adds cost effective mass storage to over 15 of the most popular microcomputers. Now everyone can enjoy the improved reliability, increased storage capacity, and faster speed of sealed-environment Winchester technology.

You can start with 5 million bytes, then expand the system with up to three add-on drives of 5, 10, or 20 million bytes. Our 5 million byte system has all of the advanced features of the larger capacity Corvus systems, including our low cost MIRROR back-up and multi-user CONSTELLATION network that allows up to 64 computers to share the Corvus data base and peripherals such as printers.

Want the full story? Contact your local computer store.



For Apple TRS-80 LSI-11 Zenith
SuperBrain Pet S-100 Bus
Alpha Micro

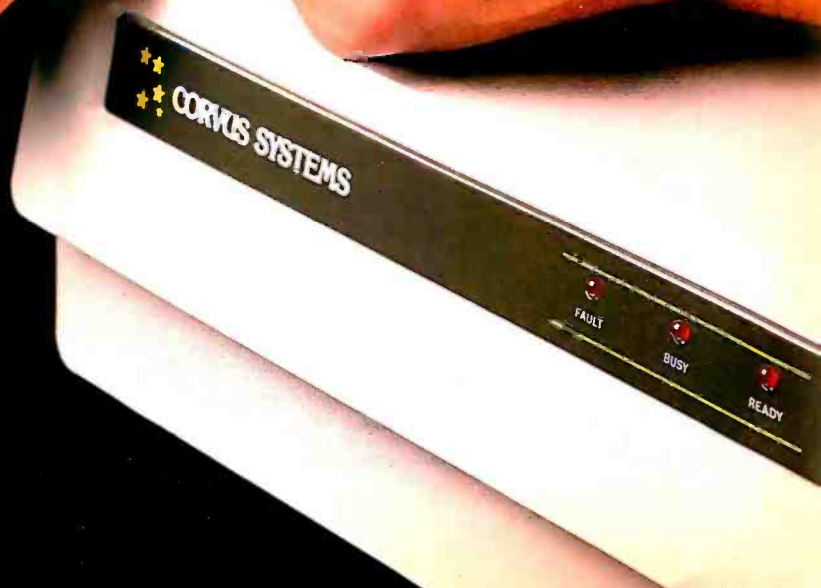

★★★ CORVUS SYSTEMS
★ ★ 2029 O'Toole Avenue
★ ★ San Jose, California 95131
408/946-7700 TWX: 910-338-0226

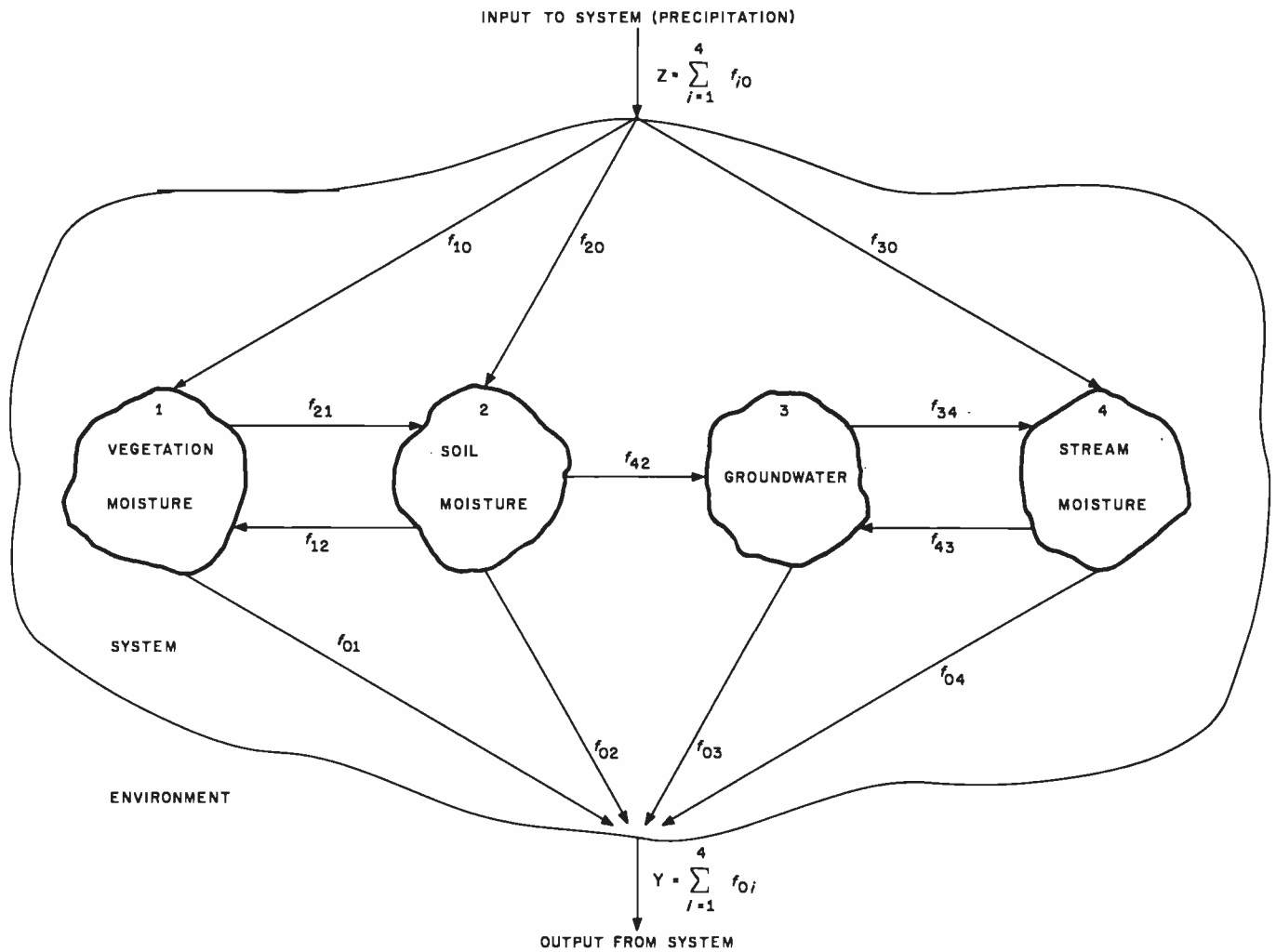

Figure 1: A conceptual model of the hydrology of the forested uplands surrounding Georgia's Okefenokee swamp. The model is subdivided into a system and its environment. The system receives environmental inputs (Z) and yields losses (Y) to the environment. Compartments represent areas of potential water accumulation. Flows and their direction are indicated by connecting arrows. Flows within the system are also given numerical designations. The first number represents the recipient-compartment number and the second represents the donor-compartment number.

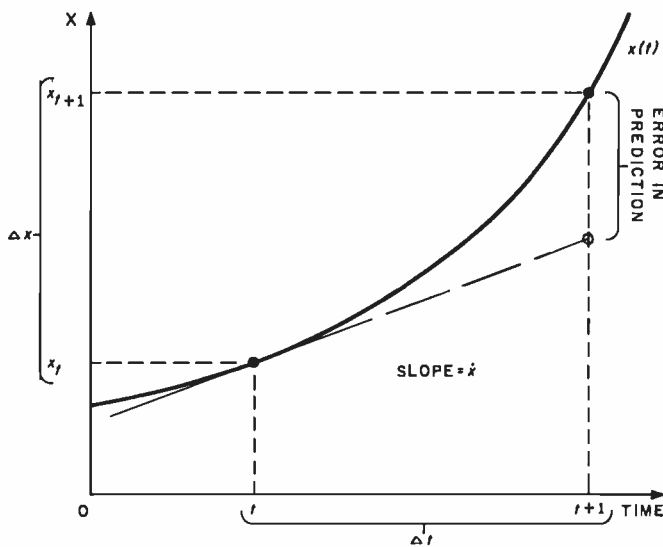
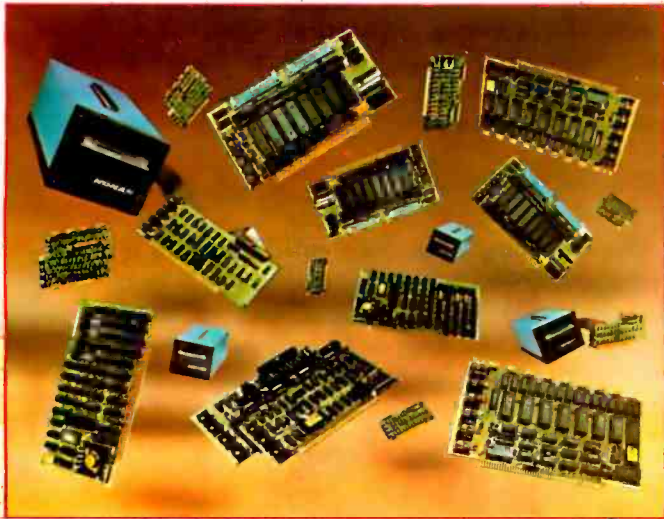

Figure 2: Geometric interpretation of Euler's method for solving differential equations. Compartment size (x) is plotted versus time (t). Actual and predicted compartment sizes are shown.

one environmental input to the system: precipitation. Hence:

$$Z = f_{10} + f_{20} + f_{30} = z_1$$

where the numerical designation of z_k represents an input from environmental input k to the system. Flows within the system are represented by lines connecting compartments; arrows show the direction of flow. These flows are classified by two numbers. The first number indicates the compartment that receives the flow, and the second represents the compartment that yields (i.e. produces) the flow. In figure 1, f_{21} designates an actual flow of moisture from vegetation moisture (compartment 1) to soil moisture (compartment 2). The output from the system (Y) back to the environment is the sum of the losses from each compartment i (f_{0i}). The purpose of the model is to be able to describe the response of each compartment (i.e. how much water is present) at all times in the future.



New Hard Disk Control At Your Fingertips.

Introducing THE DAVID™ a giant step forward.

Konan, known for its innovative, versatile selection of high performance controllers, now offers THE DAVID.

THE DAVID is a series of intelligent HARD DISK CONTROLLERS for the Apple, S-100, Radio Shack, IEEE 488 and others.

Here are all the mighty things THE DAVID does:

- Error correction. 32 bit poly, 11 bit correct.
- Flaw mapping done by controller.
- Single high-speed bidirectional port.
- Fully buffered 256 and 512 byte sectors.
- Write pre-comp/data separation if required.
- Format command. Full or partial disk.
- Read next command.
- Power on diagnostics.
- Single/double density 5 1/4" and 8" floppy available in 8" hard disk products.

Hard disks currently supported include most 5 1/4's and CDC Finch. To come are all 8" hard disks with the SA1000 interface (7-81), and SMD drives (9-81). Other drive implementations available soon.

These very low cost controllers are all host software and hardware compatible. That means total flexibility to change drive types or manufacturers, without rewriting software or designing new hardware.

In other words, THE DAVID is a giant in its own right...and every bit IN CONTROL. Put this powerful equipment to work for you. Give us a call on Konan's toll-free order line.

800-528-4563

Or write to: Konan Corporation
1448 N. 27th Avenue, Phoenix, AZ 85009
TWX/TELEX 9109511552

Konan offers a selection of other fine tape and disk controller products and is actively pursuing license agreements.

IN CONTROL and THE DAVID are registered trademarks of Konan Corporation.



The Mathematical Model

The flows into and out of each compartment can be represented by a difference, or a differential, equation. In the model, the flows have been balanced so that no compartment will have a net gain or loss of moisture. The system is said to be at *steady-state*, and the corresponding model will be *static* in nature. The relationships in the flow diagram can be depicted by a system of linear differential equations. In the steady-state example, each differential equation representing a compartment is equal to 0, since inflows and outflows are equal.

For compartment 1 (vegetation moisture), the differential equation would be of the form:

$$\frac{dx_1}{dt} = \dot{x}_1 = f_{10} + f_{12} - f_{21} - f_{01}$$

(Note: In this equation, I have used a dot centered over a variable to simplify notation. Henceforth, this will mean the derivative of a variable with respect to time.)

The actual flows (f_{ij}) can be divided by the steady-state size of the corresponding donor compartment (x_j), or by the environment input (z_k), to give two types of coefficients: intercompartmental rate coefficients and environmental input coefficients:

$$a_{ij} = \frac{f_{ij}}{x_j}$$

and:

$$b_{ik} = \frac{f_{i0}}{z_k}$$

where:

i = the recipient compartment
 j = the donor compartment

and:

k = an environmental input number

Notice that the intercompartmental coefficients a_{ij} (of

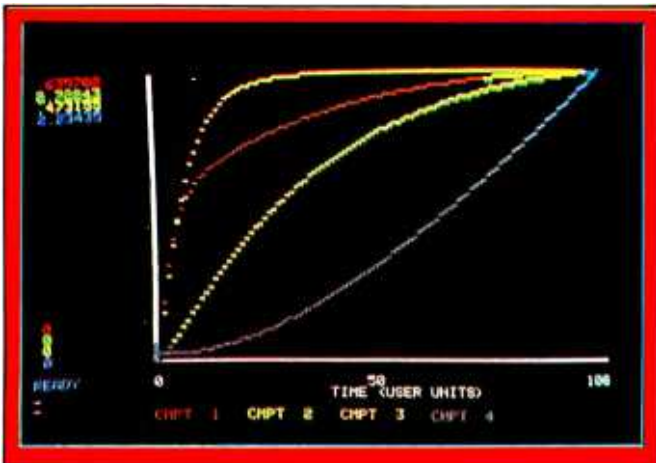

Photo 2: Zero-state response of the Okefenokee swamp hydrologic model simulated with the program in listing 2.

matrix A) have the same numerical designation as their corresponding flows. Also notice that the environment is represented by a 0 in flows. When environmental input coefficients are formed, you subdivide the total environmental input Z into the different types (k) of environmental inputs. These coefficients (b_{ik} of matrix B) are dimensionless and express the percentage of an environmental input (z_k of vector Z) that each compartment receives. These numerical notations define the position of each coefficient in an appropriate coefficient matrix. For compartment 1 (vegetation moisture), the differential equation then becomes:

$$\dot{x}_1 = a_{12}x_2 - a_{11}x_1 + b_{11}z_{11}$$

After redefining all the differential equations into coefficients multiplied by the appropriate donor-compartment size or environmental-input size, you can organize the system of equations into a single matrix equation:

$$\dot{X}_{n1} = A_{nn}X_{n1} + B_{nm}Z_{m1}$$

where:

n = the number of compartments
 m = the number of environmental inputs to the system
 \dot{X}_{n1} = a column vector of differential equations

$$\begin{bmatrix} \dot{x}_1 \\ \vdots \\ \dot{x}_n \end{bmatrix}$$

A_{nn} = an n by n matrix of intercompartmental rate coefficients

$$\begin{bmatrix} a_{11} & \cdot & \cdot & \cdot & a_{1n} \\ \cdot & \cdot & \cdot & \cdot & \cdot \\ \cdot & \cdot & \cdot & \cdot & \cdot \\ \cdot & \cdot & \cdot & \cdot & \cdot \\ a_{n1} & \cdot & \cdot & \cdot & a_{nn} \end{bmatrix}$$

X_{n1} = a column vector of initial compartment sizes

$$\begin{bmatrix} x_1 \\ \vdots \\ x_n \end{bmatrix}$$

B_{nm} = an n by m matrix of input rate coefficients

$$\begin{bmatrix} b_{11} & \cdot & \cdot & \cdot & b_{1m} \\ \cdot & \cdot & \cdot & \cdot & \cdot \\ \cdot & \cdot & \cdot & \cdot & \cdot \\ \cdot & \cdot & \cdot & \cdot & \cdot \\ b_{n1} & \cdot & \cdot & \cdot & b_{nm} \end{bmatrix}$$

What has nine lives, three forms,
multiple faces and a price tag
that almost disappears?



The Magical Microline 80 Printer

It's magic! Well, almost. The Microline 80 will run all day at 80 cps with no duty cycle limitations. The head is warranted for 200,000,000 characters. That translates to over nine years on your TRS-80™, APPLE® or other small computer.

Want to change forms? The magical Microline 80 is three printers disguised as one. There is a whisper-quiet rubber platen for cut sheets and roll paper, pins on nine inch centers for pin feed stock and optional snap-on tractors that adjust to suit all your other forms. The Microline 80 also saves paper by letting you tear off as close as one inch from the last print line.

Want to change your image? The magical Microline 80 really does tricks. It prints upper

and lower case condensed and double width characters and block graphics for charts, graphs and diagrams.

The Microline 80 is not a toy. With two motors, a rugged cast aluminum base and a head you never have to throw away, the Microline 80 is built to handle the most demanding business applications.

Which brings us to the biggest magic of all, the price tag, the one that almost disappears. If we're not the lowest, we are so close that it doesn't matter. There are stocking Microline distributors throughout the country. Call or write today for the name of the one near you and the price of the Magical Microline 80.

OKIDATA

Okidata Corporation, 111 Gaither Drive, Mount Laurel, New Jersey 08054 609-235-2600

Okidata is a subsidiary of Oki Electric Industry Company, Ltd.

and:

Z_{m1} = a column vector of environmental input sizes

$$\begin{bmatrix} z_1 \\ \cdot \\ \cdot \\ \cdot \\ z_m \end{bmatrix}$$

The matrices and vectors for the hydrologic model are:

$$A = \begin{bmatrix} -.369 & .035 & 0.0 & 0.0 \\ .189 & -.0483 & 0.0 & 0.0 \\ 0.0 & 0.0 & -.1632 & .000161 \\ 0.0 & .012 & .000444 & -.000623 \end{bmatrix} \times 1/(10 \text{ years})$$

$$X = \begin{bmatrix} 0.6500 \\ 2.8940 \\ 0.5250 \\ 55.4400 \end{bmatrix} \times 10^8 \text{m}^3 \text{ water} \quad B = \begin{bmatrix} 0.60 \\ 0.07 \\ 0.33 \\ 0.00 \end{bmatrix}$$

and:

$$Z = [.233] \times 10^8 \text{m}^3 \text{ water} / (10 \text{ years})$$

At best, this is a brief treatment of the use of linear differential equations in simulating the behavior of a collection of components. The hydrologic model herein is described by a deterministic general linear model (GLM) of donor-controlled differential equations. This type of model is among the simplest and the most straightforward to use; it has found wide acceptance in many fields. There are many books on general-systems theory and modeling that go into more detail than I can in this article. (For further reading, see references 4 and 5.) Higher-order differential equations can also be used to describe the time-varying changes in flows between compartments in a model. (See reference 2.) A nonlinear model would incorporate higher-order differential equations.

Numerical Solution of Differential Equations

Now that the model has been described with a system of linear differential equations, a method to solve these equations on a computer is needed. Several numerical methods are available for solving differential equations, but I will discuss only two methods and their implementation on microcomputers: the *Euler* and *Runge-Kutta* methods. I will briefly describe each method and list a corresponding algorithm written in BASIC (Disk BASIC 8001, for the CompuColor II microcomputer) for implementation on a microcomputer. For a more detailed description of these and other methods for solving differential equations, consult a book on numerical analysis or modeling. (See references 1 and 5.)

Euler's (Rectangular) Method

Euler's method is a simple but computationally inefficient method for solving finite differential equations. First, let's look at a geometric interpretation of this method. (See figure 2.)

Knowing the present value (state) of a compartment (x_t), you want to be able to predict the next value (x_{t+1}). Your differential equation for the compartment defines the slope of the line at time t . You project this slope to the next point in time ($t+1$), and add the change in x 's value (called Δx) to the value of x at time t (x_t). In many cases (such as in figure 2), the slope of the actual path of the compartment size may not be equal to the predicted value. In these instances, this algorithm has incorporated some error into the predicted value for the compartment size at the new time. In the Euler method, this error is proportional to the time step (Δt). This error can be reduced by decreasing the time step; however, that will increase the algorithm execution time on the computer.

The algorithm for the Euler method is:

1. $\dot{X}_t = f(X_t, Z_t, t)$
2. $X_{t+1} = X_t + \Delta t(\dot{X}_t)$

First, compute the slope of the line at t , which you assume is the same at $t+1$. In the hydrologic model, this is already determined by the time-invariant differential equations for each compartment. Second, you compute the new compartment size (x_{t+1}). Then you return to step 1 and continue the process for as many times as you wish. If you want to reduce the error in the algorithm, you can decrease your time step and perform the algorithm several times. In this way, you increase the number of iterations of the algorithm before you calculate your final value. Listing 1 is a program for the Euler algorithm written in Disk BASIC 8001.

Runge-Kutta Method

Runge-Kutta is a multistep, look-forward method for the numerical solution of differential equations. I will

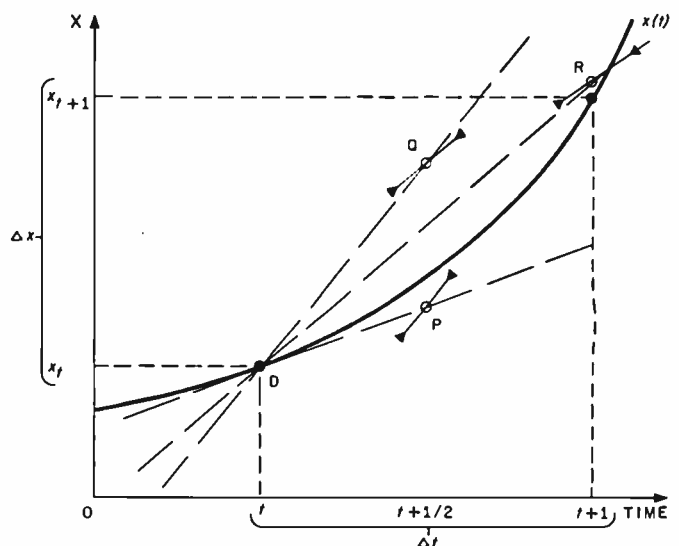

Figure 3: Geometric interpretation of the fourth-order Runge-Kutta method for solving differential equations. Compartment size (x) is plotted versus time (t). Actual and predicted compartment sizes are shown.



NO MATTER WHAT MIRACLES YOUR COMPUTER MAY PERFORM, THE 739 PUTS IT DOWN ON PAPER.

To get full advantage of your computer's versatility you must have an equally versatile printer. One designed for your office. Suited to your budget. And built to deliver all the management information, correspondence – and graphics – that good management demands.

Introducing the Centronics Model 739.

Backed by Centronics 12-year reputation for rugged dependability and superior service, the Model 739 brings big printer technology into your office environment. Still, its desk-top size, super-quiet operation and handsome styling effectively mask the 12-hour-a-day workhorse within.

You can feed the Model 739 three different ways, fan-fold forms, bond sheets, roll stock. But that's just the beginning.

It's the end result that impresses you most. The high density dot matrix characters produce printout of superior quality. Correspondence quality. True descenders, proportionally spaced and justified right and left.

In short, one printer that will meet all your needs for under a thousand dollars.

The Centronics Model 739. The strong, silent miracle-maker. You can see and try it at your nearest dealer. Or contact Centronics Data Computer Corp., Dept. I-6, One Wall Street, Hudson, N.H. 03051. (603) 883-0111.

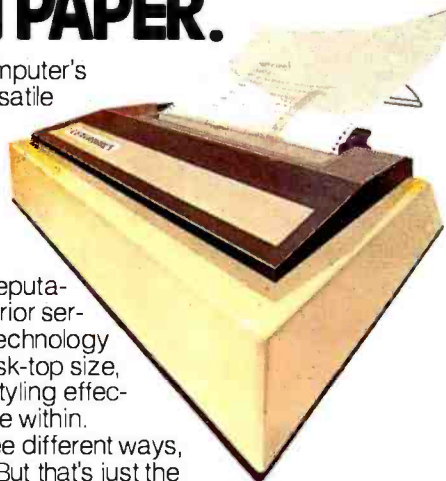

CENTRONICS® PRINTERS
THE REALITY OF COMPUTER TECHNOLOGY

discuss the fourth-order Runge-Kutta method. It is computationally more involved than Euler's method, but it incorporates less error into the prediction of the next compartment size (x_{t+1}). The geometric interpretation of this method is shown in figure 3.

As with the Euler method, knowing the present compartment value (x_t), you want to predict the next compartment value (x_{t+1}). First, you find the slope (XD) of the line at time t . Then, as in Euler's method, you calculate the compartment size (P), but at time $t + 1/2$. After you calculate the slope (XP) at P , make a second prediction of the compartment size (Q) at time $t + 1/2$. After you calculate the slope (XQ) at Q , make a third prediction of the compartment size (R), but at time $t + 1$. Again, calculate the slope (XR). Next, take a weighted average of all the slopes you calculated and determine your final prediction of the compartment size (x_{t+1}) at time $t + 1$. As with Euler's method, the Runge-Kutta method incorporates some error into your predictions; however, the error is now proportional to the fourth power of the time step (Δt) and is greatly reduced. The error can be reduced further by decreasing the time step.

The algorithm for the fourth-order Runge-Kutta method is:

1. $\dot{X}_t^D = f(X_t, Z_t, t)$
2. $X_{t+1/2}^P = X_t + \Delta t/2(\dot{X}_t^D)$
3. $\dot{X}_{t+1/2}^P = f(X_{t+1/2}^P, Z_{t+1/2}, t + 1/2)$
4. $X_{t+1/2}^Q = X_t + \Delta t/2(\dot{X}_{t+1/2}^P)$
5. $\dot{X}_{t+1/2}^Q = f(X_{t+1/2}^Q, Z_{t+1/2}, t + 1/2)$

Listing 1: *CompuColor II Disk BASIC 8001 program segment of Euler integration algorithm.*

```

190 REM ***** START SIMULATION *****
195 FOR IJ=1 TO 100
200 DT=1/KK
210 REM ***** START EULER INTEGRATION LOOP *****
215 FOR JJ=1 TO KK
220 FOR I=0 TO N
230 AX(I)=0
240 FOR J=0 TO N: AX(I)=AX(I)+A(I,J)*X(J): NEXT J
250 FOR K=0 TO NN: AX(I)=AX(I)+B(I,K)*Z(K): NEXT K
260 NEXT I
270 FOR I=0 TO N: X(I)=X(I)+DT*AX(I): NEXT I
275 NEXT JJ
280 FOR I=0 TO N: XX(IJ,I)+X(I): NEXT I
290 NEXT IJ
300 REM ***** END OF SIMULATION *****

```

6. $X_{t+1}^R = X_t + \Delta t(\dot{X}_{t+1/2}^Q)$
7. $\dot{X}_{t+1}^R = f(X_{t+1}^R, Z_{t+1}, t+1)$
8. $X_{t+1} = X_t + \Delta t(\frac{1}{6}(\dot{X}_t^D) + \frac{1}{3}(\dot{X}_{t+1/2}^P) + \frac{1}{3}(\dot{X}_{t+1/2}^Q) + \frac{1}{6}(\dot{X}_{t+1}^R))$

If you wish to reduce the error in the algorithm, you can decrease the time step (Δt), perform the algorithm several times, and save the last prediction of the compartment size. The Runge-Kutta integration method is incorporated into the GLM program in listing 2.

General Linear Model Program

So far, I have discussed the general linear model form and two different algorithms for the numerical solution of differential equations. I have combined these two topics and written a general-user program for mathematically modeling a system of components described by linear differential equations, solved for 100 time increments with a Runge-Kutta integration algorithm. This program was written in Disk BASIC and is given in listing 2. To use this program, you enter the number of compartments in and environmental inputs to your system, an intercompartmental rate coefficient matrix (**A**), the initial compartment values, an input coefficient matrix (**B**), and the environmental input values. You must also enter the desired number of iterations of the Runge-Kutta algorithm. This value is the reciprocal of the

Text continued on page 86

PLOT 2	Enter graph-plotting mode
PLOT 2, X, Y	Point at X,Y
PLOT 2, 242, X, Y	Vector to X, Y
PLOT 2, 250, X0, Y, XM	Horizontal bar at Y from X0 to XM
PLOT 2, 246, Y0, X, YM	Vertical bar at X from Y0 to YM
PLOT 3, T, L	Cursor to tab T at line L
PLOT 6, C	Defines the color of both the foreground and background
PLOT 8	Cursor to home
PLOT 9	Tab 8 spaces
PLOT 10	Line feed (move cursor down one line)
PLOT 11	Erase line
PLOT 12	Erase page
PLOT 14	Double-height text
PLOT 15	Normal-height text, with blink mode off
PLOT 16 thru PLOT 23	Changes color of foreground or background (whichever is active)
PLOT 27, 4: PRINT	
""[disk commands]":	
PLOT 27, 27	Execute floppy-disk command
PLOT 27, 10	Write text vertically
PLOT 27, 24	Write text horizontally
PLOT 28	Cursor up
PLOT 29	Enable background color
PLOT 31	Blink on
PLOT 255	Cancel graph-plotting mode

Table 1: *The use of the PLOT command in Disk BASIC 8001 (for the CompuColor II). This information will help explain certain parts of listing 2, if you convert that program to another microcomputer.*

NEW DISK SYSTEM POLISHES APPLE™



Plug into your Apple II or Apple II-plus with a Micro-Sci disk system, and you get Apple software compatibility, PLUS: Increased capacity, improved performance and higher reliability. And you save money, too!

COMPATIBILITY:

With thousands of programs currently available in Apple format—and many more being released every day—the ability to read and write diskettes interchangeable with the Apple disk II system is a MUST. The Micro-Sci disk subsystems offer this compatibility and more. Our disk system has a jumper-selectable boot PROM to move from DOS 3.2 to DOS 3.3, or to the language system at your fingertips.

CAPACITY:

The Micro-Sci A-40 system provides 40 tracks of storage (versus the Apple disk II system which offers only 35 tracks). The A-40's 5 extra tracks give you an additional 20,000 bytes of storage. And for even greater capacity, check out our A-70 system which offers a full 70 tracks of storage—exactly DOUBLE the storage capacity of the Apple disk II system!

PERFORMANCE:

Micro-Sci's disk systems' abbreviated track-to-track access time of 5msec (versus 15msec for the Apple disk II) means improved random disk access performance.

RELIABILITY:

Micro-Sci disk systems incorporate band-actuated head positioners for faster access and more accurate head positioning. Each disk system features Micro-Sci's improved media centering system which provides uncommonly accurate diskette registration, and virtually eliminates damage to the media centering hole.

PRICE:

The Micro-Sci A-40 drive, with controller, is priced at only \$549; the second A-40 drive is only \$449. The large-capacity A-70 disk drive with controller is only \$699, with the second drive priced at only \$599.

Call or write us today to order your new Micro-Sci disk system.

μ-SCI

17742 Irvine Boulevard, Suite 205, Tustin, California 92680 / Phone: 714/731-9461 / Telex: 910-346-6739

Apple and Apple II are registered trademarks of APPLE COMPUTERS INC., SAN JOSE, CALIFORNIA

NEW! S-100 - **ads**
PROM BLASTER

PROGRAMS MOST FAMILIES OF EPROMS!

- ACCEPTS 1K/2K/4K OR 8K EPROMS!
- EXTENDED DEVICE OPTION
- PHANTOM SLAVE OPTION
- ALL PROGRAMMING CHARACTERISTICS SOFTWARE CONTROLLED!
- ACCEPTS SINGLE OR 3 SUPPLY PARTS
- DEVICE ADDRESS SWITCH SELECTABLE
- ON-BOARD WAIT STATES

Put your frequently used routines into EPROM!

Bare board \$59.95
Software \$55.00
Together \$99.95
+ 2.5% for shipping

NEW! S-100
KLUGE CARD

SIMPLIFY YOUR PROJECTS WITH A PROTOTYPE BREADBOARD WITH EXTRAS!

- 4 ON-BOARD PWR. SUPPLIES UP TO 3 OF WHICH CAN BE +5, or ± 5 , ± 12
- SWITCH SELECTABLE MEMORY OR DEVICE ADDRESS
- ON-BOARD ADDRESS/ DEVICE DECODING
- BI-DIRECTIONAL DATA BUS BUFFERING
- ON-BOARD WAIT STATES
- LARGE BREADBOARD AREA

Bare board \$39.95
+ 2.5% for shipping

MASTERCARD/VISA
CHECK OR MONEY ORDER
ILL. RES. ADD SALES TAX
ACKERMAN
DIGITAL SYSTEMS, INC.
110 N. YORK RD., SUITE 208
ELMHURST, ILLINOIS 60126
(312) 530-8992

Listing 2: A general-user program written in Disk BASIC 8001 for mathematical modeling with a system of time-invariant linear differential equations. The equations are solved for 100 user time increments with a fourth-order Runge-Kutta integration algorithm. As the program is written, the simulation results are scaled and plotted versus time on a video monitor (Compucolor II microcomputer). This section of the program will have to be modified for other microcomputer systems. See table 1 for further information on the PLOT command.

```

10 REM ***** GENERAL LINEAR MODEL SIMULATION PROGRAM *****
11 REM ***** WITH RUNGA-KUTTA INTEGRATION *****
20 REM ***** BY RANDALL E. HICKS *****
21 REM ***** COPYRIGHT 1980 *****
24 PLOT 12
25 PRINT "GIVEN:"
30 PRINT "1) THE NUMBER OF MODEL COMPARTMENTS"
35 PRINT "2) THE NUMBER OF ENVIRONMENTAL INPUTS"
40 PRINT "3) A MATRIX OF INTERCOMPARTMENTAL RATE COEFFICIENTS"
42 PRINT "4) A VECTOR OF INITIAL COMPARTMENT SIZES"
45 PRINT "5) A MATRIX OF ENVIRONMENTAL INPUT COEFFICIENTS"
47 PRINT "6) A VECTOR OF ENVIRONMENTAL INPUT SIZES AND"
50 PRINT "7) THE NUMBER OF ITERATIVE INTEGRATION STEPS --"
51 PRINT
52 PRINT "THIS PROGRAM WILL USE A SYSTEM OF TRANSITION"
53 PRINT "EQUATIONS TO SIMULATE THE BEHAVIOR OF YOUR SYSTEM"
54 PRINT "USING A RUNGE-KUTTA INTEGRATION ALGORITHM WITH THE"
55 PRINT "OUTPUT PLOTTED AS A GRAPH ON THIS TERMINAL!"
74 PRINT
75 INPUT "HOW MANY COMPARTMENTS IN YOUR MODEL (N=1-7)?" :N
80 N= N- 1:PRINT
85 INPUT "HOW MANY INPUT ENVIRONMENTS IN YOUR MODEL (N=1-3)?" :NN
90 NN= NN- 1
95 DIM A(N,N),B(N,NN),XX(100,N),X(N),AX(N),XD(N),XP(N),XQ(N),XR(N),Z(NN)
100 DIM BE(N),S(N),P(N)
110 PRINT "ENTER MATRIX OF INTERCOMPARTMENTAL RATE"
115 PRINT "COEFFICIENTS -- ROW BY ROW, ONE COLUMN AT A TIME."
120 FOR I= 0 TO N
125 FOR J= 0 TO N:INPUT A(I,J):NEXT J
130 NEXT I
135 PRINT "ENTER INITIAL COMPARTMENT VALUES"
140 FOR I= 0 TO N:INPUT XX(0,I):NEXT I
145 PRINT "ENTER YOUR MATRIX OF ENVIRONMENTAL INPUT"
146 PRINT "COEFFICIENTS"
150 FOR I= 0 TO N
155 FOR J= 0 TO NN:INPUT B(I,J):NEXT J
160 NEXT I
165 PRINT "ENTER THE SIZES OF YOUR ENVIRONMENTAL INPUTS"
170 FOR J= 0 TO NN:INPUT Z(J):NEXT J
175 PRINT "ENTER THE NUMBER OF ITERATIONS OF THE ALGORITHM"
176 PRINT "BEFORE INTEGRATION COMPLETION.":INPUT KK
180 REM ***** STORE INITIAL COMPARTMENT VALUES *****
185 FOR J= 0 TO N:X(J)= XX(0,J):NEXT J:PLOT 12
190 REM ***** START SIMULATION *****
195 FOR IJ= 1 TO 100
200 DT= 1/ KK
205 REM ***** START ITERATIVE INTEGRATION LOOP *****
210 FOR JJ= 1 TO KK
215 REM ***** START RUNGA-KUTTA INTEGRATION *****
217 REM ** COMPUTE DX/DT AT TIME J-1 **
220 FOR I= 0 TO N
221 XD(I)= 0
225 FOR J= 0 TO N:XD(I)= XD(I)+ A(I,J)* X(J):NEXT J
230 FOR K= 0 TO NN:XD(I)= XD(I)+ B(I,K)* Z(K):NEXT K
231 NEXT I
240 REM ** COMPUTE FIRST ESTIMATE OF STATE(P) AT TIME IJ-1/2 **
245 FOR I= 0 TO N:AX(I)= X(I)+ (DT/ 2)* XD(I):NEXT I
250 REM ** COMPUTE DX/DT AT P **
255 FOR I= 0 TO N
256 XP(I)= 0
260 FOR J= 0 TO N:XP(I)= XP(I)+ A(I,J)* AX(J):NEXT J
261 FOR K= 0 TO NN:XP(I)= XP(I)+ B(I,K)* Z(K):NEXT K
265 NEXT I
270 REM ** MAKE SECOND ESTIMATE OF STATE(Q) AT TIME IJ-1/2 **
275 FOR I= 0 TO N:AX(I)= X(I)+ (DT/ 2)* XP(I):NEXT I
280 REM ** COMPUTE DX/DT AT Q **

```

Listing 2 continued on page 84

MULTIUSER

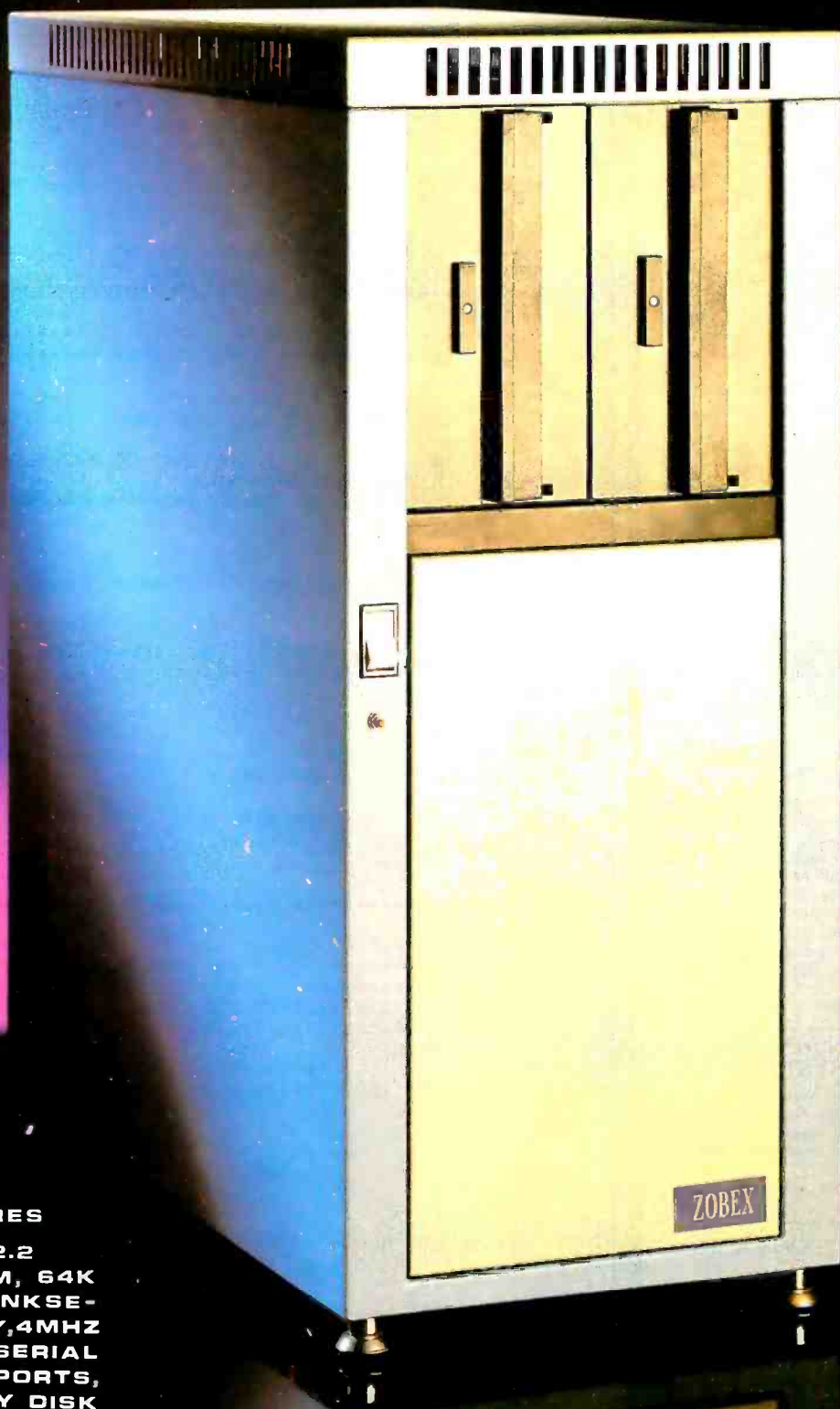

COMPUTER
ON S-100 BUS
DESIGNED TO
SATISFY A WIDE
VARIETY OF
APPLICATIONS.

STANDARD FEATURES

INCLUDE: CP/M 2.2
OPERATING SYSTEM, 64K
EXPANDABLE, BANKSE-
LECTABLE MEMORY, 4MHZ
Z80A CPU WITH 4 SERIAL
AND 3 PARALLEL PORTS,
RELIABLE 8" FLOPPY DISK
DRIVES IN A STURDY ALL
METAL CABINET.

\$4900

MP/M OPTIONAL.

CP/M AND MP/M REGISTERED TRADE MARKS OF DIGITAL RESEARCH

ZOBEX®

P.O. BOX 1847 SAN DIEGO, CA. 92112
7343-J RONSON RD, SAN DIEGO, CA. 92111
(714) 571-6971

NEW CATALOGUE LISTINGS
FROM
JOHN D. OWENS
ASSOCIATES, INC.

dBase II ASHTON-TATE...\$615

Brings power of mainframe database software to a microcomputer. Runs under CP/M®. Extremely easy to use. Manual and demo software\$50
MONEY BACK GUARANTEE.

DYNABITE SYSTEMS

Encompasses broad range of small business systems to sophisticated multi-processor, multi-user networking complexes. Hardware is modularly expandable. Extensive software includes business applications and word processing. Dynabite provides a whole package, complete with operator training, systems support, even business forms and furniture.

CAT 100 FULL COLOR GRAPHICS

Complete S-100 color imaging system with high performance video FRAME GRABBER. 3 fundamental functions are + digitization of video input in real time ++ image storage in dual-port, on-board memory +++ video input of buffered image in gray levels, NTSC color or RGB color.

Discount price \$1,875.
Write or call for option descriptions and pricing, too numerous to list here.

HOUSTON INSTRUMENTS HIPAD DIGITIZER

Create your own graphics using either stylus or optional cursor. Excellent for architectural drawing, business graphs, schematics, free form drawing, etc. More accurate and easier to use than keyboard input or joysticks. "Stream mode" allows continuous placement of coordinate pairs on 11" X 11" pad using either stylus or optional cursor. For S-100 systems and also Apple, TRS-80, PET.

Our discounted price \$ 755.

DMA-DOS North Star 8" FLOPPY SUBSYSTEM

A new operating system, completely CP/M® compatible that allows use of both 8" (Shugart single sided, double density via Tarbell controller) and 5¼" drives.

Complete hardware, software package \$1,910.

SEE OUR ADS ON PAGES
228 AND 229

JOHN D. OWENS
Associates, Inc.

12 Schubert Street
Staten Island, New York 10305

212 448-6283 212 448-2913 212 448-6298
Overseas Callers: Phone 212 448-6298

WE HAVE NO READER INQUIRY NUMBER.
PLEASE WRITE OR CALL.

Listing 2 continued:

```

285 FOR I= 0 TO N
286 XX(I)= 0
290 FOR J= 0 TO N:XX(I)= XX(I)+ A(I,J)+ AX(J):NEXT J
300 FOR K= 0 TO NN:XX(I)= XX(I)+ B(I,K)+ Z(K):NEXT K
310 NEXT I
320 REM ** MAKE ESTIMATE OF STATE(R) AT TIME J **
330 FOR I= 0 TO N:AX(I)= X(I)+ DT+ XX(I):NEXT I
335 REM ** COMPUTE DX/DT AT R **
340 FOR I= 0 TO N
344 XR(I)= 0
345 FOR J= 0 TO N:XR(I)= XR(I)+ A(I,J)+ AX(J):NEXT J
350 FOR K= 0 TO NN:XR(I)= XR(I)+ B(I,K)+ Z(K):NEXT K
355 NEXT I
360 REM ** COMPUTE FINAL VALUES FOR STATE AT TIME J **
364 FOR I= 0 TO N:X(I)= X(I)+ DT+ (X(I)/ 6+ XP(I)/ 3+ XR(I)/ 3+
XR(I)/ 6):NEXT I
370 NEXT J
375 REM ** STORE COMPARTMENT SIZES AT TIME J IN MATRIX **
380 FOR I= 0 TO N:XX(I,J)= X(I):NEXT I
385 REM ***** END OF ITERATIVE INTEGRATION LOOP *****
390 NEXT I,J
395 REM ***** END OF SIMULATION *****
405 REM ***** START OUTPUT *****
409 PLOT 12
410 PRINT "THE NUMBER OF COMPARTMENTS IN THE MODEL IS:";N+ 1
415 PRINT "THE SIMULATION HAS CONTINUED FOR 100 USER TIME UNITS."
"
420 PRINT "THE NUMBER OF ITERATIONS OF THE ALGORITHM FOR EACH"
421 PRINT "INTEGRATION WAS: ";KK
425 PRINT "THE MATRIX OF INTERCOMPARTMENTAL RATE COEFFICIENTS IS
: "
430 PRINT
435 FOR I= 0 TO N
440 FOR J= 0 TO N:PRINT TAB( J+ 10);A(I,J);:NEXT J:PRINT :PRINT
445 NEXT I
450 PRINT :PRINT
455 PRINT "TO SEE A GRAPH OF THE SIMULATION, ENTER CONT AND"
460 PRINT "HIT THE RETURN KEY."
500 END
610 FOR I= 0 TO N:BB(I)= XX(0,I):S(I)= XX(0,I):NEXT I
620 FOR J= 0 TO N
630 FOR I= 1 TO 100
640 IF BB(J)> XX(I,J) THEN 660
650 BB(J)= XX(I,J)
660 IF S(J)< XX(I,J) THEN 680
670 S(J)= XX(I,J)
680 NEXT I
690 NEXT J
830 REM ***** END OF SEARCH *****
860 FOR I= 0 TO N:P(I)= 99.0/ (BB(I)- S(I)):NEXT I
870 REM ***** SCALE VALUES CALCULATED *****
880 PLOT 12,30,16,29,23
890 PLOT 2,26,25,242,127,25,255
900 PLOT 2,26,26,242,26,127,255
910 FOR I= 0 TO N
920 PLOT 15,17+ I,3,(I+ 10+ 13),30
930 PRINT "CMPT";SPC( 1);I+ 1
931 NEXT I
950 PLOT 15,23,3,32,28
960 PRINT "TIME (USER UNITS)";
970 PLOT 3,13,27
980 PRINT "0"
990 PLOT 3,36,27
1000 PRINT "50"
1010 PLOT 3,61,27
1020 PRINT "100"
2000 FOR I= 0 TO N
2010 PLOT 15,17+ I,3,0,I
2020 PRINT BB(I):NEXT I
2030 FOR I= 0 TO N
2040 PLOT 15,17+ I,3,0,I+ 22
2050 PRINT S(I):NEXT I
2060 FOR J= 0 TO N
2070 FOR I= 0 TO 100:XX(I,J)= (XX(I,J)- S(J))+ P(J)+ 1:NEXT I
2080 NEXT J
2105 REM ***** START PLOT OF OUTPUT MATRIX *****
2110 FOR J= 0 TO N
2120 PLOT 17+ J,2,26,XX(0,J)+ 26,255
2130 FOR I= 1 TO 100

```

Listing 2 continued on page 86

"Pascal-1 helps our customers meet complex, real-time needs."

Don Cutler, Chief Systems Engineer,
Electro Scientific Industries, Inc. (ESI), Portland, Oregon

More than 125,000 microcircuit resistors per hour can be adjusted by ESI's PDP-11/04 controlled laser trimming systems. The Pascal-1 compiler has given ESI fast, precise control since 1976. ESI's Don Cutler says, "Pascal-1 offers two big advantages—real-time performance and real problem-solving power."

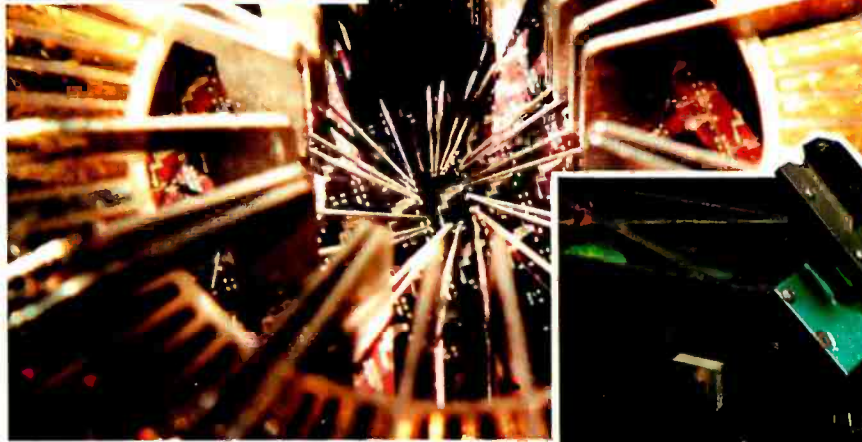

Left: Pascal-1 controls ESI's laser trimming system. The laser repairs semiconductor memory chips, replacing faulty cells with alternates.

Below: ESI dominates the industry in the computer-controlled laser adjustment of microcircuits. Pascal-1 programming flexibility gives ESI access to many different markets.

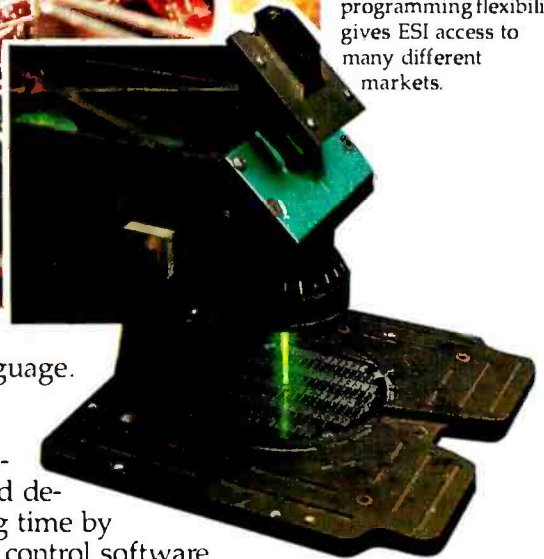

Precise control in milliseconds.

Controlling a laser beam 4 to 8 microns in diameter, the ESI system moves the laser beam positioner at accelerations up to 3.5 G's, directs a trim cut, and decides where to go next, fast enough to trim 35 resistors per second. The Pascal-1 programs directly control all aspects of the trimming system. Some ESI customers use the laser trimmer to adjust the circuits of such devices as air flow transducers, audio filters,

and heart pacers, with the microcircuit activated to simulate operation. Pascal-1 handles these processes with speed and precision.

Easy-to-follow programming.

Writing correct code is easy because of the logical structure and clarity of

the language. ESI engineers save design and debugging time by writing control software in Pascal-1. ESI's customers also apply Pascal-1 to their own specialized production processes.

Oregon Software

2340 Southwest Canyon Road
Portland, Oregon 97201
(503) 226-7760 • TWX 910-454-4779

Free case study.

Read why ESI, one of Oregon Software's 1700 customers, chose Pascal-1. Order your free copy of this eight-page case study by calling Oregon Software collect at (503) 226-7760 or by using the reader service card.

DISTRIBUTORS: Australia: Network Computer Services, Sydney/Tel: 290-3677 England: Real Time Products, London/Tel: 01-588-0667 Holland: N.H.C.S., B.V., Haarlem/Tel: 023-324951 Japan: Rikei Corporation, Tokyo/Tel: 345-1411 West Germany: AC Copy, Aachen/Tel: 0241-506096 West Germany: Peripher Computer Systems GmbH, Munchen/Tel: 089-681021

Listing 2 continued:

```
2140 PLOT Z,(I- 1)+ 27,XX((I- 1),J)+ 27,253,(I- 1)+ 27,XX((I- 1)
,J)+ 27,I+ 27,XX(I,J)+ 27,255:NEXT I
2150 NEXT J
9999 END
READY
```

Text continued from page 80:

desired time step. The program will then simulate the system of compartments for 100 time units and plot a graph of the compartments versus time. To graph the compartment sizes, you must scale the simulation values and plot them on some output device. I have included code for this in listing 2, which will run unmodified on a CompuColor II microcomputer. If you intend to run this program on another computer, check to see if Disk BASIC 8001 coding is compatible with your system. See table 1 for information on the CompuColor PLOT command.

Using the GLM Program

When the Okefenokee swamp uplands hydrologic model is simulated with this program on a microcomputer (on an 8080 microprocessor), the execution time of the Runge-Kutta algorithm is 210 seconds. When Euler's method is used, the execution time is reduced to 51 seconds. This time savings can be beneficial, depending upon the computational accuracy of the microprocessor and systems software. It can be cost-effective to use the Euler algorithm if the computer computational error is larger than the difference in the error between the Euler and Runge-Kutta methods. To give you an idea of the memory requirements necessary for a simulation, the hydrologic model can be simulated with the program in listing 2 if your microcomputer has 8 K bytes of programmable memory.

You can solve the system of linear differential equations for the size of any compartment at any time t . When inputs (Z), rate (a_{ij}) and input (b_{ik}) coefficients are constant, and t is initially equal to 0, the solution is:

$$x_i(t) = e^{\lambda_i t} x_i(0) + \left(\sum_{k=1}^m b_{ik} z_k \right) \int_0^t e^{\lambda_i(t-t')} dt'$$

zero-input response	zero-state response
------------------------	------------------------

where:

- λ_i = eigenvalue of compartment i
- = a_{ii} + behavior caused by intrasystem coupling

This is the general solution of the ordinary differential equations in the linear model. The solution has two distinct parts, which I call the zero-input response and the zero-state response. If you eliminate the zero-state response, then the solution of the equation will give you the values of each compartment when the system does not receive any environmental input (Z). This can be simulated by changing all the input coefficients (b_{ik}) to 0. In the case of the hydrologic model, you would, in effect, be asking, "How is the moisture in each compartment affected if there is no precipitation input?"

You can eliminate the zero-input response from the equation and ask, "How long would it take the system to

come to steady-state conditions if there were no moisture within the system to begin with?" This would be simulated by setting the initial compartment values (x_i) to 0. Photo 1 shows the zero-input response of the hydrologic model simulated with the program in listing 2. Photo 2 shows the zero-state response of the hydrologic model simulated with the same program.

You can start the simulation with different compartment sizes, a different environmental input size, or change the intercompartmental rate or input coefficients, and see how any or all of these changes will affect the outcome. I suggest that you devise a model that can be described with linear differential equations and simulate it at steady-state conditions. A good domestic simulation would be a model of heat losses, subsidies, and circulation within your home. If you have a slant toward business, you can simulate the flow of material or information into, within, and out of a commercial enterprise. As long as all the compartments and flows can be described in the same units, almost any type of measure can be simulated. Once you have completed the steady-state simulation, you can experiment with the GLM program to suit your taste. If you want to make the model more realistic, you can program the inputs to the system as sine waves, square waves, exponential functions, or an impulse function, instead of being constantly added as they are now. You can also test a compartment's sensitivity to a certain parameter by varying that parameter over its range and noting the differences in the compartment.

One warning: you must always be careful to analyze your simulations and decide if they actually mimic the real-world situation *before* you make sweeping generalizations and claims that you can predict how a system will behave under any given set of circumstances. With a little imagination, interesting and sometimes eye-opening results will be seen in mathematical simulations. ■

References

1. Atkinson, K E. *An Introduction to Numerical Analysis*. New York: John Wiley & Sons, 1978.
2. Bledsoe, L J. "Linear and Nonlinear Approaches for Ecosystem Dynamic Modeling." In *Systems Analysis and Simulation in Ecology, Volume IV*. Edited by B C Patten. New York: Academic Press Inc, 1976.
3. Blood, E; Haglund, B; Hagner, J; Hicks, R; Rowe, R; and Thomson, S. "A System Simulation and Analysis of an Okefenokee Swamp Hydrologic Model." Unpublished report, Institute of Ecology, University of Georgia, 1977.
4. Mesarovic, M D and Takahara, Y. *General Systems Theory: Mathematical Foundations*. New York: Academic Press Inc, 1975.
5. Padulo, L and Arbib, M A. *System Theory*. Washington DC: Hemisphere Publishing Corporation, 1974.
6. Patten, B C. "A Primer for Ecological Modeling and Simulation with Analog and Digital Computers." In *Systems Analysis and Simulation in Ecology, Volume I*. Edited by B C Patten. New York: Academic Press Inc, 1971.

A BIG HAPPENING FOR YOUR APPLE ...

LOBO's New Hard Disk Memory Systems

Mass memory for your APPLE™ ... as big and fast as a charging Elephant ... that's LOBO's new family of disk memory systems.

Now you can connect up to four 5¼-inch hard disk drives (6 megabytes each*), and/or four 8-inch hard disk drives (up to 20 megabytes each*), and/or four 14-inch disk drives (up to 58 megabytes each*) to your APPLE, all at the same time. --You'll never have to run out of memory again.

Every LOBO Hard Disk Memory System comes complete with hard disk drives,

*unformatted

APPLE and APPLIEDOS are trademarks of APPLE Computer Co.

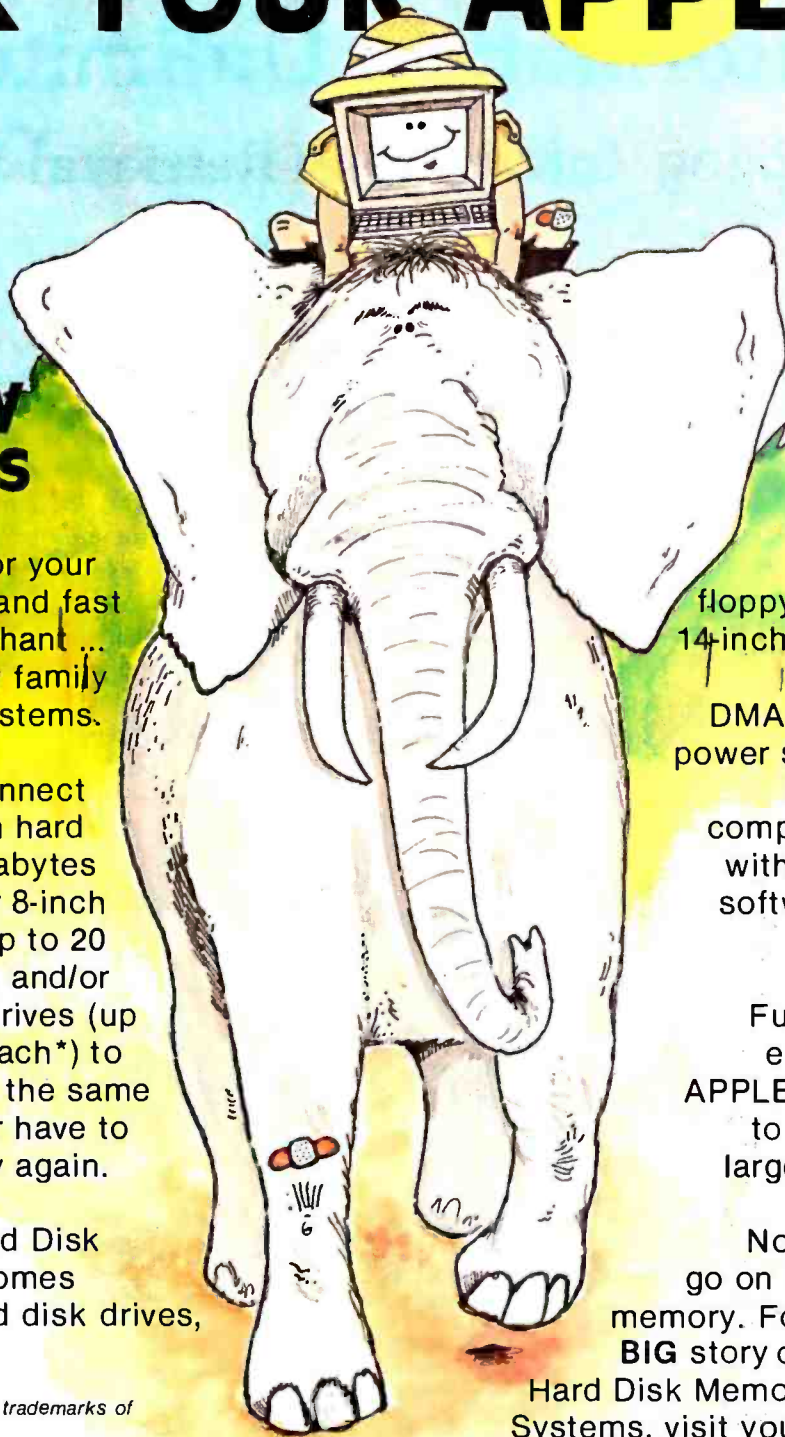

size-compatible floppy disk drive (except 14-inch model), controller,

DMA interface, chassis/power supply, cables, and DOS. And, they are completely compatible with most applications software on the market today.

Furthermore, LOBO's enhanced version of APPLIEDOS™ permits you to build a data file as large as 16 megabytes.

No, you don't have to go on Safari to find mass memory. For the **BIG** story on Hard Disk Memory Systems, visit your nearest LOBO keeper, or contact our "Maha Roger"



LOBO DRIVES, INT'L
354 South Fairview Ave.
Goleta, CA 93117
(805) 683-1576

INTERNATIONAL

Circle 199 on Inquiry card.

Information Unlimited

The Dialog^{*TM} Information Retrieval Service

Stan Miastkowski, Technical Editor

No matter where we go or what we do, we're inundated with data. Each day magazines, newspapers, books, technical journals, and the broadcast media spew forth an amazing amount of material. One quickly learns that there is no way to possibly digest more than a tiny fraction of this material, and that's why this uncontrollable avalanche of paper and words has been aptly named the "information explosion." Fueling the frustration is the Herculean task of sifting through library-card catalogs and indexes to locate specific documents. It's a difficult and inefficient way to find the information you need. In addition, new problems crop up when you attempt to physically locate the texts you managed to find references to.

A much better method is available—if you have access to a modem (modulator-demodulator) and a terminal (or personal computer with communication software). The Dialog Information Retrieval Service (part of the Lockheed Missile and Space Company, Inc) offers on-line interactive access to literally millions of references and abstracts. With Dialog, you can locate information on any subject you can possibly imagine just by typing in words or phrases describing the topic you're interested in. You can search for references by names or companies, authors or publications, dates, product codes, or patent numbers (to name only a

few). By combining terms, the information you come up with can be as narrow or as broad as you want it to be. And, reprints of the articles or papers you've found references to can be ordered directly from your terminal.

When speaking of the amount of information available on the Dialog system, the numbers become mind-boggling. Dialog has some 50 billion bytes of information available on-line in some 130 individual data bases. That works out to a rough total of about forty million individual bibliographic abstracts and references (referred to as citations). If all the citations were printed on 8½-by-11-inch paper, the stack would reach higher than the Empire State building.

The newspaper and magazine indexes are among the most popularly oriented data bases—although Dialog also offers a number of specialized data bases for those in education, industry, applied science and technology, and social science and the humanities. Business information and forecasts are also available. Eighteen new data bases were added to the system in 1980, and at least a dozen more will be available by the end of the year. The system is available 110 hours a week in fifty countries, and all data bases are updated regularly. Each day tens of thousands of new citations are added. Also, if you wish to create your own private data bases for use on the system, Dialog provides this service.



Photo 1: The Lockheed Dialog computer room operator station. The system uses two mainframe computers—an IBM 3033 and an AS-9000 (sold in the United States by National Advanced Systems). Each computer contains a complete Dialog operating system; one handles Telenet calls, and the other Tymnet. Direct dial-in calls and leased lines are divided between the computers to even the loads. Because of the large amount of computer power available, the average wait for a response to a query is ten seconds—despite the fact that hundreds of users may be logged in during peak-use periods.

*TM — Dialog is a registered trademark of the Lockheed Missile and Space Co, Inc.



TYPE-'N-TALK™ IS T.N.T.

The exciting text-to-speech synthesizer that has every computer talking.

- **Unlimited vocabulary**
- **Built-in text-to-speech algorithm**
- **70 to 100 bits-per-second speech synthesizer**

Type-'N-Talk™, an important technological advance from Votrax, enables your computer to talk to you simply and clearly — with an unlimited vocabulary. You can enjoy the many features of Type-'N-Talk™, the new text-to-speech synthesizer, for just \$345.00.

You operate Type-'N-Talk™ by simply typing English text and a talk command. Your typewritten words are automatically translated into electronic speech by the system's microprocessor-based text-to-speech algorithm.

The endless uses of speech synthesis.

Type-'N-Talk™ adds a whole new world of speaking roles to your computer. You can program verbal reminders to prompt you through a complex routine and make your computer announce events. In teaching, the computer with Type-'N-Talk™ can actually tell students when they're right or wrong — even praise a correct answer. And of course, Type-'N-Talk™ is great fun for computer games. Your games come to life with spoken threats of danger, reminders, and praise. Now all computers can speak. Make yours one of the first.

Text-to-speech is easy.

English text is automatically translated into electronically synthesized speech with Type-'N-Talk™ ASCII code from your computer's keyboard is fed to Type-'N-Talk™ through an RS 232C interface to generate synthesized speech. Just enter English text and hear the verbal

response (electronic speech) through your audio loud speaker. For example: simply type the ASCII characters representing "h-e-l-l-o" to generate the spoken word "hello."

TYPE-'N-TALK™ has its own memory.

Type-'N-Talk™ has its own built-in microprocessor and a 750 character buffer to hold the words you've typed. Even the smallest computer can execute programs and speak simultaneously. Type-'N-Talk™ doesn't have to use your host computer's memory, or tie it up with time-consuming text translation.

Data switching capability allows for ONLINE usage.

Place Type-'N-Talk™ between a computer or modem and a terminal. Type-'N-Talk™ can speak all data sent to the terminal while online with a computer. Information randomly accessed from a data base can be verbalized. Using the Type-'N-Talk™ data switching capability, the unit can be "de-selected" while data is sent to the terminal and vice-versa — permitting speech and visual data to be independently sent on a single data channel.

Selectable features make interfacing versatile.

Type-'N-Talk™ can be interfaced in several ways using special control characters. Connect it directly to a computer's serial interface. Then a terminal, line printer, or additional Type-'N-Talk™ units can be connected to the first Type-'N-Talk™, eliminating the need for additional RS-232C ports on your computer.

Using unit assignment codes, multiple Type-'N-Talk™ units can be daisy-chained. Unit addressing codes allow independent control of Type-'N-Talk™ units and your printer.

Look what you get for \$345.00. TYPE-'N-TALK™ comes with:

- Text-to-speech algorithm
- A one-watt audio amplifier
- SC-01 speech synthesizer chip (data rate: 70 to 100 bits per second)
- 750 character buffer
- Data switching capability
- Selectable data modes for versatile interfacing
- Baud rate (75-9600)
- Data echo of ASCII characters
- Phoneme access modes
- RS 232C interface
- Complete programming and installation instructions

The Votrax Type-'N-Talk™ is one of the easiest-to-program speech synthesizers on the market. It uses the least amount of memory and it gives you the most flexible vocabulary available anywhere.

Order now. Toll free.

Call the toll-free number below to order or request additional information. MasterCard or Visa accepted. Charge to your credit card or send a check for \$345.00 plus \$4.00 delivery. Add 4% sales tax in Michigan.

1-800-521-1350.

Votrax

Distributed by Vodex
A Votrax Company — Dept. RT
500 Stephenson Highway, Troy, MI 48084
(313) 588-0341

Type-'N-Talk™ is covered by a limited warranty. Write Votrax for a free copy.

At first glance, Dialog seems expensive. Each data base has an individual charge ranging from \$15 to \$300 per hour of connect time. (It should be stressed that the most-used data bases cost an average of \$50 an hour.) The cost becomes much more reasonable when you realize that an exhaustive search of any subject can be completed in an average of ten minutes. (Simple searches often take only a minute or two.) In addition, Dialog's response time is extremely fast because of the computer power available. Even during peak-use times, there is seldom a wait of more than ten seconds for the system to respond to a query.

It should be stressed that there are dangers inherent in using the Dialog system—especially if you're an "information junkie." It's extremely easy to become so enamored of Dialog's capabilities that you keep on calling up references and lose all track of time. The shock comes at the end of the month, when a very large bill arrives in the mail.

There are two ways to avoid this: the first is to *plan* what you'll be doing when you're logged on the system (explained in more detail below). The second is to keep track of your connect charges. Each time you log off or change data bases, Dialog prints an estimated charge. It's a good idea to keep a pad and a pencil next to your terminal and to keep a running total of charges at the end of every session.

Once you locate what you want, you can have the references and abstracts typed on your printer, although

this can get expensive at the normal speed of 300 bps (bits per second). A better way is to have the citations printed by Dialog's off-line high-speed printer. The cost is minimal (normally \$0.10 to \$0.25 per citation) and they are mailed out the next day. Or, as mentioned above, you can order actual reprints directly from your terminal.

Dialog History

Dialog started modestly as an in-house research and development project at Lockheed in 1963. At that time, an information sciences laboratory was established to deal with what was then recognized as the coming "information explosion." Two years later, what was essentially the first truly interactive information retrieval system was on-line for internal company use.

In 1968, Lockheed won a contract from NASA to design, program, implement, and maintain a computerized index for the half-million documents produced by the American space program. Called RECON (Remote Console Information Retrieval Service), the development process enabled Lockheed to fine-tune the specialized information retrieval command language, which was called Dialog.

After gaining more experience preparing information retrieval systems for the AEC (Atomic Energy Commission), the US Office of Education, and a number of other organizations, Lockheed, in 1972, decided to offer commercial service and officially named the system Dialog.

ATTENTION GOVERNMENT D P USERS AND PURCHASERS

We represent many fine micro products and manufacturers on the GSA Schedule, including

*Apple, Cromemco
and Computer Corporation of America*

Purchasing from the Schedule will save you the time consumed by the bid process. Products shipped throughout the United States and world-wide. Visit or write any of our stores for more information or to receive our catalogue of products represented.

**Computers,
Etc.....
the dependable store**

257 West Street, Annapolis, MD 21401 — (301) 268-6505
13A Allegheny Avenue, Towson, MD 21204 — (301) 296-0520
9330 Georgia Avenue, Silver Spring, MD 20910 — (301) 588-3748
or Call (301) 268-5801

*Career Opportunities Available * An Equal Opportunity Employer*



Photo 2: Some of the 200 hard-disk drives used by the Dialog system. Most of the CDC (Control Data Corporation) drives hold 637 megabytes of data for a total of more than 50 billion bytes of on-line storage.



State-of-the-art hardware demands state-of-the-art software

Operating Systems & Support Software from Technical Systems Consultants

To perform to its fullest capabilities, your hardware demands software designed to meet the specialized requirements of today's microprocessors. State-of-the-art software from Technical Systems Consultants keeps pace with the rapid advancements in computer technology so your hardware can live up to its full potential. Our complete line of state-of-the-art software includes:

The UniFLEX™ Operating System

UniFLEX, a true multi-user, multi-tasking system for the 6809 and 68000 microprocessors, supports such features as:

- hierarchical file systems
- device independent I/O
- four Gigabyte disk capacities
- full file protection
- inter-task communication via pipes
- I/O redirection
- task swapping
- full random-access files
- comprehensive shell command language

UniFLEX, structured for large-scale microprocessor systems, will not run with minimal systems and thus has avoided design compromise. (Off-the-shelf versions and OEM licenses are available.)

The FLEX™ Operating System

FLEX, a powerful, easy-to-use operating system designed for the 6800 and 6809 microprocessors, includes:

- dynamic filespace allocation
- random files
- batch job entry
- automatic space compression
- English error messages
- user environment control
- disk resident commands
- flexible device I/O
- printer spooling

Plus, FLEX can accommodate hard disks as well as floppies. The System is available off-the-shelf for a variety of systems and in a field-adaptable version. (OEM licenses available.)

FLEX and UniFLEX are trademarks of Technical Systems Consultants, Inc.

Support Software

Technical Systems Consultants offers a full line of state-of-the-art support software compatible to FLEX and UniFLEX, some of which are:

- native C and Pascal compilers for advanced programming
- extended BASIC for business and educational applications
- text editing and processing software
- sort/merge package for business applications
- variety of absolute and relocatable assemblers
- debug and diagnostic packages

... and more. Write or call today for our brochures describing our complete product line.

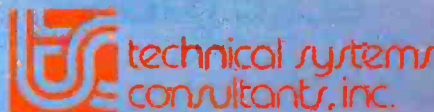

Box 2570, 1208 Kent Avenue
West Lafayette, Indiana 47906
(317) 463-2502 Telex: 27-6143

Sculpture by Joann Chaney

Industrial users continue to be Dialog's largest customers since much of the information in the specialized data bases (such as WORLD ALUMINUM ABSTRACTS or SURFACE COATING ABSTRACTS) is virtually unavailable anywhere else. Government agencies are also heavy users of Dialog's services—followed closely by educational institutions and libraries. Although personal computer users currently make up a very small percent-

age of Dialog customers, Lockheed officials told me they are in the process of adding more general-interest data bases to attract more individuals.

A Visit to Dialog

Dialog's facilities are located in Palo Alto, California. As might be expected, the hardware needed to handle the enormous amount of information contained within the Dialog system has taken over a large portion of its building. For those used to working with a personal computer and a floppy disk or two, a visit to Dialog's computer room is a humbling experience. Two mainframe computers (an IBM 3033 and an AS-9000) are both on-line at all times. When I visited Dialog in January, the AS-9000 had just been put on-line. This so-called "super-mainframe" is sold in the United States by National Advanced Systems. Since its claimed speed far exceeds that of any other mainframe, a Dialog spokesman told me he expects it to greatly increase the system's capacity.

The most interesting part of Dialog's facilities are the hard-disk drives—some 200 of them. Most are CDC (Control Data Corporation) units capable of storing 637 megabytes per drive. Although direct dial-up numbers are available, the majority of Dialog users access the system through Tymnet or Telenet (national data-communication networks that have local telephone numbers in many communities).

Lockheed officials term Dialog a value-added on-line service supplier. All of the approximately 130 data bases are put together by seventy data base producers who have contractual agreements with Dialog. The process of producing and updating each of the data bases is a large one involving literally thousands of people who review publications, journals, and newspapers—many on a daily basis. Many reviewers work at home and transfer their citations to floppy disks, which are sent to the data base producers. The final step is to transfer all the citations to IBM magnetic tape. Between ten and twenty of these tapes, each containing about 20,000 new citations, arrive at Dialog headquarters every day. Before the information is added to the system, every word in all citations is indexed. This is one of the most powerful searching features of the system.

Popular Data Bases

Although many of Dialog's data bases are extremely specialized (such as AQUACULTURE, BHRA FLUID ENGINEERING, or PHARMACEUTICAL NEWS INDEX), a number of the existing data bases are of general interest or of special significance to BYTE readers. Among them are:

- ERIC — One of the first Dialog data bases available, ERIC (Educational Resources Information Center) indexes some 700 publications of interest to every segment of the educational profession. About 3000 citations are added every month.
- COMPENDEX — This data base contains abstracted information from approximately 2000 of the world's



Photo 3: IBM reel-to-reel tape with new and updated data waiting to be placed on the Dialog system. Some twenty tapes arrive at Dialog each day from the outside organizations that prepare the data bases. Each tape contains approximately 20,000 individual references and/or abstracts.

3 NEW MODEMS!

ORIG ANS OFF HOOK SEND REC CARRIER

MICRONET
MICROMATE ELECTRONICS, INC.

1. A Smart One with auto everything built in!

- Auto Dial
- Auto Answer
- Auto Mode (originate/answer)
- "Direct Connect" for any computer with an RS232 interface.

\$299.00

2. A "Direct Connect" for the Apple.*

Does not need an interface card!

- Auto Dial
- Auto Answer
- 25 Keyboard commands.
- Will also operate interactively with your programs!

\$289.00

3. An Acoustical Modem for the Apple.*

Does not need an interface card!

- Costs less to get on line than any similar modem.
- 25 Keyboard commands.
- Will also operate interactively with your programs!

\$179.00

MICROMATE ELECTRONICS, INC.

East Coast: 2094 Front Street
East Meadow, New York 11554
(516) 794-1072

West Coast:
1116A 8th Street Suite 110
Manhattan Beach, California 90266

All "Direct Connect" modems are FCC certified.
*Registered trademark of Apple Computer, Inc.

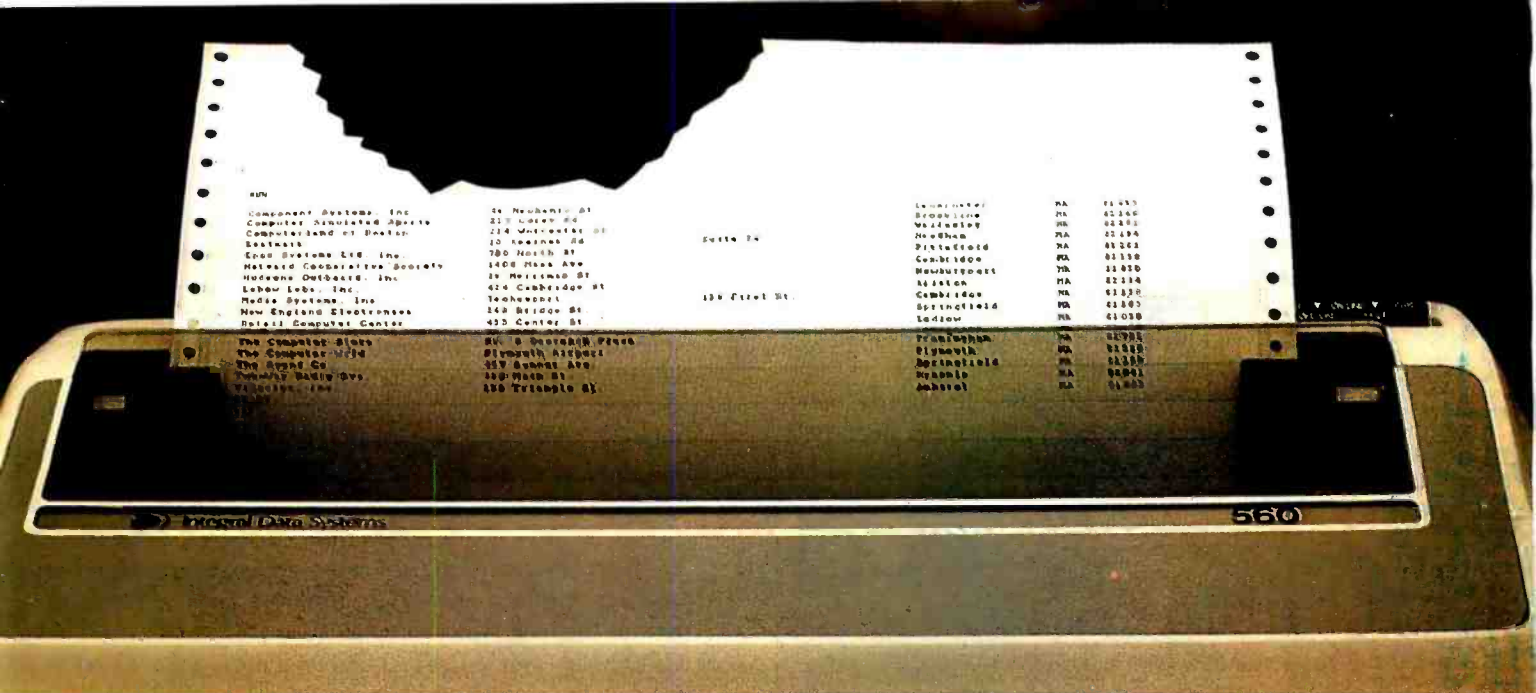

Meet the Tiger with a bigger bite.

Introducing the remarkable 132-column Paper Tiger™ 560. The first full-width matrix printer to give you fully formed characters for a low \$1695.*

The new 560 features a staggered nine-wire ballistic type print head that overlaps dots in both horizontal and vertical planes. It bi-directionally prints up to 150 dense, text quality characters per second.

The 560 also features a reliable cartridge ribbon that lasts up to four times as long

presents a breakthrough in matrix printing, offering the user excellent print quality with the efficiency of a matrix printer. Employing a unique "staggered column" head manufactured by Integral Data Systems, the 560 creates high quality printouts by overlapping dots in both horizontal and vertical planes.

Paper Tiger 560 Print Sample

as spool and cassette ribbons, separate heavy-duty stepper motors to drive the print head and advance the paper, plus true tractor feed.

And famous Paper Tiger performance comes with every new 560. Like fixed or proportionately spaced text, programmable tabbing and business forms control, automatic text justification, print formats to 220

columns, parallel and serial interfaces, self-diagnostics, and more. All inside the most compact printer of its kind.

Need more stripes? Dotplot™, our high-resolution raster graphics package, is standard on every 560.

For data processing, word processing and small business applications, this is your Tiger. The business-sized Paper Tiger™ 560.

It's a Tiger you can count on.

Call TOLL FREE 800-258-1386 (In New Hampshire, Alaska and Hawaii, call 603-673-9100.) Or write: Integral Data Systems, Inc., Milford, NH 03055.



Paper Tiger 560

 Integral Data Systems, Inc.

engineering and technical journals since 1969.

- **INSPEC** — This data base is similar to **COMPENDEX** except it also abstracts scientific bulletins and contains bibliographic references from scientific indexes. Included is a special section of computer and control abstracts.
- **ABI/INFORM** — This data base contains management and administration abstracts from some 400 business-related publications.
- **SCISEARCH** — This is an index to approximately 2600 scientific and technical publications since 1974.



Photo 4: IBM reel-to-reel tape drives used to load new and updated information into the Dialog disk drives.

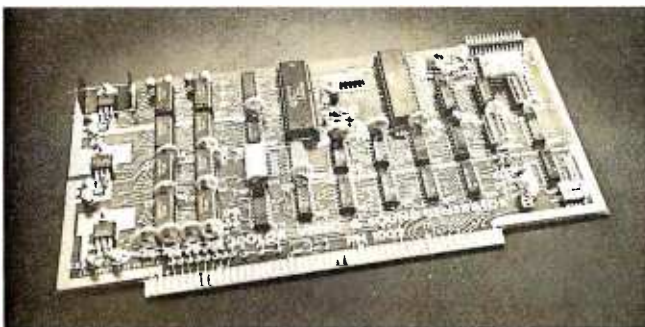

**NOW WITH
TMS 9918A**

SINGLE BOARD COLOR VIDEO
AND SOUND GENERATOR KIT \$350*
COLOR VIDEO KIT \$320*
*STANDARD KIT INCLUDES TMS 9918.
ADD \$25 FOR TMS 9918A.

COLOR VIDEO PROCESSOR

• Text, Graphics, Animation • 16 Colors • 256 x 192 Resolution • NTSC Composite Video Output • Uses TMS 9918
• Includes I/O Mapped 16K Video Memory • 3D Simulation with 32 Video Sprites • 2 Byte X-Y Positioning • Real Time Clock • 8 Level Interrupt Selection • Inexpensive RF Modulator allows easy connection to any color TV • Video over Video and Extended Graphics II Mode with TMS 9918A •

PROGRAMMABLE SOUND GENERATOR

• Music, Sound Effects, Tone Signaling, Ultrasonics • 27 Hz to 111 KHz Range • 3 Programmable Analog Channels with Separate Frequency, Volume and White Noise Control • 10 Selectable Envelope Wave Shapes under Software Control • Two 8-Bit Programmable I/O Ports for use as External Keyboard/Display Interface • Power Amplifier for driving External Speaker •

Texas residents add 5% sales tax. Prices include complete documentation with programming examples. PC board is solder-masked with gold contacts. Add \$100 for assembled and tested units. Send \$14.50 for 120 page manual, refundable with order. Compatible with Z80, 8085 and 8080 at 2 or 4 MHz on 5-100 buss.

EDA ELECTRONIC DESIGN ASSOCIATES
P.O. Box 94055 Houston, Texas 77018 (713) 999-2255

This data base contains bibliographic references only.

- **MAGAZINE INDEX** — Perhaps the most popularly oriented Dialog data base, this is a cover-to-cover index of about 370 popular American magazines since 1976 and contains some 300,000 citations. It's particularly useful for most general-purpose reference questions since it indexes all articles, news reports, editorials, product evaluations, biographical pieces, short stories, poetry, recipes, and reviews. Approximately 5000 citations are added to this data base monthly.
- **SSIE CURRENT RESEARCH** — Compiled by the Smithsonian Science Information Exchange, this data base lists and summarizes most government-funded research projects either in progress or completed within the past two years.
- **GPO MONTHLY CATALOG** — This is the catalog (updated monthly) of US government publications.
- **ENERGYLINE** — This data base contains bibliographical citations as well as abstracts on all aspects of energy.
- **CONFERENCE PAPERS INDEX** — This is an index to meetings and symposia on all scientific and technical fields. Also included are references to conference papers (many of which have never been published). This is a very large data base to which about 10,000 citations are added each year.
- **NATIONAL FOUNDATIONS** — This lists all US private foundations that award grants for charitable purposes.
- **DISCLOSURE** — This data base, updated weekly, provides extracts of reports filed with the SEC (Securities and Exchange Commission) by all publicly owned companies in the United States.
- **NATIONAL NEWSPAPER INDEX** — This data base contains front-to-back indexing of *The New York Times*, *The Wall Street Journal*, and *The Christian Science Monitor* since January 1, 1979. It contains bibliographical references to everything included in the papers, with the exception of advertisements, weather charts, stock market tables, crossword puzzles, and horoscopes. About 15,000 new citations are added monthly.
- **NEWSEARCH** — This is a *daily* update of the **MAGAZINE INDEX**, **MANAGEMENT CONTENT**, the **LEGAL RESOURCE INDEX**, and the **NATIONAL NEWSPAPER INDEX**; it is invaluable for locating references within days of an article's appearance.
- **ENCYCLOPEDIA OF ASSOCIATIONS** — This data base contains detailed information on approximately 15,000 national nonprofit organizations. Included are listings for professional societies, trade associations, labor unions, and cultural and religious organizations.
- **STANDARD AND POOR'S NEWS** — Provides extensive news coverage as well as financial reports on

DIMENSION 3

COLOR GRAPHICS

Takes your PET™, CBM™ or TRS-80™ into the future

Our VDP color board features 256 x 192 pixel resolution, 15 exciting colors on 5 planes producing 3-dimensional graphics and true animation, standard composite video output to either T.V. set or monitor (through optional R.F. Modulator)

Plus 3 channel digitally synthesized sound and 16k onboard RAM, driver software is available to maximize user flexibility. Install Dimension 3 in your present computer within minutes yourself. No technical expertise required. Dimension 3 from Dimensional Design Inc. is available through Computer City, Canada (dealer enquiries welcomed). PET, CBM are registered TM's of Commodore International. TRS-80 is a registered TM of Tandy Corporation. Dimension 3 is a registered TM of DDI Dimensional Design Inc. Artist's representation.

Introductory price offer (PET-CBM) **\$595.00 U.S.** TRS-80 **\$649.00 U.S.**

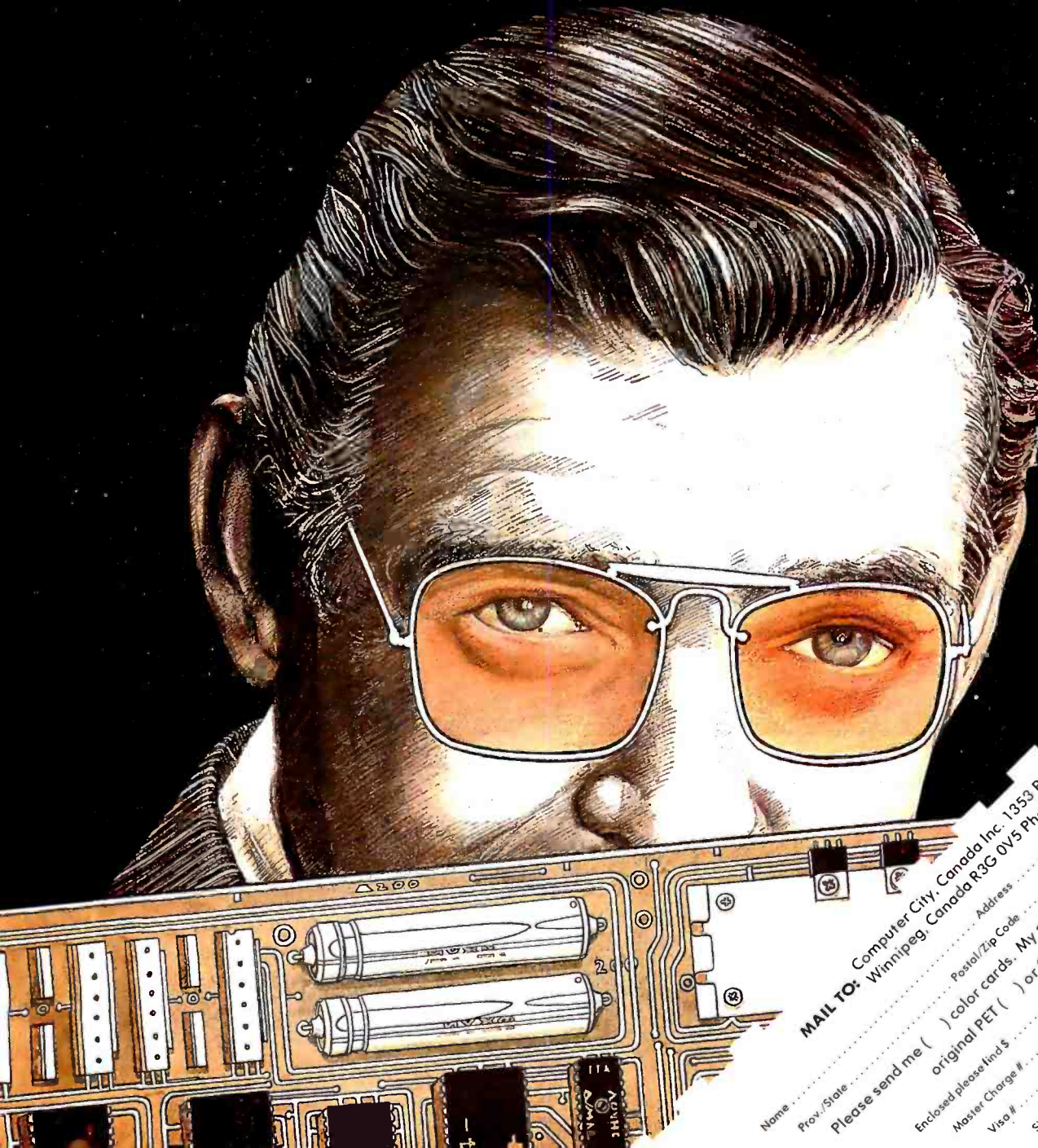

MAIL TO: Computer City, Canada Inc. 1353 Portage Avenue,
Winnipeg, Canada R3G 0V5 Phone: (204) 786-3383

Name Country
Prov./State Address
Postal/Zip Code
Please send me () color cards. My system is TRS-80 () or **\$649.00 U.S.**
original PET () or CBM () at **\$595.00 U.S.**
Enclosed please find \$
Master Charge #
Visa #
Signature
Make cheques or money orders payable to Computer City, Canada Inc.
Master Charge or Visa add 5%.



Photo 5: The Xerox 9700 high-speed printer used by Dialog for off-line printing of references. The printer operates at two pages a second and offers Dialog users a considerable savings over having their references printed out while logged onto the system. The average cost of having references printed off-line and mailed to you is \$0.10 to \$0.25 per citation.



Photo 6: Dialog's customer-service area, where specially trained personnel are available to offer advice. They can be reached by calling a toll-free number.

over 9000 companies. This data base is the equivalent of the Standard and Poor's *Daily News* and *Cumulative News* and often features full-length news stories.

- DIALINDEX — This is perhaps the most useful of the Dialog data bases and contains a collection of the file indexes for *all* data bases. DIALINDEX is a low-cost data base that allows you to ascertain which data bases contain the information you're searching for.
- NTIS — Compiled by the National Technical Information Service of the US Department of Commerce, this data base contains citations to more than 700,000 US reports covering government-sponsored research and development and engineering. Information on almost any subject imaginable is contained within this massive data base.

In addition, there are data bases covering psychology, chemistry, agriculture, medicine, biology, physics, and many other fields and disciplines. Dialog provides a free catalog of all the available data bases.

The Dialog staff and data base producers are continually adding new data bases to the system. By the end of this year, plans call for the addition of a biography index with over five million names, a book review index, an index of the Congressional Record, the Federal Index, a grants index, data from the Bureau of Labor Statistics, and Medline (a medical information data base designed for both physicians and consumers).

Accessing Dialog

There is no minimum fee or startup charges for the Dialog service. Once you've filled out an application and

SYNCHRO-SOUND
THE COMPUTER PEOPLE

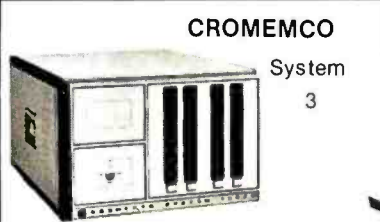

CROMEMCO
System 3



HAZELTINE
1421
Video
Terminal



ATARI
800
400

ALPHA-MICRO
Computer System



MORE SPECIALS	
Integral Data Systems Model 445	Livermore Acoustic Coupler \$159.95
Printer \$695.00	Centronics Micro Printer 349.00
Televideo Model 950 1295.00	5" Scotch Diskette Box 34.95
Industrial Micro Systems 349.00	8" Scotch Diskette Box 39.95

We have a full staff of Programmers and Computer Consultants to design, configure and deliver a Turnkey Computer System to meet your specific requirements

We carry a full line of: ADDS, QUME, CROMEMCO, SCOTCH, MAXELL, VERBATIM, ALPHA-MICRO, ATARI, INTEGRAL DATA, LIVERMORE COUPLERS, HAZELTINE, TEXAS INSTRUMENTS, DIGITAL MICRO SYSTEMS and others.



SYNCHRO-SOUND ENTERPRISES, INC.

THE COMPUTER PEOPLE 125 Mineola Ave., Roslyn Hts., N.Y. 11577

Phone Orders call: 516/484-1852 • Toll Free: 800/645-3820 • TWX 710-582-5886

CALL, WRITE OR VISIT
OUR NEW COMPUTER
SYSTEMS CENTER
10-4 Daily & Saturday

68K

WHY SETTLE FOR A 68000 BASED microCOMPUTER WHEN YOU CAN HAVE OUR 68K™ MINICOMPUTER ?

FEATURES:

- 8 MHz 68000 CPU
- Virtual memory to 4 billion bytes
- 6809 peripheral processor
- Multi-user/multi-tasking memory management
- Each RAM board accomodates 2 megabytes
- High-speed DMA for universal hard disk interface
- 6 RS-232 and 4 8-bit I/O ports standard
- Dual 8" quad-density floppys
- Extensive error checking and recovery

★ Attend the **68K SEMINAR:** our experts will field your 68K questions and discuss:

- ☞ 68000 architecture
- ☞ 68K MiniFrame™ architecture
- ☞ 68K hardware interface
- ☞ MiniFrame programming
- ☞ \$85 registration fee includes all-day seminar, lunch, and take-home documentation
- ☞ in Los Angeles

➤ Please call or write for 68K MiniFrame information and the complete 1981 seminar schedule.

from  **MicroDaSys**

Dept. 5B, P.O.Box 36051
Los Angeles, CA. 90036
(213)731-0876

detach coupon and mail ASAP

YES. Enroll me in your 68K all-day seminar.
circle day you can attend:

July	23	24	25
Aug	27	28	29
Sept	24	25	26

name: _____ work: _____
address: _____
tel. # home: _____
Enclose \$85 registration fee

MicroDaSys seminar 68K

AGRICULTURE/FOOD SCIENCE	HUMANITIES/ARTS	CHEMNAME™
AGRICOLA (U.S. National Agricultural Library)	AMERICA· HISTORY & LIFE	CHEMSEARCH™
COMMONWEALTH AGRICULTURAL BUREAU ABSTRACTS	ART BIBLIOGRAPHIES MODERN	CHEMISIS™
CRIS (Current Agricultural Research)	HISTORICAL ABSTRACTS	CONFERENCE PAPERS INDEX
FOODS ADLIBRA	LANGUAGE & LANGUAGE BEHAVIOR ABSTRACTS	DISSERTATION ABSTRACTS
FOOD SCIENCE & TECHNOLOGY ABSTRACTS	MLA BIBLIOGRAPHY (Language & Literature)	GEARCHIVE
BUSINESS/ECONOMICS	PHILOSOPHER'S INDEX	GEOREF
ABI/INFORM (Management)	RILM ABSTRACTS (Music)	INSPEC (Physics)
CHEMICAL INDUSTRY NOTES DISCLOSURE	LAW/CURRENT TOPICS	IRL LIFE SCIENCES
ECONOMICS ABSTRACTS INTERNATIONAL	CONGRESSIONAL INFORMATION SERVICE INDEX	INTERNATIONAL PHARMACEUTICAL ABSTRACTS
EIS INDUSTRIAL PLANTS	LEGAL RESOURCE INDEX	OCEANIC ABSTRACTS
EIS NON-MANUFACTURING ESTABLISHMENTS	MAGAZINE INDEX	SCISEARCH®
FOREIGN TRADERS INDEX	NATIONAL NEWSPAPER INDEX	SPIN (Physics)
MANAGEMENT CONTENTS	NCJRS (Criminal Justice)	TSCA INITIAL INVENTORY (Chemical Substances)
PHARMACEUTICAL NEWS INDEX	NEWSARCH	SOCIAL SCIENCES
THE PREDICASTS GROUP	PAIS (Public Affairs)	AIM/AFM (Vocational Education)
PTS F & S INDEXES	PTS FEDERAL INDEX	AMERICAN STATISTICS INDEX
PTS INTERNATIONAL TIME SERIES	MEDICINE	CHILD ABUSE & NEGLECT
PTS INTERNATIONAL FORECASTS	BIOSIS PREVIEWS	DISSERTATION ABSTRACTS
PTS PROMT (Market Abstracts)	EXCERPTA MEDICA	ERIC (Educational Research)
PTS U.S. TIME SERIES	INTERNATIONAL PHARMACEUTICAL ABSTRACTS	EXCEPTIONAL CHILD EDUCATION RESOURCES
PTS U.S. FORECASTS	IRL LIFE SCIENCES	LIBRARY & INFORMATION SCIENCE ABSTRACTS
TRADE OPPORTUNITIES	NIMH (Mental Health)	NCJRS (Criminal Justice)
U.S. EXPORTS	PSYCHOLOGICAL ABSTRACTS	NCEM (Educational Media)
CONTRACTS/GRANTS/CURRENT RESEARCH	SCISEARCH®	NIMS (Media for Handicapped)
CRIS (Current Agricultural Research)	NON BIBLIOGRAPHIC	POPULATION BIBLIOGRAPHY
FOUNDATION DIRECTORY	BIOGRAPHY MASTER INDEX	PSYCHOLOGICAL ABSTRACTS
FOUNDATION GRANTS INDEX	CHEMNAME™	SOCIAL SCISEARCH
FROST & SULLIVAN DM®	CHEMSEARCH™	SOCIOLOGICAL ABSTRACTS
GRANTS DATABASE	CHEMISIS™	U.S. POLITICAL SCIENCE DOCUMENTS
GPO MONTHLY CATALOG (Government Publications)	DISCLOSURE	U.S. PUBLIC SCHOOL DIRECTORY
NATIONAL FOUNDATIONS	EIS INDUSTRIAL PLANTS	TECHNOLOGY/ENGINEERING
SSIE CURRENT RESEARCH	EIS NON-MANUFACTURING ESTABLISHMENTS	BHRA FLUID ENGINEERING
ENERGY/ENVIRONMENT	ENCYCLOPEDIA OF ASSOCIATIONS	CLAIMS™/CHEM (Chemical Patents)
APTIC (Air Pollution)	FOREIGN TRADERS INDEX	CLAIMS/CHEM/UNITERM (Patents)
ENERGYLINE	FOUNDATION DIRECTORY	CLAIMS/CLASS (Patent Classification)
ENVIRLINE	FROST & SULLIVAN DM®	CLAIMS/U.S. PATENT ABSTRACTS
ENERGY INFORMATION	NATIONAL FOUNDATIONS	COMPENDEX (Engineering Index)
ENVIRONMENTAL PERIODICALS BIBLIOGRAPHY	NCEM	INPADOC (Patents)
POLLUTION ABSTRACTS	NIMS	INSPEC (Computers, Electronics)
GOVERNMENT PUBLICATIONS	PTS INTERNATIONAL TIME SERIES	ISMEC (Mechanical Engineering)
AMERICAN STATISTICS INDEX	PTS U.S. TIME SERIES	METADEX (Metals)
CONGRESSIONAL INFORMATION SERVICE INDEX	TRADE OPPORTUNITIES	NATIONAL TECHNICAL INFORMATION SERVICE
GPO MONTHLY CATALOG	TSCA INITIAL INVENTORY	NON-FERROUS METALS ABSTRACTS
NATIONAL TECHNICAL INFORMATION SERVICE	U.S. EXPORTS	PIRA (Paper, Printing, Packaging)
PUBLIC AFFAIRS INFORMATION SERVICE	U.S. PUBLIC SCHOOL DIRECTORY	RAPRA (Rubber & Plastics)
PTS FEDERAL INDEX	SCIENCE	SURFACE COATINGS ABSTRACTS
	AQUACULTURE	TRIS (Transportation)
	AQUALINE	WELDSEARCH
	AQUATIC SCIENCES & FISHERIES ABSTRACTS	WORLD ALUMINUM ABSTRACTS
	BIOSIS PREVIEWS (Life Sciences)	WORLD TEXTILE ABSTRACTS
	CHEMICAL ABSTRACTS GROUP	
	CA SEARCH	

Figure 1: Available Dialog data bases as of February 1981. Eighteen new data bases were added to the system in 1980; about a dozen more are planned to be operational by the end of 1981.

have been provided with a password, the easiest means of accessing the system is through either the Tymnet or Telenet networks. Currently, Tymnet charges \$8 per hour and Telenet charges \$5 per hour. The network connect charges are added to your Dialog monthly statement. (At the present time, Dialog bills monthly, but it is studying the possibility of billing through charge cards.) Dialog provides a list of telephone numbers and passwords/access numbers for both networks. If you have to make a toll call to access the networks, that's an addi-

tional charge. This expense is minimized, of course, for subscribers in Dialog's local area or those who have access to WATS (wide-area telephone service) lines. There are also direct-access lines to Dialog and incoming WATS lines are available at \$15 per month.

Using Dialog

There are a number of levels at which the Dialog system can be used. Most of the time, you'll find a simple search with a couple of terms the easiest way to go. A

**Higher production volume
and lower chip prices
allow us to pass these
savings on to you**

RAM Prices **SLASHED**

16K BYTE 8/16 RAM

This fully static RAM board offers you the best of two worlds. Automatically switches between 8-bit or 16-bit operation, depending upon your CPU. High reliability, low noise design. 200 nsec. chips allow 8 Mhz. 8086 operation. Has extended addressing which can be disabled by a single switch. Prices: 1-9, \$280; 10-19, \$260.

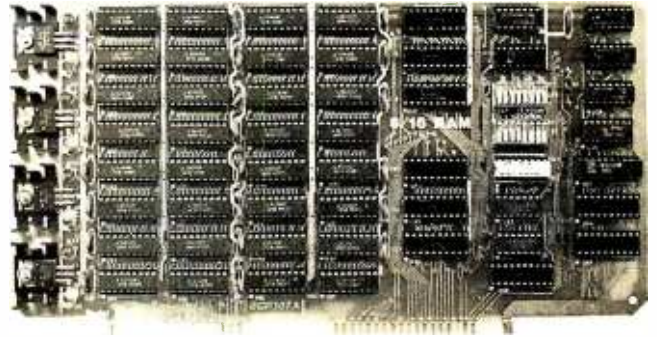

OTHER RAM SAVINGS

16K PLUS RAM—this fully static RAM has become the standard of the industry. It features 200 nsec. chips and Cromemco style bank select using port 40H. Addressable to any continuous 16K on 4K boundaries. Any 4K block may be disabled. High reliability, low noise design. Prices: 1-9, \$280; 10-19, \$260.

16K STANDARD RAM—this fully static RAM is frequently used by OEMs in systems which do not require bank select. High reliability, low noise circuits. Uses 200 nsec. chips. Addressable to any continuous 16K on 4K boundaries. Any 4K block may be disabled. Prices: 1-9, \$265; 10-19, \$245.

64K STATIC 8/16 RAM

AVAILABLE JULY 6—This state-of-the art board uses 2167 16K static 70/100 nsec. chips in a "power down" mode. This means you can expect the first 64K in a system to use 1.6 amps with subsequent boards using about .8 amps each. Built for the same high reliability you have come to expect from using our other boards. Has 24-bit extended addressing which can be disabled. Initial quantities will be limited—reserve yours now to ensure early delivery. Prices: 1-9, \$1295; 10-19, \$1195.

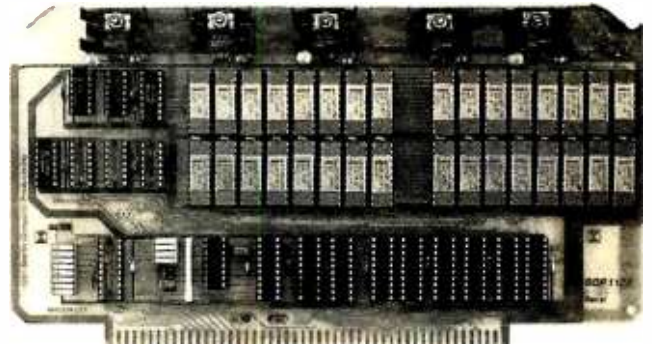

All products fully assembled and guaranteed for one year.

NEW!

OEM PRICES

To obtain an OEM price list for the above memory boards, our 8086 and Interface product lines, write to us on your letterhead. Substantial additional savings for volume purchases.

TO ORDER: Many of your local computer stores have or can order these boards for you. They may also be ordered direct from the factory. Personal checks, CODs, VISA and MC accepted. Shipping paid by SCP for prepaid orders.



Seattle Computer Products, Inc.

1114 Industry Drive, Seattle, WA. 98188
(206) 575-1830

"BEST PRINTER VALUE IN THE WORLD"
Check our prices on THE ULTIMATE IN QUALITY

Epson Printers

APPLE & MOST OTHER COMPUTERS

NEW! MX80
40, 80, 132 columns

LIST ~~\$645~~

TX 80 w/Graphics

LIST ~~\$799~~

Apple Controller & Card
& Cable

LIST ~~\$110~~

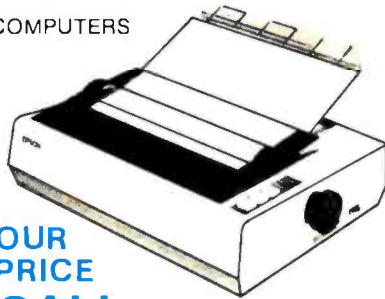

**OUR
PRICE
CALL**

- Most reliable small printers ever sold!
- Uses standard printed paper.
- Graphics option transfers screen image directly to paper.



ATARI 800
PERSONAL COMPUTER SYSTEM

\$798

IF

ATARI
MAKES
IT, WE
SELL IT

Assembler/Editor	45
Atari 400 Computer	439
Atari 820 Printer	429
Atari 810 Disk Drive	499
Atari 410 Program Recorder	69
Atari 16K RAM Module	149
Atari Basic ROM	45
Atari Visicalc	180
Basketball	30
Video Easel	30
Super Breakout	30
Music Composer	45
Computer Chess	30
Star Raiders	39
3D Tic-Tac-Toe	30
850 Interface	169
825 Printer	795

PRINTERS, MONITORS, DISCS

Anadex DP8000	850	Paper Tiger 445G w/Graphics	725	Dysan disks (pkg. 10)	50
Anadex DP8000AP	850	Paper Tiger 460 w/Graphics	1195	Memorex disks (pkg. 10)	40
Color Monitor	375	Silentype w/interface Cd	540	Opus disks (pkg. 10)	35
Daisy Wheel Printer	1795	Sanyo 9" B&W	169	Televideo 912C	699
MPI 88T	595	Sanyo 15" B&W	259	Televideo 920C	749
NEC Spinwriter #5510	2595	NEC Green Screen 12"	239	Verbatim disks (pkg. 10)	30

LEEDEX VIDEO 100
12" Black & White \$119

*** MONTHLY *
SPECIALS**

CENTRONICS 737
cable extra **\$737**

THE
POPULAR
INTERTEC

SUPERBRAIN

LIST
PRICE

32K Double Density ~~2995~~
64K Double Density ~~3495~~
64K Quad. Density ~~3995~~

OUR PRICE CALL

MEMBER BETTER BUSINESS BUREAU

LARGE STOCK OF SOFTWARE & ACCESSORIES

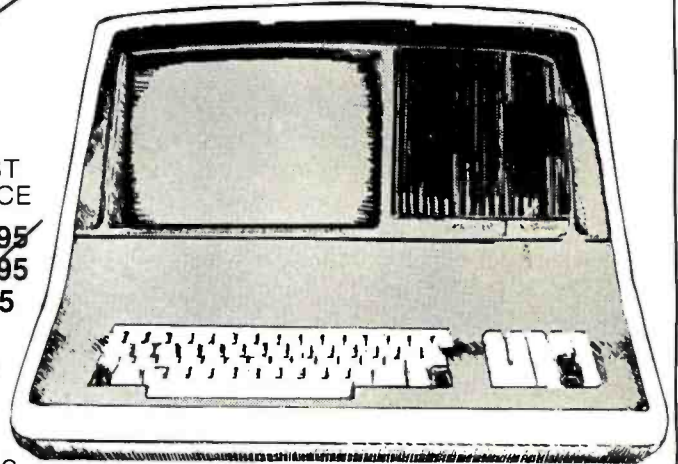

TO ORDER: Phone orders invited using Visa, Mastercard, or bank wire transfers. Visa & MC credit card service charge of 4%. Mail orders may send charge card number (include expiration date), cashiers check, money order, or personal check (allow 10 business days for checks to clear). Please include phone number. Include 3% (\$5.00 minimum) shipping, handling, and insurance in USA. Shipments

within Calif. add 6% sales Tax. Foreign orders include 1% handling — shipped freight collect. Foreign orders over \$1000 allow 6 weeks extra and include \$25 license fee. All equipment is in factory cartons with the manufactures warranty. Equipment is subject to price change and availability. We ship the same day on most orders. No C.O.D.s or P.O.s accepted. Retail store prices differ from mail order prices.



(714) 579-0330 • MAIL TO: 1251 BROADWAY, EL CAJON, CA. 92021

AUTHORIZED
APPLE
SALES &
SERVICE

COMPUTER



SPECIALTIES

DIV. OF
COMPUTER
METRICS
INC.

Circle 82 on inquiry card.

EXCITING DISCOUNTS

apple II
16K computer

DISK with CONTROLLER
NEW DOS 3.3 \$529
without ... \$445
Nearly Everything
for Apple

\$1049



WE WILL BEAT
ANY ADVERTISED PRICES
ON MOST ITEMS IF MERCHANDISE
IN STOCK

APPLE II 48K
\$1189

APPLE COMPUTER
INTERFACE CARDS

HiSpeed Serial Int. Cd.	155
Applesoft II Firmware Cd.	149
Centronics Interface Cd.	179
Apple Clock/Calendar Cd.	
by Mtn. Comp.	225
Comm. Cd. & DB25 Cable	179
Integer Basic Firmware Cd.	149
Parallel Printer Cd.	139
CCS Parallel Print Cd. 7720A	155
ROMPLUS w/keyboard filter.	165
ROMPLUS (keyboard filter extra) ...	159
SSM AIO Serial/Parallel I/O	
Assembled & Tested	189
Serial Interface Cd.	139
CCS Asynchronous 7710A	139

APPLE SOFTWARE

ALS Smarterm	324	DOS 3.3 Upgrade	49
Adventure by Microsoft	29	Dow Jones Portfolio Evaluator	45
Apple Bowl	19	Fastgammon	23
Apple Stellar Invaders	19	Forth II by Softape	45
Assembler/Disassembler	69	Fortran for Language Sys.	159
Applebug Debugger	29	Head-on	25
AppleGraph & Plot Sys.	59	Integer Basic Cassette Demos	29
Applepost Mailing List Sys.	44	Lazer Systems Lower Case + Plus ...	59
Applesoft Cassette Demos	29	Microsoft 16K Ramcard	179
Applesoft Util. Prog. — Hayden	29	PASCAL Language Sys.	459
Appewriter Word Processor	65	Sargon II Chess Game disk	34
Asteroids in Space	19	Shell Games	29
Autostart ROM Pkg.	59	Single Disk Copy Routines	35
Battleship Commander	19	Space Invader	25
Bill Budes Space Game Album	39	Star Cruiser	24
Bill Budes 3-D Graphics/Tool	39	Stellar Trek	23
Bill Budes Trilogy of Games	29	Sub-Logic FS-1 Flt. Sim./disk.	34
Cashier Retail Mgmt. Sys.	199	Tax Planner	99
Checkbook Cassette	19	The Correspondent	35
Contrib. Vols. 1-5 w/man.	29	Tranquility Base	24
Controller Bus. Pkg.	514	Visicalc by Personal Sftwe.	119
Cosmos Mission/Disk	25	Complete Peachtree Business	
CCA Data Mgmt. Sftwe.	84	Package for Apple	
3-D Animation Pack	55		
Desktop Plan Sftwe.	79		
DOS Tool Kit	65		

ACCESSORIES

Apple Joystick	47
ABT Numer. Input Keyboard A or B ..	114
A/D D/A Board by Mtn. Comp.	319
Arith. Processor 7811 A or B	339
Clear Cover for Apple Computer.	25
COPYROM by Mtn. Comp.	51
Corvus 10MByte Disk w/pwr. supp.	4395
Dan Paymar L.C. Kit 1 or 2	59
Extender Board	27
GPIO by CCS model 7490A	259
Graphics Input Tablet	649
Hayes Micromodem*	319
Introl X-10 Remote Control Sys.	239
Introl X-10 Controller Only	169
M&R Sup-R-Term 80 column board ..	329
Microsoft Z-80 Soft Card	295
Novation Cat Modem	159
Programmable Timer CCS 7440A ...	159
Prototyping Hobby Card	22
ROMWRITER by Mtn. Comp.	149
Speechlink 2000/64 Word Vocab.	215
SuperTalker Speech Synthesizer.	239
Symtec Light Pen	214
Versa-Writer Digitizer	
Drawing System	209
Videx Videoterm	319

AND MUCH MORE ...



CALL 1-800-854-2833

PHONE ORDERS

MON. - SAT. 8 to 6 P.S.T.

AUTHORIZED
APPLE
SALES &
SERVICE

COMPUTER



SPECIALTIES

DIV. OF
COMPUTER
METRICS
INC.

number of advanced searching functions are available; however, they probably won't be needed until you have quite a bit of experience on the system. Dialog's searching commands are simple, straightforward, and easy to learn. Dialog representatives do offer formal training classes on a regularly scheduled basis at locations

throughout the country. However, they're mainly designed for those with no computer experience and those who will be using Dialog as a regular part of their job (such as librarians). New users are given some free time on the system in order to have an opportunity to get a feel for how Dialog works.

Text continued on page 106

Listing 1: A typical search on the Dialog Information Retrieval Service—using the MAGAZINE INDEX data base. For the most efficient use of the system, as well as lower cost to the user, the search strategy (steps) should be planned on paper before logging in. See the text box of Basic Dialog Commands for a summary of the Dialog language. A SELECT statement can be up to 240 characters (when Boolean operators are used). Each search can create up to 98 sets, and there is a limit of one million citations per search.

```

Dialog system prompt
? SELECT COMPUTER?
  1  4251  COMPUTER?
Number of citations
Set number

? SELECT MICROCOMPUTER?
  2  308 MICROCOMPUTER?
Indicates the two terms must be adjacent to one another in the index

? SELECT STEPS PERSONAL(W)COMPUTER? OR MHOME(W)COMPUTER?
  3  122 PERSONAL(W)COMPUTER?
  4   85 HOME(W)COMPUTER?
  5  185 3 OR 4
Previously selected set number

? SELECT S5 AND JN =BYTE
      824 JN=BYTE
      6  20  S5 AND JN=BYTE
Journal name (special index field)
Set number
Format number

? TYPE 6/ 1/ 1
6/1/1
1536795
Set Item number
Dialog reference number

? TYPE 6/2/1
6/2/1
1536795
FCC regulation of personal- and home-computing devices. (Federal
Communications Commission)
Mahn, Terry G.
Byte v5 p180(7) Sept 1980 CODEN: BYTEDJ
DESCRIPTORS: United States. Federal Communications Commission-rules and
regulations; computers-rules and regulations
IDENTIFIERS: personal computers-rules and regulations

? TYPE 6/3/1
6/3/1
1536795
FCC regulation of personal- and home-computing devices. (Federal
Communications Commission)
Mahn, Terry G.
Byte v5 p180(7) Sept 1980 CODEN: BYTEDJ

? TYPE 6/4/1
6/4/1
1536795

```

Listing 1 continued on page 104

You'll be a little richer after building one of these.

H-19 Professional Video Terminal



H-8 Personal Computer with Dual Floppy Disk Storage



H-11A 16-Bit Computer with Dual Floppy Disk Storage



H-89 All-In-One Computer with Floppy Disk Storage



H-14 Serial Printer



Self-Instruction for Assembly and BASIC Programming

Richer in knowledge

Once you build your own computer, you'll know it inside out. You'll know how to make it work for you, how to make it grow as your skills grow.

Richer in savings

Build-it-yourself kits cost less — about 30% less than comparable assembled computers. And you'll probably never need to pay someone for service because no one will know your computer better than you.

Is it hard?

Not at all. Heath makes it simple with easy-to-assemble designs and with step-by-step manuals that guide you from unpacking to final plug-in. And a Heathkit helping hand is always just a phone call away.

Innovative software

Heath offers you innovative programs for running your home or business, and exciting games for your family. You can have Microsoft™ BASIC™, one of the most powerful and widely used languages.

Heath User's Group (HUG) will share with you a library of over 500 programs to make your computer serve you in ways you never imagined.

Complete hardware

Choose from three computer systems:

The H89 All-In-One Computer gives you everything in one compact, convenient unit.

The flexible H8 gives you the freedom to combine memory and interfacing for exactly the system you require.

And the powerful H11A gives you 16-bit

power for your most complex programs.

The Heathkit line includes video terminals, matrix and letter-quality printers and a complete selection of accessories. You'll even find award-winning self-instruction packages to teach yourself programming in BASIC or Assembly.

FREE CATALOG



It's all in the new 104-page Heathkit Catalog, along with nearly 400 electronic kits for your home, work or pleasure. Send for your free catalog today, or pick one up at your Heathkit Electronic Center.*

Heathkit®

*Visit your Heathkit Electronic Center in the U.S. or Canada where Heathkit Products are displayed, sold and serviced. See your white pages for the location nearest you. Heathkit Electronic Centers are units of Veritechnology Electronics Corporation in the U.S.

Write to Heath Company, Dept. 334-784, Benton Harbor, MI 49022
(In Canada write Heath Company, 1480 Dundas St. E., Mississauga, Ont. L4X 2R7)

Listing 1 continued:

FCC regulation of personal- and home-computing devices. (Federal Communications Commission)

? TYPE 6/3/1-20

6/3/1

1536795

FCC regulation of personal- and home-computing devices. (Federal Communications Commission)

Mahn, Terry G.

Byte v5 p180(7) Sept 1980 CODEN: BYTEDJ

6/3/2

1522838

The Heath H-89 computer. (evaluation)

Dahmke, Mark

Byte v5 p46(6) Aug 1980 CODEN: BYTEDJ

illustration

6/3/3

1508584

Bills introduced in Congress. (dealing with personal computers)

6)

Byte v5 p186(6) June 1980 CODEN: BYTEDJ

6/3/4

1508580

A personal computer on a student's budget.

Johnston, J.C.

Byte v5 p138(6) July 1980 CODEN: BYTEDJ

illustration

.....

.....

6/3/17

1017592

User's report: the PET 2001. (evaluation)

Fylstra, Dan

Byte v3 p114(9) March 1978

6/3/18

1017578

Personal computers in a distributed communications network.

Steinwedel, Jeff; S

Byte v3 p80(8) Feb 1978

6/3/19

1017469

Speech recognition for a personal computer system.

Boddie, James R.

Byte v2 p64(7) July 1977

6/3/20

1017464

Personal computer network.

Byte v2 p59(2) Sept 1977

? END/SAVE

Serial# 4QDI

Serial number of search strategy (steps used)

Listing 1 continued on page 106

POWER-ONE D.C. POWER SUPPLIES

Our customers select their favorite models









The choice wasn't easy. Not with 105 open frame linears and a full switcher line to choose from. Still, the top models of the past year — proudly pictured below — have been named.

Actually, this is a statement of Power-One's most popular D.C. power supplies — as determined by our customers. Obviously, applications vary widely, from

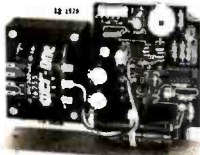
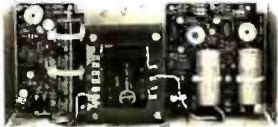
small floppies and micro-computers to large main-frame systems.

But one thing they all have in common. They're built by Power-One. Which means the most reliable power supplies available, at the lowest cost possible.

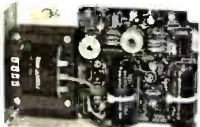
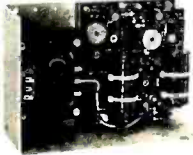
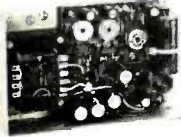
So take a look at our entire line. Send for our new 1981 Catalog and Facilities Brochure for details.

<p>Switchers</p> <ul style="list-style-type: none"> • Hi-Tech Design • High Efficiency - 75% min. • Compact/Light Weight • 115/230 VAC Input • 20 msec Hold-up • Totally Enclosed Packaging • Two Year Warrantee • 24 Hour Burn-in 	<p>SINGLE OUTPUT</p>  <p>5V to 24V Models</p> <p>SD, 60W : \$115.00 SF, 100W : \$170.00 SK, 200W : \$250.00</p>	<p>MULTIPLE OUTPUT 150 Watts</p>  <p>5V @ 20A -12V @ 3A 12V @ 5A 5V to 24V @ 3.5A User Selectable</p> <p>SHQ-150W : \$295.00</p>	<p>QUME PRINTER SUPPLY</p>  <p>5V @ 10A ± 15V @ 4.5A/16A Peak</p> <p>SP305 : \$345.00</p>
<p>Disk-Drive</p> <ul style="list-style-type: none"> • Powers Most Popular Drives • 7 "Off the Shelf" Models • Powers Drives & Controller • UL & CSA Recognized • 115/230 VAC Input 	<p>5 1/4" FLOPPY SUPPLIES</p>  <p>CP340, 1 Drive : \$44.95 CP323, Up to 4 Drives : \$74.95</p>	<p>8.0" FLOPPY SUPPLIES</p>  <p>CP205, 1 Drive : \$69.95 CP206, 2 Drives : \$91.95 CP162, Up to 4 Drives : \$120.00</p>	<p>WINCHESTER SUPPLIES 2 Models to Power any Manufacturer's Drive</p>  <p>CP379, CP384 : \$120.00</p>
<p>Open-Frame Linear</p> <ul style="list-style-type: none"> • Industry Standard Packages • 115/230 VAC Input • ±.05% Regulation • Two Year Warrantee • UL & CSA Recognized • Industry's Best Power/Cost Ratio 	<p>SINGLE OUTPUT</p>  <p>5V @ 3A 24V @ 1.2A 12V @ 1.7A 28V @ 1.0A 15V @ 1.5A 250V @ 0.1A</p> <p>HB Series : \$24.95</p>	<p>SINGLE OUTPUT</p>  <p>5V @ 6A 24V @ 2.4A 12V @ 3.4A 28V @ 2.0A 15V @ 3.0A 48V @ 1.0A</p> <p>HC Series : \$44.95 to \$49.95</p>	<p>DUAL OUTPUT</p>  <p>± 12V @ 1.0A or ± 15V @ 0.8A</p> <p>HAA15-0.8 : \$39.95</p>
<p>DUAL OUTPUT</p>  <p>± 12V @ 1.7A or ± 15V @ 1.5A</p> <p>HBB15-1.5 : \$49.95</p>	<p>TRIPLE OUTPUT</p>  <p>5V @ 2A ± 9V to ± 15V @ 0.4A</p> <p>HTAA-16W : \$49.95</p>	<p>TRIPLE OUTPUT</p>  <p>5V @ 3A ± 12V @ 1A or ± 15V @ 0.8A</p> <p>HBAA-40W : \$69.95</p>	<p>POWER FAIL MONITORS</p>  <ul style="list-style-type: none"> • Indicates pending system power loss. • Monitors AC line and DC outputs. • Allows for orderly data-save procedures <p>PFM-1 : \$24.95 PFM-2 : \$39.95</p>



NEW '81 CATALOG & FACILITIES BROCHURE

Get your free copies now!
Phone or write us direct, or circle the reader service number

POWER-ONE
D.C. POWER SUPPLIES



Listing 1 continued:

```
? BEGIN 111 _____ Dialog file number
File111:National Newspaper Index
(Copr. IAC)
Set Items Description (+=OR;*=AND;-=NOT)
-----
```

```
? .EXECUTE 4QDI _____ Execute previous search strategy
1588 COMPUTER?
7 MICROCOMPUTER?
23 PERSONAL(W)COMPUTER?
19 HOME(W)COMPUTER?
35 3 OR 4
0 JN=BYTE
```

```
? BEGIN 47
File47*:Magazine Index -
(Copr. IAC)
Set Items Description (+=OR;*=AND;-=NOT)
-----
```

```
? EXPAND COMPUTER _____ Find all index terms alphabetically close to specified term
```

Ref	Index-term	Type	Items	RT
E1	COMPUTATIONAL COMPLEXITY		1	
E2	COMPUTATIONS-----		1	
E3	COMPUTE-----		4	
E4	COMPUTED-----		3	
E5	COMPUTEK-----		2	
E6	--COMPUTER-----		3228	
E7	COMPUTER AIDED DESIGN----		24	
E8	COMPUTER AND BUSINESS EQUIPMENT MANUFACTUR--		2	
E9	COMPUTER AND COMMUNICATI ONS ASSOCIATION-----		1	
E10	COMPUTER AND COMMUNICATI ONS INDUSTRIES ASS----		1	
E11	COMPUTER AND SYSTEMS ENGINEERING LTD.-----		1	
E12	COMPUTER ANIMATION-----		5	
E13	COMPUTER APPLICATIONS CORP.-----		2	
E14	COMPUTER ARCHITECTURE----		2	

Text continued from page 102:

Searching

A Dialog spokesman stressed to me the importance of developing a general search *strategy*. This means sitting down with paper and pencil *before* logging on to the system, organizing questions or topics into logical groups, and then combining the groups through the use of logical (Boolean) relationships. This is an important point since wasting time with an inefficient searching strategy can become very expensive.

Since every word in every citation is indexed, the key to efficient searching is being as specific as possible. For example, the MAGAZINE INDEX contains 1.3 million individual citations; searching for all references to COMPUTER? (the ? is a "wildcard" character that matches any letters at the end of the word) yielded 4251 citations (see

listing 1). Obviously, steps must be taken to pare down the number of citations by being much more specific. Searching for MICROCOMPUTER? yielded 308 citations, still a healthy number. HOME(W)COMPUTER? OR PERSONAL(W)COMPUTER? yields 185 citations. (The (W) indicates the two words must be adjacent to one another.)

Besides the every-word indexing, all Dialog data bases contain special indexes that vary from file to file. If I wish to search for all home and personal computer articles in BYTE, I can AND my set of 185 citations with JN=BYTE—giving me a total of twenty citations. There are also special indexes which allow you to specify publication year, author name, article type (such as product review), or a number of other special features. Obviously, sitting down beforehand and planning your search

Can your word processor pass this screen test?

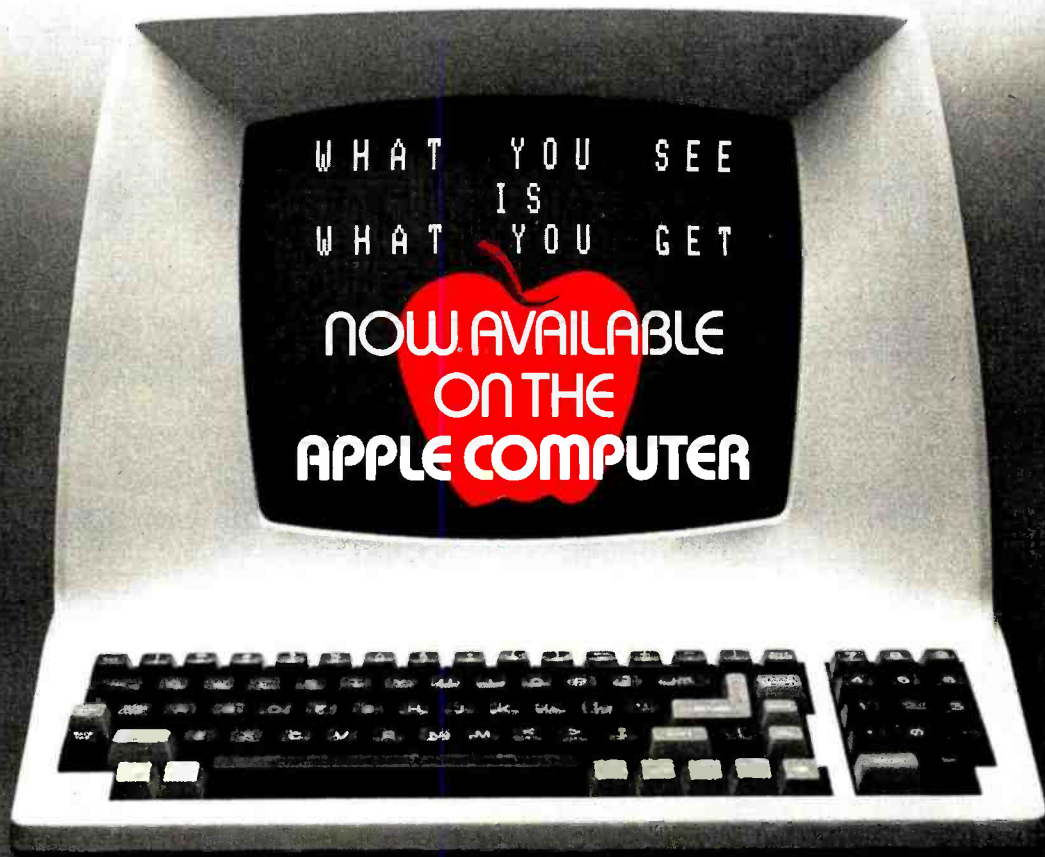

WordStar™ software does*! And does it better than any other word processing system. Not only do you get all the sophisticated features you'd expect from the high-priced WP system, with WordStar you have a true screen image of what your printout will look like **before you print it!**

With WordStar, you'll erase, insert, delete and move entire blocks of copy. Page breaks are

displayed and automatically revised on the screen. You can specify enhancements like underlining and boldfacing, and much more.

And WordStar's so much easier to learn because of its unique and extensive self-help menus. Every typist in your office can be an instant screen star. Call (415) 457-8990 and ask for a copy of our WordStar demon-

stration booklet. Remember, when you're the star, we're the star.

MicroPro™

INTERNATIONAL CORPORATION

The Star Maker

MicroPro International Corporation
1299 4th Street, San Rafael, CA 94901
(415) 457-8990 TELEX 340388
Sold through authorized dealers and distributors only. OEM inquiries invited.

*Runs on most Z80/8080/8085 microcomputers with CP/M (TM of Digital Research), 48K, and terminal with addressable cursor. Apple computer installation requires MicroSoft Softcard and 80 column video board.

Apple Computer is a registered trademark of Apple Computer, Inc.

Basic Dialog Commands

Although there are many commands available in the Dialog searching language, a small number are the only ones used for the majority of searches. They include:

- **EXPLAIN** — an on-line help file that provides a detailed description of any specified command. The file also contains a list and description of all available data bases and system news.
- **SELECT** — sets aside index terms or groups of terms you specify into numbered sets (up to 98). More than one term can be combined into a single **SELECT** statement by inserting Boolean operators between terms. For example:

```
SELECT PETROLEUM AND PRICES AND OPEC AND PY=1979
```

A command line can contain up to 240 characters.
- **SELECT STEPS** — similar to **SELECT**, except that each individual item in a single command statement is assigned its own set number.
- **EXPAND** — used to display a listing of index terms that are alphabetically close to the term entered. Each term is given a reference number that can be **SELECT**ed, and the number of individual entries for each term is listed.
- **TYPE** — displays records on-line from the sets you've previously retrieved. A number of different formats and ranges can be entered. For example, the Dialog reference number, the title only, or the full record can be displayed.
- **PRINT** — orders the specified search results to be printed off-line using Dialog's high-speed printer. The printouts are normally received in three to four days. If you've retrieved a large number of references and/or abstracts, having them printed

off-line is considerably less expensive than using connect time to dump them to your own printer.

- **END/SAVETMP** — ends a search session and saves the search strategy (individual **steps**) you've used in an individual data base. The strategy is saved until the end of the calendar day and in that period can be used in other data bases by using the **EXECUTE** command.
- **EXECUTE** — searches a data base using the search strategy saved by the **END/SAVETMP** command. This eliminates the time and expense of having to enter individual steps every time a different data base is entered.
- **END/SDI** — ends a search session and instructs the Dialog system to run the same search strategy in the specified file each time the file is updated. If new information is found, it is printed off-line and mailed to you. (This service is not available on all Dialog files.)
- **KEEP** — saves the references and/or abstracts you specify in a special set from which documents may be ordered using **DialOrder**.
- **ORDER** — automatically orders reprints specified by the **KEEP** command. The document supplier can be specified from a list supplied by Dialog.

For more information on Dialog and an application for service, contact:

Dialog Information Retrieval Service
Department 52-89/BT
3460 Hillview Ave
Palo Alto CA 94304
(800) 227-1617, ext 518
California (800) 772-3545, ext 518

makes the process proceed much more quickly, smoothly—and inexpensively.

If you have problems finding the correct search strategy, there is a toll-free hotline number to Dialog's Customer Service Department, which is open twelve hours a day. Besides helping beginning searchers, there is a specialist on each data base available who can help with a particularly complicated search.

Other Features

Dialog allows you to reconnect to the system within ten minutes of a disconnect (such as being dropped by one of the networks). Up until this time limit, all the set you've created will still be in the user area. Unfortunately, if the disconnect lasts longer, you'll have to start again from the beginning.

Users who wish to keep their own private data bases on the Dialog system can do so through the Private File Service. The cost for storage of data is \$12 per million characters per month. Currently, in order to take advantage of the Private File Service, users must supply Dialog with

IBM reel-to-reel tapes. However, Dialog's staff is in the process of developing a method that will enable users to build up their personal data bases from their own terminal.

Summary

Dialog is an invaluable service for anyone who needs to locate information on any imaginable subject from aardvarks to zymology. (Remember, the system is *not* designed to be everything to all people. Unlike the Source or Micronet, you can't play games or get the latest news from one of the wire services; not only are those services unavailable, but the cost of just "browsing" adds up very quickly.) Although the cost of the service seems expensive, the system's speed, efficiency, and interactive nature make it a net time and money saver when it's used for its intended purpose—finding references to information.

A Dialog staffer put it this way: "On the system, searching is an adventure." I can add that this adventure is *much* less frustrating than the computer game of the same name. ■

COMPUTER WAREHOUSE

CALL TOLL FREE **1-800-528-1054**

International Dealer & Personal Inquiries Invited, Prices May Vary. Tlx (0) 668382 (MCB)

ATARI

Special 32K 800 System 800 w/32K. recorder star raiders, joysticks	\$935
800 (16K)	\$770
400	Call
810 Disk Drive	Call
825 Printer	\$710
850 Interface	\$155
410 Recorder	\$70
830 Modem	\$140
Star Raiders	\$ 45
16K Memory	\$ 90
32K Memory	\$150

DISK DRIVES

Lobo Apple 1st Drive	\$490
Apple 2nd Drive	\$410

MODEMS

Novation CAT	\$155
D-CAT	\$155

SOFTWARE

Centa Systems CBASIC	Call
CP/M	Call

VIDEO TERMINALS

Adds Viewpoint	Call
Soroc IQ 120	Call
IQ 135	Call
IQ 140	Call
Televideo 912 B	\$699
912 C	\$699
920 B	\$749
920 C	\$749
950	Call
Zenith - Z - 19	\$789

PRINTERS

Centronics 737 Serial	Call
737 Parallel	Call
C.Itoh Starwriter	\$1470
Datasouth DS180	\$1470
Diablo	Call
Epson MX-80	Call
MX-70	Call
MPI-88G	Call
NEC	Call
Okidata Microline 80	\$399
Microline 82	\$620
Microline 83	\$923
Qume	Call
Texas Instruments 810 Basic	\$1480
810 Loaded	\$1739

COMPUTERS

Altos	Call
Northstar	Call
Intertec Data Superbrain 64K D/D	\$2777
Commodore 8032	\$1498
8050	\$1498
Zenith Z-89 48K	Call

DISKETTES

Memorex	Call
BASF	Call
Scotch 5¼-0, 10, 16 Sector (Qty 100)	\$250
8"-0, 32 Sector (Qty 100)	\$260

MONITORS

APF - 9" Monitor	\$115
Sanyo - 9" Monitor	\$165

We Buy and Sell Used Equipment

Experienced Equipment

Diablo, NEC, Qume	from \$2100
Centronics 779	\$450
Hazeltine 1510	\$650
Hazeltine 1420	\$600
Comprint 912	\$275
Atari 820 printer	\$400
Soroc	\$500
TI 810 Basic	\$1200
Axiom 801 HS	\$250

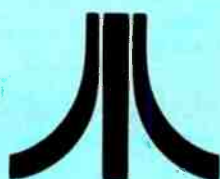

Novation



ZENITH
data systems

ATARI®

NorthStar



TeleVideo

3M TEXAS INSTRUMENTS

EPSON
EPSON AMERICA, INC.



OKIDATA

MICROTEK PERIPHERALS CORP.



2222 E. Indian School Rd. Phoenix, Arizona 85016
(602) 954-6109 1-800-528-1054

Store Hours: Tues.- Friday 10-5 MST Saturday 10-4 MST



Personal checks will delay shipping two weeks. Prices & availability subject to change without notice.

Prices reflect 3% cash discount. Product shipped in factory cartons with manufactures warranty. Add 2%, a minimum of \$5, for shipping and handling.

A Computer-Based Laboratory Timer

John Gibson
Physics Department
Alma College
Alma MI 48801

Accurate time measurement is a fundamental requirement of every elementary physics laboratory. Thanks to modern electronics, most laboratories now use digital timing devices that are activated by photocells or microswitches. This is a great improvement over the hand-operated mechanical stop-clocks that were prevalent only a few years ago, but most electronic timers are still unsatisfactory in one important respect: only the most sophisticated (and expensive) are able to rapidly make and record a succession of elapsed-time measurements.

Data acquisition and logging are natural provinces of the microcomputer. Since small microcomputers and microcomputer trainers are now so widely available, it is only natural to try to adapt them for use in a variety of laboratory measurements. This article will show how a very modest microcomputer can be wired and programmed for use as a sophisticated laboratory timer.

First we will examine the system-

independent design considerations for a microcomputer-based, two-channel, data-logging, millisecond timer. Then we will build this design on a Heath ET-3400 microprocessor trainer used with the ETA-3400 expansion accessory.

The Programmable Timer

The heart of this design is a microcomputer peripheral device called a *programmable timer*. This device connects directly to the microcomputer bus and may be configured (by software) to perform the timing measurements required. When the programmable timer and microcomputer are connected for use as a laboratory timer, there is a clear division of labor: the programmable timer performs the time measurements, and the microcomputer records the results.

Figure 1 is a programming model of a common programmable timer. In addition to its connections to the microcomputer bus, the timer also has a gate input \overline{G} , an external clock

input \overline{C} , and an output O . Inside the timer are three addressable registers:

- An 8-bit, write-only *control register* that is used to establish the timer's operating mode, in much the same way as a control register configures the operation of a common PIA (peripheral interface adapter);

- A 16-bit write-only *latch*. Its contents are divided into two 8-bit bytes, called M , for the more-significant (or high-order) byte, and L , for the less-significant (or low-order) byte. The latch's contents are preset to hexadecimal FFFF on system power-up or RESET, and they may be changed at any time by the program running in the microcomputer;

- A 16-bit write-only *counting register*. A momentary logic-0 level at the timer's gate input causes this register to be loaded with bytes M and L from the latch. The counting register then decrements on each cycle of a specified timing signal. Further operating details are dictated by the timer's operating mode.

Text continued on page 114

At Hayes, we don't believe in second best. Or planned obsolescence. We believe in taking the state of the art to the limit. Our new Smartmodem, for example, is the most sophisticated 300-baud originate/answer modem you can buy. And yet, it is perhaps the easiest-to-use modem ever.

RS-232C Compatible. Smartmodem lets any RS-232C compatible computer or terminal communicate by phone with other computers and time-sharing systems located *anywhere in North America*. You get full and half-duplex operation with both Touch-Tone* and pulse dialing.

Auto-Answer/Dial/Repeat. Smartmodem can answer the phone, dial a number, receive and transmit data, and then hang up the phone—automatically! If desired, Smartmodem will even repeat the last command. You can depend on Smartmodem for completely unattended operation.

Completely Programmable. Smartmodem can be controlled using

Hayes Stack™

Microcomputer Component Systems

any programming language. Over 30 different commands can be written into your programs or entered directly from your keyboard.

Smartmodem also includes several switch-selectable features that let you tailor performance to your exact needs. You can "set it and forget it" for the ultimate in convenience.

Built-in Audio Monitor. Thanks to an internal speaker, you can actually listen to your connection being made. You'll know immediately if the line is busy or if you reached a wrong number—

and you don't even need a phone!

Status at a Glance. Seven LED's indicate Smartmodem's current operating mode: auto-answer, carrier detect, off hook, receive data, send data, terminal ready and modem ready. You're never left in the dark!

Direct-Connect Design. Smartmodem is FCC registered for direct connection to any modular phone jack—there's no acoustic coupler to cause signal loss and distortion.

Smartmodem, Smart Buy. Professional quality features. Versatile performance. A full two-year limited warranty. A suggested retail price of only \$279.

What more could you want? Perhaps the matching Hayes Stack Chronograph, an RS-232C compatible calendar/clock system.

Check out the Smartmodem wherever fine computer products are sold. And don't settle for anything less than Hayes.



Smartmodem.
The ultimate concept in modems
is now a reality.

Hayes Microcomputer Products Inc. 5835 Peachtree Corners East, Norcross, Georgia 30092 (404) 449-8791

Hayes Stack is a trademark of Hayes Microcomputer Products, Inc. Sold only in the U.S.A. *TM American Telephone and Telegraph ©1981 Hayes Microcomputer Products, Inc.

consumer computers

mail order

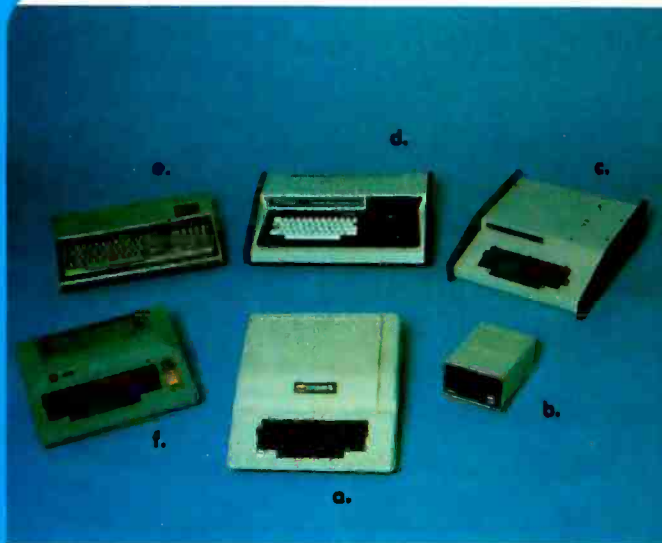

PRINTERS

ANADEX DP-9500 W/2K BUFFER	1375
ANADEX DP-9501 W/2K BUFFER	1450
BASE 2 800-B	599
C. ITOH STARWRITER 25 CPS	1750
C. ITOH STARWRITER 45 CPS	2450
A. CENTRONICS 737	825
EPSON MX-70 W/GRAPHICS	449
B. EPSON MX-80 132 col.	620
PAPER TIGER IDS-445 W/DOT PLOT	749
C. PAPER TIGER IDS-460 W/DOT PLOT	1195
PAPER TIGER IDS-560 W/DOT PLOT	1495
D. QUME SPRINT 5/45	2550
SILENTYPE W/INTERFACE	549

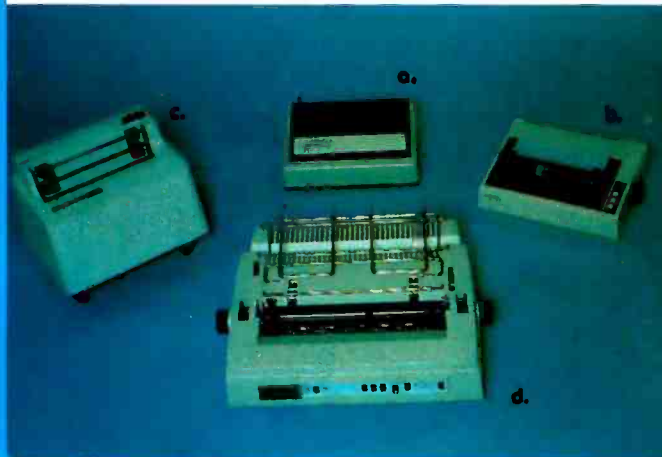

SYSTEMS

A. APPLE II PLUS 16K	1049
APPLE II PLUS 48K (APPLE Memory)	1189
APPLE II STANDARD MODELS	CALL
These are the newest models with FCC type approval to prevent RF interference.	
B. DISK II DRIVE & CONTROLLER	529
This model includes DOS 3.3 16 sector	
DISK II DRIVE ONLY (ADD-ON)	445
C. CHALLENGER 4P by OHIO SCIENTIFIC	699
C4PMF (MINI FLOPPY SYSTEM)	1599
CIP MODEL II	449
SARGON II (DISK OR CASSETTE)	35
FIG FORTH (DISK ONLY)	69
D. PMC-80 THE 'TRS-80 WORKALIKE'	629
16K LEVEL II W/PROGRAM RECORDER	
CALL OR WRITE FOR MORE INFORMATION	
E. EXIDY SORCERER II	CALL
AVAILABLE IN 16K, 32K & 48K MODELS	
5-100 EXPANSION UNIT	375
WORD PROCESSING PAC	179
DEVELOPMENT PAC	89
F. ATARI 800 16K	799
ATARI 400 16K	499
810 DISK DRIVE	499
410 PROGRAM RECORDER	69
850 INTERFACE MODULE	175



VIDEO MONITORS

A. AMDEX/LEEDEX VIDEO-100 12" BGW	139
HITACHI 13" COLOR	389
B. NEC 12" P31 GREEN PHOSPHER	CALL
PANACOLOR 10" COLOR	375
SANYO 9" BGW	179
C. SANYO 12" BGW	255
SANYO 12" P31 GREEN PHOSPHER	295
SANYO 13" COLOR	445

SHOPPING MAIL ORDER? CALL US TODAY!

We probably have what you're looking for in stock at an incredible price. Our company is an authorized dealer for sales and service for Apple Computer, Atari and Ohio Scientific. If you receive a defective product from us we will repair or replace (at our option) any product in warranty. Our Service Center will repair all Apple Computer products, in or out of warranty, whether it was purchased from us or another dealer. (call for more details)

PHONE ORDERS IN CALIFORNIA, ALASKA, HAWAII & FOREIGN (714)698-8088
 SHIPPING INFORMATION OR BACKORDERS PLEASE CALL (714)698-0260
 SERVICE CENTER AND FOR TECHNICAL INFORMATION (714)460-6502
 TELEX 695-000 ANS:BETA ATTN:CCMO

Order Dept.
Open Every Day
9 a.m. - 6 p.m.
P.S.T.

TOLL FREE ORDER LINE 800-854-6654



APPLE HARDWARE

TOP FIVE SELLERS

LANGUAGE SYSTEM W/PASCAL.	425
SILENTYPE PRINTER W/INTERFACE.	549
HAYES MICROMODEM II.	319
VIDEX VIDEOTERM 80 w/graphics.	335
Z-80 MICROSOFT CARD.	299

APPLE COMPUTER INC.

DISK II DRIVE ONLY.	445
INTEGER OR APPLESOFT II FIRMWARE CARD.	155
GRAPHICS TABLET.	649
PARALLEL PRINTER INTERFACE CARD.	155
HI-SPEED SERIAL INTERFACE CARD.	155
COMMUNICATIONS INTERFACE CARD.	185
SMARTERM 80 COLUMN VIDEO CARD.	335

MOUNTAIN COMPUTER INC.

MUSIC SYSTEM (16 Voices).	479
A/D + D/A INTERFACE.	319
EXPANSION CHASSIS.	555
INTROL/X-10 SYSTEM.	249
CLOCK/CALENDAR CARD.	239
SUPERTALKER 5D-200.	249
ROMPLUS+ CARD.	135
ROMWRITER CARD.	155

CALIFORNIA COMPUTER SYSTEMS

CLOCK/CALENDAR MODULE.	109
GPIB IEEE-488 CARD.	259
ASYNCHRONOUS SERIAL INTERFACE CARD.	129
CENTRONICS PARALLEL INTERFACE CARD.	99
We carry all CCS hardware.	Please call

MISC. APPLE HARDWARE

16K RAM UPGRADE (Apple, TRS-80, Exidy).	189
16K RAM CARD MICROSOFT.	189
ABT NUMERIC KEYPAD (old or new kybrd).	115
ABT BAR CODE READER WAND.	179
ALF 3 VOICE MUSIC CARD.	229
ALF 9 VOICE MUSIC CARD.	169
ALPHA SYNTAURI KEYBOARD SYSTEM.	1399
BIT 3 FULL VIEW 80 CARD.	349
CAT NOVATION ACOUSTIC MODEM.	169
CORVUS 10MB HARD DISK.	CALL
LAZER LOWER CASE PLUS.	50
MICRO-SCI DISK DRIVES.	CALL
PAYMAR LOWER CASE (old or new kybrd).	55
RADCOM AMATEUR RADIO INTERFACE CARD.	189
SPEECHLINK 2000 HEURISTICS.	229
SSM AIO SERIAL/PARALLEL CARD A&T.	189
SUP-R-TERMINAL 80 COL. CARD.	339
SVA 8 INCH FLOPPY DISK CONTROLLER.	345
VERSAWRITER DIGITIZER PAD.	229
VIDEX KEYBOARD ENHANCER.	115
We stock much more than listed.	Please call.

APPLE SOFTWARE

APPLE COMPUTER INC.

DOS TOOLKIT.	65
APPLEPLOT.	60
TAX PLANNER.	99
APPLE WRITER.	65
APPLE POST.	45
DOW JONES PORTFOLIO EVALUATOR.	45
DOW JONES NEWS & QUOTES REPORTER.	85
APPLE FORTRAN.	165
APPLE PILOT.	129
DOS 3.3 UPGRADE.	49
MUSIC THEORY.	45
THE CASHIER Retail Mngmnt & Inv.	199
THE CONTROLLER Gen. Bus. Sys.	519

MISC APPLICATIONS PACKAGES

VISICALC.	125
DESKTOP PLAN II.	169
CCA DATA MANAGMENT DMS.	85
EASYWRITER WORD PROCESSOR.	225
EASYMOVER MAIL SYSTEM.	225
EASYMAILER LETTER WRITER.	225
ASCII EXPRESS.	65
MICROSOFT FORTRAN.	185
MICROSOFT COBOL.	695
MICROSOFT BASIC COMPILER.	375
SUPER TEXT II.	139
PROGRAMMA APPLE PIE.	119
THE LANDLORD Apt Mngmnt package.	649
PEACHTREE BUSINESS SOFTWARE.	CALL
TAX PREPARER by HowardSoft.	89
APPLEBUG ASSEM/DISASM/EDITOR.	75
3-D GRAPHICS By Bill Budge.	53
SUPER FORTH.	49

TOP TEN GAMES

APPLE GALAXIAN.	23
FLIGHT SIMULATOR.	34
THE WIZARD AND THE PRINCESS.	32
COSMOS MISSION (SPACE INVADERS).	24
SARGON II CHESS.	32
HI-RES FOOTBALL.	39
COMPUTER QUARTERBACK.	39
ADVENTURE BY MICROSOFT.	27
PHANTOMS FIVE.	39
REVERSAL (OTHELLO).	34

**CALL OR WRITE
FOR A COMPLETE
SOFTWARE LIST**

ORDERING INFORMATION: Phone Orders invited using VISA, MASTERCARD, AMERICAN EXPRESS, DINERS CLUB, CARTE BLANCHE, or bank wire transfer. Credit cards subject to service charge: 2% for VISA & MC, 5% for AE, DC & CB. Mail Orders may send credit card account number (include expiration date), cashiers or certified check, money order or personal check (allow 10 days to clear). Please include a telephone number with all orders. Foreign orders (excluding Military PO's) add 10% for shipping; all funds must be in U.S. dollars. Shipping, handling and insurance in U.S. add 3% (minimum \$4.00). California residents add 6% sales tax. We accept COD's under \$500. OEM's, Institutions & Corporations please send for written quotation. All equipment is subject to price change and availability without notice. All equipment is new and complete with manufacturer warranty (usually 90 days). We cannot guarantee merchantability of any products. We ship most orders within 2 days.

**WE ARE A MEMBER OF THE BETTER BUSINESS BUREAU AND THE CHAMBER OF COMMERCE
SHOWROOM PRICES MAY DIFFER FROM MAIL ORDER PRICES.**

PLEASE SEND ORDERS TO:

CONSUMER COMPUTERS MAIL ORDER 8314 PARKWAY DRIVE, GROSSMONT SHOPPING CENTER NORTH LA MESA CALIF. 92041

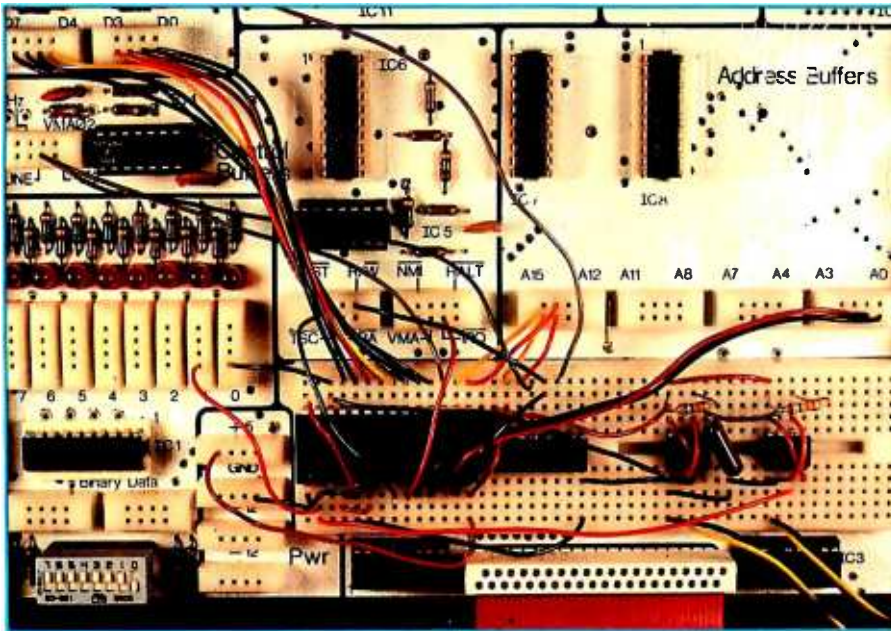

Photo 1: Heath ET-3400 microcomputer trainer wired for use as a two-channel, data-logging, millisecond timer. The picture shows all circuit components except the phototransistors, which are connected to the type-555 integrated circuits (used as input comparators) via the two yellow-black twisted pairs of wires at the lower right.



Photo 2: Lamp and phototransistor attached to one end of the air track. For best timing resolution, the lamp is mounted so that its filament is vertical.

Text continued from page 110:

The programmable timer is a versatile device with several operating modes, two of which are useful for elapsed-time measurements:

- *Pulse-width-comparison mode*, in which the timer measures the length of time its gate input is held at logic 0;
- *Frequency-comparison mode*, in which the timer measures the time between two successive logic 0s at its gate input.

These two types of time measurement are illustrated in figure 2.

Time-Interval Measurement

Each elapsed-time measurement

consists of six steps. The first three steps are performed by the programmable timer, and the last three are performed by the microcomputer.

The following three measurements are those performed in sequence by a timer programmed for operation in the *pulse-width-comparison mode* (by storing hexadecimal 58 in its control register):

1. The timer's gate input, normally at logic 1, is pulled to logic 0 at the beginning of the timed event. This loads the timer's counting register with bytes M and L from the latch.
2. The counting register then decrements on each cycle of a timing

signal applied to the timer's external-clock input and continues to do so while the gate input is held at logic 0. 3. The gate input is driven back to logic 1 at the end of the timed event. If this occurs before the counting register reaches zero, the count stops, and the timer generates a program interrupt by pulling the microcomputer's active-low \overline{IRQ} (interrupt-request) line to logic 0.

The three measurement steps performed by a timer programmed for operation in the *frequency-comparison mode* (by storing hexadecimal 48 in its control register) are as follows:

1. The timer's gate input, normally at

6809 SYSTEMS ☹ 6809 SYSTEMS ☹ 6809 SYSTEMS ☹ 6809 SYSTEMS

Featuring the GIMIX mainframe with 30 amp C.V. ferro-resonant power supply; fifteen 50 pin and eight 30 pin slot Mother Board; 2 Mhz CPU with time of day clock & battery back-up, 1K RAM, 6840 programmable timer, provisions for 9511A or 9512 Arithmetic processors, and 4 PROM/ROM/RAM sockets that can hold up to 32KB of monitor or user software.

VARIETY: you can have 32KB, 56KB, 128KB and up of static RAM. You can use 5" and/or 8" disk drives, single or double density, single or double sided, and single or double tracking with GIMIX disk controllers. You have a wide choice of serial or parallel I/O cards.

EXPANDABILITY: You can add memory, I/Os, Video or Graphics cards, Arithmetic processors, additional drive capacity, and other hardware now or in the future to this SS50 bus structured system from GIMIX or other SS50 bus compatible manufacturers

SOFTWARE VERSATILITY: GIMIX systems can use TSC's FLEX or UNIFLEX and MICROWARE'S OS-9 operating systems. A wide variety of software and languages is available for these systems.

QUALITY: All boards are assembled, burned-in, and tested and feature GOLD PLATED BUS CONNECTORS. Only top quality components are used and all boards are fully buffered for maximum system expansion. All boards come complete with bus connectors and all necessary instruction and documentation.

GIMIX designs, manufactures and tests, in-house, their complete line of products. Complete systems are available to fit your needs. Please contact the factory if you have any special requirements.

For further information, pricing and brochures, contact:

GIMIX inc.
The Company that delivers
Quality Electronic products since 1975.
1337 WEST 37th PLACE, CHICAGO, IL 60609
(312) 927-5510 • TWX 910-221-4055

GIMIX* and GHOST* are registered trademarks of GIMIX Inc.

Flex and Uniflex are trademarks of Technical Systems Consultants Inc. OS9 is a trademark of Microware Inc. See their ads for other GIMIX compatible software.

For GIMIX compatible software see Technical Systems Consultants ad page 91 and Microware ad page 333.

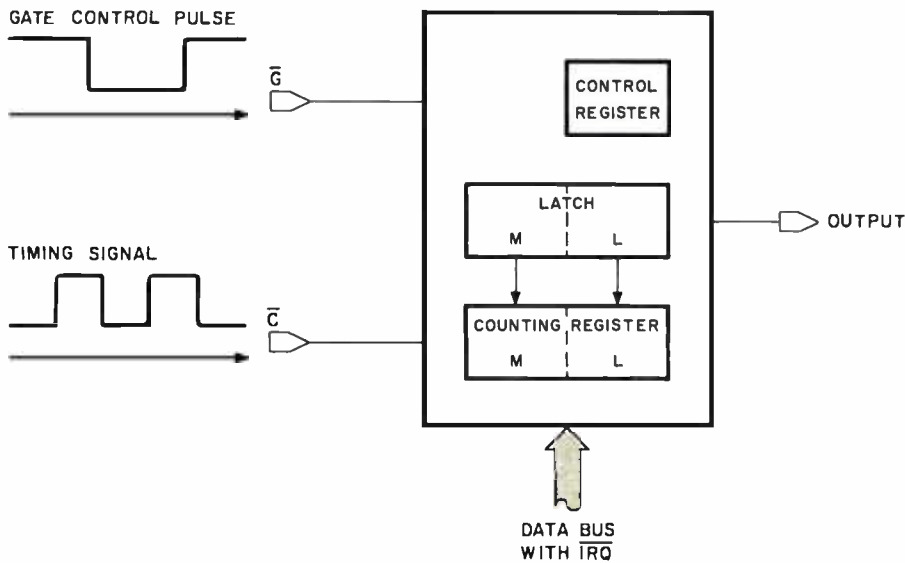

Figure 1: Model of the programmable timer, showing gate input \bar{G} , external-clock input \bar{C} , output O , the connection to the microcomputer bus, and the addressable registers. The arrows pointing from the latch to the counting register indicate the data transfer that takes place at the beginning of each count. Output O is not used in either the pulse-width-comparison or frequency-comparison modes of operation.

logic 1, is momentarily pulled to logic 0 at the beginning of the timed event. This loads the timer's counting register with bytes M and L from the

latch.
2. The counting register then decrements on each cycle of a timing signal applied to the timer's external-

clock input and continues to do so, even though the gate input returns to logic 1.

3. The gate input is again momentarily pulled to logic 0 at the end of the timed event. If this occurs before the counting register reaches zero, the count stops, and the timer generates a program interrupt by pulling the microcomputer's \overline{IRQ} line to logic 0.

For either operating mode, the timer ends its three-step sequence by signaling the microcomputer over its \overline{IRQ} line. The microcomputer's task begins when it receives the interrupt signal indicating that the timer has finished a count. The microcomputer then takes over the last three steps and:

4. Reads the timer's counting register.
5. Transforms the count into a useful measurement of elapsed time.
6. Saves the result.

We will now examine all of these

Text continued on page 118

dBASE III

Assembly-Language
Relational Database Management
for CP/M

\$595.

USE OUR CLIP-OFF™ TO AVOID A RIP-OFF
Check enclosed (U.S. funds only) \$ _____ dBASE II \$595.

Name _____
Street _____
City _____ State _____ Zip _____

**Interactive
Business
Solutions**

"Businessware™ for the Business Man"

**Interactive
Business
Solutions**

333 Cobalt Way, Suite 106
Sunnyvale, CA 94086
(408) 737-9618

Circle 178 on inquiry card.

Businessware and Clip-Off are trademarks of
Interactive Business Solutions

EXPOSE YOURSELF

(To Inexpensive, Global Telecommunications!)

- Person-to-Person Mail
- Classified Ads
- Product Reviews
- Bulletin Boards
- File Transfers
- Electronic Message Delivery

Interactive Business Solutions has contracted with **GTE/TELENET** for the corporate **TELEMAILSM** electronic communication system. Electronic message systems are the start of a complete revolution in human-to-human and human-to-machine communication.

We have decided to open our account to the general micro-computer public to encourage use of this exciting new technology. Now, for the first time, the individual user can access the same system that corporate customers have been enjoying. With any terminal and modem every user can send electronic mail and access multiple bulletin

board systems for only \$3.50 per hour during non-prime time. Non-prime time is normally 6 PM to 7 AM and weekends in the callers' local time zone.

We feel that overpriced telecommunications or exorbitant membership fees severely limit reaching thousands of computer enthusiasts who might otherwise be unable to use this revolutionary system.

Interactive Business Solutions is a software company, not a telecommunications company; by offering this low cost service we will be able to reach potential customers who might otherwise be unaware of our products.

Compare the following estimated costs of competitive systems and sign-on soon!

<u>System Name</u>	<u>Initial Fees</u>	<u>Non-prime time Cost per Hour</u>	<u>Commercial Ads</u>
The Source	\$100.00	2.75 - 4.25	ok
Compuserve	\$ 19.95	5.00	ok
TSC/MAIL	none	3.75	not allowed
TELEMAIL/IBS	none	3.50	ENCOURAGED

We look forward to welcoming you on **TELEMAIL/IBS!**

"Businessware™ for the Business Man"

**Interactive
Business
Solutions**

333 Cobalt Way, Suite 106
Sunnyvale, CA 94086
(408) 737-9618

Circle 178 on inquiry card.

Businessware and Clip-Off are trademarks of
Interactive Business Solutions

*TELEMAIL is a service mark of GTE/TELENET

USE OUR CLIP-OFF™ TO AVOID A RIP-OFF

Check enclosed (U.S. funds only) \$ _____

Name _____ Street _____ City _____ State _____ Zip _____

minimum deposit \$25.

**Interactive
Business
Solutions**
TELEMAIL/IBS

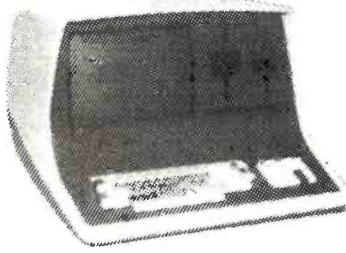

SUPERBRAIN™ QD - ONLY \$2950

Buy Factory Direct and Save! Direct from Intertec to you at the best prices in the country! Full factory warranty and shipped in factory-sealed cartons. Includes C/PM® and manual.

SUPERBRAIN 64k Double density **\$2650**
HARD DISK 10mb Winchester-type
 Intertec. List \$4995 **\$3990**

NORTHSTAR COMPUTERS

HORIZON II 32k Double Density. Reg. \$3695	\$2750	HORIZON II 64k Double Density. Reg. \$4195	\$3125
HORIZON II 32k Quad Density. Reg. \$3995	\$2965	HORIZON II 64k Quad Density. Reg. \$4495	\$3335

TERMINALS

Intertube Intertec Reg. \$895 \$720	Emulator Intertec Reg. \$895 \$720
---	--

PRINTERS - DOT MATRIX

MPI88G With graphics Reg. \$749 **\$650**
MPI 99G **\$750**
COMET C.110h with RS232 Reg. \$995 **\$450**
COMET II Parallel Reg. \$1350 **\$825**
EPSON MX80 Parallel Reg. \$645 **\$489**
EPSON MX80 RS232 Reg. \$720 **\$549**

PRINTERS-WORD PROCESSING

STARWRITER Parallel . Reg. \$2195 **\$1495**
STARWRITER RS232 Reg. \$2395 **\$1650**
STARWRITER II 45cps Reg. \$2795 **\$1795**
XYMEC Parallel Reg. \$2650 **\$1995**
XYMEC RS232 Reg. \$2875 **\$2165**
DIABLO 630 RO Reg. \$2710 **\$2050**

WORD PROCESSING

Word Star **\$320**
Mail Merge **\$110**
VTS 80 **\$449**
Benchmark **\$400**
Spellguard **\$225**
Word Pro **\$170**
NAD Mail List Structured Systems . . **\$100**
MVF Mailer **\$100**

SOFTWARE NORTHSTAR

25% OFF!

ACCOUNTING PLUS

by Systems Plus
 Accounts Receivable, Payroll, Accounts Payable, Inventory, General Ledger, Sales Order Entry, Purchase Order Entry.

Each **\$395**
PEACHTREE

A/R, A/P, G/L, P/R, INV. ea. **\$395**
 CPA, Property Mgmt. ea. **\$795**

TCS SOFTWARE

A/R, A/P, P/R, G/L. **\$100**

MVF PROGRAMS

Restaurant Inventory **\$250**
Client Billing **\$450**

DBMS PROGRAMS

Condor I **\$550**
Data Star **\$275**

C Basic Compiler **\$110**
Microsoft Basic **\$325**

*C/PM is trademark of Digital Research



To Order Call (206) 453-8159

Mastercharge, VISA add 3%. NO C.O.D.'s. All prices FOB origin.

PACIFIC COMPUTER BROKERS

11056 Palatine North, Seattle, WA 98133

Text continued from page 115:

measurement steps in detail.

Step 1 is initiated by the gating device (eg: a photocell) that is connected to the programmable timer's gate input. Figure 3 shows two circuits for coupling phototransistors to the timer.

In figure 3a, the phototransistor is illuminated normally, and the programmable timer's gate input is held at logic 1. An object passing in front of the phototransistor will cause the programmable timer's gate input to be pulled to logic 0 and held there for as long as the light is blocked. If the timer is operating in the pulse-width-comparison mode, it will measure the length of time the light is blocked. If it is operating in the frequency-comparison mode, the timer will measure the elapsed time from the first extinction of the light to the second.

In figure 3b, both phototransistors are normally illuminated, and the timer's gate input is held at logic 1. An object passing in front of either phototransistor produces a momentary logic 0 at the programmable timer's gate input. A second momentary logic 0 occurs as the object passes in front of the second phototransistor. If operated in the frequency-comparison mode, the timer will measure the time from the first extinction of the light (at one phototransistor) to the second (at the other phototransistor).

Text continued on page 122

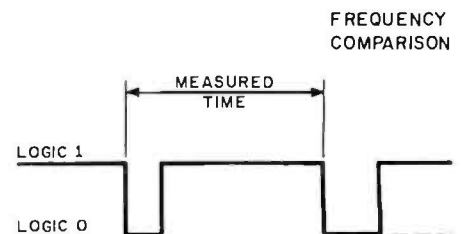
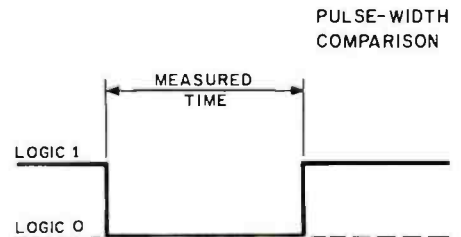
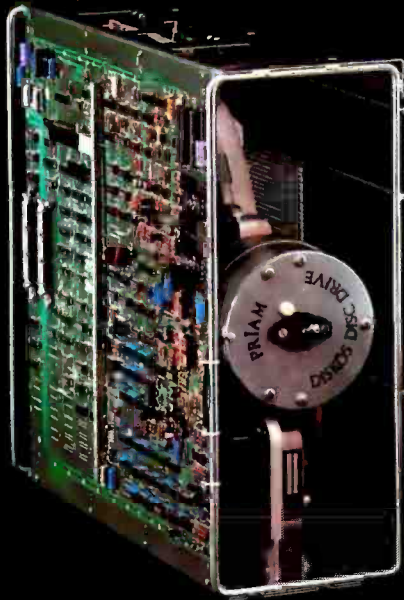

Figure 2: The time intervals measured by the programmable timer for the pulse-width and frequency-comparison modes.

THE HARD EDGE

IN SYSTEM PERFORMANCE...



31 MByte Formatted Capacity

The ADES S33 MByte Hard Disk Subsystem is the *HARD EDGE* in System Performance. The S33 transforms your S100 computer from a slow, floppy-bound machine into a high performance system. The S33 is a complete subsystem which includes the ADES PS100 S100 compatible hard disk controller card, the Priam DISKOS (TM) 3350 hard disk, an attractive desktop cabinet, power supply, CP/M* BIOS software, and ribbon cable. With its 31MB formatted capacity and a CP/M data transfer rate greater than 40K bytes/second the S33 can instantly increase the performance of any S100 computer system.

S33 FEATURES. The PS100 single card controller, which is IEEE-S100 compatible, contains an on-board processor, a 528-byte host interface RAM, and the hard disk interface. It has a fifteen command repertoire, on-board CRC to guarantee data integrity, user selectable base address, bank select feature, phantom RAM disable, and full S100 interrupt capability. It controls up to four Priam drives. In addition, the S33CBIOS software package allows easy integration into most CP/M systems. Application notes cover CBIOS integration and system boot directly from the hard disk.

EXPANDABILITY. With the S33 subsystem, you have freedom to grow in two different directions. First, the PS100 controller supports all Priam 8- and 14-inch hard disk drives, including the 68 MByte and 158 MByte models. As your database expands, so does your system's capability. Second, one PS100 controller handles up to four drives of any size and in any combination, providing a full range of capacities.

The S33 is only the first in the expanding line of ADES mass storage products. When you need an edge on your competition or more power in your personal system, look to ADES for the "*HARD EDGE* in System Performance."

*CP/M is a registered trademark of Digital Research.

ADES

ADAPTIVE DATA & ENERGY SYSTEMS

2627 Pomona Boulevard • Pomona, CA 91768

Phone: (714) 594-5858

Circle 5 on Inquiry card.

COLLECTOR EDITION BYTE COVERS

#1



#5

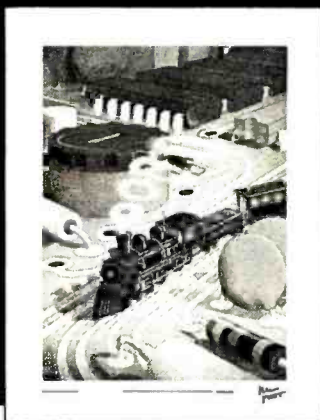

#2

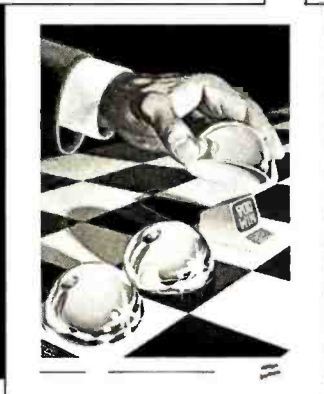

#6

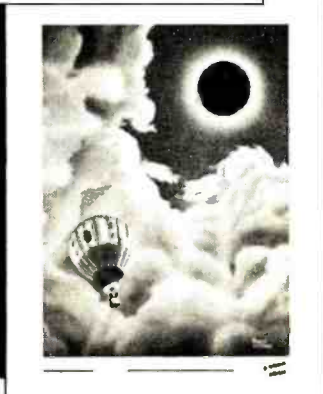

#3

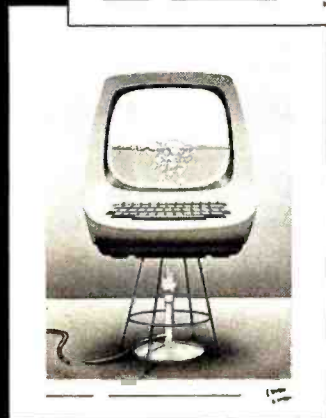

#7



#4

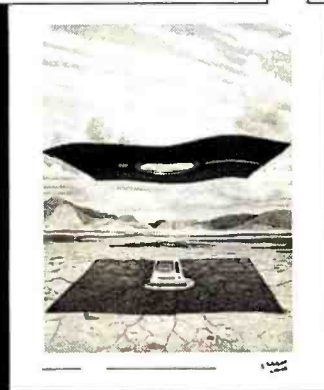

#8

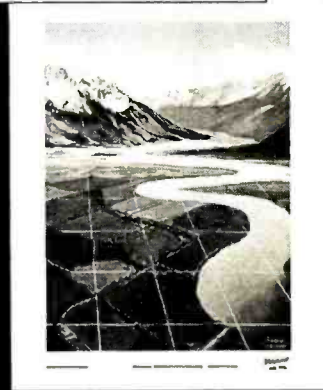

The Byte Covers shown at left are available as Collector Edition Prints. Each full color print is:

- 11" X 14" including a 1½" border.
- Part of an edition strictly limited to only 100 prints.
- Personally inspected, signed and numbered by the artist, Robert Tinney.
- Accompanied by a Certificate of Authenticity.
- Carefully packed and shipped first class.
- Priced at \$20, plus \$3 (\$6 overseas) for postage and handling. If Set 1-4 or Set 5-8 is ordered, the price for all 4 prints is only \$70.

To order, use the coupon below. Visa or MasterCard orders may call Toll Free.

Please send me the following Collector Edition Byte Covers and Certificates of Authenticity.

Qty.	Cover	Amount
_____	#1-7 Bridges of Konigsberg\$20
_____	#2-Fun and Games\$20
_____	#3-Homebrew\$20
_____	#4-Software Mirage\$20
_____	#5-Computer Engineering\$20
_____	#6-Total Eclipse\$20
_____	#7-Computer Hardware\$20
_____	#8-Perspectives\$20
_____	No.'s 1-4\$70
_____	No.'s 5-8\$70

Post. & hand. (\$3 in US, \$6 overseas) \$ _____

Total \$

- I have enclosed check or money order
 Visa MasterCard

Card # _____

Expiration Date _____

Send my print(s) to:

Name _____

Address _____

City _____

State _____ Zip _____

Mail this coupon to:

robert tinney graphics

1864 N. Pamela Dr.

Baton Rouge, LA

70815

FOR VISA OR MASTERCARD ORDERS
CALL TOLL FREE!

1-800-854-0562 / Ext. 910

Calif.: 1-800-432-7257/Ext. 910

24 HOURS A DAY! 7 DAYS A WEEK!

HEI DEALS IN CARD READERS!

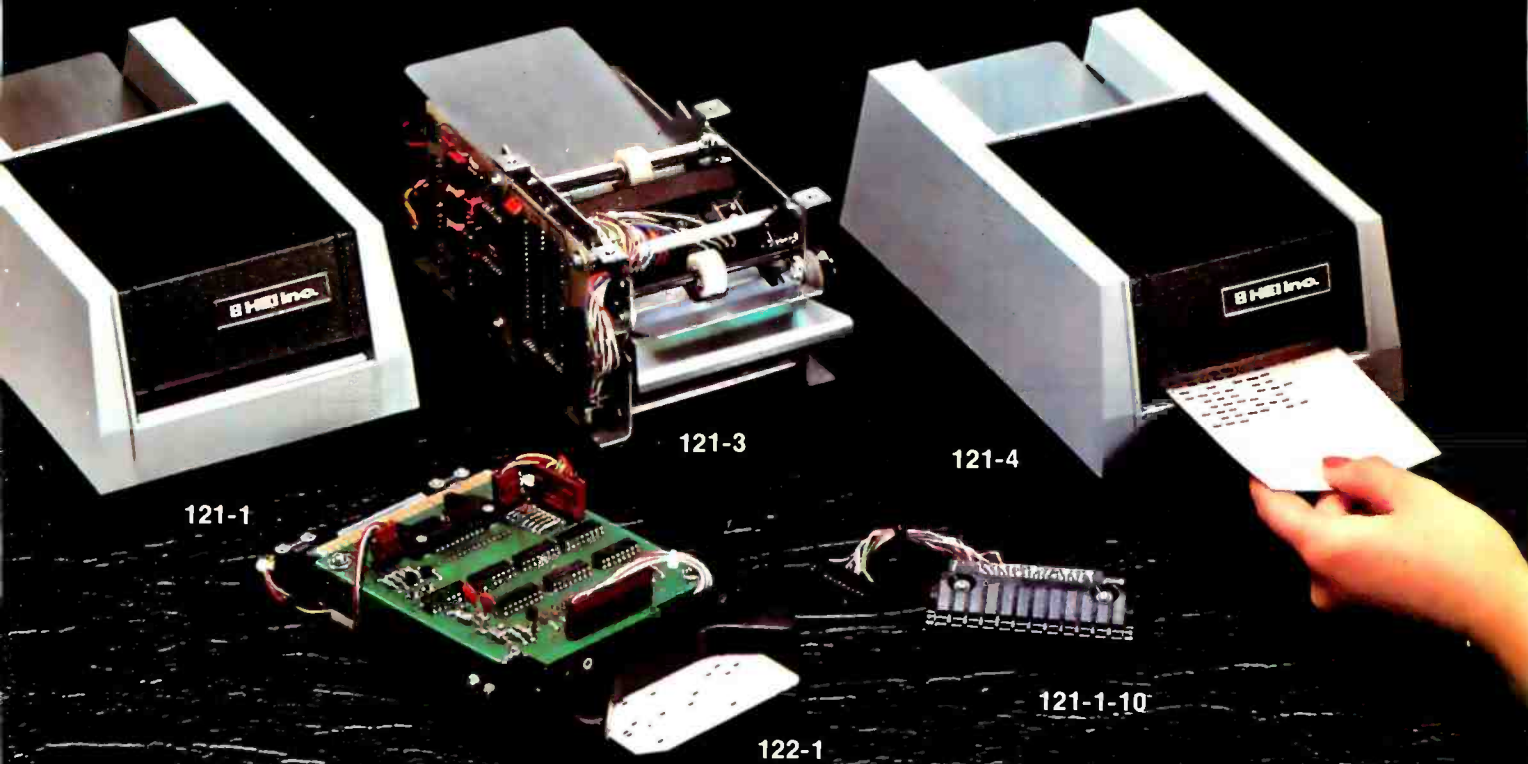

121-1

121-3

121-4

122-1

121-1-10

Whether you're looking for an optical read head for OEM use, or a complete microprocessor-controlled card reader with multiple features, bet on HEI for the best in price and performance!

- Our Model 121-1-10 read head is the most adaptable marked/punched card reader you can buy. Thirteen self-biasing channels; sharp TTL output.
- The panel-mounted 122-1 is another useful OEM card reader. For punched cards only. Parallel output, TTL level, manual feed. Low-cost and accurate.
- For simple hand-fed applications, the parallel output

- Model 121-1 is your best buy. Six-in./sec. non-reciprocating feed through.
- Need serial UART output in RS-232 format? Choose the Model 121-3. Reciprocating or feed through at 11-in./sec.
- The Model 121-4 is microprocessor-controlled, with a family of switch-selected options. Card feed-through or return at 6-in./sec., Hollerith to ASCII conversion,

- parity bit, self-test, parallel/serial output, strobe or non-strobe. A powerful reader, accurate, compact and economical.
- * These units read marked or punched cards interchangeably, either pen or pencil, and a variety of colors. All have motorized drive of hand-fed cards, and are available with or without case, with or without power supply.*

Call us and talk card readers with the HEI specialists. We have even more to tell you about the low-cost, high-performance HEI line. For data collection tasks, you can't beat HEI card readers. Bet on it!

The Optoelectronic Specialists

HEI inc.

Jonathan Industrial Center • Chaska, MN 55318 • 612/448-3510

Circle 258 on Inquiry card.

SPECTACULAR OFFERS

ORDERS ONLY

800-854-1555

BASF "FLEXYDISK"...
Superior Quality data storage medium.
Certified and guaranteed 100% error free.



SINGLE SIDED-SINGLE DENSITY

5 1/4" or 8" Diskettes 10/\$24
5 1/4" or 8" Vinyl Storage Pages 10/\$5

MAXELL DISKETTES
The best quality diskette money can buy.
Approved by Shugart and IBM.



Sold only in boxes of 10

5", 1 side \$3.30
8", 1-side \$4.25
5", 2-side \$3.90
8", 2-side \$5.60

ALL MAXELL DISKETTES ARE DOUBLE DENSITY

LIBRARY CASE...
3-ring binder album.
Protects your valuable programs on disks
Fully enclosed and protected on all sides.
Similar to Kas-sette storage box.



Library 3-Ring Binder \$6.50
5 1/4" Mini Kas - sette/10 \$2.49
8" Kas-sette/10 \$2.99

DISKETTE DRIVE HEAD CLEANING KITS
Prevent head crashes and insure efficient, error-free operation.



5 1/4" or 8" \$19.50

SFD CASSETTES
C-10 Cassettes 10/\$7
(All cassettes include box & labels)
Get 8 cassettes, C-10 sonic and Cassette/8 library album for only \$8.00
(As illustrated)



HARDHOLE
Reinforcing ring of tough mylar protects disk from damage



8" Applicator \$4 5 1/4" Applicator \$3
50/8" Hardholes \$8 5 1/4" Hardholes \$6

VISA • MASTERCARD • MONEY ORDERS
CERTIFIED CHECK • FOR PERSONAL CHECKS
ALLOW TWO WEEKS • C.O.D. REQUIRES A 10%
DEPOSIT • CAL. RES. ADD 6% SALES TAX
MIN \$2 SHIPPING & HANDLING • MINIMUM
ORDER \$10 • SATISFACTION GUARANTEED
OR FULL REFUND

Write for our free catalog

ABM PRODUCTS

8868 CLAIREMONT MESA BLVD.
SAN DIEGO, CA 92123
IN CALIFORNIA
(714) 268-3537

Text continued from page 118:

Step 2 states that the counter decrements on each cycle of an external timing signal. The period of this timing signal therefore becomes the *limit of resolution* of any time measurement. My applications required elapsed-time measurements that were accurate to the nearest ms (millisecond). This resolution was achieved by applying a 1 kHz timing signal to the timer's external-clock in-

put. (Later I will describe how this timing signal is produced by using another programmable timer to scale the microprocessor's clock frequency.)

Step 3 says that the count stops, and the microcomputer is signaled, if the timed event ends before the counting register decrements to zero. Recall that the timer's latch is preset to unsigned 65,535 (hexadecimal

Text continued on page 126

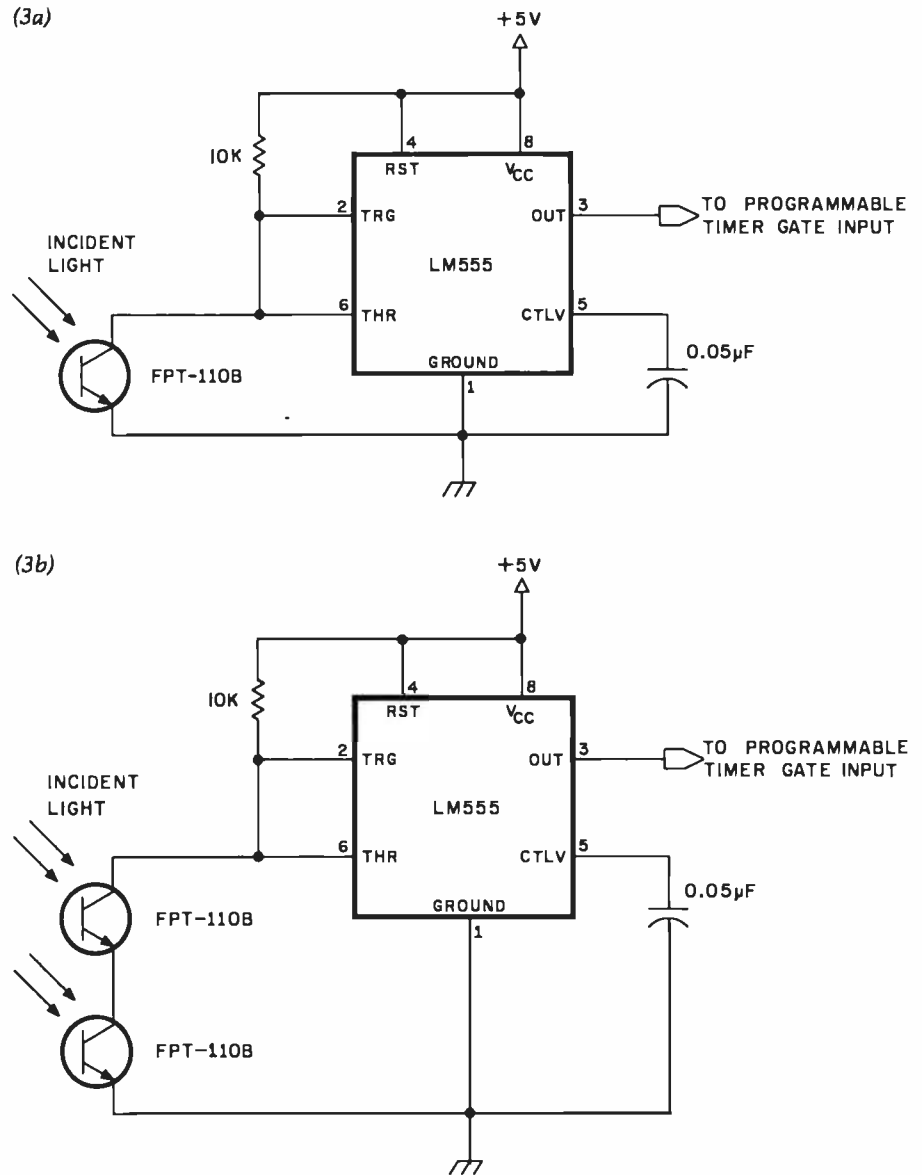

Figure 3: Two circuits for connecting phototransistors to programmable-timer gate inputs. Figure 3a shows control of the timer gate by a single phototransistor; figure 3b shows control by two phototransistors.

These type-555 integrated circuits are not used as timers; instead, they serve as inverting comparators. A 555 component connected in this manner has an input hysteresis in excess of 1.6 V, twice that of a type-7413 Schmitt trigger.

The 10 k-ohm resistor is chosen to saturate the phototransistor when illuminated, and hold it near its cutoff point when the light is blocked. The 10 k-ohm resistance is optimal for a 1 W incandescent bulb located 5 cm (approximately 2 inches) in front of the phototransistor. Other setups may require a different resistor.

The tool you need to chop your software backlog can be yours now



TRAM Drastically Cuts Development Time and Can Increase Your Productivity by 2000%

TRAM is an advanced TRansaction Access Method developed in PL/I to run on a variety of CPU's and operating systems. With its screen manager, you are completely freed from the burdens of screen communication such as location, length, rendition and even text itself. In addition, TRAM takes care of full data validation, default value generation and housekeeping of past values.

Look at what TRAM can do for you:

 **will assist you in design:**

TRAM forms, kept with your specifications, describe in detail the layout, along with the information and processing required to get and validate data. This documentation is of tremendous help when modification is required.

As an option, TRAM provides a multiple-level up-and-down generalized menu and chaining system allowing you to create tree-structured applications along with parameter passing.

 **will boost your productivity:**

TRAM takes care of line-column positions and all video attributes. TRAM has a unique "no show" feature which extends the versatility and scope of your software. TRAM has a powerful exception processing handler. TRAM controls protected areas and echoing. TRAM formats and redisplay accepted data. TRAM retains past values for each item. TRAM builds default values based on past events. TRAM checks input for consistency, magnitude, match in a predefined list and even provides an interface for a search against your own external files, or, as an option, against a built-in fast direct access code file.

All those benefits lead to a deep reduction in the actual number of lines you have to code.

 **will give you environment freedom:**

All TRAM features can be used on any display video terminal with cursor addressing. TRAM will also work on a variety of CPU's and operating systems from micros to minis and even mainframes. Any displayable text is program independent and can be in any foreign language. Even more, the date format can be any arrangement of day, month and year, with or without month spelling. And the decimal point is what you want it to be. The

menu option gives you drive independence: programs, parameters and data files are freely scattered on different disk drive, with run-time choice.

CHECK IT BEFORE YOU BUY

Ask for the demo kit and you will see how a 2000 line program is reduced to 100. Send the coupon below, along with \$50 and here is what you get:

- The screen generator and editor. You will immediately start creating and editing your own screens.
- The screen examiner. You will display and examine your new screens and see TRAM features at work.
- The utility programs you need to adapt TRAM to your environment.
- The demo program with source listing and documentation.
- The full TRAM screen manager manual set.
- A sample of TRAM screen forms.

The demo kit is for Z80, 8080 CP/M based systems with a minimum of 48K and comes on an 8" single side single density soft sectored diskette. TRAM's screen manager price is \$295 and can be yours for \$245 if bought less than 30 days after the demo.

Purchase price includes a 6 month maintenance and update period.

So act now to see how TRAM will solve your problem.

Concentrate on your application, TRAM concentrates on the technical burden.

TRAM is available now for Z80, 8080 CP/M and MP/M systems with 48K minimum and requires the PL/I-80 compiler (or the PL/I-80 run-time library if your application is not in PL/I).

Coming soon are versions for 8086/8088, Prime Computers, Data General, Digital Equipment (LSI 11, PDP 11 and VAX), IBM and others. Coming soon also are the multi-key multi-user file management system, the report writer, the file inquirer and the transaction processor.



(CP/M, MP/M and PL/I-80 are registered trademarks of Digital Research)

It isn't just for small business anymore!

Qty.		Price ea.
<input type="checkbox"/>	TRAM's screen manager (disk & doc)	\$295
	+ code file option	75
	+ menu option (with doc)	100
<input type="checkbox"/>	TRAM's menu system alone	150
<input type="checkbox"/>	TRAM demo kit	50
<input type="checkbox"/>	TRAM's screen manager - documentation only	30
<input type="checkbox"/>	TRAM's menu system - documentation only	20
<input type="checkbox"/>	PL/I compiler & run-time library (disk & doc)	500
<input type="checkbox"/>	PL/I run-time library (disk & doc)	100
	PA residents add 6% tax	
	shipping and handling	3
	TOTAL	

I understand that if I decide to buy TRAM's screen manager in less than 30 days after the demo, \$50 credit will be applied towards the total amount. I understand also that a signed software license agreement is required and that purchase price includes a 6 month maintenance and update period. Send check or money order to Reddox Corporation, Dept. B1 - 215 Chapel Crest Terrace, Pittsburgh, PA 15238

NAME _____
 ADDRESS _____
 CITY _____ STATE _____ ZIP _____

10 DAY FREE RETURN

C-TOH STARWRITER: LETTER QUALITY PRINTING FOR UNDER \$2,000!

This daisy wheel printer gives high quality at a low price. 25 cps Parallel and serial interfaces available. **Price \$1895.**

NEC THE FIRST NAME IN LETTER QUALITY PRINTERS

COMPUMART offers beautiful print-quality with NEC Spinwriter terminals. Both KSR and RO versions give unsurpassed hard copy output. CALL.

COMPUMART PRICE	List Price
5510	\$2749. \$3055.
5515	\$2849. \$3135.
5520	\$3149. \$3415.
5525	\$3249. \$3455.
5530	\$2749. \$3055.

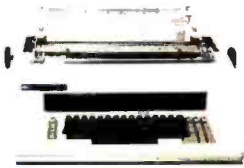

SPECS

- 5510** Receive—Only (RO). Friction feed platen, copy control, impression control, bidirectional, 10-12 pitch, 6-8 lines per inch, autoteed, ribbon-out, cover open switch, and self-test.
- 5515** RO unit, specs same as 5510s. Diablo compatible.
- 5520** KSR with numeric keypad. Specs same as 5510.
- 5525** KSR with numeric keypad. Diablo compatible, specs same as 5510.
- 5530** RO unit, same specs as 5510. Centronics parallel interface.

Super Selling Terminals

We have the following Lear Siegler Terminals in stock at prices too low to print—Call for quotes.

ADM-3A Industries favorite dumb terminal for some very smart reasons.

ADM-3A + NEW from Lear Siegler. CALL IT IS HERE!—It is the new

Intermediate Terminal from Lear Siegler. Call for details.



Dysan Diskettes—Single side, Single density, Hard or Soft Sector \$5. ea.

Memorex 3401's—5 1/4 discs \$3.25 with hub ring for Apple \$3.50.

Memory Integrated Circuits—Call for qty. discounts when ordering over 50 units.

Motorola 4116 (200 Nanosecond, Plastic) \$4.50 ea.

Fairchild 2114 (Standard Power, Plastic) \$4.50 ea.



NEW FROM INTEGRAL DATA

THE IDS 560 PRINTER. All the exciting features of the 400 series plus 1 1/2" paper capacity, 132 col. graphics printer. **Price \$1695.**



IDS 445. Priced lower than the 440 and equipped with a better print head. **IDS 445 w/graphics \$894.** **IDS 445 w/o graphics \$795.**

IDS 460 \$1,295
The 460's features include: Correspondence quality printing, high resolution graphics capability, programmable print justification.

CENTRONICS PRINTERS

The incredible Model 737. The closest thing to letter quality print for under \$1,000. 737-I (Parallel Interface) **List Price \$899. SPECIAL \$795. Sale Price \$695.**



Omni Printers from Texas Instruments

The 810—List \$1895. **SALE! \$1795.**
The 820 (RO) Package—Includes machine-mounted paper tray and cable. A compressed print option and device forms control are standard features. **\$2,155.**
The 820 (KSR) Package—Includes full ASCII Keyboard plus all of the features of the RO **\$2,395.**

EPSON MX-80

Now in stock!
The MX-80 dot matrix printer. Unequaled Epson reliability. Has all the features of the MX-70 plus more power and extra functions. **\$549. List price \$645.**

HP-41C Calculators . . . \$199.

Memory Modules. For storing programs of up to 2000 lines of program memory. **\$29.95**

"Extra Smart" Card Reader. Records programs and data back onto blank magcards. **\$199.**

The Printer, Upper and Lower case. High resolution plotting. Portable Thermal operation **\$355.**

Application Modules **\$29.95**

NEW SUPER 41-CV Systems with Quad RAMS built-in. (Maximum memory on-board leaves slots open for Application Pacs and peripherals.) The HP 41CV **\$309.00**

HP 41CV Plus Card Reader. **\$474.**

HP 41CV Plus Card Reader & Printer **\$799.**

Quad RAMS for the 41-C (Equivalent to four Memory Modules all packed into one.) **\$95.**



EXCLUSIVE from COMPUMART! Special Offer Zenith Color Video Monitor for \$349!

NEW FROM SANYO—Four Great Monitors at Low COMPUMART Prices. Sanyo's new line of CRT data display monitors are designed for the display of alphanumeric or graphic data. **9" Sanyo Monitor B/W \$169.** **12" Sanyo Monitor B/W \$289.** **12" Sanyo Monitor with green screen \$299.**

THE NEC MONITOR—Composite video using BNC connectors. 8-pin connector for VCR/VTR video loop. In/Out and television reception. **\$599.**



PM65 Expansion Accessories for the Aim-65

Call for specs and prices. Forth for Rockwell AIM-65 **\$195.**

ROCKWELL AIM 65

Our AIM system includes 4K AIM with BASIC interpreter assembler. Power Supply. Cassette recorder & Enclosure **\$799.** **4K AIM-65 \$499.** **PL65 High Level Language \$125.** **Paper for the Aim (roll) \$2.50** **Rockwell's 4 slot Motherboard (sale) \$175.** **Fourth for Rockwell AIM-65 \$175.**

Visit our giant

ANN ARBOR STORE

1250 North Main Street
Ann Arbor, Michigan

SEND FOR OUR FREE CATALOG

GILTRONIX RS-232 SWITCH

If you're tired of unplugging and replugging peripherals into your computer, then you're ready for this new product from Giltronix. The RS232-X8 is flexible—you can connect three peripherals to one computer or three computers to one peripheral. It switches the eight most important RS-232 signals. Save money and aggravation with this great product. **\$139**

COMPUMART stocks the complete line of **MATROX PRODUCTS.** Call for specs.

COMPUMART now offers the **ENTIRE DEC LSI-11 PRODUCT LINE.** Call for prices & delivery.

NOVATION CAT™ ACOUSTIC MODEM

Answer Originate. 300 Baud. Bell 103 **\$169.00**

NEW! D-CAT

Direct Connect Modem from Novation. **\$199.**



SOFTWARE FROM APPLE

Apple Plot. The perfect graphic complement for Visicalc. **\$70.**
Dow Jones News & Quotes **\$95.**

Adventure (Uses 48K) **\$35.**
DOS Tool Kit **\$75.**
Apple Fortran **\$200.**
Tax Planner **\$120.**

FROM PERSONAL software

Visicalc **\$149.**
Desk Top Plan **\$99.**
NEW FROM MUSE
The Voice **\$39.95**
Super Text **\$150.**
Address Book **\$49.95**

Miscellaneous Apple II Accessories.

Easy Writer (80 col. need a Videx) **\$249.**

NEW from Apple for the Apple II.

DOS 3.3 Convert disks to 16 sector format for 23% more storage and faster access **\$60.**

NEW for the Apple II

From MicroSoft
16K RAM Board **\$195.**
FORTRAN **\$175.**
COBOL **\$750.**
Card Reader from Mountain Hardware **\$1195.**
Hi-Res Dump for 460 Printer from the Computer Station **\$49.95**

Trend Spotter—Statistical graphics program. Works with Visicalc. **\$275.**

Exclusive—Magic Wand for the Apple—Videx. 7:80 softcard **complete system \$925.** (Requires 48K Apple and disk.)

HARDWARE ACCESSORIES FOR APPLE

Silentype Printer w/x face **\$635**
Super Sound Generator (mono) **\$159** (stereo) **\$259**
Light Pen **\$249**
X-IO Controller (plugs into paddle port) **\$49**

Mountain Computer—Expansion accessories for your Apple

Introl—IO System **\$289**
Super Talker **\$299**
The Music System **\$545**
ROM plus board w/Keyboard filter **\$199**
Clock Calendar **\$280**
Apple Expansion Chassis **\$750**
ROM Writer **\$175**
16 Channel A to D Converter **\$350**

From VIDEKI—Video Term.

80 Col x 24 line, 7 x 9 Matrix plug in compatible board for the Apple II. Price **\$325** without graphics EPROM. With graphics EPROM **\$350.**

S.S.M. Serial & Parallel Apple Interface **\$225**
ABT's Numeric Key Plan **\$110**
California Microcomputer Keyboard **\$195**

Save \$200 on Apple Accessories with purchase of an Apple II

Order accessories for your Apple, and we will give you \$200 off the purchase price of those accessories. **SAVE \$200**

APPLE III IS IN STOCK—CALL!

APPLE III Information Analyst Package—128K Apple III, Black and White Monitor 12", and information analyst software. **Price \$4740.**

IMPORTANT ORDERING INFORMATION

CALL 800-343-5504, in Massachusetts, (617) 491-2700, phones open from 8:30 a.m. to 7:00 p.m. Mon-Fri. 11:00 a.m. to 4:00 p.m. Sat. PO's. Accepted from Dun & Bradstreet rated companies—shipment

contingent upon receipts of signed purchase order.

SALE PRICES. Valid for month of magazine date only—all prices subject to change without notice. Our Ann Arbor retail store is open 11:00 a.m. to 7:00 p.m. Tues-Fri. 10:00 a.m. to 5:00 p.m. on Saturdays

1 Take a PET home with you.

2 Atari isn't here to play games.

3 Incredible values from Apple II.

4 Hewlett-Packard super special.

CompuMart carries the entire Commodore line of computers, peripherals, and accessories—call our sales force today for complete prices and specs

The CompuMart/Commodore Word Processing System

Get crisp, letter quality output and ease of operation that's unsurpassed. This system includes a Commodore 8032 32K CPU, a 4040 Dual Disk, a C-Itoh printer and X/face, and Word Pro 4 Plus (all cables included). Call for details and low prices. List \$5685. **COMPUMART \$4995.**

A complete system including a Dual Disk Drive, Tractor Printer, and an 80 column 32K CPU for under \$4,000. No interfaces needed. Cables included. List \$3,985 **CompuMart \$3635**

New accessories from Commodore for Commodore

- Visicalc **\$199**
- Word Pro 4 **\$299**
- Ozz the Information Wizard **\$395**
- Wordcraft 80 **\$395**
- Tax Preparation Planner **\$495**
- Dow Jones Portfolio Mgmt System **\$149**

- Personal Tax Calculator **\$69**
- Assembler Development Package **\$99**

SAVE \$200 on Commodore Accessories with purchase of a 32K PET. When you buy a 16K PET, apply \$100 toward PET accessories. **SAVE \$200!**

Educators Take Note!! Commodore has extended its 3 for 2 deal until 6-30-81.

Exclusive—Atari 800 Personal Computer System—includes 800 operators Manual, 16K RAM Memory Module, 10K ROM, Operating System, Power Supply, TV Switch Box **\$899.**

PERIPHERALS

Atari 410 Program Recorder **\$89.95**
850 Interface w/Cable **\$249.95**

Atari 810 Disk Drive (SIOO off with purchase) **\$699.95**
NEW Dual Disk double density **\$1499.95**

825 Printer (Centronics 737) **\$995.**
RS232 Interface w/Cable **\$249.95**
NEW! Light Pens **\$74.95**
NEW! Visicalc for Atari **\$199.**

Educators Take Note. Atari has extended its 3 for 2 deal until 6-30-81. Any educational institution that buys two Atari 800's will receive an Atari 400 absolutely **FREE.** Call our sales dept for complete details.



CALL us NOW for the most complete inventory of Apple computers, peripherals, and software. You can **Save over \$250** on our best selling Apple System. System includes a 48k Apple II, Apple Disk, DOS 3.3 & Controller, and a Sup R MOD RF Modulator. List **\$2209.**

COMPUMART Sale Price \$1895.

When it comes to Hewlett-Packard Nobody does it better than COMPUMART. Take a look at these new super specials

HP83 Basic System—includes HP-83, ROM Drawer, Mass Storage ROM, 5 1/4" Single Master Flexible Disc Drive, HP-IB Interface Module, 2 meter HP-IB cable. **\$4249.**

HP-85 System—Save \$400 on HP-85 Accessories with purchase of an HP-85. Order accessories with your HP-85 and we will save you \$400 off the purchase price of those accessories. **SAVE \$400!**

HP-85 ACCESSORIES—We carry HP Peripherals (Disk Drives to Graphics Plotters) Enhancements (BASIC Training, General Statistics, Financial Decision, Math, Linear Programming **\$95 ea.**) HP-85 Accessories (Enhancement ROMs, ROM drawer, Overhead Transparency Kit), Supplies (Plotter Pens, Tape Cartridges), Interface Modules (HP-IB Interface, HP-IB Interconnect Cables, Serial (RS-232C) Interface Module). We can get you every HP peripheral made for the HP-85.

VISICALC PLUS FOR HP-85 Everything you ever wanted from Visicalc plus plotting. **\$200.**



COMPUMART'S 4 Leading Starter Systems

from THE BEST



COMPUMART has been serving the computer needs of industry since 1971.

We stock, for immediate shipment, only those products from the finest micro-computer manufacturers.

And any product, except software, can be returned within 10 days for a full refund—even if you just change your mind.

We also honor all manufacturers' warranties.



Our expert technicians will service any product we sell that cannot be better, or faster, serviced by the manufacturer's local service center.

Call us for more information on products, product configuration and service. Our phones are open Monday thru Friday, 8:30 a.m. to 7:00 p.m. and Saturday 11:00 a.m. to 4:00 p.m.

We have a staff of highly knowledgeable sales people waiting to hear from you, and to help.

Because service is what we're all about.

800-343-5504

In Mass. Call 617-491-2700

Systems Customized

COMPUMART

65 BENT STREET, DEPT. 1106, P.O. Box 568
CAMBRIDGE, MA. 02139

Circle 67 on inquiry card.

Listing 1: Interrupt-service routine for reading a programmable timer's counting register, converting the number to a decimal elapsed time and saving the result.

Line	Label	Op Code	Comments
1		LDA A M	Read the timer's counting register and clear the timer's
2		LDA B L	interrupt request.
3		LDX POINT	Fetch the pointer.
4		CPX #LAST +3	Are all memory locations loaded?
5		BEQ DONE	Branch if all are loaded.
6		COM A	Complement the count to get the hexadecimal elapsed
7		COM B	time.
8		STA A 1,X	Save the hexadecimal elapsed time in this memory loca-
9		STA B 2,X	tion.
10		LDA A #\$80	Set bit 7 to show that this memory location has been
11		STA A 0,X	loaded.
12		BSR BD	Perform a subroutine that converts the 2-byte hexa-
			decimal number in 1,X and 2,X to a 2½-byte BCD
			number in 0,X, 1,X and 2,X.
13		INX	
14		INX	Advance the pointer to the next 3-byte memory loca-
15		INX	tion.
16		STX POINT	Save the new pointer value.
17	DONE	RTI	

FFFF) on system power-up or RESET. Unless changed by the program, this value is automatically loaded into the counting register at the beginning of each timed event. The counting register cannot decrement more than this number of counts. A 1 kHz timing signal will therefore permit a maximum time measurement of 65,535 ms, or 65.535 seconds.

Step 4 begins the program's interrupt-service routine by reading the timer's counting register. Aside from fetching the counting register's contents, this step has another purpose: the read operation causes the programmable timer to release the microcomputer's IRQ line. This is important, because it is the *only* way the timer's interrupt request can be cleared.

Step 5 indicates a need for transforming the count. The quantity read from the timer's counting register (for a 1 kHz timing signal) is the *hexadecimal* number of milliseconds *remaining* until the counter decrements to zero. To be useful, this number should be transformed into the *decimal* number of milliseconds *elapsed* during the timed event. This transformation is a two-step process:

5a. Convert the hexadecimal milliseconds remaining to hexadecimal milliseconds elapsed during the timed event.

5b. Convert the hexadecimal milliseconds to decimal milliseconds.

Step 5a is easily performed. If the timer's counting register is set to hexadecimal FFFF at the beginning of the count, the hexadecimal number of elapsed milliseconds is equal to FFFF- n_i , where n_i is the remainder read from the counting register at the end of the timed event. But, since FFFF- n_i is just the one's complement of n_i , step 5a simply requires taking the one's complement of the number read from the counting register.

Step 5b is a hexadecimal-to-decimal conversion routine. Any appropriate routine may be used here. Listing 2 contains a fully documented demonstration program that includes a suitable hexadecimal-to-decimal conversion routine.

DOCUMATE/PLUSTM

Indexes and Sorts WordStarTM

DocuMate/PlusTM Features . . .

- 8-Level Indexing
- Table of Contents Generation
- New Self-Contained Sort Feature
- "See" and "See Also" References
- New Output Format Control
- New Cross-Document Index Generation

DocuMate/Plus generates completely collated tables of contents and alphabetical multi-level indexes from WordStarTM text files of any length . . . as detailed as you desire.

DocuMate/Plus is refreshingly easy to use, and its internal sort feature can save you the cost of an expensive stand-alone sort program. Just type simple DocuMate commands right into your text file. DocuMate/Plus's "Extract" feature automatically finds and places all index references in a separate work file for sorting and collating.

DocuMate/Plus builds master indexes for many documents, such as research notes, books and articles, speeches, hardware and software documentation, and business correspondence

DocuMate/Plus is today's most flexible indexing program available for professional word processing.

DocuMate/Plus is available on standard 8" CP/M and 5¼" Northstar diskettes.

- DocuMate/Plus Program with Manual \$125.00
- Manual Only \$ 10.00
- Special Pricing to update existing DocuMate users.

ORTHO CODE

The Textware Company

THE ORTHOCODE CORPORATION
P.O. Box 6191 • Albany, CA 94706
(415) 832-8175

• WordStar is a trademark of MicroPro International • CP/M is a trademark of Digital Research

INTRODUCING A REVOLUTIONARY DOT MATRIX PRINTER WITH JUST ONE HAMMER. AT AN INCREDIBLE PRICE — JUST \$399.



The Uni-Hammer Replaces Seven... or More.

Revolutionary? We don't know what else to call it. An impact printer with a single rugged hammer, rather than the seven or more individual solenoids and print wires found in conventional dot matrix printers.

At an incredible unit price of \$399!

Because of the unique Uni-Hammer design, the GP-80M is smaller and simpler than other dot matrix printers yet costs considerably less. Which makes it a natural for OEMs needing compact, reliable, low cost printers for system use, and also for the personal or small business user who wants a quality impact printer at the lowest possible price.

How the Uni-Hammer Works

The GP-80M, which prints both graphics and alphanumerics, uses a rotating platen with protruding splines positioned behind the paper (see diagram). The character or graphics image is created by multiple hammer strikes in rapid succession as the print head advances across the paper. The precision gear train assures exact positioning of the print hammer relative to the splines on the platen, to provide excellent print quality.

A Complete Printer

The GP-80M has features comparable to printers selling for thousands of dollars. These include upper/lower ASCII character sets, ribbon cartridge, 80 columns at 12 characters per inch, adjustable tractor feed, original and 2 copies, 30 characters per second, and full graphics with a resolution of better than 60 dots per inch in both horizontal and vertical axes.

Plenty of Interfaces

Interfaces include Centronics parallel, RS232C, serial TTL, 20mA current loop, IEEE-488, Apple, TRS-80, PET, HP-85... and more.

See the GP-80M in action at your local computer store, or write for the distributor in your area.

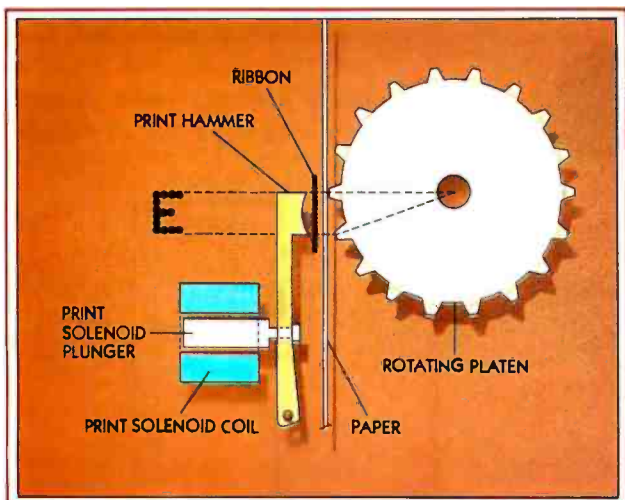

A Product of the Seiko Group

The GP-80M is manufactured by Seikosha and exclusively distributed in the USA by Axiom. It took a company such as the Seiko group, world's largest watch manufacturer, with vast experience in the design of small, intricate, precision products, to come up with a totally new concept in dot matrix printing.

AXIOM

AXIOM CORPORATION

1014 Griswold Avenue • San Fernando, CA 91340
Telephone: (213) 365-9521 • TWX: 910-496-1746

Step 6 states that the microcomputer must save the result (ie: save the transformed time measurement). If several time measurements are made in rapid succession, the computer must log these results in a manner that permits easy access.

Successive time measurements are saved in successive 3-byte memory locations in a reserved memory block. Why 3 bytes? Although the binary number read from the timer's counting register is contained in only 2 bytes, that number converted to decimal form may require five BCD (binary-coded decimal) digits (for a maximum elapsed time of 65,535 ms). Stored in "packed" BCD form, such a number occupies 2½ bytes of memory. I allow 3 bytes, because I use bit 7 of the most-significant byte as a flag that is set when the memory location has been loaded with a measured time.

Listing 1 is a set of MC6800 instructions for accomplishing steps 4, 5, and 6 of the measurement sequence. This interrupt-service routine reads

the timer's counting register, transforms the count into a decimal-radix elapsed time, and saves the result.

Lines 3, 4, and 5 of the listing merit further explanation. POINT always contains the address of the next memory location in which a time measurement will be stored. Line 3 loads the index register with this pointer. Line 4 examines the pointer to see if the allocated memory space has been exceeded. If it has, line 5 causes a skip of the remaining steps.

Notice that the testing of the pointer does not occur until *after* the timer's counting register has been read (lines 1 and 2). The counting register must *always* be read, whether or not the results are to be saved. Otherwise the timer's interrupt request will not be cleared.

A Programmable-Timer Module

Thus far, I have described how a single programmable timer may be used with a microcomputer to measure and log elapsed times of suc-

cessive events. I now wish to show how a particular commercial device, the Motorola MC6840 programmable-timer module, may be used in the design of a two-channel event timer.

Figure 4 is a pin-assignment diagram for the MC6840. This integrated circuit contains three independent programmable timers, each with gate input, external-clock input, and output. There are ten addressable registers. Nine of these are the control registers, latches, and counting registers for the three timers; the tenth is a status register containing interrupt flags. (Details of register selection for the MC6840 were described in my earlier article, "A Computer-Controlled Light Dimmer," January 1980 BYTE, page 56.)

A two-channel event timer requires the use of one programmable timer for each channel. If timer 1 is assigned to channel 1 and timer 2 is assigned to channel 2, then timer 3 may be used to scale the microprocessor clock frequency to provide the timing signal required by timers 1 and 2.

To operate as a frequency scaler, timer 3 must be configured for use in the *continuous operating mode*. This is achieved by grounding the timer's gate and loading hexadecimal 82 into its control register. The timer then produces a square wave whose frequency is equal to that of the micro-

TYPEWRITER TURNS PRINTER FOR UNDER \$300



Our simple plug-in module converts Olivetti or Olympia electronic typewriters into computer printers or computer terminals!!

- No modifications to the typewriter
- Takes only minutes to install
- NO EXPERIENCE NECESSARY
- Does not affect Olivetti warranty
- Does not affect normal typewriter functions
- All typewriter functions can be computer controlled
- RS232C, IEEE and parallel interfaces available
- KSR version turns typewriter into a computer terminal
- Fully assembled, tested and burned in

Available for the following: Olivetti ET121 R/O \$295 KSR \$445
 Olympia ES100 R/O \$295 KSR \$445

Please send me an interface kit for:
 PRAXIX 30/35 ET121 ES100 R/O
 KSR Serial Parallel IEEE

All prices in U.S. funds. Name _____
 Please make cheque or money order payable to: Address _____
 Vertical Data Systems Inc. State _____ Zip _____ Visa Mastercharge
 1215 Meyerside Dr., Unit 2A
 Mississauga, Ontario
 Canada L5T 1H3 Card Number _____ Expiry Date _____

*Module for Olivetti Praxis 30 (35) now available.

Dealer Inquiries Invited

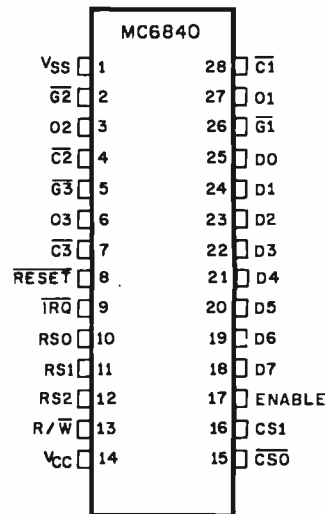

Figure 4: Pin-assignment diagram for the Motorola MC6840 programmable-timer module.

TRANSFER YOUR DATA INTO

HARDCACHE™

THE HARDCACHE SUBSYSTEM :

- ◆ **30 Megabytes [Formatted] Winchester Disk**
Average access time 48 milliseconds
- ◆ **Cartridge tape drive provides :**
Complete backup in under 10 minutes
File save/reload
Software distribution
- ◆ **S-100 Bus Intelligent Interface Card**
DMA or programmed I/O data transfer
Disk throughput optimizer
Bootstrap ROM - switch selectable
Time of day clock - battery powered
- ◆ **Compatible with**
GROMEMCO
VECTOR GRAPHICS
NORTH STAR and other
S-100 based computer systems
- ◆ **Installs on any CP/M or
MP/M system***

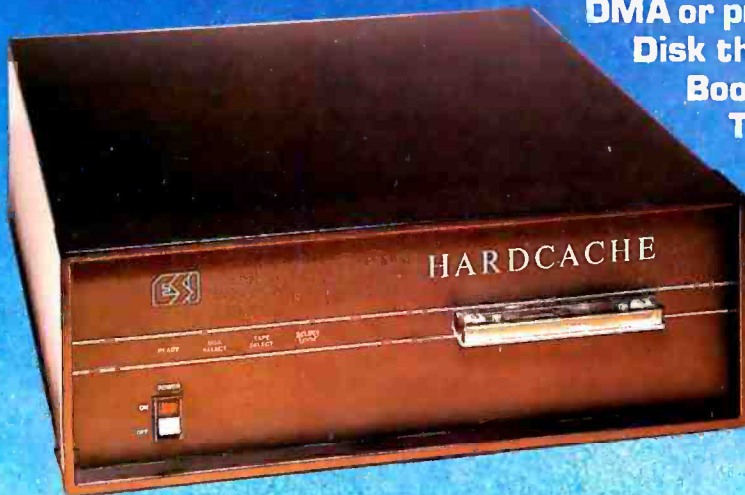

*CP/M and MP/M are registered trademarks of Digital Research.



EXECUTIVE SYSTEMS, INC.

15300 Ventura Boulevard
Sherman Oaks, California 91403
(213) 990-3457



Photo 3: The trainer's six-character LED display is used to indicate which memory locations have been loaded with elapsed-time measurements. This is how the display appears after time measurements have been logged in memory locations A and B (for phototransistor 1) and location D (for phototransistor 2).

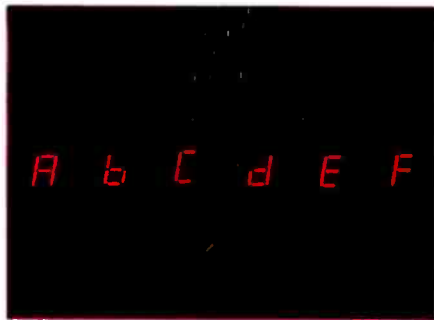

Photo 4: The trainer's six-character LED display after elapsed-time measurements have been logged in all six memory locations, A thru F.



Photo 5: A measured time is read by pressing a letter key on the trainer's hexadecimal keyboard. This is the display's appearance when the A key is pressed to read out the elapsed-time measurement (here 1.581 seconds) stored at memory location A.

processor clock divided by $2(n+1)$, where n is the 16-bit number stored in the timer's latch. (For example, given a microprocessor clock frequency of 1 MHz, storing decimal 499 [hexadecimal 01F3] in the timer's latch will cause the timer to generate a 1 kHz square wave.) Figure 5 shows the appropriate input and output connections for timer 3.

Polling the Timers

When timers 1 and 2 are operated in either the pulse-width-comparison mode or the frequency-comparison mode, either timer may signal the completion of a count by pulling the microcomputer's \overline{IRQ} line low. The microcomputer, with the aid of the MC6840's status register, then polls the timers to find which produced the interrupt.

The status register is an 8-bit, read-only register containing interrupt flags. It shares an address with control register 2 (CR2). The R/\overline{W} line selects whether CR2 is written or the status register is read. Individual bits of the status register are assigned as shown in table 1.

If a timer is configured for operation in either the pulse-width-

OMEGA RESEARCH™

presents **SHIVA™**

MULTI-USER **MULTI-TASKING**

S-100 OR APPLE II

NOW 8 OR 16 BIT!!!

The world-famous SHIVA™ Multi-User Real-Time Multi-Tasking Virtual Operating System with its unique VIRTUAL-PERSONALITY™ disk-resident library of interface routines and Virtual R.A.M. mapping is now available in two versions: SHIVA™ 1.2 for 8-bit C.P.U.'s and SHIVA™ 1.6 for 16-bit processors. SHIVA™ 1.2 pioneered the high-powered Virtual Operating System (VOS) for microprocessors with its user-reconfigurable Virtual R.A.M. assignment for up to 16-users or real-time tasks. Now SHIVA™ 1.6 continues Omega Research™'s commitment to non-obsolescence and system superiority by extending SHIVA™ into the 16-bit world of the 80's. SHIVA™ 1.6 syntax is upward-compatible with SHIVA™ 1.2, allowing SHIVA™ users to recompile SHIVA™ 1.2 programs to run under SHIVA™ 1.6 easily, so users may purchase SHIVA™ 1.2 now, and move up to a 16 bit processor later as their needs dictate with no fear of "software obsolescence." SHIVA™ 1.6 is upward compatible with CP/M or CDOS files and programs through its VIRTUAL-PERSONALITY™ disk-resident subroutines, supports hard disks as well as single or double-density floppies, features Logon and password protection, and features executive shell commands similar to UNIX in structure and versatility. SHIVA™ interfaces currently to Microsoft Basic, Cobol, and Fortran; C; Forth; UCSD Pascal Programs; Pascal/M; CBASIC-2; APL; ALGOL-60; LISP; PL/I; MAC; and new interfaces are continually in development to keep SHIVA™ users State-of-the-Art.

SHIVA™ 1.2 is available for 8080, 8085, 6800, 6502, and Z80-BASED SYSTEMS INCLUDING CROMEMCO, NORTHSTAR, VECTOR GRAPHIC, SWTP, DIGITAL GROUP, ALTOS, IMS, APPLE II, ITHACA INTERSYSTEMS, and TELETEK disk controllers. 6809 C.P.U. version is in development.

SHIVA™ 1.6 is available for 8086/8088/ and Z8000-2 based systems, with versions in development for 68000 based systems.

Both SHIVA™ versions 1.2 and 1.6 provide full disk utilities for all users. SHIVA™ 1.6 upgrades are available to registered SHIVA™ 1.2 users within one year of purchase of SHIVA™ 1.2 for half the current list price. SHIVA™ — The State-of-the-Art in microprocessor operating systems.

SHIVA™ 1.2

R.A.M. addressing to 1.048 megabytes on a Z80A-based system

Minimum system R.A.M. (single user):	4K
Additional R.A.M. per user:	2K
Maximum # of users or tasks:	16
Maximum # of physical and logical drives:	128
R.A.M. Bank capacity:	16-64K
	Banks (1.048 megabytes)
System prices:	\$400.00

SHIVA™ 1.6

R.A.M. addressing to 128 megabytes on a Z8000-2 system

Minimum system R.A.M. (single user):	4K
Additional R.A.M. per user:	2K
Maximum # of users or tasks:	16
Maximum # of physical and Logical drive:	256
R.A.M. Bank Capacity:	16-8
	megabyte banks (128 megabytes)
System prices:	\$650.00

Complete Documentation Included: Documentation available separately for \$50.00. (Applicable to later purchase of SHIVA™ system)
Signed license agreement must be returned prior to all shipments. Allow 6-8 weeks for shipping.

CP/M is a trademark of Digital Research • CDOS is a trademark of Cromemco, Inc. • UNIX is a trademark of Bell Laboratories
SHIVA™, VIRTUAL-PERSONALITY™, and OMEGA RESEARCH™ are trademarks of OMEGA RESEARCH™.

OMEGA RESEARCH™

P.O. Box 479, Linden, Ca. 95236 (209) 334-6666

9 am to 5 pm
Mon. - Fri.

MEMORY

Blackout!

A PROBLEM FOR YOUR PRESENT RAM?

Don't Curse the darkness. Get our non-volatile memory and watch elephants turn green with envy!

Are you looking for a reliable non-volatile memory on a rugged industrial-standard IEEE-696 S-100 card? Your search is over. Our CMOS memory modules have a battery backup that is guaranteed to keep programs and data intact for a year. We didn't sacrifice performance for non-volatility in the design of our CMEM module, so you get all the card you're looking for . . . we even supply the battery.

- 32K on a single board, 8 or 16-bit cpu compatible.
- Switch selectable addressing on 4K boundaries.
- Extended memory addressing through 24-bit lines.

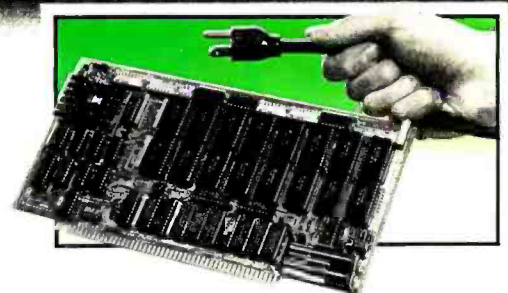
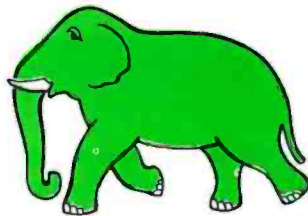

- 250 nanosec access time, no wait states required.
- Runs at 4 MHz for both 8 and 16-bit S-100 systems.
- Programs developed & stored w/out disks or tapes.
- Power fail interrupts.
- Software programmable write-protect window.
- 8K bytes-\$695, 16K bytes-\$895, 32K bytes-\$1095.

The DUAL 77 Data Acquisition and Control System is a turnkey system built to industrial standards and it comes ready to perform. As with all our systems and modules, our computer was designed with the wicked environment of the real world in mind. BASIC language makes programming easy and the built-in interface simplifies access to hundreds of sensors. The enormous expandability of the system allows its growth to meet your increasing needs, even if you enjoy learning new languages. The DUAL 77 is economical; \$9995 or higher with options.



DUAL SYSTEMS CONTROL CORPORATION
1825 Eastshore Highway, Berkeley, CA 94710
Phone (415) 549-3854 or (415) 549-3890



A/D CONVERTER

This S-100 based module is designed to withstand the rugged environment of the laboratory or in industry for general use in converting analog signals to digital information.

- 32-channel single-ended, 16-channel differential.
- 12-bit resolution and accuracy.
- 30-microsecond conversion time.
- Instrumentation amplifier on board.
- BASIC program for use provided.
- \$695 or \$785 w/1-1000 gain transducer amplifier.

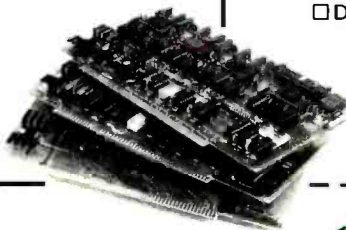

NON-STOP CLOCK

Now you can keep time even with the main power off. Our industrial level clock module utilizes a backup battery circuit for a full year.

- Day, date, hours, minutes and seconds.
- Features new LSI CMOS chip.
 - Vectored interrupt capability.
 - Dip switch selectable port address.
 - Simple BASIC or Assembly language program.
 - Precision quartz crystal clock. \$250

D/A CONVERTER

The AOM-12 analog output module is an industrial level digital-to-analog (D/A) converter which converts digital commands from the computer into analog voltages.

- 12-bit $\pm 1/2$ LSB accuracy over full 0-70°C temperature range.
- Voltage outputs of 0-10 volts, ± 5 volts, or ± 10 volts.
- Short circuit protection on all voltage outputs.
- Switch-programmable port base address for multiple boards.
- \$575



Dual Systems Control Corporation
Department B, 1825 Eastshore Highway
Berkeley, CA 94710 • (415) 549-3854

- Please send your brochure with complete details on modules.
- Please provide information on the DUAL 77 System.

Name _____ Title _____
 Company _____
 Street _____
 City _____ State _____ Zip _____

DEALER AND OEM INQUIRIES INVITED

Circle 52 on Inquiry card.

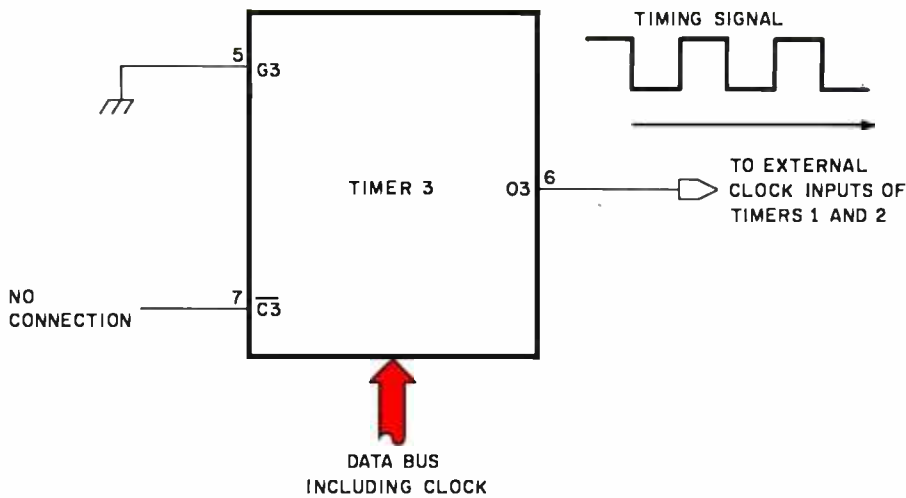

Figure 5: Connection of the MC6840's timer-section 3 for use as a frequency scaler. The microprocessor's clock frequency is divided by $2(n+1)$ to provide a timing signal to timers 1 and 2.

comparison mode or the frequency-comparison mode, then its individual interrupt flag is set whenever the timer completes a time measurement before its counting register decrements to zero. The flag is automatically cleared when the status register and the timer's counting register are read (in that order).

The composite interrupt flag is the logical OR of the individual interrupt flags. For the operating modes that I have selected for the three timers, the composite interrupt flag will be clear only if both the timer 1 and timer 2 flags are clear. (Timer 3's configuration as a scaler prevents it from affecting the composite interrupt flag.)

Bit 0:	Timer 1 individual interrupt flag.
Bit 1:	Timer 2 individual interrupt flag.
Bit 2:	Timer 3 individual interrupt flag.
Bit 3:	Composite interrupt flag.
Bits 4 thru 7:	All read as zero.

Table 1: Assignment of bits in the status register of the Motorola MC6840 programmable-timer module.

The MC6840 pulls the microcomputer's \overline{IRQ} line low when the composite interrupt flag is set, which, for these operating modes, is whenever the timer 1 or timer 2 individual interrupt flags are set. The \overline{IRQ} line is released only when both timer 1 and timer 2 individual interrupt flags are cleared.

Upon receipt of the interrupt request (\overline{IRQ} line pulled low), the microcomputer performs an interrupt-service routine that examines the status register to find which timer's interrupt flag is set. With that deter-

"TENSION HEADACHE? BUILD A MiGi AND CALL ME IN THE MORNING"



**MiGi
by Fiberfab**

MiGi: The VW based sportscar kit you build. Assembling your own sportscar is a truly relaxing and rewarding experience. While it's true you can't build one in a night, assembling one yourself in a few

weekends is as much fun as driving the completed car. It won't cure everything, but the MiGi is the perfect way to relieve the little pains of daily living.
CALL TOLL FREE 1-800-328-5671

Or mail to:
FIBERFAB
1000 Turners Crossrd.
Minneapolis, MN 55416

Enclosed is \$2 for color brochure.
Charged is \$20 for assembly manual.

Charge to my
 VISA
 American Express
 Carte Blanche

MasterCard
 Diners
 MiGi

PMN-5

Name _____ Age _____
 Address _____
 City _____ State _____ Zip _____
 Home Phone (____) _____
 Business Phone (____) _____
 Account No. _____
 Expiration Date _____

See us at
COMDEX/SRING'81
June 22-25, 1981 • New York, NY
New York Coliseum

COBOL.

The language of business. The language of Micro Focus.

CIS COBOL.

We've spoken for five years

. . . nothing but COBOL. We've put more thought into COBOL than anyone else. And more investment.

Our CIS COBOL product family brings you the most successful business programming tool ever devised — COBOL — on the most cost effective hardware.

It is designed to meet the needs of business software users through the 80's. Comprehensively. From the smallest microsystem to sophisticated, multiprocessing distributed architectures.

We speak Standard COBOL

. . . as defined by the ANSI X3.23-1974 standard. Thanks to ANSI and GSA, COBOL has the most rigorously defined and enforced standard of any software. You can buy CIS COBOL with complete security. GSA has already fully evaluated it for you — buy their Validation Summary Report.

CIS COBOL's second year of GSA certification qualifies it for government bids and other blue-chip contracts. CIS COBOL's performance and reliability are objective facts.

We speak COBOL innovatively

. . . we pioneered simple but powerful language extensions for interactive screen-handling. CIS COBOL also provides other powerful facilities vital in the microcomputer environment, like dynamic loading of segments and CALled programs.

We also take full advantage of unique hardware features. Our Apple II implementation gives you color graphics — and tone generation — all from within a CIS COBOL program!

We have our products speak COBOL too

. . . to boost your programming productivity. Our FORMS-2 utility is a COBOL source code generator. It makes possible our unique demonstration "How to create a COBOL program in 20 minutes."

The code generated by FORMS-2 is standard COBOL. You can build on it to create highly sophisticated interactive programs. We ourselves will be building on it to create even more powerful productivity tools for the 80's.

We speak COBOL on a great many systems

. . . giving you a large available market if you're developing software for resale. And a high degree of hardware independence if you're an in-house user. CIS COBOL is available off-the-shelf for any systems based on:

8080/Z80	with CP/M
8086	with CP/M-86
DEC LSI-11	with RT-11
Apple II	with CP/M.

CIS COBOL is also sold under license by over 25 computer manufacturers worldwide.

. . . and we will speak it soon on many more

. . . thanks to our System Transfer Technology, which enables us to port COBOL to new processors and operating systems more quickly than ever before. It has already enabled us to be first on a number of processors—a tradition we mean to continue.

Ask your supplier for more information or for a demonstration. Or call us direct at (408) 496-0176 for an in-depth brochure.

Micro Focus, Inc.
1601 Civic Center Drive
Santa Clara, CA 95050
Tel: (408) 984-6961
Telex: 171135
MISSION SNTA

Micro Focus Ltd.
58 Acacia Road
London N.W.8
England
Tel: (01) 722-8843/4/5/6/7
Telex: 28536 MICROF G

CIS COBOL and FORMS-2 are trademarks of Micro Focus, Inc. • CP/M is a registered trademark of Digital Research • Apple II is a registered trademark of Apple Computer, Inc. • DEC is a registered trademark of Digital Equipment Corp. • Z80 is a registered trademark of Zilog, Inc.

Circle 220 on Inquiry card.



MICRO FOCUS

The COBOL Company

Big sale on K's!

16K... \$149.95

32K... \$199.95

48K... \$249.95

64K... \$299.95

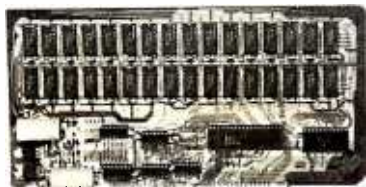

New JAWS-IB

The Ultrabyte Memory Board

Due to the tremendous success of our JAWS I, we were able to make a special purchase of first-quality components at below-cost prices for JAWS-IB. And we are sharing our cost saving with you. But don't be surprised if the next time you see this ad the prices have gone up substantially. Better yet, order now, and get the best memory on the market at the best price on the market.

ONE CHIP DOES IT ALL

Jaws-IB is the Rolls-Royce of all the \$100 dynamic boards. Its heart is Intel's single chip 64K dynamic RAM controller. Eliminates high-current logic parts... delay lines... massive heat sinks... unreliable trick circuits. JAWS-IB solves all these problems.

LOOK WHAT JAWS-IB OFFERS YOU

Hidden refresh... fast performance... low power consumption... latched data outputs... 200 NS 416 RAM's... on-board crystal... RAM Jumper selectable on 8K boundaries... fully socketed... solder mask on both sides of board... phantom line... designed for 8080, 8085, and Z80 bus signals... works in Explorer, Sol, Horizon, as well as all other well-designed \$100 computers.

10-DAY MONEY-BACK TRIAL: Try a fully wired and tested board for 10 days — then either keep it, return it for kit, or simply return it in working condition.

Continental U.S.A. Credit Card Buyers Outside Connecticut:
TO ORDER CALL TOLL FREE 800-243-7428
From Connecticut Or For Assistance:
(203) 354-9375

Please send the items checked below:

JAWS-IB kit:

- 16K... \$149.95*
- 32K... \$199.95*
- 48K... \$249.95*
- 64K... \$299.95*

JAWS-IB Fully Assembled, Wired & Tested:

- 16K... \$179.95*
- 32K... \$239.95*
- 48K... \$299.95*
- 64K... \$359.95*

EXPANSION KIT, 16K RAM Module, to expand

JAWS-IB in 16K blocks up to 64K. \$59.95

*All prices plus \$2 postage and insurance (\$4.00 Canada). Connecticut residents add sales tax.

Total enclosed: \$

- Personal Check Money Order or Cashier's Check
- VISA Master Card (Bank No. _____)

Acct. No. _____ Exp. Date _____

Signature _____

Print Name _____

Address _____

City _____

State _____ Zip _____

NETRONICS R&D Ltd.
333 Litchfield Road, New Milford, CT 06776

mined, it then performs the remaining steps (4, 5, and 6) of the program's data-acquisition routine.

Building the Timing System

I have just described the system-independent design details of a two-channel, data-logging, millisecond timer using a Motorola MC6840 programmable-timer module; I will now show you how to implement this design on a Heathkit ET-3400 microprocessor trainer.

We have seen that a millisecond-resolution timer requires a 1 kHz external timing signal, and we have seen how this external timing signal can be scaled from a 1 MHz microprocessor clock. The implementation assumes the use of an ET-3400 trainer with a 1 MHz crystal-controlled clock. This 1 MHz clock is a feature of all trainers modified for use with the Heathkit ETA-3400 expansion accessory.

The demonstration program (see listing 2) assumes the availability of

340 bytes of memory for program storage. This exceeds memory available in the trainer alone, unless some page-zero memory is used for this purpose. Addition of the ETA-3400 expansion accessory easily provides the additional program-storage space required.

Figure 6 is a complete circuit diagram for the two-channel, millisecond timer. The entire circuit (except for the phototransistors) may be wired on the trainer's built-in breadboard socket (see photo 1).

Figure 6 contains one system-dependent feature that requires explanation. The ET-3400 trainer uses a bidirectional buffer to couple its data bus to outside devices. Normally set in the write (output) state, this buffer is placed in the read (input) state by pulling the trainer's RE (read enable) line low. The 7445 binary-to-decimal decoder in figure 6 provides the address decoding needed to do this each time the trainer reads the MC6840 registers. *Text continued on page 144*

Listing 2: Complete timer-demonstration program for using the Motorola MC6840 with Heath's ET-3400 microcomputer trainer. The program (written in 6800 assembly language) assumes the availability of 340 bytes of memory for program storage, so an ETA-3400 memory-expansion module must be installed.

M68SAM IS THE PROPERTY OF MOTOROLA SPD, INC.
COPYRIGHT 1974 TO 1975 BY MOTOROLA INC

MOTOROLA M6800 CROSS ASSEMBLER, RELEASE 1.2

```

00001          NAM      TIMLOG  BY J. H. GIBSON, ALMA COLLEGE

00003 0000          ORG      0

00005 0000 0003    T11     RMB    3      / ELAPSED TIME A
00006 0003 0003    T12     RMB    3      / ELAPSED TIME B
00007 0006 0003    T13     RMB    3      / ELAPSED TIME C

00009 0009 0003    T21     RMB    3      / ELAPSED TIME D
00010 000C 0003    T22     RMB    3      / ELAPSED TIME E
00011 000F 0003    T23     RMB    3      / ELAPSED TIME F

00013 0012 0001    TEMP1   RMB    1
00014 0013 0001    TEMP2   RMB    1

00016 0014 0002    POINT1  RMB    2      / POINTER FOR TIMER #1
00017 0016 0002    POINT2  RMB    2      / POINTER FOR TIMER #2

00019          00F7      UIRQ   EQU    $00F7 / MONITOR VECTORS HERE ON IRQ

00021          * ADDRESSES IN PROGRAMMABLE TIMING MODULE

00023          8000      CR1    EQU    $8000
00024          8001      CR2    EQU    CR1+1
00025          8000      CR3    EQU    CR1

00027          8001      STATUS EQU    CR2      / CONTAINS INTERRUPT FLAGS

00029          8002      M1     EQU    CR1+2
    
```

Listing 2 continued on page 136

New from HIPLØT™

6-pen plotting for as little as \$1480*.



FCC class B tested.
UL listed.

And you can retrofit your present single pen HIPLØT for only \$395.

The new HIPLØT DMP Series 6-pen option makes high performance multi-pen plotting affordable. It's available on all six models in the HIPLØT family so you can enjoy the advantages of multi-colored plots on surfaces of 8½" × 11" (DIN A4) or 11" × 17" (DIN A3). Of course, you also get the standard HIPLØT range of capabilities such as intelligence, controls, interfaces and resolutions. There's a model for virtually every plotting application.

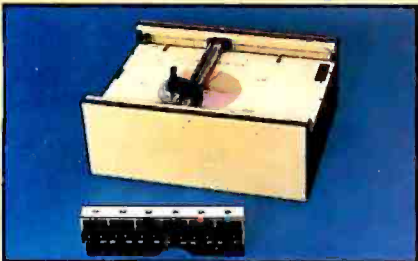

Big Performance in a Small Plotter
Since its introduction, the HIPLØT DMP Series has been recognized as the innovative plotter

line which made low-cost, high performance digital plotting a reality.

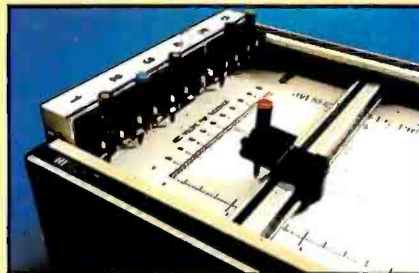

Now, with our new 6-pen option, there's an exciting new dimension in the DMP Series' versatility. Imagine two standard models with RS-232-C and parallel interfaces, four intelligent models with RS-232-C or Centronics® compatible interfaces, a choice of controls, resolutions, and pen speeds. Add to this the ability to plot with 6-pens on paper, vellum or mylar (ideal for overhead projectors) and you have the ultimate plotter price/performance combination — the perfect choice for the user or OEM.

Easily Retrofitted to Existing HIPLØT Models

If you already have a single pen DMP-2, 3 or 4, don't despair. For as little as \$395* you can upgrade these models with our 6-pen conversion kit. It's simple to do . . . and the complete change can be made by the user in only six minutes.

So why wait? Let us send you complete information on this breakthrough in affordable, multi-pen plotting. Contact Houston Instrument, One Houston Square, Austin, Texas 78753. (512) 837-2820. For rush literature requests, outside Texas, call toll free 1-800-531-5205. For technical information ask for operator #5. In Europe contact Houston Instrument, Rochesterlaan 6, 8240 Gistel, Belgium. Phone 059/27-74-45.

houston instrument
GRAPHICS DIVISION OF
BAUSCH & LOMB

™ Trademark of Houston Instrument.
* U.S. Suggested retail prices.
Centronics® registered trademark of Centronics Data Computer Corp.

NEW STATE-OF-THE-ART SS16K/IEEE 16K STATIC RAM BOARD

ONLY \$179⁹⁵

Expand your system beyond
64K — add universal bank
select option for only \$20.00

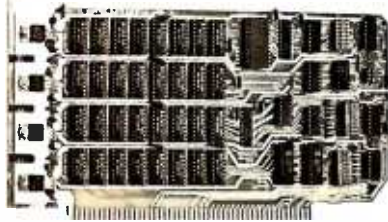

New: SS16K/IEEE RAM

It's everything you need in a 16K static RAM board — at the lowest price you've ever seen. The SS16K/IEEE comes with all the high performance features listed below. And unlike obsolete design RAM's (without bank select) you can add-on our universal software bank-selector system anytime, now just \$20.00. This makes the SS16K/IEEE capable of addressing 2,048 different banks. You can add memory beyond the 64K limit. You can expand to a multi-terminal system.

FEATURES OF SS16K/IEEE :

- Low-power 2114's
 - All inputs and outputs meet the proposed IEEE standards for the S100 bus.
 - 4.0 MHz operation.
 - Schmitt trigger buffer on all signals for maximum noise reduction.
 - Addressable on 16K boundaries, 0-64K, dip switch selectable.
 - Phantom option, dip switch selectable.
 - PWR/MWRITE option, dip switch selectable.
 - Glass epoxy PC board with gold-plated contacts and double-sided solder mask.
 - Fully socketed.
 - Four separate regulators, for maximum stability.
- WITH BANK SELECT OPTION (now just \$20.00)
YOU ADD THIS:

- Software bank selector featuring a universal decoder works with Cromenco, Alpha Micro, Netronics, most other systems, or your design. On-board dip switches: Bank Select Enable, Reset Enable, Reset Disable, Port Address, Port Data.
- LED Indicator to display status.

10-DAY MONEY-BACK TRIAL: Try a fully wired and tested board for 10 days — then either keep it, return it for kit, or simply return it in working condition.

Continental U.S.A. Credit Card Buyers Outside Connecticut:
TO ORDER CALL TOLL FREE 800-243-7428
From Connecticut or For Assistance:
(203) 354-9375

Please send the items checked below:

- SS16K/IEEE without bank select:
- Kit \$179.95*
 - Fully assembled, wire & tested \$199.95*
- SS16K/IEEE with bank select:
- Kit \$199.95*
 - Fully assembled, wired & tested \$229.95*
 - SS16K/IEEE bank select option. \$20.00*

*Plus \$2 postage & insurance (\$5.00 Canada). Connecticut residents add sales tax.

Total enclosed: \$ _____

- Personal Check Money Order or Cashier's Check
 VISA Master Card (Bank No. _____)

Acct. No. _____ Exp. Date _____

Signature _____
Print Name _____

Address _____

City _____

State _____ Zip _____

NETRONICS R&D Ltd.
333 Litchfield Road, New Milford, CT 06776

Listing 2 continued:

```

00030      8003      L1      EQU      CR1+3
00032      8004      M2      EQU      CR1+4
00033      8005      L2      EQU      CR1+5
00035      8006      M3      EQU      CR1+6
00036      8007      L3      EQU      CR1+7

00038
* THESE ET-3400 MONITOR SUBROUTINES ARE USED.

00040      FC8C      REDIS  EQU      $FC8C      / RESETS DISPLAY TO 1ST LED
00041      FE28      OUTHEX EQU      $FE28      / DISPLAYS HEX DIGIT FROM 'A'
00042      FE3A      OUTCH  EQU      $FE3A      / DISPLAYS CODED CHARACTER
00043      FD8F      ENCODE EQU      $FD8F      / RETURNS KEY'S HEX VALUE
00044      FD7B      DISPLAY EQU      $FD7B      / DISPLAYS HEX DIGIT STRING
00046
* THESE STEPS INITIALIZE TIMERS 1 AND 2 FOR USE IN
* THE PULSE WIDTH COMPARISON MODE IN WHICH AN IRQ
00048 * INTERRUPT IS GENERATED AT THE END OF EACH TIMED
00049 * INTERVAL. TIMER 3 IS USED TO SCALE THE 1MHZ
00050 * MICROPROCESSOR CLOCK TO PROVIDE A 1KHZ EXTERNAL
00051 * CLOCK FREQUENCY TO TIMERS 1 AND 2.

00053 0100
                                ORG      $100      / START FROM THIS ADDRESS.

00055 0100 0F      START  SEI
                                / MASK IRQ INTERRUPT

00057 0101 CE 01F3  LDX      $499      / SCALING FACTOR = 2(499+1)
00058 0104 FF 8006  STX      M3
                                / INITIALIZE TIMER #3

00060 0107 86 82      LDA  A  $82      / CONFIGURE TIMER #3 FOR USE
00061 0109 E7 8100    STA  A  CR3
                                / AS A SCALAR

00063 010C 86 59      LDA  A  $59      / CONFIGURE TIMERS #1 AND #2
00064 010E E7 8001    STA  A  CR2
                                / FOR PULSE WIDTH COMP MODE;
00065 0111 E7 8100    STA  A  CR1
                                / INTERNALLY RESET ALL TIMERS

00067 0114 4A
00068 0115 E7 8000    STA  A  CR1
                                / CLEAR INTERNAL RESET BIT
                                / TO ENABLE ALL TIMERS

00070
* ON IRQ, THE ET-3400 VECTORS TO LOCATION
00071 * $UIRQ, WHERE IT MUST FIND A JUMP INSTRUCTION
00072 * AND A VECTOR TO TRANSFER TO THE PROGRAM'S
00073 * IRQ SERVICE ROUTINE AT LOCATION $POLL.

00075 0118 86 7E      LDA  A  $7E      / LDA A WITH JUMP COMMAND
00076 011A 77 F7      STA  A  UIRQ
                                / STORE JUMP COMMAND AT UIRQ

00078 011C CE 018E    LDX      $POLL      / JUMP TO THIS LOCATION
00079 011F DF FB      STX      UIRQ+1
                                / STORE $POLL AT UIRQ VECTOR

00081 0121 0E      CLI
                                / CLEAR IRQ INTERRUPT MASK

00083
* INITIALIZE THE MEMORY LOCATION POINTERS

00085 0122 CE 0009    LDX      $T21
00086 0125 DF 16      STX      POINT2

00088 0127 CE 0000    LDX      $T11
00089 012A DF 14      STX      POINT1
00091
* CLEAR ALL MEMORY LOCATIONS

00093 012C 6F 00      CLEAR  CLR      0,X      / CLEAR THIS BYTE
00094 012E 08          INX
                                / POINT TO THE NEXT BYTE
00095 012F 8C 0012    CPX      $T23+3
                                / DONE YET?
00096 0132 26 FB      BNE      CLEAR
                                / GO CLEAR THE NEXT BYTE

00098
* MAIN PROGRAM LOOP

0100 0134 8D 11      RUN     BSR      SHOW
                                /SHOW LETTERS OF LOGGED TIMES
0101 0136 8D 30      BSR     KEY
                                /RETURNS DEBOUNCED KEY IN 'A'
0102 0138 24 FA      BCC    RUN
                                / GO BACK IF NO KEY PRESSED

0104 013A 4D          TST  A
0105 013B 27 C3      BEQ    START
                                / GO TO START ON '0' KEY

0107 013D 8D 35      BSR     SETX
                                / POINT TO KEYED LOCATION
0108 013F 24 F3      BCC    RUN
                                / BRANCH IF KEYS 1-9 PRESSED

0110 0141 8D 44      BSR     READOU
                                / SHOW KEYED ELAPSED TIME
0111 0143 8D 6E      BSR     RELEAS
                                / WAIT FOR KEY RELEASE
0112 0145 20 ED      RUN     RELEAS
                                / RETURN TO SHOW LETTERS

```

Listing 2 continued on page 138



SAVE \$50

We design and manufacture a complete line of industry compatible microcomputer assembled and tested boards and kits for your system. All are S-100 bus compatible and use the Z-80 microprocessor.

With over 25,000 boards and hundreds of computer systems installed throughout the world, SD Systems offers you both proven and state-of-the-art products! We provide you with a complete family of kits for all your systems needs —

SBC 100/200 — A 2.5/4 megahertz range of single board computers which are effective standing alone or combined with the complete SD board range.

ExpandoRAM III — For use with 250/200 nanosecond RAM, these high density boards offer 16 to 64K memory; the ExpandoRAM II can achieve RAM capacities up to 256K using 64K chips.

Versafloppy III — A floppy disk controller for up to four drives, supporting single/double density and single/double-sided disk formats.

VDB-8024 — A full function visual display board with a Z-80 controller that adds display capabilities to your system.

Z-80 Starter Kit — A low-cost entry into the world of microcomputers designed primarily for education and experimentation.

Prom 100 — A specialty board of SD Systems which allows you to program 2708/2716/2732 proms.

SD SYSTEMS

P.O. Box 28810 • Dallas, Texas 75228 • Telex 6829016

YOU CAN SAVE \$50

when you purchase any two SD Systems board kits from participating DEALERS and present coupons included in any two kits to participating DEALERS listed below. Coupons must be presented to participating DEALERS by 10-15-81.

A.S.A.P. COMPUTER PRODUCTS
Signal Hill, Ca. 213-595-6431

Q. T. COMPUTER SYSTEMS, INC.
Lawndale, Ca. 213-970-0952

S-100
Clark, N.J. 201-382-1318

COMPUTERS, ETC
Dallas, Texas 214-644-5030

JADE COMPUTER PRODUCTS
Hawthorne, Ca. 800-421-5500

COMPUTER CENTRE
Swansea, England, U.K.
44-792-460023

ARKON ELECTRONICS LTD
Toronto, Ontario, Canada
416-868-1315

RATIONAL SYSTEMS
Newport Pagnell,
Buckinghamshire, U.K.
0908-611349

ALPHA BYTE STORES
Calabasas, Ca. 213-883-8594

ARISIA MICRO SYSTEMS
Mississauga, Ontario Canada
416-274-6033

SIRTON PRODUCTS
Surrey, England, U.K.
UK-01-660-5617

EXCELTRONIX COMPONENT & COMPUTING, INC.
Toronto, Ontario, Canada
416-921-4114

S. M. ELECTRONICS
Mitcham Melbourne, Australia
03 874-3666

COMPROCESSING COMPUTING SYSTEMS
Sale, Victoria, Australia
011-51-443399

LYBEN COMPUTER SYSTEMS
St. Clair Shores, Mi.
313-777-7780

SD

NEW!!! THE ELECTRIC MOUTH*



for S100, Elf II, Apple, TRS-80 Level II*

From \$99.95 kit

Now — teach your computer to talk, dramatically increasing the interaction between you and your machine.

That's right: the ELECTRIC MOUTH actually lets your computer talk! Installed and on-line in just minutes, it's ready for spoken-language use in office, business, industrial and commercial applications, in games, special projects, R&D, education, security devices — there's no end to the ELECTRIC MOUTH's usefulness. Look at these features:

- * Supplied with 143 words/letters/ phonemes/ numbers, capable of producing hundreds of words and phrases.
- * Expandable on-board up to thousands of words and phrases (just add additional speech ROMs as they become available).
- * Four models, which plug directly into S100, Apple, Elf II and TRS-80 Level II computers.
- * Get it to talk by using either Basic or machine language (very easy to use, complete instructions with examples included).
- * Uses National Semiconductor's "Digitalker" system.
- * Includes on-board audio amplifier and speaker, with provisions for external speakers and amplifier.
- * Adds a new dimension and excitement to programming: lets you modify existing programs and games to add spoken announcements of results, warnings, etc.
- * Installs in just minutes.

Principle of Operation: The ELECTRIC MOUTH stores words in their digital equivalents in ROMs. When words, phrases, and phonemes are desired, they are simply called for by your program and then synthesized into speech. The ELECTRIC MOUTH system requires none of your valuable memory space except for a few addresses if used in memory mapped mode. In most cases, output ports (user selectable) are used.

Spoken Material Included	
one	eighteen
two	nineteen
three	cancel
four	case
five	cent
six	40hzerts tone
seven	50hzerts tone
eight	20ms silence
nine	40ms silence
ten	80ms silence
eleven	120ms silence
twelve	200ms silence
thirteen	300ms silence
fourteen	400ms silence
fifteen	500ms silence
sixteen	600ms silence
seventeen	700ms silence
and	800ms silence
at	900ms silence
down	1000ms silence
equal	1100ms silence
error	1200ms silence
feel	1300ms silence
flow	1400ms silence
fuel	1500ms silence
lessor	1600ms silence
limit	1700ms silence
low	1800ms silence
lower	1900ms silence
mark	2000ms silence
meter	2100ms silence
mile	2200ms silence
mile	2300ms silence
high	2400ms silence
higher	2500ms silence
hour	2600ms silence
in	2700ms silence
near	2800ms silence
right	2900ms silence
second	3000ms silence
set	3100ms silence
space	3200ms silence
speed	3300ms silence
ster	3400ms silence
start	3500ms silence
stop	3600ms silence
than	3700ms silence
the	3800ms silence
time	3900ms silence
try	4000ms silence
up	4100ms silence
volt	4200ms silence
weight	4300ms silence
ready	4400ms silence
ready	4500ms silence
right	4600ms silence

*Elf II and "The Electric Mouth" are reg. trademarks of Netronics R&D Ltd. "Apple" is a reg. trademark of Apple Computer Inc. "TRS-80 Level II" is a reg. trademark of Tandy Corp.

Continental U.S.A. Credit Card Buyers Outside Connecticut
CALL TOLL FREE 800-243-7428

To Order From Connecticut Or For Technical Assistance, Etc.,
 Call (203) 354-9375

NETRONICS R&D LTD. Dept B6
 333 Litchfield Road, New Milford, CT 06776

- Please send the items checked below:
- \$100 "Electric Mouth" kit \$99.95
 - Elf II "Electric Mouth" kit \$99.95
 - Apple "Electric Mouth" kit \$119.95
 - TRS-80 Level II "Electric Mouth" kit \$119.95

Add \$20.00 forward & tested units. All plus \$3.00 postage & insurance. Conn. res. add sales tax.

Total Enclosed \$ _____

Personal Check Cashier's Check/Money Order

Visa Master Charge (Bank No. _____)

Acct. No. _____

Signature _____ Exp. Date _____

Print Name _____

Address _____

City _____

State _____ Zip _____

Listing 2 continued:

00114							* THIS ROUTINE DISPLAYS LETTERS FOR MEMORY
00115							* LOCATIONS IN WHICH ELAPSED TIMES ARE LOGGED.
00117	0147	CE	0000	SHOW	LDX	#T11	/ POINT TO THE FIRST LOCATION
00118	014A	B6	0A		LDA	#\$0A	/ INITIALIZE DISPLAY LETTER
00119	014C	BD	FCBC		JSR	REDIS	/ INITIALIZE DISPLAY POINTER
00121	014F	E6	00	SHOW1	LDA	B 0,X	/ TEST BIT7 FOR TIME LOGGED
00122	0151	2A	05		BFL	SHOW2	/ BRANCH IF NO TIME LOGGED
00124	0153	BD	FE2B		JSR	OUTHEX	/ SHOW THE LETTER FROM 'A'
00125	0156	20	06		BRA	SHOW3	
00127	0158	36		SHOW2	FSH	A	/ SAVE THE LETTER FROM 'A'
00128	0159	4F			CLR	A	/ PREPARE TO SHOW A BLANK
00129	015A	BD	FE3A		JSR	OUTCH	/ SHOW A BLANK HERE
00130	015D	32			FUL	A	/ RESTORE KEYED LETTER TO 'A'
00132	015E	4C		SHOW3	INC	A	/ INC 'A' TO THE NEXT LETTER
00133	015F	08			INX		
00134	0160	08			INX		/ ADVANCE THE POINTER TO THE
00135	0161	08			INX		/ NEXT 3-BYTE MEMORY LOCATION
00136	0162	8C	0012		CFX	#T23+3	/ DONE YET?
00137	0165	26	E8		BNE	SHOW1	/ EXAMINE THE NEXT LOCATION
00139	0167	39				RTS	
00141							* THIS ROUTINE DEBOUNCES A PRESSED KEY AND RETURNS
00142							* ITS HEX VALUE IN ACC A. THE ROUTINE ALSO
00143							* RETURNS CARRY SET FOR KEY PRESSED, CARRY
00144							* CLEAR FOR NO KEY PRESSED.
00146	0168	C6	14	KEY	LDA	B #20	/ INITIALIZE DELAY COUNTER
00148	016A	BD	FDBB	KEY1	JSR	ENCODE	/ RETURNS KEY VALUE IN 'A'
00149	016D	24	04		BCC	KEY2	/ BRANCH IF NO KEY DOWN
00151	016F	5A			DEC	B	/ DECREMENT THE DELAY TIME
00152	0170	26	F8		BNE	KEY1	/ GO BACK, IF DELAY NOT DONE
00154	0172	0D			SEC		/ SET CARRY IF KEY DOWN
00156	0173	39		KEY2	RTS		
00158							* THIS ROUTINE USES THE HEX VALUE (IN ACC A)
00159							* OF THE KEY PRESSED TO POINT X TO THE PROPER
00160							* MEMORY LOCATION. THE ROUTINE RETURNS CARRY
00161							* SET IF KEYS A-F PRESSED, CARRY CLEAR
00162							* IF KEYS 1-9 ARE PRESSED.
00164	0174	CE	0000	SETX	LDX	#T11	/ POINT X TO FIRST LOCATION
00165	0177	C6	0A		LDA	B #\$0A	/ INITIATE 'B'
00167	0179	11		SETX1	CBA		/ DOES 'B' EQUAL KEY VALUE?
00168	017A	27	09		BEQ	SETX2	/ BRANCH IF EQUAL
00170	017C	0C			CLC		/ CLEAR THE A-F KEY FLAG
00171	017D	2B	07		BMI	SETX3	/ RTS IF 'B' > KEY VALUE
00173	017F	08			INX		
00174	0180	08			INX		/ ADVANCE THE POINTER TO THE
00175	0181	08			INX		/ NEXT 3-BYTE MEMORY LOCATION
00176	0182	5C			INC	B	/ INCREMENT 'B' AND
00177	0183	20	F4		BRA	SETX1	/ GO COMPARE AGAIN
00179	0185	0D		SETX2	SEC		/ SET THE A-F KEY FLAG
00181	0186	39		SETX3	RTS		
00183							* READOUT ROUTINE; DISPLAYS KEYED LETTER AND
00184							* ELAPSED TIME STORED IN THIS LOCATION. THE
00185							* DISPLAY IS IN SECONDS WITH RESOLUTION TO
00186							* 1 MILLISECOND, LEADING ZEROS TO THE LEFT
00187							* OF THE DECIMAL POINT ARE SUPPRESSED.
00189	0187	E6	00	READOU	LDA	B 0,X	/ FETCH BIT 7
00190	0189	2A	27		BFL	READ2	/ BRANCH IF NO TIME LOGGED
00192	018B	36			FSH	A	/ SAVE KEY VALUE (FROM 'A')
00193	018C	BD	FCBC		JSR	REDIS	/ INITIALIZE DISPLAY POINTER
00194	018F	C6	03		LDA	B #03	/ TO DISPLAY 3 BYTES
00195	0191	BD	FD7B		JSR	ISPLAY	/ DISPLAY THIS ELAPSED TIME
00197	0194	BD	FCBC		JSR	REDIS	/ RESET THE DISPLAY POINTER
00198	0197	32			FUL	A	/ RESTORE KEY VALUE TO 'A'

Listing 2 continued on page 140

Westico-The Software Express Service that really delivers.

The professional wants good software, wants it fast and backed by expert service — There's one answer — Westico, the Software Express Service that really delivers...

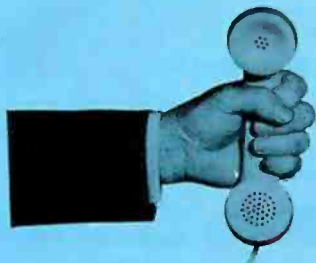

Call (203) 853-6880 for overnight delivery or... when you need expert service.

— Quality Software!

Westico constantly improves its quality software in a wide range of categories including: Accounting, Professional Time Accounting, Text Processing, Planning and Analysis, Telecommunications, Data Management, Development Tools, Language Processors.

— Your Program Overnight!

Westico knows that the speed in which you receive a program is often a key consideration in your selection. That's why Westico is the only software company to offer overnight delivery.

— Our 24-Hour Computer Hotline!

For detailed program information or for quick access ordering, just dial-up the Westico computer (300 baud) (203) 853-0816.

— The Software for a wide variety of CP/M™ and other computer systems:

TRS-80 Model II, Apple, Vector Graphic, iCom, Cromemco, North Star, Micropolis, Ohio Scientific, Altos, Dynabyte, SuperBrain and more.

— Professional Service

Westico is staffed by experts who understand your software and the equipment on which it runs. It's nice to know when you need service or advice, a Westico expert is standing by.

Send for our **NEW FREE** Catalog.

— Professional Software

Current Westico products with **new prices** for complete systems and documentation alone:

Accounting: ACCOUNTS PAYABLE 495/60 • ACCOUNTS RECEIVABLE 495/60 • CLIENT WRITE-UP 895/60 • GENERAL LEDGER 495/60 • INVENTORY CONTROL 595/60 • PAS-3 DENTAL 990/40 • PAS-3 MEDICAL 990/40 • PAYROLL 495/60 • PROPERTY MANAGEMENT 895/60.

Professional Time Accounting: DATEBOOK™ II 295/25 • ESQ-1 Legal 1495/50 • ESQ-1 Legal Demo 75/50 • PTA 595/40 • PTA Demo 75/40.

Text Processing: MAIL-MERGE™ 125/25 • MINCE 125/25 • SPELL-GUARD™ 295/25 • TEXTWRITER 125/20 • WORDMASTER™ 145/40 • WORDSEARCH™ 195/40 • WORDSTAR™ 450/60.

Planning & Analysis: MILESTONE™ 295/25 • MINIMODEL 495/50 • STATPAK 500/40 • TARGET 195/25.

Telecommunications: ASCOM 175/20.

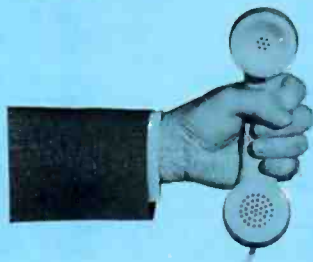

...Dial-up our 24-hour Computer Hotline (300 baud) (203) 853-0816 for program information or orders.

Data Management: CBS 395/50 • CBS Demo 75/50 • CBS LABEL OPTION 80/10 • HDBS 300/35 • MAILING ADDRESS 395/60 • MAGSAM III 145/25 • MAGSAM IV 295/25 • MDBS 900/35 • MDBS DRS 300/5 • MDBS RTL 300/5 • MDBS QRS 300/5 • PRISM/ADS 795/55 • PRISM/IMS 495/55 • SELECTOR IV 550/35 • DATASTAR™ 350/60.

Development Tools: GENERAL SUBROUTINE PAK 295/30 • APPLICATION UTILITIES 495/30 • STRING BIT™ 65/15 • STRING/80™ 95/15 • STRING/80 SOURCE 295/-.

Language Processors: LYNX Overlay loader 250/25 • BASIC COMPILER 395/25 • BASIC-80 350/25 • CBASIC-2 120/15 • NEVADA COBOL 150/25 • PASCAL/M 175/20 • PASCAL/MT+ 425/30 • PL/I-80™ 475/35 • S-BASIC™ 295/25.

Miscellaneous: SUPERSORT I 225/40 • SURVEYOR 550/60 • ULTRASORT II™ 165/15.

New from Westico

LYNX a friendly overlay linker.

LYNX is an overlay linker for creating executable programs from relocatable files produced by Microsoft's FORTRAN, COBOL, and MACRO-80 languages.

LYNX allows the construction of programs that use all available memory including that used by LYNX itself. Maximum size programs under Microsoft's L80 linker can be increased at least 9K using LYNX without overlays.

The overlay capability of LYNX is vital for programs larger than available memory. With overlays, many large programs on minicomputers or large mainframe computers can be easily moved to a microcomputer.

LYNX offers many features not found in L80. For example, LYNX can be told to get commands from a disk file. The "HELP" feature displays a complete list of LYNX commands. Mapping information can be sent to the screen, printer or disk files. LYNX can decode Microsoft REL files for inspection.

LYNX uses overlays in a tree structure. Any routine is available to any overlay that is higher on the branch than the routine itself.

Complete system with documentation \$250. Documentation alone \$25.

4 WAYS TO ORDER

- Write Westico, Inc., 25 Van Zant Street, Norwalk, CT 06855.
- Call (203) 853-6880.
- Telex 643-788.
- Dial-up our 24-hour computer (300 baud) (203) 853-0816.

MasterCard and VISA accepted.

Prices do not include shipping and are subject to change. In CT add 7½% sales tax.

Manual price may be credited toward purchase of software.

Dealer inquiries invited. Copyright © 1981 Westico, Inc.

WESTICO
The Software Express Service
25 Van Zant Street • Norwalk, Connecticut 06855
(203) 853-6880 • Telex 643-788

SOFTWARE DEVELOPMENT TOOLS FOR INDUSTRY

CP/M CROSS-ASSEMBLERS

Fast, comprehensive cross-assemblers to run under CP/M.* Extensive pseudo-ops include full listing control, nested conditionals, mnemonic synonyms, and inclusion of external source files. Generate object file, assembly listing, and symbol table from source code for nine popular microprocessor families.

XASM05 6805
XASM09 6809
XASM18 1802
XASM48 8048
XASM51 8051
XASM65 6502
XASM68 6800/6801
XASMF8 F8/3870
XASM400 COPS400

Assemblers \$200.00 each
Manual only \$25.00

8048 DEVELOPMENT PACKAGE

Now you can use the 8048 family of single-chip microcomputers without buying expensive equipment. Develop 8048 software with the XASM48 cross-assembler. Then plug our EPR-48 board into your S-100 system to program the 8748 EPROM version. (Similar packages for 8051 and TMS9940E coming soon.)

8048 Development Package ... \$574.00
EPR-48 alone \$449.00

PROM EMULATOR BOARD

Debug dedicated systems quickly. Our PSB-100 PROM Emulator is an S-100 board with up to 8K of RAM. Cable with 24-pin plug replaces PROM(s) in your target system for instant program testing.

PSB-100 PROM Emulator .. \$445.00 w/
2K RAM

avocet
systems
inc.

*Trademark of Digital Research

804 south state st.
dover, delaware/19901/302-734-0151

Visa and Mastercharge accepted. We ship on 8" single-density. Ask us about other formats. OEM AND DEALER INQUIRIES INVITED.

Listing 2 continued:

```

00199 019B 8D FE2B      JSR   OUTHEX / SHOW KEY PUSHED (FROM 'A')

00201 019B A6 00      LDA A 0,X   / GET 1ST DIGIT (AND BIT 7)
00202 019D B4 0F      AND A #$0F / MASK TO FIRST DIGIT
00203 019F 26 0C      BNE  READ1  / BRANCH IF NOT LEADING ZERO

00205 01A1 8D FE3A      JSR   OUTCH  / BLANK 2ND 7-SEGMENT LED

00207 01A4 A6 01      LDA A 1,X   / GET 2ND (AND 3RD) DIGIT
00208 01A6 B4 F0      AND A #$F0 / MASK TO 2ND DIGIT
00209 01AB 26 03      BNE  READ1  / BRANCH IF NOT ALSO ZERO

00211 01AA 8D FE3A      JSR   OUTCH  / BLANK 3RD 7-SEGMENT LED

00213 01AD 86 01      READ1: LDA A #$01
00214 01AF B7 C147      STA A $C147 / LIGHT 3RD DECIMAL POINT

00216 01B2 39          READ2: RTS

00218                  * THIS ROUTINE WAITS FOR A KEY RELEASE

00220 01B3 C6 14      RELEAS LDA B #20 / INITIALIZE DELAY COUNTER

00222 01B5 8D F0B8    REL1: JSR   ENCODE / GET KEY RELEASE CONDITION
00223 01B8 25 F9      BCS   RELEAS / KEEP TRYING UNTIL RELEASE

00225 01BA 5A          DEC B / DECREMENT THE DELAY TIME
00226 01BB 26 F8      BNE  REL1   / GO BACK IF DELAY NOT DONE

00228 01BD 39          RTS
00230                  * THIS BEGINS THE IRQ SERVICE ROUTINE THAT
00231                  * READS AND LOGS THE MEASURED TIMES.

00233 01BE B6 8001    POLL  LDA A STATUS / GET THE INTERRUPT FLAGS

00235 01C1 44          POLL1: LSR A / SHIFT TIMER1 FLAG INTO 'C'
00236 01C2 36          PSH A / SAVE THE TIMER2 FLAG
00237 01C3 24 11      BCC  POLL2  / BRANCH IF NO TIMER1 FLAG

00239 01C5 B6 8002    LDA A M1 / READ THE TIMER1 COUNT AND
00240 01CB F6 8003    LDA B L1 / CLEAR THE TIMER1 FLAG

00242 01CD DE 14      LDX  POINT1 / POINT TO THE T1X LOCATION
00243 01CD 8C 0009    CFX  #T13+3 / TIMER1 MEMORY BLOCK FULL?
00244 01D0 27 04      BEQ  POLL2  / BRANCH IF FULL

00246 01D2 8D 18      BSR  LOG   / LOG COUNT, ADV POINTER
00247 01D4 DF 14      STX  POINT1 / SAVE THE NEW POINTER

00249 01D6 32          POLL2: PUL A / RESTORE THE TIMER2 FLAG
00250 01D7 44          LSR A / SHIFT TIMER2 FLAG INTO 'C'
00251 01D8 24 11      BCC  DONE  / BRANCH IF NO TIMER2 FLAG

00253 01DA B6 8004    LDA A M2 / READ THE TIMER2 COUNT AND
00254 01DD F6 8005    LDA B L2 / CLEAR THE TIMER2 FLAG

00256 01E0 DE 16      LDX  POINT2 / POINT TO THE T2X LOCATION
00257 01E2 8C 0012    CFX  #T23+3 / TIMER2 MEMORY BLOCK FULL?
00258 01E5 27 04      BEQ  DONE  / BRANCH IF FULL

00260 01E7 8D 03      BSR  LOG   / LOG COUNT, ADV POINTER
00261 01E9 DF 16      STX  POINT2 / SAVE THE NEW POINTER

00263 01EB 3E          DONE: RTI

00265                  * THIS SUBROUTINE TRANSFORMS AND LOGS THE
00266                  * MEASURED TIMES AND ADVANCES THE POINTER.

00268 01EC 43          LOG   COM A / COMPLEMENT THE COUNT TO GET
00269 01ED 53          COM B / HEXADECIMAL ELAPSED TIME
00270 01EE 8D 5F      BSR  SAVE  / SAVE THE HEX ELAPSED TIME

00272 01F0 86 80      LDA A #$80 / SET BIT 7 TO SHOW THAT THIS
00273 01F2 A7 00      STA A 0,X / MEMORY LOCATION IS FILLED
00274 01F4 8D 04      BSR  RD    / CONVERT HEX TIME TO DECIMAL

00276 01F6 08          INX / ADVANCE THE POINTER TO THE
00277 01F7 08          INX / NEXT 3-BYTE MEMORY LOCATION
00278 01F8 08          INX

00280 01F9 39          RTS
00282                  * THIS ROUTINE CONVERTS THE 2-BYTE HEX NUMBER IN
00283                  * 1,X AND 2,X TO A 3-BYTE DECIMAL NUMBER IN

```

Listing 2 continued on page 142

C AND Pascal

Efficiency AND Portability

Flexibility AND Strong Typing

Now you don't have to compromise!

Whitesmiths Ltd. now offers portable language development systems for four families of computers. Approximately one thousand installations use our software.

We support complete versions of both C and Pascal, as compilers and cross-compilers. You get C automatically when you license Pascal, and you get native support with each cross-compiler. Test the software on your VAX before burning PROMs for your 68000 or 8080.

Whitesmiths Ltd. offers a variety of licensing arrangements, the simplest being a binary license for use on a single CPU. The full source code is available with internal documentation. Maintenance, training and sublicensing rights may also be obtained.

Call or write for more information.

Source Operating Systems	Target Machines			
	8080/Z80	LSI-11/PDP-11	VAX-11	M68000
8080/Z80 CP/M	C: \$630 Pascal: \$880	*	*	*
LSI-11/PDP-11: Iris, Unix, RT11, RSX-11/M, RSTS/E, IAS	C: \$1130 Pascal: \$1380	C: \$630 Pascal: \$880	*	C: \$1130 Pascal: \$1380
VAX-11 Unix/V32 VMS	C: \$1130 Pascal: \$1380	*	C: \$630 Pascal: \$880	C: \$1130 Pascal: \$1380
M68000 VERSA dos	*	*	*	C: \$630 Pascal: \$880

Iris is a trademark of Whitesmiths, Ltd. ■ Unix is a trademark of Bell Laboratories ■ CP/M is a trademark of Digital Research Company ■ VMS, RSX-11/M, RSTS/E, LSI-11, VAX, are trademarks of Digital Equipment Corporation ■ VERSA dos is a trademark of Motorola Corporation

*Special Order

Protect your software investment.
Whitesmiths, Ltd.

P.O. Box 1132 Ansonia Station New York, N.Y. 10023
 (212) 799-1200

NO FRILLS!
NO GIMMICKS!
JUST GREAT
DISCOUNTS
MAIL ORDER ONLY

ATARI 800

Personal Computer System **\$79900**

NORTHSTAR

Horizon II 32K **234900**
Horizon II Quad **279900**
Horizon II 64K **299900**
Horizon Quad 64K **339900**

TELEVIDEO

912 **74900**
920 **79900**

HAZELTINE

1420 **79500**
1500 **84900**
1510 **104900**
1520 **122900**

OKIDATA

Microline 80 **55900**

SOROC Technology

IQ 120 **69900**
IQ 140 **99900**

CROMEMCO

System 3 **599500**
Z2H **799500**

TELETYPE

43 **94900**
Acoustic Coupler **17900**

DECwriter IV

LA34 **97900**

TEXAS INSTRUMENT

810 Multi Copy Impact Printer **149900**

We'll meet or beat any advertised prices!

Most items in stock for immediate delivery.
Factory sealed cartons. Full manufacturer's guarantee.

DATA DISCOUNT CENTER

135-53 Northern Blvd., Flushing, N.Y. 11354
Visa • Master Charge • N.Y.S. residents add Sales Tax
Shipping F.O.B. N.Y.

Phone Orders Call 212-895-5577

Listing 2 continued:

00284					* 0,X, 1,X AND 2,X.				
00286	01FA	7F	0012	BD	CLR	TEMP1	/TO	HOLD	1000'S & 100'S COUNT
00287	01FD	7F	0013		CLR	TEMP2	/TO	HOLD	10'S COUNT
00289	0200	8D	48	BD4	BSR	FETCH	/	FETCH	REMAINDER
00290	0202	C0	10		SUB B	##10			
00291	0204	B2	27		SRC A	##27	/	SUBTRACT	10,000
00292	0206	25	06		BOS	BD3	/	BRANCH	IF REMAINDER NEGATIV
00294	0208	8D	45		BSR	SAVE	/	SAVE	REMAINDER
00295	020A	6C	00		INC	0,X	/	INCREMENT	10,000'S COUNT
00296	020C	20	F2		BRA	BD4	/	GO	SUBTRACT ANOTHER 10,000
00298	020E	8D	3A	BD3	BSR	FETCH	/	FETCH	REMAINDER
00299	0210	C0	E8		SUB B	##E8			
00300	0212	B2	03		SRC A	##03	/	SUBTRACT	1000
00301	0214	25	0A		BOS	BD2	/	BRANCH	IF REMAINDER NEGATIV
00303	0216	8D	37		BSR	SAVE	/	SAVE	REMAINDER
00304	0218	76	12		LDA A	TEMP1	/	GET	1000'S COUNT
00305	021A	B8	10		ADD A	##10	/	INCREMENT	1000'S COUNT
00306	021C	97	12		STA A	TEMP1	/	SAVE	1000'S COUNT
00307	021E	20	EE		BRA	BD3	/	GO	SUBTRACT ANOTHER 1000
00309	0220	8D	28	BD2	BSR	FETCH	/	FETCH	REMAINDER
00310	0222	C0	64		SUB B	##64			
00311	0224	B2	00		SRC A	##00	/	SUBTRACT	100
00312	0226	25	07		BOS	BD1	/	BRANCH	IF REMAINDER NEGATIV
00314	0228	8D	25		BSR	SAVE	/	SAVE	REMAINDER
00315	022A	7C	0012		INC	TEMP1	/	INCREMENT	100'S COUNT
00316	022D	20	F1		BRA	BD2	/	GO	SUBTRACT ANOTHER 100
00318	022F	8D	19	BD1	BSR	FETCH	/	FETCH	REMAINDER
00319	0231	C0	0A		SUB B	##0A			
00320	0233	B2	00		SRC A	##00	/	SUBTRACT	10
00321	0235	25	0A		BOS	BD0	/	BRANCH	IF REMAINDER NEGATIV
00323	0237	8D	16		BSR	SAVE	/	SAVE	REMAINDER
00324	0239	D6	13		LDA B	TEMP2	/	GET	10'S COUNT
00325	023B	CB	10		ADD B	##10	/	INCREMENT	10'S COUNT
00326	023D	D7	13		STA B	TEMP2	/	SAVE	10'S COUNT
00327	023F	20	EE		BRA	BD1	/	GO	SUBTRACT ANOTHER 10
00329	0241	76	12	BD0	LDA A	TEMP1	/	GET	1000'S & 100'S COUNT
00330	0243	D6	13		LDA B	TEMP2	/	GET	10'S COUNT
00331	0245	EB	02		ADD B	2,X	/	ADD	REMAINDER TO 10'S COUNT
00332	0247	8D	06		BSR	SAVE	/	SAVE	DECIMAL COUNTS
00333	0249	39			RTS				
00335									
00336									
00338	024A	A6	01		FETCH	LDA A	1,X		
00339	024C	E6	02			LDA B	2,X	/	FETCH THESE VALUES
00341	024E	39			RTS				
00343									
00344									
00346	024F	A7	01		SAVE	STA A	1,X		
00347	0251	E7	02			STA B	2,X	/	SAVE THESE VALUES
00349	0253	39			RTS				
00351					END				

SYMBOL TABLE

T11	0000	T12	0003	T13	0006	T21	0009	T22	000C
T23	000F	TEMP1	0012	TEMP2	0013	POINT1	0014	POINT2	0016
UIR()	00F7	CR1	B000	CR2	B001	CR3	B000	STATUS	B001
M1	B002	L1	B003	M2	B004	L2	B005	M3	B006
L3	B007	REDIS	FCBC	OUTHEX	FE28	OUTCH	FE3A	ENCODE	FB88
DISPLAY	FD7B	START	0100	CLEAR	012C	RUN	0134	SHOW	0147
SHOW1	014F	SHOW2	0158	SHOW3	015E	KEY	0168	KEY1	016A
KEY2	0173	SETX	0174	SETX1	0179	SETX2	0185	SETX3	0186
READO	0187	READ1	01AD	READ2	01B2	RELEASE	01B3	REL1	01B5
POLL	01BE	POLL1	01C1	POLL2	01D6	DONE	01EB	LOG	01EC
BD	01FA	BD4	0200	BD3	020E	BD2	0220	BD1	022F
BD0	0241	FETCH	024A	SAVE	024F				



The next generation of business software

If you are still searching for quality software for your small business computer, search no more. Designer Software™ is pleased to announce PHOENIX™, the first line of microcomputer software to include professional word processing and general accounting.

WORD PROCESSING

We know word processing. A year-and-a-half ago the owners of Designer Software™ wrote a well-known word processor for another company. In the last 18 months we've learned about other features you want in a word processing package. PHOENIX™ Word Processing reflects our experience. It is more powerful and flexible than other word processing packages you can buy. And since we designed "human engineering" into PHOENIX™ Word Processing from the beginning, it can compete, feature for feature, with expensive dedicated word processors.

Many people have remarked that the user's manual we wrote earlier was the best ever for microcomputer software. Even so, we felt that we could have made it more accessible to the non-technical user. With PHOENIX™ Word Processing we have a separate Training Manual with beginning, intermediate and advanced levels. By allowing you to work at your own level, we have made the learning process easier and less intimidating.

ACCOUNTING

All five PHOENIX™ general accounting packages (General Ledger, Accounts Receivable and Payable, Payroll and Inventory) were designed by CPA's based on similar packages from mini and mainframe computers. The programs are COBOL with an integral

assembly-language data base. They are fully integrated to allow automated posting to the General Ledger. An internal screen handler permits full-screen data entry for speed and ease of use. Although we made cosmetic enhancements prior to distribution, the basic programs have been user-tested for at least eighteen months.

PHOENIX™ Accounting also includes a growing number of specific application packages. We have completed or scheduled for completion Fixed Assets, Tenant Processing, Mail Management, Financial Projections and Time/Billing. Each package stands alone, but many also work in conjunction with other PHOENIX™ packages. For example, PHOENIX™ Mail Management will work very well by itself, but we also designed it to fit in easily with the merging capabilities of PHOENIX™ Word Processing.

With PHOENIX™ Accounting we have, as always, given special attention to documentation. Not being content to describe which buttons to push, we have taken the time to explain the accounting principles behind the programs and how each package fits into an automated office. To this end we created the fictional town of Smallville with a fictional company, Moustache Manufacturing. By seeing how Mr. Small and his employees use PHOENIX™ Accounting at 2M, you learn to apply it to your office as well. The Smallville sections are amusing as well as informative, and you will likely read the manual just to find out what Sidney, Mr. Small's incompetent brother-in-law, will do next.

Designer Software™

HOUSTON

If you want to know what PHOENIX™ Word Processing and accounting can do for your business, call, write, telex or use The Source to request more information.

**3400 Montrose Blvd • Suite 718 • Houston, Texas 77006
(713) 520-8221 • Telex 790510 • Source TCU671**

Designer Software and PHOENIX are trademarks of Palantir, Inc.

Text continued from page 134:

The demonstration program was used to time the motion of two colliding air cars on a linear air track. [This apparatus is a cousin to an air-hockey table....RSS] Each timer was

controlled by one phototransistor illuminated by a 1 W incandescent bulb, and each air car carried an opaque vane 10 cm long (see photo 2). The vane blocked the light as the car passed in front of the phototran-

sistor. With timers 1 and 2 operating in the pulse-width-comparison mode, the microcomputer measured how long each phototransistor was blocked as the cars approached and then recoiled from the collision. These measured times, the known lengths of the opaque vanes, and the cars' masses were then used to calculate momenta before and after the collision.

I required that each timer be able to record three elapsed times. Each timer therefore has three memory locations reserved for saving its measurements. Labeled T11 thru T23 in the demonstration program, these memory locations are accessed during readout as times A, B, and C for timer 1 and times D, E, and F for timer 2.

The trainer's six 7-segment LEDs (light-emitting diodes) are used for data display. Each experimental trial begins with the LEDs dark. The 7-segment LEDs then light individually to show letter labels of the elapsed times as they are measured (see photos 3 and 4). When the experimental trial ends, each of the keys A thru F, when pushed, will produce a display of the corresponding elapsed time (see photo 5). Pushing the zero key clears all six memory locations to prepare for another trial.

Although the demonstration program specifies operation of timers 1 and 2 in the pulse-width-comparison mode, it will just as easily support their operation in the frequency-comparison mode. To make the conversion, simply change the number stored at hexadecimal location 010D from hexadecimal 59 (for pulse-width-comparison mode) to hexadecimal 49 (for frequency-comparison mode).

Conclusion

This computer-based timer has been a stable and dependable measurement tool in my introductory physics laboratory. The students enjoy using it and appreciate the repeatability of results attained with it. I hope that you too will find it useful, and I would be interested to hear from readers who develop their own applications. ■

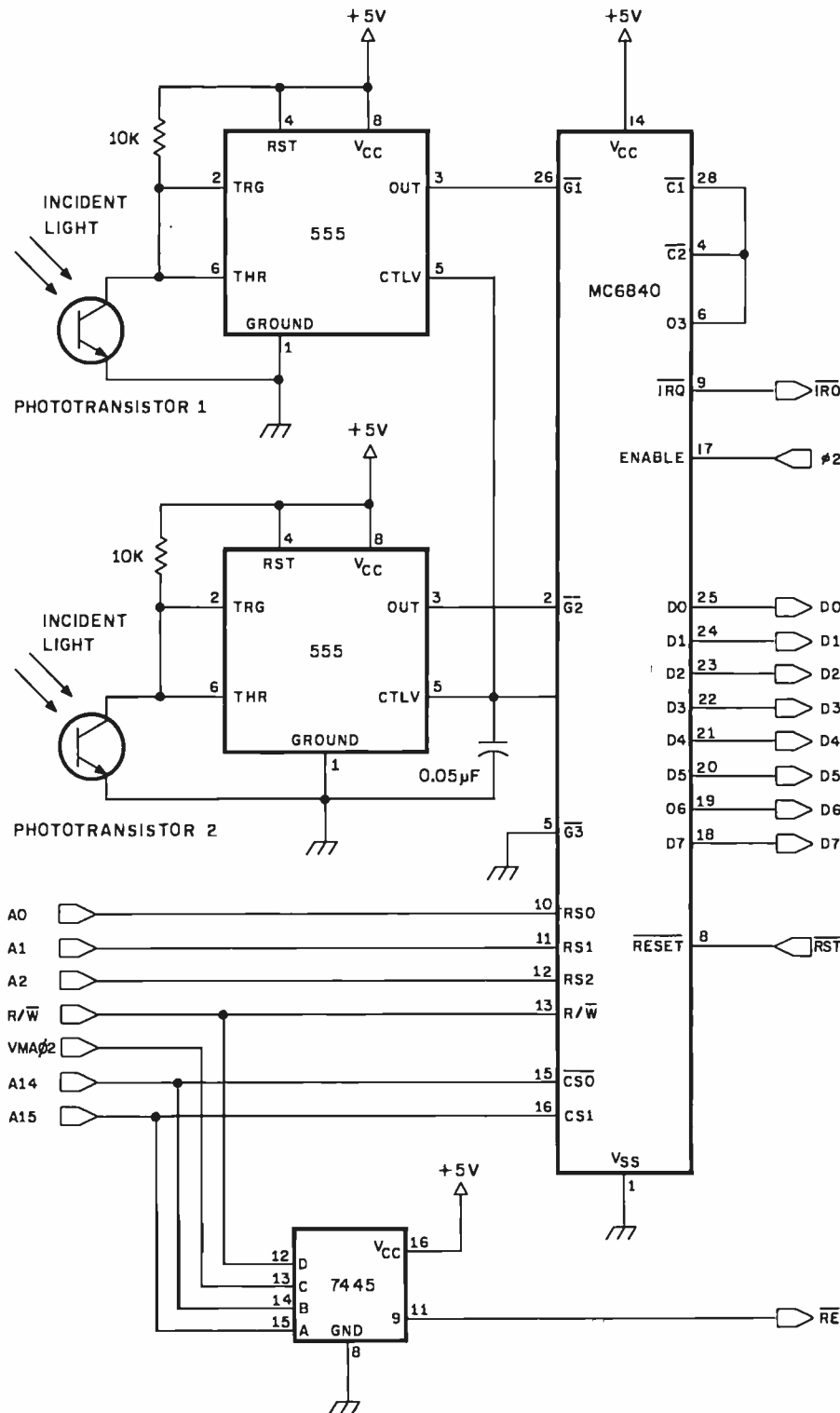
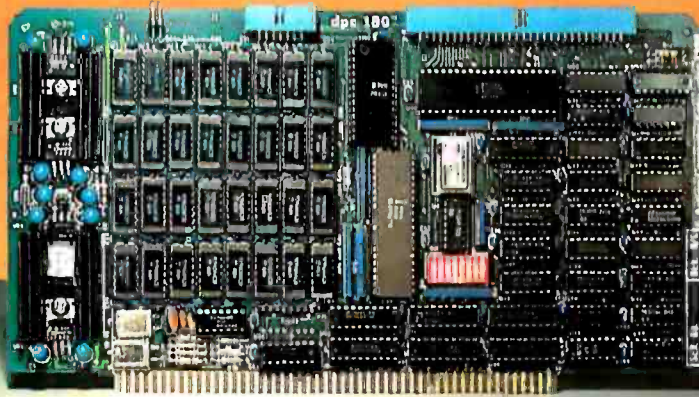
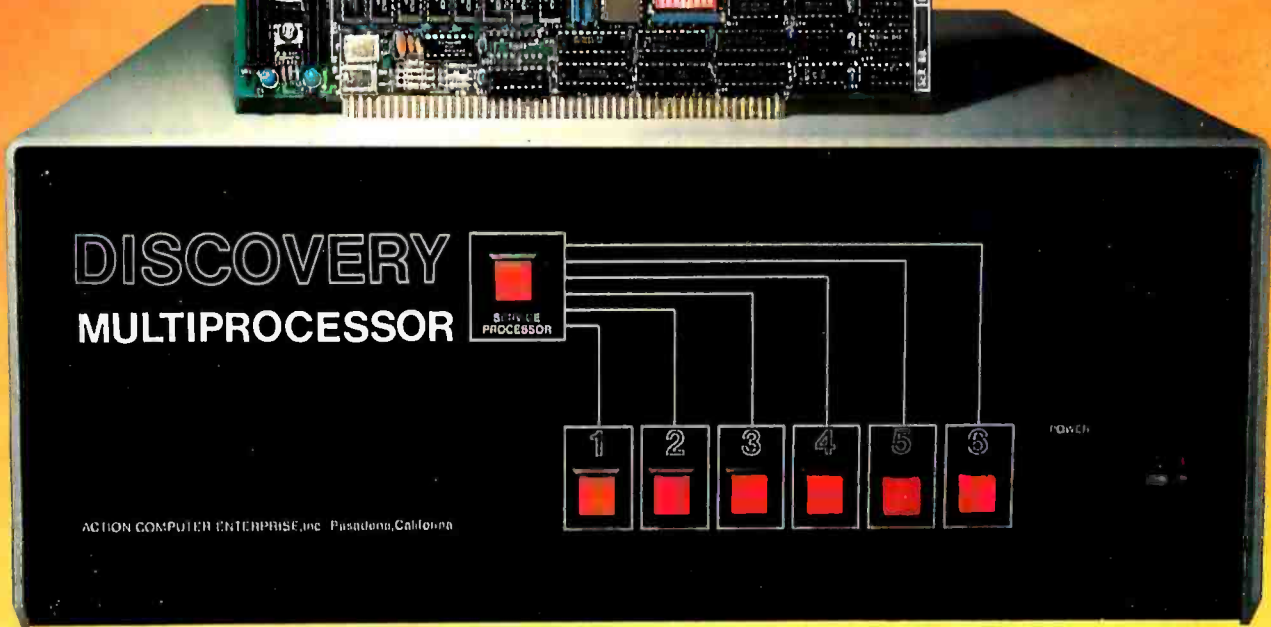

Figure 6: A complete circuit schematic diagram for the two-channel, data-logging, millisecond timer. This is designed to work with the Heath ET-3400 microprocessor trainer.

This
Single
Board...



...is the Heart
of the
Microprocessor
World's
Best Multi-User
System ...



THE DISCOVERY MULTIPROCESSOR

The dedicated power of this complete single board computer is provided to each user, making the DISCOVERY MULTIPROCESSOR unique among multi-user systems. With the power and expandability of distributed processing • With the economy of shared peripherals • With the flexibility of shared and public files • And all of this with full CP/M* and S-100 compatibility.

Multiprocessing Software Multiprocessing Hardware

Our Distributed Processing Operating System, **dpc/os**®, resides in the Service Processor, establishing a CP/M environment for each user and managing access to the shared system resources. Multiuser facilities are provided for print spooling, for interprocessor communication and for private, public and shared-update files. Several processors can be employed concurrently by a single user via the enhanced batch submit facilities. And with **DISCOVERY** all CP/M compatible programs will execute without modification, thus protecting your software investment.

The ACE 64K Distributed Processing Single Board Computer, the **dpc-180**™ gives the **DISCOVERY MULTIPROCESSOR** its own unique architecture. One DPC is dedicated to each user providing exclusive use of the onboard Z-80, 64K ram and serial I/O. Access to the shared resources is provided by an expanded DPC used as a Service Processor. Additional users can be added at any time by simply inserting additional DPC's, into the standard S-100 bus — up to a total of sixteen user processors in a single chassis!

*CP/M is a registered TM of Digital Research, Inc.

DISCOVERY has been proven in installations throughout the World. If you need the Power of Multiprocessing... it's time you discovered us!

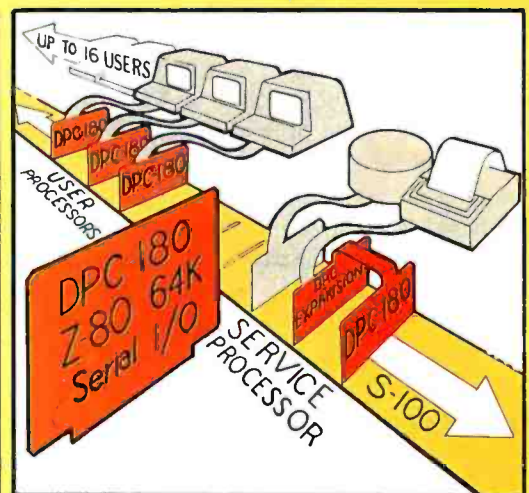

The ACE **DISCOVERY MULTIPROCESSOR** dedicates a complete 64K Z-80 Distributed Processing single board Computer, the **dpc-180**™ to each user. An expanded DPC coordinates all of the system activities.

Multiuser mainframes with 192K ram start at under \$6000. The 64K **dpc-180**™ is priced at \$1395. Immediate delivery. A complete line of standard peripherals including a 26M byte hard disk subsystem can be supplied on request. Dealer and OEM inquiries are invited.

Action Computer Enterprise, Inc.
The Multiprocessing Company

55 West Del Mar Boulevard, Pasadena, California 91105 USA • Cable ACEPAS Pasadena • (213) 793-2440

Microcomputers in Education: A Concept-Oriented Approach

George Wolfe, James Madison University
Harrisonburg VA 22807

In the wake of new technologies, there generally comes an abundance of dreams and possibilities. Inherent in these possibilities is the seed of some new transformation of great or modest proportion. Such a transformation first occurs externally, manifesting itself in the conveniences or specialized abilities the new technology offers. But soon it touches us subjectively and we find ourselves perceiving reality differently. We construct new paradigms to help us understand our changed relationship with the world, and structure new vocabularies of experience.

Familiar examples of such technologies surround us—the electric light bulb, radio and television, satellite communication, medical technology, and nuclear energy. Each of these has altered our way of life to such an extent that any citizen of our culture from a century ago could not have entertained the world view we, by nature, have today. But, the technology that possesses the greatest potential to transform society and human life is just now entering the home: the microcomputer. Unlike some previous technological advances, the computer is not merely a specialized device fulfilling a specialized function. The convenience it provides is less tangible than bringing light into the home or Broadway entertainment into the living room. The computer's role and potential are much more abstract and profound. The new promise it offers is that of AI (artificial intelligence), which we not

only create, but also, via the computer, communicate and interact with.

One of the most constructive fields to apply AI (to capitalize on its capacity to transform) is education. Various applications of microcomputers are already in the classroom and their effect has been found to be highly reinforcing to the learning process. These applications can be placed into the following categories:

- cataloging and processing of information
- learning to program a computer
- using the computer as an instructional tool; ie: CAI (computer-aided instruction)

The first two categories are self-explanatory and may even be somewhat familiar. There is no doubt that the computer can greatly increase the efficiency of a system through data processing, and that skill in computer programming is a growing necessity in our society. The third category may be somewhat less known, but clearly it is growing in use. It involves using computer programs designed to supplement students' assignments in the classroom. Such programs are usually in the form of drills, information exercises, or educational games. They often provide students with a moderate degree of interaction with the computer.

CAI has been defined in various ways and various opinions have been expressed as to its effectiveness. Certainly the value and success of CAI lies in the creative design of the programs and the appropriate setting for their use. Unfortunately, many teachers seem to view CAI as merely an automated drill instructor. Indeed, there is some value in having the computer play this role—it can hold pupils' attention and effectively reinforce their learning. Also, students learn to operate a computer long before any formal programming skill is acquired. But there is one application of CAI which as yet is relatively

About the Author

George Wolfe is a music graduate of Indiana University and has been teaching at James Madison University for the past three years. He is a member of the Association for Integrative Studies and has been privately researching integrative education and the role of the microcomputer in the classroom. Mr Wolfe has also been developing integrative arts related television programs on a grant from the School of Fine Arts and Communications at James Madison University.

SUPERBRAIN® & COMPUSTAR™ USERS' GROUP



JOIN SUPER★STAR INTERNATIONAL FOR THE REGULAR YEARLY MEMBERSHIP FEE AND RECEIVE A FREE DISKETTE WITH THE FOLLOWING PROGRAMS:

- ★ "RECOVER", It allows you to recover an erased program.
- ★ "AUTO LOAD", it enables you to load and run a program automatically.
- ★ "RETURN", it gets you back into a crashed program from CP/M.
- ★ the game "OTHELLO".

Since our first ad in March 1981, we have been contacted from as far away as South America, Europe, Australia, and Indonesia. Super★Star International is becoming a world-wide family whose members will enjoy the benefits of a wide range of hardware and software developments.

Our full color, monthly magazine will print a free program in every issue—programs like an appointment calendar and personal finance record keeping. You'll also find technical information, tips for beginners, special business uses, equipment reviews, and the Intertec Story—the people, ideas, and machines behind your computer.

WE GIVE YOU VALUE! Purchase just one commercial program and you will save more than the price of our membership fee. Rent a car or stay in a hotel offered in our discount program and save even more, not to mention insurance discounts, a market place for your personal software, and a shoulder to lean on if something isn't working quite right.

Super★Star International—with savings, service, and efficiency—we're here to win your heart.

WE NOW OFFER A WIDE RANGE OF PRODUCTS

A few may still be under development at the date of this issue.

SOFTWARE

- ★ DIAGNOSTICS—for the CPU, Memory, Disk Drives and more
- ★ WORD PROCESSING—WordStar®, MailMerge®, WordMaster®, Magic Wand®
- ★ LANGUAGES—COBOL, FORTRAN, Pascal, FORTH, BASCOM Compiler®
- ★ UTILITIES—Assemblers, Disassemblers, Monitor
- ★ GAMES—Chess, Adventure, Star Trek, Analiza®, and more
- ★ BUSINESS—Real Estate Acquisition Package; Systems Plus®, Peachtree®, and other Accounting Packages; Plus the most powerful, easy to use business package, which automatically updates all information at the point of entry; SuperSort®, DataStar®, dBASE II®, FMS-80®

HARDWARE

- ★ S-100 Adaptor
- ★ External Controls
- ★ Add-on Disk Storage

ENHANCEMENTS

- ★ Upgrades for ALL SuperBrains
- ★ SuperDOS (Fantastic!)
- ★ Add-on character sets including graphics
- ★ MTT Upgrade for the Intertube

SUPER★STAR™

INTERNATIONAL CORPORATION

3722 Chestnut Place, Denver, Colorado 80216 ★ (303) 623-7973

Dealers are invited to contact us concerning a special dealer program.



Charge membership by phone

® REGISTERED TRADEMARKS OF INTERTEC DATA SYSTEMS • REGISTERED TRADEMARKS OF DIGITAL RESEARCH • REGISTERED TRADEMARKS OF MICROPRO INTERNATIONAL • REGISTERED TRADEMARKS OF SMALL BUSINESS APPLICATIONS • REGISTERED TRADEMARKS OF MICROSOFT
® REGISTERED TRADEMARKS OF SUPERSTAR • REGISTERED TRADEMARKS OF SYSTEMS PLUS • REGISTERED TRADEMARKS OF PEACHTREE SOFTWARE • REGISTERED TRADEMARKS OF ANIMATED INC

Yearly membership fee is \$50.00 U.S., \$58 Canada, \$74 Europe & So. America, \$81 Australia, Mid East & Asia.

Your fee may be tax deductible.

Send checks with your name and address, made out to: Super★Star International (U.S. Currency)

I would like to join Super★Star International. Enclosed in my check for \$ _____

Name _____ Company _____

Address _____ Phone _____

City/State/Zip _____

Computer Model _____ Version _____

Circle 347 on Inquiry card.

REQUEST™

U.S.A. BEATS I.B.M. TO MARKET WITH TRUE RELATIONAL DATA BASE!

On Feb. 1, 1981, I.B.M. announced a relational data base for 370/3033 users... U.S.A. introduced REQUEST™ 3 months earlier for the APPLE & PET!

DATA BASES ARE A DIME A DOZEN!

Flip through any computer magazine and one company after another will promise you that their product is the ultimate in data base programs.

WE DON'T TAKE THEIR WORD FOR IT!

A recent ad for data base management even provided it's own comparison checklist to prove that their data base surpassed all other data bases on the market today.

"COMPARE...DON'T TAKE OUR WORD FOR IT," THEY SAID.

WE DID
COMPARE

21

UNTIL TODAY THERE WERE MORE THAN ~~26~~ DATA BASE MANAGERS FOR THE APPLE II.
NOW THERE'S ONLY ONE!

REQUEST



THE APPLE DATA BASE MANAGER YOU'VE BEEN WAITING FOR!

If you want an easy-to-use, flexible, and versatile data base manager, you have a choice of one: DB MASTER from Stoneware Microcomputer Products - soon to become the standard by which all others will be judged.

But don't just take our word for it. Compare the many advanced features of DB MASTER with the data base manager you're now using. Or for that matter, compare it with any data base manager on the market. No one will even come close.

FEATURES	DB MASTER		REPORT GENERATOR:	
	REQUEST	DBMS		
FILING SYSTEM:			Send reports to screen or printer	YES <u>Yes</u>
Maximum search time to find any record by its primary key	UNDER 3 SECS	<u>under 1 sec.</u>	Sort on up to 6 fields at a time	YES <u>Yes(16)</u>
True ISAM file system with multi-field primary keys	YES	<u>Yes</u>	Column subtotals and totals	YES <u>Yes</u>
Multiple secondary keys for rapid access (5-7 seconds) to records by any field	YES	<u>Yes (approx 1 sec)</u>	Subtotal and page breaks	YES <u>Yes</u>
Primary & Secondary keys maintained automatically—no need to rebuild keys after adding records	YES	<u>Yes 4064</u>	Up to 24 computed fields per report	YES <u>Yes(99)</u>
Maximum record size (bytes)	1020	<u>999</u>	Up to 9 lines of column titles	YES <u>Yes(16)</u>
Maximum number of fields/record	100	<u>999</u>	Up to 9 lines for each record	YES <u>Yes(16)</u>
Handles files with more than one diskette of data	YES	<u>Yes</u>	Maximum number of fields per report	100 <u>999</u>
Custom disk operating system (DOS) for faster data retrieval and program chaining	YES	<u>No</u>	Code fields - store short codes, print long descriptions	YES <u>Yes</u>
User-designed screen formats	YES	<u>No</u>	Comment lines and footnotes	YES <u>Yes</u>
Up to 9 screen "pages" per record	YES	<u>Yes(16)</u>	Comment fields for printing labels or headers within each record	YES <u>Yes</u>
Ten field types, including dollar/cents, phone & social security number, date, etc.	YES	<u>Yes(15)</u>	Summary only reports	YES <u>Yes</u>
Automatic data compaction for increased disk storage capacity	YES	<u>Yes</u>		
Wild card, partial string, range and Boolean search capabilities	YES	<u>Yes</u>		
Dynamic prompting (fm) - lists all available functions on screen—no need for quick reference card.	YES	<u>Yes</u>		
Password file protection	YES	<u>Yes</u>		
Four function calculator mode	YES	<u>Yes</u>		
Daily update lists for printout of all records added/edited on any day or range of dates	YES	<u>Yes</u>		

While a custom DOS is nice for speed, it does place the user in a bind, since it makes the data incompatible with APPLE'S DOS & other software. REQUEST™ is fully compatible!

REQUEST™ utilizes a sophisticated screen generation algorithm to produce screens pleasing to the eye and easy to use, AUTOMATICALLY.

REQUEST'S™ additional search functions include:

- context search
- arithmetic expression evaluation search
- multi-field relational search

AND REQUEST™ GIVES YOU ALL THESE EXTRAS

- Multiple formats for mailing labels
- REQUEST™ can be used with a modem
- On the APPLE™ REQUEST™ is compatible with 80 column boards
- High level query language or screens used to form query
- Query library stores executive queries for Run-On-Demand
- REQUEST™ will interface with Source™, VisiCalc™, and word processing packages
- Disks are readable and copyable by normal DOS

**ONLY
\$225**

**DEALER
INQUIRIES
INVITED**



THINKER™

THE INTELLIGENT ACCOUNTING SYSTEM

THINKER™ & REQUEST™ CAN BE USED
SEPARATELY OR TOGETHER AND
DATA MAY BE INTERCHANGED.

THINKER'S™ ADDITIONAL FEATURES INCLUDE —

- Compatible with REQUEST™
- Customized access to THINKER™ data via REQUEST™
- Relational analysis of THINKER™ data via REQUEST™
- Utilizes a 9 digit ZIP Code compatible with Canada & Europe
- Password protection for system security
- Daily audit trails for system integrity
- Dynamic system configurator will expand data to additional drives when needed, AUTOMATICALLY!
- Employs industrial psychological approach to achieve superior human engineering.

Introductory Price

\$495

SUPER KRAM IS REQUIRED FOR EITHER
REQUEST OR THINKER AND IS
AVAILABLE FOR \$175

Look for the RED-WHITE-BLUE
United Software Display at your local
computer dealer, or send check or
moneyorder, plus \$3.00 shipping to:

USA UNITED
SOFTWARE
OF
AMERICA

750 THIRD AVE.
NEW YORK NY 10017

(212) 682-0347

Telex 640055

SOFTWARE THAT THINKS FOR ITSELF

Before The **THINKER™**, microcomputer business systems have fallen short in two distinct areas: *FLEXIBILITY* and *INTEGRATION*. Every business is different and requires software to be pre-set to fit its own particular needs. A nip here, a tuck there, and files are extended to where the business was expected to be. . . But, a single file too short can cause the system to fail, or a single file too long wastes costly disk space. The **THINKER™** takes the guess work out of your business data processing by thinking for you.

EASY TO USE—FULLY INTEGRATED ACCOUNTING SYSTEM

The **THINKER™** consists of 6 comprehensive *interactive* modules, with all transactions applied immediately and the results are instantaneously accessible. They are;

- ACCOUNTS RECEIVABLE • ACCOUNTS PAYABLE
 - SALES ORDER ENTRY • PURCHASE ORDER ENTRY
 - INVENTORY CONTROL • MAILING LIST
- (General Ledger available in June)

FLEXIBILITY— SOFTWARE THAT GROWS WITH YOUR BUSINESS

The **THINKER™** utilizes the **DYNAFILE™** *Keyed File Allocation Scheme* which dynamically manages file length and records to meet the businessman's needs and will automatically extend itself to work on hard disks without any program modification. No disk space is wasted because the system automatically recaptures space when records are deleted. **DYNAFILE™** utilizes a sophisticated indexing scheme, allowing direct access to any record. Machine language programming insures **DYNAFILE™** speed, reliability, and integrity.

The **THINKER™** is currently available for 6502 based microcomputers. 80 column PET/CBM Computers
80 column Apple Computers

SPACE RAIDERS

A COMPUTER ADVENTURE

★
INCREDIBLE
HI-RESOLUTION
DETAIL

★
PLAYS
FROM
KEYBOARD
OR JOYSTICK!

★
SUPER FAST ACTION &
EXCITING SOUND EFFECTS

★
4 LEVELS OF PLAY- EACH
BECOMING PROGRESSIVELY
MORE CHALLENGING

BY
PAUL LUTUS
FOR
48K
APPLE
PLUS OR
STANDARD

IT'S HERE

NOW FOR APPLE II COMPUTERS

Only \$29.95

Another great
product from

USA UNITED
SOFTWARE
OF

750 THIRD AVE. AMERICA
NEW YORK NY 10017

(212) 682-0347

Telex 640055

See it at your
local computer
store

DEALER INQUIRIES INVITED

SPACE RAIDERS

Education Forum

unexplored. This is the use of the microcomputer to aid students in developing the ability to conceptualize. It is my belief that the transforming value of the microcomputer will be most fully realized through a concept-oriented approach to computer-aided instruction. The purpose of this article is to awaken educators to the solutions concept-oriented computer instruction offers our educational system.

Artificial Intelligence and Specialization

Inherent in the growth of technology is the need for specialization. New information and research, vocational training, and industrial development must accompany advancing technologies. Along with these also comes the expertise necessary to maintain that growth. With the surge of technological and industrial growth in the twentieth century modern education has shifted away from the liberal arts toward pragmatism and specialization. As this trend has increased the classical ideal of a liberal arts education has fallen by the wayside. (See reference 2, page 407.)

While certainly necessary in a technological society, there is a danger which emerges if specialization is carried too far. This danger is dependence and the loss of comprehensive viewpoints. We have seen how a technological society can become dangerously dependent on foreign energy sources needed to drive that society and maintain its standard of living. We have also witnessed how the interaction among nations, motivated by their own individual interests, demands a perspective in world leaders that must be holistic if a stable peace is going to be achieved and sustained. Thus, the many specialized technologies that have brought nations closer together and made them dependent on one another have ironically recreated the need for the Integrated Person; someone who is able to recognize and effectively apply fundamental concepts to numerous, rapidly changing, and adaptively taxing circumstances. Such an individual must necessarily possess a more comprehensive understanding of the various academic disciplines, so that he or she can make decisions that are universally beneficial.

The common belief among educators today is that this *ideal* is impossible to achieve. It certainly appears that way when we examine the flood of information present within every discipline. Education, in keeping pace with technology, has become so oriented toward information gathering and retention that the conceptual links among

Education Forum is an occasional feature in **BYTE** intended to foster debate about the uses of personal computers in the schools and colleges. We encourage reader participation. Contributors should supply their full names and addresses for publication, along with their telephone numbers, which will not be published.

Say Ahh...

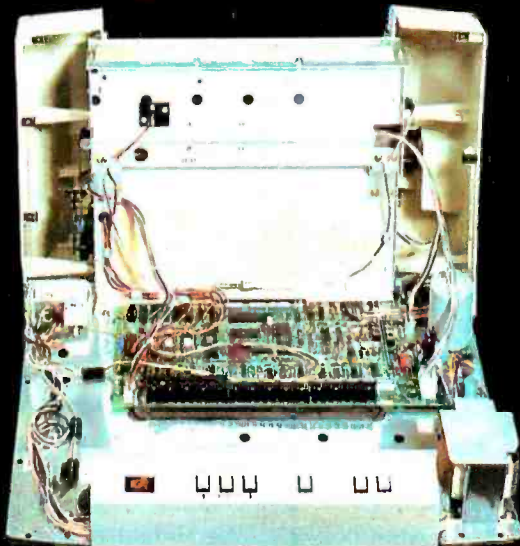

Our New grafixPLUS™ 80-column printer opens wide for easy servicing.

Introducing the newest members of our grafixPLUS™ family—the DP-9000 Series 80/132 column printers—built on the same tradition of quality printout, solid design and low cost of ownership established by our 132/220 column DP-9500 Series.

A Case for Serviceability

Not that it comes up often, but want to get inside? Simple. Just remove a few screws and the clam-shell case swings open exposing all major components. This easy access plus built-in self-test and minimum component count yields an MTTR of one-half hour. The 9-wire print head replacement's even simpler... two screws and it's out. Without opening the case. And without a service call.

Performance Plus

The DP-9000 Series prints the full ASCII 96 character set, including descenders and underlining, bi-directionally, at up to 200 CPS. Number of columns can go up to 80 or 132, depending on character density—switch or data source selectable from 10 to 16,7 characters per inch. And all characters can be printed double width. The print head produces razor-sharp characters and high-density graphics with dot resolutions of 72X75 dots/inch under direct data source control.

Interface Flexibility

The three ASCII compatible interfaces (parallel, RS-232-C and current loop) are standard, so connecting your computer is usually a matter of plug-

it-in and print. Also standard are: a sophisticated communications interface for printer control and full point-to-point communications, DEC PROTOCOL, and a 700 character FIFO buffer. An additional 2K buffer is optional.

When you're ready for a printer (or several thousand), look into the grafixPLUS DP-9000 Series from Anadex—you'll find an open and shut case for quality. Contact us today for details, discounts and demonstrations.

 **Anadex**
...the plus in printers



...close please.

SALES OFFICES: San Jose, CA (408) 247-3933

Fullerton, CA (714) 871-0501 • Wakefield, MA (617) 245-9160 • Austin, TX (512) 327-5250

ANADEX, INC. • 9825 DeSoto Avenue • Chatsworth, California 91311, U.S.A. • Telephone: (213) 998-8010 • TWX 910-494-2761

ANADEX, LTD. • Dorna House, Guildford Road • West End, Woking, Surrey GU24 9PW, England • Tel: Chobham (09905) 6333 • Telex: 858762 ANADEX G

LISP

for TRS-80 Models I & III

SuperSoft LISP allows the TRS-80 to become a complete Artificial Intelligence laboratory! It is the tool that takes you to the frontier of Computer Science.

The SuperSoft LISP is a *complete and full* implementation. (It is NOT a subset!) It contains an efficient garbage collector which optimizes the usage of user RAM, and supports the TRS-80 graphics. Below are some features:

- Runs in 16k level II (with only 6K overhead)
- Fully implements atom property list structure.
- PROG is supported.
- FUNARG device is implemented.
- Efficient garbage collection.
- Complete with LISP editor and trace.
- Allows complete range of single precision numeric data.
- Works with old as well as new ROMs.
- Contains 97 functions.
- Sample Programs.

The LISP package is supplied on tape or discette and with a complete user manual.

cassette version: \$75.00
(requires 16K level II)

Disk version: \$100.00
(requires 16K disk)

(manual only: \$15.00)

All Orders and General Information:
SUPERSOFT ASSOCIATES
P.O. BOX 1628
CHAMPAIGN, IL 61820
(217) 359-2112
Technical Hot Line: (217) 359-2691
(answered only when technician is available)



SuperSoft

First in Software Technology

TRS-80 TRADEMARK TANDY CORP

Education Forum

the academic disciplines have been all but lost. The advent of artificial intelligence has the potential to change this, because computer technology provides a means through which information within all disciplines can be effectively handled, processed, and made available. It turns out that mechanical brains manage information better than human brains (ie: a computer's memory and processing capabilities are in many ways superior in efficiency and organization to our own). Thus, the availability of information can be increased in quantity and reliability with microcomputers in the learning environment. The preoccupation of education with information can now be relieved somewhat. Rather than gearing students primarily for absorbing and retaining data, their attention can be directed toward the abilities to conceptualize, abstract, and apply available information creatively. These higher abilities remain uniquely human. We should no longer neglect their formal development for the sake of having students retain enormous amounts of information.

A movement in American education dedicated to promoting a concept-oriented approach to teaching began several decades ago with a small circle of scientists, most of whom had been strongly influenced by general systems theory. Among this group's members were Henry Margenau of Yale University and author-scientist Ervin Laszlo. Their efforts enjoyed a brief period of international recognition during the 1950s and 1960s under the auspices of the Center for Integrative Education. (See reference 1, pages v thru vii.) Their ideas have never been fully realized in the American classroom, but the microcomputer now makes the fulfillment of their approach a definite possibility. The computer is certainly the catalyst through which the integration of knowledge can be achieved in modern education and the direction of teaching changed to include principles and fundamental concepts, as well as specialized information.

Fundamentals of an Integrative Approach

The first and foremost demand of concept-oriented education is the development of thinking skills. Today, we devote much time to cultivating reading and mathematical skills, artistic abilities, and other talents in our students. But we tend to ignore the abilities to think rationally, evaluate circumstances and information accurately, and integrate two or more disciplinary perspectives. As a result, high school and college students often lack the intellectual faculties needed to grasp issues in a sharp and accurate focus.

As with other abilities, developing thinking skills takes practice, something teachers do not always have the time and understanding to offer. Properly structured and applied computer programs, however, can provide the time and mental exercise needed to sharpen students' reasoning faculties.

BMC's best seller newly available with superb functional versatility

VIDEO DISPLAY

12 inch
80 ch x 25 line
80 ch x 20 line Selectable by Programming
40 ch x 25 line
40 ch x 20 line
Color (8 colors)/Green
Smooth Scrolling

• FUNCTION KEY

Programmable
10 Keys

• FLOPPY DISC

5 Inch x 2 deck, 280 KB/deck
Dual sided — Double density

• SUPER FUNCTION KEY

Programmable
10 Keys

• PRINTER

Dot Impact
80 ch/sec.
80 ch/line, 40 ch/line
Graphic Mode
Alphabets (capital/small), Numerics,
Katakana
Various Symbols, Hiragana, Kanji
Roll Paper/Sprocket Paper
3 Copies

Dimensions: 510W x 683D x 505H mm (Color)
510W x 608D x 505H mm (Green)

Input Voltage: AC 117V/220V ±10% 50/60Hz

Option: Light pen Rom Cartridge



BMC USA INC.

Suite 600, Union Bank Bldg.

11222 La Cienega Blvd., Inglewood CA 90304 USA

Tel: 213-641-4588, Telex: 182379 bmcng

FREE COMPUTER FORMS KIT

with continuous business forms
for small computer systems

Each kit contains samples, programming guides, flyers, prices and order forms for checks, invoices, statements, envelopes, stock paper and labels to fit almost every computer system.

- Available in quantities of 500, 1,000, 2,000, 4,000, 6,000
- Low Prices (500 checks only \$32.50)

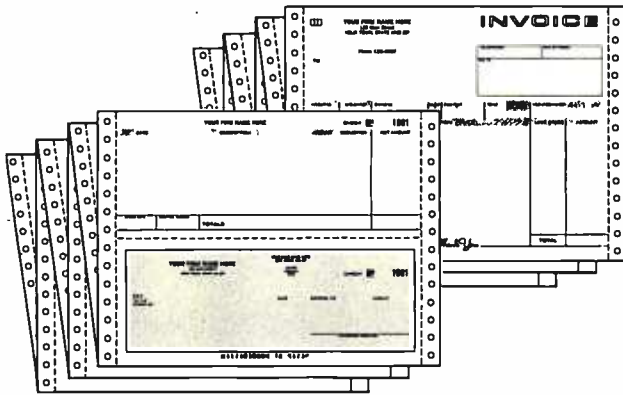

- **FAST SERVICE** — It is our policy to ship within 6 working days following our receipt of your order.
- **MONEY BACK GUARANTEE** — If for any reason you are not completely satisfied, your money will be promptly refunded.

Fast Service by mail or . . .PHONE TOLL FREE

1 + 800-225-9550

Mass. residents 1 + 800-922-8560

8:30 a.m. to 5:00 p.m. Eastern Time Monday — Friday

Please Ship FREE Kit To:	CODE 460
Name _____	
Company _____	
Street _____	
City, State and Zip _____	
Phone _____	
Computer make & model _____	

**Neb's
Computer Forms**
78 Hollis Street, Groton, Mass. 01450
A Division of New England Business Service, Inc.

Education Forum

It is possible, for example, to develop a series of logic programs ranging in difficulty from simple reasoning using concrete ideas, to complex reasoning employing abstract ideas. The relationship between logical and mathematical proof can also be incorporated into such programs. The format could be a kind of logical dialogue between student and computer. For example,

Computer: What do you say to us having a philosophical discussion? I'll start by making a simple statement, and you tell me if you think it is true or false.

"Seeing is believing."

Student: True.

Computer: I take it then, that if you see something, you believe it to be really happening or really there. Is this correct?

Student: Yes.

Computer: OK. So far you are thinking very logically. But now, let me ask you another question.

"Have you ever seen the sun rising in the morning sky?"

Student: Yes.

Computer: Do you know that the sun is not actually rising in the sky? What is actually happening is that the Earth is revolving on its axis, and in doing so, creates the illusion that the sun is moving upward. Now that I have pointed this out, do you still believe the sun is really rising in the sky?

Student: No.

Computer: But do you still see the sun rising in the morning sky?

Student: Yes.

Computer: Well then, you have to reconsider my original statement which was "seeing is believing." You said that this was a true statement, yet you just admitted that even though you have seen the sun rise in the morning sky, it is not really rising. Do you still think that in all cases "seeing is believing."

Student: No.

Computer: Very good! We simply have to recognize that illusions do exist and that seeing something does not always mean that what we are seeing is really happening or really there.... Now consider this next statement.

"The sun appears to be rising in the sky." Is this statement true or false?

Student: True.

Computer: Correct. The word "appears" is what makes the statement true because it suggests that the rising sun is indeed an illusion.

ALL THE PROGRAMS YOU'LL EVER NEED. FOR \$600.

Say goodbye to the costs and frustrations associated with writing software: The Last One® will be available very soon.

More comprehensive and advanced than anything else in existence, The Last One® is a computer program that writes computer programs. Programs that work first time, every time.

By asking you questions in *genuinely* plain English about what you want your program to do, The Last One® uses those answers to generate a totally bug-free program in BASIC, ready to put to immediate use.

What's more, with The Last One®, you can change or modify your programs as often as you wish. Without effort, fuss or any additional cost. So as your requirements change, your programs can too.

In fact, it's the end of programming as you know it.

And if, because of the difficulties and costs of buying, writing and customising software, you've put off purchasing a computer system up to now, you need delay no longer.

The Last One® will be available very soon from better computer outlets. To place your order, take this ad into your local dealer and ask him for further details. Or in case of difficulty, please write to us direct.

THE LAST ONE®

YOU'LL NEVER NEED BUY ANOTHER PROGRAM.
D.J. 'AI' Systems Ltd., Ilminster, Somerset, TA19 9BQ, England
Telephone: 04605-4117. Telex: 46338 ANYTYR G.

We've lowered the

No, the low CompuServe \$5.00 per hour charge hasn't changed, but the world of information we offer is growing steadily.



Of CompuServe's 22 large computer systems, 10 are housed here in our Dublin, Ohio Computer Center.

More Computer Power

The number of CompuServe customers keeps growing — now more than 8,000 strong. The more customers we have, the more computer power and access lines we dedicate to our Information Service. Our 22 mainframe computer systems provide sufficient power and capacity to serve thousands more.

More News

In addition to the Associated Press, we've added more news. Read The New York Times and all the news that's fit to print, including Broadway show and movie reviews, stories from Pulitzer Prize-winning

writers and more. We are continually adding new features to the information service, so check our "What's New" section regularly to see what other information is available.

TRS-80™ Color Computer and Videotex™

The CompuServe Information Service is sold in Radio Shack® Stores and, in addition to all the major brands of computers and terminals, can be used with the new TRS-80 Color Computer and Videotex terminal. Our special software formats the information in easy-to-read pages. Go forward, backward, anywhere in the CompuServe Information Service databases — even directly to a page of information.

Big System Reliability

When we say we're reliable, we mean it. In fact CompuServe computers were up and running for a 99.6 percent reliability factor last year. We've also built in many "invisible" features like data error detection and retransmission — all those technical enhancements which add up to the CompuServe Information Service being ready to use when you're ready to use it.

Radio Shack, TRS-80 and Videotex are trademarks of Tandy Corporation. ATARI is a trademark of ATARI, Inc.

cost of the world.

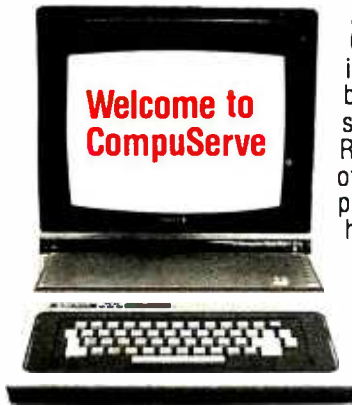

Access to all the CompuServe services, including electronic mail; bulletin board; CB simulation; newsletters from Radio Shack®, Atari®, and others; up to 128K storage free plus all the services listed here are yours. Access time is only 8½ cents per minute between 6 PM and 5 AM weekdays and all day weekends, billed to your charge card. It's a local phone hook-up in more than 260 U.S. cities.

There's an energy management system, home repair tips, discount information, personal health information and more. Better Homes & Gardens provides household information such as recipes, nutritional analyses and meal plans.



All kinds of games (including some for the kids), book and movie reviews, astrology and the latest sporting event news — even point spreads and injury lists. There's the CompuServe line printer art gallery and even a national user opinion poll for instant feedback on current events.

A complete program. The AP financial wire, newspaper financial pages, Raylux Financial Advisory Service, the Commodity News Service and personal financial programs. At a slight additional charge, you can retrieve fundamental financial data on more than 1,700 companies from Value Line, and MicroQuote offers current and historical data and special market reports on more than 40,000 stocks, bonds and options, updated daily.



While the CompuServe Information Service is designed for everyone, MicroNET Personal Computing is for the knowledgeable computer hobbyist or business person. You can buy software and have it downloaded directly to your person computer. Use programming languages such as *APL-SF*, *EXTENDED BASIC*, *MACRO-10*, *SNOBOL*, *EXTENDED FORTRAN* and *PASCAL*, use word processing and text editing programs.



Not 1985, NOW!

See for yourself what a state-of-the-art electronic information service can do. Get a demonstration at a Radio Shack® computer center or store — or write to us for further information.

CompuServe

Information Service Division
5000 Arlington Centre Blvd.
Columbus, Ohio 43220
(614) 457-8600

Circle 66 on inquiry card.

TOLL FREE OUTSIDE CAL. 1(800) 423-5886

Order from
the No 1 Dealer
in the Country!
TOLL FREE

Commodore
Call for latest price on:



CBM 8000
Business computer
CBM 2001
Business computer
CBM 2001
PET
CBM 2022
Printer
CBM 2023
Printer
CBM2040
Dual Drive
Floppy Disk
CBM 8050
Dual Drive
Floppy Disk

1(800) 423-5886

CALL IF YOU
DON'T SEE IT HERE.
SOFTWARE TOO!



Introducing The
NEC Personal Computer
Here is THE computer from NEC
Centronics and RS232 interfaces are
standard. Up to 64 K (RAM) SEND FOR
PRICE AND INFO., OR CALL TOLL FREE!

monitors

9" Black and white Only \$165.
Also available in Sanyo
12" Black and white
15" Black and white.

TRS-80*

All TRS-80 Compatible Hardware
and Software. Call us and tell us what
you need! TRS-80 is a trademark of Tandy Corp.

print wheels and thimbles

Huge selection for Qume, Diablo,
NEC. Plastic or metal.
Call 1(800) 423-5886

apple cards

Hi-Speed Serial Interface Call
Communications Interface Call
Parallel Printer Interface Call
Centronics Printer Interface Call
Hobby/Prototype Call
Integer Basic Firmware Call
Applesoft Firmware Call

NEC



Letter quality high speed printer, bi-
directional, high resolution plot-
ting, graphics.

RO with Tractor Feed \$2865.
KSR with Tractor Feed \$2995.

Paper Tiger (1P440) \$949.
With Graphics
Anadex DP9500 \$1449
DP8000 \$849.

EPSON MX-80
\$645



THE HP-85!
The HP-85 is a powerful
BASIC language computer
complete with keyboard,
CRT display, printer, and
tape drive—all in one com-
pact unit.

CALL FOR
FREE
CATALOG

16K RAM
Set of 6 \$39.95



SEND ALL MAIL ORDERS TO:

MICRO BUSINESS WORLD
18720 Oxnard
Suite 108
Tarzana, CA 91356

Telex: 182852
Answer:
MICKO TZNA

Prices subject to change without notice. Please
allow time for checks to clear. Add 2% for
shipping and handling - \$5.00 minimum. Cal.
residents please add 6% sales tax. Sorry, no COD.

Outside Cal. Call Toll Free 1(800) 423-5886. In Cal. (213) 996-2252.

WHEN IN CALIFORNIA VISIT OUR RETAIL LOCATIONS

(Retail prices may differ)

In Torrance/Lawndale
Computer World
15818 Hawthorne Blvd.
(213) 370-4842

In Woodland Hills
20929 Ventura Blvd.
(213) 704-6895

In Anahelm
521 Chapman
(near corner at Harbor)

Immediate response to your orders

U.S. and International Dealer
inquiries invited.

Education Forum

Another series of programs can be composed to help students learn to discriminate between objectively, rationally, and intuitively derived conclusions. The aim is to develop discernment in the student and provide the time and practice necessary for one to become adept at applying such thinking skills.

Interdisciplinary perspectives can be the theme of still another thinking-model program. Here, the goal is to arrive at the most plausible explanation for something by considering information from various disciplines. For example, students examine explanations based on economic influences, historical factors, or any other perspectives that are appropriate to the subject being considered.

Such a program, in addition to the ones mentioned above, can be designed for educational levels ranging from junior high school through college. (Anyone interested in more information regarding the programs discussed in this article can write the author in care of the Music Department, James Madison University, Harrisonburg VA 22807.)

With thinking skills heightened, we are now ready to pursue the second most important aspect of integrative education, concept development. Concept development often utilizes basic rules and principles, many of which have several exceptions. The idea is for the students to find the exceptions and be able to adapt the principles to suit varying circumstances. To illustrate this, let us compare the steps of an information-oriented approach to a concept-oriented one.

The information-oriented approach is basically an inductive one. That is, we begin by giving out specific facts and data, then we draw conclusions, and finally derive our concepts. (Unfortunately, many teachers today never follow through to the final step of deriving the basic concept!) A concept-oriented approach is deductive rather than inductive. After prerequisite definitions are given, students are taught a generalized concept. From there, students speculate on probable conclusions and hypotheses, then search out the necessary information in an effort to test the conclusions. What the deductive, concept-oriented approach develops is the ability to apply a general concept, and the skills to resourcefully and efficiently locate the information needed to test one's speculative conclusions. To accelerate, simplify, and reinforce this process, the needed information could be made available through a computer retrieval system.

Let us consider how this method can be employed within a discipline through the use of the microcomputer. The following example pertains to basic music theory. The prerequisite information required of the student are knowledge of the definition and labeling of music intervals, the definition of a triad, and how to read treble clef.

Computer: Now I am going to show you how to derive various types of triads by teaching you a simple harmonic concept. This concept is:
"Triads are built with intervals."

CASH FLOW PROBLEMS?



IT'S NICE TO KNOW SOMEONE WHO HAS THE SOLUTION.



MicroAge is your Solution Store . . . that means at MicroAge Computer Stores we have a wide selection of time-saving computerized business systems designed specifically to solve the daily cash flow problems every businessman faces.

MicroAge has computerized business systems that

quickly and affordably allow you to regain control of your critical accounts receivable . . . at last making it possible for you to carry out effective collection procedures on a consistent basis. MicroAge has accounts receivable program packages to automatically display and update account information; prepare trial balance including a balance-due and delinquency aging

report, and take care of dozens of other tasks that eat into your time and profit!

Computerized business systems from the MicroAge Computer Store are available in the \$5,000 to \$15,000 range, to suit the individual budget of your small business or professional practice. MicroAge backs up every system with personalized service, warranty service and repair, installation, systems consulting, even customer training. Visit the MicroAge Computer Store in your area soon with your business problems, and let us help you with the solution.

MicroAge
COMPUTER STORE
"The Solution Store" SM

9530 Viscount
El Paso, Texas
(915) 591-3349

2760-S South Havana
Aurora, Colorado
(303) 696-6950

2675 Mayfair Road
Milwaukee, Wisconsin
(414) 257-1100

1490 W. Spring Valley Rd.
Richardson, Texas
(214) 234-5955

24 W. Camelback
Phoenix, Arizona
(602) 265-0065

611 Rockville Pike
Rockville, Maryland
(301) 762-7585

1707 Monroe Avenue
Rochester, New York
(716) 244-9000

2065 El Camino Real West
Mountain View, California
(415) 964-7063

83 South 10th Street
Minneapolis, Minnesota
(612) 338-1777

2591 Hamilton Rd.
Columbus, Ohio
(614) 868-1550

5742 E. Broadway
Tucson, Arizona
(602) 790-8959

1220 Melbourne Drive
Hurst, Texas
(817) 284-3413

2525 N. Scottsdale Road
Scottsdale, Arizona
(602) 941-8794

4550-50 E. Cactus
Phoenix, Arizona
(602) 996-2910

8615 Allisonville Rd.
Indianapolis, Indiana

Coming soon to:
Salt Lake City, Utah
St. Louis, Missouri
Norwalk, Connecticut
Lincoln, Nebraska
Wichita, Kansas
San Diego, California
Portland, Oregon

FOR FRANCHISE OPPORTUNITY INFORMATION CALL (602) 968-3168

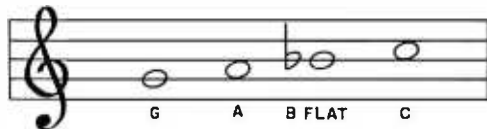

Figure 1: See text for details.

This means that by choosing an interval, and stacking notes on top of one another at the interval you have selected, you can form various types of triads and harmonic textures.

Let us begin by selecting one of the following notes on the treble clef staff shown in figure 1.

Student: A.

Computer: Now choose one of the following intervals:

- second
- third
- fourth
- fifth

Student: Fourth.

Computer: Very good. Now build the triad out of fourths using the note you selected as the

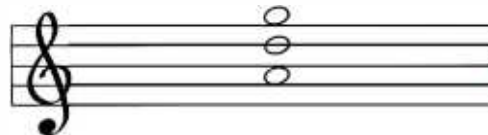

Figure 2: See text for details.

root of the chord. (List the two added notes.)

Student: D and G.

Computer: Correct! (See figure 2.)

Because this triad is built in fourths, it is called a quartal triad. Quartal harmony has been used by many twentieth-century composers. Now check the text file for information on quartal harmony and answer the following questions....

Now choose another interval...(etc)

Computer: This is a basic principle for building triads. Usually, students only learn about tertian harmony (chords built in thirds) in the early years of music theory. But by using this concept, you can jump ahead and learn to write triads which are usually considered advanced...

Turn your Selectric into a word processing system for only \$599

ESCON PRODUCTS, INC.
 12919 Alcosta Boulevard
 San Ramon, CA 94583
 Call Toll Free: 800-227-2148

A third important element of concept-oriented education is the interdisciplinary transfer of knowledge. Here, we are dealing with unifying relationships among disciplines, usually closely related disciplines. In the arts for example, there are certain fundamental aesthetic elements that are common to media. Among these are contrast, intensity, and proportion. The techniques used to employ these elements in an artwork are different for every medium, but the aesthetic purpose served is essentially the same. Microcomputer programs could be developed to teach such interdisciplinary, isomorphic relationships. If used early enough in a child's education, a network of unity could be structured among the disciplines. Then, even when specialization becomes necessary later on, a holistic perspective would always remain with the student. ■

References

1. Margenau, Henry. *Integrative Principles of Modern Thought*. New York: Gordon and Breach, 1972.
2. Meyer, Adolphe E. *An Educational History of the American People*. New York: McGraw-Hill, 1967.

Chief Relief

For years many small business system buyers thought that in order to get "real" performance and enough storage to be a "real" business system they would have to sacrifice the family jewels.

But with the introduction of the Smoke Signal Chieftain series office computers a lot of people's minds have been changed.

Because we designed the highly reliable Chieftain small business system with the most innovative combination of performance and efficiency around.

At your fingertips there are 64,000 characters of random access memory and you can address anywhere from 740,000 characters to 2 million characters with Smoke Signal's new double density controller. For larger concerns, there's a 20M byte hard disk available.

At a time when other small computer manufacturers tell you "you're on your own", Smoke Signal offers an abundance of easy-to-use software programs such as order entry, inventory control,

accounts receivable, invoice entry, payroll, word processing and much, much more. There's BASIC, COBOL and FORTRAN — even a multi-user BOS (Business Operating System) that allows for numerous users simultaneously.

Chieftain systems starting at under \$200.00 per month display performance on par with systems costing twice to three times as much.

So call (213) 889-9340 for your nearest authorized Smoke Signal dealer — he'll be glad to demonstrate the Chieftain's high reliability and ease of operation.



For dealers only, circle 331
All other inquiries, circle 330

SMOKE SIGNAL



BROADCASTING

31336 Via Colinas, Westlake Village, California 91361, (213) 889-9340



We Interrupt This Program...

Gary V Small
Rt 1 Box 126
Scarborough ME 04074

The phrase "we interrupt this program to bring you an important announcement" is as applicable to computers as it is to radio or television. The interrupt system of a computer stops the program being processed to perform a more important task.

What is an interrupt? It is a computer control-signal input that is sampled by the microprocessor during every instruction cycle. If an external device has *asserted* (activated) the interrupt line, the microprocessor will cease processing the normal flow of instructions, put an *interrupt vector* on the address lines, and load the program counter with the address pointed to by the interrupt vector. The microprocessor can then begin execution of the interrupt-handling program found at this address.

Simply stated, an interrupt is a forced, immediate branch to some specified memory address in response to an externally generated control signal. A computer system will generally use additional hardware to implement a number of possible interrupts, each with its own priority and interrupt-handling routine.

Why Interrupt?

At present, few microprocessor-based systems are interrupt driven. Any program requiring I/O (input/output) operations, or timing functions, must employ a timing loop (a sequence of instructions that takes a known interval to execute) until the operation is complete. As an example, writing eighty characters to a teletypewriter at a rate of 110 bits per second would require about eight seconds. The processor uses most of this time to constantly sample the *transmitter ready* status of the interface involved. In eight seconds, an 8080A microprocessor could process about four million instructions. As you can see, sitting in a status-checking loop is not an efficient processing method.

Now suppose that the transmitter-ready signal from the interface is used to assert the interrupt line to the microprocessor. Whenever the interface is ready to accept another character, the processor is forced to branch to the output routine. It sends the next character, then returns to the main program. For the specific example we are using, this fairly simple

procedure results in making four million additional instruction periods available.

Obviously, in many low-level applications, it really doesn't matter how much time is spent in an I/O loop because the user won't be proceeding with the program until the output is complete. However, in many higher-level applications, such as multiprogramming and high-speed instrumentation programs, it becomes imperative that the processor not be tied up. Interrupt-driven software and hardware become essential. Multiuser, multiprogramming systems become feasible only in an interrupt-driven environment.

Any programming that requires timing or periodic functions can also benefit from the use of interrupts in conjunction with a programmable timer. Tasks such as keyboard scanning or display refreshing are very simple to accommodate using an interrupt system. There is very little impact on the main program task by occasional interrupts, and a little software can replace additional hardware.

UCSD p-System* for the INTERTEC SUPERBRAIN™

With UCSD Pascal*, FORTRAN, and BASIC

VERSION IV.0

UCSD p-System includes: operating system, editor, filer, library, Z80 assembler, and documentation.

with Pascal	\$ 600
with FORTRAN	600
with BASIC	500

THE DATALEX COMPANY

1431 Twelfth Avenue, San Francisco, CA 94122
Telephone: (415) 665-4467

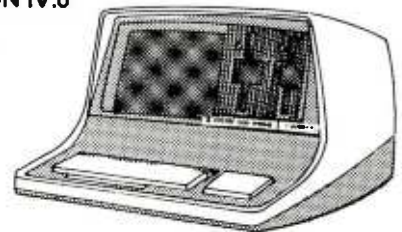

*UCSD p-System and UCSD Pascal are trademarks of the Regents of the University of California
™Trademark of Intertec Data Systems

the SIERRA PACKAGE

**SYSTEM
3000**

**SYSTEM
4000**

**SOFTWARE
SUPPORT**

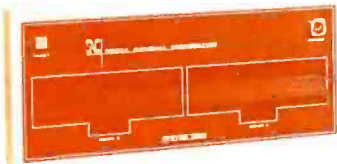

Reliable/low cost single board design w/Z80 CPU.
Supports 1 to 4 single density floppy disks.
External S100 Bus available for extended adaptability (12 slots).
Four serial RS232 ports (parallel option available).
Random Access Memory: 64K RAM standard.
Data Communications: Integrated modem or any RS232 compatible external modem.



Data Storage Power with 0.5 to 96 Megabytes available. The S100 Bus and SMD disk controller access a variety of hard disk systems:

BASF	8, 24, 40 Megabytes (fixed Winchester system)
AMPEX	32, 64, 96 Megabytes (fixed Winchester + removable cartridge)
CDC	32, 64, 96 Megabytes (fixed Winchester + removable cartridge)

Multiprocessing: Multiple computer boards can be mounted within the System 4000 chassis and each can support a separate user station with its own display terminal and printer. The terminal network is controlled by a master CPU and each slave has the computational speed and memory size necessary to execute sophisticated programs without burdening the other user stations.

SIERRA'S
PROFESSIONAL APPLICATION
SOFTWARE
General Ledger
Accounts Receivable w/invoicing
Inventory
Accounts Payable
Payroll

PLUS

Many specific market adaptations:
Wordprocessing
Medical/Dental
Property Management
Insurance
Contractor
Accountants
Manufacturing, etc.

Spanish versions available.

OPERATING SYSTEMS

CP/M
MP/M
CP/NET

LANGUAGES

Fortran
Basic
Cobol
Pascal

ALSO

Sierra provides dealers or end user:

- TIME-SHARING
 - TRAINING
 - SOFTWARE DEVELOPMENT
- as part of our complete customer support service.

Attractive dealer package offered. Please inquire.

 **SIERRA**
**The Versatile
Computer Company**

Sierra National Corporation
5037 Ruffner Street
San Diego, CA 92111
Tel: 714-277-4810
TWX: 910-335-1532

Technical Forum

Multiple programs can also run under an interrupting, time-sharing system. Each program may be assigned a certain percentage of the total processing time. A timed interrupt and executive routine are used to rotate the processor between programs. The executive program, from which the interrupt branches, acts as a "traffic cop" to give each program its fair share of time.

Multilevel Interruption

A computer system generally has

several interrupting devices. To sort out these interrupts a priority scheme is generally used. The priority scheme assigns each device in the system a priority level, according to its importance. This allows the most important I/O devices to be serviced before those of lower priority. Except in the simplest interrupt implementations, a higher-level interrupt is allowed to interrupt the current routine of a lower-priority interrupt. In this way, several interrupt routines could conceivably be nested in a busy system.

Most microprocessors have only one general-purpose interrupt input, and external hardware must be used to resolve priorities between the various interrupt lines. The hardware may also provide for additional functions, such as individually selectable interrupt levels and nesting of interrupts. The hardware involved in a very simple interrupt system is shown in figure 1a. In this system, once an interrupt occurs, the interrupt system should remain disabled until completion of the interrupt routine. With this very simple implementation a high-level interrupt may not interrupt a lower-level routine once it is in progress.

For an interrupt to be recognized by the microprocessor an *enable interrupts* instruction must have been previously executed by the program. Additionally, some devices will require that a special interrupt register be set with the proper vectoring data. When an interrupt is recognized, the contents of the program counter will be pushed onto the stack, and the start address of the interrupt routine will replace the old program-counter data.

When an interrupt occurs, the return address is saved on the stack, and the processor branches unconditionally to the interrupt routine. The microprocessor will also disable its internal interrupt system whenever an interrupt occurs. Software must enable interrupts again before other interrupts will be recognized by the device.

An interrupt routine should also do some housekeeping to insure a successful return to the interrupted program. First, the contents of all the registers should be saved so that their contents can be restored prior to resuming the interrupted program. Depending upon your hardware, you may need to output the priority level of the current interrupt for comparison with incoming interrupts.

In the case of serial devices, such as terminals or cassette decks, the microprocessor is usually interfacing with a UART (universal asynchronous receiver-transmitter). These devices have signals indicating "receiver ready" and "transmitter ready" to assert interrupt lines. The signals can be used as independent interrupts (one per device) or can

PERSONAL COMMUNICATIONS



VersaModem™... BIZCOMP's Auto-Dial, Auto-Answer Intelligent Modem for Personal Computers

We started with a new bare-bones design for the Intelligent Modem.™ Then we fine-tuned our manufacturing process to bring you the BIZCOMP Intelligent VersaModem — the most cost-effective auto-dial, auto-answer data comm peripheral available!

It's no secret that the latest microcomputer applications need automatic dialing and automatic answer. The secret is in VERSATILITY and EASE OF USE. Other auto-dialing modems commit you to a particular computer bus. Not so with the VersaModem. It gives you full dialing control using an RS232 interface. One Intelligent Modem serves computers made by Apple, Radio Shack, Commodore, Atari and many others. That's right — RS232 compatibility protects your modem investment. Ease of use is assured with BIZCOMP's unique Code-Multiplexed Design. And the message command set is designed to simplify your applications software.

Before you buy a computer modem, look at BIZCOMP's versatility. Look at BIZCOMP's quality. With BIZCOMP's VersaModem you won't need another modem. If your local computer store doesn't already have a VersaModem on display, ask them when they will!

BIZCOMP Communications...
Why not start with the best?

BIZCOMP

P.O. Box 7498 • Menlo Park, CA 94025 • 415/966-1545

Patent Pending

SYBEX DOES PASCAL...

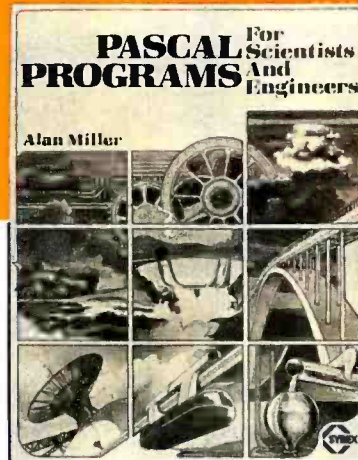
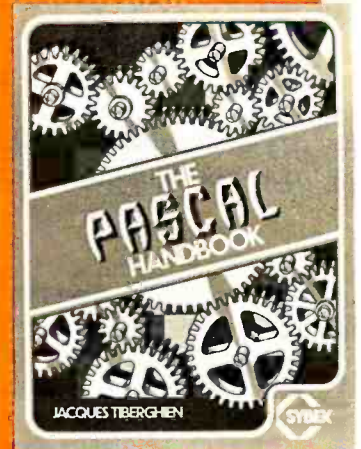
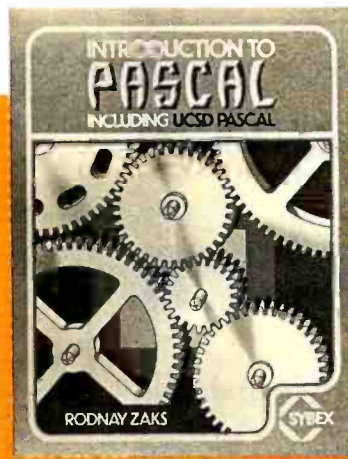

INTRODUCTION TO PASCAL

by Rodnay Zaks is a simple yet comprehensive guide to standard and UCSD Pascals: step-by-step presentation with exercises for beginners, complex concepts and extensive appendices for experienced programmers. An indispensable book for everyone who wants to learn Pascal programming.

320 pp., 100 illustr., Ref. P310, \$14.95

THE PASCAL HANDBOOK

by Jacques Tiberghien is an easy-to-read, easy-to-use dictionary containing all the features for most existing versions of Pascal (Standard, Jensen-Wirth, OMSI, UCSD, HP1000, Pascal/Z). Over 180 entries, arranged alphabetically; each includes definition, description, syntax diagram, details of implementation, variations and examples. The perfect reference tool for any Pascal user.

500 pp., 150 illustr., Ref. P320, \$14.95

PASCAL PROGRAMS FOR SCIENTISTS AND ENGINEERS

by Alan Miller is a comprehensive collection of frequently used algorithms for scientific and technical applications programmed in PASCAL. This time saving book includes programs for curve fitting, approximations, random number generation, integrals, statistical techniques and more.

250 pp., 80 illustr., Ref. P340 \$16.95 paper, \$25.00 cloth



MAIL TO:
SYBEX DEPT. B61
2344 SIXTH STREET
BERKELEY, CA 94710
PHONE ORDERS:
INSIDE CA 415/848-8233
TOLL FREE OUTSIDE CA 800-277-2346

NAME _____ SEND ME YOUR FREE CATALOG
ADDRESS _____
CITY _____ STATE _____ ZIP _____
ADD \$1.50/book UPS or 75¢/book 4th class mail or \$8/book overseas airmail
(CA add tax) Total amt. Enclosed _____ OR CHARGE MY VISA MC AM EX.
CARD NO. _____ EXP. DATE _____
SIGNATURE _____



Spelling Checker for Professionals.

SPELLGUARD eliminates spelling and typographical errors in documents prepared with CP/M¹ or CDOS² word processors.

SPELLGUARD is a unique program that leads the microcomputing industry in its efficiency, ease of use, and reliability.

FAST

- Proofreads 20 pages in under one minute.*

POWERFUL

- 20,000 word dictionary, expandable with single keystroke.
- Properly handles hyphens and apostrophes.
- Allows multiple, technical dictionaries.

RELIABLE

- Over 500 shipped by March 1981.
- 30-day money-back limited warranty.
- Industry leading SoftguardSM feature ensures diskette copy of program is undamaged.

EASY TO USE

- On-line help feature.
- Misspelled words marked in text for easy, in-context correction.
- Examples of all functions in 120 page manual.

COST EFFECTIVE

- SPELLGUARD'S unique speed and accuracy easily recovers the suggested \$295 price.

*Time estimates based on double density 8" diskettes and 4Mhz system.
 Trademarks: ¹Digital Research, ²Cromemco

Contact your local dealer or write ISA for a SPELLGUARD brochure.

The fast, accurate proofreader.

INNOVATIVE SOFTWARE APPLICATIONS
 P.O. Box 2797, Menlo Park, CA 94025
 (415) 326-0805

Technical Forum

be combined into a single interrupt. In the latter case, software can examine the device status to determine the required operation. The act of servicing the UART will clear the condition of the signals.

In dealing with parallel devices such as printers, the usual feedback is in the form of a "busy" signal; inverted, this becomes a "ready" signal that can be used to generate an interrupt. Here again, servicing the device will clear the interrupt signal.

In a good system, the interrupt

hardware will allow interrupt nesting and individual selection of interrupts (see figure 1b). The computer interrupt system is a truly useful and efficient tool for increasing the throughput and general capabilities of a microprocessor-based computer system. With interrupts a whole world of high-level applications, such as multiuser systems, becomes feasible. Once understood, the interrupts system becomes an indispensable programming tool. ■

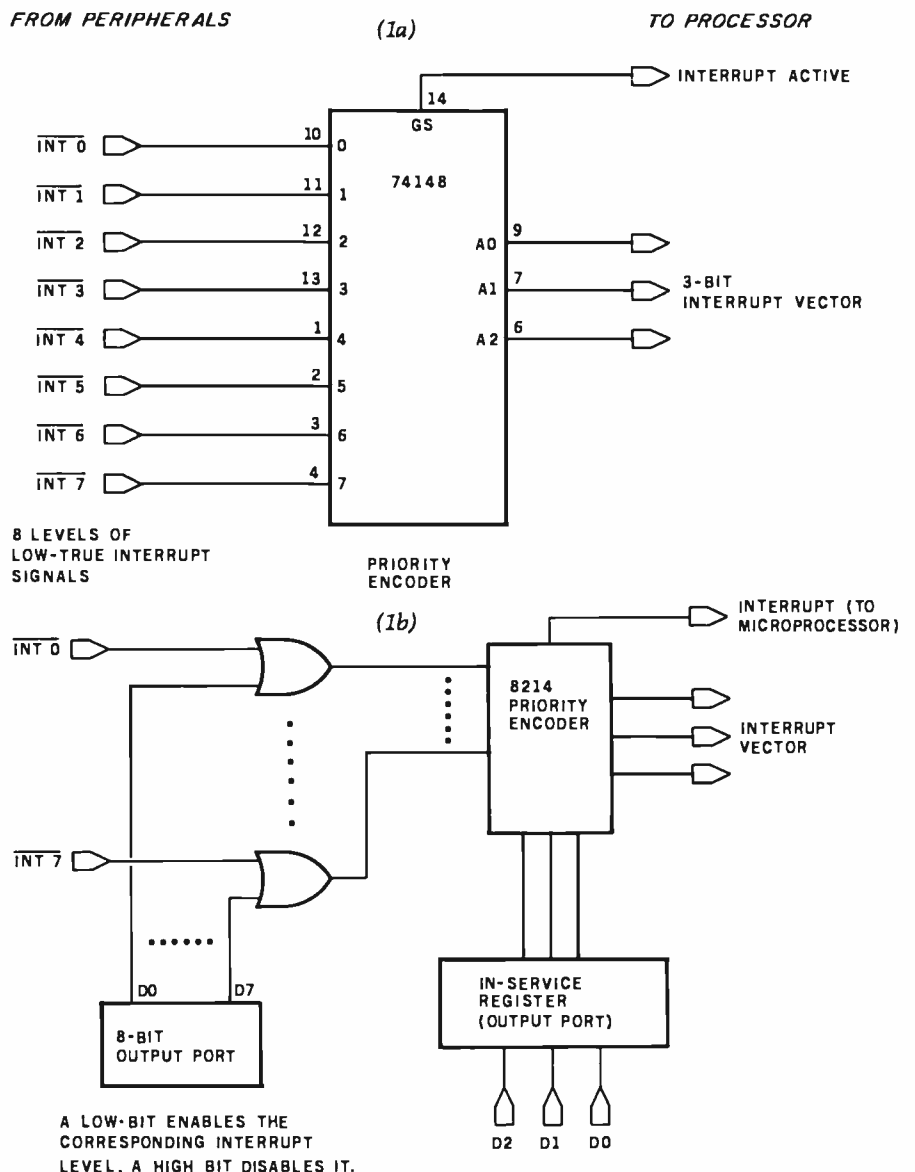

Figure 1: Hardware for handling multiple-level interrupts. This system allows a computer to handle the requests of peripheral devices in order of priority. The arrangement in figure 1a has the capacity to service eight separate priority levels. Each interrupt is completed before others are allowed. A more sophisticated scheme is shown in figure 1b. It has the ability to halt current interrupt service if a higher-level interrupt occurs (when the higher-level interrupt is finished, control is returned to the lower-priority interrupt and its service is completed).

Move Up to Tarbell



The Serious Business Machine

Do you have a small computer system that operates with mini-floppies and has limited storage capacity? Then it's time to move up to the Tarbell Empire Series System. Tarbell starts where small systems leave off, providing storage from 1 to 20 megabytes. This means Tarbell is capable of growing right along with your business. (It also makes sense to start with Tarbell if you're a first-time computer buyer.)

Tarbell is the serious general purpose business machine, backed by years of experience with disk systems. It gives you word processing, inventory control with bill of materials, mailing lists — all in addition to accounting applications: general ledger, payables, receivables, payroll with cost accounting and order entry. Whatever your need may be, Tarbell can provide the working software that gets the job done.

With the Tarbell System you get a Z80 4 Mhz CPU with memory management, timer and full interrupt capability, 2 RS-232 serial ports with handshaking, 64 K bytes of random-access memory, double density floppy disk interface, 2 double density floppy disk drives, cabinet, power supply, and cables.

The software includes: CP/M™ 2.2 disk operating system, Tarbell Disk BASIC, Tarbell Database System, and all manuals and documentation.

Tarbell also offers the MP/M™ Multi-User Operating System and 4 additional RS-232 serial ports.

The Tarbell Empire Series is delivered assembled, tested, and with a FULL six-month warranty on parts and labor.

And when you need even more mass storage, Tarbell also has a hard disk that's system-compatible and provides easy back-up.

If your business is growing or you need more than a few hundred K bytes — it's time to move up to Tarbell. Call your local Tarbell dealer for competitive prices.

Tarbell
Electronics

The One-Stop Shopping Service

950 Dovlen Place, Suite B
Carson, CA 90746
(213) 538-4251

Z80 Table Lookup

Thomas McCloud, 26572 Hickory Ave, Hayward CA 94544

Among the problems familiar to experienced programmers is that of table lookup: given a value (the argument, or *key*), search through a list of values of the same kind to find a matching entry. Then, once a match is found, extract the corresponding entry (the function, or *result*) from a second list, often of a different kind of data. This article discusses a single table-lookup routine (written specifically for a Zilog Z80 microprocessor) that, given an 8-bit value, finds a corresponding 16-bit value. As such, this article is of primary interest only to Z80 programmers. But it shows them how the special instructions peculiar to the Z80 can be used to good effect.

The routine, ZTL, is shown in listing 1. It achieves a great economy of program size, and a good economy of execution time, by using the special Z80 block-search instruction, CPDR (Compare, Decrement and Repeat). The

similar search instruction, CPIR (Compare, Increment and Repeat), may seem more natural to use. But for the routine presented here, CPDR provides more easily used "leftover information" in the BC register pair.

To show how the routine works, consider the following example. A computer-system monitor is being written. The system user types a single character command, and the system responds by performing an indicated action. The commands are:

- I — Initialize system
- D — Display hexadecimal memory dump
- G — Get a file from external media
- X — Execute a program
- E — Enter hexadecimal data into memory
- B — Set a breakpoint

Some of the commands need additional data, such as the address at which a breakpoint is to be set. However, the only current concern is to identify the command and branch to the address of the corresponding command-handling routine. Listing 2 shows the memory arrangement of the table for ZTL. (Values given for the addresses of the command-handling routines are purely arbitrary.)

The call to use the ZTL routine is shown in listing 3. Listing 4 shows a step-by-step illustration of the contents of each register involved, assuming that the program has extracted a G command from the typed input.

The first two instructions simply copy the contents of the BC register pair (used to hold the byte count) into the DE register pair (to be used later). The next instruction is the Z80 CPDR. It is executed four times in the current example. On the first execution, the G in register A is compared to the B at the location (hexadecimal 12F5) indicated by the HL register pair, the contents of HL are decremented from hexadecimal 12F5 to 12F4, and the byte count is decremented from 6 to 5. Since the bytes compared did not match, and the byte count did not go to zero, the instruction is repeated, using the new values in the HL and BC register pairs.

On the fourth execution of the CPDR instruction, the G in register A is compared to the G at the location indicated by the HL register pair (hexadecimal 12F2), the contents of HL are decremented from hexadecimal 12F2 to 12F1, and the byte count is decremented from 3 to 2. Since the bytes compared did match, the instruction is not repeated. Notice that the HL register no longer points to the G in the table; it points one location below the G. This is a nuisance caused by Zilog's choice of a "post-test



Introducing --- **DYNASTAR™ !!**

World's first "RS-232 COMPUTER"™
with DYNATYPER™ typewriter interface ---

only **\$699⁰⁰** complete system!!

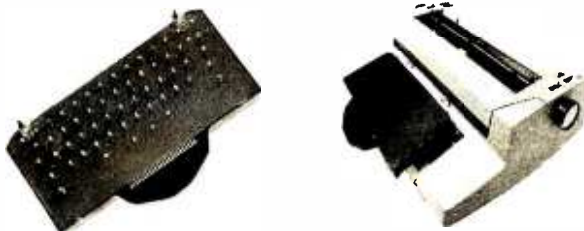

- Includes:
- DYNATYPER™ typewriter actuator (no modification to typewriter necessary.)
 - DYNASTAR™ RS-232 BASIC language computer with 2K RAM (expandable to 32K RAM/28K EPROM.)
 - Cassette interface - std., Centronics and current loop interface - optional.
- ★ Convert any dumb terminal into an intelligent storage system for timesharing with the DYNASTAR™ computer --- only \$399.00
 - ★ Create your own word processing system with your typewriter --- (DYNASTAR™ and DYNATYPER™) --- \$699.00
 - ★ APPLE/TRS-80/GPIB dedicated interface and the DYNATYPER™ (our standard product) --- \$499.00
- F.O.B. Rochester, Domestic. VISA and Master Charge accepted.
Call Ken Yanicky at 716-244-7804

ROCHESTER DATA

incorporated

3000 Winton Road South, Rochester, N.Y. 14623

Play with a full deck.

Introducing the RM 65 line of microcomputer boards.

The RM 65 line gives you the options and flexibility to design precisely the microcomputer systems you need.

And you can do it quickly and economically. Because you're offered so many design alternatives.

Application software for the RM 65 line, for example, can be programmed in a number of languages: BASIC, PL/65, FORTH and Assembly Language.

RM 65 uses a mother-board interconnect concept so any card will fit any slot.

You can choose either edge connector or Eurocard versions.

And a set of card cages allows a broad variety of packaging options.

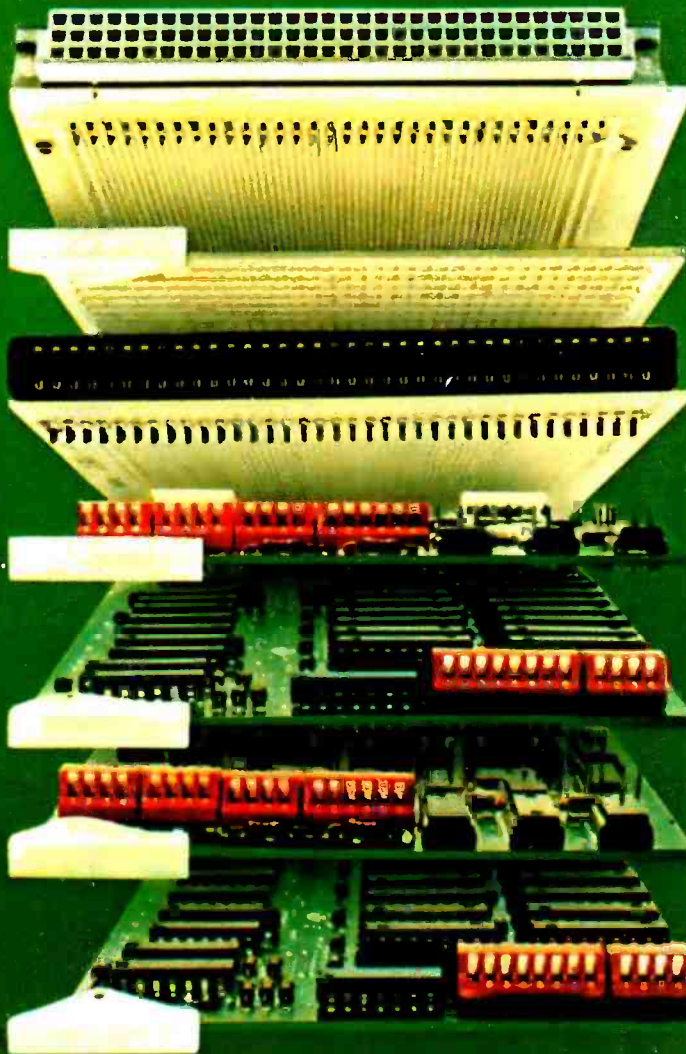

Rockwell. Your systems source.

Your functional system can be economically developed on the AIM 65 Advanced Interactive Microcomputer. At less than \$500, AIM 65—based on the high performance R6502 microprocessor—is the lowest cost development tool available for any board level system.



Rockwell stands ready with the system and application assistance your project requires. Call Rockwell for more literature. Or to schedule time at one of Rockwell's system development centers.

Rockwell International, Electronic Devices Division, P.O. Box 3669, Anaheim, CA 92803. (800) 854-8099 (In California 800-422-4230).

Single Board Computer Module
R6502 CPU, 2K bytes static RAM, 16K bytes PROM/ROM capacity, an R6522 VIA and support circuitry on a single RM 65 module.

Memory Modules

- 8K Static RAM
- 32K Dynamic RAM
- 16K PROM/ROM

Input/Output Modules

- GP I/O and Timer
- ACIA (RS232C)

Intelligent Peripheral Controller Modules

- IEEE-488 Bus Interface
- Floppy Disk Controller
- CRT Controller

Accessories

- 4 and 8-slot Card Cages
- Design Prototyping Module
- Extender Module
- Single-Card AIM 65 Adaptor
- Adaptor/Buffer Module



Rockwell International

...where science gets down to business

RM 65 MODULES

loop" approach instead of a "pre-test loop." It is not difficult to compensate for it, but it is easy to forget.

The next instruction executed is a RET NZ (return on not zero), which provides an exit when the byte for which a match is sought does not occur in the table. In the current example, this return is not taken. Following the RET NZ is an instruction to increment the contents of the HL register pair. This instruction is used to compensate for the incorrect value stored in the HL register, described above.

The next two instructions compute the address of the first (low-order due to high/low storage reversal) byte of the sought argument—the corresponding entry in the second part of the table. Suppose *B* is the beginning address of the first part of the table, *L* is the length of the first part of the table, and *I* is the position of the sought byte in the table, *I* ranging from 1 to *L*. The second part of the table starts at address $B + L$, and the sought entry starts at address $B + L + (I - 1) \times 2$. At this point in the execution of the routine, BC holds *I* - 1, because the CPDR decrements the byte count once too often, as well as the address in HL. Furthermore, the address in HL is $B + (I - 1)$ (compensated). So, when the routine adds BC to HL:

$$HL = B + (I - 1) + (I - 1)$$

Then, adding the table length *L*, saved in DE:

$$HL = B + (I - 1) + (I - 1) + L$$

so:

$$HL = B + L + (I - 1) \times 2$$

which is the address of the sought argument.

Text continued on page 174

Listing 1: ZTL, a table-lookup routine for the Z80 micro-processor. The use of the Z80's block-search instructions makes this routine short and fast, but some of the microprocessor's idiosyncrasies need compensation.

```

;NAME: ZTL
;PURPOSE: Z80 TABLE LOOKUP
;INPUTS: A = ARGUMENT (BYTE VALUE FOR WHICH
;         WORD VALUE IS TO BE FOUND.)
;         BC = LENGTH OF TABLE ARGUMENT LIST
;         HL = ADDRESS OF LAST TABLE ARGUMENT
;NOTE: TABLE MUST CONSIST OF AN ARGUMENT LIST OF
;      SINGLE-BYTE ENTRIES, FOLLOWED BY A FUNCTION
;      LIST OF CORRESPONDING SINGLE-WORD ENTRIES.
;      (WORDS STORED WITH USUAL LOW-HIGH BYTE
;      INVERSION.)
;OUTPUTS: IF NO MATCH FOUND FOR INPUT:
;         ZERO FLAG OFF (NZ)
;         IF MATCH FOUND FOR INPUT:
;         ZERO FLAG ON (Z)
;         HL = VALUE FROM CORRESPONDING
;         FUNCTION ENTRY
ZTL: EQU $
LD D,B ;COPY LENGTH FROM BC
      (BYTE COUNT) . . .
LD E,C ;. . . INTO DE (TO SAVE FOR LATER)
CPDR ;SEARCH DOWN ARGUMENT ENTRIES
RET NZ ;"NOT ZERO" MEANS NO MATCH
      FOUND
;NOTE THAT NONE OF THE FOLLOWING CHANGES THE
;ZERO FLAG
INC HL ;COMPENSATE FOR CPDR OVERSHOT
ADD HL,BC ;ADD REMNANT OF BYTE COUNT
ADD HL,DE ;ADD ORIGINAL LENGTH
;AT THIS POINT THE HL REGISTER PAIR POINTS TO THE
;DESIRED FUNCTION ENTRY
LD E,(HL) ;PICK UP LOW-ORDER BYTE
INC HL
LD D,(HL) ;PICK UP HIGH-ORDER BYTE
    
```

Listing 1 continued on page 172

S-100 USERS: GIVE YOUR COMPUTER THE GIFT OF SIGHT!

The DS-80 Digisector® is a random access video digitizer. It works in conjunction with a TV camera (either interlaced or non-interlaced video) and any S-100 computer conforming to the IEEE standards. Use it for:

- Precision Security Systems
- Moving Target Indicators
- Computer Portraiture
- Fast To Slow Scan Conversion
- Robotics
- Reading UPC Codes, schematics, paper tape, musical scores



● IMAGE PROCESSED BY DS-80 ●

CHECK THESE FEATURES:

- High resolution** — a 256 x 256 picture element scan
- Precision** — 64 levels of grey scale
- Speed** — Conversion time of 14 microseconds per pixel
- Versatility** — scanning sequences user programmable
- Economy** — a professional tool priced for the hobbyist; comes fully assembled, tested and burned in, with fully commented portrait printing software.

Price: \$349.95 MasterCharge and Visa

THE **MICRO**
WORKS

P.O. BOX 1110, DEL MAR, CA 92014 714-942-2400

**“If your database system
is so terrific,
why doesn't the world
beat a path to your door?”**

It is.

And the way is paved by the MDBS product line: database management systems second to none.

None.

The reasons are as plentiful as our product features. Such as the most important of all: increased productivity — thanks to the successful management of peopleware, hardware and software.

With MDBS database systems, you tailor the software to fit the organization easily: because our system is the most flexible around, offering speed; low cost

going in; fast startup; less programmer time . . . plus you can use it on a variety of hardware configurations using an even more extensive variety of languages.

(One example: with MDBS you can transform a programming language from an ordinary file management system into a full fledged database system without missing a beat.)

So, please take our invitation and give us a call, write or TWX. Instead of beating the *bushes*, beat the *path* . . . to success.

MDBS: We manage success.

Micro Data Base Systems, Inc./Box 248/Lafayette, IN 47902
(317) 448-1616/TWX 810 342 1881

Programming Quickies

Listing 1 continued:

```
EX    DE,HL ;PUT RESULT INTO HL (MORE
      ;USEFUL THERE)
RET      ;DONE
```

Listing 2: Arrangement of the table in memory for use by ZTL.

ADDRESS	DATA
12F0	49 [LETTER "I"]
12F1	44 [LETTER "D"]
12F2	47 [LETTER "G"]
12F3	58 [LETTER "X"]
12F4	45 [LETTER "E"]
12F5	42 [LETTER "B"]
12F6	00 [INITIALIZE ROUTINE AT ADDRESS 0000]
12F7	00
12F8	AA [DISPLAY ROUTINE AT ADDRESS 06AA]
12F9	06
12FA	0B [GET ROUTINE AT ADDRESS 070B]
12FB	07
12FC	12 [EXECUTE ROUTINE AT ADDRESS 0112]
12FD	01
12FE	08 [SET BREAKPOINT ROUTINE AT ADDRESS 0A08]
12FF	0A

Listing 3: Sample of the call to ZTL.

[NOTE: AT THIS POINT IT IS ASSUMED THAT REGISTER A ALREADY CONTAINS THE ASCII CHARACTER "G", EXTRACTED FROM INPUT, FOR WHICH THE TARGET ADDRESS IS TO BE FOUND.]

```
LD    BC,6 ;LOAD LENGTH OF ARGUMENT
      TABLE
LD    HL,12F5H ;ADDRESS OF LAST TABLE ENTRY
;FIND ADDRESS IN FUNCTION TABLE CORRESPONDING TO
;BYTE IN A
CALL ZTL ;Z80 TABLE LOOKUP
JP    (HL) ;GO TO THE ADDRESS SO FOUND
```

Listing 4: Register contents as ZTL executes (see the text for an explanation of the specific example).

INSTRUCTION EXECUTED	REGISTER CONTENTS	TABLE BYTE (HL)
	A Z-FLAG B C D E H L	
ZTL ROUTINE CALLED	47 ?? 00 06 ?? ?? 12 F5	42
LD D,B ;COPY LENGTH FROM BC (BYTE COUNT)...	47 ?? 00 06 00 ?? 12 F5	42
LD E,C ;...INTO DE (TO SAVE FOR LATER)	47 ?? 00 06 00 06 12 F5	42
CPDR ;SEARCH DOWN ARGUMENT ENTRIES	47 ?? 00 05 00 06 12 F4	45
CPDR [INSTRUCTION REPEATS ITSELF]	47 NZ 00 04 00 06 12 F3	58

Listing 4 continued on page 174

EPSON PRODUCTS

MX80/70 FRICTION FEED KIT by Orange Micro

HERE AT LAST! A friction feed kit for your EPSON MX80/70. The kit allows the user to convert his Epson printer to a friction feed and pin feed mechanism.

The friction feed will accept single sheets of your letterhead, or multiple copy forms such as invoices with up to 4 part carbon copies.

The pin feed replaces the adjustable sprocket mechanism. It allows use of 9½" wide continuous fan-fold paper which is an industry standard size.

No drilling required. Installation takes about 15 minutes. All parts are included with easy to follow instructions.

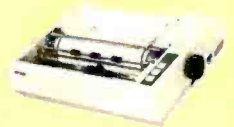

\$75.00

DEALER INQUIRIES INVITED

EPSON MX80

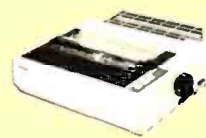

- 9 x 9 dot matrix • Lower case descenders • 80 CPS • Bidirectional, Logic seeking • 40, 66, 80, 132 columns per line • 64 special graphic characters: TRS-80 Compatible • Forms handling • Multi-pass printing • Adjustable tractors.

MX80 (List \$645) \$ CALL
MX80 Dot Graphics Upgrade..... (List \$100) \$ CALL

EPSON MX70



- Super low-priced dot resolution graphics • 5 x 7 dot matrix • User replaceable printhead • Top of Form.

MX70 (List \$495) \$ CALL

EPSON MX80 FT



- Same basic features as the MX80
- PLUS friction feed for single sheets • and adjustable tractors.

MX80 FT..... (List \$745) \$ CALL

APPLE INTERFACE

For Epson

The Grappler™ interface card is the first to provide on-board firmware for Apple high resolution dot graphics. No longer does the user need to load clumsy software routines to dump screen graphics — it's all in a chip. Actually, it's our E-PROM, and it is replaceable to accommodate the Anadex, Epson MX80 & MX70, IDS Paper Tigers, Contronics 739, and future graphics printers. The Grappler™ accepts 17 software commands including Hi-Res inverse, 90° rotation, double size, and much more.

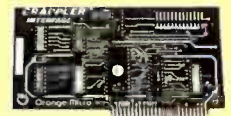

\$165.00

Includes Cable
DEALER INQUIRIES INVITED

Orange Micro

"THE COMPUTER PRINTER SPECIALISTS"

UP TO 25% DISCOUNTS! — SAME DAY SHIPMENT!

CENTRONICS 737 (RADIO SHACK LINE PRINTER IV)



Word Processing Print Quality

- 18 x 9 dot matrix; suitable for word processing • Underlining • proportional spacing • right margin justification • serif typeface • 50/80 CPS • 9½" Pin Feed/Friction feed • Reverse Platen • 80/132 columns

CENTRONICS 737-1 (Parallel) (List \$995) **\$765**
 CENTRONICS 737-3 (Serial) (List \$1045) **\$815**

VISTA — C. ITOH



Daisy Wheel Letter Quality

- 25 CPS (Optional 45 CPS) • Typewriter quality • Centronics parallel • RS 232 Serial (Optional) • Proportional spacing • Bidirectional • Programmable VFU • Self test • Diablo compatible • Friction feed (Optional tractors) • 136 printable columns • Manufactured by C. ITOH.

VISTA V300 (C. ITOH) (List \$1895) **\$ Call**

ANADEX



Dot Graphics, Wide Carriage

- 11 x 9 dot matrix; lower case descenders • Dot resolution graphics • Bidirectional, logic seeking • Up to 200 CPS • RS 232 Serial & Parallel • Forms control • X-ON/X-OFF • Up to 6 part copy.

ANADEX 9501 (List \$1650) **\$1450**

ANACOM

Low Cost, High Speed, Wide Carriage

- 9 x 9 dot matrix • Lower case descenders • Wide carriage • Adjustable tractors to 16" • 150 CPS, Bidirectional, Logic Seeking

ANACOM 150 (List \$1350) **\$ Call**

MALIBU

The Small Business Printer; Letter Quality & Speed.

- 10 x 9 dot matrix • Letter quality print; Lower case descenders • High speed; 165 CPS, Bidirectional, Logic seeking • Wide carriage • Vertical forms control • User programmable character set • Dot Resolution Graphics.

OKIDATA MICROLINE SERIES

TRS-80 Graphics Compatibility, Friction Feed



- 9 x 7 dot matrix • 80 CPS • 80, 132 columns — 64 shapes for charts, graphs & diagrams • Double wide characters • 6/8 lines per inch • Up to 3 part copy • Friction & pin feed • 200 M character head warranty

OKIDATA MICROLINE 80 (List \$800) **\$520**
 OKIDATA M82 Bidirectional, Forms handling (List \$960) **\$750**
 OKIDATA M83 Wide carriage, 9 x 9 dot matrix (List \$1260) **\$1050**

NEC SPINWRITER

High Speed Letter Quality

- 55 CPS • Typewriter quality • Bidirectional • Plotting • proportional spacing.

5510-5 RO, Serial, w/tractors (List \$2995) **\$2650**
 5530-5 RO, Parallel, w/tractors (List \$2970) **\$2625**

TELEVIDEO CRT'S

AT DISCOUNT PRICES!



TVI 912C
 TVI 920C
 TVI 950

Please Call Toll Free
 Prices are too low to
 advertise

QUANTITY PRICING AVAILABLE

IDS PAPER TIGERS

Dot Resolution Graphics, quality print, speed



- 7 wire printhead (445); 9 wire printhead (460) with lower case descenders • Over 150 CPS • bi-directional, logic seeking (460) • 8 character sizes; 80-132 columns • Adjustable tractors • High-resolution dot graphics • Proportional spacing & text justification (460).

IDS 445G 7 wire printhead, graphics (List \$895) **\$ 750**
 IDS 460G 9 wire printhead, graphics (List \$1394) **\$1150**
 IDS 560G 9 wire, wide carriage, graphics (List \$1794) **\$1590**

PRINTERS

MALIBU 165 wide carriage, graphics, letter quality .. (List \$2495) **\$ 1975**
 QUME 5/45 typewriter quality (List \$2905) **\$ 2559**

INTERFACE EQUIPMENT

CCS APPLE PARALLEL Interface & cable **\$ 150**
 APPLE II - EPSON MX80
 parallel interface board & cable **\$ 100**
 SSM AIO BOARD Apple Serial/parallel interface (List \$225) **\$ 175**
 MICROTRONICS Atari parallel interface **\$ 69**
 ATARI 850 Interface module, serial/parallel **\$ 199**
 TRS-80 CABLES to keyboard or Exp. interface **\$ Call**
 NOVATION D-CAT direct connect modem **\$ Call**

CALL FOR FREE CATALOG

(800) 854-8275
CA, AK, HI (714) 630-3322

At Orange Micro, we try to fit the right printer to your application.
 Call our printer specialists for free consultation.

Circle 268 on inquiry card.

TELEPHONE ORDERS: Mon.-Fri. 8:30 - 5:00
 The Orange Micro Printer Store (Retail):
 Mon.-Fri. 10:00 - 6:00, Sat. til 4:00

Phone orders WELCOME; same day shipment. Free use of VISA & MASTERCARD. Personal checks require 2 weeks to clear. Manufacturer's warranty included on all equipment. Prices subject to revision.

Orange Micro, Inc.
 3150 E. La Palma, Suite I
 Anaheim, CA 92806

Programming Quickies

Listing 4 continued:

```

CPDR    [INSTRUCTION REPEATS ITSELF]
        47  NZ    00 03 00 06 12 F2    47
CPDR    [INSTRUCTION REPEATS ITSELF]
        47  Z     00 02 00 06 12 F1    44
RET     NZ ;"NOT ZERO" MEANS NO MATCH FOUND
        47  Z     00 02 00 06 12 F1    44
INC     HL ;COMPENSATE FOR CPDR OVERSHOT
        47  Z     00 02 00 06 12 F2    47
ADD HL,BC ;ADD REMNANT OF BYTE COUNT
        47  Z     00 02 00 06 12 F4    45
ADD HL,DE ;ADD ORIGINAL LENGTH
        47  Z     00 02 00 06 12 FA    0B
LD      E,(HL) ;PICK UP LOW-ORDER BYTE
        47  Z     00 02 00 0B 12 FA    0B
INC     HL
        47  Z     00 02 00 0B 12 FB    07
LD      D,(HL) ;PICK UP HIGH-ORDER BYTE
        47  Z     00 02 07 0B 12 FB    07
EX      DE,HL ;PUT RESULT INTO HL (MORE USEFUL THERE)
        47  Z     00 02 12 FB 07 0B    ??
RET     ;DONE
        47  Z     00 02 12 FB 07 0B    ??
    
```

Text continued from page 170:

The next instructions pick up the low-order byte, increment HL, and pick up the high-order byte of the sought argument word. They are put directly into the DE register

pair by means of the HL register indirect instructions. If the answer is useful in DE, the routine can be ended here with a return; but, since an answer is generally more useful in the HL register pair, the routine as shown includes an exchange of DE with HL.

Finally, the routine ends with a simple unconditional return statement. It is important to note that *none* of the instructions following the CPDR will affect the zero flag. This allows the calling routine to easily determine if a match was found by examining the zero flag. The fact that the 16-bit ADD (without including previous carry) instructions do not set the zero flag is often a nuisance. But in this routine it is an advantage.

Beyond Tables

This article described a simple routine with a great deal of power. The example of usage presented dealt with finding the address of a software routine when given a single character command. However, the same routine can be called whenever you want to find 16 or fewer bits of information from a single 8-bit value. For example, it could be used to interpret single-byte codes used to store 3-digit telephone prefixes. Or it might be useful in a compiler to store a table of kinds of variables and their attributes. Hopefully, you will find that problems of your own can be solved with this simple and efficient routine. ■

we carry it all...

Commodore



VIC-20	279
8096	1890
4032N	1080
4032B	1080
8032	1499
CBM 4022 Printer	669
CBM 4040 Drive	999
CBM 8050	1449
CBM C2N Drive	87
PET-IEEE Cable	37
IEEE-IEEE Cable	46

Software

EBS Accounts Receivable Inventory System	\$595
Dr. Daley Mailing List	129
Dr. Daley Inventory	89
OZZ Information System	329
BPI General Ledger	329
Tax Package	399
Dow Jones Portfolio Management	129
Pascal	239
Visicalc- PET	149
WordPro 3 (40 col.)	186
WordPro 4 (80 col.)	279
WordPro 4 Plus (80 col.)	339

Printers

Starwriter	1495
NEC 5530	\$2495
Diablo 630	2195
Trendcom 100	299
Trendcom 200	489
Epson MX-80	499
Commodore Tally 8024	1699



Atari® 800™ 32K RAM Personal Computer



only \$759

400 8K	\$419	CXL4011 Star Raiders	45
400 16K	449	CX4111 Space Invaders	18
410 Recorder	62	CX70 Light Pen	64
810 Disk	479	CX30 Paddle	18
815 Disk	1199	CX40 Joystick	18
822 Printer	359	CX4121 Energy Czar	13
825 Printer	759	CX4108 Hangman	13
830 Modem	159	CXL4006 Super Breakout	30
850 Interface Module	164	CXL4010 3D TicTacToe	30
Microtek 16K RAM	99	CXL4005 Video Easel	30
Microtek 32K RAM	179	CXL4104 Mailing List	17
Visicalc- Atari	149	CXL4007 Music Composer	45
CX4102 Kingdom	13	CX4110 Typing	20
CXL4004 Basketball	30	CX4101 Invit. To Programming	17
CX4105 Blackjack	13	CXL4015 TeleLink	20
CXL4009 Chess	30	CXL4003 Assembler Editor	46
		Talk & Teach Courseware:	
		CX6001 - CX6017	23

No Risk, No Deposit On Phone Orders, COD or Credit Card,
Shipped Same Day You Call * **(800) 233-8950**

* on all in stock units



Computer Mail Order

501 E. Third St., Williamsport, PA 17701 (717) 323-7921

**Announces More
New Products
for your TRS-80® Model I & III****CHEXTEXT** (pronounced Check Text)

Apparat, Inc. announces CHEXTEXT, a variable length dictionary which interacts with SCRIPTSIT®, to highlight potential **spelling** and **typographical** errors in a text file.

Some of the CHEXTEXT features are:

- Variable Length Dictionary: The dictionary may be supplemented, depending on your system hardware (i.e. disk drive storage).
- Menu Driven.
- User Oriented.
- Dictionary may be complemented with unique industry jargon.
- A dual 80 track drive supports an approximate 50,000 word dictionary. Smaller dictionaries are provided with Basic CHEXTEXT Package (10,000 to 20,000 words.) Minimum system requirement—2 disk drives and 48K.
- Complete documentation.
- Reduces time required for proofreading.

Available from Apparat, Inc. for only

\$79⁹⁵

Catalog No. 2-148

TRS-80 DIGITAL TALKER:

A low cost alternative to the TRS-80 Voice Synthesizer.

Allows voice synthesis with no additional hardware on your TRS-80 Model I Level II or Model III 16K versions. The voice signals are generated via the cassette output port. A Radio Shack external speaker/AMP can be used for sound output.

Features

Comes with 16 preprogrammed words

Digits	0-9
+	Plus
-	Minus
/	Divided by
=	Equals
*	Times

And calculator mode software

Possible Applications utilizing the techniques internal to this program are:

- Talking clock
- Program reader
- Computer generated sound to aid in visual problems

Supplied on Diskette or tape (please specify) for only **\$29.95**.

Catalog No. 1-026

CATALOG CORRECTIONS

CAT #1-223 Price should be \$195.95 instead of \$39.95

CAT #1-225 Price should be \$24.00 instead of \$39.95

CAT #2-405 Price should be \$99.00 instead of \$79.00

CAT #1-403 Price should be \$549.00 instead of \$645.00

Don't forget to ask for your Free 1981 Apparat catalog when placing your order.

"On-going Support for Microcomputers"

©REGISTERED TRADEMARKS OF TANDY CORP.



Four Word Processors for the Apple II

The world of word processors has expanded rapidly in the past few years, and it appears to be only the beginning. We have seen a flourish of office automation machines from the big manufacturers, but with few exceptions the small machine software manufacturers have led the way. And, after reviewing some of the word-processing systems designed for microcomputers, we discovered that they have several advantages.

It was a temptation when reviewing these word processors to compare them to their large mainframe brothers. Eventually we stopped resisting that temptation. Both Steve and I have access in our work to such mainframe word processors as those by Wang and Honeywell. The com-

Keith Carlson
43 McDill Rd
Bedford MA 01730

Steve Haber
14 Larchmont Dr
Nashua NH 03062

parison hardly seems fair, but in reality most of the microcomputer word processors offer the features found in their larger brothers: in fact, a few of them are easier to use and learn, while still providing all of the features a user could possibly want. This will be evident in specific reviews.

There are two kinds of word processors: *screen-* or *cursor-oriented*, and *line-oriented*. Cursor-oriented

means that the editing and entry take place at the cursor, which is moved throughout the text. In line-oriented word processors, all text is entered and referred to with line numbers. Neither method appears to have a distinct advantage over the other: they are merely different ways of referencing the text.

Super-Text

Super-Text is a super word processor that, despite minor problems, exhibits some of the power-packed features you would expect in a word processor designed for a much larger machine. Super-Text (from Muse Software) can be easily adapted to your current equipment, as well as any you may acquire in the future.



Photo 1: Apple word processors: the Datacope Scribe, the Rainbow Write-On!, the IUS EasyWriter Professional system, and the Muse Super-Text II. (The cream-colored binder in the upper left corner is for Super-Text I, which has been discontinued by Muse.)

At a Glance

Name

Super-Text II

Type

Word processor

Manufacturer

Muse Software
330 N Charles St
Baltimore MD 21201
(301) 659-7212

Price

\$150

Format

5-inch floppy disk

Language

6502 machine language

Computer

Apple II or II+ with 48 K bytes of memory and one disk drive

Documentation

82 pages, 15.5 by 23 cm (6 by 9 inches); three-ring binder

Audience

Anyone needing a word-processing system

Now proven baZic can be run on any Z80[®] computer under CP/M.[®] baZic is written entirely in Z80 code—runs faster than any other BASIC interpreter. The greater execution speed is significantly advantageous for heavy number crunching, multi-user and multi-tasking operations.

baZic has all the features of North Star[®] BASIC—and then some. baZic, with minor exceptions, is 100% compatible with existing North Star BASIC programs. Our new baZic runs under all Micro Mike's timesharing and hard disk operating software.

CHECK THESE FEATURES AT YOUR COMPUTER DEALER:

- Takes full advantage of the Z80 instruction set.
- Can be used on any Z80-based microcomputer operating under North Star[®] DOS or CP/M.
- Support North Star floating point board for even faster execution of compute-intensive programs.
- The most friendly BASIC available.

- Improves performance of multi-user hard disk systems.
- baZic adds functions to assist in screen formatting, as well as features to simplify programming, e.g. APPEND as a statement, ON GOSUB, cursor-addressable PRINT, enhanced editing features, etc
- baZic as shipped includes 8, 10, 12, and 14 digit precisions, including both software and hardware floating point versions.
- baZic is also available for the Apple II[®] under CP/M with the SoftCard.[™]

OEMs and dealers contact Silverman Associates for details. 4010 Opal Street, Oakland, CA 94609. (415) 428-2954. All other inquiries should be to your dealer or Micro Mike's.

- ©North Star Computers
- ©Digital Research, Inc.
- ©Apple Computers, Inc.
- ©Zilog, Inc.
- ©Microsoft

Micro Mike's
Micro Mike's, Inc.
3015 Plains Blvd., Amarillo, Texas 79102

Hard fact:

\$150 makes your Z80-based computer run up to 40% faster!



With the Dan Paymar lowercase adapter (which allows the Apple to display lowercase letters), this processor supports true lowercase.

Super-Text also allows conversion of files for use with the Paymar lowercase adapter. However, it does not allow the reverse, so you must either keep two copies of the text file or always use an Apple II with the lowercase adapter. Most of the other Apple II word processors use reverse-video to represent uppercase letters on the screen. If you don't have a Paymar lowercase adapter, Super-Text places a reverse-video A in front of the character to be capitalized, instead of highlighting the character it-

self. This can be confusing until you get used to it, because the reversed A does not print when you print the file. We found that we had a tendency to compensate for the nonprinting character when lining up text. You have to use the control key as a shift, but Super-Text will support the use of the shift key with a minor modification to the keyboard. (Muse provides the short piece of wire and instructions for the modification.)

Super-Text does not support an 80-column board, but it simulates 80 columns by using a preview mode. This mode allows you to see what your text will look like on paper, with obvious limitations on color, super-/

subscripting, and underlining. (In any case, these limitations are dependent upon the printer that you use.)

Since you can only see the leftmost 40 columns on the screen, the preview mode allows you to move the left margin to the right to see the other half of the document; however, we found the operation awkward to use because the text scrolls past quickly. Still, this arrangement is better than wasting paper to see what you have written.

Super-Text uses the wraparound method of text entry (ie: if a word will not fit on a line, the entire word is automatically moved to the next line). Some word processors use a

WE'RE ABOUT TO DISCLOSE OUR SECRET FORMULA

THE FORMULA™ represents a new concept in report generation. It takes information management one step further into the future. THE FORMULA™ now makes it possible to visually describe the format of desired reports by using a unique full screen editor. All types of reports (including invoices, financial statements, legal forms, letters, etc.) can be defined interactively on a terminal simply by typing the format on the screen. It is programmed for multiple file access, algorithmic calculations and conditional printing. Incorporating DMA's information manager, The Configurable Business System.™ THE FORMULA™ provides a flexible framework you can easily adapt to your own individual needs.

Complete System \$595. Manual only \$60.

THE FORMULA™ runs on any 8080 or Z80 computer with CP/M*, 48K RAM, 300K total disk storage, and a CRT (min. 16x64).

DMA • WE SPEAK YOUR LANGUAGE.

*CP/M is a trademark of Digital Research.

DYNAMIC MICROPROCESSOR ASSOCIATES • 545 Fifth Avenue, New York, New York 10017 • (212) 687-7115

We ship prepaid and COD orders. Shipping & handling charges extra: \$5 UPS areas; \$7 non-UPS areas. Mexico, Canada: \$10+ elsewhere. MasterCard and VISA accepted.

Mark of the Unicorn



Amethyst

puts you in **Command**
of your text

Talk with Amethyst about words, sentences, paragraphs, chapters, quotations, footnotes, and more—it understands. Its ability to edit and display several documents and programs at once is absolutely unequalled by any other system.

Amethyst can be modified to suit your needs because we supply the source for the commands. You can arbitrarily alter the behavior of any command!

One year's support is included—we don't leave you to fend for yourself. And our thorough, readable documentation has received high acclaim from our users. Amethyst comes with the **BDS C** compiler. How many other word processing systems let you write programs as well?

Amethyst \$350 (less C compiler \$250) manual \$35

Mince (Amethyst text editor) \$125 manual \$15 demo disk \$10

Scribble (Amethyst text formatter) \$125 manual \$15

Mince and Scribble ordered together \$175

48K CP/M^R required. Available on 8" soft sector diskettes. Mince and Amethyst require a cursor-addressable terminal. Dealer, site, OEM, and **NIX versions and licenses available.

Mark of the Unicorn, P.O. Box 423, Arlington, MA. 02174 (617)489-1387



TSE-HARDSIDE

6 South St., Milford, NH 03055 (603) 673-5144
TOLL FREE OUT-OF-STATE 1-800-258-1790



APPLE II PLUS 48K \$1299

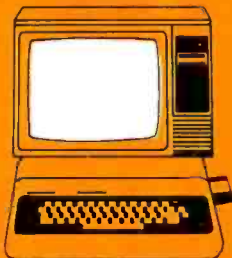

**COLOR COMPUTER
16K \$399**

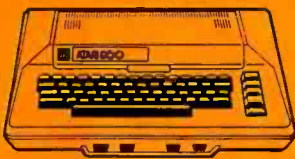

ATARI 800 16K \$829



**MODEL III
48K \$999**

TRS-80 COMPUTERS

Mod-III, 16K RAM (#26-1062) \$919.00
Mod-III, 48K RAM (#26-1062+) \$999.00
Mod-III, 48K, 2-drives,
RS-232-C (#26-1063) \$2299.00
Color Comp, 4K RAM (#26-3001) \$359.00

Color Comp, 16K RAM (#26-3001+) . . . \$399.00
Color Comp, 32K RAM (#26-3001++) . . \$479.00
Color Comp, 16K Ext Basic (#26-3002) . \$529.00
Color Comp, 32K Ext Basic (#26-3002+) \$599.00
Pocket Computer^w/Interface \$259.00

ATARI COMPUTERS

ATARI 400, 8K RAM (#36-400) \$439.00
ATARI 400, 16K RAM (#36-401) \$499.00
ATARI 400, 32K RAM (#36-402) \$629.00

ATARI 800, 16K RAM (#36-800) \$829.00
ATARI 800, 32K RAM (#36-801) \$949.00
ATARI 800, 48K RAM (#36-802) \$1019.00

APPLE COMPUTERS

APPLE-II PLUS, 48K RAM (#47-203) . \$1299.00

"hot zone" to prompt for hyphenation, but if you want hyphenation with Super-Text you must perform it manually. By embedding control characters in the text, you can instantly invoke format changes, tab stops, automatic paragraph indentation, word centering, and left margin changes. These control characters appear as reverse video letters. Super-Text formats the text upon printout, so the effects of these control characters are visible only on printout or during preview mode.

The only files Super-Text will accept, other than those written by itself, are Dr Memory files. (Dr Memory is the predecessor of Super-Text.) Muse also has add-on modules that can produce form letters (available for \$100), input files by telecommunication (\$75), and plot graphs (no price quoted).

Super-Text's ability to edit is excellent. The word processor is cursor-oriented, and it gives the user a full set of commands to move the cursor about the text. The cursor scrolls backward or forward by operator choice, and the direction is clearly marked in the lower left-hand corner. The replacement, deletion, insertion, and rearrangement of text processes are all easy to use and understand. However, one minor problem appears with insertion: normally insertion occurs in front of the current cursor location—with Super-Text, it occurs *after* the cursor location. This is unnerving and hard to get used to. Super-Text can also copy blocks of text easily throughout the text file, and it can save and load blocks of text separately, a feature that is especially helpful with "boilerplate" files used in business correspondence.

Find-and-replace operations are easy and efficient. The operations even include a "wild card" notation that will match any number of intervening characters (including none). For example, an attempt to find "COMPUT#WORLD" would match "COMPUTER WORLD" or "COMPUTING WORLD". Super-Text is loaded with prompts that make find-and-replace operations easy for the operator.

JUNE SPECIAL



MICROLINE-83

\$759.00

OFFER EXPIRES 6/30/81

TERMS: Prices and specifications are subject to change. HARDSIDE accepts VISA & MASTERCARD. Certified checks and Money Orders; Personal checks accepted (takes 3 weeks to clear). HARDSIDE Pays all shipping charges (within the 48 states) on all PREPAID orders OVER \$100.00. On all orders under \$100 a \$2.50 handling charge must be added. COD orders accepted (orders over \$250 require 25% deposit) there is a \$5.00 handling charge. UPS Blue Label, and Air Freight available at extra cost. TRS-80 is a trademark of Tandy Corp.

DYNACOMP

Quality software for*:

ATARI
PET
APPLE II Plus

TRS-80 (Level II)*
NORTH STAR
CP/M 8" Disk

GAMES, SIMULATIONS, EDUCATION AND MISCELLANEOUS

BRIDGE 2.0 (Available for all computers) Price: \$17.95 Cassette/\$21.95 Diskette
An all-inclusive version of this most popular of card games. This program both BIDS and PLAYS either contract or duplicate bridge. Depending on the contract, your computer opponents will either play the offense OR defense. If you bid too high, the computer will double your contract! BRIDGE 2.0 provides challenging excitement for advanced players and is an excellent learning tool for the bridge novice.

HEARTS 1.5 (Available for all computers) Price: \$14.95 Cassette/\$18.95 Diskette
An exciting and entertaining computer version of this popular card game. Hearts is a trick-oriented game in which the purpose is not to take any hearts or the queen of spades. Play against two computer opponents who are armed with hard-to-beat playing strategies.

CRIBbage (TRS-80 only) Price: \$14.95 Cassette/\$18.95 Diskette
This is simply the best cribbage game available. It is an excellent program for the cribbage player in search of a worthy opponent as well as for the novice wishing to improve his game. The graphics are superb and assembly language routines provide rapid execution.

STUD POKER (ATARI only) Price: \$11.95 Cassette/\$15.95 Diskette
This is the classic gambler's card game. The computer deals the cards one at a time and you (and the computer) bet on what you see. The computer does not cheat and usually bets the odds. However, it sometimes bluffs! Also included is a five-card draw poker betting practice program. This package will run on a 16K ATARI. Color, graphics, sound.

POKER PARTY (Available for all computers) Price: \$17.95 Cassette/\$21.95 Diskette
POKER PARTY is a draw poker simulation based on the book, POKER, by Oswald Jacoby. This is the most comprehensive version available for microcomputers. The party consists of yourself and six other (computer) players. Each of these players (you will get to know them) has a different personality in the form of a varying propensity to bluff or fold under pressure. Practice with POKER PARTY before going out to that expensive game tonight! Apple Cassette and diskette versions require a 32 K for larger Apple II.

NOMINOES JIGSAW (Atari, Apple and TRS-80 only) Price: \$16.95 Cassette/\$20.95 Diskette
A jigsaw puzzle on your computer! Complete the puzzle by selecting your pieces from a table consisting of 60 different shapes. NOMINOES JIGSAW is a virtuoso programming effort. The graphics are superlative and the puzzle will challenge you with its three levels of difficulty. Scoring is based upon the number of guesses taken and by the difficulty of the board set-up.

CRANSTON MANOR ADVENTURE (North Star only) Price: \$19.95
At last! A comprehensive Adventure game for the North Star. CRANSTON MANOR ADVENTURE takes you in mysterious CRANSTON MANOR where you attempt to gather fabulous treasures. Lurking in the manor are wild animals and robots who will not give up the treasures without a fight. The number of rooms is greater and the associated descriptions are much more elaborate than the current popular series of Adventure programs, making this game the top in its class. Play can be stopped at any time and the status word on diskette. Requires 32K.

VALDEZ (Available for all computers) Price: \$14.95 Cassette/\$18.95 Diskette
A simulation of suprastar navigation in the Prince William Sound and Valdez Narrows. The program uses an extensive 256x256 element radar map and employs physical models of ship response and tidal patterns. Chart your own course through ship and icebergs! For any standard terminal may be used for display.

FLIGHT SIMULATOR (Available for all computers) Price: \$17.95 Cassette/\$21.95 Diskette
A realistic and extensive mathematical simulation of take-off, flight and landing. The program utilizes aerodynamic equations and the characteristics of a real airfoil. You can practice instrument approaches and navigation using radials and compass headings. The more advanced flyer can also perform loops, half-rolls and similar aerobatic maneuvers.

STARTREK 3.2 (Available for all computers) Price: \$ 9.95 Cassette/\$13.95 Diskette
This is the classic Star Trek simulation, but with several new features. For example, the Klingons now shoot at the Enterprise without warning who also attack starbases in other quadrants. The Klingons also attack with both light and heavy cruisers and more than when who all. The situation is hectic when the Enterprise is besieged by three heavy cruisers and a starbase S.O.S. is received: The Klingoniest event!

CHESS MASTER (North Star and TRS-80 only) Price: \$19.95 Cassette/\$23.95 Diskette
This complete and very powerful program provides five levels of play. It includes casting, en passant captures and the promotion of pawns. Additionally, the board may be preset before the start of play, permitting the examination of "book" plays. To maximize execution speed, the program is written in assembly language (by SOFTWARE SPECIALISTS of California). Full graphics are employed in the TRS-80 version, and two widths of alphanumeric display are provided to accommodate North Star users.

BLACK HOLE (Apple only) Price: \$14.95 Cassette/\$18.95 Diskette
This is an exciting graphics simulation of the problems involved in closely observing a black hole with a space probe. The object is to enter and maintain, for a prescribed time, an orbit close to a small black hole. This is to be achieved without coming so near the anomaly that the tidal stress destroys the probe. Control of the craft is realistically simulated using slide jels for rotation and main thrusters for acceleration. This program employs Hi-Res graphics and is educational as well as challenging.

HODGE PODGE (Apple only, 48K Integer BASIC) Price: \$19.95 Cassette/\$23.95 Diskette
Let HODGE PODGE be your child's babysitter. Pressing any key on your Apple will result in a different and intriguing "happening" related to the letter or number of the chosen key. The program's graphics, color and sound are a delight for children from ages 10 to 9. HODGE PODGE is a non-intimidating teaching device which brings a new dimension to the use of computers in education. HODGE PODGE requires a 48K Apple running with Integer BASIC.

TEACHER'S PET I (Available for all computers) Price: \$ 9.95 Cassette/\$13.95 Diskette
This is the first of DYNACOMP's educational packages. Primarily intended for pre-school to grade 4, TEACHER'S PET provides the young student with counting practice, letter-word recognition and three levels of math skill exercises.

SPACE TILT (Apple only) Price: \$10.95 Cassette/\$14.95 Diskette
Use the game paddles to tilt the plane of the TV screen to "float" a ball into a hole in the screen. Sound ahh! Not when the hole gets smaller and smaller. A built-in timer allows you to measure your skill against others in this habit-forming action game.

MOVING MAZE (Apple only) Price: \$10.95 Cassette/\$14.95 Diskette
MOVING MAZE employs the game paddles to direct a puck from one side of a maze to the other. However, the maze is dynamically (and randomly) built and is continually being modified. The objective is to cross the maze without touching (or being hit by) a wall. Scoring is by a elapsed time indicator, and three levels of play are provided.

ALPHA FIGHTER (Atari only) Price: \$14.95 Cassette/\$18.95 Diskette
Two excellent graphics and action programs in one! ALPHA FIGHTER requires you to destroy the alien starships passing through your sector of the galaxy. ALPHA BASE is in the path of an alien UFO invasion; let five UFO's fly by and the game ends. Both games require the joystick and get progressively more difficult the higher you score!

INTRUDER ALERT (Atari only) Price: \$16.95 Cassette/\$20.95 Diskette
This is a fast paced graphics game which places you in the middle of the "Dreadnav" having no stolen plans. The dreadnavs have been alerted and are detected whenever you are all. You must find and enter your ship to escape with the plans. Five levels of difficulty are provided. INTRUDER ALERT requires a joystick and will run on 16K systems.

GIANT SLALOM (Atari only) Price: \$14.95 Cassette/\$18.95 Diskette
This real-time action game is guaranteed addictive! Use the joystick to control your path through slalom courses coming both from open and closed gates. Choose from different levels of difficulty, race against other players or simply take practice runs against the clock. GIANT SLALOM will run on 16K systems.

CRYSTALS (ATARI only) Price: \$ 9.95 Cassette/\$13.95 Diskette
A unique algorithm randomly produces fascinating graphics displays accompanied with tones which vary as the patterns are built. No two patterns are the same, and the combined effect of the sound and graphics are mesmerizing. CRYSTALS has been used in local stores to demonstrate the sound and color features of the Atari.

CHOMP-OTHELLO (Atari only) Price: \$11.95 Cassette/\$15.95 Diskette
CHOMP-OTHELLO is a truly challenging game in one. CHOMP is similar in concept to NIM, you must bite off part of a cookie, but avoid taking the poisoned portion. OTHELLO is the popular board game set fully utilize the Atari's graphics capability. It is also very hard to beat! This package will run on a 16K system.

GAMES PACK I (Available for all computers) Price: \$9.95 Cassette/\$13.95 Diskette
GAMES PACK I contains the classic computer games of BLACKJACK, LUNAR LANDER, CRAPS, HORSEACE, SWITCH and more. These games have been combined into one large program for ease in loading. They are individually accessed by a convenient menu.

GAMES PACK II (Available for all computers) Price: \$9.95 Cassette/\$13.95 Diskette
GAMES PACK II includes the games CRAZY EIGHTS, JOTTO, ACEY-DUCEY, LIFE, WUABPLUS and others. As with GAMES PACK I, all the games are loaded as one program and are called from a menu.

When you pay \$7.95 or more per program when you can buy a DYNACOMP collection for just \$9.95!
NORTH STAR SOFTWARE EXCHANGE (NSSE) LIBRARY Price: \$9.95 Diskette
DYNACOMP now distributes the 20-volume NSSE library. Most of these diskettes offer an outstanding value for the purchase price. Write for details regarding the contents of this library and quantity (four or more) purchases.

Availability

DYNACOMP software is supplied with complete documentation containing clear explanations and examples. Unless otherwise specified, all programs will run with 16K program memory space (ATARI requires 24K). Except where noted, programs are available on ATARI, PET, TRS-80 Level II and Apple (Applesoft) cassette diskette as well as North Star single density (double density computerized diskette). Additionally, most programs can be obtained on standard (IBM format) 8" CP/M floppy disks for systems running under IBMASIC.

BUSINESS AND UTILITIES

MAIL LIST 2.2 (Apple, Atari and North Star diskette only) Price: \$34.95
This program is unmatched in its ability to store a maximum number of addresses on one diskette (minimum of 1100 per diskette, more than 2000 for "double density" systems). Its many features include alphabetic and zip code sorting, label printing, merging of files and a unique keyword seeking routine which retrieves entries by a virtually limitless selection of user-defined codes. A very valuable program!

FORM LETTER SYSTEM (FLS) (Apple and North Star diskette only) Price: \$21.95
Use FLS to create and edit form letters and address lists. Form letters are produced by automatically inserting each address into a predetermined portion of your letter, and the process is completely compatible with MAIL LIST 2.2, which may be used to manage your address files.
FLS and MAIL LIST 2.2 are available as a combined package for \$49.95.

PERSONAL FINANCE SYSTEM (ATARI only) Price: \$34.95
PFS is a single disk menu oriented system composed of 10 programs designed to organize and simplify your personal finances. Features include a 300 transaction capacity; fast access; 16 optional user codes; data retrieval by month, code or name; optional printing of reports; checkbook balancing; bar graph plotting and more. Also provided on the diskette is ATARI DOS 2.

FINDIT (North Star only) Price: \$19.95
This is a three-line program which maintains information accessible by keywords of three types: Personal (eg: last name), Commercial (eg: plumbers) and Reference (eg: magazine articles, record albums, etc.). In addition to key word searches, there are birthdays, anniversary and appointment searches for the personal records and appointment searches for the commercial records. Reference records are accessed by a single keyword or by cross-referencing two or three keywords.

DFILE (North Star only) Price: \$19.95
This handy program allows North Star users to maintain a specialized data base of all files and programs in the stack of disks which in turn accumulates. DFILE is easy to set up and use. It will organize your disks to provide efficient locating of the desired file or program.

GRAFIX (TRS-80 only) Price: \$12.95 Cassette/\$16.95 Diskette
This unique program allow you to easily create graphics directly from the keyboard. You "draw" your figure using the program's extensive cursor controls. Once the figure is made, it is automatically appended to your BASIC program's source listing. Draw a "happy face" call it HIS and then print it from your program using PRINT HIS. This is a very easy way to create and use graphics.

TIDY (TRS-80 only) Price: \$10.95 Cassette/\$14.95 Diskette
TIDY is an assembly language program which allows you to remember the lives in your BASIC programs. TIDY also removes unnecessary spaces and REMARK statements. The result is a compacted BASIC program which uses much less memory space and executes significantly faster. Once loaded, TIDY remains in memory; you may load any number of BASIC programs without having to reload TIDY!

STATISTICS AND ENGINEERING

DATA SMOOTHER (Not available for ATARI) Price: \$14.95 Cassette/\$18.95 Diskette
This special data smoothing program may be used to rapidly derive useful information from noisy business and engineering data which are equally spaced. The software features choice in degree and range of fit, as well as smoothed first and second derivative calculation. Also included is automatic plotting of the input data and smoothed results.

FOURIER ANALYZER (Available for all computers) Price: \$14.95 Cassette/\$18.95 Diskette
Use this program to examine the frequency spectra of limited duration signals. The program features automatic scaling and binning of the input data and results. Practical applications include the analysis of complicated patterns in such fields as electronics, communications and business.

TFA (Transfer Function Analyzer) Price: \$19.95 Cassette/\$23.95 Diskette
This is a special software package which may be used to evaluate the transfer functions of systems such as hi-fi amplifiers and filters by examining their response to pulsed inputs. TFA is a major modification of FOURIER ANALYZER and contains an engineering-oriented spectral versus log-frequency plot as well as data editing features. Whereas FOURIER ANALYZER is designed for educational and scientific use, TFA is an engineering tool. Available for all computers.

HARMONIC ANALYZER (Available for all computers) Price: \$24.95 Cassette/\$28.95 Diskette
HARMONIC ANALYZER was designed for the spectrum analysis of repetitive waveforms. Features include data file generation, editing and storage (series as well as data and spectrum plotting). One particularly unique facility is that the input data need not be equally spaced in time. The original data is sorted and a cubic spline interpolation is used to create the data file required by the FFT algorithm.

FOURIER ANALYZER, TFA and HARMONIC ANALYZER may be purchased together for a combined price of \$44.95 (three cassettes and \$56.95 three diskettes).

REGRESSION I (Available for all computers) Price: \$19.95 Cassette/\$23.95 Diskette
REGRESSION I is a unique and exceptionally versatile one-dimensional least squares "polynomial" curve fitting program. Features include very high accuracy, an automatic degree determination option, an extensive internal library of fitting functions, data editing, automatic data and curve plotting, a statistical analysis (ie: standard deviation, correlation coefficient, etc.) and much more. In addition, new fits may be tried without reentering the data. REGRESSION I is certainly the regression program in any data analysis software library.

REGRESSION II (PARAFIT) (Available for all computers) Price: \$19.95 Cassette/\$23.95 Diskette
PARAFIT is designed to handle those cases in which the parameters are embedded (possibly nonlinearly) in the fitting function. The user simply inserts the functional form, including the parameters (A1, B1, A2, etc.) as one or more BASIC statement lines. Data and results may be manipulated and plotted as with REGRESSION I. Use REGRESSION I for polynomial fitting, and PARAFIT for those complicated functions.

MULTILINEAR REGRESSION (MLR) (Available for all computers) Price: \$24.95 Cassette/\$28.95 Diskette
MLR is a professional software package for analyzing data sets containing two or more linearly independent variables. Besides performing the basic regression calculation, this program also provides easy to use data entry, storage, retrieval and edit capabilities. In addition, the user may interrogate the solution by supplying values for the independent variables. The number of variables and data size is limited only by the available memory.

REGRESSION I, II and MULTILINEAR REGRESSION may be purchased together for \$49.95 (three cassettes) or \$61.95 (three diskettes).

BASIC SCIENTIFIC SUBROUTINES, Volume 1 (Not available for ATARI)
DYNACOMP is the exclusive distributor for the software archived in the text BASIC Scientific Subroutines, Volume I by F. Ruckdeschel (see the BYTE Magazine, Hill advertisement in BYTE magazine, January 1981). These subroutines have been a verified according to chapter, included with each collection is a menu program which selects and demonstrates each subroutine.

- Collection #1: Chapters 2 and 3: Data and function plotting, complex variables
- Collection #2: Chapter 4: Matrix and vector operation
- Collection #3: Chapters 5 and 6: Random number generators, series approximations

Price per collection: \$14.95 Cassette/\$18.95 Diskette
All three collections are available for \$34.95 (three cassettes) and \$40.95 (three diskettes).
Because the text is a vital part of the documentation, BASIC Scientific Subroutines, Volume I is available from DYNACOMP for \$19.95 plus \$3.00 postage and handling.

ROOTS (Available for all computers) Price: \$9.95 Cassette/\$13.95 Diskette
In a nutshell, ROOTS simultaneously determines all the zeroes of a polynomial and real coefficients. There is no limit on the degree of the polynomial, and because the procedure is iterative, the accuracy is generally very good. No initial guesses are required as input, and the calculated roots are substituted back into the polynomial and the residuals displayed.

Ordering Information

All orders are processed and shipped postpaid within 48 hours. Please enclose payment with order along with computer information. If paying by VISA or MasterCard, include all numbers on card. For orders outside North America add 10% for shipping and handling.

- Add \$2.50 to diskette price for 8" floppy disk (IBM format software), CP/M, Microsoft BASIC
- *TRS-80 diskettes are not supplied with DOS in BASIC

Deduct 10% when ordering 3 or more programs.

Ask for DYNACOMP programs at your local software dealer. Write for detailed descriptions of these and other programs from DYNACOMP.

DYNACOMP, Inc.

1427 Monroe Avenue
Rochester, New York 14618
24 hour mail order phone: (716) 886-7579
Office phone (9AM-5PM EST): (716) 442-8960

New York State residents please add 7.5% sales tax.



* ATARI, PET, APPLE II, TRS-80, NORTH STAR, CP/M and IBM are registered trademarks and/or trademarks.

Z8000

MICRO PRICE for MINI POWER
MICRO-MINI™ matches Series I by IBM
DELIVERING CURRENT ORDERS

You cannot buy a more powerful micro:

- Power: 1 to 32 independent users
- Memory: directly addresses to 16 Meg!
- Mapping: efficient memory management
- Disk: 2M to more than 250M
- Speed: throughput 10 times Z80
- Files: simultaneous access
- Communication: inter-user via terminals
- Security: all files password protected
- Options: expandable in the field
- Bus: Intel Multibus™ compatible
- Languages: Pascal, BASIC, COBOL, FORTRAN

SYSTEM I\$3509

Z8001 CPU board with on-board ROM monitor
 32K dynamic RAM

I/O board: 8 serial ports

Back plane: 15-slots, Multibus™ compatible
 Case: switching power, fans, cage, fixtures

SYSTEM II\$6659

Z8001 CPU with memory management circuitry
 64K dynamic RAM

I/O board: 8 serial ports

FDC board: for 4 floppies, sgl/dbl density

ZMOS: multi-user/-tasking operating system

Back plane: 15-slots, Multibus™ compatible

Case: switching power, fans, cage, fixtures

Disks: dual floppies (ss: sgl/dbl density)

CRT: Dialogue 80™ interactive/edit terminal

Call for further system specifications.



AMPEX Dialogue 80™

Dialogue 80™ fully-featured video terminal:

- Full ASCII with numeric and edit keypads
- Elegant case with detachable keyboard
- Display 24 lines with 25th status line
- 20 user programmable function keys
- 2 pages display memory (4 optional)
- 11 graphics and 21 control codes
- 10 modes including block, protect, program
- Transparent mode displays control codes

Dialogue 80™\$1045

Dialogue 80™ with phone coupler.....1194

Applications: word processing, data entry, interactive programming, data base inquiry/response/update, transaction processing, whether on-site or remote. For our system or for yours, this interactive terminal is the perfect match.

Prices: Prepaid or Purchase Order Net 10.

Prices subject to change without notice.

Warranty: 120 day minimum on all systems.

Interfacing cables free with all systems.

10% down fixes price, guarantees priority.

MasterCard and VISA cards accepted.

(312) 684-3183



5710 Drexel, Chicago, IL 60637

Even more useful (and amazing) is *autolink*. Autolink allows Super-Text to find and replace across an unlimited number of files. This action can occur in forward, backward, or even circular directions. Simply enclose the next file in colon symbols, place it at the end of the file (or the beginning, for a backward or circular link), and set the autolink flag. Any further find or replace command automatically searches the current file, loads the next, and searches it as well. Needless to say, this is a powerful feature that is unavailable on some of the big word processors.

Another feature that is neglected by some of the larger manufacturers is the split-screen mode. It is fascinating to see such a sophisticated feature in a word processor for a microcomputer. However, we wondered about the value of this feature. What can it be used for? In any case, it exists in Super-Text, and if you *can* use it—so much the better. We suspect it has only dazzle value.

In addition to Super-Text's excellent editing, there is a math mode that performs as a four-function calculator for columnar and embedded numerical data. It features an accumulator with up to fifteen-digit significance, and a decimal point that can be set by the operator. This calculator also adds up columns—even across screens. Once sums are in the accumulator, they can be easily inserted in the text, and even automatically aligned on decimal points.

The printouts look clean and professional, which is dependent, in part, on the printer you use. We used a Centronics 737, which is a "smart" (microprocessor-controlled) printer that looks good even though it is a dot-matrix printer. The printer can do many things by itself, and this is where the adaptability of Super-Text becomes a factor. Right justification is performed by space insertion, and it has the appearance of being evenly proportioned since Super-Text seems to place spaces after punctuation first, and then randomly across the line. Super-Text does not perform true proportional spacing, but the Centronics 737 does this automat-

ically with a proportional type font.

The Centronics responds to certain control characters that are sent to it to control particular features, such as underlining, choice of type font, super-/subscripting, and elongation of text (any type font may be printed as double-width characters). While Super-Text cannot directly control these printer functions, it allows six control characters which can be user-defined. (Four of these are configured for Diablo printers.) Some technical knowledge is required to redefine these control characters, but step-by-step instructions lead you through the process.

Although you can add an assembly-language printer driver to Super-Text, it is usually unnecessary. The first time you use Super-Text, you should configure it for your printer; this data is then saved on disk, and you should never again have to change your printer configuration (unless you get a different printer). The formatting parameters given at configuration time can be easily changed within the text.

Super-Text can use continuous form or single-sheet paper. It is difficult, however, to change back and forth, since you must reconfigure the printer every time that you switch. The operator can stop and start a printout at any time by the touch of a key. Page numbers can be suppressed, and made relative to the beginning of a chapter with the insertion of a control character. Page numbers can also be moved around the page for maximum flexibility. There is no provision that automatically locates the proper line for footnotes. The operator must count up lines for proper placement.

Human engineering is a weak point with Super-Text. The program does provide excellent prompts when necessary, including warnings for dangerous commands (eg: "PRESS # TO DELETE—" for deleting the entire text buffer) and multiple keystrokes to avoid accidental deletion. The problem, however, is that a lot of the control characters are not mnemonic. Also, multiple keystrokes for simple operations abound in Super-Text.

Vista



Model V1000

... Looking Out For You.

Eight Inch Floppy Disk Drive Subsystem Model V1000

The V1000, Vista's sophisticated new disk drive subsystem, sets new standards for ease of access and use. Its innovative design permits disk drives to be mounted or removed quickly and easily for system reconfiguration or servicing.

Features:

- Deluxe chassis with internal slide allows easy access.
- Storage capacity from 250 kilobytes to 2.5 megabytes.

- Desk or rack mountable.
- Accomodates both single-sided and double-sided drives.
- Industrial quality cabinet with die cast front bezel.
- Drives pull out for easy service and maintenance.

Prices:

Cabinet with (2) single sided drives w/power supply . . .	\$1595.00
Cabinet with (2) double sided drives w/power supply . . .	\$2295.00
Cabinet w/power supply	\$ 495.00



Model V200

Vista's Line of High Performance, High Reliability Products also Includes these Advanced Components

Daisy Wheel Printer Model V300

Features:

- 96-character proportional, bi-directional printing
- Interface - Parallel or RS232-C option

Prices:

V300-25cps	\$1895.00
V300-45cps	\$2195.00

Minifloppy Disk System, Model V200

Features:

- Storage capacity from 200K bytes to 12 megabytes
- Compatible with industry standard S100 main-frames.
- System software - Vista CP/M™ VOS Disk Operating System and Basic - E compiler.

Prices:

Starting as low as	\$695.00
V200-Exidy version	\$1199.00



Model V300

Vista Computer Company 1317 E. Edinger Avenue • Santa Ana, CA. 92705 • (714) 953-0523

* is a registered trademark of Digital Research

Dealer Inquiries Call Toll Free (800) 854-8017

Circle 381 on Inquiry card.

(This problem can be avoided, as demonstrated by Write-On!, another word processor designed for Apple II.) Some functions can be "undone" by using the escape key, but since most of the action takes place instantly, it is difficult to undo these commands. This is not the fault of Super-Text.

Text can be easily recovered from a "crash." If you find yourself in the Apple II monitor (denoted by an asterisk at the beginning of the line), simply type "3D0G", hit the return key, and then "CALL 4096", followed by the return key. You are placed back in Super-Text! We have yet to enter a file that exceeds the capacity

of the text buffer in Super-Text, so we don't know what happens when it fills up. The manual states that the processor will warn you when the buffer is almost filled.

Super-Text appears to use its own disk operating system, but it does use BLOAD and BSAVE to load and save text files. These operations are quick and easy. The fact that Super-Text can't be copied is probably the biggest problem. Perhaps Muse has realized how inconvenient this is, because it has provided two disks of the program. We understand its reluctance to put a copyable program on the market, but we feel that there are other ways to avoid piracy. One solu-

tion is to create a disk that can be copied a limited number of times but that produces uncopyable copies. In any event, there is a replacement policy, but there is also a \$10 media replacement charge.

Super-Text documentation comes in the form of an instruction manual. As a teaching tool, this manual is insufficient. The features are explained well, and some are supplemented with examples from the Super-Text disk. However, no quick reference card is provided, and it is sorely needed. The commands summarized at the end of each chapter explain the modes, but this is not enough, since you must leaf through the manual

COMPUTERS

IMPORTS



EPSON MX-80
Price Breakthrough - Call!

Okidata M-80	\$417
Okidata M-82	\$617
Okidata M-83	\$919



NORTHSTAR

Burned and reseed - backed by fast warranty service. Find out why our prices, availability and service make us the #1 source for the #1 S-100 system. Free games disc.

HRZ-II 64K DD	\$2595
HRZ-II 64K Quad	\$2995
HRZ-II 32K DD	\$2339
HRZ-II 32K Quad	\$2689

ADDS



The new leader! Detachable keyboard, extra port, 3 function keys, numeric keypad 24x80, RS-232, built and backed by ADDS.

ADDS Viewpoint \$589

PAPER TIGERS



445G	\$749
460G	\$1119
560G	\$1395



ALTOS

NOW MORE FOR LESS

ACS-8000-15 has 208K RAM, 1 Mg. on floppys, 6 serial and 2 parallel ports. Upgrade w/Winchester hard-disk drives and rope back-up. Multi-user or single user prices.

ACS8000-15 \$4795

TELEVIDEO



912C	\$729
920C	\$759
950	\$989

CENTRONICS



737	\$719
825	\$719

We participate in arbitration for business and customers through the Better Business Bureau of Maricopa County.



Scottsdale Systems

6730 E. McDowell Road, Suite 110, Scottsdale, Arizona 85257

(602) 941-5856

Open 8-5 Mon.-Fri.

TERMINALS



Sorac IQ 120	\$729
Sorac IQ 135	\$799
Hozeline 1421	\$779
Zenith Z-19	\$789

MORE PRINTERS

HIGH SPEED	LETTER QUALITY ::	
Anodex 9500/9501	\$1295	Diablo 630 \$2289
Doro South DS-180	\$1395	NEC 5510 \$2689
TI 810 Basic	\$1495	NEC 5520 \$2945

(*Prices include Tractors)

ORDERING

Mail-Order Only

2% cash discount included / charge cards add 2%. Prices subject to change, product subject to availability. Arizona residents add 5%. F.O.B. point of shipment Scottsdale. 0-20% restocking fee for returned merchandise. Warranties included on all products.

Now that the WICAT System100 has quietly proven itself...



We're ready to announce it.

While others were announcing their MC68000-based systems, we were proving ours. While other companies were scrambling to build and debug prototypes, WICAT's system was working successfully in Fortune 100 companies.

While others are promising 68000's, WICAT is delivering. Ask any of our Fortune 100 customers. Or ask us.

Call or write today for additional information.

WICAT Systems.

1875 South State P.O. Box 539 Orem, Utah 84057 801 224-6400



APPLE II PLUS:	YOU SAVE
16K	\$1049 22%
48K	\$1099 29%
64K	\$1269 27%
Apple III	Call

All are 1981 model with Apple RAM. 64K unit is 48K unit with Microsoft 16K RAM board.

IMPORTANT NOTE: We are an authorized dealer and repair center and will repair all Apple equipment regardless of where you purchased it.

	SAVE
Disk II & 3.3 Controller	\$ 499 23%
Disk II	\$ 439 16%
Micro Sci A70 for Apple II	
286K 5" Drive	\$ 499 16%
3.3/Pascal Controller	\$ 79 20%
Monitors, Sanyo 9" B&W	\$ 169 30%
12" B&W	\$ 249 21%
12" Green	\$ 299 21%
13" Color	\$ 449 20%
RF Modulator, M&R	\$ 25 38%
Serial Interface Card	\$ 129 35%
Apple Writer program	\$ 59 21%
Visicalc	\$ 119 21%
80 Column Video:	
Apple Smarterm	\$ 299 17%
Videx, Videoterm	\$ 249 18%
M&R, Superterm	\$ 319 14%
Language/Pascal Sys.	\$ 379 24%
Microsoft:	
Z80 Softcard	\$ 250 28%
16K RAM Card	\$ 169 16%
Silentye printer w/IF	\$ 499 22%
Centronics 737	\$ 759 26%
Interface & cable	\$ 149 23%
Epson MX 80	\$ 475 27%
" Interface & cable	\$ 95 15%
DC Hayes Micromodem	\$ 299 23%
10 Memorex 5" disks	\$ 25 45%
10 Maxell 5" disks	\$ 39 33%
Accounting Software	
" Insoft Instant"	\$ 365 66%

A full professional quality integrated GL, A/R, A/P, Payroll package with hotline support. Send for free sample printouts.

Above prices for mail orders only. Our store showroom is at 126 NE F St. Grants Pass, OR. Store prices include service and will differ. No mail order sales at Store. CALL ORDER DESK.

(800) 547-1289

TECHNICAL & OREGON:
(503) 899-7297

ORDERING INFORMATION: Minimum order \$100. Money Orders, Cashier Checks or Bank Wire Welcomed. Visa and MC orders add 3%. Personal checks accepted (allow up to 20 days to clear). Add 3% for shipping, handling and insurance. UPS ground is standard. Add 4% total for UPS Blue or 10% total for US Parcel Post. Include your telephone number. No COD's. Prices subject to change without notice. Order desk hours are 9 to 6 PST, 10 to 3 Saturdays.

**Computer
Exchange**
PO BOX 1380
Jacksonville, OR 97530

until you have memorized all of the commands. There are no listings of the program, but as it can't be modified this makes little difference. In all fairness, the program provides for any modification you might want to make, so listings are unnecessary.

Super-Text is a very good word-processing program, and it generally works very well, especially after the user has adapted to the processor's particular methods. We won't give numerical ratings, as too much depends on the user's needs, but we'll give you a hint. We prepared part of this article with the Super-Text word processor.

Write-On!

Write-On!, like Super-Text, varies little between versions. The additional features of Write-On! II include preset script margins, personalized form letter capabilities using data files, data-file editing and input, and a system for preformatting text files for the printer. Write-On! II can also convert other files into data files.

Write-On! (from Rainbow Computing) is, for the most part, written in BASIC, and it lacks the speed of Super-Text or the Datacope Scribe. Therefore, it is almost a necessity to preformat text files for the printer. Unlike Super-Text, however, the added features are worth the price: in fact, the ability to print personalized form letters justifies the expense.

The following comments apply to both versions of Write-On!, unless otherwise noted.

Write-On! is a *super* word processor, but that name was already taken. Although it lacks some of the flexibility of the other word processors, it provides a full range of commands to process text.

Write-On! supports display of lowercase letters through the use of the Paymar lowercase adapter. It would appear that Mr Paymar and his adapter have become a standard with Apple. [Paymar had the field to himself for some time, but other companies (particularly Lazer Systems) are also producing lowercase products for the Apple II....GW] The shift key can be enabled by modifying

the keyboard, as mentioned above, but Rainbow Computing does not provide the wire—just the instructions. Without the shift modification, Write-On! uses reverse video and the ESC (escape) key to denote a capital letter. The shift lock is enabled by hitting the ESC key twice.

Write-On! does not support an 80-column board, and since it does its formatting when it prints out, there is no provision for viewing a text file in its final form on the screen. There is a feature in Write-On! II that allows print image files to be saved on disk, but the main purpose of these files is

At a Glance

Name

Write-On! I and II

Type

Word processor

Manufacturer

Rainbow Computing
9719 Reseda Blvd
Northridge CA 91324
(213) 349-5560

Price

Write-On! I, \$99.95
Write-On! II, \$150

Format

5-inch floppy disk

Language

Applesoft BASIC with some 6502 machine-language subroutines

Computer

Apple II or II+ with Language Card or ROM Applesoft, 48 K bytes of memory, and one disk drive

Documentation

67 pages, 22 by 28 cm (8.5 by 11 inches); three-ring binder; Quick Reference Card

Audience

Anyone needing a word-processing system

AIM 65. The professional's microcomputer.



Printer, display, full keyboard. Under \$500.00.

For professional learning, designing and work, Rockwell's AIM 65 microcomputer gives you an easy, inexpensive head start.

- 20-column printer and display
- Dual cassette, TTY and general purpose I/Os
- R6502 NMOS microprocessor

- System expansion bus
- Read/write RAM memory
- Prom/ROM expansion sockets
- Self-prompt interactive monitor firmware
- Terminal-style keyboard
- Options include:
 - Prom Programmer module
 - RM 65 standard modules and card cages

For more on AIM 65 and how you can develop programs in assembly language, BASIC, PL/65 or FORTH, write Rockwell International, Electronic Devices Division RC55, P.O. Box 3669, Anaheim, CA 92803. For location of nearest distributor or dealer call 800-854-8099 (in California 800-422-4230).



Rockwell International
...where science gets down to business

to speed up output to the printer. (The files display gibberish when loaded and viewed on the Apple screen.)

The processor uses the wraparound technique to divide words, so touch typists can enter text quickly and easily. Unfortunately, there is no provision for hyphenation. (This seems to be the rule rather than the exception in word processors for microcomputers.) Write-On! uses control symbols embedded in the text to control tabs, text width, margins, page numbering, text centering, and paragraph indentation. These symbols take the form of "backslash-some characters-backslash" and they are also highlighted on the screen.

Write-On! will accept files not written by itself. Understandably, the process is slower than loading its own files, but the feature does exist. After we tried this command, we found that the files had to be text files in thirteen-sector format. The files that Super-Text saved would not even show up with the CATALOG com-

mand because Super-Text uses BLOAD to save its files. The ability to edit previously created text files is an important consideration when you convert from one word processor to another.

Write-On! performs its editing chores with ease and speed. The processor is line-oriented, and although I feel it is more difficult to work with, this is largely a matter of personal preference. An asterisk appears to the left of the line that is currently operating. The replace and find commands are facilitated by machine code, so they are even quicker. Blocks of text can be moved, copied, deleted, or saved easily. Write-On! does not have an autolink command for editing, so you cannot edit across files (as you can with Super-Text) but it does have a merge command similar to that in Datacope's Scribe. Text from a disk file can be inserted anywhere in the text that you are currently editing. Overall, the editing commands are easy to learn and use.

The standard Apple DOS (disk

operating system) is used. However, text files are loaded and saved using BLOAD and BSAVE, which reduces waiting time considerably. The saving and loading commands are clear and understandable, and have prompts that lead the user through the process. If you are a programmer, you can modify this function quite easily, because Write-On! is completely modifiable and copyable. There are some machine-language subroutines for *find* and *replace* functions, but those subroutines work well so there is little need to change them. The program runs in 48 K-byte machines only, but there is adequate room for lengthy files. The manual doesn't tell you what happens if the text buffer fills up, but we never encountered that problem.

There does appear to be a problem where output is concerned: there is no provision for a machine-language driver (sometimes used to drive a nonstandard printer). When initially configured, Write-On! only asks what slot your printer is in. In addi-

A REFURBISHED "SELECTRIC" ASCII TERMINAL
FOR THE SMALL BUSINESSMAN OR SERIOUS HOBBYIST.

The AJ 841 I/O terminal. Now available from dealers nationwide.

Demand for our AJ 841 I/O computer terminal has been great. And now it's getting even greater. So call your local computer shop dealer right away. Supply is limited! You may never have another opportunity like this one to buy your own *professional* terminal.



*Suggested retail price

The AJ 841 features:

- Serial RS-232 interface
- ASCII code
- 14.9 cps printout
- High quality Selectric printing
- Heavy-duty Selectric mechanism
- Off-line use as typewriter
- Documentation included
- 30-day warranty on parts and labor (details available on request)

Call toll-free now

For location of your nearest AJ dealer, call toll-free:

800/538-9721

California residents call collect 408/263-8520, Extension 263.

Available only in the continental United States

 **ANDERSON
JACOBSON**

New Products From Orange Micro

Mix APPLES and ORANGES?

... And you get GRAPHICS!

NEW

THE GRAPPLER™ Apple Interface and Cable

The Grappler™ interface card is the first to provide on-board firmware for Apple high resolution dot graphics. No longer does the user need to load clumsy software routines to dump screen graphics – it's all in a chip. Actually, it's our E-PROM, and it is replaceable to accommodate the Anadex, Epson MX80 & MX70, IDS Paper Tigers, Contronics 739, and future graphics printers. The Grappler™ accepts 17 software commands including Hi-Res inverse, 90° rotation, double size, and much more.

GRAPPLER INTERFACE COMMANDS

TEXT COMMANDS

Let CTRL-G Ring Printer Bell
Output High Bit
Turn on Video Screen, Set Line Length to 40
Don't Append LF's onto CR's
Set Left Margin to n
Set Page Length to n
Set Right Margin to n
Dump Text Screen to Printer
Don't Output High Bit
Change to New Command Character

Change Back to Command Character
Turn off Video. Set Line Length to n

GRAPHICS COMMANDS

Output Hi-Res Page 1
Output Hi-Res Page 2
Output Hi-Res Page 1 Inverse
Output Hi-Res Page 1 Rotated 90°
Output Hi-Res Page 1 Double Size
Commands May Be Used Together:
Output Page 2 Inverse Rotated 90°

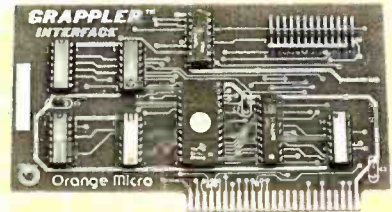

\$165.00 Includes Cable

Dealer Inquiries Invited

NEW

MX80/MX70 FRICTION FEED

HERE AT LAST! A friction feed kit for your EPSON MX80/70. The kit allows the user to convert his Epson printer to a friction feed and pin feed mechanism.

The friction feed will accept single sheets of your letterhead, or multiple copy forms such as invoices with up to 4 part carbon copies.

The pin feed replaces the adjustable sprocket mechanism. It allows use of 9½" wide continuous fanfold paper which is an industry standard size.

No drilling required. Installation takes about 15 minutes. All parts are included with easy to follow instructions.

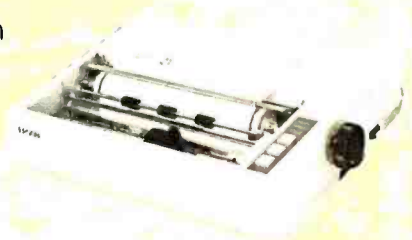

\$75.00

CALL FOR FREE CATALOG

(800) 854-8275

CA, AK, HI (714) 630-3322

At Orange Micro, we try to fit the right printer to your application. Call our printer specialists for free consultation.

TELEPHONE ORDERS: Mon.-Fri. 8:30 - 5:00
The Orange Micro Printer Store (Retail):
Mon.-Fri. 10:00 - 6:00, Sat. till 4:00



Phone orders WELCOME; same day shipment. Free use of VISA & MASTERCARD. Personal checks require 2 weeks to clear. Manufacturer's warranty included on all equipment. Prices subject to revision.

Orange Micro, Inc.

3150 E. La Palma, Suite I
Anaheim, CA 92806

tion, it is not very adaptable to particular features of different printers. Although Write-On! has several features such as underlining and boldface, it needs some user-defined control characters because it does not provide for such conditions as different type fonts, super-/subscripting, different color ribbons, or proportional spacing. It will justify to the right margin, and it does a good job of it. The text doesn't look thin in any particular spot.

Write-On! changes easily from sheet to continuous form. Page numbers can be moved to any position on the page, and numbering can be suppressed. While we were investigating page numbering, we encountered a mystery: Write-On! only allows an absolute page number, yet the manual, which was written with Write-On!, has chapter-relative page numbers (eg: 3 - 4). It seems there is a command that allows a string to be printed to the left or the right of the page number. The chapter must have been inserted as that string and then

changed at the beginning of every chapter. This is still mysterious, however, because the manual makes no mention of it. (Except for the EasyWriter Professional word processor, none of these word processors have provisions for footnoting, and Write-On! is no exception.) Write-On! also provides predefined titles. You can define up to twenty titles, which will appear at the beginning of each page.

Write-On! II even provides for form letters using data files. You can build a file of personal or company names, or addresses, and then insert them into a form letter upon printout. This is a tremendously powerful and useful feature (especially for the price). As if this is not enough, Rainbow includes a data-file converter program that takes files from mailing lists and general ledgers and automatically converts them to the proper data-file format. If you want to insert data while your text is printing, Write-On! will accept input from the keyboard and print it where you have

embedded the special control character. It even provides for a string that will print on the screen to prompt for the proper information. These are undoubtedly the most powerful features found in a microcomputer-based word processor.

The human engineering in Write-On! is superb. All of the commands are mnemonic and provoke little confusion. Most of the commands use only one keystroke, thus simplifying matters even further. Although the print module is separate from the editor program, its use is simplified by prompts and a menu selection. All of the editing and printing commands are prompted, and error traps are included so that it is difficult to inadvertently destroy several hours of typing.

Along with the excellent human engineering, Write-On! provides superlative documentation. This documentation leads the user by the hand; explanations of the various features are clear and concise, and even the complex operations make sense the

Text continued on page 196

AUTHORIZED DISTRIBUTOR AUTHORIZED DISTRIBUTOR AUTHORIZED DISTRIBUTOR AUTHORIZED DISTRIBUTOR AUTHORIZED DISTRIBUTOR AUTHORIZED DISTRIBUTOR AUTHORIZED DISTRIBUTOR AUTHORIZED DISTRIBUTOR AUTHORIZED DISTRIBUTOR AUTHORIZED DISTRIBUTOR

DIABLO Model 630

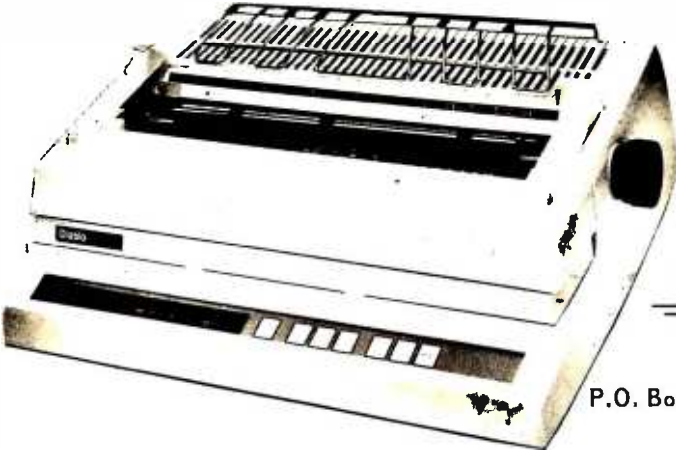

**VEYTEC has the new
DIABLO Model 630
in stock
ready for shipment.**

VEYTEC, INC.
COMPUTER SUPPLIES AND ACCESSORIES

P.O. Box 13947 • 942 E. Fairlane Ave. • Pine Castle, FL 32809
305-859-7340

Inside Florida 800/432-9205 Outside Florida 800/327-9744

WE HAVE A FACTORY TRAINED SERVICE DEPARTMENT

Circle 379 on inquiry card.

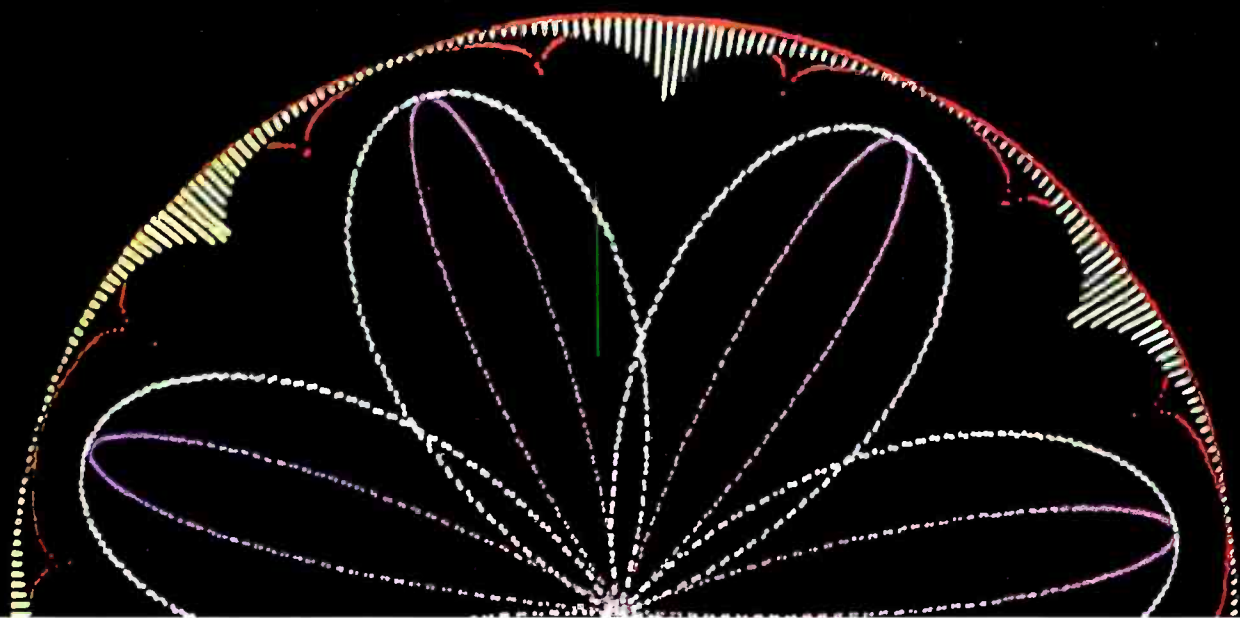

Inversions Digital Harmony

Illusion...
Calligraphy...
Visual Magic...



While Inversions delights the eye and enchants the mind, Digital Harmony lays the foundation for a whole new field of audiovisual art made possible by microcomputers. Both books pioneer new forms.

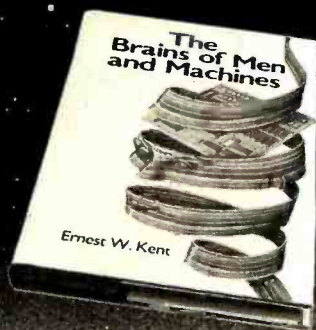
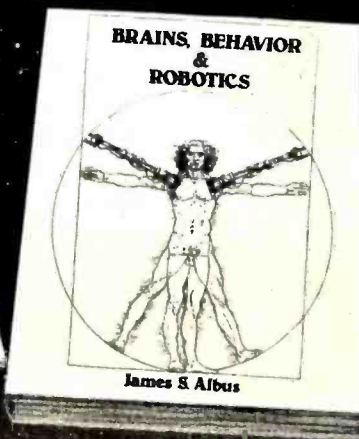
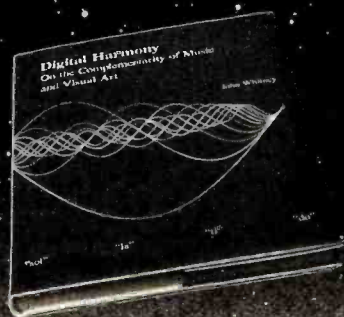

AVAILABLE FALL 1981

DIGITAL HARMONY

by John Whitney

A new synthesis of sight and sound

Digital Harmony lays the foundation for the whole new field of audio-visual art made possible by microcomputers. John Whitney, a pioneer of the special effects technology used in STAR WARS and 2001: A SPACE ODYSSEY, explains the special union of computer graphics and music. His computer-generated visual art graphically depicts the laws of harmonic motion common to all music.

Digital Harmony includes a complete description of Whitney's computer, peripherals, and film techniques. Colorful illustrations are included, as well as the program listings that generated them. The descriptions are sufficient for anyone to begin to explore this new territory as a composer and computer experimenter - transforming the small computer into an ideal instrument for creating compositions in aural and visual art.

John Whitney is on the Faculty in the Department of Art at the University of California, Los Angeles.

ISBN 0-07-070015-X
240 pages
hardcover
over 50 color photographs

\$21.95

INVERSIONS: A Catalogue of Calligraphic Cartwheels

by Scott Kim
Foreword by Douglas Hofstadter
Backward by Jef Raskin

Surprising symmetries in design and letterforms

Illusion... calligraphy... visual magic - Scott Kim's new book, *Inversions*, delights the eye and enchants the mind. Filled with intriguing designs, words that read the same right-side up and upside down, words within words, and unexpected symmetries, these compositions create a fresh way to look at the alphabet. The text includes the visual principles of symmetry, lettering, and problem solving that are basic to these images. The author also draws parallels to related exercises in perception in such diverse areas as art, music, word play, and mathematics. Scott Kim's original inversion designs first appeared in *Omni* magazine, inspiring an overwhelming reader response. An irresistible challenge, invertible writing appeals to everyone who loves beauty in mathematics and design.

Scott Kim is a doctoral student in Computer Science at Stanford University and is a concert pianist and composer.

ISBN 0-07-034546-5
128 pages
softcover
over 50 illustrations
available summer 1981

\$8.95

BRAINS, BEHAVIOR, AND ROBOTICS

by James S. Albus

Robotics design and applications

This computer-oriented guide explores how the brain functions primarily as a computer device for generating and controlling behavior. The author assesses behavior as a product of three hierarchies of computing modules:

- memory modules
- behavior-generating modules
- sensory-processing modules

A section on artificial intelligence ties this hierarchical model to vital computer science techniques such as planning, problem-solving, machine vision, natural language understanding and knowledge representation. A closing section on robotics discusses the design considerations in constructing a robot control system fashioned after this model of the brain, and explores the current and potential use of robots in our environment.

Dr. James S. Albus is Project Manager with the National Bureau of Standards.

ISBN 0-07-000975-9
400 pages
hardcover
180 illustrations

\$15.95

THE BRAINS OF MEN AND MACHINES

by Ernest W. Kent

Human models for computer design

When the "Brains of Men and Machines" series of articles first appeared in *BYTE* magazine, the response was immediate and enthusiastic. Now Ernest W. Kent has expanded his ideas about the brain into a full-length book. As researchers begin to unravel the mysteries of the brain's chemical, electrical, and synaptic circuitry, their findings are becoming immediately applicable to advances in robotic behavior and computer design. The Brains of Men and Machines "dissects" the brain to provide new insights into computer design and artificial intelligence.

It is one of the rare books that transcends disciplinary boundaries. In it the ever-increasing relationship between man and machine is freshly examined - a relationship, Professor Kent concludes, that is today being reexamined in the light of man's own neurological self-image.

Dr. Ernest W. Kent is a Professor of Physiological Psychology and Psychopharmacology at the University of Illinois at the Chicago Circle Campus.

ISBN 0-07-034123-0
304 pages
hardcover
illustrated

\$15.95

The BYTE BOOK Collection

Circle 41 on Inquiry card.

BASIC SCIENTIFIC SUBROUTINES, VOLUMES 1 AND 2

by Fred Ruckdeschel

BASIC Scientific Subroutines Vol. 1
F. R. Ruckdeschel

Valuable programs for professional and hobbyist

Designed for the engineer, scientist, experimenter, and student, this series presents a complete scientific subroutine package in BASIC.

- Volume 1 covers plotting, complex variables, vector and matrix operation, random number generation, and series approximations.
- Volume 2 continues with least-squares approximation, special polynomial functions, approximating techniques, optimization, roots of functions, interpolation, differentiation, integration, and digital filtering.

These volumes feature routines written in both standard Microsoft and North Star BASIC, extensive appendices, and subroutine cross-references.

Dr. Fred Ruckdeschel is a Principal Scientist with Dynacomp, Inc.

VOLUME 1
ISBN O-07-054201-5
336 pages
hardcover
illustrated

VOLUME 2
ISBN O-07-054202-3
384 pages hardcover
illustrated
available Fall 1981

\$19.95

\$23.95



THE BYTE BOOK OF PASCAL

Blaise W. Liffick, Editor

A powerful, structured language

Based on articles, language forums, and letters from BYTE magazine, this work is a valuable software resource. Pascal continues to be popular as a structured programming language. Written for both potential and established users, this book introduces the Pascal language and examines its merits and possible implementations. Featured are two versions of a Pascal compiler, one written in BASIC and the other in 8080 assembly language; a p-code interpreter written in both Pascal and 8080 assembly language; a chess-playing program; and an APL interpreter.

ISBN O-07-037823-1
334 pages
hardcover

\$25.00

THREADED INTERPRETIVE LANGUAGES

by Ronald Loeliger



How to implement FORTH on your Z80

Threaded languages (such as FORTH) are compact, giving the speed of assembly language with the programming ease of BASIC. They combine features found in no other programming languages. This book develops an interactive, extensible language with specific routines for the Zilog Z80 microprocessor. With the core interpreter, assembler, and data type defining words covered in the text, it is possible to design and implement programs for almost any application and equivalent routines for different processors.

Ron Loeliger is a Senior Analyst with Intermetrics, Inc.

ISBN O-07-038360-X
272 pages
hardcover
illustrated

\$18.95

BEGINNER'S GUIDE FOR THE UCSD PASCAL SYSTEM

by Kenneth L. Bowles

The most popular Pascal version explained by its creator

Written by the originator of UCSD Pascal System, this informative book is an orientation guide to the UCSD Pascal System. For the novice, this book steps through the System, bringing the user to a sophisticated level of expertise. Once familiar with the System, the reader will find the guide an invaluable reference tool for creating advanced applications. The package offers programs which may be run without alteration on:

- DEC PDP-11 or General Automation minicomputers
- Western Digital Microengines
- 8080, 8085, Z80, 6502, 6800, 9900 or AM-100 based microcomputers (including the popular Apple II and Radio Shack TRS-80 microcomputers)

Dr. Kenneth L. Bowles is Director of the Institute for Information Systems, University of California, San Diego.

ISBN O-07-006745-7
204 pages
softcover

\$11.95

YOU JUST BOUGHT A PERSONAL WHAT?

by Thomas Dwyer and Margot Critchfield



A Structured Approach to Creative Programming

Intended for both the novice programmer and the experienced computer enthusiast, this book presents practical ideas for personal computer use at home or at work.

Its approach is especially suitable for educational purposes. Written by the leading contributors of computer education material, this book is an entertaining and resourceful tool. There are over 60 ready-to-use programs written in Microsoft and Level II BASIC for the TRS-80 in the areas of educational games, financial record keeping, business transactions, disk-based files, and word processing.

Dr. Thomas Dwyer is a Professor of Computer Science at the University of Pittsburgh.

Margot Critchfield is a doctoral student in Foundations in Education at the University of Pittsburgh.

ISBN O-07-018492-5
343 pages
softcover
78 illustrations

\$11.95

BEYOND GAMES: SYSTEM SOFTWARE FOR YOUR 6502 PERSONAL COMPUTER

by Kenneth Skier



Creating programs for the Apple, Atari, Challenger and PET computers

At last, a complete programming guide-book for owners of personal computers utilizing the 6502 microprocessor. A self-contained course in structures programming and top-down design, this book presents a powerful set of tools for building an extended monitor, disassembler, hexadecimal dump routine, and text editor programs. Programs are thoroughly explained, with clear instructions for modifications.

Kenneth Skier is a Systems Programmer for Wang Laboratories, Inc., and a Lecturer at MIT.

ISBN O-07-057860-5
440 pages
softcover
illustrated

\$14.95

stimulating, provocative, problem-solving

Circle 42 on inquiry card.

BYTE June 1981 193

CIARCIA'S CIRCUIT CELLAR

by Steve Ciarcia



Practical uses for home computers

Imaginative and practical, Ciarcia's Circuit Cellar details a variety of microcomputer projects. A collection of the best articles from the popular series in BYTE magazine, this volume includes

- D/A conversion
- Programming EPROMs
- AC remote-controlled appliances
- digitized speech
- touch input video display

Complete instructions are given on how to construct each project. With amusing anecdotes and an easy-going style, Ciarcia presents his material in such a manner that even a neophyte need not be afraid of it.

ISBN 0-07-010960-5
125 pages
softcover
color photographs and diagrams

\$8.00

CIARCIA'S CIRCUIT CELLAR, VOLUME II

by Steve Ciarcia



More practical uses for home computers

Composed of popular articles from BYTE magazine, this volume tells how microcomputers can be uniquely interfaced to our environment. Projects include

- building a computer controlled home-security system
- computerizing appliances
- transmitting digital information over a beam of light
- building the Intel 8086 microprocessor system design kit
- input-output expansion for the TRS-80

ISBN 0-07-010963-X
224 pages
softcover
photographs and diagrams

\$12.95

MICRO-COMPUTER STRUCTURES

by Henry D'Angelo



Digital Electronics, Logic Design, and Computer Architecture

Today, there is an increasing demand for computer users who are not only well-versed in software, but who can also maintain, modify, and design their own hardware systems.

This text introduces computer users with little or no background in digital hardware to the basic computer structures used in microcomputer design and microcomputer interfacing. Helpful examples and end-of-chapter exercises further illustrate the various concepts presented, and a detailed bibliography provides additional reading opportunities. As a resource and textbook, it will assist

- programmers and systems analysts
- engineers and scientists
- managers
- students

Detailed Instructor's Manual also available.

Dr. Henry D'Angelo is the Associate Dean of the College of Engineering and Professor of Manufacturing Engineering at Boston University.

ISBN 0-07-015294-2 Instructor's Manual
288 pages
hardcover
314 illustrations
available spring 1981

ISBN 0-07-015298-5
softcover

\$18.95

\$8.95

BYTE Books' reputation is based on providing technically accurate, useful, and timely information. Established on the same principle as *BYTE* magazine, BYTE Book's evolved in response to the rapidly expanding audience of home and business computer users. Computer professionals and enthusiastic newcomers need to keep pace with this unabated growth. This selection of BYTE books can expand your library of knowledge and expertise.

TO ORDER, CALL TOLL FREE 800-258-5420, OR FILL OUT YOUR CHOICES IN THIS COUPON and return it with check, money order, or charge card number to:

BYTE BOOKS
70 Main Street
Peterborough,
New Hampshire 03458

BUILD YOUR OWN Z80 COMPUTER

by Steve Ciarcia



Every step spelled out for do-it-yourself buffs

For the engineer, computer technician, student, and anyone interested in building a computer rather than buying one, this practical guide shows how to build a working computer based on the Zilog Z80 microprocessor. Each computer subsystem is fully explained and supported by proven design and testing information. The description focuses on a basic single-board microcomputer containing

- easy expansion to include a video terminal
- a 1 K-byte operating system
- serial and parallel ports
- hexadecimal display
- audio cassette mass storage

Readers can modify the system to meet personal needs.

Steve Ciarcia is a Computer Consultant, Electrical Engineer, and author of "Ask Byte" and "Ciarcia's Circuit Cellar" columns in *BYTE* magazine.

ISBN 0-07-010962-1
330 pages
softcover
available summer 1981

\$15.95



BYTE BOOKS

70 Main Street
Peterborough, New Hampshire 03458

Name _____

Address _____

City _____ State _____ Zip _____

- Check enclosed in the amount of _____
-  Bill Visa. Card Number _____
-  Bill Master Charge. Card Number _____
- Expiration Date _____

Include 75c per book to cover postage and handling.

TITLE	PRICE	QUANTITY	AMOUNT
SHIPPING			
TOTAL			

order now . . . !



Circle 43 on Inquiry card.

MINDSTORMING

In most contemporary educational situations where children come into contact with computers the computer is used to put children through their paces, to provide exercises of an appropriate level of difficulty, to provide feedback, and to dispense information. The computer programming the child. In the LOGO environment the relationship is reversed: The child, even at preschool ages, is in control: The child programs the computer. And in teaching the computer how to think, children embark on an exploration about how they themselves think. Thinking about thinking turns the child into an epistemologist, an experience not shared by most adults.

Logo Computer Systems, Inc. is a new company that has been formed to develop and disseminate the LOGO methodology. During the next few months it will be announcing a line of products: hardware, software, written materials, training services.

logo
computer
systems inc.

150 Montarville Blvd
Suite 206
Boucherville, Quebec
Canada J4B 6N7
(514) 641-0966

368 Congress St
Boston, Mass.
U.S.A. 02210

(617) 451-2646

Text continued from page 190:

first time. Examples, both in the manual and in text-file form on the reverse side of the disk, accompany the tutorial narrative. Finally, there is a quick reference sheet near the back of the manual that explains every command (our version is on 14-by-11-inch printout paper, but Rainbow plans to reduce it to an 8½-by-11-inch card).

The manual also includes a question and answer sheet that tries to anticipate any problems, and a reader service card on which you can describe any problem not covered by the question and answer sheet and send to Rainbow for an answer. If you'd rather not wait for the return of the reader service card, you can call Rainbow, and they will try to solve your problem over the phone. No listings of the program are provided, but this is unnecessary as you can load and list it yourself. The program is not a marvel of documented programming, but then BASIC is not known for its accessibility.

Write-On! is amazingly error-free, and it ran the first time we put it on the computer. It can also be easily converted to the new 16-sector format. One of us thinks that Write-On! is his choice of all the word processors that we reviewed. The only reason we didn't use it to prepare this review is that it won't support all of the features of the Centronics 737, which was the printer we used for our final copy.

The Datacope Scribe

The Datacope Scribe (from Datacope) is the only word processor we reviewed that requires the Dan Paymar lowercase adapter (which provides true lowercase and uppercase letters on the monitor's screen). One would hope that use of the adapter would eliminate use of inverse characters. However, this word processor uses inverse characters to indicate the various editing functions, such as centering, underline, or new page or paragraph. All of the word processors we reviewed use inverse characters for various reasons (e.g. special character representing new paragraph). Inverse characters and

special characters are items that we will have to live with, at least for now. The Datacope Scribe does, however, provide a feature that allows us to view the text without all the special control characters: this will be described later in the review.

The Datacope Scribe utilizes two techniques found in several of the word processors for the Apple II: use of the ESC key for shift and use of Control-A for shift lock. The word processor accommodates touch typists and eliminates the need to worry about margins. Hyphenation is indicated by a hyphen when you execute the "implementation" command (the command that causes the word processor to execute all the other commands you have given it). Scribe then prompts for your approval (press RETURN). If you wish to change the location of the hyphen, press either of

The Datacope Scribe Is the only word processor described that requires the Dan Paymar lowercase adapter.

the arrow keys until the hyphen is where you want it, then press RETURN.

Tab stops are input through the use of control-Y. Each time a control-Y is pressed, an inverse ^ appears on the screen. This prints the next character at the next tab position (as given by the values in the tab position table). The word processor supports line centering, underlining and indentation.

The Datacope Scribe has the ability to specify, during input, locations where keyboard input is desired during printing. This feature is nice for adding personal touches to form letters or addresses to letters. Text files on a disk other than the one being worked on must be appended to the current file (i.e. they cannot be inserted into the middle of the file). This requires that you preplan in detail before you enter text.

Editing is accomplished with cursor control and additional support from buffer (text-blocks) movements. The Datacope Scribe includes on-line reference guides that will assist the novice during entry and edit modes. These guides provide information on the various control keys and functions. By using the customize program, these guides may be removed from the word processor to make room for more text.

After the text has been entered and edited, the define mode should be

At a Glance

Name
Datacope Scribe

Type
Word processor

Manufacturer
Datacope
PO Drawer AA
Hillcrest Station
Little Rock AR 72205

Price
\$79.95

Format
5-inch floppy disk

Language
6502 machine language

Computer
Apple II or II+ with Language Card or ROM Applesoft; 48 K bytes of memory, and one disk drive

Documentation
34 pages, 22 by 28 cm (8.5 by 11 inches); booklet form, pre-punched for three-ring binder

Hardware Required
Dan Paymar lowercase adapter and a printer

Audience
Anyone needing a word-processing system

THIS MAY BE THE MOST IMPORTANT BOOK YOU READ THIS YEAR

COMPUTER
REFERENCE
GUIDE

135 South Harper Avenue,
Los Angeles, CA 90048.

Phone: (213) 852-4886

MICROCOMPUTER
REFERENCE
HANDBOOK

The **MICROCOMPUTER REFERENCE HANDBOOK** reviews in detail more than 130 microcomputer systems from over 50 major microcomputer suppliers, including some of the latest Japanese manufacturers. It is designed to aid both first time and experienced computer users in choosing a single-board microcomputer or microcomputer system to suit their application. It is presented in four parts.

PART I. Chapters 1 to 3 include a wealth of useful information on microcomputer theory including peripheral and software capability. Succeeding Chapters provide additional microcomputer information under the following headings: *BASIC Language Summary; Guidelines for the Selection of Microcomputers in Commercial Applications; Microcomputers and Word Processing, Big Future for Desktop/Personal Computers* (containing comments by IDC, a leading industry information resource); *Future Trends in Microprocessing and Microcomputing; Communications and Networking with Microcomputers; Microcomputers in Education; and Microcomputing For The Home Hobbyist.*

PART II. Covers a range of microcomputer software from independent vendors. Products discussed are broken down into the five major system types: CP/M-based; Apple Systems; Commodore Systems; Radio Shack TRS-80 Systems; and the 6800-based models. The different programs described include operating systems, high-level languages, utilities and a wide variety of application packages.

PART III. Provides a 2 to 5 page summary on more than 130 different microcomputers and microcomputer systems from over 50 suppliers. These summaries describe hardware, software, peripherals, pricing and head office location. The different microcomputer suppliers covered include, in manufacturer order:

- APF • AI Electronics Corp. • Archives • Alpha Microsystems • Altos • Apple • Atari • CADO • California Computer Systems • Commodore • Compucolor • Compucorp • Cromemco • Data General • Datapoint • Diablo Systems • Digilog • Digital Equipment • Durango • Exidy • Findex • Hewlett-Packard • IBM • IMS • Intel • Intelligent Systems • Intertec • MicroDasy's Millie • Micro V Corp. • Micromation • Mitsubishi • Motorola • Panasonic • QASAR • National Semiconductor • North Star • Ohio Scientific • Onyx • Pertec • Radio Shack • Sinclair ZX80 • Smoke Signal • SORD • SWTPC • Tektronix • Texas Instruments • Vector Graphic • Wang • Zenith • Zilog ... plus others.

PART IV. Includes a summary on a selection of terminals and printers for microcomputers. Both visual display and keyboard printing terminals are discussed as well as a number of low and high-speed character printers.

MICROCOMPUTER
REFERENCE
HANDBOOK

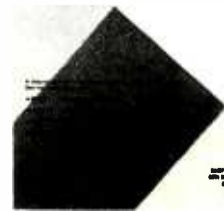

If you are interested in keeping abreast of this very important segment of the market or are planning to purchase a microcomputer for home, office or factory use then this Handbook is of vital interest to you. For just \$25 (or \$20 with introductory offer) it can save you up to six months of your own research, time and effort. The publication is printed 10.75" x 8.2" and contains over 250 pages. This publication will be available in May.

I would like to order the **MICROCOMPUTER REFERENCE HANDBOOK**. The cost of the HANDBOOK is normally \$25, plus \$2 postage and handling.

Special Introductory Offer (now extended to June 30th) is \$20, plus \$2 postage and handling.

Name Company
Address
.....
Zip Code Telephone ()

- Check enclosed (\$22) OR you may use your credit card
- Master Charge Card No.
- Visa Expiration

Californian purchases please add 6% sales tax.

Signature
(for Credit Card)

Mail this coupon or a copy to:
Computer Reference Guide, 135 South Harper Avenue,
Los Angeles, CA 90048. (213) 852-4886

B 6/81

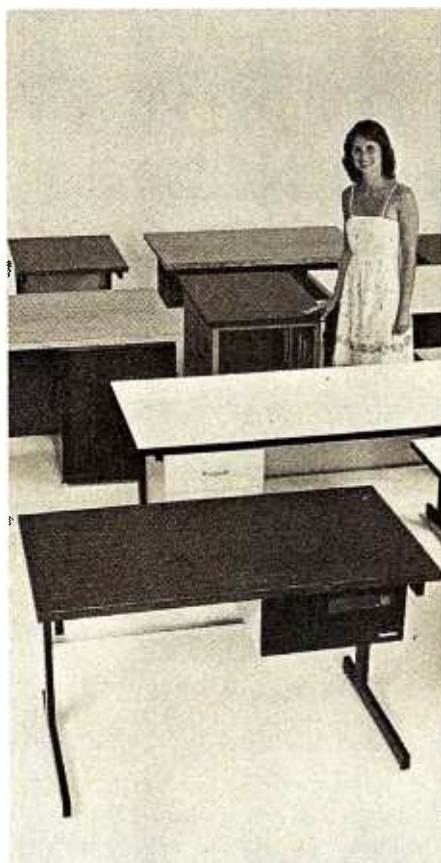

SIMPLY BEAUTIFUL.

CF&A furniture looks terrific. But beauty is more than skin deep. That's why our line of desks, stands, and enclosures also features rugged construction, low cost, and quick delivery. In a wide range of sizes and configurations. With accessories to meet your individual requirements. With a smile and a thank you.

Call CF&A. We make it simple. We make it beautiful.

CF&A

**Computer Furniture and
Accessories, Inc.**
1441 West 132nd Street
Gardena, CA 90249
(213) 327-7710

used to define the main format of the final printed text product. This feature allows you to set several parameters associated with printed output: left and right margin positions, number of lines per page, tab positions, single or double spacing between paragraphs and lines, justified right margin (yes/no), and page numbering (yes/no). Up to eight tab settings are provided. When you finish defining the format, use the implement command to prepare for viewing and/or printing. The view command enters the view mode, which displays the text on the monitor in the final output form. Of course, the view mode is limited by the Apple's 40-column display.

The Datacope Scribe is available in both DOS 3.2 and 3.3 versions, and the DOS 3.2 version will work on a DOS 3.3 Apple if you use the BASICS floppy disk first. The Datacope Scribe cannot be copied with standard copy programs. Should you develop disk problems, the processor can be replaced up to ninety days after purchase, with proof of purchase.

EasyWriter

The EasyWriter and EasyWriter Professional word processors have much in common. Anyone who changes to the Professional version should have little difficulty making the transition. Unlike Super-Text and Write-On!, however, there is a noticeable change between EasyWriter and EasyWriter Professional. EasyWriter uses Apple's 40-column display, while the Professional version uses any one of the three most popular 80-column video cards (M & R Sup'R'Terminal, Videx, or Double-Vision). This difference may be the deciding factor when you decide which version to buy. The serious user, most likely a professional, will probably purchase the video card and EasyWriter Professional and write off the cost as a business investment. The home user, unless she or he already has the video card, will purchase the 40-column version.

Both versions begin by offering a menu of activities. The Professional

version begins with the disk commands, whereas the original version displays the menu for the editor. The Professional version has added the ability to append disk files during input, which is not possible with the 40-column EasyWriter. The ability to append "glossary"-type files is just one example of the changes made to EasyWriter between versions. Input is much easier with the Professional version, because the 80-column display uses true uppercase and lowercase characters. The original EasyWriter uses the standard inverse characters for uppercase characters (as do most of the other word processors for the Apple). One nice feature about

At a Glance

Name

EasyWriter and EasyWriter Professional

Type

Word processor

Manufacturer

Information Unlimited Software
281 Arlington Ave
Berkeley CA 94707

Price

EasyWriter, \$99.95; EasyWriter Professional, \$250

Format

5-inch floppy disk

Language

FORTH (threaded 6502 machine language)

Computer

Apple II or II+ with 48 K bytes of memory and one disk drive

Documentation

50 pages, 15.5 by 23 cm (6 by 9 inches); three-ring binder

Hardware Required

Videx, M & R Sup'R'Terminal, or DoubleVision 80-column board (for Professional system only)

Audience

Anyone needing a word-processing system

4MHZ, DOUBLE DENSITY, COLOR & B/W GRAPHICS . . THE LNW80 COMPUTER



When you've compared the features of an LNW80 Computer, you'll quickly understand why the LNW80 is the ultimate TRS80 software compatible system. LNW RESEARCH offers the most complete microcomputer system at an outstanding low price. We back up our product with an unconventional 6 month warranty and a 10 days full refund policy, less shipping charges.

LNW80 Computer \$1,450.00
 LNW80 Computer w/B&W Monitor & one 5" Drive \$1,915.00
 All orders must be prepaid. CA residents please include 6% sales tax.
 Shipping and handling charge of \$15.00 must be included with every order.
 * TRS80 Product of Tandy Corporation.
 ** PMC Product of Personal Microcomputer, Inc.

COMPARE THE FEATURES AND PERFORMANCE			
FEATURES	LNW80	PMC-80**	TRS-80* MODEL III
PROCESSOR	4.0 MHZ	1.8 MHZ	2.0 MHZ
LEVEL II BASIC INTERP.	YES	YES	LEVEL III BASIC
TRS80 MODEL I LEVEL II COMPATIBLE	YES	YES	NO
48K BYTES RAM	YES	YES	YES
CASSETTE BAUD RATE	500/1000	500	500/1500
FLOPPY DISK CONTROLLER	SINGLE/DOUBLE	SINGLE	SINGLE/DOUBLE
SERIAL RS232 PORT	YES	YES	YES
PRINTER PORT	YES	YES	YES
REAL TIME CLOCK	YES	YES	YES
24 X 80 CHARACTERS	YES	NO	NO
VIDEO MONITOR	YES	YES	YES
UPPER AND LOWER CASE	YES	OPTIONAL	YES
REVERSE VIDEO	YES	NO	NO
KEYBOARD	63 KEY	53 KEY	53 KEY
HUMERIC KEY PAD	YES	NO	YES
B/W GRAPHICS, 128 X 48	YES	YES	YES
HI-RESOLUTION B/W GRAPHICS, 480 X 192	YES	NO	NO
HI-RESOLUTION COLOR GRAPHICS (NTSC), 128 X 192 IN 8 COLORS	YES	NO	NO
HI-RESOLUTION COLOR GRAPHICS (RGB), 384 X 192 IN 8 COLORS	OPTIONAL	NO	NO
WARRANTY	6 MONTHS	90 DAYS	90 DAYS
TOTAL SYSTEM PRICE	\$1,915.00	\$1,840.00	\$2,187.00
LESS MONITOR AND DISK DRIVE	\$1,450.00	\$1,375.00	---

LNW80

- BARE PRINTED CIRCUIT BOARD & MANUAL \$89.95

The LNW80 - A high-speed color computer totally compatible with the TRS-80*. The LNW80 gives you the edge in satisfying your computation needs in business, scientific and personal computation. With performance of 4 MHz, Z80A CPU, you'll achieve performance of over twice the processing speed of a TRS-80*. This means you'll get the performance that is comparable to the most expensive microcomputer with the compatibility to the world's most popular computer (TRS-80*) resulting in the widest software base.

FEATURES:

- TRS-80 Model I Level II Software Compatible
- High Resolution Graphics
 - RGB Output - 384 x 192 in 8 Colors
 - NTSC Video or RF MOD - 128 x 192 in 8 Colors
 - Black and White - 480 x 192
- 4 MHz CPU
- 500/1000 Baud Cassette
- Upper and Lower Case
- 16K Bytes RAM, 12K Bytes ROM
- Solder Masked and Silkscreened

LNW SYSTEM EXPANSION

- BARE PRINTED CIRCUIT BOARD AND MANUAL \$69.95
 WITH GOLD CONNECTORS \$84.95

The System Expansion will allow you to expand your LNW80, TRS-80*, or PMC-80** to a complete computer system that is still totally software compatible with the TRS-80* Model I Level II.

FEATURES:

- 32K Bytes Memory
- 5" Floppy Controller
- Serial RS232 120ma I/O
- Parallel Printer
- Real Time Clock
- Screen Printer Bus
- On Board Power Supply
- Solder Masked and Silkscreened

KEYBOARD

LNW80 KEYBOARD KIT \$84.95

The Keyboard Kit contains a 63 key plus a 10 key, P.C. board, and remaining components.

LNDbabler

- Assembled and Tested \$149.00

Double-density disk storage for the LNW Research's "System Expansion" or the Tandy's "Expansion Interface". The LNDbabler™ is totally software compatible with any double density software generated for the Percom's Doubler***. The LNDbabler™ provides the following outstanding features.

- Store up to 350K bytes on a single 5" disk
- Single and double density data separation
- Precision write precompensation circuit
- Software switch between single and double density
- Hardware override into single density only
- Easy plug in installation requiring no etch cuts, jumpers or soldering
- 35, 40, 77, 80 track 5" disk operation
- 120 day parts and labor Warranty

*** Doubler is a product of Percom Data Company, Inc.

00S PLUS 3.2D \$95.00

Micro Systems software's double density disk operating system. This operating system contains all the outstanding features of a well developed 00S, with ease in useability.

LNW DATA SEPERATOR

- Assembled and Tested \$17.95

The LNW Data Separator provides you with a reliable and inexpensive means of solving your disk data read error problems for your 5" single density drives. Compatible with both the LNW System Expansion and Tandy's Expansion Interface. Some soldering is required.

CASE

LNW80 CASE \$84.95

The streamline design of this metal case will house the LNW80, LNW System Expansion, LNW80 Keyboard, power supply and fan, LNDbabler™, or LNW Data Separator. This kit includes all the hardware to mount all of the above. Add \$12.00 for shipping

PARTS AVAILABLE FROM LNW RESEARCH
 4116 - 200ns RAM

- 5 chip set \$26.00
- 8 chip set \$33.50
- 16 chip set \$64.00
- 24 chip set \$94.00
- 32 chip set \$124.00

- LNW80 "Start up parts set" LNW80-1 \$82.00
- LNW80 "Video parts set" LNW80-2 \$31.00
- LNW80 Transformer LNW80-3 \$18.00
- LNW80 Keyboard cable LNW80-4 \$16.00
- 40 Pin computer to expansion cable \$15.00
- System Expansion Transformer \$19.00
- Floppy Controller (FD1771) and UART (TR1602) \$30.00

Circle 198 on Inquiry card.

LNW RESEARCH
 CORPORATION

2620 WALNUT ST.
 TUSTIN CA. 92680

VISA & MASTER CHARGE ORDERS & INFO. NO. 714-552-8946
 ACCEPTED Add \$3.00 for shipping SERVICE NO. 714-641-8850

this display is that only the letter displayed in inverse is made uppercase.

EasyWriter displays the least amount of extraneous information with the text of all the word processors covered in this review. Shift is accomplished by pressing the ESC key once; twice for shift lock. The Professional version also uses the ESC key, but allows for the wire between the shift key and 16-pin game I/O port (the game paddle connector) for easier use by a touch typist.

The method of ending paragraphs has also been improved. The original EasyWriter uses two shift-Ms, whereas the Professional uses only a return. The original version used one shift-M to end a line. The Professional's reference manual warns the typist to use the return only to start new paragraphs.

Paragraphs may be formatted to automatically indent through the use of special embedded commands, which are placed between text lines. These commands may appear more than once, thus providing the oppor-

tunity to change indentation formats several times in any document. Both versions of EasyWriter support the centering of lines of text, but the method of implementation varies. The original version uses the em-

EasyWriter has the least amount of extraneous information displayed with text.

bedded command technique, while the Professional uses a special editing tool that will be described later.

The 40-column version does not provide a method for viewing the text in final form, but the Professional's 80-column display is the image of the output. And since it is the direct image, an added capability is provided to align text, both after input and prior to printing. Through the use of "additional commands" (which

have their own menu screen), the Professional version allows you to realign margins, center lines of text, set and reset tabs, and, for use with printers such as Qume, Diablo, and Spinwriter, vary spacing between letters.

The Professional EasyWriter can translate files from the original 40-column version for use with the 80-column display. Both versions use various control keys to scroll up or down by page or line. Left or right movement on any line is performed with the Apple's normal arrow keys.

Editing is a pleasure with either version. Global search and block movement of text is supported in both versions, but global replace is supported only in the Professional. After you have finished editing, output can be tailored to each document, or you can rely on the default values. The original version accomplishes tailoring with embedded commands; the Professional version uses the additional commands to realign text (as described above), as well as optional

COMPLETE SYSTEM SUPPORT
Colonial Data SB/70
Altos
Zenith/Heath Z-89
TRS-80 MOD II

ACCOUNTING
INVENTORY CONTROL
MAILING LIST
WORD PROCESSOR

SOFTWARE PRICES START AT \$125

CALL IN YOUR ORDER NOW!
(617) 373-1599

"We're doing to SOFTWARE what 'MICRO' did for the computer."

SAM SYSTEMS, INC
P.O. Box 1225, 2 Washington Street, Haverhill, Ma. 01830

SPECIALISTS IN FULL SERVICE SYSTEMS

When Eight Is Not Enough: CP/M-86™ and CBASIC/86™

"In 1977 Compiler Systems, Inc. introduced CBASIC™ as a CP/M® programming language. It quickly became the most widely used BASIC dialect. Since then CBASIC has been adapted for use on systems supporting MP/M™ and TRSDOS."

"At Compiler Systems we learned the lessons of the past well. So well, that in the relatively short time we've been in the software business, we managed to make history ourselves. In fact, CBASIC is the standard for CP/M-based business systems."

— Gordon Eubanks, CSI president

Today CSI offers CBASIC/86 designed for 16-bit microcomputer-based systems running under CP/M-86. CBASIC/86, now available worldwide, is based on concepts first used by CBASIC including such business-oriented features as: BCD arithmetic with fourteen-digit precision; full format control of printed reports; random and sequential records of any length (not limited to 256 bytes); aids to structured design, i.e. multiple line functions and control structures as well as excellent file-handling and stringing capabilities.

But perhaps the best of CBASIC/86 becomes clear when you're using it. To learn more about CSI's commitment to support CBASIC/86 and CP/M-86 call (213) 355-1063 and discuss putting CBASIC/86 on your system.

Send this coupon today, we'll send details that go a long way toward answering your questions.

Name/Date _____

Company _____

Address _____

City/State/Zip _____

OEMs contact us for pricing

CBASIC/86 
WORLDWIDE DISTRIBUTION FROM

Compiler Systems, Inc., 37 N. Auburn Ave., P.O. Box 145
Sierra Madre, CA 91024, (213) 355-1063

The Shining Star Bytes the Big Apple!

**MICROHOUSE NOW HAS WORDSTAR
FOR APPLE II AND TRS 80!**

**SIZZLING
SOFTWARE
SAVINGS!**

WORDSTAR Apple Version

Finally, the 'Mercedes-Benz' of Word Processing Systems comes configured for one of America's favorite micros. Has all the features of the Standard WORDSTAR. Requires Microsoft's CP/M card, Videx Videoterm 80 x 24 screen conversion card (or equivalent), and at least 48K RAM.

List Price: \$375.00

Microhouse Price: **\$245.00/\$40.00**

MICPRO-WSAPPL

MAILMERGE for Apple

Custom type letters to whole lists of people, create documents using already existing paragraphs, write stock letters using 'ask variables' to insert names and addresses for one-at-a-time use. One of the most useful options on the market today.

List Price: \$125.00

Microhouse Price: **\$85.00/\$25.00**

MICPRO-MMAPPL

WORDSTAR

For CP/M[®]-based systems other than Apple. Available for TRS80[™].

List Price: \$495.00

Microhouse Price: **\$322.00/\$40.00**

MICPRO-WORDST

MAILMERGE

For CP/M[®]-based systems other than Apple.

List Price: \$150.00

Microhouse Price: **\$110.00/\$25.00**

MICPRO-MAILME

WORDSTAR CUSTOMIZATION

Package includes manual and diskette.

List Price: \$150.00

Microhouse Price: **\$95.00**

MICPRO-WSCUST

SUPERSORT I Apple Version

List Price: \$200.00

Microhouse Price: **\$130.00/\$40.00**

MICPRO-SSIAPP

SUPERSORT I

For CP/M[®]-based systems other than Apple. Can be used as a stand-alone program or can be linked to programs with a Microsoft format.

List Price: \$250.00

Microhouse Price: **\$170.00/\$40.00**

MICPRO-SUSOI

SUPERSORT II

Stand-alone-only version of Supersort I. For CP/M[®]-based systems other than Apple.

List Price: \$200.00

Microhouse Price: **\$145.00/\$40.00**

MICPRO-SUSOII

DATASTAR

List Price: \$350.00

Microhouse Price: **\$245.00/\$40.00**

MICPRO-DATAST

WORDMASTER

by MicroPro.

List Price: \$150.00

Microhouse Price: **\$119.00/\$35.00**

MICPRO-WORDMA

CBASIC 2

by Compiler Systems.

List Price: \$120.00

Microhouse Price: **\$85.00/\$15.00**

COMPIL-CBASIC

BASIC 80

Interpreter (MBASIC) by Microsoft. Versions 5.2 and 4.51 included.

List Price: \$350.00

Microhouse Price: **\$299.00/\$30.00**

MICROS-BASIC8

BASIC COMPILER

by Microsoft. Language compatible with MBASIC, but programs run 3-10 times faster. Includes MACRO80.

List Price: \$395.00

Microhouse Price: **\$330.00/\$30.00**

MICROS-BASCOM

STACKWORKS FORTH

For Z80 or 8080 (specify). Includes source and assembler.

List Price: \$175.00

Microhouse Price: **\$140.00/\$30.00**

SUPERS-FORTH

SSS FORTRAN w/RATFOR

Full ANSI '66 plus extensions. RATFOR compiles into Fortran: write structured code but keep the advantages of Fortran. Requires 32K.

List Price: \$325.00

Microhouse Price: **\$280.00/\$35.00**

SUPERS-FTNRAT

TCS/Atlanta INTERACTIVE

ACCOUNTING SYSTEM

for small businesses. Ver. 5.0. Each package can be used alone or post automatically to the General Ledger. Compiled version (nosupport language req.) Price listed is per package.

General Ledger, Accounts Receivable, Accounts Payable, and Payroll packages now available. Requires 48K RAM, 132 col. printer, 24 x 80 CRT, and CP/M[®].

List Price: COMPARE AT \$530.00

Microhouse Price: **\$79.00/\$25.00**

TCS-ACCTCM

ALL FOUR TCS PACKAGES (compiled)

List Price: Compare at \$530.00

Microhouse Price: **\$269.00/\$90.00**

TCS-ALL4CM



Software Manual
& Manual/Only

ORDER-NUMBER

embedded commands.

The provision for titling and numbering pages is one of the best we have seen for the Apple. The placement of titles and page numbers is limited only by your imagination.

Other advantages specific to EasyWriter Professional are suggestions and instructions for adding footnotes (the only word processor we reviewed that had such suggestions); capability of being linked to EasyMailer for processing of bulk mailings, and ability to transfer EasyWriter files over phone lines to other computers located anywhere in the world. (EasyMover and EasyMailer are separate programs and not part of EasyWriter. They can be obtained from Information Unlimited Software.)

Special printer characteristics are supported by both versions. Those printers that are capable of underlining, boldface printing, and super-/subscripting are conveniently accommodated.

EasyWriter's reference manual was input directly into an Addressograph Multigraph typesetting machine using the proportional spacing option. Even on a printer without proportional spacing, the text spacing is pleasing to the eye.

Many of the EasyWriter features are appealing from the human engineering aspect. Most of the commands on the menu are easy to remember and require only one key to invoke a command. The use of CTRL (control) keys is basically confined to cursor movements during editing.

Before it clears text or deletes files, EasyWriter requests verification: "ARE YOU SURE?" Insert operations can be confusing as to when the insertion mode is exited. (Datacope Scribe has probably done the best job of avoiding confusion on insert operations.)

EasyWriter manuals generally provide good, detailed explanations of the various features. Both manuals attempt to lead the user through the capabilities of the EasyWriter by presenting information that teaches its use and interlacing it with details of the various features.

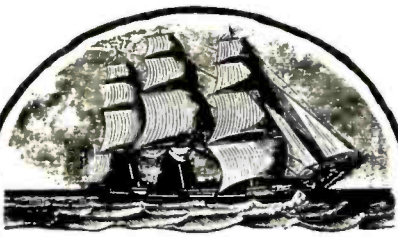

Fit to be TIDE

OR
*how WE kept
our head
above water IN*
1812.

Freedom of the seas.

That's what the War of 1812 was all about.

But it would have been sink or swim for our Navy had Americans not bought \$11,000,000 worth of government securities to keep our flag upon the waves.

Back then, folks took stock in America by putting their money where their country was. To save the good old Navy.

Today, over 9½ million modern Americans still take stock in America by buying U.S. Savings Bonds.

When you join the Payroll Savings Plan, you help yourself to safe, automatic savings. And you help your country, too.

So buy U.S. Savings Bonds.

They'll keep your savings on an even keel.

Now E Bonds pay 6% interest when held to maturity of 5 years (4½% the first year). Interest is not subject to state or local income taxes, and federal tax may be deferred until redemption.



Take stock in America.

 A public service of this publication and The Advertising Council.

Microhouse: Land of the Rising EPSON MX-70: \$378 MX-80: \$479

HOT HARD-TO-BEAT HARDWARE!

EPSON MX70

Includes Graftrax II dot-addressable graphics. Monodirectional. 80 cps. Adjustable tractor. Parallel version only.

List Price: \$450.00

Microhouse Price: \$378.00

EPSON-MX70

EPSON MX80

With its ingenious removable printhead, bidirectional and logic seeking, adjustable tractor, fine print quality. Parallel interface can be converted to RS232, IEEE 488, Apple, or Atari.

List Price: \$645.00

Microhouse Price: \$479.00

EPSON-MX80B

EPSON MX80 Serial Version

List Price: \$720.00

Microhouse Price: \$542.00

EPSON-MX80BS

EPSON MX80 FRICTION FEED

Includes tractor and friction feed plus Graphics Package. Parallel version.

List Price: \$745.00

Microhouse Price: \$569.00

EPSON-MX80FP

EPSON MX80 FRICTION FEED Serial

List Price: \$806.00

Microhouse Price: \$641.00

EPSON-MX80FS

EPSON APPLE INTERFACE

with Graphics ROM. Includes cable.

List Price: \$139.00

Microhouse Price: \$89.00

EPSON-APPLE

APPLE GRAPHICS SOFTWARE

for Epson equipped with EPSON-APPL.

List Price: \$39.95

Microhouse Price: \$34.00

EPSON-TYMAC

VIDEX VIDEOTERM SPECIAL!

Board converts your Apple screen display from 40 x 24 upper caseonly to 80 x 24 upper and lower case. Supports Apple PASCAL and MICROSOFT software. Purchase VIDEOTERM with WORDSTAR and save \$75! If purchased separately \$290.

List Price: \$345.00

Microhouse Price: \$270.00

VIDEX-VIDEOT

DIABLO 630

letter-quality printer uses plastic and metal print wheels. Fewer working parts mean less down time. 40 cps bidirectional, logic-seeking. Tractor \$225 extra.

List Price: \$2710.00

Microhouse Price: \$1999.00

DIABLO-630RO

C. ITOH STARWRITER I

Letter quality printer uses Diablo plastic printwheels and ribbons. 25 cps bi-directional, logic-seeking. Self-test. Friction feed. Parallel interface.

List Price: \$1895.00

Microhouse Price: \$1431.00

CITOH-STAR I

STARWRITER I Serial

List Price: \$1960.00

Microhouse Price: \$1502.00

CITOH-STARSI

IDS PAPER TIGER 560

List Price: \$1695.00

Microhouse Price: \$1464.00

IDS-560

IDS PAPER TIGER 460

List Price: \$1295.00

Microhouse Price: \$1072.00

IDS-460

IDS PAPER TIGER 445

New ballistic-type print head, monodirectional, up to 198 cps.

List Price: \$795.00

Microhouse Price: \$596.00

IDS-445

MORROW DISC M10

10 Megabyte hard disk subsystem. Incl. CP/M® 2.2.

List Price: \$3695.00

Microhouse Price: \$3062.00

MORROW-DISM10

MORROW DISC 2D

8 inch single-sided double-density floppy disk drive subsystem. Includes CP/M® 2.2 and MBASIC.

List Price: \$1199.00

Microhouse Price: \$995.00

MORROW-DIS2D

PRICES AND SPECIFICATIONS SUBJECT TO CHANGE WITHOUT NOTICE

CALL OR WRITE FOR FREE CATALOG

CP/M is a registered trademark of Digital Research
UNIX is a registered trademark of Bell Labs
APPLE is a registered trademark of Apple Computers
TRS80 is a registered trademark of Tandy Corp.

SHIPPING: Add \$5 per manual or software package. Add \$2.50 for COD orders. Call for shipping charges on other items. Pennsylvania residents add 6 per cent sales tax.

Microhouse™

P.O. BOX 498B
BETHLEHEM, PA 18016
(215) 868-8219

Program	Titles	Global Search and Replace	Merge from Disk	Form Letters with Data Files	User-Defined Control Characters	Displays Lowercase (with adapter)	Requires Use of 80-Column Display Board	Print Multiple Files	Search Across Files	Supports Shift Key (with keyboard modification)	Split Screen	Wild-Card Search	Quick Reference Card	Chapter-Relative Page Numbers	Copyable	Uses Standard DOS	Preview Mode	Footnote
Write-On! I	Y	Y	Y	N	N	Y	N	Y	N	Y	N	N	Y	Y ³	Y	Y	N	N
Write-On! II	Y	Y	Y	Y	N	Y	N	Y	N	Y	N	N	Y	Y ³	Y	Y	N	N
Super-Text II	N	Y	N	N	Y	Y	N	Y	Y	Y	Y	Y	N	Y	N	N	Y	N
Scribe	N	N	Y	N	Y	Y ¹	N	N	N	Y	N	N	Y ²	Y	N	N	Y	N
EasyWriter	Y	N	N	N	Y	N	N	Y	N	N	N	Y	Y	N	Y	Y	N	N
EasyWriter Professional	Y	Y	Y	N	Y	Y	Y	Y	N	Y	N	Y	N	N	N	N	Y ⁴	Y

¹Requires Paymar lowercase adapter
²On-line quick reference
³Indirectly provided
⁴Print image appears on 80-column screen

Table 1: Feature comparison of four popular word-processing programs for the Apple II.

Conclusions

Choosing a word processor is similar to deciding on a microcomputer. Each has special features (see table 1), and none of the products have all the features.

If you want a word processor that performs math operations, the Super-Text II program is for you. If you're looking for a word processor that you can modify, and you know only BASIC, then Write-On! should satisfy your requirements. If you already have one of the 80-column cards, perhaps you should choose the EasyWriter Professional version. If you are looking for a workhorse processor that will handle bulk mailings,

then the EasyWriter Professional linked with EasyMailer is also for you, although Super-Text may meet this demand, and, with some pushing, Write-On! could meet the lower end of these requirements. DataCope Scribe has some very nice features, and if you only wish to process text and can live without a find-and-replace feature, the processor will fulfill your needs.

About this time, you may be thinking, "This is a typical review that says all the products are great." Possibly this is true, but we speak with some experience as we used all of the processors while preparing this article. Each met our needs, and performed

basic text processing in less than an hour.

A few years ago, such power in a small package, and at this price, was only a dream. And even today, some of the larger systems don't have equivalent features. ■

Acknowledgments

We would like to acknowledge David A Lingwood for his "Word Processor Guidelines," presented in Call-Apple, September 1980, page 19.

Bower-Stewart & Associates SOFTWARE AND HARDWARE DESIGN

\$GOLD DISK\$ CP/M® Compatible Z-80 Software

Available for all 8-5" SS-SD IBM format systems including TRS-80®, Northstar, SD Systems. Also available on 5" double density Superbrain®.

\$175.
ppd

Un-can your canned software!

Z-80 Disassembler Feel couped up with your canned software? Our Z-80 Disassembler recreates assembly language source files from absolute code enabling users to easily tailor programs to meet their specific needs. The Preconditioner works with the Disassembler to decode ASCII.

\$50.
ppd

Great looking letters & reports!

E-Z Text A unique word processor organized around user-created text files, embellished with simple control commands, which supports such 'BIG GUYS' features as Automatic Footnoting, Table Spacing, Heading, Paging, Left & Right Margins, Proportional Spacing and MORE. at a 'LITTLE GUYS' price tag.

Credit cards: Immediate service. free 24 hr phone - we will credit invoice. Checks, M.O.'s: Ten workday hold. CA res: Add tax



State system & controller Allow time for surface mail. Trademarks: Digital Research. Radio Shack. Intertec

POST OFFICE BOX 1389 HAWTHORNE, CALIFORNIA 90250 213 / 676-5055

MAROT ANNOUNCES THE FIRST COMPUTERS POWERFUL ENOUGH TO RELIEVE GROWING PAINS.

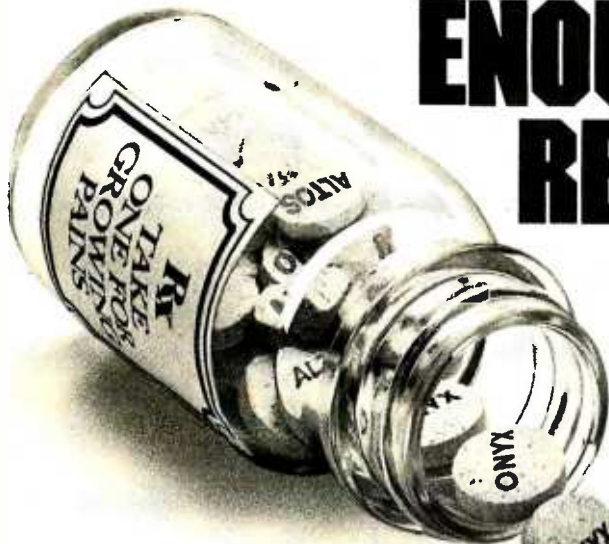

Sooner or later, your small business will look for a so-called "first" computer. And sooner or later, your small business will grow larger and need more computer capacity.

Fortunately, Marot Systems has anticipated your needs and offers two "first" computers that have the capacity to grow as large as you do.

Altos: upgradeable, portable and affordable.

Start out with a low cost multiuser Altos dual floppy based system with 208 K of RAM. It's perfect for inexpensive work stations or applications like accounting, word processing, mailing lists and more.

If you're already in need of more storage and greatly enhanced access speed, then look into the Altos 10Mb-58Mb hard disk systems. When combined with the standard 208 K of RAM, 6 serial I/O and 2 parallel ports, they become unusually



fast and powerful 4-user business or scientific systems.

All Altos systems are packaged with single board Z80 CPU, quality Shugart 8-inch disk drives, and options such as DMA (required for OASIS) floating point processors, and a cartridge tape back-up subsystem.

So as you grow, you just add onto your system. Without suffering the growing pains of eating the costs of your "first" computer.

Onyx: maximum integration in one sleek box.

The Onyx represents a new standard of quality and cost effectiveness in small business computers.

The 8-bit C8001/MU is an ideal multi-user system for business or word processing applications. It combines Z80 high speed processors, standard 128 K RAM, (expandable to 256 K), Winchester disk and integral cartridge tape drive in an efficient, compact package. And us-

Z80 is a trademark of Zilog, Inc.
C-BASIC II is a trademark of Compiler Systems
UNIX is a trademark of Western Electric Corporation

ing reentrant BASIC application programs, it allows up to 5 simultaneous operators.

When you need the power of a 16 bit computer, you want the C8002. It uses a special edition of Bell Laboratories UNIX operating system to accommodate up to 8 users involved in product development or executing application programs in C, COBOL, PASCAL or C-BASIC II.

You can also expand the RAM of the C8002 to 1 Mb and its disk capacity to over 300 Mb. So you get all the growing power you need. With none of the growing pains.

Marot: looking for good dealers for 2 great systems.

Marot, East Coast Distributor for Altos and Onyx, needs a few qualified dealers for these two hot items. If you're the great dealer we need, please contact us.



MAROT SYSTEMS, INC.

310 Madison Avenue, Suite 408,
New York, N.Y. 10017
(212) 661-8550 TWX: 710-581-2477

Circle 211 on inquiry card.

MAROT SYSTEMS INC.
310 Madison Avenue, New York, NY 10017

I am a computer consultant
 computer dealer computer user
Please send me more information on:
 Altos Onyx

Name _____

Title _____

Company _____

Address _____

City/State/Zip _____

Phone() _____



NEECO

WHY BUY FROM THE BEST?

Service... Support... Software...

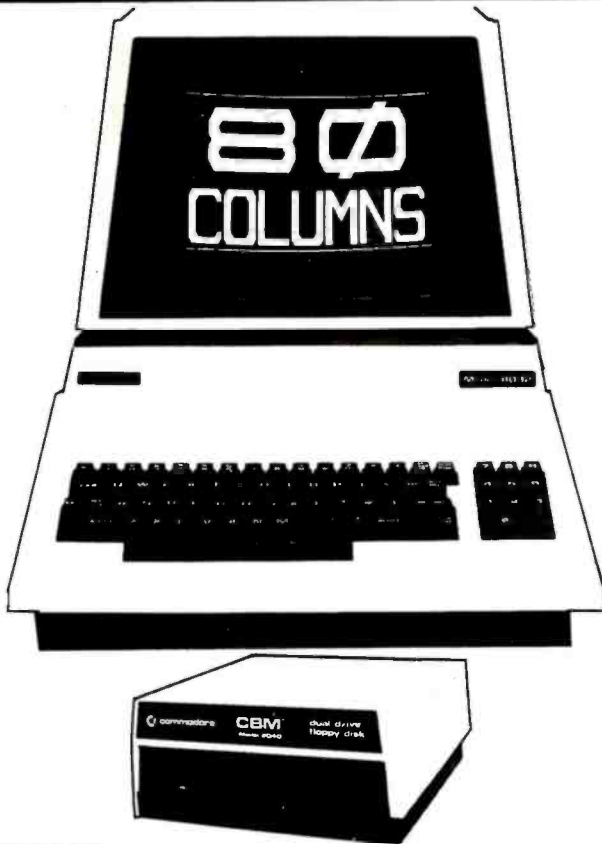

CBM™ 8000 SERIES BUSINESS COMPUTERS

The new Commodore 8000 series computers offer a wide screen display to show you up to 80-character lines of information. Text editing and report formatting are faster and easier with the new wide-screen display. The 8000 series also provides a resident Operating System with expanded functional capabilities. You can use BASIC on the 8000 computers in both interactive and program modes, with expanded commands and functions for arithmetic, editing, and disk file management. The CBM 8000 series computers are ideally suited for the computing needs of the business marketplace.

SCREEN

2000 character display, organized into twenty-five 80-column lines
64 ASCII, 64 graphic characters
3 x 8 dot matrix characters
Green phosphor screen
Brightness control
Line spacing: 1 1/4 in Text Mode
1 in Graphics Mode

SCREEN EDITING CAPABILITIES

Full cursor control (up, down, right, left)
Character insert and delete
Reverse character fields
Overstriking
Return key sends entire line to CPU regardless of cursor position

KEYBOARD

73-key typewriter style keyboard with graphic capabilities
Repeat key functional with all keys

INPUT/OUTPUT

Parallel port
IEEE-488 bus
2 cassette ports
Memory and I/O expansion connectors

MEMORY

CBM 8016: 16K (15359 net) random access memory (RAM)
CBM 8032: 32K (31743 net) random access memory (RAM)

FIRMWARE

24K or ROM contains:
BASIC (version 4.0) with direct (interactive) and indirect (program) modes
9-digit floating binary arithmetic
Tape and disk file handling software

POWER REQUIREMENTS

Volts: 110V
Cycles: 60 Hz
Watts: 100

CBM 8032 Computer \$1795

CBM™ 8050 DUAL DRIVE FLOPPY DISK

The CBM 8050 Dual Drive Floppy Disk in an enhanced version of the intelligent CBM 2040 Disk Drive. The CBM 8050 has all of the features of the CBM 2040, and provides more powerful software capabilities, as well as nearly one megabyte of online storage capacity. The CBM 8050 supplies relative record files and automatic diskette initialization. It can copy all the files from one diskette to another without copying unused space. The CBM 8050 also offers improved error recovery and the ability to append to sequential files.

HARDWARE SPECIFICATIONS

Dual Drives
Two microprocessors
974K Bytes storage on two 5.25" diskettes (ss)
Tracks 70
Sectors 17-21
Soft sector format
IEEE-488 interface
Combination power (green) and error (red) indicator lights
Drive Activity indicator lights
Disk Operating System Firmware (12K ROM)
Disk Buffer (4K RAM)

FIRMWARE

DOS version 2.0
Sequential file manipulation
Sequential user files
Relative record files
Append to sequential files
Improved error recovery
Automatic diskette initialization
Automatic directory search
Command parser for syntax validation
Program load and save

**CBM 8050
Dual Price \$1795**

CBM	PRODUCT DESCRIPTION	PRICE
4016	16K RAM-Graphics(N) or Business(B) Keyboard	\$ 995.00
4032	32K RAM-Graphics(N) or Business(B) Keyboard	\$1295.00
8032	32K RAM-80 Col. Screen-Business Keyboard	\$1795.00
4022	Tractor Feed Printer	\$ 795.00
4040	Dual Floppy-343K-DOS 2.0	\$1295.00
8050	Dual Floppy-974K-DOS 2.0	\$1795.00
4010	Voice Synthesizer	\$ 395.00
8010	300 Baud IEEE Modem	\$ 279.95
C2N Cassette	External Cassette Drive	\$ 95.00
CBMto IEEE	CBM to 1st IEEE Peripheral	\$ 39.95
IEEE to IEEE	IEEE to 2nd IEEE Peripheral	\$ 49.95
2.1 DOS	DOS Upgrade for 2040	\$ 100.00
4.0 DOS	O/S Upgrade for 40 Column Computer	\$ 100.00
Word Pro 4+	Word Processing Software used w/8032	\$ 450.00

*CBM is a registered trademark of Commodore. All prices and specifications are subject to change without notice.



NEECO

679 HIGHLAND AVE.
NEEDHAM, MA 02194

NEECO WILL MATCH ANY ADVERTISED PRICE ON CBM EQUIPMENT.

(617) 449-1760

Telex: 951021

MON-FRI 9:00 - 5:00
MasterCharge and VISA Accepted

NEECO

INTRODUCES THE CBM VIC-20 COMPUTER!

C Commodore
breaks the
computer
price barrier —

\$299.95



CBM VIC-20 PERSONAL COMPUTER

VIC-20 SPECIFICATIONS

- 8 colors - built in
- sound generation - built in
- programmable function keys
- 5K memory expandable to 32K
- standard PETBASIC in ROM
- full-size typewriter keyboard
- graphics character set
- plug-in program/memory cartridges
- low-priced peripherals
- joystick/paddles/lightpen
- self-teaching materials
- * WORKS WITH ANY HOME TELEVISION



\$74.95

C2N TAPE CASSETTE DRIVE

CALL NEECO TODAY FOR ADDITIONAL VIC-20 INFORMATION . . .

As the CBM VIC-20 is a "new" product, prices and specifications are subject to change w/o notice.

NEECO

NEECO WILL MATCH ANY ADVERTISED PRICE ON CBM EQUIPMENT FROM ANY OTHER COMPANY WITH PRODUCT IN STOCK.

(617) 449-1760

Telex: 951021

679 HIGHLAND AVE.
NEEDHAM, MA 02194

MON-FRI 9:00 - 5:00
MasterCard and VISA Accepted

News and Speculation About Personal Computing

Conducted by Sol Libes

IBM and Matsushita To Join Forces? Matsushita, the giant Japanese electronic conglomerate that markets Panasonic and Quasar products in the US, recently admitted that it had been approached by IBM in regard to manufacturing a personal computer for the US market. It's been rumored for some time that IBM is planning to market a Japanese-made personal computer in the US. Although Matsushita officials released no details regarding their talks with IBM, another report that Matsushita has already designed and built a personal computer has prompted some observers to theorize that the unit will bear the IBM name when it is marketed in the US later this year.

How Are The Personal-Computer Makers Doing? Tandy Corporation, Radio Shack's parent company, continues to have an outstanding growth record. Tandy's sales for the 1979-1980 fiscal year rose to \$1.4 billion, up from the previous year's \$1.2 billion. Its income has increased 35% since it joined the microcomputer business, which now totals 13% of its overall sales.

This year Tandy expects to add 400 more stores to its fold of nearly 8000. In the US, there will be 250 more stores and 50 computer centers. Tandy plans to open 100 outlets overseas. Foreign sales currently account for 25% of its total sales.

Each Radio Shack store stocks more than 2600 items. The largest portion of a store's sales is parts and accessories (23%), with radios, tape recorders and phonographs second (19%), other audio components third (17%), and toys and microcomputers tied for fourth place (13%). Citizen's Band radios (10%) and telephones (5%) constitute the remaining sales.

Tandy leads the field in microcomputer sales. It sold over 200,000 computers last year for a total of \$180 million.

Tandy's gross sales for the final half of calendar year 1980 were \$869 million, and profits were \$80 million, compared with \$739 million and \$60 million for the same period the previous year. The upward trend continues: sales this past January shot up to \$141 million, from \$112 million the year before.

You can still purchase a TRS-80 Model I in England. The Model I was pulled from US shelves in January because it did not comply with the Federal Communications Commission's radio-frequency-interference regulations. Also in England, TRS-80s are sold through independent computer stores as well as through Tandy-owned TRS-80 Computer Centers. So, the same dealer selling Apple IIs and Commodore PETs has TRS-80s on the display shelf. Some dealers also carry the Video Genie EG3000, the Far-Eastern copy of the TRS-80.

Apple Computer Inc also chalked up record sales and income last year. Sales for the last quarter of 1980 were

up 246%, and profits were up 180%. The demand for Apple products in the first quarter of 1981 was greater than anticipated, but the company considers it unlikely that this growth will continue into the second quarter of the year.

Apple revealed that the commissions required to sell its stock last year came to \$93.3 million, or \$1.30 a share. The stock initially sold for \$20 to \$25 a share; it peaked at a high of \$35, and it's currently selling in the neighborhood of \$25 a share.

Apple has had problems getting its Apple III computer into production. Announced in May 1980, the first Apple IIIs were not shipped until January 1981, and then only in limited quantities.

Commodore International's sales for the last quarter of 1980 were \$45 million, up from \$31 million for the same period in 1979. Commodore has announced plans to construct a \$5 million plant in the Philadelphia area to build its microcomputer systems. Commodore expects to hire 250 to 400 people for the operation and open it before year-end.

Sinclair Research, maker of the low-cost ZX80 personal computer, claims that it is number three in units shipped, behind Radio Shack and Apple.

Mattel's keyboard-equipped Intellivision personal-computer system seems to be bumping up against the same sort of buyer resistance that Texas Instruments encountered with its TI 99/4. Consumers

are put off by the keyboard unit's \$700 list price, plus \$300 for the game-playing "master" component—total cost \$1000. That's several hundred dollars more than the TRS-80 Color Computer, the Commodore VIC, and even Texas Instruments' TI-99/4. Further, Mattel has had delivery problems: it had originally intended to introduce the system in 1979. Intellivision's marketing is mainly through department stores.

First Personal Computer With Built-In Winchester-Disk Drive: Vector Graphic Inc has unveiled the first personal-computer system with a built-in Winchester-type hard-disk drive. The Model 3005 houses a video monitor, keyboard, S-100 motherboard, Z80 processor, 64 K bytes of programmable memory, a video interface called Flashwriter, a dual-mode disk controller, a Seagate Technology 5-inch Winchester drive, and up to three quad-density 5-inch floppy-disk drives. The system with one floppy-disk drive costs \$7950.

Tandy Files Suit Against Competitor: Tandy Corporation has brought suit against Personal Microcomputers Inc (PMC), Mountain View, California. Tandy accuses PMC of conspiracy and infringement on the design of the Radio Shack TRS-80 personal computer. Included in the suit are five manufacturers and dealers for Personal Microcomputers' PMC-80 personal computer. The PMC-80 is hardware- and

SOFTWARE SOFTWARE DIGITAL MARKETING™ DIGITAL MARKETING™

June 1981

DIGITAL MARKETING • 2670 CHERRY LANE • WALNUT CREEK • CALIFORNIA 94596 • (415) 938-2880

MILESTONE™ - \$295. Manual alone - \$30.
"Critical path" network analysis program for scheduling manpower, dollars and time to maximize productivity.

An interactive project management program that runs under CP/M and can relate together different skills, hourly pay rates and projects to maximize efficiency. MILESTONE could be used to track paper flow, build a computer, check a salesman's performance, or build a bridge. MILESTONE can be used by executives, engineers, managers, and small businessmen to:

- Find the critical tasks which can't be delayed.
- Discover which tasks are not time critical.
- See how manpower and expenses vary versus time.
- Investigate tradeoffs between manpower, dollars and time.
- Give plans to others using a printed project schedule.
- Change details and immediately see the results on screen.

Requires 54K RAM and CP/M. Specify Z80, 8080 or CDOS. Also available for Apple Pascal, UCSD Pascal or CP/M-86 operating systems.
Formats: 8, NS, MP, CDOS, SB, TRS2, APPL

DATEBOOK II™ - \$295. Manual alone \$25.
NOW SCHEDULES APPOINTMENTS FOR UP TO 27 DIFFERENT PEOPLE

- IMPROVED FILE STRUCTURE ALLOWS APPOINTMENTS UP TO ONE YEAR
- Replaces your office appointment calendar
- Searches for openings that fit time of day, day of week & day of year constraints
- Appointments made, modified or cancelled by a few key strokes
- Copies of day's appointments can be quickly printed

Requires 54K RAM and CP/M. Specify Z80, 8080 or CDOS. Also available for Apple Pascal, UCSD Pascal or CP/M-86 operating systems.
Formats: 8, NS, MP, CDOS, SB, APPL, TRS2

dBASE II™ - \$695. Manual alone - \$50.
Assembly language relational data base management system. Can be used interactively with English-like commands or program if using a command file. Can read your ASCII files and add the data to its own data base. Report generator and user-definable full screen operations allows use of your existing forms.

Requires 48K RAM and CP/M. Formats: 8, NS, MP, SB, APPL, TRS2

MAGIC MENU™ - \$75.
With Spellguard option - \$95.
Turns Magic Wand into a turnkey system. Allows move from EDIT to PRINT, backup of files or disks, system status, etc. from menu without returning to CP/M 2.x

Requires 56K RAM, CP/M and Magic Wand.
SPELL MENU™ - \$95. Spellbinder version of Magic Menu.
Formats: 8, NS, MP, SB, TRS2, APPL

OEMS and SOFTWARE DEVELOPERS
We can write a custom Menu for your software packages. Call us for details.

SELECTOR/86™ - \$650.
A totally self-contained CP/M-86 Data Base System providing complete data, procedural, query, and report definition functions. Allows records to be managed on a one-for-one basis, as well as in "batch" mode where several files can communicate with each other in a variety of ways. Includes "key fields". Record size is limited up to memory size (not limited up to 256 bytes). File size is unlimited up to disk storage space.
Requires CP/M-86 and CBASIC/86. Format: 8

PASCAL/M™ - \$225. Manual alone - \$20.
CP/M compatible language for 8080/8085 CPUs, supports full Jensen & Wirth plus 45 extensions to Standard Pascal including Random access files, 40 segment procedures & 16 bit BCD real type. NOW INCLUDES symbolic debugger which features trapping on stores, examining and changing variables and tracing of program execution.
Requires CP/M & 54K RAM. Formats: 8, NS, CDOS, APPL, TRS2

PASCAL/M for 8086/88™ - \$270.
Manual alone - \$20.
All features of Pascal/M for the 8086 and 8088 processors running under the 8086/88 version of CP/M.
Requires CP/M-86™ & 128K RAM. Format: 8

TRANS 86™ - \$125. Manual alone - \$20.
8086/88 Translator for existing 8080/8085 programs. The new source code can be easily edited and assembled using ACT II to produce hex code which can be executed by 8086/88. Emphasizes the extensions and features available in the 8086/88.
Requires CP/M and 32K RAM
Formats: 8, NS, CDOS, APPL

ACT I™ - \$125. Manual alone - \$15.
CP/M compatible macro assembler for Z80, 8080/85, 6502 & 6800.
One assembler that supports all major 8 bit micros. ACT features include full macro capabilities, comprehensive pseudo-ops, link-file structures, cross reference map, and algebraic expression processor. Requires 24K RAM & CP/M.

ACT II™ - \$175. Manual alone - \$20.
CP/M 2.x compatible cross assembler for 8086/88

ACT III™ - \$125. Manual alone - \$20.
CP/M 2.x compatible cross assembler for 6809.

ACT I and ACT II together™ - \$225.
Formats: 8, NS, CDOS, MP/M, TRS2, APPL

PEARL™ The application software generator Pearl asks questions that a programmer would have to answer to code the system. You answer the questions & Pearl uses built-in logic to construct both subroutines & mainline programs. The system then compiles & executes your program code.
PRODUCT/MANUAL
\$130./\$35.
\$350./\$35.
\$650./\$50.

Level 1: For Personal Computing -
Level 2: The Business Assistant -
Level 3: Adv. Software Develop.
Requires CP/M and CBASIC2. Formats: 8, NS, MP, SB, TRS2

CBASIC/86™ - \$325.
Industry standard intermediate code basic compiler with run-time interpreter for CP/M-86. Features include chaining, integer and external precision arithmetic, random and sequential records of any length (not limited to 256 bytes).
Requires CP/M-86. Format: 8

SELECTOR IV
S-BASIC
ULTRASORT-II
FABS
Textwriter III
Apple II HOME FINANCE PROGRAM
CBASIC2
Dealer Inquiries Invited

\$550.
\$295.
\$175.
\$125.
\$49.95
\$120.

PLAN80™ - \$295. Manual alone - \$30.
A financial modeling system that's easy to use yet powerful enough to replace most timesharing applications.

Lets you tackle any numeric problem that can be defined in a worksheet format. It performs complex calculations quickly and precisely and lets you examine "What If?" questions so you can evaluate more planning alternatives in greater detail.

With PLAN80 you get more than you calculated results - you know how you get them because you define rows and columns with familiar names such as UNITS, PRICE and JANUARY and express calculations in terms such as SALES=UNITS*PRICE. It's easy to review your assumptions and methods with people who have never seen PLAN80.

At any point in the PLAN80 model you may display or print results on your screen, printer or disk, save all or part of the results for use by another model, or play "What If?" by inputting new values, recalculating and displaying or printing results.

Best of all, you can incorporate PLAN80 results into any report that requires a financial model - using your word processor - to create professional results.

Requires 56K RAM and CP/M. Also available for CP/M-86, Specify Z80, 8080 or CDOS. Formats: 8, CDOS, NS, MP, 86

SPELLGUARD™ - \$295. Manual alone - \$20.
20,000+ word dictionary containing commonly used words that find spelling & typographical errors in text files. Allows review of mis-matched words & speedy search routine.
Proofs at 10,000 words/min.
Requires CP/M, 48K RAM & Magic Wand, WordStar™ or Spellbinder™
Formats: 8, NS, MP, SB, TRS2, CDOS

SPELLBINDER™ - \$495. Manual alone - \$50.
Full feature word processing system with Office Management capabilities. Its special features include ease-of-use by office personnel, flexible print formatting & output, and a powerful macro capability which allows features to be added for the unique requirements of each user. Mail list macro is included for mail merge with form letters.
Requires CP/M & 32K RAM. Formats: 8, NS, MP, CDOS, SB, APPL

MCALL™ - \$85.
Communications program designed to drive an acoustic coupler. Features include:
• Time sharing Terminal emulation
• Disk file transfer between CP/M computer & Time Sharing Computer in either direction
• Disk file transfer between two CP/M computers with error detection and correction

AMCALL™ - \$95.
Auto-answer, auto dial version of MCALL currently supports 105 88-modem & Potomac Micro-Magic MM-103 boards.
Requires CP/M. Formats: 8, NS, MP, SB, CDOS

MICROSTAT™ - \$250. Manual alone - \$25.
Powerful statistical analysis package. Includes data management sub-system for editing, sorting, ranking, logging, data file transfers PLUS eleven data transformations (e.g. linear, reciprocal, exponential, etc.)
• Frequency distributions, 8 probability distributions
• Multiple regression, correction analysis
• Time series
• Crosstabs/Chi-Square, non-parametrics
• Factorials, permutations, combinations
• Scatterplots
• ANOVA (one and two-way)
Requires 48K RAM, NorthStar Basic or CP/M & CBASIC2 or Microsoft Basic 80.
Formats: 8, NS, MP, SB, TRS2, CDOS, APPL

Apple Pascal trademark
Apple Computers Pearl trademarks
CPU Int'l Pascal/M, ACT, Trans 86 trademarks
Sarcim CBASIC2, CBASIC/86 trademarks Compiler Systems
Magic Wand trademark Peachtree Datebook II, Milestone, Textwriter III
trademarks Organic Software Ultrasort-II, FABS trademarks Computer Control Systems
Digital Research TRS-80 trademark Tandy Superbrain trademark Intertec Data Systems Microstat trademark Ecosoft
S-Basic trademark Topaz Programming UCSD Pascal trademark Regents University CA WordStar trademark Micro Pro Int'l Spell-
binder trademark Lexisoft MCALL, AMCALL trademarks Micro-Call Services Selector IV, Selector/86 trademarks Micro-App dBase II trademark
Ashton-Tate Prices subject to change without notice For shipping add \$7. per package California residents add sales tax Terms: Prepaid check,
M/C, VISA or in US COD (UPS) Dealer Inquiries Invited Prices quoted do not include dealer installation & training

software-compatible with the TRS-80 Model I. Tandy is demanding damages and an injunction. Tandy claims that the PMC-80 contains "input/output programming copied from the plaintiff's TRS-80," and that the "defendants have marketed said microcomputer under the name PCM-80, which is confusingly similar to Tandy's registered trademark TRS-80."

Chess Game Has Robot Arm: The newest model of the popular Boris computer chess game has a robotic arm that moves and captures chess pieces. Called "Boris Handroid," it features the Boris 2.5 chess program that won the 1979 European Microcomputer Chess Championship. Sensors in the chessboard detect the human opponent's moves, and Boris Handroid responds by moving its piece. The game costs \$1495 with the arm or \$295 without.

UCSD Pascal Version 6.0 Being Tested: Softech Microsystems' new 4.0 version of UCSD (University of California, San Diego) Pascal is being tested at selected user sites. Softech has not yet set a release date. The new version adds multitasking and upgraded screen-handling functions. Four new p-code instructions have been added, which will create problems for version 3 users.

The UCSD Pascal compiler translates Pascal statements into a series of p-code (pseudocode) instructions, which are then interpreted during execution by a p-code-interpretor program, except on the Western Digital (WD) Pascal Microengine, which executes p-codes according to hardware microcode. The p-code system allows the UCSD

Pascal system to operate the same way on many different systems.

Western Digital has not yet decided on how it will upgrade machines currently in the field to work with the new p-codes. WD notes that its control-store memory still has about 25% free space; therefore, an "outboard" control store on the main computer board could be added, rather than changing the entire control store.

Update On 32-Bit Microprocessors: The International Solid-State Circuits Conference (ISSCC) met in New York last February and heard presentations on two 32-bit microprocessors and some disclosures on a third.

Intel released further details on its 32-bit iAPX432 processor. It is Intel's first departure from previous architecture and instruction sets, so there is no software compatibility with its 8086 (16-bit) and 8085 (8-bit) microprocessors. Each of the iAPX432's three integrated circuits has four lines of sixteen pins. There are two general processors and an I/O (input/output) processor. The iAPX432 can link to 8086s and existing peripheral and memory integrated circuits. Intel is boasting performance of up to 2 MIPS (million instructions per second).

It took five years to engineer the iAPX432, and the company estimates that \$25 million was spent on the project. Intel expects to sell at least 10,000 sets in the first year of production, which is projected for 1982. The initial price for the set will be \$1500. Intel started shipping evaluation sets in February and is offering a board-level evaluation kit for \$4250.

Intel claims that each of the three integrated circuits contains about 200,000 tran-

sistors. Two chips operate as a pipeline pair: the 43201 processor, which contains the instruction decoder, and the 43202, which is the microexecution unit. The 43203 is the I/O processor. It provides an interface from the I/O subsystem to the protected-access environment of the central system. Each I/O subsystem uses an 8- or 16-bit microprocessor to control I/O, independent of the central system. An address space of more than 4 gigabytes (4×10^9 bytes) and a virtual memory-address space of a terabyte (10^{11} bytes) is supported.

A protection scheme is provided to limit access to programs. The iAPX432 can perform floating-point operations on 32-, 64-, and 80-bit numbers. Hardware failures can be detected by interconnecting identical iAPX432 processors in a self-checking arrangement.

The system uses compiled Ada code as its machine language. The language interpreter is contained in a 64 K-byte microcode ROM (read-only memory).

Intel has also released an Ada cross-compiler for the iAPX432. The compiler runs on a DEC (Digital Equipment Corporation) VAX-11/780 or an IBM 370. It costs \$30,000. A \$50,000 hardware link is needed to download the compiled code to Intel's 54250 development board.

With the iAPX432, Intel appears to have a two-year jump on its competition. At the conference, Hewlett-Packard (HP) disclosed that it is in the early stages of development on a 32-bit microprocessor. HP claims to have built and tested a single chip with 450,000 transistors [which is about what Intel has in its set of three integrated circuits]. It operates with an 18 MHz clock and is microprogrammed in 9 K 38-bit

words in an on-board ROM. HP will have four other peripheral devices: an I/O controller, a memory controller, a 128 K-bit program memory, and a 512 K-bit ROM. The device is still being developed and no production commitment or product use has been determined.

Texas Instruments announced that early next year it will unveil a 99000 processor. TI refuses to disclose details, but it appears that the 99000 will have 32-bit addressing without 32-bit processing.

Chairperson Andrew Allison and his IEEE (Institute of Electrical and Electronics Engineers) working group is developing a bus standard to accommodate microprocessors from 8 to 32 bits in word length. The standard will have a 32-bit multiplexed address- and data-path compatible with 32-, 16-, and 8-bit microprocessors. It will allow up to thirty-two bus masters and multitasking via a serial interprocessor link that may use interrupt arbitration. A maximum initial clock rate of more than 10 MHz will be specified.

Floppy-Disk Densities Increasing: Ten years ago, IBM introduced an 8-inch disk drive capable of storing 400 K bytes of data (unformatted) on one side of a floppy disk. Shortly afterwards, double-density encoding schemes that allowed up to 800 K bytes of storage were introduced. Then in 1976, IBM came up with the double-sided drive, which increased data storage up to 1.6 megabytes. That same year Shugart Associates introduced a drive using a 5-inch floppy disk that could store 110 K bytes on a single-sided single-density disk. Later double-density double-sided (DDDS)

TALK IS CHEAP

LET THE OTHERS TALK ABOUT PROPOSED SOLUTIONS. COMPUPRO DELIVERS RESULTS.

When you want no-excuses operation, CompuPro stands behind you with a family of cost-effective - and technologically innovative - products that conform fully to the IEEE 696/S-100 standards. High speed operation frees you from obsolescence as CPU clock speeds increase, while low power consumption saves energy and promotes reliability.

There's a time for toys and home entertainment computers; and there's a time for professional machines that are expandable, modular, and exceptionally reliable. When that time comes, CompuPro delivers the results you need.

AND NOW... THE "BIG 8" SPECIAL PACKAGE!

Our "Big 16" package promotion went over so well that we decided to come up with something equally potent for 8 bit machines. Whether you're upgrading an existing system or assembling a brand new machine, the "Big 8" is ideal - just add terminal, disk drive, enclosure, and printer and you're up and running with one of the fastest, most powerful 8 bit systems around.

This easily upgradeable package includes:

- Disk 1 DMA Disk Controller
- CPU Z with 6 MHz CPU
- Interfacer 1 or 2 (your choice; Interfacer 1 standard)
- CP/M*-80 2.2 on disk
- 32K of fast, low power, static RAM

To sweeten the deal, we'll add another 32K of RAM if you order from us or your computer store before August 1, 1981. And if you need an enclosure, Enclosure 2 (desktop version) is available with this package for only \$795 - giving you even more savings.

Total value of the package: \$2712. . .but our special package price gives you the "Big 8" for \$1995! Who says CompuPro S-100 speed and reliability can't be cost-competitive with home entertainment computers?

DISK 1: A SUPERB DISK CONTROLLER. A/T \$495, CSC \$595

This state of the art design uses properly implemented DMA with arbitration, allowing Disk 1 to co-exist on the same bus with up to 15 other DMA devices. 24 bit DMA addressing capability allows disk access to a full 16 megabyte memory map.

Disk 1 transfers data independently of CPU speed for efficient operation with older 2 MHz CPUs as well as the new high speed 8086s; handles up to four 8" or 5.25" floppy disk drives (including 96 track high density minifloppies), single or double sided, single or double density (soft sectored); includes BIOS for CP/M-80*, as well as on-board boot for automatic startup and on-board 3 wire serial interface for system initialization; and is compatible with MP/M*, OASIS*, CP/M-80, and CP/M-86.

We weren't going to put out another me-too disk controller. . .and we didn't. Want proof? The manual is available separately for \$20. The CompuPro Disk Controller is here.

COMPUTER ENCLOSURE 2 \$825 desk top version, \$895 rack mount version

Includes fused, constant voltage power supply (+8V at 25 Amps, +16V at 3 Amps, and -16V at 3 Amps); 20 slot shielded/active terminated motherboard; and rugged all-metal enclosure with AC outlets on rear, heavy-duty line filter, circuit breaker, low noise fan, and reset switch. Rack mount version includes slides for easy pull-out from rack frame.

Also available: COMPUTER ENCLOSURE 1. Same as above, but less power supply and motherboard. \$289 desktop, \$329 rack mount.

SYSTEM SUPPORT 1 \$295 Unkit, \$395 A/T, \$495 CSC

Includes sockets for 4K of extended address EPROM or RAM (2716 pinout) with one battery backup RAM socket; battery operated month/day/year/time crystal clock with BCD outputs; socket for optional math processor (9511 or 9512); full RS-232 serial port; three 16 bit interval timers; two interrupt controllers; power fail indicator; and comprehensive owner's manual with numerous software examples (manual available separately for \$20; add \$195 to the above prices for the optional 9512 math processor.)

*LEGAL CORNER: 280A is a registered trademark of Zilog. PASCAL/M is a trademark of Sorcim. CP/M and MP/M are registered trademarks of Digital Research. OASIS is a trademark of Phase 1.

CompuPro™

BOX 2355, OAKLAND AIRPORT, CA 94614

division of

GODBOUNT ELECTRONICS

(415) 562-0636

Circle 150 on inquiry card.

COMPUPRO PRODUCTS ARE AVAILABLE AT FINER COMPUTER STORES WORLD-WIDE. . .
CALL (415) 562-0636 FOR THE STORE NEAREST YOU.

SOFTWARE

8088/8086 MONITOR-DEBUGGER: Supplied on single sided, single density, soft sectored 8" disk. CP/M* compatible. Great development tool; mnemonics used in debug conform as closely as possible to current CP/M* DDT mnemonics. \$35.

PASCAL/M* FROM SORCIM: SORCIM's PASCAL/M is the best implementation we've been able to find regardless of price - a totally standard Wirth PASCAL/M* 8" disk and comprehensive manual. \$175 (specify Z-80* or 8080/8085 version).

S-100 MEMORIES FROM THE MEMORY LEADER

CompuPro memories feature fully static design to eliminate dynamic timing problems, flawless DMA, full conformance to all IEEE 696/S-100 specifications, high speed operation (10 MHz), low power consumption, extensive bypassing, and careful thermal design.

	Unkit	A/T	CSC
8K RAM 2A.....	\$159	\$189	\$239
16K RAM 14 (extended addressing).....	\$279	\$349	\$429
16K RAM 20-16 (extended addressing and bank select).....	\$319	\$399	\$479
24K RAM 20-24 (extended addressing and bank select).....	\$429	\$539	\$629
32K RAM 20-32 (extended addressing and bank select).....	\$559	\$699	\$799
128K RAM 21.....	price upon request		

NEW! 64K RAM 17. Amazingly low power in a 64K fully static RAM board: draws less than 2.0 Watts typical, 4.0 Watts guaranteed max! It's fast, too; no wait states with 6 MHz Z-80* CPUs, or up to 10 MHz with 8086/88 family CPUs. Uses IEEE extended addressing protocol; also, user may turn off 2K windows from E000 to FFFF in order to accommodate memory-mapped peripherals/disk controllers. (The CompuPro disk controller can use the full 64K since it is not memory-mapped.) \$1095 Unkit, \$1395 A/T, \$1595 CSC. 48K version also available: \$1048 A/T, \$1198.50 CSC.

HIGH SPEED S-100 CPU BOARDS

CompuPro CPU boards meet all IEEE 696/S-100 specifications (including timing). CPU 8085/88 uses two processors, an 8085 and 8088, to provide both 16 and 8 bit capability with a standard 8 bit bus.

8 Bit CPU Z (with Z80A* CPU).....	\$225 Unkit, \$295 A/T (both operate at 4 MHz), \$395 CSC (with 6 MHz CPU).
8 Bit CPU 8085 (5 MHz).....	\$325 Unkit, \$325 A/T, \$425 CSC (6 MHz)
16/8 Bit CPU 8085/88.....	\$295 Unkit, \$425 A/T (both operate at 5 MHz); \$525 CSC (with 6 MHz 8085, 6 MHz 8088).

OTHER S-100 BUS PRODUCTS

Interfacer 1 (dual RS-232 serial ports).....	\$199 Unkit, \$249 A/T, \$324 CSC
Interfacer 2 (3 parallel + 1 serial port).....	\$199 Unkit, \$249 A/T, \$324 CSC
Interfacer 3 - 5 (5 serial ports).....	\$599 A/T, \$699 CSC
Interfacer 3 - 8 (8 serial ports).....	\$699 A/T, \$849 CSC
Spectrum color graphics board.....	\$299 Unkit, \$399 A/T, \$449 CSC
20 slot motherboard w/ edge connectors.....	\$174 unkit, \$214 A/T
12 slot motherboard w/ edge connectors.....	\$129 unkit, \$169 A/T
6 slot motherboard w/ edge connectors.....	\$89 unkit, \$129 A/T
Memory Manager Board.....	\$59 unkit, \$85 A/T, \$100 CSC
Active Terminator Board.....	\$34.50 Kit, \$59.50 A/T
2708 EPROM Board (2708s not included).....	\$85 Unkit, \$135 A/T, \$195 CSC
Mullen Extender Board.....	\$59 Kit, \$79 A/T
Mullen Relay/Opto-Isolator Control Board.....	\$129 Kit, \$179 A/T

Most CompuPro products are available in Unkit form, Assembled/Tested, or qualified under the high-reliability Certified System Component (CSC) program (200 hour burn-in, more). Note: Unkits are not intended for novices, as de-bugging may be required due to problems such as IC infant mortality. Factory service is available for Unkits at a flat service charge.

TERMS: Prices shown do not include dealer installation and support services. Call res add tax. Allow at least 5% shipping; excess rounded. Orders under \$15 add \$2 handling. VISA® and Mastercard® orders (\$25 min) call our 24 hour order desk at (415) 562-0636. Include street address for UPS delivery. Prices are subject to change without notice.

floppy-disk drives were introduced that could store up to 440 K bytes (unformatted).

Recently, Shugart announced 5-inch drives in which track density was increased from 48 tpi (tracks per inch) to 96 tpi, allowing up to 1 megabyte on a DDDS drive. However, increasing the track density on 8-inch drives is more difficult because the larger disks have deformation problems that result in errors. Drive and disk makers are trying to overcome the problems by changing the disk materials and drive designs. The current objective is to increase track density to 96 or 100 tpi by early next year. It is felt that 200 tpi is feasible with different materials.

Manufacturers are trying to obtain densities of 3 and 6.5 megabytes on 5-inch floppy disks and 5 to 10 megabytes on 8-inch floppies. The 3- and 5-megabyte densities appear to be achievable in the near future; however, reaching 10 megabytes on an 8-inch disk is expected to take longer to achieve.

In the meantime, PerSci Inc has taken the wraps off an 8-inch floppy-disk drive with a storage capacity of 2.5 megabytes. It's the same size as a standard 8-inch drive, but uses four read/write heads to access both sides of two DDDS disks.

IBM To Build Josephson Computers: IBM is going to construct an experimental computer entirely based on exotic Josephson-junction devices. This will be the first of its kind, and IBM hopes to have it up and running in five years. The 5000-circuit processor, with 400 K bits of programmable memory, is expected to have a 2 ns cycle time and will be no larger than 18 by 20 by

41 mm. Josephson-junction transistors are superconductive and can switch in less than 10 ps (picoseconds). They consume very little power (usually 500 nW) and typically require a +1 V power supply.

Such a computer could be fifty times faster than current high-speed computers. Engineers have hypothesized that a Josephson-junction-based computer could have a nonvolatile solid-state magnetic memory, and, because of the greatly reduced resistance within its super-cool liquid-helium immersion, thin connectors could be used. Additional attributes could include no crosstalk between devices and immunity to thermal noise. Problems are anticipated in testing and debugging because of the thermal stresses placed on the devices.

If the project is successful, IBM expects to pack a 300,000-circuit processor (about the capacity of an IBM 3033) with 256 K bytes of cache memory and 64 megabytes of main memory into a cube less than 15 cm on a side.

Random Rumors: DEC (Digital Equipment Corporation) is working on a personal computer designed to compete with the Apple III. It's expected to be introduced by year's end. Word is that DEC tried to buy Apple some time ago but was snubbed. . . . Observers expect Apple to introduce a dual-density dual-sided disk system with 600 K bytes of storage for the Apple II and III. You can expect a 5-inch Winchester disk drive with 5-megabyte capacity to hit the shelves by late summer. Apple is considering dropping the present version of the Apple III in favor of a new model that's more busi-

ness-oriented. The new model will probably contain a hard-disk drive instead of a floppy-disk drive. Apple is scheming an upgraded Apple II with a faster microprocessor and expanded memory size. . . . The Source timesharing system is preparing to sell a low-cost (\$600) terminal with built-in modem and printer port; it has a folding keyboard for portability. . . . Texas Instruments is about to introduce a small low-cost robot arm. . . . Hewlett-Packard is preparing an under-\$2000 system, maybe for this year. . . . ADDS (Applied Digital Data Systems) says that it will soon introduce a dumb terminal priced one-third less than current models. . . .

Random News Bits: Zenith Radio Corporation has a special video display for automobile dashboards. . . . RCA has received a patent for a technique that stores up to 100 gigabits (ie: 100 billion bits) on a laser disk intended for video. A complete encyclopedia can be stored on such a disk. . . . Sears Roebuck will open five computer stores. If they are successful, Sears Roebuck will sell computers nationwide. . . . Marker Ski Bindings has a binding with a built-in microprocessor. The battery-powered unit costs \$200 and must be custom programmed for the skier. . . . Ohio Scientific's new Challenger BP-HD personal computer has a Votrax voice-synthesizer output system and a voice-input system. It requires a 10-megabyte Winchester disk to function. . . . The Votrax SC-01 Voice Synthesizer Chip is now available from the MicroMint of Woodmere, New York. The Votrax division of Votrax will not sell the device in quantities of less than five.

. . . Zilog has reduced the price of the 16-bit Z8002 microprocessor from \$45 to \$19.90, in OEM quantities of 1000. . . . Intel may reduce its prices for the 8088 and 8086. . . . IBM has a 32-bit microprocessor up and running in its labs. . . . Apple recently purchased its distributor in Great Britain, and now has well over 1000 employees. . . .

Miniaturization Continues: Semiconductor manufacturers keep on packing more capability onto a single wafer of silicon. Intelligent controllers, especially, are benefiting from such efforts. Two of the most recent products are the National Semiconductor INS8073 and the Zilog Z8 system. The Zilog product line includes a microprocessor, designated Z8671, which contains a limited-BASIC interpreter and debugging monitor in on-board read-only memory. Steve Ciarcia is using the Z8671 to build a complete computer system measuring 4 by 4½ inches with serial and parallel I/O ports and 4 K bytes of user memory. Users can program process-control and monitoring functions using the BASIC interpreter. (See next month's "Ciarcia's Circuit Cellar.")

Know Your Dealer: Sources at Radio Shack report the company has been receiving a large number of complaints because of confusion over warranty service on TRS-80s. The problem stems from the fact that Radio Shack does not honor warranties on computers purchased from dealers who are not authorized by Radio Shack. A large number of unauthorized dealers have appeared in the past year—most offering extremely low mail-order

The DataTrak™ Floppy Disk Drives from Qume® Distributed by asap

The DataTrak™ 5 double-sided double-density drive uses state-of-the-art technology to give you superior data integrity through improved disk life, data reliability, and drive serviceability using 5¼" media.

Qume's independent head load yields wear characteristics far superior to competitive drives. This superior wear performance produces savings on both diskette usage and drive maintenance.

Improved data reliability, resulting from superior amplitude and bit shift characteristics, optimizes operator efficiency and reduces processing time for end-users.

And DataTrak's unique modular design means simplified field servicing for you and your customers.

Design Features

Expanded storage capacity • Two-sided, double density

Proven head carriage assembly • Ceramic head with tunnel erase • Dual-head flex mounting arrangement • Superior head load dynamics

Precise lead screw actuator • Fast access time - 12 ms track-to-track • Low friction and minimum wear • Low power dissipation

Additional features • Industry standard 5¼" media format • ISO standard write protect • Door lock out for media protection • Requires DC voltage only • Daisy Chain up to 4 drives • Heads load on command independent of loading media

Product Specifications

Performance Specifications • Capacity: Unformatted: 437.5K or 500K bytes; Qume Formatted: 286.7K or 327.7K bytes • Recording Density: 5456 BPI • Track Density: 48 TPI • Cylinders: 35 or 40 • Tracks: 70 or 80 • Recording Method: FM or MFM • Rotational Speed: 300 RPM • Transfer Rate: 250K bits/second • Latency (avg.): 100 ms • Access Time: Track-to-track 12 ms; Settling 15 ms • Head Load Time: 50 ms

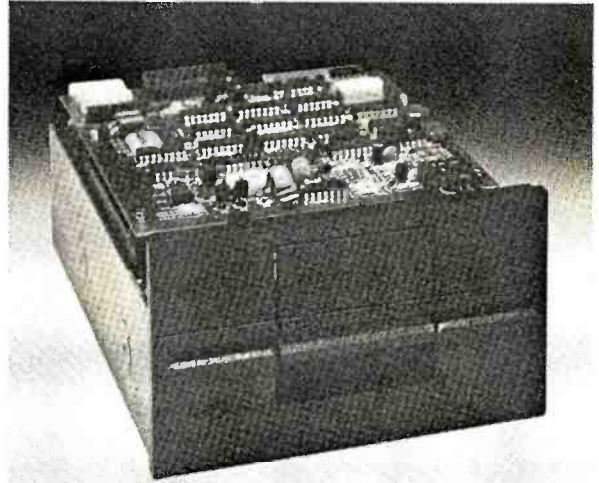

The DataTrak™ 5

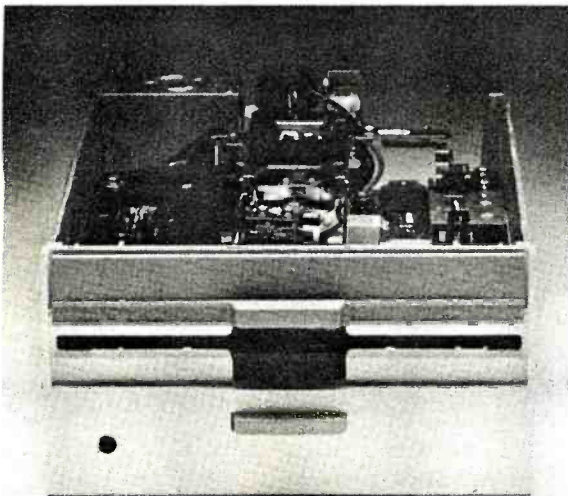

The DataTrak™ 8

The DataTrak™ 8 double-sided double-density drive uses state-of-the-art technology to give you superior data integrity through improved disk life, data reliability, and drive serviceability using 5¼" media.

Qume's innovative approach to controlling head load dynamics yields wear characteristics far superior to competitive drives. In independent evaluation, DataTrak 8 is setting industry standards for tap test performance. This superior wear performance produces savings on both diskette usage and drive maintenance.

Improved data reliability, resulting from superior amplitude and bit shift characteristics, optimizes operator efficiency and reduces processing time for end-users.

And DataTrak's unique modular design means simplified field servicing for you and your customers.

Design Features

Expanded storage capacity • Two-sided, double density

Fully IBM compatible • IBM 3740 and System 32 drives • IBM 3600 and 4964 drives • IBM System 34 drives

Proven head carriage assembly • Ceramic head with tunnel erase • Dual-head flex mounting arrangement • Superior head load dynamics

Fast, precise steel belt drive • Fast access time - 3 ms track-to-track • Low friction and minimum wear • Low power dissipation

Additional features • ISO standard write protect • Programmable door lock • Negative DC voltage not required • Daisy Chain up to 4 drives • Side-by-side mounting in standard 19" RETMA rack • Compatible with Shugart SA850/SA851

Product Specifications

Performance Specifications • Capacity: Unformatted: 1.6 Mbytes/disk; IBM Format: 1.2 M/bytes/disk • Recording Density: 6816 BPI • Track Density: 48 TPI • Cylinders: 77 • Tracks: 154 • Recording Method: MFM • Rotational Speed: 360 RPM • Transfer Rate: 500K bits/second • Latency (avg.): 83 ms • Access Time: Track-to-track 3 ms; Settling 15 ms; Average 91 ms • Head Load Time: 35 ms • Disk: Diskette 2D or equivalent

asap computer
products, inc.

1198 E. Willow
Signal Hill, CA 90806

AUTHORIZED DISTRIBUTOR FOR QUME
CALL FOR PRICE AND DELIVERY
(800) 421-7701 or (213) 595-6431 (In California)

prices on TRS-80 systems.

A Radio Shack spokesman said the company is attempting to close the pipeline to unauthorized dealers but declined comment on how the dealers are obtaining the equipment. He stressed that the majority of mail-order dealers are authorized and advertise the fact, but consumers are cautioned to be sure before ordering. If you need service on units purchased from unauthorized vendors, you'll have to pay full labor and parts rates.

DEC Drops LSI-11 Prices: Digital Equipment Corporation has lowered the prices on the 16-bit LSI-11 microcomputer products by almost 29%. Obviously, DEC is eager to compete with the new Intel 8086-, Zilog Z8000-, and Motorola 68000-based systems now

coming on the market. In fact, the new prices compete well with 8-bit microcomputer systems. A complete LSI-11 system with 32 K bytes of programmable memory and I/O interfaces, assembled in a cabinet, lists for \$2090. Also, the DEC RT-11 and FORTRAN package is now only \$640—\$40 more than the cost of a Microsoft CP/M FORTRAN package.

Packet Repeater Goes On The Air: The nation's first digital simplex packet-radio repeater (KA6M, Menlo Park, California) for amateur radio use has gone into operation. A similar system went into operation earlier in Vancouver, British Columbia, Canada. The station serves as a packet repeater and beacon. It receives a message or block of

data and, after verification, retransmits that message on the same frequency. The message may have some address or control bytes altered. The repeater extends the range and coverage of fixed and mobile stations. It is the first step in what promises to be a nationwide network of interconnected computer systems that allow toll-free communications.

Ethernet Acceptance Spreading: Ethernet, the local networking system, appears to be emerging as the de facto network standard. Although created by Xerox, Intel and DEC have agreed to support it with integrated circuits and system interfaces. Now Zilog has acknowledged that it will implement Ethernet interfaces

on its microcomputer systems. This is particularly noteworthy because Zilog is an Exxon subsidiary, and Exxon has announced its intention to develop a local-network system. Zilog's previously announced networking system Znet will still be supported by the company, in addition to the Ethernet interface.

Hewlett-Packard has made public that it will include Ethernet interfaces in some of its products. Digital Research intends to provide an Ethernet-to-CP/M software package.

MAIL: I receive a large number of letters each month as a result of this column. If you write to me and wish a response, please include a self-addressed stamped envelope.

Sol Libes
POB 1192
Mountainside NJ 07081

ENTREPRENEURS NEEDED

MORE THAN EVER IN THE MICROCOMPUTER INDUSTRY

The shortage of knowledgeable dealers/distributors is the #1 problem of microcomputer manufacturers. Over 300 new systems houses will go into business this year, but the number falls short of the 1200 needed. It is estimated that the nationwide shortage of consultants will be over 3000 by 1981. The HOW TO manuals by Essex Publishing are your best guide to start participating in the continued microcomputer boom.



HOW TO START YOUR OWN SYSTEMS HOUSE
6th edition, March 1980

Written by the founder of a successful systems house, this fact-filled 220-page manual covers virtually all aspects of starting and operating a small systems company. It is abundant with useful, real-life samples: contracts, proposals, agreements and a complete business plan are included in full, and may be used immediately by the reader.

Proven, field-tested solutions to the many problems facing the small systems house are presented.

From the contents:

- New Generation of Systems Houses • The SBC Marketplace
- Marketing Strategies • Vertical Markets & IAPs • Competitive Position/Plans of Major Vendors • Market Segment Selection & Evaluation • Selection of Equipment & Manufacturer • Make or Buy Decision • Becoming a Distributor • Getting Your Advertising Dollars' Worth • Your Salesmen Where to Find Them • Product Pricing • The Selling Cycle • Handling the 12 Most Frequent Objections Raised by Prospects • Financing for the Customer • Leasing • Questions You Will Have to Answer Before the Prospect Buys • Producing the System • Installation, Acceptance, Collection • Documentation • Solutions to the Service Problem • Protecting Your Product • Should You Start Now? • How to Write a Good Business Plan • Raising Capital

\$36. No. 10



FREELANCE SOFTWARE MARKETING
3rd edition, June 1980

Writing and selling computer programs as an independent is a business where you can get started quickly, with little capital investment • you can do it full time or part time • the potential profits are almost limitless. Since the demand for computer software of all kinds is growing at an explosive rate, the conditions for the small entrepreneur are outstanding.

This manual will show you how to sell your own computer programs using these proven techniques • direct to industries • through consulting firms • through manufacturers of computer hardware • in book form • mail order • through computer stores. It will show you how to profitably sell and license all types of software ranging from sophisticated analytical programs selling for thousands of dollars, down to simple accounting routines and games for personal computers.

The book will guide you step by step through the process of marketing, advertising, negotiating a contract, installing software, training users and providing maintenance and support. It also contains sample software contracts that have been used in actual software transactions. Also included are tips on how to negotiate with a large corporation, ways of avoiding personal liability, techniques for obtaining free computer time and hints on how to run a free-lance software business while holding a full-time job.

\$30. No. 32



HOW TO BECOME A SUCCESSFUL COMPUTER CONSULTANT
by Leslie Nelson, 2nd revised edition, Jan 1981

Independent consultants are becoming a vitally important factor in the microcomputer field, filling the gap between the computer vendors and commercial/industrial users. The rewards of the consultant can be high: freedom, more satisfying work and doubled or tripled income. **HOW TO BECOME A SUCCESSFUL COMPUTER CONSULTANT** provides comprehensive background information and step-by-step directions for those interested to explore this lucrative field.

- Established consulting markets • How to get started • Itemized start-up costs • Are you qualified? • Beginning on a part-time basis • The Marketing Kit • Should you advertise? • Five marketing tips • Getting free publicity • How much to charge
- When do you need a contract? • Sample proposals • Which jobs should be declined • Future markets • The way to real big money • Avoiding the legal pitfalls • How consultants' associations can help you • The National Register of Computer Consultants • How others did it: real-life sample cases • and much more

\$28. No. 16

COMPUTER BUSINESS OPPORTUNITIES 1981
This report covers an entire range of computer ventures. From the contents: Computer Services • Computer stores • Software Packages • Contract Programming • Third Party Field Service • Computer Supplies • Scrap Supplies and Components • Used Computers • Lease Brokerage • Computer Time Brokerage • The Independent Sales Rep • Finder's Fees • Services and much more.

No. 91 247 pages \$65.

HOW TO START & OPERATE A MAIL ORDER BUSINESS
by Julian Simon, 3rd revised edition, 536 pages, 1981

Indispensable for those selling software, equipment or supplies by mail. The first two editions of this book have fascinated readers — and brought them a fortune. The methods described here have brought millions of dollars in sales for the readers. Whether you are a newcomer starting from scratch or an established business anxious to cash in on the lucrative mail-order market, this book tells you how to create the kind of ads and mail order copy that will sell.

From the contents:

- where to go for direct-mail lists • how to get credit, deal with banks, handle interchanging • how to run one-inch ads that sell • how to get supplies and handle orders • what you may and may not do under current mail-order laws • how to make tactical decisions about handling complaints, making refunds, guarantees, trial orders.

There are fat profits to be made in mail order even for the person with limited time or capital, and this is the book that shows you how.

No. 130 \$21.95

ESSEX PUBLISHING CO. Dept. 2
285 Bloomfield Avenue • Caldwell, N.J. 07006

Send check, money order (U.S. \$), VISA or Master Charge #. Publisher pays 4th class shipping. For UPS shipping (USA only) add \$1.00 per book. For Air Mail shipping add \$2.50 per book in the USA and Canada. \$12.00 per book elsewhere. N.J. residents add 5% sales tax. For faster shipment on credit card orders call (201) 783-6940.

a new star is born!



a better computer system
any way you look at it.

The facts speak for themselves. The QUAY 500 SERIES offers more for the money than North Star Horizon® computers.

MORE TECHNICAL FEATURES. A single board computer instead of a backplane with multiple boards, means fewer parts, fewer interconnections and fewer problems □ additional disk capacity for more program storage □ DMA controlled disk transfers for increased system performance □ on-board expansion capabilities for additional parallel and serial ports, and EPROM □ AC convenience outlets □ a more compact design.

IMMEDIATE DELIVERY. The 500 SERIES is available off the shelf for virtually immediate delivery. No waiting for far off delivery dates for this one.

LOWER PRICE. The advanced technology engineered into Quay computers actually lowers our cost to manufacture. The price of the 500 SERIES is about 20% lower than the Horizon-2-32K-D — and our 520 SERIES also offers significant savings over the Horizon-2-32K-Q.



Advanced single board modular design.

The bottom line is simple. There is a new star in the computer field. The 500 SERIES by Quay. It outshines all of the competition.

COMPARE FOR YOURSELF:

SPECIFICATION	QUAY 500	HORIZON-2-32K-D
Architecture	Single Board	S100 bus
CPU	Z80A, 4MHz.	Same
Dynamic RAM (std)	64 Kb.	32 Kb.
Disk drive type	Double density	Same
No. of drives (std/max)	2/4	Same
Capacity per drive (on-line)	200 Kb.	180 Kb.
Direct Memory Access (DMA)	Yes	No
CP/M® disk operating system	Standard	Optional
Unit Price	\$2,995.	\$3,095.

SPECIFICATIONS	QUAY 520	HORIZON-2-32K-Q
Disk drive type	Quad density	Same
Capacity per drive (on-line)	400 Kb.	360 Kb.
Unit Price	\$3,495.	\$3,595.

The QUAY 500 offers technical superiority — availability — a \$2,500 price!

CP/M® is a registered trademark of Digital Research

Horizon is a registered trademark of North Star Computers, Inc.

QUAY CORPORATION

P.O. Box 386, Freehold, New Jersey 07728 ■ (201) 681-8700
Factory: Route 34, Wall Township, New Jersey 07719

DISTRIBUTOR AND REPRESENTATIVE INQUIRIES WELCOME

CP/M: A Family of 8- and 16-Bit Operating Systems

Dr Gary Kildall
Digital Research
POB 579
801 Lighthouse Ave
Pacific Grove CA 93950

This article is about microprocessors and CP/M: where they came from, what they are, and what they're going to be. Where they came from is history, what they are today is fact, and what they will become is, like any projection of technology, pure "science fiction" speculation. CP/M is an operating system developed for microcomputers. But as microprocessors changed, CP/M and its related programming tools evolved into a family of portable operating systems, languages, and applications packages.

The value of computer resources has changed dramatically with the introduction of microprocessors. Three major events have precipitated a revolution in computing: hand-threaded core memory has been replaced by mass-produced semiconductor memory; microprocessors have become plentiful; and IBM decided that the punched card is obsolete. Low-cost memory and processors have reduced the cost of computer systems to a few hundred dollars, but IBM's specification of the floppy disk standard has made the small computer system useful.

In the early days of the 8080 microprocessor, a small company called Shugart Associates was taking shape up the street from Intel. Shugart Associates, along with a number of other companies, viewed the floppy disk as more than a punched card replacement: at that time the primary

low-cost storage medium was paper tape (used in applications ranging from program development to word processing). At a cost of \$5, a floppy disk held as much data as two hundred feet of paper tape, and a disk drive retailed for only \$500—an unbeatable combination. Memory, processor, and floppy-disk technology improved, and by the mid-1970s, a floppy-based computer could be purchased for about one quarter of a programmer's annual salary. Quite simply, it was no longer necessary to share computer resources.

Since that time, microprocessors have been applied to a variety of

The 16-bit version of CP/M is basically the same as the 8-bit version, with the addition of memory management and enhancements to the file system.

computing needs beyond replacement of low-end minicomputers. Due to applications such as machine-tool movement and sensing, data acquisition, and communications, current interest lies in real-time control. In a real-time operating system, process

management can be separated from the I/O (input/output) system (which is not required in many applications). Real-time facilities allow the execution of interactive processes according to priority, and their addition or deletion in a simple fashion. This results in a custom operating system designed to solve a particular problem. In contrast to timesharing, real-time operating systems have minimal "interrupt windows" in which external interrupts are disabled. Real-time operating systems such as the Intel RMX and National Starplex packages provide this level of support.

The emerging interest in local networks poses a new challenge to designers of operating systems. Recently, Intel, DEC (Digital Equipment Corporation), and Xerox formed an alliance to promote Ethernet, a packet-switching network intended to provide point-to-point data transfer in an office environment. (In a packet-switching network, data from several slow-speed sources, such as user terminals, is collected over local lines by a single network node, which then periodically transmits the data to its destination at a much higher speed, in groups called packets.) In terms of evolution and potential, Ethernet is today what floppy disks were a decade ago. This inexpensive office network performs such tasks as the transfer of a form letter from data storage at one location to a memory typewriter in another part of the

THE ORIGINAL MAGAZINE FOR OWNERS OF THE TRS-80™* MICROCOMPUTER

* TRS-80™ IS A TRADEMARK OF TANDY CORP.

SOFTWARE
FOR TRS-80™
OWNERS

H & E COMPUTRONICS INC.

MONTHLY
NEWSMAGAZINE
FOR TRS-80™
OWNERS

MONTHLY NEWSMAGAZINE Practical Support For Model I, II & III

NOW IN OUR 4th YEAR

- PRACTICAL APPLICATIONS
- BUSINESS
- GAMBLING • GAMES
- EDUCATION
- PERSONAL FINANCE
- BEGINNER'S CORNER
- NEW PRODUCTS
- SOFTWARE EXCHANGE
- MARKET PLACE
- QUESTIONS AND ANSWERS
- PROGRAM PRINTOUTS
- AND MORE

PROGRAMS AND ARTICLES PUBLISHED IN RECENT ISSUES
INCLUDE THE FOLLOWING:

- FINCALC - A COMPLETE FINANCIAL APPLICATIONS PACKAGE
- INFORMATION SYSTEM REVIEW
- STATISTICAL COMBINATIONS
- PASCAL'S TRIANGLE
- ASSEMBLY LANGUAGE FOR BEGINNERS
- DISK FILES
- MOD-III REVIEW
- KEYBOARD THUNDER AND LIGHTING EXPLAINED
- DOS COMMANDS IN LEVEL II
- PROBABILITY CURVE GENERATOR
- CALCULATOR SIMULATIONS
- THE MEGABYTE GAP
- STOCKS AND BONDS
- BUDGET ANALYSIS (FOR BUSINESS AND HOME)
- NEWDOS/80 REVIEW
- DUTCHING - THE HORSE SYSTEM THAT CAN'T LOSE
- A SIMULATED GOLF GAME
- CONTINUOUS FORM SOURCES
- TAX/SAVER REVIEW
- AND MORE

FREE* WITH
YOUR
SUBSCRIPTION
OR
RENEWAL

FINCALC

A Complete Financial Analysis Package Used To Calculate Markup, Margin, Annuities, Compound Interest, Nominal And Effective Rates, Sinking Funds, Mortgage Calculations, Future Value, Savings and Insurance, Percentage Difference Between Two Numbers, Amortization Schedule and More

SEND FOR OUR NEW 64 PAGE SOFTWARE CATALOG (INCLUDING LISTINGS OF HUNDREDS OF TRS-80™ PROGRAMS AVAILABLE ON CASSETTE AND DISKETTE). \$2.00 OR FREE WITH EACH SUBSCRIPTIONS OR SAMPLE ISSUE

* All programs are supplied on cassette (add \$3 for Diskette Version - add \$5 for modified Mod-II Version).

COMPUTRONICS

MATHEMATICAL APPLICATIONS SERVICE™

50 N. PASCACK ROAD
SPRING VALLEY, NEW YORK 10977

ONE YEAR SUBSCRIPTION \$24

TWO YEAR SUBSCRIPTION \$48

SAMPLE OF LATEST ISSUE \$ 4

START MY SUBSCRIPTION WITH ISSUE.....

(#1 · July 1978 • #12 · June 1979 • #24 · July 1980 • #30 · January 1981)

NEW SUBSCRIPTION..... RENEWAL.....

NEW TOLL-FREE
ORDER LINE
(OUTSIDE OF N.Y. STATE)
(800) 431-2818



24 HOUR
ORDER
LINE
(914) 425-1535



CREDIT CARD NUMBER _____ EXP. DATE _____

SIGNATURE _____ NAME _____

ADDRESS _____ CITY _____ STATE _____ ZIP _____

*** ADD \$12/YEAR (CANADA, MEXICO) · ADD \$24/YEAR AIR MAIL · OUTSIDE OF U.S.A., CANADA & MEXICO ***

The Emergence of Software as a Problem-Solving Tool

Microprocessors are a natural consequence of our technology. I recently visited the British Science Museum, where two particularly interesting historical developments were on display. The first exhibit chronicled the development of the finely machined iron and brass steam engines, complete with magnificent gauges, gears, whistles, and valves, that founded the Industrial Revolution.

The second exhibit displayed progress in computing, beginning with Charles Babbage's inventions of the early 1800s. What did these exhibits have in common? They showed machines built with the same technology: Babbage's analytic engine might easily be mistaken for a small steam engine!

I followed the sequence of displays, from Babbage's difference and analytic engines to great brass calculators and early punch cards, past relay and vacuum tube processors to unit record equipment, then to transistor and random-logic computers and semiconductors and, finally, to a single Intel 8080 microprocessor.

Examined in this way, the technological momentum was obvious. Microprocessors are a direct result of our pattern of refinement through engineering. Just as a Boeing 727 is a refined version of the original Wright Brothers' invention, the microprocessor is a conse-

quence of "fine tuning" by scientists and engineers who strive to understand, simplify, and add function to mankind's tools. There were several conspicuous spaces waiting to be filled following the 8080 display.

In public television's "Connections" series, James Burke claimed that we are a society filled with machines that do everything: sew materials for our clothes, carry us from coast to coast, and print millions of newspapers daily. But the most important machines in our society do absolutely nothing by themselves. These multifunctional devices provide a variety of services depending upon our needs, and herein lies the essential advantage: in the past, we identified a need and built a machine to satisfy that need; today, technology provides us with a single machine that we can instruct, through a program, to solve almost any problem. Where are the "Thomas Edisons" who used to build machines? Most are now inventing programs.

The evolution of our electronics industry typifies refinement through engineering. Beginning with electrical and electronic switches, we began manufacturing general-purpose function chips: put a value x on the input pins, define the function f by setting voltage levels on a second set of pins, and the result, $f(x)$, magically appears on the output pins. Many

examples of such integrated circuits exist, ranging from three-state logic gates to arithmetic/logic units.

With the introduction of microprocessors, the function f may be defined through instructions in a read-only memory allowing, in principle, the implementation of any function using a single device. A design that once required connecting resistors, capacitors, and logic gates has developed into a program that instructs a multipurpose machine to perform the same function. Controlling a stoplight and balancing a checkbook are now equivalent problems: both require the invention of a program.

Refinement through engineering: does this not also apply to software? To properly frame the answer, remember that the primary purpose of a computer is to be useful. Therefore, the application program is really the only important result of a software-engineering activity. Our primary goal in refining software tools is to provide the means for rapid and accurate generation of simple, understandable, and effective application programs. We do this through three levels of software support: system languages, operating systems, and application languages. These tools form an inverted pyramid underlying application software.

LEO ELECTRONICS
8921 S. Sepulveda #208
Los Angeles, Ca 90045
213-641-3101 800-421-2418



"WANT LOW PRICES AND QUALITY"

LEO CAN FILL YOUR NEEDS

Call for 50+ piece pricing

ALL PARTS ARE 100% GUARANTEED. PRICES SUBJECT TO CHANGE WITHOUT NOTICE.
Hours Mon thru Fri 8:00 am - 5:00 pm

SHIPPING & POSTAGE

UPS (GROUND) or
PARCEL POST ADD \$2.00
UPS BLUE (AIR) ADD \$4.00
Foreign Orders ... U.S. FUNDS ONLY
Please Specify Method

MEMORY PRODUCTS

	1-10	11-49		1-10	11-49
1702A	4.85	4.65	TMS 4060	3.00	2.70
2708	4.00	3.50	4116	2.75	2.45
TMS 2716	7.50	6.50	8080A	3.50	3.00
2716 5v	7.50	6.50	8085A	11.00	9.50
2532	19.00	17.00	8216	2.60	2.40
2732	19.00	17.00	8748	55.00	52.00
2758	8.00	7.50	TMS 9900	27.00	25.00

TERMS: VISA, MASTER CARD, CASH, CHECK OR MONEY ORDER.

LS PRODUCT

LS00 .25	LS42 .75	LS109 .45	LS163 .90	LS244 1.20
LS02 .25	LS51 .30	LS123 .75	LS164 .85	LS245 1.20
LS04 .25	LS54 .30	LS138 .75	LS174 1.10	LS283 .95
LS08 .25	LS73 .40	LS139 .75	LS175 1.00	LS367 .65
LS10 .25	LS74 .40	LS151 .75	LS191 1.00	LS368 .65
LS20 .25	LS85 1.15	LS153 .75	LS193 .85	LS373 1.40
LS30 .25	LS86 .40	LS157 .75	LS195 .70	LS374 1.40
LS32 .35	LS93 .65	LS158 .80	LS221 1.15	LS377 1.45
LS38 .35	LS95 .75	LS161 .90	LS240 1.20	

CALIFORNIA RESIDENTS ADD 6% SALES TAX.

S PRODUCT

S188	3.25
S189	3.25
S287	3.25
S288	3.00
S387	3.25
S471	7.50
S472	9.00
340T5-12	.85
320T5-12	.95

CAN SUPPLY
TTL - CMOS
SOCKETS
CONNECTORS
CAPACITORS
DIP SWITCHES
DIODES
TRANSISTORS
CALL FOR PRICING

H & E COMPUTRONICS INC.

● EVERYTHING FOR YOUR TRS-80* ● ATARI* ● APPLE* ● PET* ●

*TRS-80 is a trademark of the Radio Shack Division of Tandy Corp. - *ATARI is a trademark of Atari Inc. - *Apple is a trademark of Apple Corp. - *Pet is a trademark of Commodore



★ All orders processed within 24-Hours
★ 30-Day money back guarantee on all Software

BUSINESS PAC 100

100 Ready-To-Run

Business Programs

(ON CASSETTE OR DISKETTE).....Includes 110 Page Users Manual.....5 Cassettes (Or Diskettes)

Inventory Control.....Payroll.....Bookkeeping System.....Stock Calculations.....

Checkbook Maintenance.....Accounts Receivable.....Accounts Payable.....

BUSINESS 100 PROGRAM LIST

1 RULE78	Interest Apportionment by Rule of the 78's
2 ANNUI	Annuity computation program
3 DATE	Time between dates
4 DAYYEAR	Day of year a particular date falls on
5 LEASEINT	Interest rate on lease
6 BREAKEVN	Breakeven analysis
7 DEPRSL	Straightline depreciation
8 DEPRSY	Sum of the digits depreciation
9 DEPRDB	Declining balance depreciation
10 DEPRDDB	Double declining balance depreciation
11 TAXDEP	Cash flow vs. depreciation tables
12 CHECK2	Prints NEBS checks along with daily register
13 CHECKBK1	Checkbook maintenance program
14 MORTGAGE/A	Mortgage amortization table
15 MULTMON	Computes time needed for money to double, triple, etc.
16 SALVAGE	Determines salvage value of an investment
17 RRVARIN	Rate of return on investment with variable inflows
18 RRCONST	Rate of return on investment with constant inflows
19 EFFECT	Effective interest rate of a loan
20 FVAL	Future value of an investment (compound interest)
21 PVAL	Present value of a future amount
22 LOANPAY	Amount of payment on a loan
23 REGWITH	Equal withdrawals from investment to leave 0 over
24 SIMPDISK	Simple discount analysis
25 DATEVAL	Equivalent & nonequivalent dated values for oblig.
26 ANNUDEF	Present value of deferred annuities
27 MARKUP	% Markup analysis for items
28 SINKFUND	Sinking fund amortization program
29 BONDVAL	Value of a bond
30 DEplete	Depletion analysis
31 BLACKSH	Black Scholes options analysis
32 STOCVAL1	Expected return on stock via discounts dividends
33 WARVAL	Value of a warrant
34 BONDVAL2	Value of a bond
35 EPSEST	Estimate of future earnings per share for company
36 BETAALPH	Computes alpha and beta variables for stock
37 SHARPE1	Portfolio selection model i.e. what stocks to hold
38 OPTWRITE	Option writing computations
39 RTVAL	Value of a right
40 EXPVAL	Expected value analysis
41 BAYES	Bayesian decisions
42 VALPRINF	Value of perfect information
43 VALADINF	Value of additional information
44 UTILITY	Derives utility function
45 SIMPLEX	Linear programming solution by simplex method
46 TRANS	Transportation method for linear programming
47 EOQ	Economic order quantity inventory model
48 QUEUE1	Single server queuing (waiting line) model
49 CVP	Cost-volume-profit analysis
50 CONDPFOT	Conditionality profit tables
51 OPTLOSS	Opportunity loss tables
52 FQJQJQ	Fixed quantity economic order quantity model

59 WACC	Weighted average cost of capital
60 COMBAL	True rate on loan with compensating bal. required
61 DISCBAL	True rate on discounted loan
62 MERGANAL	Merger analysis computations
63 FINRAT	Financial ratios for a firm
64 NPV	Net present value of project
65 PRINDLAS	Laspeyres price index
66 PRINDPA	Paasche price index
67 SEASIND	Constructs seasonal quantity indices for company
68 TIMETR	Time series analysis linear trend
69 TIMEOV	Time series analysis moving average trend
70 FUPRINF	Future price estimation with inflation
71 MAILPAC	Mailing list system
72 LETWRT	Letter writing system-links with MAILPAC
73 SORT3	Sorts list of names
74 LABEL1	Shipping label maker
75 LABEL2	Name label maker
76 BUSBUID	HOME business bookkeeping system
77 TIMECLCK	Computes weeks total hours from timeclock info.
78 ACCTPAY	In memory accounts payable system-storage permitted
79 INVOICE	Generate invoice on screen and print on printer
80 INVENT2	In memory inventory control system
81 TELDIR	Computerized telephone directory
82 TIMUSAN	Time use analysis
83 ASSIGN	Use of assignment algorithm for optimal job assign.
84 ACCTREC	In memory accounts receivable system-storage ok
85 TERMSPAY	Compares 3 methods of repayment of loans
86 PAYNET	Computes gross pay required for given net
87 SELLPR	Computes selling price for given after tax amount
88 ARBCOMP	Arbitrage computations
89 DEPRSF	Sinking fund depreciation
90 UPSZONE	Finds UPS zones from zip code
91 ENVELOPE	Types envelope including return address
92 AUTOEXP	Automobile expense analysis
93 INSFILE	Insurance policy file
94 PAYROLL2	In memory payroll system
95 DILANAL	Dilution analysis
96 LOANAFDD	Loan amount a borrower can afford
97 RENTPRCH	Purchase price for rental property
98 SALELEAS	Sale/leaseback analysis
99 RRCONVBD	Investor's rate of return on convertible bond
100 PORTVAL9	Stock market portfolio storage-valuation program

- CASSETTE VERSION \$99.95
- DISKETTE VERSION \$99.95
- TRS-80* MODEL II VERSION \$149.95

ADD \$3.00 FOR SHIPPING IN UPS AREAS
ADD \$4.00 FOR C.O.D. OR NON-UPS AREAS
ADD \$5.00 OUTSIDE U.S.A., CANADA & MEXICO

COMPUTRONICS
MATHEMATICAL APPLICATIONS SERVICE

50 N. PASCACK ROAD
SPRING VALLEY, NEW YORK 10977

**NEW TOLL-FREE
ORDER LINE**
(OUTSIDE OF N.Y. STATE)
(800) 431-2818

**24 HOUR
ORDER
LINE**
(914) 425-1535



NAME

DESCRIPTION

53 FQEQWSH	As above but with shortages permitted
54 FQEQQPB	As above but with quantity price breaks
55 QUEUECB	Cost-benefit waiting line analysis
56 NCFANAL	Net cash-flow analysis for simple investment
57 PROFIND	Profitability index of a project
58 CAP1	Cap. Asset Pr. Model analysis of project

Circle 154 on inquiry card.

building. When modifications are completed, the letter is typed locally or sent to a laser (or other) printer that is a shared network resource.

Most timesharing systems handle a network through simple file transfers between the machines (*nodes*) in the net, but real refinements occur when the operating system itself is distributed among the nodes. File access is provided by one *server* node, while a computing function is performed by another. To the user, a *requester* node appears as a powerful computing facility, even though it may consist of only a local microprocessor, a console, and a limited amount of memory.

What refinements have been made to operating systems? Our models have been simplified; we understand primitive operations required for reliable process synchronization in real-time systems, and the human-oriented interface in interactive subsystems has been improved. We will, no doubt, continue to refine our models for timesharing and real-time

operating systems, but the most exciting new operating system technology will develop around emerging network hardware.

Application Languages

Application languages form the top level of support for application programming. How does this level of language differ from other language levels? First and foremost, an application language contains the operations and data types suitable for expressing programs in a particular problem environment. FORTRAN (*FORmula TRANslation*), for example, was designed in the late 1950s for scientific applications; FORTRAN programs, therefore, consist primarily of algebraic expressions operating upon binary floating-point numbers expressed in scientific notation. However, FORTRAN contains only primitive file-access facilities and no decimal arithmetic, making it unsuitable for commercial data processing. COBOL (*COmmon Business Oriented Language*) has the commercial

facilities, but it excludes scientific features such as a complete transcendental-function library.

In contrast to system languages that run on a given machine, these application languages would ideally contain no machine-dependent features. An application language is either poorly designed or ill-suited for a particular problem if the programmer is forced to use extra-lingual constructs to access lower-level functions of the operating system or machine. The language must be a standard, without the necessity for various locally defined language extensions. An extended standard language is of limited value since the extensions are unlikely to exist in other implementations.

The evolution of PL/I (*Programming Language/One*) provides a good example of refinement in application languages. PL/I is not a new invention: rather, it was defined by a committee of IBM users in 1960 as a combination of ALGOL (*ALGO-rithmic Language*), FORTRAN, and COBOL, with a liberal sprinkling of new facilities. ALGOL's principal contribution was block structure and nested constructs, while FORTRAN contributed scientific processing and COBOL added commercial facilities. This combination produced a large, unwieldy language with twists and nuances that can trap the unwary programmer. Nevertheless, PL/I was quite comprehensive, and it served as the basis for uncounted numbers of application programs on large systems. One noted use of PL/I was in the implementation of the Multics operating system at MIT under Project MAC.

In 1976, an ANSI (American National Standards Institute) committee produced a standard language definition for PL/I. The standard is an implementation guide for compiler writers, and it precisely defines the form and function of each PL/I statement. Aware that PL/I was too large and complicated, the committee produced a smaller version for minicomputers, called Subset G. This new language excluded the redundancies and pitfalls of full PL/I but retained the

BUS-TO-BUS COMMUNICATION

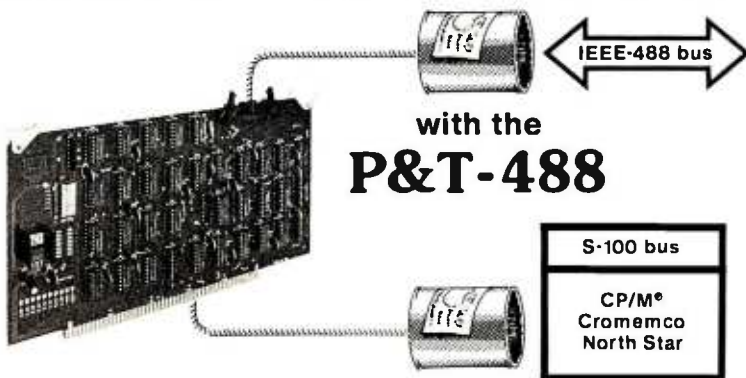

with the P&T-488

- Inexpensive S-100 computers can now communicate with the IEEE-488 instrumentation bus. The P&T-488 meets the IEEE-488 1980 standard for **controller**, **listener**, and **talker**.
- "Canned" **software** allows simple communication with the 488 bus from Basic, Pascal, and other high level languages.
- Special features include an interactive **busmonitor** program and a functional self-test program.



Price for (1) P&T-488 with software, assembled and tested: \$450 (domestic price) FOB Goleta, CA.
CP/M is a registered trademark of Digital Research.

PICKLES & TROUT
P. O. BOX 1206, GOLETA, CA 93116, (805) 685-4641

H & E COMPUTRONICS INC.

●● EVERYTHING FOR YOUR TRS-80™ ●● MODEL III

- ★ All orders processed within 24-Hours
- ★ 30-Day money back guarantee on all TRSDOS Software
- ★ Add \$2.00 for shipping in UPS Areas
- ★ Add \$4.00 for C.O.D. or NON-UPS Areas
- ★ Add \$5.00 outside U.S.A., Canada & Mexico
- ★ We will match any bonafide advertised price in any of the Major Computer Magazines

TRS-80 is a trademark of Tandy Corp.

1) GENERAL LEDGER, ACCOUNTS RECEIVABLE, ACCOUNTS PAYABLE, PAYROLL, INVENTORY CONTROL AND INVOICING (Small Business Group).....an extensive business system for the serious user.....can be used one module at a time or as a coordinated system..... \$199.95 per module.....\$1199.95 for the complete system.*

2) MASTER PAC 100.....100 essential programs.....BUSINESS.....PERSONAL FINANCE..... STATISTICS.....MATH.....GAMBLING.....GAMES.....includes 125 page manual and 5 diskettes \$59.95

3) BUSINESS PAC 100.....100 essential business programs.....INVENTORY CONTROL.....PAY-ROLL.....BOOKKEEPING SYSTEM.....STOCK CALCULATIONS.....CHECKBOOK MAINTEN-ANCE.....ACCOUNTS RECEIVABLE.....ACCOUNTS PAYABLE.....includes 125 page manual and five diskettes \$99.95

4) INFORMATION SYSTEM (The Bottom Shelf).....An in-memory information system for small mailing lists, inventories (i.e. books, articles, records, program reference files).....Can be used for anything that you would use rolodex or index card files.....Up to ten user define fields..... Programmable printouts for rolodex cards, mailing labels, etc..... Will identify all records that contain a group of characters you've entered even if that group is in the middle of a line.....Sorts data base by any field \$49.50*

5) DATA MANAGER II (The Bottom Shelf).....RANDOM ACCESS Disk based DATA MANAGE-MENT SYSTEM (Similar to INFORMATION SYSTEM above.....but RANDOM ACCESS STORAGE expands the amount of storage space available).....Used to replace index cards for medium sized mail lists, inventories, personnel records, sales prospects, etc.....Uses up to four disk drives on line.....Up to twenty user defined fields, programmable printouts for rolodex cards, etc..... will identify all records that contain a group of characters you've entered even if that group is in the middle of a line..... maintain up to 5 changeable presorted "key" files..... variable length random records (the smaller the record you define, the more records you can store) \$99.95*

6) BUSINESS MAIL SYSTEM (The Bottom Shelf).....Handles large mailing lists (up to 150,000 names)..... supports 3 or 4 line addresses.....files automatically in zip code order, alphabetical within zip code.....formats for 1 to 4 across mailing labels.....supports quick disk location of single or multiple names.....meets all industry and postal standards.....numeric code fields included for printing selected records \$125.00*

7) ANALYSIS PAD (The Bottom Shelf).....A Columnar Calculator for financial analysis, line item budgeting, cost analysis, sales analysis and almost any financial function (and many statistical functions).....create matrixes of 29 x 39.....make all entries at one time either by row or column..... add, delete, move or switch columns and rows.....edit any data from full screen display.....add, subtract, multiply and divide one column by another and put results in designated column (up to six calculations can be made and placed in designated column).....define columns as constants.....save calculations and formulas on disk.....results can be printed in a variety of report formats \$99.95*

8) CHECKBOOK II (The Bottom Shelf).....A complete in memory checkbook balancing and reconciliation program.....five column keyboard input with 5 characters for check number, 16 for payee, 4 for code.....numerical sort routine \$49.50*

9) CHECK REGISTER ACCOUNTING SYSTEM (The Bottom Shelf).....A complete random access checkbook system.....set and define up to 60 accounts with as many income accounts as you choose.....complete checkbook balancing and reconciliation.....single entry input where transaction can be dispersed over several accounts.....enables user to make a 64-character note on each transaction.....print out your own check after data entry.....prints monthly summaries of each account with month and year-to-date totals.....create a suspense file to remind you of coming expenses.....Reports generated included Check Register (for any month), notes to Check Register, Income/Expense Distribution Report, Statement of Selected Accounts, Bank Reconcile Statement, Suspense File and Full Account Distribution Statement \$74.95*

LIBRARY 100 (The Bottom Shelf).....100 Programs on a broad range of topics.....Finance..... Education.....Graphics.....Home.....Games.....CASSETTE VERSION \$49.50
DISK VERSION \$74.95

ADVENTURE (by Scott Adams).....A series of games (for ages 10-99).....wander through en- charned worlds seeking treasures..... 1. Adventureland.....2. Pirate's Adventure.....3. Mission Impossible Adventure.....4. Voodoo Castle.....5. The Count.....6. Strange Odyssey.....7. Mystery Fun House.....8. Pyramid of Doom.....9. Ghost Town.....(#1 and #2 recommended for the movie adventure).....Each adventure \$14.95 (jon cassette).....Diskette versions sold in groups of three at \$39.95 per three programs (#1 - #3, #4 - #6, #7 - #9).

HORSE SELECTOR II (Dr. Hal Davis).....New simplified version of the original Horse Selector (for flats).....The first Horse Selection System to actually calculate the estimated odds for each horse.....easy to follow rules.....uses 4 factors (speed rating, track variant, distance of the present race, distance of the last race).....calculated estimated odds.....FREE DUTCHING TABLES allows betting on 2 or more horses with a guaranteed profit \$50.00

MON-3 and MON-4 (Howe Software).....Powerful utility programs enabling you to interact directly with your TRS-80 in MACHINE LANGUAGE.....The monitor comes with complete 40-page instruction manual making it useful for both the beginner and advanced programmer..... simple commands make it easy to use.....functions include DISPLAY, DISASSEMBLE, MOVE and COMPARE, SEARCH, MODIFY, RELOCATE, PRINT, READ and WRITE, UNLOAD, SAVE and READ, INPUT and OUTPUT, SEND and RECEIVE.....MON-3 \$39.95 (for cassette)..... MON-4 \$49.95 (for disk).

(14) SMART TERMINAL (Howe Software).....enables your TRS-80 to be used as a remote terminal to a time sharing computer system \$69.95

(15) FAST SORT (Howe Software).....a series of machine-language subroutines to sort data from BASIC programs.....data may be alphabetic (string) or numeric.....easily interfaced with your BASIC programs (no machine language knowledge is over) \$9.95

(16) MAILING LIST (Howe Software).....maintains mailing lists of over 1000 names.....commands allow adding, changing, deleting, and finding names. Sorting is done in machine language subroutine.....labels printed in 1, 2 or 3 columns \$69.95

(17) HOME BUDGET (Howe Software).....combines the maintenance of your checkbook with analysis of your income, expenses and monthly bills. Handles data including bills, income, deposits, checks and debits to your checking account, and cash expenses. Computes check- book balance, list of unpaid bills, monthly and year-to-date summaries of income and expenses showing income tax deductions.....All output printed on video display or line printer.....comes with complete instructions manual \$49.95*

(18) SMALL BUSINESS ACCOUNTING (Howe Software).....Based on the DOME BOOKKEEPING SYSTEM.....keeps track of all income, expenditures and payroll for a small business of up to 16 employees.....income and expenditures can be entered on a daily, weekly or monthly basis..... computes monthly and year to date totals.....manual contains complete instructions for custom- ization Cassette version \$29.95.....Diskette version \$49.95

(19) REMODEL-PROLOAD (Racet Computes).....Renummer program lines.....move statements from one part of a program to another \$34.95

(20) GSF (Racet Computes).....Lightning fast in-memory machine language sort utility that can be made part of your BASIC programs without any machine language knowledge.....includes several other utilities to speed up your BASIC programs.....no machine knowledge necessary to use GSF in your BASIC programs \$30.00

(21) DOSORT (Racet Computes).....includes GSF (above).....extends the in memory sort to sorts on multiple disk drives \$45.00*

(22) COPSYS (Racet Computes).....allows the user to make copies of machines language cassettes without any knowledge of machine language \$20.00

(23) COMRPOC (Racet Computes).....an auto load program for disk users.....allows the user to insert a diskette into their MOD-III and have the computer take over all loading.....load a machine language program, BASIC, RUN a certain program all without pressing a single buttonallows your computer to perform 10, 20, 30 or more functions without pressing a single button \$30.00*

(24) INFINE BASIC (Racet Computes).....adds a variety of machine language subroutines to your BASIC programs (without any machine language knowledge).....fast sorts.....matrix operationscompress and uncompress data.....and more \$60.00

(25) INFINITE BUSINESS (Racet Computes).....an add on package to INFINITE BASIC.....adds a variety of routines important to the businessman (increase accuracy of calculations and more) \$30.00

(26) OMS (Racet Computes).....lightning fast machine language sort.....sorts up to 4 disk drives of information \$90.00*

(27) BLINK (Racet Computes).....allows you to RUN new programs without losing the variables stored in your previous program.....line many programs together without losing important variables \$30.00*

(28) KFS-80 (Racet Computes).....now you can use ISAM (Index Sequential Access Files) on your MOD-III.....using ISAM in your BASIC programs allows instant access of your items in your data files.....use with mail programs.....inventory programs.....etc. \$100.00*

(29) MAIL LIST (Racet Computes).....all routines are in machine language allowing for quick access \$75.00

* FOR DISK ONLY Circle 155 on Inquiry card.

COMPUTRONICS

MATHEMATICAL APPLICATIONS SERVICE

50 N. PASCACK ROAD
SPRING VALLEY, NEW YORK 10977

NEW TOLL-FREE
ORDER LINE
(OUTSIDE OF N.Y. STATE)
(800) 431-2818



24 HOUR
ORDER
LINE



(914) 425-1535

Buy by Mail and SAVE!

COMPUTERS

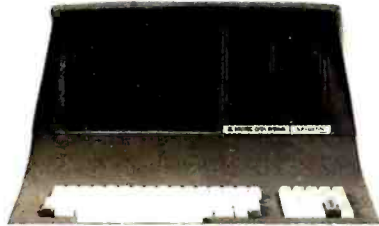

Intertec Superbrain SPECIALS

- 64K Ram, List \$3495 \$2595
- 64K Quad, List \$3995 \$2995

NorthStar

- Horizon I 32K DD List \$2695 ... \$1989*
- Horizon I QD List \$2995 \$2245*
- Horizon 2 32DD List \$3095 \$2289*
- Intersystem DPS-1 List \$1749 ... \$1495*

Call for latest NorthStar and Intersystem Prices



- Cromemco Z-2H, List \$9995 ... \$7945
- System 2, 64K List \$4695 \$3749
- System 3, 64K, List \$7995 \$6395

Disk Systems

- Thinker Toys Discus 2D \$939
- Dual Discus 2D \$1559
- Discus 2 + 2, List \$1549 \$1259
- M26 Hard Disk, List \$4995 \$3949

Printers & Terminals

- Paper Tiger IDS-445 \$649
- with graphic option \$719
- Centronics 730-1, List \$795 \$549
- 737-1, List \$995 \$769
- 704-9 180 cps \$1495
- 703-9 180 cps \$1569
- TI 810, List \$1895 \$1489
- NEC SPINWRITER 5530 \$2395
- NEC SPINWRITER 5515 \$2395
- Diablo 630 List \$27 11 \$2399
- Intertube III List \$895 \$729
- Zenith Z-19 \$719
- Televideo 912C \$679
- 920C \$799
- 950 \$999
- Hazeltine 1420 \$789
- 1500 \$845
- Soroc 120 List \$995 \$689
- IQ135 \$719
- 140 \$994

Computers Wholesale

P.O. Box 144 Camillus, NY 13031



(315) 472-2582



Most items in stock for immediate delivery. Factory sealed cartons, w/full factory warranty. NYS residents add appropriate sales tax. Prices do not include shipping. VISA and Master Charge add 3%. C.O.D. orders require 25% deposit. Prices subject to change without notice.

useful application programming features. Recently approved by ANSI, Subset G has given new life to PL/I, with manufacturer support for the Data General Eclipse and MV/8000 computers, Prime computers, Wang machines, and DEC's popular VAX computer.

Strangely, the refinements found in application languages follow those of hardware and operating systems. Large, cumbersome languages have been rejected in favor of simple, Spartan programming systems that are consistent in their design. The resulting languages are easier to implement, simpler to comprehend, and allow straightforward program composition.

PL/M: The Base for CP/M

In 1972, MAA (Microcomputer Applications Associates), the predecessor of Digital Research, consulted with the small, aspiring microprocessor division of a semiconductor memory company called Intel Corporation. MAA defined and implemented a new systems-programming language, called PL/M (*Programming Language for Microcomputers*), to replace assembly-language programming for Intel's 8-bit microprocessor. PL/M is a refinement of the XPL compiler-writing language which is, in turn, a language with elements from Burroughs Corporation's ALGOL and the full set of PL/I.

The first substantial program written by MAA using PL/M was a paper-tape editor for the 8008 microprocessor, which later became the CP/M program editor, called ED. PL/M is a commercial success for Intel Corporation and, although licensing policies have limited its general accessibility, it has become the standard language of the Intel microprocessor world, with implementations for the 8080, 8085, and 8086 families.

MAA also proposed a companion operating system, called CP/M (*Control Program for Microcomputers*), which would form the basis for resident PL/M programming. The need for CP/M was obvious: 8080-based computers with 16 K bytes of main memory could be combined with

System Languages

A system language is a high-level machine-dependent programming language used to implement so-called "system software," including operating systems, text editors, debuggers, interpreters, and compilers. In the early days of computing, virtually all system software was implemented in assembly language. One revolutionary machine, the Burroughs B5500, used a variant of ALGOL-60 as its only system-programming tool and appeared in the early 1960s. The machine was a commercial success against the other major mainframes, proving that assemblers were no longer necessary. Many successful system languages followed Burroughs' ALGOL, including the C language, produced at Bell Laboratories in the late 1960s, which served as the basis for the UNIX operating system.

A system language, by definition, matches the architecture of a particular machine or class of machines; all facilities of the machine are accessible in the language, and the language contains no non-trivial extensions beyond the basic machine capabilities. The benefit is that a compiler for the system language is easy to implement and transport from machine to machine, as long as the architecture of each machine is similar. Further, a system language requires little runtime support since application facilities, such as extensive I/O (input/output) processing, are not generally embodied in the language.

Refinements in system languages are made by increasing their usability. Their acceptance as replacements for assembly languages is encouraging. Today, one can publicly admit that system software is implemented in a high-level language without implying that it must be rewritten in assembly language to be effective.

Lifelines.

The serious publication for the serious software user.

WHAT LIFELINES READERS
READ ABOUT IN
MAY

May 1981 Vol. 1 Issue #12

LIFELINES

- A Brief Review of PASM, BUG/uBUG, PLINK and EDIT*
- Comments on SSSFORTTRAN*
- SOUNDEX Made Simple
- BASIC Comparisons: The Conclusion of the SBASIC* series
- Zoso Strikes Again—And His Target Strikes Back
- From the CP/M* Users Group: Volume 49, Including Some Useful RATFOR Programs

*PASM, BUG/uBUG, PLINK, and EDIT are trademarks of Phoenix Software Associates, Ltd.

*SSSFORTTRAN is a trademark of SuperSoft Associates.

*SBASIC is a trademark of Topaz Programming.

*CP/M is a trademark of Digital Research, Inc. The CP/M Users Group is not affiliated with Digital Research, Inc.

Lifelines is the publication dedicated to keeping you up-to-date on happenings in the explosive micro-computer world.

Lifelines specializes in news about software for CP/M* and similar operating systems.

Lifelines does it with a guarantee of high level, in-depth analysis of software uses and capabilities.

Lifelines does it with valuable information necessary to make intelligent software buying decisions.

Lifelines does it with the latest information on The CP/M Users Group.

Lifelines does it with thought provoking discussions on many of the more controversial issues facing computer users.

How can you live without Lifelines?

Subscribe Now!

\$18.00 for twelve issues: U.S., Canada, and Mexico.

\$40.00 for twelve issues: all other countries.

\$2.50 for each back issue: U.S., Canada, and Mexico.

\$3.60 for each back issue: all other countries.

All orders must be pre-paid by check to: LIFELINES, 1651 Third Avenue, New York, N.Y. 10028—Checks must be in U.S. \$, drawn on a U.S. bank. Or use your VISA or MASTERCARD. Call (212) 722-1700

LIFELINES



Operating Systems

Operating systems, too, have become more refined. But why do we have operating systems at all? In the 1960s we used expensive mainframes with power-hungry central processors and magnetic-core memory. Downtime for complicated card readers, printers, and backup data-storage devices was high, requiring constant maintenance. A card-oriented "batch" operating system provided two functions. First, it allocated processor time, memory, and peripherals to application programs in an attempt to utilize each expensive component to its fullest. Second, common I/O subroutines were a part of the operating system to avoid duplication in each application program. In the early 1960s, batch operating systems began to incorporate online terminals that allowed the programmer to interact with the program—this is

where things became interesting. With an online terminal, a program could write a prompt message, read the data entered by the operator, and write a response almost instantly.

The crude terminal systems evolved into today's timesharing computers, where program interaction is the primary function, with batch processing in the background. General Electric and Digital Equipment Corporation led the way with BASIC-based 235 and multilingual PDP-10 computers. Countless timesharing operating systems followed, including IBM's interactive APL and CP/CMS, along with UNIX from Bell Laboratories. These timesharing systems were the forerunners of personal computing: all assumed that the hardware was too expensive to dedicate, so each terminal became an emulation of a single computer.

Shugart's new (at that time) floppy-disk drives to serve as development systems. For the first time, it was feasible to dedicate a reasonably powerful computer to the support of a single engineer. But the use of PL/M on larger timesharing computers was considered sufficient, and the CP/M idea was rejected.

The CP/M Family

CP/M was, however, completed by MAA in 1974. It included a single-user file system designed to eliminate data loss in all but the most unlikely situations, and used recoverable directory information to determine storage allocation rather than a traditional linked-list organization. The simplicity and reliability of the file system was an important key to the success of CP/M: file access to relatively slow floppy disks was immediate, and disks could be changed without losing files or mixing data records. And because CP/M is a Spartan system, today's increased storage-media transfer rates simply improve overall response. The refinements found in CP/M are based on its simplicity, reliability, and a proper match with limited-resource computers.

By the mid-1970s, CP/M added a new philosophy to operating system design. CP/M had been implemented on several computer systems, each having a different hardware interface. To accommodate these varying hardware environments, CP/M was decomposed into two parts: the invariant disk operating system written in PL/M, and a small variant portion written in assembly language. This separation allowed computer suppliers and end users to adapt their own physical I/O drivers to the standard CP/M product.

Hard-disk technology added yet another factor. CP/M customers required support for disk drives ranging from single 5-inch floppy disks to high-capacity Winchester disk drives. In response, CP/M was totally redesigned in 1979 to become *table-driven*. All disk-dependent parameters were moved from the invariant disk operating system to tables in the

ATTENTION GOVERNMENT D P USERS AND PURCHASERS

We represent many fine micro products and manufacturers on the GSA Schedule, including

*Apple, Cromemco
and Computer Corporation of America*

Purchasing from the Schedule will save you the time consumed by the bid process. Products shipped throughout the United States and world-wide. Visit or write any of our stores for more information or to receive our catalogue of products represented.

**Computers,
Etc.....
the dependable store**

257 West Street, Annapolis, MD 21401 — (301) 268-6505
13A Allegheny Avenue, Towson, MD 21204 — (301) 296-0520
9330 Georgia Avenue, Silver Spring, MD 20910 — (301) 588-3748
or Call (301) 268-5801

*Career Opportunities Available * An Equal Opportunity Employer*

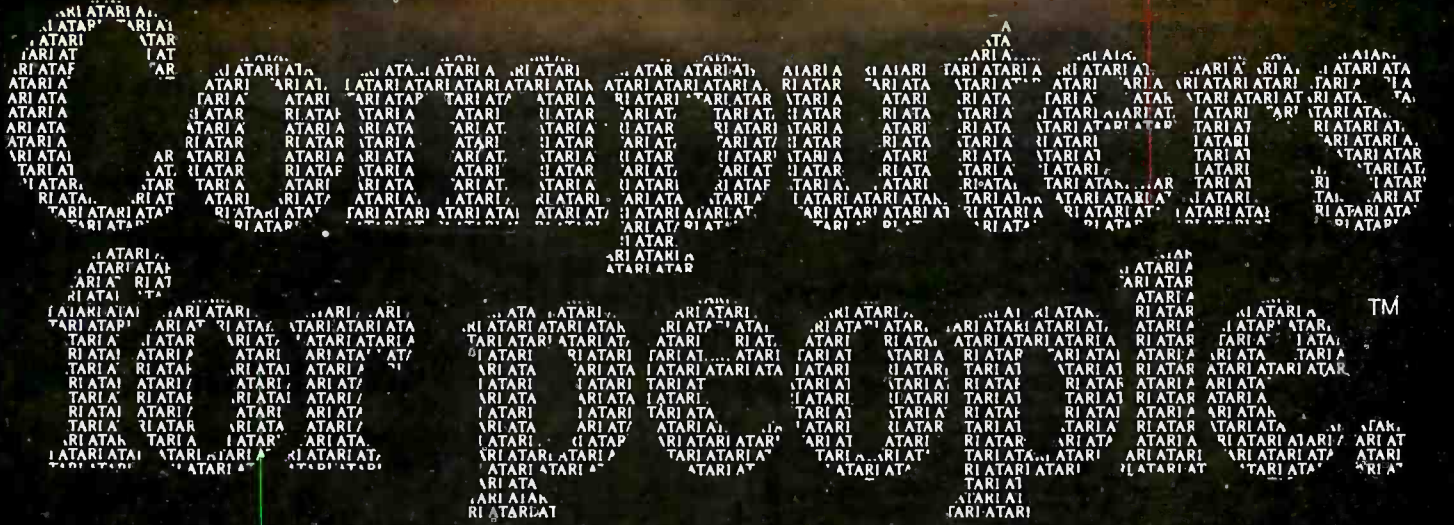

Atari graphics and sound stand in a class by themselves.”

David D. Thornburg
Compute Magazine, November/December 1980

“Its superiority lies in three areas: drawing fancy pictures (in color), playing music, and printing English characters onto the screen. Though the Apple can do all these things, Atari does them better.”

Russell Walter
*“Underground Guide to Buying a Computer”
 Published 1980, SCELBI Publications*

What computer people are saying about Computers for people.™

To find out about the ATARI® 800™ Computer first hand, ask your local computer dealer for a hands-on demonstration. Or call, 800-538-8547 (In California 800-672-1404)



ATARI

Computers for people.™

©1981 ATARI, Inc.
 A Warner Communications Company

For further information write: Atari Inc., Computer Division, 1196 Borregas Avenue, Sunnyvale, CA 94086
 Circle 29 on Inquiry card. Dept. C-11

“The Atari machine is the most extraordinary computer graphics box ever made...”

Ted Nelson
Creative Computing Magazine, June 1980

“...so well packaged that it is the first personal computer I’ve used that I’m willing to set up in the living room.”

Ken Skier, *OnComputing, Inc. Summer 1980*

“...well constructed, sleekly designed and user-friendly—expect reliable equipment, and strong maintenance and software support.

Videoplay
December, 1980



CPU's & SUPPORT CHIPS	
2114L3	- 3.95
4116 3	- 3.75
4116 2	- 3.75
8080A	- 5.95
8085A	- 12.95
AMD 2901	- 13.95
8205	- 3.95
8212	- 2.50
8214	- 3.60
8216	- 2.90
8228	- 2.75
8228	- 4.50
8251	- 4.50
8259	- 6.95
8257 (AM9517)	- 8.95
280A 510	- 17.95
8275	- 16.95
FD1791	- 34.95

RAM's

UART's	
AY5-1013	- 3.75
TR1602B	- 3.95
AY3-8500	- 1.95
PT1462B	- 3.25

INTERFACE & DRIVERS

1488	- .90
1489	- 1.10
8130	- 2.50
8131	- 2.50
8850	- 2.50
8853	- 2.50
8834	- 2.00
8837	- 2.00
8838	- 2.00
87300	- 2.00

SHIFT REGISTERS

PRINTED CIRCUIT BOARD	
4" x 6" DOUBLE SIDED EPOXY BOARD 1/16" thick \$.60 ea. ... \$142.60	

EPOXY GLASS VECTOR BOARD

1/16" thick with 1/10" spacing
4 1/2" x 6 1/2" ... \$1.95

DAT'L'S DAC-08C

8 bit DAC - \$7.95
INTERPOL D181P ANALOG SWITCH - \$11.50
2 CHANNEL DRIVERS - \$26.50
INTERPOL ICL 714-D 12C PL 12 BIT A/D CONVERTER - \$10.95
REDICION SMO 1024 ANALOG SWITCH - \$10.95

74500 .30	74574 .70	74598 1.25
74502 .30	74580 1.50	74599 1.75
74504 .40	74582 .85	745114 1.40
74508 .40	74584 1.50	74512 1.50
74510 .40	74586 1.50	74594 1.10
74512 .30	74588 1.25	74597 1.50
74514 .30	74590 1.10	74598 1.50
74516 .40	74592 1.50	74599 1.50
74518 .40	74594 1.50	74599 1.50
74520 .40	74596 1.25	74532 2.25
74522 .40	74598 1.25	74534 2.80

7 WATT LD 65 LASER DIODE IR \$8.95

25 watt Infra Red Pulse (SG 2006 equiv.)
Laser Diode (Spec sheet included) \$24.95

CLOCK CHIPS

MM1537AA	- \$5.95
MM1534	- \$4.75
MM1536	- \$4.95

TANTALUM CAPACITORS

22UF 35V 5/61.00	10UF 10V	- \$.40
47UF 35V 5/61.00	22UF 10V	- \$.30
68UF 35V 5/61.00	15UF 16V	3/61.00
1UF 35V	30UF 6V	5/61.00
2.2UF 20V	33UF 20V	1.80
3.3UF 20V	10UF 15V	1.85
4.7UF 15V	10UF 16V	1.70
6.8UF 35V	120UF 6V	1.75

SANKEN AUDIO POWER AMPS

Si 1010 G 10 WATTS	- \$ 7.50
Si 1020 G 20 WATTS	- \$ 11.00
Si 1030 G 30 WATTS	- \$ 13.50
Si 1050 G 50 WATTS	- \$ 25.00

RS232 CONNECTORS

DB 25P male	- \$3.25
DB 25S female	- \$4.25
HOOS	- \$1.50

POSTAGE RATES

ADD 10% FOR ORDERS UNDER \$20.00
ADD 5% FOR ORDERS BETWEEN \$20.00 AND \$50.00
ADD 3% FOR ORDERS ABOVE \$50.00

C/MOS	
4001	- 25 4027 - 45 4081 - 25 74CT4 - 50
4002	- 25 4028 - 80 4082 - 25 74C76 - 70
4006	- 25 4030 - 95 4093 - 75 74C85 - 130
4007	- 25 4032 - 95 4097 - 75 74C88 - 140
4008	- 80 4034 - 225 4901 - 95 74C96 - 50
4010	- 45 4040 - 90 4511 - 185 74C83 - 95
4011	- 45 4042 - 85 4514 - 185 74C90 - 125
4012	- 25 4043 - 100 4515 - 185 74C87 - 125
4013	- 37 4044 - 75 4516 - 100 74C160 - 120
4014	- 37 4046 - 90 4518 - 120 74C81 - 115
4015	- 85 4047 - 150 4520 - 70 74C83 - 115
4016	- 45 4048 - 95 4553 - 120 74C98 - 125
4017	- 37 4050 - 45 74C00 - 40 74C13 - 130
4018	- 80 4051 - 80 74C02 - 37 74C14 - 130
4019	- 45 4052 - 110 74C04 - 40 74C20 - 50
4020	- 70 4053 - 110 74C08 - 30 74C82 - 130
4021	- 37 4056 - 100 74C10 - 70 74C80 - 50
4022	- 100 4069 - 25 74C14 - 120 74C26 - 68
4023	- 25 4071 - 35 74C20 - 27
4024	- 45 4072 - 25 74C32 - 45
4025	- 25 4076 - 80 74C73 - 25
4077	- 36

SPECIALS

14 PIN HEADERS	3/\$1.00
16 PIN HEADERS	.40
24 PIN HEADERS	.75
40 PIN HEADERS	1.10
50 PIN EDGEBOARD CONN.	3.95
26 PIN EDGEBOARD CONN.	2.50
50 PIN RIGHT ANGLE CONN.	3.95
20 PIN RIGHT ANGLE CONN.	2.25
4 2516 ROM'S	23.00
8 4116-3 RAMS	28.50
MC68000L	125.00

20% Discount all 74L and S series

20% Discount

340T and 320T regulators

SPECIALS GOOD THRU JUNE 1981

CRYSTALS \$3.45 ea.		RIBBON CABLE FLAT (COLOR CODED) #30 WIRE	
2.000MHz	6.144MHz	20 cond.	-.40/per foot
4.000MHz	8.000MHz	50 cond.	-.90/per foot
3.000MHz	10.000MHz		
3.57MHz	18.000MHz		
5.000MHz	18.432MHz		
6.000MHz	20.000MHz		

MINIATURE MULTI-TURN TRIM POT'S

100, 5K, 10K, 20K, 250K, ... \$7.75 each ... 3/2.00

NO. 30 WIRE WRAP WIRE SINGLE STRAND 100' ... \$1.40

ALCO MINIATURE TOGGLE SWITCHES

MTA 206 SPDT	... \$1.05
MTA 206 DPDT CENTER OFF	... \$1.85
MSD 206 DPDT CENTER OFF FLIP SWITCH	... \$1.85

SCR's TRIAC's

100 .45	60 .60	1.40	200 .80	1.90	9.00
200 .70	.80	1.30	400 1.20	1.40	2.60 12.00
600 1.10	1.30	1.50	1.80	3.60	15.00
1000 2.00	2.45	1.25	3.00	12.50	26.00

FP 100 PHOTO TRANS. \$.50
RED, YELLOW, GREEN OR AMBER LARGE LED 2" 2' 6/11.00
RED/GREEN BIPOLAR LED'S \$.55
MLED 92R LED \$.75
MRD 148 PHOTO DARK XTOR \$.75
TL-118 OPTO-ISOLATOR \$.75
IL-5 OPTO-ISOLATOR \$.80
1 WATT ZENERS: 3.3, 4.7, 5.1, 5.6, 6.8, 8.2, 9.1, 10, 12, 15, 18, or 22V ... 6/91.00

SFC 3301 - 50 PRV 30A

FAST RECOVERY DIODE (35ns) \$2.25

20KV 250MA DIODE \$1.90

SILICON POWER RECTIFIERS

PRV	1A	3A	12A	50A	125A	240A
100	.06	.14	.35	.90	3.70	6.00
200	.07	.20	.40	1.30	4.25	9.00
400	.09	.25	.65	1.50	6.50	12.00
600	.11	.30	.80	2.00	8.50	15.00
800	.15	.35	1.00	2.50	10.50	18.00
1000	.20	.45	1.25	3.00	12.50	26.00

IN 4148 (IN914) ... 15/\$1.00

.1 or .01 of 25V ceramic disc caps. 16/\$1.00, 100/\$5.00

.5V at 800ma SOLAR CELLS 3" diameter \$4.35

7 SEGMENT DISPLAYS

FSC 8024-4 digit	DL 707 C.A. .3"	... \$7.5
C.C. 8" display	DL 747 C.A. .6"	... \$1.50
FND503 C.C. 5"	HP 3400 8" C.A.	... \$1.95
FND510 C.A. 5"	HP 3405 8" C.C.	... \$1.95
DL-704 3" C.C.		... \$8.5

TRANSISTOR SPECIALS	
2N1307 PNP GTO'S	... \$ 40
2N4004 PNP GTO'S	3/11.00
HEP6014 - PNP GTO 3	... \$ 85
TIP 121 - NPN'S SWITCHING	... \$ 95
2N2538 PNP SILENT	... \$100
MPF 8004 C.B.F.T. TRANSISTOR PNP	... \$ 75
2N3772 PNP SILENT	... \$100
2N5086 PNP SILENT	... \$100
2N4352 PNP SILENT	... \$100
2N3919 PNP SILENT	... \$100
2N4320 PNP SILENT	... \$100
2N2857 PNP SILENT	... \$100
2N2222 PNP SILENT	... \$100
2N4352 PNP SILENT	... \$100
2N3904 PNP SILENT	... \$100
2N5226 PNP SILENT	... \$100
2N5228 PNP SILENT	... \$100
2N5229 PNP SILENT	... \$100
TIP 114 PNP SILENT	... \$ 50
TIP 116 PNP SILENT	... \$ 50
TIP 117 PNP SILENT	... \$ 50
TIP 118 PNP SILENT	... \$ 50
TIP 119 PNP SILENT	... \$ 50
TIP 120 PNP SILENT	... \$ 50
TIP 121 PNP SILENT	... \$ 50
TIP 122 PNP SILENT	... \$ 50
TIP 123 PNP SILENT	... \$ 50
TIP 124 PNP SILENT	... \$ 50
TIP 125 PNP SILENT	... \$ 50
TIP 126 PNP SILENT	... \$ 50
TIP 127 PNP SILENT	... \$ 50
TIP 128 PNP SILENT	... \$ 50
TIP 129 PNP SILENT	... \$ 50
TIP 130 PNP SILENT	... \$ 50
TIP 131 PNP SILENT	... \$ 50
TIP 132 PNP SILENT	... \$ 50
TIP 133 PNP SILENT	... \$ 50
TIP 134 PNP SILENT	... \$ 50
TIP 135 PNP SILENT	... \$ 50
TIP 136 PNP SILENT	... \$ 50
TIP 137 PNP SILENT	... \$ 50
TIP 138 PNP SILENT	... \$ 50
TIP 139 PNP SILENT	... \$ 50
TIP 140 PNP SILENT	... \$ 50
TIP 141 PNP SILENT	... \$ 50
TIP 142 PNP SILENT	... \$ 50
TIP 143 PNP SILENT	... \$ 50
TIP 144 PNP SILENT	... \$ 50
TIP 145 PNP SILENT	... \$ 50
TIP 146 PNP SILENT	... \$ 50
TIP 147 PNP SILENT	... \$ 50
TIP 148 PNP SILENT	... \$ 50
TIP 149 PNP SILENT	... \$ 50
TIP 150 PNP SILENT	... \$ 50
TIP 151 PNP SILENT	... \$ 50
TIP 152 PNP SILENT	... \$ 50
TIP 153 PNP SILENT	... \$ 50
TIP 154 PNP SILENT	... \$ 50
TIP 155 PNP SILENT	... \$ 50
TIP 156 PNP SILENT	... \$ 50
TIP 157 PNP SILENT	... \$ 50
TIP 158 PNP SILENT	... \$ 50
TIP 159 PNP SILENT	... \$ 50
TIP 160 PNP SILENT	... \$ 50
TIP 161 PNP SILENT	... \$ 50
TIP 162 PNP SILENT	... \$ 50
TIP 163 PNP SILENT	... \$ 50
TIP 164 PNP SILENT	... \$ 50
TIP 165 PNP SILENT	... \$ 50
TIP 166 PNP SILENT	... \$ 50
TIP 167 PNP SILENT	... \$ 50
TIP 168 PNP SILENT	... \$ 50
TIP 169 PNP SILENT	... \$ 50
TIP 170 PNP SILENT	... \$ 50
TIP 171 PNP SILENT	... \$ 50
TIP 172 PNP SILENT	... \$ 50
TIP 173 PNP SILENT	... \$ 50
TIP 174 PNP SILENT	... \$ 50
TIP 175 PNP SILENT	... \$ 50
TIP 176 PNP SILENT	... \$ 50
TIP 177 PNP SILENT	... \$ 50
TIP 178 PNP SILENT	... \$ 50
TIP 179 PNP SILENT	... \$ 50
TIP 180 PNP SILENT	... \$ 50
TIP 181 PNP SILENT	... \$ 50
TIP 182 PNP SILENT	... \$ 50
TIP 183 PNP SILENT	... \$ 50
TIP 184 PNP SILENT	... \$ 50
TIP 185 PNP SILENT	... \$ 50
TIP 186 PNP SILENT	... \$ 50
TIP 187 PNP SILENT	... \$ 50
TIP 188 PNP SILENT	... \$ 50
TIP 189 PNP SILENT	... \$ 50
TIP 190 PNP SILENT	... \$ 50
TIP 191 PNP SILENT	... \$ 50
TIP 192 PNP SILENT	... \$ 50
TIP 193 PNP SILENT	... \$ 50
TIP 194 PNP SILENT	... \$ 50
TIP 195 PNP SILENT	... \$ 50
TIP 196 PNP SILENT	... \$ 50
TIP 197 PNP SILENT	... \$ 50
TIP 198 PNP SILENT	... \$ 50
TIP 199 PNP SILENT	... \$ 50
TIP 200 PNP SILENT	... \$ 50
TIP 201 PNP SILENT	... \$ 50
TIP 202 PNP SILENT	... \$ 50
TIP 203 PNP SILENT	... \$ 50
TIP 204 PNP SILENT	... \$ 50
TIP 205 PNP SILENT	... \$ 50
TIP 206 PNP SILENT	... \$ 50
TIP 207 PNP SILENT	... \$ 50
TIP 208 PNP SILENT	... \$ 50
TIP 209 PNP SILENT	... \$ 50
TIP 210 PNP SILENT	... \$ 50
TIP 211 PNP SILENT	... \$ 50
TIP 212 PNP SILENT	... \$ 50
TIP 213 PNP SILENT	... \$ 50
TIP 214 PNP SILENT	... \$ 50
TIP 215 PNP SILENT	... \$ 50
TIP 216 PNP SILENT	... \$ 50
TIP 217 PNP SILENT	... \$ 50
TIP 218 PNP SILENT	... \$ 50
TIP 219 PNP SILENT	... \$ 50
TIP 220 PNP SILENT	... \$ 50

TTLIC SERIES

</

Put Time and BSR/X-10 Control in Your APPLE II THUNDERCLOCK PLUS™

The THUNDERCLOCK PLUS is two peripheral systems on one card for your APPLE II, II PLUS, or III. An accurate, reliable, real-time clock/calendar and an interface for the popular BSR X-10 Home Control System.

The THUNDERCLOCK clock/calendar makes accurate time and date available to your programs: month, date, day-of-week, hour, minute, and second, in any of four software selectable formats. On-board batteries keep your THUNDERCLOCK running when your APPLE II is turned off - for up to four years before battery replacement. On-card 1K firmware makes reading or setting the time easy from APPLESOFT or INTEGER BASIC, PASCAL, or assembly language programs. And it provides software selectable interrupts at any of three rates: 64, 256, or 2048 interrupts/second. All features are software selectable - no switches or jumpers!

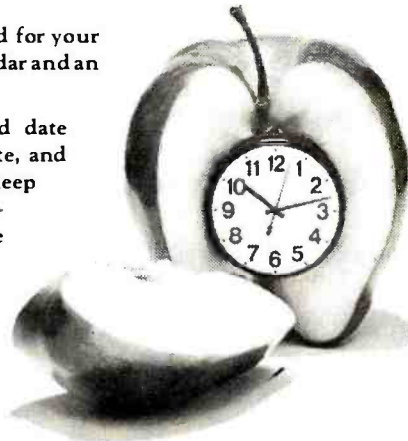

THE PLUS

Add THUNDERWARE'S X-10 ULTRASONIC INTERFACE OPTION to your THUNDERCLOCK and your programs can send all 22 BSR X-10 commands so you can remotely control lights and appliances. Plus a powerful disk software package! The THUNDERWARE SCHEDULER software lets you create schedules to control lights, appliances, security systems, or almost any other electrical device. The software includes: SCUTIL - the SCHEDULER utility that lets you make or change a schedule, and SCHED - executes your schedules in real-time using the THUNDERCLOCK. SCHED runs in the 'background' so you can run other programs in the 'foreground'. Our PASCAL software lets you use all the THUNDERCLOCK'S features and sets the file date whenever you boot. The THUNDERCLOCK PLUS is a SYSTEM for your APPLE II. Supported by intelligent, easy to use firmware, a powerful software package, and good documentation!

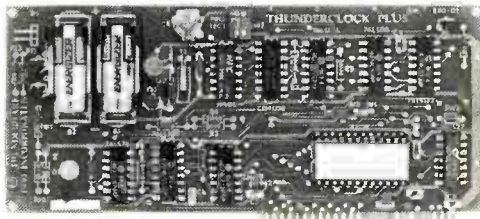

Let the THUNDERCLOCK PLUS time/date stamp your DOS files whenever you create or modify them with our DOS-DATER software.

The THUNDERCLOCK PLUS will work in any APPLE, including the APPLE III.

See your APPLE dealer.

Suggested retail prices:

- THUNDERCLOCK PLUS.....\$139
Clock/calendar card with batteries and user's manual
- X-10 INTERFACE OPTION \$49
BSR X-10 Ultrasonic interface, disk with SCHEDULER SOFTWARE & demos, and user's manual
- PASCAL SOFTWARE..... \$29
Disk with PASCAL interface for clock and X-10 interface, and user's guide
- MANUALS ONLY, each..... \$5

California residents add 6% sales tax

If your dealer doesn't carry the
THUNDERCLOCK PLUS:

ORDER TOLL FREE (VISA/MC) CALL:
800-227-6204 Ext 307 (Outside California)
800-632-2131 Ext 307 (California Only)

OR WRITE TO:

THUNDERWARE INCORPORATED
P.O. Box 13322, Oakland, CA 94661



BSR X-10 is a trademark of BSR (USA) LTD.
APPLE II is a trademark of APPLE COMPUTER, INC

the process. You can, for example, send the name of a disk file to the spooler and, while the file is being printed, edit another file in preparation for compilation. The spooler and editor share processor time to complete their respective tasks. In general, many such processes share processor time and system resources.

MP/M process communication is performed through *queues* (or waiting lines) managed by the nucleus. The spooler, for example, reads file names from an input queue posted by another process (which reads spooler command lines from

the console). When the spooler is busy printing a file, additional file names may enter the input queue in a first-in first-out order.

Process synchronization through queuing mechanisms is commonplace, but MP/M treats queues in a unique manner, simplifying their use and decreasing queue management overhead. Queues are treated as files: they are named symbolically so that a queue can be added dynamically. Like files, queues have queue control blocks that are created, opened, deleted, written, and read. In fact, the set of queue operations closely

matches the file functions of CP/M so that MP/M provides a familiar programming environment.

The implementation of queues is transparent to an operator or system programmer, but it is important to MP/M's effective operation on limited-resource computers. Queues are implemented through three different data structures, depending upon the message length. So-called "counting semaphores" count the occurrence of an event with message length zero, and are implemented as 16-bit tallies. Single-byte messages are processed using a circular buffer. Similarly, queues containing addresses are processed using circular buffers. In all other cases, MP/M uses a general linked list, which requires additional space and processing time. It is this sensitivity to the capabilities of limited-resource computers that makes MP/M effective: while real-time operating systems often incur 25 to 40% overhead, MP/M has been streamlined to increase available compute time by 7% over single-user CP/M.

Like CP/M, MP/M is separated into variant and invariant portions. The file-system interface is identical to that of CP/M, with the addition of user-defined functions to handle non-CP/M operations (such as control of the real-time clock). Field-reconfiguration of MP/M allows a variety of device protocols including CP/M-style busy-wait loops, polled devices, and interrupt-driven peripherals. In fact, the variety of interface possibilities makes the MP/M implementer a true system-software designer, since a fine-tuned MP/M system may operate considerably faster than its initial implementation.

What are the refinements found in MP/M? First, it is a state-of-the-art operating system based on current process-synchronization technology and microprocessor real-time system design philosophies. Process communication is conceptually simple and requires minimal overhead. Finally, it is the only operating system of its type that can be field-tailored to match almost any computer configuration.

*** * * WRITE OR CALL FOR FREE CATALOGUE * * ***

CALIFORNIA COMPUTER SYSTEMS HIGH IN QUALITY. LOW IN PRICE
 Z80 CPU, 4 Mhz, with one serial port; 12 slot S-100 mainframe, disk controller, 64K Dynamic Ram, CP/M 2.2[®] \$1,645.
 Sorry, we cannot guarantee this price after June 20th.
 Interfaced to 2 Shugart 8", single sided, double density drives mounted in our own, beautiful MAX BOX with power supply and fan \$1,250.
 A complete S-100 system for under \$3,000. THE BEST BUY ON THE MARKET.

IMS 5000 and 8000 Systems
 Outstanding long term reliability and performance. These systems feature a Z80A CPU, S-100 bus; double density drives (either single or double sided), DMA disk controller, 64K RAM, 2 serial & 1 parallel port. Prices include the very finest implementation of CP/M[®] available in the entire industry. Hard disk and multi user software options. Desk top or desk enclosed. 5000 DT with dual, single sided mini drives
 8000 DT with dual single sided 8" drives

PER SCI—THE KING AND QUEEN OF DRIVES!
 Model 299B: Dual headed drives, total 3.2 MB unformatted \$2,300.
 Model 277: Dual 8 inch drives, voice coil positioned, IBM compatible, 1600 K BYTES per drive, unformatted \$1,210.
 Slimline cabinet and power for either 277 or 299 \$ 300.

DRIVES
 The MAX BOX: Manufactured by John D. Owens Associates. 8" dual drive cabinet complete with power supply & fan. Will hold Qumes, Shugarts or Siemens. Excellent design and engineering \$ 325.
 With 2 Shugart 800R drives \$1,250. With 2 QUME Double sided drives \$1,650.

MPI B51... \$265.	B52... \$365.	B92... \$500.	Shugart... \$ 450.
-------------------	---------------	---------------	--------------------

HAZELTINE 1500 \$925.	IMS MEMORY 16 K static \$350.
1510 \$1,030.	32 K static \$650.
1520 \$1,265.	64 K Dynamic with parity \$755.
220 volt models, add \$100	
EXEC 80 with 15" screen \$1,115.	

TEI MAINFRAMES, S-100
 We are proud to announce that we are now a TEI stocking distributor. For the best in mainframes... TEI!!

CENTRONICS 737 \$780.	TELEVIDEO CRTs
Same as TRS-80 Model IV	912... \$780. 920... \$850. 950... \$1,050.
Apple serial/parallel interface \$195.	
EPSON MX80B \$550.	

WE EXPORT: Overseas Callers: TWX 710 588 2844
 Phone 212 448-6298 or Cable: OWENSASSOC

SEE OUR AD FOR NEW PRODUCTS ON PAGE 84

JOHN D. OWENS
Associates, Inc.
 12 Schubert Street
 Staten Island, New York 10305
 212 448-6283 212 448-2913 212 448-6298

CP/NET

CP/NET, introduced in late 1980, leads a series of network-oriented operating systems that distribute operating system functions throughout a network of nonhomogeneous processors. CP/NET connects CP/M requesters to MP/M servers through the use of an arbitrary network protocol. Similar to CP/M and MP/M, CP/NET consists of the invariant portion, along with a set of field-reconfigurable subroutines that define the interface to a particular network. For purposes of CP/NET, this interface need only provide point-to-point data-packet transmission. Since the actual data transmission media are unimportant to CP/NET, any one of the number of standard protocols can be used, from low-speed RS-232C through high-speed Ethernet. Physical connections are also arbitrary, allowing active hub-star, ring, and common-bus architectures.

The invariant portions of CP/NET operate under a standard CP/M system to direct various system calls over the network to an MP/M server. The MP/M server, in turn, responds to network requests by simulating the actions of CP/M. This simulation is transparent to an application program: any program operating under standard CP/M operates properly in the network environment.

Suppose, for example, you wish to store common business letters in a central data base under MP/M and access these letters from a CP/M-based word processor. You begin by assigning one local disk drive to the MP/M master, using the CP/NET interface. You then direct your word processing system to read the particular letter on the assigned drive, causing the data to be obtained from the server rather than from the local disk. After local update using your word processor, you can print the result on your local printer or optionally assign your listing device to the network for printing at the MP/M server.

CP/NET is accompanied by three related network operating systems: CP/NOS, MP/NET, and MP/NOS. CP/NOS is, in effect, a diskless

CP/M, which can be stored in read-only memory, and that operates with a console, memory, and network interface. MP/NET, on the other hand, is a complete MP/M system with an embedded network interface that, like CP/NET, allows local devices to be reassigned to the network. MP/NET configurations allow MP/M systems as both requesters and servers with CP/M requesters. Finally, MP/NOS contains the real-time portion of MP/M without local disk facilities. Like CP/NOS,

MP/NOS performs all disk functions through the network.

The interface protocol is publicly defined so that non-MP/M or non-CP/M systems can participate in network interactions. A server interface for the VAX 11/780, for example, is under preparation so that it can perform I/O functions for a large number of MP/M and CP/M requesters.

The principal advantage of CP/NET is that all CP/M-compatible software becomes immediately available for operation in the network en-

* * *GREETINGS TO OUR FRIENDS IN THE U.K.* * *

<p>TELETYPE - PRICES SLASHED</p> <p>Model 4320 AAA \$800 220V. model with transformer installed inside cabinet \$900 Model 43ASR, 8 level, 1" tape... \$2,595. Limited supply of Model 45 available.</p> <p>TELEBUFFER 43 ASR \$945. Circuit card designed for internal installation in the Model 43 Teletype. Changes the 43 into a buffered send/receive device, enabling it to function as a Telex without paper tape. Provides from 4K to 16K bytes of internal memory for storage of message.</p> <p>TEXAS INSTRUMENTS PRINTERS</p> <p>10% off list price on entire TI printer line.</p> <p>IBM 3101 CRT Model 10 \$1,195. Model 20 \$1,395. Selectric-like, detached keyboard. 9x16 dot matrix. Maintenance contract from IBM only \$70 per year</p> <p>ITHACA INTERSYSTEMS</p> <p>Full S-100 IEEE Compatibility! Full 24 address bits. DMA disk controller. SYSTEM 2A includes 20 slot mainframe with front panel, 64K Dynamic RAM. Z80 CPU, 4 MHZ, extended addressing capability. 4 parallel, 2 serial I/O floppy controller. Our discounted price, \$3,415.</p> <p>MARINCHIP SYSTEMS M9900</p> <p>Elegant 16 bit CPU, S-100 compatible, multi user, multi processor operating system. BASIC, FORTH, META, PASCAL, Word processor, text editor. CPU kit and software package \$ 550. Assembled \$ 700. Complete system, 64KB, two drives \$4,995.</p> <p>MICROANGELO \$2,280. High resolution graphics system. 15", 22MHZ, green phosphor screen, 72 key keyboard; includes complete cabling and software. From SCION. S-100 Graphics card \$ 960.</p>	<p>GRAPHICS SOFTWARE</p> <p>On line, real time, for the M9900 to drive the Microangelo. For use in design of PC board masks, IC masks and other applications \$1,000.</p> <p>CORVUS HARD DRIVES</p> <p>We are the S-100 CORVUS dealer in the New York area. MODEL 11, Hard Disk System . 54,820. Mirror Backup System 5 715.</p> <p>TARBELL</p> <p>Double density controller \$420. Z80 CPU \$395 Includes 2 serial ports; supports MPM* Runs at either 2 or 4 MHZ.</p> <p>UPGRADE DEC LA 35/36 \$750. Increases baud rate to 1200. Microprocessor controlled. Many options available. Enthusiastic user response. Long-term reliability. From DataSouth.</p> <p>Communications Software from from Hawkeye Grafix</p> <p>Enables communications from a micro to a terminal or to another micro, mini or maxi computer. Object Code \$75. Source Code \$250.</p> <p>3M SCOTCH" Diskettes</p> <table border="0"> <tr> <td></td> <td style="text-align: center;">5 BOXES</td> <td></td> </tr> <tr> <td></td> <td style="text-align: center;">1 BOX</td> <td style="text-align: center;">Price</td> </tr> <tr> <td></td> <td style="text-align: center;">of ten</td> <td style="text-align: center;">per box</td> </tr> </table> <p>Model 740, 8" single sided, single density. \$29.00 \$26.50 Model 741, 8" single sided, double density 38.00 35.00 Model 743, 8" double sided double density . 46.50 42.50 Model 744-0, 5 1/4" softsectored, single sided 744-10, 5 1/4" , hard sectored, single sided 29.00 26.50</p> <p>CAT from NOVATION</p> <p>Originate/Answer back \$175. CAT-D \$185. Connects directly to telephone line with a plug-in jack. AUTO-CAT \$240.</p>		5 BOXES			1 BOX	Price		of ten	per box
	5 BOXES									
	1 BOX	Price								
	of ten	per box								

WE OFFER A FULL RANGE OF EXPERT CONSULTING SERVICES

JOHN D. OWENS
 Associates, Inc.
 SEE OUR AD ON FACING PAGE

THE NEW NEVADA COBOL!

At \$149.95 you can't buy a better COBOL or one residing in less memory.

Now with the new Nevada COBOL, you can use the programs developed by professional business programmers over the past twenty years to run the big IBM machines. And you can develop and tailor programs on your micro and run them on your micro or recompile and run them on any mainframe computer. What's more you can do it for about one-fifth the cost of comparable COBOL compiler systems.

Almost all the popular microcomputers work with the CP/M operating system we use including Apple, TRS-80, North Star, Superbrain, Cromemco and so on.

Check the features; you'll go Nevada COBOL.

A powerful subset of ANSI-74, Nevada COBOL requires a scant 16K of RAM. It's available on 8" CP/M standard single density or 5-1/4" diskettes. Price includes diskette and manual. Price for manual only, \$24.95.

Four COBOL applications packages available too.

Four COBOL applications packages are currently available. Each is priced at \$24.95 for the diskette. The 73 page manual covering all four applications costs an additional \$24.95. The manual carries complete COBOL source code listings and superior documentation.

Package #1 is the Budget Plan Report Generator. Here's an extraordinary time saver and planning aid for both start-up and well established businesses.

Package #2 is the Personal Financial Planner to give you some eye opening insights into your own personal spending habits.

Package #3 is Labels so you can print name and address labels.

Package #4 is Pre-COBOL for use as a pre-processor of COBOL source programs. A great programming aid.

Order today or write for complete details.

Phone (415) 751-1522 or address Ellis Computing, 600 41st Ave, San Francisco, CA 94121. Nevada Cobol is also available at Lifeboat Associates, Discount Software, Westico, Business Micro Products, Computer Information Exchange and other quality computer stores. Mastercard, Visa, C.O.D.s, or checks accepted. California orders please include sales tax.

CP/M, TRS-80 and IBM are TM's of Digital Research. Tandy Corp and IBM respectively



ELLIS COMPUTING
SOFTWARE TECHNOLOGY

vironment, solving the problem that builders of network hardware face: the total absence of application software. Although the promise is there, networking is in its infancy, and CP/NET is truly a software package awaiting the evolution of suitable hardware.

PL/I: The Application Language

In 1978, Digital Research investigated the final level of software support: application languages. One such language was to be supported throughout the operating system product line, and the choice would have to be a multipurpose language. Further, the language would have to be an international standard to promote the generation of software by independent vendors. Standard Pascal seemed a logical choice but was rejected for several reasons. First, Pascal is an ALGOL derivative with scientific orientation. Commercial facilities in the standard language are absent: decimal arithmetic, file processing, string operations, and error-exception handling were essential. Further, separate compilation and initialization of tables were not in the language. There was a temptation to extend Pascal in order to include these features, but these extensions would have defeated the benefits of standardization.

PL/I Subset G was the obvious choice. It satisfied scientific and commercial needs and, because of subset restrictions, was consistent and easy to use. The project was a bit daring, however, because Subset G was unknown in the computer community. PL/I was viewed as a large IBM-oriented language with huge, inefficient compilers that required tremendous runtime support.

The Digital Research implementation of Subset G was started in mid-1978 and completed two years later. The compiler is a three-pass system written in PL/M. The first two passes are machine independent and produce symbol tables and intermediate language suitable for any target machine. The third pass is largely machine dependent and is dedicated to code optimization and final ma-

chine-code production. The compiler is accompanied by a linkage editor (compatible with the Microsoft format), a program librarian, a set of runtime subroutines, and a relocating macro assembler.

Thus, PL/I completes the final level of the inverted pyramid of support tools. The message should be clear to the application programmer: it is not the system language or the operating system which is important in the production of a final application. Rather, it is the availability of a standard, widely accepted application language that can provide program longevity. Once expressed in PL/I Subset G, the program can be transported through the CP/M family of operating systems to a variety of minicomputer systems. Digital Research has a long-term commitment to PL/I support for popular operating systems and processors.

New Processor Architectures

We've spent little time discussing processor refinements. What is happening to our software tools as we augment our 8-bit machines with the more powerful 16-bit processors? Will 16-bit processors replace 8-bit machines, or are they simply a temporary phenomenon in the transition to 32-bit machines?

There are several considerations when answering these questions. First, 8-bit machines are economical to produce, their software systems are mature, and they satisfy the needs of a substantial computer base. Therefore, we can safely assume that 8-bit machines are here to stay. Newer 16-bit machines are marginally faster, but they have substantially more address space. To use this additional address space, the computer must contain more memory, which increases the computer system cost.

As system costs increase, the margin between low-end minicomputers and high-end microcomputers diminishes, placing microcomputer hardware and software manufacturers such as ourselves in direct competition with major minicomputer manufacturers. The 16-bit machines, by their nature, introduce memory segmentation problems that are not

MEMOREX

**WHY SPEND MORE WHEN
YOU CAN'T BUY BETTER?
BUY MEMOREX FLEXIBLE
DISCS FROM PACIFIC
EXCHANGES AND SAVE.**

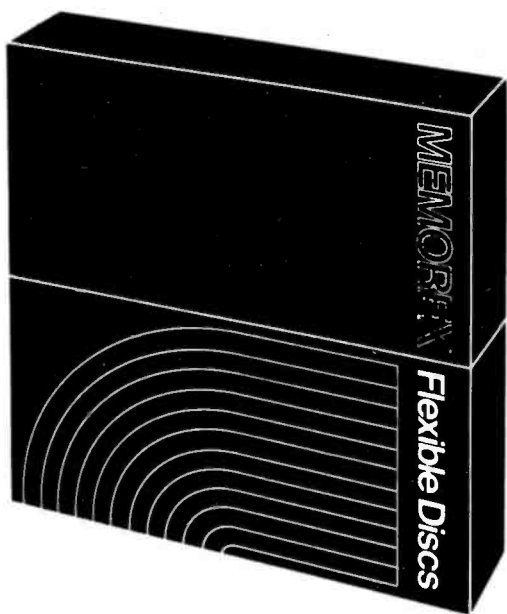

**For Data Reliability—
Memorex
Flexible
Discs**

CALL FREE FOR PRICES & INFORMATION

(800)235-4137

In California, (805)543-1037

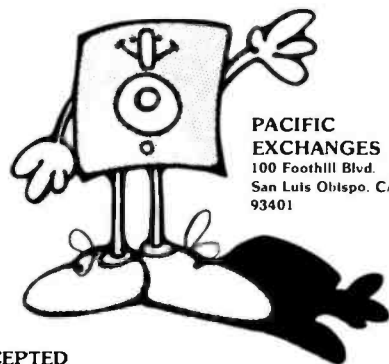

DEALER INQUIRIES INVITED



C.O.D.'s ACCEPTED

present in 32-bit processors.

Finally, we should note that 16-bit minicomputers are already outmoded, and all serious manufacturers are pushing 32-bit machines. This leads to the following conclusion: if we are tracking the minicomputer world, we can assume that the future will be with the 32-bit processors.

Currently, however, 32-bit machines are not available in quantity. Even when they are available, there will be delays while manufacturers tool up for production. At the moment, the 16-bit processors offer an intermediate solution. Digital Research has provided initial support for Intel's 16-bit machines—iAPX-186 and iAPX-286—which are versions of its 8086 product line. Intel provided PL/M-86, rehosted from the 8080 line, which was used by Digital Research to generate CP/M-86 and MP/M-86. In both cases, the fundamental design remains basically the same as that of the 8-bit version, with the addition of memory management and enhancements to the file system that match new computing resources.

A familiar program environment is retained so that program conversion is simplified.

CP/NET and related network software will be available sometime this year. Intel's 8087 (an arithmetic coprocessor for the 8086) is of particular interest since it directly supports binary and decimal operations, which substantially increase PL/M-86 execution speed.

In addition to the 8086, the CP/M family will be adapted to the 16-bit machines that prove popular, with special interest in the 32-bit architectures as they become available. During this development and rehosting, however, the 8-bit processors will continue to be supported with new tools and facilities, since this constitutes, without doubt, our best customer base for some time to come.

Software Vendors

We've concerned ourselves with three levels of software tools that support the most important level: the application programs. A major reason for CP/M's popularity is the general

availability of good application software. At last count, there were about 500 commercially available CP/M-compatible software products.

Through the combined efforts of CP/M distributors, independent vendors, and CP/M users, we are participating in a software commodity market with quality and variety that is unequaled by any minicomputer or mainframe manufacturer. The large CP/M customer base allows a vendor to produce and support a software package at low end-user cost. This increases the customer base, drawing more vendors with lower-cost good-quality products. This cyclic effect is, today, solving the "software crunch."

The tools are available, and it is the responsibility of independent software vendors to continue developing their own specialized markets. In this way, computer software technology will reach virtually all application areas where low-cost, reliable computing is required. Refinements? My friend, they're up to you. ■

Price-Performance Breakthrough at OMIKRON™

OMIKRON has set new Price-Performance standards in the micro-computer industry with the formation of COUGAR - the official Omikron Users Group.

All purchasers of our MAPPER I CP/M* Adaptor for the TRS-80 Model I are now eligible to receive Omikron's newsletter, the OMIGRAM--- offering the very best in CP/M Software at *unprecedented* group purchase rates.

Initial offerings include:

- Word Processors
- Languages
- Data Base Managers

MAPPER™ III for the Model III available soon.

Write or call now for free brochure



OMIKRON

Products that set Precedents.
1127 Hearst St Berkeley, CA 94702 (415) 845-8013

The COMPUTER FACTORY

TO ORDER CALL (212) 687-5000

SUPERBRAIN™

INTERTEC
DATA
SYSTEMS
64K
ONLY
\$3395



More than an intelligent terminal, the SuperBrain outperforms many other systems costing three to five times as much. Endowed with a hefty amount of available software (BASIC, FORTRAN, COBOL), the SuperBrain is ready to take on your toughest assignment. You name it! General Ledger, Accounts Receivable, Payroll, Inventory or Word Processing... the SuperBrain handles all of them with ease.

FEATURES INCLUDE:

- 2 dual-density minifloppies with 360K bytes of disk storage
- A CP/M Disk Operating System with a high-powered text editor, assembler and debugger.

Model QD

720K Bytes disk storage
and 64K RAM
\$3895

SUPER BRAIN HARD DISKS

10 Megabyte
List \$4995
\$4495

16 Fixed-16
Removable
\$9995



NEW 96K
80 Column
Commodore
CBM
Basic 4.0
Operating
System

- 80 column by 25 line display
- 12" CRT
- New screen editor
- Split screen processing
- Super fast string handling
- 15 additional basic commands
- Supports relative record processing

Model 8032
32K memory
\$1795

NEW!
Model 8096
96K memory
Call for price

NEW 8050 DUAL DISK \$1795
1 million bytes on-line storage
and DOS 2.0 operating system
NEW 2031 SINGLE DISK \$595

Commodore Computer

These low cost Commodore PET Business Computers have virtually unlimited business capabilities. Accounts Receivable, Inventory Records, Payroll, and other accounting functions.

- PET 16N & 32N COMPUTERS**
- Full size keyboard
 - 16 or 32,000 Bytes Memory
 - Level III Operating System
 - Full Screen Editor
 - Upper lower case & 64 graphic characters

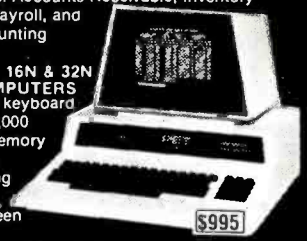

PET DUAL FLOPPY DISK

- Stores 360,000 Bytes on-line
- Microprocessor controlled
- Uses single or dual sided floppies



HI-SPEED PRINTER

- 150 characters per second • Up to 4 copies 8" wide
- Microprocessor Controlled • Prints All Graphics • Full Formatting Capability



NEW CORVUS
5 MEG
ONLY **\$3750**

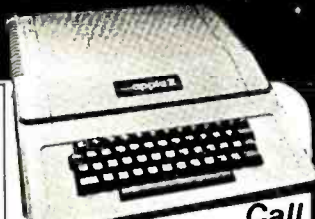

APPLE II PLUS for price

A complete self-contained computer system with APPLESOFT floating point BASIC in ROM, full ASC II keyboard in a light weight molded carrying case.

Features Include:

- auto-start ROM • Hi-Res graphics and 15 color video output.
- Expandable to 48K.

Supertalker	\$279	Micromodem	\$379
Disk	645	Superterm (24 x 80)	395
Add-on Disk	525	Speechlab	229
Pascal Card	495	Communication Card	225
Business Software	625	Modem	200
Monitor	159	Graphics Printer	595
Printer Card	180	GraphicsTablet	795

apple III
IS FINALLY HERE
128K RAM!!



FOR BEST
DELIVERY AND
SUPPORT SEE
IT AT THE
COMPUTER
FACTORY

**NEW STORES
OPENING JUNE 15**

LONG ISLAND, NY, 1301 Franklin Ave.,
Garden City (Opposite Saks Fifth Ave.)

FOREST HILLS, NY, 100-17 Queens Blvd.
(At 67th Road)

Coming Soon to Westchester

PRINTERS

EPSON

MX-70
MX-80
MX-80FT
MX-100FT
Call for Prices

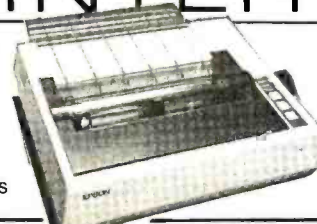

CENTRONICS

700-9
\$1795

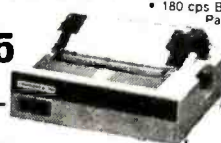

- 180 cps Bi-Directional • Up to 15" Paper Width • 9 x 9 Matrix
- Upper/Lower Case
- Tractor Feed
- RS-232 Serial Interface

704

\$1295 List \$1895
• 60 cps • Up to 15" paper width
• Tractor Feed • Parallel Interface
for Apple & TRS-80 • 2 channel
vertical forms! • Top of Form!
737 Parallel \$895

ANDERSON JACOBSON



VR-300 \$1795
(25cps Letter Quality)
EPSON MX-80 \$ 645
Paper Tiger 445 795
Paper Tiger 460 1295

MONITORS

SANYO 12" GREEN \$325
BMC 12" GREEN 295
LEEDEX 13" COLOR 449
ZENITH 13" COLOR 395
LEEDEX 12" GREEN 179

NEW
NEC
PC-8000

Call for Price

- 32K RAM
- 24K ROM
- Z80-A Micro
- Centronics and RS-232 interfaces standard
- Built-in color video interface creates vivid 8-color graphic displays
- MICROSOFT™ BASIC, plus many unique features combine to produce a high-performance DISK BASIC System.
- Five dual-level user-programmable function keys
- A built-in numeric key pad

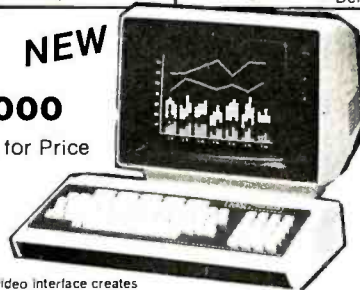

**DEALER INQUIRIES
INVITED ON DIABLO,
CENTRONICS,
SUPERBRAIN**



DIABLO
630 Special \$2495

On Site Warranty List \$2755

Min. Credit Card Order \$75

N.Y. residents add 8% sales tax
• Same day shipment on prepaid and credit card orders



TO ORDER CALL (212) 687-5000

Open

Mon-Fri. 10-6 Sat. 11-5

The COMPUTER FACTORY

485 Lexington Ave., New York, NY 10017 (46th St. Lobby)

Foreign order desk — Telex 640055

LIST—A Source-Listing Program for the C Language

Jeff Taylor, The Toolsmith
POB 22511, San Francisco CA 94122

Most UNIX-system utilities read from a standard input device and write to a standard output device. The Whitesmiths C compiler shows its heritage by doing the same. Until it informs you, for example, that there is a semi-

colon missing on some line, you don't notice that the source listing isn't being printed. LIST is a program to print source listings. (See listing 1.) Each line is labeled like the compiler's error listing. The version presented here is a system note, and you will probably want to add more features.

About the Author

Jeff Taylor is the owner of The Toolsmith, a software house. He received his bachelor's degree and did graduate work in electrical engineering, specializing in computer science, at the University of California, Davis.

LIST reads the files named on command line and writes the listing to the standard output. If the files are not named, input is taken from the standard input. The standard input and output default to the user's terminal but can be redirected to or from other devices or files, such as the line printer. Each file's listing starts a new page. At the top of each page is the file's name, the page number, and the date. Obtaining the date from the operating system depends upon your equipment; the code shown is for RT-11. The function DATE returns the number of bytes in the date and puts the date's character string in its single argument.

The C language allows an #include statement. The preprocessor of the compiler replaces the #include statement with the contents of the file it names. As an option, LIST can insert the contents of the file after the #include statement. The -n flag on the command line turns on #include processing for nonheader files. The -h option includes header files. Header files are those with the extension .H (such as STD.H, which is the standard header file supplied by Whitesmiths). The depth to which #include can be nested depends on your stack size. Listing 1 was printed by the command:

```
list -n > lp: list.c
```

where lp: is the line printer. The #include processing was performed excluding header files. The angle brackets (< and >) indicate redirection of the standard input and output, respectively.

The subroutine PAGINATE uses a technique that is described in *Principles of Program Design* by M A Jackson. If each print line could be read from a scratch

Text continued on page 246

STRETCH THE POWER

Of Your HP-85 or Commodore Pet/CBM With TNW's IEEE-488 Bus System Building Blocks...



TNW's RS-232 SERIAL INTERFACES

Connect your PET/CBM to any RS-232 Serial Printer, Plotter, CRT Terminal, Modem, or other device:

TNW-1000	ONE CHANNEL OUTPUT ONLY	\$129
TNW-2000	ONE CHANNEL INPUT AND OUTPUT	\$229
TNW-232D	TWO CHANNELS, INPUT & OUTPUT. 12 RS-232 CONTROL SIGNALS	\$369

TURN YOUR PET INTO A TERMINAL

Access Timesharing Systems and Bulletin Boards with TNW's Pterm Software and full service telephone modem:

TNW-103	AUTO ANSWER/AUTO DIAL USE WITH DAA	\$389
----------------	---------------------------------------	--------------

Pterm also works with acoustical couplers and other modems interfaced to the PET with the TNW-2000 or TNW-232D. Electronic mail and TWX Terminal programs also available. All units are addressable IEEE-488 devices, complete with power supply cabinet, full documentation and one year warranty.

TNW CORPORATION

3351 Hancock St. • San Diego, CA. 92110 (714) 225-1040
TWX910-335-1194

Visa/Mastercharge Welcome • Dealer inquiries invited

COMPUTERS—TERMINALS—MODEMS!

MODEMS AND COUPLERS

Connect your Apple, TRS-80 or any other computer or terminal to the phone lines!

Penril



**Penril
300/1200**

Penril 300/1200—Bell 212A style \$799
Bell 212A style. 1200 baud and 300 baud. Manual originate, auto-answer. Full duplex. RS232. Direct connect to phone lines via RJ11C standard extension phone voice jack. 1 year warranty.



U.S. Robotics
USR-330A
Bell 103/113 style
USR-330D
Bell 103/113 style

USR-330D \$339

Bell 103/113 style. 330 baud. Manual originate, auto-answer. Half/full duplex. RS232. 1 year warranty. Direct connect to phone lines via RJ11C standard extension phone voice jack.

USR-330A \$399
Same as USR-330D but includes auto-dial capability.



U.S. Robotics
**The
Phone Link
Acoustic
Modem**

Bell 103/113 style \$179
300 baud. Sleek, low profile. Originate and answer capability. Half/full duplex. Self-test. RS232. Light displays for On, Carrier, Test, Send Data, Receive Data. 15 oz.

Digital Equipment Corporation



DEC VT100

DEC VT100 ... \$1688

Detachable keyboard. Separate numeric keypad with function keys. Business forms character set. Reverse video. Selectable double-size characters. Bidirectional smooth-scrolling. 80 cols or 132 cols. Split screen. Settable tabs. Line drawing graphic characters. Status line. Key-Click.

CRT's

Perkin-Elmer
Corporation



Superowl 1251

Perkin-Elmer Superowl 1251 \$1564
Intelligent, editing CRT. Detachable keyboard. 32 fully programmable function keys. Intelligent printer part. Business forms character set. Block mode. Protected fields. Blinking fields. Numeric fields. Reverse video. Half intensity. Polling. Down line loading of options. Remote control of all options by host computer. Settable tabs. Status line. Separate numeric keypad. Transparent mode.

Perkin-Elmer Corporation



Bantam 550B ... \$694

Compact. Silent. Upper/lower case. 80th col. wrap-around. Bell. Integrated numeric pad. Printer port. Transparent mode. Editing features. Tabbing.

Bantam 550E... \$755

Same as 550B plus separate numeric keypad and cursor direction keys.

Bantam 550S \$879

Same as 550E plus block mode. 8 function keys, and protected fields, reverse video fields, half intensity fields, blinking fields.

550 Options

20mA Current Loop Interface \$70

Non-Glare Screen \$25

2nd page of memory (550S only).. \$100

HARDCOPY TERMINALS

& PRINTERS

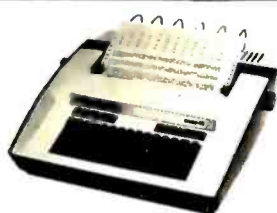

**Teletype
Model 43**

Teletype
Corporation

Teletype Model 43 KSR with RS232
and Connector Cable \$999
30 CPS. Dotmatrix. 132 cols. Truedescenders on lower case. Excellent print quality for dot matrix printer. Pin feed.

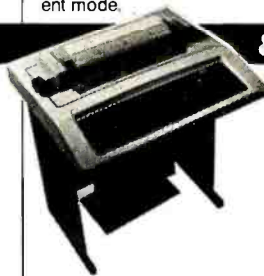

DEC LA120

Digital Equipment
Corporation

DEC LA120 ... \$2388

180 CPS. Dot matrix. Upper/lower case. 1K buffer. Designed for 1200 baud communications. 30 character answerback message. Adjustable line spacing. Adjustable character sizes including double sized characters. Settable horizontal and vertical tabs. Top-of-form capability. RS232.



Digital
Equipment
Corp.

DEC LA34DA ... \$939

30 CPS. Dot matrix. Upper/lower case. 4 character sizes. Up to 217 cols per line. 6 lines per inch settings. Friction feed. Settable tabs. RS232.

DEC LA34AA \$1095

30 CPS. Dot matrix. Upper/lower case. 8 character sizes including double size characters. 6 lines per inch settings. Up to 217 cols per line. Friction feed. Settable horizontal and vertical tabs. Top-of-form capability.

Options for LA34AA and LA34DA

Tractor Feed Mechanism \$114

Numeric Keypad w/ Function Keys.. \$69

Pedestal..... \$100

Paper Out Sensor \$25

APL Capability with APL Keycaps .. \$499

2K Buffer with Text Editor and 1200 Baud
Communications Capability \$499

NEC Corporation

NEC Spinwriter 5510 & 5520

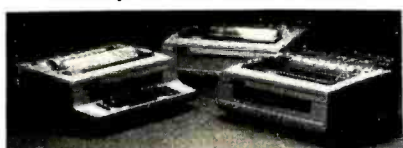

5520 KSR Spinwriter \$3088
55 CPS. Impact printer. Selectric print quality. Changeable print fonts. 110, 300 and 1200 baud data rate. Numeric keypad. Friction and tractor feed.

5510 Spinwriter \$2754
55 CPS. Impact printer. Selectric print quality. Changeable print fonts. 110, 300 and 1200 baud data rate. Friction and tractor feed.

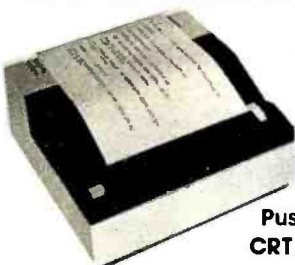

Perkin-Elmer
Corporation

**Pussycat 650/655
CRT Screen Printer**

650/655 Pussycat CRT Screen Printer. \$899
100 CPS. Extremely compact and quiet. 110 to 9600 baud rate. 2K buffer. Ideal for producing rapid, reliable hardcopy of your CRT screen display. Can be added to any CRT with our interface option.

Leasing rates and lease/purchase plan information is available on request.

All equipment is shipped with a 10 day money back guarantee.

We offer full service, on site maintenance plans on all equipment.

All equipment in stock.



U.S. ROBOTICS INC.
203 N. WABASH SUITE 1718 CHICAGO, ILL 60601

SALES
GENERAL OFFICES
SERVICE

(312) 346-5650
(312) 346-5651
(312) 733-0497

System Notes

Listing 1: The program LIST. Normal operation produces a listing with pagination, top and bottom margins on each page, and a header on each page.

```
list.c                               Page: 1           24 October 1980

list.c      1: #include <std.h>
list.c      2: #include <local.h>
list.c      3: /* lister - list 'c' source files
list.c      4: */
list.c      5:
list.c      6: FIO stdin;          /* standard input buffer */
list.c      7:
list.c      8: BOOL n_flag = NO;
list.c      9: BOOL h_flag = NO;
list.c     10:
list.c     11: #include "diagn.c"
diagn.c     1:
diagn.c     2: /* diagnostic - spit out error message */
diagn.c     3: diagnostic(fatal,args)
diagn.c     4:   BOOL fatal;
diagn.c     5:   TEXT *args;
diagn.c     6:   {
diagn.c     7:     FAST TEXT **a;
diagn.c     8:
diagn.c     9:     for(a = &args; *a != NULL; ++a)
diagn.c    10:       write(STDERR,*a,lenstr(*a));
diagn.c    11:     write(STDERR,"\n",1);
diagn.c    12:     if(fatal)
diagn.c    13:       exit(NO);
diagn.c    14:   }
list.c     12:
list.c     13: #include "pagin8.c"
pagin8.c    1:
pagin8.c    2: #include "date.c"
date.c      1:
date.c      2: /* date - return current date, if any in "buf" */
date.c      3: BYTES date(buf)
date.c      4:   FAST TEXT *buf;
date.c      5:   {
date.c      6:     BYTES itob();
date.c      7:     COUNT emt();
date.c      8:     FAST TEXT *b = buf;
date.c      9:     TEXT *cpystr();
date.c     10:     union _date {
date.c     11:       COUNT all;
date.c     12:       struct {
date.c     13:         unsigned year:5;
date.c     14:         unsigned day:5;
date.c     15:         unsigned month:5;

list.c                               Page: 2           24 October 1980

date.c     16:       };
date.c     17:     } tmp;
date.c     18:     static TEXT *months[] = {"January","February","March","April","May","June",
date.c     19:       "July","August","September","October","November","December"};
date.c     20:
date.c     21:     tmp.all = emt(0374,012<<8); /* system call */
```

Listing 1 continued on page 238

ALL THESE FEATURES... IN THIS SMALL SPACE... AT THIS LOW PRICE!

4,695

Greater computer power . . . fewer separate components . . . larger capability . . . simpler to operate . . . modular maintenance . . .

These are the unique benefits of the Quasar Data QPD-100 Floppy Disk Computer . . . plus unsurpassed reliability . . . plus 12-month warranty on all PC boards.

Its highly reliable, industry-standard MFE drive is compact. Accepts both single AND double-sided disks.

Upgradeable from the Z-80[™] microprocessor-based system to our 16 BIT microprocessor-based system by simply plugging in extra PC cards. Hard disk and multi-user systems available.

As your requirements grow, your QDP-100 can grow to fit them.

The Quasar Data QDP-100H is a larger version with 6-megabyte capacity; includes one double-sided floppy and one 5¼ microwinchester hard disk.

Both the Quasar Data QDP-100 and QDP-100H are fully compatible with all standard terminals.

Phone or write for descriptive bulletin and specifications. And ask for a demonstration. Dealer inquiries invited.

QUASAR DATA'S QDP-100 COMPUTER SYSTEM.

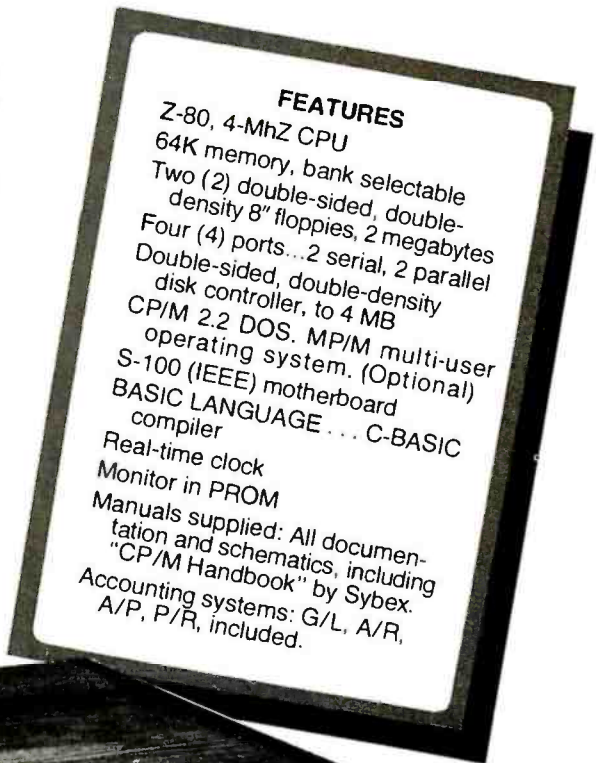

FEATURES

Z-80, 4-MHz CPU
64K memory, bank selectable
Two (2) double-sided, double-density 8" floppies, 2 megabytes
Four (4) ports...2 serial, 2 parallel
Double-sided, double-density disk controller, to 4 MB
CP/M 2.2 DOS. MP/M multi-user operating system. (Optional)
S-100 (IEEE) motherboard
BASIC LANGUAGE . . . C-BASIC compiler
Real-time clock
Monitor in PROM
Manuals supplied: All documentation and schematics, including "CP/M Handbook" by Sybex.
Accounting systems: G/L, A/R, A/P, P/R, included.



18" wide
16 7/8" deep
11" high

Complete systems available

Z-80 is a trademark of Zilog Corp.

CP/M and MP/M are trademarks of Digital Research Corp.

Quasar Data Products

10330 Brecksville Road, Brecksville (Cleveland), Ohio 44141
Phone: 216/526-0838 / 526-0839

Telex: 241596

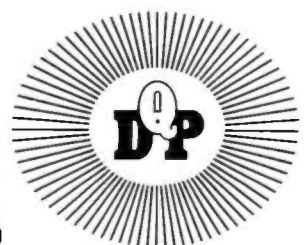

System Notes

Listing 1 continued:

```

date.c      22:  if(tmp.all == 0)      /* no date */
date.c      23:      return(0);
date.c      24:  buf += itob(buf,tmp.day,0); /* day of month */
date.c      25:  buf = cpystr(buf," ",months[tmp.month-1]," ",NULL); /* month of year */
date.c      26:  buf += itob(buf,tmp.year+1972,0); /* year A.D. */
date.c      27:  return(buf-b);
date.c      28:  }
pagein8.c   3:
pagein8.c   4: /* skip - output "n" blank lines */
pagein8.c   5: COUNT skip(n)
pagein8.c   6: FAST COUNT n;
pagein8.c   7: {
pagein8.c   8: FAST COUNT t = n;
pagein8.c   9:
pagein8.c  10: while(t-- > 0)
pagein8.c  11:     putchar('\n');
pagein8.c  12: return(n);
pagein8.c  13: }
pagein8.c  14:
pagein8.c  15: #define MARGIN1 3 /* top of page to title line */
pagein8.c  16: #define MARGIN2 2 /* title line to body */
pagein8.c  17: #define MARGIN3 2 /* body to bottom of page */
pagein8.c  18:
pagein8.c  19: TEXT *title = NULL;
pagein8.c  20: int page_size = HARD_PAGE; /* lines per page */
pagein8.c  21:

```

Listing 1 continued on page 240

<p>HARD DISK MULTIPLEXOR WITH 10 MEG HARD DISK FOR THE TRS-80* Mod II</p> <p>NOW YOU CAN HAVE THAT LARGE COMMON DATA BASE!!</p> <ul style="list-style-type: none"> • Allows up to 4 Mod II's to connect to a single controller — up to 4 hard disk drives per controller. Users may access the same file simultaneously (first-come first-served). • Uses Cameo controller and standard 10-megabyte cartridge (hard) disk drives along with RACET Hard/Soft Disk System (HSD) software. • Access times 3 to 8 times faster than floppy. Mixed floppy/hard disk operation supported • Compatible with your existing TRSDOS programs! All BASIC statements are identical. • A single file may be as large as one disk. Alternate mode allows 24-million byte record range. Directory expandable to handle thousands of files. • Includes special utilities — backup and copies, HPURGE for multiple deletions, HDCS directory catalog system, and Hard Disk Superzap. FORMAT utility includes options for specifying sectors/gran, platters/drive, logical disk size, etc. <p>HARD DISK DRIVE & CONTROLLER \$5995 RACET HSD Software \$400 Call for multiuser pricing. Dealers call for OEM pricing.</p> <p>INFINITE BASIC (Mod I & III Tape or Disk) Mod I \$50.00, Mod III \$60.00 Extends Level II BASIC with complete MATRIX functions and 50 more string functions. Includes RACET machine language sorts! Sort 1000 elements in 9 seconds!! Select only functions you want to optimize memory usage.</p> <p>INFINITE BUSINESS (Requires Infinite BASIC) Mod I & III \$30.00 Complete printer pagination controls — auto headers, footers, page numbers. Packed decimal arithmetic — 127 digit accuracy +, -, *, /. Binary search of sorted and unsorted arrays. Hash codes.</p> <p>BASIC CROSS REFERENCE UTILITY (Mod II 64K) \$50.00 SEEK and FIND functions for Variables, Line Numbers, Strings, Keywords. 'All' options available for line numbers and variables. Load from BASIC — Call with 'CTRL'R' Output to screen or printer!</p> <p>DSM Mod I \$75.00, Mod II \$150.00, Mod III \$90.00 Disk Sort/Merge for RANDOM files. All machine language stand-alone package for sorting speed. Establish sort specification in simple BASIC command File. Execute from DOS. Only operator action to sort is to change diskettes when requested! Handles multiple diskette files! Super fast sort times — improved disk I/O times make this the fastest Disk Sort/Merge available on your TRS. (Mod I Min 32K 2-drive system. Mod II 64K 1-drive. Mod III 32K 1-drive)</p>	<p>★★ NEW ★★ DISCAT (32K 1-drive Min) Mod I, III \$50.00 This comprehensive Diskette Cataloging/Indexing utility allows the user to keep track of thousands of programs in a categorized library. Machine language program works with all TRSDOS and NEWDOS versions. Files include program names and extensions, program length, diskette numbers, front and back, and diskette free space.</p> <p>★★ NEW ★★ KFS-80 (1-drive 32K Min — Mod II 64K) Mod I, III \$100.00; Mod II \$175.00 The keyed file system provides keyed and sequential access to multiple files. Provides the programmer with a powerful disk handling facility for development of data base applications. Binary tree index system provides rapid access to file records.</p> <p>★★ NEW ★★ MAILLIST (1-drive 32K Min - Mod II 64K) Mod I, III \$75.00; Mod II \$150.00 This ISAM-based maillist minimizes disk access times. Four keys — no separate sorting. Supports 9-digit zip code and 3-digit state code. Up to 30 attributes. Mask and query selection. Record access times under 4 seconds!!</p> <p>★★ NEW ★★ LPSPOOL (32K 1-drive Min) Mod I \$75.00 LPSPOOL — Add multi-tasking to permit concurrent printing while running your application program. The spooler and despooler obtain print jobs from queues maintained by the system as print files are generated. LPSPOOL supports both parallel and serial printers.</p> <p>UTILITY PACKAGE (Mod II 64K) \$150.00 Important enhancements to the Mod II. The file recovery capabilities alone will pay for the package in even one application! Fully documented in 124 page manual! XHIT, XGAT, XCOPY and SUPERZAP are used to reconstruct or recover data from bad diskettes! XCOPY provides multi-file copies, 'Wild-card' mask select, absolute sector mode and other features. SUPERZAP allows examine/change any sector on diskette include track-0, and absolute disk backup/copy with I/O recovery. DCS builds consolidated directories from multiple diskettes into a single display or listing sorted by disk name or file name plus more. Change Disk ID with DISKID. XCREATE preallocates files and sets 'LOF' to end to speed disk accesses. DEBUGII adds single step, trace, subroutine calling, program looping, dynamic disassembly and more!!</p> <p>DEVELOPMENT PACKAGE (Mod II 64K) \$125.00 Includes RACET machine language SUPERZAP, Apparal Disassembler, and Model II interface to the Microsoft 'Editor Assembler Plus' software package including uploading services and patches for Disk I/O.</p>
<p>CHECK, VISA, M/C, C.O.D., PURCHASE ORDER</p> <p>TELEPHONE ORDERS ACCEPTED (714) 637-5016</p> <p>*TRS-80 IS A REGISTERED TRADEMARK OF TANDY CORPORATION</p> <div style="display: flex; justify-content: space-between; align-items: center;"> <p style="text-align: center;"> RACET COMPUTES 1330 N. Glassel, Suite 'M' Orange, CA 92665 </p> </div>	

MICROBYTE INTRODUCES MORE PROFIT FOR YOUR BOTTOM LINE

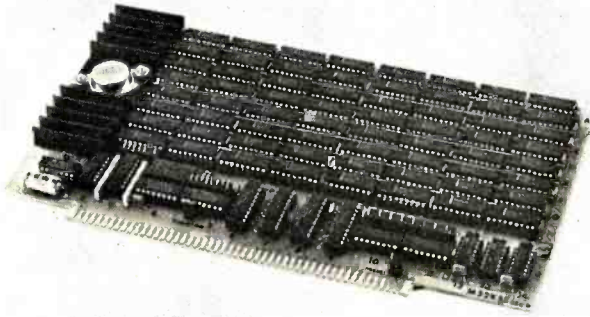

32K STATIC MEMORY BOARD

- Fully S100 bus compatible, IMSAI, SOL, ALTAIR, ALPHA MICRO
- Uses Intel low-power 2141L-4 4Kx1 Static RAM
- 2 MHz or 4 MHz operation
- Gold contacts for higher reliability
- Thermally designed heat sink (board operating temperature 0-70 °C)
- Commercially designed power bus; 7 ground bus bars; 0.1 uf decoupling capacitors
- Fully tri-state buffered
- Inputs fully low-power Schottky Schmitt Trigger buffered on all address and data lines
- Phantom is jumper selectable to pin 67
- Each 4K bank addressable to any 4K slot within a 64K boundary
- 4K hardware or software selectable
- One on-board 8-bit output port enables or disables the 32K in 4K blocks
- Selectable port address
- 4K banks can be selected or disabled on power on clear or reset
- Will operate with or without front panel
- Compatible with Alpha Micro, with extended memory management for selection beyond 64K
- No DMA restriction
- Low power consumption 800mA
- Fully warranted for 120 days from date of shipment

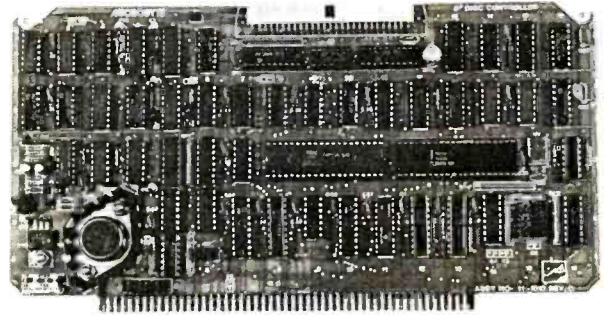

DISK CONTROLLER

- DMA to within 16M byte of memory
- State-of-the-art NEC765 LSI Controller
- IEEE-S100 compatible
- DMA arbitration allows use of multiple boards within a system
- PLL data recovery for totally reliable operation
- Write pre-comp switched at mid-disc for reliable double density operation
- Supports up to four (4) drives
- Power On, Power Off or Reset desejects drives to avoid damaging files
- Drive deselect Time Out, deselect drives not in use
- Single or double sided operation
- Single density/double density operation
- 8" standard drives
- Separate V_{CC} supply for data recovery to eliminate possible noise problems

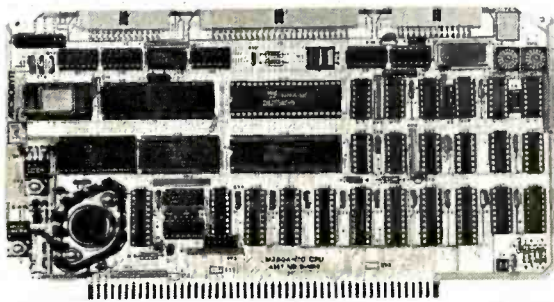

Z-80A I/O

- A complete single board Z-80A CPU with serial/parallel interface
- Fully compatible with the proposed IEEE S-100 Bus Standard
- Z-80A CPU (4MHz version of the Z-80)
- 158 instructions—superset of and upward compatible from the 8080's 78 instructions
- Up to 4K of on board Eprom with optional Z-80 monitor program — 1K(2708), 2K(2716) or 4K(2732)
- Full vectored interrupt capability
- 2MHz or 4MHz operation is jumper selectable
- Selectable auto-wait state insertion for extending M1*, MREQ*, IORQ* and/or on board ROM
- Dual RS-232 serial I/O ports using the Z80A-DART with individual baud rate selection (16 baud rates from 50-19,200 baud)
- Up to 24 bit parallel I/O port—fully programmable Intel 8255A
- Up to 8 separate counter/timers using 2 Z-80A CTC

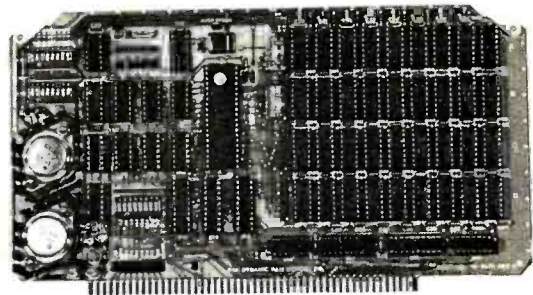

64K DYNAMIC RAM BOARD

- Fully S-100 bus compatible/Alpha Micro compatible
- 64K x 8 bit dynamic RAM
- Low power; + 8VDC @ 700 ma
+ 16VDC @ 100 ma
- 16VDC @ 25 ma
- Built-in-parity with LED indicator and vector interrupt
- Memory addressable in four 16K banks
- Hidden refresh
- Gold contacts for high reliability
- 72-hour Burn-in
- Memory mapped via DIP switch
- Built-in programmable write-protect
- Programmable control port for parity and bank control

MICROBYTE has the products — from memory boards to complete S-100 systems, and we offer the rest of the value cluster — call today for the whole story on how you can become a Microbyte dealer.

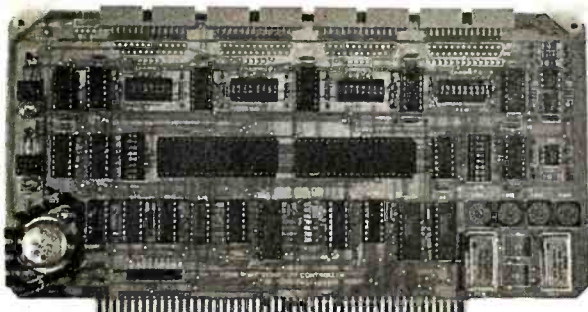

4 PORT I/O

- Quad RS-232C Serial Ports, One 20mA Current Loop Port
- Fully IEEE S-100 Bus Compatible
- Asynchronous Communications with Z80A-Dart(TM) or Synchronous Communications with Z80A-SIO/0(TM)
- Full Set of Modem Control Signals, including RI (Ring Indicator)
- Easily Configurable to Any Type of Terminal Interface
- I/O Servicing Environments: (1) Polled; (2) Bus Vector; (3) Z80 Mode 2 Vector
- Off-Board Interrupt Daisy Chain Capability
- Special Receive Conditions: (1) Framing Error; (2) Parity Error; (3) Receiver Overrun Error
- Baud Rates Selected Individually from 50 Baud to 300K Baud
- 72 Hour Burn-In

MICROBYTE 1198 E. Willow St., Signal Hill, CA 90806 • (213) 595-8571

System Notes

Listing 1 continued:

```
pagin8.c      22: /* paginate - separate stream of buffers into pages */
pagin8.c      23: paginate(buf)
pagin8.c      24:     TEXT *buf;
pagin8.c      25:     {
pagin8.c      26:     BYTES date(),itob(),lenstr(),putlin();
pagin8.c      27:     static int line;      /* line number within page */
pagin8.c      28:     static int page = 0;
pagin8.c      29:     TEXT tmp[20];
pagin8.c      30:
pagin8.c      31:     if(page != 0) /* M. A. Jackson's program inversion technique used */
pagin8.c      32:         goto resume;
pagin8.c      33:     /* read */
```

list.c . Page: 3 24 October 1980

```
pagin8.c      34:     while(buf != NULL) { /* while(!end_of_file) */
pagin8.c      35:         ++page;
pagin8.c      36:         line = skip(MARGIN1);
pagin8.c      37:         if(title != NULL) { /* output title, page # & date */
pagin8.c      38:             putlin(title,lenstr(title));
pagin8.c      39:             putlin("\t\t\t\t\t Page: ",12);
pagin8.c      40:             putlin(tmp,itob(tmp,page,0));
pagin8.c      41:             putlin("\t",1);
pagin8.c      42:             putlin(tmp,date(tmp));
pagin8.c      43:             line += skip(MARGIN2);
pagin8.c      44:         }
pagin8.c      45:         while(buf != NULL && line < page_size-MARGIN3) {
pagin8.c      46:             putlin(buf,lenstr(buf));
pagin8.c      47:             ++line;
pagin8.c      48:             /* read */
pagin8.c      49:             return;
pagin8.c      50: resume: ;
pagin8.c      51:         }
pagin8.c      52:         skip(page_size-line);
pagin8.c      53:         line = 0;
pagin8.c      54:     }
pagin8.c      55:     page = 0;
pagin8.c      56: }
list.c        14:
list.c        15: #include "incl.c"
incl.c        1:
incl.c        2: /* include - include file in s */
incl.c        3: COUNT include(file,ftn)
incl.c        4:     FAST TEXT *file;
incl.c        5:     COUNT (*ftn)();
incl.c        6:     {
incl.c        7:     FAST COUNT return_code;
incl.c        8:     TEXT *buybuf();
incl.c        9:     FAST FIO *fd;
incl.c       10:     FIO *fclose(),*fopen();
incl.c       11:
incl.c       12:     return_code = NO;
incl.c       13:     fd = (FIO *) buybuf(&stdin,sizeof(FIO));
incl.c       14:     if(fopen(&stdin,file,READ) == NULL)
incl.c       15:         diagnostic(NO,"can't open ",file,NULL);
incl.c       16:     else {
```

```
incl.c      17:      return_code = (*ftn)(file);
incl.c      18:      fclose(&stdin);
incl.c      19:      }
```

list.c Page: 4 24 October 1980

```
incl.c      20:      cpybuf(&stdin,fd,sizeof(struct fio));
incl.c      21:      free(fd);
incl.c      22:      return(return_code);
incl.c      23:      }
list.c      16:
list.c      17: #include "filem.c"
filem.c      1:
filem.c      2: TEXT *prefix = "";      /* include prefix */
filem.c      3:
filem.c      4: /* get_name = extract file name from line */
filem.c      5: BYTES get_name(line,file)
filem.c      6: TEXT *file,*line;
filem.c      7: {
filem.c      8: TEXT *delim;
filem.c      9: BYTES cpybuf(),instr(),lenstr(),n;
filem.c     10:
filem.c     11: while(*line == ' ' || *line == '\t')
filem.c     12: ++line;
filem.c     13: if(*line == '\u')
filem.c     14: n = lenstr(file);
filem.c     15: else {
filem.c     16: n = 0;
filem.c     17: if(*line == '/') {
filem.c     18: delim = "\n";
filem.c     19: ++line;
filem.c     20: }
filem.c     21: else if(*line == '<') {
filem.c     22: delim = "\n";
filem.c     23: ++line;
filem.c     24: n = cpybuf(file,prefix,lenstr(prefix));
filem.c     25: }
filem.c     26: else
filem.c     27: delim = "\t\n";
filem.c     28: n += cpybuf(file+n,line,instr(line,delim));
filem.c     29: *(file+n) = EOS;
filem.c     30: }
filem.c     31: return(n);
filem.c     32: }
list.c      18:
list.c      19: #include "detab.c"
detab.c      1:
detab.c      2: /* detab - replace tabs with blanks */
detab.c      3: BYTES detab(s,d)
detab.c      4: FAST TEXT *s,*d;
```

list.c Page: 5 24 October 1980

```
detab.c      5: {
detab.c      6: FAST BYTES i;
```

Listing 1 continued on page 266

EAST COAST

ΩMEGA Sales Co.
12 Meeting St.
Cumberland, RI 02864

1-800-556-7586

1-401-722-1027



WEST COAST

ΩMEGA Sales Co.
3533 Old Conejo Rd. #102
Newbury Park, CA 91320

1-800-235-3581

1-805-499-3678

CA. TOLL FREE 1-800-322-1873



EPSON MX-80 PRINTER
INTERFACES: IEEE \$55, TRS*80 \$35,
APPLE INTERFACE + CABLE \$90,
RS*232 \$70



ANADEx
\$1299



16K ATARI 800
\$779



DIABLO 630
\$2145
Tractor option \$245

TELEVIDEO 912C **\$669**

TELEVIDEO 920C **\$729**

TELEVIDEO 950 **\$1049**

ATARI 825 PRINTER **\$729**

ATARI 850 INTERFACE **\$169**

ATARI 810 DISK **\$449**

(Call for price list of ATARI Software)

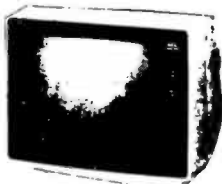

NEC MONITOR 12"
\$219

WE WILL NOT BE UNDERSOLD!

- NO SURCHARGE FOR CREDIT CARDS
- WE ACCEPT C.O.D.'S
- ALL EQUIPMENT FACTORY FRESH
W/MANUFACTURER'S WARRANTY
- STOCK SHIPMENTS USUALLY SAME DAY OR NEXT DAY
- NO HIDDEN CHARGES -
WE LIVE BY OUR PUBLISHED PRICES



EAST COAST / WEST COAST



ΩMEGA SALES COMPANY

EAST COAST

ΩMEGA Sales Co.
12 Meeting St.
Cumberland, RI 02864

1-800-556-7586

1-401-722-1027



WEST COAST

ΩMEGA Sales Co.
3533 Old Conejo Rd. #102
Newbury Park, CA 91320

1-800-235-3581

1-805-499-3678

CA. TOLL FREE 1-800-322-1873

SPECIAL OF THE MONTH!

\$429

OKIDATA
MICROLINE
80

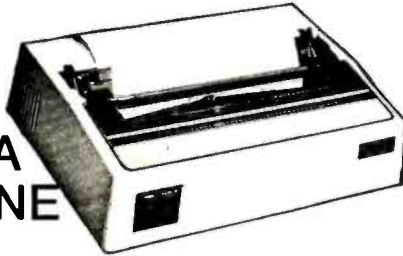

LEEDEX/AMDEK
VIDEO 100G



\$169

INTERTEC SUPERBRAIN 64K RAM	\$2849
NEC 5510 SPINWRITER	\$2395
OKIDATA MICROLINE-83	\$949
APPLE II PLUS 48K	\$1179
APPLE DISK w/ 3.3 DOS Controller	\$545
APPLE DISK w/o Controller	\$435
BASE II PRINTER	\$649
HAZELTINE 1420	\$799
NORTHSTAR HORIZON II 32K QD	\$2975
ATARI 400 8K	\$399
ATARI 400 16K	\$499
RADIO SHACK 16K Level II Model 3	\$875
RADIO SHACK 64K Model 2	\$3449



EAST COAST / WEST COAST



ΩMEGA SALES COMPANY

System Notes

Listing 1 continued:

```
detab.c      7:
detab.c      8:   for(i = 0; *d == *s; ++s)
detab.c      9:     if(*s == '\t')
detab.c     10:       do
detab.c     11:         *d++ = ' ';
detab.c     12:         while(++i%8);
detab.c     13:       else {
detab.c     14:         ++i;
detab.c     15:         ++d;
detab.c     16:       }
detab.c     17:   return(++i);
detab.c     18: }
list.c      20:
list.c      21: /* check_include - do possible include processing */
list.c      22: check_include(line)
list.c      23:   FAST TEXT *line;
list.c      24:   {
list.c      25:   FAST BYTES n;
list.c      26:   TEXT file[MAXFILE+1];
list.c      27:   int list();
list.c      28:
list.c      29:   for( ; iswhite(*line); ++line) /* skip leading blanks */
list.c      30:     ;
list.c      31:   if(cmpbuf(line,"#include ",9)) {
list.c      32:     n = get_name(line+9,file);
list.c      33:     if(cmpbuf(&file[n-23],".h",2)) { /* header file */
list.c      34:       if(h_flag)
list.c      35:         include(file,&list);
list.c      36:     }
list.c      37:     else { /* non-header file */
list.c      38:       if(n_flag)
list.c      39:         include(file,&list);
list.c      40:     }
list.c      41:   }
list.c      42: }
list.c      43:
list.c      44: /* list - label and print lines of "file" */
list.c      45: list(file)
list.c      46:   TEXT *file;
list.c      47:   {
list.c      48:   BYTES getlin(),itob();
list.c      49:   TEXT *alloc(),*buf,*line,temp[4];
```

list.c

Page: 6

24 October 1980

```
list.c      50:   FAST BYTES l,t;
list.c      51:   FAST COUNT line_number = 0;
list.c      52:   #define BORDER MAXFILE+7 /* assumes < 1000 lines */
list.c      53:
list.c      54:   buf = alloc(HARD_WIDTH+1,0);
list.c      55:   line = alloc(MAXLINE+1,0);
list.c      56:   fill(buf,BORDER,' ');
list.c      57:   buf[BORDER-2] = ':';
list.c      58:   cpybuf(buf,file,lenstr(file));
list.c      59:   while(l = getlin(line,MAXLINE)) {
list.c      60:     line[lmin(l,HARD_WIDTH-BORDER)] = EOS;
```

Listing 1 continued on page 246



if He'd used **select**[™] it wouldn't have taken seven days

Learn SELECT[®] in just 90 minutes. A whole new word processing software concept that kicks the coded key habit and frees you from complicated instruction manuals. *SELECT* is fast. *SELECT* is logical. With single key mnemonics, you'll use dozens of commands that instantly access the rich capabilities of this system. There's nothing like it.

Simply hit "C" and you'll be ready to Create a document.

Key "I" and you'll be in the Insert mode.

Key "M" and Move entire blocks of text . . . and key dozens more.

That's all there is to it. You'll get all that word processing software promises . . . plus a few surprises.

SELECT with SUPERSPELL.[®] The only microcomputer software with an integrated spelling dictionary. To proof your text all you do, of course, is to key "S". *SUPERSPELL* with its 10,000 word dictionary scans your text at computer speed then displays and corrects all your typing errors. You can increase *SUPERSPELL*'s word power and customize the dictionary by adding new words, one at a time. Ask to see it today at your local dealer.

SELECT with SUPERSPELL . . . just a little byte more.[™]

select
INFORMATION SYSTEMS[™]

SELECT will run on any machine that uses CP/M or MP/M** or its derivatives. It needs 40K of RAM and two disk drives. Special version now available for Radio Shack Mod II*** and Apple II****

* SELECT and SUPERSPELL are trademarks of Select Information Systems Inc.

** CP/M and MP/M are trademarks of Digital Research

*** A trademark of Tandy Corp.

**** A trademark of Apple Computer Inc.

919 Sir Francis Drake Boulevard • Kentfield, California 94904 • (415) 459-4003

System Notes

Listing 1 continued:

```
list.c      61:      t = itob(temp,++line_number,0);
list.c      62:      cpybuf(buf+BORDER-2-t,temp,t);
list.c      63:      detab(line,buf+BORDER);
list.c      64:      paginate(buf);
list.c      65:      if(n_flag || h_flag)
list.c      66:          check_include(line);
list.c      67:      }
list.c      68:  }
list.c      69:
list.c      70:  POOL main(ac,av)          /* handles program arguments */
list.c      71:      BYTES ac;
list.c      72:      TEXT **av;
list.c      73:  {
list.c      74:      FAST TEXT *s;
list.c      75:      TEXT buf[MAXLINE+1],*getflags();
list.c      76:
list.c      77:      if(s = getflags(&ac,&av,"h,i+n,p#",&h_flag,&prefix,&n_flag,&page_size))
list.c      78:          diagnostic(NO,"bad flag:",s,NULL);
list.c      79:      if(ac <= 0) {
list.c      80:          list("");
list.c      81:          paginate(NULL);
list.c      82:      }
list.c      83:      else {
list.c      84:          do {
list.c      85:              title = *av;
list.c      86:              include(title,&list);
list.c      87:              paginate(NULL);
list.c      88:          } while(++av.--ac!);
list.c      89:      }
list.c      90:  }
```

Text continued from page 234:

file, this is what the subroutine would look like in pseudocode:

```
read line;
while(not end of file) {
  do page header;
  while(not (end of file || bottom of page)) {
    print line;
    read line;
  }
  do page footer;
}
```

For efficiency and simplicity, a *pointer* to each line is *passed* to PAGINATE instead of read from a file. A NULL pointer indicates end-of-file. The usual method is to turn the code inside out around the read statements. Jackson advocates keeping the structure the same and replacing each read statement by an assignment to a state variable, a return statement, and a label. The state variable serves as a "bookmarker," so that execution can resume where it left off. A switch statement at the subroutine entrance will jump to the proper label on the next call. This technique may not be well received by the more fanatical GOTOless programming advocates, but this

was the first paginate subroutine I have written that worked perfectly on the first try. In PAGINATE, the page counter is used as the state variable. If PAGE equals 0, then execution continues at the first read statement; otherwise, it jumps to the read in the innermost loop.

LIST did not spring full-blown from an exhaustive design process but evolved over a period of time. As with most computer efforts, I had only a general idea of the requirements—features were added, removed, and generalized. The header-file exclusion option originally only affected the standard header file STD.H. Functions were moved around within the code to tighten up the structure or to generalize a subroutine. Concatenating the file name, line number, and source line was originally done in PAGINATE. Moving it out allowed PAGINATE to be used in other programs. Several extensions are being contemplated, but the cost (in time) to implement them exceeds the cost of not having them. Being able to exclude an include file by name (`-x filename`) would be useful on large programs with a lot of previously developed code. When the preprocessor conditional compilation statements `#if` and `#ifdef` are used, it's practical to have LIST handle them correctly. Each of these extensions would, however, require more time to implement than the existing program. ■

If your accounting system is in the Dark Ages, you should talk to **Systems Plus**

Accounting Plus brings up-to-the-minute accounting power to the microcomputer industry.

Accounting Plus is an extremely easy-to-use, fully integrated seven-module accounting system. It includes complete data entry prompting, extensive error checking and one-time-only data entry features.

Accounting Plus features: General Ledger, Accounts Receivable, Accounts Payable, Inventory, Sales Order Entry, Purchase Order Entry and payroll.

Accounting Plus is a comprehensive on-line system, with all transactions applied immediately, and results accessible without long delays associated with batch-type transactions.

Invoices, statements, checks, purchase orders and sales orders are prepared using pre-printed standard forms.

If you are ready to enjoy solid software that create functional and easy installations, call Systems Plus

Our software operates under CP/M[®], MP/M[®], or CDOS^{**} operating systems. Yesterday's dreams are available today, off the shelf.

1921 Rock St. Suite 2
Mt. View, CA 94043
415-969-7047



Systems Plus

[®]TM of Digital Research, Pacific Grove, CA
^{**}TM of Cromemco, Sunnyvale, CA

The UNIX Operating System and the XENIX Standard Operating Environment

Robert B Greenberg
XENIX Product Manager
Microsoft
10800 NE Eighth, Suite 819
Bellevue WA 98004

Never has there been a greater demand for software that is easy to use and maintain, and independent of the hardware on which it runs. As the price of software rapidly outpaces that of computers, the need to increase software productivity and reduce duplication of effort has become paramount.

Microsoft's XENIX operating system offers one solution to the software crisis developing in the microcomputer world. Unlike the operating systems offered for 8-bit machines, the XENIX system is a powerful multiuser timesharing system with hundreds of utilities and is the basis for a highly productive software development environment and a general-purpose applications system.

The XENIX operating environment combines two key elements: the design of the widely acclaimed UNIX operating system and the inclusion of the major high-level languages that are standard within the 8-bit microcomputer world (see figure 1). Microsoft's transport of the XENIX system to major 16-bit microprocessors has made it the first hardware-independent operating system.

The heart of the XENIX system is the UNIX operating system developed at Bell Laboratories and licensed by Western Electric. The UNIX system's elegant design combines power, flex-

ibility, and simplicity, and its vast array of software utilities greatly increases productivity. Thus, the UNIX system is an ideal candidate to serve as a solution to the software crisis.

Microsoft plans to make the XENIX operating system (which is an enhanced version of the UNIX system) into a commercial standard. And, in addition to supporting and enhancing the operating system

The XENIX system is one approach to solving the software crisis developing in the microcomputer world.

proper, Microsoft will adapt high-level languages, such as its BASIC interpreter and compiler, FORTRAN, Pascal, and COBOL, and other software tools, such as data-base management and communications software, to run under the XENIX operating system.

To understand the elegance of the basic UNIX design and the further enhancements in the XENIX system, we must take a closer look at the software. In this article, I will describe the main features in the UNIX operating system, discuss some of its strengths and weaknesses, and conclude with a discussion of the evolution of the XENIX operating environ-

ment from the UNIX operating system, and how it can help solve critical software issues. First, a historical overview.

Origins of the UNIX OS

The UNIX operating system was originally developed at Bell Laboratories by Ken Thompson, an employee engaged in various programming research projects. With access to an abandoned DEC PDP-7 computer that had no software, Thompson decided in 1969 to write a set of programs that would aid him in software research. Over a period of several years, and with the help of fellow researcher Dennis Ritchie, this set of programs evolved into a full operating system. By 1972, it was recoded for the DEC PDP-11 computer in a newly designed high-level language, called C. The system gained recognition within the Labs and their parent company, Western Electric.

Word of the quality of Thompson and Ritchie's UNIX operating system spread rapidly. Universities, in particular, expressed interest in obtaining UNIX, and in 1973, Western Electric agreed to distribute the system to nonprofit organizations and promptly licensed several dozen educational institutions, including Columbia University, the University of Alberta (Canada), The Children's Museum (Boston), Princeton University, and Harvard University. By 1975, UNIX had become sufficiently popular in the academic world to justify the

*UNIX is a trademark of Bell Laboratories.
XENIX is a trademark of Microsoft.*

DOES YOUR PRINTER HAVE A ONE TRACK MIND?

ANNOUNCING:

The Paper Tractor.

The Paper Tractor turns your tractor feed printer into a friction feed printing system. Inexpensively.

With The Paper Tractor you can abandon dull continuous form stock and move into new realms of high quality personalized writing paper. Without costly hardware modifications.

This revolutionary product acts as a carrier, protecting and guiding any standard letter or legal size paper through the printing area. Any paper. Bond, parchment, onionskin, vellum, NCR. Even your company or personal letterhead.

The Paper Tractor is a unique solution to the restrictive nature of the tractor feed printer.

- }) Fits 9½" or 14½" print frame.
- }) Compatible with Matrix, Impact, Daisywheel and Ink Ejection printheads.
- }) Fits front, back and dual tractor paper feeds.
- }) Designed with self-aligning feed system.
- }) Positions letter or legal size paper automatically with an edge-protecting guide.

- }) Proven with all major manufacturer printers, including Epson, Tiger, TI, GP-80M, and more.
- }) Designed for use with forward/reverse plotting printers.
- }) Inexpensive!

one for	\$19.50
two for	\$18.00 each
three or more for	\$16.50 each

Leave the boredom of continuous form behind. Display your work in style. Be dynamic with The Paper Tractor.

The Paper Tractor

P.O. Box 4218
Santa Barbara, CA 93103

- Check or Money Order
 MasterCard Visa # _____
Expiration Date _____

Please send me _____ Paper Tractors for

- 9½" 14½" wide printer.

Printer Model _____

NAME _____

STREET _____

CITY _____ STATE _____ ZIP _____

PHONE (_____) _____

Phone Orders: 800-235-6967.

In California call (805) 966-5448. Distributors welcome.

California residents add 6% sales tax.

XENIX OPERATING ENVIRONMENT

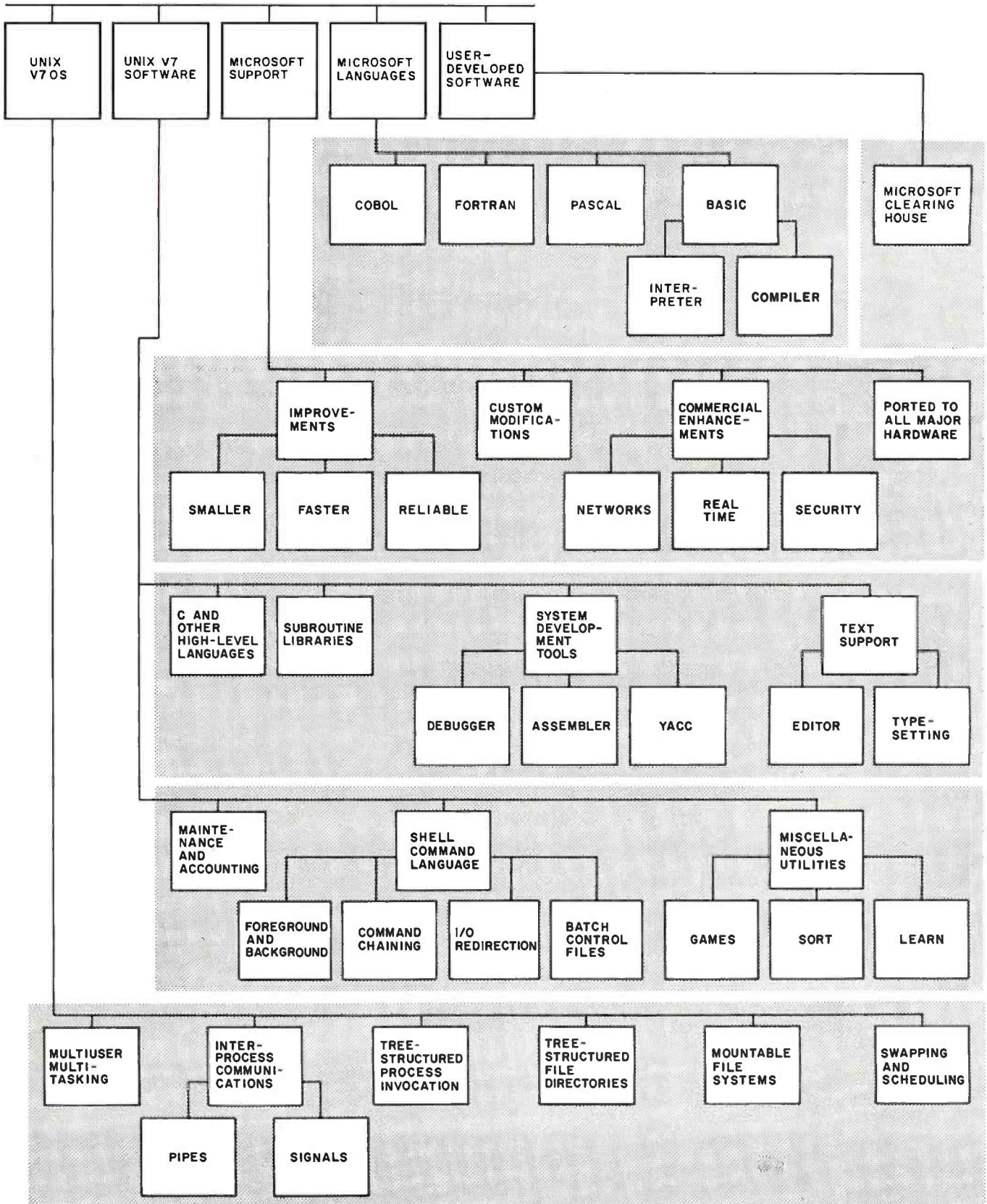

Figure 1: Microsoft's XENIX operating system. The five "layers" of the XENIX software structure are shown. XENIX, a superset of Bell Laboratories' UNIX operating system developed in the early 1970s, has a hierarchical structure. Each of the five layers depends on the layers beneath it for its operation. The bottom two layers represent the latest version of UNIX (version 7). The remaining three layers are the refinements that combine to make the XENIX system.

Let your customers know that you mean business - show with

Comp-U-Con

This years biggest events!!

10
Computer
Trade
Shows

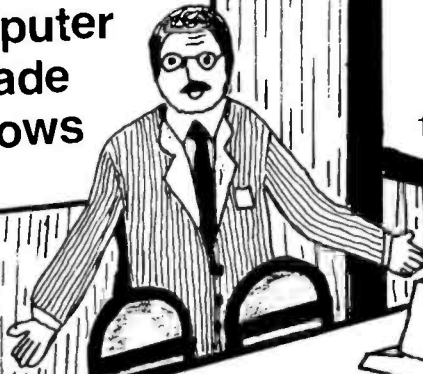

Call for Participants
in 1981's
Golden Opportunity

- The schedule of shows will be **1981**
- 1 Cleveland, Ohio — August 14-16
 - 2 Milwaukee, Wisconsin — August 20-23
 - 3 St. Paul, Minnesota — September 9-11
 - 4 Detroit, Michigan — September 24-26
 - 5 Pittsburgh, Pennsylvania — October 1-3
 - 6 St. Louis, Missouri — October 15-17
 - 7 Dallas, Texas — October 22-24
 - 8 Los Angeles, California — November 8-10
 - 9 San Francisco, California — November 19-21
 - 10 Denver, Colorado — December 3-5

Comp-U-Con Company presents — 10 Home and Business Computer Festivals — From Coast to Coast.

These shows will be directed toward the home user/hobbyist and small businessman and will be promoted by a full scale publicly appealing package of inducements — such as speakers on subjects of particular interest to the targeted groups and a drawing for a \$3000.00 computer system.

If your company has an interest in greatly increasing its sales this fall and does business within a 300 mile radius of any or all of the targeted cities. These shows are exactly what your looking for.

You may participate on two levels. You may either purchase Booth space, in which you can present and demonstrate your goods directly to the public, or you can purchase advertising space in each shows handout brochure that will be given to all that attend.

The average attendance is expected to range from 20,000 up to 35,000 people with additional information going out by mail to those who can't attend.

Please Call or Write today for complete details and costs. Write to — The Weston Research Institute, P.O. Box 175, Waverly, IA 50677 or **Call Jeff Weston, Collect at (319) 268-1953.**

Note - Because of limited space availability, an early reservation is recommended to assure you of space.

DISCOUNT Computers from HAWAII



II or II Plus

48K	\$1180.00*
3.3 Disk	\$525.00*
Lang Sys.	\$399.00*
Integer Card	\$158.00*
Apple Soft Card	\$158.00*

IDS Printer

Model 445	\$ 695.00*
Model 445G	\$ 750.00*
Model 460	\$1095.00*
Model 460G	\$1145.00*

T I Printer

Model 810	\$1625.00*
-----------	------------

VECTOR

System B	\$5299.00*
VIP	\$3599.00*
3005	\$7250.00*

Add 3% for shipping. On C.O.D.s
Pay shipping in advance.
For faster delivery send
cashiers checks.
Hawaii residents include
4% sales tax

Computer

Warehouse

P.O. Box 1777
Honolulu, HI 96806
(808) 523-1552

creation of a UNIX users' organization, later called USENIX.

The first public release of the UNIX operating system, labeled version 5, was an unpolished snapshot of a research project that was still evolving. It was replaced in 1975 with version 6, a system that is still operating today at many sites. UNIX continued to evolve, benefitting from the feedback it received from scores of internal and external test sites.

In January 1979, Western Electric released version 7. By this time, hundreds of man-years' effort has been expended on UNIX's design and software utilities, with most of the system coded in C. Research had proven that UNIX was compatible with the concepts of memory-limited computers, machine transportability, networks, and multiple-processor designs.

Unfortunately, there was no single standard design for UNIX. Because the operating system was simple and easy to change, almost every site altered it to meet their specific needs. Harvard, the University of California at Berkeley, and the RAND Corporation each offered a set of modifications. A number of incompatible versions of UNIX existed within Western Electric.

In addition, there has been a legal impediment to the UNIX system's distribution. The system is available essentially free-of-charge for educational institutions. Legally, however, Western Electric cannot be in the software business, so the commercial world is offered the operating system under noncompetitive terms: source code as is and no warranty, support, or maintenance—a steep fee for software that was never intended to serve commercial applications outside of Western Electric.

It had become clear that the support of a commercial software company was essential if UNIX was to become a software standard. In August of 1980, Microsoft announced that it would offer and support XENIX, a commercial version of the operating system, on 16-bit microprocessors. Working closely with Western Electric and a newly formed commercial users' organization, Microsoft intends to establish a stan-

dard industry version of UNIX that can provide a highly productive environment worthy of meeting the challenges of software development in the 1980s.

UNIX Design Goals

Two aspects of UNIX's origin have contributed to its design: (1) it was created in a few man-years by two people, and (2) the implementers were also major users of the system. The result is a polished, consistent, coherent design. UNIX achieves great power and flexibility, including compatible interfacing between all its features, without resorting to a large, complex program. An experienced system programmer can understand the entire operating system in weeks, rather than months.

The UNIX system's design goals unite various features supported by the UNIX system into a consistent and simple whole. The first design goal is to support a very basic level of functionality within the operating system itself, relying on normal user programs to provide sophistication. Such features as line printer queuing, login/logout, monitor commands, and file access methods are implemented as normal user programs instead of operating-system functions. This approach, which reduces the overall complexity of the system, has several advantages. Functions are more modular, and therefore easier to debug, features can be altered and upgraded without stopping the operating system, and alterations made to one feature are less likely to affect the rest of the system. Finally, individual users may create personal versions of certain features.

The second design goal is generality—that is, having a single method serve a variety of related purposes. For example, the same system calls are used to read and write disk files, devices, and interprocess message buffers. Likewise, the same naming, aliasing, and access protection mechanisms apply to data files, directories, and devices. As a final example, the same mechanism is used to trap software interrupts, user abort requests, and processor traps. The benefits of generality extend well

A definite breakthrough in Hard Disk Controllers: The HOP™ from ACT.

How we HOP™ up 5¼" Hard Disks.

Take a close look at the industry and you'll find lots of folks clamoring for the chance to utilize the new 5¼" Winchester-type Hard Disk microcomputer systems. The reason for this is obvious: the 5¼" Hard Disk packs millions of bytes of on-line data storage in the same space as a 5¼" standard floppy. Hard Disks also offer a degree of high reliability and high access mass storage that instantly obsoletes the floppies.

The problem most people had was finding a 5¼" Winchester-type Hard Disk with a decent controller package. For a while it seemed like an industry-wide problem. Until now. A company named ACT is announcing the HOP™! It's a whole new approach to affordable Hard Disk Controllers. And it works great!

Our Digital Data Separator means faster, more reliable throughput than Analog Separators.

The secret to our success lies in a new approach to Data/Clock separation. While others struggle to manhandle an Analog Data Separator into their controller cards, we at ACT took a completely different approach—a digital one.

What we came up with is the HOP™. It is a Digital Data Separator that fits the 5¼" Winchester-types like hand-in-glove.

We created a package that'll beat the pants off any other 5¼" Hard Disk or floppy it comes up against—all at a price you can't ignore.

Finally, a 5¼" Hard Disk microsequencing controller package with an efficient, floppy-like interface. We're talking about megabytes of formatted data storage to match the demands of today's (and tomorrow's) sophisticated programming. Your multi-terminal and real-time transaction oriented systems never had it so good. Or, so affordable.

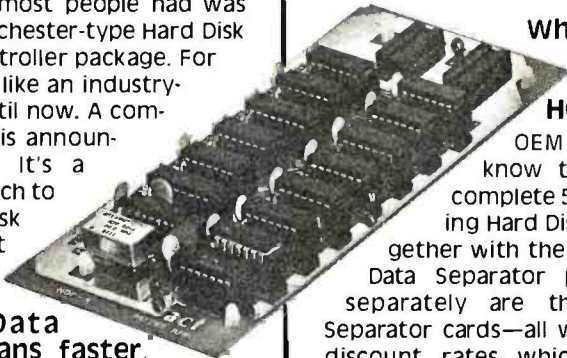

What OEM buyers should know about the ACT HOP™ package.

OEM buyers should know that ACT offers a complete 5¼" micro-sequencing Hard Disk Controller together with the remarkable HOP™ Data Separator package. Offered separately are the HOP™ Digital Separator cards—all with OEM quantity discount rates which are positively attractive.

If all this sounds good on paper, just wait until you see the HOP™ in action! Your horizons will dramatically shift—upwards.

Clip and mail the coupon for quick response to your questions. Or better yet, give us a call at (703) 471-9750, TELEX: 440-388 ACTSYS, for some no-nonsense reasons to get off the stick... and on the HOP™!

act

American Computer
and Telecommunications
Corporation

Clip and mail coupon to:

11301 Sunset Hills Road
Suite A-4, Reston, VA 22090
(703) 471-6288

HOP™ To It! ^{B61}

- Tell me more: send technical specs.
- Please set up an OEM demonstration for us.
- Send me Quantity Pricing Schedules.
- Have an ACT representative contact me.

My interest is: immediate 3months
 6 months 9 months longer

My 5¼" Hard Disk Drive interests center on:
 S-100 Microcomputer Systems
 H-89 Heathkit Computer Systems
 TRS-80 Radio Shack Computer Systems
 Other, specify _____

My Hard Disk/HOP™ package interests center on:

- Seagate Technology-ACT 5¼" Hard Disk package
- Shugart Associates
- Olivetti Peripheral Equipment
- Tandon
- Irwin International
- International Memories
- New World Computers

Name _____

Title _____

Company _____

Address _____

City/State/ZIP _____

Phone (____) _____

A HOP™ above the Rest.

The new, high performance Hard Disk Controller Package that's taking the industry by storm.

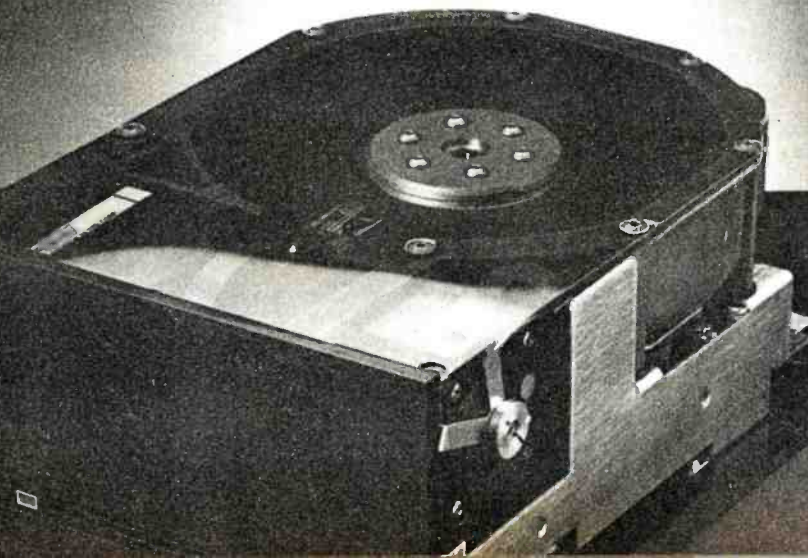

beyond the simplicity of design; UNIX programming style is notably flexible, extensible, easily learned, and easily debugged.

The third goal is to accomplish large tasks by combining several small tasks whenever possible. UNIX's filters are an excellent example. A filter is a program that processes a single stream of input to generate one output stream. The UNIX system has a large variety of filters, including those that perform multicolumn formatting, string replacement, text processing, character translation, sorting, and graphics interfacing. Programs that generate output, such as the assembler, do not include facilities for listings; this task is accomplished by feeding programs directly to the various filters. This keeps the large programs simple to use, lets a user learn about each filter separately, and allows for special combinations of formatting without multiplying the options that each program would then have to support. It also leads to a uniform appearance of formatted

output and the commands needed to produce it, and yields all the benefits of modular solutions to complex problems.

The vast number of utilities provided with the system and the ease of linking them together via pipes provide a surprising amount of functionality. For example, to find out how many people are currently using the system, you need only feed the output of the system "who" command to the utility that prints the number of lines in its input. Thus, the command line:

```
who | wc -l
```

causes the output of the who command, which might look like:

```
arw      console   Jan 30 14:20
bobg     tty00       Jan 30 01:00
henry    tty01       Jan 30 12:50
gordon   tty03       Jan 29 10:08
```

to be fed to the program "wc," for "word count." The -l option tells wc, which normally prints the

number of characters, words, and lines in a file, that we only want to see the number of lines. Thus, this composite command prints a number which is the number of users on the system:

```
> who | wc -l
4
>
```

As a final step, we can create a file called "users," which contains the line:

```
who | wc -l
```

Typing "users" causes the command interpreter (or shell) to execute that line, and type the number of current users. We have now created a new system command.

A more dramatic example is shown in the following sequence: take a program that puts each text word in a file (or files) onto a separate line. Connect the output to a program that sorts lines into alphabetical order.

ECTTM

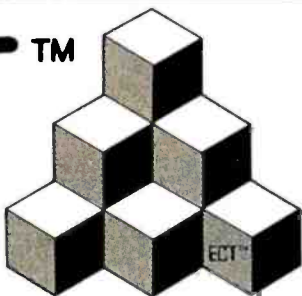

Building Blocks for Microcomputer Systems, Dedicated Controllers and Test Equipment.

R²I/O S-100 ROM, RAM & I/O BOARD

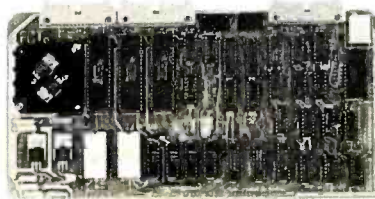

ECT's R²I/O is an S-100 Bus I/O Board with 3 Serial I/O Ports (UART's), 1 Parallel I/O Port, 4 Status Ports, 2K of ROM with the 8080 Apple Monitor Program and 2K of Static RAM.

\$295.00

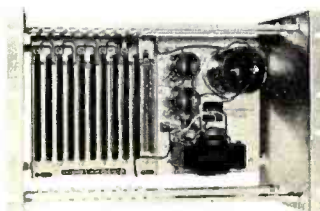

RM-10 S-100 RACK MOUNT CARD CAGE

ECT's RM-10 is a rack mount 10 slot Card Cage with Power Supply, consisting of an ECT-100 rack mount Card Cage (19"W x 12.25"H x 8"D), the MB-10 Mother Board (with ground plane and termination) all 10 connectors and guides and the PS-15A Power Supply (15A @ 8V, 1.5A @ ± 16V).

\$295.00

Specializing in Quality Microcomputer Hardware
Industrial • Educational • Small Business • Personal

Card Cages, Power Supplies, Mainframes, CPU's, Memory, I/O, OEM Variations

ECTTM ELECTRONIC CONTROL TECHNOLOGY (201) 686-8080

763 Ramsey Ave., Hillside, NJ 07205

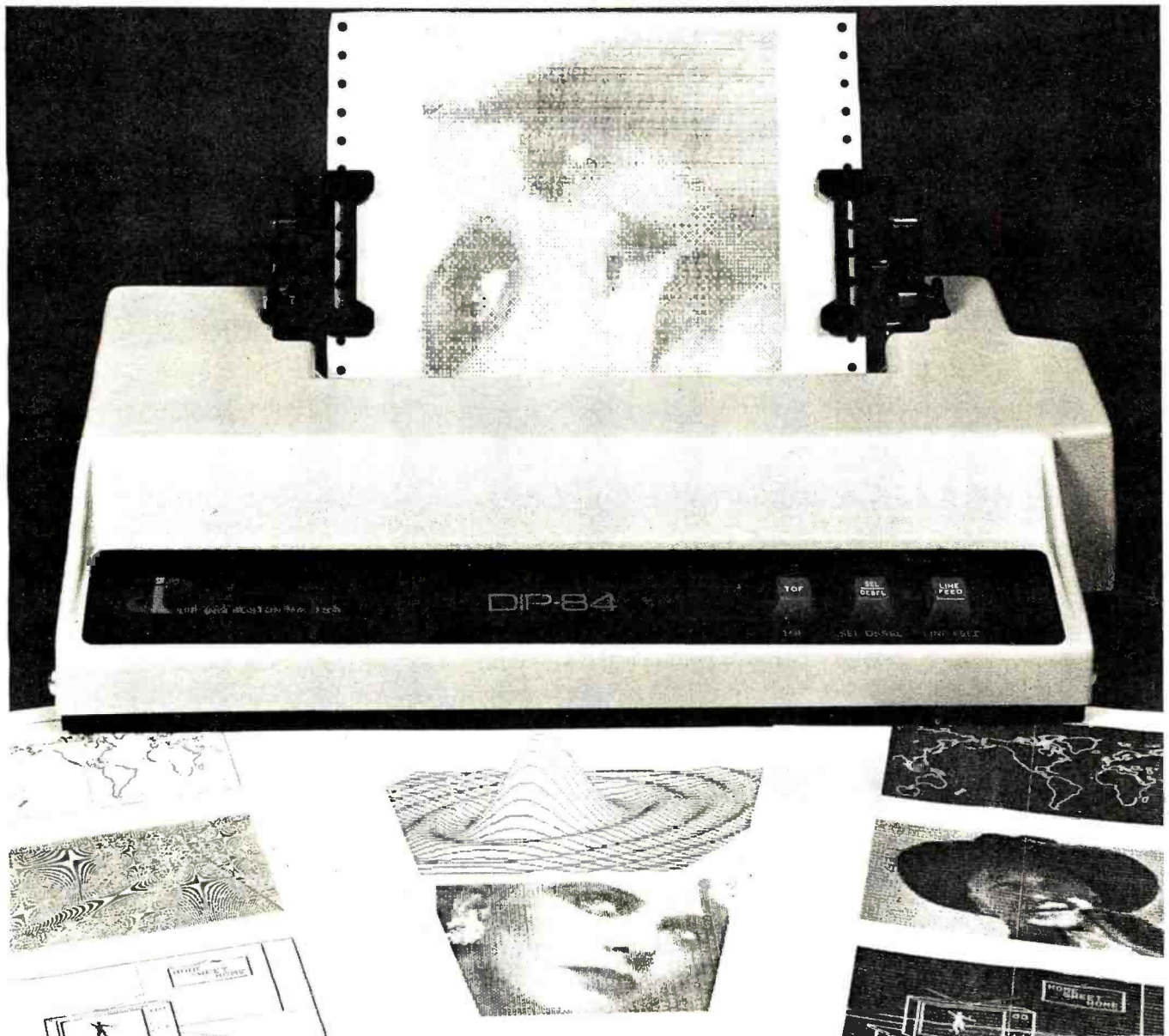

The HI-Q* Printers Now Presents The 84-G at Only \$795⁰⁰

- One for every need
- 4 models (DIP-81, 82, 84, 85) & many features to choose from
- Friction, Tractor, or both; Sheet, Roll or Fan Fold Paper
- Standard, enhanced, double or Graphic Printing
- Disposable print head rated 100 million characters
- 100 CPS bidirectional printing, 60-150 lpm with short-line cancelling
- 80, 800, or 2K FIFO buffer
 - X-on X-off, or RS232C to 9600 baud and/or parallel
 - Reliability 100% continuous duty cycle

**DISTRIBUTOR
INQUIRIES INVITED**



DIP, inc. 745 Atlantic Avenue • Boston, MA 02111 • (617) 482-4214

**High-Quotient of performance to cost.*

The output is a sorted list of all words in the text file(s). This list is fed to the program "uniq", which removes adjacent duplicate lines. The result is a data stream that contains one line for each different word in the original file(s). This stream is in turn connected to a program that reports differences between two files (one file

being a list of 30,000 words from the dictionary). Thus, typing the line:

```
prep file | sort | uniq | comm wdlst
```

will result in a list of words present in "file" but not present in "wdlst". Without writing a line of code, you have created a simple spelling program! Now, by creating a file called

"spell", which contains the line:

```
prep $* | sort | uniq | comm /usr/dict/words
```

you have created the command "spell". Note that the "\$*" is replaced by the command line interpreter with the arguments typed to the spell command. The UNIX system's command

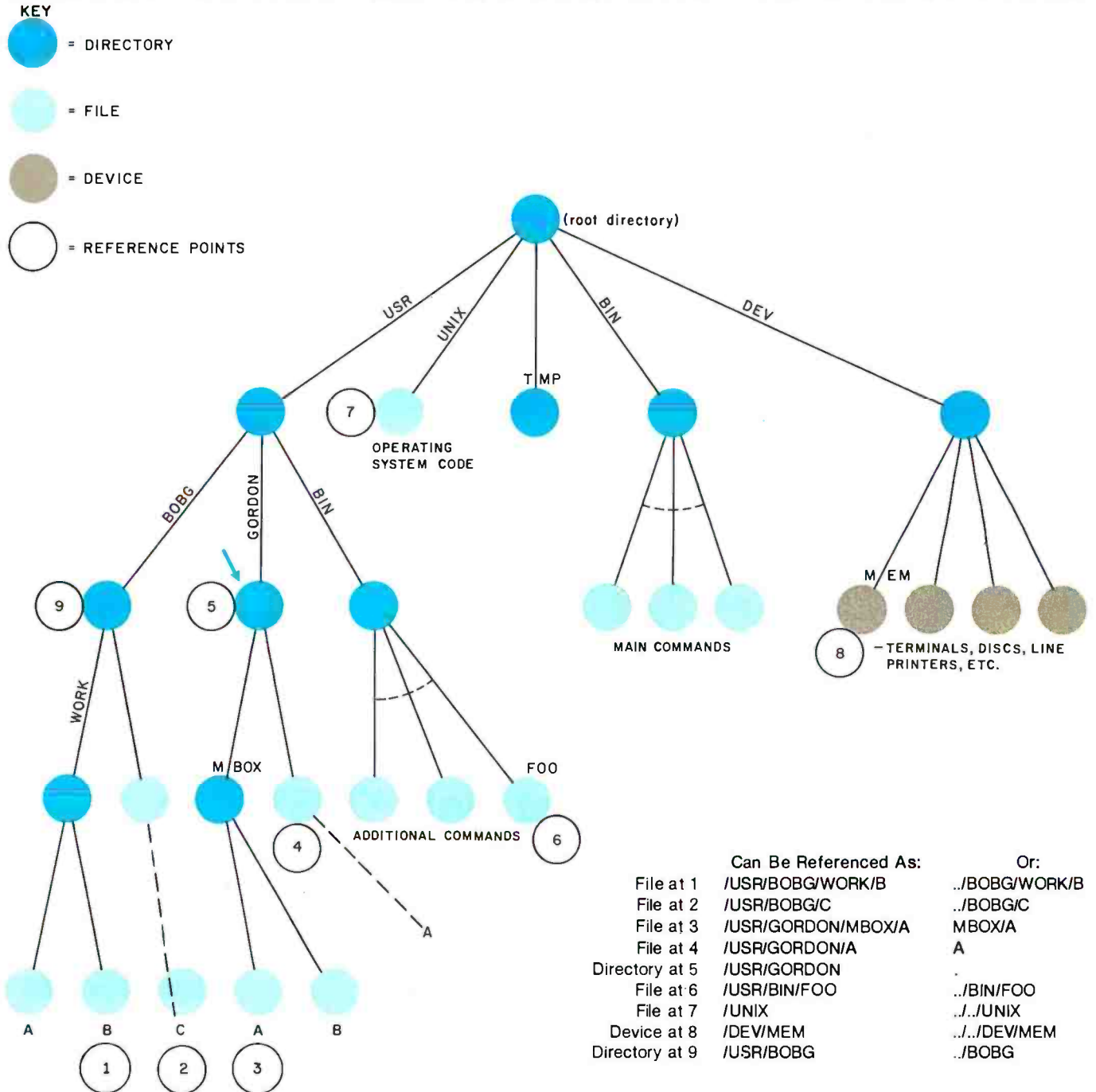

Figure 2: Hierarchical structure of the names and conventions for getting to any reference point in a typical XENIX file structure. In this example, it is assumed that the user is at reference point 5 (blue arrow). A list of instructions for getting to the various reference points appears beneath the diagram. (The file and directory labels shown here are actual labels used in the author's system.) To get to file 1, the user types "/USR/BOBG/WORK/B". XENIX then progresses down the tree from the root directory (at top) to the branches USR, BOBG, WORK, and B, arriving at point 1. Alternatively, the user can use the command "../BOBG/WORK/B", where ".." refers to the parent node of the node currently in use. In XENIX, "." refers to the node itself.

Pan Am puts the middle seat out of business.

The loss, however, is your gain.

For when you fly in our new business section,* you'll never get stuck in the middle. Or by an elbow.

Because in Pan Am's Clipper® Class, we've eliminated the bane of business travelers. The middle seat.

But we didn't stop with merely removing the seat in the center. We replaced every one of them. With seats that are totally new.

(They're the same seats selected for First Class on the next generation of jets. The ones due for delivery around 1985.)

Our new seats are wider and larger than the ones you're probably used to. Which means they're much more comfortable than seats in your business-as-usual section.

And since there are fewer of them, you get an additional dividend. Room.

What's behind our move to remove the middle seat? Same motivation that's made Pan Am the innovator in air travel: concern



for your comfort and convenience.

That's why Clipper Class is now a distinctly separate part of the plane. Especially for people who travel on business.

And the reason we offer amenities not normally found this side of First Class. Everything from special check-in facilities to gourmet food served on fine china.

The bottom line? Simply that, from nine U.S. cities to 32 destinations all over the world, no other airline offers a better business section.*

So tell your Travel Agent or Corporate Travel Department you want Clipper Class.

On the airline that believes putting the middle seat out of business is putting the business traveler first.



*New Clipper Class is currently available to selected destinations. New destinations are being added each week. And by mid-year, our new Clipper Class will be offered on our entire 747 fleet—and on certain L1011s—worldwide.

PAN AM



Say hello to Pan Am.

interpreter, the shell, is a fully interactive language in its own right.

UNIX Operating System Design

The UNIX design introduces few new concepts because it borrows heavily from the better aspects of previously existing systems. UNIX contains numerous features found in the MULTICS and AOS operating systems, and the language C is modeled after BCPL. However, the coherence and simplicity with which the chosen features interact result in an unusually elegant design that has great merit of its own.

The UNIX operating system supports a multiuser, multitasking environment. Each user has full access to the resources of the computer on a timesharing basis. UNIX implements scheduling and swapping algorithms that allow the processor and memory to service more tasks, seemingly simultaneously, than would otherwise be possible. UNIX also includes various protection schemes that protect each user from the others. This functionality contrasts markedly with the current microcomputer systems that simplify hardware operation by providing device drivers but make little attempt to extend the computer's utility.

The UNIX file system is a recursive structure originating from a *root directory*. The root directory contains the names of files and subdirectories; the subdirectories contain names of other files and additional subdirectories, etc. When a user logs into the system, he is assigned a specific subdirectory as his current working directory. Full path names for files consist of a possibly null sequence of subdirectories separated by a slash, beginning with either the root or the current working directory, and followed by the file name. By convention, the file in each subdirectory called "." refers to the parent directory (see figure 2). Thus the user has a concept of local and global files neatly organized into directory groupings.

File names refer to data files, the directories themselves, character devices such as user terminals, block devices such as magnetic tape, file

systems mounted onto other disk devices, and interprocess communications devices known as *multiplexed pipes*. Multiple names (called aliases) can be assigned to any of these objects. A set of information, including owner and access permissions, is stored with each object; the directory entries only specify names for the objects.

Programs communicate with their environment with read and write calls directed to a set of open files. Each program starts with three open files: *standard input*, *standard output*, and *error output*. Normally, these files are connected to the user's terminal, but a powerful command-language program, the shell, allows easy and invisible reassignment of these channels. A program can also open any other object (file, device, etc) named in the file system to which it has appropriate access permission. Using a special call, a program can create

pipes, data channels that allow for communication between the program and any other programs connected to an end of the pipe.

All I/O (input/output) operations are performed as byte streams, with all channels appearing to contain a sequence of bytes until a globally defined end-of-file condition is indicated. Random access is also supported, using a call to reposition within the stream. Neither record sizes nor file types are imposed by the operating system. The system handles all interrupts and buffering, and each I/O call is suspended until the requested I/O operation can be completed. All devices, files, and pipes are treated identically (with minor exceptions), which greatly simplifies I/O routines.

A program may initiate another program by issuing a system call to duplicate itself. The two programs then operate independently, with

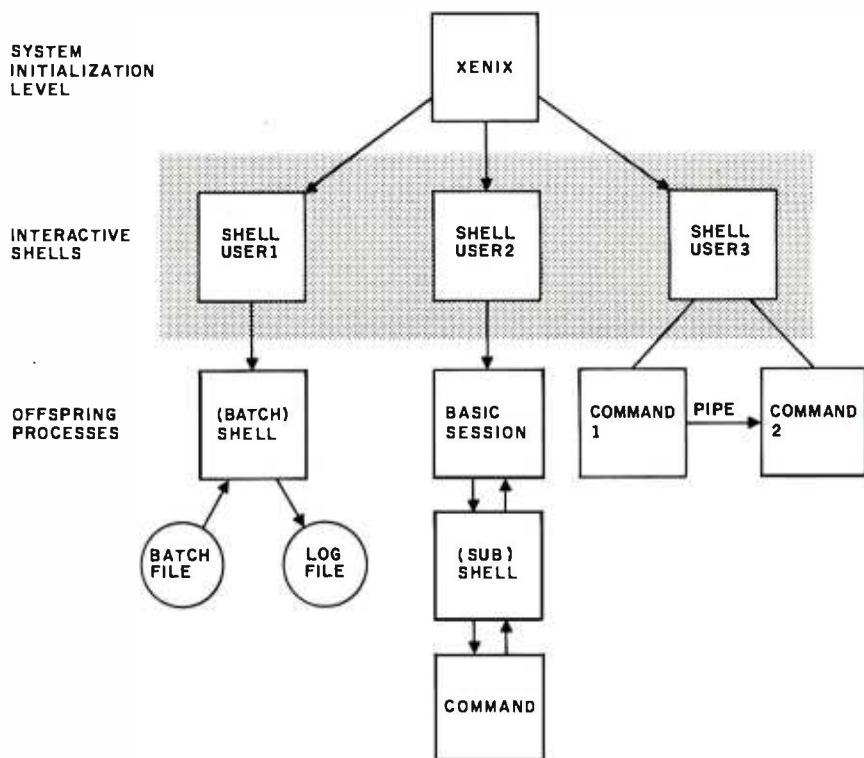
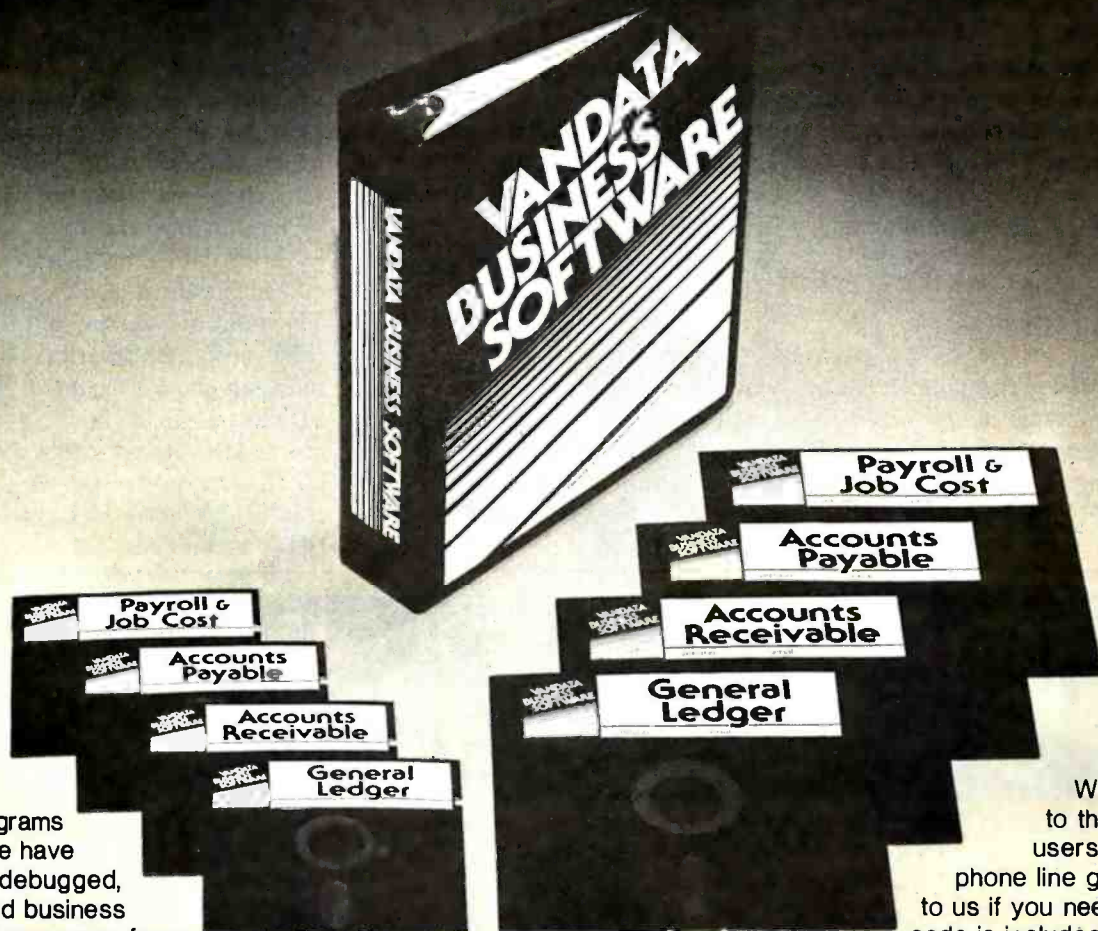

Figure 3: Tree-structured process hierarchies in the XENIX system. Three users are currently on line. The term "shell" refers to that portion of the XENIX operating system program that "surrounds" the operating system and allows it to communicate with the outside world. User 1 is running a batch shell that is executing commands from a file. User 2 has suspended a BASIC session and entered a subshell to issue a command at the system-monitor level, perhaps to send a message to another user. User 2 can then return to BASIC and resume the session. User 3 has executed a command whose output is piped through a second command.

Account on it.



With the Osborne programs as a base, we have developed a debugged, easily installed business package that compares favorably with systems costing much more.

General Ledger produces trial, monthly, and quarterly balance sheets and income statements. Journal entries can be entered manually, or automatically from the A/R and A/P systems.

Accounts Receivable is an open-item system that handles invoice, payment, credit memo, debit memo, and progress billing transactions. Customer statements are produced when desired.

Accounts Payable writes checks to specified vendors from invoice, credit memo, and debit memo transactions. You can distribute each transaction over a series of G/L accounts and job numbers.

Both the A/R and A/P systems produce aged invoice analysis listings based on user-specified time periods.

The **Payroll** system allows hourly, salaried, vacation, holiday, piecework, overtime and miscellaneous pay. Any number of deductions can be entered for each employee. 941-A and W-2 forms are produced when needed. A Job Cost subsystem keeps track of project dates and status, and records hours, cost and overhead information by employee for each job.

The checks and statements fit standard forms readily available from mail-order forms suppliers. You have your choice of a number of different formats.

We are committed to the support of our users. A tech support phone line gives you access to us if you need it. Full source code is included with every system. Our money-back guarantee speaks for itself.

Minimum requirements are 48K RAM, CP/M™ or CDOS, CBASIC2, a CRT, and a 132-column printer. We can provide standard 8", NorthStar 5" double-density, or Heath/Zenith 5" diskettes — call for availability of other formats. The price is \$295 per system, or \$995 for the complete set of four.

For more information, write VANDATA, Suite 205, 17544 Midvale Ave. N., Seattle, Wa. 98133, or call (206) 542-7611.

Vandata Business Software. *You can account on it.* Hundreds of other businesses already do.

CP/M is a registered trademark of Digital Research.

UNIX timesharing between them (see figure 3). Typically, the parent process waits for the completion of its child, and the child process executes another program in the file system by issuing a system call. However, both programs may continue execution in parallel. To synchronize their operation, they can communicate via the file system, pipes, or signals. Signals are software asynchronous interrupts that are issued by one program to another to cause the second program to interrupt its execution, process the signal, and then resume normal execution. Signals are also generated by user interrupt requests and software failures, such as divide-by-zero.

Thus, when a user compiles and links a program test.c by typing:

```
> cc test.c
```

the shell runs the C compiler (cc) as a child process. After it has spawned the child process, the shell puts itself to sleep. When the child process (the C compiler) finishes, the shell awakens and issues another prompt.

However, by simply adding an ampersand character to the command line:

```
> cc test.c &
```

you can instruct the shell not to sleep, but rather to return immediately for another command. You can then edit your documentation or some further program, while the first one is compiling. Note that typing:

```
> filename
```

causes the shell to run a copy of itself as a child. This child shell then executes, one by one, the commands in "filename." By simply adding the "&" character to the following line:

```
> filename &
```

you now have the capabilities of a full batch system, for free, as a result of the UNIX system's flexibility.

This section has presented a brief overview of the UNIX system features. A more complete descrip-

tion is available in documents from Microsoft, Western Electric, and a number of universities. I will conclude this section with a discussion of an excellent example of UNIX's multitasking abilities.

Multitasking

The multitasking and interprocess communication features of the UNIX system provide power that is unavailable in existing 8-bit computer systems. RITA, a large interpreter language for UNIX that I helped create for the RAND Corporation, provides an extensive example of the utility of these features. The RITA interpreter consists of over 100 K bytes of instructions and more than 64 K bytes of data—much larger than the current limit on UNIX program size. The solution was to split RITA into three separate programs that communicate through the use of five pipes, as illustrated in figure 4. Furthermore, separate programs are created by the interpreter to edit programs, read RITA news files, and perform UNIX commands, such as obtaining



META TECHNOLOGIES

26111 Brush Avenue, Euclid Ohio 44132

CALL TOLL FREE 1-800-321-3552 TO ORDER
IN OHIO, call (216) 289-7500 (COLLECT)



MICROPARAPHERNALIA

DISKETTES (box of ten)

5 1/4" PLAIN JANET™ \$21.95
5 1/4" PLAIN JANET™ Gold \$25.95
5 1/4" DATALIFE™ MD 525-01 .. \$26.95
8" DATALIFE™ FD34-8000 \$43.95

NEWDOS by APPARAT

NEWDOS/80 by Apparat \$149.95
NEWDOS + to
NEWDOS/80 UPGRADE CALL
NEWDOS + with ALL UTILITIES
35-track \$69.95
40-track \$79.95

BOOKS

TRS-80™ DISK
AND OTHER MYSTERIES .. \$19.95
MICROSOFT™ BASIC DECODED \$29.95
1001 THINGS TO DO WITH YOUR
PERSONAL COMPUTER \$ 7.95

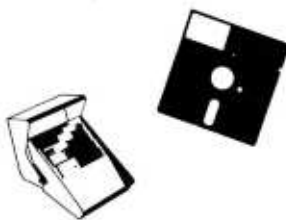

FILE BOX

DISKETTE STORAGE SYSTEM



\$24.95 for 5 1/4" disks
\$29.95 . . . for 8" disks

MTC brings you the ULTIMATE diskette storage system, at an affordable price. Storing 50 to 60 diskettes, this durable, smoke-colored acrylic unit provides easy access through the use of index dividers and adjustable tabs. Unique lid design provides dust-free protection and doubles as a carrying handle.

'RINGS' & THINGS

Help prevent data loss and media damage due to improper diskette centering and rotation with the FLOPPY SAVER™ reinforcing hub ring kit. 7-mil mylar rings in stall in seconds. Kit is complete with centering tool, pressure ring, 25 adhesive backed hub rings and instructions.

HUB RING KIT for 5 1/4" disks \$10.95
HUB RING KIT for 8" disks \$12.95
REFILLS (50 Hub Rings) \$ 5.95

Protect your expensive disk drives and your valuable diskettes with our diskette drive head cleaning kit. The kit, consisting of a pair of special "diskettes", cleaning solution and instructions, can be used for 52 cleanings. Removes contamination from recording surfaces in seconds without harming drives.

CLEANING KIT for 5 1/4" drives \$24.95

PLASTIC LIBRARY CASES

(not shown)

An economical form of storage for 10 to 15 diskettes, and is suitable for your bookshelf! Case opens into a vertical holder for easy access.

5 1/4-inch diskette case \$3.50
8-inch diskette case \$3.95

TRS-80 is a trademark of the Radio Shack Division of Tandy Corporation. DATALIFE is a trademark of VERBAJIE, PLAIN JANE, AIDS, AIDS II, CALCS III, CALCS IV, MERGE III are trademarks of MTC. 1981 by Meta Technologies Corporation, Inc.

MOST ORDERS SHIPPED WITHIN ONE BUSINESS DAY
Products damaged in transit will be exchanged.

PRICES IN EFFECT June 1, 1981 THRU June 30, 1981.
Prices, Specifications, and Offerings subject to change without notice 8106

WE ACCEPT
• VISA
• MASTER CHARGE
• CHECKS
• MONEY ORDERS
• C O D

* Add \$3.00 for shipping & handling
* \$3.00 EXTRA for C.O.D.
* Ohio residents add 6 1/2% sales tax.

CALL FOR INFORMATION ON OTHER PRODUCTS

ALPHA BYTE DOES IT AGAIN...



Call us for our never undersold price.

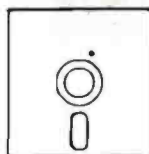

**ALPHA
BYTE
STORES**

(213) 883-8594

Circle 14 on inquiry card.

5115 Douglas Fir Road • Suite B • Calabasas, CA 91302

access to networks. Several files are written for analysis by still other programs. All this multitasking takes place invisibly: the user still thinks he or she is running a single program.

A further benefit of multitasking and device-independent I/O is an unexpected feature of RITA's three-program arrangement. Normally, the first program, UFE (user front end) allows you to type and edit program statements, which are then converted to internal form by the second program, the parser, which in turn stores them in the third program, the monitor, for evaluation. The UFE also allows the statements to be

entered from a disk file; however, due to the complex parser program, loading a large file is too time consuming for many applications. A slight alteration to the UFE, the program which creates the other two programs and the five pipes, provides the solution. The new UFE (now called RC for RITA compiler), which requires no changes to the parser or monitor, funnels the output of the parser, normally fed to a pipe, into a disk file. Thus, RC produces "compiled" files whose contents can be fed directly into the monitor, bypassing the parser, when later loaded by RITA's UFE.

An Assessment of UNIX

UNIX offers unparalleled power for such a straightforward system. For the programmer, the system is easy to learn and offers immediate functionality, even for beginners. For more experienced users, the wealth of software tools leads to a more productive environment than less complete systems.

In addition, the UNIX operating system comes with hundreds of utilities and software tools that make it a complete software development environment. There is software for accounting, text editing, formatting and typesetting, high-level languages,

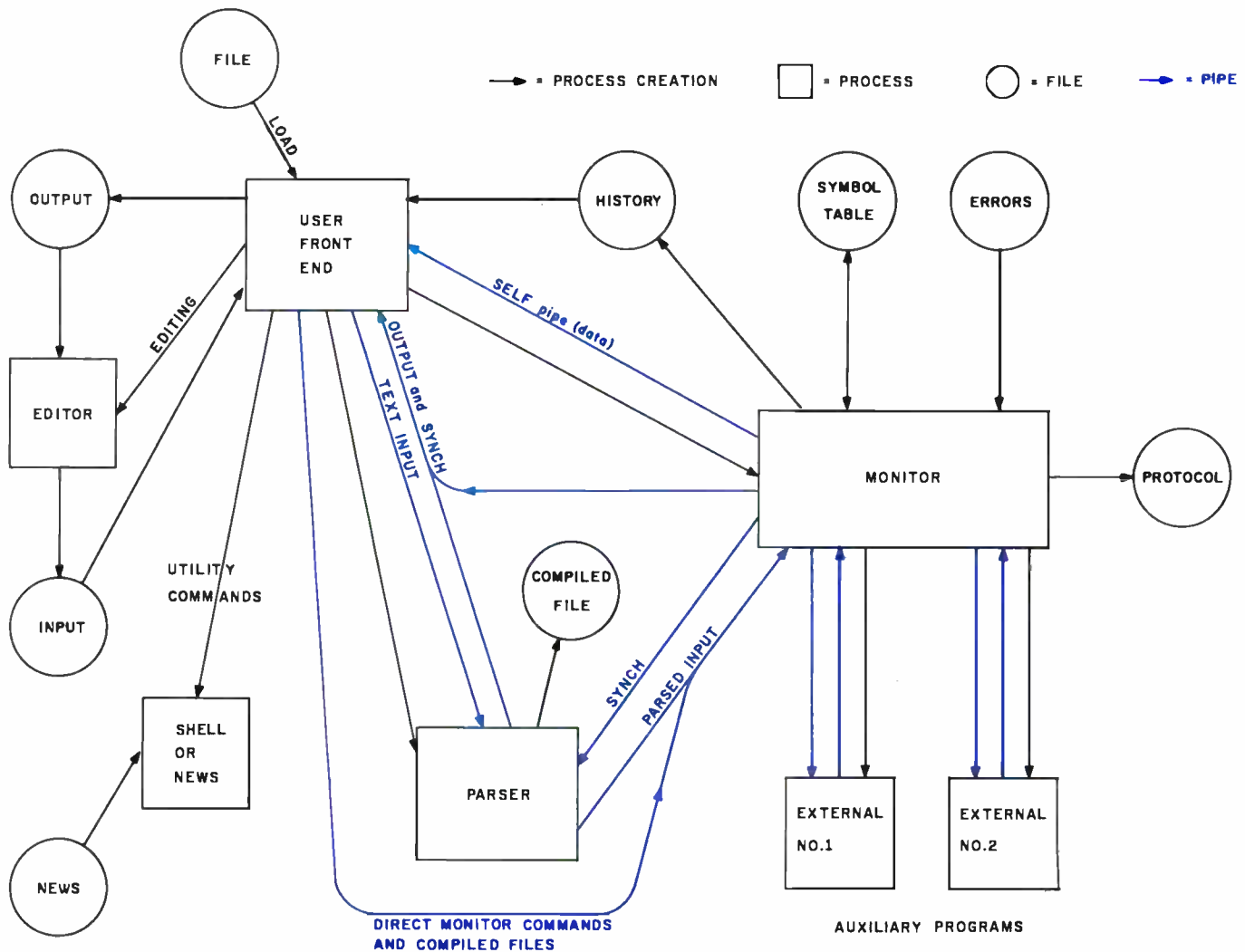

Figure 4: RITA, a program designed in part by the author to illustrate the multitasking and interprocess communication features of the UNIX system. The RITA interpreter consists of over 100 K bytes of instructions and more than 64 K bytes of data; much larger than the current limits on UNIX program size. The solution to the problem is to split RITA into three separate programs that communicate through the use of five "pipes." A different UFE (user front end) program, called the RITA compiler, can refunnel the output of the parser, normally fed to the monitor, into a disk file. Thus, the RITA compiler produces "compiled" files whose contents can be fed directly into the monitor, bypassing the parser, when later loaded by RITA's user front end. This approach allows the user to load large files that might otherwise require too much time.

Percom's DOUBLER II™ tolerates wide variations in media, drives

GARLAND, TEXAS — May 22, 1981 — Harold Mauch, president of Percom Data Company, announced here today that an improved version of the Company's innovative DOUBLER™ adapter, a double-density plug-in module for TRS-80* Model I computers, is now available.

Reflecting design refinements based on both theoretical analyses and field testing, the DOUBLER II™, so named, permits even greater tolerance in variations among media and drives than the previous design.

Like the original DOUBLER, the DOUBLER II plugs into the drive controller IC socket of a TRS-80 Model I Expansion Interface and permits a user to run either single- or double-density diskettes on a Model I.

With a DOUBLER II installed, over four times more formatted data — as much as 364 Kbytes — can be stored on one side of a five-inch diskette than can be stored using a standard Tandy Model I drive system.

Moreover, a DOUBLER II equips a Model I with the hardware required to run Model III diskettes.

(Ed. Note: See "OS-80[®]: Bridging the TRS-80* software compatibility gap" elsewhere on this page.)

The critical clock-data separation circuitry of the DOUBLER II is a proprietary design called a ROM-programmed digital phase-lock loop data separator.

According to Mauch, this design is more tolerant of differences from diskette to diskette and drive to drive, and also provides immunity to performance degradation caused by circuit component aging.

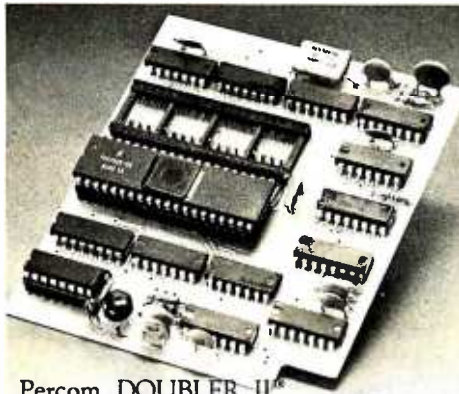

Percom DOUBLER II™

Mauch said "A DOUBLER II will operate just as reliably two years after it is installed as it will two days after installation."

The digital phase-lock loop also eliminates the need for trimmer adjustments typical of analog phase-lock loop circuits.

"You plug in a Percom DOUBLER II and then forget it," he said.

The DOUBLER II also features a refined Write Precompensation circuit that more effectively minimizes the phenomena of bit- and peak-shifting, a reliability-impairing characteristic of magnetic data recording.

The DOUBLER II, which is fully software compatible with the previous DOUBLER, is supplied with DBLDOS™, a TRSDOS* compatible disk operating system.

The DOUBLER II sells for \$219.95, including the DBLDOS diskette.

Owners of original DOUBLERs may purchase a DOUBLER II upgrade kit, without the disk controller IC, for \$30.00. Proof of purchase of an original DOUBLER is required, and each DOUBLER owner may purchase only one DOUBLER II at the \$30.00 price.

The Percom DOUBLER II is available from authorized Percom retailers, or may be ordered direct from the factory. The factory toll-free order number is 1-800-527-1592.

Ed. note: Opening the TRS-80 Expansion Interface may void the Tandy limited 90-day warranty. Circle 288 on inquiry card.

All that glitters is not gold OS-80[®]: Bridging the TRS-80* software compatibility gap

Compatibility between TRS-80* Model I diskettes and the new Model III is about as genuine as a gold-plated lead Krugerrand.

True, Model I TRSDOS* diskettes can be read on a Model III. But first they must be converted and re-recorded for Model III operation.

And you cannot write to a Model I TRSDOS* diskette. Not with a Model III. You cannot add a file. Delete a file. Or in any way modify a Model I TRSDOS diskette with a Model III computer.

Furthermore, your converted TRSDOS diskettes cannot be converted back for Model I operation.

TRSDOS is a one-way street. And there's no retreating. A point to consider before switching the company's payroll to your new Model III.

Real software compatibility should allow the direct, immediate interchangeability of Model I and Model III diskettes. No read-only limitations, no conversion/re-recording steps and no chance to be left high and dry with Model III diskettes that can't be run on a Model I.

What's the answer? The answer is Percom's OS-80[®] family of TRS-80 disk operating systems.

OS-80 programs allow direct, immediate interchangeability of Model I and Model III diskettes.

You can run Model I single-density diskettes on a Model III; install Percom's plug-in DOUBLER™ adapter in your Model I, and you can run double-density Model III diskettes on a Model I.

There's no conversion, no re-recording. Slip an OS-80 diskette out of your Model I and insert it directly in a Model III.

And vice-versa. Just have the correct OS-80 disk operating system — OS-80, OS-80D or OS-80/III — in each computer.

Moreover, with OS-80 systems, you can add, delete, and update files. You can read and write diskettes regardless of the system of origin.

OS-80 is the original Percom TRS-80 DOS for BASIC programmers.

Even OS-80 utilities are written in BASIC. OS-80 is the Percom system about which a user wrote, in Creative Computing magazine, "... the best \$30.00 you will ever spend."[†]

Requiring only seven Kbytes of memory, OS-80 disk operating systems reside completely in RAM. There's no need to dedicate a drive exclusively for a system diskette.

And, unlike TRSDOS, you can work at the track sector level, defining and controlling data formats — in BASIC — to create simple or complex data structures that execute more quickly than TRSDOS files.

The Percom OS-80 DOS supports single-density operation of the Model I computer — price is \$29.95; the OS-80D supports double-density operation of Model I computers equipped with a DOUBLER or DOUBLER II; and, OS-80/III — for the Model III of course — supports both single- and double-density operation. OS-80D and OS-80/III each sell for \$49.95.

Circuit misapplication causes diskette read, format problems. High resolution key to reliable data separation

GARLAND, TEXAS — The Percom SEPARATOR™ does very well for the Radio Shack TRS-80* Model I computer what the Tandy disk controller does poorly at best: reliably separates clock and data signals during disk-read operations.

Unreliable data-clock separation causes format verification failures and repeated read retries.

CRCERROR-TRACKLOCKED OUT

The problem is most severe on high-number (high-density) inner file tracks.

As reported earlier, the clock-data separation problem was traced by Percom to misapplication of the internal separator of the 1771 drive controller IC used in the Model I.

The Percom Separator substitutes a high-resolution digital data separator circuit, one which operates at 16 megahertz, for the low-resolution one-megahertz circuit of the Tandy design.

Separator circuits that operate at lower frequencies — for example, two- or four-

megahertz — were found by Percom to provide only marginally improved performance over the original Tandy circuit.

The Percom solution is a simple adapter that plugs into the drive controller of the Expansion Interface (EI).

Not a kit — some vendors supply an untested separator kit of resistors, ICs and other paraphernalia that may be installed by modifying the computer — the Percom SEPARATOR is a fully assembled, fully tested plug-in module.

Installation involves merely plugging the SEPARATOR into the Model I EI disk controller chip socket, and plugging the controller chip into a socket on the SEPARATOR.

The SEPARATOR, which sells for only \$29.95, may be purchased from authorized Percom retailers or ordered directly from the factory. The factory toll-free order number is 1-800-527-1592.

Ed. note: Opening the TRS-80 Expansion Interface may void the Tandy limited 90-day warranty. Circle 395 on inquiry card.

assembly support utilities, sorters and index generators, communication facilities, tools that create parsers and lexical analyzers, graphics, games, mathematical function libraries, maintenance and performance utilities, and a host of file manipulators. Few needs cannot be met through a combination of these existing utilities.

The flexibility of UNIX allows easy alteration of its user interface. Various installations have demonstrated how easy it is to completely alter the appearance of UNIX in order to serve a different class of users. That UNIX cannot be everything to everyone is overshadowed by the fact that, as it is truly general-purpose, it can perform in almost any environment.

UNIX, as supplied by Western Electric, is not without its weaknesses. The general-purpose timesharing design limits UNIX's efficiency in real-time applications, such as process control. Its standard interface is highly terse, and though this is often considered desirable by programmers, the untamed UNIX will frighten almost everyone else. The origins of many of the command names are obscure; examples include a tape command "r" to write to a tape, command "cat" which types files, and "awk", a program for finding patterns in files. However, command names can be easily changed by the user.

UNIX has not been adapted for commercial use, where the issues of reliability, stability during hardware errors, full per-user accounting, reconfigurability for a large variety of environments, and security take on special importance. For example, less expensive disk packs for larger disk drives usually contain bad spots, and UNIX does not automatically adjust for them. In the environment for which the UNIX system was developed, it was cheaper to buy perfect packs than to write a "bad spot avoidance" routine. These issues must be addressed before UNIX can be considered a sturdy, robust, and commercial piece of software.

A crucial problem, and one not restricted to UNIX, is the lack of true

applications software. Currently, there are few good accounts payable, invoicing, mailing list, income tax, or data-base management packages. UNIX provides an excellent software production environment because of its wealth of software tools utilities, but the system does not contain a similar variety of application-oriented software.

The XENIX System

Microsoft's XENIX operating system represents an attempt to preserve the strengths of the UNIX design and also meet the needs of the commercial microprocessor industry. To achieve this goal, Microsoft used the system as it was distributed by Western Electric and then added modifications, customizations, improvements, enhancements, support, and additional software.

Modifications included those necessary to transport the UNIX system from the larger PDP-11 mini-computer to the 16-bit microprocessors. Currently scheduled machines include the DEC LSI-11/23, Zilog's Z8001 and Z8002, Intel's 8086 and 286, and Motorola's MC68000. Numerous other processors are also being considered, and Microsoft will then customize the XENIX systems to the specific hardware environments of the various computer systems built around these processors. The company is also working closely with a number of hardware manufacturers to design products that will be capable of efficiently executing the XENIX software.

Improvements will include elimination of known bugs and recoding of certain routines to produce a smaller and faster operating system. XENIX will also incorporate hardware error recovery strategies, automatic file repair after crashes, power-fail and parity-error detection, and similar features, depending on the particular hardware requirements of each XENIX system.

The planned enhancements will add a number of new features to XENIX. These features include record locking, shared data segments, synchronous writing, and improved interprocess communication—all of

which are designed to make XENIX commercially viable and more compatible with the newer hardware technologies that involve distributed data processing, networking, and multiple-CPU approaches.

XENIX is a dynamic, evolving system. In its first release, its code was very close to the original UNIX version 7 source. The improvements and enhancements that I have mentioned are part of an evolving process, and the exact selection and specification of features will be developed throughout the course of 1981. Updates to XENIX will result in systems upwardly compatible from its first release.

The adaptation of Microsoft's full line of system software products to XENIX will further strengthen XENIX's role as a software standard. These products, including the BASIC interpreter and compiler, COBOL, FORTRAN, and Pascal, have already established themselves as standards within the 8-bit market; they are also compatible with corresponding ANSI (American National Standards Institute) standards. Standard high-level languages will allow the rapid introduction of existing application software into the XENIX environment.

The XENIX system will offer an ever-expanding variety of software, including data-base management, financial planning, communication, and networking packages. Microsoft is establishing a clearinghouse, wherein quality software running under XENIX may receive widespread distribution, thereby reducing duplication of effort. The combination of the UNIX operating system's strengths and Microsoft's awareness of the needs of the commercial marketplace promises to make XENIX a very powerful defense against the looming software crisis. By establishing a universal operating environment, complete with software tools to increase productivity, flexible design to widen applicability, and multiple microprocessor support to improve availability, Microsoft hopes that XENIX will become the preferred choice for software production and exchange. ■

MAIN FRAME POWER— MICRO PRICE



OSM's ZEUS multiprocessor computer system delivers main frame performance for one to 64 users—**performance impossible in a single processor micro!** We start with the S100 bus and mount a Z80A as master processor to control the shared resources of disk and printer. Then we add a separate single board Z80A processor for each user (no bank switching!) so ZEUS can **grow any time from a single user to many** with no changes in programs or files. And each user is independent of reset or program crash in other users.

OSM's MUSE operating system—the Multi User System Executive—is **many times faster than other leading operating systems.** Each user owns a resident copy of MUSE so you don't wait for the bus or interrupt the master processor to do console I/O and applications code. MUSE finds files fast with a random directory access similar to random file access. And MUSE protects shared files from simultaneous update to the same record by different users. We designed MUSE from the start for multi-user data base environments—yet MUSE is **CP/M* compatible!**

Check the other multi-processors!

Check the hardware!

- S100 compatible master processor (4MHz Z80A, 32K dynamic RAM) for disk and shared printer control
- single board processor (4MHz Z80A, 64K dynamic RAM), with I/O on board, for each user
- serial and parallel ports on each user board support optional slave printer or other user devices
- rack mountable enclosure built to highest industrial standards for reliable continuous operation
- readily field expandable to any configuration from 1 user, 64K RAM, to 64 users, 4 Megabyte RAM
- 2.4 Megabyte double sided dual density 8" floppy disk
- 26 to 96 Megabyte hard disk option
- independent user processor reset directly from each keyboard

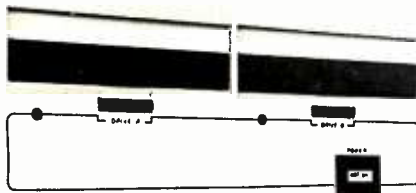

Check the operating system!

- all MUSE code written in Z80 native code (not 8080 code) for fast response
- MUSE user operating system in 7K RAM on board each user processor reduces calls to the master processor
- transfer of data between master and users via single Z80 block move command for highest speed
- random directory search provides immediate file access
- common file area for shared programs and files eliminates redundant files while individual user file areas protect each user's private files
- shared file update with record level lockout
- spool file can be displayed, updated, reprinted
- password security protects multiple user data bases
- MUSE supports standard CP/M* word processors, utilities, and languages: MBASIC, CBASIC, PASCAL, FORTRAN, COBOL, FORTH, C, PL/I, etc.

Check the price!

- Single user mainframe with dual 8" floppy drives expandable to 12 users. Begins at \$5715.00.

See us at COMDEX, booth 2912
June 23-25, New York City

**WE'RE SHIPPING ZEUS MICRO MAIN FRAMES!
CALL US TODAY 408-496-6910 ex 40**

**2364 Walsh Avenue #4
Santa Clara, CA 95051**

*CP/M is a registered trade mark of Digital Research



OSM

All the excitement of "hands-on" experience
with the newest small computers
returns to New York City in August.

New York Computer Expo

Albert Hall Sheraton Centre,
52nd St. & 7th Ave., New York, NY
Aug. 12-15, 1981

Minis / Micros / Software / Peripherals
Services / Free Lectures

Once again, the fascinating world of computers is presented in the heart of New York City for business, science, education, professionals and personal users.

It's the greatest opportunity on the east coast to get an up-date education on what's new by visiting 15,000 square feet of exhibits and attending lectures given by expert computer scientists and educators.

SPECIAL "BUSY EXECUTIVE" SESSION

New York Computer Expo presents an ancillary opportunity for the busy executive who feels it's time to become familiar with computers and the world of data processing, quickly, efficiently and at a low cost.

The aim of this special session is to show the busy executive how to approach data processing technology, how to cope with it on an administrative basis, how to keep ahead of it, and how to put this knowledge to immediate use.

The tutorial covers about five hours, and will be given once each day, Aug. 11 through Aug. 15. Each tutorial has limited registration. Hours are 9 a.m. to about 3 p.m., with time for lunch and a coffee break.

Each registrant will receive an original workbook and computer language dictionary. Four-day registration for the New York Computer Expo also is included. Total fee for the session is \$200.

EXECUTIVE TUTORIAL OUTLINE

SECTION 1. COMPUTER FUNDAMENTALS

In this section of the course you'll learn what a computer is, how it's put together and how you make it do the things you want it to do.

- A. ABC's of Computers
 - What a computer actually is and what it's not.
 - How a computer works. The its and o's of number systems.
- B. Computer Hardware
 - The basic parts of a computer.
 - CPUs--An introduction to the different types.
 - Memory--RAM, ROM, EPROM, ETC.
 - Peripherals.
- C. Computer Software
 - The anatomy of a simple computer language--BASIC.
 - Software buzzwords.
 - An overview of the major computer languages--Assembler, FORTRAN, COBOL, PASCAL, PL/I, APL, ADA, C, FORTH, LISP and more.
 - Packaged software--why you may need it.
 - Specialized software--Data base/data management systems, etc.
- D. Computer Configurations
 - Putting computers, terminals, etc. together in more complicated ways to improve efficiency.
 - Time sharing.
 - Data communications.
 - Distributed processing.
- E. A Look at the People Side of Data Processing
 - What are all those people really doing? Functions of various types of computer personnel, programmers, systems analysts, data entry personnel, operators, etc.
- F. An Overview of Computer Applications
 - An introduction to some of the things computers are being used for.

SECTION 2. HOW TO CHOOSE, INSTALL AND OPERATE A COMPUTER

- A. Defining Your Needs
 - The feasibility study. How to cost out the obvious computer applications.
 - Setting up a computerization timetable.
 - Long-range computer and office automation planning.
- B. Finding Out What's Available to Fit Your Needs
 - A comprehensive overview of the current state of the art in computers, peripherals and software. We'll even give you a peek into the future at what might be available in the years to come.
- C. How Much Work to Do in-House and How Much to Contract Out
 - An information-packed discussion of the available sources of outside help: computer stores, systems houses, contract programmers, service bureaus.
- D. How To Handle A Vendor
 - How to solicit bids and pick the best one.
 - Computer contracts--picking your way through the minefield.
- E. Construction
 - How to get from your current systems to your new system.
- F. The Care And Feeding Of Computer People
 - How to find and keep the right personnel in a very tight market.

SECTION 3. WHERE TO GET MORE INFORMATION

- Introduction to computer organizations.
- Finding other companies and executives in similar circumstances.
- A complete, annotated bibliography of the best and clearest books in the field.

ABOUT THE INSTRUCTOR

The instructor for the course is Barbara Schwartz. The course lecture and workbook is all original material created by her. She is a consultant to major corporations and small businesses and is a writer on computer and data processing topics. She has taught courses for companies and schools in simple clear English.

FREE LECTURE SCHEDULE

	August
Introduction to Small Systems for Business	12 & 13
Introduction to Personal Computing	12 & 15
Selecting a Small Computer for Business for the First-Time user	12 & 14
Computer Performance in an Accounting Environment	12 & 14
Survey of Graphic Packages Available for Micros.	12 & 13
All About Printers for Business	12
Understanding the Cost of Business Software	12 & 13
The Computer as a Scientific research Tool.....	12 & 14
CP/M Update	14
Interfacing to the Real World	13 & 15
The Multi-Lingual Microcomputer	13
Introduction to COBOL for Microcomputers	13 & 15
Using a Microcomputer for Technical Analysis of Stocks & Commodities	13 & 14
Survey of Computer-Assisted Instruction	13 & 15
All About Printers for Personal Use	13
The Next Five Years in Small Computers	14 & 15
Applying PASCAL	14
Microcomputers and Medicine	14
The Beauty of FORTRAN for Small Computers	14 & 15
The Future of the Home Terminal	15
Selecting a Small Computer for Personal Use	15
Uses of the Microcomputer in Education: New Directions	15

Subject to Change

Show Registration Fee: \$10 per day
Show Hours: 11 a.m. to 6 p.m. Daily

NEW YORK COMPUTER EXPO

Please register me for the New York Computer Expo

NAME

COMPANY (if Any)

ADDRESS

ZIP

BUSINESS TITLE (if Any)

One Day \$10 Two Days \$20 Three Days \$30 Four Days \$40

EXECUTIVE SESSION (\$200):

AUG. 11 AUG. 12 AUG. 13 AUG. 14 AUG. 15

Mail with applicable payment. Use one form per person. Registration badge will be sent by mail in early August. Check or money order only.

Your secondary (priority business) check one

- | | | |
|---|---|--|
| <input type="checkbox"/> Accounting Item | <input type="checkbox"/> Engineering | <input type="checkbox"/> Personnel Agency |
| <input type="checkbox"/> Advertising Marketing | <input type="checkbox"/> Financial Services | <input type="checkbox"/> Professional Services |
| <input type="checkbox"/> Banking Services | <input type="checkbox"/> Government/Institutional | <input type="checkbox"/> Real Estate Development |
| <input type="checkbox"/> Real Estate/College/Non-Profit | <input type="checkbox"/> Hospital | <input type="checkbox"/> Telephone (not 44) |
| <input type="checkbox"/> Communications | <input type="checkbox"/> Hotel | <input type="checkbox"/> Utility |
| <input type="checkbox"/> Computer Consultant | <input type="checkbox"/> Industrial Design | <input type="checkbox"/> Wholesale/Retail Sales |
| <input type="checkbox"/> Computer Data Unit | <input type="checkbox"/> Law Office | <input type="checkbox"/> Other (Please Specify) |
| <input type="checkbox"/> Consultant/Architect | <input type="checkbox"/> Management Consultant | |
| <input type="checkbox"/> Educator | <input type="checkbox"/> Manufacturer | |

Check your #1 priority job function

- | | | |
|---|---|---|
| <input type="checkbox"/> Account Executive | <input type="checkbox"/> Designer (Art) | <input type="checkbox"/> Salesperson (Adv) |
| <input type="checkbox"/> Administrator | <input type="checkbox"/> EDP/IBM Manager/Operator | <input type="checkbox"/> Buyer |
| <input type="checkbox"/> Bookkeeper | <input type="checkbox"/> Doctor | <input type="checkbox"/> Sales/Letter-Gr |
| <input type="checkbox"/> Computer Program | <input type="checkbox"/> Engineer (Adv) | <input type="checkbox"/> Teacher |
| <input type="checkbox"/> Controller | <input type="checkbox"/> Lawyer | <input type="checkbox"/> Translator |
| <input type="checkbox"/> Copywriter (Adv) | <input type="checkbox"/> Other Manager | <input type="checkbox"/> Typewriter Operator |
| <input type="checkbox"/> Executive (Adv) | <input type="checkbox"/> Programmer | <input type="checkbox"/> Other (Please Specify) |
| <input type="checkbox"/> General Area (Adv) | <input type="checkbox"/> Publicist | |

Send primary selected job description (letter) only with Business Physician Job

Mail prior to July 24, 1981. No foreign mail orders. New York Computer Expo, 110 Charlotte Place, Englewood Cliffs, NJ 07632 (201) 569-6542

The Ins and Outs of CP/M

James Larson
3422 Union St
San Diego CA 92103

CP/M (Control Program for Microprocessors) is the most commonly used 8080/8085/Z80 operating system. CP/M is easy to use and the Digital Research documentation is reasonably thorough and clear, especially by microprocessor-software standards. However, the documentation is lacking in one area: the explanation of I/O (input/output) and disk interfacing. This article will clarify and expand upon the documentation. A summary of the I/O and disk-interface routines, calling sequences, use of return codes, and typical subroutines using these will be presented. The use of file-control blocks (FCBs) and I/O buffers will also be explained. Finally, some details of the CP/M I/O functions and their workings will be presented.

Calling CP/M Routines

The procedure for calling CP/M routines is straightforward. I/O procedures are defined as a series of functions. Each function is assigned a unique *function number*. The function number is placed in the microprocessor's C register; the data required (*entry parameter* in CP/M parlance) is placed in the E register if only 1 byte is to be sent, or in the DE register pair if a word (2 bytes) is required. Some functions have no entry

parameters. Results (called *returned values*) are either returned as a byte in the A register or as a filled buffer (whose address is usually sent as an entry parameter). Table 1 summarizes the basic I/O functions and calling sequences. Once the registers are properly loaded, a call to the CP/M entry point at hexadecimal memory location 0005 is made. It is important to know that CP/M does not preserve the contents of these registers, so any routine calling CP/M routines must protect any registers to be preserved. A typical subroutine to call a CP/M-utility routine is shown in listing 1. Refer to the examples for specific applications of this sequence. The function numbers and their purpose, entry parameters, and returned-value codes are summarized in table 1 and table 2.

I/O Routines

Listing 2 presents several useful subroutines that make calls to CP/M I/O routines. Calls to the punch device and reader device assume that these drivers exist in your version of CP/M, though they may or may not actually be driving a physical paper-tape reader/punch. As explained in the CP/M *Features and Facilities Guide*, logical devices may or may not correspond to actual physical

devices. Writing and installing these drivers for CP/M is beyond the scope of this article.

Listing 3 shows the use of buffers for CP/M I/O. The address of the buffer is placed in the DE register pair and the call to the CP/M entry point is made. The contents of the print buffer are printed on the console until a dollar sign is encountered. The print buffer is not destroyed in this process. A typical print buffer is configured as:

```
c1 c2 c3 c4 .... ck $
```

where *k* is the number of valid characters and \$ signifies the end of the buffer. The read buffer is configured as:

```
m k c1 c2 c3 c4 .... ck
```

where *m* is the maximum number of characters allowed in the buffer, and *k* is the number of characters actually in the buffer. CP/M places characters in the buffer until a carriage return is encountered or the maximum buffer length is reached. The maximum length, *m*, may be from 1 to 256, and is defined by the user program. The value of *k*, the number of valid characters, is initially set to 0. It is set by CP/M to reflect the number of

LEADER OF THE PACK

You'll see a lot of confusing claims for disk packs and storage modules, but here are a few tips that can help you make the right choice when you're specifying your next pack:

 BASF products represent BASF technology and quality, because, unlike many suppliers, we make them ourselves.

 We polish our uncoated metal disks to a mirror finish for optimum headflight characteristics and virtually no possibility of media-induced headcrash.

 We coat, polish, and burnish each disk by our own process, assuring you of long-lasting, trouble-free operation.

 We magnetically orient all oxide particles in the disk coating for greater packing density.

 We drive-test each pack before it leaves the factory, for top performance with no surprises.

 BASF has your configuration and format*... at a competitive price, ready for immediate delivery.

 For the name of your nearest supplier, write BASF Systems Corporation, Crosby Drive, Bedford, MA 01730, or call 800-343-4600.



*For Burroughs: Front-load single disk cartridges, 80 MB Tridents.
 For CDC: 80 and 300 MB storage modules.
 Phoenix single disk cartridges.
 For Data General: 50, 100, 200, and 300 MB disk packs, top-load single disk cartridges.
 For DEC: 100 and 200 MB 12-high packs, front-load single disk cartridges, 80 and 300 MB storage modules.
 For Honeywell: Phoenix single disk cartridges, 80 and 300 MB storage modules, 100 MB packs.
 For IBM: 100 and 200 MB 12-high packs, top and front-load single disk cartridges.
 For Wang: Phoenix single disk cartridges, 80 and 300 MB storage modules, top-load single disk cartridges.



BASF

BASF Systems Corporation
 Attn.: Marketing Services, Computer Division
 Crosby Drive, Bedford, MA 01730

Please send me information on BASF disk packs.

Name/Title _____

Company _____

Address _____

City _____ State _____ Zip _____

Telephone _____

BYTE-6

characters read into the buffer from the console. The CP/M line-editing features (control R, control C, etc) may be used with this routine. Other control characters will be echoed with a leading ^ (called a circumflex), and will be inserted into the buffer. Any parity bits will be stripped by CP/M (this also applies to the single-character read functions in listing 2).

The final aspect of CP/M I/O that

requires clarifying is the I/O status byte. This is a single byte at hexadecimal memory location 0003. It was apparently included in CP/M for compatibility with Intel software and must be specifically implemented by the user in BIOS (Basic I/O System). The I/O status byte, poorly described in the *Interface Guide*, is described much better in the *System Alteration Guide*, Section 6. By varying the

value of this location, the user may reassign logical I/O devices without rewriting the system software.

CP/M Disk-Interface Routines

The use of the disk-interface routines provided by CP/M is more involved. But it is not too difficult once the basic concepts are grasped.

Text continued on page 274

Function Number	Function Description	Entry Parameters (placed in DE)	Returned Value (Returned in A or AB (A = LSB))	Typical Call **
1	Read a character from the console.	None	ASCII character	MVI C,1 ;READ FUNCTION CALL NTRY ;CPM ENTRY POINT
2	Write a character to the console.	ASCII character	None	MVI E,CHAR ;CHARACTER IN E MVI C,WRITE ;WRITE FUNCTION = 2 CALL NTRY
3	Read a character from the reader device.	None	ASCII character	MVI C,RDR ;READER FUNCTION = 3 CALL NTRY
4	Write a character to the punch device.	ASCII character	None	MVI E,CHAR ;CHARACTER IN E MVI C,PNCH ;PUNCH FUNCTION = 4 CALL NTRY
5	Write a character to the list device (usually a printer).	ASCII character	None	MVI E,CHAR ;WRITE TO PRINTER = 5 MVI C,PRNT CALL NTRY
7	Get I/O status.*	None	I/O status byte	
8	Set I/O status.*	I/O status byte	None	
9	Output print buffer to console.	Address of a print buffer	None	LXI D,PBUF ;ADDRESS OF BUFFER MVI C,BUFO ;OUTPUT BUFFER = 9 CALL NTRY
10	Input a character string from the console.	Address of a read buffer	The read buffer is filled to its maximum length or until a <CR> is typed.	LXI D,RBUF ;ADDRESS OF BUFFER MVI C,BUFI ;INPUT BUFFER = 10 CALL NTRY
11	Interrogate console for a character ready.	None	01 if a character is ready	MVI C,ASK ;INTERROGATE = 11 CALL NTRY

*If implemented
 **See listings 1, 2, and 3 for subroutines and program usage.
 NTRY is the CP/M entry point (0005).

Table 1: Summary of the basic I/O functions available on a standard CP/M system.

EXTENDED PROCESSING ANNOUNCES THE MODEL EPZ-A SINGLE BOARD COMPUTER APPLICATION ORIENTED DISTRIBUTED PROCESSING FOR THE S-100 BUS

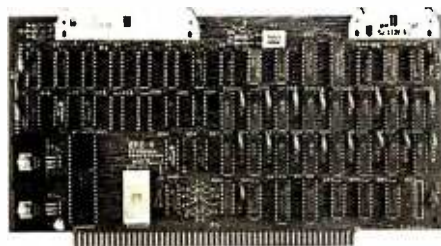

Don't make one CPU run multiple programs. Make multiple CPU's run one or more programs. The EPZ is a complete Z80A computer designed to work in PARALLEL to your existing CPU. It is designed to do YOUR applications. Use it in applications where your present CPU isn't quite fast enough by itself or where intelligence is needed to control a peripheral and your present CPU doesn't have enough time.

If even more processing capability is needed then add a second EPZ. As many as 64 EPZ's could be added if you had enough slots in your system. Each one operating independently and not taking any RAM or ROM from your present system or from each other. This is your chance to add processing power and expandability to your system and still keep your present hardware and software intact.

Features include:

- 4MHz Z80A microprocessor.
- ROM operating system.
- 8K of fast static RAM for trouble free operation.
- 8 bit parallel I/O and 2 status ports to interface with the host CPU.
- 8 bit parallel I/O and status flags to interface to the users application.
- 2K EPROM (2716) expandable to 4K (2732).
- Software supplied to interface 8080/Z80 CPU to the EPZ.

- Expansion connector and I/O connector at the top of the board. Can be expanded to 64K of RAM. All Z80A signals are available and buffered for maximum flexibility.
- The EPZ features the latest in PC board design. Including 4 layer construction for the ultimate in noise suppression. Silk screen and solder mask are also used. All IC's are in sockets.
- Comes completely assembled, tested and ready to run without any hardware modifications to your system.
- Optional utility software to interface the host to the EPZ. Contact Microbyte for details.
- Introductory price of \$595.00.

AVAILABLE EXCLUSIVELY FROM
Microbyte Computer Systems
 2626 Union Avenue, San Jose, CA 95124
 (408) 377-4691

TOMORROW'S answers for the H8® TODAY!

DG Electronic Developments provides the only enhancements to put the Heath® H8 ahead **TODAY** while maintaining its high standards, broad flexibility and high reliability.

DG-80 (Z80® Based CPU)

The DG-80 offers the **BEST** foundation for the H8 to build on for the future. Compare the DG-80 to your current Heath® 8080 CPU and see the advantages of the DG-80's superior speed and flexibility. The Z80 gives twice the processing speed coupled with twice the instruction set making your H8 a truly professional microsystem. The DG-80 aids in efficient writing of utility programs, user routines, sub-routines and use of assemblers.

DG-80 \$249 (Documentation only \$25.)

DG-FP8/ADP4 (DG80 Front Panel Monitor)

The DG-FP8/ADP4 firmware/hardware package brings the world of standardization to your H8. The FP8/ADP4 allows the full use of currently available "STANDARD" CPM software, with 4 MHz operation. You can still use your HDOS and all its related software, by simply putting a disk in your drive. The DG firmware package gives you use of the full 64K of RAM available on the 64D or 64D5. The FP8/ADP4 firmware also offers many extras including hexadecimal OR split octal display; simplification of register and memory contents display; and the full use of all Z80 registers. Supports 5¼ and 8" Heath disk drives.

DG-FP8 \$69.95. DG-ADP4 \$19.95. Purchased together \$79.95.
(Documentation only — source code not included \$15.)

DG-64D (64K RAM Memory Board)

The DG-64D is **THE BEST** memory board available for the H8! Along with the DG-80 CPU, the 64D gives a full 64K of addressable memory. Its built-in flexibility ensures future compatibility. Multi-user configurations can be achieved accessing up to eight 64D's on line with the hardware/software bank select features. Memory contents are maintained and protected during extended wait states by asynchronous refresh.

DG-64D priced from \$333 (ØK) to \$529 (64K). (Documentation only \$15.)

DG-64D5 (5-Volt Power Supply 64K RAM)

The DG-64D5 memory board offers the **ultimate** in low power consumption for the H8 computer! The 64D5 is primarily designed for use with the Heath Color Graphics board. In addition to offering **ALL** of the features of the standard 64D, the 64D5 utilizes reliable **single-supply** 5-volt-only dynamic RAMs.

Priced from \$333 (ØK) to \$799 (64K). (Documentation only \$15.)

CP/M (Standard V2.2 Disk Operating System)

The final component for the "STANDARD" H8 system is Digital Research's CP/M® V2.2. Our full line of H8 enhancements in combination with CP/M gives the user unparalleled flexibility and software availability.

CPM V2.2 \$130. (Documentation only \$25.)

All products supplied with complete documentation.

Please call or write for additional information.

AVAILABLE AT MANY HEATHKIT ELECTRONIC CENTERS

Heath® and H8® are registered trademarks of Heath Corporation, Benton Harbor, Michigan. CP/M® is the registered trademark of Digital Research of Pacific Grove, California. Z80® is the registered trademark of Zilog Corporation.

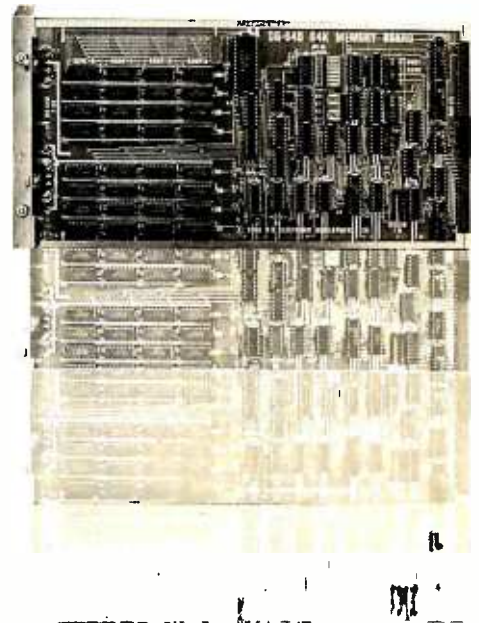
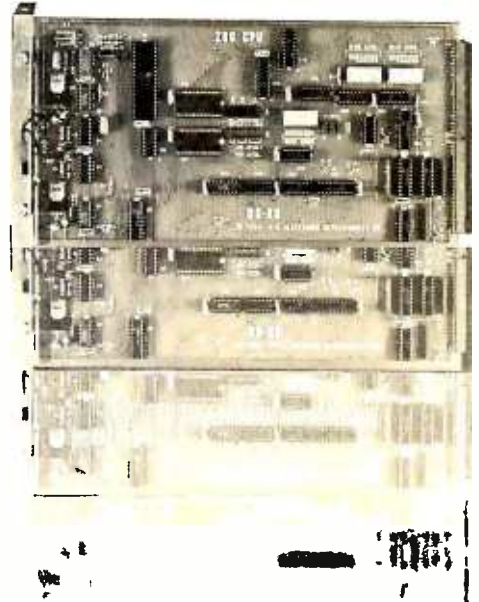

**DG ELECTRONIC
DEVELOPMENTS CO.**

Ordering Information: Products listed available from DG Electronic Developments Co., P.O. Box 1124, 1827 South Armstrong, Denison, Tx. 75020. Check, Money Order, VISA or MasterCard accepted. Phone orders (charge only) call (214) 465-7805. No COD's. Freight prepaid. Allow 3 weeks for personal checks to clear. Texas residents add 5%. Foreign orders add 30%. Prices Subject to change without notice.

Function Number	Function Description	Entry Parameters and Comments (placed in DE)	Returned Value and Comments. (Returned in A or AB (A = LSB))	Typical Call*	
12	Lift head.	None	None—head is lifted from currently logged disk.	MVI CALL	C,12 NTRY ;LIFT FUNCTION ;CP/M ENTRY POINT
13	Initialize CP/M disk access.	None	None—disk drive A is "logged in" for access. The DMA address is set to 0080H.	MVI CALL	C,13 NTRY ;INITIALIZE
14	Select and log in disk.	Value corresponding to the desired disk: A = 0, B = 1, etc	None—specified disk is selected for subsequent file operations.	MVI MVI CALL	E,DISKNO ;DISK # IN E C,SELDSK ;SELECT = 14 NTRY
15	Open file.	Address of FCB for the file to be opened	Byte address of the FCB in the disk directory, or 255H if file is not found—the disk map (DM) bytes in the FCB are filled by CP/M.	LXI MVI CALL	D,FCB ;ADDRESS IN DE C,OPEN ;OPEN = 15 NTRY
16	Close file.	Address of FCB for the file to be closed	Byte address of the FCB in the disk directory, or 255 if not found—the disk map of the FCB is written to the directory, replacing any existing data for that file.	LXI MVI CALL	D,FCB C,CLOSE ;CLOSE = 16 NTRY
17	Search for file.	Address of FCB containing name and type of file to search for. "?" matches any character.	Byte address of first FCB in directory that matches the name and type in the input FCB. If no match, 255H is returned.	LXI MVI CALL	D,FCB C,SEARCH ;SEARCH = 17 NTRY
18	Search for next occurrence.	Address of FCB as in 17, but called after 17 before any other disk access	Byte address of next match. 255H if no additional match.	LXI MVI CALL	D,FCB C,SEARN ;SEARN = 18 NTRY
19	Delete file.	Address of FCB of file to be deleted	None—FCB in directory is marked as deleted. (E5H is placed in ET field.)	LXI MVI CALL	D,FCB C,DEL ;DEL = 19 NTRY
20	Read record.	Address of FCB containing a disk map. Normally as a result of opening the file (15) and setting NR to the record to be read.	0 = successful read 1 = read past logical end of file (^Z) 2 = reading unwritten data Data read is placed in memory at the DMA address (function 26).	LXI MVI CALL JNZ	D,FCB C,READ ;READ = 20 NTRY ERROR ;HANDLE READ ERROR
21	Write record.	Same as read, but NR is set to the record to be written	0 = successful write 1 = error in extending file 2 = end of disk data 255H = no more directory space—Data written is taken from memory starting at the DMA address.	LXI MVI CALL JNZ	D,FCB C,WRITE ;WRITE = 21 NTRY ERROR ;HANDLE WRITE ERROR
22	Create file.	Address of FCB of new file, all data set to 0 except name and type	Byte address of directory entry of new file or 255H if directory is full.	LXI MVI CALL JM	D,FCB C,CREATE ;CREATE = 22 NTRY NOROOM ;HANDLE FULL ; DIRECTORY
23	Rename file.	Address of FCB with old file name and type in first 16 bytes and the new file name in the next 16 bytes	Directory address of old file, or 255H if not found. The file name and type are changed to that specified.	LXI MVI CALL	D,FCB C,RENAM ;RENAM = 23 NTRY
24	Interrogate disk log-in.	None	Byte with 1 bit set for each disk logged in. LSB = disk A, etc.	JM	NOFILE ;HANDLE NOT FOUND
25	Interrogate drive number.	None	Number of disk to be used for next access.		
26	Set DMA address.	Address of 128-byte buffer	None—subsequent reads and writes take data to/ from memory beginning at this address.	LXI MVI CALL	D,BUFF ;BUFFER ADDRESS C,26 ;DMA SET FUNCTION NTRY
27	Interrogate allocation.	None	Address of the current disk-allocation data. (Used by STAT—not well documented.)		

*See listing 3 for subroutines and program usage.

Table 2: Summary of disk-access operations and disk-utility functions available on a standard CP/M operating system.

STATE OF THE ART MEMORY SYSTEMS

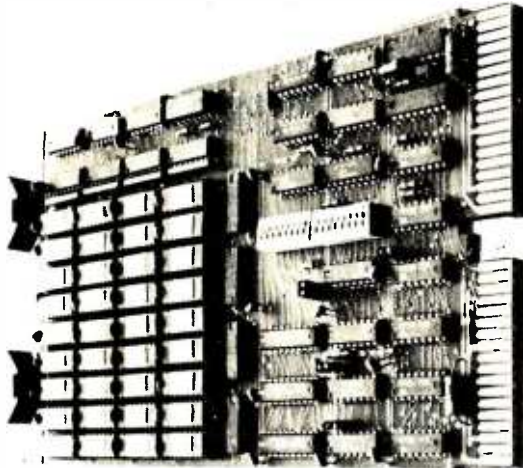

512KB SINGLE BOARD MULTIBUS® MEMORY

State of the Art Multibus Memory Design.
First to Offer 512KB on One Board.

The CI-8086 module is compatible with both 8 or 16 bit Multibus Systems.

PARITY — The CI-8086 generates and checks even parity with selectable interrupt on parity error.

FAST ACCESS AND CYCLE TIME — Data access is 270 NSEC and cycle time is 375 NSEC.

16 MEGA BYTE ADDRESSING — The memory is addressable in 16K increments up to 16 mega bytes.

LOW POWER CONSUMPTION — Total power consumption is under 8 watts.

SINGLE QTY. PRICE: 128K x 9 \$1350. 512K x 9 \$2995.

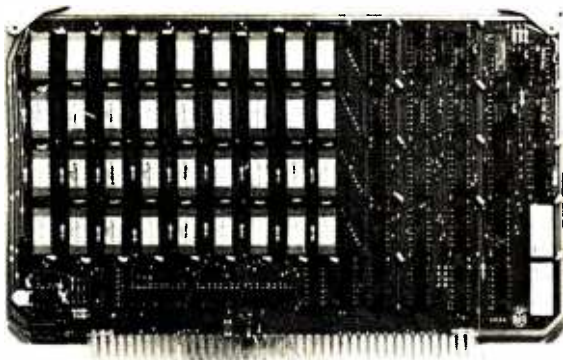

256KB LSI 11/23® SINGLE DUAL WIDTH BOARD

The First and Only 256KB Memory on a Single Dual Board.

4 MEGABYTE ADDRESS FIELD — Most memories available for the DEC PDP 11/23 are only addressable to 256K bytes (18 address lines). The CI-1123 is addressable to 4 mega bytes (22 address lines) so there is no need to worry about obsolescence.

FAST ACCESS AND CYCLE TIME — With an access time of 240 NSEC and cycle time of 400 NSEC one is insured the best throughput on the PDP 11/23 system.

PARITY — The CI-1123 generates and checks parity for each byte of memory. Totally DEC compatible.

BATTERY BACKUP POWER CONSUMPTION — Power requirement for the module is only 1.2 AMP from the 5 volt supply. The CI-1123 is easily configured for battery back-up mode of operation requiring only 300MA from a single 5 V back-up supply for 256KB memory in the down state.

SINGLE QTY. PRICE: 32K x 18 \$575. 128K x 18 \$1925.

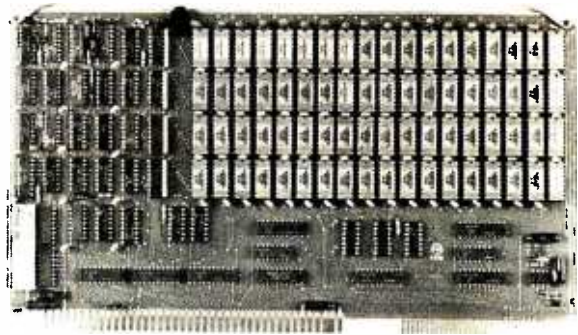

64K x 9 EXORCISER® I SINGLE BOARD MEMORY

For Exorciser I, Exorciser II and Rockwell System 65.

FAST ACCESS AND CYCLE TIME — Data access time is 225 NSEC and cycle time is 400 NSEC, allowing the unit to work as a static RAM at clock rates in excess of 1.5 mega hertz. For 2 mega hertz operation the board can be easily configured to utilize a cycle stealing refresh operation.

ADDRESSING — On-board memory select is available in 4K increments up to 64K words of memory on either the VUA or VXA control inputs.

PARITY — On board even parity with output jumper select to the system bus as a parity error or non-maskable interrupt.

Complete board power consumption is under 7 watts.

SINGLE QTY. PRICE: 64K x 9 \$575.

Tested and burned in. Full year warranty.

DON'T ASK WHY WE CHARGE SO LITTLE, ASK WHY THEY CHARGE SO MUCH.



Chrislin Industries, Inc.

31352 Via Colinas • Westlake Village, CA 91362 • 213-991-2254

Multibus is a trademark of the Intel Corp.

LSI II is a trademark of Digital Equipment Corp.

EXORCISER is a trademark of Motorola

Text continued from page 270:

Proper use of these routines provides powerful capabilities for file manipulation, creation, and alteration. Tasks such as reading an application program into the proper region of memory, sending instructions with a file name, or detecting which disk drive a given file resides on (if any) are readily handled by CP/M. Let us see how these tasks may be accomplished.

Before a file can be manipulated by CP/M, its name must be made known to the system. This is done via the file-control block (FCB). A file-

control block contains six types of information defined with 33 contiguous bytes in memory (0 to 32):

- Entry type (ET, byte 0)—assumed 0 by CP/M. CP/M places hexadecimal E5 here to signify a deleted file.
- File name (FN, bytes 1 to 8)—ASCII characters padded with ASCII blanks.
- File type (FT, bytes 9 to 11)—ASCII characters padded with ASCII blanks.
- File extent (EX, byte 12)—in 128-record segments. If file is longer

than 128 records, this byte must be incremented to access the additional records. Normally, this will be initialized to 0.

- Initialize to 0 (bytes 13 to 14)—these bits may be used by some systems (such as Micropolis), but should not be tampered with.
- Record count (RC, byte 15)—current file size in 128-byte records. Initialized to 0—correct value will be supplied by executing the OPEN statement.
- Disk allocation map (DM, bytes 16 to 31)—this map is used by CP/M to access the desired file. It is written into memory by the OPEN command, updated during access, and written back to the directory by the CLOSE command. It is not necessary to initialize this area if OPEN is used.
- Next record (NR, byte 32)—this is the number of the next record to access in the currently open extent. Normally, this will be initialized to 0 unless random access is desired or a file is to have something appended to it.

Listing 1: Structure of a typical function-calling routine. The CP/M operating system does not preserve the registers.

IOSBR:	PUSH REGISTERS	;	PRESERVE REGISTERS. DO NOT PUSH REGISTERS IN WHICH VALUES WILL BE RETURNED.
	MVI C,FUNCTION#	;	FUNCTION # MUST BE IN REGISTER C BEFORE CALLING NTRY.
	MOV E,A	;	IF A CHARACTER IS TO BE OUTPUT, IT IS OFTEN CONVENIENT TO SEND IT IN THE A REGISTER (ACCUMULATOR). IT MUST BE MOVED TO E BEFORE CALLING NTRY.
	CALL NTRY	;	CP/M ENTRY POINT, NTRY, MUST BE PREVIOUSLY DEFINED AS 0005H.
	POP REGISTERS	;	RESTORE REGISTERS—BE SURE TO USE AS MANY POPS AS YOU DID PUSHES.
	RET	;	RETURN TO CALLING ROUTINE

File-control blocks are written to the directory by each CLOSE command; they are read by each OPEN command. They maintain the disk-file allocation map, size (in 128-byte records), and extent (in 128-record segments). A separate FCB is maintained in the directory for each extent of the same file (each extent contains 128 128-byte records). That is, a file of 158 records will have an entry with extent=0 and record count=128 and another entry with extent=1 and record count=30, both having the same file name and file type.

The system maintains a default FCB at hexadecimal location 005C and a default buffer at hexadecimal location 0080. These are used by CP/M to pass information to a user program. This is best explained by considering what happens when the program given in listing 4 is run. After it has been assembled and loaded, it is run by typing its name, as is any compiled program running under CP/M. However, in addition to its name, the name of the file to be processed and the desired options must be entered. For this example program, the file to be processed must have a file type .DEM. This file is read into memory beginning at the first free memory location after the end of the program. The options

MARK GORDON COMPUTERS

DIVISION OF MARK GORDON ASSOCIATES, INC.
P.O. Box 77, Charlestown, MA 02129 (617) 491-7505

<p>COMPUTERS</p> <p>Atari 800 w/16K 799.00 4K Model III 599.00 Model II 64K System 3499.00 16K Model III 879.00</p> <p>DISK DRIVES</p> <p>40 Track 5 1/4 inch drive 314.00 80 Track 5 1/4 544.00 4 Disk Drive Cable 39.00 Lobo w/controller Call for price Lobo w/o controller Call for price</p> <p>PRINTERS</p> <p>Epson MX80 Call for price Epson MX70 Call for price Okidata Microline 80 479.00 Okidata Microline 82 699.00 Okidata Microline 83 989.00 NEC 5510 w/tractor 2679.00 Diablo 630 2495.00</p> <p>MISC HARDWARE</p> <p>Expansion int TRS-80(Ok) 269.00 Novation D-Cat Modem 166.00 16K Memory Kit 35.00 (2/65.00) Leedex Monitor 149.00 Leedex 100G 169.00 Leedex Color Monitor 399.00 Printer Cable for above 49.00 ISO-2 Isolator 54.00 AC LINE FILTER 24.00 280 Softcard 289.00 Ramcard 169.00 Videx 80 COL BOARD 289.00 Videx KBD Enhancer 109.00 DC Hayes Micro Modem II 319.00 CCS and SSM Interface Cards Call for price</p> <p>STORAGE MEDIA</p> <p>Scotch-box 10-5 1/4 27.00 Memorex-box 10-5 1/4 22.00 Plastic Storage Box 5.00 Verbatim 5 1/4 25.00</p>	<p>OPERATING SYSTEMS</p> <p>NEWDOS by APPARAT INC 49.00 NEWDOS+ by APPARAT INC 99.00 MMS FORTH DISKETTE PRIMER 79.95 NEWDOS 80 135.00 VTOS 99.00</p> <p>BUSINESS SOFTWARE FOR TRS-80, APPLE AND ATARI</p> <p>Free enhancements and upgrades to registered owners for the cost of media and mailing. 30 day free telephone support. User reference on request. Fully Interactive Accounting Package, General Ledger, Accounts Payable, Accounts Receivable and Payroll Report Generating</p> <p>Complete Package (requires 3 or 4 drives) 475.00 Individual Modules (requires 2 or 3 drives) 125.00 Inventory II (requires 2 or 3 drives) 99.00 Mailing List Name & Address II (requires 2 drives) 129.00 Intelligent Terminal System ST-80 III 150.00 The Electric Pencil from Michael Shryer 150.00 File Management System 49.00 Sort 80 59.00 LJK Letter Perfect (Atari, Apple) 139.00 DB Master (Apple) 169.00 Disk Business Software available for Model III Call for price</p> <p>FINE PRINT</p> <p>TRS-80 is a Tandy Corporation trademark. Use of above operating systems may require the use of Radio Shack TRS-DOS. Radio Shack equipment subject to the will and whim of Radio Shack.</p> <p>ORDERING INFORMATION</p> <p>We accept Visa and MasterCard. We will ship C.O.D., certified check, or money order only. There will be a 40 percent deposit required on all C.O.D. orders over \$300.00. Massachusetts residents add 5 percent sales tax. Stock to three weeks for delivery.</p> <p style="text-align: center;">TWX #710-320-7693 For information call 617-491-7505 To order, call toll-free 1-800-343-5206</p> <div style="text-align: right;">   </div> <p>The Company cannot be liable for pictorial or typographic inaccuracies. The above prices do not include shipping.</p>
---	---

Text continued on page 282

16 BIT 8086 MICRO SYSTEM

\$3990

Tec-86 / 8086 System

CP/M™ -86

TEC -86

BASIC-86

- Available Now
- IEEE 696 S-100
- 24 Parallel I/O lines (3 ports)
- Baud rates from 50 to 19200
- ROM boot for CP/M-86™
- 32K static RAM (Expandable)
- Basic-86™ - \$350
- CPU w/Vectored Interrupts
- Independent baud rate for each serial port
- Attractive, all metal desk top enclosure
- Dual 8-inch Shugart floppies with controller
- 64K Dynamic RAM opt. - Available Soon
- CP/M-86™ - \$250
- Two RS-232 Ports

S-100 Boards



8086 CPU with Vectored Interrupts

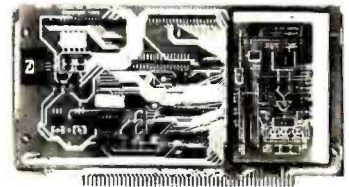

Analog to Digital Converter and Timer/Counter
16 channels expandable to 256
12,14, or 16 bit accuracy
30,40,100, or 125 KHz

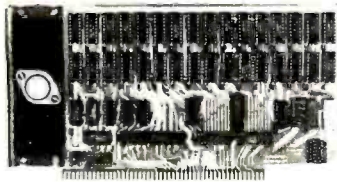

16 Kilobyte Static RAM
8 and 16 bit transfer



PROM and I/O
2 RS 232 - PIO
CP/M-86 ROM Boot

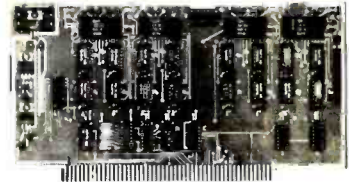

Digital to Analog Converter
4 channels - 12 bit accuracy
3 microsecond conversion rate



Real Time Video Digitizer and Display

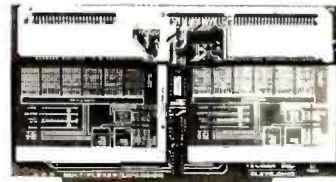

Expansion Multiplexer



Digital to Analog Companion
4-20 mA output - Filters

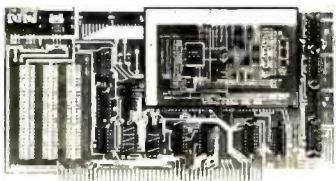

Analog to Digital Converter
16 channels - 12 bit accuracy
30 KHz Conversion rate

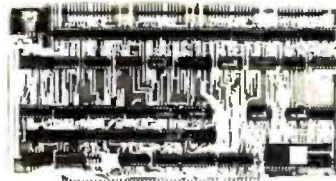

4 PIO and Timer/Counter

Apple Boards

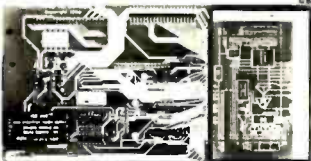

Analog to Digital Converter
16 channels
12, 14, or 16 bit accuracy
30, 40, 100, or 125 KHz

Digital to Analog Companion
4-20 mA output - Filters



Digital to Analog Converter
2 channels - 12 bit accuracy
3 microsecond conversion rate
1 parallel output port



Basic 86™ registered trademark Microsoft

Data Acquisition Systems and
Video Digitization Systems Available
23600 Mercantile Rd. • Cleveland, OH 44122

TECMAR, INC.

(216)464-7410

CP M™ registered trademark Digital Research

MTI stocks 'em all for faster delivery.

No hidden charges. Prices include delivery.
Ask about our "OED" discounts.
VISA and MasterCard orders accepted.

VIDEO TERMINALS

VT100 DECscope.....	\$ 1595
VT132 DECscope.....	1995
ADM-3A (dumb terminal).....	795
ADM-3A+ (dumb terminal).....	875
ADM-5 (dumb terminal).....	945
ADM-31 (2 page buffer).....	1185
ADM-42 (8 page buffer avail.).....	2035
1410 (Hazeltine dumb terminal).....	825
1420 (dumb terminal).....	895
1421 (Consul 580 & ADM-3A comp.).....	850
1500 (dumb terminal).....	1045
1510 (buffered).....	1145
1520 (buffered printer port).....	1395
1552 (VT52 compatible).....	1250

GRAPHICS TERMINALS

VT100 with graphics pkg.....	3160
ADM-3A with graphics pkg.....	1995
ADM-3A+ with graphics pkg.....	2075

300 BAUD TELEPRINTERS

LA34-DA DECwriter IV.....	995
LA34-AA DECwriter IV.....	1095
LA36 DECwriter II.....	1295
Teletype 4310.....	1095
Teletype 4320.....	1195
Diablo 630 RO.....	2295
Diablo 1640 KSR.....	2775
Diablo 1650 KSR.....	2835
TI 743 (portable).....	1190
TI 745 (port/built-in coupler).....	1485
TI 763 (port/bubble memory).....	2545
TI 765 (port/bubble/b.i. coupler).....	2595

600 BAUD TELEPRINTERS

TI 825 RO impact.....	1450
TI 825 KSR impact.....	1570
TI 825 RO Pkg.....	1625
TI 825 KSR Pkg.....	1795

1200 BAUD TELEPRINTERS

LA 120 RO (forms pkg.).....	2295
LA 120-AA DECwriter III (forms pkg.).....	2095
LA 180 DECprinter I.....	2295
TI 783 (portable).....	1645
TI 785 (port/built-in coupler).....	2270
TI 787 (port/internal modem).....	2595
TI 810 RO impact.....	1760
TI 810 RO Pkg.....	1950
TI 820 KSR impact.....	2025
TI 820 RO.....	1850
TI 820 KSR Pkg.....	2195
TI 820 RO Pkg.....	2025

2400 BAUD

Dataproducts M200 (2400 baud).....	2595
------------------------------------	------

DATAPRODUCTS LINE PRINTERS

8300 (300 LPM band).....	5535
8600 (600 LPM band).....	6861
2230 (300 LPM drum).....	7723
2260 (600 LPM drum).....	9614
2290 (900 LPM drum).....	12655

ACOUSTIC COUPLERS

A/J A242-A (300 baud orig.).....	242
A/J 247 (300 baud orig.).....	315
A/J AD342 (300 baud orig./ans.).....	395
A/J 1234 (Vadic compatible).....	895
A/J 1245 (300/1200 Bell comp.).....	695

MODEMS

GDC 103A3 (300 baud Bell).....	395
GDC 202S/T (1200 baud Bell).....	565
GDC 212-A (300/1200 baud Bell).....	850
A/J 1256 (Vadic compatible).....	825
A/J 1257 (triple modem w/phone).....	975

CASSETTE STORAGE SYSTEMS

Techtran 816 (store/forward).....	1050
Techtran 817 (store/for/speed up).....	1295
Techtran 818 (editing).....	1795
Techtran 822 (dual).....	2295
MFE 5000 (editing).....	1495

FLOPPY DISK SYSTEMS

Techtran 950 (store/forward).....	1395
Techtran 951 (editing).....	1995



Distributors, New York, New Jersey and Ohio.

New York:

516/482-3500, 212/895-7177, 518/449-5959

Outside N.Y.S.: 800/645-8018

New Jersey: 201/227-5552

Ohio: 216/484-6488

Listing 2: Examples of some simple I/O routines that utilize the CP/M I/O functions.

SUBROUTINE RCHAR—READS A SINGLE CHARACTER FROM THE CONSOLE. PLACES THE CHARACTER READ INTO THE ACCUMULATOR (A REGISTER).

```

RFUNC EQU 1 ;READ CONSOLE FUNCTION NUMBER
;REFER TO TABLE I OF INTERFACE
;GUIDE.
NTRY EQU 0005H ;CP/M NTRY POINT
RCHAR: PUSH H ;PRESERVE REGISTERS
        PUSH D
        PUSH B
        MVI C,RFUNC ;PLACE CODE FOR READ FUNCTION
;IN C REGISTER
        CALL NTRY ;READ A CHARACTER
        MOV A,E ;MOVE CHARACTER JUST READ INTO
;A REGISTER.
        POP B ;RESTORE REGISTERS
        POP D
        POP H
        RET
    
```

SUBROUTINE WCHAR—WRITES A SINGLE CHARACTER TO THE CONSOLE. ASSUMES THAT THE CHARACTER TO BE WRITTEN IS IN THE A REGISTER.

```

WFUNC EQU 2 ;CP/M FUNCTION NUMBER
WCHAR: PUSH H ;PRESERVE ALL REGISTERS
        PUSH D
        PUSH B
        PUSH PSW
        MOV E,A ;PLACE CHARACTER IN THE E
;REGISTER BEFORE CALLING NTRY
        MVI C,WFUNC ;PLACE FUNCTION NUMBER IN C
        CALL NTRY ;WRITE HIM
        POP PSW ;RESTORE REGISTERS
        POP B
        POP D
        POP H
        RET
    
```

SUBROUTINE CLEAR—CLEARS THE SCREEN OF A SOROC IQ-120 TERMINAL. USES SUBROUTINE WCHAR TO SEND THE CHARACTERS TO THE TERMINAL.

```

HOME EQU 42 ;HOMES CURSOR AND CLEARS SCREEN
CLEAR: PUSH PSW ;PROTECT STATUS FROM CALLING ROUTINE
        MVI A,27 ;SEND ESCAPE CODE
        CALL WCHAR ;WRITE HIM
        MVI A,HOME ;CLEAR SCREEN AND HOME CURSOR
        CALL WCHAR ;WRITE AGAIN
        POP PSW ;RESTORE STATUS
        RET
    
```

Notice of Omission

Due to a processing error the Quantex Div. ad which appeared on page 329 of the May Byte had no Reader Service Number.

For more information regarding their "no problem trial offer" circle 470 on the inquiry card in this issue.

The PRACTICAL MICROCOMPUTER PROGRAMMING™ books . . .

WHAT DO THE CRITICS SAY?

BYTE: "It was apparently Mr. Weller's goal from the beginning to present the fundamental concepts of assembly language programming in a completely nonthreatening way. He has accomplished this better than any other author to date. . . Practical Microcomputer Programming is a very powerful series. It is well written and full of essential techniques for the assembly language programmer. . . "The authors know the difference between a novice and a ninny. They never talk down. . . on every page the authors spot and clear up the small ambiguities of technical jargon that can block understanding."

Kilobaud: "A powerful plus for this book is the author's determination to demonstrate why and how to use each instruction, not merely to explain how it works. . . At no point do the authors resort to rehashing material available from the manufacturer. . . but instead choose a less theoretical, more practical approach."

Leventhal: ". . . large numbers of documented, well structured examples, and a clear readable style, a logical development of major topics."

Digital Design: "This book is the best and most lucid introduction to Z80 programming that we have seen."

CACHE: "This is an EXCELLENT book. . . dirt cheap for such great software and documentation."



IF YOU'VE TRIED THE "CHEAPIES" AND AREN'T SATISFIED WITH WHAT YOU GOT, IT'S TIME TO TRY THE REAL THING, THE ACKNOWLEDGED WORLD STANDARD OF TECHNICAL EXCELLENCE IN ASSEMBLY LANGUAGE PROGRAMMING INSTRUCTION—THE PRACTICAL MICROCOMPUTER PROGRAMMING BOOKS.

- FOR THE 6502 -

PRACTICAL MICROCOMPUTER PROGRAMMING: THE 6502 by W. J. Weller \$32.95
20 chapters, 6 appendices, 475 page Smythe sewn hardcover covering all fundamental assembly language techniques for the 6502 processor. The text explanation is re-enforced with 118 verified, real world programming examples that run on real computers. An extended 6502 language, supported by a new editor/assembler which comes with the book, circumvents many of the problems which have made the 6502 so difficult to program in the past. In addition to the fundamental technique chapters, there are special chapters covering simple graphics, elementary cryptography and random number generation and use. The source texts of both the editor/assembler and a powerful new debugging monitor for the Apple II and Apple II+ included in appendices. The object code for this software is supplied FREE to book purchasers on Apple cassette or for \$7.50 on disk when the licensing agreement from the book is returned to the publisher. The editor/assembler is also available on paper tape for users of other 6502 based systems.

- FOR THE Z80 -

PRACTICAL MICROCOMPUTER PROGRAMMING: THE Z80 by W. J. Weller \$32.95
18 chapters, 4 appendices, 481 page Smythe sewn hardcover which details assembly language technique as applied to the Z80 processor. The Z80 is treated as an 8080 superset in an 8080 extension language, which means that you don't have to discard your hard won 8080 knowledge to program the Z80. In addition to the fundamental chapters there are chapters on graphic output and full four function decimal arithmetic. The text explanation is re-enforced with 104 tested, verified programming examples. A powerful editor/assembler and debugging monitor, in source form, are provided to support the language used in the book. This software will run on ANY Z80 based computer with 10K RAM beginning at 0. Object code for both editor/assembler and debugging monitor is sent to book purchasers FREE on paper tape or, in modified form, on TRS-80 Level II cassette when the coupon from the book is returned to the publisher.

- FOR THE 8080 -

PRACTICAL MICROCOMPUTER PROGRAMMING: THE INTEL 8080 by Weller, Shatzel and Nice \$23.95
18 chapters, 3 appendices, 318 page Smythe sewn hardcover which applies fundamental assembly language technique to this most popular of processors. The text is supported by 84 separate programming examples. The book includes a special section on the handling of complex peripheral devices and exotic typefaces. Appendices give the source for an 8080 resident debugging monitor and a minicomputer cross assembler for the 8080. Also available (not shown above) are a workbook for use with this text (\$9.95) and AN EDITOR/ASSEMBLER SYSTEM FOR 8080/8085 BASED COMPUTERS (\$15.95) which supports the language used in the text. These three books together make a complete teaching package for the 8080.

- FOR THE 6800 -

PRACTICAL MICROCOMPUTER PROGRAMMING: THE M6800 by W. J. Weller \$23.95
16 chapters, 2 appendices, 299 page Smythe sewn hardcover text which details the application of fundamental assembly language technique to the 6800. 104 separate programming examples re-enforce the text explanation. Contains in addition special chapters on low precision trigonometry and random number generation and use. A resident debugging monitor for 6800 systems is included in an appendix.

NO GAMES, NO NONSENSE, NO REPRODUCTIONS OR REHASHES OF MANUFACTURER'S DATA SHEETS, JUST TESTED, ACCURATE, RELEVANT PROGRAMMING INFORMATION BACKED UP BY REAL EXAMPLES THAT RUN ON REAL COMPUTERS—THE PRACTICAL MICROCOMPUTER PROGRAMMING BOOKS. THERE IS NOTHING ELSE AS GOOD ANYWHERE, AT ANY PRICE.

Mail to: Northern Technology Books, Box 62, Evanston, IL 60204

- | | |
|---|---------|
| <input type="checkbox"/> Practical Microcomputer Programming: The 6502 | \$32.95 |
| <input type="checkbox"/> Practical Microcomputer Programming: The Z80 | \$32.95 |
| <input type="checkbox"/> Practical Microcomputer Programming: The Intel 8080 | \$23.95 |
| <input type="checkbox"/> Practical Microcomputer Programming: The M6800 | \$23.95 |
| <input type="checkbox"/> Workbook for Practical Microcomputer Programming: The Intel 8080 | \$ 9.95 |
| <input type="checkbox"/> An Editor/Assembler System for 8080/8085 Based Computers | \$15.95 |

Check enclosed (U.S. funds only)

Money order enclosed

Name _____

Street _____

City _____ State _____ Zip _____

Illinois residents add 5% sales tax

Listing 3: Program to prompt for input, clear the screen, and echo the characters entered using the techniques discussed in this article. Except for the clear-screen codes, this routine works on any CP/M system.

```

;*****
;
;   CP/M I/O UTILITIES PROGRAM
;   WRITTEN BY JAMES F. LARSON
;
;*****
;
0100          ORG      0100H
0100 03730?  JMP      BEGIN  ;SKIP TO START OF MAIN ROUTINE
;*****
;
;   EQUATES AND DATA STORAGE AREA
;
;*****
;
0005 =      NTRY   EQU      0005H  ;CPM ENTRY POINT
0009 =      PSTR   EQU      9      ;PRINT BUFFER FUNCTION
000A =      GSTR   EQU      10     ;READ BUFFER FUNCTION
0002 =      WFUNC  EQU      2      ;WRITE CONSOLE FUNCTION
002A =      HOME   EQU      42     ;HOME CURSOR AND CLEAR
000D =      CR     EQU      13     ;CARRIAGE RETURN
000A =      LF     EQU      10     ;LINE FEED
0020 =      LEN    EQU      32     ;DESIRED OUTPUT LINE LENGTH
0103      OLDSTK: DS      2        ;OLD STACK POINTER
0105      STR:    DS      257      ;INPUT STRING BUFFER
0206 454E544552PROMPT: DW      'EN', 'TE', 'R$'
020C 594F552057LEADER: DW      'YO', 'U ', 'WR', 'OT', 'E$'
;*****
;
;   SUBROUTINE PRINT -- PRINTS A STRING ENDING IN $
;   PLACE STRING BUFFER STARTING ADDRESS IN DE REGISTER
;   PRESERVES REGISTER CONTENTS
;
;*****
;
0216 E5      PRINT:  PUSH    H          ;PRESERVE REGISTERS
0217 D5      PUSH    D
0218 C5      PUSH    B
0219 F5      PUSH    PSW
021A 0E09    MVI     C,PSTR  ;PRINT FUNCTION IN C REG
021C CD0500  CALL    NTRY  ;DO IT
021F F1      POP     PSW  ;RESTORE REGISTERS
0220 C1      POP     B
0221 D1      POP     D
0222 E1      POP     H
0223 C9      RET
;*****
;
;   SUBROUTINE GETBUF -- GETS A BUFFER FULL FROM CONSOLE
;   PLACE INPUT BUFFER ADDRESS IN HL REGISTER - BUFFER
;   SHALL HAVE THE FIRST BYTE SET TO THE MAXIMUM BUFFER
;   LENGTH, THE NUMBER OF CHARACTERS PUT INTO BUFFER WILL
;   BE RETURNED AS THE SECOND BYTE OF THE BUFFER.
;
;*****
;
0224 E5      GETBUF: PUSH    H          ;PRESERVE REGISTERS
0225 D5      PUSH    D
0226 C5      PUSH    B
0227 F5      PUSH    PSW
0228 EB      XCHG   ;PLACE ADDRESS IN DE FOR CALL TO CPM
0229 0E0A    MVI     C,GSTR  ;READ BUFFER FUNCTION
022B CD0500  CALL    NTRY  ;GET UM
022E F1      POP     PSW  ;RESTORE
022F C1      POP     B
0230 D1      POP     D
0231 E1      POP     H

```

Listing 3 continued on page 280

INTRODUCING... □□□

COMES WITH: (ADDITIONAL)

- ▲ WORD STAR® WORD PROCESSOR
- ▲ ACCOUNTS PAYABLE
- ▲ ACCOUNTS RECEIVABLE
- ▲ GENERAL LEDGER
- ▲ SALES ORDER ENTRY
- ▲ INVENTORY CONTROL

ONLY

\$3450.00

QUANTITY DISCOUNTS
AVAILABLE!

INCLUDING CP/M2.2®
(\$4950.00 INCLUDING
ACCOUNTING SOFTWARE
AND WORD STAR®)



320K
MINI DRIVES
SHOWN, 8"
and 5 1/4" 10MB
HARD DISK
OPTIONAL

IMMEDIATE DELIVERY!

1 YEAR PARTS WARRANTY!

(90 DAYS ON DRIVE PACKAGE, KEYBOARD AND LABOR)

U.S. MICRO SALES S-100-8

CHECK THESE FEATURES!

TERMINAL

- Feather Touch Capacitance Keyboard
- 60 Key Standard ASCII
PLUS + Hex Keypad
PLUS + 8 Special Function Keys
PLUS + 20 Screen Editing Keys
- SOROC Type Screen Attribute Set
- Half Intensity

COMPUTER

- 8 Slot S-100
- 64K Dynamic Ram
- 4MHZ Z-80
- Serial Printer Port (150 - 19.2K)
- Double Density Disk Controller
- Programmable Baud Rate
- Programmable Keyboard Set

DISK STORAGE

- Dual Double Density
5 1/4 Single Sided Drives
- DOUBLE SIDED Option
- Double Sided, 77
Track, Option
- Color Matched Enclosure
- Self Contained Power Supply

OPTIONS:

- ◆ Dual 5 1/4" Double Sided MPI B51 (640K) add \$225.00
- ◆ Dual 5 1/4" Double Sided MPI B91 (1.2MB) add \$360.00
- ◆ Dual 8" SIEMANS FDD120-8 Drives (1MB) add \$250.00
- ◆ Dual 8" QUME Double Sided Drives (2MB) add \$625.00



WORD STAR is a TM of Micropro Inc. - CP/M2.2 is a TM of Digital Research Inc.

```

0232 C9          RET
;*****
;
;   SUBROUTINES WCHAR AND CLEAR FROM EXAMPLE 1 INSERTED HERE
;
;*****
;*****
;
;   SUBROUTINE WCHAR -- WRITES A SINGLE CHARACTER
;   CHARACTER IN A REGISTER - PRESERVES ALL REGISTERS
;*****
;
0233 E5  WCHAR:  PUSH   H           ;PRESERVE REGISTERS
0234 D5          PUSH   I
0235 C5          PUSH   B
0236 F5          PUSH   FSW
0237 5F          MOV    E,A           ;PUT CHAR IN E REGISTER
0238 0E02        MVI    C,WFUNC      ;WRITE CHARACTER FUNCTION
023A C10500      CALL   NTRY           ;PRINT HIM
023D F1          POP    FSW
023E C1          POP    B
023F I1          POP    I
0240 E1          POP    H
0241 C9          RET
;*****
;
;   SUBROUTINE CLEAR -- CLEARS SCREEN AND HOMES CURSOR ON
;   A SOROC IQ-120 TERMINAL - PRESERVES REGISTERS
;*****
;
0242 F5  CLEAR:  PUSH   FSW           ;PROTECT STATUS
0243 3E1B        MVI    A,27         ;SEND ESCAPE CODE
0245 C13302     CALL   WCHAR
0248 3E2A        MVI    A,HOME      ;CLEAR SCREEN AND HOME CURSOR
024A C13302     CALL   WCHAR
024D F1          POP    FSW
024E C9          RET
;*****
;
;   SUBROUTINE CRLF -- SENDS CRLF TO CONSOLE - PRESERVES REGISTERS
;*****
;
024F F5  CRLF:   PUSH   FSW
0250 3E0D        MVI    A,CR
0252 C13302     CALL   WCHAR
0255 3E0A        MVI    A,LF
0257 C13302     CALL   WCHAR
025A F1          POP    FSW
025B C9          RET
;*****
;
;   SUBROUTINE SAVSTK -- SAVES THE OLD STACK POINTER AND SETS
;   A NEW STACK AT CBASE (BASE OF CONSOLE COMMAND PROCESSOR).
;   CBASE IS 800H BELOW FBASE (BASE OF THE DISK OPERATING SYSTEM)
;   FBASE MAY BE READ AT NTRY+1.
;*****
;
025C C1  SAVSTK:  POP    B           ;GET RETURN ADDRESS
025D 210000      LXI    H,00         ;CLEAR HL
0260 39          DAD    SP          ;GET STACK POINTER
0261 220301      SHLI   OLI2STK      ;SAVE HIM
0264 2A0600      LHLD  NTRY+1      ;GET FBASE
0267 7C          MOV    A,H
0268 D160B      SUI    0BH         ;SUBTRACT CBASE OFFSET

```

QUALITY DISK SOFTWARE

BACKED BY ON-GOING APPLICATIONS SUPPORT

APPLE II (A)

TRS-80 (T)

HOME FINANCE PAK I: Entire Series \$49.95 (A) (T)

CHECK REGISTER AND BUDGET: This comprehensive CHECKING ACCOUNT MANAGEMENT SYSTEM not only keeps complete records, it also gives you the analysis and control tools you need to actively manage your account. The system provides routines for BUDGETING INCOME AND EXPENSE, AUTOMATIC CHECK SEARCH, and BANK STATEMENT RECONCILING. CRT or printer reports are produced for ACTUAL EXPENSE vs BUDGET, CHECK SEARCH DISPLAY RECONCILIATION REPORT and CHECK REGISTER DISPLAY by month. Check entry is prompted by user-defined menus of standard purposes and recipient codes, speeding data entry and reducing disk storage and retrieval time. Six fields of data are stored for each check: amount, check no., date, purpose, recipient and TAX DEDUCTIBLE REMINDER. CHECK SEARCH routines allow searching on any of these data fields. Up to 100 checks/mo. storage \$39.95

SAVINGS: Account management system for up to 20 separate Savings accounts. Organizes, files and displays deposits, withdrawals and interest earned for each account. \$14.95

CREDIT CARD: Get Control of your credit cards with this program. Organizes, stores and displays purchases, payments and service charges for up to 20 separate cards or bank loans. \$14.95

UNIVERSAL COMPUTING MACHINE: \$49.95 (A)

A user programmable computing system structured around a 50 row x 50 column table. User defines row and column names and equations forming a unique computing machine. Table elements can be multiplied, divided, subtracted or added to any other element. Hundreds of unique computing machines can be defined, used, stored, and recalled, for later use. Excellent for sales forecasts, budgets, inventory lists, income statements, production planning, project cost estimates-in short for any planning, analysis or reporting problem that can be solved with a table.

COLOR CALENDAR: \$29.95 (A)

Got a busy calendar? Organize it with Color Calendar. Whether it's birthdays, appointments, business meetings or a regular office schedule, this program is the perfect way to schedule your activities. The calendar display is a beautiful HI-RES color graphics calendar of the selected month with each scheduled day highlighted in color. Using the daily schedule, you can review any day of the month and schedule an event or activity in any one of 20 time slots from 8:00 A.M. to 5:30 P.M.

BUSINESS SOFTWARE: Entire Series \$159.95 (A) (T)

MICROACCOUNTANT: The ideal accounting system for small businesses. Based on classic T-accounts and double-entry booking, this efficient program provides a journal for recording posting and reviewing up to 1,000 transactions per month to any one of 300 accounts. The program produces CRT and printer reports covering:

TRANSACTION JOURNAL	BALANCE SHEET
ACCOUNT LEDGERS	INCOME AND EXPENSE STATEMENT

Includes a short primer on Financial Accounting. (48K) \$49.95

UNIVERSAL BUSINESS MACHINE: This program is designed to SIMPLIFY and SAVE TIME for the serious businessman who must periodically Analyze, Plan and Estimate. The program was created using our Universal Computing Machine and it is programmed to provide the following planning and forecasting tools.

CASH FLOW ANALYSIS	SALES FORECASTER
PROFORMA PROFIT & LOSS	SOURCE AND USE OF FUNDS
PROFORMA BALANCE SHEET	JOB COST ESTIMATOR
REAL ESTATE INVESTMENT	INVENTORY ANALYSIS

Price, including a copy of the Universal Computing Machine \$89.95

BUSINESS CHECK REGISTER AND BUDGET: Our Check Register and Budget programs expanded to include up to 50 budgetable items and up to 400 checks per month. Includes bank statement reconciling and automatic check search (48K) \$49.95

ELECTRONICS SERIES VOL I & II: Entire Series \$259.95

LOGIC SIMULATOR: SAVE TIME AND MONEY. Simulate your digital logic circuits before you build them. CMOS, TTL, or whatever, if it's digital logic, this program can handle it. The program is an interactive, menu driven, full-fledged logic simulator capable of simulating the bit-timer response of a logic network to user-specified input patterns. It will handle up to 1000 gates, including NANDS, NORs, INVERTERS, FLIP-FLOPS, SHIFT REGISTERS, COUNTERS and user-defined MACROS. up to 40 user-defined random, or binary input patterns. Accepts network descriptions from keyboard or from LOGIC DESIGNER for simulation \$159.95 (A) (T)

LOGIC DESIGNER: Interactive HI-RES graphics program for designing digital logic systems. Draw directly on the screen up to 10 different gate types, including NAND, NOR, INVERTER, EX-OR, T-FLOP, JK-FLOP, D-FLOP, RS-FLOP, 4 BIT COUNTER and N-BIT SHIFT REGISTER. User interconnects gates using line graphics commands. Network descriptions for LOGIC SIMULATOR generated simultaneously with the CRT diagram being drawn \$159.95 (A)

MANUAL AND DEMO DISK: Instruction Manual and demo disk illustrating capabilities of both program (s) \$29.95 (A) (T)

ELECTRONIC SERIES VOL III & IV: Entire Series \$259.95

CIRCUIT SIMULATOR: Tired of trial & error circuit design? Simulate & debug your designs before you build them! With CIRCUIT SIMULATOR you build a model of your circuit using RESISTORS, CAPACITORS, INDUCTORS, TRANSISTORS, DIODES, VOLTAGE and CURRENT SOURCES and simulate the waveform response to inputs such as PULSES, SINUSOIDS, SAWTOOTHs, etc. ... all fully programmable. The output is displayed as an OSCILLOSCOPE-STYLE PLOT of the selected waveforms (Apple only) or as a printed table of voltage vs time. Handles up to 200 notes and up to 20 sources. Requires 48 RAM \$159.95 (A) (T)

CIRCUIT DESIGNER: Interactive HI-RES graphics program for designing electronic circuits. Draw directly on the screen up to 10 different component types, including those referenced above. Components interconnect list for CIRCUIT SIMULATOR generated automatically. Requires \$159.95

MATHEMATICS SERIES: Entire Series \$49.95

STATISTICAL ANALYSIS I: This menu driven program performs LINEAR REGRESSION analysis, determines the mean, standard deviation and plots the frequency distribution of user-supplied data sets. Printer, Disk, I/O routines \$19.95

NUMERICAL ANALYSIS: HI-RES 2-Dimensional plot of any function. Automatic scaling. At your option, the program will plot the function, plot the INTEGRAL, plot the DERIVATIVE, determine the ROOTS, MAXIMA, MINIMA, INTEGRAL VALUE \$19.95

MATRIX: A general purpose, menu driven program for determining the INVERSE and DETERMINANT of any matrix, as well as the SOLUTION to any set of SIMULTANEOUS LINEAR EQUATIONS. \$19.95

3-D SURFACE PLOTTER: Explore the ELEGANCE and BEAUTY of MATHEMATICS by creating HI-RES PLOTS of 3-dimensional surfaces from any 3-variable equation. Disk save and recall routines for plots. Menu driven to vary surface parameters. Hidden line or transparent plotting \$19.95

ACTION ADVENTURE GAMES: Entire Series \$29.95 (A)

RED BARON: Can you outfly the RED BARON? This fast action game simulates a machine-gun DOGFIGHT between your WORLD WAR I BI-PLANE and the baron's. You can LOOP, DIVE, BANK or CLIMB-and so can the BARON. In HI-RES graphics plus sound. \$14.95

BATTLE OF MIDWAY: You are in command of the U.S.S. HORNETS' DIVE-BOMBER squadron. Your targets are the Aircraft carriers, Akagi, Soryu and Kaga. You must fly your way through ZEROS and AA FIRE to make your DIVE-BOMB run. In HI-RES graphics plus sound. \$14.95

SUB ATTACK: It's April 1943. The enemy convoy is headed for the CONTROL SEA. Your sub, the MORAY, has just sighted the CARRIERS and BATTLESHIPS' Easy pickings. But watch out for the DESTROYERS - they're fast and deadly. In HI-RES graphics plus sound \$14.95

FREE CATALOG: All programs are supplied on disk and run on Apple II w/Disk & Applesoft ROM Card & TRS-80 Level II and require 32K RAM unless otherwise noted. Detailed instructions included. Orders shipped within 5 days. Card users include card number. Add \$1.50 postage and handling with each order. California residents add 6 1/2% sales tax. Foreign orders add \$5.00 postage and handling.



SPECTRUM SOFTWARE

142 Carlow, P.O. Box 2084
Sunnyvale, CA 94087

FOR PHONE ORDERS: (408) 738-4387
DEALER INQUIRIES INVITED.



```

026A 67          MOV     H,A
026B F9          SPHL          ;SET NEW STACK POINTER
026C C5          PUSH    B          ;SET RETURN ADDRESS
026D C9          RET

;*****#*****
;
; SUBROUTINE GETSTK -- GETS OLD STACK POINTER AND RETURNS TO CPM
;
;*****#*****
026E 2A0301     GETSTK: LMLD   OLDSTK ;GET OLD STACK POINTER
0271 F9          SPHL          ;PLUG IT IN
0272 C9          RET          ;THIS WILL RETURN TO CPM

;*****#*****
;
; MAIN PROGRAM -- PROMPTS FOR INPUT, CLEARS SCREEN AND ECHOS
; THE INPUT STRING IN 32 CHARACTER LINES
;
;*****#*****
;
0273 CD5C02     BEGIN: CALL    SAVSTK ;SAVE OLD STACK POINTER
0274 110402     LXI    D,PROMPT
0279 CD1602     CALL   PRINT ;PRINT PROMPT
027C CD4F02     CALL   CRLF
027F 3EFF     MVI    A,255
0281 320501     STA    STR          ;SET MAX BUFFER LENGTH
0284 3E00     MVI    A,00
0286 320601     STA    STR+1 ;ZERO CHARACTER COUNTER
0289 210501     LXI    H,STR
028C CD2402     CALL   GETBUF ;GET A BUFFER FULL
028F CD4202     CALL   CLEAR ;CLEAR SCREEN
0292 110C02     LXI    D,LEADER
0295 CD1602     CALL   PRINT ;PRINT LEADER
0298 CD4F02     CALL   CRLF
029B 23          INX    H          ;ADDRESS STR+1
029C 46          MOV    B,M          ;NUMBER OF CHARACTERS READ IN
029D 3E20     FLIN: MVI    A,LEN          ;LINE LENGTH
029F BB          CMF    B
02A0 D2B402     JNC    ELIN ;PRINT LAST LINE
02A3 4F          MOV    C,A          ;PLACE LEN IN COUNTER
02A4 23          LINE: INX    H          ;NEXT CHARACTER
02A5 7E          MOV    A,M          ;GET HIM
02A6 CD3302     CALL   WCHAR ;WRITE HIM
02A9 05          DCR    B
02AA 0B          DCR    C
02AB C2A402     JNZ    LINE ;KEEP PRINTING TILL DONE
02AE CD4F02     CALL   CRLF
02B1 C39D02     JMP    PLIN ;NEXT LINE
02B4 23          ELIN: INX    H
02B5 7E          MOV    A,M          ;GET CHARACTER
02B6 CD3302     CALL   WCHAR
02B9 05          DCR    B
02BA C2B402     JNZ    ELIN ;PRINT TILL DONE
02BD CD4F02     CALL   CRLF
02C0 CD6E02     CALL   GETSTK ;RETURN TO CPM
02C3          END          ;00H

```

Text continued from page 274:

available are P, which prints the file on the system printer, and D, which creates a copy of the input file having type .RES. The input file may reside on drive A or B, but it is assumed to be on A unless otherwise specified. If option D is selected, the output file will be on the same drive as the input file.

Now, let us discuss the use of the default FCB and buffer. When the command DSKUTIL TEST.PD is entered in response to the CP/M prompt, the system places TEST in bytes 1 thru 4 of the FCB beginning at location 005C. PD is placed in bytes 9 and 10. The string (as typed) is also placed in the default buffer at location 0080 in the following manner:

byte 0 (that is, hexadecimal location 0080) contains the number of valid characters typed on the command line after the actual command and before a carriage return, in decimal. In this case, bTEST.PD (b represents a space—decimal ASCII 32) was typed—8 characters before a carriage return. Byte 0 of the buffer therefore

Text continued on page 300

SPEND \$62.40 TO READ THIS ADVERTISEMENT.*

A salesman generating 1.5 million dollars in sales annually for his company does so at the rate of \$12.48 per minute. That's expensive time—should it really be used in rummaging through filing cabinets, writing long reports or talking to dozens of people looking for one small, crucial piece of information?

Of course not, so you hire an accounting staff, customer support personnel, and marketing people to support the business and let your salespeople sell. But the overhead takes a large slice of that \$12.48.

A Delta system can do the work of a swarm of secretaries, a fleet of filers, a ton of telephones—simultaneously. It's a highly developed work processing system that can maintain files, generate reports, process orders and do all routine office work with speed and accuracy. It lets your people get on with the business of making money.

We at Delta Products have spent five years designing the most reliable, efficient Z80 based microcomputer available on the marketplace. It's fast—some models use multi processors to eliminate the delays associated with other multi user systems. It's expand-

able, allowing your Delta system to grow with your company's growth and change with your company's needs. And it's rugged; requiring a minimum of service or maintenance.

But the soul of any computer system is the software; therefore, having perfected the hardware technology, Delta is now dedicated to the development of application packages designed to warm the cockles of a corporate executive's heart. Our "Uni-form", for example, will keep purchase orders, account statements, sales and shipping orders indexed, cross-indexed and filed in any manner required.

And when your Delta system has helped your business grow, it's ready to grow right along with you—every Delta System is completely expandable and configurable.

You have spent five minutes reading this advertisement, at a cost of \$62.40 in potential sales. Have you calculated what a Delta system can save your company? (Hint: a Delta system can pay for itself in less than 24 hours of time saved.)

Call us today for the name of your nearest Delta distributor.

*(and save thousands later)



Delta Products
15392 Assembly Lane
Huntington Beach, CA 92649
Telephone (714) 898-1492
TELEX: 681-367 DELT MAR HTBH

Listing 4: Program using the discussed techniques to allow a user to either copy a specified file into another file or transmit its contents to the printer.

```

;*****
;
;       CPM DISK UTILITIES PROGRAM
;       WRITTEN BY JAMES K. LARSON
;
;*****
;
0100          ORG      0100H
0100 C38902          JMP      BEGIN      ;SKIP TO START OF MAIN PROGRAM
;*****
;
;       EQUATES AND DATA STORAGE AREA
;
;*****
;
0005 =        NTRY     EQU      0005H    ;CPM ENTRY POINT
0002 =        WFUNC   EQU      2        ;WRITE TO CONSOLE FUNCTION
0005 =        PFUNC   EQU      5        ;LINEPRINTER FUNCTION
0009 =        PSTR    EQU      9        ;PRINT BUFFER FUNCTION
000E =        LOGF    EQU      14       ;LOGIN AND SELECT DISK
000F =        OPENF   EQU      15       ;OPEN DISK FILE
0010 =        CLOSEF  EQU      16       ;CLOSE DISK FILE
0013 =        REMVF   EQU      19       ;DELETE A DISK FILE
0014 =        READF   EQU      20       ;READ A DISK RECORD
0015 =        WRITEF  EQU      21       ;WRITE A DISK RECORD
0016 =        MAKEF   EQU      22       ;CREATE A DISK FILE
001A =        SETF    EQU      26       ;SET DMA ADDRESS FOR NEXT READ/WRITE
0080 =        TRUFF   EQU      0080H    ;DEFAULT TEXT BUFFER
005C =        TFCB    EQU      005CH    ;DEFAULT FILE CONTROL BLOCK
0080 =        RECLEN  EQU      128      ;LENGTH OF ONE DISK RECORD
000D =        CR      EQU      13       ;CARRIAGE RETURN
000A =        LF      EQU      10       ;LINE FEED
002A =        HOME    EQU      42       ;HOME CURSOR AND CLEAR SCREEN
0103 4445      DEM:    DW      'DE'
0105 4000000000 DB      'M',0,0,0
010A 5245      RES:    DW      'RE'
010C 5300000000 DB      'S',0,0,0
0111 5052494E54DNMSG: DW      'PR','IN','TI','NG',' C','OM','PL','ET','E$'
0123 50524F4345DNPRC: DW      'PR','OC','ES','SI','NG',' C','OM','PL','ET','E$'
0137 434F4D4D41ERRMSG: DW      'CO','MM','AN','D ','OR',' F','IL','E ','ER','RO','R$'
014D 4F50454E20PFERR: DW      'OP','EN',' E','RR','OR','$ '
0159 5752495445WERR:  DW      'WR','IT','E ','ER','RO','R$'
0165          RCRDIS:  DS      1        ;STORAGE FOR NUMBER OF RECORDS READ
0166          OLDSTK:  DS      2        ;STORAGE FOR ORIGINAL STACK ADDRESS
0168 00          FLAG:  DB      00      ;INITIALIZE FLAG BITS STORAGE
0169          TFCB1:   DS      33       ;SECOND FILE CONTROL BLOCK
;*****
;
;       SUBROUTINE PRINT -- PRINTS A STRING ENDING IN $
;
;       PLACE STRING BUFFER STARTING ADDRESS IN DE REGISTER
;
;       PRESERVES REGISTER CONTENTS
;
;*****
;
018A E5        PRINT:  PUSH     H          ;PRESERVE REGISTERS
018B D5        PUSH     D
018C C5        PUSH     B
018D F5        PUSH     PSW
018E 0E09      MVI      C,PSTR    ;FUNCTION IN C REGISTER
0190 CD0500    CALL     NTRY     ;DO IT
0193 F1        POP      PSW        ;RESTORE REGISTERS
0194 C1        POP      B
0195 D1        POP      D
0196 E1        POP      H
017 C9        RET
;*****
;
;       SUBROUTINE WCHAR -- WRITES A SINGLE CHARACTER TO THE CONSOLE
;
;       CHARACTER IN THE A REGISTER - PRESERVES REGISTERS

```

Listing 4 continued on page 286

dBASE™ II vs. the Bilge Pumps.

by Hal Pawluk

We all know that bilge pumps suck.

And by now, we've found out—the hard way—that a lot of software seems to work the same way.

So I got pretty excited when I ran across dBASE II, an assembly-language relational Database Management System for CP/M. It works! And even a rank beginner like myself got it up and running the first time I sat down with it.

If you're looking for software to deal with your data, too, here are some tips that will help:



Tip #1: Database Management vs. File Handling:

Any list or collection of data is, loosely, a data base, but most of those "data base management" articles in the buzzbooks are really about file handling programs for specific applications. A real Database Management System gives you data and program independence (no reprogramming when data changes), eliminates data duplication and makes it easy to turn data into information.

Tip #2: Assembly Language vs. BASIC:

This one's easy: if you're setting up a DBMS, you're going to be doing a lot of sorting, and Basic sorts are s-l-o-w. Run a benchmark on a Basic system like S*-IV against a relational DBMS like dBASE II and you'll see what I mean. (But watch it: I've also seen one extremely slow assembly-language file management system.)

Tip #3: Relational vs. Hierarchical & Network DBMS.

CODASYL-like hierarchical and network systems, around since the 1960's, are being phased out on the big machines so why get stuck with an old-fashioned system for your micro? A relational DBMS like dBASE II eliminates the pre-defined sets, pointers and complex data structures of a CODASYL-type DBMS. And you don't need to be a programmer to use it.

dBASE II vs. everything else.

dBASE II really impressed me.

Written in assembly language (with no need for a host language), it handles up to 65,000 records (up to 32 fields and 1000 bytes each), stores numeric data as packed strings so there are no round-off errors, has a super-fast multiple-key sort, and supports ISAM based on B* trees.

You can use it interactively with English-like commands (DISPLAY 10 PRODUCTS), or program it

(so when you've set up the formats, your secretary can do the work). Its report generator and user-definable full screen operations mean that you can even use your existing forms.

And if all this makes your mouth water, but you've already got all your data on a disk, that's okay: dBASE II reads your ASCII files and adds the data to its own database.

Right now, I'm using dBASE II with my word processor for budgeting, scheduling and preparing reports for my clients.

Next come job costing, time billing and accounting.

An Unheard-of Money-Back Guarantee.

dBASE II is the first software I've seen with a full money-back guarantee.

To check it out, just send \$700 (plus tax in California) to Ashton-Tate, 3600 Wilshire Blvd., Suite 1510, Los Angeles, CA 90010. (213) 666-4409. Test dBASE II doing your jobs on your computer for 30 days. If, for some strange reason, you don't want to keep it, send it back and they'll refund your money.

No questions asked.

They know you don't need your bilge pumped.

Ashton-Tate

©Ashton-Tate 1980

Listing 4 continued:

```

;
;*****
;
0198 E5   WCHAR:  PUSH    H
0199 D5           PUSH    D
019A C5           PUSH    B
019B F5           PUSH    PSW
019C 5F           MOV     E,A      ;CHARACTER IN E REGISTER
019D 0E02         MVI    C,WFUNC
019F C00500       CALL   NTRY
01A2 F1           POP     PSW
01A3 C1           POP     B
01A4 D1           POP     D
01A5 E1           POP     H
01A6 C9           RET

;*****
;
;   SUBROUTINE PCHAR -- PRINTS A SINGLE CHARACTER ON THE PRINTER
;   CHARACTER IN THE A REGISTER -- PRESERVES REGISTERS
;
;*****
;
01A7 E5   PCHAR:  PUSH    H
01A8 D5           PUSH    D
01A9 C5           PUSH    B
01AA F5           PUSH    PSW
01AB 5F           MOV     E,A
01AC 0E05         MVI    C,PFUNC
01AE C00500       CALL   NTRY
01B1 F1           POP     PSW
01B2 C1           POP     B
01B3 D1           POP     D
01B4 E1           POP     H
01B5 C9           RET

;*****
;
;   SUBROUTINE CLEAR -- CLEARS SCREEN AND HOMES CURSOR ON
;   A SOROC IQ-120 TERMINAL -- PRESERVES REGISTERS
;
;*****
;
01B6 F5   CLEAR:  PUSH    PSW      ;PROTECT STATUS
01B7 3E1B         MVI    A,27      ;SEND ESCAPE CODE
01B9 C009801     CALL   WCHAR
01BC 3E2A         MVI    A,HOME
01BE C009801     CALL   WCHAR
01C1 F1           POP     PSW
01C2 C9           RET

;*****
;
;   SUBROUTINE CRLF -- SENDS CRLF TO CONSOLE
;
;*****
;
01C3 F5   CRLF:  PUSH    PSW
01C4 3E0D         MVI    A,CR
01C6 C009801     CALL   WCHAR
01C9 3E0A         MVI    A,LF
01CB C009801     CALL   WCHAR
01CE F1           POP     PSW
01CF C9           RET

;*****
;
;   SUBROUTINE SAVSTK -- SAVES THE OLD STACK POINTER AND SETS
;   A NEW STACK AT CBASE (BASE OF THE CONSOLE COMMAND PROCESSOR).
;   CBASE IS 800H BELOW FBASE (BASE OF THE DISK OPERATING SYSTEM).
;   FBASE MAY BE READ AT NTRY+1.
;
;*****

```

Listing 4 continued on page 288

NEW

ITS MAGIC[®]



The System/48 is the outstanding office automation computing system for the 80's . . . it's so productive we call it MAGIC[®]. Look at these features:

- Data management system
- Report generator
- Query processor
- Screen format generator
- Automatic interface code generator
- From one to eight interactive users per node
- Over half a million bytes of user memory available
- Winchester-technology hard disk with 18-million bytes (formatted capacity)
- 15-minute mean-time-to-repair
- Built-in protection from line-voltage spikes, noise, and brownouts

And, it features MAGIC[®], the Operating System that gets things done faster than you can say abracadabra because of its multi-keyed Indexed-Sequential Access Method and flexible file-organization. MAGIC[®] also offers high security, with password protection. MAGIC[®] supports global or local printers for as many users as desired.

Circle 359 on inquiry card.

MAGIC[®] also includes DataMagic II[®] — TEI's red-hot database manager. DataMagic II[®] has even more tricks up its sleeve — like automatic or manual record-lock protection and automatic transaction backout to protect the database and it runs application software written for CP/M 2.X.

Take a MAGIC[®] leap into the future!

Arrange to attend one of our regularly scheduled System/48 workshops (RSVP).

OEM and Dealer Inquiries Invited



System/48[®]

5075 S. LOOP EAST, HOUSTON, TX. 77033
(713) 738-2300 TWX. 910-881-3639

Listing 4 continued:

```

;
01D0 C1 SAVSTK: POP B ;GET RETURN ADDRESS
01D1 210000 LXI H,00 ;CLEAR HL
01D4 39 DAD SP ;GET STACK POINTER
01D5 226601 SHLD OLDSTK ;SAVE HIM
01D8 2A0600 LHLD NTRY+1 ;GET FBASE
01DB 7C MOV A,H
01DC D608 SUI 08H ;SUBTRACT CHASE OFFSET
01DE 67 MOV H,A
01DF F9 SPHL ;SET NEW STACK POINTER
01E0 C5 PUSH B ;SET RETURN ADDRESS
01E1 C9 RET

;*****
;
; SUBROUTINE GETSTK -- GETS OLD STACK POINTER AND RETURNS TO CFM
;
;*****
;
01E2 2A6601 GETSTK: LHLD OLDSTK ;GET OLD STACK POINTER
01E5 F9 SPHL ;PLUG HIM IN
01E6 C9 RET ;THIS WILL RETURN TO CFM

;*****
;
; SUBROUTINE PRT -- PRINTS THE NUMBER OF CHARACTERS IN THE B REG
; ON THE LINE PRINTER. ADDRESS OF FIRST CHARACTER TO PRINT
; IS IN HL.
;
;*****
;
01E7 7E PRT: MOV A,M ;GET CHAR
01E8 CDA701 CALL PCHAR ;PRINT HIM
01EB 23 INX H ;NEXT, PLEASE
01EC 05 DCR B ;DONE?
01ED C2E701 JNZ PRT ;NOPE, KEEP PRINTING
01F0 C9 RET ;DONE, GO HOME

;*****
;
; SUBROUTINE MOVCHR -- MOVES CHARACTERS BEGINNING AT LOCATION
; IN HL TO LOCATION BEGINNING IN DE FOR A COUNT IN REG C.
;
;*****
;
01F1 7E MOVCHR: MOV A,M
01F2 12 STAX D
01F3 23 INX H
01F4 13 INX D
01F5 0D DCR C
01F6 C2F101 JNZ MOVCHR ;GO TILL DONE
01F9 C9 RET

;*****
;
; SUBROUTINE LOGDISK -- LOGS IN A DISK AS ACTIVE FOR I/O. REG E
; CONTAINS 0 FOR DRIVE A AND 1 FOR DRIVE B.
;
;*****
;
01FA E5 LOGDISK: PUSH H
01FB D5 PUSH D ;PRESERVE
01FC C5 PUSH B
01FD F5 PUSH FSW
01FE 0E0E MVI C,LOGF
0200 CD0500 CALL NTRY
0203 F1 POP FSW
0204 C1 POP B ;RESTORE
0205 D1 POP D
0206 E1 POP H
0207 C9 RET

;*****
;

```

Listing 4 continued on page 290

The Text Solution for APPLE II®

Now APPLE II® Owners Can Solve Text Problems With VIDEOTERM 80 Column by 24 Line Video Display Utilizing 7 X 9 Dot Character Matrix

Perhaps the most annoying shortcoming of the Apple II® is its limitation of displaying only 40 columns by 24 lines of text, all in uppercase. At last, Apple II® owners have a reliable, trouble-free answer to their text display problem. VIDEOTERM generates a full 80 columns by 24 lines of text, in upper and lower case. Twice the number of characters as the standard Apple II® display. And by utilizing a 7 by 9 character matrix, lower case letters have true descenders. But this is only the start.

VIDEOTERM, MANUAL, SWITCHPLATE

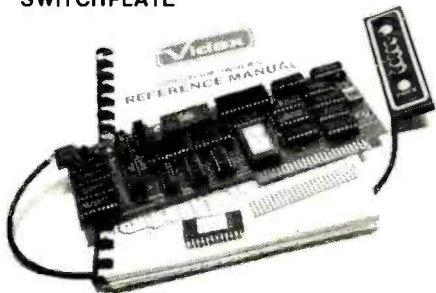

VIDEOTERM

BASICs VIDEOTERM lists BASIC programs, both Integer and Applesoft, using the entire 80 columns. Without splitting keywords. Full editing capabilities are offered using the ESCape key sequences for cursor movement. With provision for stop/start text scrolling utilizing the standard Control-S entry. And simultaneous on-screen display of text being printed.

Pascal Installation of VIDEOTERM in slot 3 provides Pascal immediate control of the display since Pascal recognizes the board as a standard video display terminal and treats it as such. No changes are needed to Pascal's MISC.INFO or GOTOXY files, although customization directions are provided. All cursor control characters are identical to standard Pascal defaults.

Other Boards The new Microsoft Softcard™ is supported. So is the popular D. C. Hayes Micro-modem II™, utilizing customized PROM firmware available from VIDEX. The powerful EasyWriter™ Professional Word Processing System and other word processors are now compatible with VIDEOTERM. Or use the Mountain Hardware ROMWriter™ (or other PROM programmer) to generate your own custom character sets. Naturally, VIDEOTERM conforms to all Apple OEM guidelines, assurance that you will have no conflicts with current or future Apple II™ expansion boards.

Advanced Hardware Design VIDEOTERM's on-board asynchronous crystal clock ensures flicker-free character display. Only the size of the Pascal Language card, VIDEOTERM utilizes CMOS and low power consumption ICs, ensuring cool, reliable operation. All ICs are fully socketed for easy maintenance. Add to that 2K of on-board RAM, 50 or 60 Hz operation, and provision of power and input connectors for a light pen. Problems are designed out, not in.

Available Options The entire display may be altered to inverse video, displaying black characters on a white field. PROMs containing alternate character sets and graphic symbols are available from Videx. A switchplate option allows you to use the same video monitor for either the VIDEOTERM or the standard Apple II™ display, instantly changing displays by flipping a single toggle switch. The switchplate assembly inserts into one of the rear cut-outs in the Apple II™ case so that the toggle switch is readily accessible. And the Videx KEYBOARD ENHANCER can be installed, allowing upper and lower case character entry directly from your Apple II™ keyboard.

Firmware 1K of on-board ROM firmware controls all operation of the VIDEOTERM. No machine language patches are needed for normal VIDEOTERM use.

Firmware Version 2.0

Characters	7 x 9 matrix	Display	24 x 80 (full descenders)
Options	7 x 12 matrix option; Alternate user definable character set option; Inverse video option.		18 x 80 (7 x 12 matrix with full descenders)

Want to know more? Contact your local Apple dealer today for a demonstration. VIDEOTERM is available through your local dealer or direct from Videx in Corvallis, Oregon. Or send for the VIDEOTERM Owners Reference Manual and deduct the amount if you decide to purchase. Upgrade your Apple II™ to full terminal capabilities for half the cost of a terminal. VIDEOTERM. At last.

PRICE:

- VIDEOTERM includes manual. . . . \$345
- SWITCHPLATE. . . . \$ 19
- MANUAL refund with purchase. . . . \$ 19
- 7 x 12 CHARACTER SET. . . . \$ 39
- MICROMODEM FIRMWARE. . . . \$ 25



7X12 MATRIX
18X80 OPTIONAL



7X9 MATRIX
12X80 STANDARD

Apple II™ is a trademark of Apple Computer Inc.
ROMWriter™ is a trademark of Mountain Hardware Inc.
Micro-modem II™ is a trademark of D. C. Hayes Associates Inc.
Softcard™ is a trademark of Microsoft.
EasyWriter™ is a trademark of Information Unlimited Software Inc.

APPLE II® OWNERS!

introducing the KEYBOARD & DISPLAY ENHANCER

- PUT THE SHIFT AND SHIFT LOCK BACK WHERE IT BELONGS
- SEE REAL UPPER AND lower CASE ON THE SCREEN
- ACCESS ALL YOUR KEYBOARD ASCII CHARACTERS

Videx has the perfect companion for your word processor software: the **KEYBOARD AND DISPLAY ENHANCER**. Install the enhancer in your APPLE II and be typing in lower case just like a typewriter. If you want an upper case character, use the SHIFT key or the CTRL key for shift lock. Not only that, but you see upper and lower case on the screen as you type. Perfectly compatible with Apple Writer and other word processors like, for example, Super-Text.

If you want to program in BASIC, just put it back into the alpha lock mode, and you have the original keyboard back with a few im-

provements. Now you can enter those elusive 9 characters directly from the keyboard, or require the Control key to be pressed with the RESET to prevent accidental resets.

KEYBOARD AND DISPLAY ENHANCER is recommended for use with all revisions of the APPLE II. It includes 6 ICs, and EPROM and dip-switches mounted on a PC board, and a jumper table. Easy installation, meaning no soldering or cutting traces. Alternate default modes are dip-switch selectable. You can even remap the keyboard, selecting an alternate character set, for custom applications.

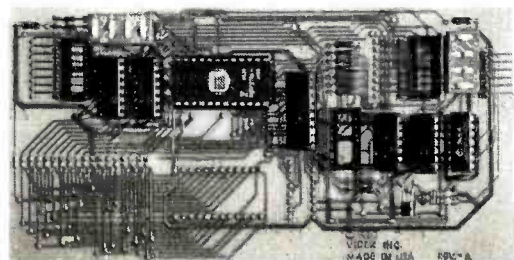

PRICE

- KDE-700 (REV. 7 or greater) \$129.
- KDE-000 (REV. 6 or less) \$129.

Apple II™ is a trademark of Apple Computer, Inc.



VIDEX
897 N.W. Grant Avenue
Corvallis, Oregon 97330
Phone (503) 758-0521



Listing 4 continued:

```

; SUBROUTINE OPEN -- OPENS FILE WHOSE FCB ADDRESS IS IN DE.
; RETURNS 255 IN REG A IF NO SUCH FILE.
;
;*****
0208 E5 OPEN: PUSH H ;PRESERVE
0209 D5 PUSH D
020A C5 PUSH B
020B 0E0F MVI C,OPENF
020D CD0500 CALL NTRY
0210 C1 POP B
0211 D1 POP D
0212 E1 POP H
0213 C9 RET
;*****
; SUBROUTINE CLOSE -- CLOSSES FILE WHOSE FCB ADDRESS IS IN DE.
; RETURNS 255 IN A IF NO SUCH FILE.
;
;*****
0214 E5 CLOSE: PUSH H
0215 D5 PUSH D
0216 C5 PUSH B
0217 0E10 MVI C,CLOSEF
0219 CD0500 CALL NTRY
021C C1 POP B
021D D1 POP D
021E E1 POP H
021F C9 RET
;*****
; SUBROUTINE DELETE -- DELETES THE FILE WHOSE FCB IS IN DE.
;
;*****
0220 E5 DELETE: PUSH H
0221 D5 PUSH D
0222 C5 PUSH B
0223 F5 PUSH PSW
0224 0E13 MVI C,REMOVF
0226 CD0500 CALL NTRY
0229 F1 POP PSW
022A C1 POP B
022B D1 POP D
022C E1 POP H
022D C9 RET
;*****
; SUBROUTINE CREATE -- CREATES THE FILE WHOSE FILENAME AND TYPE
; ARE IN THE FCB ADDRESSED BY DE. RETURNS 255 IN A IF NO
; DIRECTORY SPACE.
;
;*****
022E E5 CREATE: PUSH H
022F D5 PUSH D
0230 C5 PUSH B
0231 0E16 MVI C,MAKEF
0233 CD0500 CALL NTRY
0236 C1 POP B
0237 D1 POP D
0238 E1 POP H
0239 C9 RET
;*****;*****
; SUBROUTINE SETDMA -- SETS THE DMA ADDRESS FOR THE NEXT DISK I/O
; TO THAT IN HL. INCREMENTS HL BY 128 (READY FOR NEXT TIME).
;

```

Listing 4 continued on page 292



APPLE ACCESSORIES

LOBO Disk II/Controller	\$499.
LOBO Disk II	419.
SUPERTERM 80 Col. Card	329.
Z80 Soft Card	295.
H.S. Serial Card	179.
COMM. Card	179.
CLOCK Calendar Card	225.
ROM Plus Card/KB Filter	175.
HAYES Micromodem	319.
SUPERTalker	249.
PARALLEL Printer Card	149.
16K Ram Card	189.
GPIB IEEE488 Card	259.

SOFTWARE

VISICALC	119.00
DESKTOP Plan II	169.00
PERS Filing Syst	80.00
ADDRESS Book	40.00
SUPER Text II	125.00
CCA Data Mgmt	85.00



MODEMS

UDS 103 LP, <i>direct</i>	\$169.
103 JLP <i>Auto Answer</i>	219.
NOVATION CAT, <i>acoustic</i>	159.
D-CAT, <i>direct</i>	169.
Auto Cat	219.
Apple Cat	309.
LEXICON LX-11, <i>acoustic</i>	147.
HAYES Micromodem, S100	349.

VIDEO MONITORS

Sanyo 9" B/W	\$169.
NEC 12" Green	229.
Amdek 12" B/W (Leedex)	135.
Amdek 13" Color	399.

VIDEO TERMINALS

Ampex Dialog 80	\$995.
Ampex Dialog 30	795.
Televideo 920C	845.
Televideo 950	995.
Soroc IQ 120	795.
Soroc IQ 140	1,195.

FLOPPY DRIVES

1-SA 400 Case, power	\$399.
1-SA 800/801 Case, power	995.
2-SA 800/801 Case, power	1,495.
2-SA 850/851 Case, power	1,995.

PRINTER SALE

Diablo 630 RO	\$2,395.
Diablo 1640 RO	2,795.
Diablo 1650 RO	3,095.
Qume 3/45 RO	2,195.
Qume 3/55 RO	2,295.
Qume 5/45 RO	2,595.
Qume 5/55 RO	2,795.
C.Itoh Starwriter RO	1,695.
TI 810 RO	1,695.
TI 820 RO	1,795.
Anadex DP9500/9501	1,345.

EPSONS TOO!

NEW! NOVELL IMAGE 800

150 CPS Heavy Duty Matrix
15" wide carriage, expanded, compressed and double density "correspondence quality" printing at 80, 96 and 136 columns, true descenders, underlining, superscripts, subscripts. Up to 3K Buffer, optional character set and graphics option.
List \$1,395..... \$1,295.00

PRINT ELEMENTS

NEC Thimbles	\$14.95
Plastic Daisy Wheels for Qume, Diablo, Starwriter	6.00
Metal Daisy Wheels	59.00
IBM Selectric Elements	19.00

RIBBONS

NEC	\$77.00/Doz.
QUME	45.00/Doz.
DIABLO	66.00/Doz.
ANADEX	135.00/6 ea.
TRITEL	95.00/Doz.
TI/DEC/TTY	45.00/Doz.
EPSON	13.95/ea.
MPI/Axiom/Base 2	10.00/ea.



MAGNETIC MEDIA

Premium Quality At Bargain Prices
5 1/4" Diskettes, all Formats,
100% Certified with hub rings, box of 10
Single sided, single density 26.50 || Single sided, double density | 29.50 |
Double sided, double density	38.50
8" DISKETTES, ALL FORMATS	
100% CERTIFIED	
Single sided, single density	29.50
SSSD Error Free	34.50
Single sided, double density	39.50
Double sided, double density	49.50



MPI 88 G Matrix

High resolution dot-addressable graphics for Apple. Enhanced "correspondence quality" printing. Tractor and Friction feed. Serial and Parallel Input. 100 cps Bidirectional printing. 80, 96, and 132 column widths!

List \$799.00 \$599.00 |

Apple II I/O Card	\$110.00
PET/IEEE I/O Card	55.00
Single Sheet Feeder	25.00
QT Cover	25.00



NEC SPINWRITERS

5510 RO	\$2,595.
5520 KSR	2,895.

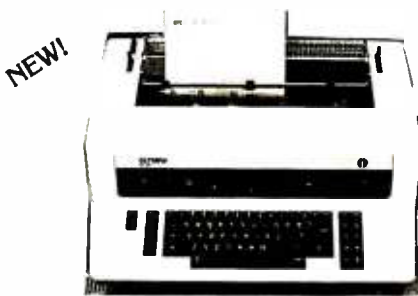

OLYMPIA ES100

Letter quality, Daisy wheel printer/typewriter interfaces to Apple, Atari, NEC, TRS80 and RS232 Serial ports. A truly cost effective letter quality printer that functions as a typewriter.

List \$1,495..... \$1,295.00

TO PLACE YOUR ORDER CALL:

TELEPHONE (714) 744-7314 TELEX 697120

or write to:

PALOMAR
Computer Products

910-105 W. San Marcos Blvd., San Marcos, CA 92069

TERMS OF SALE: Cash, check, money order, bank wire transfer, credit card or purchase orders from qualified firms and institutions. Please include telephone number with order and expiration date on credit card orders. California residents add 6% sales tax. Advertised prices are for prepaid orders F.O.B. shipping point. Add 3% for shipping in U.S. Pricing and availability subject to change without notice.

Circle 280 on inquiry card.

SuperBuys!!!!

... on computers, peripherals,
accessories and supplies!

Listing 4 continued:

```

;*****
;
SETDMA: PUSH    PSW
023A FS      PUSH    R
023B C5      PUSH    D
023C D5      PUSH    H
023D E5      PUSH    H
023E ER      XCHG    ;ADDRESS IN DE
023F 0E1A    MVI     C,SETF
0241 CD0500  CALL    NTRY
0244 E1      POP     H      ;MODIFY THIS GUY
0245 019000  LXI     R,128
0248 09      DAD     R      ;ADDRESS+128
0249 D1      POP     D
024A C1      POP     R      ;RESTORE
024B F1      POP     PSW
024C C9      RET

;*****
;
;   SUBROUTINE RDREC -- READS ONE RECORD FROM FILE WHOSE FCB IS IN
;   DE TO THE CURRENT DMA ADDRESS. RETURNS A 1 OR 2 IN REG A
;   IF EOF IS ENCOUNTERED. A ZERO IN REG A MEANS SUCCESSFUL READ.
;
;*****
;
024D E5      RDREC:  PUSH    H
024E D5      PUSH    D
024F C5      PUSH    R
0250 0E14    MVI     C,READF
0252 CD0500  CALL    NTRY
0255 C1      POP     R
0256 D1      POP     D
0257 E1      POP     H
0258 C9      RET

;*****
;
;   SUBROUTINE WRREC -- WRITES ONE RECORD TO FILE WHOSE FCB IS IN
;   DE FROM THE CURRENT DMA ADDRESS. RETURNS 0 IF A SUCCESSFUL
;   WRITE.
;
;*****
;
0259 E5      WRREC:  PUSH    H
025A D5      PUSH    D
025B C5      PUSH    R
025C 0E15    MVI     C,WRITEF
025E CD0500  CALL    NTRY
0261 C1      POP     R
0262 D1      POP     D
0263 E1      POP     H
0264 C9      RET

;*****
;
;   SUBROUTINE RDDSK -- READS FILE WHOSE FCB ADDRESS IS IN DE TO
;   MEMORY BEGINNING AT ADDRESS IN HL. ASSUMES FILE WILL FIT INTO
;   MEMORY. ENTIRE FILE IS READ IN.
;
;*****
;
0265 CD3A02  RDDSK:  CALL    SETDMA
0268 CD4D02  CALL    RDREC
026B A7      ANA     A      ;SET STATUS FLAGS - REG A WILL BE NON-ZERO
;           ; IF AN EOF WAS ENCOUNTERED
026C CA6502  JZ     RDDSK  ;READ TILL EOF
026F C9      RET

;*****
;
;   SUBROUTINE WRDSK -- WRITES TO DISK FROM MEMORY BEGINNING AT
;   ADDRESS IN HL. WRITES FILE WHOSE FCB IS IN DE. WRITES NUMBER
;   OF RECORDS IN REG B. ANY ERRORS RETURNED FROM WRREC ARE
;   REPORTED AND THE WRITE IS ABORTED.

```

Listing 4 continued on page 294

Wild Hare Software Systems Multiply the Capabilities of Data General's

RDOS
INFOS®
ICOS
DOS

Wild Hare gives Data General users a choice when upgrading to a multi-user environment and eliminates the need to use AOS. Wild Hare makes it easy for you. It creates a true multi-lingual, multi-user environment for your current system. No user software modifications are necessary. There is no need to install a new operating system. And, no expensive hardware upgrade is required.

Features

- Each user is totally independent of all other users.
- Each user may run all standard Data General software.
- Each user may independently edit, compile, execute and debug programs written in any language supported by RDOS, INFOS®, ICOS and DOS.
- Standard languages supported include: Fortran IV, Fortran V, COBOL, ALGOL, RPG, DG/L™, BASIC, PASCAL, MAC, etc.
- All NOVA's® and ECLIPSE's® are supported.
- Wild Hare guarantees its software systems on a money back basis.

**Wild Hare's Software
Gives Data General Users
A Choice!**

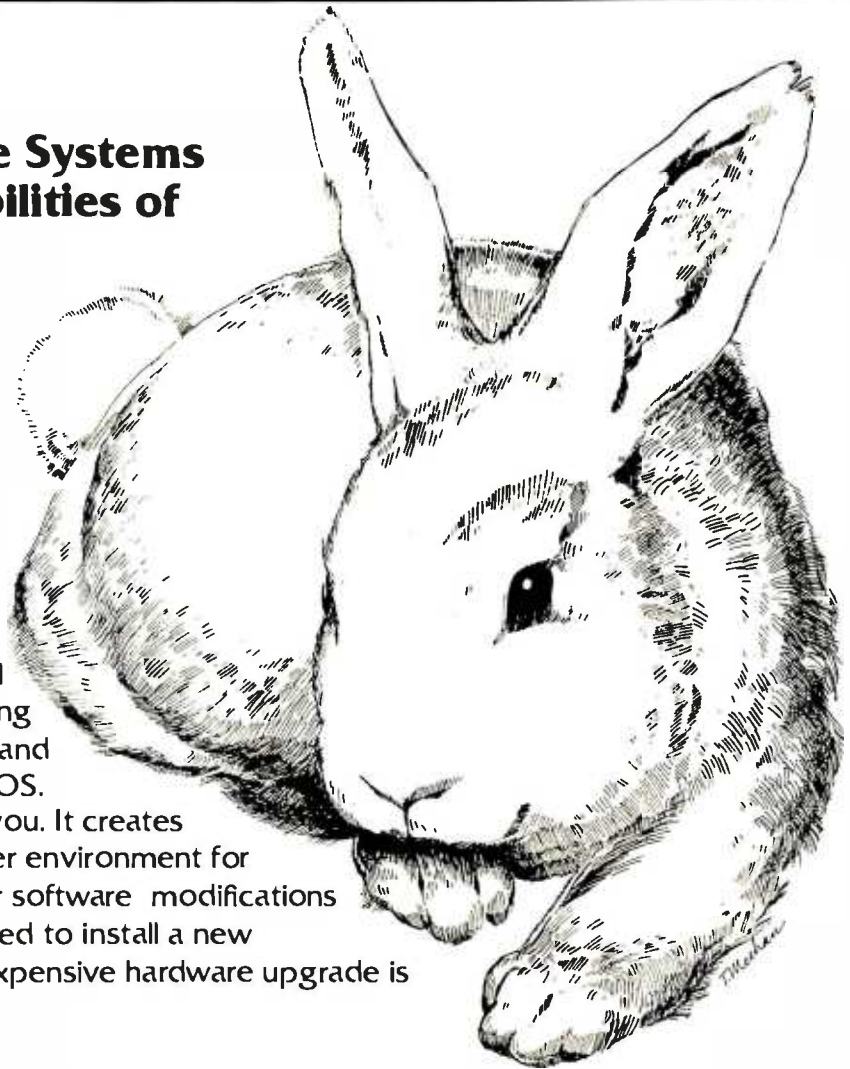

WILD HARE COMPUTER
SYSTEMS INC.

P.O. Box 3581, Boulder, Colorado 80307
(303) 494-0221

NOVA®, ECLIPSE® and INFOS® are registered trademarks of Data General Corporation.

Listing 4 continued:

```

;
;*****
;
0270 CD3A02 WRDSK: CALL SETDMA
0273 CD5902 CALL WRREC
0276 A7 ANA A ;SET STATUS FLAGS - REG A WILL BE NON-ZERO
; IF AN ERROR OCCURRED
0277 C27F02 JNZ WRER ;REPORT ERROR
027A 05 DCR B ;THUMP RECORD COUNTER
027B C27002 JNZ WRDSK ;WRITE EM ALL
027E C9 RET
027F 115901 WRER: LXI D,WERR ;PRINT ERROR MESSAGE
0282 CD8A01 CALL PRINT
0285 CDC301 CALL CRLF
0288 C9 RET
;*****
;
; MAIN PROGRAM -- READS A DISK DRIVE, FILE NAME, AND OPTIONS FROM
; THE DEFAULT BUFFER. OPTIONS ALLOW THE NAMED FILE TO BE
; PRINTED OR REWRITTEN TO A NEW FILE. ASSUMES FILE TYPE .DEM
; FOR INPUT FILE AND ASSIGNS TYPE .RES TO OUTPUT FILE.
;
;*****
;
0289 CDD001 BEGIN: CALL SAVSTK ;SAVE OLD STACK POINTER
028C CDB601 CALL CLEAR
028F 218000 LXI H,TRUFF ;COMMAND LINE IS HERE
0292 3E00 MVI A,0
0294 BE CMP M
0295 CAA303 JZ ERR ;ERROR IF NO VALID CHARACTERS
0298 46 MOV B,M ;GET NUMBER OF VALID CHARACTERS
0299 3E3A MVI A,';' ;DISK SPECIFIED?
029B 23 INX H
029C 23 INX H
029D 23 INX H ;COLON IS HERE IF A LABEL IS SPECIFIED
029E BE CMP M
029F CAAS02 JZ LISK ;LOG PROPER DISK
02A2 2B DCX H
02A3 2B DCX H
02A4 05 DCR B ;ASSUME FIRST CHARACTER BLANK
02A5 C3BF02 JMP TARG ;SKIP IF NOT NEEDED
02A8 05 LISK: DCR B ;THUMP COUNTER
02A9 05 DCR B
02AA 05 DCR B
02AB 3E42 MVI A,'B' ;DRIVE B?
02AD 2B DCX H ;BACK UP ONE
02AE BE CMP M
02AF CAB602 JZ DRB ;DRIVE B IT IS
02B2 23 INX H ;ASSUME DRIVE A
02B3 C3BF02 JMP TARG
02B6 3A6801 DRB: LDA FLAG ;FLAG DRIVE B
02B9 F604 ORI 00000100H
02BB 326801 STA FLAG
02BE 23 INX H
02BF 3E2E TARG: MVI A',' ;TARGET IS END OF FILE NAME
02C1 23 NCHAR: INX H ;NEXT CHAR
02C2 05 DCR B ;THUMP COUNTER
02C3 CAA303 JZ ERR ;ERROR IF NO COMMANDS
02C6 BE CMP M
02C7 C2C102 JNZ NCHAR ;KEEP LOOKING
02CA 23 INX H
02CB 3E50 INSTR: MVI A,'P' ;PRINT HIM?
02CD BE CMP M
02CE C2DC02 JNZ DTST
02D1 3A6801 LDA FLAG ;SET PRINT FLAG
02D4 F601 ORI 00000001B
02D6 326801 STA FLAG
02D9 C3EA02 JMP NXTINS
02DC 3E44 DTST: MVI A,'D' ;CREATE NEW DISK FILE?
02DE BE CMP M

```

Listing 4 continued on page 296

"WITH THE UCSD p-SYSTEM,TM WE CAN WRITE ONE APPLICATION THAT GOES FROM APPLE TO ZENITH."

HARRY BLAKESLEE, President, Denver Software



Our business is bigger and better than ever. A lot of the credit for that goes to the UCSD p-System software from SofTech Microsystems. It's given us ten times the market we used to have.

We can write a single, sophisticated applications program with the UCSD p-System—like our financial management package—and it just keeps on running. On Apple, Commodore, Ohio Scientific, Texas Instruments, Zenith, and more. That's the real beauty of the UCSD p-System. Any program you write for one microcomputer runs on others, both today and tomorrow. You protect your software investment, without restricting your hardware options.

And with the UCSD p-System, you can use the language of your choice—UCSD Pascal,TM FORTRAN-77, BASIC, or assembly language. All are backed by SofTech Microsystems, a leading system software company who's been around for over a decade, who knows how to develop professional quality software, and who's committed to delivering it.

Get a head start on tomorrow. With the microcomputer software that goes from "A" to "Z." Distribution licensing and single copies available. Write or call for details, so you can start going places, too.

SOFTech
MICROSYSTEMS
A SUBSIDIARY OF SOFTech

For the software that's going places.
9494 Black Mountain Road, San Diego,
CA 92126. (714) 578-6105
TWX: 910-335-1594

UCSD p-System and UCSD Pascal are trademarks of the Regents of the University of California.

Listing 4 continued:

```

02DF C2EA02      JNZ      NXTINS  ;INVALID INSTRUCTIONS ARE SKIPPED
02E2 3A6801      LDA      FLAG    ;SET FILE FLAG
02E5 F602        ORI      0000010B
02E7 326801      STA      FLAG
02EA 23          NXTINS: INX    H
02EB 05          DCR      B
02EC C2CB02      JNZ      INSTR   ;KEEP READING INSTRUCTIONS
                    ;
                    ;LOG PROPER DRIVE
                    ;
02EF 1E00        MVI      E,00    ;SET DEFAULT DRIVE A
02F1 3A6801      LDA      FLAG
02F4 E604        ANI      00000100B ;WHICH DRIVE?
02F6 CAF802      JZ       LOG     ;LOG DRIVE A
02F9 1E01        MVI      E,01    ;LOG DRIVE B
02FB CDFA01      LOG:    CALL    LOGDSK
                    ;
                    ;SET FILE TYPE .DEM
                    ;
02FE 210301      LXI      H,DEM
0301 116500      LXI      D,TFCB+9
0304 0E07        MVI      C,7     ;MOVE 7 CHARACTERS -- .DEM AND ZEROS
0306 CDF101      CALL    MOVCHR
0309 AF          XRA      A     ;CLEAR A
030A 327C00      STA      TFCB+32 ;ZERO NEXT RECORD
                    ;
                    ;READ IN FILE
                    ;
030D 115C00      LXI      D,TFCB
0310 CD0802      CALL    OPEN
0313 3C          INR      A     ;ERROR TEST - A CONTAINS 255 IF ERROR
0314 C22303      JNZ      RDSK   ;OK- GO ON
0317 114D01      LXI      D,OFERR ;PRINT OPEN ERROR
031A CD8A01      CALL    PRINT
031D CDC301      CALL    CRLF
0320 C39703      JMP     DONE
0323 21AF03      RDSK:  LXI      H,FINIS ;LOCATION OF FIRST OPEN MEMORY LOCATION
                    ;DE ALREADY CONTAINS THE FCB ADDRESS
0326 CD6502      CALL    RDISK  ;READ HIM IN
0329 3A6800      LDA      TFCB+15 ;NUMBER OF RECORDS READ IN
032C 326501      STA      RCRDS
032F CD1402      CALL    CLOSE ;TFCB IS STILL IN DE
                    ;
                    ;PRINT ON LINE PRINTER IF FLAG SET
                    ;
0332 3A6801      LDA      FLAG
0335 E601        ANI      00000001B
0337 CA5803      JZ       FILE   ;TEST FOR FILE FLAG
033A 3A6501      LDA      RCRDS ;NUMBER OF RECORDS TO PRINT
033D 4F          MOV     C,A
033E 0D          DCR     C
033F 21AF03      LXI      H,FINIS ;FIRST CHARACTER
0342 118000      LXI      D,128  ;INCREMENT
0345 0680        PRTMOR: MVI     B,RELEN ;SET RECORD LENGTH
0347 CDE701      CALL    PRT    ;PRINT ONE RECORD
034A 19          DAD     D     ;INCREMENT CHAR COUNT
034B 0D          DCR     C
034C C24503      JNZ      PRTMOR ;PRINT MORE
034F 111101      LXI      D,INMSG ;PRINT COMPLETION MESSAGE
0352 CD8A01      CALL    PRINT
0355 CDC301      CALL    CRLF
                    ;
                    ;IF FILE FLAG SET, CREATE NEW FILE
                    ;
0358 3A6801      FILE:  LDA      FLAG
035B E602        ANI      00000010B
035D CA9703      JZ       DONE
                    ;
                    ;IF FILE .RES EXISTS, DELETE IT - THEN CREATE IT
                    ;

```

Listing 4 continued on page 298

PERIPHERALS FOR ATARI 400 & 800

16K MEMORY BOARD: AT-16

- 16K 4116 RAM (200NS)
- Assembled and tested
- No modifications - hardware or software
- Compatible with Atari 800
- One year warranty
- Price: \$119.50

32K MEMORY BOARD: AT-32

- 32K 4116 RAM (200NS)
- Assembled and tested
- No modifications - hardware or software
- Compatible with Atari 400/800
- One year warranty
- Price: \$199.50

PARALLEL PRINTER CABLE: ATC-1

- Pre-tested
- 3' length
- Centronics compatible
- DB15 to Amphenol 57-30360
- Price: \$39.50

SERIAL (RS-232) PRINTER CABLE: ATC-2

- Pre-tested
- 3' length
- DB15 to DB25 connectors
- Price: \$39.50

EXTENDER BOARD: ATB-1

- Raises board 3 inches
- Ideal for prototype boards
- Price: \$39.50

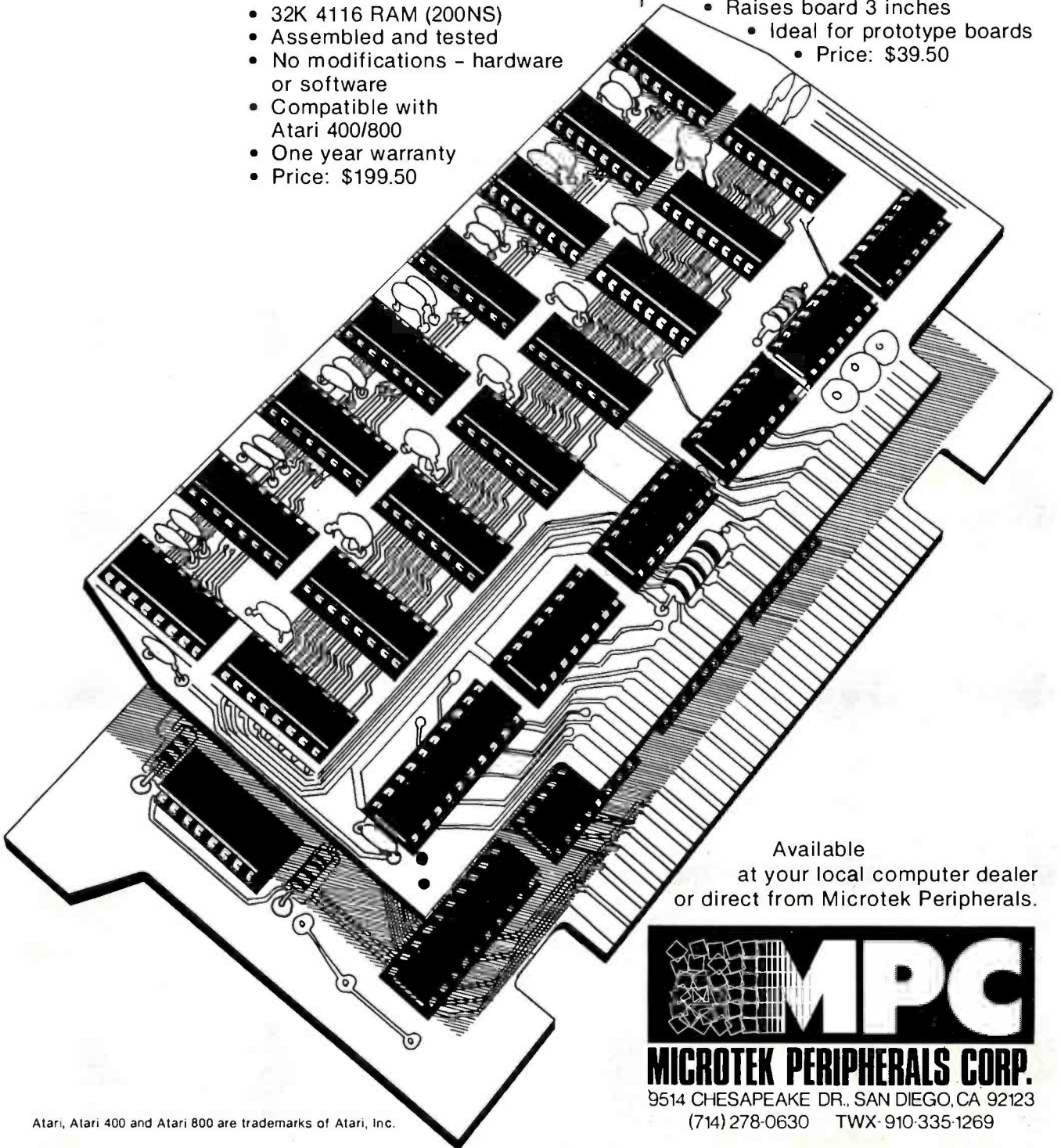

Available
at your local computer dealer
or direct from Microtek Peripherals.

MPC
MICROTEK PERIPHERALS CORP.

9514 CHESAPEAKE DR., SAN DIEGO, CA 92123
(714) 278-0630 TWX-910-335-1269

Atari, Atari 400 and Atari 800 are trademarks of Atari, Inc.

Listing 4 continued:

```

0360 215C00      LXI      H,TFCB  ;MOVE FILE NAME
0363 116901      LXI      D,TFCB1
0366 0E09        MVI      C,9
0368 CDF101      CALL    MOVCHR
036B 210A01      LXI      H,RES  ;FILE TYPE .RES
036E 117201      LXI      D,TFCB1+9
0371 0E07        MVI      C,7  ;SET TYPE AND ZERO REST OF FCB
0373 CDF101      CALL    MOVCHR
0376 AF          XRA      A    ;CLEAR A
0377 328901      STA      TFCB1+32 ;ZERO NEXT RECORD
037A 116901      LXI      D,TFCB1 ;DESTINATION FILE
037D CD0802      CALL    OPEN
0380 3C          INR      A    ;DOES FILE EXIST?
0381 C28703      JNZ     MAKUM  ;NOPE, LETS CREATE
0384 CD2002      CALL    DELETE ;YUP, LETS DELETE
0387 CD2E02      MAKUM:  CALL    CREATE ;FCB IS STILL IN DE
                                ;FILE NOW EXISTS - WRITE TO HIM
038A 3A6501      LDA      RCRDS  ;NUMBER OF RECORDS TO WRITE
038D 47          MOV     B,A
038E 21AF03      LXI      H,FINIS ;LOCATION OF FIRST CHARACTER TO WRITE
0391 CD7002      CALL    WRDSK  ;WRITE HIM
0394 CD1402      CALL    CLOSE
0397 112301      DONE:  LXI      D,DNFRC ;PRINT COMPLETION MESSAGE
039A CD8A01      CALL    PRINT
039D CDC301      CALL    CRLF
03A0 CDE201      CALL    GETSTK ;RETURN TO CPM
03A3 213701      ERR:   LXI      H,ERRMSG
03A6 CD8A01      CALL    PRINT
03A9 CDC301      CALL    CRLF
03AC C39703      JMP     DONE
03AF          FINIS:  END      100H

```

Anti-Static Dust Covers

Protect your computer and accessories.

- Anti-static vinyl helps prevent static from damaging sensitive components and causing faulty operation.
- Double-fold stitching will not rip out and is unmatched for strength and long life.
- Heavy gauge textured vinyl blends with any decor and folds easily for convenient storage.
- Over 1000 custom designs guaranteed to fit precisely.
- 100% satisfaction guarantee means we stand behind our product.

Yes, there are differences in Dust Covers. Differences which can be vitally important to the proper functioning of your system.

At Cover Craft we've manufactured the highest quality Dust Covers for the electronics industry for more than six years. We've been selected by major equipment manufacturers to make covers for their products. Our covers are in use in every state and in more than 50 countries. We know what it takes!



THE BEST
DUST COVERS
AT ANY PRICE

MOST PRICED
\$7.95 to \$11.95
PLUS POSTAGE AND
HANDLING
VISA-MasterCharge

So visit your dealer or contact Cover Craft for our latest catalog and list of over 200 dealers.

COVER CRAFT
P.O. BOX 555 • AMHERST, NH 03031 • (603) 889-6811

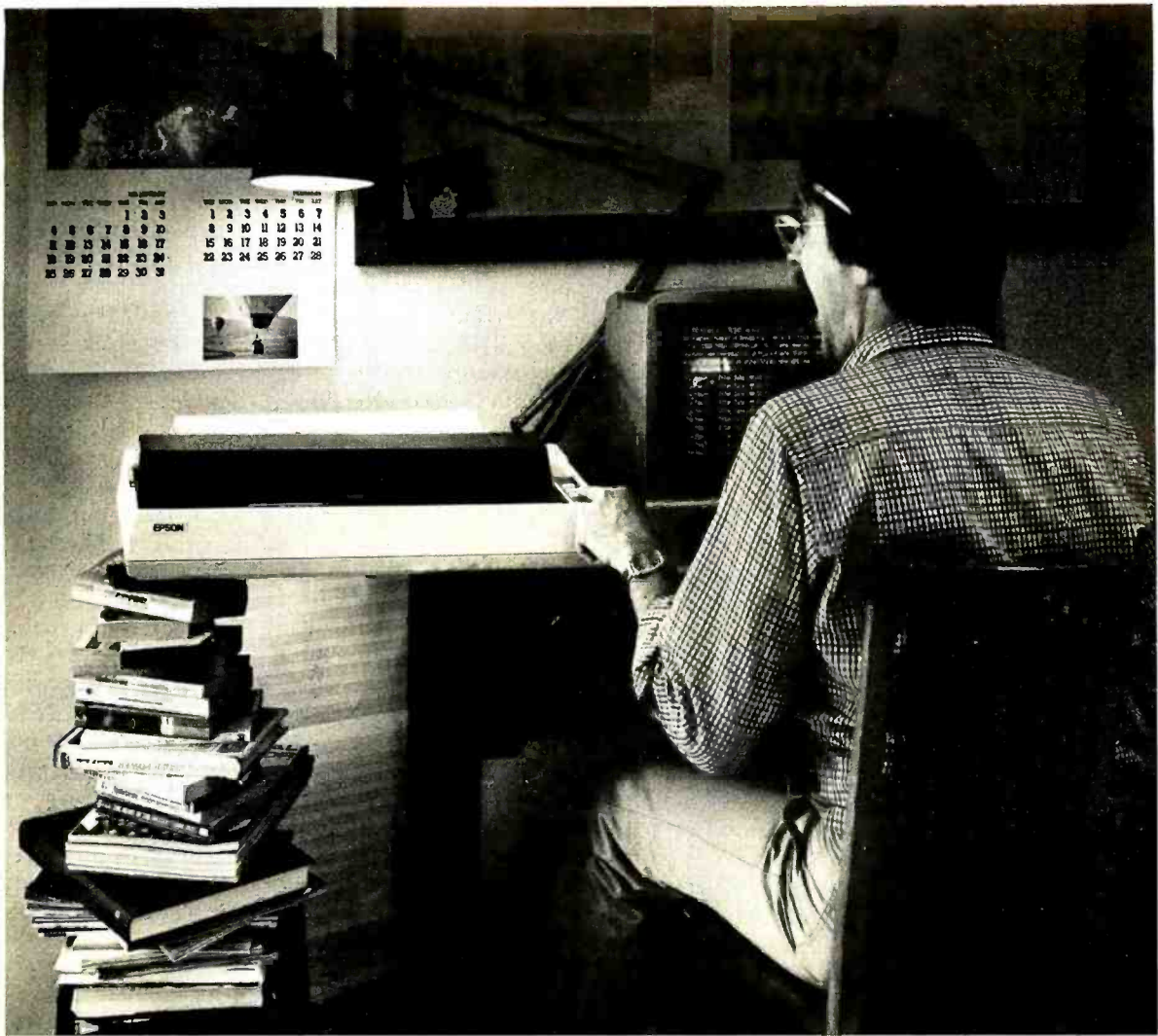

The MX-100. Not just better. Bigger.

Epson.

Our MX-80 was a pretty tough act to follow. I mean, how do you top the best-selling printer in the world?

Frankly, it wasn't easy. But the results of all our sleepless nights will knock your socks off.

The MX-100 is a printer that must be seen to be believed. For starters, we built in unmatched correspondence quality printing, and an ultra-high resolution bit image graphics capability. Then we added the ability to print up to 233 columns of information on 15" wide paper to give you the most incredible spread sheets you're ever likely to see. Finally, we topped it all off with *both* a satin-smooth friction feed platen *and* fully adjustable, removable tractors. And the list of standard features goes on and on and on.

Needless to say, the specs on this machine — and especially at under \$1000 — are practically unbelievable. But there's something about the MX-100 that goes far

beyond just the specs; something about the way it all comes together, the attention to detail, the fit, the feel. Mere words fail us. But when you see an MX-100, you'll know what we mean.

All in all, the MX-100 is the most remarkable printer we've ever built. Which creates rather a large problem for those of us at Epson.

How are we going to top this?

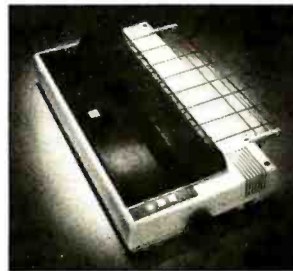

Your next printer.

EPSON
EPSON AMERICA, INC.

23844 Hawthorne Boulevard • Torrance, CA 90505 • (213) 378-2220

See the whole incredible Epson MX Series of printers at your Authorized Epson Dealer.

Getting the best prices just became as easy as 1-2-3.

ITEM PRICE

SOFTWARE APPLICATIONS

<i>Visicalc</i> ™ by Personal Software	\$ 99*
<i>WordStar</i> ™ by MicroPro™	315
<i>EasyWriter "Pro"</i> ™ by IUS	225
<i>Magic Wand</i> ™ by SBA	275

EXPANSION ACCESSORIES

<i>Microsoft Z-80</i> ™ Softcard™	\$255
<i>Micromodem</i> ™ II by Hayes™	299
<i>Videoterm</i> by Videx	275
<i>Sup-r-terminal</i> by M&R	319

PERIPHERALS & DEVICES

<i>MX 80</i> ™ by Epson	\$499
<i>737-Parallel</i> by Centronics	749
<i>460G "Paper Tiger"</i> ™ by IDS	1,125
<i>Expansion Chassis</i> by Mountain	549

*\$99 unit is for Apple II; similar low prices for units to use with other computers.

There's no such thing as a "second" in this industry. So why pay inflated prices? Our huge volume/low overhead means you can get what you've waited for *now*. Similar values on a wide variety of computer-related items.

Send check, MC or Visa.

PRICES EFFECTIVE THIS MONTH ONLY
WRITE FOR CATALOG.

COMPUTER COMPANY OF AMERICA

P.O. Box 9488,
7635 Fulton Avenue
N. Hollywood, CA 91606
(213) 765-5091

Shipping & handling: for Software (1) or Expansion (2) add \$5 for each item; for Peripherals (3) add \$15 each. California residents add 6% sales tax.

YOUR SYSTEM _____

NAME _____

ADDRESS _____

CITY _____

STATE _____ ZIP _____

MASTERCARD NO. _____

VISA NO. _____

SIGNATURE _____

EXP. DATE _____

Text continued from page 282:

contains 8. The next 8 characters are the exact line as typed: *bTEST.PD*. This buffer may now be scanned for valid commands by the user program; listing 4 illustrates a method of doing this.

If a second file name and file type had been specified, they would have been placed in the second 16 bits of the default FCB and written into the buffer. Any data placed in the buffer or FCB in this manner must be read by the user program before doing any disk access, or it will be lost. The first file name/file type may be left in the default FCB, but the second one must be moved elsewhere before accessing any file utilities (including directory utilities). In listing 4, valid commands are searched for, then the file type .DEM is placed in the FCB and bytes 12 thru 15 and 32 are zeroed. The file may now be opened and accessed.

Listing 4 illustrates one other important point about the FCB: the method of creating additional FCBs. TFCB1 is thirty-three reserved locations that serve as a second FCB in the same manner as the default FCB. The file name is moved into bytes 1 thru 8, the file type .RES is placed in bytes 9 thru 11, and the remaining bytes are defined in a similar manner to the default FCB. Using this method, additional FCBs may be created as needed. The address of the FCB of the file to be operated on is sent in the call to the CP/M entry point in register pair DE.

One other important consideration in actually reading and writing to a disk file is the need to set the DMA (direct memory access) address. This is the beginning memory address for the next disk access. The 128-byte record read from (or written to) the disk is placed into (or taken from) memory beginning at this location. When the disk system is initialized, using functions 13 or 14, the DMA address is set to hexadecimal 0080, the default buffer. It is possible to read one record to this buffer and then transfer the data to where it is needed; however, there is a simpler way illustrated in listing 4. Set the DMA address to the desired destination address and read a record. Put this function in a loop to read an entire file. Files may also be written in a similar manner (see listing 4).

Possibilities

In the course of experimenting with CP/M—trying to discover the hidden meaning in commands not thoroughly explained in the manuals—I discovered a few interesting features. These features often have no explanation in the manual. First, the directory of any disk can be read by placing ???????? and ??? in the file-name and file-type bytes of an FCB, then doing a SEARCH and SEARCH NEXT (functions 17 and 18). These two functions write directory information into the default buffer at hexadecimal location 0080, where it may be accessed for printout.

The OPEN function first finds a file name/file type match, then copies the disk map into the FCB. If a disk map is supplied with an extent, record count, and next record, the READ or WRITE functions will work without first using OPEN. The CLOSE statement merely matches the file name/file type and writes the FCB disk map to the directory.

These last two items should suggest some interesting but dangerous possibilities. The fact that CP/M marks a file as deleted by placing the hexadecimal character E5 in the entry-type field suggests a possible way to protect a file simply by making it disappear. The FCB still appears in the directory, but no longer matches any search string. This one needs more experimentation, since writing to a disk with files erased in this manner can result in destroying files only meant to be hidden.

Conclusion

This article has presented the use of the CP/M-utility routines, typical calling sequences, applications sub-routines, sent and returned values, and examples of their uses. Although written specifically for CP/M, it illustrates the general method of using utility routines supplied with an operating system. In addition, some possibilities for further experimentation with CP/M have been suggested. It is not meant to supplant the Digital Research manuals, but to supplement and clarify a portion of them. You should refer to the manuals for additional information. ■

High resolution, dot addressable graphics with vertical resolution of 72 dots per inch and up to 82 dots per inch horizontal resolution.

"Q.T." cover reduces noise to an office comfort level. This is an optional feature to our standard sound deadening case.

Single sheet feeder is very simple to use. The only front load feeder available on the market today.*

1K standard buffer permits the 88G to print while receiving data. The optional 2K buffer allows a 1920 character dump to the printer freeing the CRT.

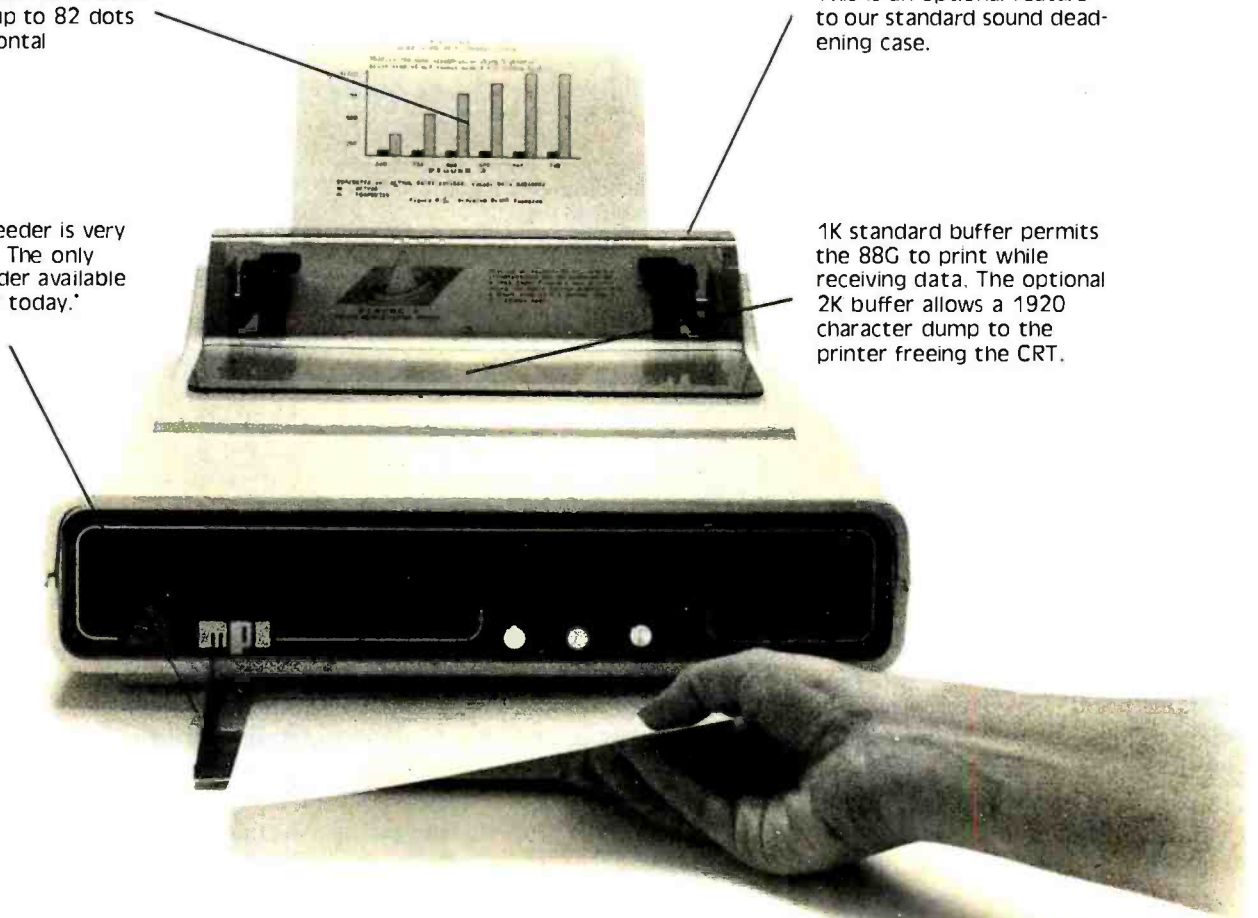

The Features Leader

Integrated Paper Handling System

Dual tractor/friction feed allows use of pin feed, roll or single sheet paper.

Versatile Interface

Data input from most computers can be supported by the 88G. RS232C serial and Centronics® type parallel is standard. Options can be added for current loop, IEEE 488 and high speed serial inputs.

Letter Quality Capability

The 88G provides a selectable 11 x 7 serif style dot matrix for correspondence printing.

Cost Effective

The 88G has more features than any other impact printer in its price class. First compare the quality of the 88G, then compare the price—the 88G wins! Single unit price is less than \$800.

*Optional



Micro Peripherals, Inc. 4426 South Century Drive Salt Lake City, Utah 84107 (801) 263-3081
The Printer People

California VITEK (714) 744-8305 Colorado PLS Associates (303) 773-1218 Florida GMI Distributors (305) 894-3354 Illinois Coombs & Associates (312) 298-4830 Massachusetts Eastmark (617) 449-0050 Minnesota Bohlig & Associates (612) 922-7011 New Jersey Hansen & Hughes (201) 652-7055 Oregon Microwave (503) 620-8150 Utah PLS Associates (801) 466-8729 Type-A-Line (801) 521-5310 International England Russet Instruments, Ltd. (0734) 868147 Telex: 849721 Phoenix Sigma International (602) 994-3435 Telex: 165-745 Sigma France IER Tel. 333.67.81 Telex: 620-289 Canada Norango (416) 449-2761

Build a Super Simple Floppy-Disk Interface

Part 2: Software

James Nicholson and Roger Camp
1046 Gaskill
Ames IA 50010

The first part of this article presented basic floppy-disk technology and a description of a simple controller design with its circuit details. This controller provides a great deal of function and flexibility when combined with some simple software.

Software

The software shown in listing 1 provides disk-formatting, reading, writing, and error-recovery functions. The software can be reassembled to allow relocation of program or page zero variables. Various entry points are shown in table 4.

Before using the FD1771 to read and write data within the sectors on the floppy disk, the disk must be formatted to conform to a certain structure. A program (entry point FORMAT) is supplied that formats all 77 tracks of a standard 8-inch disk in a standard IBM-compatible 128-bytes-per-sector arrangement (each track contains 26 sectors).

The program, when called, initializes all 6520 and 1771 electronic interfaces before writing the standard track. The initialization process guarantees that the head is positioned over the outermost track. Each track is written from a standard pattern contained in programmable memory. A 40 ms delay is generated following a step-in function to move the head to the next track. This guarantees the proper head-settling time required by the floppy-disk drive. This process

continues until all tracks have been formatted.

Sector sizes other than 128 bytes can be selected by initializing the 1771 differently. (A sector size other than 128 can lead to incompatibilities with other floppy-disk systems.) For sector lengths greater than 128, the FORMAT program must be rewritten to use an entire track image in memory. This is required because of an indexing limit of 256 using the 6502 microprocessor. Our system, using sixteen 256-byte sectors per track, has proven to be a convenient alternative.

When a disk is properly formatted, the basic I/O (input/output) program (entry point FDENT) can be used. If the system has just been turned on, entry point FDENT should be called first to initialize all interface and drive electronics. To perform disk

operations, certain variables must be set up before calling FDENT. They include the desired *command*, *track number*, and *sector number*, as well as the address in memory used for data transfer (see table 5).

The program begins by analyzing the command to determine which segment of the program must be used in response. There are three basic command types:

- head movement
- read/write sectors
- read/write raw tracks

In the case of read/write commands, the program ascertains if the head is positioned properly and, if necessary, provides the seek command to move it.

Following execution of the command by the 1771, completion

Name	Purpose
FORMAT	Write proper track format on all 77 tracks
FDINT	Initialize 6520 and 1771 interface
FDENT	Perform basic floppy-disk operations using established variables
FDIO	Uses FDENT, followed by error checking and retry

Table 4: Entry points for various floppy-disk controller operations.

Name	Length in Bytes	Purpose
DVCODE	1	Device-selection byte 00 = DVC 0, 80 = DVC 1
ERRCODE	1	FF = Error, 00 = Normal Set by FDIO
COMMAND	1	1771 Command byte
STATUS	1	1771 Completion status
TRACK	1	Desired track value
SECTOR	1	Desired sector value
FDBUF	2	Address of data buffer

Table 5: Variables used to perform floppy-disk operations. All values are listed in hexadecimal.

The numbering of all nontext material is continued from part 1 of this article.

BYTEWRITER-1

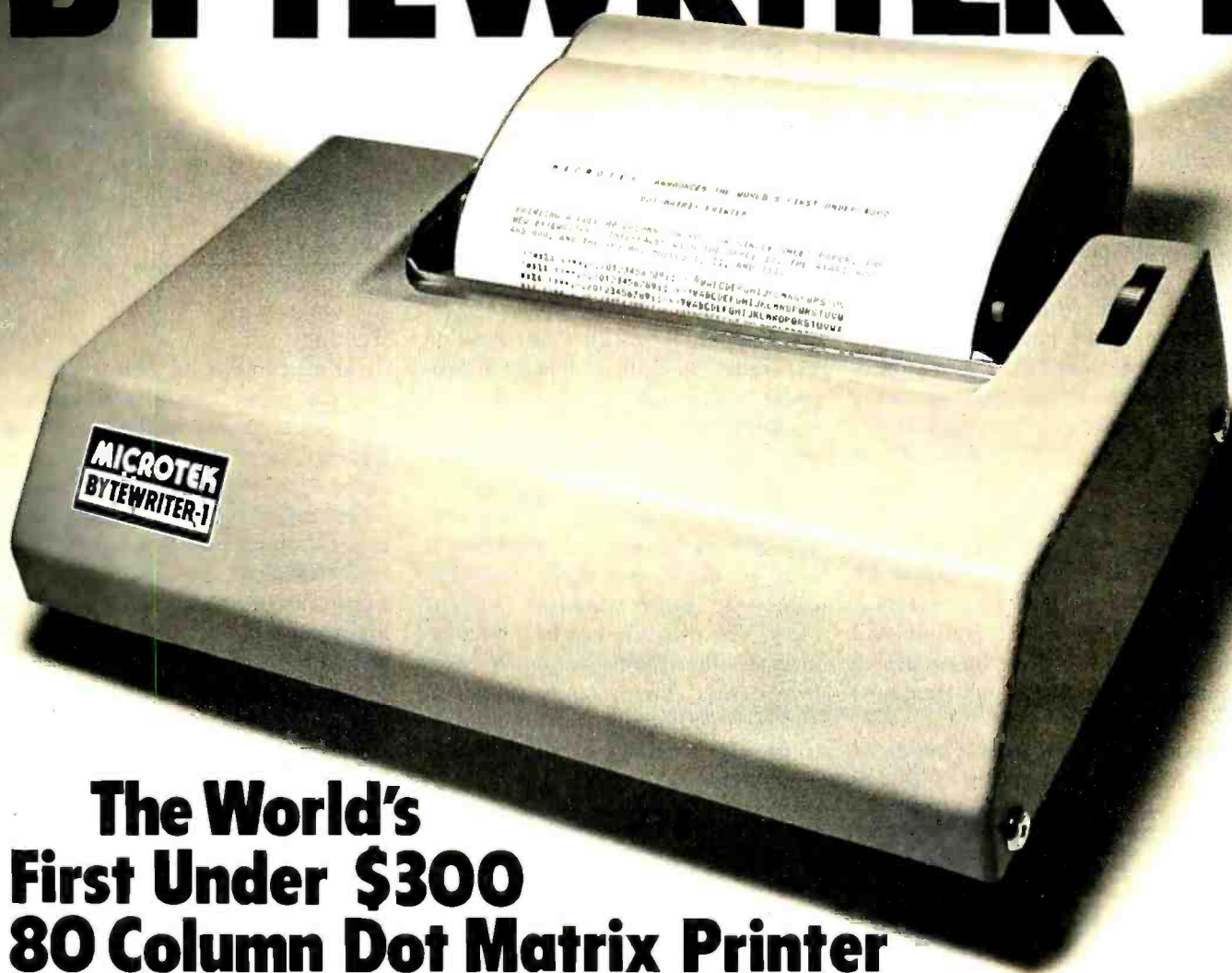

The World's First Under \$300 80 Column Dot Matrix Printer

PRICE BREAKTHROUGH FROM MICROTEK

Bytewriter-1, the \$299 printer that has taken the industry by storm! A product made possible through cost-effective design, efficient manufacturing operations, a proven low-cost print mechanism and the simplest possible control electronics. We have done extensive testing with all three models of the TRS-80, the Apple II, and the Atari 400 and 800. That is why we can guarantee you won't have any interface problems with the Bytewriter-1.

TRS-80 is a trademark of Radio Shack, Div. of Tandy Corp.
Apple II is a trademark of Apple Computer, Inc.
Atari 400 & 800 are trademarks of Atari, Inc.
Bytewriter-1 is a trademark of Microtek, Inc.

Microtek, Inc.
9514 Chesapeake Drive
San Diego, CA 92123
Tel. 714-278-0633
Outside Calif. call
toll free: 800-854-1081
TWX. 910-335-1269

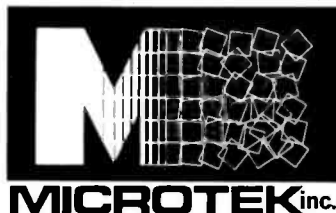

BYTEWRITER-1 SPECIFICATIONS

Printing Technology: 7-wire bi-directional impact wire matrix

Printing Speed: 60 lines per minute (80 characters per second) continuous

Character Set: 96 character ASCII (upper and lower case)

Character Size: 10 characters per inch (80 columns per line) plus expanded printing

Paper: Friction feed (synchronous), accepts single sheet and roll paper up to 9½ inches maximum width. Prints original plus 3 copies.

By the way, our replacement print-head costs less than \$30 too!
Call or write today for more information.

analysis is performed to read back and store the status, track number, and sector number from the 1771. The status can then be examined by the user program to determine if the operation was successful. No registers are saved by any of the routines previously discussed.

Although the hardware design has proven to be very reliable, an error occasionally occurs. Since it would be a great burden for each application to concern itself with error recovery, another program has been provided. Using entry point FDIO, a user program can add the error-recovery function to that provided by FDENT.

After storing all the registers, FDIO calls FDENT to perform the requested operation. Following completion, FDIO examines the status to determine if an error occurred, and, if so, the operation may be retried. Generally, read/write operations will be retried up to five times before assuming a "hard" (ie: nontransient) error.

A nonrecoverable error is indicated with hexadecimal FF in the ERRCD

COMMAND	TRACK	Variables (all values in hexadecimal)			TEST
		SECTOR	BUFADR	BUFADR + 1	
02	—	—	—	—	RESTORE
1A	20	—	—	—	SEEK
16	10	—	—	—	VERIFY
8C	10	01	00	10	READ

Table 6: Values to be set in variables for testing the controller (with the routine in listing 3). All values are listed in hexadecimal.

variable (see listing 2). This condition generally causes the application program to terminate so the error can be researched. The STATUS variable provides details about the specific problem.

Certain nonrecoverable conditions will not be retried. For example, a *busy* or *device not ready* condition causes an error condition without retry. The program can be altered to increase the sophistication to any level desired. Errors can be cataloged and recorded on another floppy disk to provide a history of all abnormal conditions.

Testing

After completing construction of the controller circuit and verifying the proper timing of the 74123 components, some simple tests can be performed to verify proper operation. These tests can be conducted with the aid of a simple program (listing 3) and table (table 6). Set your monitor to begin execution at INIT. When the break occurs, set the variables as shown for each specific test and allow program execution to continue. This procedure requires you to load the software previously discussed. Initial testing requires a *preformatted* IBM-compatible disk. Examination of the status byte following each test helps diagnose any existing problems.

The restore-drive procedure should generate stepping pulses that move the head to the track 0 position. The head-drive lead screw can be moved manually off the track 0 position to verify proper operation.

Directing the head to seek to a specific track requires the desired track value to be set in the data register of the 1771. This test also loads the head but does not attempt to perform a track verification. This test can be repeated several times with different track values to determine if the 1771 properly seeks in both directions.

If the controller moves the head correctly, the third test performs a track verification. Following the seek movement, the head is loaded, and the 1771 reads the address information recorded on the track to verify that it has located the proper track.

The fourth test attempts to read a specific sector. The data is stored beginning at location hexadecimal

Text continued on page 340

ATTENTION GOVERNMENT D P USERS AND PURCHASERS

We represent many fine micro products and manufacturers on the GSA Schedule, including

*Apple, Cromemco
and Computer Corporation of America*

Purchasing from the Schedule will save you the time consumed by the bid process. Products shipped throughout the United States and world-wide. Visit or write any of our stores for more information or to receive our catalogue of products represented.

**Computers,
Etc.....
the dependable store**

257 West Street, Annapolis, MD 21401 — (301) 268-6505
13A Allegheny Avenue, Towson, MD 21204 — (301) 296-0520
9330 Georgia Avenue, Silver Spring, MD 20910 — (301) 588-3748
or Call (301) 268-5801

*Career Opportunities Available * An Equal Opportunity Employer*

ORDERING INFO

Name, address, phone
Ship By: UPS or Mail
Shipping Chrg. Add \$2.50 up to
2 lbs. (UPS Blue)
U.S. Mail Add \$1.50 (U.S. Only)
(\$25.00 Minimum Order)

TERMS

We Accept Cash, Check, Money
Orders, Visa & Master Charge
(U.S. Funds Only)
Tax: 6% Calif. Res.
COD's & Terms Available on
Approval (School PO's Accepted)

MICROBYTE S-100 BOARDS

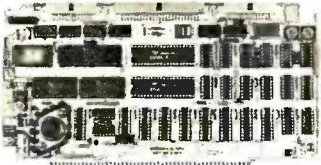

Z-80A1-I/O \$349.00
Assembled & Tested
Optional Monitor Program \$50.00

- A complete single board Z80A CPU with parallel interface
- Fully compatible with the proposed IEEE S-100 Bus Standard
- Z80A CPU (4MHz version or the Z80)
- 158 instructions—superset of and upward compatible to the 8080's 78 instructions
- 16 to 4K on board EPROM with optional Z80 monitor program—16K/32K/64K/128K/256K/512K
- Full vectored interrupt capability—3 bit with 48K/96K/192K
- DMAC or DMAC operation is jumper selectable
- Selectable software state insertion for extending M1, MREQ, IORQ and/or on board ROM
- Quad RS-232 serial I/O ports using the Z80A DART with individual baud rate selection from 50 to 200 baud
- Up to 24 bit parallel I/O ports—fully programmable Intel 8255A

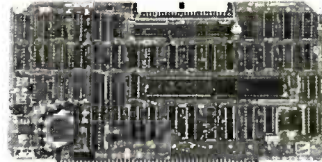

64K RAM Board
Assembled & Tested Call for Price

MICROBYTE

- Fully S-100 bus compatible
- 64K x 8 bit dynamic RAM
- Low power
 - 8 BVDCC @ 700 ma
 - 16 BVDCC @ 100 ma
 - 16 VDC @ 25 ma
- Built-in parity with LED indicator and vector interrupt
- Memory addressable in four 16K banks
- Hidden refresh
- Gold contacts for high reliability
- 72 hour Burn-in
- 15 hours mapped via DIP switch
- Built-in programmable wire probed
- Programmable control port for parity and bank control
- Alpha Micro Cleanmate

INFLATION FIGHTER

4116's (200 ns.)
Apple, TRS-80, Heath
8 for \$20⁰⁰

16-49 \$2.35
50-99 \$2.25
100 Up \$2.15

2114 L-2/200 NS

1-16 \$3.05 ea.
17-49 \$2.95 ea.
50-99 \$2.85 ea.
100 Up \$2.70 ea.

COMPONENTS

74LS240 1.25 ea.
74LS241 1.10 ea.
74LS244 1.25 ea.
74LS373 1.25 ea.
74LS374 1.25 ea.
8T245 1.45 ea.

2708/450 NS

\$4.75 ea.

OR

8/\$36⁰⁰

2716/5 VOLT

\$6.95 ea.

Major Manufacturer

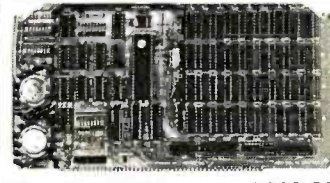

Disc Controller \$389.00
Assembled & Tested
CPM Available (Optional)

MICROBYTE

- DMAC within 16M byte of memory
- State of the art NEC75C LSI Controller
- IEEE S-100 compatible
- DMAC operation allows use of multiple boards within a system
- PLL data recovery for totally reliable operation
- Write pre-compulsed at mid disc for reliable double density operation
- Supports up to four disk drives
- Power On, Power Off or Reset del. selects pre- or post-damaging files
- Drive select. Time Out detected drives not in use
- Single or double sided operation
- Single density/double density operation
- 8" Standard drives
- Separate VCC supply for dual rec. elim. all possible noise problems

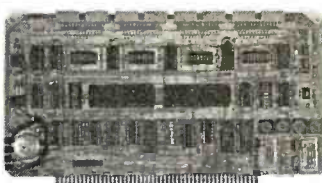

I/O Board \$289.00
Assembled & Tested
Cables Available (Optional)

MICROBYTE

- Quad RS-232C Serial Ports, One 20mA Current Loop Port
- Fully IEEE S-100 Bus Compatible
- Asynchronous Communications with Z80A Data/IO or Synchronous Communications with Z80A SIO/DM
- Full Serial Modem Control Signals including RI (Ring Indicator)
- Easily Configurable to Any Type of Terminal Interface
- I/O Sensing Environments: (1) Polled, (2) Bus Vector, (3) Z80 Mode 2 Vector
- On Board Interrupt Daisy Chain Capability
- Special Receive Conditions: (1) Framing Error, (2) Parity Error, (3) Receiver Overrun Error
- Baud Rates Selectable Individually from 50 Baud to 3000 Baud
- 72 Hour Burn-In

S.D. SYSTEM / S-100 BOARDS

EXPANDRAM I 16K \$240.00
2MHZ DYNAMIC RAM BOARD KITS 32K \$260.00
48K \$280.00
64K \$300.00

EXPANDRAM II 16K \$250.00
4MHZ DYNAMIC RAM BOARD KITS 32K \$270.00
48K \$290.00
64K \$310.00

SBC-100 KIT \$299.00
2.5 MHz/Z-80 CPU WITH SERIAL & PARALLEL I/O PORTS

SBC-200 KIT \$325.00
4MHz/Z-80 CPU WITH SERIAL & PARALLEL I/O PORTS

VDB-8024 KIT \$380.00
80x24 I/O MAPPED VIDEO BOARD WITH KEYBOARD I/O

VERSAFLOPPY I KIT \$250.00
DISK CONTROLLER FOR 8" & 5 1/4" DRIVES
S-100 BUS COMPATIBLE

VERSAFLOPPY II KIT \$350.00
NEW DOUBLE DENSITY DISK CONTROLLER FOR 8" & 5 1/4" DRIVES

PROM-100 KIT \$210.00
S-100/EPROM PROGRAMMER FOR 2708, 2716, 2732, 2758 & 2516(TI)

ALL BOARDS ARE AVAILABLE (ASSEMBLED & TESTED)
CALL FOR PRICE & DELIVERY

SYSTEM SOFTWARE AVAILABLE ON REQUEST

CALIFORNIA COMPUTER

- 2032 32K STATIC RAM BRD.
 - 2065 64K DYNAMIC RAM BRD.
 - 2116 16K STATIC RAM BRD.
 - 2200 MAINFRAME
 - 2422 DISK CONTROLLER
 - 2501 MOTHERBOARD
 - 2710 4-PORT SERIAL I/O
 - 2718 2 SER. PORT & 2 PAR.
 - 2720 4-PORT PARALLEL I/O
 - 2802 6502 CPU BOARD
 - 2810 Z-80 CPU BOARD
 - 7114A 12K ROM/PROM BRD.
 - 7424A CALENDAR CLOCK BRD.
 - 7440A PROGRAMMABLE TIMER
 - 7470 A/D CONVERTER
 - 7710A SERIAL SYNCH. BOARD
 - 7712A SERIAL SYNCH. BOARD
 - 7720A PARALLEL INTERFACE
 - 7728A CENTRONICS INTERFACE
- CALL FOR PRICE & DELIVERY

CAPACITORS

.1 @ 12 Volt
Ceramic
8¢ ea.

OR
100/\$7.00

CONNECTORS

100 PIN IMSAI
GOLD/S-100
SOLDER TAIL
\$2.40 ea.
OR
10/\$2.25 ea.

LO-PRO SOCKETS

1-99	100 Up
14 PIN .10	.09
16 PIN .12	.11
18 PIN .15	.13
20 PIN .23	.21
24 PIN .26	.24
28 PIN .30	.28
40 PIN .40	.38
(BURN/DY/TIN SOLDER TAIL)	

PRINTERS

CENTRONICS 737-1
ANADEX DP8000
ANADEX DP9500
ANADEX DP9501
TEXAS INST 810
BASE 2 800 MST
CALL FOR PRICE & DELIVERY

MICROPROCESSORS

8080A	\$ 2.50
Z80A	\$ 8.95
Z80A CTC	\$ 7.95
Z80A DART	\$13.95
Z80A SIO	\$24.95
8255 AC5	\$ 5.95
8257 AC5	\$ 8.95
8224	\$ 2.75

REGULATORS

320T5 .. .80	340T5 .. .70
320T12 .. .80	340T12 .. .75
78L1225

RS-232 CONNECTORS

	DB25P	DB25S
1-9	2.90	3.80
10-24	2.75	3.70
25 Up	2.40	3.60
	Data Phone Hood 1.00	

ATARI 800 (NEW 16K VERSION)

- COMPUTER CONSOLE •OPERATORS MANUAL
- ATARI BASIC 8K RAM •RF MODULATOR
- 57 FULL STROKE •POWER SUPPLY
- ALPHANUMERIC KEYS •ADDED OPTIONS
- PLUS 4 FUNCTION KEYS •JOYSTICKS
- EDUCATION ROM (NO CHARGE)

CALL FOR PRICE
10% OFF SOFTWARE WITH PURCHASE

ATARI OPTIONAL ACCESSORIES

MODEL #	DESCRIPTION	PRICE
810	Disk Drive System	\$ 499.00
815	Disk Drive System	\$1199.00
820	40-col. Dot Matrix Printer	\$ 349.00
822	40-col. Thermal Printer	\$ 349.00
825	80-col. Dot Matrix Printer	\$ 750.00
830	Acoustic Modem	\$ 159.00
850	Interface Module	\$ 175.00
CX853	16K RAM Module	\$ 140.00
410	Cassette Recorder	\$ 60.00

QUME DT-3 DISK DRIVE

- Double-sided/Single-Double Density
 - IBM-compatible 1.2 Mbytes/Disk
 - Fast — 3 ms. Track to Track
 - 154 Tracks/Daisy Chain 4 Drives
 - ISO Standard Write Protect
 - Programmable Door Lock
- CALL FOR PRICE & DELIVERY

DISKETTES

	Part #	Price Box of 10
Verbatim 5 1/4" (soft)	MD525-01	\$26.50
Scotch 5 1/4" (soft)	744-0	\$33.00
Scotch 5 1/4" (10-sec)	744-10	\$33.00
Scotch 5 1/4" (16-sec)	744-16	\$33.00
Memorex 5 1/4" (soft)	3421	\$24.00
Scotch 8" DS (soft)	743-0	\$49.95
Maxell 8" DS/DD	FD-2D	\$55.00

ATARI SOFTWARE

Description	Price
Basketball	\$30.00
Super Breakout	\$30.00
Chess	\$30.00
Video Easel	\$30.00
3-D Tic Tac Toe	\$30.00
Star Raiders	\$42.00
Music Composer	\$42.00
Educational Sys. ROM	\$19.95
Assembler/Editor	\$45.00
Telexlink I	\$19.95
Space Invaders	\$15.95
Kingdom	\$12.95
Blackjack	\$12.95
Biorhythm	\$12.95
Graph It	\$15.95
Energy Czar	\$12.95
Mailing List	\$16.95
Statistics I	\$16.95
Paddle Controls	\$17.95
Joysticks (pair)	\$17.95

MODEMS

NOVATION CAT
300 BAUD
ACOUSTIC COUPLER
\$149.00 ea.
NOVATION D-CAT
300 BAUD/DIRECT CONNECT
\$169.00 ea.

MONITORS

AMDEX/LEEDEX VIDEO 100
12" B&W \$139.00 ea.
SANYO VM5012
12" B&W \$275.00 ea.
AMDEX/LEEDEX 13" Color \$375.00 ea.

SHUGART SA 801R

8" Sgl.-Sided, Sgl./Dbl. Density Disk Drive
Call for Price & Delivery
Cables Available

New 16K RAM MODULE FOR ATARI 800 Computer Systems
\$89.95 each
1 YEAR WARRANTY

MAINFRAME & DISK DRIVE CABINETS from INTEGRAND

MODEL X5 — Desktop Mainframe — 5 Cards — Small Power Supply \$200
Cabinet size: 9 1/2" x 15 1/2" x 11 1/2" Cabinet painted dove grey, front panel is black. No optional colors! 5 position motherboard, 5 connectors installed, card cage with all guides, Reset switch on front panel, Power switch, 4 DB25 outputs, 1 BNC mounting hole, 70CFM fan, EMI filter, 6" power cord, line fuse, and clamped flat cable exit on rear panel. P/S4 power supply (+8@10A, +16@1 5A, -16@1 5A) Power supply is a removable module.

MODEL 7000 — Horizontal Desktop Disk/Cover — 2 Eight Inch Drives — Drives Horizontal \$250
Cabinet size: 20" x 23" x 7 1/2" Cabinet painted dove grey, front panel is black. Mounting for 2 eight-inch Shugart SA801R Floppy Disk Drives (or mechanical equivalent). Drive mounting brackets supplied. Drives not supplied. 70CFM fan, 6" three-wire line cord, power switch, line fuse, EMI filter and clamped flat cable exit on rear panel. P/S4 power supply (+5@4A, +24@5A—6A Peak, -5@ 75A All voltages regulated. Power supply is a removable module.

MODEL 8000 — Desktop Main/Frame — 15 Cards — Standard Power Supply \$255
Cabinet size: 17" x 20 1/2" x 11 1/2" Cabinet painted dove grey, front panel is black (other color schemes optional). 15-position IEEE compatible motherboard (will accept T801 terminator kit, optional), card cage with all guides, Reset switch on front panel, Power switch, 8 DB25 outputs, 2 BNC mounting holes, 70CFM fan, EMI filter, 6" power cord, line fuse, and clamped flat cable exit on rear panel. P800 power supply (+8@15A, +16@3A, -16@3A). Power supply is a removable module. Motherboard connectors optional.

MODEL 7000S — Vertical Desktop Disk/Cover — 2 Eight Inch Drives — Drives Vertical \$250
Cabinet size: 13 1/2" x 23" x 11 1/2" Cabinet painted dove grey, front panel is black. Mounting for 2 eight-inch Shugart SA801R Floppy Disk Drives (or mechanical equivalent). Drive mounting brackets supplied. Drives not supplied. 70CFM fan, 6" three-wire line cord, power switch, line fuse, EMI filter and clamped flat cable exit on rear panel. P/S4 power supply (+5@4A, +24@5A—6A Peak, -5@ 75A All voltages regulated. Power supply is a removable module.

Listing 1: Software to provide fundamental high-level operations for the disk controller (written for the 6502 microprocessor).

```

FD400/FD1771B FLOPPY DISK CONTROL                                PAGE 1
CARD # LOC      CODE      CARD 10      20      30      40      50      60      70
 2 0000          ;          .OPT CNT,XREF,MEM,LIST,ERR,GEN
 3 0000          ;
 4 0000          ; J.H.NICHOLSON 1-22-79
 5 0000          ;
 6 0000          ;
 7 0000          ; THIS SEGMENT PROVIDES BASIC CONTROL FUNCTIONS FOR EXECUTING
 8 0000          ; COMMANDS TO A PERTEC FD400 FLOPPY DISK DRIVE CONTROLLED WITH
 9 0000          ; A WESTERN DIGITAL FD1771B-01 FLOPPY DISK CONTROLLER. THE BASIC
10 0000          ; ROUTINES PROVIDE AN INTERFACE VIA A 6520 PIA TO THE FD400/FD1771B
11 0000          ; SYSTEM.
12 0000          ; THE FD1771B COMMAND, TRACK, AND SECTOR VALUES ARE PROVIDED IN
13 0000          ; PAGE ZERO VARIABLES. THE COMMAND AND OTHER NECESSARY DATA IS
14 0000          ; WRITTEN TO THE FD1771B AND THE COMMAND IS EXECUTED. FOLLOWING
15 0000          ; THE COMPLETION OF THE COMMAND(INTRQ FROM FD1771B) THE STATUS,
16 0000          ; TRACK, AND SECTOR VALUES ARE READ FROM THE FD1771B. NO ERROR
17 0000          ; RECOVERY IS PERFORMED BY THIS SEGMENT. IF THE DEVICE IS BUSY
18 0000          ; WHEN THIS SEGMENT IS GIVEN CONTROL, NORMAL COMPLETION ANALYSIS
19 0000          ; WILL BE DONE.
20 0000          ; TWO ENTRY POINTS TO THIS SEGMENT PROVIDE COMMAND EXECUTION AND
21 0000          ; PIA INITIALIZATION.
22 0000          ; FDINT.....ENTRY FOR FD1771B COMMAND EXECUTION.
23 0000          ; FDINT.....ENTRY FOR INITIALIZATION OF FD400/FD1771B.
24 0000          ;
25 0000          ;
26 0000          ; ALL FD1771B COMMANDS ARE VALID AND ARE LISTED BELOW BY FUNCTIONAL
27 0000          ; CATAGORY AS WELL AS TYPE GROUPS.
28 0000          ;
29 0000          ; BASIC : RESTORE          TYPE 1.  RESTORE
30 0000          ;          STEP          SEEK
31 0000          ;          STEP IN       STEP
32 0000          ;          STEP OUT      STEP IN
33 0000          ;          FORCE INTRQ    STEP OUT
34 0000          ;
35 0000          ; READ  : READ SECTOR     TYPE 2.  READ SECTOR
36 0000          ;          READ TRACK    WRITE SECTOR
37 0000          ;          READ ADDR
38 0000          ;          TYPE 3.  READ ADDR
39 0000          ; WRITE : WRITE SECTOR   READ TRACK
40 0000          ;          WRITE TRACK   WRITE TRACK
41 0000          ;
42 0000          ; SEEK  : SEEK          TYPE 4.  FORCE INTRQ

```

```

FD400/FD1771B FLOPPY DISK CONTROL                                PAGE 2
CARD # LOC      CODE      CARD 10      20      30      40      50      60      70
44 0000          ;
45 0000          ;
46 0000          ; WHEN GIVEN CONTROL, THIS SEGMENT ANALYZES THE COMMAND TYPE
47 0000          ; TO DETERMINE THE FUNCTIONS WHICH MUST BE PERFORMED. THE COMMANDS
48 0000          ; CAN BE SEGMENTED INTO FOUR LOGICAL FUNCTION GROUPS WHICH ARE
49 0000          ; SIMILAR TO THE FD1771B COMMAND TYPES.
50 0000          ;
51 0000          ;
52 0000          ; CMD TYPE          FUNCTION
53 0000          ; -----          -----
54 0000          ; TYPE 1(EX.SEEK)  BASIC FUNCTION
55 0000          ;
56 0000          ; TYPE 1(SEEK)     WRITE NEW TRACK, THEN BASIC
57 0000          ;
58 0000          ; TYPE 2           WRITE SECTOR REGISTER
59 0000          ;                   SPLIT TO READ OR WRITE
60 0000          ;
61 0000          ; TYPE 3           SPLIT TO READ OR WRITE
62 0000          ;
63 0000          ; TYPE 4           BASIC FUNCTION
64 0000          ;

```

Listing 1 continued on page 308

If you need M68000, Z8000, or 8086 Software, take it off our shelf.

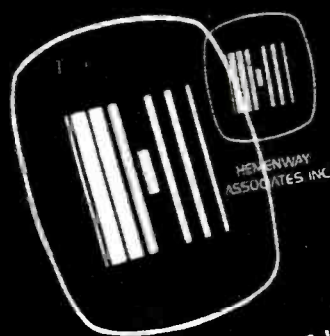

HEMENWAY ASSOCIATES, INC.

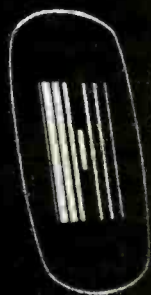

HEMENWAY ASSOCIATES, INC.



HEMENWAY ASSOCIATES, INC.



HEMENWAY ASSOCIATES, INC.



HEMENWAY ASSOCIATES, INC.



HEMENWAY ASSOCIATES, INC.



HEMENWAY ASSOCIATES, INC.



HEMENWAY ASSOCIATES, INC.



M68000
Operating Systems

M68000
Operating Systems

M68000
Assembler/Linker

M68000
Test Driver

M68000
Copilers

Why wait up to 6 months for high quality 16-bit resident system software, when you can get it now?

Hemenway Associates can give you the software tools you need to get the most out of your 16-bit hardware. Because 8086, Z8000 and 68000 Systems Software is sitting on our shelves right now.

Single user operating systems, macro assemblers, text editors, floating point packages, multi-tasking operating systems, linking loaders and PASCAL compilers are all ready for immediate delivery.

You've heard about Hemenway Associates' system designs in the pages of EDN. But now you can have Hemenway-

designed software for your 16-bit microprocessor. Our software is easily adaptable to any hardware configuration. From manufacturers evaluation boards to full-blown microcomputers. It's efficient, easy-to-use and backed by ongoing support.

So whether you're a microcomputer manufacturer, software developer or individual microcomputer owner, Hemenway has the software for you.

For the hard facts on Hemenway software, write or call: Hemenway Associates, 101 Tremont Street, Boston, Massachusetts 02108. Phone: 617-426-1931. TWX 710 321 1203. TELEX 921735.



HEMENWAY ASSOCIATES, INC.

When it comes to software, come to Hemenway.



HEMENWAY ASSOCIATES, INC.



HEMENWAY ASSOCIATES, INC.



HEMENWAY ASSOCIATES, INC.

Listing 1 continued:

```

65 0000 ;
66 0000 ; BASIC FUNCTION :
67 0000 ; 1. WRITE COMMAND TO THE FD1771B.
68 0000 ; 2. WAIT FOR COMPLETION(INTRQ).
69 0000 ; 3. COMPLETION ANALYSIS(READ STATUS, TRACK, AND SECTOR)
70 0000 ; 4. EXIT
71 0000 ;
72 0000 ; SEEK FUNCTION :
73 0000 ; 1. WRITE NEW TRACK TO DATA REGISTER.
74 0000 ; 2. WRITE SECTOR TO SECTOR REGISTER.
75 0000 ; 3. GO TO BASIC FUNCTION.
76 0000 ;
77 0000 ; READ FUNCTION :
78 0000 ; 1. SEEK TO PROPER TRACK IF NECESSARY
79 0000 ; 2. WRITE SECTOR TO SECTOR REGISTER.
80 0000 ; 3. WRITE COMMAND TO FD1771B.
81 0000 ; 4. WAIT & LOOP FOR DRQ/INTRQ READING DATA ON DRQ.
82 0000 ; 5. ON INTRQ DO COMPLETION ANALYSIS(BASIC FCTN, STEP 3)
83 0000 ;
84 0000 ; WRITE FUNCTION :
85 0000 ; 1. SEEK TO PROPER TRACK IF NECESSARY
86 0000 ; 2. WRITE SECTOR TO SECTOR REGISTER.
87 0000 ; 3. WRITE COMMAND TO FD1771B.
88 0000 ; 4. WAIT & LOOP FOR DRQ/INTRQ WRITING DATA ON DRQ.
89 0000 ; 5. ON INTRQ DO COMPLETION ANALYSIS(BASIC FCTN, STEP 3)

```

FD400/FD1771B FLOPPY DISK CONTROL

CARD #	LOC	CODE	CARD 10	20	30	40	50	60	70
91	0000								
92	0000		***** 6520 PIA						
93	0000								
94	0000	SADD	=%CC0C		6520 PIA A DATA DIRECTION				
95	0000	SAD	=%CC0C		6520 PIA A DATA REGISTER				
96	0000	CRA	=%CC0D		6520 PIA A CONTROL REGISTER				
97	0000	SBDD	=%CC0E		6520 PIA B DATA DIRECTION				
98	0000	SBD	=%CC0E		6520 PIA B DATA REGISTER				
99	0000	CRB	=%CC0F		6520 PIA B CONTROL REGISTER				
100	0000								
101	0000		***** PIA CONNECTIONS						
102	0000								
103	0000		CA1	<--	UNUSED				
104	0000		CA2	-->	PULSE(-RE CLR)				
105	0000		PA7	<-->	DAL7				
106	0000		PA6	<-->	DAL6				
107	0000		PA5	<-->	DAL5				
108	0000		PA4	<-->	DAL4				
109	0000		PA3	<-->	DAL3				
110	0000		PA2	<-->	DAL2				
111	0000		PA1	<-->	DAL1				
112	0000		PA0	<-->	DAL0				
113	0000								
114	0000		PB7	<--	INTRQ				
115	0000		PB6	<--	DRQ				
116	0000		PB5	-->	READ				
117	0000		PB4	-->	WRITE				
118	0000		PB3	-->	-MR				
119	0000		PB2	-->	A1				
120	0000		PB1	-->	A0				
121	0000		PB0	-->	-ENABLE R/W				
122	0000		CB1	<--	UNUSED				
123	0000		CB2	-->	DEVICE SELECT				
124	0000								
125	0000		***** FD1771B COMMANDS						
126	0000								
127	0000	FDRST	=%02		RESTORE				
128	0000	FDSK	=%12		SEEK				
129	0000	FDST	=%22		STEP				
130	0000	FDSTI	=%42		STEP IN				
131	0000	FDSTO	=%62		STEP OUT				
132	0000	FDRD	=%80		READ SECTOR				
133	0000	FDWT	=%A0		WRITE SECTOR				

Listing 1 continued on page 310



Teach your little Apple big-time electronic mail.

To the average manager, electronic mail means bells, whistles and fans. It means expensive special phone lines. It means a fussy, exotic mainframe that only data processing zealots understand, and only committees of senior corporate vice presidents authorize for acquisition. To top it off, the system is useless for communications outside your own company.

But now there's Micro-Courier.™ A system that gives you all the electronic mail you'll ever need without draining the corporate treasury, or entangling you in corporate red tape.

All it takes is a trip to your local Apple™ computer dealer, who can install low-cost Micro-Courier software on any Apple II desktop computer.

The rest of the equipment you already have. Your own phone line. Micro-Courier communicates over standard telephone lines, and it's designed to let you take advantage of late-night transmission rates. While you're home in bed, your Micro-Courier system will send 1,000 words of text in one minute for less than a quarter. A comparable TWX® message costs \$4.32.

But text is only the beginning. Because Micro-Courier will electronically mail much more. Charts, graphs, VisiCalc™ reports and complete programs. Built-in error checking (the kind found on big computers) ensures accurate transmission.

What's more, the system is menu-driven, so it asks for your commands in plain English. It maintains phone lists and sorts messages by individual user. Its documentation is clear and non-technical. And the scope of your network is virtually limitless, because Micro-Courier will exchange information with time-sharing systems and larger computers.

Call our toll-free number today.

MICROCOM

We make little computers talk big.

Even little budgets can now buy big-time electronic mail. Call 800-547-5995, ext. 188, toll-free, for the Micro-Courier-Apple dealer nearest you. *Dealer inquiries invited.*

Microcom, Inc., 89 State Street, Boston, MA 02109. (617) 367-6362

Apple and Apple II are trademarks of Apple Computer, Inc. VisiCalc is a trademark of Personal Software, Inc. TWX is a trademark of Western Union, Inc.

Listing 1 continued:

```

134 0000      FDRDA  = $C4          READ ADDRESS
135 0000      FDRDT  = $E4          READ TRACK
136 0000      FDWTT  = $F4          WRITE TRACK
137 0000      FDFI   = $D0          FORCE INTERRUPT
138 0000      ;
139 0000      ; ***** COMMAND QUALIFIERS
140 0000      ;
141 0000      QV     = $04          VERIFY
142 0000      QH     = $08          LOAD HEAD
143 0000      QU     = $10          UPDATE TRK REG
144 0000      QM     = $10          MULTIPLE RECORDS
145 0000      QB     = $08          IBM FORMAT

```

FD400/FD1771B FLOPPY DISK CONTROL

PAGE 4

CARD #	LOC	CODE	CARD 10	20	30	40	50	60	70
146	0000	QS	=\$01			NOT SYNC TO AM			
147	0000	QI0	=\$01			NR TO R TRANS.			
148	0000	QI1	=\$02			R TO NR TRANS.			
149	0000	QI2	=\$04			INDEX PULSE			
150	0000	QI3	=\$08			EACH 10 MS.			
151	0000	QE	=\$04			ENABLE HLD + HLT DELAY			
152	0000	QFB	=\$00			FB DATA MARK			
153	0000	QFA	=\$01			FA DATA MARK			
154	0000	QF9	=\$10			F9 DATA MARK			
155	0000	QF8	=\$11			F8 DATA MARK			
156	0000	;							
157	0000	;	***** INITIALIZATION CTL BYTES						
158	0000	;							
159	0000	QCRC	=\$F7			WRITE CRC			
160	0000	QIAM	=\$FC			INDEX ADDR MARK			
161	0000	QIDM	=\$FE			ID ADDR MARK			
162	0000	QAFB	=\$FB			FB DATA MARK			
163	0000	QAFA	=\$FA			FA DATA MARK			

Listing 1 continued on page 312

MICROCOMPEQUIP

DISCOUNTS & DEALER OVERSTOCKS

Circle 230 on inquiry card.

ALL ITEMS BELOW SOLD AS IS — NO RETURNS / NO REPAIRS
CALL FOR AVAILABILITY: LIMITED QUANTITIES

NEW EQUIPMENT

CALL FOR
OUR LOW PRICES
FOR THE FOLLOWING
MANUFACTURERS:

APPLE
ATARI
CROMEMCO
VECTOR GRAPHIC

MICROCOMPEQUIP
PO BOX 195
CROWNSVILLE, MD 21032

VISA / MC / CHECK

PHONE ORDERS:
(301) 261-1859

	Sell For	List Price
A.I. Cybernetics Speechboard	260.00	380.00
Anadex 40 Column Printer	641.00	855.00
Base 2 8K Memory Board Assembled	211.00	282.00
Commodore 2001-8 8K PET	550.00	795.00
Craig M-100 Translator	122.00	199.95
Dajen Cassette Interface	88.00	120.00
Dynabyte Naked Terminal	245.00	350.00
Digital Systems Dual 8" Single Density	2293.00	2732.00
Dutronics Poly Z-80 Upgrade Kit	123.00	169.95
Dutronics Imsai Z-80 Upgrade Kit	116.00	159.95
Eclectic Corp. Superchip for Apple II	75.00	95.00
Fidelity Electronics Ltd.		
Level 1 Chess Challenger	120.00	75.00
Level 4 Checker Challenger	100.00	115.00
Level 2 Checker Challenger	40.00	40.00
George Rtsk Inc. Pet Keyboard	176.00	250.00
Imsai CPU Board	125.00	175.00
Icom Micro Peripherals 5" Disk Drive	821.00	1095.00
Intertec Data Intertube Terminal	595.00	874.00
Kent Moore 8K RAM 450NS	148.00	197.50
Kent Moore Alpha Display Module	80.25	107.00
Mountain Hardware		
AC Control Apple	132.00	189.00
AC Remote	95.00	149.00
S-100 AC Control Kit	104.00	149.00
AC Remote Kit	67.00	99.00
AC Control-Apple Kit	104.00	145.00
Micromation Dual Memorex 8" disk drive	1467.00	1990.00
Micromation Dual Density disk controller Card	310.00	500.00
MS Corp. Apple FR-40 Interface	87.00	87.00
National Multiplex Digital Cassette Recorder	150.00	200.00
Novation 1200 Baud Modem (4202T)	274.00	375.00
Radio Shack TRS-80 Disk Drive	399.00	499.00
TRS-80 16K Computer	479.00	599.00
TRS-80 Expansion Interface	239.00	299.00

Polymorphic Systems		
8K Assembled	289.00	385.00
8K Memory Board	225.00	300.00
Poly KBD	169.00	225.00
8813	2880.00	3250.00
88-System 2	529.00	735.00
System 12 Kit	846.00	1128.00
System 6	1134.00	1575.00
Video Card	210.00	280.00
Processor Tech		
8K Dynamic Ram	175.00	250.00
16K Dynamic Ram	300.00	429.00
64K Dynamic Ram	878.00	1350.00
Extended Basic Cassette	21.00	45.00
SOL 20 W/O Memory	1270.00	1895.00
System II Kit	1262.00	1905.00
Panasonic Monitor	143.00	210.00
SD Sales 32K Dynamic Ram Board Kit	332.00	475.00
Solid State Music 16K Static Ram Board Kit	300.00	325.00
Southwest Technical (SWTPC)		
MF-68 Dual 5" Floppy	796.00	995.00
Graphics Terminal	79.00	98.50
Technical Design Labs (TDL-Xitan)		
I/O board - SMB-II	257.00	395.00
32L Series K Memory Board	559.00	799.00
Fortran IV Ser.37	279.00	349.00
Fortran IV Ser.41	279.00	349.00
Xitan Alpha 1.5	823.00	1138.00
Xitan Alpha 1	576.00	769.00
Xitan Alpha 3	854.00	1181.00
Xitan Alpha 1.5	571.00	868.00
Video Board	277.00	369.00
Technico Super Starter Assembled	293.00	300.00
Technico Super Starter Kit	199.00	299.00
Trace Elec. 32K RAM Board Assem	599.00	999.00

MULTI-USER OASIS HAS THE FEATURES PROS DEMAND. READ WHY.

Computer experts (the pros) usually have big computer experience. That's why when they shop system software for Z80 micros, they look for the big system features they're used to. And that's why they like Multi-User OASIS. You will too.

DATA INTEGRITY: FILE & AUTOMATIC RECORD LOCKING

The biggest challenge for any multi-user system is co-ordinating requests from several users to change the same record at the same time.

Without proper co-ordination, the confusion and problems of inaccurate or even destroyed data can be staggering.

Our File and Automatic Record Locking features solve these problems.

For example: normally all users can view a particular record at the same time. But, if that record is being updated by one user, automatic record locking will deny all other users access to the record until the up-date is completed. So records are always accurate, up-to-date and integrity is assured.

Pros demand file & automatic record locking. OASIS has it.

SYSTEM SECURITY: LOGON, PASSWORD & USER ACCOUNTING

Controlling who gets on your system and what they do once they're on it is the essence of system security.

(THEN COMPARE.)

Without this control, unauthorized users could access your programs and data and do what they like. A frightening prospect isn't it?

And multi-users can multiply the problem.

But with the Logon, Password and Privilege Level features of Multi-User OASIS, a system manager can specify for each user which programs and files may be accessed—and for what purpose.

Security is further enhanced by User Accounting—a feature that lets you keep a history of which user has been logged on, when and for how long.

Pros insist on these security features. OASIS has them.

EFFICIENCY: RE-ENTRANT BASIC

A multi-user system is often not even practical on computers limited to 64K memory.

OASIS Re-entrant BASIC makes it practical.

How? Because all users use a single run-time BASIC module, to execute their compiled programs, less

memory is needed. Even if you have more than 64K, your pay-off is cost saving and more efficient use of all the memory you have available—because it services more users.

Sound like a pro feature? It is. And OASIS has it.

AND LOTS MORE...

Multi-User OASIS supports as many as 16 terminals and can run in as little as 56K memory. Or, with bank switching, as much as 784K.

Multi-Tasking lets each user run more than one job at the same time.

And there's our BASIC—a compiler, interpreter and debugger all in one.

An OASIS exclusive.

Still more: Editor; Hard & Floppy Disk Support; Keyed (ISAM), Direct & Sequential Files; Mail-Box; Scheduler; Spooler; all from OASIS.

Our documentation is recognized as some of the best, most extensive, in the industry. And, of course, there's plenty of application software.

Put it all together and it's easy to see why the real pros like OASIS. Join them. Send your order today.

OASIS IS AVAILABLE FOR SYSTEMS: Altos; CompuCorp; Cromemco; Delta Products; Digital Group; Digital Microsystems; Dynabyte; Godbout; IBC; Index; Intersystems; North Star; Onyx; SD Systems; TRS 80 Mod II; Vector Graphic; Vorimex

CONTROLLERS: Bell Controls; Cameo; Corvus; Konan; Micromation; Micropots; Tarbell; Teletek; Thinkertoys; X Comp

Write for complete, free Application Software Directory.

PLEASE SEND ME:

Product	Price with Manual	Manual Only
OPERATING SYSTEM (Includes: EXEC Language; File Management; User Accounting; Device Drivers; Print Spooler; General Text Editor; etc.) SINGLE-USER MULTI-USER	\$150 350	\$17.50 17.50
BASIC COMPILER/INTERPRETER/DEBUGGER	100	15.00
RE-ENTRANT BASIC COMPILER/INTERPRETER/DEBUGGER	150	15.00
DEVELOPMENT PACKAGE (Macro Assembler; Linkage Editor; Debugger)	150	25.00
TEXT EDITOR & SCRIPT PROCESSOR	150	15.00
DIAGNOSTIC & CONVERSION UTILITIES (Memory Test; Assembly Language; Converters; File Recovery; Disk Test; File Copy from other OS; etc.)	100	15.00
COMMUNICATIONS PACKAGE (Terminal Emulator; File Send & Receive)	100	15.00
PACKAGE PRICE (All of Above) SINGLE-USER MULTI-USER	500 850	60.00 60.00
FILE SORT	100	15.00
COBOL-ANSI '74	750	35.00

Order OASIS from:

Phase One Systems, Inc.
7700 Edgewater Drive, Suite 830
Oakland, CA 94621

Telephone (415) 562-8085
TWX 910-366-7139

NAME _____
STREET (NO BOX #) _____
CITY _____
STATE _____ ZIP _____

AMOUNT \$ _____
(Attach system description; add 53 for shipping; California residents add sales tax)
 Check enclosed VISA
 UPS C.O.D. Mastercharge
Card Number _____
Expiration Date _____
Signature _____



MAKES MICROS RUN LIKE MINIS

Listing 1 continued:

```

164 0000 QAF9  =F9          F9 DATA MARK
165 0000 QAF8  =F8          F8 DATA MARK
166 0000 ;
167 0000 ; ***** PIA CONTROL COMMANDS(-MR ON)
168 0000 ;
169 0000 READ   =$29          READ FD1771B
170 0000 WRITE  =$19          WRITE FD1771B
171 0000 STAT   =$00          A1=0,A0=0  STATUS REGISTER
172 0000 TRK    =$02          A1=0,A0=1  TRACK REGISTER
173 0000 SECT   =$04          A1=1,A0=0  SECTOR REGISTER
174 0000 DATA  =$06          A1=1,A0=1  DATA REGISTER
175 0000 CMD    =$00          A1=0,A0=0  COMMAND REGISTER
176 0000 ;
177 0000 ; ***** PAGE ZERO VARIABLES/EQUATES
178 0000 ;
179 0000 TIME1  *=*+1
180 0001 TIME2  *=*+1
181 0002      *=E0
182 00E0 DVCODE *=*+1          DVC/FILE CODE
183 00E1 ERRCD  *=*+1          ERROR CODE
184 00E2 COMAND *=*+1  FD1771B COMMAND
185 00E3 STATUS *=*+1          STATUS
186 00E4 TRACK  *=*+1          TRACK
187 00E5 SECTOR *=*+1          SECTOR
188 00E6 FDBUF *=*+2          BUFFER PTR
189 00E8 ;
190 00E8      *=E200

```

FD400/FD1771B FLOPPY DISK CONTROL

PAGE 5

CARD #	LOC	CODE	CARD	10	20	30	40	50	60	70
192	0200									
193	0200									
194	0200									
195	0200	A5 E2	TYPE1	LDA	COMAND	IF NOT SEEK				
196	0202	C9 20		CMP	#\$20	ASSUME				
197	0204	B0 3A		BCS	BASIC	BASIC				
198	0206	C9 10		CMP	#\$10	IF RESTORE				
199	0208	90 36		BCC	BASIC	ASSUME BASIC				
200	020A	A9 1F		LDA	#WRITE+DATA	PIA CTL CMD				
201	020C	20 DE 02		JSR	SETUP	SET-UP PIA				
202	020F	A5 E4		LDA	TRACK	TRACK ADDR				
203	0211	C9 4D		CMP	#\$4D	IF PAST END				
204	0213	B0 33		BCS	COMPANL	RETURN				
205	0215	20 CD 02		JSR	PULSE	WRITE TRACK				
206	0218	A9 1D		LDA	#WRITE+SECT	PIA CTL CMD				
207	021A	20 DE 02		JSR	SETUP	SET-UP PIA				
208	021D	A5 E5		LDA	SECTOR	SECTOR ADDR				
209	021F	20 CD 02		JSR	PULSE	WRITE SECTOR				
210	0222	4C 40 02		JMP	BASIC	CONTINUE				
211	0225									
212	0225									
213	0225									
214	0225	A9 29	FDENT	LDA	#READ+STAT	PIA CTL CMD		** ENTRY **		
215	0227	20 DE 02		JSR	SETUP	SET-UP PIA				
216	022A	20 CD 02		JSR	PULSE	READ STATUS				
217	022D	6A		ROR	A	IF DEVICE BUSY				
218	022E	B0 18		BCS	COMPANL	DO COMPLETION				
219	0230									
220	0230									
221	0230									
222	0230	A9 10		LDA	#\$10	CMD MASK				
223	0232	24 E2		BIT	COMAND	CHECK FOR				
224	0234	10 CA		BPL	TYPE1	TYPE 1				
225	0236	50 23		BVC	TYPE2	TYPE 2				
226	0238	F0 4A		BEQ	RDATA	TYPE 3 READ				
227	023A	A9 20		LDA	#\$20	SEPERATE				
228	023C	24 E2		BIT	COMAND	FORCE INTRQ FROM				
229	023E	D0 63		BNE	WDATA	TYPE 3 WRITE				
230	0240									
231	0240									
232	0240									
233	0240	20 C2 02	BASIC	JSR	WRTCMD	WRITE CMD TO FD1771B				
234	0243	2C DE CC		BIT	SBD	WAIT FOR				

Listing 1 continued on page 314

Computers Designed for the Professional

Billings Computer Division designs and supports a complete line of computer systems for the professional user which includes an impressive library of professional applications software.

WORD/FORMS PROCESSOR PACK is a screen oriented context editor featuring word underlining, variable line spacing, right margin justification, proportional pitch, block moves, search and replace, column alignment, super- and subscripting, plus many others.

BOOKKEEPER SERIES ACCOUNTING PACK includes Payroll, Accounts Payable, Accounts Receivable, and General Ledger. Easily tailored reports make this a very versatile package designed to meet the needs of a wide variety of businesses.

LEGAL ACCOUNTING PACK is a complete cash accounting system including Fees Manager, Cash Receipts, Statements, and Check Manager. Payroll and General Ledger from Bookkeeper series also are compatible.

INVENTORY MANAGEMENT PACK is a powerful manufacturing inventory package designed to eliminate parts shortages and overstocking. Ordering and expediting reports are generated from a 52-week production schedule. Cost calculations are made for up to 19 different models.

SCREEN ASIST PACK is a program development tool which simplifies the formatting of information on the CRT screen. A special editor allows the creation of a template with protected and unprotected fields.

FORTRAN PACK includes all of the normal features plus special subroutines to allow enhanced file access and manipulation, sorting, use of screen ASIST, and many others. Overlay capability allows development of many programs normally too large for a small computer.

BASIC PACK has both EBasic for fast Basic applications and BBasic for applications requiring capabilities not normally available to Basic users, such as indexed files, structured "if-then-else" statements, Trace debug feature, formatted input and output, and others.

COBOL PACK is an ANSI 1974 version with many level two features plus the same enhancements as the FORTRAN PACK.



Billings

18600 E. 37th Terrace
Independence, MO 64057
(816) 373-0000

Please send information on becoming a Billings Dealer.

Name _____

Company _____

Title _____ Phone() _____

Address _____

City _____ State _____ Zip _____

Listing 1 continued:

```

235 0246 10 FB          BPL *-3      INTRQ
236 0248                ;
237 0248                ; ***** COMPLETION ANALYSIS
238 0248                ;
239 0248 A0 02        CMPANL LDY #2      LOOP CNT + INDEX
240 024A 98          CPLP   TYA          USE INDEX TO
241 024B 0A          ASL    A           SET A1,A0
242 024C 09 29        ORA   #READ      SET READ
243 024E 20 DE 02    JSR   SETUP      SET-UP PIA
244 0251 20 CD 02    JSR   PULSE      READ REGISTER
245 0254 99 E3 00    STA   STATUS,Y    STORE DATA
246 0257 88          DEY           DECR INDEX

```

FD400/FD1771B FLOPPY DISK CONTROL

PAGE 6

CARD #	LOC	CODE	CARD	10	20	30	40	50	60	70
247	0258	10 F0	BPL	CPLP	CONTINUE					
248	025A	60	RTS		RETURN					
249	025B									
250	025B									
251	025B									
252	025B	A9 2B	TYPE2	LDA	#READ+TRK	PIA CTL CMD				
253	025D	20 DE 02	JSR	SETUP	SET-UP PIA					
254	0260	20 CD 02	JSR	PULSE	READ TRACK					
255	0263	C5 E4	CMP	TRACK	IF NOT EQUAL					
256	0265	F0 0D	BEQ	TYPE2A	SEEK TO TRACK					
257	0267	A5 E2	LDA	COMAND	SAVE COMMAND					
258	0269	48	PHA		FOR LATER					
259	026A	A9 12	LDA	#FDSK	SEEK COMMAND					
260	026C	85 E2	STA	COMAND	SET IT					
261	026E	20 25 02	JSR	FDENT	DO SEEK					
262	0271	68	PLA		RESTORE					
263	0272	85 E2	STA	COMAND	COMMAND					
264	0274									
265	0274									
266	0274									
267	0274	A9 1D	TYPE2A	LDA	#WRITE+SECT	PIA CTL CMD				
268	0276	20 DE 02	JSR	SETUP	SET-UP PIA					
269	0279	A5 E5	LDA	SECTOR	SECTOR ADDR					
270	027B	20 CD 02	JSR	PULSE	WRITE SECTOR					
271	027E	A9 20	LDA	#S20	SEPERATE					
272	0280	24 E2	BIT	COMAND	READ					
273	0282	D0 1F	BNE	WDATA	FROM WRITE					
274	0284									
275	0284									
276	0284									
277	0284	20 C2 02	RDATA	JSR	WRTCMD	WRITE COMMAND				
278	0287	A0 00	LDY	#0	BUFFER INDEX					
279	0289	A9 2F	LDA	#READ+DATA	PIA CTL CMD					
280	028B	20 DE 02	JSR	SETUP	SET-UP PIA					
281	028E	2C 0E CC	RDL	BIT	SBD	WAIT FOR	4			
282	0291	30 B5	BMI	CMPANL	INTRQ OR		2			
283	0293	50 F9	BVC	RDL	DRQ		2			
284	0295	AD 0C CC	LDA	SAD	GET DATA BYTE		4	25 CYCLES		
285	0298	49 FF	EOR	#\$FF	INVERT DATA		2			
286	029A	91 E6	STA	(FDBUF),Y	SAVE BYTE		6			
287	029C	C8	INY		INCR BUFFER PTR		2			
288	029D	D0 EF	BNE	RDL	IF ZERO		3	2		
289	029F	E6 E7	INC	FDBUF+1	INCR BASE AND		5	+ 9 CYCLES		
290	02A1	D0 EB	BNE	RDL	CONTINUE		3			
291	02A3									
292	02A3									
293	02A3									
294	02A3	20 C2 02	WDATA	JSR	WRTCMD	WRITE COMMAND				
295	02A6	A0 00	LDY	#0	BUFFER INDEX					
296	02A8	A9 1F	LDA	#WRITE+DATA	PIA CTL CMD					
297	02AA	20 DE 02	JSR	SETUP	SET-UP PIA					
298	02AD	B1 E6	WTL	LDA	(FDBUF),Y	GET DATA BYTE	6			
299	02AF	49 FF	EOR	#\$FF	INVERT DATA		2			
300	02B1	8D 0C CC	STA	SAD	WRITE IT		4			
301	02B4	2C 0E CC	WTL1	BIT	SBD	WAIT FOR	4	25 CYCLES		

Listing 1 continued on page 317

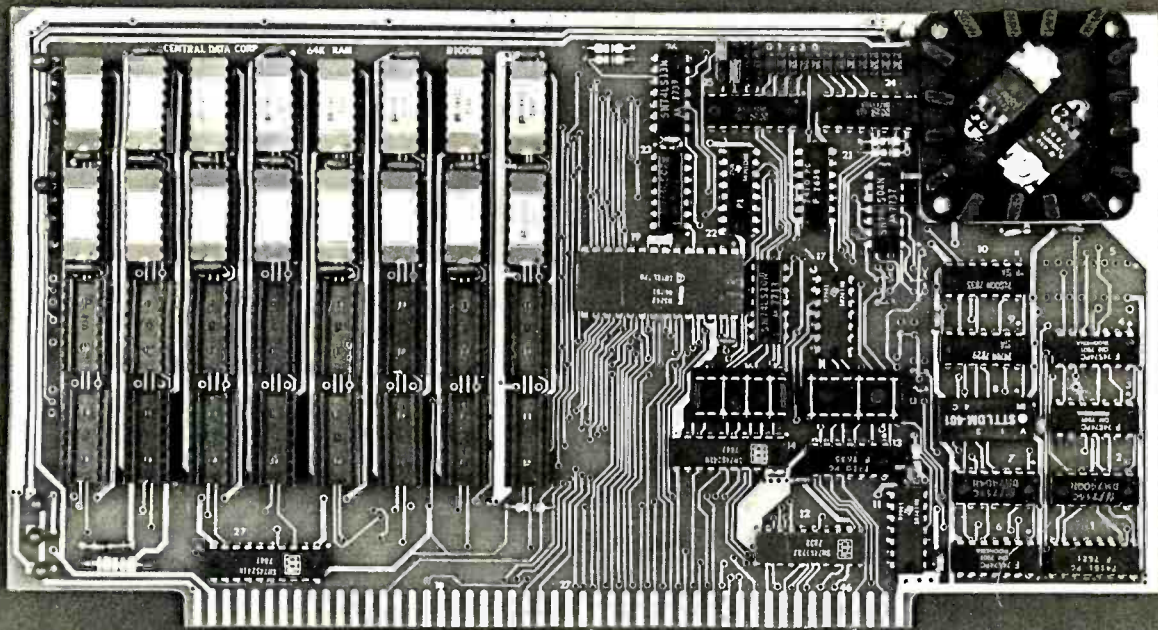

32K Board Pictured Above

Why Not the Best?

From The Dynamic RAM Company.

2MHz	4MHz
16K—\$249	\$259
32K—\$375	\$395
48K—\$500	\$530
64K—\$625	\$665

We have now been shipping our 2MHz dynamic RAM boards for over two years. Hundreds of 4MHz boards have been going out every month since early 1979. Our reliability is proven in the thousands of systems which contain our board. Many quality-minded systems houses across the country and overseas are using our boards for their equipment.

Our prices still beat all. Despite rising 16K memory chip prices (at least from reputable suppliers), Central Data continues to give you the best buy in memory today. Nobody offers a board with a capacity of 64K, assembled, tested, and guaranteed for a full year at the price we do.

Deselect around PROMs. Our boards have the important deselect feature which lets you overlap any fixed memory in your system with no interference.

Our features make the board easily used and expanded. You address our boards on 16K boundaries with mini-jumps (small shorting plugs that slide over wire-wrap pins) near the top of the board for easy access. If you want to expand your board after you have purchased it, all that you need to do is add memory. We can supply you with expansion packages (\$150-2MHz, \$160-4MHz) which include eight RAMs that you can depend on as well as two mini-jumps for addressing. And of course, our board **never** generates wait states.

Low power consumption keeps your computer running cool and reliable. The total power consumption of our 16K board is typically less than 4 watts (+8V @ 300ma, +16V @ 150ma and

–16V @ 20ma). Boards with additional memory typically increase power consumption only 1 watt per 16K!

Standard S-100 Interface. Our board is designed to interface with any standard S-100 CPU. All of the timing of the board is independent of the processor chip, and the board is set up for different processors by changing two plugs on the board.

Call or write us today. That will guarantee a fast response with more information on the board. Or make an order — you'll probably have the board in two weeks! **If you're interested, also ask for a catalog on our Z8000 16-bit processor board designed for the MULTIBUS.** All of these products are available to your local dealer, also.

Central Data Corporation, 713 Edgebrook Drive, PO Box 2530, Station A, Champaign, IL 61820. (217) 359-8010

Central Data

The A2-3D1 Graphics Family...

Now for non-programmers!

professional 3D and 2D graphics for the Apple II

The **A2-3D1** is the graphics utility you can depend on whether you're mapping a town, presenting charts at a business meeting, or animating games.

Now this versatility is available for the non-programmer with the **A2-GE1** graphics editor and programmer. Create images as you view them. Scan them, animate them, combine them, or add text or labels. With a minimum of fuss, you can prepare all sorts of scientific, business, or educational presentations.

Add the **A2-3D2** enhancement package for color, and as a bonus you'll also be able to manipulate images independently of each other—as many different objects at once as your memory will accommodate.

When it's time for some challenging and educational entertainment, run the **A2-3D/A** Saturn Navigator. You'll enjoy an adventurous flight to Saturn, enter its orbit, and rendezvous with an orbital space station that awaits your arrival.

We've reached our goal of giving you the most sophisticated graphics utilities in the marketplace.

see them now at your dealer!

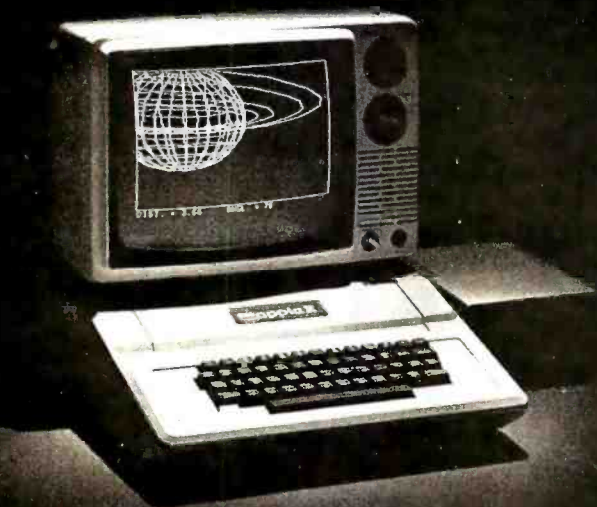

Running on the Apple II:
A2-3D/A Saturn Navigator

A2-3D1 Graphics Package
\$59.95 on disk (32K required)
\$49.95 on cassette (16K
required)

A2-3D2 Enhancement
\$24.95 on disk (48K and
A2-3D1 required)
\$19.95 on cassette (32K and
A2-3D1 required)

A2-GE1 Graphics Editor
\$34.95 on disk (48K and
A2-3D1 required)

A2-3D/A Saturn Navigator
\$24.95 on disk (48K and
A2-3D1 required)

For direct order, include \$3 for UPS or \$5 for first class mail delivery.
Illinois residents add 5% sales tax. Visa and Master Card accepted.

subLOGIC

Communications Corp.
Box V, Savoy, IL 61874
(217) 359-8482
Telex: 206995
Circle 345 on Inquiry card.

Listing 1 continued:

FD400/FD1771B FLOPPY DISK CONTROL

PAGE 7

CARD #	LOC	CODE	CARD	10	20	30	40	50	60	70
302	02B7	30 SF		BMI	CMPANL	INTRQ OR		2		
303	02B9	50 F9		BVC	WTL1	DRQ		2		
304	02BB	CS		INY		INCR BUFFER PTR		2		
305	02BC	D0 EF		BNE	WTL	IF ZERO		3	2	
306	02BE	E6 E7		INC	FDBUF+1	INCR BASE AND		5	+ 9 CYCLES	
307	02C0	D0 EB		BNE	WTL	CONTINUE		3		
308	02C2									
309	02C2									
310	02C2									
311	02C2									
312	02C2	A9 19	WRTCMD	LDA	#WRITE+CMD	PIA CTL CMD				
313	02C4	20 DE 02		JSR	SETUP	SET-UP PIA				
314	02C7	A5 E2		LDA	COMAND	GET COMMAND				
315	02C9	20 CD 02		JSR	PULSE	AND WRITE IT				
316	02CC	60		RTS		RETURN				
317	02CD									
318	02CD									
319	02CD									
320	02CD									
321	02CD	49 FF	PULSE	EOR	#\$FF	INVERT DATA				
322	02CF	8D 0C CC		STA	SAD	DATA OUT				
323	02D2	CE 0E CC		DEC	SBD	ENABLE				
324	02D5	EE 0E CC		INC	SBD	READ/WRITE				
325	02D8	AD 0C CC		LDA	SAD	DATA IN				
326	02DB	49 FF		EOR	#\$FF	INVERT DATA				
327	02DD	60		RTS		CONTINUE				
328	02DE									
329	02DE									
330	02DE									
331	02DE	A2 00	SETUP	LDX	#\$00	ASSUME READ				
332	02E0	8D 0E CC		STA	SBD	SET DVC CTL REG				
333	02E3	0A		ASL	A	CHECK				
334	02E4	0A		ASL	A	IF READ AND				
335	02E5	30 01		BMI	SET1	SET FOR INPUT				
336	02E7	CA		DEX		ADJUST DIR TO OUTPUT				
337	02E8	A9 00	SET1	LDA	#0	SET CTL FOR				
338	02EA	SD 0D CC		STA	CRA	DIR REGISTER				
339	02ED	8E 0C CC		STX	SADD	SET DATA DIRECTION				
340	02F0	A9 2C		LDA	#\$2C	RESET PIA CTL				
341	02F2	SD 0D CC		STA	CRA	TO DATA REG				
342	02F5	60		RTS		RETURN				
343	02F6									
344	02F6									

Listing 1 continued on page 318

Plug in Pascal Power...

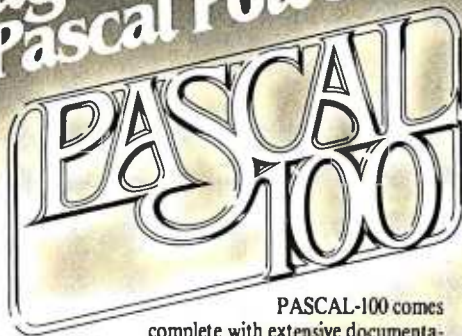

Microengine Power

Plug in PASCAL-100™ new CPU Boardset for S-100 computers. Go with the power of the Pascal Micro-engine. Run UCSD Pascal[®] up to 10 times faster than typical implementations—with twice the memory capacity. You've got the best hardware for the best software around.

On-board Z80

PASCAL-100 includes a Z80[®] processor, so you can run your current software—including CP/M[®]—without modification. Ready to convert an application to Pascal? Do it anytime, with no disruptive hardware changes.

PASCAL-100 comes complete with extensive documentation—our users say it's the best around!

New Generation S-100

PASCAL-100 is designed for the versatile, flexible S-100 bus. Fully compatible with the new IEEE-696 standard, yet works with

most pre-standard boards.

- 16 bit operation
- 128K byte memory capacity, 1 Megabyte with Extended Memory Map
- Works with 8 or 16 bit memory

Want to know more? Just circle our number on the reader service card. For fast action, call or write us directly.

OEM'S/DEALERS

Be sure to specify our PASCAL-100 OEM/Dealer Information Package

Digicomp Research
Terrace Hill Ithaca, NY 14850
(607) 273-5900



[®]Trademark of Western Digital [®]Trademark of University of California
[®]Registered Trademark of Zilog, Inc. [®]Registered Trademark of Digital Research

Listing 1 continued:

```

345 02F6 ;
346 02F6 A2 00 FDINT LDX #000 A DIR AS INPUT ** ENTRY **
347 02F8 20 E8 02 JSR SET1 SET-UP A SIDE
348 02FB AD 0C CC LDA SAD CLEAR -RE
349 02FE A0 04 LDY #004 CTL FOR B SIDE
350 0300 8C 0F CC STY CRB DATA REGISTER
351 0303 86 E0 STX DVCODE CLEAR DEVICE CODE
352 0305 E8 INX SET B SIDE
353 0306 8E 0E CC STX SBD DATA REGISTER
354 0309 CA DEX CTL FOR B SIDE
355 030A 8E 0F CC STX CRB DIR REGISTER
356 030D A2 3F LDX #03F SET B SIDE

```

FD400/FD1771B FLOPPY DISK CONTROL

PAGE 8

CARD #	LOC	CODE	CARD 10	20	30	40	50	60	70
357	030F	8E 0E CC	STX	SBDD		DIR REGISTER			
358	0312	A2 3C	LDX	#03C		SELECT			
359	0314	8E 0F CC	STX	CRB		DEVICE 1			
360	0317	A9 02	LDA	#FDRST		RESTORE CMD			
361	0319	85 E2	STA	COMAND		SAVE IT			
362	031B	20 40 02	JSR	BASIC		RESTORE DEVICE 1			
363	031E	A2 34	LDX	#034		SELECT			
364	0320	8E 0F CC	STX	CRB		DEVICE 0			
365	0323	4C 40 02	JMP	BASIC		RESTORE DEVICE 0			
366	0326								
367	0326								

FLOPPY DISK I/O & ERROR RECOVERY

PAGE 9

CARD #	LOC	CODE	CARD 10	20	30	40	50	60	70
369	0326								
370	0326								
371	0326								
372	0326								
373	0326								
374	0326								
375	0326								
376	0326								
377	0326								
378	0326								
379	0326								
380	0326								
381	0326								
382	0326								
383	0326								
384	0326								
385	0326								
386	0326								
387	0326								
388	0326								
389	0326								
390	0326								
391	0326								
392	0326								
393	0326	48	FDIO	PHA		SAVE ACC			** ENTRY **
394	0327	98		TYA		SAVE Y			
395	0328	48		PHA		REGISTER			
396	0329	8A		TXA		SAVE X			
397	032A	48		PHA		REGISTER			
398	032B	A9 05		LDA	#5	SET ERROR			
399	032D	85 E1		STA	ERRCDE	COUNT			
400	032F	A9 34		LDA	#034	START W/DVC 0			
401	0331	24 E0		BIT	DVCODE	IF NOT 0			
402	0333	50 02		BVC	SETDVC	SET TO ONE			
403	0335	09 08		ORA	#08	SET DVC 1			
404	0337	8D 0F CC	SETDVC	STA	CRB	SET PIA			
405	033A	A5 E7	RETRY	LDA	FDBUF+1	SAVE ADDR HIGH			
406	033C	48		PHA		FOR RECOVERY			
407	033D	A5 E5		LDA	SECTOR	SAVE SECTOR			
408	033F	48		PHA		FOR RECOVERY			
409	0340	20 25 02		JSR	FDENT	EXEC CMD			

Listing 1 continued on page 320

If you can't find the right program in our new catalog, it probably hasn't been written.

As the world's largest publisher of professional software for micro-computers, Lifeboat Associates offers the largest selection of state-of-the-art programs. And our new catalog has more to offer than ever. We also add the crucial dimension of after-sales service and full support to everything we sell. Order your free catalog today.



For a free catalog, mail coupon to Lifeboat Associates, 1651 Third Avenue, New York, NY 10028. Or call (212) 860-0300. Telex 640693 (LBSOFT NYK)

Name _____ Title _____
Company _____
Street _____
City _____ State _____ Zip _____

CB681

Our catalog contains full descriptions and specifications of the following:

DISK OPERATING SYSTEMS	TELECOMMUNICATIONS	MAIL LIST APPLICATIONS	THE PASCAL HANDBOOK
CP/M CONFIGURED FOR: APPLE II DATAPOINT 1550/2150 ICOM MICRO DISK ICOM 3712 ICOM 3812 ICOM 4511/PERTEC D3000 INTEL MDS MICROPOLIS FLOPPY DISK MITS/ALTAIR MOSTEK MDX NORTH STAR OSI C3 OSI C3B OSI C3C Prime TRS-80 MODEL II MP/M FOR INTEL MDS	BSTAM BSTMS LANGUAGES ALGOL-80 muSIMP APL/V80 NEVADA COBOL BASIC-80 PASCAL/M (COMPILER) PASCAL/MT BASIC-80 PASCAL/MT+ (INTERPRETER) PASCAL/Z BDS C COMPILER PL/I-80 CBASIC-2 S-BASIC CIS COBOL TINY C COBOL-80 TINY-C TWO FORTRAN-80 W'SMITHS C JRT PASCAL COMPILER muLISP XYBASIC	MAILING ADDRESS (PTREE) MAILMERGE FOR WORDSTAR NAO POSTMASTER BUSINESS APPLICATIONS ACCOUNTS PAYABLE (PTREE) ACCOUNTS PAYABLE (SSG) ACCOUNTS RECEIVABLE (PTREE) ACCOUNTS RECEIVABLE (SSG) GENERAL LEDGER II (CPAIDS) GENERAL LEDGER (PTREE) GENERAL LEDGER (SSG) GLECTOR FOR SELECTOR III-C2 INVENTORY (PTREE) INVENTORY (SSG) PAYROLL (PTREE) PAYROLL (SSG)	PASCAL USER MANUAL AND REPORT PAYROLL WITH COST ACCOUNTING-CBASIC STRUCTURED MICROPROCESSOR PROGRAMMING USING CP/M-A SELF-TEACHING GUIDE ACCESSORIES DC 300 DATA CARTRIDGE HEAD CLEANING DISKETTE FLOPPY DISK KIT FLOPPY SAVER Program names and computer names are generally trademarks or service marks of the author or manufacturing company. All software products have specific requirements for hardware and additional associated software (e.g. operating system or language). All products are subject to terms and conditions of sale. Prices and specifications are subject to change without notice. All Lifeboat software requires CP/M unless otherwise stated. Copyright © 1981 Lifeboat Associates. No portion of this advertisement may be reproduced without prior permission.
HARD DISK INTEGRATION MODULES CORVUS WITH APPLE II SOFTCARD CORVUS WITH S100 AND TRS-80 MODEL II ICOM 4511/PERTEC D3000 KONAN PLUS CDC PHOENIX XCOMP SM/S PLUS CDC PHOENIX XCOMP DFC10 FOR PERTEC D3000	LANGUAGE AND APPLICATIONS TOOLS BASIC UTILITY MOBS DRS DISK MOBS.RTL DATASTAR M/SORT FOR FABS COBOL-80 FORMS 1 FOR CIS PEARL COBOL PSORT FORMS 2 FOR CIS QSORT COBOL STRING BIT MAGSAM III STRING /80 MAGSAM IV SUPER-SORT ULTRASORT II	NUMERICAL PROBLEM-SOLVING TOOLS ANALYST STATPAK FPL T/MAKER muMATH OTHER SPECIALIZED APPLICATIONS DATEBOOK ESQ-3 DENTAL PAS-3 MEDICAL PROPERTY MANAGEMENT (PTREE) BOOKS AND PERIODICALS APL - AN INTERACTIVE APPROACH ACCOUNTS PAYABLE & ACCOUNTS RECEIVABLE-CBASIC 8080/Z80 ASSEMBLY LANGUAGE THE CP/M HANDBOOK THE C PROGRAMMING LANGUAGE CRASH COURSE IN MICROCOMPUTERS FIFTY BASIC EXERCISES GENERAL LEDGER-CBASIC INTRODUCTION TO PASCAL LIFELINES	
SYSTEMS TOOLS BUG AND uBUG SIO DESPOOL TRS-80 MODEL II DISLOG CP/M DISTEL CUSTOMIZATION EDIT UNLOCK EDIT-80 WORD-MASTER FILETRAN XASM-18 IBM/CPM XASM-48 MAC XASM-65 MACRO-80 XASM-68 PASM XMACRO-86 PLINK Z80 DEVELOPMENT PMATE PACKAGE RAID ZSD RECLAIM ZSD	WORD PROCESSING SYSTEMS AND AIDS MAGIC WAND TEX LETTERIGHT TEXTWRITER III MICROSPELL WORDSTAR SPELLGUARD WORDINDEX DATA MANAGEMENT PACKAGES CONDOOR MOBS MOBS MOBS.ORS GENERAL PURPOSE APPLICATIONS CBS SELECTOR IV SELECTOR III-C2		
ORDERING INFORMATION. COMPUTERS SUPPORTED INCLUDE: ADD S Multivision RT AVL Eagle RB Akair 8800 B1 Atos A1 Apple CP/M 13 Sector RG Apple CP/M 16 Sector RR BASF System 7100 RD Blackhawk Micropolis Mod II O2 CDS Versatile 3B O1 CDS Versatile 4 O2 Columbia Data Products A1 COMPAL-80 T1 CSSN Backup Q2 Cromenco System 3 A1 Cromenco System 2 SOSS R6 Cromenco System 2 DOSS RX Cromenco System 2 DDOSS RY Datapoint 1550/2150 Single Sided AA Datapoint 1550/2150 Double Sided AB Delta Systems A1 Digi-Log Microterm II RD Digital Microsystems A1 Durango F-85 RL Dynabyte DBB/2 R1 Ovnabyte DBB/4 A1	Exidy Sorcerer + Lifeboat CP/M Q2 Exidy Sorcerer + Exidy CP/M R4 Health HB + H17/H27 disk PW Health HB9 + Lifeboat CP/M P4 Health HB9 + Magnolia CP/M P7 Health HB9 + Health CP/M B2 Helios II P7 ICOM 2411 Micro Floppy R3 ICOM 3712 A1 ICOM 3812 A1 ICOM 4511 5440 Cartridge CP/M 1.4 O1 ICOM 4511 5440 Cartridge CP/M 2.2 O2 IMS 5000 RA IMS 8000 RA IMSAI VDP-40 A1 IMSAI VDP-42 R4 IMSAI VDP-44 R5 IMSAI VDP-80 R4 ISC Intecolor 8063/8360/8963 A1 Intertec Superbrain DOS 0.1 R7 Intertec Superbrain DOS 0.5 RJ Intertec Superbrain DOS 3.x RK Intertec Superbrain OD RS Kontron PSI-80 R5 MITS 3200-3202 B1 MSO 5.25 in. C1 Meca Delta-15.25 in. P6	Microcromation A1 Micropolis Mod I Q1 Micropolis Mod II O2 Morrow Discus A1 Mostek A1 NEC PC-8001 PV North Star Single Density R1 North Star Double Density R2 North Star Quad Density P3 Nytec Micropolis Mod II O2 Ohio Scientific C3 A3 OKI IF-800 Q2 Onyx C8001 R2 Perlec PCC 2000 A1 Processor Technology Helios II B2 Quay 500 R4 Quay 520 R5 RAIR Single Density RP RAIR Double Density R9 Research Machines 5.25 in. RE Research Machines 8 in. RH SD Systems 5.25 in. R3 SO Systems 8 in. A1 Sanco 7000 5.25 in. RO Spacebyte R1 TEI 5.25 in. A3 TEI 8 in. A1	TIP T3 TRS-80 Model I STANDARD R2 TRS-80 Model I + FEC Freedom RN TRS-80 Model I + Microcromation A4 TRS-80 Model I + Omikron 5.25 in. RM TRS-80 Model I + Omikron 8 in. A1 TRS-80 Model I + Shuttleboard 8 in. A1 TRS-80 Model II A1 TRS-80 Model III RU Vector M 2 O2 Vector System 2800 Q1 Vector System 8 Q2 Vector VIP Q2 Vista V-80 5.25 in. Single Density RB Vista V200 5.25 in. Double Density P6 Zenith Z89 + Zenith CP/M P4 Zenith Z89 + Lifeboat CP/M P4 Zenith Z89 + Magnolia CP/M P7 SS = single sided SD = single density DD = double sided DD = double density The list of available formats is subject to change without notice. In case of uncertainty, call to confirm the format code for any particular equipment.

LIFEBOAT WORLDWIDE

Lifeboat Inc.
3-23-B Wshi-shinbashi
Minato-ku, Tokyo, 105 Japan
Tel: 03-437-3901
Telex: 2422723 (ASRTYOJ)

Lifeboat Associates, Ltd.
PO Box 125
London WC2H 9LU, England
Tel: 01-836-9028
Telex: 893709 (LBSOFTG)

Lifeboat Associates GmbH
PO Box 168, Aegenstrasse 35
CH 6340 Baar, Switzerland
Tel: 042-31-2931
Telex: 865265 (MICO CH)

Intersoft GmbH
Schlossgartenweg 5
D-8045 Ismaning, W. Germany
Tel: 089-966-444
Telex: 5213643 (ISOFTD)

Lifeboat Associates, SARL
10, Grande Rue Charles de Gaulle
92600 Asnieres, France
Tel: 1-733-08-04
Telex: 250303 (PUBLIC X PARIS)

Lifeboat Associates

Software with full support.

Listing 1 continued:

```

410 0343 38          SEC          ASSUME ERROR
411 0344             ;
412 0344             ; ***** CHECK FOR BUSY/NOT READY
413 0344             ;
414 0344 A9 01       LDA  #01       CHECK
415 0346 24 E3       BIT  STATUS     FOR
416 0348 D0 3F       BNE  ER1        BUSY OR
417 034A 30 3D       BMI  ER1        NOT READY
418 034C             ;
419 034C             ; ***** DETERMINE CMD TYPE
420 034C             ;
421 034C A9 10       LDA  #010      CMD MASK
422 034E 24 E2       BIT  COMAND     SPLIT INTO
423 0350 10 19       BPL  TYP1      TYPE 1

```

FLOPPY DISK I/O & ERROR RECOVERY

PAGE 10

```

CARD # LOC  CODE          CARD 10      20      30      40      50      60      70
424 0352 50 29          BVC  TYP2      TYPE 2
425 0354 F0 37          BEQ  RDT      TYPE 3 READ
426 0356 A9 20          LDA  #020     SEPERATE
427 0358 24 E2          BIT  COMAND     FORCE INTRQ FROM
428 035A D0 27          BNE  WRT      TYPE 3 WRITE
429 035C             ;
430 035C             ; ***** RETURN
431 035C             ;
432 035C 18           RTN1  CLC          NO ERROR
433 035D A9 00          LDA  #0        CLEAR
434 035F 85 E1          RTN2  STA  ERRCODE  ERROR CODE
435 0361 68           PLA          CLEAR STACK
436 0362 85 E5          STA  SECTOR     OF SECTOR
437 0364 68           PLA          AND ADDR HIGH
438 0365 68           RTN3  PLA          RESTORE X
439 0366 AA           TAX          REGISTER
440 0367 68           PLA          RESTORE Y
441 0368 A6           TAY          REGISTER
442 0369 68           PLA          RESTORE ACC
443 036A 60           RTS          RETURN
444 036B             ;
445 036B             ; ***** TYPE 1 RECOVERY
446 036B             ;
447 036B A9 18          TYP1  LDA  #018     CHECK FOR
448 036D 25 E3          AND  STATUS     BOTH CRC AND
449 036F F0 EB          BEQ  RTN1
450 0371 C9 18          CMP  #018     NOT FOUND
451 0373 F0 14          BEQ  ER1      ERRORS
452 0375 A9 30          LDA  #030     STOP IF
453 0377 24 E2          BIT  COMAND     STEP IN
454 0379 D0 0E          BNE  ER1      OR STEP OUT
455 037B F0 26          BEQ  RDT1     RETRY SEEK AND RESTORE
456 037D             ;
457 037D             ; ***** TYPE 2 SEPERATION
458 037D             ;

```

Listing 1 continued on page 322



ADVANCED MICRO SYSTEMS • 26188 ADAMOR ROAD • CALABASAS, CA. 91302
OPEN MON.-FRI. 10-8 SAT. 10-6 Tel.: (213) 880-4670

COMPLETE QUALITY SYSTEMS AT LOW, LOW PRICES !

ALL SYSTEMS ALLOW MULTI-USER, MULTI-TASKING, UPWARD EXPANDABILITY AND INCLUDE:

**INCLUDING ONE YEAR
FREE WARRANTY
ON PARTS & LABOR**

1. TELEVIDEO 912C

2. ANADEX DP-9500 SERIES
GRAPHIX PLUS PRINTER

3. 64K DYNAMIC RAM

5. PLUS ONE OF THE FOLLOWING DISK DRIVE SETS :

a. 2x5 1/4" FLOPPY (400K BYTES) FOR	b. 2x8" FLOPPY (1M BYTES) FOR	c. 2x8" FLOPPY (2M BYTES) FOR	d. 8" FLOPPY 5 1/4" WINCHESTER (6MB) FOR	e. 8" FLOPPY 8" HARD DISK (11 MB)FOR	f. 8" FLOPPY 14" HARD DISK (27 MB)FOR
\$5500.	\$5800.	\$6300.	\$7900.	\$8110.	\$9195.

SYSTEMS ARE DELIVERED AS AVAILABLE. PRICES, TERMS, SPECIFICATIONS SUBJECT TO CHANGE WITHOUT NOTICE. ALLOW 30-60 DAYS FOR DELIVERY. PRICE FOB CALABASAS, CA 91302. DECISION I - TRADEMARK OF MORROW DESIGN. PRICES ARE FOR PREPAID (DEPOSIT) ORDERS.

AUTOMATED EQUIPMENT INCORPORATED



18430 Ward, Fountain Valley, CA 92708

Call Toll-Free for latest low prices!
1-800-854-7635 Outside CA
714-963-1414 Inside CA
1-800-854-7635 Outside Cont. USA
Prices change daily to meet competition.



TERMINALS

TELEVIDEO 912 B	CALL
TELEVIDEO 912 C	CALL
TELEVIDEO 920 B	CALL
TELEVIDEO 920 C	CALL
SOROC IQ-120	675
ZENITH A-19	750
HAZELTINE 1500	995
TELEVIDEO 950	CALL



NORTHSTAR

HRZ-1D-32K	CALL
HRZ-2D-32K	CALL
HRZ-1Q-32K	CALL
HRZ-2Q-32K	CALL
ADDITIONAL 16K RAM	CALL
ADDITIONAL 32K RAM	CALL
HARD DISK SYSTEM	CALL
SPECIAL MEMORY CONFIGURATIONS AVAILABLE, INCLUDING SYSTEMS GROUP.	



PRINTERS

NEC 5510 (TRACT., RIB., THIM)	\$2600
NEC 5515 (TRACT., RIB., THIM)	2600
NEC 5520 (TRACT., RIB., THIM)	2900
NEC 5530 (TRACT., RIB., THIM)	2540
TI-810	1495
TI-820	1625
EPSON MX 100	CALL
EPSON MX 80	CALL
EPSON MX 70	CALL
ANADEX DP-9500/9501	CALL

VIP's customers need top quality and service within stringent budgetary limits. naturally, they call A.E.I.

Item: A.E.I. tests virtually every item sold, before shipping.

Item: A.E.I. initializes every piece of software, and makes a copy. If you have a problem, A.E.I. can check to locate the problem by using the in-house duplicate, saving you time.

Item: A.E.I. has in-house expertise on every item offered.

Item: A.E.I. prices are competitive with the lowest, no-service, no in-house expertise dealer.

40% OF ALL A.E.I. SALES ARE TO PUBLIC AND SEMI-PUBLIC INSTITUTIONS.

A partial list** of A.E.I. customers who purchased during the last quarter of 1980 includes: University of Nebraska, Univer-

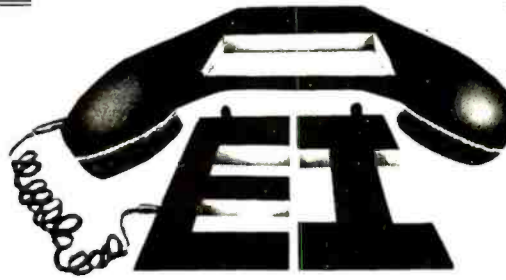

sity of Virginia, U.S. Dept. of Interior, University of Kentucky, University of California, Massachusetts Institute of Technology, U.S. Air Force, Naval Air Development Center, Brown University, University of Oregon, University of Utah, Ohio State University, University of Southern California, California State Dept. of Water Resources, University of Michigan, and Princeton University.

In the private sector, an equal number of major national organizations purchased during the same period.

You can call A.E.I. too!

VIP's Call A.E.I.

*With our normal fast shipping, we have time to test expedited shipment may preclude testing.
**A.E.I. does not wish to imply that any of these fine organizations endorse A.E.I., merely that A.E.I. is proud to have them as customers.

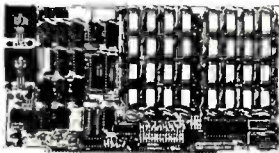

S.S.M.	KIT	ASM
CB2 Z80 CPU	\$200	\$265
VB1C VIDEO	140	190
VB2 VIDEO	155	210
VB3 VIDEO	375	440
IO4 INTERFACE	165	225
SB1 SYNTHESIZER	195	270

MEASUREMENT SYSTEMS MEMORY

DM3200 32K 4MHZ	480
DM6400 64K 4MHZ	595
DMB3200 32K 4MHZ BANK SELECT	630
DMB6400 64K 4MHZ BANK SELECT	745

DYNABYTE SYSTEMS ALSO AVAILABLE—CALL FOR THE EXCITING NEWS ABOUT NEW COMPETITIVE PRICING!

WE WILL TRY TO BEAT ANY
ADVERTISED PRICE.

TERMS: All prices listed are cash discounted and subject to change. COD's are 2% additional. Universities and well-rated firms Net-10.

SHIPPING: ADDITIONAL IN ALL CASES.

TECHNICAL ASSISTANCE:

WE TRY TO HELP INTERFACE AND TROUBLESHOOT—CALL (714) 963-1414.

Open Monday-Friday, 8:00 a.m.-5:00 p.m.

Dealer Inquiries Invited.



MORROW

DECISION 1 BASIC	\$1550
DISCUS-1 2 DRIVE	1550
DISCUS 2D 1 DRIVE	935
DISCUS 2D 2 DRIVE	1550
DISCUS 2+2 1 DRIVE	1250
DISCUS 2+2 2 DRIVE	2190
DISC JOCKEY 2D	350
DISCUS M26 HARD DISC	3925
ADDITIONAL HARD DISC	3685
DISCUS M10	2990

MISCELLANEOUS

NEC THIMBLES	\$16
NEC RIBBONS	7
RS232C CABLE 5'	20
RS 232 CABLE 10'	25
LEDEX MONITOR	145
NOVATION CAT	145

SOFTWARE

WORDSTAR	\$330
MAILMERGE	100
DATASAR	250
N.S. PASCAL	160
MAGIC WAND	290
C BASIC	100

GRAHAM-DORIAN

JOB COSTING	\$700
INVENTORY	475
CASH REG.	475
APARTMENT	475
MEDICAL	700

ADDITIONAL SOFTWARE DISCOUNTS WITH SYSTEM PURCHASE

DISCS—BOX OF 10

VERBATUM 5 1/4 1 SIDE	\$27
VERBATUM 5 1/4 2 SIDE	45
VERBATUM 8 1 SIDE	35
VERBATUM 8 2 SIDE	55
OTHERS	CALL
PLASTIC STORAGE BOXES	3

OUR SYSTEMS WORK!

All systems normally tested and configured in our repair facility before delivery. Service contracts available. Prompt repairs and warranties.

Circle 32 on inquiry card.

Listing 1 continued:

```

459 037D A9 20      TYP2  LDA  #$20      SEPERATE
460 037F 24 E2      BIT  COMAND      READ
461 0381 F0 0A      BEQ  RDT         FROM WRITE
462 0383           ;
463 0383           ; ***** WRITE RECOVERY
464 0383           ;
465 0383 A9 60      WRT   LDA  #$60      ERROR MASK
466 0385 24 E3      BIT  STATUS      STOP IF WRITE
467 0387 F0 04      BEQ  RDT         PROTECT/FAULT
468 0389 A9 0F      ER1   LDA  #$FF      SET ERROR CODE
469 038B D0 D2      BNE  RTN2       RETURN
470 038D           ;
471 038D           ; ***** COMMON RECOVERY
472 038D           ;
473 038D A9 0C      RDT   LDA  #$0C      ERROR MASK
474 038F 24 E3      BIT  STATUS      IF ERROR
475 0391 D0 10      BNE  RDT1       RETRY
476 0393 A9 10      LDA  #$10      CHECK FOR
477 0395 24 E3      BIT  STATUS      NOT FND
478 0397 F0 C3      BEQ  RTN1       NONE RETURN

```

FLOPPY DISK I/O & ERROR RECOVERY

PAGE 11

```

CARD # LOC      CODE      CARD 10      20      30      40      50      60      70
479 0399           ;
480 0399 24 E2      BIT  COMAND      IF MULTIPLE
481 039B F0 06      BEQ  RDT1       SECTOR OPERATION
482 039D A9 1B      LDA  #$1B       CHECK
483 039F C5 E5      CMP  SECTOR     FOR END OF
484 03A1 F0 B9      BEQ  RTN1       TRACK
485 03A3           ;
486 03A3           ; ***** CHECK ERROR COUNT
487 03A3           ;
488 03A3 C6 E1      RDT1  DEC  ERRUDE  DECR ERROR CNT
489 03A5 10 05      BPL  RDT2       RETURN
490 03A7 68         PLA         WITH
491 03A8 68         PLA         ERROR
492 03A9 4C 65 03  JMP  RTN3       CONDITION
493 03AC           ;
494 03AC           ; ***** RETRY OPERATION
495 03AC           ;
496 03AC 68         RDT2  PLA         RESTORE
497 03AD 85 E5      STA  SECTOR     SECTOR
498 03AF 68         PLA         RESTORE
499 03B0 85 E7      STA  FDBUF+1   ADDR HIGH
500 03B2 4C 3A 03  JMP  RETRY     RETRY

```

Listing 1 continued on page 324

IMPOSSIBLE! 32K OF S-100

STATIC RAM FOR \$399 !?!?!?

No, it's not impossible; in fact, we think we've lucked into the S-100 value of the year.

Recently a leading manufacturer of static memory for S-100 systems (we can't say who) received a batch of electrically perfect 32K static RAM boards with some minor cosmetic defects. Intended for sale as Assembled / Tested units, the company got as far as soldering the sockets in place before the problem was discovered. We were in the right place at the right time and bought the entire lot; we're offering these memories in kit form with all components and complete documentation. Simply insert the ICs into the appropriate sockets, solder in a few other parts - and you're up and running. Best of all, you'll have the same reliable, ultra-high speed, fully static, and low power performance you've come to expect from the boards made by this prominent company.

Don't miss out on the memory deal of the year - these are limited quantity, first-come-first-served.

TB-4 S-100 EXTENDER BOARD/LOGIC PROBE

\$59 Kit, \$79 Assembled/Tested.

With built-in logic probe for painless troubleshooting, large "kluge" area for building custom circuits or testers, edge connector label that identifies all pins, jumper links in power lines for easy current measurement/fusing, and gold plated connector surfaces for optimized electrical contact. New interlaced ground and signal traces improves performance and reduces noise; even works with the new generation of high clock frequency boards.

If you ever need to examine or fix an S-100 board, the TB-4 is for you.

CONDITIONS OF SALE: VISA® / Mastercard® accepted; call (415) 783-2866. Include \$1.50 for shipping and handling. California residents add tax.

MULLEN Computer Products
BOX 6214, HAYWARD, CA 94544

TRS-80® MODEL III OWNERS

We think our disk system for expanding your capacity is just as good as theirs - and we know it costs much less . . .

COMPLETE SYSTEMS AND COMPONENTS*

TRS-80® MOD III SYSTEM

with 2 disk drives

SAVE \$500 OFF LIST PRICE

\$1,895

16K RAM, Model III Basic \$899

MTI DISK DRIVES for MODEL III

Internal Kits

Disk Drive 1 \$649
Disk Drive 2 \$279

External Add-on Kits

Disk Drive 3 \$379
Disk Drive 4 \$359

Model III DOS & Manual \$21.95

16K RAM Kit \$59

RS-232 Serial Interface \$95

PRINTERS

Anadex 9500 \$1,449

Microline 82 \$849

Microline 83 \$1,060

Centronics 779 \$1,069

Centronics 700 \$1,129

Base 2 \$649

Centronics 737 \$839

Epson MX-80 \$579

Malibu \$2,093

Daisy Wheel \$1,799

Save 5% Off with Purchase of MOD III System or Disk Drive



New low cost internal disk kit available to expand your storage capability. With this kit, now, you may expand your Model III computer up to four MTI 40 track disk drives, giving 175,000 bytes of storage per drive for a total of 700K.

The kit includes one 40 track disk drive, controller, power supply, cables, mounting hardware and installation documentation.

Manufacturer Direct Price ONLY **\$649**



MICROCOMPUTER TECHNOLOGY, INC.

3304 W. MACARTHUR, SANTA ANA, CA 92704

★ PHONE (714) 979-9923 ★ TELEX #678401TAB IRIN

*Uses MTI Memory, Disk Drives & Components

® TRS-80® IS A REGISTERED TRADEMARK OF TANDY CORPORATION

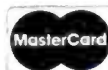

ALL PRICES CASH DISCOUNTED
FREIGHT FOB FACTORY
ASK FOR FREE CATALOG

CARD #	LOC	CODE	CARD	10	20	30	40	50	60	70
502	03B5									
503	03B5									
504	03B5									
505	03B5									
506	03B5									
507	03B5									
508	03B5									
509	03B5									
510	03B5									
511	03B5									
512	03B5									
513	03B5	20 F6 02	FORMAT	JSR	FOINT	INIT SYSTEM			** ENTRY **	
514	03B6	A2 00		LDX	#0	A SIDE				
515	03BA	8E 00 CC		STX	CRA	DIRECTION				
516	03BD	CA		DEX		SET TO				
517	03BE	8E 0C CC		STX	SADD	OUTPUT				
518	03C1	A2 2C		LDX	#12C	A SIDE				
519	03C3	8E 0D CC		STX	CRA	DATA				
520	03C4									
521	03C4									
522	03C4									
523	03C4	A9 4C		LOA	#14C	SET				
524	03C8	8D 00 05		STA	REND	TRACK COUNT				
525	03CB	A9 FF		LOA	#1FF	SET TRK				
526	03CD	8D 03 05		STA	RTN	TO ZERO				
527	03DD	A9 FE	GD	LDA	#1FE	SET SECTOR				
528	03D2	8D 01 05		STA	RSN	TO ONE				
529	03D5	A2 1A		LDX	#1A	SECTOR CNT				
530	03D7	A0 FD		LDY	#RSTR-REND	WRITE LENGTH				
531	03D9									
532	03D9									
533	03D9									
534	03D9	A9 0B		LOA	#255-FDWT	STOR FD1771B				
535	03DB	8D 0C CC		STA	SAD	COMMAND				
536	03DE	A9 19		LDA	#WRITE+CMD	STORE PIA				
537	03E0	8D 0E CC		STA	SBD	COMMAND				
538	03E3	CE 0E CC		DEC	SBD	ENABLE				
539	03E6	EE 0E CC		INC	SBD	READ/WRITE				
540	03E9	A9 1F		LDA	#WRITE+DATA	STORE PIA				
541	03EB	8D 0E CC		STA	SBD	COMMAND				
542	03EE									
543	03EE									
544	03EE									
545	03EE									
545	03EE	EE FE 05	WDT	INC	RSTR+1	DELAY 6 CYCLES				
546	03F1	89 00 05		LOA	REND,Y	STORE A				
547	03F4	8D 0C CC		STA	SAD	DATA BYTE				
548	03F7	2C 0E CC	MWP	BIT	SBD	WAIT FOR				
549	03FA	30 12		BMI	NEXT	INTRQ				
550	03FC	50 F9		BVC	MWP	DR DRQ				
551	03FE	88		DEY		DECR INDEX				
552	03FF	0D ED		BNE	WDT	CONTINUE				
553	0401	CE 01 05		DEC	RSN	INC SECTOR				
554	0404	A0 8A		LDY	#RDRM-REND	INDEX VALUE				
555	0406	CA		DEX		DECR SECTOR CNT				
556	0407	0D E8		BNE	WDT+3	CONTINUE				

CARD #	LOC	CODE	CARD	10	20	30	40	50	60	70
557	0409									
558	0409									
559	0409									
560	0409	2C 0E CC	TRKEND	BIT	SBD	WAIT FOR				
561	040C	1D FB		BPL	TRKEND	INTRQ				
562	040E									
563	040E									
564	040E									
565	040E	20 35 04	NEXT	JSR	DELAY	DELAY 40 MS.				
566	0411	A9 B5		LOA	#255-POSTI-QN	STORE FD1771B				
567	0413	8D 0C CC		STA	SAD	COMMAND				
568	0416	A9 19		LOA	#WRITE+CMD	STORE PIA				

LSI 11/23[®] COMPUTER WITH 256KB MEMORY \$5175.00



C-103 DESK TOP COMPUTER. Available with LSI 11/23 or LSI 11/2. Complete computer system enclosed within a VT-103 video terminal, immediate delivery. Only \$4500 with LSI 11/2 and 64K Memory. \$6100 with LSI 11/23 and 96K Bytes Memory or \$7520 with 256KB Memory.

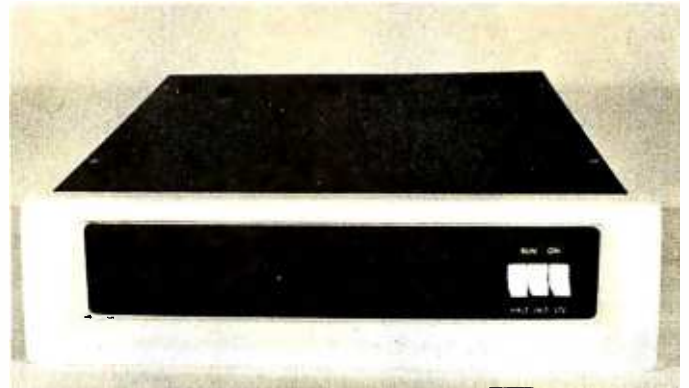
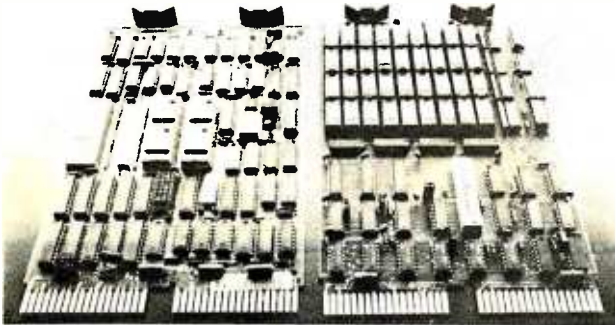

LSI 11/23 CPU with 256KB Memory **\$4175**

10 Megabyte Cartridge Disk System **\$4995**

1 Megabyte RX02 Floppy Disk System **\$2950**

RT11 V4 Operating System. **\$1085**

RSX11M Operating System **\$3250**

CI 1103LK — LSI 11/2 CPU, 64KB Memory, Power supply, KEV 11 in 16 slot rack mountable chassis. **\$2450**

PDP 1103SE — LSI 11/2 CPU, 64KB Memory, power supply, KEV 11 in 8 slot rack mountable chassis. **\$2695**

CI-11/23 AC — LSI 11/23 CPU, MMU, 256KB Memory, power supply, in 16 slot rack mountable chassis. **\$5175**

DON'T ASK WHY WE CHARGE SO LITTLE, ASK WHY THEY CHARGE SO MUCH.



Chrislin Industries, Inc.

31352 Via Colinas • Westlake Village, CA 91362 • 213-991-2254 • TWX 910-494-1253

DEC, LSI, PDP, are Trademarks of Digital Equipment Corp.

Listing 1 continued:

```

569 0418 8D 0E CC      STA  SBD      COMMAND
570 041B CE 0E CC      DEC  SBD      ENABLE
571 041E EE 0E CC      INC  SBD      READ/WRITE
572 0421 2C 0E CC      SLP  BIT  SBD  WAIT FOR
573 0424 10 FB          BPL  SLP      INTRQ
574 0426 20 35 04      JSR  DELAY    DELAY 40 MS.
575 0429 CE B3 05      DEC  RTN      INCR TRACK
576 042C CE 00 05      DEC  REND     DEC TRK CNT
577 042F 10 9F          BPL  GO       CONTINUE
578 0431 20 F6 02      JSR  FDINT    RESTORE DRIVE
579 0434 60             RTS          STOP
580 0435                ;
581 0435                ; ***** DELAY 40 MS.
582 0435                ;
583 0435 A9 40          DELAY LDA #40    MAJOR LOOP VALUE
584 0437 85 00          STA  TIME1     MAJOR LOOP CNT
535 0439 A9 4A          DL2  LDA #4A    MINOR LOOP VALUE
586 043B 85 01          STA  TIME2     MINOR LOOP CNT
587 043D C6 01          DL1  DEC TIME2  DECR MINOR CNT
588 043F D0 FC          BNE  DL1      CONTINUE
589 0441 C6 00          DEC  TIME1     DECR MAJOR CNT
590 0443 D0 F4          BNE  DL2      CONTINUE
591 0445 60             RTS          RETURN

```

FD400/FD1771B FLOPPY DISK FORMAT

PAGE 14

```

CARD # LOC      CODE      CARD 10      20      30      40      50      60      70
593 0446                *****255/256*256
594 0500                ;
595 0500                ; ***** RECORD FORMAT
596 0500                ; (REVERSED AND INVERTED)
597 0500 00          REND  .BYTE $00
598 0501 00                .BYTE $00,$00,$00,$00,$00,$00,$00,$00,$00
598 0502 00
598 0503 00
598 0504 00
598 0505 00
598 0506 00
598 0507 00
598 0508 00
599 0509 00                .BYTE $00,$00,$00,$00,$00,$00,$00,$00,$00
599 050A 00
599 050B 00
599 050C 00
599 050D 00
599 050E 00

```

Listing 1 continued on page 328

INVENTORY CONTROL SYSTEM
 WITH PARTS EXPLOSION FOR
 FINISHED GOODS AND ASSEMBLIES
 Parts requirements forecasting & Pull Sheets
 Reorder Reports
 Economic Order Quantities
 5000 Items per 8" disk
**AVAILABLE FOR CROMEMCO. CPM/M.
 AND OASIS OPERATING SYSTEMS**

Hardware requirements: 64k RAM,
 132 Column printer.
 Manual and 8" floppy disk \$250.
 Multi-level explosion version \$499.
 Job Costing \$350.

Accounts Receivable, Accounts Payable,
 Order Entry, General Ledger, Payroll and
 Mailing List programs also available.

FEITH SOFTWARE, INC.
 204 MARVIN RD.
 ELKINS PARK, PA. 19117
 (215) 782-8240

Circle 141 on inquiry card.

LEARN Having trouble
 learning to use
 your computer?

Reference manuals don't teach. Most BASIC
 texts don't cover specific personal computers.

TIS solves these problems
 with step-by-step books
 tailored for your machine.

For PET/CBM
 Understanding Your PET/CBM \$16.95
 Vol 1: Basic Programming
 PET Graphics \$ 6.95

For OSI CIP/C4P
 Understanding Your C1P/C4P \$ 9.95
 A Workbook of BASIC Exercises

Money Back Guarantee. VISA/MC accepted.
 All prices include UPS or 1st Class postage.

TIS, Dept B
 Box 921
 Los Alamos, NM 87544



Circle 366 on inquiry card.

LISP
 INTERPRETER FOR THE TRS-80*

SEE THE AUGUST, '79 ISSUE OF
 BYTE TO FIND HOW EASY IT IS TO
 USE LISP.

- INCLUDES MORE THAN 30
 FUNCTIONS & PREDICATES.
- CODED FOR HIGH-SPEED
 OPERATION.
- FULL ARITHMETIC CAPABILITY.
- USER'S MANUAL.
- SUPPLIED ON CASSETTE FOR 16K-
 64K LEVEL II.

SEND \$50 IN CHECK OR MONEY ORDER
 TO:

CYBER INNOVATIONS
 WORLD TRADE CENTER
 P. O. Box 58657
 DALLAS, TEXAS 75258

*TRADEMARK OF TANDY CORPORATION

Circle 393 on inquiry card.

LOWEST PRICE - BEST QUALITY

NORTH STAR



North Star Horizon 2

2-5 1/4 Disk Drives
32K Double Den
Factory assem. & tested
Factory guaranteed
List 3095

only **\$2274**

**POWERFUL NORTH STAR BASIC FREE
SUPERB FOR BUSINESS & SCIENCE**

FACTORY ASSEMBLED & TESTED	LIST	ONLY
HORIZON-1-32K-DOUBLE DEN	\$2695	\$1980
HORIZON-2-32K-QUAD DENSITY	3595	2674
HORIZON-2-64K-QUAD + HARD DISK	9329	7149
HORIZON RAM ASSM 16K = \$389.		32K = \$579
HORIZON RAM KIT SALE! 16K = \$314		32K = \$469
HORIZON DISK DRIVE SALE DOUB DEN SAVE!		315
NORTH STAR HARD DISK 18 Mb	4999	\$3929
PASCAL-PLUS 14, 18 OR 36 DIGIT PRECISION		249

SUPERBRAIN ZENITH

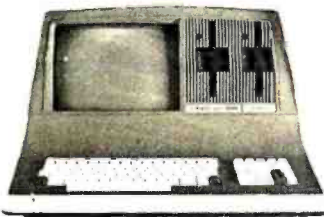

SUPERBRAIN QD 64K

List \$3995 only \$2995



Z-89 48K

List \$2895 only \$2299

TERMINALS Z-19 \$725

INTERTUBE III only \$725

DIP-81 PRINTER only \$395



MICROTEK \$675

NEC PRINTER \$2569

TRACTOR, THIMBLE, RIBBON

InterSystems

ITHACA INTERSYSTEMS 2A



Z-80A CPU 4 MHz
64K Dynamic RAM
Front panel
V I/O—with interrupts
FDCII Disk Controller
20 slot motherboard

LIST \$3795

Call for price
Too low to advertise

PASCAL/Z + THE FASTEST PASCAL \$375

GET READY FOR ITHACA'S Z-8000

8086 16 BIT CPU & SUPPORT CARD SEATTLE \$575

MORROW 8" DISK

DISCUS 2D + CP/M® 600K ONLY \$938

DISCUS 2 + 2 + CP/M® 1.2 MEGA B. \$1259

ADD DRIVES 2D = \$650 2 + 2 = \$975

2D-DUAL + CP/M® ONLY \$1555



MORROW HARD DISK

26,000,000 BYTES!!

LIST \$4995 ONLY \$3995

CP/M® IS INCLUDED!

SAVE ON MEMORY AND PROGRAMS

SYSTEMS MEMORY 64K A & T 4MHz	\$599	RCA-COSMAC VP-111 99 RCA-COSMAC VP-711	\$199
SYSTEMS MEMORY 64K BANK SELECT	\$789	COLOR! RAINBOW 385	
CENTRAL DATA 64K RAM	\$599	SPECTRUM	\$289
ITHACA MEMORY 8/16-bit 64K	\$845	EZ-80 Machine Language Tutor	\$25
SEATTLE MEMORY 8/16 BIT 16K 4MHz	\$275	EZ-CODER Translates English to BASIC	\$71
SSM KITS Z-80 CPU	\$221	ECOSOFT FULL ACCOUNTING PKG	\$315
VIDEO BRD V83 4MHz	\$412	BOX OF DISKETTES	\$29
ANADIX PRINTER DP-9500-1	\$1349	SECRETARY WORD PROCESSOR	The Best! \$99
CATNOVATION MODEM	\$169	TEXTWRITER III Book Writing Program	\$112
TARBELL DISK CONTROLLER DD	\$445	GOFAST NORTH STAR BASIC Speeder	Upper \$71
ECONORAM 2A 8K ASSM	\$179	Which Computers are BEST?	
NSSE 1-22 & P01 TERRIFIC PROGRAMS	ONLY \$10. EACH	BROCHURE	FREE
NORTHWORD 294 MAILMAN 234		North Star Documentation refundable	w/HRZ \$20
INFOMAN	\$364		
TARBELL COMPUTER-PHONE			
AMERICAN SQUARE COMPUTERS BEATS ADV. PRICES			

square
American  **Computers**

919-889-4577

KIVETT DR. JAMESTOWN N.C. 27282

919-883-1105

® CP/M is a registered trademark of Digital Research, Inc.

Listing 1 continued:

```

599 050F 00
599 0510 00
600 0511 00          . BYTE $00,$00,$00,$00,$00,$00,$00,$00
600 0512 00
600 0513 00
600 0514 00
600 0515 00
600 0516 00
600 0517 00
600 0518 00
601 0519 00          . BYTE $00,$00,$00
601 051A 00
601 051B 00
602 051C 08          . BYTE $08
603 051D FF          . BYTE $FF,$FF,$FF,$FF,$FF,$FF,$FF,$FF
603 051E FF
603 051F FF
603 0520 FF
603 0521 FF
603 0522 FF
603 0523 FF
603 0524 FF
604 0525 FF          . BYTE $FF,$FF,$FF,$FF,$FF,$FF,$FF,$FF
604 0526 FF
604 0527 FF
604 0528 FF
604 0529 FF
604 052A FF
604 052B FF
604 052C FF
605 052D FF          . BYTE $FF,$FF,$FF,$FF,$FF,$FF,$FF,$FF
605 052E FF
605 052F FF
605 0530 FF
605 0531 FF
605 0532 FF

```

Listing 1 continued on page 330

From Ballet on Broadway to Billiards in Dallas...

... people are finding unique ways to use the Powerful SciTronics REMOTE CONTROLLER



Whether it's the intricate lighting for a Broadway Ballet or the simple remote lighting of pool tables in a Dallas billiards hall, people are finding out SciTronics Remote Controller can meet their needs.

Here's Why:

- Controls 256 BSR remote switches—not just 16
- Hardware driven—requires minimum software
- No ultrasonic link—prevents erratic operation
- No BSR command module necessary

- S-100 CONTROLLER BOARD **\$159.**
- S-100 REAL TIME CLOCK BOARD **\$159.**
- ENCASED CONTROLLER **\$184.**
(TRS-80, Apple II etc.)
- ENCASED CONTROLLER & REAL TIME CLOCK (TRS-80, Apple II etc) **\$269.**
- APPLE II CLOCK BOARD **\$129.**

Real Time Clock gives Remote Controller an added dimension!

Real Time Clocks are now available to make your remote controller even more powerful. The RTC feature allows for energy consumption scheduling, event scheduling and much more. Your imagination is your only limitation when it comes to the ways which this RC/RTC combination can be used.

Real Time Clocks feature:

- Lithium battery back-up
- Crystal controlled accuracy (.002%)
- Clock generates interrupts (seconds, minutes, hours) for foreground/background operation
- Complete software in BASIC to Set and Read clock

Send check or money order to:

SciTronics Inc.
523 S. Clewell St., P.O. Box 5344
Bethlehem, PA 18015
(215) 868-7220

Please list system with which you plan to use peripheral. Master Charge and Visa accepted. PA residents add sales tax. COD's accepted.

ROBOTS

The Future Machines

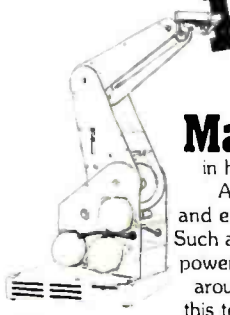

Intelligent machines are rapidly appearing in homes, automobiles, offices, and factories. Affordable cameras, speech synthesizers, and even robot arms are now on the market. Such advances are giving microcomputers the power to see, hear, grasp objects, and to move around the room. Where can you learn about this technology? In **Robotics Age Magazine**, the journal of intelligent machines.

Robotics Age reports the experience of hobbyists building their own robots, the latest products from industry, and the most powerful techniques from research labs. The face of the world is changing. Join us as we enter the Robotics Age.

YES! I want to stay up-to-date on this fascinating new technology!



Name _____ Title _____

Company _____ Address _____

City _____ State/Province/Country _____ Postal Code _____

	United States	Canada Mexico*	Foreign Rates*
<input type="checkbox"/> 1 year (6 issues)	\$15	\$17	\$19
<input type="checkbox"/> 2 years (12 issues)	\$28	\$32	\$36
<input type="checkbox"/> 3 years (18 issues)	\$39	\$45	\$51

*US Funds on US Bank
 Bill VISA MasterCard Bill me (N America only)

Card Number _____ Expires _____

Signature _____

Send to: **ROBOTICS AGE**, PO Box 423, Tujunga, California 91042

Save on Calculators

Model	Retail	Your Cost
New Hp-41CV 2.2K bytes, 4 mem. modules built-in, slanted keyboard	\$325.00	\$269.95
System One, HP41CV & Card Reader	495.00	394.95
System Two, HP41CV-Card Reader & Printer	840.00	669.95
Card reader for 41C/41CV	215.00	179.95
Printer for 41C/41CV	385.00	299.95
HP-41C new price	250.00	189.95
Quad Ram to upgrade the HP41C to 2.2K bytes, leaving 3 ports. Plugs into the 41C	95.00	84.95
Optical Wand for 41C/41CV	125.00	109.95
Memory Modules for 41C/41CV	39.50	27.95
HP-34C Scientific	160.00	119.95
HP-38C Bus /R/E	160.00	119.95
HP-33C Scientific	90.00	78.95
HP-32E Adv. Scientific	55.00	49.95
HP-37E Bus Calc.	75.00	63.95
HP-67 Programmable Sci.	375.00	299.95
HP-97 Prog. Printer Sci.	750.00	579.95
HP 85 Computer	3250.00	2495.00
New HP-83 Computer, similar to HP-85 without printer & cassette		1795.00



HEWLETT PACKARD

Olympic Sales is an HP authorized dealer.

Call us for the best deal.

*C stands for continuous memory.

One year guarantee by HP on all calcs, 90 days on computers. All units complete.

apple computer



APPLE II and APPLE III
 Huge inventory of Apple II computers. 16K-32K-48K. Disk drives, monitors, 80 column card. Dow Jones & Quote Reporter.
 Pascal-Fortran-DOS 3.3, etc. You name it...we've got it at super low prices.

Immediate delivery on Apple III computers 96K and 128K systems. Call us!

Apple II personal computer

Computers at unbeatable prices

Texas Instruments 99/4 console computer	\$449.95
TI-5230 printer (was \$495)	169.95
TI-59	199.95
PC 100C	149.95
Epson MX80 printer	499.95
Epson MX70 printer	399.95
Atari 800 16K console computer	759.95
Atari TV Game	144.95
Mattel Intel TV Game	239.95
Mattel Race Horse Analyzer	59.95
Centronics printer P1 for Apple & Radio Shack computers. Was 495.00	189.95

Call us for best prices

Centronics printers	17 models
Novation models CD-CAT/CAT	7 models
Shugart disk drives	6 models
Paper Tiger printers	5 models
Hazeltine video display terminals	7 models
Diablo printers	4 models
DEC VT100 & VT103	2 models

Casio Watches

M-12	12 Melody Alarm, Memorabilia Melodies
CA-90	Calc watch, alarm, many features
F-81	Stp watch, auto. calndr, daily alarm
C-70	Calc watch, many features
F-500P	Sprts quartz, stp watch, auto calndr

Our prices are so low we don't dare advertise them. Call us.

RCA VideoDisc SFT 100 player \$459.95 (Many motion picture discs available) Call us
 SCM Typewriters - 320 models Seiko watches - Royal - Victor - Canon - Sharp - Casio and more.

Prices f.a.b. L.A. Minimum freight & handling charge - \$4.95 In CA, add 6% sales tax. Goods subject to availability. We'll beat any advertised price if competitor has goods on hand. Request our famous 100 page catalog, in writing. Call Mon-Sat 7AM-6PM. Outside CA, toll free 800-421-8045 Inside CA, toll free 800-252-2153

OLYMPIC SALES COMPANY, INC.
 216 South Oxford Ave - P.O. Box 74545 - Los Angeles, CA 90004
 Order Desk (213) 739-1130 - Customer Service (213) 739-1100 - Telex 67-3477

BYTE BACK ISSUES FOR SALE

The following issues are available:
 1976: July

1977: April thru December except October

1978: February thru December except November

1979: January thru December except March

1980: January, March thru August, and December

1981: February to current issue

Cover price for each issue through August 1977 is \$1.75 Domestic; \$2.75 Canada and Mexico; \$3.75 Foreign.

September 1977 through October 1979 issues are \$2.50 Domestic; \$3.50 Canada and Mexico; \$4.50 Foreign.

November 1979 to current is \$3.00 Domestic; \$4.00 Canada and Mexico; \$5.00 Foreign.

Send requests with payment to:

BYTE Magazine

70 Main St, Peterborough NH 03458
 Attn: Back Issues

Please allow 4 weeks for domestic delivery and 8 weeks for foreign delivery.

* Payments from foreign countries must be made in US funds payable at a US bank.

Disc/3 MART, INC.

GO FOR IT!

FOR PRICE, QUALITY & RELIABILITY

ADDS REGENT 25	\$ 925.00
ANACOM Printer (Ser./Par.) 150CPS	1095.00
ANADEX Printer DP-9000	1299.00
ANANEX Printer DP-9500/9501	1350.00
BASE 2 Printer with options	625.00
CENTRONICS Printer 779 w/tractor	975.00
CENTRONICS Printer 730 (Parallel)	675.00
CENTRONICS Printer 737 (Parallel)	775.00
EATON Dot Matrix Parallel	399.00
EPSON MX 80	499.00
MICRO-TERMS	Call
OKIDATA Microline Series	Call
TELEVIDEO 920-B	795.00
PAPER TIGER 460G	1175.00
TRIMM-Printer Stand with basket	95.00

CALL FOR QUOTES ON ANY OTHER MICRO PRODUCTS

We are dealers for BASF, DYSAN, 3M(SCOTCH) Disks, Cartridges, Mag Tape, etc. In addition we carry a complete line of Printer Ribbons and other data processing accessories.

1840 LINCOLN BLVD.,
 SANTA MONICA, CA 90404
 (213) 450-5911 (CALL COLLECT)

Disc/3 MART, INC.

PRICES SUBJECT TO CHANGE

Listing 1 continued:

FD400/FD1771B FLOPPY DISK FORMAT

PAGE 15

CARD #	LOC	CODE	CARD	10	20	30	40	50	60	70
605	0533	FF								
605	0534	FF								
606	0535	FF			.BYTE	\$FF,\$FF,\$FF,\$FF,\$FF,\$FF,\$FF,\$FF				
606	0536	FF								
606	0537	FF								
606	0538	FF								
606	0539	FF								
606	053A	FF								
606	053B	FF								
606	053C	FF								
607	053D	FF			.BYTE	\$FF,\$FF,\$FF,\$FF,\$FF,\$FF,\$FF,\$FF				
607	053E	FF								
607	053F	FF								
607	0540	FF								
607	0541	FF								
607	0542	FF								
607	0543	FF								
607	0544	FF								
608	0545	FF			.BYTE	\$FF,\$FF,\$FF,\$FF,\$FF,\$FF,\$FF,\$FF				
608	0546	FF								
608	0547	FF								
608	0548	FF								
608	0549	FF								
608	054A	FF								
608	054B	FF								
608	054C	FF								
609	054D	DF			.BYTE	\$DF,\$DF,\$DF,\$DF,\$DF,\$DF,\$DF,\$DF				
609	054E	DF								
609	054F	DF								
609	0550	DF								
609	0551	DF								
609	0552	DF								
609	0553	DF								
609	0554	DF								
610	0555	DF			.BYTE	\$DF,\$DF,\$DF,\$DF,\$DF,\$DF,\$DF,\$DF				
610	0556	DF								
610	0557	DF								
610	0558	DF								
610	0559	DF								
610	055A	DF								
610	055B	DF								
610	055C	DF								
611	055D	DF			.BYTE	\$DF,\$DF,\$DF,\$DF,\$DF,\$DF,\$DF,\$DF				
611	055E	DF								
611	055F	DF								
611	0560	DF								
611	0561	DF								
611	0562	DF								
611	0563	DF								
611	0564	DF								
612	0565	DF			.BYTE	\$DF,\$DF,\$DF,\$DF,\$DF,\$DF,\$DF,\$DF				
612	0566	DF								
612	0567	DF								
612	0568	DF								
612	0569	DF								

FD400/FD1771B FLOPPY DISK FORMAT

PAGE 16

CARD #	LOC	CODE	CARD	10	20	30	40	50	60	70
612	056A	DF								
612	056B	DF								
612	056C	DF								
613	056D	DF			.BYTE	\$DF,\$DF,\$DF,\$DF,\$DF,\$DF,\$DF,\$DF				
613	056E	DF								
613	056F	DF								
613	0570	DF								
613	0571	DF								
613	0572	DF								
613	0573	DF								
613	0574	DF								

Listing 1 continued on page 332

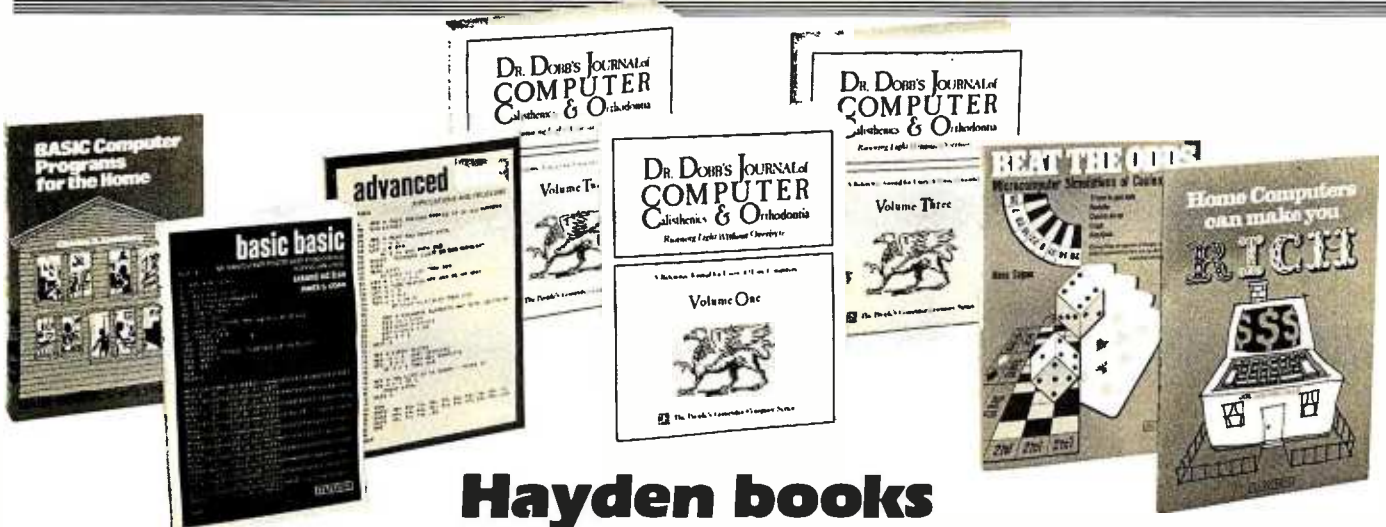

**Hayden books
will help you have fun,
save time,
save energy,
and maybe —
even get rich!**

MUSICAL APPLICATIONS OF MICROPROCESSORS (Chamberlin) Covers all current electronic and computer music performance techniques as they apply to micro-processors. Features unpublished techniques that are practical with microprocessors. And, signal-processing techniques are presented and applied to the powerful 16-bit microprocessors. #5753-9, \$24.95

THE JOYS OF MINIS AND MICROS: Data Processing with Small Computers (Stein and Shapiro) Covers technical and management aspects of the use of small computers. Discusses the size of the computer and how to choose the right machine for you. #5156-5, \$9.95

INTRODUCTION TO VSAM (Atkinson-DeSanctis) Shows the manager and technician working with a COBOL DRIVEN IBM 370 DOS/VS how to convert the files and accessing program of a data base supported by the indexed Sequential Access Method. #5159-X, \$11.95

HOME COMPUTERS CAN MAKE YOU RICH (Weisbecker) Teaches the home computer owner and non-owner how to make money by consulting, programming, inventing. #5177-8, \$6.50

BASIC COMPUTER PROGRAMS FOR BUSINESS: Vol. 1 (Stenberg) With more than 35 programs ranging from budgets to accounts payable, each program has a description of its functions, a listing in BASIC, a symbol table and samples. #5162-X, \$9.95

BEAT THE ODDS: Microcomputer Simulations Of Casino Games (Sagan) Provides simulations of Trente-et-Quarante, Roulette, Chemin-de-Fer, Craps, and Blackjack, all written in BASIC. #5181-6, \$7.95

DR. DOBB'S JOURNAL OF COMPUTER CALISTHENICS & ORTHODONTIA: Running Light Without Overbyte Vols. 1, 2, & 3 (The People's Computer Company) Vol. 1 (1976) holds the first ten issues of Dr. Dobb's Journal and reflects the changes that took place in personal computing. Vol. 2 (1977) documents the growth of the small computer as a tool. Vol. 3 (1978) details the new interest in programming languages. Vol. 1, #5475-0; Vol. 2, #5484-X; Vol. 3, #5490-4; each \$18.95 each.

HOW TO PROFIT FROM YOUR PERSONAL COMPUTER: Professional, Business, and Home Applications (Lewis) Describes the uses of personal computers in business applications, such as accounting, inventory, mailing lists and others. #5761-X, \$10.75

PASCAL WITH STYLE: Programming Proverbs (Ledgard, Nagin and Hueras) Helps PASCAL users write more accurate programs with guidelines and samples of programs. #5124-7, \$7.70

BASIC COMPUTER PROGRAMS FOR THE HOME (Stenberg) Offers more than 75 programs such as finances, kitchen, automotive, recreational and a listing in BASIC, a symbol table and sample data. #5154-9, \$9.95

THE FIRST BOOK OF MICROCOMPUTERS: The Home Computer Owner's Best Friend (Moody) Chapters discuss language, architecture, machine functions, home applications and much more. #5121-2, \$5.95

BASIC BASIC: An Introduction to Computer Programming In Basic Language, Second Edition (Coan) Contains more than 100 sample problems complete with results. #5106-9, \$10.50

SIXTY CHALLENGING PROBLEMS WITH BASIC SOLUTIONS, Second Edition (Spencer) Contains sixty games, puzzles, mathematical recreations and science and business problems. #5180-8, \$7.70

ADVANCED BASIC: Applications And Problems (Coan) A useful book for the programmer acquiring BASIC as a second or third language or a student seeking more about BASIC. #5855-1, \$10.75

SMALL COMPUTER SYSTEMS HANDBOOK (Libes) Enables the small computer user to purchase, assemble and interconnect components and program the microcomputer. #5678-8, \$9.95

COMPUTERS IN ACTION: How Computers Work, Second Edition (Spencer) Features microprocessors, floppy disks, COM units and languages. #5757-1, \$7.25

HOW TO BUILD A COMPUTER-CONTROLLED ROBOT (Loofbourn) Contains an introduction to the robot and construction of the basic framework, power supply, speed control and directional control circuits. #5681-8, \$9.75

THE S-100 BUS HANDBOOK (Bursky) Discusses CPU, memory, input/output, computer fundamentals and more. #0897-X, \$14.50

ORDER NOW!

Hayden Book Company, Inc.
50 Essex Street, Rochelle Park, NJ 07662

Please send me the book(s) checked on 15-day FREE examination. At the end of that time, I will send payment, plus postage and handling, or return the book(s) or software and owe nothing. On all prepaid orders, publisher pays postage and handling — same return guarantee. Residents of NJ and CA must add sales tax. Offer good in US only. Payment must accompany orders from PO Box Numbers. Name of individual ordering must be filled in.

- 0897-X 5154-9 5181-6 5681-8
- 5106-9 5156-5 5475-0 5753-9
- 5121-2 5159-X 5484-X 5757-1
- 5180-8 5162-X 5490-4 5761-X
- 5124-9 5177-8 5678-8 5855-1

Name _____

Address _____

City/State/Zip _____

BYTE 6/81-009

Available at your local computer store!

Hayden
Book Company, Inc.

50 Essex Street, Rochelle Park, NJ 07662

Listing 1 continued:

```

614 0575 DF .BYTE $DF,$DF,$DF,$DF,$DF,$DF,$DF,$DF
614 0576 DF
614 0577 DF
614 0578 DF
614 0579 DF
614 057A DF
614 057B DF
614 057C DF
615 057D DF .BYTE $DF,$DF,$DF,$DF,$DF,$DF,$DF,$DF
615 057E DF
615 057F DF
615 0580 DF
615 0581 DF
615 0582 DF
615 0583 DF
615 0584 DF
616 0585 DF .BYTE $DF,$DF,$DF,$DF,$DF,$DF,$DF,$DF
616 0586 DF
616 0587 DF
616 0588 DF
616 0589 DF
616 058A DF
616 058B DF
616 058C DF
617 058D DF .BYTE $DF,$DF,$DF,$DF,$DF,$DF,$DF,$DF
617 058E DF
617 058F DF
617 0590 DF
617 0591 DF
617 0592 DF
617 0593 DF
617 0594 DF
618 0595 DF .BYTE $DF,$DF,$DF,$DF,$DF,$DF,$DF,$DF
618 0596 DF
618 0597 DF
618 0598 DF
618 0599 DF
618 059A DF
618 059B DF
618 059C DF
619 059D 04 .BYTE $04 DATA AM
620 059E FF .BYTE $FF,$FF,$FF,$FF,$FF,$FF DATA FLD SYNC
620 059F FF
620 05A0 FF

```

FD400/FD1771B FLOPPY DISK FORMAT

PAGE 17

CARD #	LOC	CODE	CARD	10	20	30	40	50	60	70
620	05A1	FF								
620	05A2	FF								
620	05A3	FF								
621	05A4	00								
621	05A5	00								
621	05A6	00								
621	05A7	00								
621	05A8	00								
621	05A9	00								
622	05AA	00								
622	05AB	00								
622	05AC	00								
622	05AD	00								
622	05AE	00								
623	05AF	08								
624	05B0	FF	RSL							
625	05B1	FE	RSN							
626	05B2	FF								
627	05B3	FF	RTN							
628	05B4	01								
629	05B5	FF								
629	05B6	FF								
629	05B7	FF								
629	05B8	FF								
629	05B9	FF								

Listing 1 continued on page 334

Does timesharing on a small system make sense?

It does with OS-9™ Level One!

Now two (or more) acts can share your microcomputer stage. You will no longer have to walk away from your computer while it is busy running a long program. Because OS-9 is a multitasking operating system, you can be running a BASIC program while editing a PASCAL program, for example. This lets you make more efficient use of your time and your system, even if you only use one terminal. If your application requires multiple, independent terminals, one OS-9 system can do the work of several single-user systems.

The convenience of an advanced operating system

Sophistication does not require complexity. Many OS-9 users say that it is actually easier to use than the older 6800-type operating systems. Consider how easy it is to run multiple programs: to run a program you just type its name and hit 'return.' To run a program as a separate job, you type its name, an '&' character, then hit return. The program runs as usual, but OS-9 comes back immediately and is ready for your next command. Simple commands let you see each program's status, set its priority, or abort it.

The file management system has fast, byte-addressable random-and sequential-access files. The tree-structured multiple directory system lets you create separate disk directories for each user, project, or

application. Command line I/O file redirection means you specify what device and/or files a program will use when you run it, not when you write it.

Efficiency and hardware versatility

No other operating system can run on such a broad range of hardware: the overall RAM requirement for Level One is 32K to 56K RAM. Memory utilization is superlative because OS-9 lets multiple tasks "share" the same reentrant program. For example, if two users run BASIC09, only one "copy" is actually loaded into memory. The Level Two version of OS-9 can utilize up to a megabyte of memory on systems having memory management hardware (both versions come with complete timesharing support).

OS-9's device independent I/O system can handle almost any number and combination of I/O

devices: five or eight inch diskettes, winchester disks, disk cartridges, serial and parallel ports, memory-mapped video displays, and more.

Microware® offers a large selection of "stock" device interface software modules, or you can create your own: all the information you need is in the manuals.

Excellent support and documentation

Each OS-9 package comes with a User's Manual and a System Programmer's Manual that cover every aspect of OS-9. If you have special requirements, you can even purchase the Source Code for most of OS-9 and related software. At Microware® we take pride in offering the best customer support in the business. Technical advice and assistance by phone, mail or telex is available during all business hours.

Superb software tools

In addition to BASIC09, Microware® offers: an Interactive Assembler, Macro Text Editor, Stylograph Word Processor, Interactive Debugger, and coming soon, COBOL, PASCAL and C language compilers.

Microware® software is available for most popular 6809 computer systems. Source listings and yearly maintenance update service are sold separately for most programs.

Please call or write for our free catalog. We accept phone orders and MasterCard and VISA orders.

MICROWARE®

Microware Systems Corporation
5835 Grand, Des Moines, Ia 50312
(515) 279-8844 TWX 910-520-2535

Listing 1 continued:

```

629 05BA FF
630 05BB RNORM =*-1
631 05BB 00 .BYTE $00,$00,$00,$00,$00,$00,$00,$00
631 05BC 00
631 05BD 00
631 05BE 00
631 05BF 00
631 05C0 00
631 05C1 00
631 05C2 00
632 05C3 00 .BYTE $00,$00,$00,$00,$00,$00,$00,$00
632 05C4 00
632 05C5 00
632 05C6 00
632 05C7 00
632 05C8 00
632 05C9 00
632 05CA 00
633 05CB 00 .BYTE $00,$00,$00,$00,$00,$00,$00,$00
633 05CC 00
633 05CD 00
633 05CE 00
633 05CF 00
633 05D0 00
633 05D1 00
633 05D2 00
634 05D3 00 .BYTE $00,$00
634 05D4 00
635 05D5 03 .BYTE $03 INDEX MARK
636 05D6 00 .BYTE $00,$00,$00,$00,$00,$00,$00,$00

```

FD400/FD1771B FLOPPY DISK FORMAT

PAGE 18

CARD #	LOC	CODE	CARD	10	20	30	40	50	60	70
636	05D7	00								
636	05D8	00								
636	05D9	00								
636	05DA	00								
636	05DB	00								
636	05DC	00								
636	05DD	00								
637	05DE	00								
637	05DF	00								
637	05E0	00								
637	05E1	00								
637	05E2	00								
637	05E3	00								
637	05E4	00								
637	05E5	00								
638	05E6	00								
638	05E7	00								
638	05E8	00								
638	05E9	00								
638	05EA	00								
638	05EB	00								
638	05EC	00								
638	05ED	00								
639	05EE	00								
639	05EF	00								
639	05F0	00								
639	05F1	00								
639	05F2	00								
639	05F3	00								
639	05F4	00								
639	05F5	00								
640	05F6	00								
640	05F7	00								
640	05F8	00								
640	05F9	00								
640	05FA	00								
640	05FB	00								
640	05FC	00								
640	05FD	00								
641	05FE		RSTR	=*-1						
642	05FE			.END						

Listing 1 continued on page 336

It's not hard to win . . .

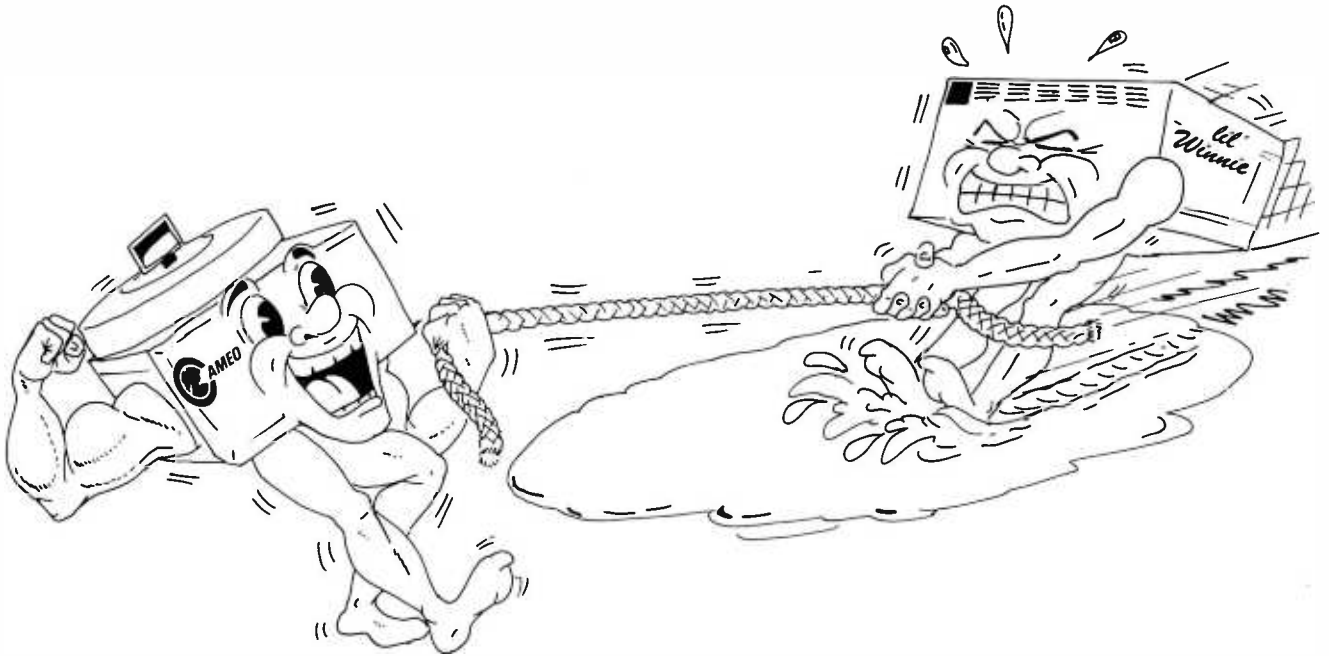

*with fast, reliable,
mass storage*

- The Cameo cartridge disk subsystem provides 40 to 100 times the storage capacity of floppy disks. Data transfer rates and reliability are correspondingly faster.
- Our cartridge feature lets you . . . COPY . . . BACK UP . . . EXTEND . . . or REMOVE your data base easily by just removing the disk pack as you now remove your floppy.
- The densely packed cartridges, although storing five million characters each, are byte-for-byte less expensive than floppy diskettes!
- Available on most 8-bit microprocessors (Apple, Heath, S-100, TRS-80 and others*) with most major operating systems (CPM, APPLE DOS, TRS DOS, OASIS, PASCAL, MPM, SCREEN EDIT and others*).

● CALL OR WRITE FOR MORE INFORMATION ●



AMEO ELECTRONICS INC.

1626 CLEMENTINE • ANAHEIM, CA 92802 • (714) 535-1682

*REGISTERED TRADE MARKS

Listing 1 continued:

END OF MDS/TECHNOLOGY 650X ASSEMBLY VERSION 5
 NUMBER OF ERRORS = 0. NUMBER OF WARNINGS = 0

SYMBOL TABLE

SYMBOL	VALUE	LINE	DEFINED	CROSS-REFERENCES									
BASIC	0240	233	197	199	210	362	365						
CHD	0000	175	312	536	568								
CHPANL	0248	239	204	218	282	302							
CDMAND	00E2	184	195	223	228	257	260	263	272	314	361	422	
			427	453	460	480							
CPLP	024A	240	247										
CRA	CC00	96	338	341	515	519							
CRB	CC0F	99	350	355	359	364	404						
DATA	0006	174	200	279	296	540							
DELAY	0435	583	565	574									
DL1	0430	587	588										
DL2	0439	585	590										
DVCODE	00E0	182	351	401									
ERRCODE	00E1	183	399	434	488								
ERJ	0389	468	416	417	451	454							
FDBUF	00E6	188	286	289	298	306	405	499					
FDEMT	0225	214	261	409									
FOFL	0000	137	****										
FOINT	02F6	346	513	578									
FOID	0326	393	****										
FDRD	0080	152	****										
FORDa	00C4	134	****										
FORDT	00E4	135	****										
FORSF	0002	127	360										
FDSK	0D12	128	259										
FDST	0022	129	****										
FDST1	0042	130	566										
FDSTD	0062	131	****										
FDMT	00A0	133	****										
FDMTT	00F4	136	534										
FDRMAT	0385	513	****										
GD	0300	527	577										
NEXT	040E	565	549										
PULSE	02C0	321	205	209	216	244	254	270	315				
QAFa	0DFA	163	****										
QAFB	0DFB	162	****										
QAF8	0DF8	165	****										
QAF9	0DF9	164	****										
Q0	0008	145	****										
QCRC	0DF7	159	****										
QE	0004	151	****										
QFA	0001	153	****										
QFB	0000	152	****										
QF8	0011	155	****										
QF9	0010	154	****										
QH	0008	142	566										
QIAH	0DFC	160	****										
QIDH	0DFE	161	****										
QID	0001	147	****										
QI1	0002	148	****										
QI2	0004	149	****										
QI3	0008	150	****										
QH	0010	144	****										
QS	0001	146	****										

SYMBOL	VALUE	LINE	DEFINED	CROSS-REFERENCES				
QU	0010	143	****					
QV	0004	141	****					
ROATA	0284	277	226					
ROL	028E	281	283	288	290			
ROT	038D	473	425	441	447			
ROFI	03A3	488	455	475	481			
ROF2	03AC	496	489					
READ	0029	169	214	242	252	279		

Listing 1 continued on page 338

IF YOU CAN WAIT A MINUTE, WE CAN SAVE YOU \$1,000.

With the Starwriter™ Daisy Wheel 25 cps printer from C. Itoh.

A business letter, written on a 45 cps word-processing printer, might take about two minutes to print.

With the Starwriter, it might take closer to three.

The typical 45 cps printer retails for about \$3,000.

But the Starwriter 25 retails for about \$1,895—thus saving you about \$1,000.

And therein lies the biggest difference between the Starwriter 25 and the more expensive, daisy wheel printers.

The Starwriter 25 comes complete and ready-to-use, requiring no changes in hardware or software. It uses industry-standard ribbon cartridges, and it's "plug-in" compatible to interface with a



wide variety of systems, to help lower system-integration costs.

Using a 96-character wheel, it produces excellent letter-quality printing on three sharp copies with up to 163 columns, and offers the most precise character-placement available, for outstanding print performance.

C. Itoh's warranty:

3 months on parts and labor, supported by one of the best service organizations in the industry.

\$1,000 OFF ^{B6}

**Leading Edge Products, Inc.,
225 Turnpike Street,
Canton, Massachusetts 02021**

Dear Leading Edge:
I'd like to know more about the Starwriter, and how spending a minute can save me a grand. Please send me the name of my nearest dealer.

Name _____

Title _____

Company _____

Address _____

City _____

State _____ Zip _____

Phone: Area Code _____

Number _____

LEADING EDGE.®

Leading Edge Products,™ Inc., 225 Turnpike Street, Canton, Massachusetts 02021

Dealers: For immediate delivery from the Leading Edge Inventory Bank™ call toll free 1-800-343-6833

In Massachusetts, call collect (617) 828-8150. Telex 951-624

Listing 1 continued:

REND	0500	597	524	546	576	530	554															
RETRY	033A	405	500																			
RNORM	05BA	630	554																			
RSL	05B0	624	****																			
RSN	05B1	625	528	553																		
RSTRT	05FD	641	530	545																		
RTN	05B3	627	526	575																		
RTN1	035C	432	449	478	484																	
RTN2	035F	434	469																			
RTN3	0365	438	492																			
SAD	CC0C	95	284	300	322	325	348	535	547	567												
SADD	CC0C	94	339	517																		
SBD	CC0E	98	234	281	301	323	324	332	353	537	538	539										
			541	548	560	569	570	571	572													
SBDD	CC0E	97	357																			
SECT	0004	173	206	267																		
SECTOR	00E5	187	208	269	407	436	483	497														
SETDVC	0337	404	402																			
SETUP	02DE	331	201	207	215	243	253	268	280	297	313											
SET1	02E8	337	335	347																		
SLP	0421	572	573																			
STAT	0000	171	214																			
STATUS	00E3	185	245	415	448	466	474	477														
TIME1	0000	179	584	589																		
TIME2	0001	180	586	587																		
TRACK	00E4	186	202	255																		
TRK	0002	172	252																			
TRKEND	0409	560	561																			
TYPE1	0200	195	224																			
TYPE2	025B	252	225																			
TYPE2A	0274	267	256																			
TYP1	036B	447	423																			
TYP2	037D	459	424																			
WDATA	02A3	294	229	273																		
WDT	03EE	545	552	556																		
WLP	03F7	548	550																			
WRITE	0019	170	200	206	267	296	312	536	540	568												
WRT	0383	465	428																			
WRTCMD	02C2	312	233	277	294																	
WTL	02AD	298	305	307																		
WTL1	02B4	301	303																			

INSTRUCTION COUNT

ADC	0
AND	1
ASL	3
BCC	1
BCS	3
BEQ	11
BIT	19
BMI	5
BNE	15
BPL	8
BRK	0
BVC	6
BVS	0
CLC	1
CLD	0
CLI	0
CLV	0
CMP	6
CPX	0
CPY	0
DEC	9
DEX	4
DEY	2
EOR	4
INC	6
INX	1
INY	2
JMP	4
JSR	27
LDA	52
LDX	8
LDY	6

Listing 1 continued on page 340

First SARGON,

And now... REVERSAL

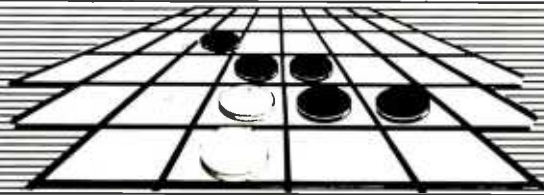

Hayden Games and Gameware

★ **REVERSAL** (Spracklens) Winner of the software division of the First International Man-Machine OTHELLO™ Tournament, this version of the 200 year old game Reversi, features 27 levels of play and high-resolution color graphics and sound. Special "Kibitz" option gives you hints in playing. Written by the authors of SARGON II, the first great computer chess program! **07004, Apple II tape, \$29.95; 07009, Apple II disk, \$34.95.**

★ **BLACKJACK MASTER: A Simulator/Tutor/Game** (Wazaney) A serious game that performs complex simulations and evaluations of playing and betting strategies. **05303, TRS-80 Level II tape, \$24.95; 05308, TRS-80 Disk Version, \$29.95**

★ **SARGON II** (Spracklen) The first great computer chess program! "...an excellent program which will provide a true challenge for many players... Save your money and buy SARGON II..." '80 Software Critique. **03403, TRS-80 Level II; 03404, Apple II; 03410, OSI C1P; 03440, OSI C4P; each tape \$29.95. 03408, TRS-80 Level II Disk; 03409, Apple II Disk; 03414, PSI C1P Disk; 03444, OSI C4P Disk; 03484, C8P Disk; each \$34.95**

MICROSAIL (Johnson) A true test of your nautical skills as you race against wind, tides, and time. **04401, PET tape, \$11.95**

GRIDIRON: A Microfootball Game (Microllair Associates) Be both offensive and defensive quarterbacks. Includes time-outs, penalties, and the two-point conversion option used in college football. **03003, TRS-80 Level II tape, \$12.95**

MAYDAY (Breitenbach) Out of fuel! Try to avoid crashing with this challenging airplane flight simulation. **02601, PET tape, \$9.95**

STARCLASH (Walton) An exciting game of galactic strategy for one or two players. **05903, TRS-80 Level II tape, \$16.95**

ROYAL FLUSH: Competitive Poker Solitaire (Wazaney) A game you can play alone or with any number of players. High score wins in this poker-based, fun-filled card game. Choose from possible game variations. **07101, PET; 07103, TRS-80 Level II, each tape, \$14.95**

BACKGAMMON (Wazaney) A classic game of skill and luck played against a preprogrammed opponent. **02501, PET; 02503, TRS-80 Level II; each tape, \$10.95**

BATTER UP!!: A Microbaseball Game (Savon) Action-packed baseball with 3 levels of play. **02801, PET; 02803, TRS-80 Level II; each tape, \$10.95**

New from Hayden

★ ★ **HISTO-GRAPH** (Boyd) A calendar-based histogram or bar-graph production system. Allows the user to enter numeric data that relates to a date, and reproduces that data as a high-resolution histogram. **09009, Apple II Disk, \$29.95**

★ ★ **OP-AMP DESIGN** (Gabrielson) Provides the necessary values for your design and will suggest appropriate op-amp types. Includes a choice of six op-amps, and the program will then determine if your selection of an op-amp will be acceptable within your chosen parameters. Can be updated to accommodate future op-amps. **09704, Apple II tape, \$16.95**

★ ★ **DOUBLE PRECISION FLOATING POINT FOR APPLESOFT™** (S-C Software) Extends the accuracy of the arithmetic available on the Apple from nine digits to a full 21-digit precision on all functions in Applesoft compatible format. **09409, Apple II Disk, \$49.95**

★ ★ **DATA-GRAPH** (Boyd) Aids in the preparation of graphs and charts. Numeric data can be entered into Data-Graph and used to create colorful one-, two-, or four-quadrant graphs. **09109, Apple II Disk, \$49.95**

More from Hayden

FINPLAN: A Financial Planning Program for Small Businesses (Montgomery) Allows you to enter data from a balance sheet into the program, to make assumptions about the future growth of business, and to have the computer project results for up to a five year period based on those assumptions. And if you change any data, the program revises all resulting data automatically. The disk version can be used only with TRSDOS Vers on 2.3. **05103, TRS-80 Level II tape, \$69.95; 05108, TRS-80 Level II Disk Version, \$74.95**

DATA MANAGER: A Data Base Management System and Mailing List (Lutus) Store information on a floppy disk, and retrieve it quickly and easily by specific names, or by category. **04909, Apple II Disk Version, \$49.95.**

PROGRAMMING IN APPLE™ INTEGER BASIC: Self-Teaching Software (Banks & Coan) Teach yourself Apple Integer BASIC and control your own progress at all times with this interactive programmed instruction format. **05004, Apple II, tape, \$29.95; 05009, Apple II Disk Version, \$39.95**

APPLE™ ASSEMBLY LANGUAGE DEVELOPMENT SYSTEM: An Assembler/Editor/Formatter (Lutus) Write and modify your machine language programs quickly and easily. **04609, Apple II Disk Version, \$39.95.**

Apple is a trademark of the Apple Computer Co., Inc. and is not affiliated with Hayden Book Co., Inc.

ORDER NOW!

Hayden Book Co. Inc.
50 Essex St., Rochelle Park, NJ 07662

Send me the software checked below. A check or money order is enclosed. I understand that Hayden pays shipping and handling costs and that I can return any disk or tape within 10 days if it is defective or I am dissatisfied with it for any reason. Residents of NJ and CA must add sales tax. Offer good in US only. Name of individual ordering must be filled in.

81-009

- | | | |
|--------------------------------|--------------------------------|--------------------------------|
| <input type="checkbox"/> 02501 | <input type="checkbox"/> 03444 | <input type="checkbox"/> 05409 |
| <input type="checkbox"/> 02503 | <input type="checkbox"/> 03484 | <input type="checkbox"/> 05509 |
| <input type="checkbox"/> 02601 | <input type="checkbox"/> 04401 | <input type="checkbox"/> 05903 |
| <input type="checkbox"/> 02801 | <input type="checkbox"/> 04609 | <input type="checkbox"/> 07004 |
| <input type="checkbox"/> 02803 | <input type="checkbox"/> 04909 | <input type="checkbox"/> 07009 |
| <input type="checkbox"/> 03003 | <input type="checkbox"/> 05004 | <input type="checkbox"/> 07101 |
| <input type="checkbox"/> 03403 | <input type="checkbox"/> 05009 | <input type="checkbox"/> 07103 |
| <input type="checkbox"/> 03404 | <input type="checkbox"/> 05103 | <input type="checkbox"/> 09009 |
| <input type="checkbox"/> 03408 | <input type="checkbox"/> 05108 | <input type="checkbox"/> 09109 |
| <input type="checkbox"/> 03414 | <input type="checkbox"/> 05303 | <input type="checkbox"/> 09409 |
| <input type="checkbox"/> 03440 | <input type="checkbox"/> 05308 | <input type="checkbox"/> 09704 |

Name _____

Address _____

City/State/Zip _____

BYTE 6/81

- Denotes Gameware Package
- Denotes New Program

Available at your
local computer store!

Hayden

Book Company, Inc.

50 Essex Street, Rochelle Park, NJ 07662

Listing 1 continued:

```

LSR      0
NOP      0
ORA      2
PHA      6
PHP      0
PLA      10
PLP      0
ROL      0
ROR      1
RTI      0
RTS      7
SBC      0
SEC      1
SED      0
SEI      0
STA      27
STX      10
STY      1
TAX      1
TAY      1
TSX      0
TXA      1
TXS      0
TYA      2

```

SYMBOLS = 101 (LIMIT = 800) # BYTES = 837 (LIMIT = 8192)

LINES = 853 (LIMIT = 3000) # XREFS = 257 (LIMIT = 1600)

Listing 2: Example of a routine that reads disk track 3 into memory, starting at location hexadecimal 1000. This routine also illustrates the use of the ERRCODE variable.

```

JSR FDINT      Initialize
LDA #$9C      Read multiple
STA COMMAND   sector command
LDA #$03      Request track
STA TRACK     number 3
LDA #0        Set buffer
STA FDBUF     address
LDA #$10      at
STA FDBUF + 1 hexadecimal 1000
JSR FDIO      Do I/O
LDA STATUS    check for
BNE ERROR     error

```

Listing 3: Simple testing program for a disk controller/6502 microprocessor combination. When the BRK (break) occurs, the variables listed in table 6 can be set to test the various controller functions.

```

INIT  JSR FDINT
      BRK
      BRK
GO    JSR FDINT
      BRK
      BRK
      JMP GO

```

Text continued from page 304:

1000. The status byte indicates if the read operation was successful. If the read test appears good, various other commands should be attempted to increase your familiarity with the 1771 and drive operation.

Extensions

With the addition of an external multiplexing circuit to switch the floppy-disk control lines, multiple drives can be controlled. Multiple drives, however, add a new software-control problem. Since the 1771 re-

tains the current head location, it is necessary to update the track register when switching between drives. A memory variable to contain the head location of each drive can be used to adjust the 1771's register.

A simplified version of the floppy-disk controller can be used to operate 5-inch disk drives in either single- or dual-density. In addition, this disk design is extensible to a more elaborate controller that uses a dedicated 6502 to communicate over a parallel or serial interface to a host computer.

Conclusion

Floppy-disk drives provide sufficient capacity and performance to meet the needs of most microcomputer users. By combining hardware and software, a floppy-disk system can be constructed economically without sacrificing any function or performance. The 6502 microprocessor, with a few hundred bytes of program, can control head movement and data transfer by utilizing the 1771 controller. The software provides a flexible, yet economic, solution to mass-storage problems. ■

MAPS
Multi-Application Processing System

WORD PROCESSING ORDER PROCESSING ACCOUNTING (MORE!)

MAPS
CT-80
CENTRAL PROCESSOR

THREE COMPUTERS IN ONE!
THE DIGIAC MAPS® CT-80 SYSTEM

Multi-User, Multi-Tasking, Cost Effective.

- 3 business systems can run concurrently - that's 3 times the overall system productivity!
- Time share word processing, accounting, order processing, inventory, forms processing, billing & more!
- 3 workstations can share data base - preparations can be done by several operators concurrently!
- All workstations can share common peripherals.
- Uses DIGIAC MAPS-80 operating system. (Digital Research MP/M)
- High level language processors including Fortran - Basic - Pascal - Cobol.
- Complete Turn-key system for ease of operation & learning!

DIGIAC CORPORATION

For Additional Information Contact:
MAPS, Commercial Products Division of:
DIGIAC CORPORATION
175 Engineers Road, Smithtown, NY. 11787
Phone: (516) 273-8600
MP/M is a trademark of Digital Research Corp.

MICROSTAT
NOW AVAILABLE FOR CBASIC2*

MICROSTAT is *the* statistics package for microcomputers, and is proving itself to users around the world, including:

Stanford, Harvard, Johnson & Johnson, Duke, University of Washington, UCLA, Lockheed, University of Pennsylvania, Oklahoma State, U.S. Geological Survey, Monsanto, University of Toronto, Sweden's National Central Bureau of Statistics, Utah State, Butler University, SUNY, Van Camps, Texas A&M, University of Wisconsin

and a growing list of other organizations. MICROSTAT's Data Management Subsystem (DMS) makes creating your own data files easy and includes numerous editing and transformation capabilities. Files produced by DMS can then be used to generate statistics in all common statistical areas (e.g., descriptive statistics, ANOVA, correlation, multiple regression, probability and hypothesis tests, nonparametrics and others) plus some not so common ones. Whether pure research or industrial quality control, MICROSTAT is the statistics package for you.

MICROSTAT sells for \$250.00 and is supplied on 8" SD or 5 1/4" (North Star) disks. The user's manual sells for \$18.00 and includes sample data and printouts. Please specify version when ordering. Foreign inquiries, please write directly to us.

ECOSOFT
P.O. Box 68602
Indianapolis, IN 46268
(317) 283-8883

master charge
THE INTERBANK CARD

* CBASIC2 is a registered trade mark of Compiler Systems Inc.

*** LOMAS DATA PRODUCTS PRESENTS ***

IEEE - S100 BUS 64K DYNAMIC RAM

Don't buy an outdated RAM board, buy the LOMAS DATA PRODUCTS 64K RAM board. The LDP 64K RAM is the only board that you can buy today and upgrade to a full 256K bytes on one board. The LDP 64K RAM offers the following advanced features:

- 8202 Dynamic RAM controller
- No waitstates with a 5 MHz 8088 or 8086
- 24 address lines for IEEE 696 compatibility
- Parity for ERROR control in large memory configurations
- 256K upgrade kit available in August
- Meets all IEEE 696 specifications

Introductory price of \$695 until June 15. After June 15 \$795.

LDP72 ADVANCED FLOPPY DISK CONTROLLER

- Meets all IEEE 696 specifications
- Advanced Intel 8272 LSI controller
- Digital data recovery circuit requires no adjustments for reliable operations
- Supports up to 4 drives
- May mix 5" and 8" drives on the same board

LDP88 CPU BOARD

The LDP88 CPU board offers the 16 bit processor of the future while maintaining compatibility with your present 8 bit boards. The LDP88 offers the following features:

- 2 R5232 Serial Ports, one capable of synchronous data transfer
- 2 8 bit parallel ports
- An 8" 1/4" Winchester Controller port
- A real time interrupt
- A socket for an 8231/9511 or 8232 math processor (math processor optional)
- Meets all IEEE 696 specifications

All these features are available for only \$325 (assembled and tested).

LDP88 CPU BOARD

- 9 vectored interrupts
- 1K of RAM
- Up to 8K of ROM/EPROM
- CP/M-86 support

LDP1 8088 MAINFRAME

Why settle for an 8 bit system of the past when you can invest in the 16 bit system of the future. The LDP1 includes the LDP88, LDP72, and the LDP 64K Dynamic RAM board. Options include: a second 8" floppy drive, 2 serial ports, 2 parallel ports, an 8" Winchester drive (Sept. 81).

PRICES	KIT	ASSEMBLED & TESTED
LDP 64K RAM	N/A	\$695.00
LDP88	\$349.95	399.99
LDP72	219.95	274.95
5-100 prototype board	29.95	
86-DOS	195.00	
CP/M-86	250.00	
Micro Soft Basic 86	500.00	
	350.00	(86-DOS required)
PASCAL/M	270.00	(with LDP1 and 86-DOS)
LDP1 with CP/M-86 or 86-DOS	\$3295.00	(CP/M-86 required)

LOMAS DATA PRODUCTS

11 Cross Street
Westborough, MA 01581
Telephone (617) 366-4335

PASCAL/M is a trademark of Sorcim
CP/M-86 is a trademark of Digital Research
86-DOS is a trademark of Seattle Computer Products

Ask BYTE

Conducted by Steve Ciarcia

Easy Data Entry?

Dear Steve,

I enjoyed your article "Build a Low-Cost, Remote Data-Entry Terminal." (See the September 1980 BYTE, page 26.) Your idea is close to the type of device I need: a simple data-entry terminal that has a ten-character display and can be used to record data, ten characters at a time, using an audio-cassette recorder. Is there an easy way to use your device for this?

Roy Pittman
Stillwater OK

The remote data-entry terminal described in that article will do some of the things

you want, but not everything. It cannot support more than an 8-bit display without circuit modification. It can, however, easily store and send up to fourteen characters entered sequentially on the keypad (refer to the last paragraph, on page 32 of the article).

Although it is a little involved and requires some extra button pushes to load the characters, the data-entry terminal could be used as you have suggested. To do it, you first press the Control-Escape to enter the storage mode (the remote terminal sends a hexadecimal FA output to the recorder). Decoding the FA code will allow automatic turn-on of the recorder. The

next one to fourteen keys pressed will be stored. They are automatically sent as a single message when a Control-semicolon is typed.

As designed, the data rate is 1200 bps (bits per second). To lower the data rate to something more manageable, say 300 bps, you simply lower the crystal frequency proportionately. To remotely switch a tape recorder on and off, you can use the keyboard function decoder that I described in a previous article. (See "Build a Keyboard Function Decoder," July 1978 BYTE, page 98.) . . . Steve

Backup Supplies

Dear Steve,

Allow me to add another request for backup power supplies. I want to use a computer for Bible translating for tribal people, but our electric power not only blacks out for a few minutes to several days, but when the local welder starts work, the lights dim each time he strikes an arc.

My son had a computer damaged when a copying machine was turned on, so I wonder about the welder. I had decided on a solution similar to the ideas you have mentioned, but I felt that I couldn't design a sine-wave inverter and that a computer probably wouldn't accept the square wave from a Heathkit inverter. How about the motor/generator rigs used by the military for B+ power supplies? A 1974 McMaster-Carr catalog shows that they were available in 24, 28, 32, 63, and 110 VDC input and 250 to 2000 W output at 115 V 60 Hz. Prices ranged from \$200 to \$600.

Of course, this wouldn't be

as efficient as a solid-state inverter, and would need maintenance (since the rigs have brushes) but it might be easier and cheaper to buy equipment on the surplus market.

Also, who publishes *Digital Design*?

Russell Reed
Pinamalayan, Oriental
Mindoro, Philippines

Motor/generator combinations are definitely a reasonable backup power system. That was all there was before solid-state converters. I cannot speak for the condition of a World War II surplus unit, but if it operates, it can be an economical solution to your problem. In fact, many computer manufacturers (such as Control Data) frequently use motor/generators in their installations. Be careful to monitor the output frequency as well as the voltage when you first start it. The years may have taken their toll on the regulator section.

Digital Design is published by Benwill Publishing Corporation, 1050 Commonwealth Ave, Boston MA 02215. The issue covering uninterruptible power supplies was February 1980 (Volume 10, Number 2). . . . Steve

Bank Switching

Dear Steve,

With the recent price reduction of dynamic memory circuits, a 64 K-byte memory system can be built with 32 devices (at \$96) or 128 devices (for \$64). I read BYTE and other fine publications and I keep coming across an interesting concept called bank switching. What exactly is bank switching? Also, an idea I have is to latch the data at a port bus to provide a

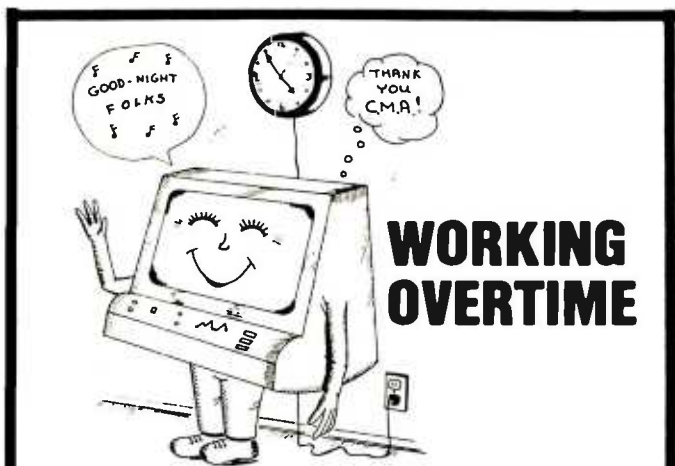

WORKING OVERTIME

APPLICATIONS WHICH SAVE TIME

Payroll, Word Processing, Accounting & Financial Management, Educational Administration, Legal, Medical & Dental Systems

Check your Local Dealer or Contact:
Charles Mann & Associates

7594 San Remo Trail
Yucca Valley, Ca. 92284
(714) 365-9718

Apple II

TRS-80

TI 99/4



COMPLETE LINE OF ATARI PRODUCTS

20% OFF

Atari 800 with 32K..... \$810	Atari 822 Printer..... \$360
Atari 800 with 40K..... \$870	Atari 400 with 8K..... \$399
Atari 815 Dual Disk Drive... \$1200	Atari 400 with 16K..... \$399
Atari 825 Printer..... \$650	Atari 410 Cassette..... \$69
Atari 820 Printer..... \$299	Atari 850 Interfaced Module.. \$176

SPECIAL 25% OFF Atari 810 Disk Drive \$460

NOW IN STOCK

Ramcrum 32K RAM Modules.. \$199	Vlscalc..... \$170
Kurta Graphics Tablet..... \$560	Atari 16K RAM Boards..... \$100
Epson MS80 Printer..... \$520	

ALSO

SOFTWARE BY POI, THESIS, BIT BUCKET AND MORE!

Z19 Terminals..... \$800	PLUS
Novation DCAT Modems..... \$169	NEC Spinwriters, Diablo Printers,
Intertec Super Brain 64K..... \$2810	Complete lines of Centronics
	Printers and Commodore Equip-
	ment. All at reduced prices.



The Bit Bucket
 168 NORTH BEACON STREET
 P.O. BOX 365
 NEWTON HIGHLANDS, MA 02161
 617-783-3144

Comp Case

• AP104

• AP101	Apple II with Single Disk Drive	\$109
• AP102	Apple II with Double Disk Drives	119
• AP103	Apple II, 9 inch Monitor & Double Drives ...	129
• AP104	Apple ///, two additional Drives & Silentype	139
• AP105	12 inch monitor plus accessories	99
• RS201	TRS-80 Model I, Expansion Unit & Drives ...	109
• RS202	TRS-80 Monitor or TV set	84
• RS204	TRS-80 Model III	129
• RS205	Radio Shack Color Computer	89
• P401	Paper Tiger 440/445/460	99
• P402	Centronics 730/737 - Line Printer II/IV	89
• P403	Epson MX70 or MX80	89
• CC90	Matching Attaché Case	75

computer case company

5650 INDIAN MOUND CT. COLUMBUS, OHIO 43213 (614) 868-9464

Measure, Control, Document...

Computer Systems and Peripherals designed to coordinate with the Apple Computers that let you measure, monitor, regulate, control and document with laboratory precision, at affordable cost.

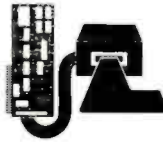

AI3 Analog Input System (A/D, 12bits)
 Measure voltages with 0.024% precision
 Monitor 16 separate inputs under program control
 Choose from 8 voltage ranges under program control; 100mV to 10V
 Make a reading in 20 microseconds

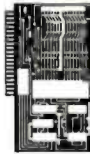

AI02 Analog Input System (A/D, 8bits)
 Measure voltages with 0.4% precision
 Monitor 16 separate inputs under program control
 Match most sensors with a standard 5 volt range
 Signal Conditioning System SC14 available



A003 Analog Output System (D/A, 8 bits)
 Control voltage levels from a simple program
 Conversion in less than 3 μsec.
 Standard 0 to 10 V Range
 Jumpers select 0 to 5V or 5 to 5V
 2, 4, or 8 channel models
 Each channel has its own memory
 Each channel has range, offset adjustments



DI09 Digital Interface
 Monitor or control 32 circuits in any combination
 Measure time intervals or count pulses
 Plug into BCD, parallel, or switch closure instrument outputs

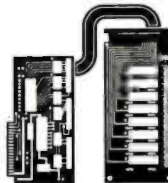

UI16 Isolated Power Interface
 Control 110VAC circuits from a program
 Operate DC relays or solenoids
 Receive logic pulses in noisy environments
 Avoid interference and grounding problems in large systems
 Start with one circuit -- expand to dozens



PR12 Intelligent Printer System
 Clear, readable printing on standard paper
 Intermix graphics and text of three sizes
 A true **printing system** including intelligent interface, and a complete manual.

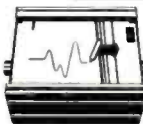

PL12 Intelligent Plotter System
 Produce detailed pen drawings from a program
 8 x 10 Plotting surface with .005" resolution
 Automatically plot from Basic arrays and strings
 A true **plotting system** including intelligent interface and complete manual.

Interactive Structures has been producing laboratory systems and interfaces for Apple Computer since 1977. Our technology is in use in thousands of applications -- from our own SpaceLab instrumentation system to automobile engine research and woodstove analysis.

Contact us for the details on affordable laboratory computing.

IS Interactive Structures, Inc.
 P.O. Box 404
 Bala Cynwyd, PA 19004
 215-667-1713

Heath®/Zenith

Buss: The Independent Newsletter of Heath Co. Computers has the information you need to improve your Heath® or Zenith computer system. Buss is not affiliated with the Heath Co. Each issue has news on hardware and software products from suppliers other than Heath®. Buss can help you to upgrade your computer and could save you a lot of money. Plus, Buss has programming hints and evaluations of many Heath® products.

As a subscriber to Buss, you will be in contact with over 3,800 other Heath® enthusiasts. It is a chance to communicate your experiences with the Heath®/Zenith systems and it could save you a lot of "banging your head against the wall."

Buss is published about every three weeks and mailed first class (airmail overseas). There are about 16 back issues in stock, available for the same price as current issues. A full refund is guaranteed any time you're not satisfied.

- 12 issues - \$17.96 (\$25 overseas)
- 18 issues - \$24.96 (\$35 overseas)
- 24 issues - \$29.96 (\$45 overseas)

U.S. dollars only, payable on a U.S. bank or by international postal money order. Send your payment to: Buss, 325-B Pennsylvania Ave., S.E., Washington, DC 20003 or you can charge your subscription on VISA or MasterCard by calling Buss at (202) 544-0900.

Ask BYTE

total address bus of 24 bits. Can I do this?
Simon Chapman
 Petaluma CA

Memory is indeed becoming inexpensive these days. Many personal computers will soon contain more than 64 K bytes of memory. To use the extra memory, they must, of course, use bank switching.

A bank of memory is some portion of memory that can be directly addressed by the processor. If you had an Apple II computer with 48 K bytes of memory, all 64 K bytes (including read-only memory) would be in the same bank of memory. Addressing the 64 K requires 16 address bits. If you were to add another 64 K of directly addressable memory, 17 bits would be required. Since the 6502 microprocessor (and the Z80 for that matter) has only 16 address bits, the additional bit must be created under program control.

The typical method is to dedicate a latched output port to this function. To access this second bank of memory, a program in the first bank sets the port output high, simulating the seventeenth address bit. The computer then works exclusively in the second bank. To return to the first bank, a program in the second bank resets the port to a low level.

As you can see, it can get complicated switching back and forth. Mirror images of the operating-system software would have to be resident in both banks. The solution to this problem is to bank-switch memory in 32 K-byte increments rather than 64 K bytes. The typical system would have the first 32 K-byte bank contain the operating system and switch up to eight individual 32 K banks occupying the second 32 K range. Activation of one of the eight boards is

handled by setting a bit on an output port (each bit is a separate memory-bank enable) through the always resident operating system. In most cases, the bank-switching is transparent to the user and takes only a few instructions.

Perhaps as soon as I get some of the new 64 K-byte integrated circuits, I'll discuss this topic in greater depth in an article. . . . Steve

Computer Stores

Dear Steve,

I have a degree in electronics and my fiancée has a degree in business management. We live in a small town and would like to open a computer store, for small businesses, homes, and industry. Where can I get some help and ideas on getting started? There are no computer-related jobs around here, and I feel like I'm being left out.

Bill Bass
 Bristol TN

Starting a computer store is a costly and tough job. When you first open a computer store, most personal-computer manufacturers will only ship cash-on-delivery, and many items must be in stock for you to sell them. When hobbyists walk into a computer store, rather than ask if you have it in stock. Your advantage is not price—mail-order houses are generally much cheaper—so it must be demonstration and availability that sells your products.

Turnover of stock is the key to success. Make sure there is a large enough market in your area before committing to this endeavor, and only believe about a quarter of the people who say they will buy something from you if you open a store.

The best way to get an education on owning a com-

TERMINALS FROM TRANSNET

PURCHASE PLAN • 12-24 MONTH FULL OWNERSHIP PLAN • 36 MONTH LEASE PLAN

	DESCRIPTION	PURCHASE PRICE	PER MONTH		
			12 MOS.	24 MOS.	36 MOS.
DEC	LA360ECwriter II	\$1,095	\$105	\$ 58	\$ 40
	LA34 DECwriter IV	995	95	53	36
	LA34 DECwriter IV Forms Ctrl.	1,095	105	58	40
	LA120 DECwriter III KSR	2,295	220	122	83
	LA120 DECwriter III RO	2,095	200	112	75
TEXAS INSTRUMENTS	VT100 CRT DECscope	1,595	153	85	58
	VT132 CRT DECscope	1,995	190	106	72
	T1745 Portable Terminal	1,595	153	85	58
	T1765 Bubble Memory Terminal	2,595	249	138	93
	T1783 Portable KSR, 120 CPS	1,745	167	93	63
DATAMEDIA	T1785 Portable KSR, 120 CPS	2,395	230	128	86
	T1787 Portable KSR, 120 CPS	2,845	273	152	102
	T1810 RO Printer	1,895	182	102	69
	T1820 KSR Printer	2,195	211	117	80
	DT80/1 CRT Terminal	1,695	162	90	61
LEAR SIEGLER	DT80/5 APL CRT	2,095	200	112	75
	DT80/5L APL 15" CRT	2,295	220	122	83
	ADM3A CRT Terminal	875	84	47	32
	ADM31CRT Terminal	1,450	139	78	53
	ADM42 CRT Terminal	2,195	211	117	79
HAZELTINE	1420 CRT Terminal	945	91	51	34
	1500 CRT Terminal	1,095	105	58	40
	1552 CRT Terminal	1,295	125	70	48
TELEVIDEO	920 CRT Terminal	895	86	48	32
	950 CRT Terminal	1,075	103	57	39
NEC SPINWRITER	Letter Quality, 55/15 RO	2,895	278	154	104
	Letter Quality, 55/25 KSR	3,295	316	175	119
QUME	Letter Quality KSR, 55 CPS	3,395	326	181	123
	Letter Quality RO, 55 CPS	2,895	278	154	104
HEWLETT PACKARD	2621A CRT Terminal	1,595	153	85	58
	2621P CRT Terminal	2,750	263	154	99
CENTRONICS	730 Desk Top Printer	715	69	39	26
	737 W/P Desk Top Printer	895	86	48	32

FULL OWNERSHIP AFTER 12 OR 24 MONTHS • 10% PURCHASE OPTION AFTER 36 MONTHS

ACCESSORIES AND PERIPHERAL EQUIPMENT

ACOUSTIC COUPLERS • MODEMS • THERMAL PAPER • RIBBONS • INTERFACE MODULES • FLOPPY DISK UNITS

OTHER POPULAR TERMINALS, COMPUTER PERIPHERALS AND COMPUTERS AVAILABLE.



TRANSNET CORPORATION
 1945 ROUTE 22 • UNION, N.J. 07083 • (201) 688-7800
 TWX 710-985-5485

A is for Apple.

---And the first thing you should know about Apple is Farnsworth Computer Center for sales, service, instruction, easy access, ---and one of the finest showrooms you will find.

Featuring now---
Apple II Plus w/ 48K
Disk Drive w/ 3.5
System Price *1795
List *2175**

RTR SOFTWARE Pkg.-
Market Charter and
Dow Log SALE *199

apple computer
Authorized Dealer

**FARNSWORTH
COMPUTER CENTER**
1891 N. Farnsworth Ave. (at the E-W Tollway)
Aurora, Il. 60505 Ph. (312)851-3888
Weekdays 10-8: Sat. 10-5

**READ AMERICA'S
NUMBER 1 NON-SELLER.**

Not for sale in any bookstore! Not available at any price!
The new Consumer Information Catalog!
It's the free booklet that lists over 200 helpful Federal publications; more than half, free. On topics like home repairs. Money management

Nutrition. Information that could help you to a better way of life.
To get your free copy, just write:
**CONSUMER INFORMATION CENTER,
DEPT. E
PUEBLO, COLORADO 81009**

CSA General Services Administration

Beneath Apple DOS

A technical manual by Don Worth and Pieter Lechner

Become an expert on the intricacies of Apple's DOS (Disk Operating System). BENEATH APPLE DOS is the perfect companion to Apple's DOS 3.3 Manual. Containing eight chapters, three appendices, a glossary, an index, and over 160 pages, this manual will serve to completely fill in the many gaps left by Apple's DOS 3.3 Manual. Written for Apple users with DOS 3.3, 3.2 or earlier versions, any Apple disk user would welcome having this carefully written manual at his fingertips.

LEARN . . .

- How DOS 3.3 differs from other DOS versions.
- How disks are protected.
- How to reconstruct a damaged diskette CATALOG.
- How tracks are formatted.
- How to use the disk directly, *without* DOS.
- How to call DOS's file manager.
- How every routine in DOS works.
- How to customize DOS to your needs.
- How to overcome DISK I/O ERRORS.
- About the "secret" file types — S and R.

**A DETAILED
LOOK AT DOS**

INCLUDES . . .

- Large quantities of excellent diagrams and tables.
- Source listings of useful disk utilities.
- Glossary of over 150 technical terms.
- Exhaustive description of DOS program logic.
- Handy reference card.
- Useful patches to DOS.
- Many programming examples.

Book - \$19.95

CALL OR WRITE FOR OUR CATALOG OF SOFTWARE PROGRAMS FOR THE APPLE II AND APPLE II PLUS®

WHERE TO GET IT: Call us for the name of the Quality Software dealer nearest you. If necessary you may order directly from us. Mastercard and Visa cardholders may place orders by telephone. Or mail in your check or bankcard number. California residents add 6% sales tax. **SHIPPING CHARGES:** Within North America orders must include \$1.50 for first class shipping and handling. Outside North America the charge for airmail shipping and handling is \$5.00. Pay in U.S. currency.

QS QUALITY SOFTWARE
6660 Reseda Blvd., Suite 105, Reseda, CA 91335
(213) 344-6599

*Apple II and Apple II Plus are trademarks of Apple Computer, Inc.

Ask BYTE

puter store is to visit one in another town (make sure it's not close enough to be a competitor) and ask the owner the questions you are posing to me. This is a new field and, unfortunately, there are as many failures as there are successes. Be careful, but don't hesitate to strike out on your own. . . . Steve

Double Characters

Dear Steve,

I would like to acquire a home terminal, since terminal time at school is sometimes difficult to get. Is it possible to build a circuit to connect between the output of a TRS-80 Color Computer or a Videotex and my television or monitor that would double the number of characters per line that these machines display?

The Videotex seemed like the answer to my problems, but I need more than 32 characters to log on to the

system I use.

Eric Lutz
Columbia PA

When you buy a computer, you get what you pay for. The hardware to produce 32 characters is cheaper than that to produce 64. While it's quite possible that some hobbyist will design a circuit to do the conversion you suggest, it hasn't happened yet. Also, I wouldn't buy equipment on the presumption that you can easily redesign it.

As for logging onto a computer, the number of characters displayed on the screen is usually immaterial. The software-terminal program used with the computer should "wrap around" at the end of 32 characters onto the next line (even though you haven't hit the carriage-return key yet). The length of the line you send is entirely determined by when you type a carriage return (after 50, 75, or any number characters).

I wouldn't be especially concerned about a 32-character display given the price/performance ratio of the machine. . . . Steve

Comparing Frequency

Dear Steve,

I am looking for a circuit that compares two input signals and detects which has the greater frequency. The project I am building has a +5 V supply, so it would be handy to use TTL (transistor-transistor logic). Are there single integrated circuits to perform this function?

Marvin Green
Tualatin OR

There are various ways to compare frequencies. The comparison can be either analog or digital. One analog method is to use frequency-to-voltage converters and simple "window" comparators. (This technique is reliable only at lower frequen-

cies.)

Since you mentioned +5 V, you're probably more interested in a digital-frequency comparator. Generally this is accomplished by comparing the phases of the two signals. An integrated circuit specifically designed for this purpose is the Motorola MC4044 Phase Comparator. (Determining $A > B$ or $B > A$ requires additional circuitry.)

If you know the ranges of the frequencies that you wish to compare, often it is easier to compare one unknown to some preset limits. (See figure 1.) Two retriggerable one-shots have their periods set for the upper limit (F_1) and lower limit (F_2) of the capture range. When the unknown frequency (F_0) is applied, it is gated through the remaining circuitry to provide logic outputs such as $F_0 > F_1$, $F_0 > F_2$, $F_0 < F_1$, or $F_0 < F_2$ Steve

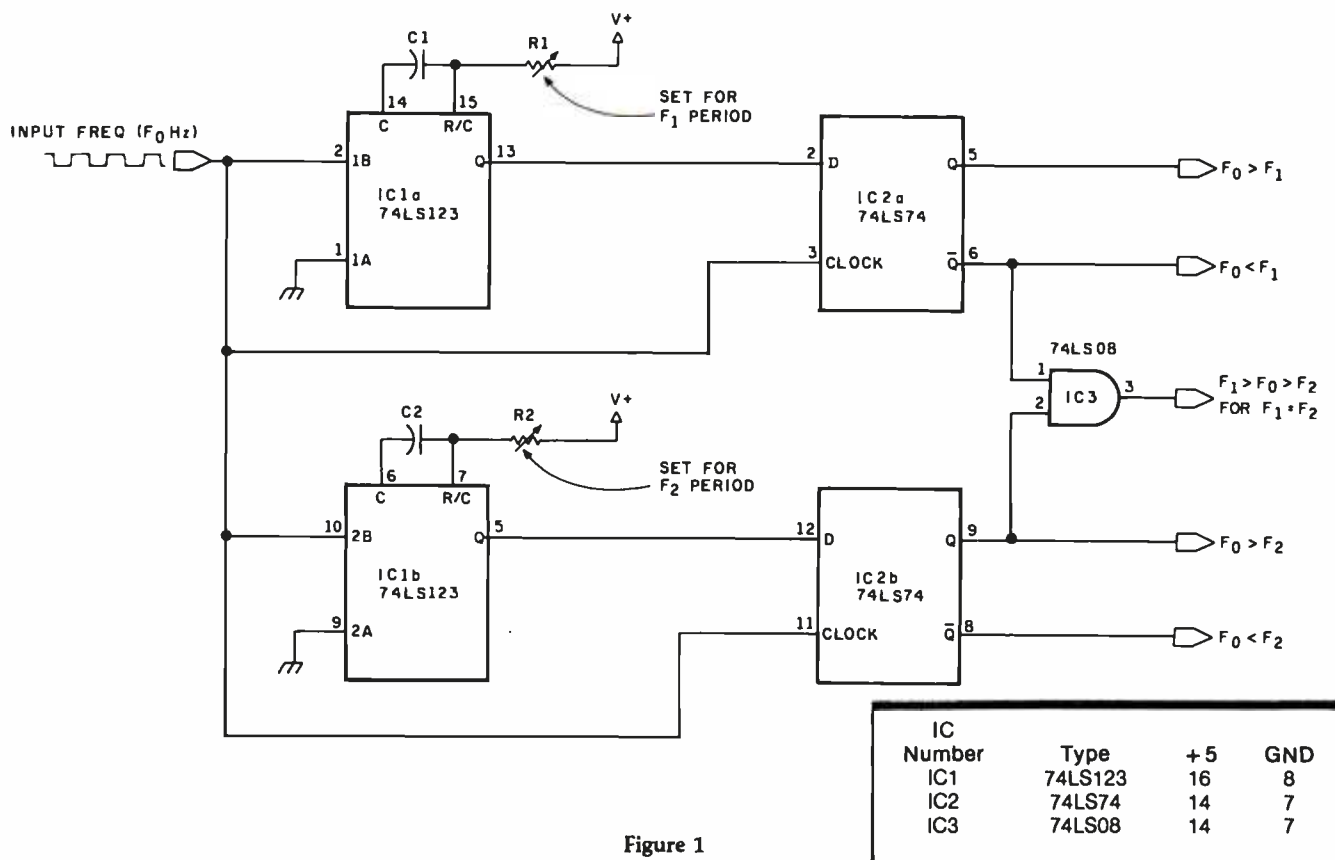

Figure 1



Fully TRS-80® Compatible

MPI B/51 DISK DRIVE

Includes: Case and Power Supply

In Stock! Limited Quantities.

\$321.00

We pay UPS charges in Continental U.S. Guaranteed for 90 days!

- 40 tracks
- 102K per disk
- 5 ms track-to-track

030181

Save time . . . Order by phone
Toll free: 1-800-621-3229
IN ILLINOIS CALL: 312-987-1024

FREE CATALOG

Hundreds of other computer products at major savings.

Complete systems and a wide selection of accessories at a discount.

Midwest Computer Peripherals

1467 S. Michigan Ave. Chicago, IL 60605

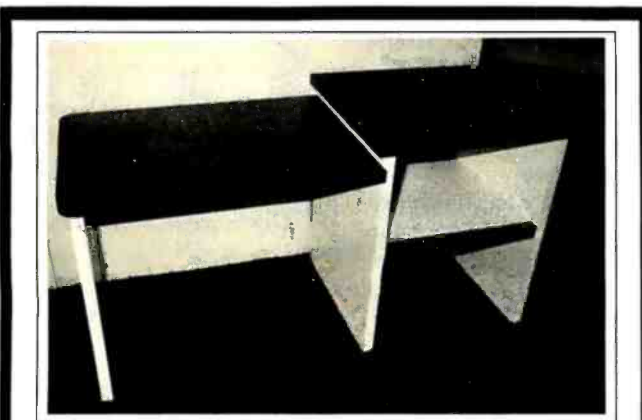

COMPUTER SYSTEM DESK

Overall Dimensions 60" L x 24" D x 30" H
Terminal Surface 34" L x 24" D x 27" H
Shelf Will Accept 21" W x 24" D x 12 1/4" H

- Designed for commercial use
- Easy to assemble and disassemble
- Radius on outside corners of tops for operator safety
- Separate shelf for computer and disk drives below work surface
- Lower terminal height for operator comfort
- Standard table height section for printers or work area
- Durable formica covered tops, shelf & legs
- Open back on shelf for cables and ventilation
- Modular construction—can add on as system expands
- Enhances user production by providing effective equipment layout

PRICE \$230.00 + SHIPPING (125 LBS)

COMPUTER CROSSROADS

3800 SOUTH TAMiami TRAIL
SARASOTA, FLORIDA 33579
813-349-0200



FOR ONLY \$129.95 Learn Computing From The Ground Up

Build a Computer kit that grows with you, and can expand to 64k RAM, Microsoft BASIC, Text Editor/Assembler, Word Processor, Floppy Disks and more.

EXPLORER/85

Here's the low cost way to learn the fundamentals of computing, the all-important basics you'll need more and more as you advance in computer skills. For just \$129.95 you get the advanced design Explorer/85 motherboard, with all the features you need to learn how to write and use programs. And it can grow into a system that is a match for any personal computer on the market. Look at these features: 8085 Central Processing Unit, the microprocessor "heart" of the Explorer/85; 64k of RAM (the millions who will buy and use the 8080/8085 in a year alone). . . . Four 8-bit plus one 6-bit input/output ports from which you can input and output your programs, as well as control exterior switches, relays, lights, etc. . . . a cassette interface that lets you store and reload programs you've learned to write. . . . deluxe 2,000 byte operating system/monitor makes it easy to learn computing in several important ways. . . . It allows simpler, faster writing and entering of programs. . . . It permits access by you to all parts of the system so you can check on the status of any point in the program. . . . It allows tracing each program step by step, with provision for displaying all the contents of the CPU (registers, flags, etc.) . . . and it does much more!

You get all this in the starting level (Level A) of the Explorer/85 for only \$129.95. Incredible! To use, just plug in your 8VDC power supply and terminal or keyboard/display— if you don't have them, see our special offers below.

- Level A computer kit (Terminal Version) . . . \$129.95 plus \$3 P&I*
- Level A kit (Hex Keypad/Display Version) . . . \$129.95 plus \$3 P&I*
- LEVEL B— This "building block" converts the motherboard into a two-slot S100 bus (industry standard) computer. Now you can plug in any of the hundreds of S100 cards available.
 - Level B kit . . . \$49.95 plus \$2 P&I*
 - S100 bus connectors (two required) . . . \$4.85 each, postpaid.
- LEVEL C— Add still more computing power to the "building block" mounts directly on the motherboard and expands the S100 bus to six slots.
 - Level C kit . . . \$39.95 plus \$2 P&I*
 - S100 bus connectors (five required) . . . \$4.85 each, postpaid.

- LEVEL D— When you reach the point in learning that requires more memory, we offer two choices: either add 4k of a memory directly on the motherboard, or add 4k to 64k of memory by means of a single S100 card, our famous "JAWS".
 - Level D kit (CHECK ONE) . . . 4k on-board . . . \$49.95 plus \$2 P&I*
 - 16k S100 "JAWS" . . . \$149.95 plus \$2 P&I*
 - 32k S100 "JAWS" . . . \$199.95 plus \$2 P&I*
 - 48k S100 "JAWS" . . . \$249.95 plus \$2 P&I*
 - 64k S100 "JAWS" . . . \$299.95 plus \$2 P&I*
- LEVEL E— An important "building block" that activates the 8k ROM/EPROM space on the motherboard. Now just plug in one 8k Microsoft BASIC or your own custom programs.
 - Level E kit . . . \$5.95 plus 50¢ P&I*

Microsoft BASIC— It's the language that allows you to talk English to your computer! It is available three ways:

- 8k cassette version of Microsoft BASIC (requires Level B and 16k of RAM minimum; we suggest a 16k S100 "JAWS"— see above) . . . \$64.95 postpaid.
- 8k ROM version of Microsoft BASIC (requires Level B & Level E and 4k RAM; just plug into your Level E sockets. We suggest either the 4k Level D RAM expansion or a 16k S100 "JAWS" . . . \$89.95 plus \$2 P&I*.)
- Disk version of Microsoft BASIC (requires Level B, 32k of RAM, floppy disk controller, 8" floppy disk drive) . . . \$325 postpaid.

TEXT EDITOR/ASSEMBLER— The editor/assembler is a software tool (a program) designed to simplify the task of writing programs. As your programs become longer and more complex, the assembler can save you many hours of programming time. This software includes an editor program that enters the programs you write, makes changes, and saves the programs on cassettes. The assembler performs the clerical task of translating symbolic code into the computer-readable object code. The editor/assembler program is available either in cassette or a ROM version.

- Editor/Assembler (Cassette version; requires Level "B" and 8k (min.) of RAM—we suggest 16k "JAWS"— see above) . . . \$59.95 plus \$2 P&I*
- Editor/Assembler (ROM version, supplied on an S100 card; requires Level B and 4k RAM (min.)— we suggest either Level D or 16k "JAWS") . . . \$99.95 plus \$2 P&I*.

- 8" FLOPPY DISK— A remarkable "building block" Add our 8" floppy disk when you need faster operation, more convenient program storage, perhaps a business application, and access to the literally thousands of programs and program languages available today. You simply plug them into your Explorer/85 disk system— it accepts all IBM-format CP/M programs.
 - 8" Floppy Disk Drive . . . \$499.95 plus \$12 P&I*
 - Floppy Controller Card . . . \$199.95 plus \$2 P&I*
 - Disk Drive Cabinet & Power Supply . . . \$69.95 plus \$3 P&I*
 - Drive Cables (set up for two drives) . . . \$25.00 plus \$1.50 P&I*
- CP/M 2.2 Disk Operating System: Includes Text Editor/Assembler, dynamic debugger, and other features that give your Explorer/85 access to thousands of existing CP/M-based programs. \$150.00 postpaid.

NEED A POWER SUPPLY? Consider our AP-1. It can supply all the power you need for a fully expanded Explorer/85 (note, disk drives have their own power supply). Plus the AP-1 fits neatly into the attractive Explorer steel cabinet (see below).

- AP-1 Power Supply kit (8V @ 5 amps) in deluxe steel cabinet . . . \$39.95 plus \$2 P&I*
- NEED A TERMINAL?** We offer you choices: the least expensive one is our Hex Keypad/Display kit that displays the information on a calculator-type screen. The other choice is our ASCII Keyboard/Computer Terminal kit that can be used with either



- Plug in Netronic's Hex Keypad/Display
- Add Level B to convert to 64k RAM
- Add 4k RAM
- Plug in Level E here: or accept Microsoft BASIC or Editor/Assembler in ROM
- Add two S100 boards
- Add your own custom circuits (prototype area)
- Connect terminal

a CRT monitor or a TV set (if you have an RF modulator).

- Hex Keypad/Display kit . . . \$69.95 plus \$2 P&I*
- ASCII Keyboard/Computer Terminal kit featuring a full 128 character set, u.k.I case, full cursor control, 75 ohm video output, convertible to bauder output, selectable baud rate, RS 232-C or 20 mA I/O, 32 or 64 character by 16 line format . . . \$149.95 plus \$3 P&I*



- Steel Cabinet for ASCII Keyboard/Terminal . . . \$19.95 plus \$2.50 P&I*
- RF Modulator kit (allows you to use your TV set as a monitor) . . . \$6.95 postpaid.
- 12" Video Monitor (10MHz bandwidth) . . . \$199.95 plus \$5 P&I*
- Deluxe Steel Cabinet for the Explorer/85 . . . \$49.95 plus \$3 P&I*
- Fan for cabinet . . . \$15.00 plus \$1.50 P&I*



ORDER A SPECIAL-PRICE EXPLORER/85 PAK—THERE'S ONE FOR EVERY NEED.

- Beginner Pak (Save \$26.00)— You get Level A (Terminal Version) with Monitor Source Listing (\$25 value) AP-1.5-amp. power supply, Intel 8085 Users Manual . . . (Reg. \$199.95) SPECIAL \$169.95 plus \$4 P&I*
- Experimenter Pak (Save \$33.40)— You get Level A (Hex Keypad/Display Version) with Hex Keypad/Display, Intel 8085 User Manual, Level A Hex Monitor Source Listing, and AP-1.5-amp. power supply . . . (Reg. \$279.95) SPECIAL \$246.95 plus \$6 P&I*
- Special Microsoft BASIC Pak (Save \$103.00)— You get Levels A (Terminal Version), B, D (4k RAM), E, 8k Microsoft in ROM, Intel 8085 User Manual, Level A Monitor Source Listing, and AP-1.5-amp. power supply . . . (Reg. \$439.70) SPECIAL \$326.95 plus \$7 P&I*

ADD A ROM-VERSION TEXT EDITOR/ASSEMBLER (Requires Levels B and D or S100 Memory) . . . \$99.95 plus \$2 P&I*

Starter 8" Disk System— Includes Level A, B floppy disk controller, one CDC 8" disk-drive, two-drive cable, two S100 connectors; just add your own power supplies, cabinets and hardware. . . . (Reg. \$1065.00) SPECIAL \$999.95 plus \$13 P&I*.

- 32k Starter System, \$1049.95 plus \$13 P&I*
- 48k Starter System, \$1295.95 plus \$13 P&I*
- 64k Starter System, \$1145.95 plus \$13 P&I*

- Add to any of above Explorer steel cabinet, AP-1 five amp. power supply, Level C with two S100 connectors, disk drive cabinet and power supply, two sub-D connectors for connecting your printer and terminal . . . (Reg. \$225.95) SPECIAL \$199.95 plus \$13 P&I*
- Complete 64k System, Wired & Tested . . . \$1650.00 plus \$20 P&I*

*Special Complete Business Software Pak (Save \$625.00)— Includes CP/M 2.2 Microsoft BASIC, General Ledger, Accounts Receivable, Accounts Payable, Payroll Package . . . (Reg. \$1325) SPECIAL \$699.95 postpaid.

*P&I stands for "postage & insurance." For Canadian orders, double this amount.

Continental Credit Card Buyers Outside Connecticut: **TO ORDER Call Toll Free: 800-243-7428**

To Order From Connecticut, or For Technical Assistance, call (203) 354-9375

★ (Clip and mail entire ad) ★

SEND ME THE ITEMS CHECKED ABOVE
Total Enclosed (Conn. Residents add sales tax): \$_____ Paid by:

Personal Check Cashier's Check/Money Order
 VISA MASTER CARD/BankNo. _____

Acct. No. _____ Exp. Date _____

Signature _____

Print Name _____

Address _____

City _____ State _____ Zip _____

NETRONICS Research & Development Ltd.
333 Litchfield Road, New Milford, CT 06776

Software Received

This is a list of software packages that have been received by BYTE Publications during the past month. The list is correct to the best of our knowledge, but it is not meant to be a full description of the product or the forms in which the product is available. In particular, some packages may be sold for several machines or in both cassette and floppy-disk format; the product listed here is the version received by BYTE Publications.

This is an all-inclusive list that makes no comment on the quality or usefulness of the software listed. We regret that we cannot review every software package we receive. Instead, this list is meant to be a monthly acknowledgment of these packages and the companies that sent them. All software received is considered to be on loan to BYTE and is returned to the manufacturer after a set period of time. Companies sending software packages should be sure to include the list price of the packages and (where appropriate) the alternate forms in which they are available.

Apple

Address Book, name and address file and telephone dialer for the Apple II. Floppy disk, \$49.95. Muse Software Company, 330 N Charles St, Baltimore MD 21201.

Data Fixer, disk software-repair utility for the Apple II. Floppy disk, \$29.95. Image Computer Products, 615 Academy Dr, Northbrook IL

60062.

Data Plot, on-screen data-graphing program for the Apple II. Floppy disk, \$59.95. Muse Software Company, (see above).

Invasion Force, graphics game for the Apple II. Cassette, \$19.95. Compu-Things, 708 Broadway, Chelsea MA 02150.

Monitor Extender, machine-language utility for the

Apple II. Cassette, \$19.95. Image Computer Products (see above).

Spelling, three educational games for the Apple II. Floppy disk, \$21.95. Software by Witzel, POB 2123, Littleton CO 80161.

Super Bar and Wine Guide, wine selection guide and bar recipe program for the Apple II. Floppy disk, \$24.95. Cine-Aero Productions, 1821 N Frederic St, Burbank CA 91505.

Super Text Form Letter Module, add-on module to Super Text II word-processing package for the Apple II. Floppy disk, \$100. Muse Software Company (see above).

Super Text II, word processor for the Apple II. Floppy disk, \$150. Muse Software Company (see above).

Atari

Shuttle Ascent Simulation, space-shuttle simulation for the Atari 800. Cassette, \$9.95. Starbound Software, POB 214, Cocoa Beach FL 32931.

Commodore

Addition, educational program for the Commodore PET. Cassette, \$20. Teaching Tools, POB 12679, Research Triangle Park NC 27709.

Create-A-Base, data-base management program for the Commodore CBM. Floppy disk, \$360. Micro Computer Industries Ltd, 1520 E Mulberry, Fort Collins CO 80524.

Subtraction, educational program for the Commodore PET. Cassette, \$20. Teaching Tools (see above).

Exidy

Toolkit, screen editor and enhancements for the Exidy Sorcerer. Cassette, \$69.95. North American Software, POB 1173 Station B, Downsview, Ontario, M3H 5V6, Canada.

Sword, word processor for the Exidy Sorcerer. Cassette, \$34.95. North American Software (see above).

Super Graphic Scratch Pad Version 2.2, graphics utilities for the Exidy Sorcerer. Cassette, \$24.95. North American Software (see above).

Radio Shack

Aviation, aviation-calculation package for the TRS-80 Pocket Computer. Cassette, \$24.95. Radio Shack, 1 Tandy Ctr, Fort Worth TX 76102.

Cheaptalk, voice-output routines for the TRS-80 Model I. Cassette, \$19.95. Alan Saville, POB 5190, San Diego CA 92105.

Income Property Analysis System, business-analysis program for the TRS-80 Model I or III. Floppy disk, \$225. Advanced Business Microsystems, 5801 Marvin D Love Fwy, #103, Dallas TX 75237.

LDOS, disk operating system for the TRS-80 Model I. Floppy disk, \$149. Galactic Software Ltd, 11520 N Port Washington Rd, Mequon WI 53092.

Olympic Decathlon, multi-player graphics game for the TRS-80 Model I. Floppy disk, \$24.95. Microsoft Consumer Products, 400 108th Ave NE, Suite 200, Bellevue WA 98004.

RSM Patch, modification package to Small Systems Software's RSM for the TRS-80 Model III. Cassette, \$9.95. Remarkable Software, POB 1192, Muskegon MI 49443.

SECS, full-screen editor for the TRS-80 Color Computer. Cassette, \$29.95. Datasoft Inc, 16600 Schoenborn St, Sepulveda CA 91343.

SIGMON, machine-language monitor for the TRS-80 Color Computer. Cassette, \$29.95. Datasoft Inc (see above). ■

Keep magazines, catalogues, journals
NEAT AND ORGANIZED
in home, office, workshop!

End Clutter! Find it fast —
the first time with handy, husky,
heavy duty fiberboard

SHELF FILES

Eliminate the mess of loose magazines, catalogs and newspapers. Find what you want when you want it by using these handy shelf or desk top files. Adhesive ID labels included.



6 POPULAR SIZES AVAILABLE

From digest size to newspaper size! Popular letter and magazine size (9" x 11½", 3¾" box width) — 8 for \$13.59. 25 for \$31.95 prepaid. Sturdy, heavy-duty fiberboard will last for years! Charge it! Call or mail coupon today.

Professional Aids Co., Suite 161

3685 Commercial Ave., Northbrook, IL 60062 312/291-0558

Please rush postpaid Fiberboard Desk and Shelf Files as checked below:

How Many	Qty.	Size	Price	Total Price	<input type="checkbox"/> Check for Free Catalog
8		Letter Size	\$13.59		
25		Letter Size	\$31.95		

Charge it to Visa Mastercharge TOTAL: _____

Acct. No. _____ Exp. Date _____

Name _____

Address _____

City/State/Zip _____

Illinois Residents add 6% Sales Tax, please. Other sizes from digest to newspaper available.

DEC LSI-11 Components

Dependable service
at discount prices
Domestic
and Export

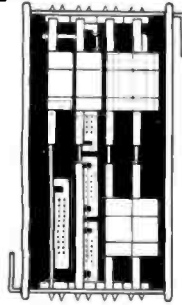

Mini Computer Suppliers, Inc.

25 Chatham Rd., Summit, N.J. 07901
Since 1973
(201) 277-6150 Telex 13-6476

©Mini Computer Suppliers, Inc.
1979

COMPUTER HOBBYIST SPECIALS!



Add \$40 for Hdlg. and Pkg.
Pay Shipping When Delivered.

SAVE!!

Daisy Wheel Terminals

RS-232, used, off-lease. Features Diablo Hytype 1 printer, up to 30 CPS, plot & text modes, dual pitch and much, much more. Includes data, operation manual, schematics. "As-is" machines may need some service.

TESTED & FUNCTIONAL "AS-IS" ONLY
NOW ONLY **\$1199⁰⁰** **\$799⁰⁰** ea

Modified I/O "SELECTRIC*-II" Printer

Stepper driven platen & carrier. Takes Selectric II tape cartridges. Steppers reduce mechanical failure rate. Uses opto-sensors for all feedback and keyboard sensing and solenoids for character selection & functions. Sophisticated design. Rebuild into a typewriter or drive with a micro processor for bi-directional printing & 4-way plotting. Does not include drive circuitry or power supply. Mostly whole "as-is", no type element included. Includes I/O data & schematics. Fantastic possibilities. Removed from sophisticated word processors.



NOW ONLY
\$399⁰⁰ EACH

Add \$20 For Hdlg. & Pkg. - Pay Shipping When Del.



Write or Call for our Bargain-Packed PERIPHERAL FLYER!!



Prices are Subject to Change on All Items



CFR Associates, Inc.

MAIL ORDERS:
Box 144, Newton, N.H.
03858



PHONE ORDERS:
617/372-8536
(Sorry, No Collect Calls)
MasterCharge & VISA Welcome



WAREHOUSE:
18 Granite Street
Haverhill, Mass. 01830



META TECHNOLOGIES

26111 Brush Avenue, Euclid Ohio 44132
CALL TOLL FREE 1-800-321-3552 TO ORDER.
IN OHIO, call (216) 289-7500 (COLLECT)

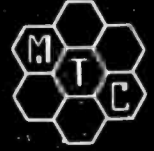

MICROPARAPHERNALIA DISKETTES (box of ten)

- 5 1/4" PLAIN JANETTM \$21.95
- 5 1/4" PLAIN JANETTM Gold \$25.95
- 5 1/4" DATALIFETM MD 525-01 .. \$26.95
- 8" DATALIFETM FD34-8000 \$43.95

NEWDOS by APPARAT

- NEWDOS/80 by Apparat \$149.95
- NEWDOS + to
NEWDOS/80 UPGRADE CALL
- NEWDOS+ with ALL UTILITIES
- 35-track \$69.95
- 40-track \$79.95

BOOKS

- TRS-80TM DISK
AND OTHER MYSTERIES .. \$19.95
- MICROSOFTTM BASIC DECODED \$29.95

1001 THINGS TO DO WITH YOUR PERSONAL COMPUTER

BY MARK SAWUSCH

333 pages
\$7.95

333 pages, written in simple terms, of "what-to-do" and "how-to-do-it". Suitable not only for microcomputers, but for programmable calculators as well. Includes program listings, formulas, a glossary of computer terms and more! Definitely a MUST BUY!

A PARTIAL LIST OF APPLICATIONS

- | | | |
|---|--------------------------|-------------------------------|
| Electric Memorandum | Income Tax | Simultaneous Equation Solver |
| Energy Efficiency Computation | Speed Reading | Real Estate Evaluation |
| Test Your Typing Speed | Check Digit Generator | Astrology |
| Statistical Analysis | Personality Test | General Purpose Clock/Timer |
| Options Analysis | Morse Code | Recipe Index/Calculator |
| Logic Circuit Analysis | Finances and Investments | RPN Calculator |
| Antenna Design | Biorythm | Amateur Radio |
| Carpenter and Mechanic's Helper | Letter Writing | Computer Assisted Instruction |
| Calculation of the Number of Days Between Two Dates | | Robotwar |

TRS 80 is a trademark of the Radio Shack Division of Tandy Corporation. DATALIFE is a trademark of VERBATIM. PLAIN JANE AIDS, AIDS III, CALCS III, CALCS IV, MERGE III are trademarks of MTC. 1981 by Meta-Tech Industries Corporation, Inc.

MOST ORDERS SHIPPED WITHIN ONE BUSINESS DAY
Products damaged in transit will be exchanged.

PRICES IN EFFECT June 1, 1981 THRU June 30, 1981.
Prices, Specifications, and Offerings subject to change without notice.

WE ACCEPT
• VISA
• MASTER CHARGE
• CHECKS
• MONEY ORDERS
• C.O.D.

*Add \$3.00 for shipping & handling
*\$3.00 EXTRA for C.O.D.
*Ohio residents add 6 1/2% sales tax.

CALL FOR INFORMATION ON OTHER PRODUCTS

Books Received

BASIC, A Hands-On Method, Second Edition, Herbert D Peckham. New York: McGraw-Hill, 1981; 17.5 by 23.5 cm, 306 pages, softcover, ISBN 0-07-049160-7, \$12.95.

BASIC-Pack Statistics Programs for Small Computers, Dennie Van Tassel. Englewood Cliffs NJ: Prentice-Hall, 1981; 21 by 28 cm, 230 pages, softcover, ISBN 0-13-066381-6, \$16.95.

Basically Speaking, A Guide to BASIC Programming for the Interact Computer, Micro Video Corporation. Ann Arbor MI: Micro Video Corporation, POB 7357, 1980; 23 by 28 cm, 201 pages, softcover, ISBN-none, \$14.95.

Data Structures Using Pascal, Aaron M Tenenbaum and Moshe J Augenstein. Englewood Cliffs NJ: Prentice-Hall, 1981; 18.5 by 24.5 cm, 545 pages, hardcover, ISBN 0-13-196501-8, \$23.95.

The 8085 Microprocessor, Fundamentals and Applications (Hands-On), Howard Boyet. New York: MTI Publications, 1980; 18 by 25.5 cm, 420 pages, softcover, ISBN-none, \$17.95.

First Course in Data Processing with BASIC, J Daniel Couger and Fred McFadden. Somerset NJ: John Wiley & Sons, 1981; 21.5 by 28 cm, 443 pages, softcover, ISBN 0-471-08046-2, \$17.95.

First Course in Data Processing with BASIC, COBOL, FORTRAN, and RPG, J Daniel Couger and Fred McFadden. Somerset NJ: John Wiley & Sons, 1981; 21.5 by 28 cm, 532 pages,

softcover, ISBN 0-471-05581-6, \$20.95.

Fundamentals of Programming in BASIC, Robert C Nickerson. Cambridge MA: Winthrop Publishers, 1981; 17.5 by 23.5 cm, 400 pages, softcover, ISBN 8-87626-305-8, \$12.95.

Introduction to Computer Operations, Second Edition, W M Fuori; A D'Arco; and L Orilia. Englewood Cliffs NJ: Prentice-Hall, 1981; 18.5 by 24.5 cm, 620 pages, hardcover, ISBN 0-13-480392-2, \$19.

Introduction to Computer Data Processing, Third Edition, Wilson T Price. New York: Holt, Rinehart and Winston, 1981; 19 by 24 cm, 577 pages, hardcover, ISBN 0-03-056728-9, \$18.95.

Invitation to Pascal, Harry Katzan Jr. Princeton NJ: Petrocelli Books, 1981; 16.5 by 24 cm, 233 pages, hardcover, ISBN 089433-103-5, \$17.50.

MA-2 Microcomputer Applications, Volume 1, Howard Boyet and Ron Katz. New York: MTI Publications, 1979; 15.5 by 23 cm, 461 pages, softcover, ISBN 0-89704-026-0, \$16.

MA-2 Microcomputer Applications, Volume 2, same as above, 290 pages, ISBN 0-89704-027-9, \$9.

Microprocessor System Debugging, Noordin Ghani and Edward Farrell. Somerset NJ: John Wiley & Sons, 1980; 18.5 by 28.5 cm, 143 pages, softcover, ISBN 0-471-27860-2, \$43.50.

Microprogrammed Control and Reliable Design of

Small Computers, George D Kraft and Wing N Toy. Englewood Cliffs NJ: Prentice-Hall, 1981; 16 by 24 cm, 428 pages, hardcover, ISBN 0-13-581140-6, \$21.95.

The Pascal Handbook, Jacques Tiberghien. Berkeley CA: Sybex, 1981; 18 by 23 cm, 500 pages, softcover, ISBN 0-89588-053-9, \$14.95.

Programming with FORTRAN/WATFOR/ WATFIV, David T Basso and Ronald D Schwartz. Cambridge MA: Winthrop Publishers, 1981; 17.5 by 23.5 cm, 407 pages, softcover, ISBN 0-87626-638-3, \$12.95.

Systems Analysis and

Management: Structure, Strategy and Design, Donald V Steward. Princeton NJ: Petrocelli Books, 1981; 16.5 by 24 cm, 287 pages, hardcover, ISBN 0-89433-106-X, \$25.

TRS-80 Assembly Language, Hubert S Howe Jr. Englewood Cliffs NJ: Prentice-Hall, 1981; 18.5 by 24.5 cm, 186 pages, hardcover, ISBN 0-13-931139-4, \$15.95.

Using Microprocessors and Microcomputers: The 6800 Family, J D Greenfield and W C Wray. Somerset NJ: John Wiley & Sons, 1981; 19.5 by 24.5 cm, 460 pages, hardcover, ISBN 0-471-02727-8, \$22.95. ■

BYTE's Bits

Terminal Helps Partially Sighted and Legally Blind

Some partially sighted individuals can now work with computer terminals thanks to M Daniel Simkovitz, a partially sighted Wayne State University researcher in electrical engineering. The device, called the Low Vision Terminal System (LVTS), allows people with poor vision to see and read computer output.

The LVTS is a microprocessor-based system that enlarges letters and characters to more than three inches in height. The size of the letters and characters and the speed of their movement are controlled by the user. The display can move horizontally one line at a time or scroll vertically through the

text. Other possible beneficiaries of the LVTS could be secretaries, data acquisition personnel, or anyone accustomed to working with terminals for long periods. By adjusting the height and speed of the characters, eye strain can possibly be reduced.

Dr Edward R Fisher, associate dean for research and graduate programs at the College of Engineering, assisted Mr Simkovitz with the patent process. A US patent is pending in Wayne State University's name. The two are now searching for a manufacturer that will help develop and market the LVTS. For more information, contact Dr Fisher, (313) 577-3861, or Dan Simkovitz, (313) 577-3902, at Wayne State University, Detroit MI 48202. ■

Clipper™

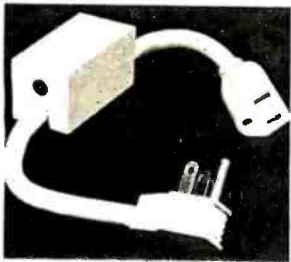
LINE VOLTAGE TRANSIENT CLIPPING

Features Parallel Operation 5000 Hits/Second

PROTECTS:

- Computers
- Micro-Computer Systems
- Word Processors
- Cash Registers
- Power Supplies

PROTECTS AGAINST:

- High Energy Voltage Transients
- On-Off Switching
- Lightning Induced Transients
- Inrush of On/Off Power



DYMARC
INDUSTRIES, INC.



678F
UL LISTED

TRANSIENT VOLTAGE SURGE SUPPRESSOR

7133 Rutherford Rd. Baltimore, Md. 21207
(301) 298-3130 800-638-9098



APPLYING MICROCOMPUTER TECHNOLOGY TO THE MANUFACTURING INDUSTRY

CENTEC Process Systems Inc.

ANNOUNCING



First in a Series

- Tools Built by and for Manufacturing Industry Professionals
- Programs are in Basic for Apple II®, TRS-80® and ATARI®
- Cases Stored on Disc for Later Recall

Discounted Cash Flow "DCF"

- Escalation of Individual Parameters
- Multiple Depreciation Methods
- Variable Interest and Tax Rates
- Investment Tax Credits and Loss Carry Forwards
- Many Other Unique Features

Manufacturing Cost Estimator "MCE"

- Prepares Detailed Manufacturing Costs to your Specification
- Effect of Changes Instantaneously Recalculated and Printed
- Data Formatted for Entry in "DCF"

LOWEST PRICES

16K 5100 STATIC RAM

RAM 16

\$179.

BY COMPUTER SYSTEM RESOURCES

- Expandable to 1/2 million byte system.
- 4 MHz operation with no wait states
- Addressable in 4K steps
- 1K segment disable for ROMs, etc.
- Exclusive memory protect feature



1 YEAR FACTORY WARRANTY

SATISFACTION GUARANTEED OR MONEY REFUNDED

RAM 65

\$189.

BY COMPUTER SYSTEM RESOURCES

- Expandable to 16 million byte system
- I/O port bank select
- Ideal for multi-user systems
- 4 MHz operation with no wait states
- Plus all of the RAM 16 features



INNOVATIVE PRODUCTS

7131 OWENSMOUTH AVE. / #21D
CANOGA PARK, CALIFORNIA 91303
213 / 883-3244

Startrek 4.0 and Startrek 3.5

Scott Mitchell, 346 S Taylor St, Manchester NH 03103

Startrek 3.5 is the descendant of Lance Micklus's Startrek 3.0. It has been revised five times and is thoroughly debugged. It is the most widely distributed Startrek game. At first I thought it was unfair to compare Startrek 4.0 by Jeff Hamilton with Startrek 3.5, but after playing version 4.0, I found features in it that I liked, and many that BYTE readers might prefer.

Startrek 3.5 is a menu-driven program. After each sequence of events, you are returned to a list that has eleven command numbers and one invisible command. From this list, you pick and choose commands as if it were a menu. Commands include control of phasers, photon torpedoes, impulse and warp drives, long- and

short-range sensor scans, and alert status. You can display the ship's current status, call up damage control to see what is or isn't functioning, call for repairs, or have the science computer tell you what objects are in your quadrant. The ship's computer command takes you into a subsystem that scans its data base for data on Klingon warships, starbases, class F stars, planets, unexplored areas, etc. The computer obtains this information each

At a Glance

Name
Startrek 4.0

Type
Game

Author
Jeff Hamilton

Manufacturer
The Programmers Guild
POB 66
Peterborough NH 03458

Price
\$14.95 tape, \$19.95 disk

Format
Cassette or 5-inch floppy
disk

Language
BASIC

Computer
TRS-80 Model I

Documentation
Two pages, 11.5 by 18 cm
(4½ by 7 inches)

Audience
All space-war game fans

Challenge
Very good

Name
Startrek 3.5

Type
Game

Author
Lance Micklus

Manufacturer
Adventure International
POB 3435
Longwood FL 32750

Price
\$14.95 tape, \$19.95 disk

Format
Cassette or 5-inch floppy
disk

Language
BASIC

Computer
TRS-80 Model I

Documentation
Thirteen-page pamphlet, 6
by 15.5 cm (2½ by 6 inches)

Audience
All space-war game fans

Challenge
Excellent

CAT-100 FULL COLOR GRAPHICS

The original 256-color imaging system with high resolution video FRAME GRABBER for the S-100 bus.

Capture and digitize a video frame in 1/60 of a second. Select the best resolution for your application, from 256 to 1280 pixels per TV line. Display your digitized or computer processed image with 256 gray levels or 256 colors on standard B&W, NTSC or RGB color TV monitors.



Compact two-board basic system

Features:

- Highest possible quality 480x512x8 digital video image presently available on the market
- Input capability from TV camera or other sources
- Variety of synchronization choices
- 2 selectable video A/D conversion circuits
- Choice of: 1, 2, 4, 8, 16 or 32 bits per pixel
- 32K-byte image memory on the basic system
- 32, 64, 128 & 256K byte system capacity
- Lightpen input
- Photographic trigger control input
- Software selectable system parameters
- Interfaces for TRS-80 and other processors
- Comprehensive line of accessories, monitors and support software

240x256 Digitized Image, 16 levels

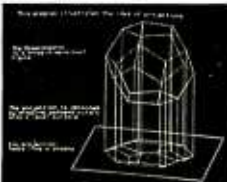

480x512 Computer-generated

SEND FOR FREE CATALOG



DIGITAL GRAPHIC SYSTEMS
441 California Ave., Palo Alto, CA 94306 415/494-6088

**DISK DRIVE WOES?
PRINTER INTERACTION?
MEMORY LOSS?
ERRATIC OPERATION?**

Don't Blame The Software!



Power Line Spikes, Surges & Hash could be the culprit!
Floppies, printers, memory & processor often interact! Our unique ISOLATORS eliminate equipment interaction AND curb damaging Power Line Spikes, Surges and Hash.

- ISOLATOR (ISO-1) 3 filter isolated 3-prong sockets; integral Surge/Spike Suppression; 1875 W Maximum load, 1 KW load any socket \$62.95
- ISOLATOR (ISO-2) 2 filter isolated 3-prong socket banks; (6 sockets total); integral Spike/Surge Suppression; 1875 W Max load, 1 KW either bank \$62.95
- SUPER ISOLATOR (ISO-3), similar to ISO-1 except double filtering & Suppression \$94.95
- ISOLATOR (ISO-4), similar to ISO-1 except unit has 6 individually filtered sockets \$106.95
- ISOLATOR (ISO-5), similar to ISO-2 except unit has 3 socket banks, 9 sockets total \$87.95
- CIRCUIT BREAKER, any model (add-CB) Add \$ 8.00
- CKT BRKR/SWITCH/PILOT (-CBS) Add \$16.00

Master-Charge, Visa, American Express
Order Toll Free 1-800-225-4876
(except AK, HI, MA, PR & Canada)

ESP Electronic Specialists, Inc.

171 South Main Street, Natick, Mass. 01760
Technical & Non-800: 1-617-655-1532

A.25 BISYNC SDLC/SDMA

Software for Your Microcomputer

8080 Z80 8086 Z8000

WINTERHALTER & ASSOCIATES, INC.
SPECIALISTS IN DATA COMMUNICATIONS
3825 ZEEB ROAD
DEXTER, MICHIGAN 48130
313-426-3029 or
313-665-5582

IBM 2770
IBM 2780
IBM 3270
IBM 3741
IBM 3780
IBM 3776

MARYMAC INDUSTRIES, INC.

**In Texas
Question & Answers
1-713-392-0747**

**21969 Katy Freeway
Katy (Houston) Texas 77450**

**To Order
1-800-231-3680
800-231-3681**

We would like to thank all of our customers in every state in the U.S. as well as France, Germany, Mexico, South America, New Zealand, Canada, and Australia that have purchased the TRS-80® from us.

WE OFFER ON REQUEST

- Federal Express
- Houston Intercontinental Airport Delivery
- U.P.S. BLUE
- References from people who have bought computers from us probably in your city

Save 10% 15% OR MORE

WE ALWAYS OFFER

- NO extra charge for Master Charge or Visa
- We always pay the freight and insurance
- Toll free order number
- Our access to the manufacturer's giant warehouse in Ft. Worth, Texas enables us to keep you in stock

® TRS-80 is a Registered Trademark of Tandy Corp

ED McMANUS



No Tax on Out of Texas Shipments!

Model III In Stock

JOE McMANUS



time you request a sensor scan. The invisible command saves the game on disk or cassette.

Startrek 4.0 is not a menu-driven game; instead it runs in real time. To compare the two, let's say you were battling a Klingon warship and you fired your photon torpedoes and missed. The Klingon fired back and knocked out your science computer. At this point, 3.5 returns to the menu and waits for you to enter your next move. On the other hand, in version 4.0, you must think and act quickly because situations occur as in real-time events. For example, a Klingon can wander into your quadrant, spot and fire at you, and leave you dangling in space while you slipped out for a snack. Ship repairs also go on in real time. In general, Jeff Hamilton's Startrek 4.0 has the same commands as Startrek 3.5, but they are displayed in a small window on your control console as you enter them.

Startrek 3.5 has extensive and reasonably quick graphics. Sounds have been added to the game, but they are kept simple so as not to become tiring after many hours of play. Startrek 4.0 doesn't have sound and uses rather simple graphics. The screen accurately demonstrates what is happening, and it shakes wildly when you are hit.

The objective of 4.0 is to destroy all the Klingons within thirty-two stardates, while stopping at a starbase only twice. The objective of 3.5 is to destroy twenty Klingons by a certain stardate, but the game does not end there. You must also explore and collect as much data as you can about an entire region, and you must locate and orbit

all class M planets. As you're doing that, you must cope with pulsars, black holes, and, of course, the crafty Klingons. When you have destroyed twenty Klingons and feel you have collected enough data, you dock at a starbase, where Starfleet Command rates your performance on a scale of 1 to 100%.

Startrek 3.5 has a three-dimensional universe (8 by 8 by 3) with 192 quadrants; a quadrant has 64 (8 by 8) sectors. Startrek 4.0 has a two-dimensional universe (8 by 8) with 64 quadrants. Again, each quadrant has 64 (8 by 8) sectors.

In Startrek 4.0, the computer can be used to help you figure out the exact coordinates to fire photon torpedoes or to navigate the ship. This helps your accuracy when you first start playing the game. Klingon warships using a cloaking device that makes them seem invisible are an extra problem in version 4.0, because they are immune to the photon torpedoes when in this state. In 4.0, but not in 3.5, if a star is in your path, you must navigate around it. In version 3.5, you must be true to your Starfleet orders, and never destroy a planet, star, or starbase, or the game ends immediately. The Klingons can maneuver out of the way of photon torpedoes and phaser fire.

Conclusions

While Startrek 3.5 is my personal favorite, Startrek 4.0 has an interesting angle to it. To some, the real-time aspect of 4.0 may make all the difference, but, all in all, both games are smooth-running and well debugged. ■

SAVE SALE SAVE SALE SAVE SALE SAVE



TRS-80
COMPUTERS

Model II 64K 3360.00 freight included
Model III 32K 2150.00 freight included
Daisy Wheel Printer 1710.00 freight included

We can save you more on all the TRS-80 Computers, and we will! All carry the factory warranty and all items are brand new. We have the full line of TRS-80 computer products. Call collect (303) 945-2864 for price quotes.

WE PAY ALL SHIPPING
NO TAXES ON OUT OF STATE SHIPMENTS
W-B SPORTING GOODS

Authorized **Radio Shack** Sales Center No. G527
727 Grand Avenue
Glenwood Springs, Colorado 81601
CALL COLLECT (303) 945-2864

SAVE SALE SAVE SALE SAVE SALE SAVE

SUMMER 1981 SHORT COURSES

PASCAL PROGRAMMING
AND MODERN
PROGRAMMING METHODOLOGY Date: July 13-16

STRUCTURAL DESIGN
FOR EARTHQUAKES Date: July 13-17

GEO-SIGNAL PROCESSING Date: July 13-17

WIDEBAND INTEGRATED CIRCUIT
DESIGN TECHNIQUES Date: July 27-31

DIGITAL AVIONICS SYSTEMS
FOR AIRCRAFT Date: July 27-31

MODERN INERTIAL NAVIGATION
SYSTEMS WITH EXTERNAL AIDING Date: August 3-7

DRILLING AND DRILLING FLUIDS Date: August 3-7

YOUR 1982 PARTICIPATION
IS INVITED

- As A Course Lecturer
- As A Course Coordinator

UNIVERSITY OF SOUTHERN CALIFORNIA
Continuing Engineering Education
Powell Hall 216, University Park
Los Angeles, California 90007
(213) 743-6708



MEGABYTER

8"
IBM
Diskette

ZVX4 FOUR TIMES THE BYTE

The ZVX4 MEGABYTER is for the APPLE II user who wants to DOUBLE file size, expand the capability of existing business software, and make other SERIOUS applications more viable.

Now you can have compatibility with IBM, INTEL, CP/M*, Z80 Softcard*, UCSD Pascal, and others.

Look what the MEGABYTER dual density 8" floppy disk controller, with its LSI circuitry and reliable industry standard IBM 3740 format, means to you:

INCREASED STORAGE

- Increase online storage to 2 Mega bytes
- Double your maximum accounts and file size
- Add high capacity efficient hard disk backup
- Control up to 4 Shugart SA800/SA850 drives

IMPROVED COMPATIBILITY

- Operate APPLE DOS 3.1/3.2/3.3, mini disks
- Preserve existing software investment
- Interchange data with other computers

SIMPLIFIED OPERATION

- Reduce disk handling and I/O slot usage
- Gain automatic single/double density operation
- Change to double sided drives with one switch

Available at your Apple dealer. Call or write today!!



SORRENTO VALLEY ASSOCIATES
11722 SORRENTO VALLEY ROAD
SAN DIEGO, CA 92121
(714) 452-0101

* CP/M trademark of Digital Research, Inc.
Z80 Softcard trademark of Microsoft, Inc.

OHIO DATA

Modem Kit

300 Baud Acoustic Coupler

\$69.00

- Includes:
- Power Supply
 - Speakers
 - Printed Circuit Board
 - All Integrated Circuits, Resistors & Capacitors
 - Instruction and Trouble Shooting Book

Order Direct or Call for the Location of the Closest Dealer

Add \$4.00 for Shipping Charge.
Ohio Residents add 6.5% for Sales Tax

VISA



MASTERCARD

OHIO DATA PRODUCTS CORPORATION

14600 Detroit Avenue • Cleveland, Ohio 44107 • (216) 221-9000
Allow 6 weeks for Delivery

GENERAL LEDGER • PAYABLES RECEIVABLES • ORDER ENTRY INVENTORY CONTROL • PAYROLL JOB COSTING • WORD PROCESSING DATA BASE MANAGEMENT

Quick up and running
Step by step instruction manual
Complete instructions—over 900 pages
Free telephone assistance
All Bookkeeping packages are Interactive or Stand Alone
Originally developed by Osborne and Associates
Return within 15 days if not satisfied for refund
CRT independent—runs on any terminal
Requires 2.2 CP/M and 2.07 C-Basic
Up and running on: Altos, any 8" Single density CP/M system format, Altos, Cromemco, Dynabyte, TRS-80 Mod II, Northstar DD, Vector Graphics.
Many others. Sample data with each program

General Ledger	\$195	Inventory	\$395
Payables	\$195	(Manufacturing)	
Receivables	\$195	Inventory	\$395
Payroll and Job Costing ..	\$195	(Wholesale)	
Order Entry	\$395	Inventory	\$395
Manuals for above	\$20	(Retail)	
		Manuals for above	\$20

MARATHON COMPUTER SYSTEMS

575 Middlefield Road Suite #J
Palo Alto, CA 94301, 415-328-5391
VISA • Master Charge • C.O.D. • Company Check
TRS-80 is a Trademark of Radio Shack, Inc.
CP/M is a Trademark of Digital Research, Inc.

The BDS C Compiler

Christopher Kern, 201 I St SW, Apt 839
Washington DC 20024

The ubiquitous Pascal compiler has joined the ubiquitous BASIC interpreter as a staple of the microcomputer programming environment, bringing with it the concepts of hierarchical program design, orderly program development, and legibility that generally fall together under the heading "structured programming."

But for those who are not ideologically committed to the proposition that Pascal is the most congenial programming language—and who have access to an 8080-based computer and the CP/M operating system—I would like to suggest an alternative: a language created at Bell Laboratories, named, with characteristic concision, C. C provides the same structured programming approach as Pascal, but it has a cleaner and crisper syntax, one that

is both closer to the ultimate machine language of the computer and, paradoxically, somewhat easier to become familiar with than Pascal.

My recommendation is largely a product of my experience with one of the best and least expensive programming language packages I have come across: the C compiler developed by BD Software (by Leor Zolman of Cambridge, Massachusetts). I have been using the BDS C compiler for over a year, and I think many hobbyists who aren't already using a modern, high-level language could easily switch to C from their BASIC interpreter. C, like BASIC, can be learned quickly, but it has resources that BASIC, even in its ingeniously extended forms, can't match. And while the BDS C compiler does not provide as convenient a programming environment as BASIC—no compiled language really can—it comes about as close as possible to eliminating the worst annoyance of many compilers running on microcomputer systems: the long wait between idea and execution as the compiler cranks out an assembly-language file that must itself be compiled (run through an assembler) before the object program can be tested.

The operation of the compiler is relatively straightforward and quite fast. The command "CC1 filename.C" reads in the source program (which has been prepared using the host system's editing facilities and saved as a file on disk), parses it, and leaves the resultant intermediate file in memory. As CC1 goes out of business, it calls in another program, CC2, as an overlay (ie: it takes the place of the previous program). CC2 is the code generator: it saves the C machine-code program on disk in a special relocatable format. The relocatable machine-code program is turned into executable, absolute machine code by the linker, CLINK, which also merges the user's program with previously compiled program files (such as the standard C function library) if necessary. The entire source file is read into memory before compilation begins, but because it is possible to link separately compiled modules together, the available memory space of the computer does not limit source-program size. If the source code is too long to fit into the available memory at

At a Glance

Name
BDS C compiler

Type
8080 compiler

Distributor
Lifeboat Associates
1651 Third Ave
New York NY 10028

Price
Complete package,
\$145; documentation
only, \$25

Format
Available for all
CP/M systems

Computer
Any 8080-based com-

puter running Digital Research's CP/M operating system (programs compiled by the BDS C compiler can be tailored to run on any 8080-family computer)

Documentation
70 pages; 22 by 28 cm
(8½ by 11 inches)

Audience
Application programmers and system programmers who require a C compiler running in an 8080 environment

Main/Frames from \$200

- 14 Basic Models Available
- Assembled & Tested
- Power Supply: 8v@15A, ± 16v@3A
- 15 Slot Motherboard (connectors optional)
- Card cage & guides
- Fan, line cord, fuse, power & reset switches, EMI filter
- 8v@30A, ± 16v@10A option on some models

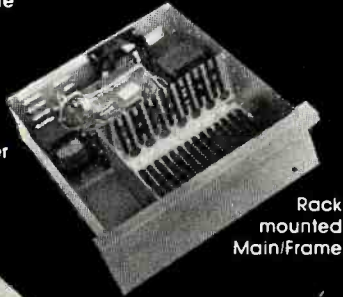

Rack mounted Main/Frame

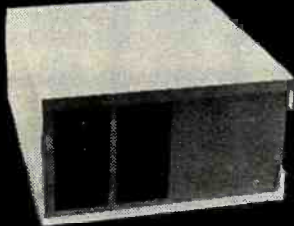

8" Floppy Main/Frame (includes power for drives and main/frames)

Write or call for our brochure which includes our application note: 'Building Cheap Computers'

INTEGRAND

8474 Ave. 296 • Visalia, CA 93277 • (209) 733-9288
We accept BankAmericard/Visa and MasterCharge



Boards for S-100 BUS from S.C. Digital "CPUI-Z80"

Advanced Z80A based CPU board
\$219 Assembled and Tested
\$149 Kit *(less Interrupt)

Features: Model CPUI-Z80

- 2/4 Mhz SW selectable.
- Built in 8 Prioritized Vectored Interrupts with 8 possible levels of Nested Interrupts using powerful Mode 2 of Z80, all done in Hardware, expandable with external ckt.
- Vector Jump on RESET, in 4K increments.
- Supports 2K of EPROM (not supplied), DMA, dynamic RAM refresh . . . many more.

*Kit comes with all parts except chips connected to Interrupts.



"INTERFACE: 1" I/O, Memory Interface Board

\$229 A & T
\$209 A & T, Without Cassette Interface
\$154 Kit, Without Cassette Interface
\$ 15 Parts For Cassette Interface

Features: Model 3SPC

- 3 Serial w RS232C or 20ma Current Loop, 1 Parallel
- 4K of EPROM/ROM and 4K of RAM (ROM/RAM not supplied).
- Built in Kansas City Standard Cassette interface usable to 1200 Baud.
- Generates all popular baud rates up to 19.2K baud, including 110 & 134.5.
- SW settable Address, Baud Rates, Ports.
- CTS (Clear to Send) Displayed as a status bit on CH 3.

"UNISELECT" 16K Static RAM with universal Bank Select, 200 ns mem chips.
Model 16KUS \$235 A & T \$209 Kit \$ 38 Bare Board, Documentations

All boards meet IEEE-S100 standards. Fully socketed, solder masks, gold contacts, and guaranteed for one full year. Kit guaranteed parts, only.

Delivery: from stock to 72 hours. Ordering: You may call for M.C., Visa or C.O.D. orders. (Add \$4.00 for C.O.D.) Personal checks o.k., but M.D. speeds shipment. Takes 7 to 15 days to clear personal checks before shipping.

Undamaged boards can be returned within 10 days for full refunds. Illinois residents add 5 1/4% sales tax.

D.E.M. & DEALER PRICING AVAILABLE

S.C. Digital P.O. Box 906 Phone: Aurora, IL 60507 (312) 897-7749

Why Do Professionals Prefer

BECAUSE

- Unique software • Technical support • Quick delivery • Established company • Release 2 CP/M! (some packages under UNIX* and TRSDOS*)
- Quality software • In-house expertise • Fast response • User orientation • Competitive prices
- Customer service • Verbatim® media • Onyx hardware (CP/M and UNIX versions).

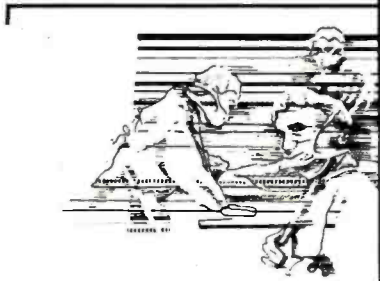

BECAUSE

Unique swift routing cybernetics response system gives you no-nonsense technical answers that save you time. Call: (714) 848-1922.

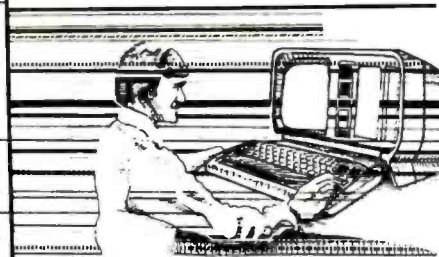

- NEW RM/COBOL! applications:
 - Order Entry/Inventory • Receivables • Payables • General Ledger • Financial Modeling • Client Accounting—and more on the way!
- NEW CBASIC2! applications:
 - REAP (Real Estate Acquisition Package).

Business
Medical
Real Estate
Computer Systems

Software from Cybernetics?

RM/COBOL—The new standard for microcomputer COBOL! The only COBOL for CP/M (also on TRSDOS & UNIX) with alternate keys (multi-key ISAM), CRT screen handling, interactive debug, and the most useful Level 2 features. Compatible with RSCOBOL—but runs faster.

Plus existing CBASIC2 packages:
APH (Automated Patient History)
Osborne & Assoc.—Payroll • Payables/Receivables • General Ledger
NAD* (Name and Address)
PMS (Property Management System)

Inquire for details
Trademarks of: Ryan-McFarland Corp., Computer Systems, Inc., Digital Research, Bell Telephone Laboratories, Inc., Tandy Corp., Verbatim, Inc., Cybernetics, Inc., Structured Systems Group, Inc., *Small Business Applications, Inc.

TRS-80! Model II CP/M—The fastest Mod II CP/M with the most features. Outstanding teaching documentation for newcomers to CP/M, multiple CRT emulation, down loading package, support for CORVUS 10 Mb hard disk. Many additional user-oriented features.

And system software packages:
MAGIC WAND® Editing/Word Processing
CBASIC2 Compiler BASIC
QSORT® Soft Merge Package



Distributed in U.K. by:
Microcomputer Applications Ltd
11, Riverside Court, Caversham, Reading, England
TEL: (0734) 470425



8041 Newman Ave., Suite 208
Huntington Beach, CA 92647
(714) 848-1922

Communication Arts, Huntington Beach, Ca

one time, it can simply be divided up and compiled in pieces. The use of a separate linker also makes it possible to create libraries of compiled functions (such as the C standard library, which supplies a number of basic input/output and utility functions in every system that supports the C language) that can be used in the future as, essentially, part of the language itself.

The manual states that the parser (CC1) operates at about twenty lines of source code per second and that the code generator (CC2) runs at about seventy lines of source per second. In practice—at least on floppy-disk-based systems—the main limitation on compilation speed is the speed of disk input and output. On very long programs, there may be a wait of perhaps a minute while

CC1 crunches away. Obviously this can be shortened considerably by compiling only the part of the program that is being worked on and linking it with other, previously compiled, routines. Even with relatively long programs that are compiled as a unit, however, I did not find the delay in compilation to be objectionably long.

For most users, the speed at which a compiled program runs, not the length of time required to compile it, is what really matters. I am reluctant to express this in terms of a benchmark, since the proposed benchmarks I have seen (1) require assumptions about the type of program that will be compiled that cannot hold from one user to the next; (2) can be properly compared only between systems that have both the same processor throughput and the

A Comparison of C and Pascal

C programs and Pascal programs look quite a bit alike. They should—the two languages have a lot in common, including sets of similar primitive operations that make direct Pascal-to-C or C-to-Pascal translation feasible. Yet enough differences exist to give the two languages a distinctly different "feel."

The most visible difference is block structure; C programs do not have the true block structure found in Pascal programs. A C program is a collection of separate functions; thus one function cannot be nested within another and called as a separate entity. C functions may contain blocks of code that are either executed completely or not at all, but they are not named as functions themselves, and they must be included in-line as part of the normal program flow within the function.

C uses only functions, where Pascal distinguishes between functions and procedures. In practice, the only real difference is that any C function can return a value to its calling routine. This is but one example of C's relaxed programming philosophy. Other examples include the ability to assign freely between integers and characters, and between pointers and unsigned integers, the latter providing virtually unlimited opportunity to perform address arithmetic within the host system's available memory space. There are times when this flexibility is very convenient, but there is a price: the compiler won't prevent a foolish move if the programmer insists on it. Whereas Pascal takes a very rigid, protective, and rather mathematical attitude toward program construction, C allows the programmer a certain amount of freedom. This makes sense: Pascal was designed as a teaching language, and C is a production programming language that allows the programmer to do things that he may want to do, at the expense of some conceptual niceties.

Both C and Pascal allow parameters to be passed to subroutines by value and by reference. This means that the called subroutine can receive either its own local copy of a parameter (which it can alter at will without changing the value of the variable as far as the calling routine is concerned), or a reference to the calling routine's variable (which can be subsequently altered by the subroutine that has been called).

Each language also provides pointers—variables that point to memory locations, such as the beginnings of arrays. In

Pascal, pointers tend to be used sparingly, while in C they are much more common. Here again, C is unwilling to protect the programmer from himself. Pointers are risky. If they are misused, they can point somewhere entirely unexpected and clobber an innocent piece of unrelated code with predictably disastrous results. They can, however, make for extremely efficient programs, and C encourages their use.

C has been described as a relatively low-level language. It generally operates on the same primitive data objects as the computer itself, and it does not provide certain composite operations. For example, a string in C is a series of characters beginning at a given memory location, not a discrete entity that can be passed or assigned as a unit. Explicit functions are used to provide more sophisticated facilities for manipulating data objects, as well as for input and output. The more common primitive operations are provided in the C standard function library. Others must be written by the programmer.

One of C's most distinctive features is its unusual—and unusually concise—set of operators. C has multiple assignment operators that lead to expressions of the form $x += 1$ or $y >> = 4$. These mean, respectively, "let x equal x plus one" and "let y equal y logically shifted right 4 bits." Another unique C concision is the $?:$ (if... then) operator. It is used in expressions of the form $y = x > 0 ? 1 : 0$. This means "if x is greater than 0 let $y=1$; otherwise, let $y=0$."

BASIC exists in thousands of dialects. The same diffusion seems to be taking place—to a lesser extent, fortunately—with Pascal. Thus far, not many compilers operate on variations of C, so true portability between computers still exists. I know of three microcomputer C compilers: the BDS compiler (which implements a very complete subset of the language); one for a considerably more restricted (and slightly archaic) subset of C that was published, in C source code, in the May 1980 issue of Dr Dobb's Journal of Computer Calisthenics and Orthodontia (this compiler is available from Walt Bilofsky, 14478 Glorietta Dr, Sherman Oaks CA 91423, in CP/M and Heath HDOS formats); and Whitesmiths' C Compiler, which provides the full C language for various 8080-family and DEC LSI-11 systems (Whitesmiths Ltd, POB 1132, Ansonia Sta, New York NY 10023). An excellent C-like interpreter is available from tiny-c associates, POB 269, Holmdel NJ 07733 (see my review of tiny-c: "A User's Look at tiny-c," December 1979 BYTE, page 196). A tiny-c compiler is also available.

DISCOUNT SOFTWARE

Ad#14

CP/M users: specify disk systems and formats. Most formats available.
 ✓ (New items or new prices)

CP/M*	ARTIFICIAL INTELLIGENCE	DISK WITH MANUAL ONLY	Medical.....	\$849/\$40
			Dental.....	\$849/\$40
COMPLETE BUS. SYSTEM				
Creator.....	\$269/\$25		Reporter.....	\$169/\$20
Both.....	\$399/\$45			
COMPUTER CONTROL				
Fabs.....	\$159/\$20		UltraSort II.....	\$159/\$25
COMPUTER PATHWAYS				
Pearl (level 1).....	\$ 99/\$25		Pearl (level 2).....	\$299/\$40
Pearl (level 3).....	\$549/\$65			
DIGITAL RESEARCH				
CP/M 2.2				
NorthStar.....	\$149/\$25		TRS-80 Model II (P&T).....	\$159/\$35
Micropolis.....	\$169/\$25		Cromemco.....	\$189/\$25
PL/I-80.....	\$459/\$35		BT-80.....	\$179/\$25
Mac.....	\$ 85/\$15		Sid.....	\$ 65/\$15
Z-Sid.....	\$ 95/\$15		Tex.....	\$ 70/\$15
DeSpool.....	\$ 50/\$10			
DYNAMIC MICRO-PROCESSOR ASSOC.				
Ascom.....	\$109/\$15		CBS.....	\$369/\$45
DMA-DOS.....	\$179/\$35			
GRAHAM-DORIAN				
General Ledger.....	\$729/\$40		Acct Receivable.....	\$729/\$40
Acct Payable.....	\$729/\$40		Job Costing.....	\$729/\$40
Payroll.....	\$493/\$40		Inventory.....	\$493/\$40
Cash Register.....	\$493/\$40		Apartment Mgt.....	\$493/\$40
KEY BITS				
String/80.....	\$ 84/\$20		String/80(source).....	\$279/\$na
WordSearch.....	\$179/\$25			
MICRO-AP				
S-Basic.....	\$269/\$25		Selector III.....	\$269/\$25
Selector IV.....	\$469/\$35			
MICRO DATA BASE SYSTEMS				
HDBS.....	\$269/\$35		DRS or QRS or RTL.....	\$269/\$35
MDBS PKG.....	\$1295/\$60			
MICROPRO				
WordStar.....	\$324/\$60		Customization Notes.....	\$ 89/\$na
Mail-Merge.....	\$114/\$25		WordStar/Mail-Merge.....	\$434/\$85
DataStar.....	\$249/\$60		WordMaster.....	\$119/\$40
SuperSort I.....	\$199/\$40			
MICROSOFT				
Basic-80.....	\$294/\$30		Basic Compiler.....	\$329/\$30
Fortran-80.....	\$349/\$30		Cobol-80.....	\$574/\$30
M-Sort.....	\$125/\$20		Macro-80.....	\$144/\$20
Edil-80.....	\$ 84/\$20		MuSimp/MuMath.....	\$224/\$25
MuLisp-80.....	\$174/\$20			
ORGANIC SOFTWARE				
TextWriter III.....	\$111/\$20		DateBook.....	\$269/\$25
Milestone.....	\$269/\$25			
OSBORNE				
General Ledger.....	\$ 59/\$20		Acct Rec/ Acct Pay.....	\$ 59/\$20
Payroll w/Cost.....	\$ 59/\$20		All 3.....	\$129/\$57
All 3 + CBASIC-2.....	\$199/\$71			

PEACHTREE*	
General Ledger.....	\$399/\$40
Acct Receivable.....	\$399/\$40
Acct Payable.....	\$399/\$40
Payroll.....	\$399/\$40
Inventory.....	\$399/\$40
Property Mgt.....	\$799/\$40
CPA Client Write-up.....	\$799/\$40
Mailing Address.....	\$349/\$40
SOFTWARE WORKS	
Adaptl.....	\$ 69/\$na
Ratfor.....	\$ 86/\$na
SOHO GROUP	
MatchMaker.....	\$ 97/\$20
WorkSheet.....	\$177/\$20
STRUCTURED SYSTEMS	
GL or AR or AP or Pay.....	\$599/\$40
Inventory Control.....	\$449/\$40
Analyst.....	\$199/\$25
QSort.....	\$ 89/\$20
SUPERSOFT	
Forth (8080 or Z80).....	\$149/\$25
Diagnostic II.....	\$ 84/\$20
Other.....	less 10%
TCS	
GL or AR or AP or Pay.....	\$ 79/\$25
All 4.....	\$269/\$99
WHITESMITHS	
"C" Compiler.....	\$600/\$30
Pascal (incl "C").....	\$850/\$45
"DATA BASE"	
FMS-80.....	\$649/\$45
dBASE II.....	\$629/\$50
Condor.....	\$599/\$30
T.I.M.....	\$329/\$35
"PASCAL"	
Pascal/MT+.....	\$429/\$30
Pascal/Z.....	\$349/\$30
Pascal/UCSD.....	\$299/\$30
✓ Pascal/M.....	\$189/\$20
"WORD PROCESSING"	
SpellGuard.....	\$249/\$25
Spell Binder.....	\$349/\$45
Magic Wand.....	\$289/\$45
VTS/80.....	\$489/\$65
"OTHER GOODIES"	
Tiny "C".....	\$ 89/\$50
Tiny "C" Compiler.....	\$229/\$50
✓ CBASIC-2.....	\$ 98/\$20
Nevada Cobol.....	\$129/\$25
MicroStat.....	\$224/\$15
Vedit.....	\$ 99/\$15
Prof Time Bill (Asyst).....	\$549/\$40
ESQ-1.....	\$1349/\$50
MiniModel.....	\$449/\$50
StatPak.....	\$449/\$40
Micro B +.....	\$229/\$40
✓ BSTAM.....	\$149/\$10
APPLE II*	
MICROSOFT	
Softcard.....	\$292
Fortran.....	\$179
Cobol.....	\$574
PERSONAL SOFTWARE	
✓ Visicalc.....	\$ 99
CCA Data Mgr.....	\$ 84
✓ Desktop/Plan II.....	\$159
✓ Visiplot.....	\$149
✓ Visitrend/Visiplot.....	\$229
✓ Visidex.....	\$159
✓ Visiterm.....	\$129
Zork.....	\$ 34
PEACHTREE*	
General Ledger.....	\$224/\$40
Acct Receivable.....	\$224/\$40
Acct Payable.....	\$224/\$40
Payroll.....	\$224/\$40
Inventory.....	\$224/\$40
"OTHER GOODIES"	
Super-Text II.....	\$127
Data Factory.....	\$129
DB Master.....	\$159
Ledger Plus.....	\$549
Charles Mann.....	less 15%
STC.....	less 15%
✓ IUS.....	less 15%

ORDERS ONLY—CALL TOLL FREE VISA • MASTERCHARGE

1-800-854-2003 ext. 823 • Calif. 1-800-522-1500 ext. 823

Overseas—add \$10 plus additional postage • Add \$2.50 postage and handling per each item • California residents add 6% sales tax • Allow 2 weeks on checks. C.O.D. ok • Prices subject to change without notice. All items subject to availability • ®—Mfgs. Trademark.

THE DISCOUNT SOFTWARE GROUP

6520 Selma Avenue, #309 • Los Angeles, CA 90028 • (213) 666-7677

DISCOUNT PRICES

APPLE II COMPUTERS

16K APPLE II	1089.00
32K APPLE II	1134.00
48K APPLE II	1179.00
DISK W CONTROLLER	545.00
DISK ONLY	475.00
APPLESOFT CARD	159.00
INTEGER CARD	159.00
PASCAL SYSTEM	425.00
SILENTYPE PRINTER	525.00



RAM MEMORY

FOR TRS-80, APPLE II
 16K SET 4 116's 45.00

NORTH STAR COMPUTERS



HRZ-1D-32K-ASM	2125.00
HRZ-2D-32K-ASM	2475.00
HRZ-1Q-32K-ASM	2375.00
HRZ-2Q-32K-ASM	2990.00

VERBATIM DISKETTES

BOX OF 10 5 1/4"	29.50
BOX OF 10 8"	39.50

FREDERICK COMPUTER PRODUCTS
 MUNICIPAL AIRPORT
 FREDERICK, MD, 21701
 (301) 694-8884

Expand Your HEATH/ZENITH-89

- The MDBS Networking Data Base System with Query, Recovery, Logging, Restructure, more \$1400
- Mass Storage
 8" REMEX drives, single \$1650
 dual \$2350
- ST506 5MBμ Winchester, with two drive ACT controller \$1400
 \$2500
- GRAPHICS for the Z-89
 Maxtek 512x256 graphics board \$ 850
- New IDS Tiger 560 Printer, 14.5", Hi-Res Matrix with Plot and Word Processing firmware \$1595
- PLUS, the whole Magnolia Microsystem line (discounted up to 10%)

Add 1% shipping & insurance. Calif. residents add sales tax.



1445 Koli Circle, Suite 111, San Jose, CA 95112 • (408) 947-1101
 (call 800/555-1212 for our toll free number)

same disk-access speed, and (3) are of dubious value when used to compare different programming languages because it is unlikely that the benchmark programs will be of equivalent efficiency in all languages.

Having said all that, I will venture the opinion (acknowledging that it may be even more misleading than a benchmark program) that programs compiled on the BDS compiler run very fast indeed. Not as fast as those coded in assembler, obviously, but much faster than any BASIC interpreter, considerably faster than any pseudo-code Pascal system (a technique that amounts to semi-compilation, with object code being generated for a "pseudo-machine" that is emulated by the host computer), and *about as fast* as those created by any microcomputer compiler I have seen. I have used BDS C to compile a rudimentary LISP interpreter, and while it's no match for a machine-coded LISP, the project demonstrated to my satisfaction that the BDS compiler is suitable for system-programming purposes.

BDS C is a true subset of the standard C language. Very little is left out. The most serious omissions are the lack of static variables and initializers. Several library functions are supplied to remedy the latter, although initialization remains somewhat more awkward than in standard C. Also absent are floating-point real numbers and long (32-bit) integers. A series of subroutines to perform floating-point conversions and arithmetic is sup-

plied with the package, but this is not as convenient a way to provide real numbers as building them into the language the compiler accepts directly.

A considerable amount of work has been done to relieve the programmer of some of the more tedious aspects of the CP/M operating system. Library functions permit the use of the standard CP/M carriage-return/line-feed sequence to terminate a line or, at the user's option, the single newline character that is standard in other C programming environments. Buffered file routines are supplied as part of the standard library, which permits the programmer to write data to disk a character at a time instead of in blocks of 128 characters, as required by CP/M. Dynamic storage allocation and deallocation are also provided, so the user can create and dismantle complex data structures at run-time, and therefore reuse the memory area allocated to them (even though CP/M itself contains no allocation mechanism).

It's a shame the BDS compiler doesn't go one step further and provide redirected input and output; this would have permitted the user to write a program using a single I/O stream and then specify at run-time whether the program was to communicate with the console, a modem, a disk file, etc. Some high-level language compilers provide a debugging option that allows the user to trace program execution and print out variable values. Alas, BDS C is not one of them. Short of that, the best debugging tool I

**YOUR APPLE SPECIALIST
HAS THE WORD PROCESSOR
FOR YOU...
WRITE-ON!™**

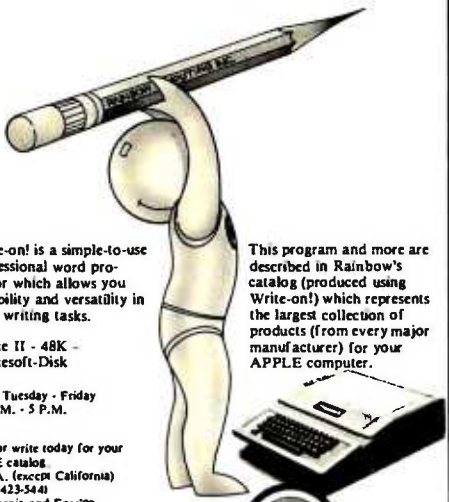

Write-on! is a simple-to-use professional word processor which allows you flexibility and versatility in your writing tasks.

Apple II - 48K - Applesoft-Disk

Open Tuesday - Friday
10 A.M. - 5 P.M.

Call or write today for your FREE catalog
U.S.A. (except California)
(800) 423-5441
California and Foreign
(213) 349-0300
For technical questions: Phone (213) 349-5560

This program and more are described in Rainbow's catalog (produced using Write-on!) which represents the largest collection of products (from every major manufacturer) for your APPLE computer.

RAINBOW COMPUTING, INC.
Garden Plaza Shopping Center
9719 Reseda Boulevard, Dept. BYW
Northridge, California U.S.A.
91324

apple computer inc.

• TRS-80 • APPLE 2 • ATARI • SCORCERER •

PET • TRS-80 • APPLE 2 • ATARI • SCORCERER • PET • TRS-80

FREE CATALOG
over 150 items
ORDER TOLL FREE
(800) 327-7172
IN FLORIDA (305) 862-6917
nuf said

SCORCERER • TRS-80 • APPLE 2 • ATARI • SCORCERER • PET

TRS-80 • APPLE 2 • ATARI • SCORCERER

ai Adventure INTERNATIONAL
(305) 862-6917
A DIVISION OF SCOTT ADAMS, INC.
BOX 3435 • LONGWOOD, FLA. 32750

**INTRODUCING
COGNIVOX Series VIO-1000
A Revolutionary New
Voice Input and Output Peripheral**



**High Fidelity Voice Response
Industrial Quality Recognition**

PET — AIM-65 — APPLE II

COGNIVOX series VIO-1000 is a top-of-the-line voice I/O peripheral for business and educational applications and the demanding hobbyist.

It can be trained to recognize words or short phrases drawn from a vocabulary of 32 entries chosen by the user. It will talk back with up to 32 words or short phrases. In disk based systems, response vocabularies can be stored on the disk and brought to memory as needed, giving an effectively unlimited number of vocabulary entries. The quality of voice response is excellent, and it is far superior to that of speech synthesizers.

COGNIVOX series 1000 comes complete and ready to plug into your computer (the computer must have at least 16K of RAM). It connects to the parallel I/O port of the PET, to the game paddle connector on the Apple and to the J1 port on the AIM-65. Connectors are included as required. Also included are a microphone, cassette with software and extensive user manual. A built-in speaker/amplifier is provided as well as a jack for connecting an external speaker or amplifier.

Software supplied with COGNIVOX includes two voice operated, talking video games, VOTH and VOICETRAPH. These games are absolutely captivating to play, and the only voice operated talking games that are commercially available.

Adding voice I/O to your own programs is very simple. A single statement in BASIC is all that is required to say or to recognize a word. Complete instructions on how to do it are provided in the manual.

In keeping with the VOICETEK tradition of high performance at affordable price, we have priced COGNIVOX series 1000 at the unbelievably low, introductory price of \$249 (plus \$5 shipping in the US, CA add 6% tax. Foreign orders welcome, add 10% for handling and shipping via AIR MAIL.) When ordering, please give the make and model of your computer, the amount of RAM and whether you have disks or not.

In addition to COGNIVOX series VIO-1000, VOICETEK manufactures a complete line of voice I/O peripherals for most of the popular personal computers. Speech recognition-only peripherals are available for the 8K PET and the 4K AIM.

For more information call us at 805-685-1854 or write at the address below.

Dealer Inquiries invited.

VOICETEK

Dept B, P.O. Box 388
Goleta, CA 93116

CATCH THE \$-100 INC. BUS!



	LIST PRICE	OUR SPECIAL CASH PRICE
Morrow Designs Discus IID Double Density Disk System w/CP/M & Microsoft Basic A&T	1199.00	959.00
Godbout XX-20-32K Static Memory Board A&T	699.00	549.00
S.D. Systems VDB 80x24 Kit	437.00	349.00
Ithaca Intersystems MPU-80 Series II Z-80 A&T	395.00	316.00
SANYO 12" Black & White Monitor	300.00	209.00
Potomac Micro-Magic Modem A&T	399.00	339.00

Subject to Available Quantities • Prices Quoted Include Cash Discounts. Shipping & Insurance Extra.

We carry all major lines such as
S.D. Systems, Cromemco, Ithaca Intersystems, North Star,
Sanyo, ECT, TEL, Godbout, Thinker Toys, SSM.
For a special cash price, telephone us.

S-100, inc.
7 White Place, Clark, N.J. 07066
201-382-1318

Hours: Mon. - Fri. — 10 a.m. to 6 p.m.

THE FORTH SOURCE™

Specializing in the FORTH language.

Printed Material

Using FORTH, Manual	\$25.00
PDP-11 User's Guide	20.00
Systems Guide to fig-FORTH	20.00
CalTech FORTH Manual	11.00
TinyPASCAL in fig-FORTH	10.00
fig-FORTH Cross Compiler	30.00

PLUS many source listings

Machine Readable H89 & Z89 Disks & Documentation

Operating System, with tutorial	\$135.00
fig-FORTH, CP/M, with tutorial	135.00
TinyPASCAL, with source	75.00
fig-FORTH, CP/M	65.00

Write for complete FORTH List.

**MOUNTAIN VIEW PRESS
PO BOX 4656
Mt. View, CA 94040**

have found comes right out of the C standard library. It is the function "printf", which allows various data objects to be printed in appropriate formats and number bases while the program is being run.

The compiler accepts a number of optional directives that allow the user to:

- Place the generated code in any memory location (including read-only memory, as long as some program-mable memory will be available somewhere in the target system)
- Optimize the object code for speed (which increases the amount of code generated) or for size (which slows the object program down a bit), and to control the way the compiler allocates space
- Save an intermediate file on disk between the two compiler phases
- Display the source text on the user's console during compilation

The linker also supports a number of useful options, including several that permit the programmer to create overlay segments that use the same data elements. This feature is not commonly available in microcomputer compilers for high-level languages.

The assembly-language source code for the run-time package is also supplied (the run-time routines contain

the interface to the CP/M operating system). This permits the user to create a customized run-time package that allows BDS C programs to run under other 8080 operating systems. Those who sell application programs will, no doubt, be happy to learn that there are no royalty requirements for programs that include the run-time package in either its original or customized form.

In addition to the compiler and the linker, the BDS C package contains a librarian program, CLIB (used to manipulate compiled function libraries), the C standard library along with some useful extensions for the microcomputer (and specifically the CP/M) environment, and a collection of sample programs that is of more than passing interest.

The precise sample programs that are delivered with any package may vary, but the copy of BDS C Version 1.4 that I received from Lifeboat Associates in New York contained a fairly sophisticated telecommunications program for connecting a microcomputer system through a modem to another microcomputer (or a time-sharing system), several impressive games (some requiring a cursor-addressable video terminal), and several utility programs, including two that permit the compiler to be used from terminals that generate uppercase characters only. The package also includes a lucidly written manual for the compiler and a copy of the outstanding C language manual, *The C Programming Language*, by Brian W Kernighan and Dennis M Ritchie. ■

REFORMATTER™

opens new files!

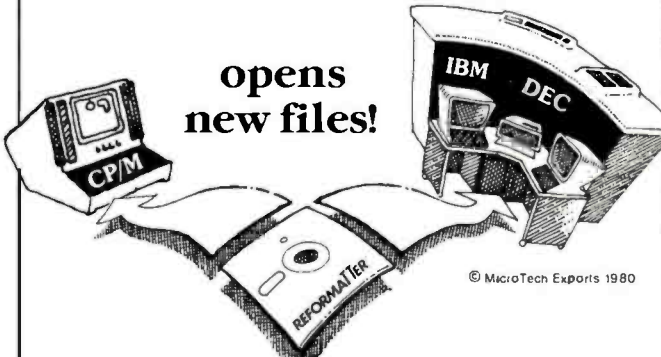

© MicroTech Exports 1980

With **REFORMATTER** disk utilities you can read and write IBM 3740 and DEC RT-11 single density formatted diskettes on your CP/M® system.

REFORMATTER enables you to access large system databases, improve data exchange with other organizations, increase program development capabilities, and use your micro in distributed processing.

REFORMATTER programs feature bi-directional data transfer and full directory manipulation. ASCII/EBCDIC conversion provided with CP/M ↔ IBM. *MP/M is now fully supported.*

Program Data Sheets, Application Guides, and Machine Compatibility Guides available.

Each program \$195.00 from stock. Specify CP/M ↔ IBM or CP/M ↔ DEC. Order from MicroTech Exports, Inc., 467 Hamilton Ave., Suite 2, Palo Alto, CA 94301 ☐ Tel: 415/324-9114 ☐ TWX: 910-370-7457 MUH-AJTS ☐ Dealer and OEM discounts available.

CP/M® is a registered trademark of Digital Research.

TURTLES



TEACH™

Fantastically fun, the Terrapin™ Turtle rolls, blinks, beeps, draws, and feels. Learn, teach and demonstrate geometry, assembly and high level programming, life sciences, Artificial Intelligence. Interface this small home robot to TRS-80, APPLE, DEC—any digital computer (not included). Send for brochure and prices.

Terrapin, Inc.
 678 Massachusetts Ave. # 205
 Cambridge, Mass. 02139
 (617) 492-8816

 Terrapin, Inc.

ADD EXCITING MUSIC TO YOUR APPLE®!



A L F's 9-voice Music Card MC1 is only \$195.

Here's what our customers have said:
(Excerpts from unsolicited letters. Copies of original letters available on request.)

About the A L F system:

It's a rare enough occurrence when hardware/software lives up to one's expectations. For something to exceed one's wildest hopes — as the ALF synthesizer certainly does — is a real treat. My congratulations to all concerned.

—Dhahran, Saudi Arabia

I myself have told several people that next to a disk, I consider the [ALF] synthesizer to be the most important peripheral they could purchase for their system. Very excellent job! Keep up the good work.

—Oak Ridge, Tennessee

I recently purchased 2 of your Apple music boards. Out of the peripherals I have for my Apple, I enjoy them the most. It has to be the most enjoyable thing that has ever been invented. I hope you continue to develop products as clever and enjoyable as this one. The Entry program has to be one of the most sophisticated programs I have ever seen. It proves that a hardware manufacturer DOES have the ability to also produce quality software. It is almost worth the price of the boards just for the Entry program.

—Burbank, California

About ease of use:

I have had my Music Card MC1 for a little more than a week now and I have almost completed entering "The Maple Leaf Rag". I found it to be a lot simpler than I thought and so I am very, very pleased. My family isn't because I sit up to all ends of the night playing with the blasted thing!

—Cypress, Texas

ALF has opened up my head and ears and enabled me to do things musically which I would like to be able to do on [conventional] instruments. As much as I love the instruments I try to play, I just don't have the talent and technique to play what is in my head. By golly, the ALF board doesn't know about my limitations, though. I can play hell out of that thing, playing notes and tempos which previously have existed only in my head. Many thanks from a frustrated musician and satisfied ALF "player".

—Demopolis, Alabama

About documentation:

I don't know much about hardware, but I have been a programmer for 15 years and I have never seen a better piece of software documentation than your user manual. It is a joy to study!

—Lancaster, California

About the competition:

Recently, I purchased an [ALF] 9-voice board and a couple of music albums. . . . all I can say is that I wish I had listened and played with it before I purchased the Mtn. Hardware board. It sounds about the same and is vastly superior in software, ease of use, and price. The Entry program is a joy to use and it's easier than Mtn. Hardware's, but then, I guess you guys know that already. (Oh yes, you wouldn't happen to know of anyone that wants to buy a Mtn. Hardware system? \$450 or best offer?)

—Kirkland, Washington

I would like to tell you that after having used the system ONLY ONE DAY, that I am absolutely delighted with it. In addition, I purchased the three boards although I ALREADY own Mountain Hardware's music system. Now that I have seen and own your system, I am putting my "old" one up for sale. I think that your software makes it far easier to enter music, and that the software routines allow for far greater flexibility. Again, I extend my compliments to you. As I said, I have owned another music system, and consider myself therefore, qualified to make a judgement between the use of the two. Yours is the clear choice!

—Levittown, New York

See your local Apple® dealer or write:



ALF Products Inc.
1448 Estes Denver, CO 80215

Apple is a trademark of Apple Computer Inc.

Radio Shack® COLOR COMPUTER PROGRAMS



Graphic Games
Color Invaders —
Action Games



Programmer's Tool Kit
Editor • Assembler • Diagnostics



Many, many more!
Books • Memory • Accessories

Shipping from stock Call or Write:



6809 Specialists Encinitas, CA 92024 • (714) 436-3512

Computerware is a trademark of Computerware.

Radio Shack is a registered trademark of Tandy Corp.

LEAPAC SERVICES

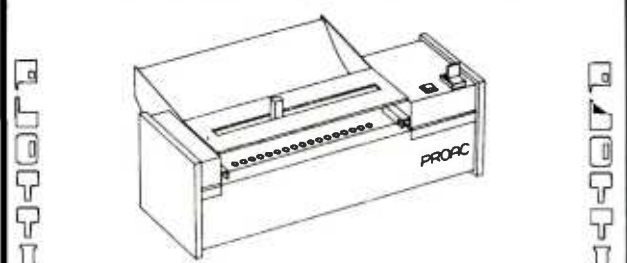

L20 PLOT PACKAGE \$16000
L70 & L3P PACKAGES \$36000
MAURO PLOTTER MP 750 PLOTTER \$695 00
with L70 package \$79500
with L20 & L3p packages \$95000

MAURO PLOTTER — Uses 11 wide paper of any length such as B bond or 17 graph paper. Plotting resolution is 200 steps per inch with DOS tracking error at plotting speeds of up to 2" per second. Uses standard fiber tip pens that can be obtained at any Stationery Store. Requires only 5 briefs of parallel output dot vector driver software in source is supplied with the plotter for IBM PC Z80 8507 & 5800 micro processors. APPLE TRS 80 and RS 232 interface cards are available as options.

LEAPAC SOFTWARE — Complete two-dimensional and perspective plotting software packages are available including ASCII character annotation and curve plotting. This software is hardware independent and will not become obsolete as you upgrade your plotting equipment. The software is supplied as BOB0 Z80 relative to using hardware (800) or MICROSOFT compatible products (FORTRAN 80 COBOL 80 COMPILER BASIC and MACRO 80 on CP/M or S-1, NORTHSTAR TRS 80 or HEALTH 80 compatible drives).

L20 PACKAGE — Two dimensional plot package that contains over 75 pre-written annotations to help you window your drawings, annotate your drawings, and draw elliptical curves. Contains CalcCompComp table cards such as PLOTS PLOT WHERE FACTOR etc.

L3P PACKAGE — Perspective or three dimensional plot package that contains over 70 entries that allow you to plot perspective figures such as the sell portrait above. Routines for STEREO GENERAL TONER ZOOMING FLY BY'S and ANIMATION are built into the package for minimal programming effort.

Write for more detailed information. A package of 6 users guides is available for L30 DOS containing over 180 pages describing the use of the above packages. Credit back on purchase of packages.

Besides the Mauro Plotter interface optional drivers are available for CalComp and Houston Instrument Drum plotters, Houston Instrument HPLOT DMP 346 & 7 plotters, and daisy wheel or spindle printers such as DIABLO 1620 & 1640 OLIVE SPRINT 5 and NEC 5510 & 5520.

LEAPAC SERVICES (816) 381 1717
8245 MEDITERRANEAN WAY SACRAMENTO, CALIFORNIA 95828

CP/M is a registered trade mark of Digital Research, Inc.
HPLOT & DMP are trade marks of Houston Instrument.
TRS 80 is a trade mark of Tandy Corporation.
Z80 is a trade mark of Zilog Inc.

GOOD IDEA!

You can save buying wholesale through our firm. As your agent we will buy computers on the wholesale market for you. Our fee is one fourth of what we save you off list price. Access to over 500 manufacturers. Minimum fee of \$75. Call for other prices.

READ THIS →

← COMPARE THESE

	Wholesale	Fee	You Save
COMPUTERS			
Altos 8000-2	3,015	371	1,113
Altos 8000-5	4,017	494	1,482
Altos 8000-10	5,695	701	2,103
Archives 64K QD	4,450	512	1,536
Calif. Comp. Sys. 64K 1.2 MEG	3,987	428	1,284
Cromemco System 3	5,357	659	1,977
Cromemco System 2 W/128K	4,345	535	1,605
Dynabyte 5400-A2 64K 1 MEG	4,617	769	2,307
Dynabyte 5400-B2 64K 2 MEG	5,217	869	2,607
Superbrain 64K QD	2,250	261	783
CRT'S			
ADDS R20	550	110	330
DEC VT 100	1,305	130	390
Hazeltine	832	107	371
IBM 3101 Model 10	1,140	60	180
Lear Siegler ADM 3A+	710	58	174
Leedex 13" Color Monitor	350	25	75
NEC 12" Monitor	190	18	54
Televideo TVI-920C	670	80	240
Zenith Z-19	687	77	231
PRINTERS			
Anadex 9501	1,150	125	375
Centronics 737	650	86	258
Diablo 1650 R/O	2,195	400	1,200
Epson MX-80B	410	58	174
IDS 560G	1,220	119	357
C. Itoh	1,250	186	558
NEC 5510 W/Tractors	2,450	225	675
Qume 5/45 R/O	2,035	215	645
Sellum I	CALL		
TI 810 Basic	1,355	135	558
SOFTWARE			
Wordstar	245	63	189
Magic Wand	200	50	150
Spellguard	250	0	0
Pearl III	350	88	264

The Purchasing Agent

1635 School Street, Suite 101
Moraga, CA 94556 (415) 376-9020
International Telex 470851

Prices subject to change without notice.

Book Reviews

Musical Applications of Microprocessors

by Hal Chamberlin
Hayden Book Company, Inc
Rochelle Park, NJ
1980, 661 pages, hard-cover \$24.95

Reviewed by
Dick Moberg
404 S Quince St
Philadelphia PA 19147

This book is the culmination of many years of experimentation by one of the leaders in the field of computer music for small systems. Its depth of coverage and usefulness are unsurpassed by any other single publication.

A review cannot start without first looking at the book's author. Hal Chamberlin has been involved with microcomputers since their origin. His newsletter, *The Computer Hobbyist*, pioneered construction articles on tape, disk, and graphic interfaces long before there were any books or major publications on the subject. Combining his music and computer talents eventually led him to form a company, Micro Technology Unlimited, and to receive an award for his contributions at the 1979 Personal Computer Arts Festival. He is an avid writer for personal-computer magazines. His clear and often humorous style is prevalent throughout his book.

Before we look at the contents, let's discuss the book's intended audience. Being a long-time computer hobbyist with several years of childhood music lessons, I would target this book for the computer tinkerer or the musician with some syn-

TEXAS COMPUTER SYSTEMS

Radio Shack

Authorized Sales Center

We offer the lowest prices on

TRS-80 COMPUTERS

MODEL II 64K
\$3349

An excellent computer for your business needs. Easy expandability & compatibility. No formal operator training needed. All accessories available — disk expansions, printers and software. Quick delivery — airfreight from Dallas.

Model III 16K LIH 5849
Color Computer 4K LI \$339

Model III 32K 2 Disks - 5Call
Pocket Computer & Acc. 5Call

PRINTERS

DAISY WHEEL II
\$1695

Carbon ribbon typewriter quality for word processing. 43 cps. Standard Centronics parallel interface. Full 16" width, individual sheets or friction feed. Tractor feed \$250 extra. Fastest Daisy Wheel available at this price.

EPSON MX-80
5Call

Letter quality matrix similar to Line Printer IV and Centronics Printer but has full software control of 40, 80, 66 or 132 columns. 80cps bidirectional, tractor feed, disposable printhead \$300 less than nearest competitive printer. Best buy in multi-strike letter quality printer. Lists at \$645. Our price includes cable & shipping.

ANADEX 9500/9501
\$1385

200cps 7x9 or 9x9 matrix dot addressable graphics, excellent quality & price. 10, 12, 133, 167 cps. 8 or 8 1/2 in. standard carriage. Serial and current loop interfaces included.

LINE PRINTER V
\$1616

80cps. Designed for heavy business use. Bidirectional. 7x9 matrix.

LINE PRINTER VI
\$1015

Fast, versatile. Takes single sheets & pin red forms. 100 cps bidirectional, low profile. List \$1160.

CUSTOM SOFTWARE FROM TCS

Model I & III Programs
for the Epson MX-80 Printer

you get 8 programs for one low price. A library analysis or tape of programs and subroutines designed for gaining maximum use of the Epson MX-80 printer.

BIGLETT/800—Produce large graphic letters and dump them to the printer/screen/disk. Works from any Basic program.

EPSON/800—Subroutine to easily use all of the EPSON printer commands. Works into any Basic program.

DEFINITE/800—Collection of pre-defined commands accessible from any Basic program. Auto-line centering, titles with borders, etc.

DIRTY/800—Labor program with 100's of REM remarks to guide you thru the use of your computer.

JUL PATCH—A patch to NEWDOS 2.1/80's 2nd screen printer function to print graphics from screen in the Regular Epson printer mode.

ARTICLE—Complete article on many printer possibilities plus new ideas, concepts, & inside shooting tips.

Model I or III, Tape or Disk
\$39.95 for all 6 programs.

\$29.95 if purchased with Epson printer

The DOS Disk Library of Programs

A library of 5 programs for NEWDOS/80, NEWDOS 2.1, TRSDOS (Model I & III)

DIRMAINT—A super directory/maintenance program. Purge copy.

rename, reformat, etc., quickly with minimum typing. Super graphic displays for easy use.

FILEMAINT—Creates master directory of all files on your library of diskettes. Master file is handled on disk, not on memory, for maximum speed. Access any file in 2 seconds. 48K supports 200 diskettes. 32K about 100. Takes less than hour for 100 diskettes thru system.

CHARABLE/800—A super character file creation editor & assembler for NEWDOS/80. Very fast, easy to use. Reads and edits existing files.

HOMEMAIL—Unique home meaning list that stores data by modifying program itself. Fast & efficient for home use with less than 100 names.

DABMILE—Maintains excellent records of auto gas use & complete reports on MPG, etc. Also provides car maintenance alerts.

Model I or III Disk **\$39.95 for all 5 programs**

Infinite Basic Diskette

A diskette of programs written in RACET's Infinite Basic. User must have Infinite Basic (both modules). Extremely useful program with REM remarks to guide you in easy use of the 100 extra commands provided by this software system.

Included on the disk is program to maintain a Video Cassette Library, an in-memory mailing list, a demonstration of matrix techniques and equation solution, a screen input system routine. Also a complete article on Infinite Basic with valuable information on commands that are glossed over in the original documentation.

Model I or III Disk **only \$39.95**

We can Air Freight from Dallas to major a/p near you for fast, efficient service. Call for information

*Payment: Money Order, Cashier's Check, Certified Check, Personal Checks require 3 wks. to clear. VISA, MC, add 3%.

**Prices subject to change any time.

*No tax out of state. 1% a/c S.S.

**All items new, guaranteed by manufacturer.

***Delivery subject to availability.

****Shipping extra. Quoted by phone.

TEXAS COMPUTER SYSTEMS

An Authorized RADIO SHACK® Sales Center F701

Box 1174, Brady, Texas 76825

TOLL FREE Number 800-351-1473

Texas Residents 915-597-0673



Free. Fast. And
a phone call
away.

INMAC INTRODUCES
THE SOLUTION TO YOUR MICRO SUPPLY
AND ACCESSORY NEEDS.

- One-Stop Shopping. This new catalog offers over 1,000 products specifically for Micro Computers. Compatible with Apple, Atari, Northstar, TRS-80s and many others.
- Convenient Ordering. By mail or phone, ordering supplies and accessories from this catalog will be quick and easy.
- Fast Delivery. We'll ship your order within 24 hours from our distribution centers in New Jersey, California, Illinois and Texas. Overnight delivery available.
- Top Quality Products. Virtually all our products are guaranteed for at least one year. Risk-free trial of any product for 45 days.

Send for your FREE
Inmac Catalog or call
(408) 727-1970.
Available June 1, 1981.

Inmac
Dept. Micro, 2465 Augustine Drive,
Santa Clara, CA 95051

MAIL ORDER DISCOUNTS



APPLE II PLUS 48K
\$1,149

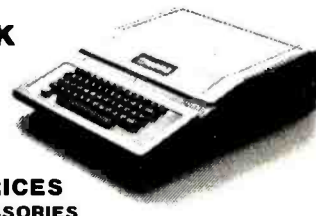

APPLE III CALL FOR PRICES
ACCESSORIES

DISK II DRIVE & CONTROLLER (DOS 3.3).....	525	MICROSOFT Z-80 SOFTWARE SYSTEM.....	290
DISK II DRIVE ONLY.....	445	MICROSOFT 16K RAM CARD.....	169
INTEGER BASIC FIRMWARE CARD.....	149	VIDEO 80 COLUMN BOARD.....	295
APPLESOFT II FIRMWARE CARD.....	149	HAYES MICROMODEM II.....	299
MARSUP-R-MOD RF MODULATOR.....	30	LEDEX 12" B&W MONITOR.....	149
CENTRONICS PRINTER INTERFACE CARD.....	179	SANYO 12" GREEN MONITOR.....	265
HIGH-SPEED SERIAL INTERFACE CARD.....	145	SILENTYPE PRINTER W/INT. CARD.....	535
SSMAIO SERIAL/PARALLEL I/O CARD.....	185	EPSON MX-80 PRINTER W/INTERFACE.....	699
LANGUAGE SYSTEM W/PASCAL.....	395	EPSON MX-70 PRINTER W/INTERFACE.....	499
DAN PAYMAR LOWER CASE ADAPTER.....	45	QUME SPRINT 5145 PRINTER.....	2,550

SOFTWARE

APPLE DOSTOOLKIT.....	65	APPLE FORTRAN.....	159
APPLE PLOT.....	60	APPLEWRITER.....	65
TAX PLANNER.....	99	DOW JONES PORTFOLIO EVALUATOR.....	45
APPLE PILOT.....	125	DOW JONES NEWS & QUOTES REPORTER.....	85
VISICALC.....	115	THE CONTROLLER BUSINESS SYSTEM.....	515
DESKTOP PLAN.....	79	SUPER INVADER (DISK).....	23
CCA DATA MANAGEMENT.....	79	BASF 5 1/4" DISKETTE (10).....	30

TO ORDER: Please send cashier's check, money order or personal check (allow 10 business days to clear), VISA and Master Card credit card service add 2%. American Express credit card service add 5%. Shipping, handling and insurance in U.S. add 3% (minimum \$3). California residents add 6% sales tax. Foreign orders add 10% for shipping. Equipment is subject to price change and availability. All equipment carries factory warranty. TELEX: 697120 DATAMAX-SDG

computer age, inc.

Authorized Apple Dealer & Service Center
4688 CONVOY ST., SUITE 105, SAN DIEGO, CA 92111 (714) 565-4062

MICROMAIL HAS WHAT YOUR SYSTEM NEEDS.

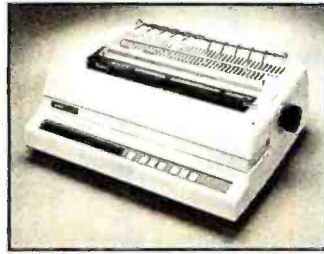

DIABLO

630

The Diablo Model 630 is a reliable, high quality, full-character serial printer for anyone who is seeking superior print quality at a low cost. This is the first Diablo printer to offer complete interchangeability between metal and plastic print wheels. And the sophisticated and discerning user does not sacrifice print quality to obtain this versatility. Every aspect of the Diablo 630 design has been focused on maintaining outstanding print quality. Terminals also have self-test, extensive internal diagnostics and automatic bidirectional printing.

\$1,999.00

With Adjustable Forms Tractor add \$200.00

ANADEX

DP-9500/9501

The Anadex Models DP-9500 and DP-9501 Alphanumeric Line Printers are designed for all printer applications, including those requiring high density graphics. Standard features include three standard interfaces (RS 232C, Centronics Parallel, and Current Loop), software selectable print sizes including compressed and expanded print, heavy-duty nine-wire printhead (permits true underlining and descending lower case letters), and fast bi-directional printing. The model 9501 offers slightly higher graphics resolution and a slightly slower print speed than the model 9500.

\$1,299.00



TEXAS INSTRUMENTS

Fast, reliable, and widely supported, the T.I. 810 has proven itself to be a solid printer for business or industry.

SPECIAL T.I. PRICES

810/2

(includes upper/lower case option)

\$1,549.00

810/2 VFC/CP

(includes u/1 case, forms control & compressed print)

\$1,679.00

Prices good through June 15, 1981

PRINTERS

C.R.T.'s

TELEPRINTERS

ANADEX

DP9000 \$1199
DP-9001 \$1199

Just like the 9500/9501, but 5 inches narrower. Uses paper up to 9.5 inches wide.

DIABLO

1640 RO \$2469
Uses plastic daisywheels, prints up to 45 c.p.s.

1650 RO \$2799
Uses metal daisywheels, prints up to 40 c.p.s.

NEC

High Quality, 55 c.p.s.

5510 \$2595

Serial Interface

5530 \$2595

Parallel Interface

TeleVideo

912C \$ 699
920C \$ 749
950 \$ 995

NEW! Features a detachable keyboard & programmable function keys.

SOROC

IQ120 \$ 689
IQ140 \$1099
IQ135 \$ 849

NEW! Microprocessor controlled, programmable function keys.

C. ITOH

CIT100 \$1625

DEC

VT-100 \$1650

DEC

LA 34 \$ 969
Dot-matrix, 30 c.p.i. Adjustable character sizes & line spacing.

LA 34 AA \$1099
Includes programmable forms length control.

TELETYPE

43 \$ 999
Very reliable 30 c.p.s. teleprinter. Ideal for use with 300-baud acoustic couplers or modems.

DIABLO

1640 KSR \$2699
Uses plastic daisywheels, prints up to 45 c.p.s.

1650 KSR \$2799
Uses metal daisywheels, prints up to 40 c.p.s.

NEC and DIABLO prices include forms tractor.

To Order: Send check to MICROMAIL, P.O. Box 3297, Santa Ana, CA 92703. Personal or company checks require two weeks to clear. Visa/MasterCard accepted. C.O.D. requires a 15% deposit. **Handling:** Add 3% to orders less than \$750, 2% to orders \$751 - \$2000, 1% to orders over \$2000. NOTE: Handling charges are waived on orders pre-paid in advance by check. **Shipping:** We ship FREIGHT COLLECT via UPS or Motor Freight. Air and Express delivery is available.

MICROMAIL

P.O. Box 3297
Santa Ana, CA 92703
Phone: 714/731-4338
TWX: 910 595 1146

Book Review

thesizer knowledge. The non-musician will find the introductory parts on waveforms and music theory sufficient for understanding the rest of the book. The musician with no background in computing or electronics should have available some of the excellent paperback volumes now available on op (operational) amps, TTL (transistor-transistor logic) circuits, and microcomputers. But, even for the computer-musician novice, this is a book that is readily understandable.

Musical Applications of Microprocessors is divided into three sections: "Background," "Computer-Controlled Analog Synthesis," and "Digital Synthesis and Sound Modification."

Section I covers background material in music synthesis and microprocessors. The first chapter, "Music Synthesis Principles," starts with a discussion on the goals of music making, comparing conventional instruments with electronic-synthesis techniques. It emphasizes that with electronic synthesis, a musician is limited only by his imagination as to the accuracy, complexity, and variety of sounds that can be achieved with this medium. Next, the author discusses the relationship of the physical parameters of waveforms — frequency, amplitude, and harmonics — to the musical concepts of pitch, loudness, and timbre. The chapter ends with a history of electronic sound synthesis from the teleharmonium to the microprocessor.

Chapter 2 presents the terminology and techniques of sound modification. It starts with a section on tape-recording techniques (re-arranging tape splices, speed transposition, etc) and then compares these to their electronic counterparts. Other electronic techniques such as

filtering, spectrum shifting, reverberation, and chorus synthesis are discussed. The chapter concludes with a discussion on analyzing natural sounds for subsequent modification.

The next chapter, on voltage-control methods, explains the conventional techniques of using voltage to control frequency, amplitude, and harmonics. Each of these techniques is later explained in regard to its implementation with analog and digital circuits or by using software programming. The modular nature of conventional synthesizers is also discussed.

Chapter 4 addresses waveform synthesis by the computer by digital-to-analog conversion and looks at the advantages and limitations of using this method. Music-programming systems and languages, including MUSIC V and Hal's NOTRAN (NOte TRANslation language), are briefly described.

The background section concludes with a chapter on microprocessors. There is an interesting comparison between the 8080, LSI-11, and 6502 microprocessors showing where each (and similar processors) should be used in the grand scheme of a music-synthesis system. The author claims that the 8-bit 8080/Z80 family are the optimal microprocessors for synthesizer control, the 16-bit LSI-11 for direct microprocessor synthesis of music, and the 8-bit 6502 for replacing dedicated logic. Although the choice of processor will vary from one designer to the next, this section gives the design criteria and the desired microprocessor parameters for each area of application.

The remaining two sections of the book offer technical how-to information regarding microcomputers in music synthesis. There's a discussion on the use of a

DISK DOCTOR

for CP/M



A Program to Recover "Crashed" Discettes AUTOMATICALLY!

Maybe it was a lightning storm, static from the rug, or just too late at night to be working. Whatever the cause, when a discette "crashes" and valuable data or programs are destroyed, the loss is enormous, both in time and money.

DISK DOCTOR is a program which automatically recovers bad discettes. Best of all DISK DOCTOR does not require any knowledge of CP/M file structure! If you can operate CP/M, then you can use DISK DOCTOR. The entire system is menu driven with key information displayed.

DISK DOCTOR is comprised of five "wards", each capable of performing a specific discette recovery operation.

- **Ward A:** Verifies discettes and locks out bad sectors without touching the good files that remain.
- **Ward B:** Copies whatever can be read from a "crashed" file and places it into a good file under user control.
- **Ward C:** Copies discettes without stopping for bad sectors. Bad sectors are replaced by spaces.
- **Ward D:** "Un-erases" files. That is, Ward D will recover accidentally erased disk files.
- **Ward E:** Displays directory of recoverable erased files.

DISK DOCTOR will pay for itself the first time it is used.

Best of all, DISK DOCTOR operates almost complete automatically. The small amount of user interaction is explained in the manual as well as prompted by DISK DOCTOR.

Requires: 48K CP/M, two drives needed for complete operation.

DISK DOCTOR: \$100.00
Manual Alone: \$10.00

CP/M Formats: 8" soft sectored, 5" Northstar, 5" Micropolis Mod II, Vector MZ, Superbrain DD/QD, Apple II+



All Orders and General Information:
SUPERSOFT ASSOCIATES
P.O. BOX 1628
CHAMPAIGN, IL 61820
(217) 359-2112

Technical Hot Line: (217) 359-2691
(answered only when technician is available)

SuperSoft
First in Software Technology

CP/M REGISTERED TRADEMARK DIGITAL RESEARCH

IS BASIC TOO SLOW?

OSBORNE McGraw-Hill's
Assembly Language books
help you speed up your programs

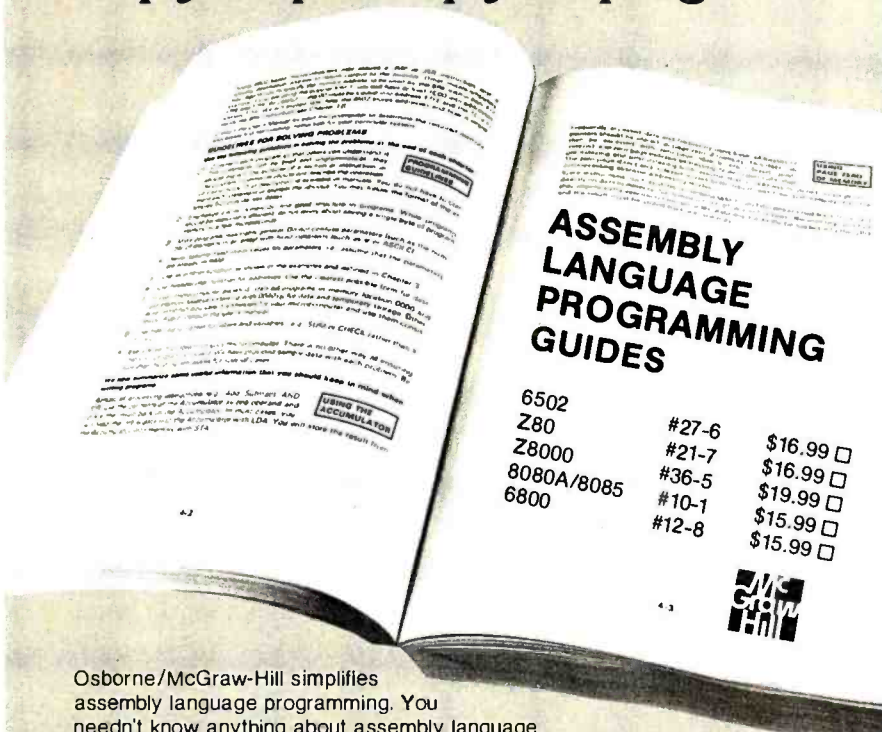

Osborne/McGraw-Hill simplifies assembly language programming. You needn't know anything about assembly language to use our ALP series. Each book is a straightforward, self-teaching textbook that is concise and easy to understand. Each book explains assembly language programming, describes the function of assemblers, structured programming, and presents many fully debugged practical programming examples.

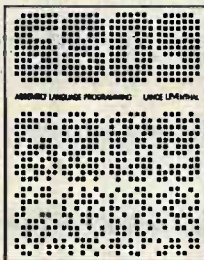

BRAND NEW!

6809 Assembly Language Programming

While everyone's been talking about the new 16-bit microprocessors, the 6809 has emerged as the hottest new device. This book will help you understand why. It offers you everything you need to program Motorola's 6809 microprocessor in assembly language and allow you to take full advantage of the 6809's unique design.

#35-7 680 pp. \$16.99

Make check payable to: Osborne/McGraw-Hill
630 Bancroft Way, Berkeley, CA 94710 Dept. B16

Phone Orders: (415) 548-2805
Toll Free: 800-227-2895

Name

Address

City/State/Zip

Plus .75/item 4th class \$1.25/item UPS \$2.50/item Air Mail \$10.00/item Overseas
(California residents add applicable tax.) Please send me your free catalog.

Total amount enclosed \$ or charge my Visa Mastercharge

Card # Expiration Date

Signature

Book Review

microcomputer as a controller of standard or custom analog sound-synthesizing equipment, and how a computer can simulate the analog module's functions in software to provide direct music synthesis.

The first chapter of the computer-controller section explains circuit details of the three voltage-controlled synthesizer modules—voltage-controlled oscillator, voltage-controlled amplifier, and voltage-controlled filter. Component values are provided along with construction tips for building those modules.

The next chapter, on data-conversion techniques, starts with a tutorial on the terminology regarding the use of D/A (digital-to-analog) and A/D (analog-to-digital) converters. All circuits for the various conversion techniques are given, along with component values and available devices. One impressive circuit shows how to make a 128-channel microcomputer-controlled D/A converter for less than \$50.

The remaining four chapters in this section deal with the "systems" aspects of a computer-controlled synthesizer. A chapter on signal routing shows how the computer and various switching devices can replace the ever-confusing patch cords on conventional analog synthesizers. Two chapters on input devices follow: one entirely on keyboard-input methods and one on other devices such as ribbon controllers, joysticks, and digitizers. The last chapter describes the role of computer-graphics displays as aids in computer music composition.

The last section of the book, on direct computer synthesis of music, gives details on digital sound generation and filtering techniques, and includes the techniques that the author

U.S.A.

ARISTO/POLKS

314 5th Ave. (32 ST) N.Y.C., N.Y. 10001
Telephone: (212) 279-9034

EPSON -

MX70
\$ 399



NEW
Friction/Tractor model
- NOW AVAILABLE
call for price

MX80T
\$ 499

The worlds first printer with disposable print heads. Built in dependability with an extensive range of features

OKIDATA -

Microline 80

80
\$ 449



Tractor Unit
\$ 75

83 \$ 949

The small, quiet, light, highly dependable printer with three way paper handling. Single sheet/roll/pin feed.

TEC RO STARWRITER

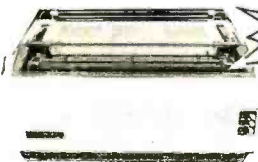

RS232 and Tractor version available

\$ 1495

Typewriter quality Daisy Wheel Printer Parallel or Centronics Interface *Diablo Wheels and Ribbons compatible

Atari

MODEL 400 \$429
MODEL 800 \$799

TYMAC APPLE TO CENTRONICS INTERFACE CARD including CABLE

\$ 119.99

MAXELL FLOPPY DISCS

5" MDI \$40 } per 10 discs
8" FDI \$55 }

All European trade enquiries to:

NORTHAMBER LTD

Great Oak House, Esher, Surrey, England, KT10 9BR Telephone: 0372 62071

EUROPE

Circle 79 on inquiry card.

has pioneered through much of his previous writings. The section opens with a discussion of quality data-conversion techniques. Three chapters follow on digital sound-generation methods, including separate chapters on filtering and percussive sound generation. The chapter on digital tone-generation techniques includes the author's table-look-up method for generating precomputed waveforms and algorithms, and includes uses of Fourier techniques for "synthesis from scratch." The digital-filtering chapter gives techniques for reverberation and chorus effects.

Direct computer synthesis of music is usually not a real-time technique. But, as the author points out, these techniques are very useful for those designing real-time systems for live performances.

A fascinating chapter follows on the analysis of natural sounds for modification and resynthesis. Methods of three-dimensional spectral plotting for harmonic visualization are covered. Also mentioned are some advanced techniques for sound analysis, such as linear prediction, autocorrelation, and homomorphic analysis.

The last two chapters deal with digital hardware and music-synthesis software. The digital synthesis of music can be accomplished by using either hardware or specific software techniques, or a combination of the two. These chapters discuss the trade-offs of each method. Among other topics the hardware chapter presents circuits for digital multiplexed oscillators, Fourier-series tone generators, and hybrid voice modules. Some of the available music-synthesis boards for small computer systems are also analyzed.

The last chapter describes

Z-80 FORTH \$50.00

Fast, interactive, and flexible language well suited for real time applications. Full fig-FORTH* and FORTH-79* vocabularies, plus extensions for access to all CP/M** functions. Uses standard CP/M compatible random access files for screen storage. Eight-inch soft-stored single density diskette includes: interpreter/compiler, line editor, screen editor, Z-80 assembler, decompiler, utilities, and demonstration programs. 60 page user manual supplied. Requires Digital Research CP/M 2.x or MP/M 1.x. Price includes tax and shipping by first class mail or UPS.

Laboratory Microsystems
4147 Beethoven Street
Los Angeles, CA 90066

* Forth Interest Group.
** CP/M is a trademark of Digital Research, Inc.

Circle 190 on inquiry card.

!! REAL TIME !!

The TIME MACHINE from ALPHA OMEGA COMPUTER SYSTEMS isn't just another digital clock chip surrounded by interface circuitry. It's an intelligent microcomputer based peripheral device.

The TIME MACHINE communicates with your computer via a serial I/O port at a user selectable data rate between 300 and 2400 baud. RS-232, RS-422, or current loop communication may be used.

Battery protection against power loss is included. The TIME MACHINE automatically computes day of the week and leap year. Buffered output pulses at one second, one minute, and one hour intervals are provided.

Dimensions are 2.5 x 4.75 x 7.5 inches. Batteries, power supply, and communication cable are included.

Price is only \$450 single lot and quantity discounts are available. Dealer inquiries invited. Off the shelf delivery.

ALPHA OMEGA COMPUTER SYSTEMS, INC.
P.O. Box 727 / Corvallis, Oregon 97330
Manufacturer of Computer and Control Systems (503) 754-1911

Circle 15 on inquiry card.

WANTED:

APPLE, PET, TRS-80, CP/M SOFTWARE

Westico is a publisher and distributor of professional software for microcomputers. If you have a new program ready for distribution or want your existing programs to reach a larger market, contact:

Phillip Woellhof, V.P. Mktg.
Westico, Inc.
25 Van Zant Street
Norwalk, CT 06855
(203) 853-6880

To increase your profits, take advantage of Westico's worldwide promotion and distribution.

WESTICO
The Software Express Service

NEW!

CTA 16K Apple RAM Expansion Board

The Model AXP-16K Expansion Board provides a 48K Apple II with an additional 16K of memory. The board is compatible with the Language Card and related software. The extra memory is obtained by disabling the Apple ROM and using its address space for RAM. Model AXP-16K comes with an operating manual.

Software Compatibility

Integer Basic, Applesoft II, Fortran, Pascal, Lisa version 2.0, Microsoft Z80 Softcard, Others.

Special Low Introductory Price

179⁹⁵

HURRY!



GTC-101 Terminals

We still have a few of these powerful, reliable standard data terminals. Order Today! Limited Quantities.

Reg. \$999.00
Clearance Price Only **\$795**

CTA COMPUTER TECHNOLOGY ASSOCIATES

118 Castellano
El Paso, Texas 79912
(915) 581-3500

Visa/MasterCard/Diner's Club Accepted.

TO ORDER: Send us your check, money order or credit card number and exp. date. Personal or company checks require two weeks to clear. Credit card users can call with card information.

SHIPPING: We ship terminals PREPAID by motor freight. Air and express delivery are available on all products.

There is no handling charge.

*Apple II is a registered trademark of Apple Computer Inc.

DEALER INQUIRIES WELCOME

Book Review

the hierarchy of music-software systems with examples from each level. Fixed-point-arithmetic routines for the 6502 processor are given, along with Fourier-series routines for waveform-table filling and much more. The chapter ends with a discussion of the high-level NOTRAN music-composition language.

In summary, this book is a milestone in microcomputer history. Its publication marks the progression — from novelty to serious instruments of expression — of musical applications of small computer systems. With little modification, the book could serve as a reference source on generalized data collection, signal processing, and process control using microcomputers. ■

BYTE's Bits

Errata Sheets for Osborne Books

If you have been having trouble running some of the CBASIC programs in Osborne/McGraw-Hill business books, a simple request will bring quick relief in the form of errata sheets. The sheets should have been sent with every ordered copy of *Payroll with Cost Accounting*, *Accounts Payable and Accounts Receivable*, and *General Ledger*. If errata sheets weren't included in your book, contact Sean Dugan, Customer Relations, Osborne/McGraw-Hill, 630 Bancroft Way, Department B10, Berkeley CA 94710, (415) 548-2805. ■

CP/M DATA ENTRY "RADAR"

RADAR is a high speed data entry system that will run on any CP/M system providing a "3741" style key-to-disk environment. RADAR is ideal for replacing KEYPUNCH machines and older, slower key-to-disk systems like the 3741's and 42's.

Features:

- Verify Mode
- Check Digit Processor
- Auto Dup/Manual Dup
- 16 Accumulators
- Parameter Driven (No Programming)
- "Virtual" File Access
- Add or Delete Records
- Record Retrieval By Number Or Content
- Full Editing Capability
- Operator Prompts
- Extremely Fast (Written In Assembly Language)

In addition to "heavy-duty" data entry, RADAR is also the ideal "front-end" for many applications programs, providing aquisition and retrieval of keyed data with a degree of reliability simply not possible with any other technique. RADAR can cut programming time by more than 30%, simply because there is no longer any need to write the "input" portion of a program, just let RADAR handle it!

Write or call for free brochure. The RADAR manual is also available separately for \$25.00.



P.O. Box 3373A
Birmingham, AL 35255
Phone: 205-933-1659

Clubs and Newsletters

Atari Users Group

The Bay Area Atari Users Group meets on the first Monday and on the third Tuesday of each month at 7 PM. The Monday-night meeting takes place at Foothill College, and the Tuesday-night meeting is at Interim Electronics, 447 S Bascom Ave, San Jose, California. The group publishes a newsletter. The dues for the group are \$12 per year. The club currently has eight disks of public-domain software for sale at \$5 per disk. The monthly meetings feature speakers discussing micro-computer uses and the Atari. Write to the Bay Area Atari Users Group, c/o Foothill College, 12345 El Monte Rd, Los Altos Hills CA 94022.

Just for LAUGHS

The Louisville Apple User Group—Hardware and Software (LAUGHS) has separate meetings for the business, software, and special-interest subgroups. A monthly newsletter is published. The subscription rate is \$15 per year. For information, contact LAUGHS, c/o Pat Connelly, 3127 Kayelawn Dr, Louisville KY 40220.

Behavioral Sciences AIM-65 Users Group

Workers in the behavioral and biological sciences who are currently using or are interested in using the Rockwell AIM-65 are invited to participate in this group. Areas of study include hardware and software for experimental control, data acquisition, statistical analyses, and other applications. If you are interested, please write, out-

lining areas of interest and current or planned projects, to Dr J W Moore Jr, POB 539, Middle Tennessee State University, Murfreesboro TN 37132.

OSI Group In Northern California

The Ohio Scientific Users Group of Northern California has been formed. For details, write to Rod Freeland, c/o Public Interest Computer Services, POB 1061, Berkeley CA 94701; or call (415) 654-9880 after 1 PM.

68XX Users Group

This is a group for those hobbyists who have a strong interest in Motorola 68XX microprocessors. The group meets on the second Tuesday of each month in Santa Clara at American Microsystems Inc. Contact the 68XX Users Group at POB 18081, San Jose CA 95158.

Boston Group Promotes Artificial Intelligence

The Boston Subchapter of Robotics International of SME has been formed under the auspices of the Society of Manufacturing Engineers. The group has been developed to provide a forum for the exchange of information between engineers, scientists, industrial producers, and users of robotics technology.

For more information on the Boston chapter and the national group, contact Robotics International of SME, One SME Dr, POB 930, Dearborn MI 48128. ■

HOW TO START A COMPUTER BUSINESS

"Computer Business Opportunities 1981" annual report covers the best moneymaking ventures - consulting, software packages, dealerships, systems houses, services, repping, maintenance, vertical markets and much more - plus 20 steps on how to start, where to be in the 80's, the small business market, common entrepreneur's mistakes, financing, marketing, competing with biggies, directory of services and self-help sources, going part-time to full-time. Nowhere under one cover is a better industry perspective for self-employment planning. Contents from key back-articles of "Computer Opportunities," the entrepreneur's newsletter since 1978, "Low Capital Computer Business Guide" (10,000 copies sold), and continuous research from our field seminars. Over 200 pages ring-bound, \$65.00, check, Visa, Mastercharge, or written company P.O. 30 day refund guarantee.



DATASEARCH INCORPORATED

4954 William Arnold Road / Dept. E
Memphis, Tennessee 38117

For faster service on credit card orders, phone 901/761-9090

TWICE THE BYTE!



8" DISK CONTROLLER NOW—DOUBLE SIDED OPTION!

- DOUBLES APPLE II STORAGE
- APPLE DOS COMPATIBLE
- SHUGART 800 OR 850 COMPATIBLE
- IBM 3740 DATA ENTRY CAPABILITY
- CP/M, UCSD PASCAL CAPABILITY

Available at your local APPLE Dealer: \$400.



SORRENTO VALLEY ASSOCIATES
11722 SORRENTO VALLEY RD.
SAN DIEGO, CA 92121

Event Queue

June 1981

June 6-9

Atlanta Small Computer Show, Atlanta Hilton, Atlanta GA. Producers of small computers, peripheral equipment, supplies, and services will be exhibiting at this show. Business owners, corporate and government executives, data processing managers, doctors, lawyers, and other professionals, are expected to attend. Obtain additional information from The Atlanta Small Computer Show, 4060 Janice Dr, Suite C-1, East Point GA 30344, (404) 767-9798.

June 7-19

Computer Camps, Northeast Louisiana University (NLU), Monroe LA. NLU is offering two one-week sessions for

students in grades nine thru twelve. Beginners and advanced programmers are welcome. The cost is \$125 per session for room, board, fees, and text materials. Contact Dr Paul Ohme, Department of Mathematics, NLU, Monroe LA 71209, (318) 342-2186.

June 9-11

Understanding and Using Computer Graphics, Chicago IL. This seminar will cover the latest technology on graphic systems. It will be headed by Carl Machover. Contact Bob Sanzo, Frost & Sullivan Inc, 106 Fulton St, New York NY 10038, (212) 233-1080.

June 14-18

The Second National Conference of the National Computer Graphics Association,

Baltimore Convention Center, Baltimore MD. Computer graphics demonstrations and workshops will be held along with exhibits and seminars. Contact the National Computer Graphics Association Inc, 2033 M Street NW, Suite 330, Washington DC 20036, (202) 466-5895.

June 16-18

NEPCON East '81, New York Coliseum, New York NY. This exposition is aimed at engineers, prototype developers, production specialists and testing personnel. Technical programs will be presented. Contact Industrial & Scientific Conference Management Inc, 222 W Adams St, Chicago IL 60606, (312) 263-4866.

June 17-19

National Educational Computing Conference, North Texas State University, Denton TX. This conference will provide a forum for discussion between individuals, and institutions with interests in educational computing. Computer literacy, computer education for teachers, and computers in education are some of the topics to be covered. Contact Dr Jim Poirot, NECC-81, General Chairman, Computer Sciences Department, North Texas State University, Denton TX 76203.

June 21-26

Computer Workshops for Educators, Northeast Louisiana University (NLU), Monroe LA. This program will cover a wide variety of topics. Room, board, and tuition is \$135. Contact Dr Paul Ohme, Department of Mathematics, NLU, Monroe LA 71209, (318) 342-2186.

June 22-23 and June 24-27

Digital Electronics for

Automation and Instrumentation and Microcomputer Design Interfacing, Programming, and Application Using the Z80, 8080, and 8085, Virginia Polytechnic Institute and State University, Blacksburg VA. These two workshops allow participants to design and test concepts with the actual hardware. For more information, contact Dr Linda Leffel, CEC, Virginia Tech, Blacksburg VA 24061, (703) 961-5241.

June 23-25

Comdex/Spring '81, Madison Square Garden and New York Statler Hotel, New York NY. Contact the Interface Group, 160 Speen St, Framingham MA 01701, (800) 225-4620; in Massachusetts (617) 879-4502.

June 29-July 1

The Nineteenth Annual Meeting of the Association for Computational Linguistics, Stanford University, Stanford CA. Syntax, parsing, and sentence generation, computational semantics, discourse analysis and speech acts, speech analysis and synthesis, machine translation and machine-aided translation, and mathematical foundations of computational linguistics are some of the topics that will be discussed. Contact Don Walker, Artificial Intelligence Center, SRI International, Menlo Park CA 94025, (415) 326-6200, ext 3071.

July 1981

July 9-10 and July 20-21

Software Engineering, Denver CO and Seattle WA. Designed for systems analysts, designers, programmers, and managers, this seminar examines the latest developments in software engineer-

DISCOUNT PRICES

Microcomputers & Peripherals



North Star • SWTPC • Lear-siegler
Hazeltine • Centronics • Cromemco
Wabash • Perkin Elmer and others

Fast, off the shelf delivery.
Call TOLL FREE 800/523-5355

MARKETLINE SYSTEMS, Inc.
2337 Philmont Ave., Huntingdon Valley, Pa. 19006
215/947-6670 • 800/523-5355

Dealer Inquiries Invited

ing. For more information, contact Battelle, Seminar and Studies Program, 4000 NE 41st St, POB C-5395, Seattle WA 98105, (206) 525-3130.

July 29-31

The 1981 Microcomputer Show, Wembley Conference Centre, London, England. Seminars on microcomputer applications in business, production, and in education will be presented. Topics for conference sessions include hardware availability, software packages and development, automatic test equipment, robotics, and process control. Exhibits from major European and American manufacturers will be featured. Contact TMAC, 680 Beach St, Suite 428, San Francisco CA 94109, (800) 227-3477; in California (415) 474-3000.

August 1981

August 24-27

Software Design, Reliability, and Testing, Sheraton Motor Inn, Lexington MA. This four-day seminar is for engineers, programmers, and technical managers. It examines concepts and tech-

niques for developing and testing reliable, cost-effective software. It also addresses management concerns and recommended policies. Tuition is \$600, which includes course notes, luncheon, refreshments, and an evening reception. Contact the Institute for Advanced Professional Studies, One Gateway Ctr, Newton MA 02158, (617) 964-1412.

August 24-28

The Seventh International Joint Conference on Artificial Intelligence, University of British Columbia, Vancouver, British Columbia, Canada. This conference examines computer applications of medical diagnosis, computer-aided design, robotics, programmable automation, speech understanding, vision, and other related topics. Tutorial programs and artificial-intelligence exhibits will be presented. For more information, contact Louis G Robinson, American Association for Artificial Intelligence, Stanford University, POB 3036, Stanford CA 94305, (415) 495-8825.

August 25-28

Vector and Parallel Pro-

cessors in Computational Science, Chester, England. This conference will concentrate on hardware, software, algorithms, applications, and case studies concerning vector and parallel processors. For information, contact Mrs S A Lowndes, Science Research Council, Daresbury Laboratory, Daresbury, Warrington, WA4 4AD, England.

August 26-29

The Fifth Annual National Small Computer Show, New York Coliseum, New York NY. There will be daily lectures, and a five-hour seminar will be presented daily for executives who need an introduction to the understanding, acquisition, and use of computers in business. The registration fee for the show is \$10 per day. The seminar for executives is \$200, which includes all materials and show registration. For information, contact the National Small Computer Show, 110 Charlotte Pl, Englewood Cliffs NJ 07632, (201) 569-8542.

August 28-30

Personal Computer Arts Festival '81 (PCAF '81), Philadelphia Civic Center,

Philadelphia PA. This show will include technical sessions, demonstrations, and exhibits, as well as the annual computer-music concert and computer graphics film and video show. PCAF '81 is being held in conjunction with the Personal Computing '81 show. For complete details, contact the address below.

The PCAF '81 Committee invites persons interested in microcomputer-music and digital-sound synthesis, computer composition tools, signal processing, computer-generated visual art, and other computer-based creations, to talk, demonstrate, display, or perform at PCAF '81. To participate, send a half-page description of a topic or performance (include tapes, prints, or slides, if possible) before July 1 to PCAF '81, POB 1954, Philadelphia PA 19105. ■

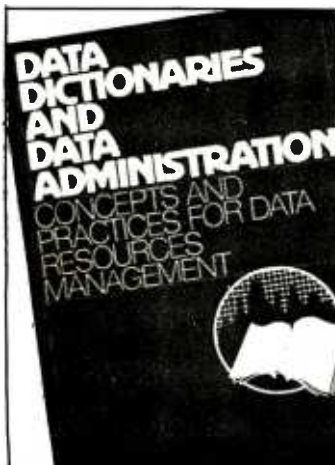

McGraw-Hill Bookstore

How to plan and control effective information systems development

DATA DICTIONARIES AND DATA ADMINISTRATION
by Ronald G. Ross

How to develop goals for a system, how to manage it and how to plan strategies for it. Numerous tables and diagrams. 384 pp. \$24.95 Published by Amacom

Please print clearly.

McGraw-Hill Bookstore 8Y6
1221 Avenue of the Americas
N.Y., N.Y. 10020



Please send me _____ copies of
Data Dictionaries and Data Administration
at \$24.95 each.

Check or Credit Card:
MasterCard _____ Visa _____ AmerExp _____

Account No. _____ Expires _____

Name _____

Address _____

City _____ State _____ Zip _____

Add sales tax plus \$1.75 postage, handling

ANNOUNCING

**MMSFORTH VERSION 2.0:
MORE FOR YOUR RADIO SHACK
TRS-80 MODEL I OR MODEL III !**

- ★ **MORE SPEED**
10-20 times faster than Level II BASIC
- ★ **MORE ROOM**
Very compact compiled code plus VIRTUAL MEMORY makes your RAM act larger. Variable number of block buffers. 31-char.-unique wordnames use only 4 bytes in header!
- ★ **MORE INSTRUCTIONS**
Add YOUR commands to its 79-STANDARD-plus instruction set! Far more complete than most Forths: single & double precision, arrays, string-handling, clock, more.
- ★ **MORE EASE**
Excellent full-screen Editor, structured & modular programming
Word search utility
Optimized for your TRS-80 with keyboard repeats, upper/lower case display driver, full ASCII, single- & double-width graphics, etc.
- ★ **MORE POWER**
Forth operating system
Interpreter AND compiler
8080 Assembler
(Z80 Assembler also available)
Intermix 35- to 80-track disk drives
Model III System can read, write & run Model I diskettes!
VIRTUAL I/O for video and printer, disk and tape (10-Megabyte hard disk available)

mmsFORTH

**THE PROFESSIONAL FORTH
FOR TRS-80**

(Over 1,500 systems in use)

Prices:
MMSFORTH Disk System V2.0 (requires 1 disk drive & 16K RAM, 32K for Model III) ... \$129.95*
MMSFORTH Cassette System V2.0 (requires Level II BASIC & 16K RAM) \$89.95*

**AND MMS GIVES IT
PROFESSIONAL SUPPORT**

Source code provided
MMSFORTH Newsletter
Many demo programs aboard
MMSFORTH User Groups
Inexpensive upgrades to latest version
Programming staff can provide advice, modifications and custom programs, to fit YOUR needs.

MMSFORTH UTILITIES DISKETTE: includes FLOATING POINT MATH (L2 BASIC ROM routines plus Complex numbers, Rectangular-Polar coordinate conversions, Degrees mode, more), plus a full Forth-style Z80 ASSEMBLER; plus a powerful CROSS-REFERENCER to list Forth words by block and line. All on one diskette (requires MMSFORTH V2.0, 1 drive & 32K RAM) \$39.95*

THE DATAHANDLER V1.1: a very sophisticated database management system operable by non-programmers (requires MMSFORTH V2.0, 1 drive & 32K RAM) \$59.95*

MMSFORTH GAMES DISKETTE: real-time graphics & board games w/source code. Includes BREAKFORTH, CRASHFORTH, FREEWAY, OHELLO & TICTACFORTH (requires MMSFORTH V2.0, 1 drive & 32K RAM) \$39.95*

Other MMSFORTH products under development

FORTH BOOKS AVAILABLE

MicroFORTH PRIMER - comes with MMSFORTH; separately \$15.00*
USING FORTH - more detailed and advanced than above \$25.00*
THREADED INTERPRETIVE LANGUAGES - advanced, excellent analysis of MMSFORTH-like language. \$16.95*
PROGRAM DESIGN & CONSTRUCTION - Intro. to structured program, good for Forth ... \$8.95*
FORTH '79 STANDARD MANUAL - official reference to 79 = STANDARD word set, etc. . \$10.00*
CALTECH FORTH MANUAL - good on Forth internal structure, etc \$10.00*
FORTH SPECIAL ISSUE, BYTE Magazine (Aug. 1980) - we stock this collector's item for Forth users and beginners \$4.00*

* - ORDERING INFORMATION: Software prices include manuals and require signing of a single system, single-user license. SPECIFY for Model I or Model III! Add \$2.00 S/H plus \$1.00 per additional book; Mass. orders add 5% tax. Foreign orders add 20%. UPS COD, VISA & M/C accepted; no unpaid purchase orders, please.

Send SASE for free MMSFORTH information.
Good dealers sought.

Get MMSFORTH products from your computer dealer or
**MILLER MICROCOMPUTER
SERVICES (B6)**

61 Lake Shore Road, Natick, MA 01760
(617) 653-6136

Book Reviews

**TEX and
METAFONT: New
Directions In
Typesetting**

by Donald E Knuth
Digital Press,
Bedford, MA 1979
\$12.00

Reviewed by
Richard Fritzon
25 Callodine Ave
Buffalo, NY 14226

TEX and METAFONT is primarily documentation for two programs that Donald E Knuth has written. TEX is a text-formatting program for preparing documents and METAFONT is a program for designing new fonts for digital typesetting devices (such as high-density raster-scan printers). The two manuals are preceded by a forty-page talk that Dr Knuth presented to the American Mathematical Society on the subject of mathematical typography.

Normally, program manuals are not very interesting, even to people who are using the program, and, unfortunately, most people are not yet using TEX or METAFONT. However, if you are interested in how a well-designed program can produce high-quality camera-ready text, if you are interested in mathematical methods for designing new type fonts, or if you are just interested in how a world-renowned computer scientist goes about designing, writing, and documenting his programs, read this book.

The introductory lecture, "Mathematical Typography," describes two aspects of the same subject: how to make it easy to compose mathematical papers of very high visual quality (ie: easy to read, beautiful to look at),

**If you're looking for
the best prices
in the U.S.A. on**



**TRS-80[®]
MICROCOMPUTERS**

We have consistently offered the TRS-80 line at savings up to 20%, which means you can save \$150 to \$1500 by buying directly from Computer Discount of America.

**TRS-80 Model II, 64K System,
with disc drive only \$3385.00**

Other TRS-80 Model II, or Model III computers and systems, Color Computers, and Pocket Computers are in stock at similar savings.

Our savings are as big on expansion interfaces, printers, diskettes - everything for your TRS-80 System.

**ATARI[®]
MICROCOMPUTERS**



We have the full line of ATARI personal computers and systems, including Models 400 and 800.

The computers, accessories, and hardware are brand new, in factory sealed cartons, and carry a full factory warranty.

Most models are in stock for immediate delivery (usually within 7-10 days), and a price quote is as near as your phone.

So if you're looking for the **best prices in the U.S.A.**, for micro-computers and accessories, call Computer Discount of America, Inc., West Milford, New Jersey 07480. 201-728-8080. **NO TAX ON OUT-OF-STATE SHIPMENTS.**

TOLL FREE 800-526-5313

**Computer
Discount
of America**

Authorized TRS-80 dealer, store B-282.

WHAT'S BETTER THAN AN ISAM

And Will Turn

- MICROSOFT'S BASIC
- COBOL
- FORTRAN
- DIGITAL'S PL/I-80
- CBASIC
- PASCAL/MT+
- S-BASIC
- CROMEMCO 16K BASIC

into first class application languages?

MICRO B+™

The first and most complete implementation of **B-TREE** index structures for micro-computers. **B-TREES** eliminate index file reorganization.

Search

An index of over

10,000 Key Values In Less Than One Second

On A Floppy Disk System for only

\$260.00!

System Houses:
MICRO B+™

Available in Language C

FAIR COM 2606 Johnson Drive
Columbia, MO 65201
(314) 445-3304
© 1980 Fair Com

Shipping \$4 USA / \$8 Foreign
We accept VISA and MASTERCARD

PL/I-80 is a trademark of Digital Research
CBASIC is a trademark of Compiler Systems, Inc.
S-BASIC is a trademark of Topaz Programming
PASCAL/MT+ is a trademark of MT Micro Systems

and how to use mathematics in the design of good-looking type fonts. It contains very brief introductions to both TEX and METAFONT, but, more interestingly, Dr Knuth describes some of the history of typesetting and typefont design and some of the history of his investigations into mathematical typesetting and font design, including some of the decisions he made while designing the two programs. His prose is comfortable and enjoyable. If you find it necessary to skip the more technical mathematics, you're skipping only about one page of Dr Knuth's lecture.

Judged by its manual, TEX is unlike any other text-formatting program. The care and thought that went into its design set a standard for programs of this kind, and programs in general, that few can meet. It uses a novel algorithm for splitting text into equal-length lines which considers the appearance of the entire paragraph in which the line appears, not just the line itself. It has extensive facilities for handling mathematical formulas in a manner that is easy for the typist but yields professional-looking output. (Naturally it supports proportionally spaced type fonts, multiple-column page formats, footnote references, and other features which are essential for full typesetting capability.) The manual is easy to read, and while it certainly makes you wish you had a copy of TEX to run on your own computer, you don't need it to enjoy reading the manual. (Dr Knuth says that he intends to publish the programs in a book, putting them in the public domain.)

As far as I know, METAFONT, the typeface-design program, is unique. It allows you to write programs, in a special METAFONT language, that specify the shapes of a family of characters — that is, it allows you to design your own type fonts. Currently though, only high-density raster-scan

MICROSETTE CASSETTES



C-10



C-20

COMPUTER CASSETTES



C-60



C-90

AUDIO CASSETTES

Microsette, the undisputed industry leader in short cassettes for micro-computer applications also offers equally high grade audio cassettes at budget prices. Credit card buyers may phone (415) 968-1604.

LOOK AT OUR PRICES

Length	10 Pack	50 Pack
C-10	\$ 7.50	\$32.50
C-20	\$ 9.00	\$39.00
C-60	\$13.50	\$57.50
C-90	\$17.50	\$77.50

UPS shipment in Cont. USA incl.
We can not ship to P.O. Boxes

Length	Qty.	Price	Total
SUBTOTAL			
Calif. Cust. add Sales Tax			
TOTAL			

Check or money order enclosed
 Charge to: Visa Master Card
 Account No. _____
 Expiration Date _____

SIGNATURE _____

B6

MICROSETTE CO.
475 Ellis Street
Mt. View, CA 94043

MBC
Systems inc.

CALL

(203) 342-2747

COMPUTERS

HEWLETT-PACKARD		
HP-85		\$ 2795
HP-83		\$ 1990
NORTH STAR		
HR2-2D-32K FAC ASM		\$ 2795
HR2-2Q-32K FAC ASM		\$ 2995
HDA-18	CALL FOR PRICE!!	
COMMODORE BUSINESS MACHINES		
8032 LARGE SCREEN		\$ CALL
4032 40 COL.SCREEN		\$ CALL
8050 DUAL DRIVE		\$ CALL
4040 DUAL DRIVE		\$ CALL
INTERTEC SUPERBRAIN		
SUPERBRAIN 64K 2D		\$ 2890
SUPERBRAIN 64K 2Q		\$ 3490
10 MEG HARD DISK		CALL
ALTOS SYSTEM		
ASC8000-2 1 MEG FD		\$ 3490
ASC8000-2D 2 MEG		\$ 4390
ASC8000-10 4 USERS		\$ 6795
ONYX C8002		\$14900

PRINTERS

DIABLO 630		\$ 2375
1640 R/O		\$ 2990
1650 R/O		\$ 3390
SPINWRITER 5510 OR 30		\$ 2595
5520 SERIAL KSR		\$ 2995
C.ITOH DAISY WHEEL		\$ 1775
ANADEX 9500 OR 9501		\$ 1490
PAPER TIGER 445G		\$ 820
460G		\$ 1250
560G 132 COL		\$ 1395
CENTRONICS 730-1		\$ 590
737-1		\$ 820
779-2 TRACTOR FED		\$ 950
EPSON MX-80		\$ 595
MX-80FT FRIC/TRACTOR		\$ 695
MX-70		\$ 425
OKIDATA MICRO 80		\$ 499
80		\$ 690
83		\$ 995

TERMINALS

TELEVEDIO 920C		\$ 890
MODEL 950		\$1075
HAZELTINE 1400		\$ 599
MODEL 1420		\$ 890
1500		\$ 990
INTERTEC INTERTUBE III		\$ 775
EMULATOR		\$ 775
SOROC 120		\$ 850
135		\$ 899
NEC 12" GREEN MONITOR		\$ 250
SANYO 12" GREEN		\$ 320
SANYO 13" COLOR		\$ 495
LEEDEX 13" COLOR		\$ 425

SINCE 1977 COMPLETE SALES AND SERVICE. MOST ITEMS IN STOCK!! VISA AND MASTER CHARGE WELCOME PRICES SUBJECT TO CHANGE

(203) 342-2747

Multi-Business Computer Systems

28 MARLBOROUGH STREET
PORTLAND, CONN. 06480

TWX 710 428-6345
M-F 9-6 SAT. 9:30-3:00

Book Review

printers can print the new fonts, and these devices are still extremely expensive. Consequently, the micro-computer applications for a font-design program are limited. However, like the TEX manual, the META-FONT manual is both interesting and informative. It reads as though the author were standing at times in front of you lecturing and, at other times, behind you looking over your shoulder, helping. Even if you are just interested in the design of type fonts by Dr Knuth's analytic method, you will find this book useful. (The manual includes many exercises. While they are interesting to read, if you're not actually trying to learn to use TEX or META-FONT you may well want to skip them; I did.)

I used to think that only a hard-core, lost soul computer hacker could enjoy reading a manual for a program he might never use. This book has made me reconsider. ■

BYTE's Bugs

Correction

The name of the manufacturer of the wire-wrap prototyping board mentioned in "What's Inside Radio Shack's Color Computer?" (March 1981, BYTE, page 90) should have been Vector Electronic Company. We apologize for any confusion this may have caused. ■

Notice of Omission

Due to a processing error the Washington Computer Service ad which appeared on page 27 of the May Byte had no Reader Service Number.

For more information regarding their "no problem trial offer" circle 475 on the inquiry card in this issue.

S-100 6809 controls floppy

NEW!



- Control: 3 Mini Floppy Drives
- Serial RS-232C port with 14 baud rates
- Two parallel ports
- 16 I/O decoded address lines
- 24K bytes of EPROM space, or 12 Kbytes of RAM space
- Accept all JEDEC pin-out Byte-Wide memory ICs
- Multi-Vendor software adaptable
- Industry, Business, Home and University use
- Assembled and tested \$395.00. 60 day delivery
- Checks or C.O.D. orders accepted
- DEALER INQUIRIES INVITED

LOGICAL DEVICES, INC.

781 W. Oakland Park Blvd.
Ft. Lauderdale, Fla. 33311
Tel: (305) 555-8103

Circle 200 on Inquiry card.

?? APPLE*-ITIS ??

Hardware or Software Problems?
Save time and money by having your own diagnostic disk. Determine immediately if you have a hardware problem.

XPS's **APPLE*-CILLIN** can help you cure your problems fast and easily.

Order **APPLE*-CILLIN** for \$29.95**

XPS inc.

323 York Road
Carlisle, PA 17013

*trademark of Apple Computer Inc.
**PA Residents add 6% sales tax
Requires 48K and one Disk II*

Circle 391 on Inquiry card.

APPLE OWNERS!

Combine your APPLE computer with our high speed dual channel AID and controller boards to create your own:

DIGITAL STORAGE SCOPE

- Sample rate DC to 3.5 Mhz.
- 1024 Sample Buffer Memory
- Pretrigger Viewing
- Dual or Single Channel Trace
- Trigger either channel
- Programmable Scale Select

All trace parameters are entered through keyboard to the onboard software included in PROM. High resolution graphics used to display waveforms.

Price for two board system \$495. California residents add 6% sales tax.

RC ELECTRONICS, INC.
7265 Tuolumne
Goleta, California 93117
(805) 968-6614

Circle 308 on inquiry card.

Factory Direct

ELIMINATE THE MIDDLE MAN!

16K^{STATIC} RAM



RAM 16

COMPARE OUR FEATURES!

S-100 • 16K X 8 Bit Static RAM • 2114 1K X 4 Static RAM Chip • 2 or 4 MHz • 4K Step Addressable • 1K Increment Memory • Protection from Top Board Address Down or from Bottom Up • Deactivates up to 6 1K Board Segments to Create Holes for Other Devices • Phantom Line DIP Switch • DIP Switch Selectable Wait States • 8 Bank Select Line Expands to 1/2 Million Bytes • All Data Address and Control Lines Are Input Buffered • Ignores I/O Commands at Board Address • **Our Most Popular Board — Over 5000 Now in Use Worldwide!**

A & T Factory Direct Price:

Singly \$199.00
 2 or 3 each \$189.00
 4 up each \$179.00

**One Year Warranty
 DON'T PAY MORE!**



NEW! — RAM 65

All of the Above Advanced Features PLUS: Bank Selection by I/O Instruction Using Any One of 256 DIP Switch-Selectable Codes • This Allows Up to 256 Software Controlled Memory Banks! • **Our Most Advanced 16K Add-On Board.**

A & T Factory Direct Price:

Singly \$224.00
 2 or 3 each \$214.00
 4 up each \$204.00

**One Year Warranty
 DON'T PAY MORE!**

All of our Boards Are the Highest Quality MIL SPEC G-14 Fibreglass. All utilize Solder Mask over Copper Technique for Higher Reliability!

MIX AND MATCH FOR BEST PRICING.

Include \$3.00 shipping & handling per order. California residents include 6% sales tax.

TERMS: Cash, checks, money orders or purchase orders from qualified firms or institutions. Pricing and availability subject to change without notice. International sales in U.S. funds only. COD's include 25% with order.

Quality Computer Parts

P.O. BOX 743, DEPT. B1
 CHATSWORTH, CA 91311
 Telephone (213) 882-3142

BYTE's Bits

First Annual Undergraduate Paper Competition in Cryptology

Cryptologia, a magazine devoted to cryptology, has announced a contest for undergraduate students who have an interest in the study of encoding and decoding. A \$300 award will be given to the student whose paper on any aspect of cryptology is judged the most valuable. Topics can include technical, historical, and literary subjects concerning cryptology.

Papers must be no more than twenty typewritten pages in length, double-spaced and referenced. Four copies must be submitted. Only original works that have never been published should be submitted. Authors must be enrolled in an undergraduate curriculum at the time of composition. All copies become the property of *Cryptologia* and the magazine assumes publication rights on all entries.

The papers will be judged by the editors of the magazine, and the winner will be announced on April 1, 1982, with publication of the winning paper in the July 1982 issue of *Cryptologia*. For information, contact *Cryptologia*, Albion College, Albion MI 49224. ■

Give to the college of your choice.



CF
AE Council for Financial Aid to Education, Inc.
680 Fifth Avenue, New York, N.Y. 10019
Ad
Council A Public Service of This Magazine & The Advertising Council.

What do you want your computer and video player to do that they can't do now?

- A. Display video segments then automatically switch to computer text.
- B. Display multiple-choice options at each stage of the presentation, then, depending on the choice made, replay any portion of text and/or video, or move on to new material.
- C. Show any portion of the computer text and/or video (randomly accessed) depending on the pace and/or choices of the user.
- D. ALL OF THE ABOVE . . . and do it all on one screen.

If you checked D, contact us for more information on Cavri Interactive Video. We offer a reasonably priced, sophisticated system that links an Apple* or an RS-232 interfacing computer with a Sony or Panasonic video player and TV screen — **with no modification**. Included are simple, straightforward instructions for writing your programs. Plus frame-accurate stops and switches with no accumulated error.

Write or call today and join the many companies, large and small, that are improving their audiovisual training and testing with the new technology pioneered by Cavri.

Training, of course, is only one application. Now you can catalogue anything — for example, a museum can videotape its paintings, sculptures, and artifacts, then show them by artist, subject, date, or any other grouping, regardless of the sequence in which they were recorded on the videotape. Tell us your application, and we can help by supplying the system and guidance on programming and videotape or videodisc production.



interactive video

26 Trumbull Street, New Haven, CT 06511
 (203) 562-4979

*TM — Apple Computer Co.

An Easy-to-Use A/D Converter

Robert Daggit
1648 Hillview Rd
New Brighton MN 55112

With the addition of an analog-to-digital converter and some simple sensors, a microcomputer can monitor analog voltages, read light levels, sense temperatures, or read the analog output from laboratory instruments. The six-channel A/D

(analog-to-digital) converter that I will describe reads positive voltages from 0 to 3 V, with either 8 or 10 bits of accuracy. It interfaces to the computer through an 8-bit bidirectional peripheral port whose I/O (input/output) lines are individually programmable and latched when used as outputs.

Conversion times are voltage-dependent, with an approximate range of 1 to 2 ms (milliseconds). A sample program segment and subroutine written in 6502 assembly language are included to illustrate the use of the converter.

About the Author

Robert Daggit is a Senior Research Technician at the Systems and Research Center of Honeywell Inc in Minneapolis. He is interested in the application of microprocessors to small, dedicated systems for laboratory use.

Once started, the converter operates asynchronously with respect to the computer and requires a minimum of code in the user's pro-

gram. Major components of the A/D converter unit, shown as a schematic diagram in figure 1, are a Fairchild Semiconductor $\mu A9708$ analog-to-digital-converter integrated circuit, a clock, a 12-bit counter, and a 16-bit output multiplexer. The $\mu A9708$ features an analog input multiplexer, controlled by address lines A0 thru A2, that selects one of eight input sources. Address 0 selects the internal zero voltage, and address 7 selects the internal reference voltage. Addresses 1 thru 6 select user inputs I1 thru I6, as shown in figure 1. Although the manufacturer rates the $\mu A9708$ at 8 bits of accuracy, it performs well at 10 bits of accuracy. A series of voltage readings taken at 0.1 V intervals from 0 to 3 V compared favorably with readings taken with a Fluke Model 8000A Digital Multimeter. Voltage differences ranged from 2 to 11 mV (millivolts). The greatest relative error, defined as the absolute value of the voltage difference divided by the multimeter reading, was less than 2%.

In order to read one of the analog channels, the channel address is placed on the address lines, and the ramp-start input (pin 3) is set low. The ramp-stop output (pin 7) goes high at this time. With the address lines stable for a signal-acquisition time of about 1 ms, the ramp capacitor, C1, charges to the voltage

FINDING SOLUTIONS AND BEING COMPETITIVE IS OUR BUSINESS.

Having problems and looking for a computer to help solve them? Are you finding computer dealers come in one of two ways? Either Full system support with Full price or Take it or Leave it with Low price. At Omega we don't believe that you should have to make a choice. Yes, we're in business to sell products but also, to solve your problems. Our prices will be the lowest possible. Our support and product quality will be second to none. Check out our Mail Order prices in this ad (our retail prices will be higher). See if you don't agree with our first claim. For our second claim, call us with your data processing needs and problems. Better yet, come in and see us. Finding solutions and being competitive is our business. We never forget either of them.



APPLE III	CALL
APPLE II "PLUS" 48K	\$ 1169.95
HEWLETT PACKARD 85 or 83	CALL
APPLE II ACCESSORIES:	
Disk II with controller	\$ 535.00
Disk II 2nd drive	455.00
Graphics Tablet	665.00
Language System with PASCAL	395.00
Silentype Printer W/Int	526.00
Integer Firmware Card	152.00
Microsoft Z-80 Softcard	259.00
Videx videoterm 80 col Card	279.00
Sanyo 12" Green Monitor	269.00

Supplies:	
Scotch Diskettes - Best of Quality!	
744-0, 10, 32	\$ 27.00
740-0 SS/SD 0 Sector	31.00
741-0 SS/DD 0 Sector	37.00
743-0 DS/DD No Format	44.00

New Products:	
Videx L/C Adapter	110.00
Microsoft 16K RAM Card	169.00
D.C. Hayes Micromodem II	315.00
Novation DCAT Modem	195.00
EPSON MX-80	CALL

Mail Order Terms of Sales: Price based on prepaid orders. NO COD's. Allow 14 working days for personal and company checks to clear. Order under \$100.00 add \$3.00 for shipping and handling. All orders (unless specified in ad) within Continental U.S. shipped U.P.S. no charge. APO or out of Continental U.S. write or call for shipping charges. All prices subject to change and all offers subject to withdrawal without notice. CA residents add 6% sales tax.

OMEGA MICRO COMPUTERS

The Problem Solving Company 3447 Torrance Boulevard • Torrance, California 90503 • (213) 370-9456

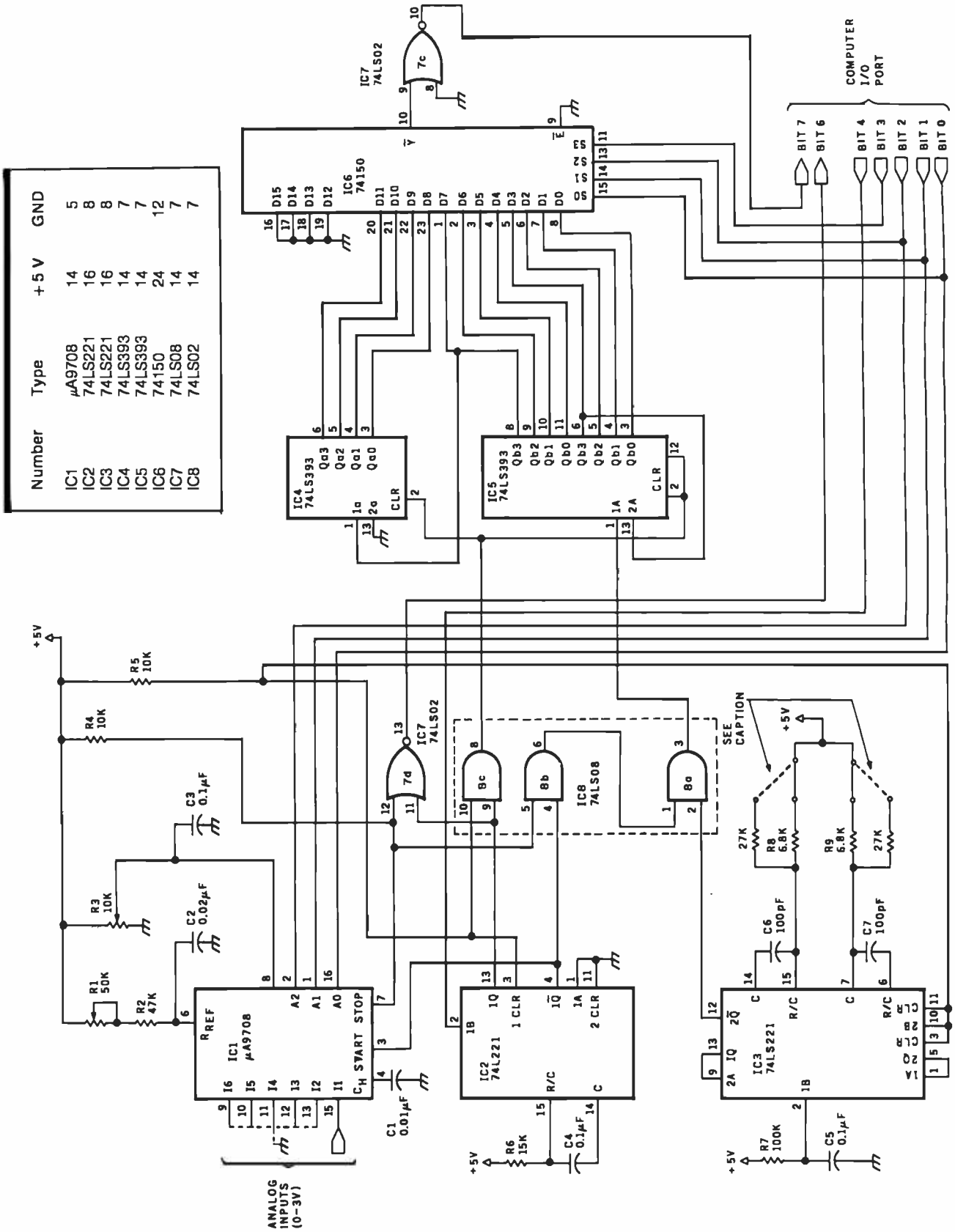

Figure 1: Schematic diagram of the A/D converter. Inputs I1 thru I6 of IC1 are the user's analog-input channels. The input voltage is converted to a binary number in the counter (IC4 and IC5), where it is retained until needed. The binary output is read in bit-serial fashion by the output multiplexer, IC6. Interface to the computer is through an 8-bit I/O port.

Easy selection of 8 or 10 bits of accuracy is accomplished by installing the clock timing components (C6, C7, R8, and R9) on a DIP header (see figure 2).

Lowest Prices on Personal Computers



800™ \$789

ATARI® List \$1080

ATARI® 400...\$429

hp HEWLETT PACKARD HP-85

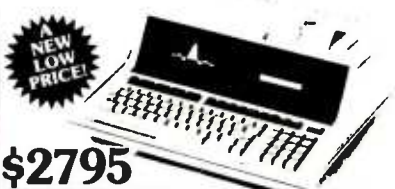

\$2795

HP-85 Accessories

- 5 1/4" Dual Master Disc Drive List \$2500... \$2125
- 5 1/4" Single Master Disc Drive List \$1500... \$1275
- HP 7225A Graphics Plotter List \$2050... \$1845
- HP-85 16K Memory Module List \$395... \$355
- HP-85 Application Pacs Standard List \$95... \$85
- Serial (RS-232C) Interface Module List \$395... \$355
- GPIO Interface Module List \$495... \$445

new HP-83 List \$2250
\$1895

HP-41CV with five times more memory



built in.
List \$325
\$249

HP-41C
List \$250
\$199

- HP-32E Scientific w/Statistics — \$53.95
- HP-33C Scientific Programmable \$79.95
- HP-34C Advanced Scientific Programmable — 123.95
- HP-37E Business Calculator — \$49.95

Personal PC computer Systems

609 Butternut Street
Syracuse, N.Y. 13208
(315) 475-6800

Prices do not include shipping by UPS. All prices and offers subject to change without notice.

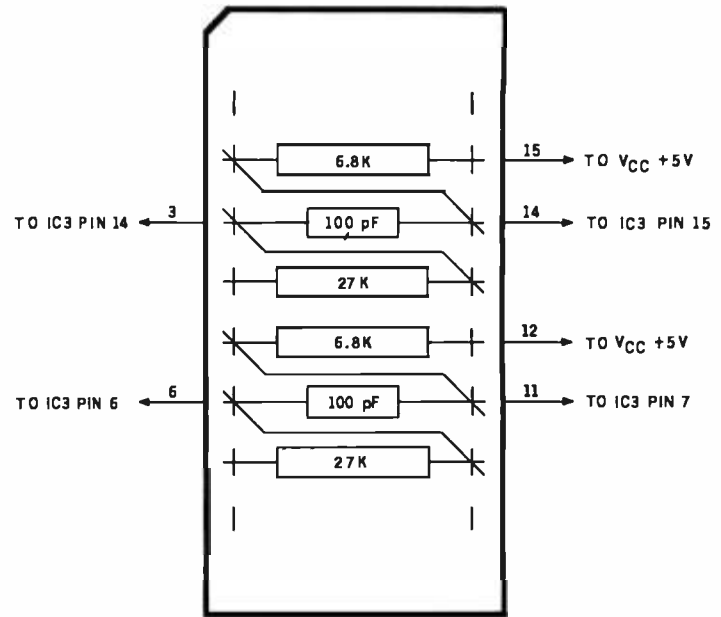

Figure 2: Wiring of the DIP header (top view). This optional feature may be installed for easy selection of 8 or 10 bits of accuracy. The clock timing components are mounted on the header in such a way that when it is reversed in its socket, the time constants of IC3 (a 74LS221 monostable multivibrator) are appropriately changed.

Listing 1: A program segment, written for the 6502 microprocessor, that illustrates use of the A/D converter. Hexadecimal 10 is added to the channel address, and this value is then written to the interfacing I/O port to start the conversion. Data from the counter is read when needed.

Address	Object Code	Label	Mnemonics	Comments
0250	A9 10		LDA H#10	;CHANNEL 0 ADDRESS
0252	8D 01 A8		STA DRA	;INITIATE A/D CONVERSION
0255	20 30 03		ISR RDADC	;READ CHANNEL 0 COUNT
0258	85 D0		STA D0	
025A	86 D1		STX D1	
025C	A9 17		LDA H#17	;CHANNEL 7 ADDRESS
025E	8D 01 A8		STA DRA	;INITIATE A/D CONVERSION
0261	20 30 03		ISR RDADC	;READ CHANNEL 7 COUNT
0264	85 C0		STA C0	
0266	86 C1		STX C1	
0268	A9 11		LDA H#11	;CHANNEL 1 ADDRESS
026A	8D 01 A8		STA DRA	;INITIATE A/D CONVERSION
026D	A9 02		LDA H#02	
026F	20 7C 05		ISR SUBM	;COUNT(REF) - COUNT(0)
0272	A5 C0		LDA C0	
0274	A6 C1		LDX C1	
0276	85 A0		STA A0	;SAVE CORRECTED REF COUNT
0278	86 A1		STX A1	
027A	20 30 03		ISR RDADC	;READ CHANNEL 1 COUNT
027D	85 C0		STA C0	
027F	86 C1		STX C1	
0281	A9 02		LDA H#02	
0283	20 89 05		ISR CMPM	;IS COUNT(1) < COUNT(0)?
0286	10 08		BPL SKIP	
0288	A5 D0		LDA D0	;SET COUNT(1)
028A	85 C0		STA C0	; TO
028C	A5 D1		LDA D1	; COUNT(0).
028E	85 C1		STA C1	;
0290	A9 02	SKIP:	LDA H#02	
0292	20 7C 05		ISR SUBM	;COUNT(1) - COUNT(0)

at the selected input. The ramp-start input is then set high. This disconnects the input voltage from the ramp capacitor, which now discharges linearly at a controlled rate through resistors R1 and R2. When the ramp capacitor is discharged, the ramp-stop output goes low. Since the capacitor's discharge time is directly proportional to the input voltage, a counter running during the interval from the conditions ramp-start-high to ramp-stop-low will, at the end, contain a count that is proportional to input voltage.

In this circuit, a low-to-high transition of peripheral-port bit 4 triggers IC2, a 74LS221 monostable multivibrator. Its Q output goes high to clear the counter, while the \bar{Q} output holds the ramp-start line low, allowing the μ A9708 (IC1) to acquire the voltage from the selected channel. Upon timing out, IC2's outputs change states, raising the ramp-start line to a high logic level and turning on the counter. When the ramp-stop line goes low, the counting stops, and peripheral-port bit 6 goes high to signal the computer that the conversion is complete. The counter value is the useful output of the converter, and is retained until it has been read and the next conversion cycle has begun.

The clock, IC3, is a multivibrator whose frequency is set to about 1 MHz by the 100 pF capacitors, C6 and C7, and 6.8 k-ohm resistors, R8 and R9, for a 10-bit count. An 8-bit count is selected by replacing R8 and R9 with 27 k-ohm resistors. If the frequency-determining components are installed symmetrically on a header, as shown in figure 2, the 8- or 10-bit counts can be selected by simply unplugging the header and reversing it.

A ripple counter and a 16-bit output multiplexer, controlled by address lines A0 thru A3, complete the circuit.

Before the circuit is used, all unused analog inputs should be grounded and the reference voltage and ramp slope should be set. The 10 k-ohm potentiometer, R3, is first adjusted until the reference voltage at pin 8 of IC1 is exactly 3 V, as in-

COMING FOR JUNE See it at COMDEX
Booth 1632

The
Multi-User
system that is
COMPLETE
and ready to run

MULTI/os™

Multi Word Processing
Multi Data Entry
Multi Inventory Control
Multi Order Entry

With a **Shared** data base
of up to
975,000,000 bytes

InfoSoft
SYSTEMS INCORPORATED
23 SYLVAN ROAD SOUTH
WESTPORT CONN 06880
(203) 226-8837

SciTronics introduces . . .

REAL TIME CLOCKS

with full Clock/Calendar Functions

The Worry-free Clocks for People
Who Don't Have Time to Worry!!

What makes them worry-free?

- Crystal controlled for high (.002%) accuracy
- Lithium battery backup for continuous clock operation (6000 hrs!!!)
- Complete software in BASIC-including programs to Set and Read clock
- Clock generates interrupts (seconds, minutes, hour) for foreground/background operation

Applications:

- Logging Computer on time
- Timing of events
- Use it with the SciTronics Remote Controller for Real Time control of A.C. operated lights and appliances

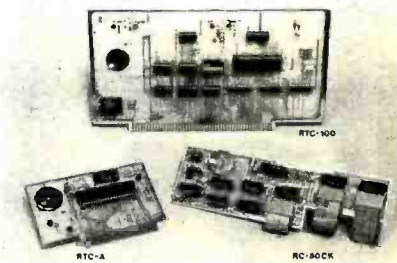

Versions available for:

- S-100 bus computers **RTC-100 \$159**
- Apple II computer **RTC-A \$129**
- SciTronics RC-80 owners **RC-80CK \$109**

Send
Check or
money
order to:
SciTronics Inc.
523 S. Clewell St., P.O. Box 5344
Bethlehem, PA 18015
(215) 868-7220

Please list system with which you plan to use controller • Master Charge and Visa accepted. COD's accepted. PA residence add sales tax.

The reachable star.

The STAR puts a quality 300 bps RS232C modem within reach of the small computer user...the same modem selected by IBM, GE, RCA, and ADP. The price? Under \$200!

We've designed this compact modem with exclusive triple-seal acoustic cups, crystal controlled oscillator, and built-in diagnostics and indicators. It's packaged inside an attractive injection molded case...and we stand behind the STAR with a two year warranty!

STAR models are available that interface directly with RS232C machines such as APPLE, ATARI, and NORTH STAR or IEEE 488 machines such as the PET, and that operate with either U.S. or European frequencies.



Available throughout the U.S., Canada, and Europe. For information and nearest dealer, call (408) 734-9810 or TWX 910-339-9519.

PRENTICE

Prentice Corporation
266 Caspian Drive
Sunnyvale, CA 94086

indicated by an accurate voltmeter. Then the converter connected to the computer is run in a loop, repeatedly addressing and reading the reference voltage at address 7. The 50 k-ohm potentiometer, R1, is adjusted until the count is just under hexadecimal FF for an 8-bit count, or hexadecimal 3FF for a 10-bit count.

In normal use, the program must first configure the peripheral-port bits 0 thru 4 as outputs and bits 5 thru 7 as inputs, and it must clear bit 4. Voltage readings are taken by writing

the value of the channel address plus hexadecimal 10 to the peripheral port and then waiting until bit 6 goes high. The channel address should not be changed during this time. Reading of the counter data automatically clears peripheral port bit 4, enabling its low-to-high transition when the next address is written to the port. The counter is read a bit at a time by writing the address of the desired bit into the peripheral port, reading the port, and then left-shifting bit 7 (the counter data bit) into a register pair

Listing 2: RDADC, a 6502 subroutine to read data from the counter in the converter. The 16-bit counter value is returned in the accumulator and X register. Status bits reflect the condition of the high-order byte.

```

;          ***** READ A/D CONVERTER *****
;
;          THIS SUBROUTINE READS THE COUNTER OF THE A/D CONVERTER.
;          IT RETURNS THE HIGH-ORDER BYTE IN THE ACCUMULATOR
;          AND THE LOW-ORDER BYTE IN THE X REGISTER.
;
;          SCRATCH LOCATIONS USED: F0,F1
;
0330 A9 40      RDADC: LDA    H#40    ;LOAD MASK TO TEST BIT 6
0332 2C 01 A8   LPI:  BIT    DRA    ;IS A/D CONVERSION COMPLETED?
0335 50 FB      BVC    LP1      ;IF NOT, LOOP UNTIL DONE
0337 A2 0F      LDX    H#0F    ;LOAD INDEX REGISTER/COUNTER
0339 8E 01 A8   LP2:  STX    DRA    ;BIT ADDRESS
033C AD 01 A8   LDA    DRA    ;READ BIT
033F 2A        ROL    A        ;ROTATE ACCUMULATOR
0340 26 F1      ROL    F1      ;ROTATE MEMORY LOCATION F1
0342 26 F0      ROL    F0      ;ROTATE MEMORY LOCATION F0
0344 CA        DEX
0345 10 F2      BPL    LP2     ;BRANCH IF POSITIVE
0347 A6 F1      LDX    F1      ;LOAD LOW-ORDER BYTE
0349 A5 F0      LDA    F0      ;LOAD HIGH-ORDER BYTE
034B 60        RTS
    
```

Reference Designation	Part
IC1	μA9708, A/D converter
IC2,IC3	74LS221, monostable multivibrator
IC4,IC5	74LS393, dual 4-bit binary counter
IC6	74150, 1 of 16 data selectors
IC7	74LS02, quad 2-input NOR gate
IC8	74LS08, quad 2-input AND gate
C1	0.01 μF, polyester
C2	0.02 μF, ceramic
C3,C4,C5	0.1 μF, ceramic
C6,C7	100 pF, ceramic
R1	50 k-ohm, 10-turn potentiometer
R2	47 k-ohm, ¼ W, 5% tolerance
R3	10 k-ohm, 10-turn potentiometer
R4,R5	10 k-ohm, ¼ W, 10%
R6	15 k-ohm, ¼ W, 5%
R7	100 k-ohm, ¼ W, 10%
R8,R9	6.8 k-ohm or 2.7 k-ohm, ¼ W, 5%

Table 1: Parts list for circuit of figure 1. Capacitor C1 should be a low-leakage type. No precision tolerances are required.

or 2 bytes of memory that will contain the 16-bit count. The sequence is repeated for each bit, starting with the most-significant bit at hexadecimal address 0F and ending with the least-significant bit at address 00.

The most efficient operation will result when the analog-to-digital conversion is initiated at a point in the program that occurs a number of instructions before the voltage reading is required. The computer is then free to execute the intervening instructions before having to wait for completion of the conversion. The hand-assembled program segment, shown in listing 1, illustrates the use of the converter and the RDADC subroutine (see listing 2). Note the instructions inserted between the initiation of the conversion at hexadecimal address 026A and the reading of the output at address 027A.

A nonzero count is always obtained, even when reading 0 V. This count must be subtracted from the reference voltage and channel counts. Thus, the computation for a linearized and scaled voltage reading becomes:

$$V(i) = \frac{\text{Count}(\text{Channel } i) - \text{Count}(0)}{\text{Count}(7) - \text{Count}(0)} \times V_{\text{REF}}$$

where V_{REF} is the reference voltage.

Long-term drift effects are minimized by reading the zero and reference voltages each time a channel is sampled. When reading very small input voltages, the possibility exists that a channel count may be smaller than the zero count. The apparent instability resulting from this condition is avoided by simply setting the channel count equal to the zero count.

The uses for such a converter are many and diverse. For example, if you are an energy-conscious homeowner, you may wish to monitor temperatures throughout your home. Or, if you are an amateur horticulturist, you may wish to monitor light intensity and temperatures of air and soil to optimize growing conditions for plants or cuttings. Whatever the application, I hope that this converter, with its 8 bits of accuracy for table subscripts or 10 bits of accuracy for better resolution, will serve you well. ■

(212) 986-7690

MAIL ORDER ONLY

Micro Computer Your One Stop For... Quality and Huge Savings

DISCOUNT Company

QUALITY • DELIVERY • SERVICE

60 E. 42nd St. Suite 411 New York, NY 10017

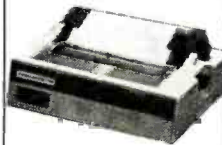

CENTRONICS
CALL FOR PRICES



EPSON
Call for Best Price & Delivery



COMMODORE

16K - \$859
32K - \$1079
2022 - \$695
2040 - \$1079
8050 - \$1495
8032 - \$1495



SUPERBRAIN*

64K - \$2595
64KQD - \$3295



ATARI
800—\$759

MONITORS

Sanyo 9" — B & W — \$180
Sanyo 12" — B & W — 239
Sanyo 12" — Green — 279
NEC 12" — Green — 259
BMC 12" — Green — 269
Zenith 13" — Color — 379



DIABLO
630
\$ 2195

MAIL ORDER ONLY

Send Certified Check (Personal or Company Checks require 2 weeks to clear.)
We pay all shipping and insurance charges except items marked with asterisk.
VISA, MasterCharge add 5% N.Y.S. Residents add appropriate sales tax.

*(DENOTES ITEMS SHIPPED F.O.B. NYC)

PHONE (212) 986-7690

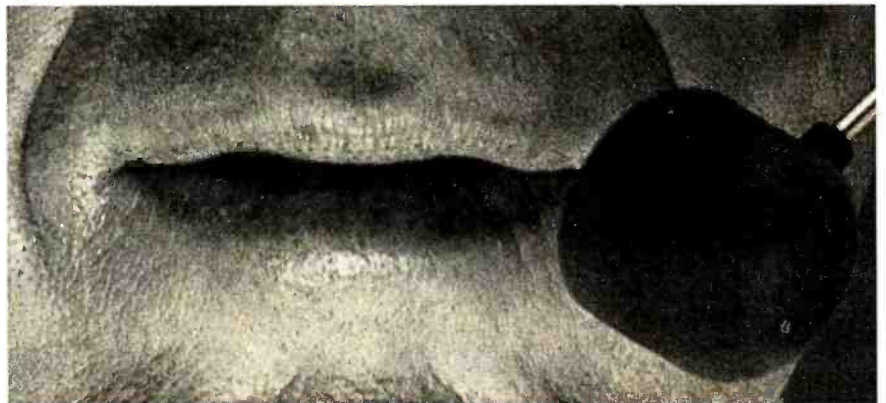

Spoken to your Apple®
relately?

With the Heuristics™ 2000 speech recognition board, you can train your Apple computer to recognize 64 words or phrases of your choice (or multiples thereof). Any command for any application.

The advanced Heuristics 2000, with microphone included, brings a whole new hands-off approach to data entry and program control — for a surprisingly low \$259. An optional head-set microphone (shown above) is also available.

TALK TO YOUR APPLE FOR ONLY \$259.

What's more, speech recognition is also available for S-100 computers, with our Heuristics 20S and 50 boards.

The 2000 also makes a very practical starter system for the Heuristics 5000 and 7000 industrial/commercial speech recognition units. These commercial units start at \$2500.

So the next time you have data to enter, words to process or menus to select, don't work your fingers to the bone. Talk to your Apple instead.

HEURISTICS 2000

The talk of the computer industry.™

Heuristics, Inc., 1285 Hammerwood Avenue, Sunnyvale, CA 94086 • 408/734-8532

Technical Forum

A Votrax Vocabulary

Timothy A Gargagliano and Kathryn L Fons
1394 Rankin St, Troy MI 48084

This vocabulary of 139 entries can be stored in as little as 770 bytes. The ASCII codes shown are for the TRS-80 voice synthesizer. Using Votrax symbology, however, this vocabulary is applicable to many other synthesizers, including the new SC01 phoneme speech chip.

(February 1981 BYTE, page 164), in which they presented an overview of the physiology of speech and a look at how Votrax voice synthesizers are programmed. Since that article contained only general guidelines for programming voice synthesizers, they decided to provide us with more specific information in the form of this list of common computer terms and how they would be programmed....SM]

[In February, Kathryn Fons and Tim Gargagliano coauthored an article entitled "Articulate Automata"

A	.A1	AY	Y	Votrax			
	@	*	&	ASCII			
E	.E	E1	AY	Y	Votrax		
	E	E	*	&	ASCII		
S	.S	E1	AY	Y	Votrax		
	S	E	*	&	ASCII		
D	.D	E1	AY	Y	Votrax		
	D	E	*	&	ASCII		
E	.E1	Y	Votrax				
	E	&	ASCII				
F	.EH1	EH2	F	Votrax			
	3	4	F	ASCII			
J	.J	E1	AY	Y	Votrax		
	J	E	*	&	ASCII		
H	.A1	AY	Y	T	CH		
	@	*	&	T	C		
					ASCII		
X	.AH1	EH3	I3	Y	Votrax		
	;	5	#	&	ASCII		
J	.D	J	EH3	A1	AY	Y	Votrax
	D	J	5	@	*	&	ASCII
K	.K	EH3	A1	AY	Y	Votrax	
	K	5	@	*	&	ASCII	
L	.EH1	EH3	UH3	L	Votrax		
	3	5	8	L	ASCII		
M	.EH1	EH2	M	Votrax			
	3	4	M	ASCII			
N	.EH1	EH3	N	Votrax			
	3	5	N	ASCII			

Technical Forum

Vocabulary continued:

BREAKB B	R R	A1 @	AY x	K K	Votrax ASCII					
BUSB B	UH1 6	UH3 8	S S	Votrax ASCII						
CABLEK K	A1 @	Y &	B B	UH3 8	L L	Votrax ASCII				
CHARACTERK K	EH1 3	R R	EH1 3	K K	T T	ER /	Votrax ASCII			
CLEARK K	L L	AY x	I3 #	R R	Votrax ASCII					
CLOSEK K	L L	01 0	U1 U	Z Z	Votrax ASCII					
CONTINUEK K	UH1 6	N N	T T	I1 I	I3 #	N N	Y1 Y	IU (U1 U	Votrax ASCII
COSINEK K	01 0	U1 U	S S	AH1 ;	EH3 S	Y &	N N	Votrax ASCII		
DATAD D	AE1 9	EH3 S	T T	UH2 7	UH3 8	Votrax ASCII				
DESKD D	EH1 3	EH3 S	S S	K K	Votrax ASCII					
DEVICED D	EH1 3	EH3 S	V V	UH3 8	AH2 A	Y &	S S	Votrax ASCII		
DISKD D	I1 I	I3 #	S S	K K	Votrax ASCII					
DISPLAYD D	I1 I	S S	P P	L L	A1 @	I3 #	Y &	Votrax ASCII		
DRIVED D	R R	AH1 ;	EH3 S	Y &	V V	Votrax ASCII				
EDITEH1 3	D D	I1 I	T T	Votrax ASCII						
ELSEEH1 3	EH3 S	L L	S S	Votrax ASCII						
ENABLEEH1 3	N N	A1 @	Y &	B B	UH3 8	L L	Votrax ASCII			

ENDEH1	EH3	N	D	Votrax															
	3	S	N	D	ASCII															
ENTEREH1	EH3	N	T	ER	Votrax														
	3	S	N	T	/	ASCII														
ERASEAY	I1	R	A1	AY	Y	S	Votrax												
	*	I	R	@	*	&	S	ASCII												
ERROREH1	ER	O1	R	Votrax															
	3	/	O	R	ASCII															
ESCAPEEH1	EH3	S	K	A1	Y	P	Votrax												
	3	S	S	K	@	&	P	ASCII												
EXECUTEEH1	K	PA0	S	EH1	K	Y1	IU	U1	T	Votrax									
	3	K	0	S	3	K	Y	(U	T	ASCII									
EXPONENTEH1	EH3	K	PA0	S	P	O1	U1	N	EH1	N	T								
	3	S	K	0	S	P	O	U	N	3	N	T								
FEEDF	E1	Y	D	Votrax															Votrax
	F	E	&	D	ASCII															ASCII
FIELDF	E1	Y	L	D	Votrax														
	F	E	&	L	D	ASCII														
FIXF	I1	I3	K	PA0	S	Votrax													
	F	I	#	K	0	S	ASCII													
FLOPPYF	L	AH1	UH3	P	Y	Votrax													
	F	L	;	8	P	&	ASCII													
FORF	O2	O2	R	Votrax															
	F	[[R	ASCII															
FORMATF	O2	O2	R	M	AE1	EH3	T	Votrax											
	F	[[R	M	9	S	T	ASCII											
FORWARDF	O2	O2	R	W	ER	D	Votrax												
	F	[[R	W	/	D	ASCII												
FRAMEF	R	A1	AY	Y	M	Votrax													
	F	R	@	*	&	M	ASCII													
FREEF	R	E1	Y	Votrax															
	F	R	E	&	ASCII															
GETG	EH1	EH3	T	Votrax															
	G	3	S	T	ASCII															
GLITCHG	L	I1	I3	T	CH	Votrax													
	G	L	I	#	T	C	ASCII													

Technical Forum

Vocabulary continued:

GOSUBG	01	U1	S	UH1	UH3	E	Votrax				
	G	0	U	S	6	8	E	ASCII				
GOTOG	01	U1	T	IU	U1	Votrax					
	G	0	U	T	(U	ASCII					
HUNDREDH	UH1	UH3	N	D	R	EH3	D	Votrax			
	H	6	8	N	D	R	5	D	ASCII			
IFI1	I3	F	Votrax								
	I	#	F	ASCII								
INKEYI1	I3	N	K	AY	Y	Votrax					
	I	#	N	K	*	&	ASCII					
INPUTI1	I3	N	P	00	T	Votrax					
	I	#	N	P	\$	T	ASCII					
INSTRINGI1	I3	N	S	T	R	I1	I3	NG	Votrax		
	I	#	N	S	T	R	I	#	+	ASCII		
INSTRUCTION	.I1	I3	N	S	T	R	UH1	K	SH	UH1	N	Votrax
	I	#	N	S	T	R	6	K	>	6	N	ASCII
KEYBOARDK	AY	Y	E	01	02	R	D	Votrax			
	K	*	&	E	0	L	R	D	ASCII			
KILLK	I1	I3	L	Votrax							
	K	I	#	L	ASCII							
LEFTL	EH1	EH3	F	T	Votrax						
	L	3	5	F	T	ASCII						
LENL	EH1	EH3	N	Votrax							
	L	3	5	N	ASCII							
LENGTHL	EH1	EH3	N	TH	Votrax						
	L	3	5	N	=	ASCII						
LEVELL	EH1	EH3	V	UH3	L	Votrax					
	L	3	5	V	8	L	ASCII					
LINEL	AH1	Y	N	Votrax							
	L	;	&	N	ASCII							
LISTL	I1	I3	S	T	Votrax						
	L	I	#	S	T	ASCII						
LOADL	01	U1	D	Votrax							
	L	0	U	D	ASCII							
LOCKL	AH1	UH3	K	Votrax							
	L	;	8	K	ASCII							

LOGL	AW2	AW2	G	Votrax				
	L	2	2	G	ASCII				
MANUALM	AE1	EH3	N	Y1	U1	UH3	L	Votrax
	M	9	5	N	Y	U	8	L	ASCII
MEMORYM	EH1	EH3	M	O2	O2	R	Y	Votrax
	M	3	5	M	E	E	R	&	ASCII
MERGEM	ER	D	J	Votrax				
	M	/	D	J	ASCII				
MIDM	I1	I3	D	Votrax				
	M	I	#	D	ASCII				
MODELM	AH1	UH3	D	UH3	L	Votrax		
	M	;	8	D	8	L	ASCII		
MICROM	UH3	AH2	AY	K	R	O1	U1	Votrax
	M	8	A	*	K	R	O	U	ASCII
MILLIONM	I1	I3	L	Y	UH3	N	Votrax	
	M	I	#	L	&	8	N	ASCII	
NAMEN	A1	AY	Y	M	Votrax			
	N	@	*	&	M	ASCII			
NEXTN	EH1	EH3	K	PA0	S	T	Votrax	
	N	3	5	K	0	S	T	ASCII	
NEWN	IU	U1	U1	Votrax				
	N	(U	U	ASCII				
NOTN	AH1	UH3	T	Votrax				
	N	;	8	T	ASCII				
ONAH1	UH3	N	Votrax					
	;	8	N	ASCII					
OPENO1	P	I1	N	Votrax				
	O	P	I	N	ASCII				
ORO1	O2	R	Votrax					
	O	E	R	ASCII					
OUTUH3	AH2	U1	T	Votrax				
	8	A	U	T	ASCII				
PEEKP	E1	Y	K	Votrax				
	P	E	&	K	ASCII				
PHASEF	A1	AY	Y	Z	Votrax			
	F	@	*	&	Z	ASCII			

Vocabulary continued on page 390

Technical Forum

Vocabulary continued:

POINTP	O1	I3	AY	N	T	Votrax
	P	O	#	*	N	T	ASCII
POKEP	O1	U1	K			Votrax
	P	O	U	K			ASCII
POSITIONP	UH1	UH3	Z	I1	SH	UH3 N
	P	6	8	Z	I	>	8 N
							ASCII
POWERP	AH1	UH3	W	ER		Votrax
	P	;	8	W	/		ASCII
PRINTP	R	I1	I3	N	T	Votrax
	P	R	I	#	N	T	ASCII
PUTP	001	001	T			Votrax
	P	X	X	T			ASCII
RANDOMR	AE1	EH3	N	D	UH1	M
	R	9	S	N	D	6	M
							ASCII
READR	E1	Y	D			Votrax
	R	E	&	D			ASCII
REMARKR	E1	M	AH1	R	K	Votrax
	R	E	M	;	R	K	ASCII
REPEATR	E1	P	E1	AY	T	Votrax
	R	E	P	E	*	T	ASCII
RESETR	E1	S	EH1	EH3	T	Votrax
	R	E	S	3	S	T	ASCII
RESTORER	E1	S	T	O2	O2	R
	R	E	S	T	[[R
							ASCII
RESUMER	E1	Z	IU	U1	U1	M
	R	E	Z	(U	U	M
							ASCII
RETURNR	E1	T	ER	R	N	Votrax
	R	E	T	/	R	N	ASCII
REWINDR	E1	W	AH1	AY	Y	N
	R	E	W	;	*	&	N
							D
							ASCII
RIGHTR	UH3	AH2	Y	T		Votrax
	R	8	A	&	T		ASCII
SAVES	A1	AY	Y	V		Votrax
	S	@	*	&	V		ASCII
SELECTS	EH2	L	EH1	K	PA0	T
	S	4	L	3	K	0	T
							ASCII
							Votrax

SETS S	EH1 3	EH3 5	T T	Votrax ASCII				
SHIFTSH >	I1 I	I3 #	F F	T T	Votrax ASCII			
SINES S	AH1 ;	EH3 5	Y &	N N	Votrax ASCII			
STEPS S	T T	EH1 3	EH3 5	F F	Votrax ASCII			
STOPS S	T T	AH1 ;	UH3 8	F F	Votrax ASCII			
STRINGS S	T T	R R	I1 I	I3 #	NG +	Votrax ASCII		
SUPPLYS S	UH1 6	F F	L L	AH1 ;	EH3 5	Y & Votrax ASCII		
SYSTEMS S	I1 I	S S	T T	EH1 3	M M	Votrax ASCII		
TABT T	AE1 9	EH3 5	B B	Votrax ASCII				
TANGENTT T	AE1 9	EH3 5	N N	D D	J J	EH1 3	N N T T	Votrax ASCII
THENTHV <	EH1 3	EH3 5	N N	Votrax ASCII				
TIMET T	AH1 ;	EH3 5	Y &	M M	Votrax ASCII			
TRACET T	R R	A1 @	AY *	Y &	S S	Votrax ASCII		
THOUSANDTH =	AH1 ;	UH3 8	U1 U	Z Z	EH3 5	N N	D D	Votrax ASCII
USERY1 Y	IU (U1 U	U1 U	Z Z	ER /	Votrax ASCII		
USINGY1 Y	IU (U1 U	U1 U	Z Z	I1 I	I3 #	NG +	Votrax ASCII
VALUEV V	AE1 9	EH3 5	L L	Y1 Y	IU (U1 U	Votrax ASCII	
ZAPPEDZ Z	AE1 9	EH3 5	P P	FA0 0	T T	Votrax ASCII		

The Impossible Dream:

Computing e to 116,000 Places with a Personal Computer

Stephen Wozniak
Apple Computer Inc
10260 Bandley Dr
Cupertino CA 95014

The 1960s were a decade of unrest, turbulence, and accomplishment. Man walked on the moon, *Star Trek* was launched, and the first million digits of π were determined by a computer. Today, as we face the early 1980s, Robert Truax, a backyard hobbyist, is constructing a private spacecraft, *Star Trek* has been revived as a movie, and personal computers are a reality. As a people, passion drives us to explore the unknown reaches of our universe. It is pleasing to note that this exploration is no longer the exclusive domain of governments and large institutions.

The purpose of this article is to share my experiences in computing the mathematical constant e to 116,000 digits of precision on an Apple II computer. Although this computation has little intrinsic value or use, the experience was stimulating and educational. The problems I was forced to overcome gave me insights that greatly contributed to new floating-point routines. These routines were, in some cases, two to three times as fast as those currently implemented in some of our languages at Apple. Because I wanted to develop my own solutions to the problem, I did not research existing techniques for computing e to great precision. Therefore, my approaches are quite possibly not state-of-the-art.

I first calculated e to 47 K bytes of precision in January 1978. The program ran for 4.5 days, and the binary result was saved on cassette tape. Because I had no way of

detecting lost-bit errors on the Apple (16 K-byte dynamic memory circuits were new items back then), a second result, matching the first, was required. Only then would I have enough confidence in the binary result to print it in decimal.

Before I could rerun the 4.5 day program successfully, other projects at Apple, principally the floppy-disk controller, forced me to deposit the project in the bottom drawer. This article, already begun, was postponed along with it. Two years later, in March 1980, I pulled the e project out of the drawer and reran it, obtaining the same results. As usual (for some of us), writing the magazine article consumed more time than that spent meeting the technical challenges.

Little Things Add Up

To compute the value of e , a method or formula must be found or derived. The *CRC Standard Mathematical Tables* handbook (see references) provides the well-known formula:

$$e = 1 + 1/1! + 1/2! + 1/3! + \dots$$

We know that e is approximately 2.71828. For the sake of simplicity, we will deal with the fractional part only (.71828, etc) and abbreviate it *efrac*.

$$efrac = 1/2! + 1/3! + 1/4! + \dots$$

Because each term is less than one-half the prior term, this series converges with the property that the sum of all terms beyond a specified n th term is less than that n th term. Thus, if the series is truncated after n terms, the maximum error in the computation is less than $(1/n!)$. This property relates the number of terms used, n , to the precision obtained in the computation. Because this series contains a factorial in the denominator of the terms, it is said to converge rapidly. This means that great precision can be obtained with relatively few terms. For example,

Just before this issue went to press, Steve Wozniak told me that he had redesigned the theoretical "e-machine" that uses dedicated hardware for calculating e . The machine, which costs under \$10,000, would use disk storage on a hard disk to replace large amounts of programmable memory. Steve estimates that a calculation of e to 100,000,000 places (ten times as many places as the current calculation of e) could be made in three months of calculation time....GW

the *CRC Standard Mathematical Tables* handbook lists $100!$ as 9.3326×10^{157} , signifying that 100 terms will yield almost 158 digits of precision. The rate of convergence is sufficient that, for the problem at hand, neither algebraic manipulation of the series for faster convergence nor selection of a different formula is necessary.

Divide and Conquer

The following algorithm accomplishes the evaluation of the series for e . Of course, all critical routines should be implemented in highly optimized machine (assembly) language for speed. An extra hour spent optimizing the innermost loops could save days of computation time. Even self-modifying code should be used to save a critical microsecond! Binary arithmetic should be used to obtain maximal precision and the fastest possible computation time. Later, the result can be converted to decimal as it is printed.

The algorithm is as follows (also see figure 1):

1. Divide available memory equally into two arrays, TERM and E. The TERM array will contain successive terms ($1/i!$) and is initialized to 0.5 ($1/2!$). The E array will contain the running total of the terms and is also initialized to 0.5 . Both arrays can be thought of as long bit streams of the fractional parts of the numbers they represent.
2. Set the variable DIVISOR to an initial value of 3.
3. Divide TERM by DIVISOR, forming $1/(DIVISOR!)$. Multiprecision division techniques will be discussed later.
4. Add TERM to E, keeping the assumed decimal points aligned. This sum will always be purely fractional (ie: it will never equal or exceed 1).
5. Increment the DIVISOR variable.
6. Repeat steps 3, 4, and 5 until TERM is reduced to all zeros or until a predetermined maximum divisor is reached.

This basic computation algorithm utilizes only 50% of available memory for the result. By rearranging the series for e , we can arrive at an approach that utilizes 100% of the memory.

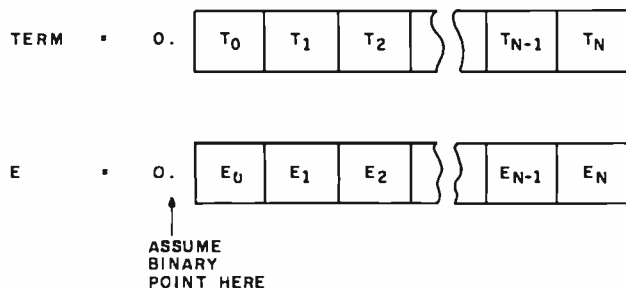

Figure 1: Memory usage in the first algorithm to calculate e . Equal amounts of memory are devoted to a sequence of bytes representing the value of the current term being calculated (TERM) and the sum of all terms calculated thus far (E). Both numbers are seen as binary fractions (ie: the leftmost bit represents $1/2$, the next bit represents $1/4$, etc).

We begin by reversing the order of terms in e frac:

$$efrac = 1/2! + 1/3! + \dots + 1/(n-1)! + 1/n! \quad (n \text{ terms})$$

$$= 1/n! + 1/(n-1)! + \dots + 1/3! + 1/2!$$

We then develop the following identity:

$$\frac{1}{i!} + \frac{1}{(i-1)!} = \frac{1}{i(i-1)!} + \frac{1}{(i-1)!}$$

$$= \frac{\frac{1}{i} + 1}{(i-1)!}$$

By repeatedly applying this identity to the formula, we get:

$$efrac = \frac{\frac{\frac{1}{n} + 1}{(n-1)} + 1}{3} + 1$$

$$\frac{2}{2}$$

On inspection, the second series is equivalent to the first for n terms. A notable property of the new series is that the computation begins with the n th (greatest) divisor and ends with 2 (the smallest). The algorithm for computing e with this series is as follows:

1. Allocate all available memory to the E array (which stores the value of e frac, the fractional part of e). Initialize it to zero.
2. Set the initial value of DIVISOR to n , the precalculated maximum term (where $n!$ is greater than the precision of the result to be computed).
3. Add 1 to E and divide by the current DIVISOR. The addition may simply imply setting the carry before dividing.
4. Decrement the DIVISOR.
5. Repeat steps 3 and 4 until the divisor equals 1.

Divisor	E (after step 3)
5	$1/5$
4	$1/4 + 1/(4 \times 5)$
3	$1/3 + 1/(3 \times 4) + 1/(3 \times 4 \times 5)$
2	$1/2 + 1/(2 \times 3) + 1/(2 \times 3 \times 4) + 1/(2 \times 3 \times 4 \times 5)$ $(1/2! + 1/3! + 1/4! + 1/5!)$

Table 1: Example of the calculation of e by the first algorithm.

An example of this algorithm for $n=5$ is given in table 1.

How Large Is It?

An associate of mine once discovered that integrated circuit layouts could be conveniently specified in nano-acres! In the computation of e , it is more meaningful to specify the precision of the result in decimal digits rather than in the number of bytes allocated. The following formula performs the conversion:

$$\log_{10}(x) = \log_{256}(x) \times \log_{10}(256)$$

$$(\text{number of digits}) = (\text{number of bytes}) \times (2.40824)$$

For example, assume that 14 K bytes of memory are allocated to the fraction of e . The number of digits of accuracy this represents is given by the following:

$$\begin{aligned} \text{number of digits} &= 14 \times 1024 \times 2.40824 \\ &= 34524.5 \text{ digits} \end{aligned}$$

The process of calculating the number of terms needed to compute e to this precision is less straightforward. What must be determined is the minimum value of n , where $n!$ is greater than the precision corresponding to available memory. For the above example, this is the minimum n such that $n!$ is greater than 10^{34524} . The *CRC Standard Mathematical Tables* handbook lists Stirling's Formula, an equation useful for calculating the

magnitude of $n!$ for reasonably large n :

$$\lim_{n \rightarrow \infty} \frac{n! \exp(n)}{n^{(n+0.5)}} = \sqrt{2\pi}$$

Taking the natural logarithms of both sides, we get:

$$\lim_{n \rightarrow \infty} \ln(n!) = \frac{\ln(2\pi)}{2} + [\ln(n)] [n+0.5] - n$$

Dividing by $\ln(10)$ to obtain the result in common (base-10) logarithms, we see the following:

$$\lim_{n \rightarrow \infty} \log_{10}(n!) = \frac{\log_{10}(2\pi)}{2} + [\log_{10}(n)] [n+0.5] - \frac{n}{\ln(10)}$$

The integer portion of this result gives us one less than the number of digits in $(n!)$.

The HP-41C calculator program in listing 1 calculates $\log_{10}(n!)$ (the number of digits in $n!$), given n .

By trial and error, it is easy to zero in on the minimum n for which $\log_{10}(n!)$ is greater than 34,524, the number of digits of precision corresponding to 14 K bytes of memory. Table 2 shows a set of values for n in the order in which they were calculated to find the desired value.

The value 9716 is found to be the minimum suitable value of n . Because it is difficult to relate the precision of $n!$ to that of $1/n!$, a slightly higher value (perhaps 9720) should be used for n . This will also compensate for minor formula or calculation errors.

A Multiprecision Division Algorithm

The problem at hand calls for the division of a very large dividend (possibly several kilobytes) by a moderate divisor (2 bytes). The general approach is to shift the divisor relative to the dividend, from the most significant bits toward the least, performing the familiar subtract/replace and shift technique that we call long division.

A few general optimizations should be considered. First, the following algorithm assumes that the divisor is less than 32,768 (2^{15}). If the divisor were to exceed 32,768, it would have to be compared to a value that could exceed 16 bits (2 bytes). Because indexed operations on the 6502 microprocessor are slower than absolute, direct, zero-page, or register operations, a few "fast" memory locations are allocated to hold the temporary (ie: relating to the current byte) dividend/quotient, and remainder. These locations are designated A0 (dividend/quotient), and A1 and A2 (2-byte remainder), and they should be allocated to the most accessible memory locations (or registers). The high-order byte of

Listing 1: *The FACTLOG program for the Hewlett-Packard HP-41C calculator. This program calculates the approximate number of digits in the number (n!).*

```
LBL ALPHA FACTLOG ALPHA ENTER LOG LASTX .5 + *
x <> y LN / -
PI ENTER + LOG 2 / + RTN
```

OVER 8 MBytes OF SOFTWARE AT \$8* PER DISKETTE FULL

The exchange library of The CP/M® Users Group has nearly 50 volumes of software available. Everything from editors, assemblers, languages, games, tools and more—and almost everything in full source code.

Send \$6** for full library catalog.

THE CP/M USERS GROUP

1651 Third Avenue, New York, N.Y. 10028.

*Domestic price. Inquire for overseas price.

**The complete catalog of CPMUG is available for \$6 prepaid to the U.S., Canada and Mexico. \$11 prepaid to all other countries.

© CP/M is a registered trademark of Digital Research. The CP/M Users Group is not affiliated with Digital Research.

the fraction array E is assumed to be E(0), and the low-order byte is E(n). Remember that the 2-byte divisor, NH and NL, represents a whole number, and that the dividend represents a binary fraction with the binary point directly to the left of the MSB (most significant bit) of E(0).

In the algorithm that follows, the A0 byte represents the current byte, E(i), of the dividend at step 2. By step 6, however, all the digits of the dividend have been shifted out to the left (to the A1, A2 combination), and the digits of the new quotient have been shifted into A0 from the right. A0 is actually doing the work of two 8-bit registers.

Of course, all computation should be done in binary for maximum precision and speed. While targeted for 8-bit machines, these techniques are applicable to machines of longer word lengths.

The "add 1 and divide by n" algorithm (see figure 2) is as follows:

1. Initialize the remainder (locations A2 and A1) to 1, effectively adding 1.0 to the fractional dividend prior to dividing. (A2 is the most significant byte of the remainder.) This accommodates the algorithm developed for calculating *e*. An unmodified divide operation would call for initializing the remainder to zero. Initialize the index, *i*, to zero.
2. Move the next dividend byte, E(*i*), to location A0 to divide it by *n*. Shift A0 left 1 bit, moving the MSB into the carry bit.
3. Rotate the 16-bit remainder (A2 and A1) to the left by 1 bit, and rotate the carry bit from A0 into the LSB (least significant bit) of A1. This corresponds to the "shift" portion of the subtract-and-shift algorithm for division. No overflow can occur from this shift because the residual remainder must be less than twice the divisor, which in turn is less than $32,768 (2^{15})$.

n	log ₁₀ (n!) (number of digits in n!)
10000	35659.5
9000	31681.9
9700	34461.4
9800	34860.3
9730	34581.0
9720	34541.2
9710	34501.3
9715	34521.2
9716	34525.2

Table 2: Trial-and-error determination of the number of terms, *n*, needed to obtain 34,524 digits of precision in the calculation of *e*. In the algorithm used to calculate *e*, the smallest contribution to the final value is made by the term (1/*n*!). The number of digits in (*n*!) is determined by estimating the value of *n*! and taking the logarithm to the base 10. The desired value of *n* is the first integer value greater than 34,524.

4. Compare the remainder, A2 and A1, to the divisor locations NH and NL. If the remainder is greater, then replace it with the difference of the two and set the quotient bit to 1. Otherwise, clear the quotient bit.
5. Rotate the quotient bit into the LSB of A0, and rotate the MSB of A0 into the carry bit.
6. Perform steps 3, 4, and 5, a total of eight times. Then replace E(*i*) with the byte in A0 (which is now the quotient of the byte-wide division just finished). Increment the index, *i*, and continue at step 2 until the last byte, E(*n*), has been processed.

Special Optimizations

I drive a small car and have found that it is helpful to accelerate or decelerate slightly in advance of certain stretches of the road (especially hills and downgrades) to obtain an adequate performance. Similarly, it is

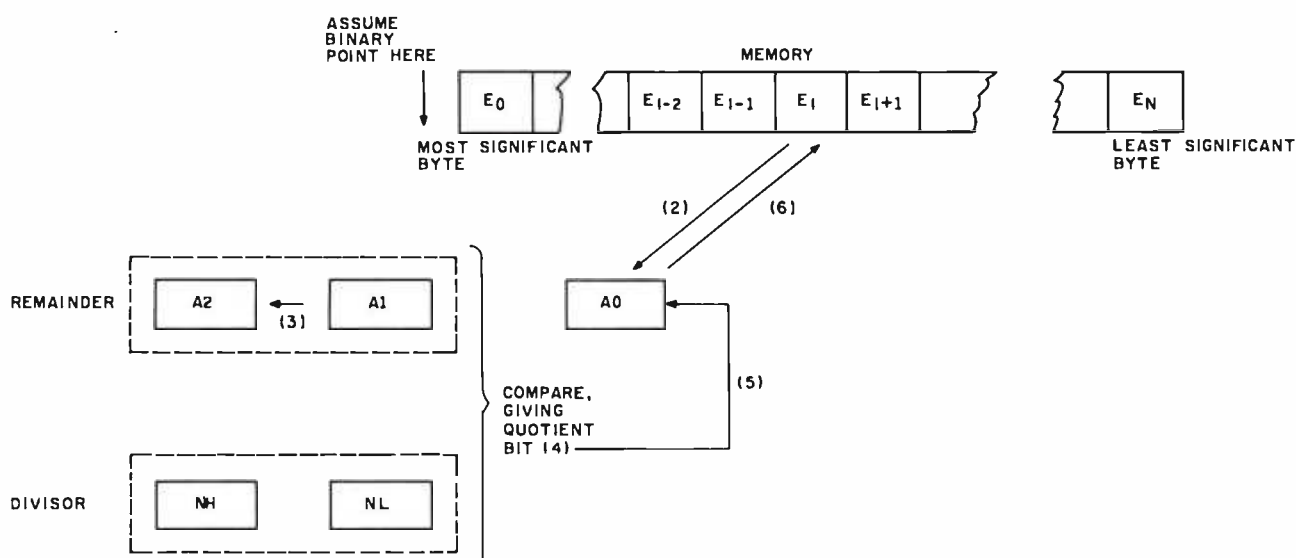

Figure 2: Memory usage in the multiple-byte "add 1 and divide by n" division algorithm. The second algorithm (given in the text) reduces memory usage by 50% by using one long string of bytes in the computation process. The E array is divided 1 byte at a time by the 2-byte divisor. The A0 byte is used to store both the dividend and the quotient at different points in the algorithm. The numbers in parentheses refer to numbered steps in the algorithm.



A Message to our Subscribers

From time to time we make the BYTE subscriber list available to other companies who wish to send our subscribers promotional material about their products. We take great care to screen these companies, choosing only those who are reputable, and whose products, services, or information we feel would be of interest to you. Direct mail is an efficient medium for presenting the latest personal computer goods and services to our subscribers.

Many BYTE subscribers appreciate this controlled use of our mailing list, and look forward to finding

information of interest to them in the mail. Used are our subscribers' names and addresses only (no other information we may have is ever given).

While we believe the distribution of this information is of benefit to our subscribers, we firmly respect the wishes of any subscriber who does not want to receive such promotional literature. Should you wish to restrict the use of your name, simply send your request to BYTE Publications Inc, Attn: Circulation Department, 70 Main St, Peterborough NH 03458. Thank you.

sometimes necessary to compensate for the inherent deficiencies of microprocessors (eg: their size) by carefully implementing specific optimizations. For example, the comparison performed in step 4 (discussed above) would normally be done by subtracting the low, and then high bytes, and possibly preserving the difference for replacement of the remainder. Within certain processors, it may be faster to first compare the high bytes, since they frequently dictate the comparison result (255 out of 256 times for arbitrary contents). Also, the critical steps 3, 4, and 5 can be coded eight times in-line to avoid the overhead time of a loop. And because the divisor changes infrequently, it can be coded as fast immediate-mode data. After each full divide, the code, which resides in programmable memory, can be modified for the next divisor.

The 6502 assembly-language program in listing 2 calculates e in 14 K bytes of memory. In order to keep the listing brief for this article, the program is not fully optimized. The major operation (add 1, divide) is not coded in-line eight times but is instead implemented as a loop. Because the Y register is used as a loop counter, it is not available as an index to the e array, and time-consuming increment instructions must be performed on the instructions at EREF1 and EREF2. Also, it is slightly faster not to move the current dividend byte of e into a separate fast location (A0 in the algorithm).

The e array begins at hexadecimal location 800 (which is the most significant byte of the array). This secondary text-screen page of the Apple II allows you to view roughly the first 1 K bytes of e as they are calculated. Although the character representation is not readily useful, it is at least comforting to observe that the program is working on the correct section of memory. Do not execute this program until you read further and have a good idea of how long it runs before completion. Also, remember that although the result is in binary and somewhat meaningless, it will later be converted to decimal and printed.

Tomorrow Is a Long Time

The execution time of this program is proportional to the number of divisions performed (9719 for the above example), the number of bytes being divided (14 K bytes in this case), and the average divide time per byte.

The average divide time per byte is calculated as follows. In listing 2, the numbers in parentheses are the cycle times of all significant instructions of the divide routine. Careful analysis shows that when the high-order dividend (remainder) byte is less than the high-order divisor byte, 23 cycles are used. When the former is greater than or equal to the latter, 39 cycles are used, with approximately 13.5 additional cycles (on the average) if the two are equal. Statistically, the remainder will be less than the divisor half of the time and greater than or equal to the divisor half of the time. Analysis reveals that the 2 bytes will be equal approximately one out of every $2H$ comparisons, where H is the high-order divisor

To further improve service to our customers we have installed a toll-free

WATS line in our Peterborough, New Hampshire office.

If you would like to order a subscription to BYTE, or if you have a question related to a BYTE subscription, you are invited to call*

(800)258-5485

between 8:00 AM and 4:30 PM Eastern Time. (Friday 8 AM - Noon).

*Calls from continental U.S. only.

9178

**BYTE's
Toll-free
Subscriber
W.A.T.S. Line**

(800) 258-5485

We thank you and look forward to serving you.

byte contents. In the example, H varies from 37 down to 0, so the average frequency of equality is 1 in 37. Using this "Judge factor," the average cycle time per 1-bit partial division is computed as follows:

$$\begin{aligned} \text{cycles per bit} &= 2^{1/2} + 2^{2/2} + 2^{3/2} \\ &= 31.3649 \text{ cycles} \end{aligned}$$

Every byte divided includes eight of the above itera-

tions plus an overhead of 21 cycles, giving the following average:

$$\begin{aligned} \text{cycles per byte} &= (\text{cycles per bit} \times 8 \text{ bits per byte}) \\ &\quad + 21 \\ &= 31.3649 \times 8 + 21 \\ &= 271.919 \text{ cycles} \end{aligned}$$

The average time per cycle on the Apple II is a function of the crystal frequency (14.31818 MHz) and the fre-

Text continued on page 399

Listing 2: A 6502 machine-language program for calculating e to 34,524 decimal digits. The result is in binary and must be converted to decimal by the programs shown in listings 3 and 4.

```
SOURCE FILE: BCALC1
0000:          1          LSTON
0000:          2          *****
0000:          3          *
0000:          4          *   CALCULATION OF E -- 14K   *
0000:          5          *
0000:          6          *   WOZ           20-APR-80   *
0000:          7          *
0000:          8          *   EXAMPLE PROGRAM   *
0000:          9          *
0000:         10          *****
0000:         11          *
0000:         12          * LOCATIONS $800-3FFF ARE USED *
0000:         13          * FOR THE (BINARY) FRACTION OF *
0000:         14          * E. LOCATION $800 IS THE MOST *
0000:         15          * SIGNIFICANT BYTE, $3FFF IS *
0000:         16          * THE LEAST SIGNIFICANT. THIS *
0000:         17          * CORRESPONDS TO APPROXIMATELY *
0000:         18          * 34524 DIGITS. *
0000:         19          *
0000:         20          *****
0000:         21          *
0000:         22          * THE FIRST DIVISOR IS 9720 *
0000:         23          * AND THE LAST IS 2. 9720 *
0000:         24          * FACTORIAL IS GREATER THAN *
0000:         25          * 10 ^ 34524. *
0000:         26          *
0000:         27          *****
0000:         28          *
0000:         29          * THE MAJOR OPERATION, IS AN *
0000:         30          * INCREMENT (+1) OF E FOLLOWED *
0000:         31          * BY A MULTI-PRECISION DIVIDE *
0000:         32          * BY THE CURRENT DIVISOR. *
0000:         33          * EACH SUCCESSIVELY LESS SIG- *
0000:         34          * NIFICANT BYTE OF E, TOGETHER *
0000:         35          * WITH THE RESIDUAL REMAINDER *
0000:         36          * A1 AND A2, IS DIVIDED BY THE *
0000:         37          * CURRENT 2-BYTE DIVISOR. THE *
0000:         38          * 8-BIT QUOTIENT IS LEFT IN E *
0000:         39          * AND THE RESIDUAL REMAINDER *
0000:         40          * IN A1 AND A2 (ACC HOLDS A2). *
0000:         41          *
0000:         42          *****
0000:         43          A1      EQU 0          (CURRENT BYTE OF E IS A0, ACC IS A2)
0000:         44          PCOUNT EQU 1      COUNTS RAM PAGES OF E ARRAY.
```

Listing 2 continued on page 398

Listing 2 continued-

0800:	45 E	EQU	\$800	E, BINARY FRACTION, TO \$3FFF.
0038:	46 NUMPAG	EQU	\$38	14K IS 56 RAM PAGES.
25F8:	47 N	EQU	9720	(N FACTORIAL IS > 34524 DIGITS)
25F8:	48 NL	EQU	N&\$FF	LO BYTE OF N.
0025:	49 NH	EQU	N/256	HI BYTE OF N.

```

----- NEXT OBJECT FILE NAME IS ECALC1.OBJO
0240:      51      ORG      $240
0240:A9 38      52 NXTDVR LDA #NMPAG  INIT RAM PAGE COUNTER
0242:85 01      53      STA PCOUNT  FOR 56 PAGES.
0244:A9 01      54      LDA #1
0246:85 00      55      STA A1      INIT RESIDUAL REMAINDER TO 1. (FOR +1)
0248:A9 08      56      LDA #E/256
024A:8D 5C 02   57      STA EREF1+2  MODIFY CODE SO THAT REFS
024D:8D 78 02   58      STA EREF2+2  TO E POINT TO FIRST BYTE.
0250:A9 00      59      LDA #0      (ACC IS ALSO A2 OF RESIDUAL REMAINDER)
0252:8D 5B 02   60      STA EREF1+1
0255:8D 77 02   61      STA EREF2+1
0258:A0 08      62 NXTBYTE LDY #8      (2) COUNTER--8 BITS PER BYTE.
025A:0E 00 08   63 EREF1  ASL E      (6) MSB OF DIVIDEND BYTE TO CARRY.
025D:26 00      64 NXTBIT  ROL A1     (5) SHIFT 3-BYTE DIVIDEND.
025F:2A         65      ROL A      (2) (ACC IS A2)
0260:C9 25      66 NHREF1  CMP #NH     (2) IF HI BYTE LESS THAN DIVISOR
0262:90 12      67      BCC EREF2     (3/2) THEN QUOTIENT BIT IS 0.
0264:D0 06      68      BNE REPLACE  (3/2) (TAKEN IF GREATER)
0266:A6 00      69      LDX A1     (3) COMPARE LOW BYTES IF HI BYTES EQUAL.
0268:E0 F8      70 NLREF1  CPX #NL     (2)
026A:90 0A      71      BCC EREF2     (3/2) IF LESS, QUOTIENT BIT IS 0.
026C:AA         72 REPLACE TAX      (2)
026D:A5 00      73      LDA A1     (3) REPLACE RESIDUAL REMAINDER A1 AND A2
026F:E9 F8      74 NLREF2  SBC #NL     (2) WITH RESIDUAL REMAINDER
0271:85 00      75      STA A1     (3) MINUS CURRENT DIVISOR.
0273:8A         76      TXA      (2) (HI BYTE OF RESIDUAL REMAINDER)
0274:E9 25      77 NHREF2  SBC #NH     (2) (GUARANTEED TO SET CARRY)
0276:2E 00 08   78 EREF2  ROL E      (6) QUOTIENT BIT INTO A0 LSB, MSB TO CARRY.
0279:88         79      DEY      (2) NEXT OF 8 BITS.
027A:D0 E1      80      BNE NXTBIT  (3/2) LOOP--NOTE: CARRY = QUOTIENT BIT.
027C:EE 5B 02   81      INC EREF1+1  (5)
027F:EE 77 02   82      INC EREF2+1  (5) MODIFY CODE REFS TO E ARRAY.
0282:D0 D4      83      BNE NXTBYTE  (3) (NO BYTE OVERFLOW)
0284:EE 5C 02   84      INC EREF1+2
0287:EE 78 02   85      INC EREF2+2  (MODIFY HI BYTE)
028A:C6 01      86      DEC PCOUNT
028C:D0 CA      87      BNE NXTBYTE  LOOP UNTIL DONE 56 RAM PAGES.
028E:AD 69 02   88      LDA NLREF1+1
0291:D0 06      89      BNE NXTDVR2
0293:CE 61 02   90      DEC NHREF1+1  DECR IMMEDIATE REFS TO
0296:CE 75 02   91      DEC NHREF2+1  CURRENT DIVISOR.
0299:CE 69 02   92 NXTDVR2 DEC NLREF1+1
029C:CE 70 02   93      DEC NLREF2+1
029F:AD 69 02   94      LDA NLREF1+1
02A2:4A         95      LSR A
02A3:0D 61 02   96      ORA NHREF1+1  LOOP IF DIVISOR > 1.
02A6:D0 98      97      BNE NXTDVR
02A8:60         98      RTS      (DONE)

```

*** SUCCESSFUL ASSEMBLY: NO ERRORS

Text continued from page 397:

quency-dividing circuitry that generates the microprocessor clock. Due to color-graphics considerations, a slight adjustment (to eliminate display jitter) is made, which introduces a constant multiplying the crystal period, and gives us the following time per machine cycle:

$$\begin{aligned}\text{time per cycle} &= 912 / ((65)(14.31818 \text{ MHz})) \\ &= 0.9799269 \mu\text{s}\end{aligned}$$

The division time per byte (in μs) and time per program execution can now be calculated:

$$\begin{aligned}\text{time per byte} &= \text{cycles per byte} \times \text{time per cycle} \\ &= 271.919 \text{ cycles} \times .9799269 \mu\text{s} \\ &\quad \text{per cycle} \\ &= 266.46 \mu\text{s} \\ \text{time per program} &= \text{time per byte} \times \text{number of} \\ &\quad \text{bytes} \times \text{number of divisions} \\ &= 266.46 \mu\text{s} \times (14)(1024) \times 9719 \\ &= 37.126 \text{ seconds} \\ &= 10.3 \text{ hours}\end{aligned}$$

Note that as you compute e to greater precision, both the number of divisors and the length of each division increase. Also, at some point, a 2-byte division no longer suffices and a 3-byte division must be used. This causes the execution time to vary with roughly the second power of the precision sought. For example, three times the precision takes ten times as long to calculate!

Running the Example Program

If you wish to try the example program before branching out on your own, a few suggestions should be heeded. First, it is a shame to run a program for 10 hours and then find out it contained a minor bug. By changing N (the maximum divisor) to 1000 and NUMPAG to 4 (for 1 K bytes of precision), a quick trial/practice version can be assembled. The practice run allows the user to get the obvious mistakes out of the way with minimum consequence and verify that the assembly is correct. The following commands will clear the memory locations used, run the program, and finish in about 4.5 minutes (273 seconds). Hexadecimal location 0800 should contain B7, and location 0BFF should contain 24 upon completion. As mentioned previously, you can watch the calculation proceed by displaying the secondary text screen on the Apple II. During the trial run, it should be constantly changing.

The following two lines (to be entered when the Apple II is in monitor mode) allow you to run the test program:

```
"800:0 N801 < 800.BFEM
"C055 240C C054
```

The first line clears the area of memory that will be used, and the second line switches the video display to text

page 2 (which will contain the value of e being computed), runs the program of listing 2, then returns to text page 1 when the program is complete.

The real (10-hour) example program should be run twice, and the results compared to verify that the program does not contain a minor bug and that the constants were properly determined. As discussed below, it is not necessary to initialize memory before running the program if the constant n has been properly selected. Therefore, it is recommended that the program be run first with initialized memory and later with random (uninitialized) memory. These results, when compared, should be identical. Once you have confidence in the binary result, save it on tape or floppy disk for printing in decimal.

Go Forth and Multiply

The computed binary fraction must next be converted to decimal and printed. The general method of converting a binary fraction to a decimal fraction is to repeatedly multiply it by decimal 10 (in binary). The carry from each multiplication (integer portion of product) is the next decimal digit. Because the most significant digits are generated first, the result can be printed as it is generated.

A higher-level language such as BASIC should be used to format the output, but unless you are planning a short vacation, highly optimized machine language should be used for the base conversion. The 6502 programs in listing 3 accomplish the conversion. Subroutine INIT is called once to generate a 256-entry, multiply-by-100 lookup table. Subroutine MULT scans the e array, from the least toward the most significant bytes, multiplying each byte by 100 via a fast table lookup. It also handles carries. The resultant carry is a 2-digit number between 0 and 99 that is returned to BASIC for printing. Note that multiplying by 100, instead of 10, generates 2 digits per pass.

Seeing Is Believing

The BASIC formatting program in listing 4 should produce an attractive printout. No single program will suffice, due to the fact that printers and people are so varied. The considerations include page headers (title, date, page number), lines per page, spacing between lines, digits per line, digit groupings (eg: groups separated by a space or two), and margins. For example, the poor horizontal registration of a Centronics 779 printer is painfully obvious with single-spaced printouts but almost undetectable with double-spaced ones. A little trial and error will insure that your printout is a perfect "10."

The program in listing 4 was used with an NEC (Nippon Electric Company) Spinwriter. It prints 60 digits per line (twelve groups of 5 digits, separated by single blanks) and 60 lines per page. The page heading is simply the letter e and the page number, carefully aligned with the left and right margins. The text " $e = 2.$ " precedes the first digit of the printout. The program ends after printing 34,500 digits, despite the fact that an additional 24 digits are re-

Text continued on page 402

THE FASTEST, MOST POWERFUL HIGH-LEVEL LANGUAGE SYSTEM FOR THE APPLE

Developed from an extended version of FORTH, microSPEED combines the benefits of compiled code and hardware arithmetic processing for maximum microcomputing performance

COMPLETE SYSTEM \$495.00
USER'S MANUAL ONLY 35.00

INFORMATION HOT LINE (301) 627-6650

applied analytics incorporated

5406 Roblee Dr. Upper Marlboro, Md. 20870

- * Runs six to sixty times faster than Basic
- * Programming capabilities well beyond Applesoft
- * Auxiliary Processor [AM9511] for fast Floating Point
- * High-speed, extended high resolution graphics
- * Software development time cut in half
- * Exceptionally compact, compiled code
- * Extensible, structured language to meet your needs
- * Requires 48K Apple II or II+, single Disk

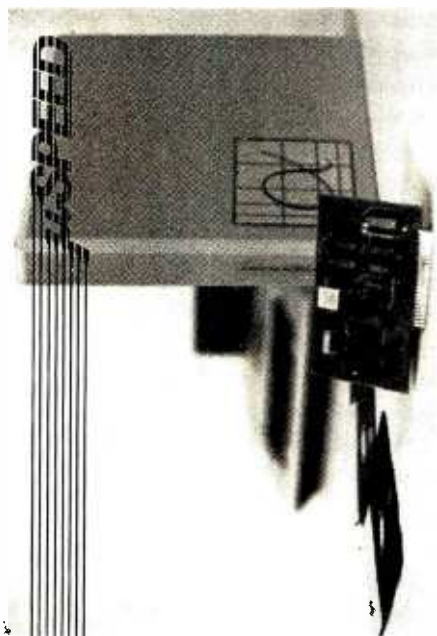

Listing 3: A BASIC driver program to print e from binary to decimal form. The program uses the machine-language program EPRNT, shown in listing 4.

```

SOURCE FILE: EPRNT
0000:      1 *****
0000:      2 *
0000:      3 *      'E' PRINTOUT ROUTINES      *
0000:      4 *
0000:      5 *      14K VERSION                *
0000:      6 *
0000:      7 *      WOZ          20-APR-80      *
0000:      8 *
0000:      9 *****
0000:     10 *
0000:     11 * THESE SUBROUTINES PERFORM      *
0000:     12 * THE CRITICAL OPERATIONS      *
0000:     13 * FOR CONVERTING THE 14K        *
0000:     14 * BINARY VERSION OF 'E'      *
0000:     15 * TO DECIMAL FOR PRINTING.    *
0000:     16 * THEY ARE INTENDED TO BE      *
0000:     17 * CALLED FROM A BASIC PROGRAM  *
0000:     18 * WHICH DOES THE ACTUAL        *
0000:     19 * PRINTING.                    *
0000:     20 *
0000:     21 *****
0000:     22 *
0000:     23 * THE BINARY REPRESENTATION      *
0000:     24 * OF THE FRACTIONAL PART OF    *
0000:     25 * E (OR ANY OTHER NUMBER      *
0000:     26 * TO BE CONVERTED TO DECIMAL) *
0000:     27 * IS STORED IN LOCATIONS $800  *
0000:     28 * (MOST SIGNIFICANT) TO $3FFF  *
0000:     29 * (LEAST). THE SUBROUTINES      *
0000:     30 * INIT AND MULT RESIDE IN THE    *
0000:     31 * $4000 PAGE OF MEMORY AND     *
0000:     32 * USE TABLES PRODLO AND        *
0000:     33 * PRODHI IN THE $4100 AND        *
0000:     34 * $4200 PAGES RESPECTIVELY.   *
0000:     35 * LOMEM MUST BE SET TO $4300  *
0000:     36 * (17152 DECIMAL) OR GREATER   *
0000:     37 * FROM BASIC.                  *
0000:     38 *
0000:     39 *****
0000:     40 *
0000:     41 * SUBROUTINE INIT MUST BE        *
0000:     42 * CALLED ONCE TO GENERATE        *
0000:     43 * 'MULTIPLY BY 100' TABLES      *
0000:     44 * PRODLO AND PRODHI. INIT      *
0000:     45 * MUST BE CALLED BEFORE MULT.   *
0000:     46 *
0000:     47 * SUBROUTINE MULT PERFORMS      *
0000:     48 * A 'MULTIPLY BY 100' ON THE    *
0000:     49 * NUMBER 'E'. IT RETURNS        *
0000:     50 * THE NEXT TWO DIGITS OF THE     *
0000:     51 * DECIMAL EQUIVALENT AS A

```

```

0000:      52 * NUMBER BETWEEN 0 AND 99 IN *
0000:      53 * LOCATION 1 (WHERE BASIC *
0000:      54 * CAN PEEK IT FOR PRINTING). *
0000:      55 * *
0000:      56 *****

0000:      58 XSAV EQU 0 X-REG SAVE LOCATION.
0001:      59 RESULT EQU 1 RESULT BYTE FROM MULTIPLY.
0002:      60 PCOUNT EQU 2 COUNTS NUMBER OF RAM PAGES OF E.
4100:      61 PRODLO EQU $4100 LOW BYTE TABLE (100 * IDX).
4200:      62 PRODHI EQU $4200 HI BYTE TABLE (100 * IDX).
0800:      63 E EQU $800 E, BINARY FRACTION, TO $3FFF.
0038:      64 NUMPAG EQU 56 56 PAGES IN 14K
003F:      65 LASTPAG EQU $3F LAST (LEAST SIGNIFICANT) PAGE OF E.
0000:      66 *
0000:      67 *****
0000:      68 *

----- NEXT OBJECT FILE NAME IS EPRNT.OBJO
4000:      69 ORG $4000
4000:86 00 70 INIT STX XSAV PRESERVE X-REG FOR INT BASIC.
4002:A9 00 71 LDA #0 STARTING PRODUCT LO BYTE.
4004:AA 72 TAX STARTING PRODUCT HI BYTE.
4005:A8 73 TAY STARTING INDEX TO PRODUCT TABLES.
4006:99 00 41 74 PRODCEN STA PRODLO,Y STORE LOW BYTE OF 100 * Y.
4009:48 75 PHA PRESERVE A-REG
400A:8A 76 TXA HI BYTE OF CURRENT PRODUCT.
400B:99 00 42 77 STA PRODHI,Y STORE HI BYTE OF 100 * Y.
400E:68 78 PLA RESTORE A-REG (PRODUCT LOW BYTE).
400F:18 79 CLC
4010:69 64 80 ADC #100 ADD 100 FOR NEXT PRODUCT.
4012:90 01 81 BCC NXTPROD
4014:E8 82 INX
4015:C8 83 NXTPROD INY NEXT OF 256 PRODUCTS.
4016:D0 EE 84 BNE PRODCEN
4018:A6 00 85 LDX XSAV RESTORE X-REG FOR INT BASIC.
401A:60 86 RTS (RETURN)
401B: 87 *
401B: 88 *****
401B: 89 *
401B:A9 38 90 MULT LDA #NUMPAG
401D:85 02 91 STA PCOUNT 56 PAGES IN 14K.
401F:A9 3F 92 LDA #LASTPAG
4021:8D 32 40 93 STA MULT1+2 INIT E REFS FOR LEAST
4024:8D 38 40 94 STA MULT2+2 SIGNIFICANT RAM PAGE.
4027:A0 00 95 LDY #0 INIT INDEX TO E (WILL DECR TO $FF FIRST TIME)
4029:A2 00 96 LDX #0 TRICK TO CLEAR RESIDUAL CARRY.
402B:18 97 CLC
402C:BD 00 42 98 MULBYT LDA PRODHI,X (4) HI PROD BYTE IS RESIDUAL CARRY.
402F:88 99 DEY (2) NEXT MORE SIGNIFICANT BYTE OF E.
4030:BE 00 08 100 MULT1 LDX E,Y (4) (GET IT)
4033:7D 00 41 101 ADC PRODLO,X (4) TIMES 100, PLUS RESIDUAL CARRY.
4036:99 00 08 102 MULT2 STA E,Y (5) RESTORE PRODUCT BYTE.
4039:98 103 TYA (2) LAST BYTE THIS PAGE?
403A:D0 F0 104 BNE MULBYT (3/2) NO, CONTINUE.
403C:CE 32 40 105 DEC MULT1+2 (6)

```

Listing 3 continued:

```
403F:CE 38 40 106      DEC  MULT2+2    (6) NEXT MORE SIGNIFICANT PAGE.
4042:C6 02 107      DEC  PCOUNT     (5) DONE 56 PAGES?
4044:DO E6 108      BNE  MULBYT    (3) NO, CONTINUE.
4046:7D 00 42 109    ADC  PRODHI,X  RETRIEVE FINAL CARRY.
4049:85 01 110      STA  RESULT    SAVE AS TWO-DIGIT RETURNED VALUE.
404B:A6 00 111      LDX  XSAV      RESTORE X-REG FOR INT BASIC.
404D:60 112      RTS           (RETURN)
```

*** SUCCESSFUL ASSEMBLY: NO ERRORS

Listing 4: EPRNT, a machine-language program that converts a binary number for printing as a decimal number.

FORMATTER PROGRAM - APPLE INTEGER BASIC

FILE E1 IS 'E' FROM \$800 TO \$3FFF

FILE EPRNT.OBJO IS INIT AND MULT SUBRS

CAUTION: MUST SET LOMEM TO 17152!

```
10 D$="": PRINT D$;"NOMON C,I,0": PRINT D$;"BLOAD E1,A$800": PRINT D$;
   "BLOAD EPRNT.OBJO,A$4000": PRINT D$;"PR#2"
20 INIT=16384;MULT=16411: CALL INIT:ODDEVEN=0
30 FOR PAGE=1 TO 10: PRINT : PRINT "      E";: FOR I=1 TO 63: PRINT " "
   ;: NEXT I: PRINT "PAGE ";PAGE/10;PAGE MOD 10: PRINT
40 FOR LINE=1 TO 60: IF PAGE>1 OR LINE>1 THEN 50: PRINT " E=2.";: GOTO
   60
50 PRINT "      ";
60 FOR GROUP=1 TO 12
70 FOR DIG=1 TO 5: GOSUB 200: NEXT DIG
80 PRINT " ";: NEXT GROUP
90 PRINT : IF PAGE=10 AND LINE=35 THEN 110: NEXT LINE: REM QUIT AFTER 34500
   DIGITS
100 PRINT : PRINT : PRINT : NEXT PAGE
110 PRINT D$;"PR#0": END : REM TURN PRINTER OFF
190 REM
192 REM SUBROUTINE 200 PRINTS NEXT DIG
194 REM
200 IF ODDEVEN=1 THEN 220: CALL MULT
210 PRINT PEEK (1)/10;: GOTO 230
220 PRINT PEEK (1) MOD 10;
230 ODDEVEN=1-ODDEVEN: RETURN
```

Text continued from page 399:

quired in order to be correct. The final page and line number were precalculated to detect this stopping point. Lines 200 thru 230 make up a digit-printing subroutine that calls the assembly-language multiply-by-100 routine (MULT) every other digit.

Analysis of the Algorithm

The specified algorithm has the property that the contents of e at a given stage of computation will yet be divided by $(i!)$, where i is the current divisor. The first im-

plication of this property is that the allocated memory need not be initialized, since it will all be reduced to insignificance when divided by $n!$ (because n , the starting divisor, was specifically chosen such that $n!$ is greater than the significance corresponding to that much memory).

An interesting aspect of this implication is that the result is perfect to the last calculated bit, despite the fact that terms beyond the n th have been omitted. Additional terms (before the n th) would simply cause the allocated

IF YOU NEED \$5,000...20,000 EVEN UP TO 500,000 TO START A NEW BUSINESS OR TO EXPAND AN EXISTING FIRM—THEN READ WHY YOU TOO WILL CALL THIS INCREDIBLE MONEY RAISING MANUAL

“THE SMALL BUSINESS BORROWER’S BIBLE”

Practically prepares the loan application for you line-by-line...the “proper” way.
All properly prepared applications are processed faster...no red tape!
Guaranteed Loans...Direct Loans...and Immediate Loans are available now!

Most men and women seriously interested in starting their own business are eligible to apply — including those who already own a business and need capital fast for expansion...or to stay afloat...even if they've been flatly refused by banks and turned down elsewhere! Yet, too, many never qualify, simply because they do not know how to “properly” prepare the loan application...

In order to help those people applying for these guaranteed and direct loans fill out their loan applications the “right way,” ICC Business Research, through its diligent compilation and research efforts, has successfully assembled and published a comprehensive, easy-to-follow seminar manual: *The Money Raiser's Guaranteed and Direct Loans Manual*, that will quickly show you practically everything you'll need to know to prepare a loan application to get federally Guaranteed and Direct Loans.

Here are just some of the many important benefits the Money Raiser's Guaranteed and Direct Loans Manual provides you with:

- a completely filled in sample set of actual SBA loan application forms, all properly filled in for you to easily follow—aid's you in quickly preparing your own loan application the right way. Each line on the sample application forms is explained and illustrated in easy-to-understand language.

- fast application preparation procedures for getting loans for both new start up business ventures and established firms.
- advises you on how to properly answer key questions necessary for loan approval and in order to help avoid having your application turned down—gives you advice on what you should not do under any circumstances.
- what simple steps you take to guarantee eligibility—no matter if you do not presently qualify.
- where you can file your application for fastest processing.

At this point the most important question you want answered is: Just where is all this loan money coming from? Incredible as it may sound—these Guaranteed Loans, Direct Loans, and Immediate Loans are indeed available right now — from the best, and yet, the most overlooked and frequently the most ignored and sometimes outright ridiculed...“made-fun-of” source of ready money...fast capital, in America — THE UNITED STATES GOVERNMENT.

Of course, there are those who upon hearing the words “UNITED STATES GOVERNMENT” will instantly freeze up and frown and say:

“...only minorities can get small business loan money from the government!”

Yet, on the other hand (and most puzzling) others will rant on and on and on that:

“...don't even try, it's just impossible — all those Business Loans Programs are strictly for the Chryslers, the Lockheeds, the big corporations...not for the little guy or small companies.” etc.

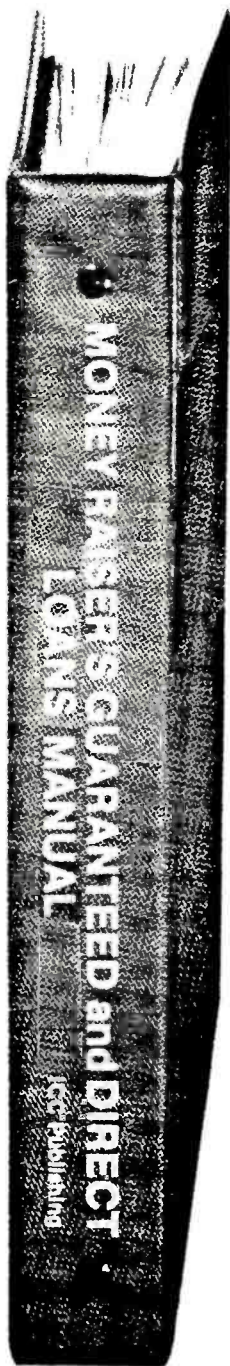

Still there are those who declare:

“...I need money right now...and small business government loans take too darn long. It's impossible to qualify. No one ever gets one of those loans.”

Or you may hear these comments:

“...My accountant's junior assistant says he thinks it might be a waste of my time!” “Heck, there's too much worrisome paperwork and red tape to wade through!”

Frankly — such rantings and ravings are just a lot of “bull” without any real basis — and only serve to clearly show that lack of knowledge...misinformation...and and not quite fully understanding the UNITED STATES GOVERNMENT'S Small Business Administration's (SBA) Programs have unfortunately caused a lot of people to ignore what is without a doubt — not only the most important and generous source of financing for new business start ups and existing business expansions in this country — but of the entire world!

Now that you've heard the “bull” about the United States Government's SBA Loan Program — take a few more moments and read the following facts:

- Only 9.6% of approved loans were actually made to minorities last year
- What SBA recognizes as a “small business” actually applies to 97% of all the companies in the nation
- Red tape comes about only when the loan application is sent back due to applicant not providing the requested information...or providing the wrong information
- The SBA is required by Congress to provide a minimum dollar amount in business loans each fiscal year in order to lawfully comply with strict quotas. (Almost 5 billion this year)

Yet, despite the millions who miss out — there are still literally thousands of ambitious men and women nationwide who are properly applying — being approved — and obtaining sufficient funds to either start a new business, a franchise, or buy out or expand an existing one. Mostly, they are all just typical Americans with no fancy titles, who used essentially the same effective know-how to fill out their applications that you'll find in the Money Raiser's Guaranteed and Direct Loans Manual.

So don't you dare be shy about applying for and accepting these guaranteed and direct government loans. Curiously enough, the government is actually very much

GUARANTEE #1
Simply — look over this most effective money raising loan preparation assistance manual for 15 days — and, then, if you are not convinced that it can actually help you obtain the Business Loan you need right away — just return it for a full and prompt refund.

interested in helping you start a business that will make a lot of money. It's to their advantage — the more money you make the more they stand to collect in taxes. In fiscal 1981, our nation's good old generous “uncle” will either lend directly or guarantee billions of dollars in loan requests, along with technical assistance and even sales procurement assistance. Remember, if you don't apply for these available SBA funds somebody else certainly will.

Don't lose out — now is the best time to place your order for this comprehensive manual. It is not sold in stores. Available only by mail through this ad, directly from ICC Business Research, the exclusive publisher, at just a small fraction of what it would cost for the services of a private loan advisor or to attend a seminar.

For example:
Initially, this amazing Guaranteed and Direct Loans Manual was specially designed to be the basis of a Small Business Loan Seminar — where each registrant would pay an admission fee of \$450. But our company felt that since the manual's quality instructions were so exceptionally crystal-clear that anyone who could read, could successfully use its techniques without having to attend a seminar or pay for costly private loan advisory assistance services.

Therefore, for those purchasing the manual by mail, no 3 day class, no course and accommodations are required. And rather than \$450 we could slash the price all the way down to just a mere \$35 — a small portion of a typical seminar attendance fee — providing you promptly fill in and mail coupon below with fee while this special “seminar-in-print” manual offer is still available by mail at this relatively low price!

Remember, this most unique manual quickly provides you with actual sample copies of SBA Loan application and all other required forms—already properly filled in for you to easily use as reliably accurate step-by-step guides—thus offering you complete assurance that your application will be properly prepared, and thereby immediately putting you on the right road to obtaining fast, no red-tape loan approval.

GUARANTEE #2
Even after 15 days — here's how you are still strongly protected — if you decide to keep the manual — and you apply for an SBA Loan anytime within 1 year...your loan must be approved and you must actually receive the funds or your money will be refunded in full.

YOU GET NOT 1 BUT 2 STRONG BINDING GUARANTEES!
YOUR LOAN MUST ACTUALLY BE APPROVED OR YOUR MONEY BACK

Of course, no one can guarantee that every request will be approved — but clearly we are firmly convinced that any sound business request properly prepared — showing a reasonable chance of repayment and submitted to SBA — will be approved. Only because we are so confident that this is a fact do we dare make such a strong binding seldom-heard-of Double Guarantee. No stronger guarantee possible! It actually pays for you to order a copy of this remarkable manual — 100% tax deductible as a business expense...Don't delay—send for yours right now!

NO RISK LOAN OPPORTUNITY FORM

Detach and rush for COMPLETE PREPARATION ASSISTANCE FOR LOAN APPROVAL

Please rush me _____ copies of the “Money Raiser's Guaranteed and Direct Loans Manual,” each at a \$35 fee plus \$2.50 handling and shipping under your 2 strong binding Guarantees.

Enclosed is full payment:
 Check Money Order
 C.O.D. \$5 Deposit required
Send payment with order. Save C.O.D. Fee

Name _____ Please Print Clearly

Address _____

City _____

State _____ Zip _____

My telephone is: () _____
(in case we have a question about your order)

MAIL TO: ICC Business Research
307 Forest Hill Avenue
Winston-Salem, N.C. 27105

THE EASY NO-NONSENSE WAY TO RAISE CAPITAL FAST!

memory to have different contents (ie: be initialized arbitrarily) when the n th term is reached. Since division proceeds from high toward low significant bits, arbitrary data beyond a specified least significant byte can never affect the contents of that byte or any more significant byte. There can be no accumulated truncation errors such as those encountered with summation-of-terms approaches.

The second implication is that, at a given stage of calculation, only the most significant bytes of e (ie: those that will not subsequently be divided to insignificance) need to be divided! The first divisions can be very short, only a few bytes or so, while the last ones must encompass all of e . For a given divisor, i , the number of (least significant) bytes of e which need *not* be divided is $\log_{256}(i!)$, which may be calculated by the HP-41C program in listing 5. Note that it calls the previously written program FACTLOG, which calculates the number of digits of $(i!)$. The algorithm used is:

number of bytes of $i!$ = number of digits of $i!/\log_{10}(256)$

It is unfeasible to precalculate the number of bytes to leave undivided (or the number to divide) for each divisor and to save it in a table because the table would consume a great deal of memory. As an alternative, the divisors can be broken into blocks of, say, 1 K bytes each, and for each block a fixed number of bytes (of e)

can be divided. The number of bytes to divide for a given block is calculated as the total number of bytes in the e array minus the number of insignificant bytes (calculated as above) corresponding to the minimum divisor of the block, plus a "guard" byte or two to cover slight calculation errors.

In a later program that calculated e to 116,000 digits, I used 47 K bytes (188 pages of 256 bytes each) of memory, and the maximum divisor was 28,800. The divisors were grouped into fifteen blocks of 2 K-byte divisors each, and the number of memory pages not to be divided were precalculated for each block (see table 3). This version of the program used a lookup table to determine how many pages to divide (188 minus the number *not* to divide) for each divisor. This technique proved extremely beneficial because it reduced the computation time from four days to two.

The 47 K-byte version used virtually all the memory in a 48 K-byte Apple. The e array occupied hexadecimal locations 400 thru BFFF. A starting divisor of 28,800

Listing 5: *The FACTBYT program for the Hewlett-Packard HP-41C calculator. This program calculates the precision to which the multibyte division has to be carried out for a given divisor. See table 3 for details.*

LBL ALPHA FACTBYT ALPHA XEQ ALPHA FACTLOG ALPHA 256 LOG / RTN

HERE IT IS!!!

The First Edition (April, 1981) of the

COMMODORE SOFTWARE ENCYCLOPEDIA

is now available from your
authorized COMMODORE Dealer, for ...

\$4.95

OVER 150 PAGES! MORE THAN 500 SOFTWARE ENTRIES!

The next edition of the COMMODORE SOFTWARE ENCYCLOPEDIA will be available in 90 to 120 days. If your software is not listed and you would like to have it listed in the next edition, please submit details to:

SOFTWARE DEPARTMENT



commodore
BUSINESS MACHINES, INC.

Computer Systems Division

300 Valley Forge Square, 681 Moore Road
King of Prussia, PA 19406



Or call our
SOFTWARE HOTLINE
Number

1-800-523-5622

THE ADVANTAGES OF THE FUNCTIONAL GROUP:



Diversity of projects.
Varied technical
challenge.

Involvement from concept through implementation.

Broad interaction and cooperation between software and hardware.

We've got it all at Harris Composition Systems in Melbourne, Florida.

We're pioneers in word processing. And the world's first and leading supplier of total word processing systems for use in the newspaper industry.

And we're now extending that "system-oriented" approach into the *office systems* field—integrating data processing, word processing,

electronic mail, advanced communications and networking. With an ambitious program representing the largest investment Harris Corporation has ever made to develop a new product.

That means the opportunity for personal participation and immediate contribution—across the board—in both newspaper word processing and office systems.

For experienced professionals with expertise in
 Real Time Software and Hardware/Firmware Development
 Digital Design
 Analog Design
 Applications Programming.

All supported by a billion dollar, Fortune 500 corporation. All in a modern, stimu-

lating work environment. All in beautiful, affordable Melbourne, Florida—on the shores of the deep blue Atlantic.

Send your resume and salary history to: **Daphne Cumberland, Composition Systems Division, Dept. BT, P.O. Box 2080, Melbourne, Florida 32901.** Or call COLLECT (305) 242-5321, in Florida. Outside Florida call 1-800-327-1493.

Share the advantages with us.

100% PURE OPPORTUNITY.



HARRIS
COMMUNICATION AND
INFORMATION PROCESSING

An Equal Opportunity Employer M/F/V/H.

RUN BIG CPM* PROGRAMS ON YOUR MODEL 1 TRS-80*

WITH 39 or 54K of use space. Can use Mixed Drivers 5 1/4 or 8" (Variable Tracks) Compatible with all TRS*80 Operating Systems and all TRS*80 Programs. (usable on 48K disk systems only) Boards fit into keyboard enclosure.

FREEDOM OPTION.....\$245

MEMORY EXPANSION OPTION....\$295

Send Check or Money Order to:
(MASS. RESIDENTS. PLEASE INCLUDE 5% TAX)

F.E.C. Ltd.

P.O. Box 2368 • Woburn, MA. 01888

(617) 944-5329

PRINTERS

BASE 2

850 \$735
APPLE INTF. \$140

OKIDATA
p 80 \$ CALL S
p 82 \$ CALL S

EPSON
MX-80 \$ CALL S
MX-70 \$ CALL S

ANACOM
150 \$ CALL S

PLEASE ADD 3% FOR S&H TO ORDER

TECHNICAL INNOVATIONS

P.O. BOX 803
HILLSBORO, OR 97123
503-648-6423

Circle 356 on inquiry card.

AFFORDABLE

Here at KLOFOX, affordable is not a motto, it's a way of doing business. Prices start at \$1695.00, for a single 8" drive system.

All systems feature a single board 2-80 CPU (NO BUSS HEADACHES), runs CP/M 2.2 (BIOS INCLUDED), reliable SD recording, 64K bytes of RAM, four channel CTC, and either an 80 x 24 full-featured video interface or a two channel serial interface. PLUS a six month full warranty*.

OPTIONS:

2 Channel parallel interface- add \$29.95
Both serial & video interface- add \$95.95
Single to dual drive conversion kit with drive and necessary hardware- add \$495.00
ALL options may be installed by customer.

KLOFOX
PO BOX 93
SAN LUIS OBISPO, CA 93406
(805) 541-0384

*CP/M is a trademark of Digital Research.

*Only 90 days on drives.

Circle 188 on Inquiry card.

Range of Divisors in Same Group	Number of Insignificant Bytes	Number of Pages That Can Be Left Uncalculated
2 to 2047	0	0
2048 to 4905	2448	9.6
4096 to 6143	5406	21.1
6144 to 8191	8558	33.4
8192 to 10239	11836	46.2
10240 to 12287	15206	59.4
12288 to 14335	18652	72.9
14336 to 16383	22158	86.6
16384 to 18431	25718	100.5
18432 to 20479	29325	114.5
20480 to 22527	32972	128.8
22528 to 24575	36656	143.2
24576 to 26623	40374	157.7
26624 to 28671	44123	172.4
28672 to 30719	47900	187.1

Table 3: Table of truncated multibyte divisions that can be made during the second algorithm. Due to the nature of the second algorithm, most divisors need not carry the division out the entire length of the multibyte dividend. By grouping divisors and not calculating the bytes that are unimportant to that particular group, calculation time can be significantly decreased.

resulted in 115,925 digits of precision. Because the result occupied screen memory, it had to be written to cassette tape by the calculation program before returning to the Apple II monitor. Because there was no memory available for a BASIC program, the output formatting program was coded in assembly language and resided in parts of pages 0 and 1. Pages 2 and 3 were used for the multiply-by-100 tables.

On the Horizon

As with any limitless search, there remains the challenge to compute e to even greater precision. Unfortunately, the computation time of the specified algorithm is exponentially related to the precision sought. Divide operations on high-speed computers (approximately 12 μ s per 32 bits) are two orders of magnitude faster than the 6502 routines. The ultimate approach is to construct a custom "divide machine." Current technologies and low programmable memory prices make it feasible to construct such a machine with a thousand-fold performance improvement over the 6502 microprocessor. With such a machine, e could be computed to 100,000,000 digits within a couple of years (one year constructing and testing, one year computing). Such a machine would require power supply backup and error-correcting memory. The memory should be purchased at the latest possible date due to decreasing prices.

Once a few simple concepts are understood, the computation that I have described is as easy as π (see listing 6). Why do people spend time computing these numbers to such absurd precision? Because they're there, I suppose. Who knows what great discoveries will be made by personal computer owners in the coming years? Rest assured that a guaranteed place in the mathematics Hall of Fame awaits the discoverer of the next greatest prime number. ■

Listing 6: A partial printout of the value of e . The first line agrees with the fifty-place value for e that is given in the CRC Standard Mathematical Tables.

E

PAGE 01

E=2.71828 18284 59045 23536 02874 71352 66249 77572 47093 69995 95749 66967
 62772 40766 30353 54759 45713 82178 52516 64274 27466 39193 20030 59921
 81741 35966 29043 57290 03342 95260 59563 07381 32328 62794 34907 63233
 82988 07531 95251 01901 15738 34187 93070 21540 89149 93488 41675 09244
 76146 06680 82264 80016 84774 11853 74234 54424 37107 53907 77449 92069
 55170 27618 38606 26133 13845 83000 75204 49338 26560 29760 67371 13200
 70932 87091 27443 74704 72306 96977 20931 01416 92836 81902 55151 08657
 46377 21112 52389 78442 50569 53696 77078 54499 69967 94686 44549 05987
 93163 68892 30098 79312 77361 78215 42499 92295 76351 48220 82698 95193
 66803 31825 28869 39849 64651 05820 93923 98294 88793 32036 25094 43117
 30123 81970 68416 14039 70198 37679 32068 32823 76464 80429 53118 02328
 78250 98194 55815 30175 67173 61332 06981 12509 96181 88159 30416 90351
 59888 85193 45807 27386 67385 89422 87922 84998 92086 80582 57492 79610
 48419 84443 63463 24496 84875 60233 62482 70419 78623 20900 21609 90235
 30436 99418 49146 31409 34317 38143 64054 62531 52096 18369 08887 07016
 76839 64243 78140 59271 45635 49061 30310 72085 10383 75051 01157 47704
 17189 86106 87396 96552 12671 54688 95703 50354 02123 40784 98193 34321
 06817 01210 05627 88023 51930 33224 74501 58539 04730 41995 77770 93503
 66041 69973 29725 08868 76966 40355 57071 62268 44716 25607 98826 51787
 13419 51246 65201 03059 21236 67719 43252 78675 39855 89448 96970 96409
 75459 18569 56380 23637 01621 12047 74272 28364 89613 42251 64450 78182
 44235 29486 36372 14174 02388 93441 24796 35743 70263 75529 44483 37998
 01612 54922 78509 25778 25620 92622 64832 62779 33386 56648 16277 25164
 01910 59004 91644 99828 93150 56604 72580 27786 31864 15519 56532 44258
 69829 46959 30801 91529 87211 72556 34754 63964 47910 14590 40905 86298
 115125 81589 55664 00700 37088 40705 00444 70875 66622 00000 00000 00000
 E

PAGE 10

92105 78191 37103 01889 79206 40888 39747 67667 14472 73142 54467 92350
 05246 18849 23745 53075 75734 90270 73424 96298 87999 69420 94595 96100
 87025 01329 45332 53580 45689 28570 72412 07965 91980 92255 50560 06197
 12835 41270 20207 25839 94171 17552 09208 20151 09650 95266 85113 89757
 71508 10849 44350 82854 58749 91294 38575 63115 66832 45668 27992 99186
 15390 09255 87171 68404 95663 99195 91540 34218 36453 72120 23678 60865
 53647 45175 65487 93189 25644 08527 44891 90918 19341 16675 83563 43975
 88860 46349 41311 18752 41038 42546 79379 99203 54691 04119 35443 11321
 91360 68129 65756 85836 11774 56465 46748 61061 98859 14148 05799 31872
 53675 31243 47033 54826 37527 08135 31055 70818 04964 24985 84646 14797
 34675 99315 94651 47870 25065 27108 35087 82350 65653 23317 97738 65666
 61816 52390 01766 49884 85456 05496 13002 15776 11525 58133 96184 02706
 78149 00350 25287 68236 07822 10739 71023 39146 87015 97358 68589 01529
 70103 47780 50329 21540 14359 59529 86834 04657 47175 62321 96640 51540
 14779 53167 46172 62087 27304 82063 46524 69109 95332 73755 61090 57837
 84559 45469 16022 36876 89641 42596 01646 89647 10634 80741 09928 54648
 23530 83540 13233 29248 64037 31800 31952 02317 47620 65377 26163 71744
 53605 49726 69060 17111 76761 04777 49716 66890 15216 38389 74311 71418
 06222 22345 71856 79415 07299 52620 10862 05084 78312 74747 91909 99688
 99372 75229 05367 47850 20500 03863 00365 26218 80067 09266 74104 80602
 73419 97756 66002 94279 41090 40006 46542 81074 45400 76164 29525 36246
 02614 76180 47174 43228 89953 28582 83977 62184 60096 76692 67581 27030
 28065 19535 45205 31735 36808 95458 99021 80783 14577 58912 80203 97005
 36331 93821 10009 54432 41244 19794 91929 16205 23442 13463 95653 84078
 12094 16214 83500 11558 83618 42116 42839 92454 02759 07196 21537 57018
 70670 83731 01224 61413 62048 92655 56681 09467 07638 65360 83015 84761
 115125 81589 55664 00700 37088 40705 00444 70875 66622 00000 00000 00000



META TECHNOLOGIES

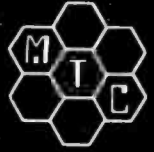

26111 Brush Avenue, Euclid Ohio 44132
CALL TOLL FREE 1-800-321-3552 TO ORDER
IN OHIO, call (216) 289-7500 (COLLECT)

FILE BOX DISKETTE STORAGE SYSTEM



\$24⁹⁵ for 5 1/4" disks
\$29.95 . . . for 8" disks

MTC brings you the **ULTIMATE** diskette storage system, at an affordable price. Storing 50 to 60 diskettes, this durable, smoke-colored acrylic unit provides easy access through the use of index dividers and adjustable tabs. Unique lid design provides dust-free protection and doubles as a carrying handle.

'RINGS' & THINGS

Help prevent data loss and media damage due to improper diskette centering and rotation with the **FLOPPY SAVER™** reinforcing hub ring kit. 7-mil mylar rings install in seconds. Kit is complete with centering tool, pressure ring, 25 adhesive backed hub rings and instructions.

HUB RING KIT for 5 1/4" disks . . . \$10.95
HUB RING KIT for 8" disks . . . \$12.95
REFILLS (50 Hub Rings) . . . \$ 5.95

Protect your expensive disk drives and your valuable diskettes with our diskette drive head cleaning kit. The kit, consisting of a pair of special "diskettes", cleaning solution and instructions, can be used for 52 cleanings. Removes contamination from recording surfaces in seconds without harming drives.

CLEANING KIT for 5 1/4" drives . . . \$24.95

PLASTIC LIBRARY CASES (not shown)

An economical form of storage for 10 to 15 diskettes, and is suitable for your bookshelf! Case opens into a vertical holder for easy access.

5 1/4-inch diskette case . . . \$3.50
8-inch diskette case . . . \$3.95

MICROPARAPHERNALIA DISKETTES (box of ten)

5 1/4" PLAIN JANET™ . . . \$21.95
5 1/4" PLAIN JANET™ *Gold* . . . \$25.95
5 1/4" DATALIFE™ MD 525-01 . . . \$26.95
8" DATALIFE™ FD34-8000 . . . \$43.95

NEWDOS by APPARAT

NEWDOS/80 by Apparat . . . \$149.95
NEWDOS + to
NEWDOS/80 UPGRADE . . . CALL
NEWDOS + with ALL UTILITIES
35-track . . . \$69.95
40-track . . . \$79.95

BOOKS

TRS-80™ DISK
AND OTHER MYSTERIES . . \$19.95
MICROSOFT™ BASIC DECODED \$29.95
1001 THINGS TO DO WITH YOUR
PERSONAL COMPUTER . . . \$ 7.95

Let Your TRS-80™ Test Itself With THE FLOPPY DOCTOR & MEMORY DIAGNOSTIC

by THE MICRO CLINIC

A complete checkup for your Model I. THE FLOPPY DOCTOR completely checks every sector of 35- or 40-track disk drives. Tests motor speed, head positioning, controller functions, status bits and provides complete error logging. THE MEMORY DIAGNOSTIC checks for proper write/read, refresh, executability and exclusivity of all address locations. Includes both diagnostics and complete instruction manual.
SYSTEM DIAGNOSTICS . . . \$19.95

An improved version of the SYSTEM DIAGNOSTICS above. Designed for single or double density, 35-, 40-, 77-, or 80-track disk drives. Includes new and modified tests. Features THE FLOPPY DOCTOR, Version 3.0.

SYSTEM DIAGNOSTICS-V3 . . \$24.95

Single Sided, Soft-Sector'd 5 1/4-inch,
(for TRS-80™) Mini-floppy

DISKETTES

\$21⁹⁵ box of 10

These are factory fresh, absolutely first quality (no seconds!) mini-floppies. They are complete with envelopes, labels and write-protect tabs in a shrink-wrapped box.

PLAIN JANE™ DISKETTES

The Beautiful Floppy
with the Magnetic Personality™

Thousands of people have switched to this low-cost alternative. These quality diskettes are packaged in a plain white box . . . no fancy printing, fancy names or fancy labels, not even our own (labels cost money). Trust us.

PLAIN JANET™ Diskettes . . . \$21.95
10 boxes of 10 . . . (each box)\$21.50

PLAIN JANE™ *Gold*

Introducing MTC's premium generic diskette. Single-Sided, Soft-Sector'd, DOUBLE-DENSITY, 5 1/4-inch diskettes with reinforcing HUB-RINGS. Individually 100% ERROR-FREE certified. Invest in GOLD!

PLAIN JANET™ *Gold* . . . \$25.95

VERBATIM'S PREMIUM DISKETTES AT
AFFORDABLE PRICES

DATALIFE™

Seven data-shielding improvements mean greater durability and longer data life. These individually, 100% error-free certified diskettes feature thicker oxide coating, longer-lasting lubricant, improved liner, superior polishing and more! Meets or exceeds IBM, Shugart, ANSI, ECMA and ISO standards. Reinforcing HUB RINGS help prevent data loss and media damage, reducing errors.

Buy the best . . . buy DATALIFE™

VERBATIM DATALIFE™ DISKETTES

5 1/4-inch (box of 10)
MD525-01 . . . \$26.95
10 boxes of 10 . . . (each box)\$25.95

8-inch FLOPPIES

Double-Density, FD34-8000 . \$43.95

CALL FOR INFORMATION ON
OTHER PRODUCTS

TRS-80 is a trademark of the Radio Shack Division of Tandy Corporation. DATALIFE is a trademark of VERBATIM. PLAIN JANE, AIDS-I, AIDS-III, CALCS-III, CALCS-IV, MERGE-III are trademarks of MTC.
©1981 by Metatechnologies Corporation, Inc.

**MOST ORDERS
SHIPPED WITHIN
ONE BUSINESS DAY**
Products damaged in
transit will be exchanged.

**PRICES IN EFFECT
June 1, 1981 THRU
June 30, 1981.**
Prices, Specifications,
and Offerings subject to
change without notice.
8106

WE ACCEPT
• VISA
• MASTER CHARGE
• CHECKS
• MONEY ORDERS
• C.O.D.

• Add \$3.00 for shipping
& handling
• \$3.00 EXTRA for C.O.D.
• Ohio residents add 6 1/2%
sales tax.

What's New?

SYSTEMS

CCS

Microcomputer Systems

A new line of S-100 Z80-based microcomputer systems from California Computer Systems provides real-time hardware-vector interrupt and interrupt-nesting capabilities. Multiprocessing with interleaved data-transfer rates of up to 2 megabytes per second can be achieved using direct memory access. The main board has two programmable real-time clocks, two 8-bit parallel interface channels, and two programmable RS-232C serial I/O (input/output) channels, one of which may be used for synchronous communication. The chassis contains a nineteen-slot motherboard and a power supply.

The CCS OASIS multitasking operating system features re-entrant and relocatable program capabilities, and employs an ISAM (indexed-sequential access method) file structure. Task-to-task communication, file protection, timekeeping, spooling, overlay, and device-independent I/O are accomplished through software. The operating system is supported with debug, editing, relocatable-linkage, and file-sort utilities. CP/M and MP/M can be used with the system. A BASIC interpreter and compiler, FORTRAN, COBOL, and Pascal compilers are also available.

Optional boards include printer and terminal interfaces, 16 K-, 32 K-, and 64 K-byte memory boards, floppy-disk subsystems and expansions, and Winchester-type disk subsystems and expansions. Prices for the CCS systems range up to \$9100. Contact California Computer Systems, Marketing Department, 250 Caribbean Dr, Sunnyvale CA 94086, (408) 734-5811.

Circle 524 on inquiry card.

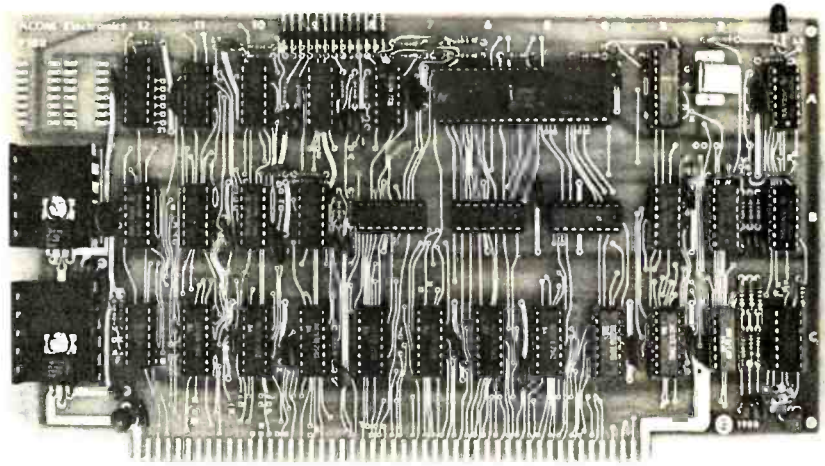

Acom's 8088 Board

The P188 is an S-100 bus 8088 microprocessor board that will run as a stand-alone processor or as a slave. Jumpers allow configuring the card to run in different operating modes, as well as with static or dynamic memory. The 8088 microprocessor has 16-bit internal architecture, addresses 1 megabyte of mem-

ory, and features 8- and 16-bit signed and unsigned arithmetic in binary or decimal, including multiply and divide.

The P188 costs \$345 assembled and tested, and \$275 in kit form. For more information, contact Acom Electronics, 4151 Middlefield Rd, Palo Alto CA 94303, (415) 494-7499.

Circle 525 on inquiry card.

Single-Board 6800 Computer

The ACS 12-PRO requires a power supply and terminal to operate. The 6800-based system provides two programmable 16-bit timers, an RS-232C serial port, two 8-bit parallel ports with handshake control, and up to 4 K bytes of programmable memory and 6 K bytes of PROM (programmable read-only memory).

The ACS 12-PRO is supplied with Datricon's 4 K D-FORTH operating system. With 1 K bytes of programmable memory, D-FORTH, and a manual, the ACS 12-PRO sells for \$495. For additional details, contact Datricon Corporation, 7911 NE 33rd Dr, Suite 200, Portland OR 97211, (503) 284-8277.

Circle 526 on inquiry card.

Where Do New Products Items Come From?

The information printed in the new products pages of BYTE is obtained from "new product" or "press release" copy sent by the promoters of new products. If in our judgment the information might be of interest to the personal computing experimenters and homebrewers who read BYTE, we print it in some form. We openly solicit releases and photos from manufacturers and suppliers to this marketplace. The information is printed more or less as a first-in first-out queue, subject to occasional priority modifications. While we would not knowingly print untrue or inaccurate data, or data from unreliable companies, our capacity to evaluate the products and companies appearing in the "What's New?" feature is necessarily limited. We therefore cannot be responsible for product quality or company performance.

What's New?

PERIPHERALS

Apple IEEE-488 Interface

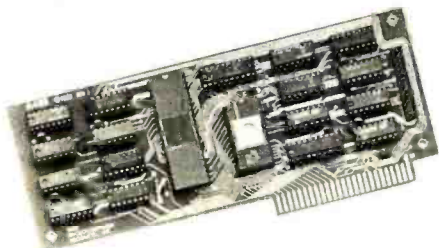

The A488 interface card permits the Apple II and the Apple II Plus to operate as IEEE-488 bus controllers. The A488 uses an MC68488 LSI 488-controller integrated circuit that decreases the number of circuits required. The board has 2 K bytes of firmware in EPROM (erasable programmable read-only memory). For special-purpose firmware development, the EPROM can be replaced by programmable memory. The A488 allows bus and

system control with character-string instrument commands for set-up, measure, clear, local, trigger, serial-poll, and respond functions. Any equipment on the bus can be designated by a name of up to sixteen characters. Up to fifteen pieces of equipment can be connected to the A488 across a distance of up to 20 meters (66 feet) from the Apple. The card's driver firmware is linked to string routines within Applesoft; floating-point processing of numeric data is easily done. Error checking is included, and software timing loops are not needed.

The A488 is priced at \$475 from SSM Microcomputer Products Inc, 2190 Paragon Dr, San Jose CA 95131, (408) 946-7400.

Circle 527 on inquiry card.

Printer for Under \$1000

The Model 445 Paper Tiger printer features a seven-wire ballistic-type print head and tractor-feed motor drives. The 445 can print at speeds up to 198 cps (characters per second). Functions include bold text and the ability to print 80 columns at 10 pitch and 132 columns at 16.7 pitch. Other features include the 96-character upper- and lower-case ASCII (American Standard Code for Information Interchange) character set, six or eight lines-per-inch vertical spacing, multiline buffering, and RS-232C- and Centronics-compatible parallel interfaces. Transmission rates from 110 to 1200 bps (bits per second) are selectable. Variable form length, perforation skipping, and the ability to handle six-part forms and roll paper are other features.

Integral Data Systems' DotPlot graphics capability is offered as an option. DotPlot enables printing the full range of graphics characters. The Paper Tiger Model 445 costs \$795 and the DotPlot package is \$99. Contact Integral Data Systems Inc, Milford NH 03055, (603) 673-9100.

Circle 529 on inquiry card.



Turn IBM Typewriters Into RS-232Cs

California Micro Computer's 5060 and 5061 modules enable the IBM Model 50, 60, and 75 electronic typewriters to perform as RS-232C-compatible computer I/O (input/output) devices. The modules can be installed and removed easily without requiring modifications to the typewriter. The model 5061 is a print-only

version, while the 5060 allows the typewriter to perform full terminal functions. Both units offer ASCII coding with full buffering. The 5061 costs \$497 and the 5060 is \$860.

For further information, contact California Micro Computer, 9323 Warbler Ave, Fountain Valley CA 92708, (714) 968-0890.

Circle 528 on inquiry card.

Extend the TRS-80 Color Computer Bus

The Color Connection is a device that extends the TRS-80 Color Computer system bus as a System-50 bus (SS-50). Using the Color Connection, floppy-disk drives and video terminals can be added, and the Color Computer's 16 K-byte internal memory can be expanded. The Color Connection sells for \$99.95 from Percom Data Company, 211 N Kirby, Garland TX 75042, (800) 527-1592; in Texas, (214) 272-3421. Circle 530 on inquiry card.

Computerize your bookkeeping without terrifying your bookkeeper.

Introducing The Boss.™ the most advanced, yet most understandable, financial accounting system. Designed to automate your bookkeeping without confusion or mistakes.



Typical screen format - actual photograph.

If "fear of the unknown" is standing between you and computerization, you should find out about The Boss.

The Boss system is immediately comprehensible to bookkeepers because it utilizes virtually the same format they're used to.

So even someone with no previous computer experience can easily learn and operate The Boss system.

Features seldom found in packaged software.

The Boss system is fully interactive, fully departmentalized and exceptionally fast. It can generate an astounding number of complex reports at the touch of a button.

General Ledger and Accounts Receivable and Payable transactions can be entered in any order in a single program.

Up-to-the-minute financial reports can be obtained without batch processing.

The Boss system computes financial ratio analysis.

It protects data from unauthorized personnel as well as computer malfunction.

And it has the largest programming and storage capacity of any micro system.

The Boss runs on most small business computers with CP/M® or similar operating systems. Its cost is only \$2,495.

Get full support from Lifeboat.

The Boss is brought to you exclusively and supported completely by Lifeboat Associates, world's largest computer software publisher. For more information about how you can profit from this extraordinary financial accounting system, send us the coupon below. Or call (212) 860-0300.

For more information on The Boss, mail coupon to Lifeboat Associates, 1651 Third Avenue, New York, NY 10028.

Name _____

Title _____

Company _____

Street _____

City _____

State _____

Zip _____



BB681

Boss is a trademark of Balcones Computer Corp. CP/M is a trademark of Digital Research, Inc.

Lifeboat Associates

Software with full support

What's New?

PERIPHERALS

Low-Cost Color-Graphics Terminal



RCA's VP-3301 is a microprocessor-controlled terminal with color graphics, reverse video, programmable and resident character sets, selectable data rates and formats, a flexible-membrane keyboard, and audio feedback. The VP-3301 can be connected to modems for communication with most timesharing and data-base computer networks. The software-selectable character-display

format can produce either 40 characters by 24 lines or 20 characters by 12 lines. Characters and background can be displayed in one of eight colors or gray scales. The communications interface is RS-232C or 20 mA current-loop. Configuration control includes line/local, uppercase only, full- and half-duplex, data-word formatting, plus two control-code options. The video output can be directly connected to monitors or, with an RF (radio frequency) modulator, to a television set. The suggested price for the VP-3301 is \$369 from RCA Microcomputer Products, New Holland Ave, Lancaster PA 17604, (717) 397-7661.

Circle 531 on inquiry card.

8-Inch Floppy-Disk Drives

Matchless Systems, 18444 S Broadway, Gardena CA 90248, (213) 327-1010, has announced the MS-800 8-inch floppy-disk drive. The drive is compatible with the TRS-80 Models I and II, the Apple II, and S-100 systems. The MS-800 has a capacity of 256 K bytes of storage. The data transfer rate is 256 k bps (bits per second) and the track-to-track access time is 10 ms. The prices range from \$995 to \$1595, which includes all hardware (such as the controller), software, and documentation. Circle 532 on inquiry card.

S-100 I/O Board

The MFIO is an I/O (input/output) board designed for S-100 bus systems. It features four serial RS-232C ports with independent data rates of 50 to 19.2 k bps. It also includes 24 bits of parallel I/O configurable for four ports, five timer/counters, sixteen levels of vectored-interrupt control, and an optional battery-powered real-time clock/calendar. The MFIO costs \$595. For more information, contact Digicomp Research, Terrace Hill, Ithaca NY 14850, (607) 273-5900.

Circle 533 on inquiry card.

Series 47-TR Plotter

The Series 47-TR Strip Chart/Plotter is a curve tracer with alphanumeric capabilities. Its plotting area is 25 cm (10 inches) wide. The plotter features an RS-232C- or IEEE-488-compatible port and bidirectional paper drive. It requires two 8-bit words formatted to provide analog pen position. Pen speed is 75 cm per

second with a position accuracy of $\pm 0.15\%$, full scale. Paper can be incremented up to 2 cm per second at 0.0127 cm per step. The 47-TR is priced at \$945. For details, contact Pedersen Instruments, 2772 Camino Diablo, Walnut Creek CA 94596, (415) 937-3630.

Circle 534 on inquiry card.

Graphics Terminal for the North Star

The Sigma 1042S high-resolution, memory-mapped graphics terminal is designed for the North Star microcomputer. The display provides a 640 by 800 dot matrix backed by a 64 K-byte display memory. The display memory is divided into sixteen 4 K-byte blocks, which are individually selectable for mapping onto a main-memory window of only 4 K bytes. The 1042S terminal can also be used as a word-processing work station. In this application mode, it includes variable spacing, multiple fonts, and scientific-character capabilities. Reverse video, blinking, and intensification are offered as hardware features. The terminal can be used as a system console under CP/M. The 1042S costs \$4000.

For more information, contact Sigma Information Systems USA Inc, 556 Trapelo Rd, Belmont MA 02178, (617) 484-2063.

Circle 535 on inquiry card.

Cash Register Scans Bar Code

The CE-1000 bar-code-scanning cash register can keep track of your entire inventory. It is designed for use with the Commodore CBM microcomputer and includes software, firmware, and hardware. The unit can read UPC (Universal Product Code) bar codes found on most products for point-of-sale operations, making it useful for convenience, liquor, food, record stores, and other small businesses.

The CE-1000 bar-code scanner costs \$1350. For more information, contact Creative Equipment, 50 NW 68 Ave, Miami FL 33126, (305) 261-7866.

Circle 536 on inquiry card.

What's New?

PUBLICATIONS

The Sizzle Sheet

The Sizzle Sheet is a marketing-communications guide for those who market computers, communications and information products, systems, and services. Featured are reviews and reports, editorials on the news, business and trade press, plus special issues.

For details, contact The Sizzle Sheet, POB 801, 150 Speen St, Framingham MA 01701, (617) 875-0013.

Circle 537 on inquiry card.

Symbol Manipulation Using LISP

This is a manual for the LISP programming language. The book introduces the basics of LISP programming and demonstrates how it is used in practice. It also discusses how artificial intelligence systems are built. Case studies and problems in pattern matching, natural-language understanding, and problem solving are included. An appendix offers a sample terminal session, lists basic LISP functions, and explains differences between MACLISP and INTERLISP.

Symbol Manipulation Using LISP costs \$13.95, and is published by Addison-Wesley, Reading MA 01867, (617) 944-3700.

Circle 538 on inquiry card.

Printronic Printers Described in Brochure

A color brochure describing Printronix dot-matrix printers is available from Printronix Inc. The brochure discusses the Printronix hammer-bank printing mechanism and includes examples of graphics, bar codes, labels, and alphanumeric forms. For your free copy, contact Printronix Inc, 17421 Derian Ave, POB 19559, Irvine CA 92713, (714) 549-7700.

Circle 539 on inquiry card.

Magazine for TI 99/4 Users

99'er Magazine is a bimonthly magazine with news about the TI 99/4 and other TMS9900-based personal-computer systems. It features tutorial articles, software, book and product reviews, opinions and news items, and a question-and-answer technical forum.

Each issue is divided into sections for education, games and simulations, home activities, and business, scientific, or professional applications. Regular features include columns on the Logo language, CAI (computer-aided instruction), speech-synthesis usage, interfacing with peripherals, computer chess, The Source and TEXNET, news from user groups, and lessons in programming techniques. Advertisements from suppliers of software, peripherals, and other related products and services are also included. A bulletin-board page for noncommercial messages is provided for its readers.

The subscription rate is \$15 for one year. Contact 99'er Magazine, Emerald Valley Publishing Company, 2715 Terrace View Dr, Eugene OR 97405, (503) 485-8796. Circle 540 on inquiry card.

GamesMaster Catalog

The GamesMaster Catalog has listings of board, computer, electronic, hand-held, fantasy, and other kinds of games. One section is exclusively devoted to Dungeons and Dragons-type games. Nearly 1000 games are described in full detail, including landscape sets and miniature pieces.

For a copy of the catalog, contact Boynton & Associates Inc, Clifton House, Clifton VA 22024, (703) 830-1000.

Circle 541 on inquiry card.

Computer Crimes Books

The Computer/Law Journal has published a two-volume set on computer crimes. This first volume contains an introduction by Senator Abraham Ribicoff, author of the Federal Computer Crimes Protection Act. There are articles by well-known scholars like Donn Parker, Susan Nycum, John Taber, Rob Kling, and Jay Becker.

Volume two has a history of the Stanley Mark Rifkin case and a compilation and analysis of all federal and state statues and bills addressing computer crimes, as well as a case digest, bibliography, and book reviews. Both issues are available for \$16 each, plus \$1 per issue postage. Contact the Center for Computer/Law, 530 W 6th St, 10th floor, Los Angeles CA 90014.

Circle 542 on inquiry card.

Computer Books from Entelek

This catalog of computer books from Entelek features books on programming languages, microcomputers, robots, calculators, and educational uses of computers. The catalog is free from Entelek, Ward-Whidden House/The Hill, POB 1303, Portsmouth NH 03801.

Circle 543 on inquiry card.

1981 Computer-Science and Engineering Books

A catalog of MIT Press books in the computer-science and engineering fields is available. This catalog describes over fifty books. Most of the books are offered at a 20% discount through December 1981. Copies of the catalog can be obtained from The MIT Press, Promotion Department, 28 Carleton St, Cambridge MA 02142, (617) 253-5642.

Circle 544 on inquiry card.

What's New?

SOFTWARE

Merge Your 737 Printer and Scripsit

Until Apparat Inc introduced Flextext, TRS-80 Model I users could not use all of the features of the Centronics 737 printer (Radio Shack Line Printer IV) with Scripsit, Radio Shack's word-processing program. Flextext is a utility for Scripsit and the 737 printer that supports proportional or compressed character sets in normal and extended modes, right-justified formatting using the proportional or compressed character sets, underlining in any of the Scripsit-selectable formats and Flextext-selectable character sets, super- or subscripts, and the intermixing and combining of the 737's features anywhere in a document. Flextext requires at least one disk drive and a TRSDOS-type operating system. The program costs \$29.95 from Apparat Inc, 4401 S Tamarac, Denver CO 80237.

Circle 545 on inquiry card.

Chinese Lessons Program

Chinese greetings, times, seasons, numbers, foods, and other commonly used terms are contained in eleven computer-instruction lessons. Color, graphics, and sound are used in each lesson. Memory aids, meanings, and pronunciations are presented with the Chinese characters. The proper stroke sequence for each character is shown and can be repeated at the user's pace.

The Chinese lesson program is available for \$29.95 on a double-sided 5-inch floppy disk for the Apple II with 48 K bytes of programmable memory and a single disk drive. For details, contact Computer Translation Inc, Department BPI, POB 7004 University Sta, Provo UT 84602, (801) 224-1169. Circle 546 on inquiry card.

Utilities for the TRS-80 Color Computer

Mint Software's utilities for the Color Computer require 16 K bytes of memory. There are three cassette-based programming utilities available: Renumber, which provides the capability to load a program, renumber and save it; Squeeze, which will compress BASIC code to utilize minimum memory; and Merge, which allows two separate programs on cassette to be merged and saved. Other aids for cross-referencing line numbers and variables are available. The programs cost \$19.95. A 16 K-byte memory expansion is also available for \$70. Contact Mint Software, 6422 Peggy St, Baton Rouge LA 70808, (504) 766-2318.

Circle 547 on inquiry card.

DMADOS for 8080/Z80 Systems

DMADOS is a single-user, CP/M-compatible 8080 and Z80 disk operating system. It maintains up to sixteen user-defined passwords, allows files to be declared write-protected or invisible to the directory, and can function as a batched console processor. Using DMADOS, up to six print files can be sent to a background print task for printing. User-oriented prompting and error messages are provided.

DMADOS offers support for floppy- and hard-disk files of up to 4.2 megabytes. It is supplied with several utilities and a manual. DMADOS is available on 8-inch floppy disks or North Star double/quad-density formats. For more information on this \$200 operating system, contact John D Owens Associates Inc, 12 Schubert St, Staten Island NY 10305, (212) 448-6283.

Circle 548 on inquiry card.

Electronics Designers Program

Wiremaster is for small electronics companies with printed-circuit layout and wrapped-wire prototyping production problems. Connection data is derived from the schematic diagram and fed to Wiremaster in a CP/M text file. Outputs include a network map showing all pins and wires, a wire list sorted by lengths and levels, a parts list, and checklists that detect all wiring errors. The resulting information can then be used for printed-circuit-board layout, error checking, wiring, component stuffing, and system debugging.

Wiremaster comes on a single-density 8-inch CP/M floppy disk with a manual for \$150. It runs on Z80 and TRS-80 Model II CP/M systems with 48 K bytes of memory. Contact Afterthought Engineering, 7266 Courtney Dr, San Diego CA 92111, (714) 277-7863.

Circle 549 on inquiry card.

Dragonquest

In a race against the sun, you search for Smaegor, Monarch of Dragonfolk, who has kidnapped the Princess of the Realm and holds her in an unknown place. You must search the land, seeking the tools needed for the ultimate battle. On the river Delta and in the Temple of Baathteski, clues abound. But where is the Princess? This is the scenario of Dragonquest, an adventure game from The Programmer's Guild, POB 66, Peterborough NH 03458, (603) 924-6065. It runs on TRS-80 Model I microcomputers, and costs \$15.95 on cassette or \$21.95 on a floppy disk.

Circle 550 on inquiry card.

INCREDIBLE? BELIEVE IT!

PRINTERS



150 cps bidirectional-9x9 dot matrix, quietized case, 136 col, vertical form control and many other functions

\$1195

We feel this printer offers the best price/performance ratio available. RS-232 serial to 19,200 baud

supporting X-ON, X-OFF or Current Loop — add \$40



Teletype 40, 300 LPM-typewriter quality, RS-232 interface. This quality printer is available in many configurations including forms access, quietized case, etc.

Only from **\$2495**

Teletype 43

from **\$995**

NEC Spinwriter-55 cps, bidirectional, letter quality

R.O./tractors **\$2795** KSR/tractors **\$3050**

DIABLO 630-40 cps, bidirectional, daisy wheel, plot/graph **\$2270**

C. ITOH Starwriter, 25 cps, daisy wheel **\$1575**

C. ITOH Starwriter, 45 cps, daisy wheel **\$1849**

EPSON MX-80, 80 cps, 9x9 dot matrix **\$545**

ANADEX 9500/9501, up to 200 cps, high resolution dot **\$1349**

OKIDATA Microline 80, 80 cps, 9x7 dot matrix **\$525**

Microline **82**, bidirectional, friction/pin feed **\$625**

Microline **83**, bidirectional, 120 cps, uses 15" paper **\$995**

T1-810, 150 cps, Basic **\$1695**

Package-Compressed print, vertical form control **\$1830**

CENTRONICS 704-9,180 cps, 9x9 dot matrix, 132 col, RS-232 **\$1595**

704-11,180 cps, 9x9 dot matrix, 132 col, parallel **\$1695**

730,100 cps, 7x7 dot matrix, same as R.S. LPII **\$660**

737,80 cps, nx9 dot matrix, same as R.S. LPIV **\$849**

proportional spacing

DEC LA-34 **\$1085**

S-100 SPECIALTIES



These high quality, reliable products have made CCS defacto industry standard for S-100 products Assembled and tested:

2200 H.D. Mainframe, 20 a. P.S., 12 slot MB **\$434** **\$399**

2065C 64K dynamic RAM/Bank Select **\$720** **\$580**

2810A Z-80 CPU, serial port, ROM monitor **\$310** **\$259**

2422A Floppy Cont, CP/M 2.2, ROM monitor **\$425** **\$345**



CB2 Z-80 CPU **\$344** **\$295**

2P + 2S I/O interface **\$290** **\$249**

Similar savings on the full S-100 and Apple lines of **CCS, SSM, NNC, MORROW, DELTA, NORTHSTAR, ITHACA INTERSYSTEMS** and **GODBOUT**.

TERMINALS

TELEVIDEO 912 C **\$950** **\$725**

920 C **\$1030** **\$789**

950 **\$call**

SOROC IQ 120 **\$995** **\$729**

IQ 140 **\$1395** **\$1149**

INTERTUBE III or **EMULATOR** (multi-terminal) **\$call**

DEC VT-100 **\$2050** **\$1575**

Similar savings for our **HAZELTINE** and **LEAR SIEGLER** lines

5 1/4" DISK DRIVE SALE

MPI 8-51 40 track, 102K Byte drives. These drives come complete with enclosure and power supply. They can be mixed with each other and Radio Shack® drives on the same cable. 90 day warranty. **ONLY \$314**

8" DISK DRIVE SALE

8" SHUGART SA801R

Premium double sided drives: **8" SHUGART SA851R**

\$425

\$625

2 for **\$1190**

QUME DATATRACK 8

\$650

2 for **\$1250**

Enclosure, power supply for 2 8" drives (horizontal) **A&T**

NNC industrial grade enclosure for 2 drives with P.S. **\$299**

POWER 1, power supply for 2 8" drives **\$415**

MORROW Discus 20 + CP/M® **\$135**

Discus 2 + 2 + CP/M® **\$963**

Discus 2 + 2 + CP/M® **\$1259**

HARD DISK SPECIALS

CORVUS 10MB and controller **List \$5350** **only \$call**

20MB and controller **\$call**

Constellation Network Multiplexer **\$750** **\$call**

Mirror Video Tape Disk Backup **\$790** **\$call**

MORROW 29MB + controller + CP/M 2.2® **\$4995** **\$3995**

CAMEO cartridge drive controller **\$1500** **\$1275**

controller, **CDC Hawk Drive** (5 fix, 5 rem) **\$6995** **\$5995**

controller, **Western Dynex** (5 fix, 5 rem) **\$5995** **\$5099**

We carry the full line of **KONAN** disk and tape controllers and subsystems.

FULLY CONFIGURED BUSINESS SYSTEMS

The following are some examples of the fully assembled and tested business and scientific computer systems which we offer. All include CP/M 2.2, 64K bytes dynamic RAM, Z-80A 4mh CPU. We offer a full line of quality, tested software.

CCS 2210A w/floppy controller, 1 serial port **\$1849**

CCS 300-1A w/1.2MB floppy drives, 2 serial, 2 parallel ports **\$4849**

CCS 400-1A w/10MB hard disc, 2 serial, 2 parallel ports **\$6999**

Optional CP/M for **CCS 300, 400** (OASIS available) **\$150**

NNC 80 w/1MB floppy drives, 2 serial, 3 parallel ports **\$3799**

NNC 80W w/.5MB floppy, 8.4MB hard disc, (OASIS optional) **\$6693**

ALTOS single and multi-user systems **\$call**

MORROW Decision 1, MICROSOFT basic, UNIX **\$call**

PERSONAL COMPUTERS

APF Imagination Machine, basic, color, sound, tape, etc. **\$399**

ATARI 400 **\$512**

800 with 16K RAM **\$895**

LOOK HERE!

NNC 2 board set Z-80A CPU, CP/M 2.2, floppy disc controller

2 serial, 3 parallel ports, PROM, I/O cable **\$765**

SUPERBRAIN **\$call**

OSBORNE book-keeping programs (unaltered, require C-BASIC 2)

includes comprehensive documentation

General Ledger, Payroll, Account Rec./Payable each **\$99**

all three **\$250**

TCS business software G/L, Payroll, A/R, A/P each **\$150**

all four **\$500**

ALL OF OUR PERIPHERALS CAN BE CONFIGURED FOR RADIO SHACK® MODEL II

DEALER and INTERNATIONAL INQUIRIES WELCOME

WASHINGTON COMPUTER SERVICES

an affiliate of **WASHINGTON ELECTRIC COMPANY** est. 1912

CUSTOM COMPUTER ROOM WIRING SINCE 1960

97 Spring Street

New York, N.Y. 10012

Hours: 8AM-5:30PM (EST) Mon.-Fri.

TO ORDER: CALL OUR TOLL-FREE NUMBER:

★ (800) 221-5416 ★ In N.Y. State and for technical information call 1-(212) 226-2121

For fast delivery, send certified checks, money order or call to arrange direct bank wire transfers. Personal or company checks require two to three weeks to clear. All prices are mail order only. Prices subject to change without notice; call for latest prices. Prices include 2% cash discount. N.Y. residents add sales tax.

Radio Shack® is a trademark of the Tandy Corp. CP/M® is a trademark of Digital Research



What's New?

MISCELLANEOUS

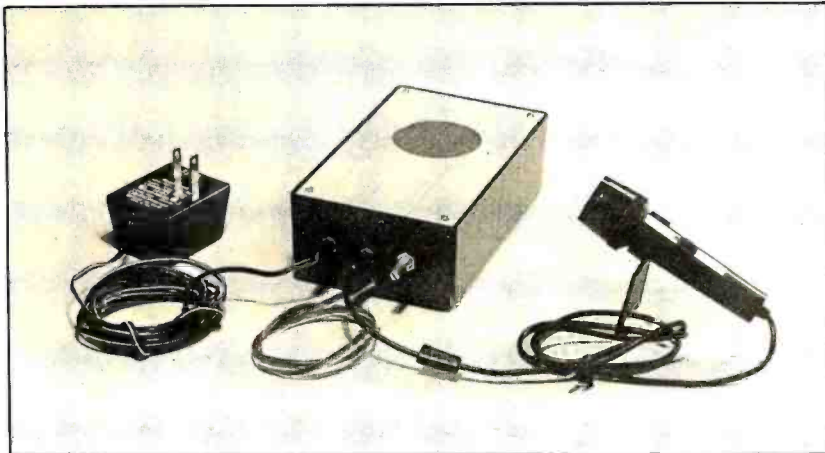

Voice Recognition for Z80 Systems

The Cognivox Model VIO-232 voice peripheral is designed for microcomputers using the Z80 microprocessor with a minimum-size programmable memory of 16 K bytes. The VIO-232 can be programmed to recognize words or short phrases from up to 32 entries, and it can answer with up to 32 words or short phrases. The

recognition and voice response vocabularies can be different, allowing a dialogue with the computer. Vocabularies larger than 32 words are possible. The Cognivox VIO-232 includes a microphone, power supply, amplifier, speaker, and manual. The price is \$149 from Voicetek, POB 388, Goleta CA 93116.

Circle 551 on inquiry card.

RS-232C-to-Current-Loop Adapter

The ADA400 is a bidirectional RS-232C-to-current-loop adapter, ideal for use with KIM-1 microcomputers. It allows the utilization of an RS-232C-interface terminal instead of a current-loop-interface teletypewriter. The ADA400 does not alter the data-transfer rate. It uses standard power supplies with low current requirements. The adapter can be modified to become an RS-232C-to-TTL (transistor-transistor logic) and TTL-to-RS-232C adapter. The ADA400 retails for \$24.50. More information can be obtained from Connecticut microComputer Inc, 34 Del Mar Dr, Brookfield CT 06804, (203) 775-4595.

Circle 552 on inquiry card.

Record-Retrieval System for PL/I-80

BT-80 is a single-user record-retrieval system based on the B-tree index-organization technique. BT-80 is useful in PL/I-80 applications where single- or multi-keyed access to data records is required. Its facilities can be accessed from PL/I-80 or assembly-language application programs. The system includes utilities that provide access to command-level functions.

BT-80 runs under the CP/M 2.0, MP/M, and CP/NET operating systems. To operate, BT-80 requires the PL/I-80 runtime library and LINK-80 linkage editor. For complete details, contact Digital Research, POB 579, 801 Lighthouse Ave, Pacific Grove CA 93950, (408) 649-3896. Circle 553 on inquiry card.

Battery Backup for the PET

Backpack is a battery backup system for the Commodore PET. It is designed for installation within the computer case. Backpack provides 6 to 10 minutes of full-power emergency backup to the computer (video display included) during power failures. The batteries are recharged from the computer's power supply. No special wiring is needed to install the device. Backpack comes assembled for \$225.

For more information, contact ETC Corporation, POB G, Apex NC 27502, (919) 362-4200.

Circle 554 on inquiry card.

Datapro Rates Word-Processing Systems

Thirteen word-processing systems have been named to the 1980 Datapro Honor Roll. Selection of these systems was based on results of a mail survey, which is contained in a thirty-page report, Word Processing Systems User Ratings. This report also contains general information about word-processing systems. The report is available for \$15 from Datapro Research Corporation, 1805 Underwood Blvd, Delran NJ 08075, (609) 764-0100.

Circle 555 on inquiry card.

Floppy-Disk Carrier Case

The En Route case carries up to fifty 8- and 5-inch floppy disks during travel. It is small enough to fit under an airplane seat. The case has a polyethylene inner lining to prevent dust buildup. A key lock is included. The En Route case costs \$65 from Inmac, 2465 Augustine Dr, POB 4780, Santa Clara CA 95051, (408) 727-1970.

Circle 556 on inquiry card.

Let onComputing be your guide to personal computing.

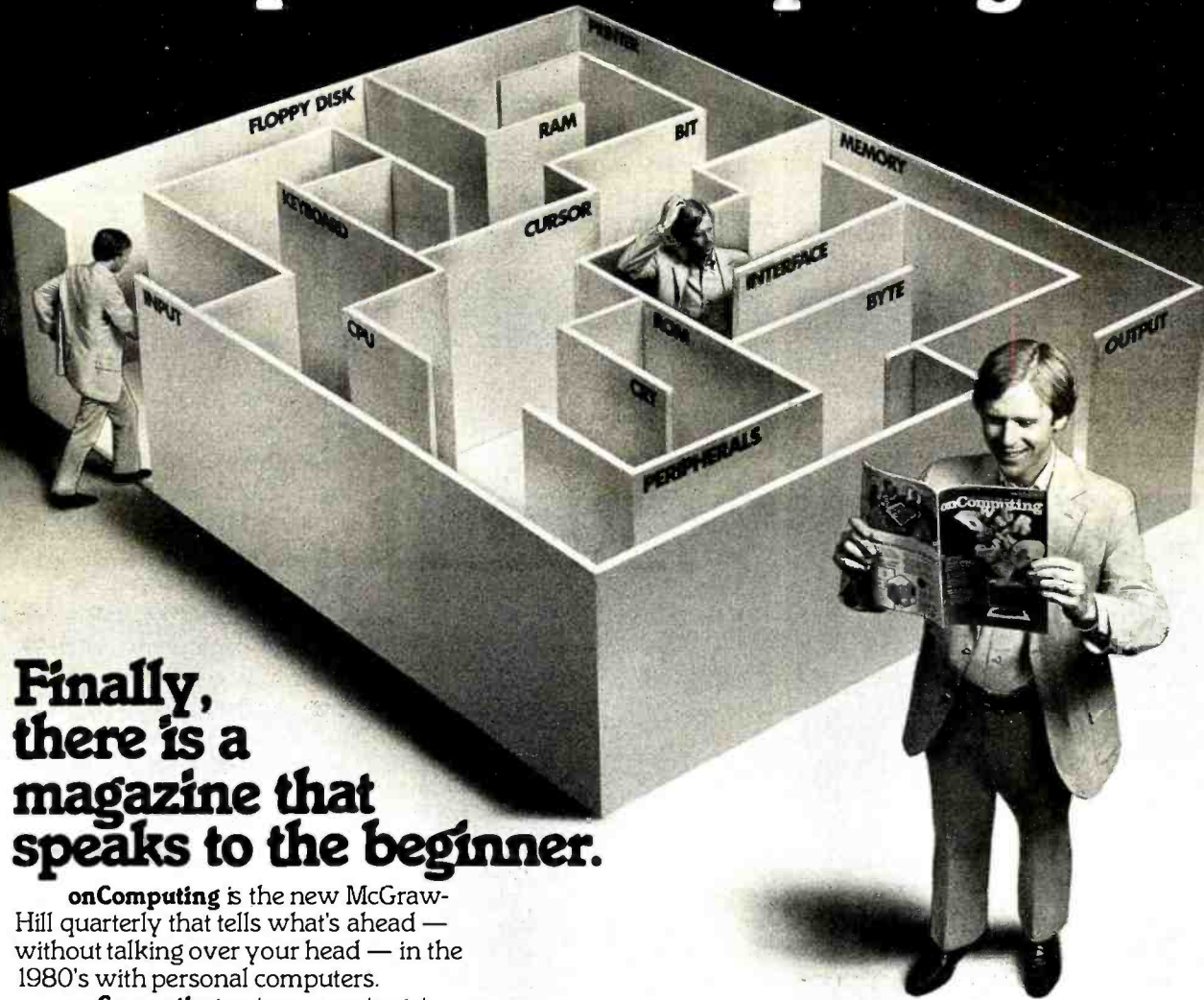

**Finally,
there is a
magazine that
speaks to the beginner.**

onComputing is the new McGraw-Hill quarterly that tells what's ahead — without talking over your head — in the 1980's with personal computers.

onComputing puts you on target with all the applications that go beyond your imagination.

- Personal computers in the home.
- Classrooms.
- They bring computer music.
- Electronic mail.
- Robots.
- They manage your personalized investment.
- The list goes on and on in **onComputing**.

If you're a beginner with personal computers, get the most understood magazine on computers, **onComputing**. And even if you're an experienced computer user, **onComputing** has the information you need in today's fast-growing personal computer market.

onComputingTM



Get onto onComputing. Call 800-258-5485.

onComputing Subscription Dept. P.O. Box 307, Martinsville, NJ 08836

7861

DOMESTIC subscription rate:

U.S. 1 yr. (4 issues) @ \$8.50 Canada & Mexico, 1 yr. (4 issues) @ \$10.00

FOREIGN (to expedite service, please remit in U.S. funds drawn on a U.S. bank)

Europe (and all other countries, except above), 1 Yr. @ \$12.00 — surface delivery.

Bill Visa Bill Master Charge Bill me (North America only)

Card Number

Expiration

Signature

Name (please print)

Street/Apartment Number

City

State/Province/Country Code

Please allow 6-8 weeks for processing

What's New?

MISCELLANEOUS

Universal Development System

The UDS-1000 universal development system is a floppy-disk-based system that uses the Z80 microprocessor. Various cross-assemblers for software development are supplied from a selection including the Texas Instruments TMS1000 and the TMS-1400 series; Rockwell R6500/1, MM75, -76, -77, and -78 series; Motorola 6800; Mostek 3870; Intel 8748, 8048; RCA 1802; NSC COP 420; OKI OLMS42; and other microprocessors. In addition to the cross-

assembler, a ROM (read-only memory) emulation board for prototype testing and an EPROM (erasable programmable ROM) programmer are included. The price of the system, including 64 K bytes of programmable memory, a 24-line by 80-character video terminal, an 80 cps (characters per second) printer, ROM emulation, and the EPROM programmer board, is \$8750. For information, contact Multitech Electronics Inc, 10322A N Stelling Rd, Cupertino CA 95014, (408) 252-4212.

Circle 557 on inquiry card.

Spelling Error Detection/Correction Package

Proof/it is a set of programs that scans the words in a text file and compares them with those in one or more dictionaries. Words that are not found are flagged as possible errors. Correctly spelled words can be added automatically to the dictionary. Corrections can be directly substituted for incorrectly spelled words in the text file. A package including manual and software on a floppy disk with over 10,000 words in the dictionary is \$125. Software on a 5-megabyte hard-disk pack with over 30,000 words in the dictionary is \$100 more. The manual can be purchased separately for \$10.

Proof/it runs on Alpha Micro AM-100 computers with 32 K bytes of memory. For information, contact Datalab Inc, 617 E University, Suite 250, Ann Arbor MI 48104, (313) 995-0663.

Circle 559 on inquiry card.

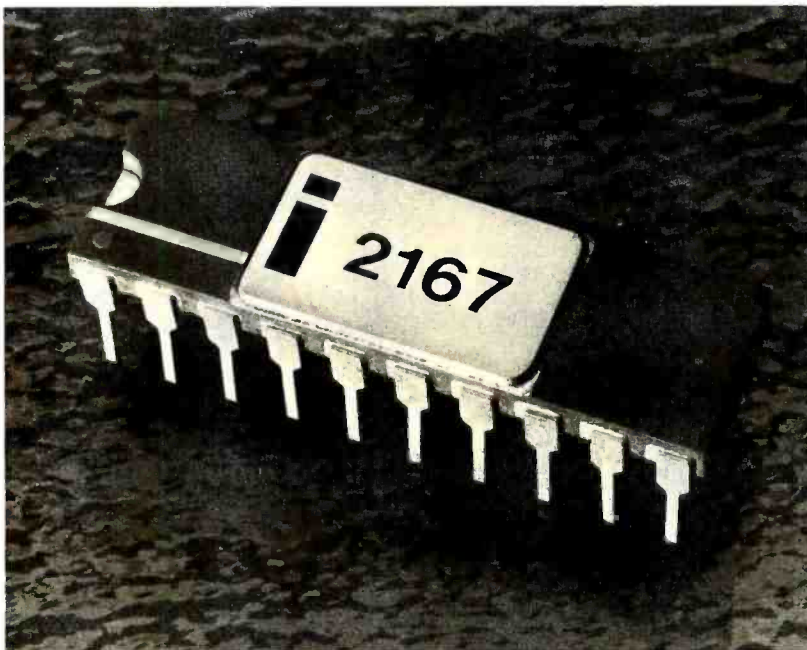

16 K by 1-Bit Static Memory

The 2167 is a 16 K by 1-bit programmable static memory device from Intel. The 2167 can replace Intel's 2147 and 2141 static circuits. Compared to these devices, the 2167 has a greater density and lower power consumption. It also has a 55 ns access speed. The HMOS (high-performance metal-oxide semiconductor) device does not require clocking or

timing strobes. The 2167's inputs and outputs are TTL-compatible and are unlatched. Address setup and hold timings are not required.

Prices for the 2167 are \$68.55 per unit, in quantities of 100. For further details, contact Intel Corporation, 3585 SW 198th Ave, Aloha OR 97005, (503) 642-6344.

Circle 558 on inquiry card.

Daisy-Wheel Printer

The Starwriter letter-quality daisy-wheel printer runs at 25 cps. The Starwriter comes with a Centronics-compatible parallel interface, and uses Diablo ribbons and print wheels. The Starwriter has graphics capabilities and is code-compatible with Oume and Diablo printers. The printer accommodates paper widths of up to 38 cm (15 inches), and can make three copies. The Starwriter is available for \$1779 from Computer Textile Inc, 10960 Wilshire Blvd, Suite 1504, Los Angeles CA 90024, (213) 477-2196.

Circle 560 on inquiry card.

INSULATION DISPLACEMENT SOCKETS

RIGHT ANGLE HEADERS

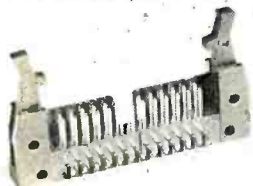

Pins	PC Mounting	Wire Wrap
10	IDH10SR .80	IDH10WR 1.75
20	IDH20SR 1.25	IDH20WR 2.75
26	IDH26SR 1.85	IDH26WR 3.60
34	IDS34SR 2.15	IDH34WR 4.15
40	IDH40SR 2.50	IDH40WR 4.90
50	IDH50SR 3.15	IDH50WR 6.15

EJECTOR EARS .25 EACH

CARD EDGE CONNECTORS



Pins	Part No.	Price
10	IDE10	3.25
20	IDE20	3.50
26	IDE26	4.05
34	IDE34	4.85
40	IDE40	5.65
50	IDE50	5.90

RIBBON CABLE

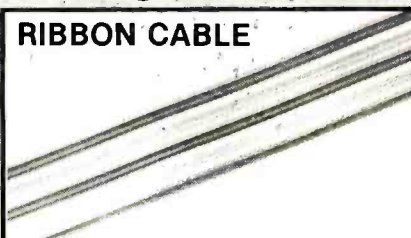

	Conductors: Solid Color		Color Coded	
	10 ft.	100 ft.	10 ft.	100 ft.
10	2.90	17.00	4.00	30.00
14	3.40	23.80	5.00	42.00
16	3.70	27.20	5.60	48.00
20	4.40	34.00	7.00	60.00
24	5.00	40.80	8.00	72.00
26	5.40	44.20	8.60	78.00
34	6.80	57.80	11.00	102.00
40	7.80	68.00	13.00	120.00
50	9.50	85.00	16.00	150.00

25 PIN "D" CONNECTORS



Style	Part #	Price
SOLDER STYLE		
Male	DB25P	.2.25
Female	DB25S	3.00
Hood	DB25C	1.10
INSULATION DISPLACEMENT		
Male	IDC25P	4.95
Female	IDC25S	5.25
Hood	IDC25C	1.35

SOCKETS



Pins	Part No.	Price	Stain Relief
10	IDS10	1.25	.25
20	IDS20	2.02	.25
26	IDS26	2.65	.25
34	IDS34	3.50	.25
40	IDS40	4.05	.25
50	IDS50	5.06	.25

CABLE PLUGS



Pins	Part No.	Price
14	IDP14	1.25
16	IDP16	1.40
24	IDP24	2.25
40	IDP40	3.65

WIRE WRAP WIRE

WIRE KITS

Length	100/Bag	500/Bag	1K/Bag	Length	100/Bag	500/Bag	1K/Bag	Kit No. 1	\$9.95	Kit No. 3	\$32.95
2.5"	\$1.25	\$3.58	\$ 6.19	6.5"	\$1.92	\$6.44	\$11.81	250 3"	100 4 1/2"	500 2 1/2"	500 4 1/2"
3.0"	1.30	3.86	6.78	7.0"	1.99	6.76	12.44	250 3 1/2"	100 5"	500 3"	500 5"
3.5"	1.37	4.15	7.37	7.5"	2.08	7.07	13.09	100 4"	100 6"	500 3 1/2"	500 5 1/2"
4.0"	1.42	4.44	7.94	8.0"	2.14	7.38	13.73			500 4"	500 6"
4.5"	1.48	4.74	8.54	8.5"	2.18	7.69	14.36	Kit No. 2 \$24.95 Kit No. 4 \$59.95			
5.0"	1.54	5.04	9.13	9.0"	2.24	8.11	15.01	250 2 1/2"	250 5"	1000 2 1/2"	1000 4 1/2"
5.5"	1.58	5.38	9.72	9.5"	2.30	8.32	15.65	500 3"	100 5 1/2"	1000 3"	1000 5"
6.0"	1.65	5.66	10.31	10.0"	2.39	8.71	16.28	500 3 1/2"	250 6"	1000 3 1/2"	1000 5"
								500 4"	100 6 1/2"	1000 4"	1000 6"
								250 4 1/2"	100 7"		

Kynar precut wire. All lengths are overall, including 1" strip on each end. Colors and lengths cannot be mixed for quantity pricing. Choose from colors Red, Blue, Black, Yellow, White, Green, Orange, and Violet.

ORDERING INFORMATION:

- Orders under \$25 include \$2 handling
- All prepaid orders shipped UPS Ppd.
- Visa, MC & COD's charged shipping.
- All prices good through cover date.
- Most orders shipped same day.
- Byte must be mentioned to get sale price.

Write or call for 1981 catalog

- IC Sockets
- Vector Board & Pins
- Bishop Drafting Aids
- OK Tools
- RN IDC Crimp Connectors

"NEW" WIRE WRAP SOCKETS FEATURING A SELECTIVE PLATING METHOD THAT WILL SAVE YOU MONEY BY HAVING GOLD ONLY WHERE IT COUNTS.

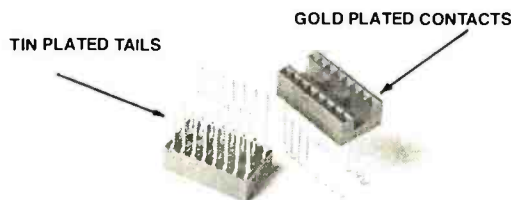

3 Level closed entry.

RN Side Wipe contact design gives twice the contact area for high reliability.

Size	Quantity/Tube	Price ea.*	Price/Tube
8	52	.41	21.32
14	30	.47	14.10
16	26	.51	13.26
18	23	.70	16.10
20	21	.87	18.27
22	19	.94	17.86
24	17	.96	16.32
28	15	1.25	18.75
40	10	1.70	17.00

*FOR REFERENCE. MUST BE ORDERED IN TUBE QUANTITIES.

TOLL FREE ORDERING NUMBER 1-(800)-423-7144

What's New?

MISCELLANEOUS

Memory Board for the SBC 86/12A

The CI-8086 memory board is designed for Intel's Intellec SBC 86/12A microcomputer. Available with 32 K to 512 K bytes on a single board (depending on what memory components are used), the module is compatible with 8- and 16-bit Multibus-based systems. The CI-8086 generates and checks even parity with selectable interrupt on parity error. It features a 250 ns data-access time and a 375 ns cycle time. The memory is addressable in 16 K-byte increments up to a total of 16 megabytes of memory. Power consumption is under 8 W. The price is \$1500 for the 128 K-byte

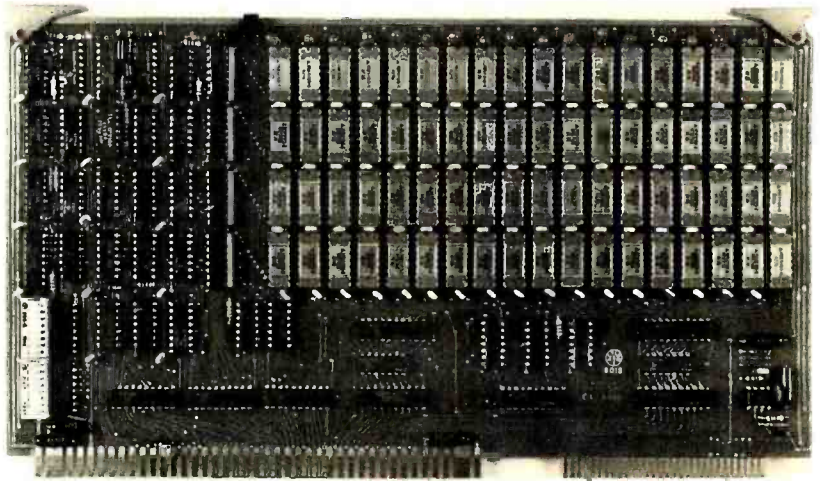

board and \$4700 for the 512 K-byte module. The CI-8086 is available from Chrislin Industries Inc, 31352 Via Colinas, #102,

Westlake Village CA 91361, (213) 991-2254.

Circle 561 on inquiry card.

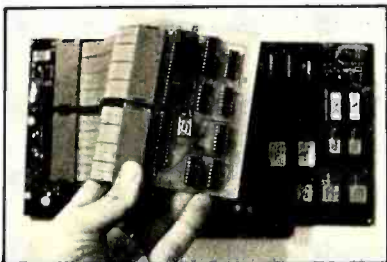

Replace an 8080 with an 8085

A 50 to 250% throughput increase can be achieved with the Series II Microprocessor Enhancement Modules. These modules perform 8080A in-circuit emulation using a code-compatible 8085A-2 microprocessor. Installation requires less than five minutes, involving only the replacement of the system 8080A processor and status latch with connectors. The modules are offered for most 8080A products at \$350 in OEM (original equipment manufacturer) quantities. An Evaluation Design Pack is available for \$500. Contact Paragon Systems Inc, POB 2050, Corvallis OR 97330, (503) 758-1029. Circle 562 on inquiry card.

12-Bit CMOS Converters

The DAC1218 and the DAC1219 are 12-bit CMOS (complementary metal-oxide semiconductor), 4-quadrant, multiplying, D/A (digital-to-analog) converters. The devices offer 12-bit monotonicity, maximum differential linearity error of ± 0.5 LSB (least significant bit), and feature a design technique resulting in TTL (transistor-transistor logic) compatibility. Power-supply voltages can range from +5 to +15 V; typical power consumption is 20 mW. The DAC1218 has a maximum linearity error specification of 0.012%, and the DAC1219 is rated at 0.024%.

In OEM quantities of 100, the DAC1218 sells for \$10.75 each, and the DAC1219 is priced at \$9.75 each. For additional information, contact National Semiconductor Corporation, 2900 Semiconductor Dr, Santa Clara CA 95051, (408) 737-5000.

Circle 563 on inquiry card.

Expand Atari's Memory

The RAMCRAM memory modules can expand the Atari 400's memory to 32 K bytes and the Atari 800's to 48 K. RAMCRAM plugs into the Atari internal memory-module slot, replacing the Atari's module. Each RAMCRAM module contains 32 K bytes of programmable memory. The suggested retail price is \$320.

An 8-slot bus-expansion board for the Atari and Apple microcomputers, with power supply, controller, and software, is available for further memory expansion. This memory-board bus can hold up to eight RAMCRAMs, offering 256 K bytes of programmable memory. Its suggested retail price is \$850.

For further details on both of these devices, contact Axlon Inc, 170 N Wolf Rd, Sunnyvale CA 94086, (408) 730-0216.

Circle 564 on inquiry card.

New Commodore VIC 20 Computer

Now Available

Introducing the first full-featured, expandable color computer priced under \$300!

Now, a new computer — the VIC 20 — offers a full range of special features and expansion capabilities which rival the features of existing microcomputers selling for 4 or 5 times as much!

The new VIC (Video Interface Computer) connects to any television set or monitor and provides 5K bytes of memory.

Check these outstanding features:

- **Color:** 8 character colors, 8 border colors, 16 screen colors
- **Sound:** 4 internal amplifiers including 3 tone (music) generators and 1 sound (noise & sound effects) generator. Each amplifier has 3 octaves. Sound uses a television or monitor speaker.
- **Memory:** 5K RAM (Random Access Memory) expandable externally to 32K RAM
- **Keyboard:** Full typewriter keyboard with special screen editing keys & PET graphics
- **Graphics:** Full PET keystroke graphics
- **Language:** PETBASIC
- **Programmable Function Keys:** 4 programmable function keys (8 separate functions)



- **Plug-In Program & Memory Expansion Cartridges:** (programs plug directly into the back of the computer...each program can be up to 27K)
- **Full Computer Accessories:** disk drive, printer, tape cassette, game controls & more
- **Connects to any TV set/monitor:** (Built-in RF Modulator)

Expansion Features & Peripherals

The VIC 20 is designed so a first time user can begin using it immediately with plug-in program cartridges, and build his system gradually as his needs (or budget) allow.

VIC system peripherals will include a tape cassette unit, single floppy disk drive, printer — and a broad range of add-on accessories which tailor the system to a variety of applications.

FREE with purchase the VIC 20 Personal Computer Manual. This User Manual is very unique as it is the most comprehensive manual ever written for a personal computer. The key ingredient is that no previous knowledge of programming or even typewriting is required. The manual is designed for the first-time owner along with extensive appendices for both the more experienced computerists and the beginners.

A "User Friendly" Computer

The new VIC computer is designed to be the most *user friendly* computer on the market...friendly in price, friendly in size, friendly to use and expand.

With the VIC, Commodore is providing a computer system which helps almost anyone get involved in computing quickly and easily...with enough built-in expansion features to let the system "grow" with the user as his knowledge and requirements become more sophisticated.



ANCRONA

STORES DO NOT ACCEPT MAIL ORDERS

MAIL ORDER

P.O. BOX 2208Y CULVER CITY, CA 90230

PHONE ORDERS (213) 641-4064

VISIT A STORE
NEAR YOU
TODAY...

CULVER CITY

11080 Jefferson Blvd.
Culver City, CA 90230
(213) 390-3595

PORTLAND

1125 N.E. 82nd Ave.
Portland, OR 97220
(503) 254-5541

SUNNYVALE

1054 E. El Camino Real
Sunnyvale, CA 94087
(408) 243-4121

ATLANTA

3330 Piedmont Rd. N.E.
Atlanta, GA 30305
(404) 261-7100

HOUSTON

2649 Richmond
Houston, TX 77098
(713) 529-3489

SANTA ANA

1300 E. Edinger Ave.
Santa Ana, CA 92705
(714) 547-8424

TUCSON

4518 E. Broadway
Tucson, AZ 85711
(602) 881-2348

Clip out this Order Blank and Send For Your Computer Today!

QTY	DESCRIPTION	PRICE	EXTENSION
	VIC-20 Personal Computer	\$299.95	
	Tape Cassette/Recorder	74.95	
	Software Cassettes — 6-Pak	59.70	
	VIC Programming Reference Guide	15.00	

Sub Total

Tax (6% Calif)

Shipping & Handling

5.00

TOTAL



ANCRONA

P.O. BOX 2208Y
CULVER CITY, CA 90230

Name _____

Address _____

City _____ State _____ Zip _____

What's New?

MISCELLANEOUS

Eight Amp Power Supply for OEMs

The CEI Model FD503 is an 8 A power supply that provides outputs of +5 VDC at 8 A, +12 VDC at 2.5 A, -5 VDC at 1 A, -12 VDC at 0.5 A, and +24 VDC at 1.5 A continuous, 4 A surge. Floppy-disk drives can plug into the output connectors of the supply. The FD503 regulates positive outputs to 0.1% and negative outputs to 1%. Options include 100, 115, or 230 VAC power use; AC step-down for 115 V Shugart motors; and interconnecting cables. The CEI FD503 is priced at \$139 each in lots of 100. Contact CEI Corporation, POB 501, Grenier Industrial Park, Londonderry NH 03053, (603) 623-8888.

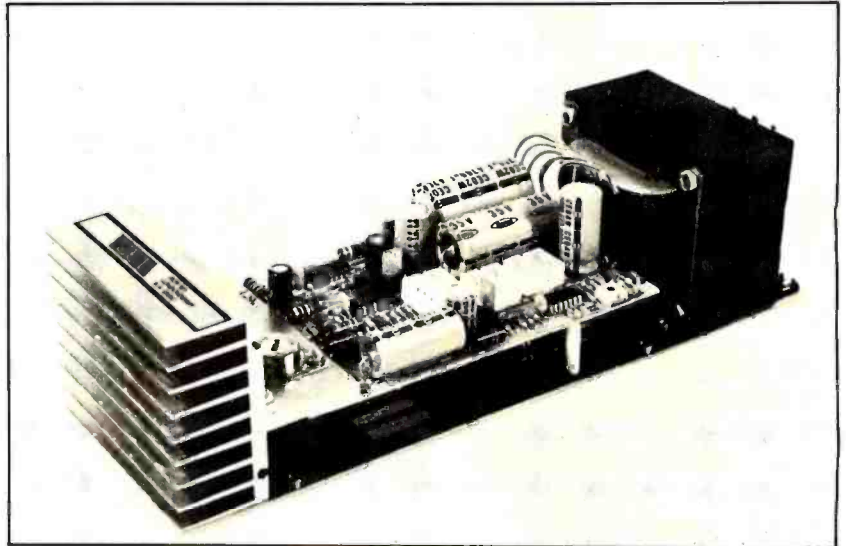

Circle 565 on inquiry card.

Universal Floppy-Disk-Controller Circuit

The TMS9909 floppy-disk-controller integrated circuit can control any floppy-disk drive while interfacing with any 8- or 16-bit microprocessor. It can read

from and write onto partial sectors, read from or write onto single or multiple sectors of hard- and soft-sectored disks, as well as simultaneously control 5- and 8-inch drives. The TMS9909 provides CRC (cyclic redundancy

check); data transfer rates of 125, 250, and 500 k bytes per second with one crystal; hard and soft formatting for 5- and 8-inch disks; and side selection for double-sided disks. Users can program the device for all major track parameters and various track-stepping, settling, and head-loading times. The TMS9909 supports single- and double-density formats on up to four drives. The TMS9909 has a memory-mapped microprocessor interface that supports an external DMA (direct memory access) interface. This allows designers to build only one interface for all floppy-disk formats.

For further details, contact Texas Instruments, Inquiry Answering Service, POB 25012, MS 308, Dallas TX 75265, attn: TMS9909.

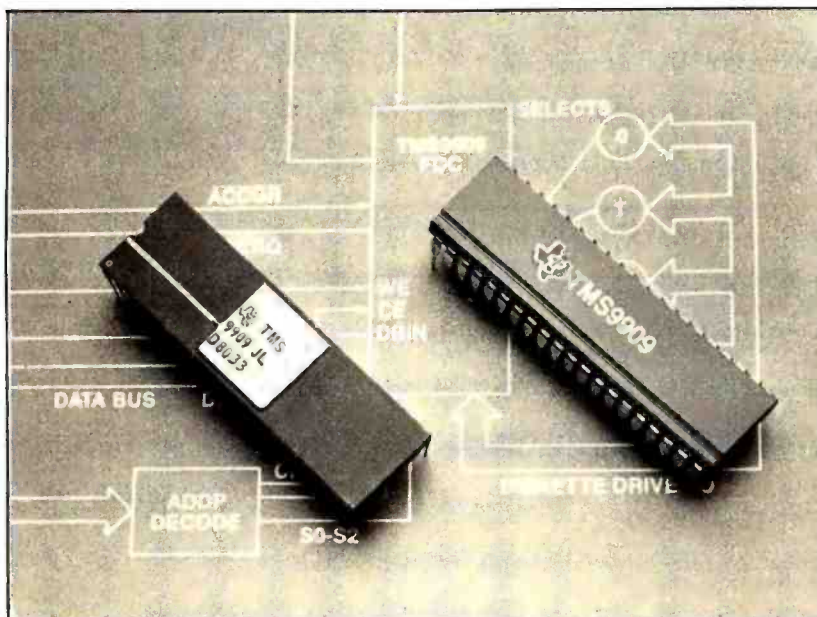

Circle 566 on inquiry card.

COMPUTER STOP

ORDER BY PHONE
MON.—SAT.
10-6

2545 W. 237 St. Torrance, CA. 90505

(213) 539-7670 PST
TELEX: 678401 TAB IRIN

LOWEST PRICES IN THE WEST, NORTH, SOUTH & EAST



APPLE III OPTION A:	3850
APPLE III 96K	
Information Analyst Package	
12" B/W Monitor	
APPLE III OPTION B:	4350
SAME AS OPTION A PLUS:	
DISK II for APPLE III	
APPLE III OPTION C:	4800
SAME AS OPTION A PLUS:	
DISK II FOR APPLE III	
SILENTYPE Thermal Printer	

APPLE HARDWARE

Parallel Printer Interface Card	160
Communications Card	195
High Speed Serial Interface	175
Pascal Language System	425
Centronics Printer Interface	185
Applesoft Firmware Card	160
Integer Firmware Card	160
Disk][with Controller DOS 3.3	529
Disk][only	475
Graphics Tablet	625

OTHER HARDWARE

Alf Music Synthesizer (3 Voice)	245
9 voice	175
ABT Numeric Keypad	119
Micromodem][.....	295
Apple Clock	245
Rom Plus with Keyboard Filter	175
Introl/X-10 System	250
Romwriter	150
DoubleVision 80 x 24 Video Interface	295
CCS Arithmetic Processor	399
CCS Parallel Interface	119
16K Ram Card	195
Microworks DS-65 Digisector	339
SVA 8 inch Disk Controller	335
Sup-R-Mod	30
CCS Synchronous Serial Interface	159
CCS Asynchronous Serial Interface	159
Corvus 10 Meg. Hard Disk	4395
Corvus Constellation	595

MISCELLANEOUS/SUPPLIES

16K RAM (200-250 NS)	49
Verbatim Datalife Diskette (Box of 10)	30
Dysan Diskettes (Box of 5)	22
Apple Diskettes (Box of 10)	45
Verbatim Diskette Boxes (Holds 50 Disks)	18
Silentye Paper (Box of 10 rolls)	40



MONITORS/DISPLAYS

Leedex Video 100 12"	140
Sanyo 9" Monitor	195
KG-12C Green Phos. Monitor	275
Sanyo 12" Green Phosphor. Monitor	275
NEC 12" Green Phosphor. Monitor	275
Sanyo 12" B/W Monitor	250

PRINTERS

Apple Silentye with Interface	525
IDS 445 (Paper Tiger) with Graphics	795
IDS 460 with Graphics	1199
IDS 560 with Graphics 10)	1695
Centronics 737	895
NEC Spinwriter (RO, Serial)	2650

SOFTWARE

The Controller	525
Apple Post (Mailing List Program)	40
Easywriter Professional System	195
Apple Pie 2.0	95
DB Master Data Management	150
The Cashier	210
Apple Writer	65
Visicalc	125
CCA Data Management System	90
Full Screen Mapping for CCA DMS	59
Pascal Interactive Terminal Software (PITS)	29
Basic Interactive Terminal Software (BITS)	29
Data Capture	29
Data Factory DMS	95
Apple Plot	55
Apple Pilot	120
Magic Wand Word Processor (Needs Z-80 Softcard)	345
Dow Jones Portfolio Evaluator	45
Fortran	140

ORDERING INFORMATION: Phone orders Invited using VISA, MASTERCARD or bank wire transfers. VISA & MC credit card service charge of 2%. AE credit card service charge of 5%. Mail order may send charge card number (Include expiration date), cashier's check, money order or personal check (allow 10 business days to clear.) Please include a telephone number with all orders. Foreign orders (excluding Military PO's) add 10% for shipping. All funds must be in U.S. dollars (letters of credit permitted). Shipping, Handling and insurance in U.S. add 3% (minimum \$4.00). California residents add 6% sales tax. Our low margins prohibit us to send COD or on purchase orders or open account (please send for written quotation). All equipment is subject to price change and availability. Equipment is new and complete with the manufacturer warranty. We do not guarantee merchantability of products sold. All returned equipment is subject to a 15% restocking fee. We ship most orders within 2 days.

WE ARE A MEMBER OF THE CHAMBER OF COMMERCE.

RETAIL STORE PRICES MAY DIFFER FROM MAIL ORDER PRICES.

PLEASE SEND ORDERS TO:
COMPUTER STOP, 2545 W. 237 St., TORRANCE, CA 90505



ELECTRONICS CENTER

CALL TOLL FREE

1-800-228-4097

Call Toll Free For
 "Unbelievable"
 Low Low
 Prices On These
 Lines:

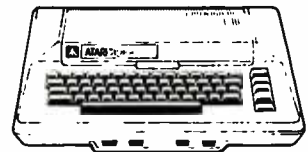

- APPLE — ATARI — BASE 2
- CENTRONICS
- COMMODORE — DC HAYES
- HAZELTINE — LEEDEX
- MACROTRONICS — MAXELL
- MOUNTAIN HARDWARE
- NORTH STAR — PANASONIC
- SANYO — SYNCOM

YOUR

ELECTRONICS PLAYGROUND

1840 "O" Street Lincoln, Nebraska 68508
 In Nebraska Call (402) 476-7331



WE WILL NOT BE UNDERSOLD

DISK DRIVES



FOR TRS-80* Model I
 CCI-100 5 1/4", 40 Track (102K) \$314
 CCI-280 5 1/4", 80 Track (204K) \$429

ADD-ON DRIVES FOR ZENITH Z-89
 CCI-189 5 1/4", 40 Track (102K) \$394
 CCI-289 5 1/4", 80 Track (204K) \$499
 Z-87 Dual 5 1/4" system \$995

External card edge and power supply included. 90 day warranty/one year on power supply.

RAW DRIVES 8" SHUGART 801R \$425
 5 1/4" TEAC or TANDON \$CALL POWER SUPPLIES \$CALL

MORROW DESIGNS/THINKER TOYSTM
 DISCUS 2D 1 DRIVE \$ 938 2 DRIVE \$1635
 DISCUS 2 + 2 1 DRIVE \$1259 2 DRIVE \$2245
 DISCUS Hard Disk M26 \$3990 M10 \$2999

DISKETTES — Box of 10
 5 1/4" Scotch \$35 Maxell \$40 BASF/Verbatim \$26.95
 8" Scotch \$50 Maxell \$55 BASF/Verbatim \$36.00
 PLASTIC FILE BOX—Holds 50 5 1/4" diskettes \$19.00
 PLASTIC LIBRARY CASE 5 1/4" \$3.00 8" \$ 4.00
 SCOTCH HEAD CLEANING DISKETTE \$25.00
 FLOPPY SAVER \$11.95 RINGS \$ 6.95

SYSTEM SPECIAL

Apple II Plus 48K w/drive and controller. Epson MX-80 printer and interface. SUP-R Mod RF Modulator: List \$2965 You Pay \$2299

COMPUTERS/TERMINALS

ARCHIVES 64K, 2-Drives, 77 Track \$5495
 ALTOS ACS8000 Series \$CALL
 TRS-80* II-64K \$3499 III-16K \$ 899
 TRS-80* Expansion Interface \$ 299
 ZENITH 48K, all-in-one computer \$2200
 ZENITH Z-19 \$ 735
 TELEVIDEO 920C \$CALL 950 \$CALL
 IBM 3101 Display Terminal \$1189
 ATARI 400 \$ 479 800 \$ 795
 MATTEL INTELLIVISION \$ 229
 APPLE PERIPHERALS \$CALL

MONITORS

APF 9" B & W TVM-10 \$120
 BELL & HOWELL 9" B & W BHD911 \$199
 LEEDEX 12" B & W \$ 129 13" Color \$369
 SANYO 9" B & W VM4509 \$155
 SANYO 12" B & W DM5012 \$226
 SANYO 12" Green Screen DM5112 \$238
 SANYO 13" Color DMC6013 \$416
 ZENITH 13" Color \$349

TELECOMMUNICATIONS

LIVERMORE STAR MODEM 2-year guarantee \$125
 UNIVERSAL DATA SYSTEMS UDS-103 \$179
 D-CAT HARD WIRED DIRECT MODEM \$189
 AUTO-CAT Auto Answer, Direct Connect Modem \$249
 D.C. HAYES MICRO-MODEM \$329

PRINTERS



NEC Spinwriter
 Letter Quality High Speed Printer R.O. \$2395
 R.O. with tractor feed \$2595
 KSR with tractor feed \$2895

CJTOH Starwriter \$1695 Starwriter II \$1895
 EPSON MX-80 \$CALL MX-70 \$CALL
 PAPER TIGER
 IDS 445 Graphics & 2K buffer \$ 699
 IDS 460 Graphics & 2k buffer \$1050
 IDS 560 Graphics \$1450
 ANADEX DP-8000 \$ 849 DP-9500/01 \$1345
 OKIDATA
 Microline 80 Friction & pin feed \$ 420
 Microline 80 Friction, and pin & tractor feed \$ 520
 Microline 82 Friction & pin feed feed \$ 620
 Microline 83 120 cps, uses up to 15" paper \$ 849
 CENTRONICS 730 \$ 595 799 \$ 969 737 \$ 749
 TI-810
 TRS-80* software, compressed print & vert. form control \$1865

16K RAM KITS 2 for \$37 \$19
 200 ns for TRS-80*, Apple II, (specify): Jumpers \$2.50

S-100 CALIFORNIA COMPUTER SYSTEMS



MAINFRAME Model 2200A \$349
 Z80 CPU Model 2810 \$269
 MOTHER BOARD Model 2501 \$106
 16K STATIC RAM, 200ns Model 2116C \$309
 32K STATIC RAM, 200ns Model 2032C \$619
 64K DYNAMIC RAM Model 2065C \$599
 FLOPPY DISC CONTROLLER Model 2422A \$359
 EXTENDER BOARD Model 2520K \$ 52
 2P + 2S I/O Model 2718A \$309

APPLE ACCESSORIES AND SOFTWARE

VISICALC \$120.00
 DB MASTER \$159.00
 Z-80 SOFTCARD \$269.00
 VIDEX BOARD \$259.00
 16K CARD \$169.00
 APPLE JOYSTICK \$ 49.00
 SUP-R MOD \$ 29.00
 CCS CARDS \$CALL
 GALAXIAN \$ 22.95
 SPACE ALBUM \$ 35.00
 ASTEROIDS \$ 17.95
 FLIGHT SIMULATOR \$ 29.00
 WIZARD & PRINCESS \$ 28.00
 SARGON 2 \$ 29.00
 HI-RES FOOTBALL \$ 35.00
 MYSTERY HOUSE \$ 21.00



For fast delivery, send certified checks, money orders or call to arrange direct bank wire transfers. Personal or company checks require two to three weeks to clear. All prices are mail order only and are subject to change without notice. Call for shipping charges.

DEALER (NATIONAL/INTERNATIONAL) INQUIRIES INVITED

Send for FREE Catalogue

The CPU SHOP

TO ORDER CALL TOLL FREE 1-800-343-6522

TWX: 710-348-1796 Massachusetts Residents call 617/242-3361

5 Dexter Row, Dept. B06M
 Charlestown, Massachusetts 02129
 Hours 10AM-6PM (EST) Mon.-Fri. (Sat. till 5)

Technical Information call 617/242-3361
 Massachusetts Residents add 5% Sales Tax
 Tandy Corporation Trademark® Digital Research
 Circle 97 on inquiry card.





CALIFORNIA COMPUTER SYSTEMS

- 32K RAM BOARD A&T.
- 450 NSEC\$579.95, 200 NSEC\$629.95
- 16K RAM A&T.
- 450 NSEC\$255.95, 200 NSEC\$285.95
- 64K DYNAMIC A&T.
- 200 NSEC\$548.95
- Z80 PROCESSOR A&T.\$259.00
- DISC CONTROLLER\$339.95
- APPLE IEEE INSTRUMENTATION INTERFACE KIT 7490. A & T\$275.00
- ARITHMETIC PROCESSOR FOR APPLE 7811A. A & T\$342.80
- APPLE ASYNCHRONOUS SERIAL INTERFACE 7710A. A & T\$137.10
- APPLE SYNCHRONOUS SERIAL INTERFACE 7712A. A & T\$153.95
- ALL OTHER CCS PRODUCTS AVAILABLE



- PB-1 2708 & 2716 Programming Board with provisions for 4K or 8K EPROM. No external supplies required. Textool sockets. Kit\$143.00
- CB-1A 8080 Processor Board. 2K of PROM 256 BYTE RAM power on/rest Vector Jump Parallel port with status. Kit\$146.00 PCBD\$31.95
- VB-3 80x24 VIDEO BOARD. Graphics included. 4MHZ. Kit\$379.95
- IO-4 Two serial I/O ports with full handshaking 20/80 ma current loop. Two parallel I/O ports. Kit\$168.00 PCBD\$31.95
- VB-IC 64 x 16 video board, upper lower case Greek composite and parallel video with software. S-100. Kit\$143.00
- CB-2 Z80 CPU BOARD. Kit\$199.95
- AIO APPLE SERIAL/PARALLEL KIT\$144.95
- ALL OTHER SSM PRODUCTS AVAILABLE



WAMECO INC.

- MEM-3 32K STATIC RAM 2114 24 bit addressing\$36.95
- FDC-1 FLOPPY CONTROLLER BOARD will drive shugart, pertek, remic 5" & 8" drives up to 8 drives, on board PROM with power boot up, will operate with CPM™ (not included). PCBD\$43.95
- FPB-1 Front Panel. IMSA! size, hex displays. Byte, or instruction single step. PCBD\$48.50
- QM-12 MOTHER BOARD, 13 slot, terminated, S-100 board only\$39.95
- CPU-1 8080A Processor board S-100 with 8 level vector interrupt. PCBD\$28.95
- RTC-1 Realtime clock board. Two independent interrupts. Software programmable. PCBD\$25.95
- EPM-2 2708/2716 16K/32K EPROM CARD. PCBD\$28.95
- QM-9 MOTHER BOARD. Short Version of QM-12. 9 Slots. PCBD\$33.95
- MEM-1 8K x 8 RAM 2102. Buffered PCBD\$31.95
- PTB-1 POWER SUPPLY AND TERMINATOR BOARD. PCBD\$28.95
- IOB-1 SERIAL AND PARALLEL INTERFACE. 2 parallel. one serial and cassette. PCBD\$28.95
- 2708\$7.50 2114L 450 NSEC\$4.99
- 2716\$25.95 2114L 200 NSEC\$5.99

JUNE SPECIAL SALE ON PREPAID ORDERS
(Charge cards not included on this offer)

10% OFF ON WAMECO BARE BOARDS AND WAMECO BARE BOARDS WITH MIKOS PARTS.
7% OFF OF CCS AND SSM KITS BARE BOARDS AND A & T UNITS.

RAM SALE WAMECO 32K RAM WITH MIKOS PARTS. 2114L-3\$289.95
(NOT USABLE IN 10% OFF SALE)

- MIKOS PARTS ASSORTMENT WITH WAMECO AND CYBERCOM PCBDS**
- MEM-3 less RAM\$ 95.95
 - With 2114L-4\$350.00
 - With 2114L-2\$390.00
 - CPU-1 with MIKOS #2 8080A CPU\$99.95
 - QM-12 with MIKOS #4 13 slot mother board\$110.95
 - RTC-1 with MIKOS #5 real time clock\$65.95
 - EPM-2 with MIKOS #11 16-32K EPROMS less EPROMS\$65.95
 - QM-9 with MIKOS #12 9 slot mother board\$99.95
 - FPB-1 with MIKOS #14 all parts for front panel\$144.95
- MIKOS PARTS ASSORTMENTS ARE ALL FACTORY MARKED PARTS. KITS INCLUDE ALL PARTS LISTED AS REQUIRED FOR THE COMPLETE KIT LESS PARTS LISTED. ALL SOCKETS INCLUDED.
- LARGE SELECTION OF LS TTL AVAILABLE PURCHASE \$50.00 WORTH OF LS TTL AND GET 10% CREDIT TOWARD ADDITIONAL PURCHASES. PREPAID ORDERS ONLY.**

MIKOS

MONDAY - FRIDAY, 8:00 TO 12:00, 1:00 TO 5:30
THURSDAYS, 8:00 TO 9:00 P.M.

(415) 728-9121
P. O. Box 955 • El Granada, CA 94018
Please send for IC, Xistor and Computer parts list

VISA or MASTERCARD. Send account number, interbank number, expiration date and sign your order. Approx. postage will be added. Check or money order will be sent post paid in U.S. If you are not a regular customer, please use charge, cashier's check or postal money order. Otherwise there will be a two-week delay for checks to clear. Calif. residents add 6% tax. Money back 30-day guarantee. We cannot accept returned IC's that have been soldered to. Prices subject to change without notice. \$10 minimum order. \$1.50 service charge on orders less than \$10.00.

LEADER Instruments Corp.

Oscilloscopes

2 YEAR WARRANTY
Probes included on all scopes



20 MHz, TRIGGERED
• Single trace, automatic trigger for highly stable, bright display.
• 17.5nSec rise time. • 10mV/cm to 20V/cm Vertical Sensitivity; 11 steps.



20 MHz, DUAL TRACE
• Add, subtract modes on CH-1 & CH-2 facilitate easy checkout for simultaneous pulses, signal levels, distortion & noise cancelling.



30 MHz, VARIABLE DELAYED SWEEP, DUAL TRACE
• Built in variable delay circuitry—1/4 Sec to 5 Sec. • 5mV/Div. Vertical Sensitivity.

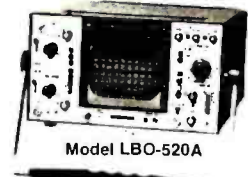

35 MHz, FIXED DELAY, DUAL TRACE
• Dual trace. 35 MHz bandwidth.
• 5mV/cm Vertical Sensitivity; • 10.0 ns

COLOR BAR GENERATORS, BRIDGES, TESTERS.

NTSC Color Bar Pattern Generator

Model LCG-396



- NTSC colorbars
- Provides full field (GV) insertion plus on/off control chroma and luminance
- Better checking and adjusting purity and white balance via red, blue, green wheel rotators
- Dots and single crossbars for convergence, raster and all other alignment requirements
- 75Ω, 100Ω and RF output for TV and VTR equipment
- Equalizing pulse phase locked to color sub-carrier

Completely Portable, Battery Operated TV Color Analyzer

Model LCG-397



- RF, IF composite video outputs
- 0-100% variable color burst for easy chroma service
- 18 convergence patterns — 10-bar gated, 3-bar gated and rainbow patterns
- 3 dot patterns, 2 crosshatch patterns
- 3 vertical lines and 3 horizontal lines plus gear scale
- Oscilloscope trigger outputs
- Battery operated. 4 standard "C" cells 1.5V each

Transistorized LCR Bridge

Model LCR-740



- Highly accurate digital readout
- Measures Inductance (L), Capacitance (C) and Resistance (R) within .05% accuracy
- Readouts variable with built-in 10¹ overrange
- Loss Factor scale (D)
- Operates on 1.9V battery or through built-in AC adapter

FM Multiplex Stereo Generator

Model LSG-231



- RF Composite and Audio Outputs
- Checks separation, balance and alignment in the field on the bench
- 19MHz Pilot signal - 7% accuracy
- 19kHz stereo signal - 7% accuracy
- Composite Stereo output 87MHz, S.C.A. switch selectable
- Extra modulation capability
- Sensitivity peaking meters

Order with Confidence and get the Fordham Advantage!

Call for our prices **TOLL FREE**
(800) 645-9518
in N.Y. State call (516) 752-0050

FORDHAM
855 Conklin St. Farmingdale, N.Y. 11735



- Master Charge
- BankAmericard
- VISA • COD
- Money Order
- Check
- COD's extra

16K MEMORY—\$22.00

FOR APPLE - TRS-80 - EXIDY - S100

NEC—MOSTEK—NATIONAL—FUJITSU

4116 EQUIVALENT

2114-300ns

4116 200NS DYNAMIC RAM 8 for \$22.00
 4116 150NS DYNAMIC RAM 8 for \$28.00

2114 300NS STATIC RAM 8 for \$26.00



IMSAI COMPATIBLE PRODUCTS



I-8080 S-100 ENCLOSURE Sheet Metal Kit

Just like THE ORIGINAL IMSAI: Mainframe with blue cover, cardguides and hardware spaced for PS-28D Power Supply, up to 22 slot motherboard.

- Kit of all metal parts and hardware with documentation* \$115.00
- Thinker Toys WunderBuss 20 for above w/o conn.* \$ 79.50
- S-100 Connectors—each* \$ 3.50
- 8015 Blank jump-start panel w/3 switches* \$ 32.50
- 8035 Jump start panel for 2 SA-400* \$ 78.50

PS-28D Power Supply Parts Kit:

Mounts in the I-8080 enclosure, supplies + 8V @ 28A, +/- 16V @ 3A, kit includes board, transformer, documentation, and all components. Improved from original.

- Kit* \$ 95.50

PIO 4-4

4 parallel inputs and outputs (8212) \$160.00

SIO 2-2 VIO-F

2 serial I/O ports, good to 9600 baud ... \$175.00
 Improved memory mapped video I/O board, includes keyboard port, 256 character EPROM's, firmware, monitor
Assembled & Tested \$275.00

DIO-C/D CPM® 2.2 CPA

2 board disk controller for 8" or 5¼" ... \$350.00
 For DIO including documentation \$175.00
 Improved Imsai style front panel works with Z80, etc. \$225.00

MPU-A MPU-B

8080 processor board—requires CPA .. \$100.00
 8085 3MHz processor SBC w/serial plus parallel port, monitor \$250.00

RAM III 64K MEMORY

64K byte dynamic RAM board—Utilizes the Intel 3242 refresh controller and a single delay line for totally internal refresh. Uses time proven 4116 RAMS. Memory mapped I/O boards are allowed to coexist by the use of phantom. Board select via A16 thru A20 extended address lines.

- Assembled & Tested* \$350.00
- Bare Board w/docs* \$ 40.00

IKB-1 MDX DE 8

Intelligent keyboard uses 8035 \$149.50
 Dual SA400 drive enclosure \$ 75.00
 Dual 800R/801R horizontal style enclosure w/power supply and fan \$240.00
Case Only \$100.00

VIO-X

New port mapped video I/O board w/8085 processor, 8275 CRT controller, keyboard port, firmware. *Assembled & Tested* \$295.00

IEEE 488 + 3P

New IEEE-488 I/O interface with 3 parallel ports. *Assembled & Tested* \$450.00

COMPLETE SYSTEMS

I-8080 SYSTEM

The basic 8080 based S-100 system. Includes CPA front panel, 20 slot 10 MHz motherboard (with all 20 connectors), MPU-A 8080 CPU board, PS-28D power supply (+ 8V @ 28A, +/- 16V @ 3A), and chassis. COMPLETELY ASSEMBLED & TESTED.

- With MPU-A* \$ 680.00
- Without MPU-A* \$630.00

I-8015 Complete System w/MPU-B

The complete 8085 system, includes MPU-B, RAM III, 10 slot terminated motherboard, PS-28D, and jumpstart front panel. A complete 64K system!

- Assembled & Tested* \$1250.00

I-8025 Complete System

Includes I-8015 system and DS-8 Disk system w/CPM 2.2 and disk controller board set.

- Assembled & Tested* \$2700.00

I-8035

The complete 8085 system w/2 each TANDON TM-100 5¼" disk drives, DIO-D, MPU-B, RAM III, chassis, 10 slot motherboard and power supply. Includes CPM® 2.2.

- Assembled & Tested* \$2295.00

VDP-40

Desk-top 8085 micro-computer system with keyboard, 9" CRT display, 10 slot S-100 board, disk controller, 64K dynamic RAM, 2 each TANDON 5¼" disk drives, 28 amp power supply.

- Assembled & Tested* \$2895.00

DS-8

Dual 801R horizontal style 8" disk enclosure w/power supply, fan, and 2 Shugart 801R drives.

- Assembled & Tested* \$1100.00
- Above w/DIO-C & CPM 2.2* \$1500.00

DS-5

Dual 5¼" disk enclosure w/power supply, fan, and room for 2 drives \$ 195.00

Ask about documentation, repair service, firmware and software for your system.



1771 Junction Avenue
 San Jose, California 95112
 (408) 295-7171

TERMS: (1) PREPAID Send check or M.O. for merchandise amount only - we pay the shipping within U.S. only.
 (2) UPS COD or Bankcard orders by phone or mail - shipping charges added.
 California Residents add 6.5% Sales Tax.

SUNNY LOW LOW COST POWER SUPPLIES FOR S-100, FLOPPY DISKS.



KIT 1, 2 & 3 For S-100



R3 For Three 8" or 5 1/4" Disk Drives

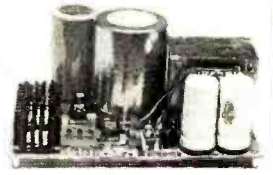

S3 2 in 1 Unit for S-100 and two 8" or 5 1/4" Disk Drives. It fits most Disk System Mainframes.

S-100 POWER SUPPLY KITS (OPEN FRAME WITH BASE PLATE, 3 HRS. ASSY. TIME)

ITFM	USED FOR	@ + 8 Vdc	@ - 9 Vdc	@ + 16 Vdc	@ - 16 Vdc	@ + 28 Vdc	SIZE W x D x H	PRICE
KIT 1	15 CARDS SOURCE	15A		2.5A	2.5A		12" x 5" x 4 7/8"	52.95
KIT 2	SYSTEM SOURCE	25A		3A	3A		12" x 5" x 4 7/8"	59.95
KIT 3	DISK SYSTEM	15A	1A	2A	2A	4A	14" x 6" x 4 7/8"	67.95

DISK DRIVE POWER SUPPLY "R3" REGULATED, OPEN FRAME, ASSY. & TESTED 67.95

SPECS: +5V @ 5A OVP, -5V @ 1A + 24V @ 5A. SHORTS PROTECT. 2 SIZES AVAIL. 1.) 9" (W) x 6 1/4" (D) x 4 7/8" (H), 2.) 9" (W) x 5 3/8" (D) x 5 1/4" (H) OPTION: 1.) REPLACE +24V BY +12V, 2.) FOR SIZE 1 ONLY, ADD +12V @ 1A, AT AN ADDITIONAL \$12.00.
IDEAL FOR THREE 8" or 5 1/4" FLOPPY DISK DRIVES, SUCH AS SHUGART 801/851, SIEMANS FDD 100-8/200-8 OR 100-5 ETC.

DISK SYSTEM PWR SUPPLY "S3" OPEN FRAME, ASSY. & TESTED. COMPACT SIZE: 10" (W) x 6" (D) x 5" (H) 92.95

REGULATED OUTPUTS FOR DISK DRIVES: +5V @ 4A, -5V @ 1A, +24V @ 4A (OR +12V @ 4A). SHORTS PROTECT. UNREGULATED OUTPUTS FOR S-100: +8V @ 14A, +16V @ 3A. (OPTION: ADD OVP FOR +5V. ADD \$5.00)
A COMPLETE UNIT FOR DISK SYSTEM WITH THE MAINFRAME CONTAINING 12 SLOTS & TWO 8" or 5 1/4" DISK DRIVES.

POWER TRANSFORMERS (WITH MOUNTING BRACKETS)

ITEM	PRIMARY	SECONDARY #1	SECONDARY #2	SECONDARY #3	SIZE W x D x H	PRICE
T1	110/120	2 x 8 Vac. 15A	28 Vac. CT. 2.5A		3 3/4" x 3 3/8" x 3 1/8"	21.95
T2	110/120	2 x 8 Vac. 25A	28 Vac. CT. 3.5A		3 3/4" x 4 3/8" x 3 1/8"	27.95
T3	110/120	2 x 8 Vac. 15A	28 Vac. CT. 2.5A	48 Vac. CT. 2A	3 3/4" x 4 3/8" x 3 1/8"	29.95
T4	110/120	2 x 8 Vac. 6A	28 Vac. CT. 1.5A	48 Vac. CT. 3A	3 3/4" x 3 3/8" x 3 1/8"	22.95
T5	110/120	2 x 8 Vac. 6A	28 Vac. CT. 2A		3" x 3" x 2 1/2"	14.95

SHIPPING For each power supply \$5.50 in Calif., \$7.50 in other states, \$14.00 in Canada. For each Transformer \$5.00 in all States, \$10.00 in Canada. Calif. Residents add 6% Sales Tax.

MAILING ADDRESS:
P.O. BOX 4296
TORRANCE, CA 90510

SUNNY INTERNATIONAL
(TRANSFORMERS MANUFACTURER)
(213) 328-2425 MON-SAT 9-6

SHIPPING ADDRESS:
22129 1/2 S. VERMONT AVE
TORRANCE, CA 90502



74LS00	.26	74LS155	1.15
74LS02	.26	74LS158	.75
74LS03	.26	74LS160	.95
74LS04	.26	74LS161	.85
74LS08	.28	74LS162	.95
74LS09	.26	74LS163	1.60
74LS10	.26	74LS164	.65
74LS20	.26	74LS165	.65
74LS21	.28	74LS170	1.75
74LS22	.26	74LS174	.75
74LS26	.49	74LS175	.75
74LS27	.26	74LS190	.75
74LS30	.28	74LS193	.96
74LS32	.32	74LS195	.96
74LS38	.32	74LS196	.85
74LS42	.65	74LS221	1.40
74LS48	.79	74LS240	1.65
74LS51	.25	74LS241	1.65
74LS54	.35	74LS243	1.45
74LS74	.38	74LS244	1.45
74LS75	.60	74LS245	2.25
74LS83	.44	74LS253	.95
74LS85	.95	74LS257	.95
74LS86	.95	74LS258	.95
74LS90	.69	74LS259	2.85
74LS93	.69	74LS279	.44
74LS107	.45	74LS283	1.00
74LS112	.38	74LS293	1.85
74LS113	.48	74LS298	1.20
74LS122	.48	74LS366	.95
74LS123	.95	74LS367	.55
74LS126	.69	74LS368	.55
74LS138	.69	74LS373	1.39
74LS151	.44	74LS374	1.39
74LS153	.44	74LS386	.65

LOGIC PROBE KIT

BUY FIVE OR MORE FOR \$16.95



\$17.95

MISC.

2102	.89
450NS	5/13.25
8038	2.75
NE555	.27
AY5-1013A	3.95
1488	1.25
1489	1.25
8T26	1.30
8T28	1.30
8212	2.95
8216	2.95
IS410SCR	.95
IT410TRIC	.95
7905	.85
7908	.85
7915	.85
7918	.85
7805	.85
7806	.85
7808	.85
7812	.85
MC1330A1P	1.60
MC1350P	1.15
MC1358P	1.50
LM380	1.20
LM565N	.95
LM741	.25
MC1458P	.55
LM720	.30

Apple Expansion Kit
16K Memory Add-On
Includes Instructions
\$19.50

TRS80
16K Add-On
Instructions &
Dip Switches
\$25.95

CPU's	Price
Z-80	8.95
Z-80A CTC	12.50
Z-80A CPU	12.50
Z-80 002 16-64K	129.00
80B5A	11.50
2901A	12.50
MC6800	9.50

concord COMPUTER PRODUCTS

1971 SO. STATE COLLEGE
ANAHEIM, CALIF. 92806
(714) 937-0637

VISA CHECK - M/O
NO COD

\$10. MIN ORDER / CA. RES. ADD 6%
FRT.
10-44\$ 2.00\$ 250-494\$ 8.00
50-99 4.00 500-999 10.00
100-24 7.90 1000-1 12.00

EPROMS/RAM'S

2716	7.25ea	8 for 6.50ea
5V 450NS		
2708	4.25ea	8 for 4.00ea
450NS		
2732	24.50ea	4 for 19.50ea
4116	30.00ea	8 for 17.50
200NS	3.75ea	8 for 19.50
2114L	30.00ea	4 for 13.75
200NS	3.75ea	4 for 14.25

ATARI® 800™
PERSONAL COMPUTER SYSTEM

800 Computer	\$299	\$799
400 Computer	\$439	
80col Imp.Prt'r	\$75	
40col.Th.Prt'r	\$379	
Prog.Rec'd'r	\$65	

VISCALC: APPLE- \$139.00
ATARI- \$179.00

video 100



MSM5832 MICROPROCESSOR \$745

REAL-TIME CLOCK

The MSM5832 is a monolithic, metal-gate CMOS integrated circuit that functions as a real-time clock. Calendar for use in bus-oriented microprocessor applications. The chip has 32 768 Hz crystal-controlled oscillator time base is counted down to provide addressable 0.01 s date of SECONDS, MINUTES, HOURS, DAY OF WEEK, DATE, MONTH, and YEAR. Data access is controlled by 4-bit address; chip selects, read, write and hold inputs. Other functions include 1.2K 24K format serial non-volatile year, identification and manual 30 second correction.

COLOR

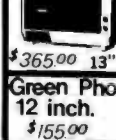

Green Photo 12 inch. \$155.00

apple II plus

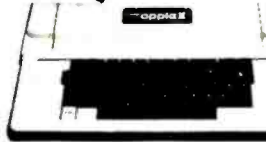

48K: \$1199.00
64K: \$1399.00

With the purchase of the APPLE II select from the below SPECIAL PRICING!

Base2 printer	\$599
Disk II Microl	585
Disk II	475
Ser Printer Cd	175
SupRMod	23
3way I/O Select	33
Video 100 12"	125
Firmware Card	149
UHF/FDCA Cable	5

APPLE VIDEOPACE CARDS

CENTROTEC PLASTER	1.00
COMPUTERTECH Monitor & cables	1.00
BORN IN CONVENTS 4.4 x 1.3	1.00
UTHERS BASIC PRINTER	1.00
ELECTRIC PRINTER	1.00
PLATE UNIFORM PRINTER	4.00
PARALLEL PRINTER	1.00
VIDEO/VIDEO PRINTER	1.00
VIDEO PRINTER	1.00

Logic Probes

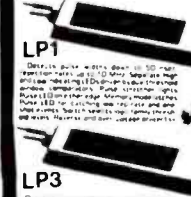

LP1 \$40 LP3 \$60

apple clock/calendar \$124.95

IC SOCKETS

8 PIN	10/120
14	10/140
16	10/160
18	10/190
20	10/280
22	10/280
24	10/280
28	10/380
40	10/475

Logic Probes

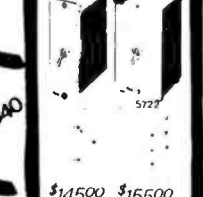

LP1 \$40 LP3 \$60

apple clock/calendar \$124.95

IC SOCKETS

8 PIN	10/120
14	10/140
16	10/160
18	10/190
20	10/280
22	10/280
24	10/280
28	10/380
40	10/475

Logic Probes



LP1 \$40 LP3 \$60

apple clock/calendar \$124.95

IC SOCKETS

8 PIN	10/120
14	10/140
16	10/160
18	10/190
20	10/280
22	10/280
24	10/280
28	10/380
40	10/475

SOROC TECHNOLOGY, INC.



IQ120 \$689

No "Glitches", Surges Or Interference

THE SOROC TURNS AN ORDINARY OUTLET INTO A CONTROLLED POWER SOURCE FOR UP TO EIGHT DEVICES.
\$87.90

6502, Z80, 8080 AND 8085 USERS

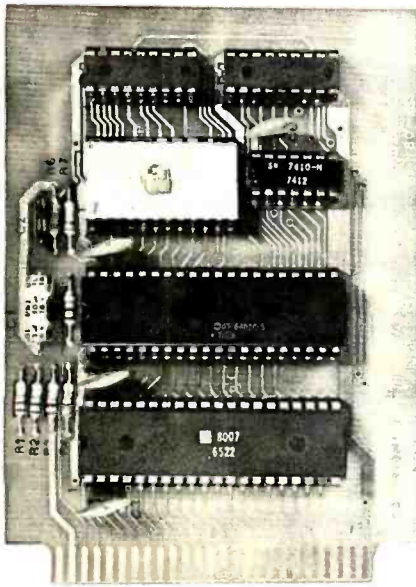

**JOHN BELL
ENGINEERING'S
6502 AND Z80
MICROCOMPUTERS**
ARE DEDICATED COM-
PUTERS DESIGNED FOR
CONTROL FUNCTIONS.

THESE BOARDS FEATURE:

- 2048 BYTES EPROM
- 1024 BYTES RAM
- ALL BOARDS INCLUDE COMPLETE DOCUMENTATION
- 50 PIN CONNECTOR INCLUDED IN KITS AND ASSEMBLED UNITS
- 2716 AVAILABLE SEPARATELY

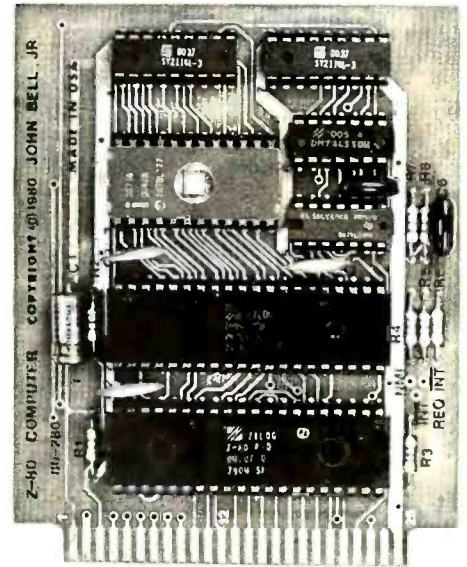

**JOHN BELL ENGINEERING'S 6502
MICROCOMPUTER, 2716 EPROM PROGRAM-
MER AND APPLE II PARALLEL INTERFACE
PLUS THE APPLE II MICROCOMPUTER — A
COMPLETE DEVELOPMENT SYSTEM.**

6502 MICROCOMPUTER FEATURES:

- 1024 BYTES RAM
- 2048 BYTES EPROM
- USES ONE 6522 VIA (DOC. INCL.)
- 2 8 BIT BIDIRECTIONAL I/O PORTS
- 2 16 BIT PROGRAMMABLE TIMER/COUNTERS
- SERIAL DATA PORT
- LATCHED I/O WITH HANDSHAKING LOGIC
- TTL AND CMOS COMPATIBLE

80-153 ASSEMBLED \$110.95
BARE BOARD \$49.95 KIT \$ 89.95

USE YOUR 6502 OR Z80 MICROCOMPUTER TO CONTROL EVERYTHING!

- YOUR HOME SECURITY SYSTEM
- HEAT CONTROL
- LIGHT CONTROL
- SOLAR HEATING AND POWER SYSTEMS
- AUTOMATIC CONTROL OF TAPE RECORDERS
- TRAFFIC LIGHT CONTROL
- IRRIGATION SYSTEMS
- AUTOMATIC CONTROL OF VIDEO RECORDERS
- ROBOT CONTROL
- AUTOMATIC DIALER
- AUTOMATED SLIDE SHOW CONTROL
- COMMUNICATION SYSTEMS FOR THE DISABLED
- THE WORLD

**JOHN BELL ENGINEERING'S NEW Z80
MICROCOMPUTER FEATURES:**

- Z80 CPU SOFTWARE COMPATIBLE WITH Z80, 8080 AND 8085 MICROPROCESSORS
- 2048 BYTES EPROM
- 1024 BYTES RAM
- SINGLE 5V POWER SUPPLY AT 300MA
- CLOCK FREQUENCY IS 2MHZ, RC CONTROLLED
- Z80 PIO (DOC. INCL.)
- 2 8 BIT BIDIRECTIONAL I/O PORTS
- LATCHED I/O WITH HANDSHAKING LOGIC
- TTL AND CMOS COMPATIBLE

80-280 ASSEMBLED \$129.95
BARE BOARD \$49.95 KIT \$119.95



JOHN BELL ENGINEERING

ALL PRODUCTS ARE AVAILABLE FROM: **JOHN BELL ENGINEERING**

P.O. BOX 338 • REDWOOD CITY, CA 94064 • (415) 367-1137

*SEND FOR OUR COMPLETE CATALOG! ADD 6% SALES TAX IN CALIFORNIA. ADD 5% FOR SHIPPING AND HANDLING.

VISA

MASTER
CHARGE



FLOPPY DISK DRIVES

Qume DT-8\$599 — 2/\$1150
 Virtually the industry standard. High quality/reliability. Full featured, double-sided, double density.
 Mitsubishi!!!!!! \$649
 Up & coming potential giant of the double sided/double density realm.

Shugart 851R \$649
 Double sided/double density

Tandon double sided mini-floppy.
 Shugart compatible, double density.
\$350 — 2/\$640

Shugart 800/801R....\$475 — 2/\$900

SA400 mini-floppy. 35 track, double density.....\$299 — 2/\$525

Siemens FDD100-8D\$395 — 2/\$755

SPECIAL SPECIALS (very limited supply)

SBC 80/30 CPU card (used) \$475.
 SBC 604 \$150.
 SBC 614 \$150.
 UDS 103J modem card (used) \$100.
 UDS 801A dialer card (used) \$100.
 all used gear here comes with 90 day warranty.

CRYSTALS ... most major values. Call for case size, etc.

\$2.75/ea. 25/\$2.50 100/\$2.20
 3.57954/\$.99 ea — 100/\$.80

CONNECTORS... many types in stock. IDC, etc. all connectors \$3.00 ea. 50/\$2.75 — 100/\$2.50 — call for particulars —

CONTROLLERS

Tarbell single density kit\$210
 Tarbell single density A & T\$290
 Tarbell double density A & T\$475
 MDA LSI-11 floppy controller\$1175



SPECIAL!! CCS 2422A floppy disk controller with CP/M version 2.2 \$375

FLOPPY POWER SUPPLY: Handles two units with the greatest of ease.



.....\$109



CABLE KITS:
 One drive \$30
 Two \$35
 Three \$40
 Four \$45
 Includes all wire, cable + connectors to hook up most drive systems.

DISKETTES: Single sided \$39/10 — Double sided \$59/10

Qume S/5 — Daisy Wheel Printer

Sprint 5/45 RO \$2699
 Sprint 5/55 RO 2829
 Sprint 5/45 KSR 3029
 Sprint 5/55 KSR 3159
 Forms Tractor 210
 Pinfeed platen 155
 Paper Guide 30
 Paper Basket 50
 many print wheels, ribbons, & more available.

Terms of sale: cash or checks, purchase orders from qualified firms and institutions. Minimum order \$25. CA residents add 6% tax. Prices subject to change without notice. All goods subject to prior sale. Minimum shipping/handling charge \$4.00.

Electrolabs

POB 4436, Stanford, CA 94305 (415) 321-5601

LOBO Add-On Disk Drive Subsystems For Apple, TRS-80, S-100 Based Computers

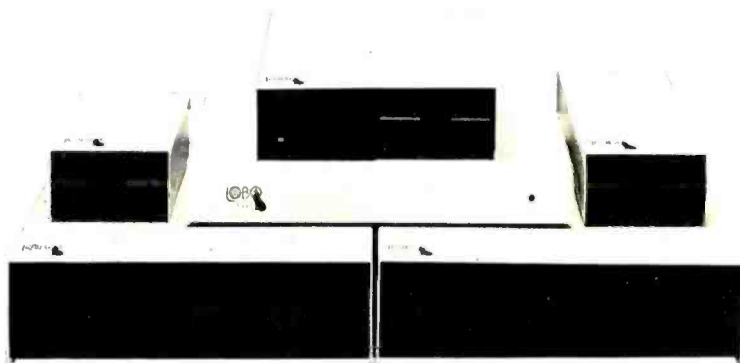

Expansion and enhanced capabilities are key words in achieving full utilization of your computer system. Our complete line of LOBO disk drive subsystems are the ideal, cost-effective way to provide the expansion capabilities you need to meet your system growth requirements. All of our subsystems are complete, thoroughly-tested, 100% burned-in, and feature a 1 year 100% parts/labor warranty.

APPLE

*Double Density Controller

3101 Minifloppy. \$399 3101i Minifloppy w/interface card \$489
 8101CA One SA800 in cabinet w/power, DDC* Controller, cable and manual \$1449
 8202CA Two SA900 in cabinet w/power, DDC* Controller, cable and manual \$1889
 5101CA One SA850 in cabinet w/power, DDC* Controller, cable and manual \$1759
 5202CA Two SA850 in cabinet w/power, DDC* Controller, cable and manual \$2364
 LCA-22 Double Density Controller only \$599

S-100 BASED COMPUTERS

MODEL NO. DESCRIPTION
 4101C SA400 in cabinet w/power \$369
 8212C Two SA801 in cabinet w/power \$1329
 5212C Two SA851 in cabinet w/power \$1799

GENERAL

MODEL NO. DESCRIPTION
 8212C Two SA801 in cabinet w/power \$1329
 5212C Two SA851 in cabinet w/power \$1799

TRS80

MODEL NO. DESCRIPTION
 4101C SA400 in cabinet w/power \$369
 8101C II One SA800 in cabinet w/power for Mod. II \$909
 8202C II Two SA800 in cabinet w/power for Mod. II \$1349
 LX80 Double-density expansion interface \$641
 RS232 Dual Serial Port Option \$75



JR INVENTORY CO.,
 P.O. Box 185, Santa Ynez, Ca., 93460
 (805) 688-8781

DIGITAL RESEARCH COMPUTERS

(214) 271-3538

32K S-100 EPROM CARD

NEW!

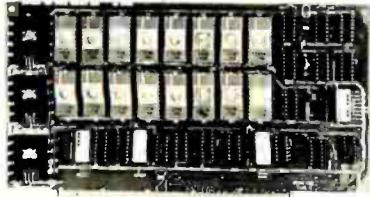

\$79.95
KIT

USES 2716's

Blank PC Board - \$34

ASSEMBLED & TESTED
ADD \$30

SPECIAL: 2716 EPROM's (450 NS) Are \$9.95 Ea. With Above Kit.

KIT FEATURES:

1. Uses +5V only 2716 (2Kx8) EPROM's.
2. Allows up to 32K of software on line!
3. IEEE S-100 Compatible.
4. Addressable as two independent 16K blocks.
5. Cromemco extended or Northstar bank select.
6. On board wait state circuitry if needed.
7. Any or all EPROM locations can be disabled.
8. Double sided PC board, solder-masked, silk-screened.
9. Gold plated contact fingers.
10. Unselected EPROM's automatically powered down for low power.
11. Fully buffered and bypassed.
12. Easy and quick to assemble.

32K SS-50 RAM

\$329.00 KIT

For 2MHZ
Add \$10

Blank PC Board
\$50

For SWTPC
6800 - 6809 Buss

Support IC's
and Caps
\$19.95

Complete Socket Set
\$21.00

Fully Assembled,
Tested, Burned In
Add \$30



At Last! An affordable 32K Static RAM with full 6809 Capability.

FEATURES:

1. Uses proven low power 2114 Static RAMS.
2. Supports SS50C - EXTENDED ADDRESSING.
3. All parts and sockets included.
4. Dip Switch address select as a 32K block.
5. Extended addressing can be disabled.
6. Works with all existing 6800 SS50 systems.
7. Fully bypassed. PC Board is double sided, plated thru, with silk screen.

16K STATIC RAM KIT-S 100 BUSS

PRICE CUT!

\$169.95
KIT

FOR 4MHZ
ADD \$10

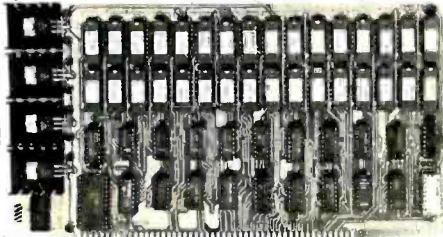

KIT FEATURES:

1. Addressable as four separate 4K blocks.
2. ON BOARD BANK SELECT circuitry. (Cromemco Standard!). Allows up to 512K on line!
3. Uses 2114 (450NS) 4K Static Rams.
4. ON BOARD SELECTABLE WAIT STATES.
5. Double sided PC Board, with solder mask and silk screened layout. Gold plated contact fingers.
6. All address and data lines fully buffered.
7. Kit includes ALL parts and sockets.
8. PHANTOM is jumpered to PIN 67.
9. LOW POWER: under 1.5 amps TYPICAL from the +8 Volt Buss.
10. Blank PC Board can be populated as any multiple of 4K.

BLANK PC BOARD W/DATA-\$33

LOW PROFILE SOCKET SET-\$12

SUPPORT IC'S & CAPS-\$19.95

ASSEMBLED & TESTED-ADD \$35

**OUR #1 SELLING
RAM BOARD!**

16K STATIC RAM SS-50 BUSS

PRICE CUT!

\$159 KIT

FULLY STATIC!

FOR 2MHZ
ADD \$10

FOR SWTPC
6800 BUSS!

ASSEMBLED AND
TESTED - \$35

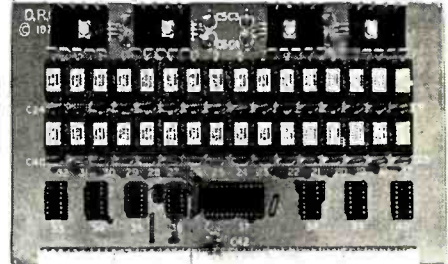

KIT FEATURES:

1. Addressable on 16K Boundaries
2. Uses 2114 Static Ram
3. Fully Bypassed
4. Double sided PC Board. Solder mask and silk screened layout
5. All Parts and Sockets included
6. Low Power: Under 1.5 Amps Typical

BLANK PC BOARD-\$35

COMPLETE SOCKET SET-\$12

SUPPORT IC'S AND CAPS-\$19.95

NEW! STEREO! S-100 SOUND COMPUTER BOARD NEW!

At last, an S-100 Board that unleashes the full power of two unbelievable General Instruments AY3-8910 NMOS computer sound IC's. Allows you under total computer control to generate an infinite number of special sound effects for games or any other program. Sounds can be called in BASIC, ASSEMBLY LANGUAGE, etc.

KIT FEATURES:

- TWO GI SOUND COMPUTER IC'S.
 - FOUR PARALLEL I/O PORTS ON BOARD.
 - USES ON BOARD AUDIO AMPS OR YOUR STEREO.
 - ON BOARD PROTO TYPING AREA.
 - ALL SOCKETS, PARTS AND HARDWARE ARE INCLUDED.
 - PC BOARD IS SOLDERMASKED, SILK SCREENED, WITH GOLD CONTACTS.
 - EASY, QUICK, AND FUN TO BUILD, WITH FULL INSTRUCTIONS.
 - USES PROGRAMMED I/O FOR MAXIMUM SYSTEM FLEXIBILITY.
- Both Basic and Assembly Language Programming examples are included.

SOFTWARE:

SCL™ is now available! Our Sound Command Language makes writing Sound Effects programs a SNAP! SCL™ also includes routines for Register-Examine-Modify, Memory-Examine-Modify, and Play-Memory. SCL™ is available on CP/M compatible diskette or 2708 or 2716. Diskette-\$24.95 2708 - \$19.95 2716 - \$29.95. Diskette includes the source. EPROM'S are ORG at E000H.

4K STATIC RAM

National Semi. MM5257. Arranged 4K x 1. +5V, 18 PIN DIP. A Lower Power, Plug in Replacement for TMS 4044. 450 NS. Several Boards on the Market Will Accept These Rams. SUPER SURPLUS PURCHASE! PRIME NEW UNITS!

8 FOR \$16 32 FOR \$59.95

COMPLETE KIT!

\$84.95

(WITH DATA MANUAL)

BLANK PC
BOARD W/DATA
\$31

(With Pin
Out Data)

4K DYNAMIC RAM BLOWOUT! SAME AS INTEL 2107B!

4K RAMS AT AN UNBELIEVABLE 50¢ EACH!!!

Prime, new, National Semi., 1979 date coded, full spec. parts. N.S. #MM5280-5N. Same as INTEL 2107B-4, T.I. TMS4060, NEC uPD411, etc. We bought a HUGE QTY. from a West Coast Distributor at truly DISTRESS PRICES! One of the most popular and reliable RAM's ever made. These parts have been used by almost all Major Computer Main Frame Mfg. the world over! Arranged as 4K x 1, 270 NS Access Time, 22 Pin Dip. These units DO NOT use multiplexed addressing, thus making REFRESH and other timing very simple. See INTEL MEMORY DESIGN HANDBOOK for full application notes. THE NAT. SEMI. MEMORY DATA BOOK is available at most Radio Shack Stores. Prime units in original factory tubes!

#5280-5N 4096 BITS x 1 270 NS ACCESS

8 FOR \$4.95 32 FOR \$16

CRT CONTROLLER CHIP

SMC #CRT 5037. PROGRAMMABLE FOR 80 x 24, ETC. VERY RARE SURPLUS FIND. WITH PIN OUT. \$12.95 EACH.

NEW! G.I. COMPUTER SOUND CHIP

AY3-8910 As featured in July, 1979 BYTE! A fantastically powerful Sound & Music Generator. Perfect for use with any 8 Bit Microprocessor. Contains: 3 Tone Channels. Noise Generator, 3 Channels of Amplitude Control, 16 bit Envelope Period Control, 2-8 Bit Parallel I/O 3.D to A Converters, plus much more! All in one 40 Pin DIP. Super easy interface to the S-100 or other busses. \$11.95 PRICE CUT!

SPECIAL OFFER: \$14.95 each Add \$3 for 60 page Data Manual:

TERMS: Add \$2.00 postage. We pay balance. Orders under \$15 add 75¢ handling. No C.O.D. We accept Visa and MasterCard. Tex. Res. add 5%. Tax. Foreign orders (except Canada) add 20% P & H. Orders over \$50, add 85¢ for insurance.

Digital Research Computers

(OF TEXAS)

P.O. BOX 401565 • GARLAND, TEXAS 75040 • (214) 271-3538

*TRADEMARK OF DIGITAL RESEARCH.

WE ARE NOT ASSOCIATED WITH DIGITAL RESEARCH OF CALIFORNIA, THE SUPPLIERS OF CPM SOFTWARE.

ALL SALES ARE MADE SUBJECT TO THE TERMS OF OUR 90 DAY LIMITED WARRANTY. A COPY OF THIS WARRANTY IS AVAILABLE FREE, ON REQUEST.

NEW

POCKET COMPUTER NEWSLETTER
P.O. BOX 232, Seymour, CT 06483

FOR POCKET COMPUTER USERS!

News and Product Reviews
Programming Tips
Operating Timesavers
Tutorials
Customizing Your Unit
Short Cuts
Practical Programs
Technical Details
Inside Information
Application Forums

— and more!

YES! Sign me up as a charter subscriber. Enclosed is my \$20.00 for 10 issues. (\$24 to Canada. \$30 elsewhere.)

Not sure. Enclosed is \$2 for a sample issue.

Name _____
Addr _____
City/St _____ Zip _____

Circle 283 on Inquiry card.

SOFTWARE AUTHORS

Turn Your Programs Into Cash

Enjoy a money paying hobby and build your reputation as a successful software author with SOFTWARE WORKS. SOFTWARE WORKS is a fast growing publisher of quality micro-computer software. You reach a larger market and increase your profits with SOFTWARE WORKS' nationwide promotion and distribution. We take care of packaging, documentation and conversion to other computers.

To get started, send for your FREE software author's information kit TODAY. Just fill out and mail this coupon to:

SOFTWARE AUTHORS INFORMATION KIT

SOFTWARE INC.

SOFTWARE WORKS, INC.
P.O. Box 3080, Seattle, WA 98109
CWA 284738

Please rush me a Software Author's Information Kit

NAME _____
ADDRESS _____
CITY _____

Circle 336 on Inquiry card.

CABLES

EIA RS-232-C

- Quality Cables
- Immediate Delivery
- Low Prices

*16-25 conductor (M or F) 15.85 & .50/ft.
13-15 " " 13.90 & .40/ft.
9-12 " " 12.90 & .30/ft.
5-8 " " 12.10 & .25/ft.
1-4 " " 11.30 & .15/ft.

SPECIFY: Male or female connectors
Length of cable
Pins to be connected

*Plus Shipping - All orders pre-paid or C.O.D.

Communication Cable Company (215) 964-9404
319 Louella Ave.
Wayne, PA 19087

Circle 63 on Inquiry card.

ANALOG ↔ DIGITAL DIGITAL ↔ ANALOG

CONVERSION MODULES

SOFTWARE GAIN CONTROL

High accuracy — programmable gain instrumentation amplifier — custom board test — \$100 — 2 to 15 kHz conversion time — mixable high and low inputs — gain from 1 to 1024 — 12 bit — sample and hold amplifier — 8-channel differential — 16-channel — analog to digital high accuracy — programmable gain instrumentation amplifier — custom board test — \$100 — 2 to 15 kHz conversion time — mixable high and low inputs — gain from 1 to 1024 — 12 bit — sample and hold amplifier — 8-channel differential — 16-channel — analog to digital high accuracy — programmable gain instrumentation amplifier — custom board test — \$100 — 2 to 15 kHz

For additional details about the AD-100-4 and other fine California Data Corporation 100% individually tested, high reliability products, circle the reader service card number below or for faster response write or call us.

CALIFORNIA DATA CORPORATION
3475 Old Conejo Road, Suite C-10
Newbury Park, CA 91320
(805) 498-3651

Circle 45 on inquiry card.

FACTORY PRIME STATIC RAM CHIPS

2114 Super Low Power	
200ns. 1Kx4	\$ 2.90
6514 CMOS 300ns. 1Kx4	\$ 6.90
6116 CMOS 200ns. 2Kx8	\$22.50

Add \$5.00 Handling on Orders Under \$200.00

FACTORY PRIME From the same shipments used in GIMIX Professional quality boards.

32KB STATIC RAM CARDS

for the SS50 and SS50C BUS

(16KB — \$298.12), (24KB — 348.14)
(32KB — \$398.15)

NEW! 64KB BATTERY BACK UP CMOS RAM CARDS

Two independently addressable 32KB blocks, each with extended addressing.
(56KB - \$994.56), (64KB - \$1088.64)

2MHZ 6809 56KB SS50 SYSTEMS \$2498.29

DISK SYSTEMS AVAILABLE

GIMIX inc.

1337 W. 37th Place • Chicago, IL 60609
(312) 927-5510 • TWX 910-221-4055

The Company that delivers.
Quality Electronic products since 1975.
GIMIX® and GHOST® are Registered Trademarks of GIMIX INC.

Circle 149 on Inquiry card.



NEW! for the '89 from

MAGNOLIA MICROSYSTEMS

DOUBLE DENSITY DISK CONTROLLER

for both 5 1/4" & 8" drives

only **\$595** complete
including CP/M™2.2

MAGNOLIA MICROSYSTEMS, INC.
2812 Thornadyke W., Seattle 98199
(206) 285-7266 (800) 426-2841

CP/M is a trademark of Digital Research.

Circle 206 on Inquiry card.

9 TRACK TAPE DRIVES

800 BPI 45 IPS FULL MANUAL \$4850 VALUE		\$2400 NEW IN ORIGINAL BOXES
--	---	--

PERTEC Model 8840A-9-45
INDUSTRY STANDARD INTERFACE
CAPABLE OF IND. STD. ANSI-IBM DATA FORMAT

- READ/WRITE DATA IN STANDARD ANSI-IBM COMPATIBLE FORMAT
- DUMP WINCHESTERS AND HARD DISKS: 10 inch reel hold up to 3600' of tape = 34.56 Megabytes unblocked.
- EXCHANGE DATA & PROGRAMS WITH LARGE MAIN FRAMES AT SCHOOL, WORK, SERVICE BUREAUS ETC.
- BARGAIN PRICED MINI-COMPUTER UPGRADE. OEM List \$4850

A large OEM overstock makes these industry standard drives available at a fraction of their current list price. Full size drives handle up to 10.5 inch reels of standard inexpensive 1/2 inch mag tape. 19 inch rack mount or use right out of the box on steel shipping frame.

SPECIFICATION SUMMARY: 9-track, 800 BPI, dual head (read after write), 45 IPS read/write, 200 IPS rewind, BOT/EOT sensing, 110 VAC/60Hz, solid state, recent manufacture, all VCO signals TTL/DTL compatible, tension arm tape buffering, full control panel. Call or write for full set of technical specifications.

INTERFACES: Electrolab encourages the development of interfaces to popular systems. Interfaces exist for popular minis and are being developed for several hobby computers. If you'd like to develop and document an interface to a popular small system call to discuss discounts.

ELECTROVALUE INDUSTRIAL INC.
P.O. BOX 157-B
MORRIS PLAINS, NJ 07950
Phone reservations and questions are welcome
FACTORY DIRECT MAIL ORDER 201/267-1117

Circle 204 on Inquiry card.

ATARI OWNERS

SCREEN PRINT INTERFACE

Obtain hardcopy of any screen image (graphics and / or text) on either a TRENDCOM 200 or IDS 440 Paper Tiger printer. Simply attach the supplied parallel printer cable and load the software from cassette (may be transferred to Disk). Obtain a "picture" of the screen on your printer under direct (CTRL?) or program (XIO) control. Works in all graphics / text modes as well as LPRINT and LIST "P".

Only \$139

Parallel Printer Interface for the ATARI 400 / 800

Connects to controller jacks 3&4 works with BASIC / DOS / ASSEMBLER three printer connectors available:

	ATARI 400 / 800
TRENDCOM 100 / 200	A4P-1 A8P-1
CENTRONICS 730 / 737	A4P-2 A8P-2
CA SOLENTICS 36 PIN*	A4P-3 A8P-3

CA sales add 6% tax
MC / VISA accepted **\$69.95**

*Fits all other parallel Centronics plus Anodex, Base 2, Epson, Comprint and Microtek. Order by part number. ATARI is a recognized trademark of ATARI, Inc.

MACROTRONICS, Inc. (R)
1125 N. Golden State Blvd. / Suite G
Turlock, CA 95380 (A) (209) 667-2888 / 634-8888

Circle 204 on Inquiry card.

wabash®

When it comes to Flexible Disks, nobody does it better than Wabash.

MasterCard, Visa Accepted.
Call Free: (800) 235-4137



PACIFIC EXCHANGES
100 Foothill Blvd
San Luis Obispo, CA 93401 (In Cal call (805) 543-1037)

Circle 276 on inquiry card.

QUEST
ELECTRONICS

P.O. Box 4430X
Santa Clara, CA 95054

Will calls: 2322 Walsh Ave.
(408) 988-1640 TWX 910-338-2139

Same day shipment. First line parts only. Factory tested.
Guaranteed money back. Quality IC's and other components at factory prices.

INTEGRATED CIRCUITS

7400TTL	19	LM200K-5	1.35	CD4026	2.50	2114L 450n	4.00	CONNECTORS		KEYBOARDS	
7402N	15	LM200K-13	1.35	CD4027	2.50	4116 200ms	4.50	30pin edge	2.50	56 key ASC keyboard kit	\$675.00
7402N	15	LM200K-15	1.35	CD4028	2.50	8116 200ms	4.50	14 pin edge	2.15	Fully assembled	77.50
7404N	25	LM200K-15	1.35	CD4029	1.25	MM5262	4.00	86 pin edge	4.00	53 key ASC keyboard kit	6.00
7404N	25	LM200K-15	1.35	CD4030	1.25	MM5262	4.00	100 pin edge	4.50	Fully assembled	7.00
7414N	70	LM200K-15	1.35	CD4031	1.00	MM5320	5.94	100 pin edge WW	5.25	Enclosure Plastic	14.95
7414N	70	LM200K-15	1.35	CD4032	1.00	MM5330	5.94	100 pin edge WW	5.25	Meta Enclosure	29.95
7420N	35	LM200K-5	1.35	CD4033	1.00	PD4110-3	4.00	IC SOCKETS		LEDS	
7422N	35	LM200K-10	1.00	CD4034	85	PD4110-4	5.00	Solder Tin Low Profile		Red T018	15
7430N	25	LM339N	1.00	CD4035	85	PS101L	8.95	Pin 1 UP Pin 10 UP		Green, Yellow T018	15
7432N	58	LM339N-5	1.35	CD4036	1.67	XR0A	2.95	15 22 30		Jumbo Red	20
7445N	87	LM339N-8	1.35	CD4037	45	82525	2.90	14 14 24 35		Green, Orange, Yellow Jumbo	25
7447N	87	LM339N-12	1.35	CD4038	45	9102A	1.50	16 16 28 47		Opto LED Mounting Clips	85.125
7450N	77	LM339N-15	1.35	CD4039	1.13	HD0165-5	6.95	18 27 36 51		Epilopy Red, Amber, Green, Yellow (94)	
7450N	77	LM339N-15	1.35	CD4040	1.42	MM57100	4.50	20 29 40 57		2 level 14pin WW	2.7
7474N	35	LM3401-5	1.35	CD4041	40	GM73500	9.95	2 level 14pin WW		WIRE WRAP LEVEL 3	
7475N	49	LM3401-8	1.35	CD4042	40	MCMB8754	15.00	Pin		MAX-100 B digit Freq. Ctr.	\$149.95
7485N	88	LM3401-12	1.35	CD4043	40	3288	3.50	16 CR9 28 100		DK WIRE WRAP TOLDS	\$18.00
7489N	170	LM3401-15	1.35	CD4044	50	410D	4.00	100 pin edge WW	4.00	Printable Manual	\$18.00
7490N	43	LM3401-18	1.35	CD4045	41	416	4.16	100 pin edge WW	4.16	Complete in AP Products in stock.	
7492N	43	LM3401-24	1.35	CD4046	45	CLOCKS					
7493N	69	LM3401-30	1.35	CD4047	45	MM5321	1.50				
74100N	135	LM3401-36	1.35	CD4048	1.45	MM5332	1.90	1 MHz	4.50		
74107N	35	LM3878N	1.00	CD4049	40	MM5333	1.90	2 MHz	4.50		
74121N	34	LM393	1.60	CD4050	3.5	MM5334	1.90	4 MHz	4.25		
74123N	34	LM393	1.60	CD4051	3.5	MM5335	1.90	8 MHz	4.25		
74124N	34	LM393	1.60	CD4052	3.5	MM5336	1.90	16 MHz	4.25		
74125N	34	LM393	1.60	CD4053	3.5	MM5337	1.90	32 MHz	4.25		
74126N	34	LM393	1.60	CD4054	3.5	MM5338	1.90	64 MHz	4.25		
74127N	34	LM393	1.60	CD4055	3.5	MM5339	1.90	128 MHz	4.25		
74128N	34	LM393	1.60	CD4056	3.5	MM5340	1.90	256 MHz	4.25		
74129N	34	LM393	1.60	CD4057	3.5	MM5341	1.90	512 MHz	4.25		
74130N	34	LM393	1.60	CD4058	3.5	MM5342	1.90	1024 MHz	4.25		
74131N	34	LM393	1.60	CD4059	3.5	MM5343	1.90	2048 MHz	4.25		
74132N	34	LM393	1.60	CD4060	3.5	MM5344	1.90	4096 MHz	4.25		
74133N	34	LM393	1.60	CD4061	3.5	MM5345	1.90	8192 MHz	4.25		
74134N	34	LM393	1.60	CD4062	3.5	MM5346	1.90	16384 MHz	4.25		
74135N	34	LM393	1.60	CD4063	3.5	MM5347	1.90	32768 MHz	4.25		
74136N	34	LM393	1.60	CD4064	3.5	MM5348	1.90	65536 MHz	4.25		
74137N	34	LM393	1.60	CD4065	3.5	MM5349	1.90	131072 MHz	4.25		
74138N	34	LM393	1.60	CD4066	3.5	MM5350	1.90	262144 MHz	4.25		
74139N	34	LM393	1.60	CD4067	3.5	MM5351	1.90	524288 MHz	4.25		
74140N	34	LM393	1.60	CD4068	3.5	MM5352	1.90	1048576 MHz	4.25		
74141N	34	LM393	1.60	CD4069	3.5	MM5353	1.90	2097152 MHz	4.50		
74142N	34	LM393	1.60	CD4070	3.5	MM5354	1.90	4194304 MHz	4.50		
74143N	34	LM393	1.60	CD4071	3.5	MM5355	1.90	8388608 MHz	4.50		
74144N	34	LM393	1.60	CD4072	3.5	MM5356	1.90	16777216 MHz	4.50		
74145N	34	LM393	1.60	CD4073	3.5	MM5357	1.90	33554432 MHz	4.50		
74146N	34	LM393	1.60	CD4074	3.5	MM5358	1.90	67108864 MHz	4.50		
74147N	34	LM393	1.60	CD4075	3.5	MM5359	1.90	134217728 MHz	4.50		
74148N	34	LM393	1.60	CD4076	3.5	MM5360	1.90	268435456 MHz	4.50		
74149N	34	LM393	1.60	CD4077	3.5	MM5361	1.90	536870912 MHz	4.50		
74150N	34	LM393	1.60	CD4078	3.5	MM5362	1.90	1073741824 MHz	4.50		
74151N	34	LM393	1.60	CD4079	3.5	MM5363	1.90	2147483648 MHz	4.50		
74152N	34	LM393	1.60	CD4080	3.5	MM5364	1.90	4294967296 MHz	4.50		
74153N	34	LM393	1.60	CD4081	3.5	MM5365	1.90	8589934592 MHz	4.50		
74154N	34	LM393	1.60	CD4082	3.5	MM5366	1.90	17179869184 MHz	4.50		
74155N	34	LM393	1.60	CD4083	3.5	MM5367	1.90	34359738368 MHz	4.50		
74156N	34	LM393	1.60	CD4084	3.5	MM5368	1.90	68719476736 MHz	4.50		
74157N	34	LM393	1.60	CD4085	3.5	MM5369	1.90	137438953472 MHz	4.50		
74158N	34	LM393	1.60	CD4086	3.5	MM5370	1.90	274877906944 MHz	4.50		
74159N	34	LM393	1.60	CD4087	3.5	MM5371	1.90	549755813888 MHz	4.50		
74160N	34	LM393	1.60	CD4088	3.5	MM5372	1.90	1099511627776 MHz	4.50		
74161N	34	LM393	1.60	CD4089	3.5	MM5373	1.90	2199023255552 MHz	4.50		
74162N	34	LM393	1.60	CD4090	3.5	MM5374	1.90	4398046511104 MHz	4.50		
74163N	34	LM393	1.60	CD4091	3.5	MM5375	1.90	8796093022208 MHz	4.50		
74164N	34	LM393	1.60	CD4092	3.5	MM5376	1.90	17592186444416 MHz	4.50		
74165N	34	LM393	1.60	CD4093	3.5	MM5377	1.90	35184372888832 MHz	4.50		
74166N	34	LM393	1.60	CD4094	3.5	MM5378	1.90	70368745777664 MHz	4.50		
74167N	34	LM393	1.60	CD4095	3.5	MM5379	1.90	14073749155328 MHz	4.50		
74168N	34	LM393	1.60	CD4096	3.5	MM5380	1.90	28147498310656 MHz	4.50		
74169N	34	LM393	1.60	CD4097	3.5	MM5381	1.90	56294996621312 MHz	4.50		
74170N	34	LM393	1.60	CD4098	3.5	MM5382	1.90	112589993226624 MHz	4.50		
74171N	34	LM393	1.60	CD4099	3.5	MM5383	1.90	225179986453248 MHz	4.50		
74172N	34	LM393	1.60	CD4100	3.5	MM5384	1.90	450359972906496 MHz	4.50		
74173N	34	LM393	1.60	CD4101	3.5	MM5385	1.90	900719945812992 MHz	4.50		
74174N	34	LM393	1.60	CD4102	3.5	MM5386	1.90	1801439891255984 MHz	4.50		
74175N	34	LM393	1.60	CD4103	3.5	MM5387	1.90	3602879782511968 MHz	4.50		
74176N	34	LM393	1.60	CD4104	3.5	MM5388	1.90	7205759565023936 MHz	4.50		
74177N	34	LM393	1.60	CD4105	3.5	MM5389	1.90	1441151913047872 MHz	4.50		
74178N	34	LM393	1.60	CD4106	3.5	MM5390	1.90	2882303826095744 MHz	4.50		
74179N	34	LM393	1.60	CD4107	3.5	MM5391	1.90	5764607652191488 MHz	4.50		
74180N	34	LM393	1.60	CD4108	3.5	MM5392	1.90	11529215304383776 MHz	4.50		
74181N	34	LM393	1.60	CD4109	3.5	MM5393	1.90	23058430608767552 MHz	4.50		
74182N	34	LM393	1.60	CD4110	3.5	MM5394	1.90	46116861217535104 MHz	4.50		
74183N	34	LM393	1.60	CD4111	3.5	MM5395	1.90	92233722435070208 MHz	4.50		
74184N	34	LM393	1.60	CD4112	3.5	MM5396	1.90	184467448870140416 MHz	4.50		
74185N	34	LM393	1.60	CD4113	3.5	MM5397	1.90	368934897740280832 MHz	4.50		
74186N	34	LM393	1.60	CD4114	3.5	MM5398	1.90	737869795480561664 MHz	4.50		
74187N	34	LM393	1.60	CD4115	3.5	MM5399	1.90	1475739511611223296 MHz	4.50		
74188N	34	LM393	1.60	CD4116	3.5	MM5400	1.90	2951479023222446592 MHz	4.50		
74189N	34	LM393	1.60	CD4117	3.5	MM5401	1.90	5902958046444893184 MHz	4.50		
74190N	34	LM393	1.60	CD4118	3.5	MM5402	1.90	11805916892889783776 MHz	4.50		
74191N	34	LM393	1.60	CD4119	3.5	MM5403	1.90	23611833785779567552 MHz	4.50		
74192N	34	LM393	1.60	CD4120	3.5	MM5404	1.90	47223667571559135104 MHz	4.50		
74193N	34	LM393	1.60	CD4121	3.5	MM5405	1.90	94447335143118270208 MHz	4.50		
74194N	34	LM393	1.60	CD4122	3.5	MM5406	1.90	18889466286236540416 MHz	4.50		
74195N	34	LM393	1.60	CD4123	3.5	MM5407	1.90	37778932572473080832 MHz	4.50		
74196N	34	LM393	1.60	CD4124	3.5	MM5408	1.90	75557865144946161664 MHz	4.50		
74197N	34	LM393	1.60	CD4125	3.5	MM5409	1.90	1511157302898923233296 MHz	4.50		
74198N	34	LM393	1.60	CD4126	3.5	MM5410	1.90	3022314605797846466592 MHz	4.50		
74199N	34	LM393	1.60	CD4127	3.5	MM5411	1.90	6044629211595692933184 MHz	4.50		
74200N	34	LM393	1.60	CD4128	3.5	MM5412	1.90	12089258423913385866592 MHz	4.50		
74201N	34	LM393	1.60	CD4129	3.5	MM5413	1.90	24178516847826771733184 MHz	4.50		
74202N	34	LM393	1.60	CD4130	3.5	MM5414	1.90	48357033695653543466368 MHz	4.50		
74203N	34	LM393	1.60	CD4131	3.5	MM5415	1.90	96714067391307086932736 MHz	4.50		

INVENTIVE VISICALC™ USERS.

*Get Paid Royalties
For Your Software.*

We want your best VisiCalc™ model. A generalized model of broad interest, or a highly specialized model for a particular application.

We want your most useful VisiCalc™ utility. One that provides new tools and features for working with VisiCalc™ models.

We are a new software publisher preparing to market VisiCalc™ related products. We want superior software for our inaugural marketing campaign. Earn money from your work. Send your working prototype for our evaluation now.

**Ergonomic
Software**

P.O. BOX K
NEW YORK
NY 10028

VisiCalc™ is a trademark of Personal Software, Inc.

INTERFACE EXPANSION BOARD

For the TRS 80™

MD
MICRO-DESIGN



The Interface Expansion Board gives your computer these features:

Phone Modem

2K E-PROM OPTION

32 K Memory

Real-Time Clock

Parallel Port

RS-232 Port

Dual Cassette Line

Floppy Disk Controller*

On Board Supply

Silk Screen

Solder Mask

Expansion Port

Manual

In Stock Now

PC Board & user manual

MDX-1

64.95

MDX-2*

74.95

Add 500 for shipping
& handling Texas residents
add 5% sales tax

MANUALS \$7.95

FREE PAMPHLET AVAILABLE
Call or write

MICRO-DESIGN

P.O. Box 748
Manchaca, Texas 78652
512-282-0225



*TRS 80 is a Trademark of Tandy Corp

Circle 219 on Inquiry card.

ZEN is HERE NORTH STAR SOFTWARE

SCREEN EDITOR
DISK ASSEMBLER
MONITOR

ZEN™ is an open program complete with source files and self assembly capabilities. It may be changed to any custom version you prefer. There are no secrets or locked-in formats. Features include very convenient screen and line editing with justification, choice of line and file sizes as well as the use of North Star key choices -- can be changed. A full list of the commands and features can not be written here but it has many conveniences not found in operating systems costing much more -- such as no line numbers, conditional and partial print assembly, some Basic utilities, and the best monitor ever designed for the micro-processor. -- all in ZEN™ itself. Need 24K min.

5" diskette \$75. Must state N.S. release #
Manual alone \$15. CA residents add 8%

Send check to:

ZENRAD CONTROLS COMPANY
1575 A.P.S.
Santa Barbara CA 93103

DEALER INQUIRES WELCOME.

Circle 392 on Inquiry card.

INDUSTRIAL CROSS-MACRO ASSEMBLERS

written in FORTRAN IV

New two-pass macro assemblers for all popular micros can be run on any general-purpose computer with standard FORTRAN. Each assembler supports macros, conditional assembly, and relocatable object code. All the original mnemonics and addressing modes, many assembler directives, long error messages and more. Produces printed assembly listing and object code file.

PROGRAM NO.	FOR MACHINE	PKG. PRICE
MASAM68E3	MC68000	\$500
MASAM6809	MC6809	400
MASAM6805	MC6805	400
MASAM6801	MC6801	350
MASAM6800	MC6800	300
MASAM6502	MC6502	375
MASAM8085	8080/8085	350
MASAM802	CDP1802	300

Packages include detailed users' manual, printed source listing (well commented), source on magnetic tape, and IDM's Software Support Service. Card decks also available. Dealer inquiries invited.

IDM Intelligent devices of Minnesota
P.O. Box 492 Anoka, Mn. 55303
(612) 427-0787

Circle 181 on inquiry card.

CHIPS & DALE

Specializing in memory chips

2114 L Static Ram \$ 275
300ns

4116 Dynamic Ram 275
200ns

2716(5v) Eprom 735
450ns

2732(5v) Eprom 1850
450ns

all Chips are fully guaranteed

CHIPS & DALE, P.O. Box 31607

Seattle Washington Zip 98103

Add \$2.00 Shipping & Handling

COD \$2.00 Wash. residents add

54% Sales Tax 1-206-542-9126

Circle 58 on inquiry card.

WIREMASTER

A COMPILER FOR HARDWARE

- WIREMASTER is a software tool to aid in the design, layout, and construction of electronic hardware. It is intended primarily for wire wrap, though it is also highly useful in the layout, error-checking, and troubleshooting of PC boards.

- Inputs are easily derived directly from the schematic diagram and fed to WIREMASTER in a CP/M™ text file. Outputs include a network map that graphically shows all pins and wires, a wire list sorted by lengths and levels, a parts list, wrap count and continuity checklists, plus signal and pin cross-references.

- The resulting information is then used for PC board layouts, error-checking, wiring, component-stuffing, and system-debugging. This forms a complete and easily updated documentation package. Although it runs on small computers, WIREMASTER can handle large projects.

- WIREMASTER runs on any 2801 CP/M system of 47K or larger, including TRS-801 Model II and Apple with SoftCard.

Complete Package—\$150; Manual only—\$5

AFTERTHOUGHT ENGINEERING

7266 Courtney Drive

Santa Diego, California 92111

(714) 279-2868

Trademarks: *Digital Research, †Tandy Corp, ‡Microsoft

Circle 10 on inquiry card.

HEADERS



PRINTED
CIRCUIT

RIGHT ANGLE MOUNT

34 PIN HEADER

3M 3413-1003 \$1.25 EA

40 PIN HEADER

ALPHA ST. 50 EA

50 PIN HEADER

3M 3433-1002 \$1.75 EA

40 PIN CONNECTOR

3M 3417

\$1.50

EACH

22/44 EDGE CONNECTOR

TIN SOLDER TAIL .155" x .200"

LARGE QUANTITIES AVAILABLE

\$1.35 each 10 for \$12.50

7-17vdc S.S. BUZZER



CMOS compatible

Max current 10ma

Sound output

70dB @ 20 cm

\$1.25 each

DPDT CENTER OFF

MINI TOGGLE

rated

5 AMP at 120 V

4 X 40 bushing

\$2.00 ea.

Litronix FRL-4403

diffused red led

with built in flashing unit

T 1 x 4 package

Pulse rate 3hz x 5v 20 ma

2 for \$1.70

ALL ELECTRONICS CORP.

P.O. BOX 20406
905 S. Vermont Ave.
Los Angeles, Calif. 90006
(213) 380-8000

Mon. - Fri. Saturday
9 AM - 5 PM 10 AM - 3 PM

SEND FOR FREE CATALOG

TERMS
• Quantities Limited
• Min. Order \$10.00
• Ship. U.S.A.
• Calif. Res. Add 6%
• Prompt Shipping

Circle 12 on Inquiry card.

FULL ELIZA FOR YOUR MICRO!

AT LAST! A FULL IMPLEMENTATION of the original ELIZA program is now available to run on your microcomputer! Created at MIT in 1966, ELIZA has become the world's most celebrated artificial intelligence demonstration program. ELIZA is a non-derivative psychotherapist who analyzes each statement as you type it in and then responds with her own comment or question. Response time is virtually instantaneous and her remarks are often tactfully appropriate. Designed to run on a large mainframe, ELIZA has hitherto been unavailable to small computer users except in greatly stripped down versions lacking finesse and sophistication which made the original program so fascinating. Now, a new version possessing the full power and changed expression of the original is available to run on any CP/M based microcomputer system with at least 40K of RAM. Supplied as a 3.5" disk (machine language) fits on a standard 8 inch diskette. The program is being offered for a limited time at the introductory price of only \$25. And if you want to find out how it does it or teach her to do more, we will include the complete Source Program, written in MICROSOFT BASIC-80, Version 5.0X, (totally \$20 add'l. local. order your copy of ELIZA today and you'll never again wonder how to respond when one of your friends says, "Okay, let's see what this computer of yours can actually do!"

HERE IS AN ACTUAL SAMPLE OF ELIZA'S CONVERSATIONAL ABILITY:

(ELIZA'S COMMENTS ARE PRINTED IN CAPITAL LETTERS)

All marriage alike
IN WHATWAY?
They're always buggin' us about something or other.
CAN YOU THINK OF A SPECIFIC EXAMPLE?
Well, my boyfriend made me come here.
YOUR BOYFRIEND MADE YOU COME HERE. - THAT'S INTERESTING.
I need some help, that much is certain.
WHAT WOULD IT MEAN TO YOU IF YOU GOT SOME HELP?
Perhaps I could learn to get along with my mother.
TELL ME MORE ABOUT YOUR FAMILY.
You see, like my father, in some ways,
WHAT RESEMBLANCE DO YOU SEE?
You are afraid of me.
DOES IT PLEASE YOU TO BELIEVE I AM AFRAID OF YOU?
My father is afraid of everybody.
WHAT ELSE COMES TO MIND WHEN YOU THINK OF YOUR FATHER?
Bullies.
DOES THAT HAVE ANYTHING TO DO WITH THE FACT THAT
YOUR BOYFRIEND MADE YOU COME HERE?

ARTIFICIAL INTELLIGENCE RESEARCH GROUP

921 NORTH LA JOLLA AVENUE
LOS ANGELES, CALIFORNIA 90045
(213) 659-7398 (213) 654-2214
MC, VISA, and CHECKS ACCEPTED

Circle 25 on Inquiry card.

QUARTZ CRYSTALS

3210 0	5.2425	9.9235	20.000	35.2885	42.8510	45.8120
5300	5.510	9.9948	20.493	35.3536	42.8758	47.3758
1.000 A	5.7143	9.9860	22.1184	37.9529	42.9258	47.8509
1.8432	5.565	10.000	22.5758	38.3768	42.9578	48.000
1.8437	5.562	10.2458	28.3556	38.4448	43.0008	48.3005
2.000 A	6.000	10.4968	28.5008	38.6258	43.0378	48.6568
2.2871 A	6.144	10.7355	28.7378	38.8258	43.0748	48.7005
2.4576 A	6.3000	10.8755	27.000	39.3128	43.1858	48.8758
2.500 A	6.2970	10.8366	27.0005	39.5058	43.2588	48.7005
2.6657	6.400	11.1360	27.5508	39.6668	43.3358	49.7258
2.9500	6.5336	11.155	29.4008	39.7538	43.3708	49.8728
3.000 A	6.72538	11.2185	28.5278	39.8758	43.4078	50.2558
3.067	6.75840	11.2880	28.7588	39.9258	43.4378	51.0558
3.200	6.9003	11.4776	29.8758	40.4448	43.4448	51.3128
3.2758	7.0063	11.5566	29.3378	40.5928	43.5568	51.7718
3.500	7.0336	11.6816	30.0648	40.8128	43.6798	51.8568
3.5718	7.2015	12.442	30.8258	41.8338	43.6658	52.8128
4.000	7.1835	14.3182	30.8258	40.8758	43.7778	56.7505
4.843	7.2586	14.4308	30.8768	40.8888	43.8128	60.6005
4.3426	8.000	15.000	31.4378	40.9258	43.8148	60.7505
4.803	8.0556	15.4408	31.7538	41.0008	43.8518	66.7505
4.9103	8.1415	15.5056	31.9008	41.1658	43.8868	70.4005
4.9503	8.1818	15.000	32.000	41.3768	43.9258	75.0005
4.8303	8.3300	15.3848	33.2005	41.9278	44.0008	80.8338
4.9152	8.4998	17.2248	33.6258	42.0008	44.0378	93.6668
5.000	8.5766	17.2422	34.5558	42.5838	44.3768	100.6668
5.0668	8.6556	18.000	34.7538	42.6258	44.7778	101.6668
5.1703	8.9628	18.4328	34.9718	42.7005	45.1258	103.6668
5.1850	8.9806	19.4950	35.9256	42.7538	45.3005	103.6668
5.1856	8.4728	19.7500	36.000	42.8148	46.7005	104.9918
ALL A - \$2.99	ALL O - \$1.99					10.00 MORE OUTPUT 5"

ADD \$1.00 SHIPPING
CAL. RES. ADD 6% SALES TAX
FREE OSCILLATOR SCHEMATICS
WITH ANY ORDER
QUALITY COMPUTER PARTS
P.O. BOX 743 / CHATSWORTH, CA 91311

Circle 303 on inquiry card.

NEED A LETTER QUALITY PRINTER BUT DON'T WANT TO PAY THE PRICE?

Then American Business Computers Has Just The Printer For You!

*Starwriter furnishes 3 clear
copies using a 96-character wheel.
It produces 136 printable columns*

*The Starwriter accommodates
paper widths up to 381 mm (15").
In addition, feeding continuous forms or
in-fold paper*

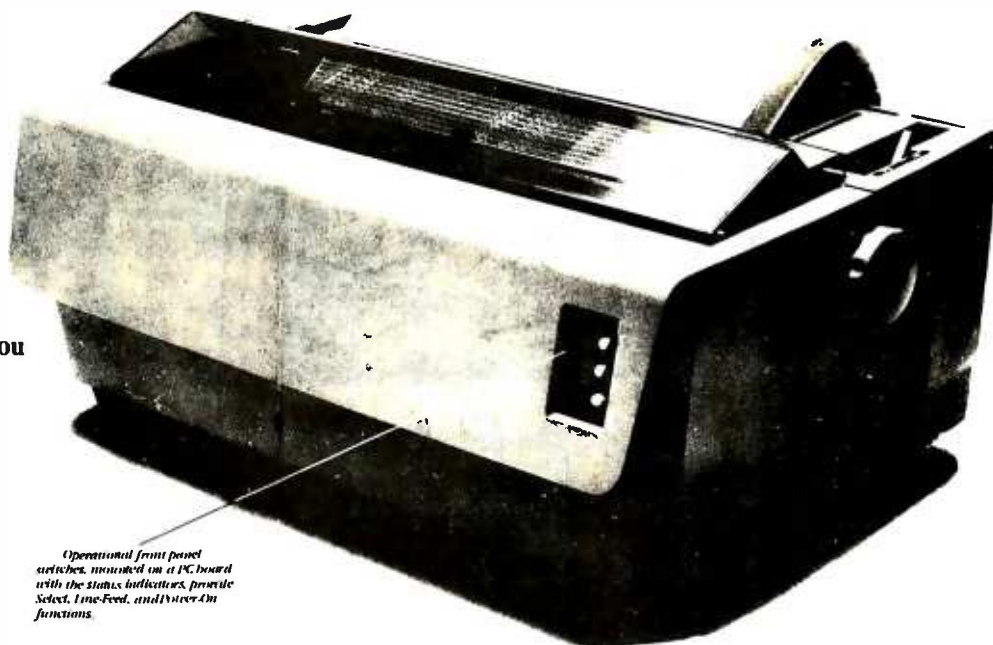

**Call Us For A Price
That Will Pleasantly Surprise You**

*Operational front panel
switches, mounted on a PC board
with the status indicators, provide
Select, Line-Feed, and Printer-On
functions.*

The Starwriter Daisy Wheel Printer is designed to fill a distinct gap in the peripheral marketplace. A speed of 25 cps and its low price make it the ideal choice for today's systems designer interested in achieving superior price/performance ratios.

Incorporating the latest LSI technology, the Starwriter is built by one of the world's most respected computer peripheral manufacturers. The printer is furnished complete and ready-to-use, requiring no changes in hardware or software. Starwriter offers an industry standard parallel interface, as well as RS232-C interface. Total plug compatibility and a wide variety of interface matching capabilities help lower the system integration costs for OEMs and end-users.

Using a 96-character wheel, the Starwriter produces letter-quality printing on 3 sharp copies with up to 136 columns. Starwriter offers the highest degree of vertical and horizontal positioning, resulting in the most precise character placement in the industry. The easy-to-change character wheel also makes our printer a perfect choice for international applications. Compatible with sheet feeders, starwriter accommodates paper widths to 381 mm (15") and uses industry standard ribbon cartridges.

Along with a self-test capability and a programmable VFU (Vertical Format Unit), Starwriter furnishes the operator with all desirable status functions, commands and program selectable switches. Panel lamps indicate the current Paper, Select and Power status.

The easy plug-in compatibility of Starwriter and its outstanding print performance makes the Starwriter perfect for TRS-80*, Apple*, and S-100 users.

Starwriter is backed up by a one-year warranty (3 months on parts and labor, 9 succeeding months on parts) and is further supported by a strong, fully trained and technically proficient service organization. The Starwriter is available for immediate shipment in any quantity desired.

For more information, call American Business Computer, 118 So. Mill Street, Pryor, Oklahoma 74361; Telephone 918-825-4844.

*TM of Tandy Corp

*TM of Apple Computer Corp.

AMERICAN BUSINESS COMPUTERS

118 So. Mill Street
Pryor, Oklahoma 74361
Telephone 918-825-4844

Dealer Inquiries Invited

COED

CRT ORIENTED EDITOR

- For Data General Systems: RDOS (DOS) and AOS (MP/OS).
- Easier to use and more powerful than: EDIT, SPEED, LINEDIT and SED.
- Faster and more flexible than other screen editors.
- Includes source code, complete users manual, and 1 year support.
- Non Data General Terminal support.

\$500 for single CPU license after July 1, \$750

Contact:



132 E. St., #3B
Davis, CA 95616
(916) 758-9355

Systems Programming for
Data General Computers

Circle 222 on inquiry card.

D TYPE CONNECTOR MOUNTING HARDWARE

at less than 1/2 the price

- Similar to Ansley #609-003
- Standard 4-40 male and female threads
- Complete with lock washers and 4-40 small pattern nuts

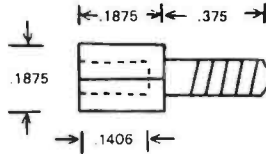

100 pc.	\$40.00
500 pc.	\$35.00/c
1000 pc.	\$30.00/c

Over 1000 — please inquire

CCB Machine Products

1347 Brookline Rd.
Cleveland, Ohio 44121
1-216-381-1291

Circle 138 on Inquiry card.



RS232C Computer compatible Paper Tape Transmitter/Model 612

Stops and starts on character at all speeds, uses manual control or X-on, X-off 90-260 volt, 50-60 Hz power, 50-9600 baud, up to 150 char/sec synchronous or asynchronous; gated internal or external clock. RS 232C, current loop or parallel output, reads 5-8 level tape, 7-11 frames per character, even or odd parity. Desk top or rack mount.
Addmaster Corporation, 415 Junipero Serra Drive, San Gabriel, CA 91776, (213) 285-1121, Telex 674770 Addmaster SGAB

Circle 6 on inquiry card.

MEMOREX Floppy Discs

Lowest prices. **WE WILL NOT BE UNDERSOLD!!** Buy any quantity 1-1000. Visa, Mastercharge accepted. Call free (800)235-4137 for prices and information. All orders sent postage paid.



PACIFIC EXCHANGES
100 Foothill Blvd.
San Luis Obispo, CA
93401 (In Cal call
(805) 543-1037)

Circle 277 on inquiry card.

ONE BOARD CP/M SYSTEM!



only \$750
Asm., Tested
& Burned-In
for one week

Features:

- 8 1/2 by 12 inches
- 10 MHZ 8085 CPU
- 64K RAM
- 3 RS-232 channels
- 8272 Floppy Disk Controller
- Handles Single/Double Density
- One to Four Drives. 8011t or 850R.

Documentation \$15.

CP/M Floppy Disk Operating System \$150
Check or Money Order

autocontrol

INCORPORATED
11744 Westline Industrial Drive
St. Louis, MO 63141
(314) 432-1313

Circle 30 on inquiry card.

AC-85 CP/M® SYSTEM

Asm., Tested
& Burned In
for one week **\$2450**

Features:

- One board 8085 Computer
- 2 - SA800R* (1.2 megabytes)
- CBIOS Diskette
- Installed and wired in a cabinet with P/S and Fan ready to plug-in
- Manual
- 17 1/2" W x 17" D x 10" H
- SYSTEM with 2 SA850R (2.4 mbytes)

\$2750.00

CP/M Floppy Disk Operating System \$150
Check or Money Order

autocontrol

INCORPORATED
11744 Westline Industrial Drive
St. Louis, MO 63141
(314) 432-1313

® CP/M is a registered trademark of Digital Research, Inc.

Circle 31 on Inquiry card.

Fine Software Tools in C



The Toolbox

- list prints that missing source listing
- xref cross reference C programs.
- sort alphabetize by all or part of text line.
- col arrange text in columns on page
- print paginates text for hard copy
- and more

All programs are in portable Whitesmith C xref and list are compatible with the compiler's error listing. Title lines on list and print output includes the date on RT-II systems. Source code on 8" floppy and manual available immediately for \$45 (tax and shipping included) Specify RT-II or CP/M format

The Toolsmith
Dept. BYTE
P. O. Box 22511
San Francisco, CA 94122

RT-II is a trademark of Digital Equipment Corp
CP/M is a trademark of Digital Research

Circle 365 on inquiry card.

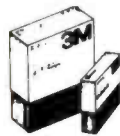

Scotch®

DISKETTES

SAVE 40% Write for our complete list.

5 1/4" Sgl. Dens. 26.70/10
Specify soft, 10 or 16 hard sectors

8" Sgl. Dens. 27.30/10
8" Dbl. Dens. 35.80/10
Specify soft or 32 hole hard

Add \$2.00 shipping - Michigan add 4% tax

LYBEN COMPUTER SYSTEMS
27204 Harper Ave.
St. Clair Shores, MI 48081

Authorized Distributor
Information Processing Products



Circle 203 on Inquiry card.

RS-232 PROBLEMS?



LET THE RS-232 TESTER HELP YOU SOLVE YOUR COMPUTER INTERFACE PROBLEMS. DESIGNED TO CONNECT IN SERIES WITH ANY RS-232 INTERFACE, IT DISPLAYS THE STATUS OF SEVEN OF THE MOST IMPORTANT LINES: TRANSMIT DATA, RECEIVE DATA, REQUEST TO SEND, CLEAR TO SEND, DATA SET READY, CARRIER DETECT, AND DATA TERMINAL READY. THE RS-232 TESTER REQUIRES NO POWER AND MAY BE LEFT IN THE LINE PERMANENTLY.

\$39.95 POST PAID
B & B ELECTRONICS
BOX 475/MENDOTA, IL 61342

Circle 34 on inquiry card.

The Time Machine™



\$135 REAL TIME CLOCK AND CALENDAR

- Introducing an Intelligent real time clock and calendar peripheral for the Apple II:
- Read and set time routines in 2K EPROM driver.
 - Counts seconds, minutes, hours, days, days of week, month and years.
 - Six date formats including: 12-JUN-1981
 - Two interrupt programs in EPROM.
 - Nicad battery and applications diskette.
 - Basic, Pascal, and Machine language compatible.

FOR FREE BROCHURE CALL (801) 486-4839



DISTRIBUTED BY
The COMPUTER ROOM
1879 South Main Street
San Lake City, Utah 84115
(801) 486-4839

TRADEMARK OF APPLE COMPUTER CORPORATION.

Circle 144 on inquiry card.

SAVE
20 to 30%



BUY WHOLESALE!

Sale thru 4/30/81 on Zenith/Heath Z-89 64K system, listing for \$3045

Anyone may buy 1 for \$2375
or 2 for \$2284 each
or 3 for \$2193 each

Call or write for prices on other Zenith, North Star, and other Z-80 based computer systems, modules, peripherals, and supplies at New England's oldest independent computer store.

Computer Mart, Inc.
1395 Main Street
Waltham, MA 02154
(617) 899-4540

Circle 334 on inquiry card.

EPSON

DOT MATRIX PRINTER MX-80 F/T

Friction and removable, variable width Tractor

**NOW IN STOCK
CALL FOR DISCOUNT PRICE**

Also in Stock **MX-80 \$499-Lower! Call!**

NEW! Graphics ROM for MX-80. CALL!

We also stock direct connect cables for TRS-80, Apple, Atari, Pet or RS 232

CALL 800-344-7493
(209) 667-2888 (within CA)



MACROTRONICS, inc.
1125 N. GOLDEN STATE
TURLOCK, CA 95380

Circle 205 on inquiry card.

8088

\$100 BOARD

**16 BIT PROCESSING
ACOM'S P188**

KIT \$275

ASSEM. & TESTED \$345

ACOM Electronics

4151 Middlefield

Palo Alto, CA 94303

(415) 494-7499

Circle 4 on inquiry card.



IPEX **NEW!**

Interface Converts
Your Typewriter
into Printer



- Finest Print Quality
- Easy Installation
- Fits IBM SELECTRIC® typewriter with no modification.
- For TRS-80®, Apple®, or any parallel or RS232 port.
- Write or phone for more information, today!
- Low cost
- Quick delivery

— U.S. and worldwide sales —



IPEX INTERNATIONAL INC.
16140 Valerio St.
Van Nuys, CA 91406 USA
TEL: 213/781-0020 TLX/TWX: 910-495-1767

Circle 182 on inquiry card.

EAST COAST COMPUTERS

P.O. BOX 295

WHITEHOUSE STA., NJ 08889

VERBATIM 5" DISKETTES	22.00
MEMOREX 5" DISKETTES	21.00
PLASTIC BOX	3.00
LEEDEX MONITOR	107.00
16K MEMORY KIT	35.00
CAT MODEM	144.00
ATARI 400	479.00
MX-80	459.00
TRS-80 16K MODEL III	859.00

TRS-80 is a registered trademark of Tandy Corp.

TERMS: MASTERCHARGE, VISA,
CHECK, MONEY ORDER,
U.S. FUNDS ONLY. NJ RESIDENTS
ADD SALES TAX ADD 5% FOR
SHIPPING AND HANDLING.

Circle 152 on inquiry card.

PRO-SOFT MEDICAL BILLING



Our software for the Apple
keeps the Doctor away...

...away from needless
billing drudgery.

The Pro-soft Medical Billing System for the Apple II features:

- Up to ten physicians
- Immediate Superbill
- Over 7000 accounts
- MediCare, Medi-Cal, Other
- RVS and IDCA codes
- Menu driven, easy to use
- Support and training

For more information call or write us - today!



Professional Medical Software
(213) 248-2884
3604 Foothill Boulevard
La Crescenta, CA 91214



Circle 300 on inquiry card.

***COMPUTER SURPLUS**

Used micro computer systems 100% functional, \$600 to \$1500. Video terminals & keyboards, \$50 to \$700. Stringy floppy units-brand new, \$300. All the above with documentation. Computer cabinets, 19" rack, \$50 to \$100. Power supplies, capacitors, ribbon cable, cooling fans, misc. components & hardware. We buy used microcomputer systems—all types. Also deal in IBM, Univac. **New PERKIN-ELMER mod. 550 TERMINALS... prices too low to quote.**

CALL VIC CLOUGH at
(216) 473-0866

DATA HARDWARE

701 Beta Dr. #4
Cleveland Ohio 44143

DEALERS WELCOME

Circle 103 on inquiry card.

PASSWORD DISTRIBUTORS

QUME DT 5 \$ 295

QUME DT 8 \$ 525

**1 YEAR
WARRANTY \$ 50**

**QUANTITY DISCOUNTS
IMMEDIATE DELIVERY**

PHONE: (408)432-4250
SCOTTS VALLEY, CALIFORNIA

UNITED KINGDOM REP
KARADAWN
PHONE: WARRINGTON (0925)572-668
WARRINGTON, CHESHIRE, U.K.

Circle 385 on inquiry card.

NEW TECHNOLOGY AVAILABLE TO THE HOBBYIST

RU-2 HOBBYIST ROBOT

- entire unit or separate modules may be purchased
- may be interfaced with "Control Talker II," or manually controlled

\$1495.

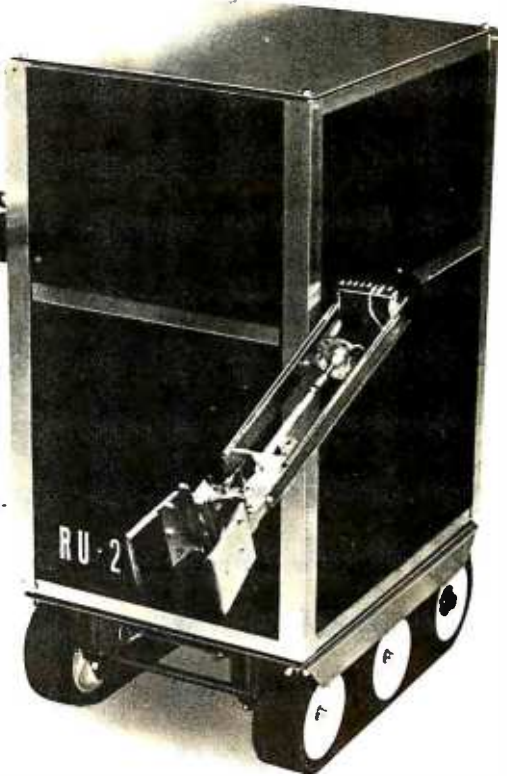

"CONTROL TALKER II"

"Control Talker II" can control stepping motors (up to eight), relays, counters, etc. and support a variety of uses including robotics, telephone dialing, security systems, numerical control, measuring—virtually countless applications. Also has added speech output to advise of status, etc.

Put one to work for you today.

- 110V 50/60 HZ
- 32 input lines (TTL)
- 32 10 Amp (50V) output lines
- *Z-80 based system, single board
- 8K PROM—user supplied, 4K RAM
- voice output

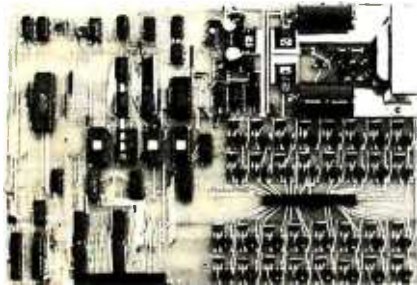

\$550.

*Z-80 is a registered trademark of Zilog, Inc.

Hobby-Robotics Co.

NEW "FAST TALKER"

Low Data Rate S-100 Speech Board

- new technology speech processor allows unlimited speech possibilities
- uses Texas Instrument TMS 5200 V.S.P.
- software voice data assembler
- 32 word sample vocabulary included
- audio amp
- assembled and tested
- delivery from stock

\$289.

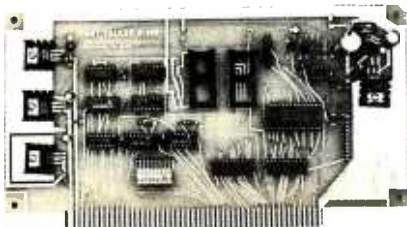

6809E CPU CARD FOR *APPLE II™

- includes editor and assembler
- initialization subroutines are included on disk
- board is slot independent
- jumpers for 6809E interrupts
- full handshaking between 6809E and 6502

\$379.

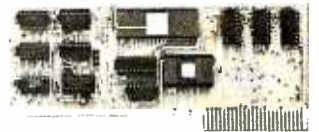

*Apple II is a registered trademark of Apple Computer Inc.

S-100 SERIAL PORT CARD

- with 4 ports
- all handshaking lines provided
- easy to interface

\$269.



Southern Semiconductor, Inc.

6030 Unity Drive, Suite J, Norcross, Georgia 30071, (404) 449-6666

Southern Semiconductor continues to handle California Computer Systems as well as a complete line of resistors, capacitors, crystals, sockets and integrated circuits. Write or call today for catalog.

- Minimum order: \$10.00
- Ga. residents add 3% sales tax
- Dealer, OEM and institutional inquiries invited
- Prices good in U.S.A. only
- Master card and Visa welcome



Sprint 68 Microcomputer



CONTROL COMPUTER DEVELOPMENT SYSTEM

6800 MPU, serial I/O, 48K RAM, dual 8" drives, WIZRD multitasking DOS, editor, assembler, 12K BASIC, all for \$399.95.

OPTIONS

C, PL/W, PASCAL, FORTRAN, EROM programmer, analog I/O, parallel I/O, 488 GPIB interface, CMOS RAM/battery, power fail detect/power on reset



Wintek Corp.
1801 South Street
Lafayette, IN 47904
317-742-8428

Circle 387 on inquiry card.

Close- Out!!



Desk Top Computer

This unit is a computerized Electronic Secretary. It keeps time, date, calendar, message, and meeting files. Originally sold thru a major mail order house for over \$450.

Technically, it's a 6507 MICRO. ROM. RAM, Panaplex Alpha Display, NI-Cad battery, Power Supply, Keyboard, Wood and Aluminum Case with Schematic and operating instructions.

Most of these Computers are warranty returns. We are offering Refurbished, like new, units for \$99.95 and AS IS (most have minor problems) units for \$44.95. Add \$4.95 for shipping and handling. All units are complete as described. All sales are final. California Residents add 6.5% sales tax.

Send Payment with order or call our Order Line 408-272-2320 and use your MC or VISA card.

Solid State Surplus

P.O. Box 32418/San Jose, CA 95152

Circle 337 on inquiry card.

MICRO DESIGN CONSULTANTS

1 Bit through
32-Bit Machines

We handle concept
through production
prototypes with
complete documentation.

HARDWARE - 916/723-1050

David Jenkins

7214 Springleaf Court
Cirrus Heights, CA 95610

SOFTWARE - 916/381-1717

Richard Lerseth - LEAPAC

8245 Mediterranean Way
Sacramento, CA 95826

Circle 193 on inquiry card.

RAM

For ATARI

Get the most from your ATARI 400. Memory expansion to a full 48K is now possible with our 48K Board. Expand your ATARI 800 with our 32K Board.

48K Board \$299

32K Board \$199

INTEC

Suite # 111

3387 Del Rosa Ave. North
San Bernardino, CA 92404

(714) 864-5269

CA residents add 6 percent tax

ATARI is trademark of ATARI, Inc.

Circle 175 on inquiry card.



\$199.

THE BEST, most useful, spelling -- proofreading package available. Independent reviews prove it - write for copies. Requires 32K CP/M*, MP/M*, CDS*, or GROMIX*. Works with any console device. Compatible with Magic Wand*, WordStar*, Electric Pencil*, WordMaster* and ED. Fully tested. Professional, first class software. Delivered ready to run - no user reconfiguration required. Excellent documentation and 8" 5D soft-sectored, or 5 1/4" disk: DD or QD for NorthStar* or SuperBrain*; Micropolis*; DD Micropolis II; Apple* II w/Microsoft Z80, specify 13 or 16 sector disk.\$199.

SPELLGUARD* and Magic Wand*(I.I)\$499.

We rigorously select, use and support the software we sell. Orders promptly acknowledged and shipped. Checks must clear before shipment. Our low prices reflect full cash discount while maintaining quality customer service. Visa & MasterCard add 3%. Shipping \$3. per order. Phone & export orders welcome. * = trademark.



49 Pelican Court, Syosset, NY 11791
(516) 921 - 3083 Write for catalog!

Circle 285 on inquiry card.

SAVE \$100

on the NEW
Business-Sized

Paper Tiger™

560

only \$1595*

see Integral Data Systems ad
elsewhere in this issue

*plus shipping; Calif. res. add sales tax



1445 Koll Circle, Suite 111, San Jose, CA 95112
(408) 947-1101

(call 800/555-1212 for our toll free number)

Circle 354 on inquiry card.

If you use
Mini or Micro Computers,
Printers, Terminals,
Word Processors

We have
MINI-PAK

Stock Continuous Forms

Small convenience containers. Easy to use and store. High quality bond and carbonless paper. Shipped promptly.

14 1/2 x 11 1/8 Green Bar	1 Part 15 lb.	2 ctns. 21.50/ctn.	3 and up 19.50/ctn.	Shp. & handling Perctn. 4.85
(also available in 2, 3 and 4 part)				
9 1/2 x 11 Blank Wiper to 8 1/2 x 11	1 Part 15 lb.	2 ctns. 16.50/ctn.	3 and up 14.00/ctn.	Shp. & handling Perctn. 3.85
(also available in 20 lb., 2 and 3 part)				
8 1/2 x 11 1/8 Green Bar	1 Part 15 lb.	2 ctns. 15.50/ctn.	3 and up 13.00/ctn.	Shp. & handling Perctn. 3.45
(also available 2, 3 and 4 part)				

SEND CHECK OR MONEY ORDER
PA. Residents add 6% sales tax.



168 E. Lancaster Ave.
Wayne, PA 19087
(215) 687-4548

Circle 351 on inquiry card.

IS YOUR North Star OUT OF SORTS?

INCREASE YOUR BASIC'S
SORTING POWER OVER 1800%!

N*SORT is easy to use and will perform sorts on one and two dimensional or string arrays using optional sort keys. For example, to alphabetize A\$:

10 A\$ = "ZYXWVUTS" \ REM Define String
20 SRT A\$, LEN(A\$), 1 \ REM Sort A\$

N*SORT interfaces to any release 4 or later North Star Basic and can be yours for ONLY \$89 plus \$1.50 shipping

Calif. Res. add 6% tax.

Send check VISA or M/C
Complete Brochure Available



1269 Rubio Vista Road, Altadena, Calif. 91001
(213) 791-3202

Circle 351 on inquiry card.

DISCOUNT PRICES

on

CENTRONICS • CROMEMCO
LEAR SIGLER • NORTH STAR
DIABLO • HAZELTINE, ETC.

- NEW, FULL WARRANTY
- QUICK DELIVERY
- Hundreds of Satisfied Customers
- Call for DISCOUNT Price List



DIGITAL DATA SYSTEMS, INC.

1551 NW 65th Avenue, Plantation, FL 33313

(305) 792-3290

OUR 8TH YEAR OF SERVICE

Circle 112 on inquiry card.



THE STAR MODEM

From Livermore Data Systems

RS232 MODEM SALE \$135
 IEEE 488 MODEM SALE \$199
 RS232 CCITT \$170
 IEEE 488 CCITT \$280

STAR Modem is the price performance leader with a full 2 YEAR FACTORY WARRANTY.

MILOT Intelligent Plotter

by Watanabe Instruments (Digiplot)

SPECIAL \$1145



Has all intelligent functions for producing graphs and drawings including 8 vector and 4 character commands. Solid and broken lines can be specified. Character generator for alpha, numeric, and symbols. Characters can be rotated in 4 orientations, and can be 16 sizes. Coordinate axes drawn by specifying graduation interval and number of repetitions. Parallel ASCII interface, 11 x 17 paper.

We carry Apple II+ from Bell & Howell

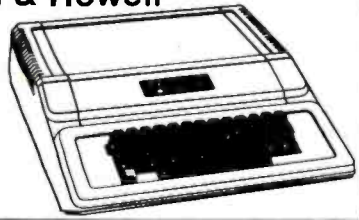

REVERSAL (Spracklen) 32K Apple	28.00
Super FORTH 48K Apple	40.00
Energy Miser - 32K Apple	24.50
Data Manager (Lutus) 24K Apple	40.00
Histo-Graph (Boyd) 48K Apple	24.50
Data-Graph (Boyd) 48K Apple	40.00
Apple II User's Guide (Osborne)	12.00
Introduction to Pascal (Sybex)	10.30
Pascal Handbook (Sybex)	12.00
Graphics Cookbook for Apple	9.90
Musical Applications of Micros (Chamberlin)	20.00
Basic FORTRAN (Coan)	7.25

PROGRAM YOUR OWN EPROMS
 Branding Iron for PET/CBM \$79
 EPROM Programmer with software for all ROM versions. Includes all necessary hardware and software to program or copy 2716 and 2532 EPROMS.

KMMM Pascal for PET \$75
 Subset of standard Pascal with true machine language translator for faster execution. 16K with tape or disk.

Paper-Mate Word Processor \$39.95
 PET/CBM full featured 60 command system by Michael Riley. Uses either tape or disk and any printer. Includes in-text commands, floating cursor, scrolling, etc.

EARL for PET (disk file based) \$65
 Editor, Assembler, Relocator, Linker to generate relocatable object code.

FLEX-FILE Data Base for CBM/PET \$60
 Random file handling system with Report Writer and Mail Label Handler. By Michael Riley.

FORTH for PET/CBM or Apple \$65
 A full-featured FORTH with extensions conforming to Forth Interest Group standards. Includes assembler, string processing capabilities, disk virtual memory multiple dimensioned arrays, floating point and integer processing.

6502	7.45	10/6.95	50/6.55	100/6.15
6502A	8.40	10/7.95	50/7.35	100/6.90
6520 PIA	5.15	10/4.90	50/4.45	100/4.15
6522 VIA	6.45	10/6.10	50/5.75	100/5.45
6532	7.90	10/7.40	50/7.00	100/6.60
2114-L200 ns RAM	3.75	25/3.50	100/3.25	
2114-L300 ns RAM	3.15	25/2.90	100/2.65	
2716 EPROM (5 volt)	9.90	5/9.45	10/8.90	
TMS 2532 EPROM			20.00	
4116-200 ns RAM			8 for 29.00	
S-100 Wire Wrap			2.65	



CBM-PET SPECIALS
 Up to \$315 free merchandise with purchase of one of following CBM-PET items:

8032 32K - 80 Column CRT	1795	315	FREE
8050 Dual Disk Drive - 950,000 bytes	1795	315	
4016 Full Size Graphics Keyboard	995	170	
4032 Full Size Graphics Keyboard	1295	230	
8096 96K - 80 Column CRT			
2040/4040 Dual Disk Drive - 340K	1295	230	
4022 Tractor Feed Printer	795	140	
CBM Voice Synthesizer	395	50	
C2N External Cassette Deck	95	12	
Used CBM/PET Computers			CALL
VIC Personal Computer	300	25	

WRITE FOR SYSTEM PRICES

DISK SPECIALS

SCOTCH (3M) 5 1/4"	10/2.85	50/2.75	100/2.65
SCOTCH (3M) 8"	10/2.90	50/2.80	100/2.70
Verbatim 5 1/4"	10/2.45	50/2.40	100/2.35
(add 1.00 for 5 1/4" Verbatim plastic storage box)			
Verbatim 8" Dbl. Dens.	10/3.45	50/3.35	100/3.25
BASF 5 1/4"	10/2.60	20/2.50	100/2.40
BASF 8"	10/2.65	20/2.55	100/2.45

WE STOCK MAXELL DISKS
 Diskette Storage Pages 10 for 3.95
 Disk Library Cases 8" - 2.85 5" - 2.15

ATARI 800 \$745
 All Atari Modules 20% OFF

ATARI EDUCATIONAL PLAN Write for details.

A P Products 15% OFF
A P Hobby-Blox 15% OFF

ALL BOOK and SOFTWARE PRICES DISCOUNTED

The 8086 Book (Osborne)	14.00
Z8000 Assembly Language Programming	16.90
PET Personal Computer Guide (Osborne)	12.75
PET and the IEEE-488 Bus (Osborne)	13.60
6502 Assembly Language (Osborne)	14.45
Programming the 6502 (Zaks)	10.45
6502 Applications Book (Zaks)	10.45
6502 Software Cookbook (Scelbi)	9.45
CP/M Handbook (w/ MP/M) Zaks	11.85
Practical BASIC Programs (Osborne)	13.60
Some Common BASIC Programs (Osborne)	12.75

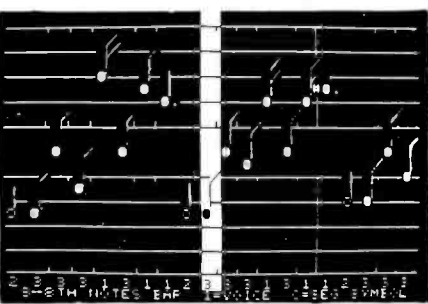

4 PART HARMONY MUSIC SYSTEM for PET
 The Visible Music Monitor, by Frank Levinson, allows you to easily enter, display, edit, and play 4 part harmony music. Includes whole notes thru 64ths (with dotted and triplets), tempo change, key signature, transpose, etc. The KL-4M unit includes D to A converter and amplifier (add your own speaker).
 KL-4M Music Board with VMM Program \$59.90

*** EDUCATIONAL DISCOUNTS ***
 Buy 2 PET/CBM Computers, receive 1 FREE

WordPro 3+ - 32K CBM, disk, printer	250
WordPro 4+ - 8032, disk, printer	385
OZZ Data Base System for CBM 8032	335
VISICALC for PET or ATARI	170
BPI General Ledger, A/P, A/R for PET/CBM	270
Programmers Toolkit - PET ROM Utilities	34.90
PET Spacemaker II ROM Switch	36.00
2 Meter PET to IEEE or IEEE to IEEE Cable	40.00
Dust Cover for PET	6.90
IEEE-Parallel Printer Interface for PET	110.00
IEEE-RS232 Printer Interface for PET	120.00
The PET Revealed	17.00
Library of PET Subroutines	17.00
Source Hookup over 1000 programs/services	88

Circle 1 on Inquiry card.

SINGLE-BOARD VERSATILITY!

The New
BASYS/1
can:

- directly drive motors and solenoids
- operate for weeks on a few flashlight batteries
- work reliably from -40 to +85°C.
- monitor 80 keys and drive 10-digit LED displays
- fit in a 4.5 x 6.5 x 1" space

... and a lot more. BASYS/1 is a CMOS single board computer for real-world control applications. It contains a COSMAC 1802 CPU, up to 2K RAM, 8K ROM, and versatile serial, parallel, and multiplexed I/O. ROM monitor supplied for machine language programming, or order optional Integer BASIC or 8TH (our version of FORTH). Expansion boards also available.

BASYS/1 with 1K RAM, .5K ROM. Kit \$185, assembled \$220

TECHNICAL MICRO SYSTEMS, INC.

TMSI 366 Cloverdale
Ann Arbor, MI 48105
(313) 994-0784



Circle 355 on inquiry card.

Are you playing
with a full deck?



If you are holding an AIM, SYM, KIM, PET or OSI, then you need our 1981 Product Guide to fill your hand.

The Computerist deals only superior products:

- Dram Plus — RAM, EPROM, Programmer and I/O.
- Video Plus — Instant video up to 132 by 30, plus communication and keyboard ports.
- Mother Plus — Supports multi-board expansion, cassette control and more.
- Proto Plus — Add custom circuits easily.
- Power Plus — Triple voltage supply.

Why stand when you can take a guaranteed hit?

For the best deal in town,
write or call for our free 1981 Product Guide

34 Chelmsford St., Chelmsford, MA 01824
617/256-5515
THE COMPUTERIST®

Circle 362 on inquiry card.

COMPUTERS!



OHIO SCIENTIFIC

CIP SERIES II — \$479.00

OUR PRICE — \$399.00

other OSI discounts available

**COMPUTERS
PLUS**

2749 S. 108th St.
MILWAUKEE, WI 53227
(414) 321-1770
IN WISCONSIN

CALL NOW TOLL FREE
1-800-558-0870

Circle 80 on inquiry card.

**COMPUTER
EQUIPMENT
& SOFTWARE
BARGAINS**



EVERY MONTH

BUY, SELL OR TRADE ALL TYPES OF COMPUTER EQUIPMENT AND SOFTWARE (pre-owned and new) among 20,000 readers nationwide in BIG (11x14") pages. Classified ads are only 10¢ per word and are indexed for easy and fast location. Subscription: \$10 a year / 12 issues. Money back guarantee. Sample copy, \$1.50.

COMPUTER SHOPPER

P.O. Box F-14
Titusville, FL 32780
(305) 269-3211

MasterCard or VISA subscription orders only,
call TOLL FREE 1-800-528-6050 Ex. 184.

Circle 81 on inquiry card.

dysan **Dysan**
CORPORATION

Solve your disc problems, buy 100% surface tested Dysan diskettes. All orders shipped from stock, within 24 hours. Call toll FREE (800) 235-4137 for prices and information. Visa and Master Card accepted. All orders sent postage paid.



**PACIFIC
EXCHANGES**
100 Foothill Blvd.
San Luis Obispo, CA
93401. (In Cal call
(805) 543-1037.)

Circle 278 on inquiry card.

COMPUSERVE
APPLICATIONS AND
SYSTEMS PROGRAMS FOR THE
PDP 11, LSI 11 WITH RSX11 OR IAS.

Word Processor

Mass Mailing

Payroll, Order Entry, Accounts
Receivable/Payable, Inventory Control,
General Ledger

Full Screen Editor for the VT100
modifiable for any terminal

Many other applications

Source Code for all programs available.

For inquiries and orders call or write

Compuserve Systems Corporation
350 E 76 St. Room 2C
N.Y., N.Y. 10021
212-581-1300

Circle 68 on inquiry card.

ALL FOR QUALITY COMPONENTS
SLUIDER

BUSINESS COMPUTERS FROM SLUIDER
The OT Computer Systems Inc. SYSTEM 1+ with 64K Ram, Dual 8" Disks, 1 M.B. Disk Storage Clock, EPROM Burner, and CPM 2.2 from Digital Research represents an exceptional Cost/Performance Value with a List of \$3595. Our Price is even better at \$3235 with OT 1 year warranty. All OT A&T Boards 10+ off

ALL DYNABYTE BUSINESS COMPUTERS ARE COMPLETELY EXPANDABLE To Hard Disk, Multiuser, MultiProcessors, & 16 bit Processors.

\$200 A2 64K 5" Drives 650K CPM 1.4 \$3495.
\$300 B2 64K 8" Drives 2 MB CPM 1.4 \$295.
MPM configured for Dynabyte 5 or 8" 650.
Gothout Electronics A & T Boards 315.
CPU 2 4 MHz 24 address lines Zilog Z80A 235.
CPU 2 6 MHz 24 address lines Zilog Z80R 335.
CPU 8085/8088 5 MHz 8 & 16 bit Processor 340.
SYSTEM SUPPORT 1 315.
Disk 1 with CPM BIOS 395.
Ram 17 64K Static 10 Mhz low power 1099.
Ram 20 32K Static 10 Mhz 559.

CALL ON MORROW'S NEW COMPUTER & DISKS

EPSON MX80 Printer Parallel 475.

Micro Pro Word Star Super Word Process 300.

All Prices Subject To Change Without Notice

Shipping Extra, Min. \$3.00. Systems Freight

Collect, EPSON \$8.00. Many Items Not Listed

PO BOX 951

WESTMINSTER, CA 92683

714 845 1746

Circle 329 on inquiry card.

PROOF

IS HERE

- *PROOFREADS SPELLING
- *FINDS TYPOGRAPHICAL ERRORS
- *CHECKS OVER 250,000 WORDS
- *ERRORS HIGHLIGHTED OR IN REVERSE VIDEO
- *USER EXPANDABLE DICTIONARY
- *SIMPLE TO USE
- *COMPATIBLE WITH ALL Z80+ CP/M+ TEXT FILES
- *FAST

\$150

IPS

IMAGE PROCESSING SYSTEMS

6409 Appalachian Way
Madison, Wisconsin 53705
(608) 233-5033

†Registered Trademark

Circle 169 on Inquiry card.

OKI DATA

MICROLINE PRINTERS
NEW IN ORIG. CARTON
FULL WARRANTY

MODEL 80 - \$419.00

MODEL 82 - \$569.00

MODEL 83 - \$859.00

M.C. & VISA ACCEPTED
NO C.O.D.s, ORDER NOW
FAST SERVICE

PRINTERS

P.O. BOX 602
EDWARDSVILLE, IL
62025

1-618-465-4645

Circle 390 on inquiry card.

16K

Memory

8/\$19.95

4116-200ns

NEC

Mostek

ALL MERCHANDISE 100% GUARANTEED!

CALL US FOR VOLUME QUOTES

LS SERIES

74LS00	.32	74LS155	1.19
74LS01	.28	74LS156	.95
74LS02	.38	74LS157	.79
74LS03	.32	74LS158	.82
74LS04	.35	74LS160	.94
74LS05	.28	74LS161	.99
74LS08	.38	74LS162	.99
74LS09	.38	74LS163	.99
74LS10	.32	74LS164	.99
74LS11	.29	74LS165	.99
74LS12	.29	74LS166	2.40
74LS13	.38	74LS168	1.79
74LS14	.99	74LS169	1.79
74LS15	.35	74LS170	1.89
74LS20	.26	74LS173	.82
74LS21	.30	74LS174	1.19
74LS22	.34	74LS175	1.09
74LS26	.40	74LS181	2.19
74LS27	.35	74LS190	1.15
74LS28	.39	74LS191	1.31
74LS30	.35	74LS192	.88
74LS32	.39	74LS193	.98
74LS33	.54	74LS194	1.80
74LS37	.78	74LS195	1.39
74LS38	.39	74LS196	.82
74LS40	.25	74LS197	.82
74LS42	.78	74LS221	1.25
74LS47	.78	74LS240	1.89
74LS48	.78	74LS241	1.89
74LS51	.35	74LS242	1.89
74LS54	.35	74LS243	1.89
74LS55	.32	74LS244	1.79
74LS73	.44	74LS245	2.89
74LS74	.48	74LS251	1.32
74LS75	.58	74LS253	.89
74LS76	.50	74LS257	.89
74LS78	.59	74LS258	.89
74LS83	.90	74LS259	2.89
74LS85	1.23	74LS260	.68
74LS86	.45	74LS266	.68
74LS90	.70	74LS273	1.69
74LS92	.82	74LS275	3.39
74LS93	.71	74LS279	.69
74LS95	1.11	74LS283	1.03
74LS96	.86	74LS290	1.25
74LS107	.43	74LS293	1.89
74LS109	.49	74LS295	1.09
74LS112	.48	74LS298	1.24
74LS113	.48	74LS352	1.59
74LS114	.55	74LS353	1.59
74LS122	.55	74LS363	1.39
74LS123	.99	74LS365	.99
74LS124	2.99	74LS366	.99
74LS125	.99	74LS367	.99
74LS126	.88	74LS368	.99
74LS132	.69	74LS373	1.85
74LS136	.58	74LS374	1.81
74LS138	.79	74LS377	1.48
74LS139	.79	74LS385	1.90
74LS145	1.19	74LS386	.65
74LS148	1.39	74LS390	1.90
74LS151	.79	74LS393	1.90
74LS153	.79	74LS395	1.69
74LS154	2.39	74LS670	2.20

SPRING MEMORY SALE

RAMS		100pcs		EPROMS				
2101	(450ns)	2.49	2.29	1702	(1us)	4.95	100pcs	4.75
2102-1	(450ns)	.99	.95	2708	(450ns)	4.95	4.75	
21L02-1	(450ns)	1.29	1.15	2758(5v)	(450ns)	9.95	Call	
2111	(450ns)	2.99	2.49	2716(5v)	(450ns)	7.95	6.95	
2112	(450ns)	2.99	2.79	2716-1(5v)	(350ns)	12.95	10.95	
2114	(450ns)	2.95	2.85	TMS2516	(450ns)	9.95	9.50	
2114L-2	(200ns)	8/29.95	3.10	TMS2716	(450ns)	9.95	8.95	
2114L-3	(300ns)	8/24.95	2.95	2732	(450ns)	29.95	Call	
4027	(250ns)	4.95	3.95	TMS2532	(450ns)	21.95	Call	
4116-15	(150ns)	8/21.95	2.65	TMS25L32	(450ns)	29.95	Call	
4116-20	(200ns)	8/19.95	2.35	TMS2564	(500ns)	179.95	Call	
4116-30	(300ns)	8/18.99	2.29					

NEED YOUR ORDER
SHIPPED TODAY?
THEN CALL TOLL FREE

800-538-5000

IN CALIF.

800-662-6233

(effective 4-14-81)

BEFORE YOU BUY, CALL US.
WE WILL BEAT
ANYONE'S PRICES

6800

6800	11.75
6810	4.60
6820	5.75
6821	6.40
6828	9.95
6834	19.95
6850	5.75
6852	5.75
6875	6.95

8080

8080A	3.95
8085A	12.95
8212	2.75
8214	5.25
8216	2.75
8224	2.95
8226	3.49
8228	4.95
8238	5.50
8251	6.95
8253	12.95
8255	6.50
8257	16.95
8259	14.95
8275	49.95
8279	15.95

Z80

Z80	9.95
Z80A	12.95
Z80-CTC	7.65
Z80-DMA	18.00
Z80-PIO	7.60
Z80-SIO/2	27.50
Z80-SIO/9	20.50

MISC.

1771-B01	24.95
3242	9.95
AY5-1013	4.99
8T26	2.49
8T28	2.49
8T97	1.69
8T98	1.69

T.V. CIRCUITS

MC1330	1.89
MC1350	1.29
MC1358	1.79
LM380	1.29
LM565	.99
LM741	.29
LM1310	2.90
LM1800	2.99
LM1889	2.49

7400 SERIES

7400	.19	7450	.19	74123	.59
7402	.19	7472	.29	74151	.69
7404	.24	7473	.34	74153	.59
7406	.29	7474	.35	74154	1.49
7407	.29	7475	.49	74156	.69
7408	.24	7476	.35	74157	.69
7410	.19	7483	.65	74161	.79
7420	.19	7486	.35	74163	.89
7430	.19	7490	.49	74164	.89
7432	.29	7491	.69	74173	1.39
7440	.19	7492	.59	74174	.89
7442	.49	7493	.49	74175	.89
7445	.69	7496	.74	74176	.89
7446	.69	74100	1.19	74192	.79
7447	.59	74107	.34	74193	.79
7448	.69	74121	.34	74196	.79

IC SOCKETS

8 pin ST	10/1.29	8 pin WW	.59
14 pin ST	10/1.49	14 pin WW	.69
16 pin ST	10/1.69	16 pin WW	.69
18 pin ST	10/1.99	18 pin WW	.99
20 pin ST	10/2.89	20 pin WW	1.09
22 pin ST	10/2.99	22 pin WW	1.39
24 pin ST	10/2.99	24 pin WW	1.49
28 pin ST	10/3.99	28 pin WW	1.69
40 pin ST	10/4.99	40 pin WW	1.99

ST = SOLDER TAIL WW = WIREWRAP

VOLTAGE REG'S

7805T	.89	7905T	.99
7812T	.89	7912T	.99
7815T	.99	7915T	1.19
7824T	.99	7924T	1.19
7805K	1.39	7905K	1.49
7812K	1.39	7912K	1.49
78L05	.69	79L05	.79
78L12	.69	79L12	.79
78L15	.69	79L15	.79

TRANSISTORS

2N2222	10/1.00	100/8.99
2N3904	10/1.00	100/8.99
2N3906	10/1.00	100/8.99
2N3055	.79	10/6.99

LEDS

Jumbo Red	10/1.00
Jumbo Green	6/1.00
Jumbo Yellow	6/1.00
5082-7760 .43°C	.79
MAN74 .3°C	.99
MAN72 .3°C	.99

CMOS

4001	.35	4024	.99	4070	.49
4002	.39	4025	.29	4071	.49
4007	.25	4027	.65	4072	.49
4009	.49	4040	1.29	4081	.39
4010	.49	4042	.99	4093	.99
4011	.35	4046	1.79	4098	2.49
4012	.29	4047	2.49	4503	.69
4013	.49	4049	.49	4508	3.95
4016	.59	4050	.69	74C04	.39
4017	1.19	4060	1.39	74C14	1.49
4020	1.19	4066	.79		
4023	.29	4069	.39		

LINEAR

LM301v	.34	LM556	.69	LM1488	1.39
LM308v	.98	LM565	.99	LM1489	1.39
LM309K	1.49	LM566v	1.49	LM1800	2.99
LM311v	.64	LM567v	1.29	LM1889	2.49
LM317v	2.29	LM723	.49	LM3900	.59
LM318v	1.49	LM733	.98	75451v	.39
LM323K	4.95	LM741v	.29	MC1330v	1.89
LM324	.59	LM747	.79	MC1350v	1.29
LM339	.99	LM748v	.59	MC1358	1.79
LM377	2.29	LM1310	2.90		
LM380	1.29	LM1414	1.59		
LM555v	.39	LM1458v	.69		

T = TO-220 V = 8 pin K = TO-3

DIP SWITCHES

4 position	.99
5 position	1.02
6 position	1.06
7 position	1.09
8 position	1.14



JDR MICRODEVICES, INC.
1101 South Winchester Blvd.
San Jose, California 95128
800-538-5000 408-247-4852

TERMS: Include \$2.00 for shipping. \$10.00 minimum order.
Send SASE for complete catalog. Bay Area Residents add
6 1/2% sales tax Calif. Residents add 6% sales tax. We
reserve the right to limit quantities and substitute
manufacturer. Prices subject to change without notice.
Foreign orders add suff. postage.

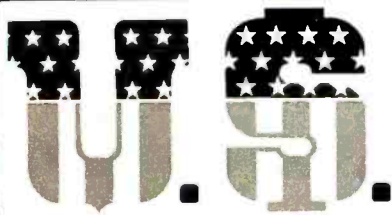

MICRO SALES

DEALS □ DEALS □ DEALS

SHOP HERE AND
SAVE!
(MINIMUM ORDER \$10.00)

This is **ABSOLUTELY** the **LOWEST PRICE EVER** for a Hi Speed (300 NS) LO-LO Power 32K RAM. 4K by 1 Chips are organized in Selectable Banks.

\$299

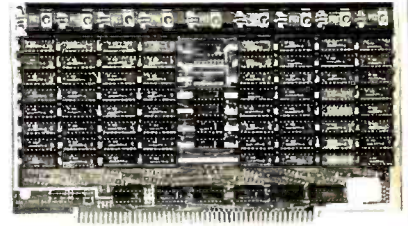

★ Extended Address Lines A16 - A17

★ Phantom Line

★ 9 Regulators

(KIT)

SCHOOLS

DIP SWITCHES	POS.	PRC.
	4	.88
	5	.92
	6	.95
	7	.99
	8	1.05
	9	1.15
	10	1.19

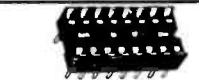

PINS	PC	WW
8	.10	.26
14	.13	.29
16	.16	.32
18	.18	.34
20	.22	.38
24	.32	.48
28	.34	.50
40	.45	.61

AMP - Need we say more? There is a difference in sockets! These aren't the lowest prices you can find. But, if you've been "burned" before by bad connections in your computer, a few pennies for the best is worth it!

RESISTORS .02 ea!

(100 PACK) ½W				
1.0	75	2.7K	22K	220K
4.7	100	3.3K	24K	330K
6.8	150	3.9K	27K	470K
10	220	4.7K	33K	680K
15	330	6.8K	39K	1M
22	470	10K	47K	1.5M
27	680	12K	68K	2.2M
33	1K	15K	100K	4.7M
47	1.5K	18K	150K	10M
68	2.2K	20K		

WIRE WRAP WIRE

Packed in 500 Lot Bundles (Length includes 2" x 1" Strip)

Color - R, Bu, G, Y, Bk, W

50 ft. \$1.65 - 100 ft. \$3.00 - 500 ft. \$9.50

2.5-3.25	4.0-3.75	6.0-4.75
3.0-3.35	4.5-4.00	7.0-5.00
3.5-3.50	5.0-4.50	8.0-5.50
		10.0-6.50

OK WIRE WRAP TOOL \$5.95

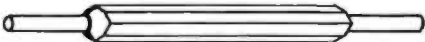

COMPUTER GRADE ELECTROLYTICS

Capac.	Volt	Type	\$
150,000	15	CAN	12.50
18,000	25	CAN	5.50
6,000	50	CAN	5.75
10,000	16	AXIAL	4.95
4,700	35	AXIAL	3.50



HOBBIEST

LM323K 5V. 3A. REGULATOR

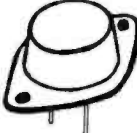

\$5.50



TAB MOUNT

7805 +5V 1A
7905 -5V 1A
7812 +12V 1A
7912 -12V 1A



HEAT SINKS 49¢ \$1.25

◆ GOLD ◆

S-100-CONNECTOR

TI or Better

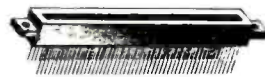

SOLDER TAIL WIRE WRAP

\$2.50 \$3.25

DIP PLUGS

PART#	PINS	PRICE
08DP	8	.40
14DP	14	.55
16DP	16	.58
24DP	24	.95
40DP	40	1.50



Socket and Dip Plug priced based on gold not exceeding \$700 per ounce.

CONNECTORS

DUAL ROW .100		CARD EDGE	
PINS	PRICE	PINS	PRICE
20	2.35	20	3.35
26	3.00	26	3.80
34	3.85	34	4.65
40	4.50	40	5.50
50	5.50	50	5.90

RIBBON - 20 to 34 @ 1.00 ft.
40 & 50 @ 1.30 ft.

CRIMPING 2.00 / CONNECTOR

OEM'S

Z-80-A

\$6.95

4MHZ Beastie with extra instructions!

Z-80 SUPPORT

CTC - \$6.55

SIO - \$25.50

PIO - \$6.50

DMA - \$18.75

All 4MHZ (who wants 2MHZ?)

74LSXX

74LS00	.33	74LS107	.59	74LS221	2.95
74LS01	.33	74LS109	.59	74LS240	2.95
74LS02	.33	74LS112	.59	74LS241	2.49
74LS03	.33	74LS113	.59	74LS242	1.95
74LS04	.59	74LS114	.49	74LS243	1.95
74LS05	.39	74LS122	.59	74LS244	2.95
74LS06	.39	74LS123	1.19	74LS245	8.95
74LS07	.39	74LS124	1.49	74LS247	1.19
74LS08	.59	74LS125	.89	74LS248	1.19
74LS09	.39	74LS126	.89	74LS249	1.69
74LS10	.29	74LS132	.79	74LS251	1.79
74LS11	.39	74LS133	1.19	74LS253	.95
74LS12	.39	74LS136	.69	74LS257	1.95
74LS13	.69	74LS138	.99	74LS258	1.95
74LS14	1.25	74LS139	.99	74LS259	2.95
74LS15	.49	74LS145	1.25	74LS260	.75
74LS20	1.95	74LS148	1.49	74LS266	1.15
74LS21	3.7	74LS151	.79	74LS273	1.75
74LS22	.29	74LS154	2.49	74LS275	4.39
74LS26	.39	74LS155	1.49	74LS279	.79
74LS27	.49	74LS156	1.49	74LS283	1.49
74LS28	.39	74LS157	1.49	74LS289	5.75
74LS30	.49	74LS158	1.49	74LS290	1.29
74LS32	.95	74LS160	.75	74LS293	1.95
74LS33	1.95	74LS161	1.99	74LS295	1.95
74LS37	.75	74LS162	1.25	74LS298	1.29
74LS38	.39	74LS163	1.25	74LS324	1.75
74LS40	.25	74LS164	2.15	74LS352	1.65
74LS42	1.39	74LS165	1.49	74LS353	1.65
74LS47	.79	74LS166	2.49	74LS365	.95
74LS48	.79	74LS168	2.95	74LS366	.79
74LS35	.25	74LS169	1.95	74LS367	.99
74LS54	.25	74LS170	1.95	74LS368	.99
74LS55	.70	74LS173	1.25	74LS373	2.95
74LS73	.79	74LS174	1.49	74LS374	3.95
74LS74	.59	74LS175	1.49	74LS377	1.95
74LS75	.79	74LS181	2.15	74LS378	1.95
74LS76	.79	74LS189	6.95	74LS379	1.95
74LS78	.49	74LS190	.99	74LS386	.59
74LS83	.95	74LS191	1.95	74LS390	1.95
74LS85	1.49	74LS192	1.95	74LS393	1.95
74LS86	.95	74LS193	1.95	74LS395	1.95
74LS90	.75	74LS194	1.49	74LS490	4.95
74LS92	.75	74LS195	.95	74LS668	1.69
74LS93	.95	74LS196	.95	74LS669	1.89
74LS95	1.29	74LS197	1.95	74LS670	3.55
74LS96	1.29				

OUR BUYERS ARE IN CONTACT WITH EVERY MAJOR SUPPLIER AND O.E.M. BUY HERE AT 1000 PIECE

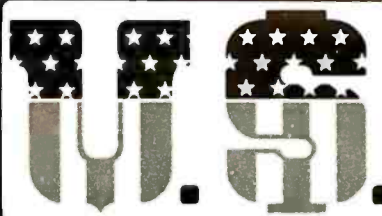

MICRO SALES

QUANTITY PRICES

ALL MERCHANDISE 100% GUARANTEED! 15 DAY FULL CASH REFUND!

11 EDISON DRIVE ★ NEW LENOX ★ ILLINOIS 60451
CALL TOLL FREE: 1-800-435-9357 ★ MONDAY thru SATURDAY
(ILLINOIS RESIDENTS CALL: 815-485-4002) ★ 8:00 a.m. to 6:30 p.m.

TERMS: Prepayment - C.O.D. up to \$100.00 - M/C Visa
\$5.00 Processing and Handling added to each order PLUS
Shipping Charges. Please allow personal check
to clear before shipment.

JUST HOT STUFF

POWER SUPPLIES

If you can beat these prices we will be truly amazed. OEM's at 500 lot pay more than this. Call or write for full spec. sheets.

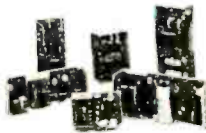

DISK POWER SUPPLIES			
PRIAM-SHUGART-CENTURY-MICROPOLIS			
+5V @ 9A	-5V @ 8A	+24V @ 7A	US-384 89.00
SHUGART - SIEMANS - MPI 5 1/2"			
+5V @ 5A	+12V @ 9A		US-340 33.50
+5V @ 2A	+12V @ 4A		US-323 56.25
SHUGART - SIEMANS - CDC 8"			
+5V @ 1A	-5V @ 5A	+24V @ 1.5A	US-205 52.50
+5V @ 2A	-5V @ 5A	+24V @ 3A	US-206 69.00
+5V @ 3A	-5V @ 6A	+24V @ 5A	US-162 89.00
+5V @ 1.7A	-5V @ 1.5A	+24V @ 2A	US-272 69.00
+5V @ 2A	+12V @ 4A	-12V @ 4A	US-HTAA 37.50

TELEVIDEO 950

Televideo 950 - \$950.00
Televideo 912C - 665.00
Televideo 920C - 720.00
ADDS R-25 - 710.00

Also have 920C, SOROC, HAZELTINE, etc. What we don't have is room on this page. Call Toll Free 800 number for prices.

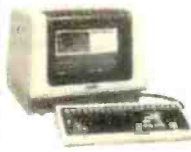

C-ITOH PRINTER

\$499.00

Look closely at the photo and see other adds in this rag at \$995.00. Perfect units, warranted. Only 500 pcs. Same story, manufacturer had too many.



S-100 CARD EXTENDER

\$12.50

(Gold Contacts)

As long as there is a price war, we will fight your battle. Compare at your local Dept. store and buy U\$ MICRO.



MEMOREX - VERBATUM - WABASH BASF FLOPPIES

BOX OF 10 ONLY:

5 1/4"	SOFT	\$2.65 ea.
5 1/4"	HARD 10	2.65 ea.
5 1/4"	HARD 16	2.65 ea.
8"	SOFT 1D	3.25 ea.
8"	SOFT 2D	3.85 ea.
8"	SOFT 2DDS	5.00 ea.



SPECIAL OF THE QUARTER

S1-MOD (KIT)

\$189.00



Complete S-100 12 Slot Computer. Ample system power with regulated power for drives. Excellent for Subsystem or Hobby use. 4 hours to build. 16 conn. incl., less fans)

DUAL DRIVE SUBSYSTEM

\$995.00

\$195.00 w/no Drives

If this looks like a Lobo Drive System, don't be fooled. Just because it looks like one, works like one, smells like one, and tastes like one (?) doesn't mean it has to cost like one!



2 SHUGART 801R POWER SUPPLY

TWIN VERTICAL DRIVES

5" \$550.00 - 8" \$980.00

Attractive, convenient and compact Two Drive Mass Storage includes Power Supply, Drives, Cabinets and Cables. Double Sided, Double Track available too! \$145.00 Kit (Less Cable)



Z-80 CPU (KIT)

The first time this world popular CPU offered in Kit. 2 serial, 3 parallel, CTC, EProm Z-80 at 4 mhz. Software buad rate, etc. (less Prom & cable) \$212.00



EXPANDABLE RAM

★SPECIAL★SPECIAL★SPECIAL★

This is the best all around 64K board you can buy. If after you see it, you don't agree return for full refund. Bank Select by extended address lines or I.O. 40H.



★\$389.00 A&T★

U\$ - D\$K \$255.00

Double Density 8" and 5" Disk Controller designed for S-100 IEEE standards. Uses Western Digital 1795, 1691 2143 Chip Set.



FANS \$14.95

These are brand new, in the box fans. Not noisy bearing pullouts. Never again at these low prices!



3-1/8"

4-5/8"

SPECIALS OF THE MONTH

4116s

\$3.25

Expansion 16K Dynamic RAMs for Apple, TRS-80 S-100 systems. T.I., Mostek Intel, Call for manufacturer.

200 NS

INTEL

8251 \$4.95

8255 \$6.50

VERY POPULAR I.O. CHIPS BY LEADING MANUFACTURER

2114s

\$2.95

One of the world's two most popular STATIC RAMs. Factory prime tested units. Sold in lots of 8 only. FUJITSU, HITACHI, etc.



200 NS

TMS-4044

\$4.25

MM-5257

INTEL 2147

250 NS

CMOS Version \$4.50!

The other of the world's most popular STATIC RAMs. This one is 4K by 1 organization. Don't buy Gold, buy these, the price won't last!

2716s

\$7.50 (450 NS)

2708s

\$6.95 (450 NS)

Remember when 2716s were \$50.00 and hard to get? These units are so beautiful it's hard to part with them. But we will, for a small price. Guaranteed!

SHUGART DRIVE



8" 801R

\$395.00

Manufacturer had too many, buys at 1000 piece rate, sales dropped, so we got 'em. Fantastic buy, get them while they last! Full warranty.

8" 851R \$585.00

SIEMANS DRIVE

8" 100-8

\$375.00

Very Special Price on these BRAND NEW current production units Add \$10.00 for Extended 1 Year Warrantee!

7400

SN7400N	19	SN74123N	59
SN7401N	22	SN74125N	39
SN7402N	22	SN74126N	44
SN7403N	23	SN74127N	45
SN7404N	22	SN74132N	65
SN7405N	23	SN74136N	95
SN7406N	23	SN74139N	95
SN7407N	23	SN74141N	69
SN7408N	26	SN74142N	295
SN7409N	23	SN74143N	235
SN7410N	22	SN74144N	295
SN7411N	29	SN74145N	62
SN7412N	29	SN74147N	195
SN7413N	29	SN74148N	120
SN7414N	59	SN74150N	29
SN7415N	29	SN74151N	67
SN7417N	29	SN74152N	67
SN7420N	22	SN74153N	61
SN7421N	35	SN74154N	119
SN7422N	29	SN74155N	82
SN7423N	29	SN74156N	89
SN7425N	29	SN74157N	69
SN7426N	29	SN74158N	165
SN7427N	29	SN74160N	95
SN7428N	45	SN74161N	95
SN7430N	22	SN74162N	89
SN7432N	29	SN74163N	87
SN7437N	29	SN74164N	97
SN7438N	29	SN74165N	97
SN7439N	29	SN74166N	120
SN7440N	24	SN74167N	135
SN7441N	19	SN74170N	159
SN7442N	27	SN74172N	95
SN7443N	79	SN74173N	79
SN7444N	79	SN74174N	89
SN7445N	79	SN74175N	85
SN7446N	79	SN74176N	85
SN7447N	79	SN74177N	85
SN7448N	79	SN74179N	160
SN7450N	23	SN74180N	75
SN7451N	23	SN74181N	175
SN7453N	23	SN74182N	175
SN7454N	23	SN74183N	195
SN7455N	29	SN74185N	195
SN7460N	23	SN74186N	95
SN7470N	39	SN74188N	30
SN7472N	39	SN74189N	15
SN7473N	39	SN74191N	115
SN7474N	36	SN74192N	85
SN7475N	36	SN74193N	85
SN7476N	36	SN74194N	85
SN7479N	460	SN74195N	85
SN7480N	59	SN74196N	85
SN7481N	110	SN74197N	85
SN7482N	110	SN74198N	39
SN7483N	55	SN74199N	139
SN7485N	65	SN74221N	139
SN7486N	39	SN74251N	95
SN7488N	19	SN74252N	95
SN7490N	39	SN74279N	89
SN7491N	65	SN74283N	215
SN7492N	52	SN74284N	30
SN7493N	49	SN74285N	390
SN7494N	49	SN74290N	195
SN7495N	65	SN74298N	95
SN7496N	62	SN74365N	68
SN7497N	310	SN74366N	68
SN74100N	99	SN74376N	79
SN74107N	32	SN74366N	79
SN74109N	32	SN74393N	190
SN74116N	195	SN74393N	190
SN74121N	29	SN74490N	190
SN74122N	39		

74LS00

74LS00N	35	74LS164N	119
74LS01N	28	74LS165N	89
74LS02N	28	74LS166N	246
74LS03N	28	74LS168N	89
74LS04N	39	74LS169N	189
74LS05N	28	74LS170N	199
74LS06N	39	74LS173N	89
74LS08N	39	74LS174N	99
74LS10N	28	74LS175N	99
74LS11N	39	74LS181N	220
74LS12N	28	74LS190N	115
74LS13N	47	74LS191N	115
74LS14N	125	74LS192N	98
74LS15N	39	74LS193N	98
74LS20N	39	74LS194N	115
74LS21N	38	74LS195N	95
74LS22N	38	74LS196N	89
74LS26N	39	74LS197N	89
74LS27N	39	74LS221N	149
74LS28N	39	74LS240N	195
74LS29N	39	74LS241N	195
74LS32N	39	74LS242N	195
74LS37N	79	74LS243N	195
74LS38N	39	74LS244N	195
74LS50N	26	74LS245N	495
74LS52N	79	74LS246N	110
74LS53N	79	74LS248N	110
74LS54N	79	74LS249N	169
74LS51N	26	74LS251N	179
74LS55N	35	74LS252N	98
74LS56N	35	74LS253N	98
74LS57N	35	74LS257N	98
74LS58N	35	74LS258N	98
74LS59N	59	74LS259N	295
74LS60N	68	74LS260N	69
74LS62N	45	74LS261N	249
74LS63N	45	74LS262N	59
74LS64N	69	74LS273N	175
74LS65N	119	74LS275N	440
74LS66N	45	74LS279N	59
74LS67N	75	74LS283N	110
74LS68N	129	74LS290N	129
74LS69N	75	74LS293N	195
74LS70N	110	74LS294N	110
74LS71N	98	74LS298N	129
74LS72N	45	74LS324N	175
74LS73N	45	74LS347N	195
74LS74N	195	74LS348N	195
74LS75N	195	74LS349N	195
74LS114N	65	74LS353N	165
74LS122N	65	74LS363N	149
74LS123N	119	74LS365N	99
74LS124N	135	74LS366N	99
74LS125N	89	74LS367N	73
74LS126N	89	74LS368N	73
74LS132N	79	74LS373N	275
74LS136N	79	74LS374N	275
74LS138N	89	74LS375N	69
74LS139N	89	74LS377N	195
74LS140N	125	74LS385N	195
74LS148N	149	74LS386N	65
74LS151N	79	74LS390N	195
74LS152N	79	74LS393N	195
74LS154N	249	74LS395N	170
74LS159N	236	74LS399N	236
74LS162N	99	74LS424N	99
74LS167N	99	74LS566N	175
74LS168N	99	74LS567N	229
74LS169N	81	74LS595N	199
74LS171N	115	74LS596N	199
74LS172N	115	74LS597N	199
74LS163N	99	74LS598N	199

16K Upgrade ONLY \$39.95 SPECIFY COMPUTER

NON-LINEAR SYSTEMS, INC. **TOUCH TEST 20**

DIGITAL MULTIMETER

The U.S. Model TouchTest 20 is a 2 1/2 digit multi-meter with 1000 readings of measuring 10 parameters including 10 current ranges and 44 ranges Features touch test and annunciator lamp indication of control settings which include function range and on-off control

\$319.95

BECKMAN Digital Multimeters

AS LOW AS \$100

Choice of Models - The ECH 310 has all the features 7 functions 29 ranges plus 2.5% vdc accuracy

The ECH 300 has a 0.5% vdc accuracy and all the above features but without Insta-Diag™ continuity function or the 10 amp current range

TECH 300 Digital Multimeter	\$110
TECH 310 Digital Multimeter	\$140
TECH 330 Digital Multimeter	\$189
VC201 Vinyl Carrying Case	\$10
DC202 Deluxe Carrying Case	\$24
HP-211 High Voltage Probe	\$35
HP-221 AC Current Clamp	\$42
DL-241 Deluxe Test Lead Kit	\$35
TL-242 Spare Test Leads	\$6

Vista COMPUTER COMPANY

APPLE™ 40 CHARACTER TYPE-AHEAD BUFFER

MODEL 150

\$49.95

CONTINENTAL SPECIALTIES

Metal LM-3 40-channel Logic Monitor	585.00
Metal LM-1 Logic Monitor	60.00
Metal LM-2 Logic Monitor	147.00
MAX-100 MHz Portable Frequency Counter	149.00
Model LP-1 Digital Logic Probe	500.00
Model LP-2 Economy Logic Probe	280.00
Model LP-3 High Speed Logic Probe	77.00
Model LPK-1 Logic Probe Kit	21.95
Model LTC-1, LTC-2 Logic Analysis Kits	220-250

Proto Clips

14-Pin Chip	PC-14	\$ 4.25
16-Pin Chip	PC-16	\$ 4.50
24-Pin Chip	PC-24	\$ 9.50
40-Pin Chip	PC-40	\$14.95

Proto Boards

PB-4	16,95	PB-104	94.00
PB-100	18.00	PB-203	57.00
PB-102	25.00	PB-203A	129.00
PB-103	43.00		

SEMICONDUCTORS SPEAK

DIGITALKER™ Speech Synthesis System

The DIGITALKER is a speech synthesis system consisting of multiple integrated MOS integrated circuits. It contains a speech synthesizer chip (SPC) and speech ROM and when used with external filter, amplifier, and speaker, produces a speech signal which is intelligible, smooth, and clear. It includes the major functions and emphasis of a natural speech. Also, female and child's voices can be synthesized.

- Completely independent system, not requiring a decoder chip.
- Designed to be easily interfaced to most microprocessors.
- 256 words, 8-bit resolution.
- Naturalization and emphasis analog speech.
- Addresses 128K of ROM/flash.
- Communications with static or clocked dynamic ROMs.
- TTL compatible.
- MICROBUS™ compatible.

DIGITALKER™ DT1000. Self contained board that - with just a speaker and a power supply - can retrofit any desired combination of 144 words. **\$485.00**

DIGITALKER™ DT1000. Chip set for building Digitalker into your own evaluation design. **\$95.00**

National Semiconductor

ADVANCED COMPUTER PRODUCTS

Apple® II 48K Apple® II Plus \$1250

DISK SYSTEM SPECIAL

Apple II Plus w/48K Supermod V/ideo Modulator Disk II w/Controller Integer Based ROM Card

ACP PRICE \$1995.00

Hi-Speed Serial I/O	\$189.00	D565 Digi-Sector	6349.00	Integer ROM Card	\$189.00
Centronics Printer I/O	180.00	Apple Graphics Tablet	5750.00	Photo Card	2195
AppleSoft II Firmware	189.00	DC Hayes Modern II	3499.95	M & R Modulator	2995
Apple Disk	269.00	Disk II w/Connector & Box	3500	Cassette	54.95
Intro II X-10 System	1799.95	Disk II	459.00	16K Upgrade Kit	54.95
Intro II X-10 Controller	269.95	Passive Lang. System	450.00	Desktop Plan	98.00
All Music Synthesizer	259.95	Printer: Printer Card	16.50	8 Floppy Controller	3500.00
16 Ch. Analog Output	2499.95	Communications Card	1890.00	Heintzics SpeechLab	1790.00
2 Ch. Analog Output	1649.95	Business Software Pkg.	6250.00	Romulus +	1690.00
13-Key Keypad	119.95	Corvus 10 Megabyte Drive		Superlaker	2790.00
Vtc-Calc	1250.00			Cassette	2500.00

Apple III \$3995

- Apple III Option A: Apple III 96K Information Analysis Package. \$3995.00
- 12" BW Monitor \$3995.00
- Apple III Option B: Same as Option A Plus: Disk II for Apple III. \$4395.00
- Apple III Option C: Same as Option A Plus: Disk II for Apple III. \$4395.00
- Apple III Option C: Same as Option A Plus: Disk II for Apple III. \$4785.00
- To substitute 128K Apple III for 96K Apple III. Add \$450.00

NEW APPLE PRODUCTS

- APPLE FAN™ - Current/temperature/pressure/acceleration/rotation speed/speed for Apple. \$4995
- BIT 3™ - A 24 Video Board for Apple. \$3299.95
- "BRAINWAVE" Heurist P Channel HEDS-3000 Bar Code Interface to Apple. \$1990.00
- "SEC APPLE A/D" - Channel A/D interface completely assembled and tested. \$99.50
- APPLE FORTH™ for data encryption and security. \$1750.00
- APPLE GRAPHIC™ for graphics interface to Base 2. \$1499.00
- "D" Drive for Apple Computer. DOS Two II. \$1450.00
- MICRODOS™ - OS system. \$3199.95
- DISKSECTOR™ Converts video input to Hi-Res graphics. \$3499.95
- California Microprocessors. \$1249.95
- VisiCalc Keyboards Numeric keypad with space, space ESC and keyboard for VisiCalc compatibility. \$169.00
- DOS 3.3 Upgrade Kits 23% more storage in 16 sector format. \$6500
- Mountain Hardware Music Board best yet - 16 channels. \$55000
- Control II Revision IIIA 20% overall processing speed increase and supports standard graphics. Reduced disk handling. Additional user checking improved manual Vendor file expansion. \$145.00
- Pascal Revision Kit. Adds excellent and changing capabilities to Pascal environment. \$6500
- Mountain Hardware Expansion chassis 8 processors for Apple hardware or software structure. Includes power supply. \$59.95
- Small Term Apple 80 x 24 Video Card. \$3499.00
- System X-10. Apple Samepage with Apple Intelegraph Interface. \$549.90
- NEW California Computers Apple's Apple Disk. \$1249.95
- Only 280 Software for SYSTEMS CPM 22 & M BASIC. \$325.00
- SEC ECNO II Speech Synthesizer. \$249.95

NEW APPLE SOFTWARE

1. CREATSTRIVE - Apple II version of Striker's Ram Atari disk. \$3485
2. RETROBAND™ Heurist P Channel HEDS-3000 Bar Code Interface to Apple. \$1099.95
3. ALTERBASIC™ \$299.95
4. "Bird Brain" - Hi Res simulation of Western Gunfight and Sheet Shoving. Same author as Nasr. \$2995
5. Apple Tax Pay Program™ \$69.95
6. NEW-DOS™ for 8008 \$149.95
7. NEW Apple 280 CPM Software. Call for prices.

ATARI® 800 & 400 Personal Computer System

ATARI 800 \$825.00 ATARI 400 \$449.00

ATARI 800 Includes: Computer Console, BASIC Lang. Cartridge, BASIC Language Programming Manual, 800 Operator's Manual w/Notebook, 16K RAM Module, Power Supply, TV Switch Box.

SINGLE BOARD COMPUTER SELECTION GUIDE

BOARD	PROCESSOR	ACP PRICE	ENCLOSURE	BOARD	PROCESSOR	ACP PRICE	ENCLOSURE
DK-800	6800	240.00	N/A	SB-800	280	230.00	N/A
SYMA-1	6502	239.00	Add 39.95	AIM-65	6502	375.00	Add 49.95
Cymatic	280	409.00	N/A	ENCL-65	1802	199.00	Add 49.95

MATEL ELECTRONICS INTELLIVISION

ACF LOW PRICE **\$259.95**

Now! Special TV. Adapter lets you use your existing T.V. set as a computer display. **\$499.00** Console only.

GAME CARTRIDGES \$26.95

BASEBALL	HOCKEY	POKER/BLACKJACK
FOOTBALL	BASKETBALL	ROULETTE
AUTO RACE	MOTORBIKE	HORSE RACING
TENNIS	ADVENTURE	SPACE BATTLE
GOLF	CHESSERS	ARMOR BATTLE
SOCCER	GOALS	SPACE BATTLE
SKING	MATH FUN	SEA BATTLE
BOUNCE	BACKGAMMON	WORD FUN
	ARCADE	

RETAIL STORES OPEN MON-SAT P.O. Box 17329 Irvine, Calif. 92713 Direct Order Lines: (714) 558-8813 (800) 854-8230 or (800) 854-8241 DRIVER'S LICENSE & MAJOR CREDIT CARD IS REQUIRED ON ALL CHECKS. MONEY ORDER OR CASHIER CHECK WILL FACILITATE THE SHIPMENT OF YOUR PURCHASE.

California Digital

Post Office Box 3097 B • Torrance, California 90503

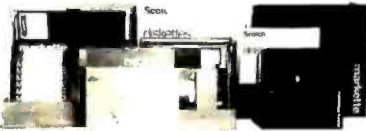

DISKETTES

FREE PLASTIC LIBRARY CASE INCLUDED WITH THE PURCHASE OF EVERY BOX OF DISKETTES

Private Labeled for California Digital by one of the most respected producers of magnetic media. Each diskette is certified double density at 40 tracks. To insure extended media life each diskette is manufactured with a reinforced hub-hole. And of course, a plastic library case is included with every box of diskettes. MHI-CDSK01K10 Please specify computer or required sectors.

\$24.95
BOX

Ten boxes \$22.75 One hundred boxes \$21.50

Memorex 3401	10x	10 boxes	Scotch 7410(10)0110	10x	10 boxes
Verbatim 525(01K10)	29.00	27.00	Bycan	15.00	13.00

8 1/2" INCH	Scotch	box	10 bx.	Dyan box	10 bx.	MKN box	10 bx.
Single side/40 den.	740-0	33.	32.	3740/1	549.	547.	3060 9. 3. 3.
Single side/double den.	741-0	45.	43.	3740/1d	75.	73.	3090 37. 38.
Single side/32 sector	740-32	35.	33.		na.	na.	
Double side/double D.	743-0	65.	59.		na.	3115 19. 18.	

SCOTCH brand head elevating kit. \$24.95 MNA-CMSK08 please specify 5 1/4" 8" Prices available on request for: tape, cartridges, diskpacks, volum diskettes.

MEMORY

TRS-80 \$25
APPLE II \$25

16k memory (8) 4116's

Factory prime. Unconditionally guaranteed for one full year. Add \$3.00 for TRS-80 jumpers and instructions.



DYNAMIC

	ea.	32+	100+	1K+
4116-200ns	3.25	3.00	2.75	2.50
4116-150ns	3.75	3.50	3.25	3.00
4164 64K	49.50	45.00		

STATIC

21L02 450ns.	1.19	1.05	.99	
21L02 250ns	1.49	1.45	1.39	
2114L4 450ns	3.95	2.95	2.75	2.50
2114L3 300ns	4.25	3.75	3.00	2.75
4044-4 450ns	4.95	4.50	4.25	4.00
4044-2 250ns	5.50	4.95	4.50	4.35
5257-3 300ns	4.47	4.25	4.05	3.75

EPROM

2708 450ns	4.95	4.50	3.75	3.25
2716 5V.	7.95	6.50	5.00	4.50
2716 tri-volt	9.95	9.00	8.25	7.50
2732 bitel	19.00	17.50	16.00	
2532 TI	21.50	19.00		
2764	*			



direct connect **MODEM** Your Choice \$169

Direct connect modems eliminate loss of information due to the carbon compression associated with acoustic modems. Choose either of these two great units.

The Universal Data Systems 103LP is switch selectable between answer and originate modes. Fully Bell 103 compatible. Directly connects to the new modular telephone bank. 100% power from the telephone line. No need to locate modem in proximity to C.Tower receptacle. MOD-103LP 2 years.

Navigation "B" Cat connectors to host the new "Bell" modular handsets. Ideal for multiple line office telephony. Requires external A.C. power. MOD-BGAT 2 Yrs.

UDS 103J/LP AUTO ANSWER \$219



26 Megabyte Hard Disk Drive from **GEORGE MORROW'S Thinker Toys** \$3950

Other Morrow Products	Price	Basic Jackson 23 computer	\$2150
Additional hard disk	23650	disk Jackson 23 Controller	1050
Linexa 23 1 drive	238	AT23 hard disk Controller	524
Busca 23 2 drives	1827	Serial/parallel Interface	310
Busca 23 1 1/2" drive	1850	"Bus" Keyboard	272
Busca 24 2 drives	2257	8110 Gen 35-Megabyte hard	2500

HEWLETT PACKARD \$2650



The Hewlett Packard HP-85 is a complete, low cost portable computer system. This self contained package includes CPU, keyboard, printer, CRT display and cassette tape drive. SYS-10185 30 lbs.



The new BSR timer runs your home just like a clockwork. Runs at 100ms and operates while your away from home. Completely compatible with your existing System X-10 devices.

BSR Timer eight channel	\$65.00	Appliance Module 500 W.	\$12.85
Master control console	\$4.05	120V/100V/200V Switch	\$3.95
Ultrasonic Controller	19.95	240V full control wall switch	14.50

S-100 Mother Board \$35

Quiet Buss



8803-18 18 slot IMSAI

SWITCHES



HP SWITCHES	PK.	THORNTON	ea.	100+
4	1.88	.75	.59	
7	1.29	.63	.70	
8	1.05	.91	.87	
12	1.10	.99	.91	

CONNECTORS



GOLD EDGE CONNECTORS	each	10+	100+
5-100 125" centers	\$2.95	\$25.00	
Insol solder 125" row	\$2.95	\$25.00	
Insol wire wrap (27")	3.95	4.50	
Sullins HI-Hel. 125"	4.50	4.50	
Sullins HI-Hel. WAV	5.15	4.50	
Sullins (Althal. 140")	4.95	4.50	

INTEGRATED CIRCUIT SOCKETS	each	200+	each	1000+
8 pin 4-10 4-20	3.45	3.45	3.45	
14 pin 10-20	4.15	4.15	4.15	
16 pin 12-11	5.00	4.15	4.15	
18 pin 12-11	4.80	4.15	4.15	
24 pin 12-11	5.80	4.15	4.15	
40 pin 12-11	1.60	1.47	1.47	

SPECIAL \$295 SHUGART SA800/1

Your Choice 115V. 60Hz or 230V. 50Hz.

These Shugart eight inch disk drives were originally purchased by major computer manufacturers. Upon failing incoming inspection the drives were sent back to Shugart for realignment.

California Digital has negotiated an extremely attractive agreement to purchase the entire inventory of the SA800's. We are offering the drives on a first come basis at only \$295. (Subject to remaining inventory on hand.) Installation manual \$10 additional. Warranty 30 days from date of receipt. NOTE: The SA800/1 is standard mount and not the "R" suffix rack mount unit. SPC-800/115 or SPC-800/230 16 lbs.

Shugart Associates



\$395 801/R Disk Drive 15 lbs.

Shugart 801/R with CP 200 power supply, muffin exhaust fan, complete in dual enclosure with all the necessary connecting cables. Documentation included. 36 pounds. MSD-1001 \$795 Same as above but with two Shugart 801/R disk drives. \$1195

NEW from Shugart Technology 5 Megabyte Hard Disk Drive



Packaged in the same physical size as the industry standard 5 1/4" minifloppy disk drive. The micro-Winchester stores thirty times as much data (6.38 megabytes unformatted), accesses data twice as fast (170 milliseconds) and transfers data twenty times faster (5.0 megabits per second.)

The ST506 is factory sealed to protect the media from environmental contaminants. Requires only DC voltage. Dual California Digital 5 1/4" enclosure. \$1500 ST506 drive and power supply.

Shugart Associates SA400 removable media disk drive for above package. add: \$300 S-100 & Apple controller scheduled for spring release.

DATA INPUT TERMINAL

This keystation terminal was recently perfected from the CMC division of the Perdec Corporation. The unit was originally designed for inputting data directly onto magnetic tape.

The system is comprised of a premium cast aluminum and fiberglass enclosure, along with a Honeywell 1500 series full effect keyboard. Thirty display lamps indicate the operator of the system status. Your inch long speaker acknowledges acceptance of data and alerts the operator of pending problems. The most of all this "UNIX" terminal with a 10th-Imagination, can be retrofitted to make the perfect home for an S-100 computer and video display or other modifications will accept the Honeywell A81-85 microcomputer.

Five volt regulated power supply is available for an additional \$70. (See June Byte) All units are in excellent condition. Original acquisition over \$700. 22 lbs.

Regulated Power Supply 5 VOLT 5AMP \$1195

This 12801 surplus power supply was removed from working equipment. Pass transistor regulation outputs five volts at a maximum ripple free output. Suitable for TTL logic applications. SPC-101 6 pounds.

TOLL FREE ORDER LINE
(800) 421-5041
TECHNICAL & CALIFORNIA
(213) 679-9001
TWX 910 325-6212

All merchandise sold by California Digital is premium grade. Shipping: First five pounds \$2.00; each additional add \$4.00. Foreign orders 10% shipping. Excess will be refunded. California residents add 6% sales tax. COD's discouraged. Open accounts extended to state supported educational institutions and companies with a "Strong Dun & Bradstreet." Warehouse: 15608 Inglewood Blvd. Visitors by appointment.

Circle 46 on inquiry card.

California Digital

Post Office Box 3097 B • Torrance, California 90503



MEMOREX
8" DISKETTES
\$25 WITH FREE LIBRARY CASE

Recently the Memorex Corporation had a concession on a contract for a truck load of eight inch diskettes. California Digital was fortunate to be offered this load of prime magnetic media. These diskettes are "UNBRANDABLE" but are guaranteed first quality Memorex Brand. (\$2500 single den.) Like all diskettes and by California Digital, a library case is supplied free with the purchase of over 500. This offer is subject to remaining inventory on hand.

World's Best Selling Printer

EPSON
MX80

Immediate Delivery

Only \$475

Correspondence quality printing. A lot of printers costing a lot more can't touch the MX-80's performance. It gives you a choice of 40, 80, 166 or 132 columns of printing in as many as four distinct printing density modes, a total of twelve different combinations which can accommodate nearly any printing requirement.

Bi-directional printing. Logical seeking of shortest lines. 80 CPS. 64 graphics characters. Forms handling. The list of standard features goes on and on. The fact is that there are few printers that can compete with the MX-80 at ANY price. And none - ZERO - in its extraordinarily affordable price range.

ACDEFGHIJLMMNOPRSTUVWXYZACDEFGHIJ
.....

SUPER BUY



NEW
from INTEGRAL DATA
460
Paper Tiger
with GRAPHICS \$1150

The 460 Paper Tiger uses a dot matrix character formation technique in which the placement of the dots overlap both horizontally and vertically to achieve a correspondence quality print. The printer's nine-wire print head uses staggered needle rows to create vertically overlapping dots. The head is driven bi-directionally under microprocessor control by a stepper motor driven mechanism. "Two K" buffer allows the printer to accept the entire content of a 1.520 character CRT screen. With graphics suggested retail price \$1,395. 27 lbs. PRG-460C

NEC Spinwriter
5510P/S
\$2795



The word processing quality Spinwriter prints at speed up to 45 characters per second. The Model 5510P/S is supplied with both parallel and RS-232 serial interfaces. Also included is the tractor and mechanism, along with print ribbon. P/N: 5510P/S. 70 lbs. Keyboard (USR) Model 5520P/S available \$2995. P/N: 5520P/S. 75 lbs.



TEC V-300
Word Processing
Daisy Wheel Printer
\$1595

Finally a reasonably priced letter quality printer... Bi-directional printing at 25 characters per second. Full 136 print positions wide. Proportional spacing 1/12" horizontal, 1/8" vertical. Uses standard Diablo brand interchangeable daisy print wheels. Intel 8085 CPU microprocessor controlled. Interfaces via Centronics parallel connector. Shipping 58 lbs. P/N: V-300.

TELETYPE MODEL 43

- 4320 KEYBOARD MODELS
- TTL serial output AAA \$ 995
 - RS232 serial AAK 1050
 - Friction 80 column AAE 1100
 - Friction 80 RS232 AAL 1195
 - Bell 103 Modem AAB 1495



ULTRA-VIOLET PRODUCTS UVSTTE
UV EPROM ERASER

\$65

CENTRONICS

730 \$595
737 \$750



Both the Centronics 730 and the 737 are capable of accepting standard office letterhead or pin feed continuous forms. For higher resolution the 737 implements a nine wire dot matrix print head. Parallel interface. Add \$65 for RS232. PRC-730P (S). PRC-737P (S) 17 lbs.

IBM 3101
Display Terminal

IBM Direct Price \$1295
California Digital

discount price \$1195



New from the Amplex Corporation. The Dialogue 80 features removable keyboard, displayable two pages (four optional) dual program keys, half intensity protected fields and status line. Transmits data either block, line or character mode. Excellent value. VDT-D80 shipping 47 lbs.

AMPEX
DIALOGUE 80
CRT TERMINAL
\$995

VIDEO TERMINALS

- ADDS Regent 25 numeric cluster VDT-R25 \$850
- ADDS Regent 30 25th status line VDT-R30 950
- ADDS Regent 40 limited graphics VDT-R40 1195
- ADDS Regent 60 Block mode VDT-R60 1495
- Amplex Dialogue 80 two page (detach VDT-D80 995
- Digital Equipment VT-100 VDT-V100 1595
- Digital Equipment VT-132 VDT-V132 1895
- Direct VP-800A emulator VDT-P800 call
- Hazeltine 1410 VDT-H1410 750
- Hazeltine 1420 VDT-H1420 795
- Hazeltine 1500 VDT-H1500 850
- Hazeltine 1510 VDT-H1510 1025
- Hazeltine 1520 VDT-H1520 1225
- Hewlett Packard 2621A VDT-HP21A
- Hewlett Packard 2621P VDT-HP21P
- IBM 3101-10 character mode green VDT-3101 1195
- IBM 3101-20 block mode VDT-31012 1395
- Lear Siegler 3A upper case only VDT-L3A 850
- Lear Siegler ADM5 VDT-L5 945
- Lear Siegler ADM31 VDT-L31 1385
- Lear Siegler ADM42 VDT-L42 1995
- Soroc IQ 120 VDT-Q120 675
- Soroc IQ 135 NEW VDT-Q135 850
- Soroc IQ 140 detachable keyboard VDT-Q140 1150
- Televideo 912C VDT-T912 665
- Televideo 920C VDT-T920 745
- Televideo 950C detachable keybd. VDT-T950 985
- Zenith Z-19 VDT-Z-19 735

VIDEO MONITORS

- BMC KG12C 18MHz P-31 grn phosphor \$259
- Leedex/Ardek 12" 100 129
- Leedex 100 green 169
- Leedex 100-80 197
- Hitachi color 13" 389
- Zenith color 13" 379
- NEC green phosphor Panasonic color 10" 219
- Sanyo 9" BW 149
- Sanyo 12" green phos. 235
- Sanyo 15" BW 259
- Sanyo 13" color 419

ACCESSORIES FOR THE
APPLE COMPUTER

- CALIFORNIA COMPUTER SYSTEMS
Arithmetic Processor 7811 B/C \$319
Asynchronous serial interface 7710 129
Centronics interface card 7728 95
12K PROM Module 7114 85
Clock/Timer, Bat. back-up 742-4 89
Parallel interface 7720A 99
Programmable Timer 7740A 99
Analog/Digital converter 7470A 99
- MICROSOFT PRODUCTS
Apple II-40 CPU card 378
D. C. HAYES PRODUCTS
Microemul for Apple 319
COMPUTER STOP PRODUCTS
Double Vision 180 Column Video 250
- INTERACTIVE STRUCTURES
16 Channel A/D card A10/2 275

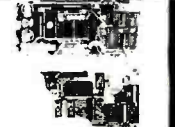

- MOUNTAIN COMPUTER PRODUCTS
Intro X-10 system for BSR \$239
Intro X-10 card only 163
16 channel AD/DA 8 bit 319
Apple Clock battery back-up 225
Superlaser SD200 245
ROM Plus with filter 165
ROM Writer/Programmer 119
APPLE BRAND PRODUCTS
Apple Language card 450
Floppy disk with controller 580
Floppy disk without controller 495
Apple parallel interface 175
SSM MICROCOMPUTER
Dual serial parallel interface A10 390
SORENTO VALLEY ASSOCIATES
8" floppy controller (Pascal) 360

S-100 BOARDS
Assembled • Tested • Burned-in

- CPU BOARDS
Calif. Computer 2810A Z-80 DMA, 4MHz B1/C-C2B10 \$250
Godout Z-80 24 bit, 4MHz B1/C-C2B10 230
Godout 5085/5088 dual 16 bit processor B1/C-C2B 375
Measurement Systems Z-80 3 serial 2 parallel serial time clock, 8 vector B1/C-C2B 285
SD Systems S10C-280 Z-80 with serial A parallel I/O ports B1/C-C2B 385
Teletek TPC-1 single board CPU & floppy disk controller plus I/O B1/C-C2B 695
- MAINFRAMES
Calif. Computer 2200A 12 slot 4 power supply ENJ-C2200 330
TEL 12 slot table ENJ-T12 485
TEL 22 slot table ENJ-T22 650
Godout mainframe ENJ-GM1
- MEMORY BOARDS
Calif. Computer 2065A 61K dynamic memory B1/C-C2065 \$329
Calif. Computer 2016 18K static memory B1/C-C2016 250
Calif. Computer 2032 32K static memory B1/C-C2032 385
Godout Ram 17 64K static memory 16 bit B1/C-G17 1025
SD Systems Kaxandorum II 16K dynamic B1/C-K216 295
61K dynamic I/O-M-K264 375
Measurement Systems M18B-100 for Alpha Micro B1/C-M18B-100 685
- FLOPPY DISK CONTROLLER
Calif. Computer 2422A with 2 x CPU B1/C-C2422 329
Godout Disk Controller features the NEC 765 controller, DMA arbitration B1/C-G13 395
Measurement Systems 765 comp. simple & double density, Error recovery B1-M1 110
SD Systems Versafloppy II double density B1-V1-2 119
Turbell D/II B1/T-172 119
Narrow Design Disk Jockey II single density B1-J1 105
Narrow Design Disk Jockey II double density B1-D12 315
- INTERFACIAL BOARDS
Calif. Computer 2718 I/O type board B1/C-C2718 199
Narrow Design Switchboard 2 serial/4 par BDT-NSB 219
Narrow Design Multiboard 4 serial/8 par BDT-M18B 275
Godout Interfacial One 2 serial/2 par B1/C-G12 199
Godout Interfacial Two 4 serial/4 par B1/C-G12 199

- SPECIALTY BOARDS
CIT Computer real time clock/calendar B1/C-C13 135
Artex Elec. Wire wrap prototype board B1/C-AW 25
Artex Elec. Central Purpose proto board B1/C-AP 26
Godout Spectrum color board B1/C-G13 295
D.C. Hayes 5-100 Micro-modem B1/C-M100 310
Shelton Products extender board A logic probe H1/H5-M111 410
Altek Products 4350-control board kit B1/C-A13 125

Rotron Muffin Fan

\$14.77 \$12.00 @ 100
10.50 @ 1000



115 VAC, 7 Watts WR2A1
Factory fresh Muffin fans
NOT pull-outs. EMF-4M



All merchandise sold by California Digital is premium grade. Shipping: First five pounds \$2.00; each additional add \$.40. Foreign orders 10% shipping. Excess will be refunded. California residents add 6% sales tax. CODs discouraged. Open accounts extended to state supported educational institutions and companies with a "Strong Dun & Bradstreet." Warehouse: 15608 Inglewood Blvd. Visitors by appointment.

TOLL FREE ORDER LINE
(800) 421-5041
TECHNICAL & CALIFORNIA
(213) 679-9001
TWX 910 325-6212

Circle 46 on Inquiry card.

A P PRODUCTS

DIP JUMPERS

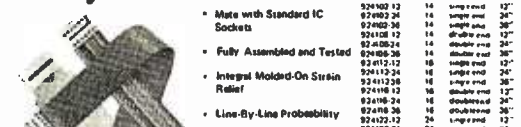

• Made with Standard IC Sockets
 • Fully Assembled and Tested
 • Integral Molded-On Strain Relief
 • Line-By-Line Probability

Dip Jumpers are used for jumpering within a PC Board; interconnecting between PC Boards, backplanes and mother-board; and interfacing input/output signals.

7400		
SN7400N .25		SN74156N .79
SN7401N .20		SN74157N .89
SN7402N .25	SN7472N .29	SN74160N .89
SN7403N .25	SN7473N .55	SN74161N .89
SN7404N .25	SN7474N .35	SN74162N .89
SN7405N .29	SN7475N .49	SN74163N .89
SN7406N .25	SN7476N .35	SN74164N .89
SN7407N .25	SN7477N .50	SN74165N .89
SN7408N .25	SN7478N .55	SN74166N .89
SN7409N .29	SN7479N .99	SN74167N .99
SN7410N .25	SN7482N .69	SN74170N 1.75
SN7411N .25	SN7483N .69	SN74171N 1.75
SN7412N .25	SN7484N .35	SN74172N 1.39
SN7413N .49	SN7485N .89	SN74173N 1.39
SN7414N .69	SN7486N .89	SN74174N .79
SN7415N .29	SN7487N .59	SN74175N .79
SN7416N .29	SN7488N .45	SN74176N .79
SN7417N .29	SN7489N .45	SN74177N .79
SN7418N .25	SN7490N .49	SN74178N .79
SN7419N .25	SN7491N .59	SN74179N .79
SN7420N .25	SN7492N .45	SN74180N .79
SN7421N .25	SN7493N .45	SN74181N .79
SN7422N .45	SN7494N .69	SN74182N .79
SN7423N .45	SN7495N .69	SN74183N .79
SN7424N .45	SN7496N .69	SN74184N .79
SN7425N .29	SN7497N 1.00	SN74185N 2.49
SN7426N .29	SN7498N 1.00	SN74186N 2.49
SN7427N .25	SN7499N 1.39	SN74187N 1.25
SN7428N .49	SN7499N .39	SN74188N 1.25
SN7429N .25	SN7499N .39	SN74189N .89
SN7430N .25	SN7499N .39	SN74190N .89
SN7431N .25	SN7499N .39	SN74191N .89
SN7432N .25	SN7499N .39	SN74192N .89
SN7433N .25	SN7499N .39	SN74193N .89
SN7434N .25	SN7499N .39	SN74194N .89
SN7435N .25	SN7499N .39	SN74195N .89
SN7436N .25	SN7499N .39	SN74196N .89
SN7437N .25	SN7499N .39	SN74197N .89
SN7438N .25	SN7499N .39	SN74198N .89
SN7439N .25	SN7499N .39	SN74199N .89
SN7440N .25	SN7499N .39	SN74200N .89
SN7441N .25	SN7499N .39	SN74201N .89
SN7442N .25	SN7499N .39	SN74202N .89
SN7443N .25	SN7499N .39	SN74203N .89
SN7444N .25	SN7499N .39	SN74204N .89
SN7445N .25	SN7499N .39	SN74205N .89
SN7446N .25	SN7499N .39	SN74206N .89
SN7447N .25	SN7499N .39	SN74207N .89
SN7448N .25	SN7499N .39	SN74208N .89
SN7449N .25	SN7499N .39	SN74209N .89
SN7450N .25	SN7499N .39	SN74210N .89
SN7451N .25	SN7499N .39	SN74211N .89
SN7452N .25	SN7499N .39	SN74212N .89
SN7453N .25	SN7499N .39	SN74213N .89
SN7454N .25	SN7499N .39	SN74214N .89
SN7455N .25	SN7499N .39	SN74215N .89
SN7456N .25	SN7499N .39	SN74216N .89
SN7457N .25	SN7499N .39	SN74217N .89
SN7458N .25	SN7499N .39	SN74218N .89
SN7459N .25	SN7499N .39	SN74219N .89
SN7460N .25	SN7499N .39	SN74220N .89
SN7461N .25	SN7499N .39	SN74221N .89
SN7462N .25	SN7499N .39	SN74222N .89
SN7463N .25	SN7499N .39	SN74223N .89
SN7464N .25	SN7499N .39	SN74224N .89
SN7465N .25	SN7499N .39	SN74225N .89
SN7466N .25	SN7499N .39	SN74226N .89
SN7467N .25	SN7499N .39	SN74227N .89
SN7468N .25	SN7499N .39	SN74228N .89
SN7469N .25	SN7499N .39	SN74229N .89
SN7470N .25	SN7499N .39	SN74230N .89

74LS		
74LS00 .29		74LS192 1.15
74LS01 .20		74LS193 1.15
74LS02 .25	74LS92 .75	74LS194 1.15
74LS03 .25	74LS93 .75	74LS195 1.15
74LS04 .25	74LS94 .75	74LS196 1.15
74LS05 .25	74LS95 .75	74LS197 1.15
74LS06 .25	74LS96 .75	74LS198 1.15
74LS07 .25	74LS97 .75	74LS199 1.15
74LS08 .25	74LS98 .75	74LS200 1.15
74LS09 .25	74LS99 .75	74LS201 1.15
74LS10 .25	74LS100 .75	74LS202 1.15
74LS11 .25	74LS101 .75	74LS203 1.15
74LS12 .25	74LS102 .75	74LS204 1.15
74LS13 .25	74LS103 .75	74LS205 1.15
74LS14 .25	74LS104 .75	74LS206 1.15
74LS15 .25	74LS105 .75	74LS207 1.15
74LS16 .25	74LS106 .75	74LS208 1.15
74LS17 .25	74LS107 .75	74LS209 1.15
74LS18 .25	74LS108 .75	74LS210 1.15
74LS19 .25	74LS109 .75	74LS211 1.15
74LS20 .25	74LS110 .75	74LS212 1.15
74LS21 .25	74LS111 .75	74LS213 1.15
74LS22 .25	74LS112 .75	74LS214 1.15
74LS23 .25	74LS113 .75	74LS215 1.15
74LS24 .25	74LS114 .75	74LS216 1.15
74LS25 .25	74LS115 .75	74LS217 1.15
74LS26 .25	74LS116 .75	74LS218 1.15
74LS27 .25	74LS117 .75	74LS219 1.15
74LS28 .25	74LS118 .75	74LS220 1.15
74LS29 .25	74LS119 .75	74LS221 1.15
74LS30 .25	74LS120 .75	74LS222 1.15
74LS31 .25	74LS121 .75	74LS223 1.15
74LS32 .25	74LS122 .75	74LS224 1.15
74LS33 .25	74LS123 .75	74LS225 1.15
74LS34 .25	74LS124 .75	74LS226 1.15
74LS35 .25	74LS125 .75	74LS227 1.15
74LS36 .25	74LS126 .75	74LS228 1.15
74LS37 .25	74LS127 .75	74LS229 1.15
74LS38 .25	74LS128 .75	74LS230 1.15
74LS39 .25	74LS129 .75	74LS231 1.15
74LS40 .25	74LS130 .75	74LS232 1.15
74LS41 .25	74LS131 .75	74LS233 1.15
74LS42 .25	74LS132 .75	74LS234 1.15
74LS43 .25	74LS133 .75	74LS235 1.15
74LS44 .25	74LS134 .75	74LS236 1.15
74LS45 .25	74LS135 .75	74LS237 1.15
74LS46 .25	74LS136 .75	74LS238 1.15
74LS47 .25	74LS137 .75	74LS239 1.15
74LS48 .25	74LS138 .75	74LS240 1.15
74LS49 .25	74LS139 .75	74LS241 1.15
74LS50 .25	74LS140 .75	74LS242 1.15
74LS51 .25	74LS141 .75	74LS243 1.15
74LS52 .25	74LS142 .75	74LS244 1.15
74LS53 .25	74LS143 .75	74LS245 1.15
74LS54 .25	74LS144 .75	74LS246 1.15
74LS55 .25	74LS145 .75	74LS247 1.15
74LS56 .25	74LS146 .75	74LS248 1.15
74LS57 .25	74LS147 .75	74LS249 1.15
74LS58 .25	74LS148 .75	74LS250 1.15
74LS59 .25	74LS149 .75	74LS251 1.15
74LS60 .25	74LS150 .75	74LS252 1.15
74LS61 .25	74LS151 .75	74LS253 1.15
74LS62 .25	74LS152 .75	74LS254 1.15
74LS63 .25	74LS153 .75	74LS255 1.15
74LS64 .25	74LS154 .75	74LS256 1.15
74LS65 .25	74LS155 .75	74LS257 1.15
74LS66 .25	74LS156 .75	74LS258 1.15
74LS67 .25	74LS157 .75	74LS259 1.15
74LS68 .25	74LS158 .75	74LS260 1.15
74LS69 .25	74LS159 .75	74LS261 1.15
74LS70 .25	74LS160 .75	74LS262 1.15
74LS71 .25	74LS161 .75	74LS263 1.15
74LS72 .25	74LS162 .75	74LS264 1.15
74LS73 .25	74LS163 .75	74LS265 1.15
74LS74 .25	74LS164 .75	74LS266 1.15
74LS75 .25	74LS165 .75	74LS267 1.15
74LS76 .25	74LS166 .75	74LS268 1.15
74LS77 .25	74LS167 .75	74LS269 1.15
74LS78 .25	74LS168 .75	74LS270 1.15
74LS79 .25	74LS169 .75	74LS271 1.15
74LS80 .25	74LS170 .75	74LS272 1.15
74LS81 .25	74LS171 .75	74LS273 1.15
74LS82 .25	74LS172 .75	74LS274 1.15
74LS83 .25	74LS173 .75	74LS275 1.15
74LS84 .25	74LS174 .75	74LS276 1.15
74LS85 .25	74LS175 .75	74LS277 1.15
74LS86 .25	74LS176 .75	74LS278 1.15
74LS87 .25	74LS177 .75	74LS279 1.15
74LS88 .25	74LS178 .75	74LS280 1.15
74LS89 .25	74LS179 .75	74LS281 1.15
74LS90 .25	74LS180 .75	74LS282 1.15
74LS91 .25	74LS181 .75	74LS283 1.15
74LS92 .25	74LS182 .75	74LS284 1.15
74LS93 .25	74LS183 .75	74LS285 1.15
74LS94 .25	74LS184 .75	74LS286 1.15
74LS95 .25	74LS185 .75	74LS287 1.15
74LS96 .25	74LS186 .75	74LS288 1.15
74LS97 .25	74LS187 .75	74LS289 1.15
74LS98 .25	74LS188 .75	74LS290 1.15
74LS99 .25	74LS189 .75	74LS291 1.15
74LS100 .25	74LS190 .75	74LS292 1.15

74S		
74S00 .50		74S234 1.25
74S01 .50		74S235 1.45
74S02 .50	74S333 .55	74S236 1.45
74S03 .50	74S334 .55	74S237 1.45
74S04 .50	74S335 .55	74S238 1.45
74S05 .50	74S336 .55	74S239 1.45
74S06 .50	74S337 .55	74S240 1.45
74S07 .50	74S338 .55	74S241 1.45
74S08 .50	74S339 .55	74S242 1.45
74S09 .50	74S340 .55	74S243 1.45
74S10 .50	74S341 .55	74S244 1.45
74S11 .50	74S342 .55	74S245 1.45
74S12 .50	74S343 .55	74S246 1.45
74S13 .50	74S344 .55	74S247 1.45
74S14 .50	74S345 .55	74S248 1.45
74S15 .50	74S346 .55	74S249 1.45
74S16 .50	74S347 .55	74S250 1.45
74S17 .50	74S348 .55	74S251 1.45
74S18 .50	74S349 .55	74S252 1.45
74S19 .50	74S350 .55	74S253 1.45
74S20 .50	74S351 .55	74S254 1.45
74S21 .50	74S352 .55	74S255 1.45
74S22 .50	74S353 .55	74S256 1.45
74S23 .50	74S354 .55	74S257 1.45
74S24 .50	74S355 .55	74S258 1.45
74S25 .50	74S356 .55	74S259 1.45
74S26 .50	74S357 .55	74S260 1.45
74S27 .50	74S358 .55	74S261 1.45
74S28 .50	74S359 .55	74S262 1.45
74S29 .50	74S360 .55	74S263 1.45
74S30 .50	74S361 .55	74S264 1.45
74S31 .50	74S362 .55	74S265 1.45
74S32 .50	74S363 .55	74S266 1.45
74S33 .50	74S364 .55	74S267 1.45
74S34 .50	74S365 .55	74S268 1.45
74S35 .50	74S366 .55	74S269 1.45
74S36 .50	74S367 .55	74S270 1.45
74S37 .50	74S368 .55	74S271 1.45
74S38 .50	74S369 .55	74S272 1.45
74S39 .50	74S370 .55	74S273 1.45
74S40 .50	74S371 .55	74S274 1.45
74S41 .50	74S372 .55	74S275 1.45
74S42 .50	74S373 .55	74S276 1.45
74S43 .50	74S374 .55	74S277 1.45
74S44 .50	74S375 .55	74S278 1.45
74S45 .50	74S376 .55	74S279 1.45
74S46 .50	74S377 .55	74S280 1.45
74S47 .50	74S378 .55	74S281 1.45
74S48 .50	74S379 .55	74S282 1.45
74S49 .50	74S380 .55	74S283 1.45
74S50 .50	74S381 .55	74S284 1.45
74S51 .50	74S382 .55	74S285 1.45
74S52 .50	74S383 .55	74S286 1.45
74S53 .50	74S384 .55	74S287 1.45
74S54 .50	74S385 .55	74S288 1.45
74S55 .50	74S386 .55	74S289 1.45
74S56 .50	74S387 .55	74S290 1.45
74S57 .50	74S388 .55	74S291 1.45
74S58 .50	74S389 .55	74S292 1.45
74S59 .50	74S390 .55	74S293 1.45
74S60 .50	74S391 .55	74S294 1.45
74S61 .50	74S392 .55	74S295 1.45
74S62 .50	74S393 .55	74S296 1.45
74S63 .50	74S394 .55	74S297 1.45
74S64 .50	74S395 .55	74S298 1.45
74S65 .50	74S396 .55	74S299 1.45
74S66 .50	74S397 .55	74S300 1.45
74S67 .50	74S398 .55	74S301 1.45
74S68 .50	74S399 .55	74S302 1.45
74S69 .50	74S400 .55	74S303 1.45
74S70 .50	74S401 .55	74S304 1.45
74S71 .50	74S402 .55	74S305 1.45
74S72 .50	74S403 .55	74S306 1.45
74S73 .50	74S404 .55	74S307 1.45
74S74 .50	74S405 .55	74S308 1.45
74S75 .50	74S406 .55	74S309 1.45
74S76 .50	74S407 .55	74S310 1.45
74S77 .50	74S408 .55	74S311 1.45

Low Prices,

Printers

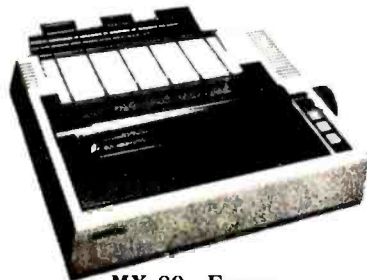

MX-80 - Epson
132 column, 9 x 9 dot matrix, multiple fonts
PRM-27080 Save \$100.00 Call
MX-70
PRM-27070 With Graftax II Call
Interface & Cable for Apple \$110.00

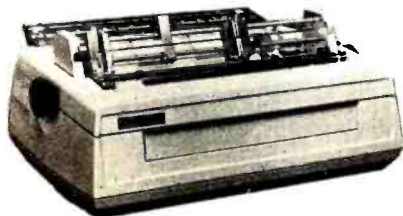

SPINWRITER - NEC
65 cps. bi-directional, letter quality printer with deluxe tractor mechanism, both parallel and serial interfaces on-board, 16K buffer, ribbon, print thimble, graphics, micro-space justification, data cable, and self test/diagnostic ROM.
PRD-55511 without 16K buffer ... \$2795.00
PRD-55512 with 16K buffer \$2895.00

Accessories for TRS-80



DISK DRIVES for TRS-80
23% more storage. 8 times faster, 40 track with free patch. 120 day warranty.
MSM-12410C Save \$125.00 !!! \$325.00

8" DISK DRIVES for MODEL II
2 double density drives with cabinet, power supply, & cables
END-000433 Kit \$1050.00
END-000434 Assembled \$1250.00
WCA-5036A Cable (required) \$29.95

Special Purchase - Save \$50.00
Novation Cat Modem
300 baud, answer and originate



(We have only ~~790~~ 265 available at this special price)

IOM-5200A List price \$189.95 \$139.95
D-CAT 300 baud, direct connect modem
IOM-5201A Special sale price \$189.00
AUTO-CAT Auto answer/originate, direct connect
IOM-5230A Special sale price \$239.95

Accessories for Apple



16K MEMORY UPGRADE
Add 16K of RAM to your TRS-80, Apple, or Exidy in just minutes. We've sold thousands of these 16K RAM upgrades which include the appropriate memory chips (as specified by the manufacturer), all necessary jumper blocks, fool-proof instructions, and our 1 year guarantee.
MEX-16100K TRS-80 kit \$29.00
MEX-16101K Apple kit \$29.00
MEX-16102K Exidy kit \$29.00

16K RAM Card - Microsoft
(There is life after 48K)
MEX-16300A A & T \$174.95

Z-80* CARD for APPLE
Two computers in one, Z-80 & 6502, more than doubles the power & potential of your Apple, includes Z-80* CPU card, CP/M 2.2, & BASIC 80
CPX-30800A A & T \$279.95

Atari 800 \$799.95

APPLE CLOCK - Cal Comp Sys
Real time clock w/battery back-up
IOK-2030A A & T \$109.95

APPLE STICK - Micromate
Joy stick with pots for Apple II
SYA-1510A A & T \$49.95

VISICALC - Personal Sftwr
The ultimate program for your Apple II
SFA-24101005M Complete package \$139.95

DOS 3.3 UPGRADE - Apple
Upgrade your old DOS to the improved 3.3
IOD-2233A Complete kit \$64.95

DISK DRIVE for APPLE
5 1/4" disk drive with controller for your Apple
MSM-12310C with controller \$475.00
MSM-123101 w/out controller \$375.00

8" DRIVES for APPLE
Controller, DOS, two 8" double density drives, cabinet, power supply, & cables
Special Package Price Kit \$1399.95

PRINTER INTERFACE - C.C.S.
Centronics type I/O card w/ firmware
IOI-2041A A & T \$99.95

AIO, ASIO, APIO - S.S.M.
Parallel & serial interface for your Apple (see Byte pg 11)
IOI-2050K Par & Ser kit \$129.95
IOI-2050A Par & Ser A & T \$159.95
IOI-2052K Serial kit \$89.95
IOI-2052A Serial A & T \$99.95
IOI-2054K Parallel kit \$69.95
IOI-2054A Parallel A & T \$89.95

A488 - S.S.M.
IEEE 488 controller, uses simple basic commands, includes firmware and cable, 1 year guarantee. (see April Byte pg 11)
IOX-7488A A & T \$399.95

Disk Drives

JADE's new dual disk sub-assemblies include: Handsome metal cabinet with proportionally balanced air flow system, assembled & tested dual drive power supply, quiet whisper type cooling fan, power-cable kit, lighted power switch, approved fuse assembly, line cord, Never-Mar rubber feet, and all necessary hardware to mount 2-8" disk drives - it's all American made, guaranteed for six months, and it's in stock!

Dual 8" Sub-Assembly Cabinet
END-000421 Cabinet kit \$225.00
END-000420 Bare cabinet \$59.95

Single sided, double density disk drive sub-system
END-000423 Kit w/2 8" drives \$975.00
END-000424 A & T w/2 8" drives \$1195.00

Double sided, double density disk drive sub-system
END-000426 kit w/2 8" drives \$1495.00
END-000427 A & T w/2 8" drives \$1695.00

8" DISK DRIVES
Highly reliable double density floppy disk drives
Shugart 801R single sided, double density
MSF-10801R SA-801R \$425.00
Special Sale Price 2 for \$790.00

Shugart 851R double sided, double density
MSF-10851R SA-851R \$595.00
Special Sale Price 2 for \$1150.00

Siemens FDD100-8D2 single sided, double density
MSF-201120 6 mo warranty \$385.00
Special sale price 2 for \$750.00

Qume Datatrak 8 double sided, double density
MSF-750080 SA-851R compatible ... \$599.95
Special sale price 2 for \$1160.00

JADE DISK PACKAGE
Double density controller, two 8" double density floppy disk drives, CP/M 2.2 (configured for controller), hardware and software manuals, boot PROM, cabinet, power supply, fan, & cables
Special Package Price Kit \$1395.00

Diskettes

DISKETTES - Jade
Bargain prices on magnificent magnetic media
5 1/4" single sided, single density, box of 10
MMD-5110103 Soft sector \$27.95
MMD-5111003 10 sector \$27.95
MMD-5111603 16 sector \$27.95
5 1/4" double sided, double density, box of 10
MMD-5220103 Soft sector \$39.95
8" single sided, single density, box of 10
MMD-8110103 Soft sector \$33.95
8" single sided, double density, box of 10
MMD-8120103 Soft sector \$39.95
8" double sided, double density, box of 10
MMD-8220103 Soft sector \$49.95

Video Monitors

13" COLOR MONITOR - Zenith
The hi res color you've been promising yourself
VDC-201301 \$449.00

12" GREEN SCREEN - NEC
20 MHz, P31 phosphor video monitor with audio, exceptionally high resolution - A fantastic monitor at a very reasonable price
VDM-651200 12" monitor \$259.95

Leedex / Amdek
Reasonably priced video monitors
VDM-801210 Video 100 12" B&W .. \$149.95
VDM-801230 Video 100-80 12" B&W \$189.95
VDM-801250 12" Green Phosphor ... \$189.95
VDC-801310 13" Color I \$399.95

Fast Service.

S-100 CPU

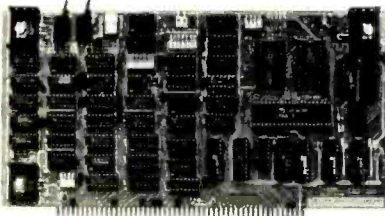

CB-2 Z-80 CPU - S.S.M.

2 or 4 MHz Z-80 CPU board with provision for up to 8K of ROM or 4K of RAM on board, extended addressing. IEEE S-100, front panel compatible.

CPU-30300K Kit \$239.95
CPU-30300A A & T \$299.95

THE BIG Z* - Jade

2 or 4 MHz switchable Z-80* CPU with serial I/O, accommodates 2708, 2716, or 2732 EPROM, baud rates from 75 to 9600

CPU-30201K Kit \$145.00
CPU-30201A A & T \$199.00
CPU-30200B Bare board \$35.00

2810 Z-80* CPU - Cal Comp Sys

2/4 MHz Z-80* CPU with RS-232C serial I/O port and on-board PROM, software programmable baud rate generator, 1K of on-board RAM, Z-80 CTC.

CPU-30400A A & T \$269.95

SBC-200 - SD Systems

4 MHz Z-80* CPU with serial & parallel I/O ports, up to 8K of on-board PROM, software programmable baud rate generator, 1K of on-board RAM, Z-80 CTC.

CPC-30200K Kit \$339.95
CPC-30200A Jade A & T \$399.95

S-100 I/O

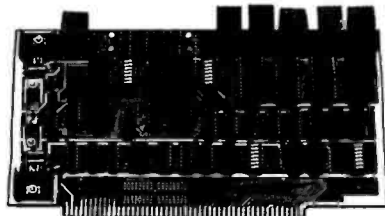

I/O-4 - S.S.M.

2 serial I/O ports plus 2 parallel I/O ports

IOI-1010K Kit \$159.95
IOI-1010A A & T \$219.95
IOI-1010B Bare board \$35.00

S.P.I.C. - Jade

Our new I/O card with 2 SIO's, 4 CTC's, and 1 PIO

IOI-1045K 2 CTC's, 1 SIO, 1 PIO .. \$199.00
IOI-1045A A & T \$259.00
IOI-1046K 4 CTC's, 2 SIO's, 1 PIO .. \$259.00
IOI-1046A A & T \$319.00
IOI-1045B Bare board w/ manual ... \$59.95
IOI-1045D Manual only \$20.00

Motherboards

ISO-BUS - Jade

Silent, simple, and on sale - a better motherboard
6 Slot (5 1/4" x 8 3/4")

MBS-061B Bare board \$19.95
MBS-061K Kit \$39.95
MBS-061A A & T \$49.95

12 Slot (9 1/4" x 8 3/4")

MBS-121B Bare board \$29.95
MBS-121K Kit \$69.95
MBS-121A A & T \$89.95

18 Slot (14 1/2" x 8 3/4")

MBS-181B Bare board \$49.95
MBS-181K Kit \$99.95
MBS-181A A & T \$139.95

S-100 Memory

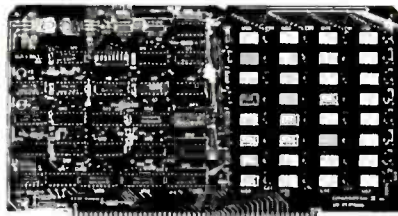

EXPANDORAM II - SD Systems

4 MHz RAM board expandable from 16K to 64K

MEM-16630K 16K kit \$275.95
MEM-32631K 32K kit \$295.95
MEM-48632K 48K kit \$315.95
MEM-64633K 64K kit \$335.95
Assembled & tested add \$50.00

64K RAM - Calif Computer Sys

4 MHz bank port / bank byte selectable, extended addressing, 16K bank selectable, PHANTOM line allows memory overlay, 8080 / Z-80 / front panel compatible.

MEM-64565A A & T \$575.00

MEMORY BANK - Jade

4 MHz. IEEE S-100, bank selectable, 8 or 16 bit, expandable from 16K to 256K

MEM-99730B Bare board \$55.00
MEM-99730K Kit, no RAM \$219.95
MEM-16730K 16K kit \$249.95
MEM-32731K 32K kit \$289.95
MEM-48732K 48K kit \$324.95
MEM-64733K 64K kit \$359.95
Assembled & tested add \$50.00

32K STATIC RAM - Jade

2 or 4 MHz expandable static RAM board uses 2114L's

MEM-16151K 16K 4 MHz kit \$169.95
MEM-32151K 32K 4 MHz kit \$299.95
Assembled & tested add \$50.00

16K STATIC RAM - Cal Comp Sys

2 or 4 MHz 16K static RAM board, IEEE S-100, bank selectable, Phantom capability, addressable in 4K blocks

MEM-16160A 16K 2 MHz A & T ... \$286.95
MEM-16162A 16K 4 MHz A & T ... \$289.95
MEM-16160B Bare board \$50.00

S-100 PROM Boards

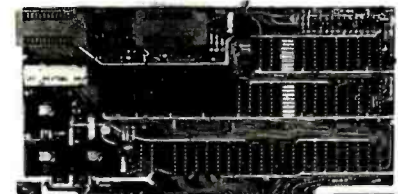

PB-1 - S.S.M.

2708, 2716 EPROM board with built-in programmer
MEM-99510K Kit \$139.95
MEM-99510A A & T \$199.95

PROM-100 - SD Systems

2708, 2716, 2732, 2758, & 2516 EPROM programmer
MEM-99520K Kit \$219.95
MEM-99520A Jade A & T \$269.95

EPROM BOARD - Jade

16K or 32K uses 2708's or 2716's, 1K boundary
MEM-16230K Kit \$79.95
MEM-16230A A & T \$119.95

Mainframes

MAINFRAME - Cal Comp Sys

12 slot S-100 mainframe with 20 amp power supply
ENC-112106 A & T \$429.95

S-100 Disk Controller

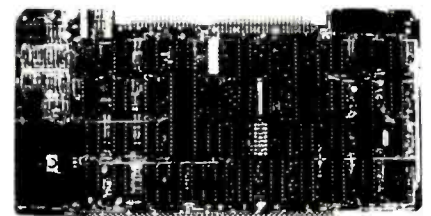

DOUBLE-D - Jade

Double density controller with the inside track, on-board Z-80A* printer port, IEEE S-100, can function on an interrupt driven buss

IOD-1200K Kit \$299.95
IOD-1200A 8" A & T \$389.95
IOD-1205A 5 1/4" A & T \$389.95
IOD-1200B Bare board \$65.00

DOUBLE DENSITY - Cal Comp Sys

5 1/4" and 8" disk controller, single or double density, with on-board boot loader ROM, and free CP/M 2.2* and manual set.

IOD-1300A A & T \$369.95

VERSAFLOPPY II - SD Systems

New double density controller for both 8" & 5 1/4"

IOD-1160K Kit \$339.95
IOD-1160A A & T \$379.95

S-100 Video

VB-3 - S.S.M.

80 characters x 24 lines expandable to 80 x 48 for a full page of text, upper & lower case, 256 user defined symbols, 160 x 192 graphics matrix, memory mapped, has keyboard input.

IOV-1095K 4 MHz kit \$345.00
IOV-1095A 4 MHz A & T \$395.95
IOV-1096K 80 x 48 upgrade \$39.95

VDB-8024 - SD Systems

80 x 24 I/O mapped video board with keyboard I/O, and on-board Z-80A*

IOV-1020K Kit \$399.95
IOV-1020A Jade A & T \$459.95

VIDEO BOARD - Jade

64 characters x 16 lines, 7 x 9 dot matrix, full upper/lower case ASCII character set, numbers, symbols, and greek letters, normal/reverse/blinking video, S-100.

IOV-1050K Kit \$99.95
IOV-1050A A & T \$125.00
IOV-1050B Bare board \$29.95

2114L Low Power 4MHz

1 - 19 \$3.35
20 - 99 \$2.99
100 or more \$2.50

Place Orders Toll Free

Continental U.S. Inside California
800-421-5500 800-626-1710

For Technical Inquires or Customer Service call:
213-973-7707

JADE Computer Products

4901 W. Rosecrans, Hawthorne, Ca 90250

TERMS of SALE: Cash, checks, credit cards, or Purchase Orders from qualified firms and institutions. Minimum Order \$15.00. California residents add 6% tax. Minimum shipping & handling charge \$1.00. Pricing & availability subject to change

MODEM SALE \$129.00

THE STAR
MODEM
from
LIVERMORE

FEATURE
FITS GTE HANDSETS!
2 YEAR WARRANTY

EXCLUSIVE ACOUSTIC CHAMBERS
The exclusive triple seal of Livermore's new flat mounted cups locks the handset into the acoustic chamber yielding superior acoustic isolation and mechanical cushioning. Designed to adapt to most common handsets used throughout the world, the STAR offers the utmost in flexibility and transmission reliability.

Specifications:

- Data Rate: 0 to 300 baud
- Compatibility: Bell 103 and 113; CCITT
- Frequency Stability: ±0.3 percent. Crystal controlled
- Receiver Sensitivity: -50 dBm ON, -53 dBm OFF
- Modulation: Frequency shift keyed (FSK)
- Carrier Detect Delay: 1.2 seconds ON; 120 msec OFF
- EIA Terminal Interface: Compatible with RS 232 specifications
- Teletype Interface: 20 milliampere current loop
- Optional Interfaces: IEEE 488; TTL; TTY 43
- International (CCITT) frequencies available
- Switches: Originate/Off/Answer; Full Duplex/Test/Half Duplex
- Indicators: Transmit Data, Receive Data, Carrier Ready, Test
- Power: Supplied by 24 VAC/150 MA UL/CSA listed wall-mount transformer. Input 115 VAC, 2.5 watts. (A 220 VAC, 50 Hz adaptor is available upon request.)
- Dimensions: 10" x 4" x 2"
- Weight: 1.74 lbs. (3 lbs. shipping weight including AC adaptor.)
- Warranty: Two years on parts and labor, excluding the AC adaptor which carries the manufacturer's warranty

Part No.	Description	List Price	SALE PRICE
LIV-STAR	RS232, TTL, 20 MA Current Loop	\$199.00	\$129.00
LIV-STAR-V21	CCITT European Standard	\$229.00	\$208.00
LIV-IEEE	IEEE 488 Standard	\$395.00	\$278.00
LIV-IEEE-V21	IEEE 488, CCITT Standard	\$465.00	\$369.00

CABLES

Part No.	Description	Price
CND-RS232BF	RS232 8 Cond 8 ft	\$19.95
LIV-121	IEEE to IEEE 2 Meter	\$59.95
LIV-12PET	IEEE to Pet 2 Meter	\$59.95

PROTECT YOUR INVESTMENT
PROTECT YOUR DATA WITH



GOF-IBAR46

- Inductively isolated grounds
- Sockets individually filter isolated
- Each socket isolated from power line

LIST PRICE \$79.95
SALE PRICE \$39.95



GOLD S-100 CONNECTORS

Part No.	SOLDER TAIL PRICE			
	1-9	10-24	25-99	100-249
S100 STG	3.20	2.90	2.50	2.20
WIRE WRAP PRICE				
Part No.	1-9	10-24	25-99	100-249
S100 WWG	4.00	3.75	3.50	3.25

TOLL FREE **1** ORDER TODAY
PRIORITY ONE ELECTRONICS

2708 \$8.50 EA.
450ns 8K EPROM 8/\$32.00

2716 \$11.95 EA.
450ns 5 Volt only 8/\$48.00
16 K EPROM

2114-3L
4096 BIT (1024x4) 300ns
LOW POWER STATIC RAM
8/\$30.00
100 + \$3.00

5257-3L
(TMS 4044)
4096x1 300ns
LOW POWER STATIC RAM
8/\$50.00
100 pcs. + \$4.75

TRS-80/APPLE MEMORY EXPANSION KITS

4116's RAMS
from Leading Manufacturers

100% GUARANTEED (16Kx1 200ns) 1,000's SETS SOLD
8 for \$28.00

ADD \$3.00 FOR PROGRAMMING JUMPERS
FOR TRS-80 KEYBOARD

4116's 100 pcs & UP \$3.00 each
1000 pcs & UP \$2.75 each

Shugart

SA801R SALE



SHU-SA801R \$425.00
2 OR MORE \$395.00 ea.



California Computer Systems

CSS2422A LIST \$400.00
FLOPPY DISK CONTROLLER SALE \$375.00
WITH CP/M VERSION 2.2
IEEE S-100 COMPATIBLE SINGLE/DOUBLE DENSITY
5 1/4" 1/8" DISK DRIVES
SINGLE/DOUBLE HEADED
ASSEMBLED & TESTED

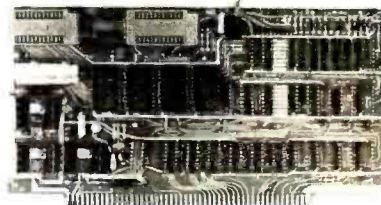

PB1 2708/2716 PROGRAMMER & 4K/8K EPROM BOARD

PB1 has two separate programming circuits so 2708 or 2716 (5v) type of EPROMs can be programmed without modifying the board. Programming voltage is generated on-board; no need for an external power supply. Programming sockets are Dip Switch addressable to any 4K boundary. And complete software is provided for programming and verifying EPROMs.

Unused EPROM sockets don't take memory space, so you are never committed to the full 4K or 8K of memory.

SPECIFICATIONS

Memory capacity 4096/8192 bytes (four sockets)
Memory type 2708 EPROM (not included)
2716 EPROM + 5V type (not included)

Addressing: Any 4K boundary
programmer Dip switch selection
..... Separate 2708 and 2716 sockets
On-board Any 4K/8K boundary above 8000 Hex
EPROMs Dip switch selection
..... Unused sockets do not enable data bus drive
Wait states 0 to 4 clock cycles
Buffering All lines buffered
Special feature LED indicator for programming mode
Switch to turn-off programming
voltage prevents accidental ROM programming
Textool sockets (for programming only)

	List Price	Our Price
SSMPB1K Kit		\$179.00
SSMPB1A Assembled & Tested	\$265.00	\$230.00

MB8A 1K/16K EPROM BOARD

The MB8A provides sockets to support up to 16 2708 EPROMs—the most widely used EPROM in the microcomputer industry. The board disables in 1K increments simply by removing the 1K EPROMs. For example, with 8 EPROMs, it acts as an 8K board.

The MB8A's Magic Mapping enables the user to overlay RAM and ROM at the same address in any desired increment when used with RAM boards equipped with Phantom Disable.

	List Price	Our Price
SSMMB8AK Kit		\$114.00
SSMMB8AA Assembled & Tested	\$179.00	\$159.00

ECONOROM 2708

16K x 8 EPROM BOARD USING 2708

The ECONOROM 2708 EPROM board is the ideal memory board for the user who wishes to place his software in reliable, low cost, and non-volatile 2708 EPROMs. With its on-board Power-On-Jump circuitry, the ECONOROM 2708 board is the ideal addition to any IEEE 696/S-100 system.

	List Price	Our Price
GBT125U Unkit		\$ 85.00
GBT125A Assembled & Tested	\$135.00	\$120.00
GBT125C CSC	\$195.00	\$175.00

Ciarcia's Circuit Cellar

MICROMOUTH

SPEECH PROCESSOR
AS FEATURED IN JUNE BYTE, PAGE 46

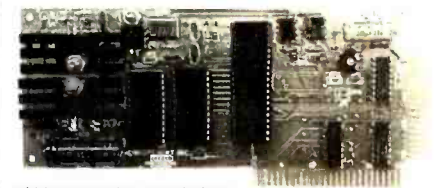

- 144 expression vocabulary
 - Assembled and Tested
 - Complete Documentation
 - Connect to a speaker or Power Amplifier
 - Plugs into Apple II
 - Plug compatible with TRS-80 Model 1
 - May be adapted to run on the S-100, H-8, or any parallel port.
- OUR PRICE
MMI-94V0 APL for use with APPLE II, or parallel to run with other parallel parts \$149.00
MMI-94V0 TRS1 TRS-80 Model compatible complete with interface cable and AC Adapter, less enclosure. \$169.00



PRIORITY ONE ELECTRONICS
9161-B DEERING AVE. • CHATSWORTH, CA 91311

Terms: U.S.; VISA, MC, BAC Check, Money Order, U.S. Funds Only. CA. residents add 6% Sales Tax. MINIMUM PREPAID ORDER \$15.00. Include MINIMUM SHIPPING & HANDLING of \$2.50 for the first 3 lbs., plus 25¢ for each additional pound. Orders over 50 lbs. sent freight collect. Just in case...please include your phone no. Prices subject to change without notice. We will do our best to maintain prices thru JUNE, 1981. SOCKET and CONNECTOR prices based on GOLD, not exceeding \$700.00 per oz.

Sales Prices are for prepaid orders only. Credit Card orders will be charged appropriate freight.

Circle 297 on inquiry card.

DETACH OUR CATALOG FROM THE MAY BYTE

DETACH OUR CATALOG FROM THE MAY BYTE

VISIT OUR GIANT NEW RETAIL STORE

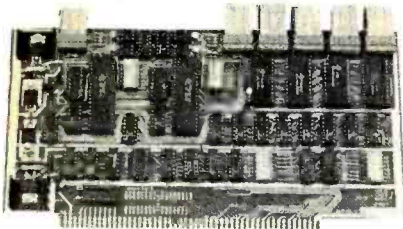

I/O 2 Parallel & 2 Serial I/O Board

Number of parts • Two serial ports with status • Two parallel inputs • Two parallel outputs • **Serial Interface** - Current-loop by optical isolators • 20/60 ma current loop • EIA receivers and drivers • 55 to 9600 baud • 134.5 baud (optional) for running electrics • UART presets by dip switch: —stop bits, —word length, —parity even and odd • + 5V, 12V & — 12V available at connector • **Parallel Interface** - Latch type—8212 • + 5V & — 12V available at connector • **Addressing** - Dip switch addressing of serial I/O to any four port boundary • Dip switch addressing of parallel I/O to any two port boundary • **Prototyping area** - 2 x 16 pin spare patterns

	List Price	Our Price
SSM04K Kit		\$210.00
SSM04A A&T	\$290.00	\$260.00

INTERFACE I 2 Serial

Our I/O board gives you unparalleled flexibility and operating convenience. We include such features as:

- 2 Independently addressable serial ports (dip switch selectable addresses)
- Real LSI Hardware UARTs for minimum CPU housekeeping.
- RS232C, current loop (20mA), & TTL signals on both ports.
- Precision, crystal-controlled Baud rates up to 19.1 Kbaud (individually dip switch selectable)
- Transmit & receive interrupts on both channels, jumperable to any vectored interrupt line.
- Industry standard RS232 level converters with five RS232 handshaking lines per port.
- Optically isolated current loop with provisions for both on-board & off-board current sources.
- UART parameters, interrupt enables, & RS 232 handshaking lines are software programmable with power-on hardware default to customer specified hard-wired settings for maximum flexibility.

	List Price	OUR PRICE
GBT133U UNKIT		\$199.00
GBT133A A&T	\$249.00	\$219.00

INTERFACER II 3P/1S

- 1 Independently addressable serial port
- RS232C: 20mA current loop, & TTL signals
- Precision crystal controlled Baud rate generator
- Up to 19.2K Baud
- Transmit and receive interrupts, jumperable to and vectored interrupt line
- Five RS232 handshaking lines
- Optically isolated current loop
- 3 parallel I/O
- Utilizes LS TTL octal latches for latched I/O data with 24mA drive current
- Enable & strobe bits on each port (each with selectable polarity)
- Interrupts for each input port
- Separate 25 pin connector with power for each channel and a status port for interrupt mask & port status

	List Price	OUR PRICE
GBT150U UNKIT		\$199.00
GBT150A A&T	\$249.00	\$219.00

TOLL FREE!!!

1-800-423-5922



SPECTRUM S-100 COLOR GRAPHICS BOARD



The SPECTRUM COLOR GRAPHICS Board is actually three products in one: a full-function color graphics generator; a parallel I/O port; and an 8K static RAM board. These three sections work together to create a new standard of flexibility in the generation of color graphics.

ALPHANUMERIC AND GRAPHICS MODES AVAILABLE

MODE	DENSITY	AVAILABLE COLORS	RAM USED
ALPHA	32 X 16	2	512 BYTES
SEMIGRAPH	64 X 32	8	512 BYTES
GRAPHICS	64 X 64	4	1K BYTES
GRAPHICS	128 X 64	2	1K BYTES
GRAPHICS	128 X 64	4	2K BYTES
GRAPHICS	128 X 96	2	1.5K BYTES
GRAPHICS	128 X 96	4	3K BYTES
GRAPHICS	128 X 192	2	3K BYTES
GRAPHICS	128 X 192	4	6K BYTES
GRAPHICS	256 X 192	2	6K BYTES

	LIST PRICE	OUR PRICE
GBT144U UNKIT		\$299.00
GBT144A A&T	\$399.00	\$349.00
GBT144C CSC	\$449.00	\$399.00
GBT20 SUBLOGIC UNIVERSAL GRAPHICS INTERPRETER SOFTWARE		\$35.00

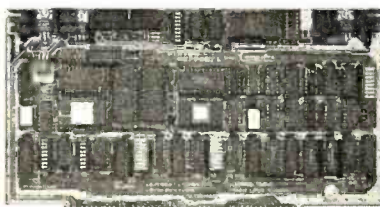

SYSTEM SUPPORT 1 MULTIFUNCTION BOARD

This multi-purpose S-100 board provides your computer with the most needed system support functions - at less cost than buying numerous single function boards. Includes sockets for 4K of extended address EPROM or RAM (2716 pinout), 1 socket with battery backup; crystal controlled month/day/year/time clock with BCD outputs; optional high speed math processor (9511 or 9512); full RS-232 serial port; three 16 bit interval timers (cascade or use independently); two interrupt controllers service 15 levels of interrupts; power fail indicator with provision to switch CMOS memory to battery backup; and comprehensive owner's manual with numerous software examples. Conforms fully to all IEEE 696/S-100 standards.

Want to make your S-100 system more versatile? System Support 1 is the answer.

- 4K of EPROM or RAM (2716 type).
- 15 levels of vectored interrupts.
- 3 interval of 16 bit interval timers.
- Real time clock/calendar with battery backup capability
- Full RS-232C serial port with software selectable baud rate.
- Optional high speed math processor (9511 or 9512, your choice).
- 1, 2, 4 or 8 wait states selectable to accommodate the fastest CPUs.
- ROM/RAM can be enabled or disabled by PHANTOM.
- ROM/RAM can respond to full IEEE extended address (24 bits).

	List Price	Our Price
GBT 162U unKit		\$295.00
GBT 162A A&T	\$395.00	\$360.00
GBT 9512 Math Chlp		\$195.00

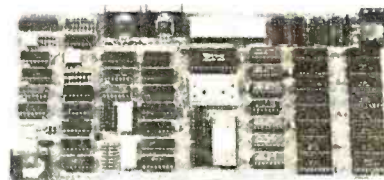

VB3 80 Character Video Board

VB3 is the perfect video interface for word processing and other applications requiring 80 characters per line. It produces a standard 80 x 24 display or as much as 80 x 48 for a full page of text. VB3 can display upper and lower case characters, up to 256 user defined symbols, and a 160 x 192 matrix for graphics.

VB3 is memory mapped, but occupies memory only when activated. So one or more VB3s can be located at the same address with a full 65K of memory still available to the user.

It generates both US and European T.V. rates and includes a keyboard input. Software includes a CP/M compatible driver routine.

SPECIFICATIONS:

Display - 80 char. per line, up to 48 lines • Graphics up to 160 x 192 matrix • Upper & lower case characters • Up to 256 user defined symbols (optional EPROM) • Software controlled options: Inverted video, graphic char. (2x4), 1 level of gray, blinking char., underline, strike thru, blank-out char., cursor.

Timing • Software controlled timing, top & bottom margins, horiz. position • U.S. & European T.V. timing • Full Interlace or non-interlace • Crystal—16 MHz (dot rate)

Interface • Composite video, =75 OHM • Vert./horiz. drive output & sync input • Memory mapped Keyboard • Keyboard port with status • Dip switch addressing of ports

On-board RAM • 4096 Bytes (8192 bytes optional) • 2114L (250 nsec or 450 nsec) • Switch addressing, 8K increments • On-board bank-select of RAM

Buffering • All lines buffered

Software • CP/M compatible driver routine • Powerful terminal simulator routine

	List Price	SALE PRICE
SSM-VB3K24 80x24 KIT	\$425.00	\$359.00
SSM-VB3A24 80x24 A&T	\$499.00	\$450.00
SSM-VB3K48 80x48 KIT	\$475.00	\$425.00
SSM-VB3A48 80x48 A&T	\$549.00	\$495.00
SSM-VB3UP 24x48 Line Upgrade Kit		\$50.00

Video Interface Software

- CP/M Compatible 8" Disk, containing
- CP/M BIOS Driver
- Super Intelligent Terminal Routines
- Graphics Routine
- Menu-Driven Initialization Routine
- Misc. User - Contributed Programs

	OUR PRICE
SSM-VB3SFT Video Interface Software	\$50.00

VB1C Memory Mapped Video Board

One of the most popular S-100 video boards available, this VB1C is software controlled and memory mapped. Memory Mapping means that locations in the 1K (1024 byte) on-board RAM memory correspond with locations in the 64 x 16 (1024) character display.

The 1K memory can be addressed at any 1K increment via DIP switch.

The VB1C features a 128 x 48 matrix for graphics upper and lower case, Greek letters, and black on white or white on black. Software includes a driver routine for cursor control, scroll-up, and X-Y graphic control.

	List Price	SALE PRICE
SSM-VB1CK KIT	\$179.00	\$159.00
SSM-VB1CA A&T	\$242.00	\$205.00

VB2 I/O Mapped Video Board

The VB2, is an I/O controlled video interface board. With a TV monitor, the VB2 becomes a video terminal. No other I/O card is required for keyboard input and video display.

The VB2 cursor, linefeed, carriage return, backspace, and clear-screen are hardware controlled. The display is 64 x 16, all upper case, and is selectable for white on black, or black on white. The board produces a clear, bright display, and features adjustable picture size and character width. Circuitry is provided to drive a speaker for a tone.

	List Price	SALE PRICE
SSM-VB2K KIT	\$199.00	\$169.00
SSM-VB2A A&T	\$269.00	\$229.00

PRIORITY ONE ELECTRONICS

9161-B DEERING AVE. • CHATSWORTH, CA 91311

Terms: U.S.; VISA, MC, BAC Check, Money Order, U.S. Funds Only. CA. residents add 6% Sales Tax. MINIMUM PREPAID ORDER \$15.00. Include MINIMUM SHIPPING & HANDLING of \$2.50 for the first 3 lbs., plus 25¢ for each additional pound. Orders over 50 lbs. sent freight collect. Just in case... please include your phone no. Prices subject to change without notice. We will do our best to maintain prices thru JUNE, 1981. SOCKET and CONNECTOR prices based on GOLD, not exceeding \$700.00 per oz.

Sales Prices are for prepaid orders only. Credit Card orders will be charged appropriate freight.



DETACH OUR CATALOG FROM THE MAY BYTE

DETACH OUR CATALOG FROM THE MAY BYTE

ORDER TOLL FREE 1-800-423-5922 CA., AK., HI., (213) 709-5464

Circle 297 on inquiry card.

VISIT OUR GIANT NEW RETAIL STORE

SCOPE SALE OUR LOWEST PRICES OF THE YEAR!



Single and dual trace, 15 thru 100 MHz. All high sensitivity Hitachi oscilloscopes are built to demanding Hitachi quality standards and are backed by a 2-year warranty. They're able to measure signals as low as 1mV/division (with X5 vertical magnifier). It's a specification you won't find on any other 15 or 30 MHz scopes. Plus: Z-axis modulation, trace rotation, front panel X-Y operation for all scope models, and X10 sweep magnification. And, 30 thru 100 MHz oscilloscopes offer internal signal delay lines. For ease of operation, functionally-related controls are grouped into three blocks on the color coded front panel. Now here's the clincher: For what you'd expect to pay more, you actually pay less. Check our scopes before you decide. All scopes complete with probes.

Hitachi...The measure of quality.
HITV302B

30MHz DUAL TRACE OSCILLOSCOPE
List \$995.00
SALE \$819.00



HITV152B DUAL TRACE 15MHZ (no delay)
LIST \$735.00 **SALE \$629.00**



HIT-V202
20MHz DUAL TRACE

LIST PRICE: \$850
SALE PRICE: \$775.00

- Dynamic range 8 div.
- TV sync-separator circuit
- Built-in signal delay line (V-352)
- X-Y operation
- Sweep-time magnifier (10 times)
- Trace rotation system
- Fine-adjusting, click-positioning function

HIT-V352
35MHz DUAL TRACE WITH DELAY

LIST PRICE: \$1150.00
SALE PRICE \$950.00

- Economically priced dual trace oscilloscope
- Square CRT with internal graticule (illuminated scale)
- High-accuracy voltage axis & time axis set at $\pm 3\%$ (certified at 10° to 35°C)
- High-sensitivity 1mV/div.
- Low drift
- 2 Year Warranty

50MHz & 100 MHz
DUAL TRACE WITH
CALIBRATED TIME DELAY

HIT V550B
50MHz with
3rd TRACE
TRIGGER VIEW
LIST \$1745.00
SALE

HIT V1050
100MHz with
3rd & 4th TRACE
TRIGGER VIEW
LIST \$2390.00
SALE

\$1495.00 \$1995.00

The HITACHI V550B (50MHz) and V1050 (100MHz) offer all the capabilities you might expect from a lab grade oscilloscope. Capabilities such as 3rd trace trigger view, a bright 6" square CRT, and a max. sweep rate of 2ns/div (V1050) 5ns/div (V550B). Also, features you may not expect like, sensitivity of 1mV/div (V550B) .5mV/div (V1050) @ 10MHz, automatic focus correction.

MORROW DESIGNS

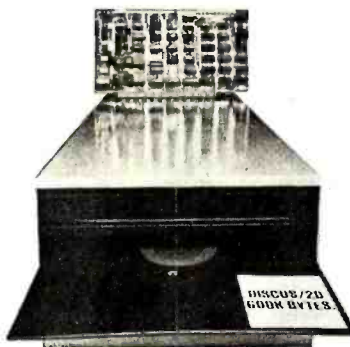

DISCUS/2D™
DOUBLE DENSITY DISK SYSTEM

COMPLETE WITH
CP/M V2.2 AND
MICROSOFT BASIC V5.2

Why not go all the way to the professional/industrial standard of 600K byte/side disk memory with your S-100 system? The new DISCUS/2D™ full-size, double-density floppy disk system is actually less expensive than many mini-floppy systems.

And Morrow Designs TM hasn't just made full-size, double-density disk memory affordable...we've made it more functional.

The data format is soft-sectored and compatible with IBM's new System 34. And DISCUS/2D™ accepts both single-density and double-density disks for complete flexibility in data storage.

And DISCUS/2D™ is even more attractive because it's priced and delivered as a truly complete system. It's complete with all hardware. It's complete with all necessary software. And it's completely assembled, tested and warranted.

Specifications:

- CP/M V2.2 and Microsoft Basic V5.2 Standard
- Plug compatible with Shugart, Remex and Siemens single- or double-sided drives
- Double/single-density capability utilizing MFM and FM data formats
- Western Digital 1791 LSI floppy disk controller chip
- Uses 2K of S-100 address space:
 - 1K PROM with built-in disk drive and I/O utility subroutines incorporating memory mapped I/O
 - 1K 2114-3L 300 ns access time RAM for disk data offering and general purpose use
- Starting address of memory space is 340,000 (E000 hex) for compatibility with other popular ROM based systems
- Phase-locked data separator and crystal controlled disk data write precompensation capability to insure the highest standards of data integrity in double density mode.
- Compatible with all 2, 4 and 5 MHz systems which conform with the proposed IEEE standard for the S-100 bus
- 1602 UART with crystal-controlled baud-rate generator
- Sixteen switch selectable baud rates from 50 to 19,200 bits/second
- TTY current loop and industry standard RS232C serial interface
- Power-on-jump circuitry for automatic bootstrap loading from the disk drive
- Power supply requirements: + 8V @ 1200 ma; + 16V @ 150 ma; -16V @ 70 ma.

• ROM utility subroutines:

Bootstrap load	Seek
Terminal input	Set sector
Terminal output	Set DMA address
Horne	Disk read
Disk write	DMA status
Select drive	Disk status
Terminal panic detect	Disk error
Terminal status	Switch density

SINGLE SIDED

MDSF-1218	Single Drive	List Price	\$1199.00	SALE PRICE	\$950.00
MDSF-1228	Double Drive	\$1994.00		\$1598.00	

DOUBLE SIDED

MDSF2218	Single Drive	\$1545.00	\$1198.00
MDSF2228	Double Drive	\$2740.00	\$2190.00

CompuPro™ from GODBOUT ELECTRONICS

10 MHz STATIC RAM SALE



32K ECONORAM XX

32K Bank Select. IEEE S-100 compatible. Features one 32K block that can be addressed on 4K boundaries. Compatible with the IEEE proposed standard of 24 address lines as well as all currently used bank select configurations. Any or all of the eight 4K byte blocks may be disabled to create as many windows in memory to avoid any system memory conflicts.

10 MHz OPERATION

GBT164A16	16K RAM A&T	List Price	\$399.00	SALE PRICE	\$319.00
GBT164A24	24K RAM A & T	\$539.00		\$449.00	
GBT164A32	32K RAM A&T	\$699.00		\$499.00	



ECONORAM 17
64K STATIC S-100 MEMORY

For critical high density applications where dynamic memory poses possible problems with DMA or speed, the Godbout RAM 17 64K STATIC RAM board represents the long awaited solution. Conforming fully to the IEEE 696/S-100 bus standard, RAM 17 provides 24 address lines for 16 megabytes extended addressing capability, and runs on far less power than dynamic memory.

- Meets or exceeds all IEEE 696/S-100 specifications
- Fully static design uses less power than dynamics (2W)
- 24 bit extended addressing
- 2K Window at E000, E800, F000, or F800 HEX (ideal for many floppy disk controller boot prompts)
- THAT'S RIGHT 64K STATIC-2 WATTS
- On board RAM's may be replaced by 2716 EPROM's (pin for pin)
- CSC and Assembled/Tested boards are designed for CPU speeds up to 10 MHz
- Thorough bypassing of all supply lines
- INCREDIBLE LOW POWER OPERATION (2 WATTS)
- Does DMA
- THAT'S 2 WATTS OF STATIC 64K RAM

GBT 175A4B	48K A&T	List Price	\$1048.50	Sale Price	\$950.00
GBT 175A64	64K A&T	\$1395.00		\$995.00	

GBT 161 8085 CPU BOARD
GBT 1612 8085/8088 CPU BOARD

- 8088 & 8085A CPU
- S-100 IEEE COMPATIBLE
- SWITCHABLE CPU'S
- 5 MHZ OR 2 MHZ SWITCHABLE
- POWER ON JUMP TO ANY 256 BYTE BOUNDARY
- POWER ON JUMP CAN BE DISABLED
- CPU CAN JUMP ON POWER ON ONLY OR POWER ON AND RESET
- 24 BIT EXTENDED ADDRESSING
- IMSAI FRONT PANEL COMPATIBLE
- AVAILABLE WITH 8085A ONLY

BOARD WITH 8085 ONLY

GBT161A	Assembled & Tested	List Price	\$325.00	Our Price	\$305.00
---------	--------------------	-------	------------	----------	-----------	----------

BOARD WITH 8085 & 8088

GBT1612A	Assembled & Tested	\$425.00	\$399.00
----------	--------------------	-------	----------	----------



PRIORITY ONE ELECTRONICS

9161-B DEERING AVE. • CHATSWORTH, CA 91311

Terms: U.S.; VISA, MC, BAC Check, Money Order, U.S. Funds Only. CA. residents add 6% Sales Tax. MINIMUM PREPAID ORDER \$15.00. Include MINIMUM SHIPPING & HANDLING of \$2.50 for the first 3 lbs., plus 25¢ for each additional pound. Orders over 50 lbs. sent freight collect. Just in case...please include your phone no. Prices subject to change without notice. We will do our best to maintain prices thru JUNE, 1981. SOCKET and CONNECTOR prices based on GOLD, not exceeding \$700.00 per oz.

Sales Prices are for prepaid orders only. Credit Card orders will be charged appropriate freight.



ORDER TOLL FREE 1-800-423-5922 CA., AK., HI., (213) 709-5464

Circle 298 on inquiry card

DETACH OUR CATALOG FROM THE MAY BYTE

DETACH OUR CATALOG FROM THE MAY BYTE

TEAMS UP WITH PRIORITY ONE ELECTRONICS TO INTRODUCE THE NEXT GENERATION OF IEEE/696 S-100 COMPUTERS

8 BIT

There are still a lot of 8 bit machines out in the world, matched with plenty of 8 bit software - but very few of these machines are working up to their peak capacity. We want the "Big 8" system to change all that, and bring professional level computing power to all the owners of older S-100 machines. And if you're assembling an 8 bit system from the ground up, "Big 8" gets you off to the best possible start ... regardless of price.

Here's what you get

1. CPU Z, our high speed, high performance Z80* based CPU board. Includes a 6 MHz CPU for maximum throughput and highest operating speed.
2. Disk 1 DMA floppy disk controller.
3. 64K of fast static RAM with 24 bit extended addressing.
4. InterfacE71 - Dual Serial I/O card or InterfacE II 3 Parallel 1 Serial I/O Card.
5. CP/M* -80 2.2.
6. All documentation and manuals.

It all adds up to \$2712.00

TOTAL PACKAGE PRICE

\$1950.00

SAVE \$762.00

ORDER PART NO. GBT-SPEC-C

Big 8 System with InterfacE I

ORDER PART NO. GBT SPEC-D

Big 8 System with InterfacE II

SAVE EVEN MORE, when you add 2 Shugart 801R disk drives, and a dual Cabinet with Power Supply.

This package adds up to \$3962

TOTAL PACKAGE PRICE

\$3050.00

GBT-SPEC-E with InterfacE I

GBT-SPEC-F with InterfacE II

16 BIT

Step up to the world of 16 Bit computers now and save hundreds, even thousands of dollars if you act right now! We have made a one time only special buy from Godbout on the nucleus of a Powerful 16 Bit S-100 Computer. We have a limited number of these systems in stock, because of the special pricing we can't go back for more, so hurry! Orders will be filled on a first come basis. NO RAINCHECKS.

Here's what you get

1. 16 bit/8 bit Dual Processor (w/6 MHz 8088)
2. System Support 1 with Serial I/O. Real time clock, Interval Timers & More!
3. Disk 1 DMA Floppy Disk Controller (w/BIOS for CP/M *2.2)
4. 64K of fast static RAM (w/IEEE 24 bit extended addressing)
5. Sorcim's powerful PASCAL/M* - 8086 software on disk
6. Digital Research's CP/M* - 86 software on disk
7. I/O and Disk Controller cables, plus full documentation on all hardware and software

*PASCAL M is a trademark of Sorcim; CP/M is a registered trademark of Digital Research

It all adds up to \$3430.00

A) TOTAL PACKAGE PRICE

\$2495.00

SAVE \$935.00

ORDER PART NO. GBT SPEC-A

SAVE EVEN MORE, when you add 2 Shugart 801R disk drives, and a dual Cabinet with Power Supply.

This package adds up to \$4680.

B) TOTAL PACKAGE PRICE

\$3595.00

SAVE \$1085.00

ORDER PART NO. GBT-SPEC-B

THE ULTIMATE SYSTEMS CALL FOR THE ULTIMATE SYSTEMS ENCLOSURE



Power Supply

- Twenty-five Amps at 8.0 volts D.C.
- Three Amps each at + 16 and - 16 volts D.C.
- Outputs vary less than 5% over input range of 100 VAC to 130 VAC
- Constant voltage transformer
- All outputs fused

Enclosure

- Quiet fan provides for cool system operation
- Two switched convenience outlets on the rear
- Line filter for electrical noise suppression
- Circuit breaker for safe operation
- Lighted RESET BUTTON FOR "POWER ON" indication
- Punchouts on rear for 12 DB-25 connectors
- Punchouts on rear for 2 DD-50 connectors
- Positive pressurized for ease of filtration
- Provisions for mounting a front panel
- Physically 18.5" deep, 7" high, and 17" wide (rack front panel 19" wide)

CompuPro™ from GODBOUNT ELECTRONICS

Now ... a place to put all those CompuPro or other S100 boards. The enclosures are available in either desk top or rack mount (including slides) and both have the following features:

ORDER TODAY!

SAVE!



PRIORITY ONE ELECTRONICS®

9161-B DEERING AVE. • CHATSWORTH, CA 91311

ORDER TOLL FREE (800) 423-5922 CA, AK, HI CALL (213) 709-5464

Terms: U.S.; VISA, MC, BAC Check, Money Order, U.S. Funds Only. CA. residents add 6% Sales Tax. MINIMUM PREPAID ORDER \$15.00. Include MINIMUM SHIPPING & HANDLING of \$2.50 for the first 3 lbs., plus 25¢ for each additional pound. Orders over 50 lbs. sent freight collect. Just in case... please include your phone no. Prices subject to change without notice. We will do our best to maintain prices thru JUNE, 1981. SOCKET and CONNECTOR prices based on GOLD, not exceeding \$700.00 per oz. Sales Prices are for prepaid orders only. Credit Card orders will be charged appropriate freight.

Circle 298 on inquiry card.



Motherboard

- Actively terminated at both ends of motherboard
- Ground shield between every signal trace
- Front panel provisions on the 20 slot version

	LIST PRICE	OUR PRICE
GBT ENC20RM	895.00	825.00
20 slot Rack Mount		
GBT ENC20DK	825.00	760.00
20 slot Desk Top		
Shipping Weight 55 lbs		
When purchased with any of the above systems.....		
GBT ENC20RM		\$750.00
GBT ENC20DK		\$685.00

FLEX-FORTH



apple

\$25

KIM

\$21

A Complete Structured Language With:

- COMPILER/INTERPRETER
- OPERATING SYSTEM
- 6502 ASSEMBLER (With Macros)
- FIG SCREEN EDITOR

FLEX-FORTH is a full-featured F.I.G. standard FORTH with virtual memory files.

For: APPLE II 48K (Disk) \$25.
KIM 16K (Cassette) \$21.
Price includes user manual.

Source listing with either, add \$20.
Shipped Free.

GEOTEC
1920 N.W. Milford Way
Seattle, Wa. 98177

Apple is a trademark of Apple Computer Co.
KIM is a trademark of MOS Technology.

Circle 147 on inquiry card.

PROOFREADER™

For The TRS-80™

Let your TRS-80 proofread your Scripsit, Pencil or other documents. Proofreader checks every word of your document in its 38,000 word dictionary in under 5 minutes. Unknown words listed on screen or to a file. Requires Model-I, 32K, 1 disk \$54.00

RATFOR

Rational Fortran preprocessor allows structured programming using Fortran. An excellent, fast implementation with extensions and manual. Requires Model-I, 48K, 2 disks \$49.00

PPRATFOR- Automatically pretty prints and indents Ratfor. Requires Ratfor. \$30.00 Alone / \$74.00 For Both

SOFT-TOOLS are professional quality software tools developed for the TRS-80 by a PhD in Computer Science.

Order Postpaid: SOFT-TOOLS
MHE Box 14
Tijeras, NM 87059

Dealer Inquiries Invited

Circle 332 on inquiry card.

Double Side Disk Drives



Disk Drive Subsystem with Dual Double Side Drives, Power Supply and Cable. Total Capacity 2.4 M-Byte. Fully Assembled and Tested

Only !!

1. Table Top Version \$1,695.00
2. Rack Mount Version 1,695.00
3. Pair of Slides with Attachment for Rackmount 35.00
4. \$100 Disk Controller (handles single & double density in 256, 512 & 1024 byte sectors, single & double side) 350.00
5. Double Side Disk Drives (1.2 mb) 535.00 (Qume DT/8)

Call Now (408)496-6910
OSM Computer Corporation
2364 Walsh Avenue
Santa Clara, CA 95051

Circle 160 on inquiry card.

Hard Copy Printer For Your Computer

Completely Refurbished
Teletype Model 33 RO

Friction Feed Table Model, 110 Baud, 8 Level ASCII, operated from 20MA or 60MA Loopspecify.

\$279.95

Also Available with built in Modem to accommodate your computer, we supply the Hardware, Software and Instructions.

\$329.95

Check or M.O., \$50. deposit on C.O.D. orders, N.J. Residents add 5% Sales Tax

RED ARROW
ELECTRONICS CORP.

1217 Summit Ave.,
Union City, N.J. 07087
(201) 863-7916

Circle 314 on inquiry card.



PERSONAL COMPUTER SERVICE
ELECTRONICS
52 JACKSON DRIVE SOUTH
POUGHKEEPSIE, NEW YORK 12603

We at PCSE firmly believe that you deserve the most for your hard earned capital. Therefore we are offering you this lifetime membership offer.

For the nominal sum of five dollars our firm will:

- 1- Guarantee any item purchased thru us to carry a minimum of 10 - 12% off manufacturers list
- 2- Inclusion of free shipping anywhere in the USA except large ticket items which we feel should be insured
- 3- Free catalog(s) and updated brochures as they become available

Our service will be fully guaranteed or your fee cheerfully refunded

NAME _____
ADDRESS _____
CITY _____ STATE _____ ZIP _____
COMPUTER MAKE _____

APPLE ATARI OTHERS Apple is a trademark of Apple Computer, Inc. ATARI is a recognized trademark of ATARI, Inc.

Circle 289 on inquiry card.

MICRO

The 6502/6809 Journal

• For the serious user of the Apple, PET/CBM, OSI, Atari, AIM, SYM, and KIM.

• The premier 6502 resource journal—now also covering the 6809!

• Internationally respected by professionals in business, industry, and education.



Order today!

We accept VISA & Mastercard.

\$18.00 in the U.S.
\$21.00 foreign
surface mail
(Ask for air rates)

MICRO
P.O. Box 6502
Chelmsford, MA
01824
(617)256-5515

Circle 314 on inquiry card.

A NEW WIRELESS AC REMOTE CONTROL INTERFACE for the Sears and BSR X-10 home control system. Use your present TRS-80 Level II, Apple II or S100 computer to provide complete home security through control of lights, appliances and motors with a few simple BASIC commands.

As featured in:
"COMPUTERIZE A HOME" BYTE, January 1980

Busy Box - Assembled & tested
For TRS-80 .. \$109.95
For S100 119.95
For Apple II ... 114.95

Realtime control software - TRS-80 19.95
To order call (516) 374-6793
or write: The MicroMint Inc.
917 Midway,
Woodmere, NY 11598



BUSY BOX

DEALER INQUIRIES
INVITED



Circle 314 on inquiry card.

Data Acquisition and Control for the TRS-80* \$180 ppd.

The STARBUCK-8882 is a complete eight channel data acquisition and control system, plug compatible with the Model I Level II TRS-80. It includes 8 protected analog inputs (0-5 Vdc with 8 ± 1 bit accuracy), 8 protected digital inputs, 8 optoisolated digital outputs, and two joystick ports. Interrupt-driven software package allows simultaneous data acquisition and storage while using the TRS-80 for any other purpose!

Application manual covers home security, energy monitoring, weather station use, appliance control, graphics and games. Price includes case, power supply, extra expansion card edge connector cable, complete software package and detailed applications manual. Manuals only are available for \$4.00 ppd. To order, write:

STARBUCK DATA CO.
P.O. Box 24, Newton, MA 02162

Massachusetts residents add 5% sales tax.
*TRS-80 is a trademark of Tandy Corp.

Circle 289 on inquiry card.

Low Prices

AMPEX

- Dialogue 80 CRT Terminal \$995.

ADDS

- Viewpoint with detachable keyboard \$650.
- Regent 25 Terminal \$830.

TI

- 810 Printer Basic \$1,595.

BASE 2

- 850 Printer \$695.

Ask for our prices of other products. Add \$5 per unit for processing.

CASH WITH ORDER 5% OFF

Computer Designs and Services

5575 Magnatron Blvd., Ste.D

San Diego, CA 92111

Tel: 714-571-2763

TWX: 910-335-1620

Overseas inquiries invited.

Circle 74 on inquiry card.

Receive \$100 to \$150 from Centronics
with proof of purchase from **MMM**

Super Savings on Centronics® Printers

Ideal for TRS-80®, Apple®, etc...

Serial
Versions
of 704,
730, 737
available

CENTRONICS® 730

Same as Radio Shack Line Printer II
LIST PRICE \$795

NOW ONLY \$599
(add \$7.50 for shipping)



**Big factory
REBATES
on already small
MMM prices**

less **\$100.** on 730

CENTRONICS 779-2

Same as Radio Shack Line Printer I w/ tractor
LIST PRICE \$1350

(Ship freight collect)

NOW ONLY \$799

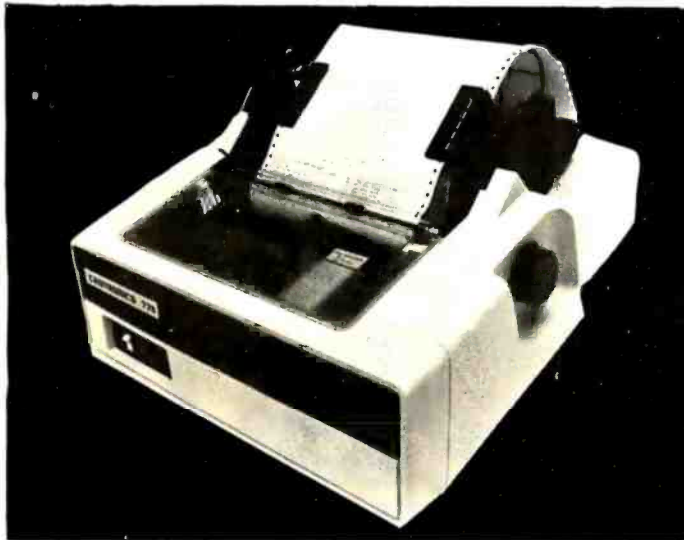

CENTRONICS® 737 LIST PRICE \$995

Same as Radio Shack Line Printer IV
Featuring Correspondence Quality and Proportional Spacing

NOW ONLY \$799 less \$150.



MiniMicroMart, Inc.

1618 James Street, Syracuse, NY 13203 (315) 422-4467

TWX 710-541-0431

Computers, Disk Systems



data systems



Z89-FA
List \$2895

OUR PRICE \$2395

Z-89GA
List \$2595..... \$2149

A-87 Two Drive
Minifloppy System List \$1195..... \$989

Z-47DA..... \$3695
8" Two Megabyte List \$3695..... \$3059

INTERSYSTEMS

formerly ITHACA AUDIO

The new Series II CPU Board features a 4 MHz Z-80A CPU and a full-feature front panel. 20-slot actively terminated motherboard, with 25 amp power supply (50/60 Hz operation, incl. 68 cfm fan). DPS-1. List \$1795 **\$1495**



COMPLETE SYSTEM with InterSystem 64K RAM, I/O Board and double density disk controller board. Full 1-year warranty.
List \$3545..... **\$2995**

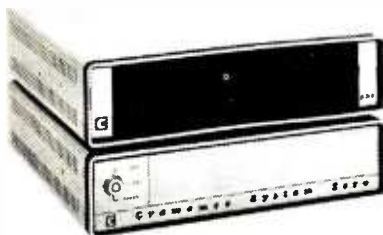

NEW! CROMEMCO SYSTEM ZERO

List \$995..... **OUR PRICE \$849**

NEW! CROMEMCO SYSTEM ZERO/D

A complete 64K Computer with Double Density Disk Controller..... List \$2995

OUR PRICE \$2545

Companion Disk drive for above —
Quad Density — Total of 780 Kilobytes of storage on the two drives..... List \$1295

OUR PRICE \$1099

Only \$3644 for a complete 64K Disk System

SUPERBRAIN

By INTERTEC



64K Double or Quad Density units available. Uses two Z-80 CPU's. Commercial-type terminal with 12" monitor. Dual double density minifloppies. Over 350 kilobytes of storage (twice that with quad density drives). Two serial RS232 ports, I/O ports standard. Expandable with optional S-100 interface. Comes with CP/M™ 2.2 operating system. MiniMicroMart can supply a wide range of CPM development and application software.

w/64K Double Density, List \$3495 .. **\$2869**
w/64K Quad Density, List \$3995..... **\$3395**



HEWLETT PACKARD

HP-41CV

\$259.



AVAILABLE NOW!

HP-41 System I—\$399.

(The HP-41CV and HP 82104A Card Reader) List \$495.

HP-41 System II—\$679.

(The HP-41CV and HP 82104A Card Reader, HP 82143A Printer/Plotter) List \$840.

HEWLETT-PACKARD

HP-85A



Desk-Top Computer
List \$3250
\$2749

HP83 List \$2250..... \$1899

MORROW

THINKER TOYS® DISCUS M26™

26 megabytes of formatted storage
List \$4,995

\$4,199



THINKER TOYS® DISK SYSTEMS

Now includes CP/M® 2.2

Discus 2D, List \$1199..... \$998
Discus 2D, dual-drive, List \$1994..... \$1669
Discus 2 + 2. A&T, List \$1549..... \$1299
Dual Discus 2 + 2. A&T, List \$2748..... \$2299

All Morrow floppy disks include CP/M® 2.2 and Microsoft Basic 80

MORROW Discus 2D's IN STOCK

NEW! CROMIX FROM CROMEMCO

A New UNIX Like Disk Operating System,
With true multi-user, multi-tasking capabilities

List \$295..... **OUR PRICE \$249**

NEW! DOUBLE DENSITY CONTROLLER BOARD FROM CROMEMCO

With built-in diagnostics

16 FDC Controller, List \$595 **OUR PRICE \$505**

RADIO SHACK TRS-80™

10% OFF!



Mini Micro Mart, Inc.

1618 James Street, Syracuse, NY 13203

(315) 422-4467

TWX 710-541-0431

Circle 245 on Inquiry card.

Terminals and Printers

Intertec EMULATOR

Software compatible with a Soroc IQ-120, Hazeltine 1500, ADM-3A or DEC VT-52. Features block mode transmission and printer port; 12" anti-glare screen; 18-key numeric keypad; full cursor control. List \$895

OUR PRICE \$749



NEW INTERTUBE III

List \$995 **ONLY \$749**

12" display, 24 x 80 format, 18-key numeric keypad, 128 upper/lower case ASCII characters. Reverse video, blinking, complete cursor addressing and control. Special user-defined control function keys, protected and unprotected fields. Line insert/delete and character insert/delete editing, eleven special line drawing symbols.

TELEVIDEO TVI-912C



Upper and lower case, 15 baud rates: 75 to 19,000 baud, dual intensity, 24 x 80 character display, 12 x 10 resolution. Numeric pad. Programmable reversible video, auxiliary port, self-test mode, protect mode, block mode, tabbing, addressable cursor. Microprocessor controlled, programmable underline, line and character insert/delete. "C" version features typewriter-style keyboard. List \$950

OUR PRICE \$789

920C (with 11 function keys, 6 edit keys and 2 transmission mode keys, List \$1030

ONLY \$849

950C List \$1195 **\$1039**

HAZELTINE

1500

ONLY \$879



1410 w/numeric keypad, List \$900 \$749
1420 w/lower case and numeric pad **849**
1510, List \$1395 **1089**
1520, List \$1650 **1389**

SOROC



IQ-120

List \$995

SPECIAL \$729

IQ135 \$749

IQ-140 List \$1495 SPECIAL \$1149

CENTRONICS PRINTERS

NEW 730, parallel, friction, tractor \$599
NEW 737 parallel, friction, tractor \$799
779-2 w/tractor (same as TRS-80 Line Printer I), List \$1350 \$799
704 RS232 serial version, \$2350 \$1595
704-9 RS232 180CPS \$1595
704-11 Parallel 180CPS \$1695

NEC SPINWRITER™



Terminal/Keyboard as well as RO Printer Only models available.

CALL FOR PRICES!

PAPER TIGER®



IDS44 5G PAPER TIGER \$698
Buffer w/graphics option, incl. buffer, .. \$789
TRS-80 cable \$45

NEW IDS 460

**QUALITY PRINTING AT MATRIX
SPEED—LOGIC SEEKING
PROPORTIONAL SPACING**
w/auto text justification

NEW IDS PAPER TIGER 460 List \$1295 **\$1099**
NEW IDS PAPER TIGER 460G List \$1394 **\$1149**
NEW IDS 560G List \$1794 **\$1499**

TI-810

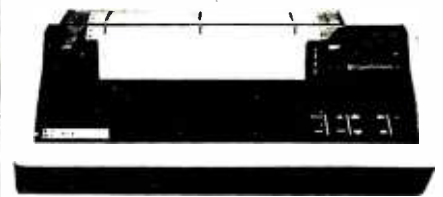

TI-810 Basic Unit, \$1895 **ONLY \$1595**
TI-810 w/full ASCII (Lower case), vertical forms control, and compressed print. **\$1795**
TI-745 Complete printing terminal with acoustic coupler, List \$1695 **\$1399**

ANADEX

DP9500/DP9501 PRINTERS

DP-9500, List \$1650 **\$1349**
DP-9501, List \$1650 **\$1349**
ANADEX DP-8000
80-Col. Dot Matrix. **\$849**

OKIDATA

Microline 80 List \$599 **ONLY \$499**
Tractor Feed Option **\$109**
Serial interface **\$ 99**
Microline 82 List \$799 **\$679**
Microline 83 List \$1260 **\$1069**

AXIOM IMP I

Epson MX-80 List \$645 **\$499**

Above prices reflect a 2% cash discount (order prepaid prior to shipment). Add 2% to prices for credit card orders, C.O.D.'s, etc. Prices are f.o.b. shipping point. Prices are subject to change and offers subject to withdrawal without notice. **WRITE FOR FREE CATALOG.**

MiniMicroMart, Inc.

1618 James Street, Syracuse NY 13203 (315) 422-4467 TWX 710-541-0431



Unclassified Ads

FOR SALE: Hazeltine 1500. Display terminal with typewriter-style keyboard and numeric pad. Unit was used only a few hours for display purposes. \$650. John Joslyn, (213) 658-7190 days, (213) 763-0843 evenings.

FOR SALE: MITS Altair 88-DCDD floppy-disk drive and controller. Recently aligned and all ECOs installed. With all manuals and software including Altair Disk BASIC. \$700. Diablo printer with stand, print wheels, ribbons, paper, and full documentation. \$1250. Will deliver within 75 miles. Call to arrange demonstration. Alan Frisbie, 3786 E Mountain View, Pasadena CA 91107. (213) 351-2351 days, 796-7872 evenings.

FOR SALE: Two Burroughs 89352 video terminals—one complete, one without keyboard and video-driver boards. 960-character display screen. Flexible cursor controls. 5 by 7 dot matrix. Six baud rates. RS-232B. Manual and extra circuit boards included. \$500 for the pair. Steve Olson, 6500 Halsey Dr, Woodridge IL 60517. (312) 852-0365.

WANTED: S-100 bus computer, must have video display, two 8-inch disk drives, and 48 K programmable memory. I have amateur radio equipment for trade. Dale Hutchinson, 10818 Brentway Dr, Houston TX 77070.

FOR SALE: Heathkit H-8 computer with 32 K bytes of memory. System includes serial I/O interface, cassette recorder/player, and H-9 video terminal. All manuals, documentation, and software included. Extras are dust covers and special program tapes. \$1100 includes shipping. Keith Morlock, Rt #5 Box #263, Columbus MS 39701. (601) 328-8880.

WANTED: Information where I can find the King James Version of the Bible in computer-readable format on disk or cassette. I will accept collect calls if you have this information. Steven Tilden, 4771 S Warren Ave, Tucson AZ 85714. (602) 746-0569.

FOR SALE: TI Programmable 58. In excellent condition; almost brand new. Master Library Module and manuals included. Will sell for \$75 or best offer. Eddie Stein, 7 Cumberland Ct, Rockville MD 20850. (301) 279-9533.

FOR SALE: Floating-point math board for RCA VIP with driver software, uses MM57109 uP; \$35 US. HP-55 programmable calculator with timer, includes statistics and math manuals. Best offer or will consider trade for R/S Quick Printer II. Frank Shinyer, 10545 129 St, Edmonton Alberta, T5N 1W9 Canada.

FOR SALE OR TRADE: 64 K dynamic programmable-memory board for H-8 bus. Works through address selectables/serial I/O port. Brand new, never really used, only tested. [Mom bought me this, but she doesn't know a byte from a carburetor.] I will give a 90-day warranty and documentation to first \$500 check or money order, or will swap for two working W/HB-16s. Kurt Schultz, 115-1 Roxanne Ct, Walnut Creek CA 94596.

FOR SALE: Barely used Apple communication card and Novation CAT modem. With cables and software. \$275. Chris Pino, 125 Mansfield, New Haven CT 06511. (203) 562-0773.

FOR SALE: Centronics 101 printer, uppercase and lowercase. Cost over \$5000, sell for \$2500 or best offer. Machine is too large for my Commodore. Jerry Gaines, 4104 Fountain Green, Lafayette Hill PA 19444. (215) 828-4800.

WANTED: Old mechanical calculators. Please describe what you have in detail, and include a picture if possible. SASE please. Dick Rubinstein, 15 Maugus Ave, Wellesley Hills MA 02181.

FOR SALE: Apple graphics tablet in excellent condition; \$450. Hitachi high-resolution 9-inch black-and-white monitor; \$125. SwTPC PR-40 printer with parallel card for Apple slot two; \$175. Comprint 912s, a fast 80-column printer with full uppercase and lowercase for RS-232 input; \$250. Apple serial interface card, bidirectional RS-232 with DB-25 connector; \$100. Frank Jaubert, 823 Euclid St, Houston TX 77009. (713) 868-0034.

WANTED: I have a National Semiconductor IMP-16C 16-bit microprogrammable microcomputer, CUTIL monitor, PACE instruction set, figFORTH for PACE, 6-slot card cage, wire-wrap board, power supply, and documentation, all new. I need a front panel or serial interface, or schematics for same. If not, I'll sell all for \$2150. Lee A Hart, 366 Cloverdale, Ann Arbor MI 48105. (313) 994-0784.

UNCLASSIFIED POLICY: Readers who are soliciting or giving advice, or who have equipment to buy, sell or swap should send in a clearly typed notice to that effect. To be considered for publication, an advertisement must be clearly noncommercial, typed double spaced on plain white paper, contain 75 words or less, and include complete name and address information.

These notices are free of charge and will be printed one time only on a space available basis. Notices can be accepted from individuals or bona fide computer users clubs only. We can engage in no correspondence on these and your confirmation of placement is appearance in an issue of BYTE.

Please note that it may take three or four months for an ad to appear in the magazine.



64K BYTE EXPANDABLE RAM
DYNAMIC RAM WITH ONBOARD TRANSPARENT REFRESH GUARANTEED TO OPERATE IN NORTHSTAR, CROMEMCO, VECTOR GRAPHICS, SOL, AND OTHER 8080 OR Z-80 BASED S100 SYSTEMS * 4MHZ Z-80 WITH NO WAIT STATES.
* SELECTABLE AND DESELECTABLE IN 4K INCREMENTS ON 4K ADDRESS BOUNDARIES.
* LOW POWER—8 WATTS MAXIMUM.
* 200NSEC 4116 RAMS.
* FULL DOCUMENTATION.
* ASSEMBLED AND TESTED BOARDS ARE GUARANTEED FOR ONE YEAR AND PURCHASE PRICE IS FULLY REFUNDABLE IF BOARD IS RETURNED UNDAMAGED WITHIN 14 DAYS.

	ASSEMBLED / TESTED
64K RAM	\$595.00
48K RAM	\$529.00
32K RAM	\$459.00
16K RAM	\$389.00



S100 MAINFRAME AND CARD CAGE

- * W/ SOLIO FRONT PANEL . . . \$239.00
- * W/ CUTOUTS FOR 2 MINI-FLOPPIES . . . \$239.00
- * 30 AMP POWER SUPPLY . . . \$119.00
- * 8 SLOT MOTHERBOARD . . . \$149.00
- * 19 SLOT MOTHERBOARD . . . \$199.00

16K MEMORY EXPANSION KIT ONLY \$58

FOR APPLE, TRS-80 KEYBOARD, EXIOY, AND ALL OTHER 16K DYNAMIC SYSTEMS USING MK4116-3 OR EQUIVALENT DEVICES.

- * 200 NSEC ACCESS, 375 NSEC CYCLE
- * BURNED-IN AND FULLY TESTED
- * 1 YR. PARTS REPLACEMENT GUARANTEE
- * QTY. DISCOUNTS AVAILABLE



VISTA V-200 MINI-FLOPPY SYSTEM

- * S100 DOUBLE DENSITY CONTROLLER
 - * 204 KBYTE CAPACITY FLOPPY DISK DRIVE WITH CASE & POWER SUPPLY
 - * MODIFIED CPM OPERATING SYSTEM WITH EXTENDED BASIC
- \$695.00**

BETA
COMPUTER DEVICES

1230 W. COLLINS AVE.
ORANGE, CA 92668
(714) 633-7280

Call, residents please add 8% sales tax. Mastercard & Visa accepted. Please allow 14 days for checks to clear bank. Phone orders welcome. Shipping charges will be added to all shipments.

32K BYTE MEMORY
RELIABLE/COST EFFECTIVE EXPANDABLE RAM FOR 6502 AND 6800 SYSTEM—AIM 65 *KIM *SYM *PET *S44 BUS
* PLUG COMPATIBLE WITH THE AIM-65/SYM EXPANSION CONNECTOR BY USING A RIGHT ANGLE CONNECTOR (SUPPLIED) MOUNTED ON THE BACK OF THE MEMORY BOARD.
* MEMORY BOARD EDGE CONNECTOR PLUGS INTO THE 6800 S 44 BUS.
* CONNECTS TO PET OR KIM USING AN ADAPTOR CABLE.
* RELIABLE—DYNAMIC RAM WITH ON BOARD INVISIBLE REFRESH—LOOKS LIKE STATIC MEMORY BUT AT LOWER COST AND A FRACTION OF THE POWER REQUIRED FOR STATIC BOARDS.
* USES +5V ONLY, SUPPLIED FROM HOST COMPUTER.
* FULL DOCUMENTATION, ASSEMBLED AND TESTED BOARDS ARE GUARANTEED FOR ONE YEAR AND PURCHASE PRICE IS FULLY REFUNDABLE IF BOARD IS RETURNED UNDAMAGED WITHIN 14 DAYS.

ASSEMBLED WITH 32K RAM	\$395.00
& WITH 16K RAM	\$339.00
TESTED WITHOUT RAM CHIPS	\$279.00
HARD TO GET PARTS (NO RAM CHIPS) WITH BOARD AND MANUAL	\$109.00
BARE BOARD & MANUAL	\$49.00

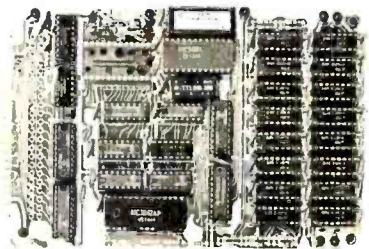

PET INTERFACE KIT—CONNECTS THE 32K RAM BOARD TO A 4K OR 8K PET. CONTAINS: INTERFACE CABLE, BOARD STANDOFFS, POWER SUPPLY MODIFICATION KIT AND COMPLETE INSTRUCTIONS. **\$49.00**

U.S. PRICES ONLY

ADVENTURE ENTHUSIASTS: I am trying to form a noncommercial original adventure software exchange. I need people who are interested in writing and exchanging adventure software. I am proposing a national mail-correspondence club dedicated to this purpose. I have written a BASIC adventure to start things off with. If you have an interest in this idea, please write me. Paul Callahan, 632 Deaver Dr. Blue Bell PA 19422.

FOR SALE: Heath H-9 modified for a 24 by 80 display. All manuals included. \$200. Michael L Couch, 1218 18th St. West Des Moines IA 50265. [515] 223 0549.

WANTED: Good clean copy of BYTE magazine for December 1975 (#4). Please give price including packaging and transportation. George Frater, 1730 Mariposa Dr. Las Cruces NM 88001.

FOR SALE: HP-67 calculator with standard pack. cards, manuals, and all original accessories, including case, charger, and program pad. Brand new in original box. Perfect condition. \$300 or best offer. Robert Perrino, 470 Claremont Rd. Springfield PA 19064. [215] 544-0947 after 9 PM.

FOR SALE: SwTPC 4 K memory; \$50. 8 K memory; \$100. JPC CK-7 real-time clock with auxiliary power supply; \$50. MicroWare RT/68 monitor read-only memory; \$50. All in excellent working condition with full documentation. C R Silvia, POB 234. Hines IL 60141.

FOR SALE: Three Forms Feed Option Kits (LAXX-LV) for DECwriter LA35 or LA36. Adjustable for many different form lengths. Regular price is \$175 per kit. These are new, in original cartons, for \$100. Also, BYTE issues 1 thru 16. No splits, please. Marshall MacFarlane, 13506 Lakebrook, Fenton MI 48430. [313] 629 0961 after 7 PM ET.

WANTED: Contact with owners of Disk Jockey 2D 8-inch disk system and switchboard I/O. Would like to interface Centronics 779 to system. Also, Wameco OMB12 for sale. \$75 or best offer. Daniel Snyder, 561 5th St. Butler PA 16001. [412] 287-1625.

WANTED: Manuals for Altair 8800 computer system. Will purchase. Don Averill, Eastern New Mexico University Sta #33, Portales NM 88130.

WANTED: Still photographs of pre-1960 computers, computer facilities, and computer scientists and engineers; also, cine footage, sound or silent, in any size, of same. Would also like to hear from other computer archivists/historians to form possible association or similar special-interest group. H Kent Craig, POB 975. Cary NC 27511. [919] 851-5017 evenings.

FOR SALE: Dot-matrix printer. Emako 20 (manufactured by C Koh). 60 lpm, pin feed, 96 ASCII characters, 80-column, with cable for TRS-80, plugs into expansion interface. Original \$770, asking \$400. Also, twelve 5-inch diskettes; \$2.50 each. Philip Crawford, 1720 E 1st St #10. Long Beach CA 90802. [213] 591-2484.

FOR SALE: Okidata Microline 80 printer with forms tractor, pin and friction feeds. State of the Arts 80 cps dot matrix. Includes parallel interface cable, 80- or 132-column. Excellent condition, complete with manual. \$500. Clay Roberts, POB 129. Comptche CA 95427. [707] 937-4753.

FOR SALE: Twenty-three years of computing history. 276 issues of DATAMATION magazine. November 1957 thru December 1980. (Only two issues missing.) \$500 plus shipping. R L LaFara, 10632 E 79th, Indianapolis IN 46236. [317] 823-6366 evenings.

WANTED: I am interested in exchanging ideas about possible ways computers can be used as an aid for guitar playing, in particular the application of computers for arranging and composing music on the guitar. I am currently writing a program that will find an optimum tuning for a given piece of music from the thousands that are possible. Bruce Johnston, 655 Sharp Ln 130. Baton Rouge LA 70815.

GIFT: HP-9100-A computing calculator. Sixteen registers store 197 steps. All math and trig functions, conditional jumps. In operating condition, but erratic. Will donate for cost of shipping. Winslow Palmer, 114 Montrose Dr. Fort Myers FL 33907. [813] 481-0027.

FOR SALE: APF Imagination Machine microcomputer. Power supply, RF modulator, cassette recorder, joysticks, and much software included—ready for hookup to television (it has color graphics and sound). Like new condition, over twenty programs, including Space Destroyers, Boxing, Baseball, and Hangman. The value of this system with software is over \$800, willing to sacrifice for \$600 or best offer. Bruce Chapman, 316 Newtown Rd. Richboro PA 18954.

FOR SALE: Pascal Microengine. Western Digital desk-top computer with 16-bit processor, 32 K words (64 K bytes) of programmable memory, floppy-disk controller, two RS-232C asynchronous/synchronous ports, and software (UCSD Pascal), \$3400. G Mann, 9 Aberdeen, Irvine CA 92714. [714] 731-6145.

FOR SALE: Z80 Starter Kit from S D Systems, assembled and tested. Will sell for \$325. Lee Rathbun, POB 126B, Minden NV 89423. [702] 782-4455.

FOR SALE: Altair 8800B with processor, front panel, and motherboard; \$400. 3P+S; \$100. 8 K static 300 ns; \$100. Two 216 16 K static memory boards; \$200 each. North Star single-density disk controller board; \$50. 4 K MITS static memory; \$75. Will sell as package for \$900. Bob Fiorella, 27 Kirkwood Dr. Glen Cove NY 11542. [516] 676-1480 after 6 PM ET.

FOR SALE: Hewlett-Packard (Moseley) 8.5-by 11-inch flatbed plotter, good condition; \$150. Digital Group PT-96 complete printer, like new; \$300. Complete DISKMON for 5-inch floppies (original, including ROM, etc); \$30. Digital Group 5-slot memory-extension motherboard with all connectors installed; \$20. 10-day return privilege guarantee on all above. Jerry E Flanders, 1767 Gregory Lake Rd. N Augusta SC 29841. [803] 278-0984 after 6 ET.

FOR SALE: 16 K Atari 800 personal computer. Brand new and unused. Unopened in original carton, with manual. Cost \$1080, for \$810 plus shipping. Atari disk drive, brand new. Cost \$700, for \$520 plus shipping. HP-97 desk-top programmable printing calculator, one month old. Cost \$750, for \$650 plus shipping. Extensive software library for Atari, TRS-80; write for details. Doug Solomon, 208 Overbrook, Freehold NJ 07728.

FOR SALE: SwTPC 6800 computer, 16 K programmable memory, teletypewriter interface, parallel interface, cassette recorder, cables, dual cassette recorder, 16 by 32 terminal, 64-character set, 9-inch black-and-white monitor. Complete with \$100 worth of software and 4 K and 8 K BASIC. Editor/Assembler tapes. Asking \$550 or best offer. John Antypas, 49 DeLaurenti Ct, Walnut Creek CA 94598. [415] 943-7409.

WANTED: Bally computer users. Would like to exchange information on the Bally home computer. Want old newsletters, system information, and read-only memory listings. If you know of a group (or person) using the Bally, I would like to have their mailing address. Also, give them my address so we can exchange information. Interested in additional unit at a good price, also other hardware. BALL.Yuser@exch. POB 28355, Columbus OH 43228.

BOMB

BYTE's Ongoing Monitor Box

Article #	Page	Article	Author(s)
1	24	RAMCRAM Memory Module for the Atari	Pelczarski Nelson
2	36	Logo for Personal Computers	
3	46	Build a Low-Cost Speech-Synthesizer Interface	Ciarcia
4	72	Mathematical Modeling: A BASIC Program to Simulate Real-World Systems	Hicks
5	88	Information Unlimited: The Dialog Information Retrieval Service	Miastkowski Gibson Carlson, Haber
6	110	A Computer-Based Laboratory Timer	Kildall
7	176	Four Word Processors for the Apple II	Greenberg Larson
8	216	CP/M: A Family of 8- and 16-Bit Operating Systems	Camp, Nicholson Mitchell Kern Daggitt
9	248	The UNIX Operating System and the XENIX Standard Operating Environment	
10	268	The Ins and Outs of CP/M	
11	302	Build a Super Simple Floppy-Disk Interface, Part II	Wozniak
12	352	Star Trek 4.0 and Star Trek 3.5	
13	356	The BDS C Compiler	
14	378	An Easy-to-Use A/D Converter	
15	392	The Impossible Dream: Computing e to 116,000 Places with a Personal Computer	

March BOMB Results

Gregg Williams and Franklin C Crow tied for first place for their articles, "Structured Programming and Structured Flowcharts" and "Three-Dimensional Computer Graphics, Part I." A check for \$100 will be sent to Mr Crow. (Being a BYTE employee, Gregg is not eligible for the prize money.) The second-place prize of \$50 goes to Tim Ahrens, Jack Browne, and Hunter Scales for their article, "What's Inside Radio Shack's Color Computer?" The next two places went to Steve Ciarcia's "Build the Disk-80" and Jim Howard's "What Is Good Documentation?"

Reader Service

- 1 AB COMPUTERS 441
- 2 ABM PRODUCTS 122
- 3 ACKERMAN DIGITAL SYS 82
- 4 ACOM ELECTRONICS 438
- 5 ACTION COMPUTER 145
- 6 ADAPTIVE DATA & ENERGY 119
- 7 ADDMASTER CORP 436
- 8 ADV COMP PROD 446, 447
- 9 ADV MICRO SYS 320
- 10 ADVENTURE INT'L 360
- 11 AFFERTHOUGHT ENG 434
- 12 ALF PRODUCTS INC 363
- 13 ALL ELECTRONICS CORP 434
- 14 ALPHA BYTE STORAGE 59
- 15 ALPHA BYTE STORAGE 261
- 16 ALPHA OMEGA COMP SYS 369
- 17 ALTOS COMP SYS 60, 61
- 18 AMER BUSINESS COMP 435
- 19 AMER COMP & TELECOMM 253
- 20 AMER RED BALL TRANS 62
- 21 ANADEX 151
- 22 ANCRONA 421
- 23 ANDERSON JACOBSON 188
- 24 APPARAT INC 175
- 51 APPLE COMPUTER INC 115
- 52 APPLIED ANALYTICS 400
- 79 ARISTO-POLK 369
- 25 ARTIFICIAL INT'L RESEARCH 434
- 26 ASAP COMP PROD INC 213
- 27 ASAP COMP PROD INC 305
- 28 ASHTON-TATE 285
- 29 ATARI PERSONAL COMP 225
- 30 AUTOCONTROL INC 436
- 31 AUTOCONTROL INC 436
- 32 AUTOMATED EQPTMNT 321
- 33 AVOCET 140
- 34 AXIOM CORP 127
- 35 B & B ELECTRONICS 436
- 36 BASF SYSTEMS 269
- 37 BELL, JOHN ENGR 429
- 38 BETA COMP DEVICES 462
- 39 BILLINGS COMP CTR 313
- 40 BIT BUCKET, THE 343
- 41 BIZCOMP 164
- 42 BMC INTERNATIONAL 153
- 43 BOWER-STEWART 204
- 44 BUSS/CHARLES FLOTO 344
- 45 BYTE BOOKS 191
- 46 BYTE BOOKS 192
- 47 BYTE BOOKS 193
- 48 BYTE BOOKS 194
- 49 BYTE BACK ISSUES 329
- 50 BYTE SUBJ 396
- 51 BYTE WATS 396
- 52 CADO SYSTEMS 12
- 53 CALIF DATA CORP 432
- 54 CALIF COMP SYS 21
- 55 CALIF DIGITAL 448, 449
- 56 CAMCO DATA SYS INC 335
- 57 CAVRI SYSTEMS INC 377
- 58 CCB MACHINE PROD 436
- 59 CENTEC CORP 351
- 60 CENTRAL DATA CORP 315
- 61 CENTRONICS 79
- 62 CFR ASSOC INC 349
- 63 CHATSWORTH DATA CORP 20
- 64 CHIPS & DALE 434
- 65 CHRISLIN INDUSTRIES 273
- 66 CHRISLIN INDUSTRIES 325
- 67 COMMODORE BUSN MACH 404
- 68 COMMUNICATION CABLE 432
- 69 COMP-U-CON 251
- 70 COMPILER SYS INC 201
- 71 COMPUMART 124, 125
- 72 COMPUSERVE 156, 157
- 73 COMPUSERVE SYS 442
- 74 COMPUTER AGE 365
- 75 COMPUTER CASE CO 343
- 76 COMPUTER CITY CANADA 95
- 77 COMPUTER CO OF AM 300
- 78 COMPUTER CROSSROADS 347
- 79 COMPUTER DESIGNS 458
- 80 COMPUTER DISC OF AM 374
- 81 COMPUTER EXCHANGE 186
- 82 COMPUTER FACTORY 233
- 83 COMPUTER FORMS 440
- 84 COMPUTER FURN & ACCESS 198
- 85 COMPUTER MAIL ORDER 174
- 86 COMPUTER MART 438
- 87 COMPUTER REFRNCE GDE 197
- 88 COMPUTER SHOPPER 442
- 89 COMPUTER SPLCTIES 100, 101
- 90 COMPUTER STOP, THE 423
- 91 COMPUTER TECHNOLOGY 370
- 92 COMPUTER WRHSE-HI 252
- 93 COMPUTER WRHSE 109
- 94 COMPUTERS ETC 224
- 95 COMPUTERS ETC 90
- 96 COMPUTERS ETC 304
- 97 COMPUTERS PLUS 442
- 98 COMPUTERS WHOLESALE 222
- 99 COMPUTERIST, THE 442
- 100 COMPUTERWARE 363
- 101 COMPUTEX CORP 182
- 102 COMPUIVIEW PROD INC 67
- 103 CONCORD COMP PROD 428
- 104 CONSUMER COMP 112, 113
- 105 CORVUS SYS INC 73
- 106 COVER CRAFT 298
- 107 CPM USERS GRP 394
- 108 CPU SHOP, THE 425
- 109 CREATIVE SOFTWARE 438
- 110 CROMEMCO 1, 2
- 111 CRYSTAL COMPUTER 45
- 112 CYBER INNOVATIONS 326
- 113 CYBERNETICS INC 357
- 114 D-G ELEC DEV CO 271
- 115 DATA DISCOUNT CTR 142

- 103 DATA HARDWARE 438
- 104 DATALEX COMPANY, THE 162
- 105 DATASEARCH 371
- 106 DATASOUTH COMP CORP 63
- 107 DELTA PRODUCTS 283
- 108 DENVER.SFTW CO, THE 70, 71
- 109 DESIGNER SOFTWARE 143
- 110 DIGIAC CORP 341
- 111 DIGICOMP RESRCH CORP 317
- 112 DIGITAL DATA SYS 440
- 113 DIGITAL GRAPHIC SYS 352
- 114 DIGITAL MARKETING 6
- 115 DIGITAL MARKETING 209
- 116 DIGITAL RESEARCH 69
- 117 DIGITAL RESEARCH COMP 431
- 118 DIP INC 255
- 119 DISC/3 MART INC 329
- 120 DISCOUNT SFTW GRP, THE 359
- 121 DJ "AI" SYS LTD 155
- 122 DMA 178
- 123 DOW JONES 31
- 124 DUAL SYS CONTROL CORP 131
- 125 DYNARC INDUSTR INC 351
- 126 DYNABYTE BUSN COMP C III
- 127 DYNACOMP 181
- 128 EAST COAST COMP 438
- 129 ECOSOFT 341
- 130 ELECTROVALUE IND 432
- 131 ELECTROLABS 430
- 132 ELECTRONIC CONTROL 254
- 133 ELECTRONIC DESIGN 94
- 134 ELECTRONIC SPECIALISTS 353
- 135 ELECTRONICS CENTER 424
- 136 ELLIS COMPUTING 230
- 137 ERSON AMERICA 299
- 138 ERGONOMIC SFTW INC 434
- 139 ESCON 160
- 140 ESSEX PUBL 214
- 141 EXECUTIVE BUSN SYS 129
- 142 FEC LTD 406
- 143 FAIRCOM 375
- 144 FARNSWORTH COMP CTR 345
- 145 FEITH SOFTWARE 326
- 146 FIBERFAB INC 132
- 147 FORDHAM 426
- 148 FREDERICK COMP PROD 359
- 149 GEOTEC 458
- 150 GIMIX INC 114
- 151 GIMIX INC 432
- 152 GODBOUT ELECTR 211
- 153 GORDON, MARK COMPS 274
- 154 H & E COMPUTRONICS 217
- 155 H & E COMPUTRONICS 219
- 156 H & E COMPUTRONICS 221
- 157 HANLEY ENGINEERING 437
- 158 HARRIS CORP 405
- 159 HAYDEN BOOK CO INC 331
- 160 HAYDEN BOOK CO INC 339
- 161 HAYES MICROCOMP PROD 111
- 162 HEATH COMPANY 103
- 163 HEI INC 121
- 164 HEMENWAY ASSOC 307
- 165 HEURISTICS 383
- 166 HIGH TECHNOLOGY INC 10
- 167 HOUSTON INSTRUMENTS 135
- 168 HOUSTON INSTRUMENTS 135
- 169 HW ELECTRONICS 34
- 170 ICC BUSN RESEARCH 403
- 171 IMAGE PROCESSING SYS 442
- 172 IMS INTERNATIONAL 17
- 173 INFOFOT SYSTEMS INC 381
- 174 INMAC 365
- 175 INNOVATIVE PROD 351
- 176 INNOVATIVE SFTW APPL 166
- 177 INTEC 440
- 178 INTEGRAL DATA SYS 93
- 179 INTEGRAND 357
- 180 INTERACTIVE BUSN 116, 117
- 181 INTERACTIVE STRUCT 343
- 182 INTERTEC DATA SYS 65
- 183 INTLGNT DEVICES MN 434
- 184 IPEX INT'L 438
- 185 ITHACA INTERSYSTEMS 8, 9
- 186 JADE COMP PROD 452, 453
- 187 JAMECO ELECTR 450, 451
- 188 JDR MICRODEVICES 443
- 189 JR INVENTORY CO 430
- 190 KLO-FOX 406
- 191 KONAN CORP 75
- 192 LABORATORY MICROSYS 369
- 193 LEADING EDGE PROD 337
- 194 LEAPAC SERVICES 363
- 195 LEAPAC SERVICES 440
- 196 LEO ELECTRONICS 218
- 197 LIFEBOAT ASSOC 411
- 198 LIFEBOAT ASSOC 319
- 199 LIFELINES 223
- 200 LNW RESEARCH 199
- 201 LOBO DRIVES INTL 87
- 202 LOGICAL DEVICES 376
- 203 LOGO COMP SYS 195
- 204 LOMAS DATA PRODUCTS 341
- 205 LYBEN COMP SYS 436
- 206 MACROTRONCS 432
- 207 MACROTRONCS 438

- 208 MAGNOLIA MICROSYS 432
- 209 MALIBU ELECTR CORP 13
- 210 MANN, CHARLES & ASSOC 342
- 211 MARATHON COMP SYS 355
- 212 MARK OF THE UNICORN 179
- 213 MARKETLINE SYS INC 372
- 214 MAROT SFTW SYS INC 205
- 215 MARYMAC INDUSTRIES 353
- 216 MCGRAW-HILL BOOKS 373
- 217 MEAS SYS & CONTROLS 22, 23
- 218 META TECHNOLOGIES 408
- 219 META TECHNOLOGIES 268
- 220 META TECHNOLOGIES 408
- 221 META TECHNOLOGIES 349
- 222 MICRO AGE COMP STORE 159
- 223 MICRO BUSINESS WORLD 158
- 224 MICRO COM 309
- 225 MICRO COMP DISC CO 383
- 226 MICRO DATA BASE SYS 171
- 227 MICRO DESIGN 434
- 228 MICRO FOCUS LTD 133
- 229 MICRO HOUSE 202, 203
- 230 MICRO MAGAZINE 458
- 231 MICRO METRIC 436
- 232 MICRO MIKE'S 177
- 233 MICRO MINT 458
- 234 MICRO PRO INT'L 107
- 235 MICRO SCI 81
- 236 MICRO WORKS, THE 170
- 237 MICROBYTE 239
- 238 MICROBYTE/EXT PROCSS 270
- 239 MICROCOM TECH INC 323
- 240 MICROCOMPEQUIP 310
- 241 MICRODAYS 97
- 242 MICROMAIL 366
- 243 MICROMATE ELECTR INC 92
- 244 MICROSETTE INC 375
- 245 MICROSOFT (CPD) 25
- 246 MICROTECH EXPORTS 362
- 247 MICROTEK INC 303
- 248 MICROTEK PERIPH CORP 297
- 249 MICROWARE 333
- 250 MIDWEST COMP PERPH 347
- 251 MIKOS 426
- 252 MILLER MICROCOMP SERV 374
- 253 MINI COMP SUPPLIERS 349
- 254 MINI MICRO MART 459
- 255 MINI MICRO MART 460
- 256 MINI MICRO MART 461
- 257 MOUNTAIN COMPUTER 19
- 258 MOUNTAIN VIEW PRESS 361
- 259 MPI 301
- 260 MTI INC 276
- 261 MULLEN COMP PROD 322
- 262 MULTI BUSN COMP INC 376
- 263 MUSYS 43
- 264 NEBS 154
- 265 NEECO 206, 207
- 266 NETRONICS 134, 136, 138, 347
- 267 NORTHERN TECH BOOKS 277
- 268 NY COMP EXPO 266, 267
- 269 OHIO DATA PROD CORP 355
- 270 OHIO SCIENTIFIC INSTR C IV
- 271 OKIDATA CORP 77
- 272 OLYMPIC SALES 329
- 273 OMEGA MICRO COMPUTER 378
- 274 OMEGA RESEARCH 130
- 275 OMEGA SALES 242, 243
- 276 ONMIKRON 232
- 277 ONCOMPUTING 417
- 278 ORANGE MICRO 172
- 279 ORANGE MICRO 173
- 280 ORANGE MICRO 189
- 281 ORGON SOFTWARE 85
- 282 ORTHOCODE GROUP 126
- 283 OSBORNE COMPUTERS 53
- 284 OSBORNE/MCGRAW-HILL 368
- 285 OSM COMP 265
- 286 OSM COMP 458
- 287 OWENS ASSOC 84, 228, 229
- 288 PACIFIC COMP BRK 118
- 289 PACIFIC EXCHANGES 231
- 290 PACIFIC EXCHANGES 432
- 291 PACIFIC EXCHANGES 436
- 292 PACIFIC EXCHANGES 442
- 293 PAGE DIGITAL 419
- 294 PALOMAR COMP EQUIP 291
- 295 PAN AM WORLD AIRWAYS 257
- 296 PAN AMERICAN ELEC INC 424
- 297 PAPER TRACTOR 249
- 298 PASSWORLD DISTR 438
- 299 PC NEWSLETTER 432
- 300 PCD SYSTEMS INC 24
- 301 PELICAN PROGRAMS 440
- 302 PERCOM DATA 7
- 303 PERCOM DATA 35
- 304 PERCOM DATA 263
- 305 PERCOM DATA 263
- 306 PERSONAL COMP SERV 458
- 307 PERSONAL COMP SYS 380
- 308 PERSONAL SOFTWARE 28, 29
- 309 PHASE ONE SYS INC 311
- 310 PICKLES & TROUT 220
- 311 POWER ONE INC 105
- 312 PRENTICE CORP 382
- 313 PRINTACOLOR 64

- 297 PRIORITY ONE 454, 455
- 298 PRIORITY ONE 456, 457
- 299 PROF AIDS 348
- 300 PROF COMP STORE 438
- 301 PURCHASING AGENT, THE 364
- 302 QUALITY COMP PARTS 377
- 303 QUALITY COMP PARTS 434
- 304 QUALITY SOFTWARE 345
- 305 QUASAR DATA PROD INC 237
- 306 QUAY CORP 215
- 307 QUEST ELECTR 433
- 308 RC ELECTRONICS 376
- 309 RACET COMPUTES 238
- 310 RADIO SHACK 15
- 311 RADIO SHACK-GLNW SPR 354
- 312 RAINBOW COMPUTING INC 360
- 313 RCA SOLID STATE 26
- 314 RED ARROW ELECTR 458
- 315 REDDOX CORP 123
- 316 ROBOTICS AGE 329
- 317 ROCHESTER DATA 168
- 318 ROCKWELL INT'L 169
- 319 ROCKWELL INT'L 187
- 320 S & M SYSTEMS 200
- 321 S C DIGITAL 357
- 322 S-100 INC 361
- 323 SCION CORP 5
- 324 SCITRONICS 328
- 325 SCITRONICS 381
- 326 SCOTSDALE SYSTEMS 184
- 327 SD SYSTEMS 137
- 328 SEATTLE COMP PRODS 99
- 329 SELECT INFO SYS 245
- 330 SIERRA NATIONAL 163
- 331 SINCLAIR RESEARCH 51
- 332 SLUDER 442
- 333 SMOKE SIGNAL BRDCSTG 161
- 334 SMOKE SIGNAL BRDCSTG (DEALERS ONLY) 161
- 335 SOFT-TOOLS 458
- 336 SOFTTECH 295
- 337 SFTWORK INC 432
- 338 SOLID STATE SALES 226
- 339 SOLID STATE SURPLUS 440
- 340 SORRENTO VALLEY ASSOC 355
- 341 SORRENTO VALLEY ASSOC 371
- 342 SOUTHERN COMP SYS 370
- 343 SOUTHERN SEMICNDTRS 439
- 344 SOUTHWEST TECH PROD C II
- 345 SPECTRUM SOFTWARE 281
- 346 SSM MICRO COMP PROD 11
- 347 STARBUCK DATA CO 458
- 348 STRUCTURED SYS GROUP 55
- 349 SUBLOGIC 316
- 350 SUNNY INT'L 428
- 351 SUPER STAR INT'L 147
- 352 SUPERSOFT 30, 48, 152, 367
- 353 SYBEX 165
- 354 SYNCHRO SOUND 96
- 355 SYSTEMS INTERFACE CONS 14
- 356 SYSTEMS PLUS 247
- 357 SZ SOFTWARE SYSTEMS 440
- 358 TARBELL ELECTR 167
- 359 TARCO DEVELOPMT CORP 359
- 360 TARCO DEVELOPMT CORP 440
- 361 TECH MICRO SYS 442
- 362 TECHNICAL INNOVATIONS 406
- 363 TECHNICAL SYS CONSUL 91
- 364 TECMAR INC 275
- 365 TEL INC 287
- 366 TERRAPIN INC 362
- 367 TEXAS COMP SYS 365
- 368 THUNDERWARE 227
- 369 TINNEY, RBT GRAPHICS 120
- 370 TNW CORP 234
- 371 TOOLSMITH, THE 436
- 372 TOTAL INFORMATION SVC 326
- 373 TRANS NET CORP 344
- 374 TRANSWARE CORP 27
- 375 TSE/HARDSIDE 180
- 376 US MICRO SALES 279
- 377 US MICRO SALES 444, 445
- 378 US ROBOTICS 235
- 379 UNITED SFTW AM 148, 149, 150
- 380 UNIV OF SOUTHERN CA 354
- 381 URBAN SFTW CORP 32
- 382 VANDATA 259
- 383 VECTOR GRAPHICS 49
- 384 VERTICAL DATA SYS INC 128
- 385 VEYTEC INC 190
- 386 VIDEX 289
- 387 VISTA COMPUTER CO 183
- 388 VOICETEK 361
- 389 VOTRAX 89
- 390 WASHINGTON COMP SERV 415
- 391 WESTICO INC 139 369
- 392 WHITE COMP SYS 33
- 393 WHITESMITH'S LTD 141
- 394 WICAT SYSTEMS 185
- 395 WILD HARE COMP SYS 293
- 396 WILET CORP 440
- 397 WINTERHALTER & ASSOC 353
- 398 WW COMPONENT SUPPLY 427
- 399 WW ELECTR 442
- 400 XPS INC 376
- 401 ZENRAD CONTROLS 434
- 402 ZOBEX 83

To get further information on the products advertised in BYTE, fill out the reader service card with your name and address. Then circle the appropriate numbers for the advertisers you select from the list. Add a 1B-cent stamp to the card, then drop it in the mail. Not only do you gain information, but our advertisers are encouraged to use the marketplace provided by BYTE. This helps us bring you a bigger BYTE. The index is provided as an additional service by the publisher, who assumes no liability for errors or omissions. *Correspond directly with company.

BYTE READER SERVICE

For fastest service transfer mailer label from wrapper to coupon provided at the right. Requests cannot be honored unless zip code is given. This card valid for 90 days only. **NOTE**—If label is missing or defaced fill out coupon carefully—**PLEASE PRINT**—this is the only way to get requested material to you.

Name _____
 (Title) _____ (Company) _____
 Address _____
 City _____ State _____ Zip _____

1 21 41 61 81	101 121 141 161 181	201 221 241 261 281	301 321 341 361 381	401 421 441 461 481	501 521 541 561 581	601 621 641 661 681
2 22 42 62 82	102 122 142 162 182	202 222 242 262 282	302 322 342 362 382	402 422 442 462 482	502 522 542 562 582	602 622 642 662 682
3 23 43 63 83	103 123 143 163 183	203 223 243 263 283	303 323 343 363 383	403 423 443 463 483	503 523 543 563 583	603 623 643 663 683
4 24 44 64 84	104 124 144 164 184	204 224 244 264 284	304 324 344 364 384	404 424 444 464 484	504 524 544 564 584	604 624 644 664 684
5 25 45 65 85	105 125 145 165 185	205 225 245 265 285	305 325 345 365 385	405 425 445 465 485	505 525 545 565 585	605 625 645 665 685
6 26 46 66 86	106 126 146 166 186	206 226 246 266 286	306 326 346 366 386	406 426 446 466 486	506 526 546 566 586	606 626 646 666 686
7 27 47 67 87	107 127 147 167 187	207 227 247 267 287	307 327 347 367 387	407 427 447 467 487	507 527 547 567 587	607 627 647 667 687
8 28 48 68 88	108 128 148 168 188	208 228 248 268 288	308 328 348 368 388	408 428 448 468 488	508 528 548 568 588	608 628 648 668 688
9 29 49 69 89	109 129 149 169 189	209 229 249 269 289	309 329 349 369 389	409 429 449 469 489	509 529 549 569 589	609 629 649 669 689
10 30 50 70 90	110 130 150 170 190	210 230 250 270 290	310 330 350 370 390	410 430 450 470 490	510 530 550 570 590	610 630 650 670 690
11 31 51 71 91	111 131 151 171 191	211 231 251 271 291	311 331 351 371 391	411 431 451 471 491	511 531 551 571 591	611 631 651 671 691
12 32 52 72 92	112 132 152 172 192	212 232 252 272 292	312 332 352 372 392	412 432 452 472 492	512 532 552 572 592	612 632 652 672 692
13 33 53 73 93	113 133 153 173 193	213 233 253 273 293	313 333 353 373 393	413 433 453 473 493	513 533 553 573 593	613 633 653 673 693
14 34 54 74 94	114 134 154 174 194	214 234 254 274 294	314 334 354 374 394	414 434 454 474 494	514 534 554 574 594	614 634 654 674 694
15 35 55 75 95	115 135 155 175 195	215 235 255 275 295	315 335 355 375 395	415 435 455 475 495	515 535 555 575 595	615 635 655 675 695
16 36 56 76 96	116 136 156 176 196	216 236 256 276 296	316 336 356 376 396	416 436 456 476 496	516 536 556 576 596	616 636 656 676 696
17 37 57 77 97	117 137 157 177 197	217 237 257 277 297	317 337 357 377 397	417 437 457 477 497	517 537 557 577 597	617 637 657 677 697
18 38 58 78 98	118 138 158 178 198	218 238 258 278 298	318 338 358 378 398	418 438 458 478 498	518 538 558 578 598	618 638 658 678 698
19 39 59 79 99	119 139 159 179 199	219 239 259 279 299	319 339 359 379 399	419 439 459 479 499	519 539 559 579 599	619 639 659 679 699
20 40 60 80 100	120 140 160 180 200	220 240 260 280 300	320 340 360 380 400	420 440 460 480 500	520 540 560 580 600	620 640 660 680 700

BYTE'S BOMB is your direct line to the editor's desk. Each month, the two top-rated authors receive bonuses based on your votes. To cast your vote, first look at the list of this month's articles and corresponding article numbers (located in the unclassified ads section on the page preceding the Reader Service list), then rate each article as **Excellent, Good, Fair, or Poor** by circling the appropriate number in each column below. Your feedback helps to produce the best possible magazine each month.

Article No.	1	2	3	4	5	6	7	8	9	10	11	12	13	14	15	16	17	18	19	20	21	22	23	24	25
Excellent	801	805	809	813	817	821	825	829	833	837	841	845	849	853	857	861	865	869	873	877	881	885	889	893	897
Good	802	806	810	814	818	822	826	830	834	838	842	846	850	854	858	862	866	870	874	878	882	886	890	894	898
Fair	803	807	811	815	819	823	827	831	835	839	843	847	851	855	859	863	867	871	875	879	883	887	891	895	899
Poor	804	808	812	816	820	824	828	832	836	840	844	848	852	856	860	864	868	872	876	880	884	888	892	896	900

Comments _____

BYTE READER SERVICE

For fastest service transfer mailer label from wrapper to coupon provided at the right. Requests cannot be honored unless zip code is given. This card valid for 90 days only. **NOTE**—If label is missing or defaced fill out coupon carefully—**PLEASE PRINT**—this is the only way to get requested material to you.

Name _____
 (Title) _____ (Company) _____
 Address _____
 City _____ State _____ Zip _____

1 21 41 61 81	101 121 141 161 181	201 221 241 261 281	301 321 341 361 381	401 421 441 461 481	501 521 541 561 581	601 621 641 661 681
2 22 42 62 82	102 122 142 162 182	202 222 242 262 282	302 322 342 362 382	402 422 442 462 482	502 522 542 562 582	602 622 642 662 682
3 23 43 63 83	103 123 143 163 183	203 223 243 263 283	303 323 343 363 383	403 423 443 463 483	503 523 543 563 583	603 623 643 663 683
4 24 44 64 84	104 124 144 164 184	204 224 244 264 284	304 324 344 364 384	404 424 444 464 484	504 524 544 564 584	604 624 644 664 684
5 25 45 65 85	105 125 145 165 185	205 225 245 265 285	305 325 345 365 385	405 425 445 465 485	505 525 545 565 585	605 625 645 665 685
6 26 46 66 86	106 126 146 166 186	206 226 246 266 286	306 326 346 366 386	406 426 446 466 486	506 526 546 566 586	606 626 646 666 686
7 27 47 67 87	107 127 147 167 187	207 227 247 267 287	307 327 347 367 387	407 427 447 467 487	507 527 547 567 587	607 627 647 667 687
8 28 48 68 88	108 128 148 168 188	208 228 248 268 288	308 328 348 368 388	408 428 448 468 488	508 528 548 568 588	608 628 648 668 688
9 29 49 69 89	109 129 149 169 189	209 229 249 269 289	309 329 349 369 389	409 429 449 469 489	509 529 549 569 589	609 629 649 669 689
10 30 50 70 90	110 130 150 170 190	210 230 250 270 290	310 330 350 370 390	410 430 450 470 490	510 530 550 570 590	610 630 650 670 690
11 31 51 71 91	111 131 151 171 191	211 231 251 271 291	311 331 351 371 391	411 431 451 471 491	511 531 551 571 591	611 631 651 671 691
12 32 52 72 92	112 132 152 172 192	212 232 252 272 292	312 332 352 372 392	412 432 452 472 492	512 532 552 572 592	612 632 652 672 692
13 33 53 73 93	113 133 153 173 193	213 233 253 273 293	313 333 353 373 393	413 433 453 473 493	513 533 553 573 593	613 633 653 673 693
14 34 54 74 94	114 134 154 174 194	214 234 254 274 294	314 334 354 374 394	414 434 454 474 494	514 534 554 574 594	614 634 654 674 694
15 35 55 75 95	115 135 155 175 195	215 235 255 275 295	315 335 355 375 395	415 435 455 475 495	515 535 555 575 595	615 635 655 675 695
16 36 56 76 96	116 136 156 176 196	216 236 256 276 296	316 336 356 376 396	416 436 456 476 496	516 536 556 576 596	616 636 656 676 696
17 37 57 77 97	117 137 157 177 197	217 237 257 277 297	317 337 357 377 397	417 437 457 477 497	517 537 557 577 597	617 637 657 677 697
18 38 58 78 98	118 138 158 178 198	218 238 258 278 298	318 338 358 378 398	418 438 458 478 498	518 538 558 578 598	618 638 658 678 698
19 39 59 79 99	119 139 159 179 199	219 239 259 279 299	319 339 359 379 399	419 439 459 479 499	519 539 559 579 599	619 639 659 679 699
20 40 60 80 100	120 140 160 180 200	220 240 260 280 300	320 340 360 380 400	420 440 460 480 500	520 540 560 580 600	620 640 660 680 700

To get further information on the products advertised in BYTE, fill out the reader service card with your name and address. Then circle the appropriate numbers for the advertisers you select from the list. Add an 18-cent stamp to the card, then drop it in the mail. Not only do you gain information, but our advertisers are encouraged to use the marketplace provided by BYTE. This helps us bring you a bigger BYTE. The index is provided as an additional service by the publisher, who assumes no liability for errors or omissions. *Correspond directly with company.

PLACE
FIRST
CLASS
POSTAGE
STAMP
HERE

BYTE

READER SERVICE
PO BOX 2114 GPO
NEW YORK NY 10116
USA

PLACE
FIRST
CLASS
POSTAGE
STAMP
HERE

BYTE

READER SERVICE
PO BOX 2114 GPO
NEW YORK NY 10116
USA

BYTE

SUBSCRIPTIONS

For a subscription to BYTE, please complete this card.

Name _____

Address _____

City _____

State _____ Zip _____ Country _____

Card No. _____

Expiration date _____

Four digits above name—Master Charge only _____

Signature _____ Date _____

Please allow eight weeks for processing. Thank you.

4161

USA

Canada
Mexico

- | | | |
|----------------------------------|-------------------------------|-------------------------------|
| <input type="checkbox"/> 1 year | <input type="checkbox"/> \$19 | <input type="checkbox"/> \$21 |
| <input type="checkbox"/> 2 years | <input type="checkbox"/> \$34 | <input type="checkbox"/> \$38 |
| <input type="checkbox"/> 3 years | <input type="checkbox"/> \$49 | <input type="checkbox"/> \$55 |

- \$43 Europe (air delivery) payment enclosed
 \$35 Elsewhere (surface mail) payment enclosed
 (Air mail rates available upon request)

Please remit in US funds drawn on a US bank. Thank you.

- Check enclosed (**Bonus:** [North America only] one EXTRA issue—receive 13 issues for the price of 12)

-  

- Bill me (North America only)

BYTE

SUBSCRIPTIONS

For a subscription to BYTE, please complete this card.

Name _____

Address _____

City _____

State _____ Zip _____ Country _____

Card No. _____

Expiration date _____

Four digits above name—Master Charge only _____

Signature _____ Date _____

Please allow eight weeks for processing. Thank you.

4161

USA

Canada
Mexico

- | | | |
|----------------------------------|-------------------------------|-------------------------------|
| <input type="checkbox"/> 1 year | <input type="checkbox"/> \$19 | <input type="checkbox"/> \$21 |
| <input type="checkbox"/> 2 years | <input type="checkbox"/> \$34 | <input type="checkbox"/> \$38 |
| <input type="checkbox"/> 3 years | <input type="checkbox"/> \$49 | <input type="checkbox"/> \$55 |

- \$43 Europe (air delivery) payment enclosed
 \$35 Elsewhere (surface mail) payment enclosed
 (Air mail rates available upon request)

Please remit in US funds drawn on a US bank. Thank you.

- Check enclosed (**Bonus:** [North America only] one EXTRA issue—receive 13 issues for the price of 12)

-  

- Bill me (North America only)

*Note our special offer!
 Send cash with your order
 and receive 13 issues
 for the price of 12 for
 each year you subscribe.
 (North America only, please)*

Don't Miss An Issue!

Have BYTE delivered to your door.

Each month BYTE will bring you the latest in microcomputer technology.

DISCOVER and IMPLEMENT new ideas. Don't miss the original information presented in the pages of BYTE.

With BYTE you'll always be among the first to know about the important breakthroughs, worthwhile new equipment, and innovative projects in the world of computing.

CHALLENGE US to deliver the very best ideas in microcomputers and advanced technology to you. Return the attached card today!

Subscribe to BYTE—the world's leading computer magazine.

PLACE
STAMP
HERE

BYTE SUBSCRIPTIONS
PO Box 590
Martinsville NJ 08836
USA

PLACE
STAMP
HERE

BYTE SUBSCRIPTIONS
PO Box 590
Martinsville NJ 08836
USA

The Dynabyte Difference:

Unequaled price/performance
with total expandability.

Buying the powerful Dynabyte 5615 isn't only smart, it's cost efficient.



The 5615 is the sure way to get the system you need. With more power for the price. You can select memory to 400 KB on our S-100 bus architecture. Choose from 3 sizes of Winchester to 45 MB and have diskette back-up to your system also. If it's tape back-up you need, then choose our 5700. If you need less storage, our 5¼" floppy 5200, our 8" floppy 5300 or our 5400 system using both floppies, with up to 3.6 MB capacity, can be yours.

The 5615 system is available with either single user CP/M or our enhanced MP/M for multi-user applications. Our MP/M operating system supports up to eight terminals, with a separate or shared spooler, and up to sixteen printers with no required partition space. Add to this multi-tasking, bank switching, record lockout, type-ahead and DMA and you have an MP/M operating system that supports a

host of existing languages and meets minicomputer standards.

No multi-user applications library is so responsive to your needs. The 5615 features Business Manager,™ the fully integrated, menu-driven, well documented, easy to install accounting system that gives you file/record protection, HELP commands, multi-level security, keyed data access, internal disk management, available source code and more.

System expandability, power and price/performance are further enhanced by on-hand availability, quantity discounts, 180-day warranty and a national WATS line for support.

Whether you use or sell computer systems, you should ask about the microcomputer that puts minicomputer capability in your hands. That's the 5615. That's the Dynabyte Difference. Call Mike Seashols, V.P. Marketing (800) 227-8300. In California (415) 329-8021. Dynabyte, 115 Independence Drive, Menlo Park, California 94025.



A cost effective 10 megabyte system from the leader in Winchester based microcomputers.



Ohio Scientific has put a low-cost, high-performance 8" non-removable hard disk together with its popular desk-top micro-computer system. This yields approximately 10 megabytes of fast hard disk capability at a tremendous cost/performance benefit over floppy based microcomputer systems.

C3-D

The 10 megabyte system is also available with the added advantage of triple microprocessors — the 6502A, 68000 and Z-80A. This allows you to make maximum use of Ohio Scientific's extensive software library as well as programs offered by independent suppliers and publishers. \$7,600.

C2-D Standard Features

- 52K RAM
- 8" floppy disk drive for program transport and backup.
- OS-65U small business operating system.
- 9-digit precision BASIC by Microsoft.
- Available in OEM quantities at attractive discounts.

For literature and the name of your local dealer,
CALL 1-800-321-6850 TOLL FREE.

OHIO SCIENTIFIC

a **MACOM** Company

1333 SOUTH COLUMBIA ROAD, AURORA, OH 44202 • (216) 831-5600