

THE BROADCAST ENGINEERS' JOURNAL
116-03 91ST AVENUE, RICHMOND HILL 18, N. Y.

POSTMASTER: IF UNDELIVERABLE FOR ANY
REASON, NOTIFY SENDER, STATING REASON,
ON FORM 3547, POSTAGE FOR WHICH IS
GUARANTEED

3014
2014
2014

Sec. 562, P. L. and R.
U. S. POSTAGE
PAID
New York, N. Y.
Permit No. 2961

F A GENRES WGBF-NEWA
2232 E POWELL
EVANSVILLE 14 IND
S145

The Broadcast Engineers' Journal

Since
1934...
Of, By,
and For

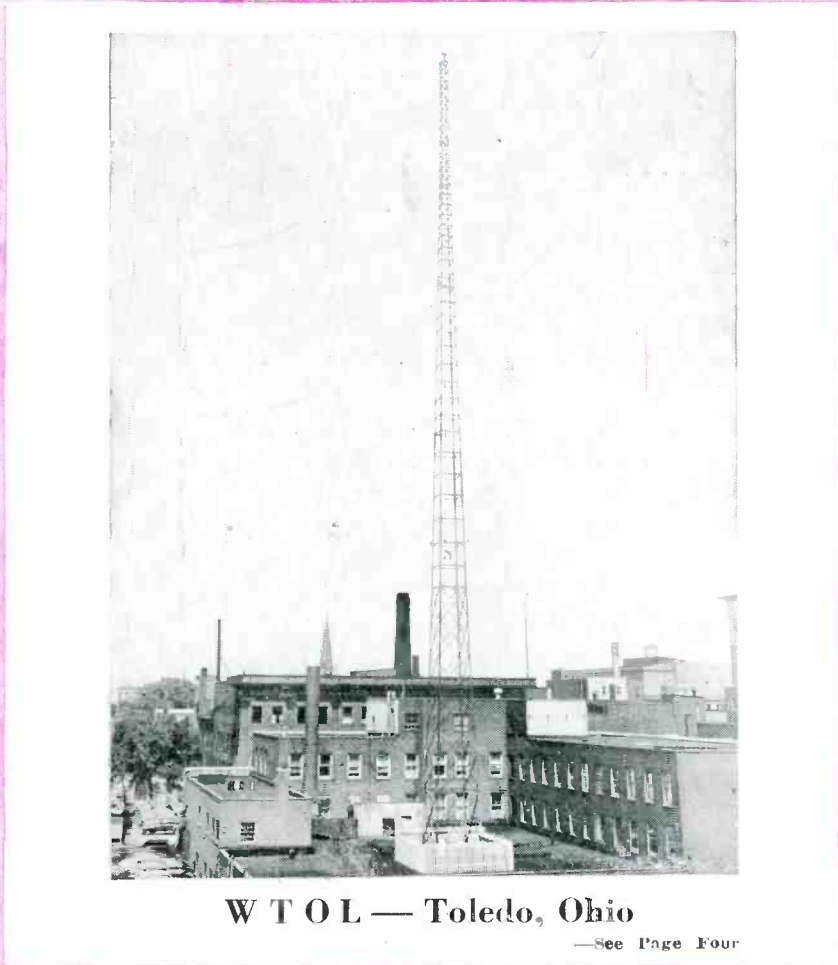

W T O L — Toledo, Ohio

—See Page Four

SEPT.
1944

VOL. 11
No. 9

The Broadcast Engineer

GOULD-MOODY "BLACK SEAL" GLASS BASE INSTANTANEOUS RECORDING BLANKS . . .

RECORDING AMERICA'S POWERFUL VOICE

Transmitter of America's Powerful Voice is Radio . . . awake twenty-four hours a day . . . talking to our friends and our enemies . . . transporting Broadway and Hollywood and the girl next door to the boys over there . . . building morale on the home front.

Recording America's Powerful Voice . . . in leading broadcasting stations from coast-to-coast . . . are Gould-Moody "Black Seal" Glass Base Instantaneous Recording Blanks. Made entirely of glass, "Black Seals" are as thin as aluminum, thereby eliminating the necessity of recorder adjustments. No foreign inserts . . . no metal grommets . . . no ageing, hardening or deterioration. Every disc has four holes . . . center-flow thread action . . . may be played back for months without appreciable loss of fidelity. Enclosure of your preference rating extensions with your order will expedite deliveries.

SHARE YOUR BLOOD WITH A WOUNDED SOLDIER
—donate a pint to the Red Cross today

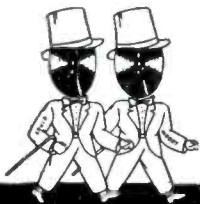

THE GOULD-MOODY COMPANY

RECORDING BLANK DIVISION

395 BROADWAY, NEW YORK 13, N. Y.

THE BROADCAST ENGINEERS' JOURNAL

Contents Copyright, 1944, by A.T.E. Publications, Inc.

Volume 11, No. 9



September, 1944

TABLE OF CONTENTS

Page

| | |
|---|----|
| Parabolic Reflectors for U-H-F Transmission..... | 3 |
| Highlights from WTOL—Toledo's Friendly Station | 4 |
| Twenty Years with Tom Manning and the Sports Mike | 6 |
| The Discernibility of Changes in Program Band Width | 9 |
| N.A.B.E.T. Activities | 14 |
| New York News | 15 |
| From Hollywood | 19 |
| Washington News | 22 |
| Denver News | 23 |
| Hudson Chapter News..... | 24 |
| New Television Stations..... | 25 |
| Omaha News | 25 |
| From San Francisco..... | 26 |
| Chicago News | 28 |

THE BROADCAST ENGINEERS' JOURNAL

Trustees: V. J. DUKE, H. E. HILLER, G. B. RILEY, R. A. SCHLEGEL, D. A. ULLMAN

ED. STOLZENBERGER
Managing Editor

Coordinator..... F. R. ROJAS
Treasurer..... C. W. PHELAN
Assistant Treasurer..... D. J. MOLONEY
Contributing Photographer..... SERGEI DE SOMOV

ASSOCIATE EDITORS

Chicago..... A. W. HJORTH
Cleveland..... BERT PRUITT
Denver..... KENNETH N. RAYMOND
Engineering Chapter..... V. J. DUKE
Hollywood..... NORMAN DEWES
Hudson Chapter..... RICHARD H. DAVIS
KFI-KECA..... E. F. WILMSHURST
New York..... G. F. ANDERSON, JR.
San Francisco..... S. A. MELNICOE
Washington..... R. E. SHENTON
WLW-WSAI-WLWO..... HOMER A. RAY, JR., BOB BROCKWAY
WOW, Omaha..... ROY "TEX" GLANTON
WPTF, Raleigh..... H. W. ROOD

The Broadcast Engineers' Journal is a privately printed monthly publication issued by A.T.E. Publications, Inc., a corporation of the State of New Jersey. Address all communications to Editor's office: E. Stolzenberger, 116-03 91st Avenue, Richmond Hill 18, L. I., N. Y. Telephone Virginia 9-5553. **THE BROADCAST ENGINEERS' JOURNAL IS THE OFFICIAL PUBLICATION OF THE N.A.B.E.T.**

Advertising rates and information supplied on request. Subscription, \$1.50 per year; \$3.00 for three years. Single copies, except Christmas Yearbook, 25c; Christmas Yearbook free to subscribers. All remittances in advance. Foreign: Add postage.

Nothing appearing in The Broadcast Engineers' Journal shall be construed to be an expression of The Broadcast Engineers' Journal or the National Association of Broadcast Engineers and Technicians, but must be construed as an individual expression of the author or authors.

NATIONAL N.A.B.E.T. OFFICE
Suite 1009, Investment Bldg., Washington 5, D. C.
A. T. Powley, President



This War . . .

is daily emphasizing the importance of dependability and permanence in all of our equipment.

This is especially true of
**Radio Recording
Equipment**

The Test of Time has proven

**SCULLY
Master Recorders**

to be unsurpassable as precision,
superb recording machines

BUY U. S. WAR BONDS NOW
and plan to install
SCULLY MASTER RECORDERS
After the Victory!

**SCULLY
Machine Company**

62 Walter Street

Bridgeport, Conn.

Telephone BRidgeport 4-5300

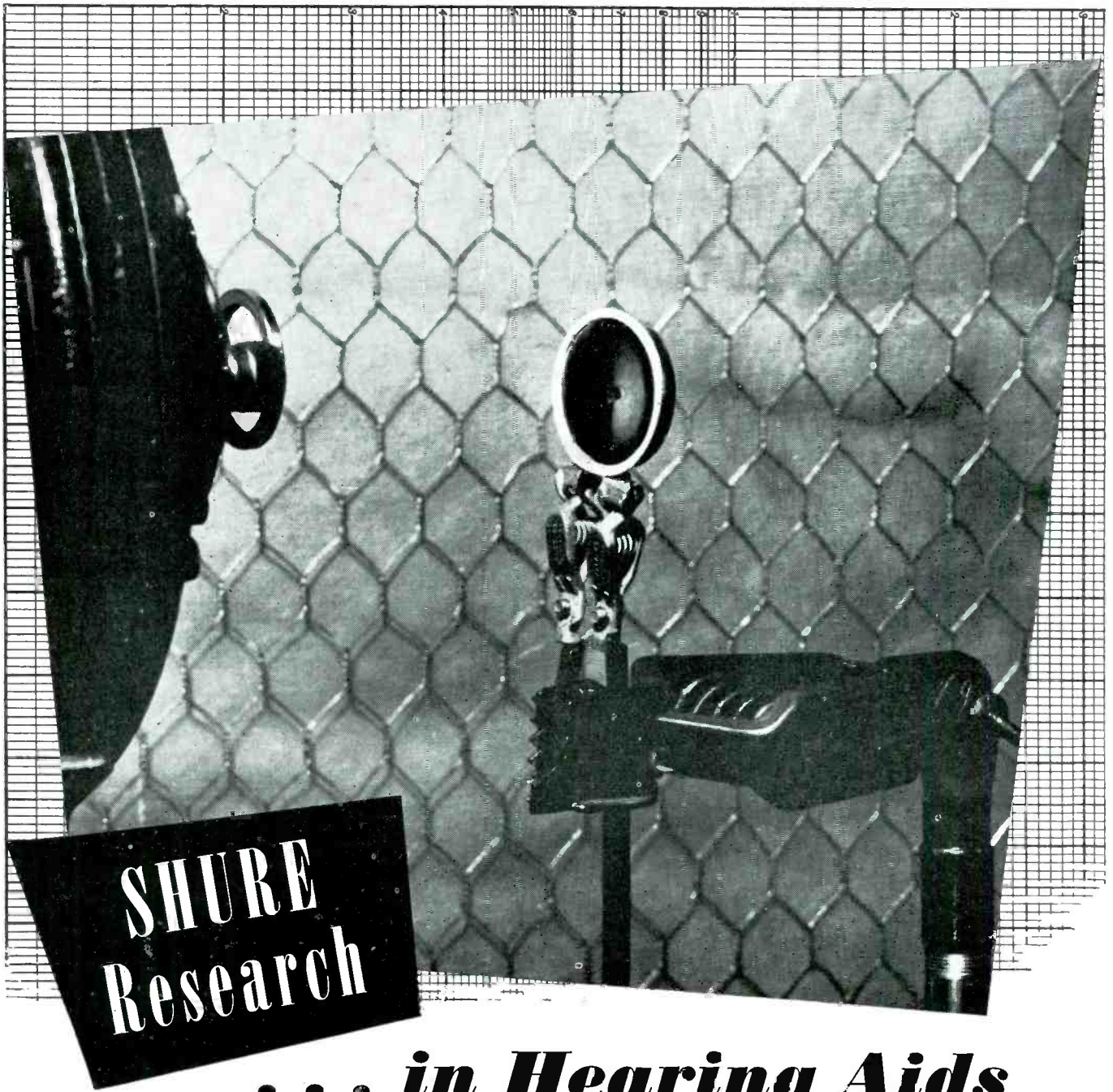

**SHURE
Research**

... in Hearing Aids

A vital component of the Hearing Aid is the Microphone which must be small, light, moisture-proof and possess the frequency response adapted to the Hearing Aid Device. Often the Microphone must be chosen to fit the threshold of hearing of the patient. Shure Research has succeeded so well in controlling the frequency response and output level of small size Hearing Aid Microphones that, today, Shure Brothers produces microphones for practically every major manufacturer of Hearing Aids.

SHURE BROTHERS, 225 West Huron Street, Chicago
Designers and Manufacturers of Microphones and Acoustic Devices.



Parabolic Reflectors for U-H-F Transmission

(NOTE: The term ULTRA HIGH FREQUENCIES is generally accepted as relating to those frequencies of the radio spectrum lying between 300 and 3000 megacycles. These radio waves, between 10 centimeters and 1 meter in length, are sometimes known as microwaves or centimeter waves.)

By Jordan McQuay

THE increasing use of ultra high frequencies in the range between 300 and 3000 megacycles (10 to 100 centimeters) has resulted in a number of technical circuit difficulties, mainly due to the idiosyncracies of the extremely short wave lengths involved. Special tubes and other components frequently are necessary for the operation of circuits at these frequencies, and their adjustment is critical and usually very delicate. In short, many problems beset the radio engineer in the realm of centimeter operation which were never important at lower frequencies of operation.

But in at least one important instance, the task is considerably easier: the antenna transmission and the antenna reception of ultra high frequency waves—since such waves behave very similarly to light or optical waves.

Although the basic laws of physics govern both electrical and optical waves as a similar phenomena, there is a subtle difference between the two over most of the usual radio frequency ranges. For example, radio waves in the broadcast band are subject to reflection and refraction under circumstances which do not have the same effect upon light waves. However, as the operating frequency of radio waves becomes higher and higher (i.e., the wave length becomes shorter and shorter), they tend to act more as light waves and less like electrical (radio) waves. Thus, in the ultra high frequency range (300 to 3000 megacycles), the tiny radio waves manifest properties very similar to *but not always exactly like* light rays. This is particularly true in the radiation and reception of u-h-f waves, as has already been noted.

While circuits in the ultra high frequency range are used for a variety of purposes, the use of such short wave lengths usually implies that some *directivity* is involved, i.e., it is desired to limit the transmissions from a u-h-f radiator to one, two or a few certain receivers.

To obtain such directivity, a radiating device incorporating a paraboloid reflector is used frequently. Such a unit generally consists of a radiating member (usually a half-wave dipole) situated at the focal point of a parabolic reflector. The reflector has no electrical connection with the u-h-f transmitter. And the entire unit can be used equally as well for either transmission or reception purposes.

But before discussing the technical aspects of the parabolic reflector, first consider a few of the basic laws of optics which govern the operation of such a device.

Light waves are reflected from an optically smooth and (usually) polished surface in such a manner that the angle

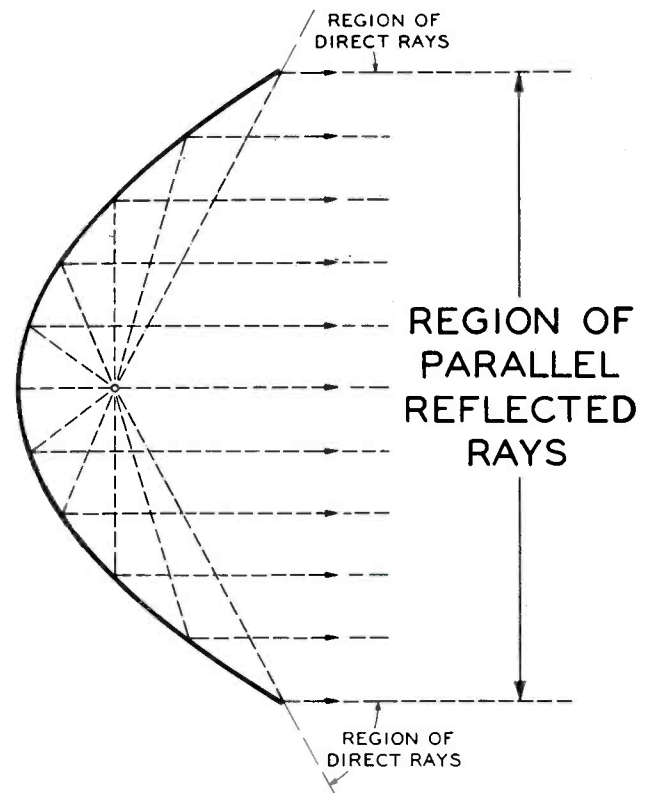

Figure 1—Illustrating the Reflection of Light Rays from a Parabolic Reflector.

made between the reflected ray and the surface is equal to the angle made between the incident ray and the surface. A concentrated beam of light may be formed by partially surrounding the source of light with a reflecting surface of such a shape that, due to the law of light reflection, parallel rays of light are produced. A reflecting surface whose cross section is a simple paraboloid fills this requirement. The optical result of placing a source of light at the focal point of a paraboloid is shown in figure 1. It should be noted that parallel reflected rays are obtained only when the original rays come from the focal point of the paraboloid. For this reason, the source of light must be very small, a point of light, if possible—in order to obtain a perfectly focussed beam. And the source of light must be situated precisely at the focal point of the paraboloid. Rays of light from the source which do not strike the reflector are known as *direct rays*. By extending the edges of the paraboloid, the region of direct light waves from the source will be lessened considerably. It is very necessary, therefore, that the paraboloid be large with respect to the operating frequency of the rays

U-H-F REFLECTORS

or waves. Because, the larger the paraboloid *the more nearly the source approximates a point* and the smaller will be the region of direct rays. A small *secondary* reflector is sometimes used mounted in front of the source of light, to reflect most of the direct rays back into the main parabolic reflector; the *secondary* reflector is usually spherical and merely re-directs the rays back into the paraboloid which then gives them the proper direction.

So much for our optical analogy.

Radio waves can be reflected or focussed by conducting surfaces, much in the same manner that light can be reflected or focussed by polished surfaces. And the principles of light waves could be applied to all radio frequency waves, regardless of wave length.

But this is not practical for *all* radio frequencies.

Because the dimensions of the paraboloid must be quite large to satisfy the condition that the source of energy be a point. Parabolic reflectors for operation at wave lengths

longer than about one meter would be entirely too large and unwieldy for directional operation. For this reason (e.g., a limitation of size only) parabolic reflectors generally are reserved for use at radio frequencies well about 300 megacycles, where the distance corresponding to a wave length is small enough to permit the construction of reflecting surfaces of practical size. The higher the frequency, of course, the smaller the paraboloid.

Parabolic reflectors are fed generally by means of a single dipole of half the wave length of the transmitter. While such a dipole is not a point source of energy, at extremely high frequencies it becomes so very small in actual physical size that it, at least, approaches a point.

Reflectors are constructed with a width (edge to edge of the paraboloid) of about eight to ten wave lengths. A surface of copper or other highly conductive metal is employed to obtain high reflection of radio waves. It has been found that the presence of small perforations in the reflector does not alter the reflecting characteristics of the paraboloid, and it is thus possible to minimize wind resistance for extremely windy outdoor installations.

Highlights from WTOL—Toledo's Friendly Station

By F. J. Sheehan, Chief Engineer

Toledo, Ohio . . . six A. M. and the sun is trying persistently to break through the early morning clouds. A clinking noise and a mysterious hum followed by a loud blast of the "Star Spangled Banner" and WTOL, **Toledo's Friendly Station**, has opened up its transmitter and doors for another day's work. **John Sheehan**, Chief Engineer, settles back comfortably (?) in his chair for that thirty second nap he's been promising himself for many years. **Ken Zank**, Sunrise Serenade announcer, opens one eye long enough to slam the right platter on the right turntable at the right time. Dawn has broken and WTOL, Blue Network affiliate, and home of reasonably sane announcers and sufficiently sound engineers, has opened up.

Nine A. M. rolls around and we find the announcers, continuity girls, salesmen, switchboard operators, and accounting clerks buzzing with activity.

And inasmuch as we have spoken of activity we may as well tell you that **Jeanette Rodenhauser** and **Lee Rodenhauser**, continuity writer sisters—both blonde—are on their way to Texas. Each will say "I DO" to the man who has been in each of their hearts for many a year. Jan's groom will wear the Navy blue while Lee's will represent the Army Air Corps.

Frank Ridgeway, ex-Chief Engineer, is now Captain Ridgeway, thanks to Uncle Sam, and is located in Washington, D. C. **Joe Weygandt**, engineer, is now in the Naval

Radio School in Texas, while **Stan Neubrecht** finds himself absorbed in the fascinating duties of the OWI. **Jean Wright**, ex-Program Director, writes scripts out in Los Angeles and **Marie Huffman**, former secretary to the station manager, finds herself in Riverside, California, busy in that best game of them all—RADIO. **Wilma Ballmer**, switchboard operator, remains at home to await the stork and she's confident the "little one" will be six foot tall "just like my Woody!"

Chuck Haltemann, former Program Director, has joined the Blue announcing staff in Chicago and **Harry Prue**, engineer, has joined the chorus of Anchors Aweigh at Chicago's Great Lakes Training Station.

See Front Cover. Photograph taken from the rear of the Bell Building in which WTOL is located. WTOL first took to the air on February 28th, 1938, with 100 watts on 1200 KC, daytime only. In 1939 WTOL went to 250 watts, unlimited time. WTOL is a member of the Blue Network. The antenna, studios, transmitter and offices are shown in photograph. The Bell Building is located at the corner of Madison and Erie Street in the heart of Toledo. WTOL is now on 1230 KC with 250 watts, full-time.

That just about covers the news from WTOL. So long for now, gang, and we'll be seeing you again in these pages with more Friendly Highlights from **Toledo's Friendly Station**.

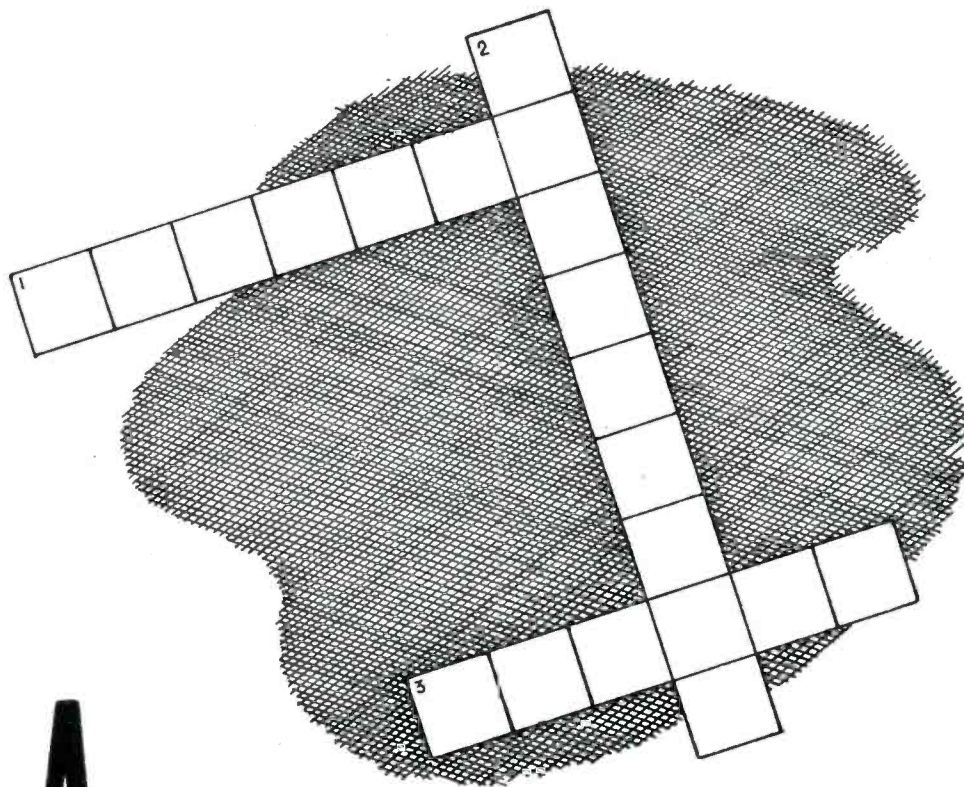

A crossword puzzle for broadcast engineers

Horizontal

- (1) Come ahead!
- (3) Empty cartridges

Vertical

- (2) Noting for posterity

If you're wondering about the solution, perhaps we can give a few more hints that will help. For example, the three words we're thinking of are superior in five ways. (1) They're flat; (2) there is no surface noise; (3) there is no trouble with threads (threads not statically charged); (4) they reproduce clearly, and (5) they have long playing life. Not only that, but studio engineers throughout the country tell us they're tops for long life and true tone. Heck . . . we've probably given you too much of a hint already. But if you haven't guessed it, the solution is ADVANCE RECORDING BLANKS . . . you'll find them the solution, too, where high quality recording for transcription is imperative.

Advance
Recording Products
Company

BUY WAR BONDS AND STAMPS

36-12 34th STREET • STILLWELL 4-7837 • LONG ISLAND CITY, N. Y.

Twenty Years with Tom Manning and the Sports Mike

By Bert Pruitt

TOM MANNING has done plenty of sportscasting. Twenty years of reporting just about cover everything you can think of in the sports field.

The New York Yankees were playing the Chicago Cubs for the World's Championship of Baseball in Chicago a few years ago. Tom Manning, along with several thousand spectators, saw Babe Ruth point at the right field wall. The King of Swat poled her over the fence and proved that he had been properly named.

Tom has seen home runs smacked with two strikes on the last batter in the last of the 9th. He's seen inferior fighters land lucky KO punches that surprised the fighters more than it did the spectators in the ten dollar seats. He's seen no-hit-no-run pitching classics and he's been witness to the screwball capers of baseball players such as Dizzy Dean. Going back a few years further, he's given the inning by inning reports of the games where the late Lou Gehrig was idolized and cheered in the enemy parks as well as at home. Tom's seen about all there is to be seen in sports.

Well, that's what he thought before the Ohio State-Illinois football game this past November. Since then he isn't so sure. The game was played at Columbus, Ohio, and what he saw that afternoon just about tops anything he's seen since he became WTAM's ace Sports Reporter twenty years ago.

Let's turn the typewriter over to Tom Manning for a key by key report of what really took place down there at Columbus last November . . . Take it away, Tom Manning!

In football anything can happen and this season in the Ohio State-Illinois game everything did happen. First Ohio was ahead then Illinois. In the last minute of the fourth quarter, Ohio gained possession of the ball with the score 26 to 26. The Buckeyes tried a pass play consuming all but 7 seconds, the clock had been stopped because it was an incomplete forward pass, time for just one more desperate play. By now thousands of excited spectators had left their seats and were standing around the edge of the gridiron, waiting to rush out on the field to "just touch" one of the players. The Ohio Center passed the ball and a second forward pass was attempted, then we heard the gun, ending the game and the rush was on by the fans. There was the usual mob scene down there on the playing field and the players and officials were literally pushed into their dressing rooms by the wave of humanity . . . We broadcasters, eager to "Sign-Off" and catch trains, gave a brief resume and the closing cue. About that time we noticed two Ohio State players returning, pulled their sweaters over their heads, then two of the four officials also making their way back on the field. **RIGHT HERE WHAT WOULD YOU DO? WELL SO DID WE . . .** The alert engineering crew in the

control room at the home studio accidentally heard us on the monitor yelling for a return of facilities. At first they thought we were "nuts" but back came control and a description of the commotion. Illinois was "off-side" and the headlinesman had blown the horn which the Chief Timer failed to hear. Because of the rush of humanity he was unable to prevent the other officials and players from leaving the field. Ten minutes later both teams were back on the gridiron and the rule permits the offending team "One More Play". Paul Brown, Ohio's coach, ordered a placement kick. The teams lined up and from 26 yards out, Bill Stungis booted a perfect goal for three points and a 29-26 victory for the Buckeyes. A check-up of WTAM's listeners showed that they were still tuned to that station because of the fact that following this broadcast scores of other important games are transmitted, and too, the network was to follow with another football broadcast of a "Far West" game . . . We've heard of games being pulled out of the fire but here is one that was "Pulled Out of the Showers".

"Yes," said Tom, handing the portable back to us, "I've seen a lot of exciting things in sports but that one just about tops them all!"

We asked Tom what was happening in sports twenty years ago. He looked surprised when we asked him that question. We will never know what he was thinking as he looked at our thinning hair.

"Well, that's a long time back . . . but I have a picture of Tris Speaker and Ty Cobb taken about twenty years ago . . . Could you use that one?"

"Tom," we said, "that's like asking a starving prospector if he could use a paying gold mine!"

One thing led to another and the first thing you know, Tom was digging through a stack of pictures. To anyone else they wouldn't be anything but interesting pictures. They are more than that to him. Each picture has a special story of its own that rekindles pleasant memories along the sports trail of years gone by. There was a picture of the christening of the Cruiser Cleveland . . . A picture of the Army flyers, Fortney and Settle, taking off on a stratosphere-balloon flight that was destined to carry them higher into the stratosphere than man had yet gone. (The late Jon Larson, New York Field Eng., was in Akron with the Chicago Mobile Unit for this broadcast) . . . There were pictures of Manning and Alvin McMahon riding a boat down one of the main streets of Portsmouth, Ohio, during the 1937 floods that left 500,000 homeless along the Ohio and Mississippi rivers. There were pictures of Bobby Jones, Jack Dempsey, Gar Wood, Bill Tilden, Joe Lewis, and the late Bill Cummings.

"Here's an unusual picture." Tom handed the picture to us and we couldn't make heads or tails of it. "The jockey

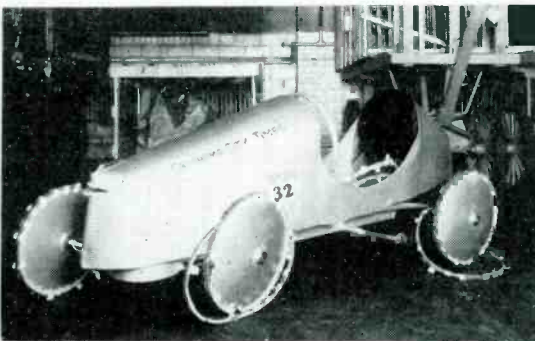
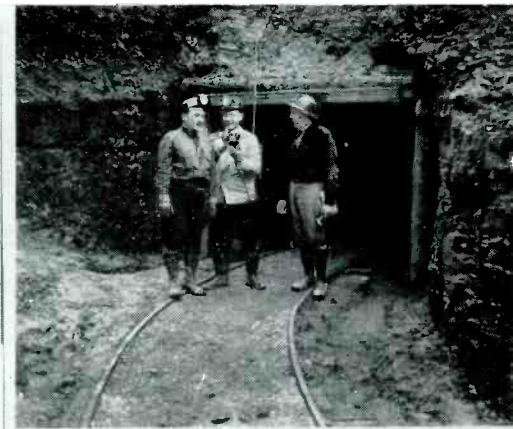

Top left: Ty Cobb, Babe Ruth, Tris Speaker, Max Rosenblum (Daddy of Sandlot Baseball) and Tom Manning in the Cleveland Stadium. Center: Engineer Alvin McMahon, Tom Manning, and a native of Portsmouth, Ohio, broadcasting from Portsmouth during the 1937 floods. Right: Tom Manning broadcasting from mine entrance at Straightsville, Ohio. Bottom left: Broadcast from the scene of the U. S. Navy Dirigible Airship Shenandoah disaster near Ava, Ohio, during September, 1925. Center: Soap Box Derby Racer that sent McNamee and Manning to hospital. Right: The late Graham McNamee being carried to an ambulance after the Soap Box Derby mishap at Akron, Ohio.

riding the losing horse seems to be sitting hind-end-too . . . how come," we questioned.

"That's me on the losing horse and that's a portable transmitter on my back!"

"Good heavens," we apologized, "we haven't had our glasses changed since we moved into our new studios . . . We'd better have that taken care of immediately . . . did you win the race?"

"No, but I believe I was the first announcer to get saddle sores from short-waving the results of a race from the back of a horse!"

"Say Tom, didn't you broadcast the results of a sulky race out at the Randall tracks a few years ago?"

"Yes . . . and I participated in the race and, to my knowledge, that is the only time it was ever done!"

"Well, Tom," we said, "we'll make that statement in the BEJ and find out if it's the only time it's been done . . . the readers of the Journal will soon let us know if the statement isn't true!"

"I get fan mail like that too!" Tom was thumbing through several pictures then suddenly stopped. He was gazing at a picture. We couldn't see it from where we were sitting so we naturally wondered what it was. After a few moments he handed us the picture, saying: "There was one of the grandest fellows in radio!"

The picture was one of the late Graham McNamee.

Tom pointed at the picture . . . "Graham and I were down at Akron doing the Soap Box Derby . . . Ever see a Derby?"

We told him we hadn't.

"Well," he continued, "the youngsters ride their little home-made racers at those Derbies and after seeing the drivers average upwards of 120 miles an hour down at the Indianapolis Speedway, these cars look harmless enough. Well, Graham and I were down there doing the Derby a few years ago when one of the youngsters lost control and his racer jumped the railing and plowed into us . . . Graham and I went to the hospital for a few days!"

Anything can happen in sports!

The Army and Navy "E" was awarded to the Universal Microphone Company, Inglewood, Calif., on July 26th, with the benefit of bandstand and fanfare. Among the prominent persons attending were James L. Fouch, president, Cecil L. Sly, vice-president, the mayor of Inglewood, and high ranking Army and Navy officers.

We are glad to report receipt of a V-Mail from Lt. Col. F. C. Shidel, from somewhere on the European front; he is receiving our *Journal*; has met Major W. R. Brown and Lt. Royston; says "Col. Sarnoff connected with same thing I am in." Promises the *Journal* some hot stories when the lid is off.

JAMES

Crystals

KNIGHTS

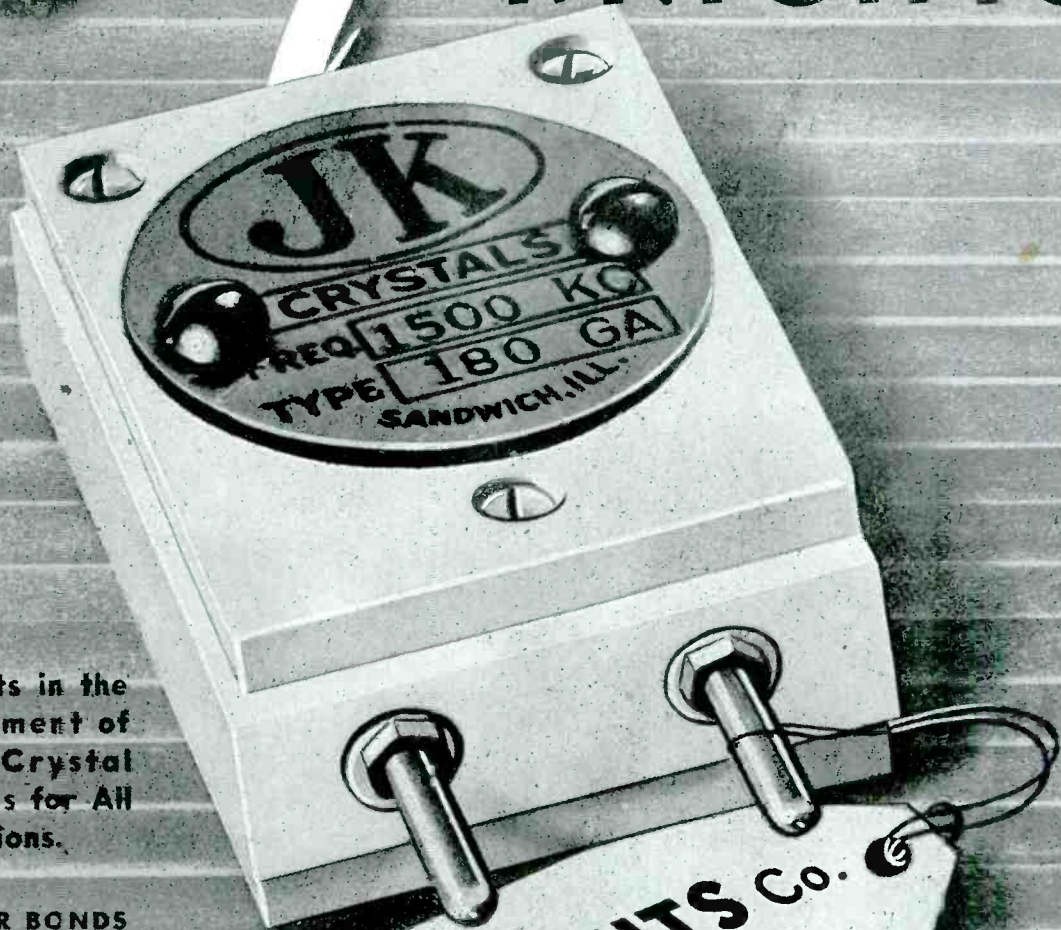

Specialists in the
Development of
Quartz Crystal
Products for All
Applications.

**BUY WAR BONDS
FOR VICTORY!**

The **JAMES KNIGHTS** Co. 
SANDWICH, ILLINOIS



CRYSTALS

CRYSTALS FOR THE CRITICAL

The Discernibility Of Changes in Program Band Width*

By D. K. Gannett and Iden Kerney

A Timely Article of Unusual Interest
to the AM and FM Broadcast Industry

[Reprinted by permission of *The Bell System Technical Journal*, Vol. XXIII, No. 1, January, 1944]

One of the factors that should be considered in determining how wide a transmission band is required for high fidelity broadcasting is the ability of people to perceive the effects of restricting the band to various limits, when listening to typical radio programs. Tests are described in which this was directly measured. The tests were concerned only with the physical ability to hear the differences in band width and disregarded the question of the enjoyment or aesthetic appreciation of wider bands. It is concluded that changes in band width are detectable about twice as readily with music as with speech; that one must go from 8 to 15 kc. to obtain a change as readily detected as a change from 5 to 8 kc.; and that both these changes, for speech, are just sufficient to have an even chance of being detected by listeners having experience in such tests.

THE question of how wide a frequency band it is necessary to transmit to provide high fidelity broadcasting involves consideration of a number of factors. Among these are the limits of hearing of the human ear, the spectra of program material, the aesthetic sensibilities of listeners, the effect of room noise in studios and homes, and the acoustic properties of rooms. A true engineering solution of the problem would attempt to assign numerical values

* This paper is a publication, substantially without change, of a report prepared some time ago before work non-productive to the war effort was suspended.

to each of these factors, and then to combine them in some way to obtain a figure of merit versus band width. Sufficient information to do this in a complete and satisfactory manner is not available, however, and in practice the final answer is usually obtained by the exercise of judgment, bolstered by such technical data as can be found on the component factors.

The first two of the above factors, the limits of hearing and the spectra of program material, have been separately investigated and the results published in the technical literature by a number of experimenters. Because of the intangibles involved, however, even these two sets of data cannot readily be combined, forgetting the other factors, with complete assurance that their contribution to the answer is established. The authors, therefore, undertook a series of tests to measure directly their combined effect. These experiments tested the ability of critical listeners to hear changes in band width on direct comparison when listening to representative program material. The purpose of this paper is to present the data from these tests. Similar experiments have of course been done before. The excuse for this paper is that the experiments represent a complete set of data and the analysis of the data is believed to be in such form as to be useful in further consideration of the requirements of program fidelity.

The circuit arrangements used for the tests are shown schematically in Fig. 1.

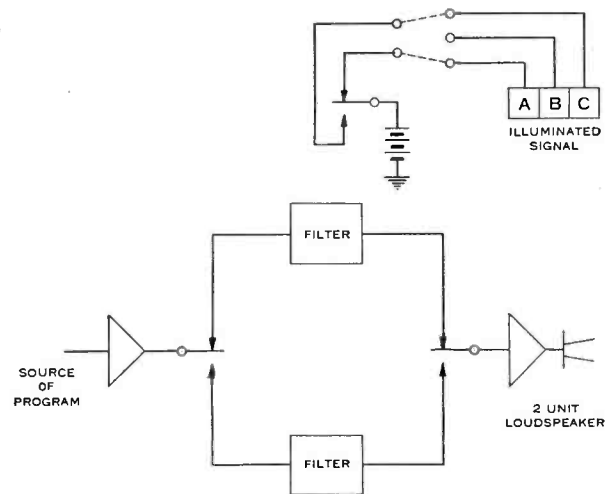

Figure 1—Arrangement for testing program band widths.

The essential features are a source of program, a switch for connecting into the circuit either of two low-pass filters, and a high-quality loudspeaker. Controls for adjusting levels, volume indicators, etc., are omitted from the diagram. The arrangements included a signal visible to the listeners in which one of the letters, A, B, or C, could be illuminated. On a given test two of these letters were associated with the switch so that one letter was illuminated for one position and the other letter for the other position. The choice of letters among the three was varied more or less at random for different tests. Low pass filters were available to provide cut-offs of 3, 5, 8, 11 and 13 kc. When no filter was inserted the band was considered to extend to 15 kc. as this was about the upper limit of transmission of the testing circuits and loudspeaker. The lower limit of the transmitted band for all conditions was approximately 40 cycles.

In conducting a test, a group of observers listened to comparisons between two of the available band widths, the conditions being switched every few seconds until a sufficient number of comparisons had been made. The conditions were unknown to the observers, being designated to them only by the letters in the signal. At the conclusion of the test the observers were asked to mark on a ballot which letter appeared to coincide with the wider band (not which they preferred). A series of tests consisted of comparisons between substantially all of

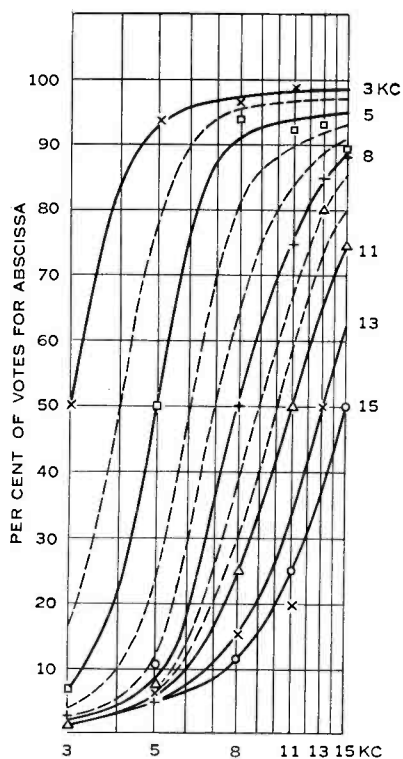

Figure 2—Music.

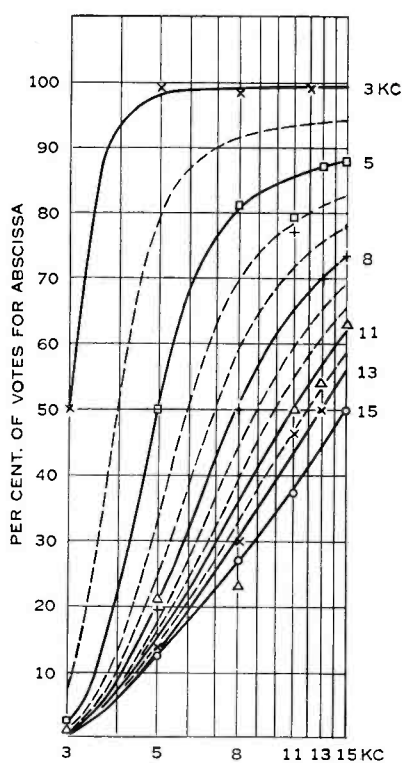

Figure 3—Speech.

Figures 2 and 3—Detectability of changes in band width.

the possible band widths among those available. There were also included in some of the series as a check, one or two tests in which the band width was the same for both positions of the switch. Ten complete series of tests were carried out, two on each of five different programs.

The programs consisted of a dance orchestra, two large symphony orchestras, speech from a male speaker repeating a test sentence, and a radio dramatic sketch. The programs, except for the spoken test sentences, were obtained by special arrangement over direct wire lines from the studio or theater in which the performance took place. The entire system from microphones to and including the loud-speaker had a substantially flat transmission characteristic from 40 to 15,000 cycles, with no filters in the circuit. The loud-speaker was of the two-unit type and was one of a number built for the demonstration of auditory perspective in 1933. The tests were conducted in the program laboratory of the Bell Telephone Laboratories where the acoustic noise level was about +30 deci-

bels. The noise contributed by the electrical parts of the system was considerably below the acoustic noise. The loudness of the programs was adjusted to about unity reproduction, that is, to the volume that would be heard by listeners in a favorable position at the original performance.

The observers were engineers having a considerable experience in tests of program quality. They were doubtless therefore considerably more critical than the average radio listener. The number of observers varied somewhat during the tests but averaged about sixteen. The ages of the observers were in the 30's and 40's so that neither very young nor very old ears were represented.

The immediate outcome of the tests was some 2,000 ballots which were meaningless until analyzed. Before the analysis could be made, however, it was necessary to decide how to express the results.

There are no familiar units to express fidelity or program quality. It was decided therefore to employ the very useful concept of the limen and the liminal

unit. These terms have occasionally been applied to other subjective data and may be roughly defined as the least change in a quantity which is detectable. In the present case, if the band widths being compared differ greatly, there will be a nearly unanimous agreement among the observers as to which is the wider. If they differ only slightly, however, many of the observers will vote wrongly for the narrower band and on successive repetitions of the test many will reverse themselves. An average of a large number of votes will show a plurality for the wider band, the margin of choice increasing as the difference in band width is made greater. A significant measure of the detectable difference in band width will be taken to be that difference such that 75% of the observers correctly select the wider band and 25% wrongly select the narrower band. This difference in band widths will be designated one "difference limen." The sensory effect of a change of one difference limen will be called one "liminal unit".

The significance of the vote of 75 to 25% is assumed to be as follows: On a particular test some of the observers can detect the difference between the conditions while the remainder will guess. Of the latter, half are likely to guess right and half wrong. When 25% vote wrongly they are assumed to be guessing and must be paired with another 25% who also guessed but happened to guess right. Therefore a vote of 75 to 25% is taken to indicate that 50% of the observers were guessing and the remainder could actually detect the difference. The difference limen may now be more specifically defined as that difference in band widths which is detectable to half the observers.

It may be commented that this attempt to explain the definition of "liminal unit" is perhaps over-simple. The observers themselves are frequently uncertain whether they are guessing or are influenced in their choice by some minute difference. The test could be done with a single observer, repeated many times to obtain the same number of observations as with a group. When the conditions are nearly equal he will vote

about as often one way as the other, but as the difference between the conditions is increased he will vote a larger per cent of the time correctly for the wider band, just as did the group. When the two conditions are separated by one difference limen he will vote correctly 75% of the time and wrongly 25% of the time, which may be said, in line with the argument given earlier, to indicate that he is guessing half the time and can discern the difference half the time. The difference limen could therefore be defined as that threshold difference for which there is an even chance of its discernment by a listener.

Having chosen a method of expressing the results, the analysis can now be attacked. The first step is to group together all tests on similar types of program material, and to determine for each band width comparison the per cent of votes for the wider and narrower band, respectively. The data thus obtained for music and speech are shown by the solid curves of Figs. 2 and 3. A curve labeled 8 kc., for example, shows the per cent of the total votes which selected as the wider each of the other band widths to which 8 kc. was compared. The points, although somewhat irregular, fell systematically enough to permit drawing the smooth curves with the application of some judgment and having due regard to the necessary symmetry between them. (For example, the 8 kc. curve at an abscissa of 5 kc. must agree with the 5 kc. curve at an abscissa of 8 kc.) A much larger volume of data would be needed to obtain points falling accurately on a smooth curve. To facilitate obtaining the best approximations, the curves were plotted on several kinds of coordinates, including rectangular, semi-logarithmic (shown in the illustrations), probability and logarithmic probability.

The dotted curves were interpolated between the solid curves and progress in steps of 1 kc. The interpolation was readily accomplished with considerable accuracy. For example, points for the 10 kc. curve are obtained from the values of each of the solid curves corresponding to an abscissa of 10 kc.

From these curves, the difference lim-

ens for each band width were determined by reading directly the bands corresponding to votes of 25% and 75%. The bands at which these votes occur therefore by definition differ from the reference band by one limen. The following table gives the intervals of one limen as thus derived from the curves.

Differences in Upper Limit of Program Band in KC, Corresponding to One Limen

| MUSIC | SPEECH |
|-------------|------------|
| 3—3.6 | 3—3.3 |
| 3.3—4—4.8 | 3.4—4—4.8 |
| 4.1—5—6 | 4.1—5—6.9 |
| 5—6—7.4 | 4.6—6—9.4 |
| 5.8—7—9.3 | 5.1—7—12.8 |
| 6.4—8—11 | 5.5—8 |
| 6.9—9—12.2 | 5.8—9 |
| 7.4—10—13.4 | 6.2—10 |
| 8—11—15 | 6.4—11 |
| 9.8—13 | 7—13 |
| 11—15 | 7.6—15 |

The difference limens are seen to vary with the frequency of cut-off, increasing as the frequency increases. Since each difference limen corresponds to a sensory effect of one liminal unit, it is obvious that the reciprocal of the difference limen gives the rate of change of liminal units with changes of program band width in terms of liminal units per kilocycle. Therefore, curves of liminal units versus the upper limit of the program band may be constructed from the figures in the table. Such curves are plotted in Fig. 4. The actual mechanics of the process used to plot the curves was as follows, taking the data for "music" for illustration. The lowest frequency occurring in the table is 3 kc., and it is seen that raising the band width to 3.6 kc. will bring about a subjective increase of one liminal unit. Therefore, on an arbitrary scale, 3 kc. was plotted at 0 and 3.6 kc. at one liminal unit. Next a smooth curve was drawn through these points and the location of 3.3 kc. (next line of table) was determined by interpolation. Since 4 kc. is one liminal unit above 3.3 kc., and 4.8 is one liminal unit above 4 kc., these points were plotted and the curve extended through them. By a similar process the curve was extended step by step up to 15 kc. Finally, the origin was shifted so as to express

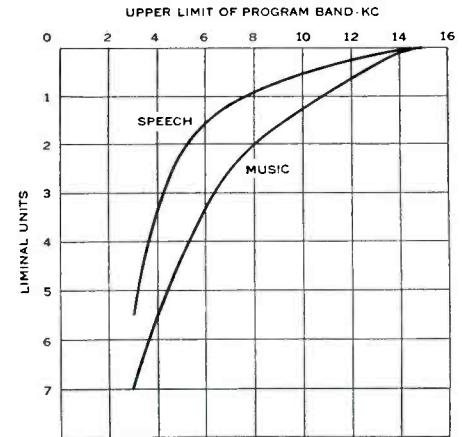

Figure 4—Ability to detect changes in program band width.

the liminal curve with respect to 15 kc. instead of 3 kc.

It was mentioned above that a number of tests were introduced without the knowledge of the observers in which the conditions were not changed, the band width remaining constant while the illuminated letters were switched. This produced the most interesting psychological result that observers voted nearly two to one for the letter appearing in the right-hand position in the signal, on each of the six tests of this kind. This raises the question as to whether this effect impaired the results on the other tests.

In the course of the tests, comparisons between each pair of band widths were presented 10 times, 6 times with music and 4 times with speech. The letters corresponding to the two conditions were assigned more or less at random from the three letters A, B, and C. Taking 11 of these groups of tests in which the narrower band was represented about as often by the right hand as by the left hand of the pair of letters chosen, the average vote for the right-hand letter was 51.1% and for the left-hand letter was 48.9%. The difference between these two figures is too small to be significant. It is therefore concluded that when there was a real difference, the observers were not measurably influenced by their slight subconscious predilection for the right-hand letter. It would be interesting to correlate this phenomenon with the right or left-handedness of the observers. This point illustrates the ex-

(Continued on Page Thirteen)

Presto is taking Orders for Post-War Deliveries

NOW YOU CAN PLAN AHEAD

As a station manager, you have probably been getting reports from your engineers saying that your transcription recording and playback tables are nearing the end of their useful life.

Like your car and other pre-war mechanical equipment they are showing the effects of four or more years of hard, continuous service during times when replacement parts have been hard to get, some of them inferior substitute materials, and when skilled personnel has not been available for proper operation and maintenance.

YOU CAN BE AMONG THE FIRST to get your station equipment back in shape if you place your order for new turntable equipment now. Presto will assign your order a preference number based on the date and time of the postmark on your order. This number will appear on our acknowledgement.

NO PRIORITY NEED BE FURNISHED as no shipments will be made until the military demand for equipment is completely satisfied and priority restrictions are removed. When that time comes, your Presto preference number will take the place of a government priority in determining the delivery of Presto equipment.

NO DEPOSIT IS REQUIRED. Simply fill out the Presto post-war order form. If you need more information, send for the complete Presto catalog. Be assured that any improvements that may be added in our post-war products will be included in the equipment you receive. There will be no major changes in Presto equipment during the first year or two after the war because until that time our engineering department will be devoted entirely to war work. The fully developed equipment designs that gave you service during the long war period should, we believe, be adequate for the time immediately after the war. You will, however, receive the benefit of our experience in manufacturing recording and reproducing equipment for military service which we have gained during wartime.

WHY ARE WE TALKING ABOUT "POST-WAR" NOW?

It may seem premature until you know these facts:

1 Since early in 1942, Presto, like all other electronic equipment manufacturers, has been 100% in war work. This has meant manufacturing a variety of equipment needed more critically than recording equipment.

2 At the same time, the military demand for sound recording and reproducing equipment has been far beyond any prudent estimate we could have made.

3 Shortages have occurred continually in parts, principally motors, rubber parts and aluminum castings, as well as in labor, which have further impaired our efforts to keep shipments of our standard recording equipment up to date.

4 As a result, our backlog of orders is such that many orders received now, even those bearing AA-1 priorities, may not be shipped for eight to twelve months. By that time, government priorities may not be necessary.

Your order now will help us to plan our production schedule in advance for various types of equipment, resulting in speedier deliveries for you.

Your order, placed today, will not become binding on either of us until we give you firm price and delivery quotations based on post-war material costs and labor conditions. If your plans should change after you have placed your order, simply cancel the order and release your preference number to the next in line. That's all there is to it.

WHEN YOU ORDER BROADCASTING EQUIPMENT FOR NEW STATIONS, AM, FM OR TELEVISION, specify Presto transcription recording and playback tables. Many manufacturers of high grade radio transmitters and studio input equipment do not make turntable equipment. Therefore, ask the transmitter manufacturer to include Presto tables. They will pass your requirements on to us. We will deliver when they do.

WRITE TODAY FOR THE PRESTO POST-WAR ORDER FORM

Complete catalog sent on request



PRESTO RECORDING CORPORATION

242 WEST 55th STREET, NEW YORK 19, N.Y., U.S.A.

Walter P. Downs Ltd., in Canada

BACK THE ATTACK—BUY WAR BONDS

Changes in Program Band Width

(Continued from Page Eleven)

trema care that must be taken in conducting judgment tests of this sort to insure that no irrelevant factors affect the statistical result.

The curves of Fig. 4 permit drawing the following conclusions:

1. Increases in band width can be detected up to 15 kc. for both music and speech. The fact that this is true for speech is rather surprising. However, above about 5 kc., changes in band width are twice as readily detectable on music as on speech.

2. It requires an increase in band width from 8 to 15 kc. to be as readily detected as an increase from 5 to 8 kc., for both speech and music.

3. The following intervals correspond to one liminal unit and are therefore just discernible half of the time to the observers:

Speech: 5 to 8 kc.; 8 to 15 kc.

Music: 5 to 6½ kc.; 6½ to 8 kc.; 8 to 11 kc.; 11 to 15 kc.

In considering these conclusions, the fundamental assumption and limitations of the data should be borne in mind. First, the data were obtained from tests with a certain group of observers and on certain program material. Curves of somewhat different slope would doubtless be obtained with observers of different average age, experience, musical appreciation, etc. It is likely, however, that this would affect the absolute importance of the different intervals in liminal units rather than the relative values. As noted earlier, the observers in these tests were considerably more experienced and critical than average radio audiences. The program material tested was representative of most of the programs on the air, but different results would be obtained with material markedly different in nature. This would probably be particularly true of selected sound effects. Secondly, it should not be forgotten that the results are based only on the ability of the ear to detect the changes, with no weighting for factors such as aesthetic values or personal preferences, or for the effects of room noise and other factors

present in the practical case. Thirdly, it should be appreciated that comparison tests such as these are very sensitive tests, showing up differences that could not be detected under usual home listening conditions.

Table I

Upper Frequency Limit
Versus Unrestricted Band,
Corresponding to One
Liminal Unit

| MUSICAL INSTRUMENTS | |
|----------------------|---------------|
| 1. Flute | 13,500 cycles |
| 2. Snare Drum | 13,000 |
| 3. Violin | 13,000 |
| 4. Soprano Saxophone | 12,700 |
| 5. Oboe | 12,700 |
| 6. 14 in. Cymbals | 12,000 |
| 7. Bass Clarinet | 10,500 |
| 8. Piccolo | 10,200 |
| 9. Bassoon | 10,000 |
| 10. Cello | 9,800 |
| 11. Bass Saxophone | 8,600 |
| 12. Clarinet | 8,500 |
| 13. Trumpet | 8,300 |
| 14. Bass Viol | 7,800 |
| 15. Trombone | 7,200 |
| 16. Bass Tuba | 6,300 |
| 17. French Horn | 6,100 |
| 18. Piano | 5,600 |
| 19. Bass Drum | 4,300 |
| 20. Timpani | 3,500 |
| SPEECH | |
| Male | 7,300 |
| Female | 9,200 |
| SOUND EFFECTS | |
| Footsteps | 12,000 |
| Handclapping | 15,000 |
| Key Jingling | 15,000 |

It is of interest to compare the above results with previously published data. In a paper "Audible Frequency Ranges of Music, Speech and Noise,"¹ W. B. Snow gave data for 20 musical instruments, certain noises, and speech. The data showed the frequency limitations as compared with unlimited bands (about 15 kc.) which yielded a vote of 60 to 40%, and 80 to 20% among a considerable number of observations. In Table I these data have been interpolated to determine the limits that would correspond to a vote of 75 to 25%, in line with the criterion assumed in this paper. In making the interpolation, it was assumed that the curve of per cent of observers

¹ Jour. Acous. Soc. Amer., July 1931; Bell Sys. Tech. Jour., Oct. 1931.

voting correctly for the wider band versus logarithm of the frequency is a straight line in the range of interest.

Table II

Lower Frequency Limit
Versus Unrestricted Band,
Corresponding to One
Liminal Unit

| MUSICAL INSTRUMENTS | |
|-----------------------|-----------|
| 1. Bass Viol | 53 cycles |
| 2. Bass Tuba | 55 |
| 3. Timpani | 60 |
| 4. Bass Drum | 72 |
| 5. Bass Saxophone | 72 |
| 6. Bassoon | 74 |
| 7. Bass Clarinet | 80 |
| 8. Cello | 83 |
| 9. Snare Drum | 87 |
| 10. Piano | 95 |
| 11. Trombone | 110 |
| 12. French Horn | 125 |
| 13. Clarinet | 140 |
| 14. Trumpet | 160 |
| 15. Soprano Saxophone | 210 |
| 16. Violin | 230 |
| 17. Oboe | 240 |
| 18. Flute | 250 |
| 19. 14 in. Cymbals | 370 |
| 20. Piccolo | 510 |
| SPEECH | |
| Male | 115 |
| Female | 190 |
| SOUND EFFECTS | |
| Footsteps | 95 |
| Handclapping | 135 |
| Key Jingling | 915 |

It is difficult to interpret these data from individual instruments in terms of results to be expected from whole orchestras and other music as usually heard. However, comparing Table I with Fig. 4, it will be seen that the frequency limit determined from the present tests as corresponding to one liminal unit for music falls about one third the way down the list of instruments in the table, and the limit corresponding to two liminal units falls about two thirds down the table, which seems reasonable. Also the frequency limit found in the present tests to correspond to one liminal unit for speech lies between the figures given in the table for male and female speech, which is a good check.

The present tests did not include measurements on the lower end of the frequency band. However, some clue to the results that would be expected may be obtained from Mr. Snow's paper. Table II, derived from Mr. Snow's data in a manner similar to that just described,

(Continued on Page Seventeen)

N.A.B.E.T. ACTIVITIES

I have received permission to reprint the following letter which has been circulated in IBEW locals throughout the country. It is a just cause which this local is fighting for. In making this stand against a determined effort of encroachment upon their jurisdiction, Local 1218 is not only fighting for the rights of IBEW members but is also fighting for the rights of every technician in the radio industry. NABET appreciates this effort because it is a step further toward the time when all radio technicians will be happily united in one radio union, of, by, and for radio men.



A. T. Powley,
President, NABET.

RADIO BROADCAST TECHNICIANS
I. B. E. W. LOCAL 1218
Detroit, Michigan

July 2, 1944

Mr. Ed. J. Brown, President
1200 Fifteenth St., N. W.
Washington, D. C.

Dear Sir and Brother:

Your letter of May 27, 1944, received and in view of certain statements made therein we feel that you should be brought up to date on a few points.

Your opening statement that some independent organization has caused some annoyance to the IBEW by encroaching upon our jurisdiction. Who is the organization and what are they doing? Why all the HUSH-HUSH about it? If any organization independent or otherwise is encroaching upon our jurisdiction we should know about it. We see no reason why the International Office should keep the thing behind a curtain of camouflage. You certainly can't refer to NABET because they control only 16 stations and have only about 400 members. The only encroachment upon the jurisdiction of the IBEW that we have heard of is that of Mr. Petrillo and the AF of M. It is inconceivable that the I. P. or any group in Washington would waive jurisdictional rights over any work or the operation of any equipment or equipments over which they have claimed exclusive jurisdiction and at the present time have many contracts in effect specifically covering this work; namely platter spinning. Just what sort of encroachment has been suffered at the hands of this independent group? We would be very interested in finding out where we have suffered by this action.

As to the consideration given this matter by yourself and Mr. Petrillo in order to combat this so-called encroachment: As soon as you start to talk to Mr. Petrillo you should have stopped the encroachment of the AF of M right then and for sure. You refer to a telegram some five years old sent by President Wm. Green to WTMV. Appar-

ently you are attempting to establish a precedence and a priority claim for the AF of M on the matter. If you want to go back into ancient history, the operators at WWJ have played all recordings and transcriptions for the past 24 years and furthermore intend to continue playing them in spite of Mr. Petrillo et al. To this end the Technicians at WWJ joined the IBEW and the contract in part says, "The work covered by this agreement shall include all work—including the cutting and playing of records and/or transcriptions".

This is not exactly in line with your statement that in some IBEW contracts this work may be done by the technicians. Our investigations show that in the majority of broadcasting stations the technicians do the platter spinning. Certainly the AF of M members that have horned in on the platter spinning business are in the minority and a very small minority at that. Besides that, the musicians' claim to the playing of transcriptions, whether they have music on them or not, is definitely an encroachment on a technical aspect of the broadcast business. It seems to us that they would have as good, if not a better, claim to the running of motion picture projectors, because the sound tract on the film certainly at times contains music, and at least speech, just like a non-musical, dramatic or straight sales talk on a one-minute transcription. Furthermore, a pick-up head actuated by the sound tract on a transcription or a phonograph record causes a voltage to be generated in the unit, in exactly the same manner that sound waves striking the diaphragm of a microphone causes a voltage to be generated in the coil of the microphone. When either of these units are associated with a broadcasting station it is the job of the technician to operate and have control of them. Also the source of power for a turn-table is an electric motor. The closing of the switch applying electric power to the motor is certainly not the type of work intended to be covered by a card in the AF of M. As has already been pointed out by other loyal brothers of the Radio Broadcast Division of the IBEW, if this thing is not stopped now we will lose our shirt. Now as to the operation of the fader controlling the so-called "tone-volume" of the pick-up head. This fader is just as much a piece of electrical equipment as any motor starter or speed control device, inasmuch as it controls the amount of voltage that is applied to the input of the line amplifiers or the output switching system in a radio station.

Quoting from the Constitution of the IBEW, Article 28, Section 6: JURISDICTION "They shall have jurisdiction over the following work: The installation, operation, inspection, maintenance and repair of radio, television, voice and sound production, and reproduction apparatus and appliances by means of which electricity is applied in such transmission and transference, production and reproduction of electrical effects." We think that this matter is very clearly and concisely covered in the Constitution. Section 29 of the Constitution states three ways in which the Constitution may be amended or changed. To the best of our knowledge none of these have been used in changing or amending Article 28. Consequently our conclusions on this point are that it is not only highly undesirable but unconstitutional as well.

Your "wonder" if the local unions realize the importance of having the aid and assistance of the AF of M is well

put. You should know by this time that this has long been a source of wonder not only to the IBEW but to all other locals of any labor organization. Mr. Petrillo has the wheels on the top locked and you do the putting while he does the taking. This observation is from an IBEW member of forty years' standing and adds up to what others were wont to learn the hard way.

As to your agreement of March 15, 1944, with Mr. Petrillo, in which you completely sold out the Radio Broadcast Technicians on this matter, well you have already heard enough from the various radio locals to know how we feel about it. As to the last paragraph in your letter: This matter has already been brought to our attention very forcibly so your "White Paper" wasn't necessary on this point. We intend to enforce our contracts the way they are written.

While it is highly desirable that all broadcast operators be united in a single union, more so now than ever before, we do not think that any work now being done or work that may be done in the future should be traded off for or under any consideration.

In conclusion, we think that this horse trade which was supposed to have kicked NABET in the back door of IBEW, with the help of Petrillo, will have exactly the opposite effect. Figure it out yourself, this is America, there is a war on, the main reason for same being to maintain a world where rule by force will not be tolerated. Being normal red-blooded Americans these fellows are not going to take this think lying down and if they make any move at all you can rest assured that it will not be into the IBEW. We firmly believe that the only course left open is to recall any and all agreements between the AF of M and the IBEW. Also we feel that any question affecting jurisdiction of any group of the IBEW should be submitted to a referendum of the membership involved. Hoping this will aid in a speedy and proper settlement of this jurisdictional question.

We remain,
Transcription Committee
Local 1218 Detroit, Michigan
(signed) D. B. Stewart
(signed) A. J. Doran

NEW YORK NEWS

By George F. Anderson, Jr.

A phrase that is being used here in New York this summer is, "Gawd but It's Hot" and there is no exaggeration when we repeat it. There is one consoling thought though and that is, that the studios are air cooled and we mean cooled.

A change took place in August that is causing the laddies in MCD to wear their coats; the wall, that has been in front of the MCD window, has been torn down and now for the first time since the United States entered into the second world conflict, MCD is again on view for the visitors from the forty-eight States and the continents.

MCD spent a hectic night August 14, with the announcement that the invasion of the southern coast of France was in progress. The Blue beat NBC to the punch with the release of the bulletin from Algiers regarding the invasion. The cause, was a slight mix-up in the operation of NBC's Studio 5R, Flash Studio, it was not engineering trouble.

An error was made last month in the news about the boys from the field department covering the Demmy Convention. With apologies to Tony Hutson and Irving Grabo, here is the correct item: Among those from New York covering the convention are, Al Wies Fe NBC, Tony Hutson FE BNC, not NBC, Art Poppele MTCE NBC, and Irving Grabo FE BNC. Pardon me, boys, must be the heat?

The lounge has acquired a few new items this last month. A rug, coffee percolator, and a stand to hold the cups, percolator, coffee, sugar and milk. It is rumored that the rug is the result of campaign promises of Henry "Gabe" Gabrielson for NBC studio councilman. Seeing as how he was elected and we have a new rug, it looks as though he fulfilled his campaign promise!

The percolator is a donation of Harry Hiller and is an excellent affair that will brew eight cups of that nectar of the Gods. The stand was obtained through the efforts of Alex Horwath.

In the recent council elections, the present council consists of MCD—Milton Kitchen, MTCE—Ed. Costello, Field—Tony Hutson, Recording—Chuck Beardley, NBC Studio—Henry "Gabe" Gabrielson, BNC Studio—Pat Simpson, WEA—J. M. Flynn, WJZ—Wm. Mullaney, Boundbrook—Stan Crabtree.

"Call the Cops—Murder—In Radio City. Where?—Studio 3E—Who Done Did It?!! Ah, the thrilling episode of a murder investigation in a broadcasting studio and solved between the opening commercial and the closing NBC cue. No—no—It wasn't a case of the engineer bumping the director off but where the director slew in cold blood a poor defenseless actor. And it all took place while Jos Silva SE NBC was putting the Charlie Chan show thru its pages. Oh, yes, before I forget it, the murder took place in the script not in real life. 'Twas only a radio show and not an actual deed.

In a recent news reel release titled "News Front," shown across the street in the News Reel Theater, a scene was taken in Studio 4J and the handsome and distinguished chappie behind the console is none other than the Blue network's pride and joy, Fan Fare, Norbert "Highpockets Bertie" O'Leary. Fade out.

The Blue network has leased the Vanderbilt Theater for a theater studio and it will be in operation sometime in September. The Vanderbilt was formerly used by NBC for the 'Waring broadcast'. The new control room for the theater will be located on the balcony slightly off center and will have a twelve position mixer.

Kenneth Arber, formerly Sergeant Arber AUS, and before that SE NBC is back with us. Ken went ashore with the first landing wave at Fedhalla, 24 miles north of Casablanca, and later was a MCD operator for the Allied radio station in Algiers. Ken tells us that he had a submachine gun in his hands when he hit the beach and had never fired it before but he soon learned how to use it effectively. While in Algiers he worked under Major

Walter Brown also from NBC, with Lt. Victor Tervola and Lt. Arthur Perry, also NBCites. Brownie is at the present time in Normandy, Vic in Italy, and we think Art Perry is in Africa.

George Mathes SE NBC, has joined the ranks of those who own their own homes and he is very pleased with it. However he has one little complaint, no electric refrigerator, and he finds it very difficult to prevent buttermilk and eggs from spoiling. Hollis Young SE NBC, has sold his home in Yonkers and purchased another in either Larchmont or Mamaroneck, and is now a devotee of the New York, New Haven, and Hartford RR.

Capt. Thomas Gootee, AUS, of Chicago fame has been here in Radio City and we understand that he has one show "on the air" and another "in the works".

We wonder if this column is long enough yet? No comments from the editor, please.

D. C. "Red" Shultis MTCE, had Alex Horwath and Harold Luedeke as visitors, while on vacation at Highland Lake, N. J. The three did some fishing and caught some beauties. This was Harold's first excursion into the pleasures of angling for the finny brethren and he enjoyed it very much. Pete Narkon SE BNC, who recently decided to live a normal life and changed from night studio to day studio, spent a few days fishing on Lake Candlewood in Connecticut and one of his catches was a fifteen inch large mouth bass. Is going back for the big one that got away!

The lads and lassies in recording had a spot of trouble dumped in their laps one Sunday eve when the air conditioning in the racks of the fifty watt recording amplifiers quit. Along with this ten of their fifty watt amps decided it was too hot and left for the day. One of them before quitting changed its output a trifle, only 22 DB on the pluss side. Oh, well, so the grooves on the transcriptions do "overlap".

Jack Paine SE NBC leaves us this month to say hello to Uncle Sam. Jack says that he is going to take life easy as a private. Good luck, Jack.

They say that "Twos Company and Threes a Crowd" but don't believe it. As Mr. and Mrs. John C. MacDonald can prove with the arrival of Sandra Marie MacDonald. Miss Sandra joined the MacDonald family on July 23rd, and with her diaper on she weighed seven pounds and two ounces. Sandra has two brothers whose ages are five and one and a half.

Mr. Walter Mullaney FE NBC saw Harold Ashworth Ex NBC FE in Boston!!!!

Say, has anyone heard the rumor that the OPA is lifting the gasoline rationing in September. Well, Bob Johnson SE NBC did and he almost used up his gasoline allotment for his boat before he found out that it was a gag—started for his benefit by some of those dastardly studio engineers. Of course I didn't believe it or have anything to do with it. I think that I shall see if there is any coffee being served in the lounge. Bing, Bong, Bing.

A New TWIST TO CRYSTAL CLEANING

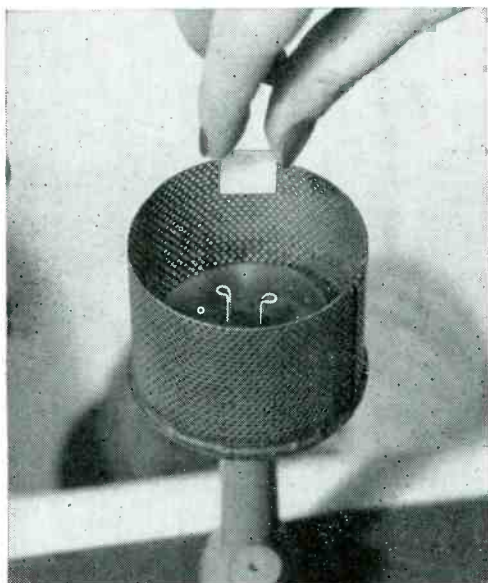

THIS is an actual photograph of the centrifugal air drier, or "spinner," used in Bliley production to facilitate clean handling of crystals during finishing and testing operations. Quartz blanks are dried in 5 seconds in this device which is powered with an air motor and spins at 15,000 r.p.m.

Little things like lint or microscopic amounts of foreign material can have a serious effect on crystal performance. The "spinner" eliminates the hazards encountered when crystals are dried with towels and makes certain that the finished product has the long range reliability required and expected in Bliley crystals.

This technique is only one small example of the methods and tests devised by Bliley Engineers over a long period of years. Our experience in every phase of quartz piezoelectric application is your assurance of dependable and accurate crystals that meet the test of time.

BLILEY ELECTRIC COMPANY - - - ERIE, PA.

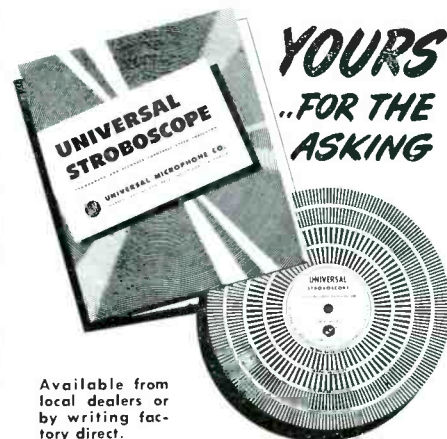

Available from local dealers or by writing factory direct.

UNIVERSAL STROBOSCOPE

This handy phonograph turntable speed indicator, complete with instructive folder, is now available gratis to all phonograph and recorder owners through their local dealers and jobbers. As a recorder aid the Universal Stroboscope will assist in maintaining pre-war quality of recording and reproducing equipment in true pitch and tempo. Universal Microphone Co., pioneer manufacturers of microphones and home recording components as well as Professional Recording Studio Equipment, takes this means of rendering a service to the owners of phonograph and recording equipment. After victory is ours—dealer shelves will again stock the many new Universal recording components you have been waiting for.



Band Width

(Continued from Page 13)

gives the lower limit of the frequency band corresponding to a degradation of one liminal unit compared with transmitting a much lower frequency.

The frequency corresponding to one liminal unit for speech may be taken as the mean of the figures for male and female speech, or about 150 cycles. In the case of music, it may be expected that at the lower as well as the upper end of the frequency range one liminal unit for an orchestra should fall about one third the way down the list of individual instruments, and two liminal units about two thirds the way down the list. This would make one liminal unit for music correspond to about 80 cycles and two liminal units to about 150 cycles. This speculation leads to the interesting hypothesis that the relations are probably the same at the lower as at the upper end of the frequency scale, that is, changes in band widths are twice as readily detected for music as for speech, and that the frequency limit corresponding to one liminal unit for speech corresponds to two liminal units for music.

RMA Parts Division Co-Sponsors October Parts Conference

FURTHER evidence of the importance attached to the forthcoming Electronic Parts & Equipment Industry Conference is presented in the fact that the Radio Manufacturers Association Parts Division has become a co-sponsor of the event, along with the Sales Managers Club (Eastern Division), the Association of Electronic Parts & Equipment Manufacturers (formerly the Sales Managers Club, Western Division) and the National Electronic Distributors Ass'n. The Conference takes place on Thursday, Friday and Saturday, October 19-20-21, at the Stevens Hotel, Chicago. Parts jobbers' and parts manufacturers' reservation blanks are obtainable by addressing the Electronic Parts & Equipment Industry Conference, P. O. Box 5070-A, Chicago 80, Ill.

Broadcast Engineers' Journal—September, 1944 17

THROUGH THE DEAFENING ROAR

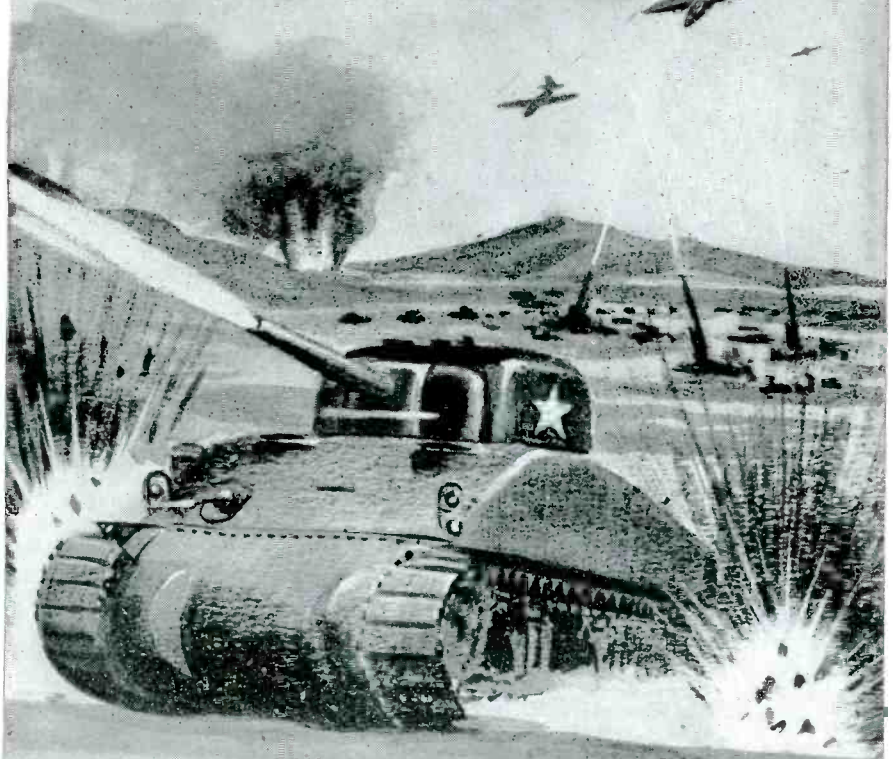

Noise Meets Its Master with Permoflux Acoustical Devices

Permoflux Dynamic Acoustical Devices, operating under extreme noise conditions, have proved the essentiality of uniform, wide frequency response. No other single factor contributes more to the intelligible transmission of vital war messages. With the coming of Peace, there will be many Permoflux engineered products to improve the efficiency and operation of speech transmission equipment.

BUY WAR BONDS FOR VICTORY!

TRADE MARK
PERMOFLUX

PERMOFLUX CORPORATION
4916-22 W. Grand Ave., Chicago 39, Ill.

PIONEER MANUFACTURERS OF PERMANENT MAGNET DYNAMIC TRANSDUCERS



Research gives TELEVISION new horizons

● TELEVISION RAYS—like human sight—do not “bend” far beyond the curvature of the earth. They travel in a straight line to the horizon—and from the horizon off into space. In preparing television as a service to the public, research has sought ways to extend television’s program service by radio relaying from city to city.

A solution to this problem has been perfected by RCA engineers: the radio relay station—capable of picking up and automatically “bouncing” tele-

vision images from station to station. With such relays supplementing a coaxial cable, entertainment, sports and news events could be witnessed simultaneously by Americans from coast to coast.

Today, RCA’s research facilities are devoted to providing the Allied fighting forces with the most efficient radio and electronic equipment available. Tomorrow, these same skills and energies will continue to serve America in developing and creating new and finer peacetime products.

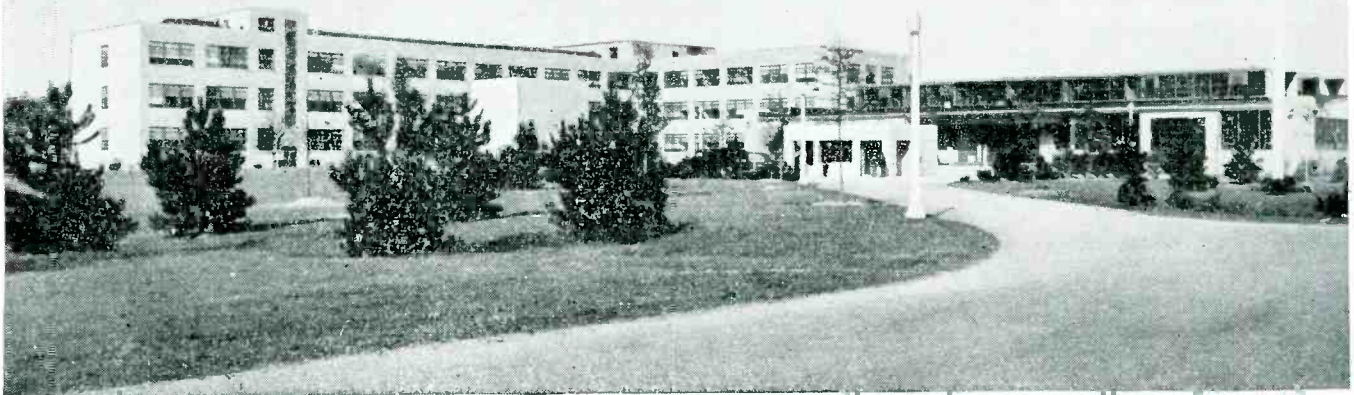

RADIO CORPORATION OF AMERICA
RCA LABORATORIES • PRINCETON • NEW JERSEY

RCA
leads the way in
radio—television—
phonographs—records
—tubes—electronics



Listen to RCA's "The Music America Loves Best"—Sunday, 4:30 P.M., E.W.T., over the NBC Network ★ BUY WAR BONDS EVERY PAY DAY ★

from HOLLYWOOD

By Norman Dewes

Deadlines . . . movies . . . transfers . . . Tropics tickets . . . Television . . . new PAX gimmick . . . summer . . . SUN . . . ducks . . .

THESE advancing deadlines continue to catch us with our columns down . . . managing editor **Stolzie** is stealthily managing to move up the issue date of the Journal a few days each month so that **EVENTUALLY** the current issue will contain the current news, the Utopia for **ANY** monthly mag . . . we're **FOR** it, and have invested in a genuine plastic **CRYSTAL BALL** against the day when he calls for **NEXT** month's news . . . in **ADVANCE** . . .

STREET SCENE . . . many citizens of Radio City maintain that there **OUGHT** to be a cross-walk or maybe even an underpass across Vine Street from the Artists' entrance to the Tropics and points north and south . . . anyway, there **ISN'T** any, and if you undertake to make the **PERILOUS** crossing against the swarms of "B" and "C" card holders who apparently drive with their **EYES SHUT**, you are either among the **QUICK** or the **DEAD** (*Eiler's Joke Book, 1944*) . . . **ANYHOW** . . . periodically members of the mounted Gendarmerie take up stations in the shadows on both sides of the street and proceed to issue Tickets to the Tropics for a nominal sum . . . some **THREE SLUGS** . . . inasmuch as you always need a **QUICK ONE** to recover from the trip over, and at least **ONE MORE** to fortify yourself for the journey back, the whole thing proves pretty expensive. The other night, groups of **IRATE OBSERVERS** stationed themselves on both sides and yelled warnings to those who didn't or couldn't see the cops . . . credulous crossers saved themselves the toll charge by going up to the corner and over, but **CERTAIN SMARTIES** didn't . . . yuh, yuh, yuh . . . as we say, there **OUGHT** to be a cross-walk . . .

SUN . . . has finally shown up, or rather **DOWN** . . . as we labor over our perspiring pencil the man on the radio sez it was 97.8 degrees today in Los Angeles (Chamber of Commerce figures . . . apply correction factor of 1.2) . . . the large amounts of **LOW HUMILITY** around Radio City makes it **SEEM** warmer, maybe . . . anyhow, some **GENUINE** sun-tans are glowing among the gals, making it hard to tell the difference between leg make-up and the **REAL THING**, without getting your face slapped . . . ours is frequently, but we manage to **TELL** a lot of **DIFFERENCE** . . .

MOVIES . . . moving in on the shows and studios in profusion lately, for some behind-the-scenes scenes of broadcasting . . . Columbia set up their **IATSE** equipment down in "D" to shoot some stuff for "Screen Snapshots," "Mail Call" was shuttered in "B" with **DeGrazzio SE** co-starring and Scientific Films photo-d a "Popular Science of the Screen" short about unusual occupations, to wit, **GIRL** Sound Effects men . . . with our gals **Leona 'n Dottie** actually **ACTING** for the flickering frames . . . they looked mighty **FETCHING** in pan make-up, too . . . making with the **FX** all over the place. The **MALE** lead was played by our popular young leading man **Don Baker**, lead-tracer

from Maintenance, who in a nice suit stood on one of our studio booms and made like a **MIKE MAN** . . . understand **Don** and the gals are hiring an **AGENT** to take care of the **OFFERS**, as soon as the thing is released . . . see your local theater, **SOON**.

TELEVISION . . . sat in with the **BRAINS** in the Equipment Room the other night and saw some good **PICTURES** on **Sax's** big RCA video receiver which **Johnny Morris**, Maint. Super and **Lew Winkler**, ME were lining up over in a dark corner . . . **John** was up on the roof three stories above, on top of the antenna mast and he and **Lew** were hollering tuning instructions up and down a convenient **CONDUIT** pipe . . . quite a contract between modern and ancient communication methods. Stations heard and seen were **Don Lee's** 1000 watter up on the Hollywood Hills and **W6XYZ**, "Hollywood's Newest Television Station" over by Paramount and operated by Television Productions, Inc. The stuff from Mount Lee came in like a ton of bricks, being only a few miles airline-of-sight away, and the sigs from **W6XYZ**, 100 watts on Channel 4 (78-84 mc) were quite clear and steady, altho there was some visual **QRM** and **N**. Production of the live stuff was somewhat reminiscent of the movies of the twenties, but nothing that a little **EXPERIENCE** won't fix. Observing from a layman's viewpoint, we felt that we would like one of the gadgets in **OUR** home, which is the proper way to feel, if the thing is ever going to be here to **STAY**. We would like to know **MORE ABOUT** it however . . . and wonder if **NY** wouldn't part with a little **INFORMATION** for the boys out west . . .

BLUE . . . first program for **KECA** staged and aired from the Blue Playhouse, as Blue now officially operating their local outlet . . . sales and program offices are functioning from **Sunset 'n Highland**, with alterations due to start soon, pending **WPB** approval and **GA** from **NY** Mr. **George O. Milne**, Blue Chief Engineer and **Johnny Johnstone** from the New York office are out here to look things over and arrange for operating personnel of the station. **George** has famby with him and plans to stay a week or so, so trip looks like a combo vac and biz jaunt . . . spent a day or two in San Fran too, we understand. **Baxter** takes **ANOTHER** physical and it looks as tho he **PASSED** this one . . . he will look well in suntans . . . not much hope for his retrieval, as the fellow is only 21 . . . **Johnny Eilers** having a spot of trouble in securing a satisfactory orchestra balance, so recommends that the Director employ a **CONTACT** microphone, placed in very **STRATEGIC** position . . . not a bad idea a-tall . . . a loud **WHOOSH** as our **Coke Bloke Ragsdale** passes thru, not even pausing to refresh . . . the guy is always **ENROUTE** and taking it on the **FLY** . . . **Doty** holding the **ENDS** together at **RKO** . . . it seems a mike cable or **SOMETHING** gave out just before show time, so **Ben** preserved the connection throughout the entire program and **SAVED** the network (according to those **MAD** fellows in **Publicity**) . . . a **NEAT** trick, and we wish we had seen it . . . **O'Kelly** fixing to transfer back to his old love **NBC**, **NY** having **OK-ed** a swap with **McGaughey** Hlyd **NBC SE**, who has been

trying to make the Blue for some time. We regret to lose **Jake**, but welcome **Bob** and vice versa . . . lots of luck to both of us. **LaCroix** building a FB rumpus room onto his garage during vac and spare time . . . gave a fair-well pahty to **Ralph Rogers**, Blue announcer-leaving-for-the-Navy and we helped initiate the BAR . . . you shoulda witnessed **Bar-tender LaCroix** trying to **HURDLE** it instead of crawling underneath . . . he **MISSED**. Speaking of parties, **Heffernan**, **SE** and **Cooley**, NBC Rec. slung one too for **Lt. Rogers** (one, two and you were **OUT**) . . . We **LEFT** just as they were starting to play "Pass the Grapefruit" . . . an innocent little game, played **WITHOUT HANDS** . . . **Lorenz** fishing somewhere up in the mountains . . . no reports as yet . . . **Powell** busy building record machines for producers and doing well with it . . . especially financially . . . **Banks** on ice with appendicitic . . . due for operation as soon as hosp reservation comes up but meanwhile in bed with Scotch on one hand, soda on the other and **ICE** in the **MIDDLE** . . .

DUCKS . . . this is a **LONG** story and most of the **DETAILS** cannot be published, but here is a brief resume of a very **FUNNY** situation . . . it **SEEMS** that the Summer Institute classes were winding up and the boys 'n gals wanted to giv **Prof. Arnold Marquis**, who was always saying quote, If you don't do this, you're a **DEAD DUCK**, unquote, a **SUITABLE** gift . . . so they go out and buy a very expensive quackless Muscovie duck, with about a four foot wingspread and present it to him on the night of the final party in "B" . . . **Arnold**, somewhat taken aback, keeps it in the booth, where it flies around during the **TC** airing of a script by one of the students, upsetting production and doing some things no gentleman duck **SHOULD** do . . . after the show, he gives it to engineer **Art Brearley** who takes it home to give to **Joe Kay**, Field Super who is wanting to buy a duck for his little son . . . next day it turns out that **Arnold** has bequeathed the thing to **Jennings Pierce** for his farm, so back goes the duck to NBC, in the back of **Art's** station wagon where it is parked on the Parking Lot to be picked up by a secretary. Wires get crossed somewhere and it gets delivered to the offices of one of our big agencies, **LOOSE** . . . the duck is getting fed up on all this nonsense by this time and proceeds to go **BESERK**, a la Fred Allen's eagle. It flies all over the swank offices of the agency, frequently behaving in the **SAME UNGENTLEMANLY** manner as before . . . and frantic phone calls ensue to attempt to find an owner. They finally locate **Arnold** who captures the thing and gives them a check to cover re-furnishing the offices. The **DUCK** is now peacefully floating about out at the **Jennings Pierce** farm, and as a **SEQUEL** to the whole affair, **Joe Kay** comes down to work to find two **BABY** ducks under his desk and **DeWolf** feeding them water out of an ash tray . . . **Art** had kindly purchased 'em for **Joe** as a consolation prize. **Joe** only wanted one but had to take **TWO**, as the man said that one would die of lonesomeness . . . anybody wanna buy a **DUCK**???

AROUND THE BUILDING . . . annex is completed and Sound Effects has moved in . . . ample space was created for all the sound trucks and speaker boxes and miscellaneous props such as doors, rain machines and the like. Inside entrance opens right onto the main corridor, a double door having been knocked thru the building wall next to the Re-Recording Room. Extra space is used to store large show props and scenery and at the far end orchestra risers, chairs and gear for the road shows is kept,

where it can be loaded directly on the moving vans thru large doors which open right on the Parking Lot. So far, no new Field Shop space has been allotted for **Joe Kay**, and it looks as tho there won't **BE** any . . . as usual, the engineer seems to have again become the **FORGOTTEN MAN** . . . it **WAS** a good idea, tho. The Maintenance Men are building a new three-place dubbing jeep (a 3-turntable contraption on wheels) . . . **Johnny Morris** sez he's gonna mount a seat on each side for an announcer and engineer and turn it over to the Blue for a portable **STUDIO** . . . give 'em a mike and just plug 'em in **ANYWHERE** . . . Goodyear Andy Devine show, rehearsing **VERY EARLY** on Saturday morning has a caterer cart in a **HUGE** tureen of coffee and crates of donuts for cast and crew . . . engineer **Fry** spreads the **WORD** and all the early birds **GET THEIRS** . . . early shift Blue announcers and engineers join in **YAMI YOGURT** orgies in Studio "M" . . . it's some kind of cultured milk you buy at an all-night market up the street and eat with a spoon . . . looks **PRETTY HORRIBLE**, but mike men claim it gives 'em cultured **VOICES** . . . it just gives us the **SNAFFLES** . . . more fall biz than ever before in sight, with Company unable to hire any more men due to manpower ceilings . . . studios will soon become a real problem . . . the **CLEVER ONES** in Maintenance have doped out a deal whereby you dial 5 on the **PAX** to get Master Control and if the line is buzzy you don't have to wait but are cut in on the conversation at once . . . very handy if you're in a **HURRY** . . . funny thing about that **PAX** (our studio interphone system) . . . we always thot that "Pax" meant peace . . . why did they **EVER** name it that???

CHIPS . . . **Ray Ferguson** coming back to NBC after several years as civilian employee with the Signal Corps . . . "Fergie" or "Flight Four" as he was known as in them thar days, starts in again as **SE Aug. 16th** . . . **Charlie Russhon** in to say hello and covered all over with medals and glory received during Special Events in the Burma campaign . . . including the Purple Heart . . . **Steve Hobart** just in from vac up and down Coast . . . dropped in on Doc Stewart up in Ventura . . . sez Doc has quite a lay-out, being West Coast listening post for the Blue for the Chungking pick-ups . . . several guys thru from Chi . . . ex-engineers now in Army . . . guests of **Jim Thornbury** in Rec . . . **McGauhey** and **Dewes** join the U. S. Chess Federation and attend weekly meetings of the Hollywood Chess Club . . . **Oscar Wick**, Maintenance vacationing on island "X" in the Pacific (shush-s-s-it's Catalina) . . . the island from which he come . . . and still owns property on or something, making so he can commute with the Coast Guard . . . **Prof. Brearley** giving finals and diplomas to his class of 67 Institute Engineering students . . . sez it's a long-awaited moment, to **GIVE** 'em instead of take 'em . . . **Ralph Reid** planning to go East on vac to visit folks in New England states . . . has been trying to line up train seats from the **OTHER** end over the Morse . . . we understand that **Ralph** cooks **TOO**, and plans a feed for the fellows soon . . . **Al Korb** swimming around in his pool these warm days . . . lucky fellow . . . **Ralph Clements** spending three weeks at beach with family and kids . . . **De** spent his two with **FLU** . . . **Bob Morris**, **SE** threatening to get married . . . **THINK IT OVER**, son, think it over . . . **Rhoda** our fair NBC Eng. Secretary vac in Laguna . . . **B. F.** is in South Pacific with the U. S. Navy and **Rhoda** has trousseau and ring **READY** and bags packed for a merger . . . as soon as her ship comes in . . . **BCNU** . . .

To meet your most exacting requirements . . .

ATTENUATORS by TECH LABS . . .

T-PAD ATTENUATORS

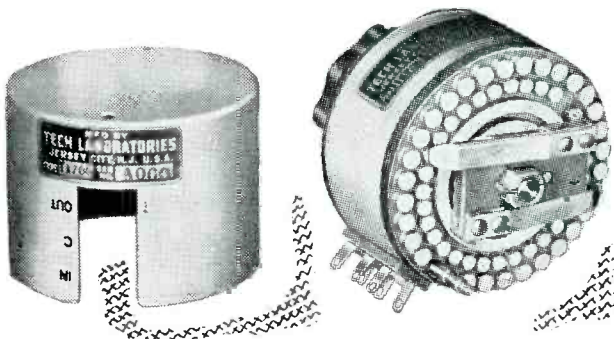

TYPE 700 Attenuators embody all improvements made during the war on our former Type 95 units. These improvements include silver contacts; improved die cast detent housing and detent gear which will stand up for a half million revolutions and more; special wiper springs of stainless silver which keep contacts clean and eliminate the necessity of periodic cleaning, and also greatly improves the noise level. In addition, the rotor hub is pinned to the shaft, preventing unauthorized tampering and keeping the wiper springs in perfect adjustment. Write for Bulletin No. 431.

MIDGET ATTENUATORS

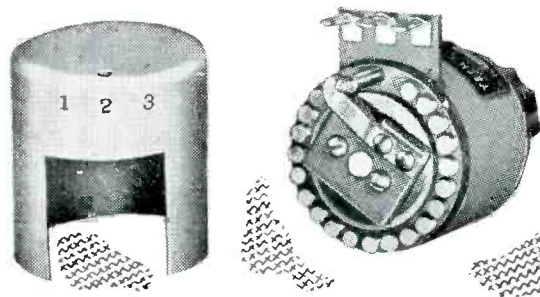

TYPE 600 Midget Attenuators represent a crystallization of all the improvements and experiments made during the war. These units also have silver contacts and special silver alloy wiping springs which stay bright and clean and reduce maintenance and noise level. The hubs are also pinned to the shaft and all other parts are as rugged and mechanically perfect as is possible in this small size. Write for Bulletin No. 431.

These units can also be furnished as Ladders, Potentiometers, Dual Potentiometers and Tandem units.

CONSULTATION SERVICE . . .

You are invited to consult with our Engineering Department on your "special design" problems.

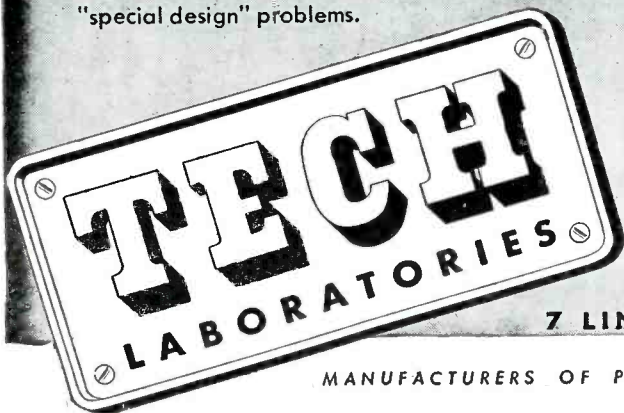

TECH LAB. MICROHMMETER . . .

gives direct and instantaneous readings of resistance values down to 5 microhms and up to 1,000,000 megohms. Furnished in two models. Accuracy in all measurements to better than 2%. Entirely AC operated. Write for Bulletin No. 432.

7 LINCOLN STREET, JERSEY CITY 7, N. J.

MANUFACTURERS OF PRECISION ELECTRICAL RESISTANCE INSTRUMENTS

Washington News

By R. E. Shenton

WHAT with Washington being in the middle of its vacation period, at least speaking for NBCites hereabouts, news comes in odd and far between snatches, making coherent accounts of local mianderings rather more difficult than usual. The weather is torrid, the humidity drenching and the nights still and sleepless; *hoi polloi*, whenever possible, take life serenely, move only when necessary. Thus, the setting—follows, the news.

The early days of August saw fit to usher into the world a junior op at the home of Mr. and Mrs. Walter Ward. The youngster, weighing just over six pounds at birth, is yclept Steven Wade Ward, and mother and son are doing excellently. Pop Wally, by the way, is sojourning at the Ager Road Annex (transmitter to the outside world) doing vacation relief work, and catching mice with his Electronic Mouse Trap. Reports of some lively chases, Wally after mouse, have come to us, but as far as we can ascertain, the quarry has been continually successful in eluding the hunter, no relation to Dan. Always the successful promoter, Mr. Ward, Sr., tracked down a box of stogies and the traditional cigar passing went on—business as usual, you know.

Among the recent visitors to the studios was ex-Studio Engineer Harold Thomasson, now Lt. H. Thomasson of the Air Forces. Added to his khaki blouse is a pair of silver wings, looking like a Life Saver which has passed on to that Promised Land where angelic pinions are in order. Hazy at the significance of the device, we inquired and were informed that they signify a Flying R - - - - Observer.

Harold whispered the cryptic cognomen into our ear, made us take a blood oath not to repeat THAT word. Nonetheless, we can say that he has finished his theory assimilation in Florida, and was en route to the midwest to begin some spine-tinglingly interesting, and quite as secret, tactical training. Congratulations are definitely in order to Lt. Thomasson, both for the new wings, and for the advance to the final stages of training in a very complex course.

Most interesting engineering happening of recent weeks is the presentation of the "Raleigh Room with Hildegard" show from the local Statler Hotel. Being a variety show, complete with band, studio audience, and all the other New York features so seldom introduced into Washington studios, there is a gala air about the proceedings which is quite a tonic to the local gang. Field Supervisor K. B. Williams has been handling the technical end of the job, and WRC announcers Banghart, Batchelder and Ludlam have copped tasty commercial orations so dear to the hearts of the speakin' lads.

One humorous incident which arose from the Raleigh show transpired between the aforementioned Mr. Banghart and the Statler Hotel. Relaxing in the lounge in that resplendent edifice, Ken found that he had run out of cigarettes, so he summoned a waiter, who leapt to attention at his side. "Bring me," he commanded, beaming at New York producers, publicity men, Raleigh executives, *et al.*, round about him, "a package of fresh RALEIGH cigarettes, plain". The courier dissolved into the thick

If you have not been using or have not yet tried Allied's New Glass Base Discs, a trial will convince you of their merits and superior quality — at no premium in the cost to you. We invite you to try this disc — that is how we obtain new customers. We feel certain that you will

reorder — that is how we build sales volume — from satisfied users. Your telephone call, letter, wire or cable will receive our prompt and courteous attention.

PROMPT DELIVERY direct from the manufacturer to any part of the United States, Canada, South America and to some foreign countries. ALSO AVAILABLE recoating service for your old aluminum discs. Delivery in one week. Details on request.

ALLIED RECORDING PRODUCTS CO.

21-09 43rd Avenue

Phone STillwell 4-2318
Cable: Allrecord New York

Long Island City, N. Y.

ALLIED GLASS BASE RECORDING DISCS

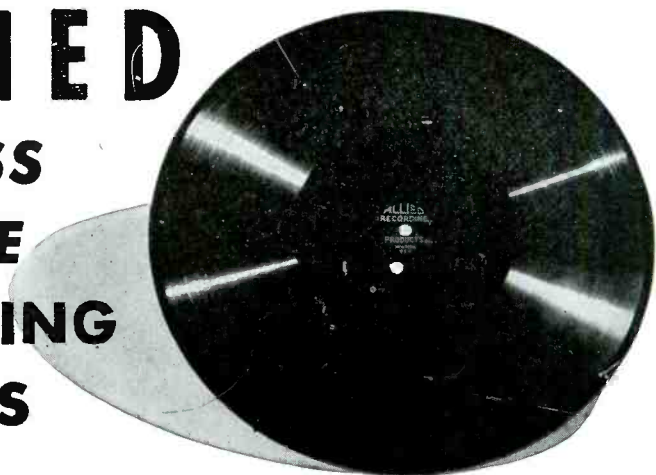

carpet, returned a moment later with the breath-takingly shocking reply: "I'm sorry, sir. We haven't any Raleighs." Let us hasten to add before a nasty libel suit arises, that Announcer Banghart was given several cartons of the brand-of-the-night by the ever alert group that never wishes to allow their product to slip out of the public eye (or mouth), and a good time was had by all, but especially by Supervisor Bill Chew who smokes Raleighs anyway.

A recent visit to the 400 Club, Washington version, with Johnny Rogers, fortunate engineer who was selected to do the ten minute local pickup of the trio operating there, rewarded us with a humorous conclusion for the column this month. To the left, as one enters the establishment, is situated the hat check booth, complete with girl, who tried her level best to make John (and yrs trly who was struggling with the OP5-X) check our cases. We were, however, adamant, and held onto the baggage with fervor. The whole thing struck John so funny, though, that he managed to fall half-way up the flight of stairs to the lounge. Seeing this happen, the hat-check girl remarked, quite shrewdly, we thought: "See, I told you, you ought to check that!" Maybe she had something there at that—what do you think?

We think we'd better wind this column up, and drink another long tall one. Keep your faders clean, and we'll drop in again next month.

Denver News By K. N. Raymond

Vacationing is chopping along as customary at this season. Stan Neal says his sailing excellent this year; Walter Morrissey cautiously dodging hayfever while mountaineering; C. A. Peregrine—a member of the Mountain Climbing Club by virtue of having scaled four of Colorado's 14,000 foot peaks, is now working on his fifth!

Some Can; G. Pogue first time up at the rod caught a couple that measured 18 and 16 inches; and some (experts) can't—and want to take lessons! D. Kahle, one of our successful fishermen, now getting his shootin' rods ready for the duck and pheasant seasons.

G. Dutton SE switched to nite trick and having trouble keeping housekeepers! The vision of a radioman is truly infinite (it says here) OR—if there's work involved . . . well A. Blake faced the Oriental torture of removing his wall paper; his genius combined a spray gun, some water, and an Electrolux . . . Try it!

The shingle now reads J. Finch, SPA—Sump Pump Authority—and general plumbing! Pre-training: a foot of water in the basement, a tangle with the OPA, etc. M. Hall busy home-site hunting; Joe Rohrer trying to hide a 30 foot tower. Working the Waistline Down Dep't now includes V. Andrews, D. Dobbins, Russ Thompson, and Ken Raymond. When the tractor motor is too strong for the wheels, the wheels become torn off in a hurry; skeptical?—it happened to G. Carpenter "our" farmer. Next time you plan a trip across the country do it "right" with a stop-over at DENVER.

20-WATT UNIVERSAL AMPLIFIER

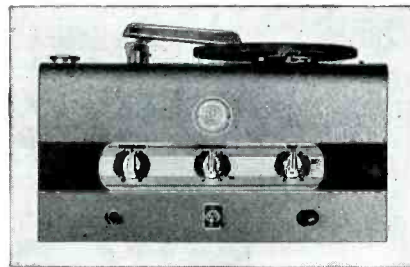

Plug in for A.C. or 6-volt auto battery; no power pack necessary. Uses mike and built-in phono at same time. 78 RPM motor, 9-inch turntable, crystal pick-up, separate on-off switch. Long-playing needle included. Continuously variable tone control on inclined eye-level control panel. Use one or two 8-ohm speakers without need of extra transformer. Has one 6SJ7GT, one 6SC7, two 6L6Gs in push-pull, two 6X5GTs.

Model 6720, with tubes, F. O. B. New York \$56.28

Model 6721, same as 6720, less phono player \$42.87

TERMINAL RADIO CORP.

85 CORTLANDT STREET, NEW YORK 7, N. Y.

PHONE WOrth 2-4415

HUDSON CHAPTER NEWS By Richard H. Davis

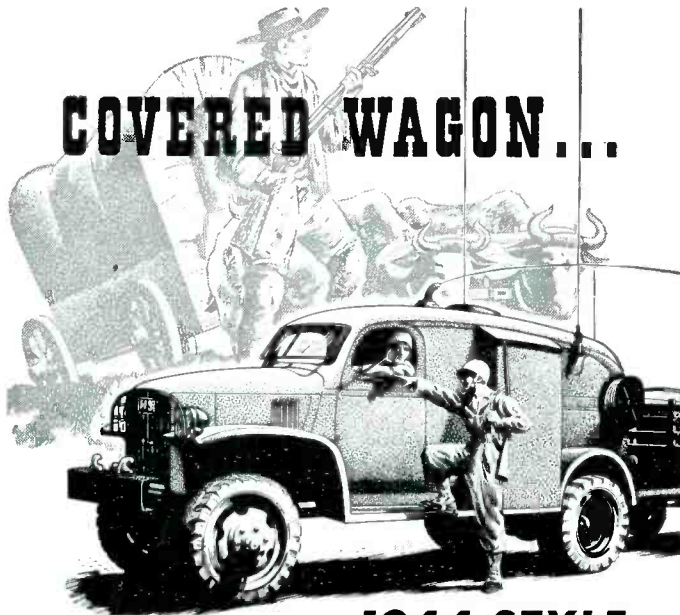

...1944 STYLE

BLAZING NEW TRAILS TO FREEDOM

... The covered wagon 1944 style is the SCR-299—the famous piece of mobile radio equipment built by Hallicrafters. It is blazing new trails to freedom in all corners of the world, wherever men fight; and by extending Allied lines of communications, it is playing an important part in saving American lives and in shortening the war.

Just as the pioneers faced new frontiers with courage and strength, the men and women who make Hallicrafters equipment face the post war period solid in the conviction that they are helping to stake out exciting new territories. You can win yourself a share of these new lands with short wave communications equipment. Hallicrafters were famous before the war as the makers of the ham's "ideal radio." They earned a reputation for the development of "the radio man's radio" and that reputation was solidified in war time. In peace, out of this intensive experience and realistic know-how they will continue to make the finest that can be made. There will be a Hallicrafters set for you in our post war line.

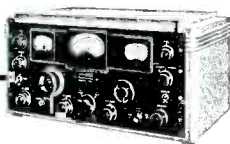

Hallicrafters short wave communications receivers like this will help push back the horizons of tomorrow and make new radio history. This is a 1.5 tube, 6 band receiver of amazing range and performance.

BUY A WAR BOND TODAY!

hallicrafters RADIO

THE HALLICTRAFTERS CO., MANUFACTURERS OF RADIO AND ELECTRONIC EQUIPMENT, CHICAGO 16, U. S. A.

A BIG "Welcome Home" to "ED" Franke TE who arrived back in this country after covering the "D" Day activities for Mutual via a tape recorded with Larry Meier as commentator. Most of the recording took place aboard a man of war. Ed looks fine and promises a good story when certain restrictions are lifted. He was in England during part of the "Buzz" bombing and has no liking for it. They sound like a motorcycle running "Wide Open". One item which "Ed" comments on is the "GI" steak, or "Spam". He has had it at least 1,000 ways. If a new dish appeared on the table just move a piece over a little and "Eureka". Back to US via Air, with supper in Britain and breakfast on this side of the water, with a New York lunch Ed says was quite a "kick".

"Hax" Hadden MC supervisor will schedule all technical assignments and co-ordinate operations with Dumont Television Station WABD and WOR in connection with Tuesday night "WOR Video Varieties".

"Bill" Taylor formerly SE now in production division of Program Department as Production Supervisor. Good Luck, Bill.

"Johnnie" Cooke SE vacationing in a nice cool cellar (Beer?) that is what he says.

Frank Ennis, Recording back from Atlantic City after absorbing a lot of Vitamin D during his vacation.

"Geo" Riley TE and Hudson Chapter Chairman visiting his home town of Phenixville, Pa., recently.

With August as the hottest on record in N. Y. three major fires broke out which WOR covered. It happened on the week end of August 11th, 12th and 13th. The engineers and others are forming the WOR-son squad to take care of similar events. Ray McEntee, Recording took Sound-scriber equipment to Hoboken for the Pier No. 4 fire and with Paul Killiam as commentator recorded several hours of interviews with Coast Guardsmen and fire fighters. A side light on this fire is that at WBAM (WOR's FM Station) 10 miles away and 43 floors up a thorough search was made for the source of the "insulation" smell in the transmitter room. Next came the Luna Park fire with Ed Pearson as commentator on Saturday. On Sunday Palisades Amusement Park caught fire. Eric Fields SE grabbed the recording equipment and made a fast taxi trip. At the park they had to park in the midst of the fire engines. In order to get some juice to run the recorder it was necessary to do some smooth and fast talking to a local house owner; this accomplished, about four hours of commentary by Bob Shepard and Jeff Smith were put on acetate. The park was about 75 percent destroyed. All this in a temperature of 95 in the shade! whew!

Second Invasion

This time the invasion was so routine that the "night owls" Breitegger and Williamson handled all the details. The next ones will probably be scheduled on the "Nemo" sheet.

"Dough" Hawkins, Recording in Washington recently on a visit . . .

"Mac" Benoit SE at the Mutual No. 2 Theater, amusing himself listening to the stage hands comments on the various shows while they're setting up. These birds don't have any caution about "dead" mikes!

A report of the South Seas says that the pop bottles that we're missing are doing service as insulators. The first

thing we will know an "insulator makers union" will claim that the "pop bottlers union" is making insulators and thus are unfair to them!

The Recording Dep't misses De Lannay who has been out for a short time with a bum knee. Especially when you have 14 turntables to keep going sez "Bart" Simpson.

Well, that's all for now and since everybody is on vacation I might as well go too. 73 . . .

New Television Stations

From FCC Report No. 1594.

WGAR Broadcasting Co., Cleveland. Channel No. 3.

From FCC Report No. 1602.

A. B. DuMont Labs, Passaic, N. J. Channel No. 4.

Columbia Broadcasting System, New York. Experimental, 401 to 417 mc.

From FCC Report No. 1603.

Warner Bros. Broadcasting Corp., Hollywood. Channel No. 3.

From FCC Report No. 1604.

Albuquerque Broadcasting Co., Albuquerque, N. M. Channel No. 1.

From FCC Report No. 1605.

Zamoiski Co., Baltimore. Channel No. 6.

Pulitzer Publishing Co., St. Louis. Channel No. 1.

From FCC Report No. 1606.

WKY Radiophone Co., Oklahoma City, Okla. Channel No. 1.

KLZ Broadcasting Co., Denver. Channel No. 3.

From FCC Report No. 1608.

WFBM, Inc., Indianapolis. Channel No. 2.

From FCC Report No. 1610.

General Television Corp., Boston. Channel No. 1.

United Detroit Theatres Corp., Detroit. Channel No. 4.

From FCC Report No. 1612.

Globe-Democrat Publishing Co., St. Louis. Channel No. 1.

Consolidated Broadcasting Corp., Los Angeles. Channel No. 7.

Omaha News By Roy Glanton

I note with interest, in the June issue, the small amount of time lost by various NBC owned stations. It prompts me to put in a word about the amount of time (1 hour—10 minutes—39 seconds), lost by WOW. It is small considering the total hours on the air during 1943, 8,360 hours!

Being a key station for the 7th Service Command, Air Alert Service, we were on the air continuously 24 hours per day for 12 months, 10 days. We were allowed only 3½ hours off every 8 days for maintenance.

The loss of time broken down is as follows:

| | Hrs. | Mins. | Sec. |
|--------------------------|------|-------|------|
| Due to storms..... | 0 | 11 | 45 |
| tubes | 0 | 32 | 07 |
| power line failures..... | 0 | 10 | 58 |
| all other | 0 | 15 | 49 |
| | 1 | 10 | 39 |

A total of 31 minutes was lost during time we were on the air with carrier only for air-alert service. Total loss of

program time 40 minutes and 39 seconds.

Mark McGowan is spending his vacation in a cabin in the mountains somewhere WNW Denver. Lucky guy! Al Maller is next on the vacation list, expecting to spend the time fishing.

The last account we had of Dick Peck he was in Italy. In letters to some of the fellows here he told of having been to Rome, where he saw St. Peter's, Vatican City, and sundry other places of interest.

Louis DeBoer, newest addition to the WOW staff, has made application for membership in NABET.

WOW's 460-ft. tower shines from afar with its new coat of white and orange paint.

Members of the WOW staff (65 in number) had a group picture made a few days ago to be used in a souvenir brochure, which the station is getting out.

Al Maller treated the gang to a steak dinner at our favorite steak house, Marchio's. Incidentally, a lot of heat having been put on Chief Kotera, he has agreed to buy steaks August 14th. Roy Glanton wishes they would postpone the steak dinners until he gets his new "China Clippers," because in the meantime he has to eat soup!

The Answer
TO YOUR
PROCUREMENT PROBLEMS
MAY LIE
BETWEEN THESE COVERS!

OVER 10,000 ITEMS IN STOCK! EVERYTHING IN RADIO PARTS • TUBES and ELECTRONIC EQUIPMENT

Buy Another Bond —Today!

SUN RADIO & ELECTRONICS CO.
212 FULTON ST. • NEW YORK 7

Send for this **FREE** 800 page **BUYING GUIDE**

Available without cost to authorized purchasing agents who write on station letterhead. Address Box BS.

Telephone BARclay 7-1840

From SAN FRANCISCO

By S. A. Melnicoe, K. Martin, A. Wauchope

San Francisco Chapter members are all agog over the news that Clark "Red" Sanders, Blue FE, has been named to accompany the group of Blue war correspondents who leave shortly for their assignment with General MacArthur's headquarters. Red was limping around for several days as the result of several strategically located injections. The Blue is now looking for a couple of replacements. Blue studio engineers are wondering who will inherit Red's junkets.

J. "he's really that tall" McDonnell claims he can't go because the Pullman company berths just don't fit. Cliff



Bill Baldwin and Clark "Red" Sanders; (rear row, left to right) Cleve Roberts and Arthur Feldman confer with G. W. "Johnny" Johnstone, center, on plans for the Blue Network's coverage of the impending battles in the Pacific. Baldwin, Sanders, Roberts and Feldman will leave shortly for their assignment with General MacArthur's headquarters.

"too much overtime" Rothery says he can't sleep on trains. And so it goes. "Andy" Andresen was away on another "coke" trip and couldn't be reached for comment.

Courmettes & Gaul OPTICIANS

55 West 49th Street
R. C. A. Building (Main Floor), New York

EYE EXAMINATIONS

Prescriptions Filled . . . Prompt Repair Work

Invisible Contact Lenses Fitted

San Francisco has lost its glamorous gal engineer. Come about midnight one of these gorgeous July nights and who should get past the guard but a sailor demanding the new address of "Gentle Annie" Dunnaway. Careful questioning revealed that he was none other than the gal's husband on a long-expected but just-realized leave from his naval duties. The address was duly communicated and early next A. M. there was Ann with the news that she was leaving us; yeah, she was going home. And this time she was NOT going to stop off at Denver. We will sure miss her, the lounge doesn't seem the same without our Annie. Be on the lookout, youse guys back East. Rumor hath it that Ann may head your way shortly as her husband may be stationed in your vicinity, and, if so, well, maybe you'll be as lucky as we were. Good luck, Ann.

A busy visitor at San Francisco this week is G. O. Milne, Blue chief engineer, conferring with Bev Palmer on changes in the local Blue setup.

San Francisco NABET Chapter had a well-attended meeting latter part of July. J. Alan O'Neil submitted his resignation as chapter chairman due to the pressure of personal business. A successor is in the process of being chosen.

The installation of the new windows in the MCD has the boys turning their heads these days. Could it be the

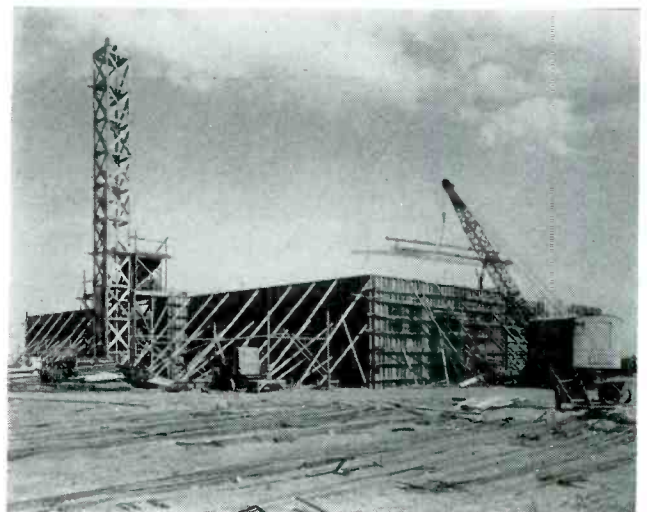

This view shows the building for the Dixon transmitters in the process of construction and gives some idea of the size of the installation.

attractive receptionist, Jere to you, that the Blue has stationed at the third floor desk. Studio engineers seriously considering taking up a collection for "neck oil" for Messrs. Jefferson, Kolm, Kilgore, Summers, Parkhurst, et al.

KPO was awarded the National Security Award of the OCD by the Ninth Civilian Defense Region Office. A cer-

tificate and flag were presented to General Manager John W. Elwood for "maintenance of a superior standard of protection and security".

When Commander P. A. "Bud" Sugg, ex-NBC Supervisor, was here a few weeks ago we learned for the first time that he is now technical commander in charge of naval air, radio, radar and electrical training for the entire navy. He has served as naval liaison officer for the Seventh Interceptor Command, on Admiral Nimitz's staff at Pearl Harbor, as first commander of the Pacific Fleet Radar School and as member of the Bureau of Aeronautics Radar Training. Bud wears the green ribbon denoting commendation from Admiral Nimitz, the yellow pre-Pearl Harbor ribbon and the Asiatic and American Pacific ribbons.

The boys at KGO were wondering how come the floodlight cables were in such good condition this year. Gopher damage was down to almost nil. Councilman Herb Kramer came up with the answer. The station's victory garden has proved to be a source of much more tasty morsels. He has been trapping gophers ever since. Instead of following the horses south Shorty Evans headed for Reno and the Bank Club. Nope, he didn't even break even! Darn, there goes another good yarn! Shortly will now devote his time to some of the "little brown" ants at the KGO transmitter that spread their wings and attack anything, even engineers, in military formation. Rumor has it Jim Ball is converting his vacuum tube voltmeter into a death ray for the insects.

"People Are Funny" spent the last weekend in San Francisco with Sam "I only weigh 190" Melnicoe at the controls. He lost two pounds trying to find Sonny Tufts' voice!

No progress report in re: the Dixon transmitters. All we know is that they're in the process of being installed. The accompanying photo shows the house going up. Big, isn't it!

Amperex Affiliates with North American Phillips

Effective July 1st, Amperex Electronic Products of Brooklyn has been reorganized, and the business will be continued as Amperex Electronic Corporation. Personnel, management, and policies remain unchanged except for the retirement of N. Goldman, due to ill health. A. Senauke is President, Nicholas Anton is V. P. in charge of Manufacturing, and Samuel Norris is V. P. in charge of Sales. As part of the reorganization, Amperex becomes affiliated with North American Phillips Co., Inc. In addition to its own research and engineering facilities, Amperex will benefit



Samuel Norris, V. P.
In Charge of Sales

from the knowledge, research and experience of the Phillips organization.—Ed. S.

CAPPS*

SAPPHIRE is, and has always been, the only material for making cutting styli for high class recordings.

CAPPS* Patented Sapphire Styli (2187512) are the original and accepted standard for high class professional acetate recordings.

Imitated but not equalled

FRANK L. CAPPS & CO.

244 W. 49th STREET NEW YORK CITY

Telephone Circle 6-5285

* Reg. U. S. Pat. Off.

If you require information on

INSURANCE

of any kind, call

HERBERT LEROY RICE AGENCY

10th Floor, RCA Building
Suite 1017

Telephone
NBC Extension 140

Aaron Lippman & Co.

246 Central Avenue Newark, N. J.

Radio and Electronic Equipment

We Expedite — Ask Anyone



NBC Photo

Preparing for the postwar era of television are these engineers of NBC's Central Division and of the Blue's Chicago office, who are being instructed by Clarence Radius, former chief instructor of RCA Institute's Chicago school and now head of the audio-video engineering department at the school's New York branch. Each weekly session is presented four times. Seated are: Front row, H. C. Eckland (BNC), G. J. Kemp (BNC), R. H. Parker (BNC), George Maher (NBC); second row, Mary Ellen Trottner (NBC), G. Mehren (BNC), A. J. Forgach (BNC), A. J. Schroeder (NBC), A. D. Aldred (NBC), A. W. Hjorth (NBC); in background: third row, J. V. Lato (BNC), G. J. DeVlieg (NBC), H. C. Johnson (NBC), L. N. Balsley (NBC); fourth row, H. L. Cavanah (NBC), W. J. McDonnell (BNC).

CHICAGO NEWS By Arthur Hjorth

Chicago coolest large city during nation-wide record breaking heat wave. Columnist and wife Carmen decided Texas too hot for vacation so stayed near the lake.

Captain Ralph Brooks and wife Marguerite with Alan Scarlett and Doris vacationed along the shores of Lake Michigan on board the Brooks' yacht the "DOLPHIN". Details and pictures promised for next issue.

SOS letters to all Chicago Chapter points outside of Merchandise Mart resulted in replies from no one but "Andy" Forgach at WENR-WLS transmitter. 'Andy' reports letter from MAJOR AHLGRIM in England with five other officers paying \$500 (five hundred United States dollars), a month for their apartment. Advises that Lt. Ponte in Italy reports operation of a 5 KW rig a bit difficult on forty-two cycle current. 'Mac' McDonnell is walking the floor these nites. Fifteen-month-old Charlene is the daughter of Joyce Lee who is Ethel and 'Mac's' daughter, thus making Mr. and Mrs. McDonnell, grand-mama and grandpop. And are they proud!! Harold Rawson, Harve Kohnitz and Andy Forgach are so impressed with their crops at the transmitter that they are offering nice juicy melons FREE. Transmitter boss H. B. Courchene is vacationing at Phoenix, Arizona. Lt. Johnson in the Navy at Philly and Lt. Bombaugh at San Diego haven't been heard from in months. All these newsy items from WENR-WLS transmitter.

So many candidates in most groups voting for councilmen that many run-offs are in the process. Only Ed. 'Burr' Whyland of WLS, Art. Elkins of NBC Maintenance and

Art. Hjorth Day Studio were elected in the first balloting. Picture of our new Council headed by Chairman 'Bev' Fredendall with our Texas Secretary-Treasurer Frank Golder will appear in the next issue. (I hope.) (Me too—Eds.)

Frank Schnepfer has now acquired the title of Commodore by the purchase and command (with the help of wife Virginia and wee Ronnie and Bonnie Lou of the twenty-six foot "ketch," the "DINORO".

Versatile Carl Cabasin of NBC Field handled an NBC network show, a Blue network show, a local stint for 'Q,' cut some records from another studio, worked in the recording room a few hours and did a field pick-up, all in the same day. With television classes he would have done a video show, but couldn't find any cameras around so had to quit!

Don Fitch shifted from nites to days and now currently can be silently heard on VIC and SADE, HYMNS OF ALL CHURCHES and BACK-STAGE WIFE.

Wedding anniversaries this month for CLARA and MAC MacCornack (fourteen years), NANCY and JOHN Miller (fifteen years), ARDITH and VERNON Mills (thirteen years), DELLA and CHUCK Ostler (four years), EDINE and BOB Rudd (thirteen years), VIRGINIA and FRANK Schnepfer (fourteen years), BOBBIE and H. (Harry?) White (seventeen years), VERA and ED. Whyland (nine years), and MARY ESTHER and HERB Wyers (three years), just newlyweds. Sho' a mess of weddings in September.



KEITH THOMAS

History of Communications Number Seven of a Series

EARLY COMMUNICATIONS BY AIR



MODEL
1700-UB



While electronics use the ether and other media, one of the most speedy methods of communications in the early days was through the air by carrier pigeon. With a finely printed note fastened to the leg, these birds faithfully reached home to bring in the latest news events and stock market reports.

Today news commentary reaches into your homes in a flash of a second via electronic voice communications making use of the various types of Universal broadcast microphones. This being a modern age, the battle front is brought into the homes of the informed peoples of the democracies via military microphones such as those now being manufactured by Universal for the Allied Armed Forces.

< Model 1700-UB, illustrated at left, is but one of several military type microphones now available to priority users through local radio jobbers.

UNIVERSAL MICROPHONE COMPANY
INGLEWOOD, CALIFORNIA



FOREIGN DIVISION: 301 CLAY STREET, SAN FRANCISCO 11, CALIFORNIA • CANADIAN DIVISION: 560 KING STREET WEST, TORONTO 1, ONTARIO, CANADA



Beyond what the eye can see . . .

It's an easy matter to disassemble a DAVEN ATTENUATOR, as we have done here. And even a hasty glance is sufficient to gain a favorable impression. The resistive network*, with its demand of infinite skill and patience . . . the new, large detent gear on the stainless steel attenuator shaft . . . the detent gear roller and spring recessed within the steel attenuator cover . . . the new positive stop, eliminating stress on the rotor hub . . . the tarnish-proof silver alloy contacts . . . the unique two-piece, dust-tight steel cover—these, and other features, have won wide acceptance for DAVEN ATTENUATORS. *Because*, beyond what the eye can see is a certainty of dependability that is rooted in DAVEN'S long experience and leadership in designing and building good attenuators. Specify DAVEN ATTENUATORS.

DAVEN ATTENUATORS are made in the following circuits: Ladder, T or H, Potentiometer (Potential Dividers), L and Rheostat, balanced or unbalanced. Any desired impedance, number of steps and DB per step; with or without detent.

**Resistive network completely wire wound under exclusive DAVEN patent. New attenuator construction, patent pending.*

Buy More War Bonds and Hold on to Them Until Maturity

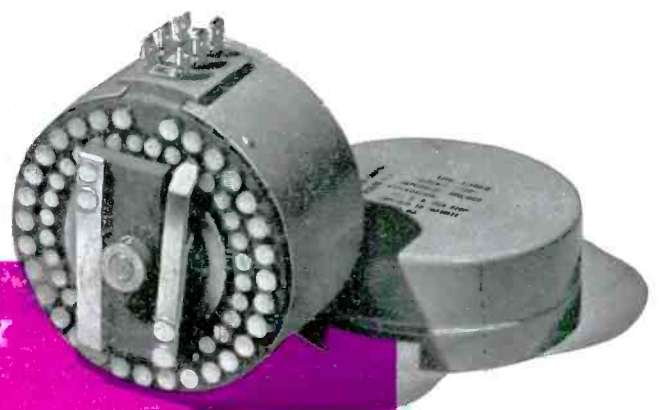

THE **DAVEN** COMPANY

191 CENTRAL AVENUE
NEWARK 4, NEW JERSEY