

NOVEMBER 1984

\$3.00

BME

BROADCAST MANAGEMENT/ENGINEERING

PROGRAMMING &
PRODUCTION
ROCK RADIO REUNION

Undercover ENG



Also in this issue:

Analog Component Production ■

TV Monitors for Raster Graphics ■ RTNDA Preview

The Leader Sync/Test Generators.

Every important feature for under \$2,000.

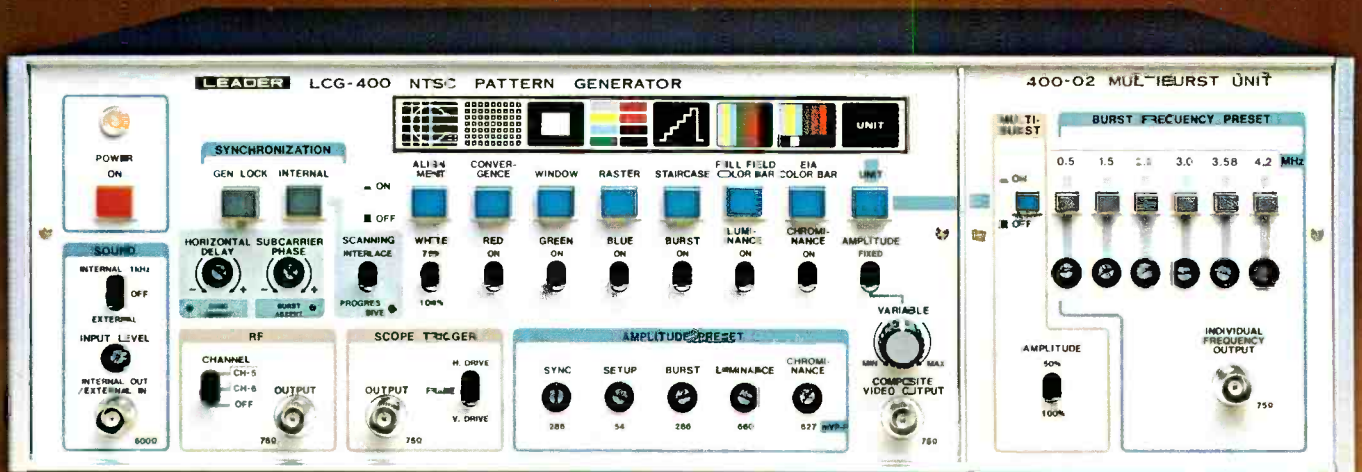

Precise NTSC sync/test pattern generators.

Leader's LCG-400 series sync/test generators provide accurate reference signals for any off-the-air broadcast or non-broadcast operation. Available in either multi-burst or sweep marker configurations, the LCG-400 provides EIA and full-field color bars as well as staircase, raster (in eight colors), window, convergence and cross-hatch test signals... plus gen-lock capabilities and a host of auxiliary outputs. As a matter of fact, Leader's sync/test generators do virtually everything the \$4,000 generators do... except cost as much.

A network-proven 50 MHz oscilloscope.

The Leader LBO-517 oscilloscope makes accurate and detailed measurements. It offers sensitivities of 1 mV to 10 MHz and 5 mV to 50 MHz. Two main and two auxiliary channels can be displayed on main and delayed time bases (8 traces) simultaneously while intensifying



LBO-517 50 MHz Oscilloscope.

the delayed portion. Composite triggering provides *stable* viewing of two asynchronous inputs. Positive, stable triggering on composite video signals, at either H or V rates, is automatic. Leader's new dome-mesh 20 kV CRT assures bright, clearly defined displays, even at the highest or lowest sweep rates. Very competitively priced.

The Leader Vectorscope is unique.

Only the Leader LVS-5850 NTSC Vectorscope offers CRT-generated phase/amplitude targets that are as bright and clear as the vectors themselves. Now you can easily verify NTSC Vectors in darkened control rooms. And, electronically generating the targets eliminates non-linearity errors caused by CRT aging. You can mount it in your existing console, view it from any angle



LVS-5850 NTSC Vectorscope.

or distance, and be confident that what you see is what you've got.

Two-year warranty. Evaluation units.

A history of high reliability permits Leader to provide a generous two-year warranty (even on the CRT)... backed by factory service depots on the East and West Coasts. Evaluation units are

available to all qualified customers.

Call toll-free (800) 645-5104 to request: an evaluation unit, our latest catalog, the name of your nearest "Select" distributor and additional information.

For video engineers who know the difference.

LEADER
Instruments Corporation

380 Oser Avenue
Hauppauge, N.Y. 11788 (516) 231-6900
Regional Offices:
Chicago, Los Angeles, Dallas.

Circle 100 on Reader Service Card

THE TBC THAT SKIPPED A GENERATION

FORTEL introduces the most significant advancement in the history of time base correction. The TBC³² Time Base Corrector™ — a powerful innovation in performance, cost, size, and weight. A TBC so advanced it has been described as having, ... "skipped a generation in the development cycle."

FORTEL's TBC³² is unique. It is the only digital time base corrector on a SINGLE PRINTED-CIRCUIT CARD. The compact power of the TBC³² delivers performance that meets or exceeds that of all other 1" Type "C," 3/4" and 1/2" composite heterodyne TBCs.

The industry's most advanced TBC features:

—Optional 8 or 9 bit digitizing at 14.3 MHz sampling rate for unsurpassed SNR, K Factor, and differential phase and gain.

—A superwide 30 line correction window easily corrects even the most severe time base errors, and provides dynamic tracking without expensive memory options.

—Exclusive DYNA-TRAC™ dynamic tracking

capability for up to 2X reverse through 4X forward play speed, including slow motion and stop action, and shuttle mode viewing of ± 50 play speed.

—Phase CompII™ velocity compensation and superior DOC based on line averaging.

—Super compact size (1 3/4" single rack unit height), lightweight (15 pounds), and low power consumption.

—The industry's best one-year warranty on parts and labor.

At \$12,995, the TBC³² is thousands of dollars less than the latest models from Ampex and Sony. Models that offer far less performance and features.

FORTEL's POWER OF INNOVATION sets new performance standards for 1" Type "C," 3/4" and 1/2" heterodyne TBCs, while reducing size, weight, power consumption

and, best of all, price. Quality...made in the USA Call or write FORTEL today for more information on the TBC³² — the TBC that skipped a generation.

TM TBC³² Time Base Corrector, DYNA-TRAC, and Phase Comp II are trademarks of FORTEL Incorporated.



FORTEL Incorporated
2985 Gateway Drive
Norcross, Georgia 30071
404-447-4422



WHILE EVERYONE ELSE HAS BEEN PROMOTING A FORMAT, SONY HAS BEEN PERFECTING A SYSTEM.

Over the last three years, Sony's rivals in the combination camera/recorder arena have spent considerable time inventing wonderful things to say about their new formats. But apparently, they've overlooked inventing many wonderful new products to go along with these formats.

Sony has taken a different course.

In 1982, Sony introduced Betacam™ and the BVW-10 play-

back unit. An evolutionary system that didn't force stations to abandon their existing 3/4" and 1" equipment.

Then, in 1983, Sony expanded the system with the three-tube Betacam, the BVW-40 edit/recorder, and the world's first battery-operated 1/2" field playback unit.

And this year at NAB, Sony announced a major breakthrough in cart machine technology with Betacart.™ A system

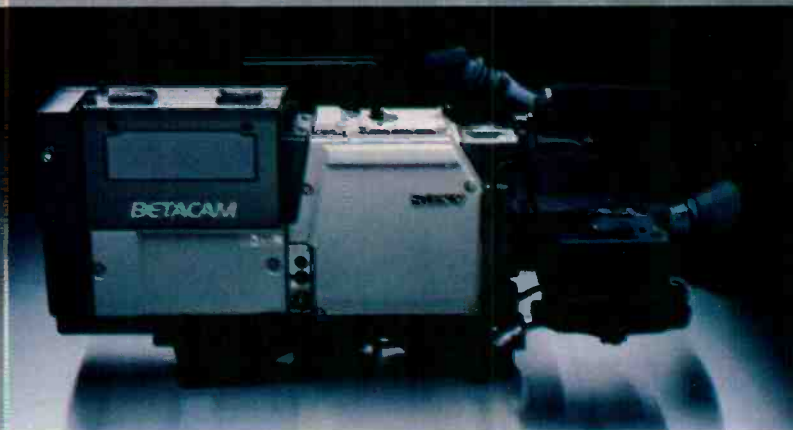

that demonstrated the Betacam format's strength beyond the newsroom, beyond the studio, and beyond field production. At the same time, Sony also unveiled the world's lightest camera/recorder, the BVW-2 Newsmaker.™ And a prototype coder/decoder system that will make it possible for Betacam to be transmitted by microwave. Each of these products is the result of Sony's dedication to

the needs of the ENG and EFP industry. Work which has earned the Betacam format widespread acceptance by television stations and production companies around the world. Which only makes sense. After all, in this business you don't win sales on the merits of your arguments. You win them on the merits of your products.

SONY
Broadcast

FEATURES

42 UNDERCOVER ENG

Hidden cameras and concealed microphones can get stories that would be inaccessible by ordinary ENG techniques. *BM/E* takes you undercover to examine these covert newsgathering methods . . . by *Eva J. Blinder, Senior Editor*

On the cover: Sony's Betacam.

55 THE ANALOG COMPONENT DREAM

Activities by the SMPTE, product developments, and innovations by broadcasters and facilities are paving the way for what could be the not-so-distant future: the "pure" all-component plant . . . by *Michael Greenhouse, Associate Editor*

72 TV MONITORS FOR VIDEO GRAPHICS

There is a host of features which must be taken into account when choosing a picture monitor.

83 INDEXTRON: A NEW BEAM-INDEX PICTURE TUBE

Using beam indexing instead of a metal plate to focus the electron beam, this new picture tube development makes possible a picture 70 percent brighter than conventional tubes . . . by *Robert Rivlin, Editor*

91 RTNDA: EXPANSION AND "HOW-TO" SESSIONS IN SAN ANTONIO

BM/E gives you a full preview of this major show.

NEXT MONTH

■ TENTH ANNIVERSARY BEST STATION AND FACILITY DESIGN COMPETITION

DEPARTMENTS

10 Editorial

The Digital Audio Dilemma Solved

12 Broadcast Industry News

Hurricane Diana puts Ku-band to water test as CBS gives Betacam another major convert

23 RADIO PROGRAMMING AND PRODUCTION: Rock Radio Reunion Generates Nostalgia and Profits for WCBS-FM

New York's WCBS-FM reunites radio legends of the 60s . . . by *Judith Gross*

35 TELEVISION PROGRAMMING AND PRODUCTION: Small-Market TV Station Takes the Big-Market Outlook

New Hampshire UHF independent WNHT positions itself for success and influence . . . by *Eva J. Blinder*

100 Advertisers Index

105 Great Idea Notebook: Station-Run Weather Forecasting Service

109 FCC Rules and Regulations: The New Window System: A Well-Intentioned Mistake?

115 Broadcast Equipment

118 Business Briefs

UPTOWN DOWNTIME?

GET TOUGH . . .

MRC-1

Can you afford down-time when the competition is just a twist of the dial away? The MRC-1 Microprocessor Remote Control from Moseley runs remote-site applications like television, radio or earth-satellite transmitters at peak efficiency, and makes day-to-day operation simple. It controls up to 9 remote sites, monitoring each site with as many as 32 status channels, 32 telemetry channels, and 64 command lines.

Tailor MRC-1 operation to your exact specifications during setup. Calibrate telemetry channels at the keyboard for linear, direct power or indirect power scaling. Specify upper and lower limits for any telemetry channel or mute it. Set status inputs to trigger an alarm on either a rising waveform, falling waveform or both. Designate command lines to be momentary or latching. Let command line outputs function as the raise or lower output of any telemetry channel.

MRC-1 options simplify data management. Moseley Memory protects setup data from extended shutdowns by storing it in EAROM for up to 10 years. Status and telemetry data may be recorded at chosen intervals on the Logger. The CRT displays all status and telemetry inputs from any site, in plain-English, and duplicates all command functions from the keyboard. The Multiple Direct Command option offers instant access to 10 pre-selected control functions.

With 6 years of field-proven durability, the MRC-1 has your remote site under control whether it's across town or in orbit. Tough competition? Get Moseley tough and take it easy.

Circle 102 on Reader Service Card

- MULTIPLE REMOTE SITES
- EACH SITE EXPANDS TO 64 COMMAND LINES AND 32 CHANNELS STATUS AND TELEMETRY
- SMART TERMINALS AT CONTROL AND REMOTE SITES
- 32 STATUS INPUTS DISPLAYED SIMULTANEOUSLY
- KEYBOARD CALIBRATION OF TELEMETRY



Get Moseley Tough,
Contact Moseley Marketing.



MOSELEY ASSOCIATES, INC.

A Flow General Company . Santa Barbara Research Park

111 Castilian Drive . . . Goleta, California 93117
(805) 968-9621 . Telex: 658-448 . Cable: MOSELEY

They know why...

■ "We can work around lights on the studio floor with far less concern about noise."

W. E. (Bill) Thompson
KPRC TV, Houston, TX

■ "The quietest cable we have ever used."

Jim Bartel, Engineer
Victor Duncan, Inc.
Film & Video
Equip. Dist.

■ "The flexible, smooth surface eliminated our kinking and twisting problems."

Jim Van Waay, Pres.
V. J. Electronics
Sound Contractor

CANARE MICROPHONE CABLES are becoming the professional's first choice.

- Unique "Star-Quad" 4 conductor configuration plus high shield density reduce hum and noise to less than 1/10 that of the leading 2 conductor microphone cable.
- Excellent frequency response preserved due to low capacitance provided by dielectric qualities of Polyethylene insulation.
- Tough, flexible jacket available in 10 colors for easy identification.

L-4E6S cable - sug. ret. 40¢/ft.

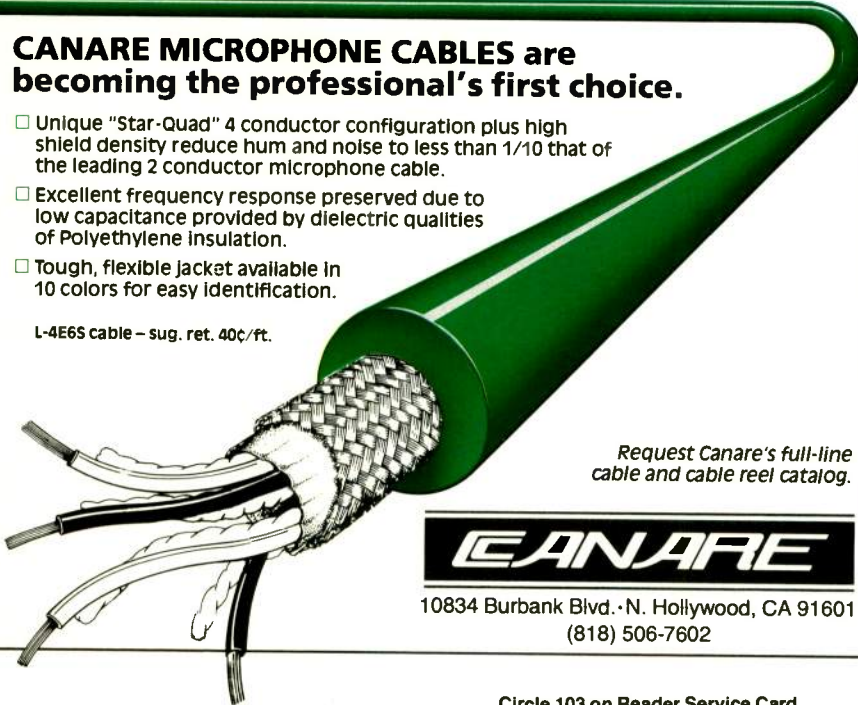

Request Canare's full-line cable and cable reel catalog.

CANARE

10834 Burbank Blvd. • N. Hollywood, CA 91601
(818) 506-7602

Circle 103 on Reader Service Card

BRYSTON



Bryston's 2B-LP

Bryston has been known and respected for years as the manufacturer of a line of amplifiers which combine the transparency and near-perfect musical accuracy of the finest audiophile equipment, with the ruggedness, reliability and useful features of the best professional gear. Thus, Bryston amplifiers (and preamplifiers) can be considered a statement of purpose to represent the best of both worlds - musical accuracy and professional reliability to the absolute best of our more than 20 years' experience in the manufacture of high-quality electronics.

The 2B-LP is the newest model in Bryston's line, and delivers 50 watts of continuous power per channel from a package designed to save space in such applications as broadcast monitor, mobile sound trucks, headphone feed, cue, and any installation where quality must not be limited by size constraints. As with all Bryston amplifiers, heatsinking is substantial, eliminating the requirement for forced-air cooling in the great majority of installations. This is backed up by very high peak current capability (24 amperes per channel) and low distortion without limiting, regardless of type and phase angle of load. In short, the 2B-LP is more than the functional equivalent of our original 2B in spite of the fact that it occupies only half the volume, and will fit into a single 1.75" rack-space.

The usefulness of the 2B-LP is extended by a long list of standard features, including: Balanced inputs; female XLR input jacks; dual level-controls; isolated headphone jack; and individual two-colour pilot-light/clipping indicator LEDs for each channel. In addition, the channels may be withdrawn from the front of the amplifier while it is in the rack, vastly facilitating any requirement for field-service, including fuse-replacement.

Of course, in keeping with Bryston's tradition of providing for special requirements, the 2B-LP can be modified or adapted to your wishes on reasonably short notice, and at nominal cost.

Best of all, however, the 2B-LP is a Bryston. Thus the sonic quality is unsurpassed. The difference is immediately obvious, even to the uninitiated.

Other amplifiers in Bryston's line include the model 3B, at 100 watts per channel, and the model 4B, at 200 watts per channel. All ratings continuous power at 8 ohms at less than 0.1% THD or IMD.

IN THE UNITED STATES

BRYSTON VERMONT
RFD #4, Berlin, Montpelier, Vermont 05602

IN CANADA

BRYSTON MARKETING LTD
57 Westmore Dr., Rexdale, Ontario, Canada M9V 3Y6

BM/E

BROADCAST MANAGEMENT/ENGINEERING

Publishing Director
Charles C. Lenz, Jr.

Editor Emeritus
James A. Lippke

Publisher
William McGorry

Editor
Robert Rivlin
Senior Editor
Eva J. Blinder
Associate Editor
Michael Greenhouse

Assistant Editor
Douglas Damoth
Copy/Research Editor
Michael Starr

FCC Counsel
Bechtel & Cole
Broadcast Financial Consultant
Mark E. Battersby

Contributing Editor
Bryan D. Boyle
Special Projects Editor
C. Robert Paulson

Art Direction
Lee Muslin
Design Assistant
Annette Fernandez

Production Director
Nick Tartaglia
Production Manager
Connie Lubrano

Advertising Assistant
Sharon Porges
Marketing Services Director
Liz Schroeder

Marketing Services
Kathryn Petersen

Controller
Michael J. Lanni
Assistant Controller
Andrea Bettke

BROADBAND INFORMATION SERVICES, INC.
295 Madison Ave., New York, N.Y. 10017
212-685-5320, Telex: 64-4001

Publishers of:
BM/E—Broadcast Management/Engineering
BM/E's World Broadcast News



BM/E BROADCAST MANAGEMENT ENGINEERING (ISSN 0005-3201) is published monthly by Broadband Information Services Inc. All notices pertaining to undeliverable mail or subscriptions should be addressed to 295 Madison Ave., New York, NY 10017. BM/E is circulated without charge to those responsible for station operation and for specifying and authorizing the purchase of equipment used in broadcast facilities in the U.S. and Canada. These facilities include AM, FM and TV broadcast stations, CATV systems, ETV stations, networks and studios, audio and video recording studios, telecine facilities, consultants, etc. Subscription prices to others \$24.00 one year, \$36.00 two years. Foreign \$36.00 one year, \$60.00 two years. Air Mail rates on request. Copyright 1984 by Broadband Information Services, Inc., New York City. Second class postage paid N.Y., N.Y. and additional mailing offices.

New stereo features for Optimod-AM.

Trying to deal with the varying processing requirements of the different AM stereo systems can make anyone feel a little schizophrenic! Fortunately, moving jumpers on our new optional second-generation #1-S card can change its personality to perfectly harmonize the processing to the stereo system you choose, even if you change later.

The new #1-S card limits single-channel negative modulation to -75% to prevent distortion in Motorola-system stereo receivers, or to avoid excessive "compatibility controller" gain reduction in Harris exciters. In Motorola installations, the single-channel modulation limiter also prevents mono distortion and excessive occupied bandwidth *dynamically* (instead of limiting separation above 5kHz). This permits use of large amounts of preemphasis and achieves the brightest stereo sound and best-defined stereo imaging. Unlike techniques used in other processors, this control occurs in the stereo difference channel and cannot punch "holes" in the mono or otherwise degrade the performance of mono radios.

A bonus is an adjustable "stereo enhancement" control usable with *any* of the four stereo systems. It dynamically boosts the stereo difference signal up to 6dB, and can yield dramatic increases in perceived stereo separation and loudness.

We offer multiple equalization personalities too! In addition to our original high frequency equalizer which is computer-optimized to yield an FM-like sound on today's *typical* AM radios, we now supply two alternate plug-in equalizers. One offers smoothest sound from the new wider-band AM stereo radios, while the other splits the difference.

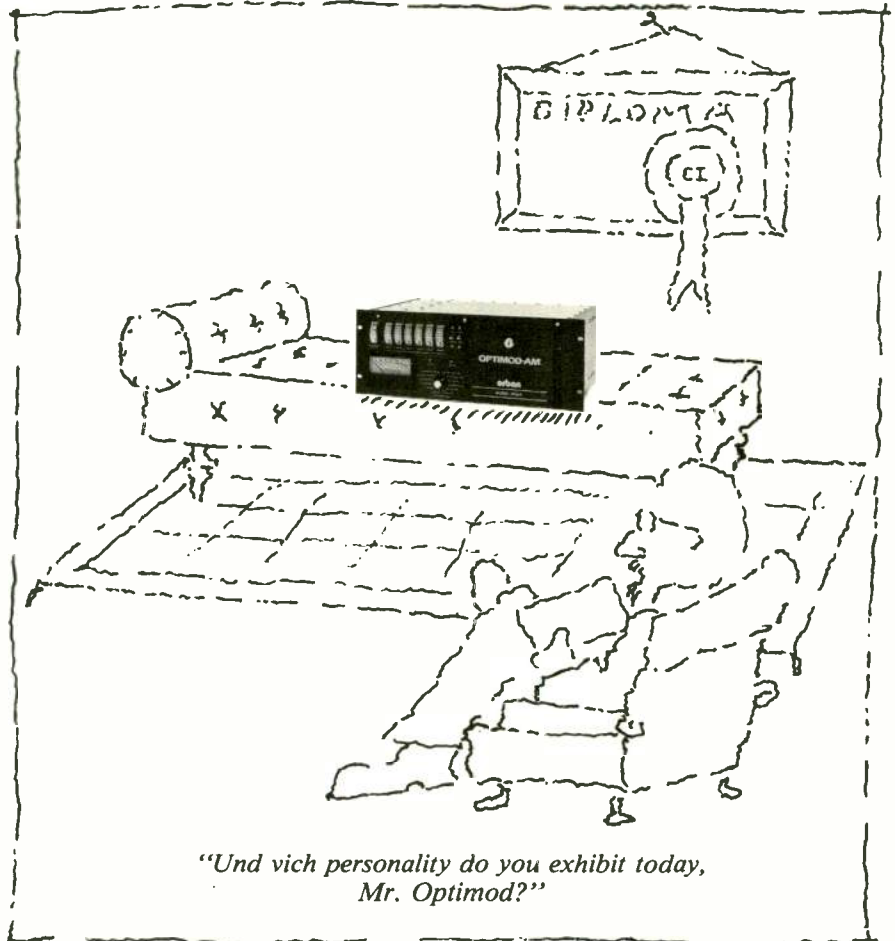

Whichever equalizer personality you choose, our six-band limiter with steep-slope crossovers creates a remarkably consistent equalization texture from source to source. This consistency is complemented by the 9100A's uncannily natural sound—the result of using only *two* carefully-harmonized stages of AGC from input to output. Compared with other designs which cascade up to *six* stages of AGC, OPTIMOD-AM's smoothness can pay off with lower fatigue and longer time-spent-listening. OPTIMOD-AM doesn't just attract listeners—it holds them!

If stereo isn't yet in the cards but you still want OPTIMOD-AM's outstanding sonics, our mono 9100A/1

is the logical choice. You get super mono sound now—and easy, economical, plug-in stereo conversion if you need it later.

Thanks to OPTIMOD-AM's modular, plug-in design, all of the new features can be field-retrofitted to any existing 9100A at low cost. For more information on the processors with the winning personalities, see your Orban broadcast products dealer or contact us directly.

Orban Associates Inc.
645 Bryant St.
San Francisco, CA 94107
Toll Free: (800) 227-4498
In California: (415) 957-1067
Telex: 17-1480

orban

ORBAN PROCESSING KEEPS YOU COMPETITIVE

Circle 180 on Reader Service Card

Midwest puts on a great show because it uses the best components

One of the reasons that the Midwest M-40 Series is the most advanced class of large mobile teleproduction units available today is our policy of only using the finest components. This "no compromise" design philosophy ensures a system of superior quality and reliability. Our M-40 units give you up to 47 feet of unparalleled technical and creative capacity. Because we only use the best components . . . from companies like Ikegami.

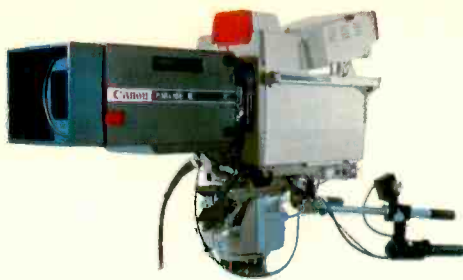

Ikegami HK-322 automatic color cameras make Midwest picture perfect

In the M-40, we wanted the ability to produce the best possible pictures.

So we selected the HK-322 as a basic building block of the system.

When the position as the world's most popular field camera passes from the Ikegami HK-357A, it will be to the HK-322. This fully automatic color camera sets the new standard for picture resolution, signal-to-noise ratio and registration accuracy. Standard computer set-up takes much of the hassle out of preparing for remote telecasts. With the Ikegami HK-322, the Midwest M-40 delivers perfect pictures everytime.

Ikegami HL-79E Series plays dual role for Midwest units

The Ikegami HL-79E Series camera was selected for use aboard the Midwest M-40 because it can handle two separate functions with superlative results. Although it's renowned as the perfect hand-held camera, the HL-79E Series can easily be converted into a field camera that produces higher quality images than many other manufacturers' top-of-the-line studio models.

**Ikegami delivers
super performance in**

A colorful geometric background consisting of overlapping triangles in shades of purple, red, orange, yellow, and green. On the right side, a portion of a yellow ladder is visible, extending upwards.



Ikegami 9-Series color monitors give Midwest "true to life" pictures

Ikegami 9-Series Color Monitors are standard in the Midwest M-40 mobile unit because of their superb resolution and ability to reproduce colors that are amazingly life-like. This performance is unmatched by any other monitor in the world. Since the 9-Series monitors use In-Line Gun CRTs, they provide more than excellent colorimetry and



fantastic resolution. They also offer high stability, unit interchangeability, low power consumption, and convenient pull-out circuit panels. By using the Ikegami 9-Series, the Midwest M-40 can reproduce colors that are true to life.

This exceptionally fine performance is due to Ikegami's painstaking attention to detail. Designed to meet the most rigorous performance standards, the HL-79E Series also offers optional automatic set-up, either via its own set-up computer or by interface into the HK-322 set-up computer for total system integration. With the HL-79E Series, Midwest's M-40 offers you the versatility required to produce network quality productions in any circumstances.

Midwest road shows



MIDWEST
Communications Corp.

One Sperti Drive
Edgewood, KY 41017

For more information on how Midwest and Ikegami can deliver world class performance for your company, contact any Midwest office in the U.S. or call toll free (800) 543-1584.

Cincinnati, OH 606-331-8990	Nashville, TN 615-331-5791
Columbus, OH 614-476-2800	Bristol, TN 615-968-2289
Dayton, OH 513-298-0421	St. Louis, MO 314-225-4655
Cleveland, OH 216-447-9745	Atlanta, GA 404-875-3753
Pittsburgh, PA 412-364-6780	Virginia Beach, VA 804-464-6256
Indianapolis, IN 317-872-2327	Charlotte, NC 704-399-6336
Detroit, MI 313-689-9730	Richmond, VA 804-262-5788
Grand Rapids, MI 616-796-5238	Washington, DC 301-577-4903
Louisville, KY 502-491-2888	Miami, FL 305-592-5355
Lexington, KY 606-277-4994	Tampa, FL 813-885-9308
Charleston, WV 304-722-2921	

Circle 106 on Reader Service Card

The Digital Audio Dilemma Solved

For some time the broadcast industry has been involved in a fierce debate about if and when digital audio will make its appearance at the local station level. On the one hand there are the future prognosticators who, armed with the brilliant performance specs of digital ATRs and the general movement in society towards digital everything, predict it is just around the corner. On the other hand, there are the "pragmatists" who argue that analog recording techniques now offer sound quality equal to or even better than digital, and point with alarm at the enormous costs incurred by switching to a digital recording format.

Judging from the recent AES show in New York City, however, it's clear that the debate is over, and that digital has won. Never have there been more broadcasters at the show, and never has their interest in digital recording been higher.

It doesn't matter what format you choose—the DASH stationary head variety proposed by Sony and Studer (the two companies have now resolved their differences and are producing machines with fully interchangeable tapes), or the Mitsubishi version, or one of the other recording systems on the market. The fact is that digital audio is everywhere, and affordable by virtually everyone.

Many stations have already begun dipping their toes in the digital waters with the acquisition of CD players and recordings. This simple and inexpensive introduction to digital sound has been widely praised by users. Digital satellite transmission of audio programs to radio stations around the country is yet another demonstration of the superiority, and timeliness, of digital audio. Digital processing is now an accepted fact of life, and acceptance of the digital console is growing rapidly. Why then, the reluctance among broadcasters to embrace the digital ATR? Its sky-high S/N and absence of modulation noise, harmonic distortion, and generational loss make it a natural for the quality-minded station.

The "wait and see" period is over. It's time to move forward now, time to stop wondering whether local stations will ever adopt digital recorders and instead to ask more meaningful questions, such as "two tracks or eight?"

Worth Its Wait In Gold.

For Harrison Reliability

Sure, Harrison has waited to enter the U.S. broadcast market. When you're a stickler for precise engineering and a perfectionist when it comes to quality performance – you've got to take your time to get it right. *Get it just right for you.*

No Compromises

It can be tough getting the right console to match your specifications. About as easy as fitting a square peg in a round hole, right? Harrison Systems has anticipated your need for versatility. A good deal of time and research goes into our consoles in order to bring you the smartest, most efficient technology and service. We've got the system that fits the size and scope of your needs, whether it be:

- Teleproduction
- Video Sweetening and Post-Production
- Video Edit Suite
- Film Sound Post-Production
- On-Air Broadcasting
- Broadcast Production
- Live Sound Reinforcement
- Music Recording and Scoring

At Harrison Systems, we give you choices – not excuses or unnecessary fluff. Our systems are designed to bring you long-lasting, clean performance and reliability.

Harrison Puts You In Good Company

Organizations like Swiss Broadcasting and Belgian Radio and Television have believed in the superior quality of Harrison Stereo Broadcast Audio Consoles for years and have chosen Harrison for multiple broadcast installations. Swedish Television has selected 8 TV-3 consoles and has committed to several more. This year's Winter Olympics in Yugoslavia received the main audio feed from a TV-3.

At Last

At Harrison, we take the time to listen to your needs. We design our consoles with the flexibility to fit your operation. And although our standards may be high for our consoles – our prices are very, very reasonable. We think you'll find it's been worth the wait – in golden, Harrison-true performance. Call us for a demonstration and see for yourself.

For Harrison Innovation

Introducing Harrison's TV-3, PRO-7 and TV-4, the broadcast consoles you've been waiting for:

TV-3 For large scale TV audio, remote production, studio production, post-production and sweetening ■ Adapts to wide range of tasks ■ Available in a variety of configurations for customization ■ Plus many options.



Now Available
AIR-7 For on-air stereo radio broadcasting, combining sophisticated technology with simple operation.

PRO-7 Designed for comprehensive use in broadcast, live sound, motion picture teleproduction ■ Two major configurations ■ Simple to operate ■ Cost-effective ■ Independent mix decision capability ■ Long-term performance achieved through thick-film laser-trimmed resistor networks ■ Plus many options.

TV-4 For medium scale on-air production, remote production, studio production, sweetening and post-production ■ Three major, simplified configurations ■ Easy to install ■ High-speed, low noise, low distortion amplifiers allow for best possible electronic performance ■ Plus many options.

Harrison's new VSI Fader Section, which allows for simultaneous interface with automation and video editor/switcher, is available for TV-4 and PRO-7 consoles.



Why wait any longer? Call or write Harrison Systems, Inc., P.O. Box 22964, Nashville, TN 37202; (615) 834-1184, Telex 555133.

**Harrison**

Hurricane Diana Puts Ku-band To Water Test

As tropical storms go, the picture looked familiar: a reporter holding a microphone, palm trees tossing in the background, and furious sheets of rain falling. But the feed was live via satellite on the Ku-band, and for many stations, the reporter was their own.

When Hurricane Diana struck the Carolina coast, NBC and CBS had arranged to uplink their feeds on the Ku-



NBC's Robert Hager goes live via Ku from Wilmington in 50 mph winds and rain.

band. The storm had been wandering around, giving news directors fits as they tried to decide where to send their crews and set up operations, with no time for landlines or even RFI studies so that C-band uplinks could be cleared against directional microwave. Also, with something as strong and unpredictable as a hurricane, no one wanted to risk everything on the regional microwave system since some links might run out of emergency generator fuel or be blown down.

Because of this, NBC sent a Ku-band mobile uplink to Wilmington, NC. VideoStar Connections, Inc., an Atlanta-based supplier of transportable uplinks, delivered and set up a truck overnight from its fleet. CBS also asked VideoStar for a Ku-band uplink, but in Myrtle Beach, SC, where Encore Video Productions, a production house, often supplies the network with regional material.

The main worry with Ku, of course, has been rain attenuation. Although NBC is installing Ku-band dishes with affiliates, (see *BM/E*, April 1984, News section) the network did hedge its bets the first morning by microwaving



In Myrtle Beach, CBS's Ku-band uplink, courtesy of VideoStar, waits the last few hours for hurricane Diana.

morning news packages an hour in advance. But despite the large amount of water overhead in a storm of that size, the signal out of Wilmington was "exemplary," according to Dan Gannon, news operations manager at NBC's satellite desk in New York.

In Myrtle Beach, however, CBS seemed to have some trouble "punching through," says Rik Dickinson, president of Encore Video, and they had to switch satellites. But once the connection was made, affiliates who had "gotten wind of it and started piling in," fed themselves and even sister stations as far away as Detroit.

"With Ku-band," says Bert Medley, who was in charge of NBC's re-

mote site, "you have tremendous freedom in tight situations when the phone company can't help you." During the worst part of the storm, Thursday morning when gusts increased from their normal 50 miles per hour to 90 miles per hour, both dishes were briefly stowed and were then set back up by noon. In the interim, WWAY, the ABC affiliate in Wilmington, sent live feeds on the microwave system to WRAL-TV in Raleigh for uplinking on C-band. With networks, news organizations, plus affiliates standing in line, everyone was on a "pretty rigid schedule," Medley says; the rest of the time, Ku meant "we didn't have to flip coins over who would go first."

CBS Gives Betacam Another Major Convert

CBS Operations and Engineering has publicly committed the network to a new ENG format with the purchase of over \$11 million of Sony Betacam equipment. This comes on top of last summer's decision by the Canadian Broadcasting Corp. to buy substantial numbers of Betacam cameras and VCRs, plus the European Broadcasting Union's adoption of Betacam as its ENG format.

CBS already owned 13 BVP-3 Betacam cameras, and will now add four field systems which include BVP-30 cameras, BVV-1 field recorders, and BVW-20 field playback units. The network will also receive 32 BVW-40 recorder/editors and four BVC-10 Beta-cassette playback units.

Sony has described the deal by say-

ing it had entered into "a long term agreement with CBS" and that "initially" the network will use the equipment at its New York news center and at WCAU-TV, its O&O in Philadelphia. A CBS spokesperson would not confirm any plans beyond this purchase. The network has merely chosen the "best available equipment at the time," he maintained; "we're not locked in."

CBS gave no details as to how far in the production and airing process the news center will retain the component format. (See "The Analog Component Dream" elsewhere in this issue.) It is possible the network may use WCAU-TV to determine the best method of sending component material to affiliates.

FROM THE PEOPLE WHO BRING YOU THE CHARTS...

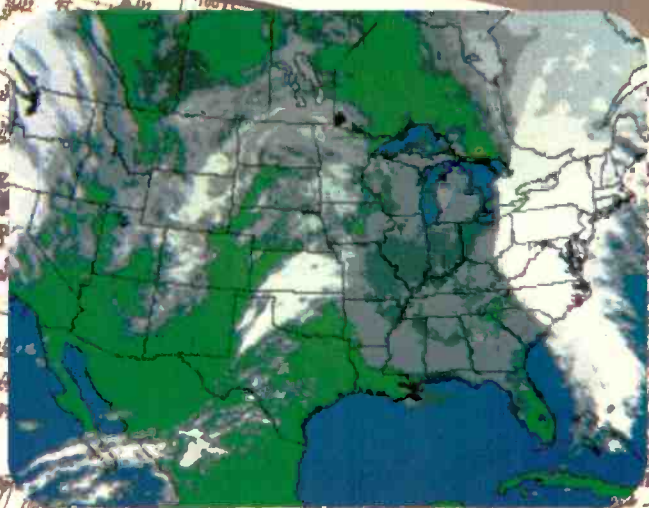
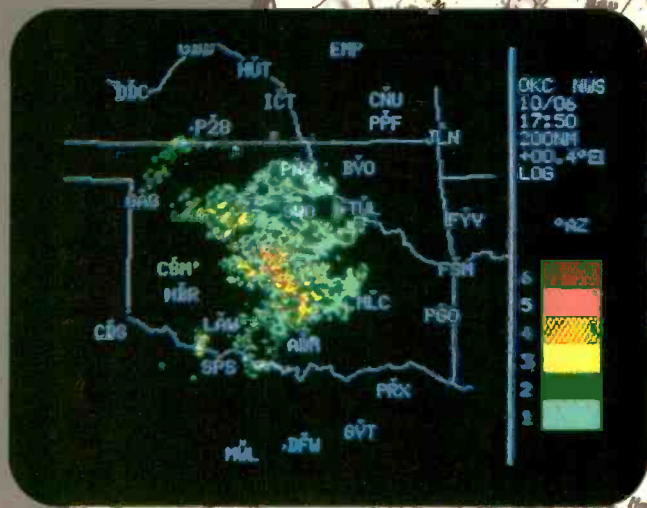

**LIVE RRWDS
COLOR WEATHER RADAR**

**PLUS COLOR SATELLITE
AND WEATHER GRAPHICS**

You already know Alden as the first name in facsimile weather chart systems. In fact, you probably already use one of our chart recorders.

Now Alden introduces a new family of systems to add live color radar and satellite/weather graphics to your information sources.

LIVE RADAR. Alden's C2000R system brings you live weather radar information via a new network of National Weather Service radar transmitters, called RRWDS. The C2000R accesses these radar sites easily and cost-effectively using standard voice-grade telephone lines on either a direct line or dial-up basis.

Display different precipitation levels in up to 6 colors, with level flashing for easy identification, or store multiple-region and time-lapse pictures. Numerous other features make its low price a pleasant surprise.

GRAPHICS. Alden's C2000S is a low-cost, high-performance unit for displaying weather information from private and government data bases. Color satellite pictures, surface weather, temperature contours and hourly NWS pictures are available, with 16 selectable colors, zoom, flash and loop capability.

BOTH. Alden's C2000R/S offers the combined capability in one system. Our "building-block" design permits field conversion of the stand-alone C2000R or the C2000S into the C2000R/S model at any time. All systems offer the flexibility to acquire not only today's data, but the data of the future.

Call or write us for complete information. Alden Electronics,
1188 Washington Street, Westborough, MA 01581.
Telephone 617/366-8851.

Name _____
 Company _____
 Address _____
 City _____ State _____ Zip _____
 Phone _____

ALDEN ELECTRONICS

The First Name in Weather

Circle 108 on Reader Service Card



Fidelipac's Arthur Constantine demonstrates the Dynamax cart player.

RCPC Plays To Mixed Reviews

The first annual Radio Convention and Programming Conference, widely hailed as the first radio convention jointly planned by NAB and NRBA, failed to elicit the unanimous praise of attendees. While broadcasters found a program chock-full of excellent workshops, they also found exhibit hours too short to permit them to visit the floor. Exhibitors complained that floor traffic was too light and that the physical setup of the exhibits discouraged visitors, although a minority claimed satisfaction with both the arrangements and the audience.

The program planning committee evidently gave serious thought to the needs of engineers, for each session offered at least one technical workshop. "AM Stereo's Four," for example, sparked fireworks as proponents of the competing technologies defended their systems. The atmosphere stayed calm until Leonard Kahn's statements about receiver characteristics with the Motorola system prompted Motorola's Norm Parker to accuse Kahn of lying. During the lively discussion that followed, an engineer of a Motorola AM station, also refuted Kahn's figures. Kahn, meanwhile, used RCPC to announce a new all-system receiver which he said would provide inexpensive, high-quality reception.

At the session on AM stereo conversion, chief engineers of four stations—one for each of the four systems—described the problems and rewards of conversion to stereo. All stressed the

importance of a properly tuned antenna with low IMD figures, and carefully chosen audio processing; none found station coverage area reduced by the switch.

Not all was roses on the three exhibit floors, however. Exhibitors consigned to the second- and third-floor areas complained that attendees rarely made it up the escalator. In fact, at times it appeared that few attendees knew of the existence of the higher floors.

Even so, a sprinkling of new products appeared. Harris, for example, had a new 3.5K FM transmitter. Business computers were news at the BIAS and Ficon booths, with both companies marketing new systems. Fidelipac introduced a new cart recorder/player, Dynamax, with a variety of sophisticated features. Meanwhile, Capitol Magnetics was stressing the ruggedness of its carts in a hospitality suite.

Radio Engineers Debate Future of Profession

Is there a future for radio engineering? More reliable equipment and less government regulation seem to be spelling the demise of the radio station engineer, at least in small and medium markets. The RCPC provided a forum for engineers to discuss the pressures facing their profession at a special meeting of the Society of Broadcast Engineers.

Addressing the meeting, SBE president Roger Johnson of KOY, Phoenix, described the decline of radio engineering staffs, in both numbers and status, since the 1950s. In the 1930s and 1940s, he said, the chief engineer was

"the man of stature" at a radio station, next to the GM. Today, however, many stations no longer have full-time engineers, relying instead on a contract engineer for all the stations in a market.

The best engineers will always find jobs, Johnson predicted, although full-time work in small markets may be a thing of the past. Johnson foresees the rise of service companies, with consulting engineers maintaining staffs of qualified engineers to service local stations.

With the FCC now out of the business of qualifying engineers, SBE's certification program will become even more important in helping stations find competent engineers.

The SBE certification program has been in existence since 1975, although it has not caught on like wildfire. Somewhat more than 2600 broadcast engineers are certified nationally. To become certified, an engineer must take one of four exams: broadcast engineer AM/FM, broadcast, engineer television, senior broadcast engineer AM/FM, or senior broadcast engineer television. Each exam consists of 50 multiple-choice questions, testing knowledge used in day-to-day station operations, with one or more essay questions on the senior level exams. To take the exams, an applicant must have five years suitable work experience (10 years for senior level exams).

A particularly attractive feature of certification—to station managements, if not to engineers—is that it must be renewed every five years.

Certification may have taken off slowly, but some observers feel it is picking up momentum. The statement "certification desirable" is beginning to show up in want ads, and engineering managements are beginning to take notice. For example, Robert Sudock, technical operations manager for Metromedia's KTTV, Los Angeles, who supervises a staff of 40, has run into very few SBE-certified engineers—perhaps one or two percent out of hundreds of resumes examined each year. "It gives me a little more confidence in looking at the person," Sudock explains. "What can you tell on a resume? The SBE program reinforces their background. I would feel... more comfortable, more apt to pursue the interview."

(Prepared with assistance from Glenn Calderone—Ed.)

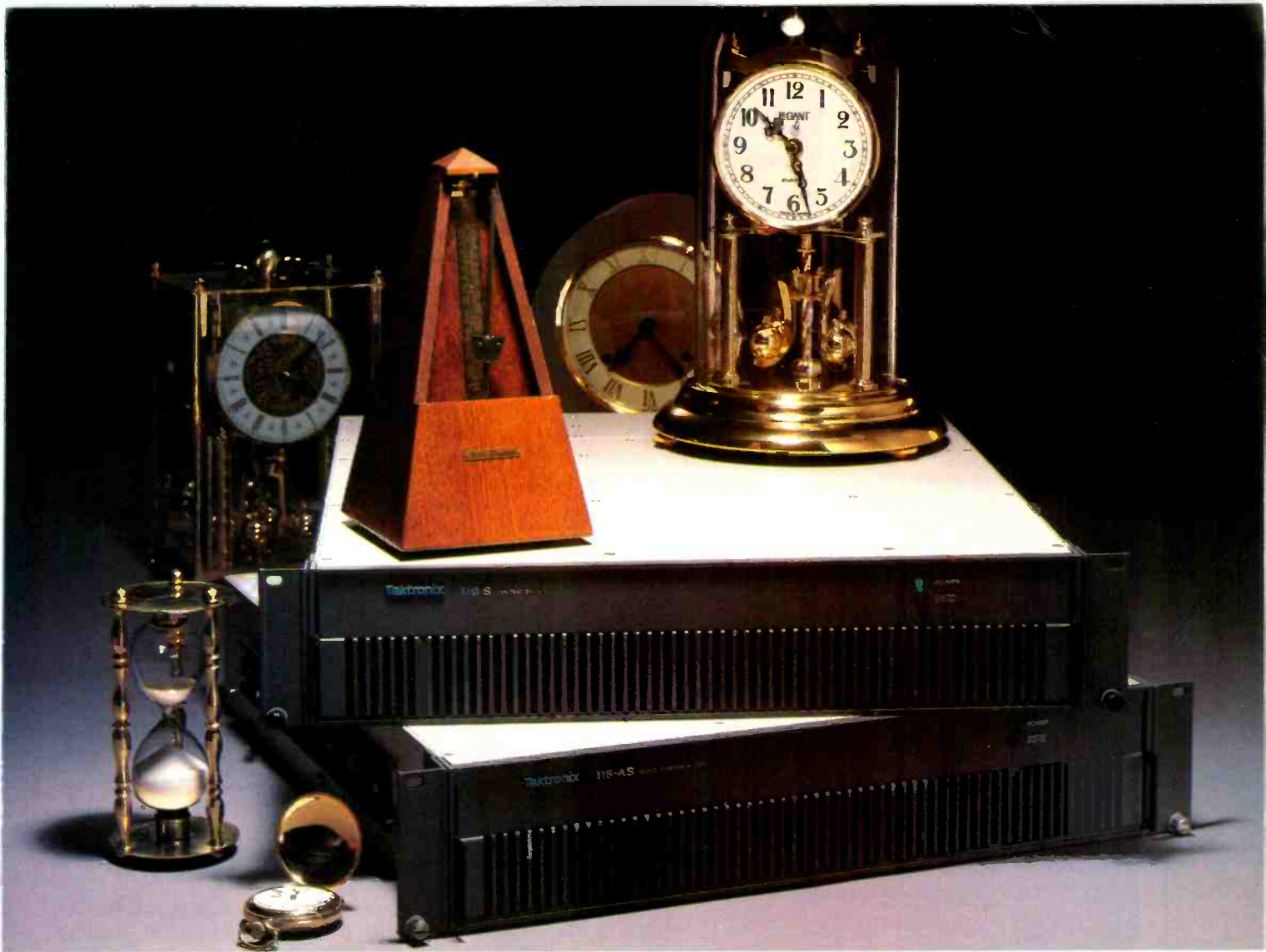

PERFECT TIMING!

Anytime your video and audio signals go into our synchronizers, they come out in perfect time. It makes for a difference your viewers can't see!

Start with the Tek 110-S for transparency no other frame synchronizer can match. Our high noise immunity genlock circuitry and adaptive clamping ensure the 110-S will track noisy signals longer and at the same time minimize streaking in the picture.

Add optional four-field memory and you get accurate color framing with no decoder artifacts

or 140 ns picture shifts. Your picture is virtually camera clear.

Now! You can include time base correction for heterodyne color VTRs in your 110-S package. This option features auto VTR signal recognition and infinite window correction range. It provides time base correction without feedback to the VTR. Ideal for remote location feeds.

The new Tek 118-AS Audio Synchronizer works in tandem with the 110-S to eliminate lip sync errors. The 118-AS solves the audio-to-video problems introduced by four-field memory

video synchronizers and other large-memory digital devices. The 118-AS features automatic and manual delay correction, wide dynamic range and low distortion. And with 18-bit floating point code and 93.75 kHz sampling, the 118-AS sets the same high performance standards as the 110-S.

Don't settle for less than perfect timing! Call your Tektronix Television Sales Engineer for a demonstration today. Or call Tek toll-free at 1-800-547-1512 for complete details. (In Oregon, 1-800-452-1877.)

Tektronix
COMMITTED TO EXCELLENCE

CMX/Orrox Plans To Buy ADDA Corp.

Orrox Corp. and ADDA Corp. have announced that Orrox, manufacturer of CMX videotape editing equipment, has signed an agreement to buy ADDA, maker of digital signal processing equipment. A subsidiary of ADDA, Control Video Corp., also manufactures video editors in addition to other video processing equipment.

When reached by telephone, Sam R. Goodman, chairman and CEO of Orrox, had no comment about possible future plans for Control Video's editing equipment lines. In Orrox's prepared

statement, Goodman said that CMX and ADDA have the best equipment, "each in its own field." Orrox's chairman also described CMX as "the ultimate in videotape editing" while ADDA was called "the leading edge in digital time base correction, frame synchronization, and still storage."

Under the reported terms of the purchase, shareholders of ADDA, a private company, will receive up to 3,400,000 shares of Orrox common stock. Orrox says that combined annual sales of the two California-based companies exceed \$25 million. The purchase must be approved by the directors and shareholders of both companies.

Cable Deregulation Bill Passes in Congress

With the NCTA and the National League of Cities in what appears to be a truly final agreement, the House of Representatives has passed cable legislation deregulating cable rates after two years. As of presstime, the House bill was headed for a conference where a compromise with the Senate version would be worked out.

Essentially what has come out of the long-standing battle is two more years of rate regulation, as the cities had asked for. Cable operators would be entitled to an automatic five percent rate increase annually. They also have the right to stop offering programming that rises steeply in cost. Operators who have already altered their services or rates, based on the Supreme Court's decision giving the FCC precedence over local authority, will be grandfathered into this new arrangement. Franchise fees would be capped at five percent of gross annual revenue.

Edens Buys Harte-Hanks Radio Except KKBQ

Harte-Hanks Communications, Inc. reports it has agreed to the buy-out of seven of its radio stations by Gary Edens, president and CEO of Harte-Hanks Radio Group. Edens says the Radio Group also plans to sell two other stations, KKBQ-AM-FM, Houston, to Gannett Company, Inc.

Terms of the purchase were not officially disclosed, though the price has been at \$40 million for Edens' stations and \$35 million, a record, for the Houston combo. Edens says all the AM/FM combinations rank number "one or two" in their markets. It has been observed that with some radio stations appreciating in market value due to the FCC's recent deregulation of radio group ownership limits, leveraged buy-outs may become more frequent.

KKBQ will give Gannett 15 radio stations, breaking the twenty-year old 7-7 rule.

Edens Broadcasting, Inc., based in Phoenix, has been recently formed for the takeover with Gary Edens as chairman and CEO. Several station managers currently heading the Harte-Hanks radio group will accompany Edens, among them J. Philip Goldman, WRVQ-FM, and L.G. Jones, WRVA-



This fall marks the tenth anniversary of the Associated Press' radio network, the AP Network News. Starting as an offshoot of the Broadcast News department in New York, Network News set up shop in small offices four blocks from the White House (shown above) with 14 employees producing 18 newscasts per

day for 200 affiliates. Ten years later, the service has been joined by AP's radio and television wires, moved from New York to consolidated facilities (below) with a staff of 70 and a fully computerized newsroom including switching. Network News distributes 54 newscasts daily plus actualities and features to 1100 affiliates.



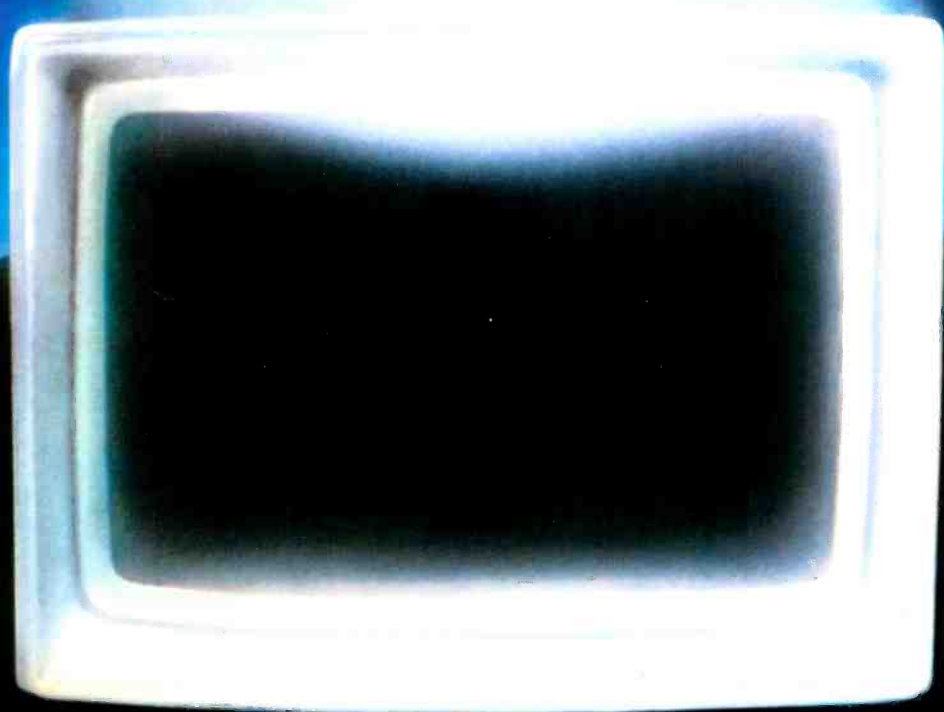

How new broadcast technology
will improve your broadcast quality.

Panasonic® presents the technology



NTSC. YIQ. Now you can make the most out of both. Because now Panasonic lets you do what you couldn't do before: Enhance your existing NTSC equipment with the higher performance and lower operating costs of the Panasonic YIQ M-Format. The result: 1-inch performance from 1/2-inch equipment.

Recam.™ We've got your configuration.

ENG, EFP, and Studio. The three key Recam configurations. In either three-tube Plumbicon™ or Saticon† versions. And now you can use all Recam cameras and VCRs with all your existing equipment because they're all YIQ/NTSC compatible.

The Recam B-100B camcorder. It gives a single operator total control of both video and audio. With video playback and two-channel audio monitoring in the viewfinder. In the field, Recam gives you up to two hours from its on-board battery compared to just 20 minutes from some other camcorders.

In the studio, Recam cameras can be fitted with an optional 5-inch viewfinder and camera control unit for total broadcast versatility.

*Plumbicon is a registered trademark of N.V. Philips
†Saticon is a registered trademark of Hitachi, Ltd.



ENG Camcorder



Studio Configuration



EFP Configuration

Any
VTR



Any
VTR
or
System

The AK-30 stands head-to-head with the bestselling broadcast camera in the world.

Digital registration. Image-enhancing circuitry. Dual white balance with memory. Three high-focus-field Plumbicon tubes. It's the Panasonic AK-30. And it will challenge even the bestselling broadcast camera in the world. With the industry's highest S/N ratio: 62dB. And a razor-sharp 650 lines horizontal resolution. ENG, EFP and Studio



configurations. It works with triax and has a negative film switch for telecine use.

Triax
Adapter

Only Panasonic gives you 1-inch color playback quality in the field from a 1/2-inch portable.



Up to now, if you wanted the quality of 1-inch color playback in the field, you had the hassle and expense of 1-inch equipment. Now all you need is the Panasonic AU-220 portable VCR.

It's YIQ compatible. So you get 1-inch color performance from 1/2-inch equipment. The AU-220 also records and plays standard NTSC.

In the studio or van, the AU-220 doubles as an ideal source VCR when you add the AU-S220 adapter. It provides power, a drop-out compensator, and a fully corrected broadcast signal when you add a TBC, vectorscope and WFM.

For field playback on a budget, choose the AU-100KB and get black and white video confidence in the viewfinder.

behind component compatibility.

When it comes to post-production, Panasonic speaks the language.

The Panasonic RS-422 Serial Interface can improve VCR systems control. Because it lets you control high performance YIQ M-Format VTRs from your existing VTRs and editing systems. The Panasonic AU-300B editing recorder, the AU-TB30 internal TBC, the AU-A30 full-function editing controller and AT-Series color monitors. Complete compatibility for total control.

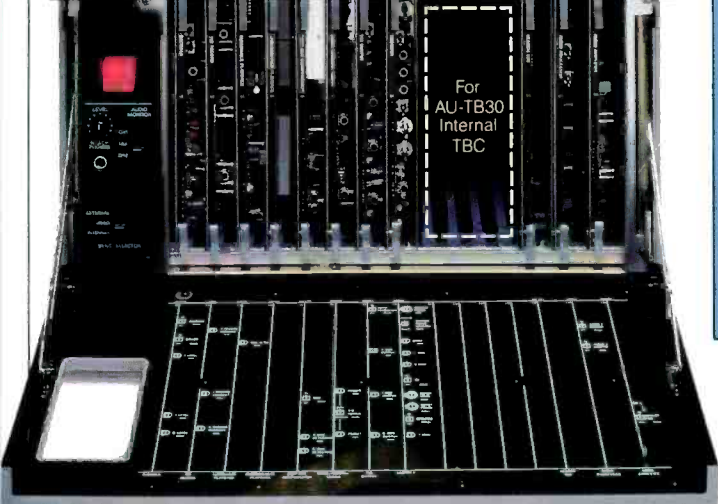

SIMPLE EDITING

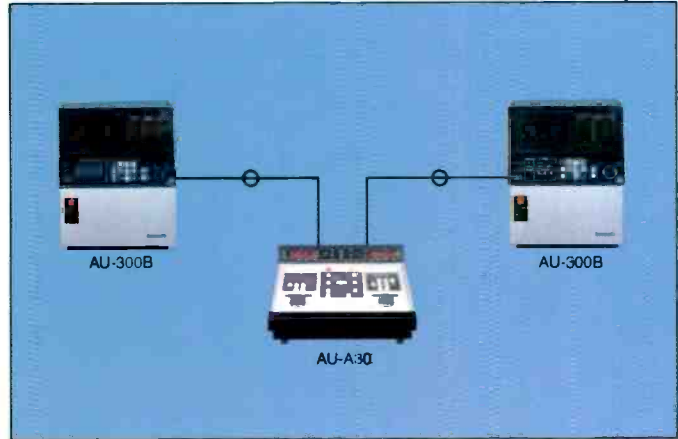

MULTI-SOURCE EDITING

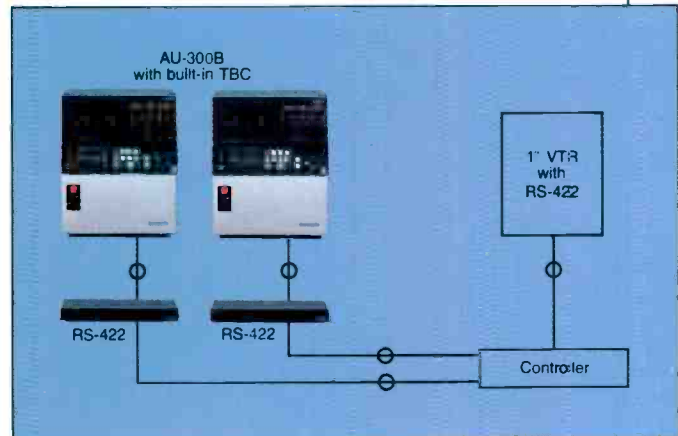

INTER-FORMAT EDITING

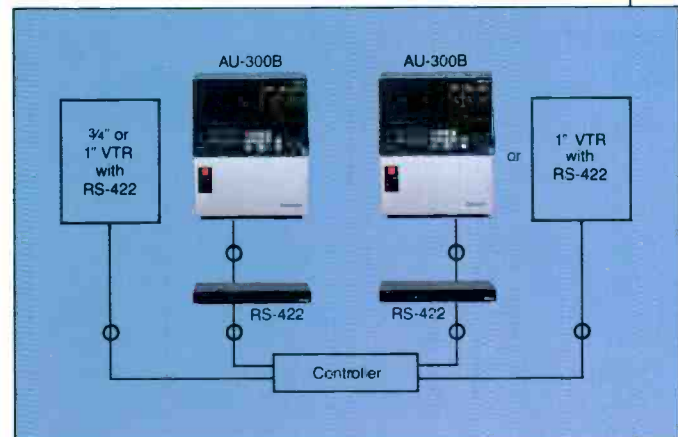



Only from Panasonic. Automatic, continuous, reliable broadcasting.

It's the MVP-100 and it will revolutionize your station. Because it lets you program in advance, and automatically air, everything from news spots to commercials to station IDs. Even complete program-length material. All with YIQ quality, time-code accuracy and computer-controlled reliability. At a lower operating cost than conventional cart machines. Its recorders, spot players, and up to 24 modular transports operate independently. So the MVP-100 can even be programmed to override a breakdown the moment broadcast continuity has been interrupted to virtually eliminate dead air.



Panasonic Broadcast Systems.

Panasonic broadcast components can enhance any broadcast system. Not only will we make your images look better with advanced M-Format technology, we'll make it easier for you to originate, produce and broadcast them.

Panasonic Broadcast Systems. Watch us improve your broadcast quality.

Call your nearest Panasonic regional office:

Northeast: (201) 348-7336
 Southeast: (404) 925-6835
 Central: (214) 256-2222
 West: (714) 895-7200
 Canada: (416) 624-5010

Panasonic
Industrial Company

NEWS

AM, both in Richmond, VA, R. Michael Horne, KOY/KQYT, Phoenix and Michael D. Osterhout, WRBQ-AM/FM in Tampa/St. Petersburg. The seventh station in the deal is WSGN-AM of Birmingham.

Edens says he foresees "no significant changes" for the stations, but he does plan to pick up properties in "other attractive growth markets."

Exceptional Engineering Nets Six Emmies

Six companies have picked up engineering Emmies this year for technical developments ranging from circular polarization to time compression. Those honored by the National Academy of Television Arts and Sciences are Sony, Ampex, Kudelski, Lexicon, Tektronix, and RCA.

Sony was cited for "materially improving the quality and efficiency of animation production" with its new stationary-tape, single-frame recording techniques incorporated into a one-inch type-C compatible format. Sony is

utilizing this technology in its BVH-2500 VTR. Also, Sony chairman and co-founder Akio Morita was given NATAS' Directorate Award for his leading role in the broadcast field.

Ampex and Kudelski both received Emmies for their development of "an extremely lightweight and compact" portable one-inch type-C VTR, the VPR-5.

Lexicon was singled out for developing its model 1200 Audio Time Compressor and Expander.

Tektronix also picked up an award, for "continued technical excellence and leadership" in the areas of television test, measurement, and monitoring engineering.

For its pioneering work on circular polarization, RCA received an Emmy, its ninth. In addition, the Trustees award, the Academy's most prestigious award for individuals, was given posthumously to Vladimir K. Zworykin for his half century of "conception and invention" with RCA. He is credited with the first practical tube for picture transmission.

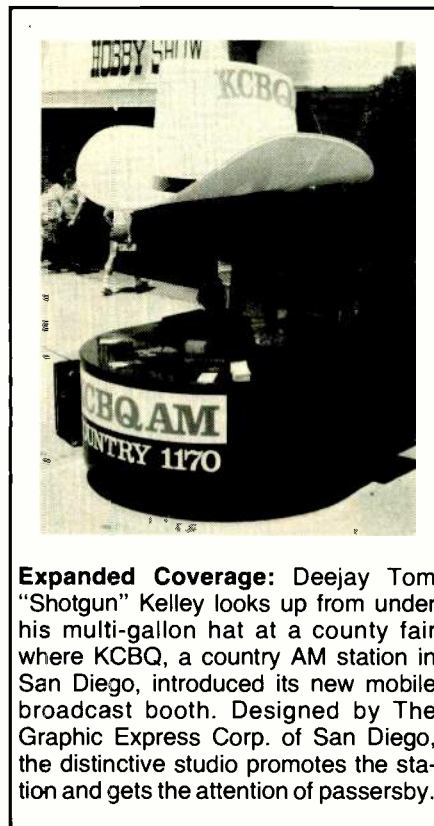

Expanded Coverage: DeeJay Tom "Shotgun" Kelley looks up from under his multi-gallon hat at a county fair where KCBQ, a country AM station in San Diego, introduced its new mobile broadcast booth. Designed by The Graphic Express Corp. of San Diego, the distinctive studio promotes the station and gets the attention of passersby.

NEWS BRIEFS

For 1985 the Television Bureau of Advertising predicts local advertising will rise 13 to 15 percent, national and regional 10 to 12 percent, and network 9 to 11 percent. In the current year, final figures for these same categories are expected to reach 18, 15 to 17, and 16 to 18 percent respectively. All figures will continue to be subject to "considerable variation" by region, market, and market size, "particularly with the number of new stations coming on the air". . . . TvB also reports that in the first half of 1984, **retail advertising for computer sales and service** soared 193 percent over the comparable period in 1983, from \$2.1 million to \$6.2 million. Computer spot ad sales went from \$1.5 million to \$3.6 million. The highest rollers were Computerland and IBM Products Center.

Three **new ADIs** have been created by Arbitron in the 1984-85 rankings: Flagstaff, AZ at ADI 102; Sarasota, NY at 158; and Hagerstown, MD at 195. The Helena, MT ADI has been merged with Missoula-Butte, while Dallas-Ft. Worth has bumped Washington for eighth place. The number of U.S. TV households has risen 1 percent

this year to over 85 million. . . . **A.C. Nielsen** has announced no addition to its 205 markets or DMAs. It ranks Washington eighth over Dallas and puts Cleveland tenth, as opposed to Arbitron's Houston. . . . According to a reader survey conducted by *Nation's Business* magazine, published by the U.S. Chamber of Commerce, over 70 percent of respondents watch **business-oriented programs**, and 42 percent say they want more of that brand of programming.

The Radio Advertising Bureau reports that in the first half of 1984 **local radio billings** rose 15.3 percent over the same period in 1983. . . . Arbitron is breaking out **San Diego-North County** as a separate metro area for the first time this fall. . . . Bonneville Broadcasting System is buying **Schulke Radio Productions, Ltd.** from Cox Communications, Inc. . . . **WOR-AM**, New York, has donated its **60-year written and recorded archives** to the Library of Congress. Among the talk and entertainment programs available are *Year in Review* broadcasts from 1936-43 and a Rinso commercial featuring Beverly Sills.

The **RTNDA's regional award for overall excellence**, the Edward R. Murrow Award, has been won this year by eight stations. In radio, WHDH, Boston; KRLD, Dallas; WCXI, Detroit; and KIRO, Seattle. In television, WBZ, Boston; WSMV, Nashville; WCCO, Minneapolis; and KRON, San Francisco.

Broadcast engineers now have their own **computer bulletin board**, available 24 hours a day without charge. Operated by Bryan Boyle, *BM/E's* contributing editor and a computer expert with ABC Radio Network, the BBS operates at 300 baud, Bell 103 standard, 8 bits with 1 stop, and no parity. Hook up by calling (212) 933-9459. First access requires a short, online registration survey which will be kept confidential. Boyle suggests that users may want to donate \$10 to the SBE's Ennes Scholarship Fund. . . . The Professional Film and Video Equipment Association will hold its **Production Solutions '85** show December 6-8 at the Sound Stage in Hollywood. Admission is free, and over 25 companies will be exhibiting at the "hands-on, talk shop" event for production pros.

IN THE BATTLE OF THE ROUTING SWITCHERS, THERE'S A NEW HEAVYWEIGHT CHAMPION.

	3M Series H 128 x 32	Fernseh TVS-TAS 2000	Grass Valley GL 440	Grass Valley Horizon	Utah Scientific AVS-1
VIDEO					
Crosstalk Video to Video	-65/4.43	-60/4.43	-60/5	-60/5.5	-60/4.4
Hum & Noise (0-4.2 mHz)	-75	-75	-65	-75	-
(IRE WEIGHTING)	-82	-	-	-	-75
Frequency Response (dB to mHz)	± 1/5.5	± 1/5.5	± 1/5	± 1/5	± 1/5
Diff Gain (10-90%)	3.58	.1%	.1%	.25%	.1%
Diff Phase	.1°	.1°	.25°	.1°	.12°
AUDIO					
Crosstalk (dB/kHz) Audio to Audio	-88/20	-85/15	-80/15	-80/15	-75/20
Hum & Noise (dB below out) / FILTER	-122/15k	-109/*	-92/15k	-104/15k	-109/15k
Freq Resp @ Max Out (dB/dBm)	±.1/30	±.2/24	±.1/24	±.1/24	±.2/24
Over Freq Range	20-20k	30-15k	20-20k	30-15k	30-15k
Com Mode Rej Ratio (dB)	-80	-75	-80	-65	-70

*Data not available

Data based on manufacturers specification as of 4/83

Compare our Series H Hybrid Switching Systems to the competitors and the advantages are easy to see. If you'd like to compare a few more specs, call us toll-free at 1-800-328-1684. In Minnesota, call toll-free

1-800-792-1072. Outside the continental U.S., call International Operations collect at 1-612-736-2549. You'll be knocked out by all our advantages. Broadcast and Related Products Division.

3M hears you...

3M

Circle 111 on Reader Service Card

RADIO

programming & production

Rock Radio Reunion Generates Nostalgia and Profits for WCBS-FM

By Judith Gross

How does a radio station get listeners to keep the phones ringing off the hook for 48 consecutive hours? Simple. It makes radio history.

New York's WCBS-FM recently did just that when it took its oldies format one step further with a "Rock & Roll Radio Greats" weekend.

The event reunited on New York City airwaves the legendary voices of WABC-AM's All Americans: Ron Lundy, Dan Ingram, Charlie Greer, Bob Lewis, Herb Oscar Anderson and "Cousin" Bruce Morrow; plus WMCA-AM's Good Guys: Harry Harrison, Joe O'Brien, Jack Spector and Dean Anthony.

Some of the famous voices had been absent from radio since the two former rock rivals went all talk, WMCA in 1970 and WABC in 1982.

Putting it together

Getting the entire gang together in one place and producing a smooth two days of nostalgia with relatively few hitches proved to be somewhat more of a task than WCBS program director Joe McCoy had first imagined when he came up with the reunion idea this spring.

"We already had Harry Harrison and Ron Lundy as regulars, and Bruce Morrow and Jack Spector were doing their weekly shows for us. I thought getting them together with the rest of the big names in radio seemed like the next logical step," said McCoy.

Contacting some of the super jocks, like Dan Ingram, who is still around town doing voice overs and a weekly music survey program, was easy. Joe O'Brien and Dean Anthony were

Judith Gross, formerly technology and radio editor of Broadcast Week is now associate editor of communications for MIS Week and an independent writer.



"Cousin Brucie" Morrow launches into his trademark "Eiyee" wail during the WCBS-sponsored reunion.

brought in from WHUD, Peekskill and WHLI, Long Island, respectively. Herb Oscar Anderson had to be lured into the metropolis from his Catskill, NY, farm. But the biggest problem proved to be finding former WABC overnighter Charlie ("swing, Charlie, swing") Greer.

Greer had dropped out of sight, and it took nothing less than an ad in a trade publication to locate him, in retirement in an obscure part of Ohio.

Once the gang was assembled, McCoy sprung the reunion idea and the response was one of effusive support.

"These guys aren't just doing it for themselves, or even their fans," McCoy observed. "They went ahead with it for each other. Neither the Good Guys nor the All Americans wanted to let their 'team' down." And McCoy also pointed out that when they arrived at WCBS's studios, they instinctively split into WMCA and WABC factions by going into separate rooms.

The station went to the limit in promoting the weekend, first with on air enticements and teasers, later with

spot TV commercials. The TV ads were the station's first use of spots for a single special, rather than the institutional ads which are run during ratings periods. WCBS threw a party several days before the weekend, appropriately enough in a rock club. But some of the embellishments that would etch the weekend indelibly into the minds of those who tuned in went on behind the scenes.

McCoy contacted JAM, the jingle producer from Dallas, to obtain special jingles—for use one-time only—with that well-remembered "60s" sound. JAM had produced the original WABC musicradio and "77" jingles, and the reunion weekend shouts and songs were almost exact replicas. JAM producers recorded them gratis, having been 60s rock radio fans themselves, with the provision that WCBS would "kill" them after the weekend.

McCoy and several producers assembled tributes to two additional personalities who played prominent roles in rock radio: Murray "The K" Kaufman, who died in 1982, and

RADIO PROGRAMMING



New York rock radio veterans Ron Lundy, Herb Oscar Anderson, Dan Ingram, and Charlie Greer cut up during Lundy's airshift of the rock radio reunion.

WMCAer B. Mitchell Reed, who died last year. The recordings were snatches of airchecks salvaged and edited, and were aired during the evening airshifts.

During the airshifts, McCoy had more than the usual quota of engineers available to help the DJs, some of

whom had been away from the mic for a while. Some, such as Joe O'Brien and Jack Spector, ran their own boards, while others worked in tandem with an engineer. Two studio control rooms were a flurry of activity, with extra mics in place for on-air interviews,

phone calls pouring in and being recorded for later airing, and several aircheck/archive tapes running continuously. McCoy explained that recordings of the entire weekend were being donated to New York's Museum of Broadcasting, and might also be condensed into an album for possible sale at some point in the future.

Radiophiles who took special note of the 1960s sound, probably noticed some differences listening to their favorite DJs during the reunion than what they remembered from the heyday of AM radio's grip on baby-boomer listeners. Most former rock AM stations saturated their sound in maximum compression for an unmistakable fullness which became their trademarks. WCBS added some compression to its FM sound, but it was noticeably less than what was fashionable two decades ago. The rock radio reunion also marked the first time many of the famous voices could be heard in stereo. But the memories and the music were the same.

On-air nostalgia

Music director Barbara Temple had

This new portable UHF Field Strength Meter gives you accurate readings across the entire band.

Someone once said that "Certainty is Security." That is the main idea behind field strength measurements. They verify the signal level and rf environment at the point of reception. You know for certain what's out there.

It is now easy for UHF stations to achieve this certainty. With the new FIM-72 from Potomac Instruments.

Tune the entire UHF band

From 470 to 960 MHz. The received signal strength is shown in volts and dB, with a 140 dB measurement range. Select peak or averaging detection; wide or narrow IF bandwidth. Seven 20dB logarithmic ranges assures precise readings. Internal demodulators (AM and FM) provide audio monitoring of the selected signal.

It is easy to use

Find the desired signal on the spiral dial. Calibrate the meter using the internal generator, then read the signal strength from the mirrored meter. The field strength is easily determined from the supplied calibration data.

Laboratory applications

The FIM-72 includes a precision rf generator that tracks the tuned frequency. Typical measurements include insertion loss, VSWR, and filter response.

Call Potomac Today

Place your order for this new UHF field intensity meter. Put it to work. And then you will know for certain.



POTOMAC INSTRUMENTS
932 PHILADELPHIA AVE. SILVER SPRING, MD 20910
(301) 589-2662



Get it out of your system.

Television is an electronic medium. Yet TV graphics still involve messy paints, glue, air brushes, razors, and other paraphernalia.

MCI/Quantel's Paint Box can put your TV graphics into the electronic medium.

So you can get all the messy paraphernalia out of your system. Digitally.

The Paint Box lets you do a lot more than you can do with traditional art materials. A lot faster. And with typical Quantel picture quality.

It gives you over 16 million colors. If that's not enough, you can mix your own, just like you'd do with paints.

It's incredibly versatile. You can produce the look of oils, watercolors, chalk, pencil. You can make stencils. Air brush. Cut and paste. Even animate.

You can grab TV frames off the air, resize them, retouch them, mix them with graphics.

You can set type from a large variety of the highest quality fonts.

And you can interface the Paint Box to Quantel's DLS 6000 Library System for a totally digital still-picture system. It's awesome.

Call your local MCI/Quantel office. They'll be glad to show you a demonstration tape. Or get in touch with us directly at 415/856-6226. Micro Consultants, Inc., P.O. Box 50810, Palo Alto, California 94303.

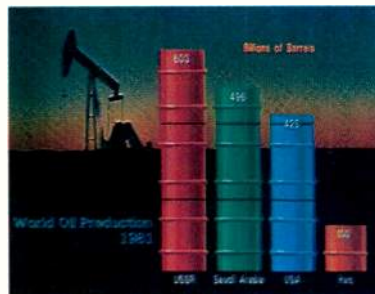

Graphics like this are easy on the Paint Box.

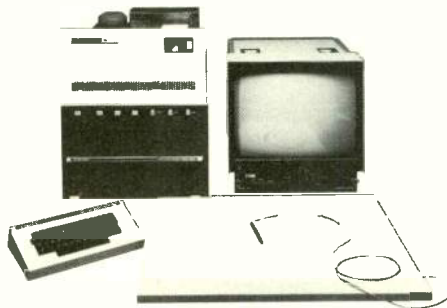

MCI/QUANTEL
The digital video people.

Canon in Action at the 1984 Olympics

The world saw the Games through Canon Lenses.

For 16 days during the summer of 1984, the world saw the Games of the XXIIIrd Olympiad through Canon TV lenses.

From a crane high above the Los Angeles Coliseum, a Canon PV 40 x 13.5 was able to show the spectacle of the Games unfolding, and with its awesome 40X reach, isolate a single athlete on the field.

At venues throughout Southern California, a total of 135 Canon lenses captured every aspect of those rare moments that are now sports history. ABC cameras were equipped with Canon PV 40 x 13.5, PV 25 x 20 and PV 18 x 12 lenses. A Canon J20 x 8.5 was used on ABC's Super Slo-Mo

camera, while a Canon J25 x 11.5 was shooting aerial pictures from the Goodyear® blimp. ENG camera operators used the Canon J13 x 9BIE and the incredible new J18 x 9BIE for the extra reach that brought us face-to-face with the competitors.

Canon broadcast lenses were also the choice of many independents on the scene in Los Angeles, because Canon's proven performance and reliability assured them of getting the shots they needed at this once-in-a-lifetime event.

If you watched the 1984 Olympics, you've already seen the most spectacular demonstration of Canon TV lenses we could possibly arrange. But we'll be happy to do another just for you.





PV40 x 13.5BIE



PV40 x 13.5BIE and PV25 x 20BIE



J13 x 9BIE



PV40 x 13.5BIE and PV25 x 20BIE

Canon®

Optics Division

Canon USA, Inc., Head Office: One Canon Plaza, Lake Success, N.Y. 11042 (516) 488-6700
Dallas Office: 11311 Stemppens Freeway, Suite 1, Dallas, Texas 75229 (214) 620-2541 Chicago Office: 140 Industrial Drive, Elmhurst, Ill. 60126 (312) 833-3070
West Coast Office: 123 Paularino Avenue East, Costa Mesa, Ca. 92626 (714) 979-6000
Canon Canada, Inc., 6390 Dixie Road, Mississauga, Ontario L5T 1H7, Canada (416) 678-2730

© 1984 Canon U.S.A., Inc.

Circle 114 on Reader Service Card

RADIO PROGRAMMING

put together a playlist from the station's gold selections that paid tribute to the decade which changed young people's listening habits irreversibly. Each DJ played a countdown of the 15 top hits of one year, from 1960 on Joe O'Brien's shift, to 1969 in the final hours of the weekend with Bob Lewis.

In between the music, the radio greats spiced up the programs with bits of precious old tape containing unforgettable moments in their own personal on-air histories. Listeners again heard

the screams of crowds gathered in the streets during the Beatles' first U.S. tour, the bizarre "Paul McCartney is dead" rumors which led to the ousting of WABC DJ Robie Young by then station program director Rick Sklar and a security guard, and the only time his colleagues could recall veteran Dan Ingram losing his composure on the air: when Bruce Morrow "showered" a shopping bag full of men's underwear on him after a forecast of "brief showers."



Jack ("Your main man Jake") Spector smiles his famous "Hello, Bubby" during his stint on the nostalgia weekend.

Each shift was punctuated by original name IDs and the same theme music which gave each personality his own identity: Cousin Brucie's "Go-Go" song recorded by the Four Seasons; Bob Lewis's "Bobaloo" Doo-wop theme and Ingram's jazzy closing theme, which had to be re-recorded in stereo first. Herb Oscar Anderson, the "morning mayor," sang "Hello Again," and former Good Guys played old recordings of slightly off-key parodies hyping themselves to the tune of "Bye Bye Blackbird."

Jack O'Brien brought his former sidekick/alter ego "Benny" back to the airwaves, Ron Lundy said "Hello Luv" to everybody, Dean ("Dino on your radio") Anthony played "actors and actresses" by giving initials and taking guesses, and Ingram joked with his "Kimosabe" monicker and "Tonto" routine, remembering to celebrate the "honor group of the day—people who grew up listening to me."

The mood went from hilarity to sentimentality, and occasional lapses into mushiness added, rather than detracted, from the end result.

Remembering the 60s

Anderson actually shed tears while reminiscing about the Vietnam era after a phone-in from a veteran. Anderson's program had been aired on ships bound for Southeast Asia during those painful years, and his show became the most popular among Vietnam-bound young men, mostly due to his support of them while anti-military protests raged at home.

But the tone could not stay somber for very long, as DJs stayed after their airshifts or dropped by early to joke around, on and off-mic, ad-libbing and doing their best to make each other laugh and get the last word or "one-

**If price were no object
they'd still be your first choice.
At \$1,480, they're incomparable!**

Cipher Digital 735 Series Time-Code Readers



735V (video display)



735L (LED display)

PRODUCT FEATURES:

- Wide-speed bi-directional decoding, 1/30th to 60X play speed
- Intelligent "Error Bypass" provides correct output even when input code is defective
- Decodes and displays Time or User data
- Reformatted Time-Code output for computer editor or dubbing
- Optional serial RS-232/422 or parallel BCD data outputs
- Multi-size, full positioning video character display (735V)
- Ideal for producing "burned-in" workprints for off-line editing (735V)

For detailed information or demonstration,
contact our Sales Department:



Sales/Marketing Headquarters:
150 Huntington Avenue • Boston, MA 02115
Tel: (617) 267-1148 • Telex: 940536

Superior Time-Code Products

Circle 115 on Reader Service Card

Let Telex Bankroll You to a Tape Duplicating System

For only \$268.50* a month you can own a basic Telex 6120 system, without interest or finance charges.



Basic monaural cassette-to-cassette system \$358.00 down and 12 monthly payments of \$268.50.



One of many system configurations available for cassette-to-cassette, reel-to-cassette, reel-to-reel duplicating.

As you may know, the Telex 6120 is considered to be the most advanced and reliable in-cassette tape duplicating system on the market. To make this system affordable, we have a special, time limited offer to non-profit and commercial organizations. So even if your budget is small, or your funding is limited or you rely on donations, you probably qualify to buy a state-of-the-art Telex tape duplicating equipment now. Here is how it works. You select the 6120 system of your choice. Make a 10% downpayment and pay the balance in up to 12 months, without interest or finance charges. For example, the downpayment for a basic monaural cassette-to-cassette duplicating system is \$358.00 with a monthly payment of \$268.50. If you duplicate tapes as a commercial service, you'll pay for the system with just a few hours of operation. If you're non-profit and send out for your duplicating, you can do it yourself and save more than enough to buy the equipment. Either way, within a year you'll own the system outright.

Of course, you can select system configurations for reel-to-cassette or reel-to-reel duplicating. Mono or stereo systems are available. And because the Telex 6120 is based on the building block principle, you can expand a basic system when needed.

This special offer is based on two conditions:

1. Your purchase is subject to credit approval by a participating dealer.
2. This offer expires December 31, 1984.

Please contact us now.

We'll send you complete

technical information about the system. You'll get the names of participating dealers. We'll include our price list. We'll even provide you with a chart that lets you determine how quickly a basic system can pay for itself.

Remember, • Minimal Investment up front

• Pay as you go for up to 12 months • No interest or finance charge • This offer expires December 31, 1984

You must act now. Write to Audio Visual Department, Telex Communications, Inc., 9600 Aldrich Avenue So., Minneapolis, MN 55420 U.S.A. or call us toll free during business hours at 800-828-6107. In Minnesota call 612-887-5531.

*Payments are based on the suggested list price of \$3580.00 for a basic monaural cassette-to-cassette high speed series 6120 tape duplicating system with a 10% downpayment of \$358.00, and 12 monthly payments of \$268.50. Offer available only through participating dealers and does not include state or local taxes. Offer expires December 31, 1984.

TELEX®

TELEX COMMUNICATIONS, INC.

Circle 116 on Reader Service Card

RADIO PROGRAMMING

up" each other.

There was a steady stream of visitors, who were promptly placed in front of mics to give their renditions of 1960s radio remembrances.

Former DJ Gary Stevens, now with broadcasting owner Doubleday, said the weekend was reminding listeners of how much fun radio used to be. Former WABC nighttime voice Chuck Leonard dropped in to join the party-like atmosphere. Singer Lenny ("Since I Fell For You") Welsh and Sid Bernstein, the man who brought the Beatles to America

and later managed such well-known rock acts as the Young Rascals, were guests on Jack ("Your main man Jake") Spector's show. In addition to interviews, Bernstein took his turn answering the relentless phone-ins which kept the WCBS switchboard lit up during, and even well after reunion programs were on the air.

Calls came in and were aired from some well-known listeners such as singer Jay Black (Jay and the Americans) who phoned to wish Bruce Morrow well.

Enthusiastic response

Nancy Widman, WCBS-FM general manager, was surprised at the response and the stated gratitude of the listeners. Although the reunion special had gotten the enthusiastic support of sponsors—it was completely sold out—she hadn't expected it to trigger the outpouring of feelings swarming in from the callers.

"I'm overwhelmed by the response and thrilled about the warmth and emotion," she said. "Our station is built on nostalgia and memories, so this weekend was a celebration of everything we represent."

Memories aside, while the radio reunion reminded listeners of what radio was, it also brought home to them—and to the men behind the mic—what is different about it today.

"There was this rivalry between the Good Guys and the All Americans, but we also had a great deal of respect for each other. Radio today is not like that," noted Dean Anthony.

"Communicating on the radio is so important," said Bob Vanderheyden, CBS radio vice president, in a call-in during the reunion. "If we could get rid of the research people, we could get back to radio again."

"We have some very talented people in radio today," commented Morrow, on-mic. "I wish the people in charge of radio would let them to do their thing." Ingram agreed. "They've got to widen the goalposts and let the folks on-air score touchdowns."

If the hunger for "radio as it used to be" is that strong among DJs and listeners alike, maybe WCBS will take a hint and repeat the rock radio reunion again, as almost every caller suggested. Tempting as that may be to station management, with full weekend sponsorship and unceasing accolades from fans calling in, PD McCoy conceded that it isn't likely, calling the event "radio like you'll probably never hear it again."

And while it may have all been as fresh in listeners' minds as if it were only yesterday, Dan Ingram's quip as he closed his show wryly affirms the fact that nostalgia almost always reminds us of how much and how irrevocably things have changed.

"Everything's the same as it was 20 years ago," Ingram said of his airshift. "Except now when I do the show I need reading glasses."

BM/E



MAXERASE
Audio/Video Tape Degausser

Erases any width tape, on any diameter reel and even on high coercivity tapes. MaxERASE-16A is truly a universal audio/video tape degausser plus it has some outstanding advantages.

MaxERASE-16A erases thoroughly, evenly and prevents "spoking." A patented 30-second, one-pass erasure is achieved with the most intense magnetic field available. MaxERASE-16A even erases a 1500 Oersted tape completely in a single pass.

Christie Electric
Communications Equipment Div.
20665 Manhattan Place
Torrance, Calif. 90501
213 320-0808
800 421-2955

CHRISTIE
ELECTRIC CORP.

Ampex Listened When You Described Your Ideal VTR.

VTR SYSTEM DESCRIPTION

TRANSPORT

- The VTR shall have
- The VTR shall provide unthreading.
- The VTR shall have ends or head
- The VTR shall need for sp

CONTROL

"User friendly" control panel

- All control panel; set-up
- The
- The



Spot needs to 2 hr reels

Handling 6 1/2" to 11 1/4" reels with equal precision and gentleness. Prior to gently slow the tape down in preparation for winding the tape and prevent damage to tape in the feed without the

audio confidence

- The VTR shall be
- The VTR shall be
- The audio electronics shall include
- The audio head stacks shall be constructed of

DIAGNOSTIC SYSTEM

- The VTR microprocessors shall perform continuous self-checks of system warning LED if a non-standard or fault condition exists. The operator will be able to system code in the numeric readout to trace the fault to a particular assembly in the
- A logic probe shall be used in conjunction with the microprocessors in the VTR to troubleshoot all of the integrated circuits which are in communication with the microprocessors.

VIDEO SYSTEM

*AST**

- The VTR shall include Automatic Scan Tracking as a standard feature
- The VTR shall be capable of disturbance-free variable play speeds from -1 to 3X.
- The VTR shall include video confidence head and circuitry to allow monitoring of the video during record.

Video Confidence

PACKAGING

- The VTR shall be modular in design to facilitate ease of servicing and to insure highest reliability.
- The VTR shall be offered in a variety of configurations to meet many space and budget criterion.

TIME BASE CORRECTOR

new TBC

- State-of-the-art time base corrector design shall be utilized to attain a TBC performance-matched to the VTR.
- The TBC shall include integral dropout compensation, velocity compensation and color processing.
- The TBC shall be capable of supplying pictures at shuttle ranges of up to 500 fps, forward or reverse normal tape speed.
- The TBC shall be capable of being time-shared between a 1/2" VTR and a Type C 1" VTR.

Tabletop & Console

**CONSOLE WITH OVERHEAD
PICTURE MONITOR—ONE OF
6 CONFIGURATIONS
AVAILABLE**

**HI FI SPEAKERS LET YOU
APPRECIATE SUPERIOR AUDIO
QUALITY OF VPR-6 WITH
EXCELLENT STEREO PHASE
RESPONSE.**

**HANDLES SPOT TO 2 HOUR
REELS WITH EQUAL PRECISION
AND GENTLENESS**

**BRUSHLESS DC SCANNER
MOTOR AND INDIVIDUALLY
REPLACEABLE HEADS**

**LOGICAL, EFFICIENT CONTROL
PANEL—ALL OPERATOR
CONTROLS UP FRONT**

**TBC-6 WITH 32 LINE MEMORY
AND 28 LINE CORRECTION
WINDOW; PERFORMANCE
MATCHED TO VPR-6.**

**DUAL NUMERIC READOUTS—
ONE FOR TAPE TIME/TIME
CODE; ONE FOR CUE POINTS,
DIAGNOSTIC CODES, TAPE
SPEED, SETUP CODES**



Now, Here It Is. The New VPR-6.

When hundreds of users worldwide told us what they wanted in a one-inch VTR, we listened closely and then designed and built it. It's our new VPR-6, the easiest VTR to operate, service and maintain of any in its class. And it's in the price/performance ratio that most users want.

Smart, yes. Complicated, no.

Intelligent but not intimidating, the new VPR-6 offers features that allow you to get the job done more productively. For example, virtually all machine setup procedures can be done at the highly efficient control panel. Most board-edge controls typically found in VTR's have been eliminated.

You insisted on fast but gentle tape handling... the VPR-6 shuttles tape at speeds approaching 500 ips and handles all reel sizes from spot to 2 hours with equal precision and gentleness. The servo microprocessor senses when the end of the tape is near and slows down the reels and scanner and unthreads the tape gently.

You asked for power-down memory... so we built in a long-life battery to protect setups, edit and cue points and all editor configuration parameters.

"Make it easier to troubleshoot," you said, and we built in an extensive diagnostics system that constantly monitors many system conditions and warns you if a fault occurs. You can even run from the control panel a diagnostic routine using a logic probe to test every IC in direct communication with the two microprocessors.

A tried and true transport

You demanded reliability. Not wanting to tamper with success, we borrowed the tape transport and mechanical

printed wiring boards and backplane connectors throughout. The modular package allows convenient access to any part of the VTR for easy maintenance.



A TBC to Match

Because you wanted play speeds from -1 to 3X normal and picture in shuttle, we also developed the new TBC-6 digital time base corrector, performance-matched to the VPR-6. Its 32-line memory and 28-line correction window are the largest in any TBC appropriate for a VTR of this type.

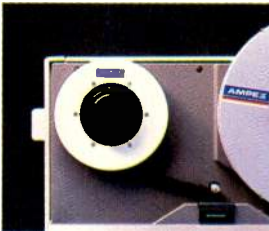

State of the art editing

So much for recording and playback, how about editing? The VPR-6 has all the capabilities you asked for, including split audio-video auto edit and auto tag. RS-422 serial communications capability lets VPR-6 function efficiently in a state-of-the-art editing system with the Ampex ACE and other edit controllers.

First-rate audio

"Make audio better," you said, and we did. The VPR-6 has audio (as well as video) confidence playback. The audio system also offers high quality stereo phase and an optional fourth audio channel for EBU systems.

Selection of styles

Most users may agree on capabilities, but you prefer a variety of configurations to choose from. So, we offer the VPR-6/TBC-6 in four console styles as well as tabletop and rackmount versions. Many Ampex video accessories work with it, including some you may now own.

In production now

The VPR-6 is too good to wait for, so it's already in factory production. Ask your Ampex video sales engineer to quote price and delivery for any model in any world standard, and watch his face light up!



design of our reliable and proven VPR-80. We also eliminated most wire harnesses in favor of more reliable

to quote price and delivery for any model in any world standard, and watch his face light up!

AMPEX

Ampex Corporation • One of The Signal Companies

Atlanta 404/491-7112 • Chicago 312/593-6000 • Dallas 214/960-1162 • Dayton 513/254-6101 • Los Angeles 818/240-5000 • New York/New Jersey 201/825-9600 • Salt Lake City 801/487-8181 • San Francisco 415/367-2296 • Seattle 206/575-0156 • Washington, DC 301/530-8800
Canada, Toronto 416/821-8840

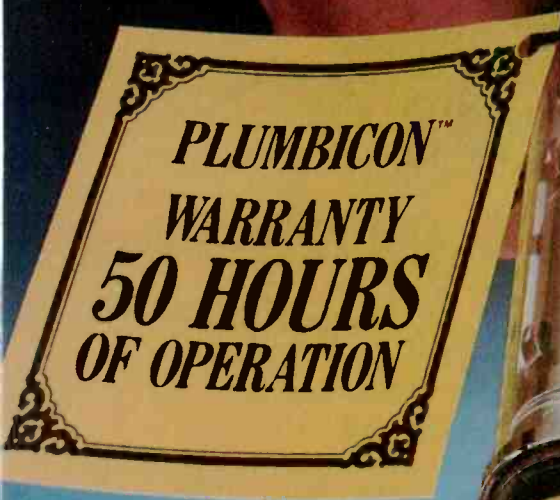

We're so confident about Saticon II performance, we don't have to count the hours.

Our Saticon II warranty is measured from the date the tube is placed in service, with full adjustment for up to *six months*, regardless of actual service hours. The Saticon II in-service warranty covers, in effect, full-time operation for the entire six months—more than **4,000 hours of service**.

Plumbicon's warranty is based on hours of service with full adjustment for just **50 hours** of service. If Plumbicon were used at a minimum of only one hour a day, this 50 hours service warranty would expire in **less than seven weeks**.

In what may be a more typical comparison, if Saticon II averaged 30 hours of service per week, after six months the service would total to 780 hours. Compare this with the Plumbicon warranty of only 50 hours of service. Saticon's full adjustment warranty period is still **15 times longer** in this "real world" example.

Saticon's pro-rated adjustment policy is better, too. Should a Saticon tube fail after the six month in-service period, we'll pro-rate the cost of its replacement for 12 months, regardless of service hours. With Plumbicon, pro-rated adjustment is limited to only 1,000 of total service.

*Used by permission of trademark owner.

Saticon II not only gives you the best warranty in the business, it also gives you best performance in your cameras. The improved Saticon II photoconductor ensures high resolution, distortion-free color, very low lag, high sensitivity and depth of modulation. Pictures are clearer, sharper and crisper. Highlight memory (without red trail) is significantly reduced.

For more information contact your RCA distributor or write to RCA Camera Tube Marketing, New Holland Avenue, Lancaster, PA 17604-3140. Or call (800) 233-0155. In Penna., phone (717) 295-6040. Overseas, contact RCA Sunbury-on-Thames, Middlesex, England. Hong Kong. Mexico 16DF, Mexico. Rexdale, Canada.

Our convenient camera tube selection guide will help you compare the performance characteristics and design features of all major camera tubes. Call or write today for your copy.

RCA
Take out the doubt.

TELEVISION

programming & production

Small-Market TV Station Takes the Big-Market Outlook

By Eva J. Blinder, Senior Editor

It may be the state capitol, but Concord, NH, is still too small to be counted as an ADI. Nevertheless, the management at new UHF independent WNHT, Ch. 21, feels the station is positioned not only for success, but for influence.

WNHT's transmitter site, 11 miles from the station atop Fort Mountain in Epson, NH, allows the station to reach all New Hampshire's major cities—Concord, Manchester, Dover, Nashua, and Portsmouth—with its A contour. Its B contour brings the station into parts of Massachusetts and Maine. In all, WNHT reaches about 80 percent of the population of New Hampshire.

Compared to neighboring Massachusetts, however, New Hampshire is sparsely populated. Despite its wide-ranging signal, WNHT faces many of the budgetary realities shared by small-market stations and fledgling stations alike.

Quality and efficiency

According to general manager J.A. "Skip" Simms, achieving success on a relatively small budget requires careful planning and a commitment to quality.

"We designed the station," he explains, "so that people would have all the tools they needed to get the job done, and at the same time so we'd need the fewest people." The staff is small—about 32 people total—and for many, WNHT is their first experience in the broadcasting industry. Department heads, however, are experienced. Several, like chief engineer Bob Judevine, were attracted not by high salaries (since WNHT cannot compete with larger markets) but by the "New Hampshire lifestyle," according to Simms.

Careful planning was evident everywhere during a recent tour of the station. WNHT occupies the first floor and



General manager J.A. "Skip" Simms in WNHT's master control room.

part of the second floor of a small office building, with all facilities except the control room downstairs. The construction budget (the entire facility was built for \$3 million) did not allow more than one studio, so the single ground-floor studio was designed for maximum flexibility. Its L-shape allows several show sets with completely different looks to share the studio at the same time. In the short arm of the L is the news set, which lets viewers look over the anchor's shoulder into the newsroom, where the station's logo is prominently displayed. (The newsroom also houses a Colorgraphics weather system, which receives ESD weather graphics and the AP newswire.) All the cameras—four news cameras, two studio cameras, a production camera that can serve as a third studio camera, and the telecine camera—are economical Hitachi FP-22s. WNHT is an affiliate of CNN Headline News, and also has its own news staff of eight people.

Also produced in the studio are several talk shows, including *FYI New Hampshire* and *New Hampshire Top-*

ics, both weekly half-hours, and *New Hampshire Today*, which airs live each weekday from 10:00 to 10:30 a.m. and is aimed primarily at women. The set for these shows is situated in the "elbow" of the studio and has moveable furniture to give each show a different look. (The furniture is stored off-camera in the long arm of the L when not in use.) Extra baffling on the studio ceiling has largely solved an echo problem in the large studio. The lighting system and dimmer packs in the studio are by Strand Century.

Nearby is the audio booth, equipped with a small mono Broadcast Electronics console, a Technics turntable, and an Otari MR-5050 reel-to-reel ATR.

Multiuse control room

Upstairs, the control room is divided into three basic areas, which will probably be partitioned off from each other in the future, Simms says. Nearest the entrance is the production area, built around an eight-input Grass Valley Group 1600 production switcher, situated so the operator looks down into the

TELEVISION PROGRAMMING

production studio through a large window. The GVG's capabilities are enhanced with a 20x20 Utah Scientific routing switcher that feeds one input of the GVG, in essence adding 20 additional channels. Installed next to the switcher are a 3M D-8800 character generator with logo compose and camera compose capabilities and a variety of fonts, and a Strand Century Matrix lighting board to control the studio lights. The audio board is a Broadcast Electronics Slide-Mod. Also in this area are a Sony VO-5850 U-Matic recorder and a Convergence ECS-90 cuts-only editor, both used primarily for promotion and public service.

Just behind the editor and VTR used for promotion is the station's commercial production setup. While management chose to go with economical VO-5850s throughout the plant, it felt its commercial operation required the quality of one-inch. The commercial editing bay, therefore, has three Sony 1180 Type C machines, controlled through a Convergence ECS-104. Fortel TBCs give the station freeze frame

and slow-mo capability.

Local commercial production

The station's production efforts deserve some mention, since they illustrate a problem common to small markets and those underserved with television. Many of the businesses WNHT wishes to attract as advertisers have never used television before; some are skeptical about its ability to sell, others are intimidated by the process of producing a commercial. At press time, the station had not participated in the ratings, but was planning to subscribe to Arbitron soon in order to be able to offer potential advertisers some numbers. Meanwhile, it is relying on testimonials from satisfied customers, which it has edited into a videotape presentation. The station programs six hours a day of Financial News Network, and can point to the high-income viewers the network attracts.

As an enhancement to its commercial production abilities, the station has acquired the Image West special effects package, eight tape reels containing

over 1000 effects. WNHT is giving its advertisers the opportunity to purchase "exclusive rights" to one or more of the effects in the package, which would then be used to give their ads a unique "look." Although advertisers were still taking a wait-and-see attitude on the effects package at press time, the station has used it to good effect in producing its own promos, openers, and bumpers.

Automated master control

Across the room from the one-inch bay is master control itself, with two more 1180 one-inch VTRs and a used RCA TR-70 quad machine. The two-inch VTR is used strictly to dub shows and commercials received in the quad format to ¾-inch for air. All taped material airs from seven Sony U-Matics, six of which go through the station's LaKart automation system from Lake Systems.

The LaKart takes much of the credit for the station's ability to operate smoothly with its small staff and small

6139

FOR EXCELLENCE IN PERFORMANCE

LED OR
INCANDESCENT
LAMP
PUSH-BUTTONS

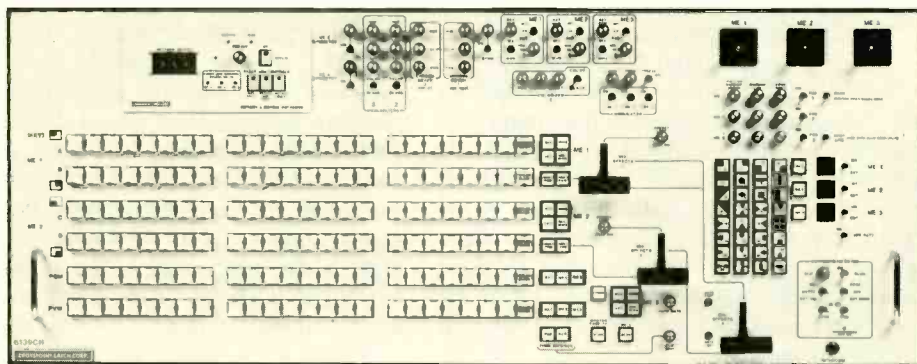

The quality of the 6139 is superb. You could not ask for more. Even if you ignored all else, the 6139 would be selected for its single most important feature - its quality.

There are several models to choose from, 8, 16 or 24 inputs; LED or incandescent lamp buttons; fully computerized ("K" versions). The 7239 AUTO DRIVE™ is the most sophisticated computer controller in the industry.

- 3 MIX EFFECTS SYSTEMS
- TEST MODE FOR SYSTEM TIMING
- MASTER FADE TO BLACK
- QUAD SPLIT
- TWO CHROMA KEYERS (OPTIONS)

- DOWNSTREAM KEYER WITH EDGE
- COMPUTER CONTROL OPTION
- EDITOR INTERFACES
- ROTARY AND MATRIX WIPE OPTIONS
- BLANKING PROCESSOR

Prices start at \$14,500. for 8 input version and go up to over \$70,000. with all options.

CROSSPOINT LATCH CORP.

95 PROGRESS STREET • UNION, NJ 07083
(201) 688-1510 • TELEX 9104901990



Our cart machines work the way Arthur does. At various speeds.

Ordinarily Arthur runs at 3.75, 7.5 or 15 i.p.s. (ideas-per-second). He also has a few unique variations. And so do Fidelipac's new Dynamax™ CTR100™ Series Cartridge Machines.

They have a variable speed DC Servo Motor that will run at 3.75, 7.5 and 15 i.p.s. (inches-per-second). But, the motor can be controlled externally to run at speeds from as much as 30% below each of those speeds to 30% above them. And do it without loss of cue tone sensing or clock accuracy.

Music cartridges can be played uptempo. Special effects can be created and pitch controlled. And Vary Speed enables you to interlock with

other machines using a SMPTE controller or a 9600 Hz-based synchronizer.

Vary Speed is just one of many standard features our new cart machines have. No cart machine comes close to offering what the Dynamax CTR100 Series offers. And the price is right. Substantially lower than the ITC 99B, for example.

Don't consider buying any machine until you've invested 15 minutes of your time. Write for, and read our new CTR100 Brochure, or call Art Constantine, our VP Sales. You'll be glad you did.



DYNAMAX™
BROADCAST PRODUCTS BY FIDELIPAC

Circle 179 on Reader Service Card

TELEVISION PROGRAMMING

budget. According to Simms, the station designed its master control operation around LaKart, which automates all station breaks aired on WNHT and some complete programs.

LaKart's automation capabilities have allowed the station to dispense with a master control switcher, although the MC operator has a router that allows him to take various sources as needed. "What we saved in the cost of the switcher just about paid for LaKart," Simms asserts. He adds, "We are asking the master control operator to do an awful lot of things. LaKart is supposed to make his job easier so he has time for all the other things." The "other things" include recording shows off satellite, monitoring the remotely controlled transmitter, and monitoring video control.

MC operator Kevin McCarthy agrees that LaKart has made his job simpler. He estimates that it takes him a full hour to program the events for the entire day on the system's touch-screen display. McCarthy, who is relatively new to LaKart despite five years' previous television experience, programs

commercial breaks into the system but starts each break manually at the appropriate time, rather than having LaKart start them automatically. "I have a lot of confidence in the system," he explains. "It's only glitched once since I've been here. But it's still a lot more fun to do it myself. I like to feel I have a little input." The station does fully automate the *Merv Griffin Show*, however; as the show is recorded off satellite, time code is recorded on the tape, allowing McCarthy to program the commercial break starts and stops into the program. At air time LaKart takes over, running all material from the station break preceding the show to the one following it.

Satellite capability

The station is committed to satellite technology, with three receivers and two TVRO dishes. The third receiver allows WNHT to receive two signals off one of the dishes and also lets the station offer teleconferencing services to its community. The large conference room on the station's first floor was

designed with community service in mind; much larger than the station's own needs require, it is made available to community groups for their meetings and is set up for use as a teleconference site. The studio is also available for larger teleconferences.

The dishes bring in a variety of programming off satellite, allowing the station to air Financial News Network live while recording other satellite-distributed material for later airing. The satellite system, which uses Scientific-Atlanta receivers, was supplied as a package by American Horizon of Terre Haute, IN.

WNHT signed on-air April 16, and it is still early to make predictions about its future. Ad sales are slow but steady, according to Simms, as the sales staff tries to convince conservative New England businesses that they should try television. Nonetheless, the elements for future success are in place: a young, lean staff with experience where it counts; a thoughtfully designed facility built on a budget without sacrificing quality; and a strong position at the heartbeat of New Hampshire. **BM/E**

Simply AWESOME!

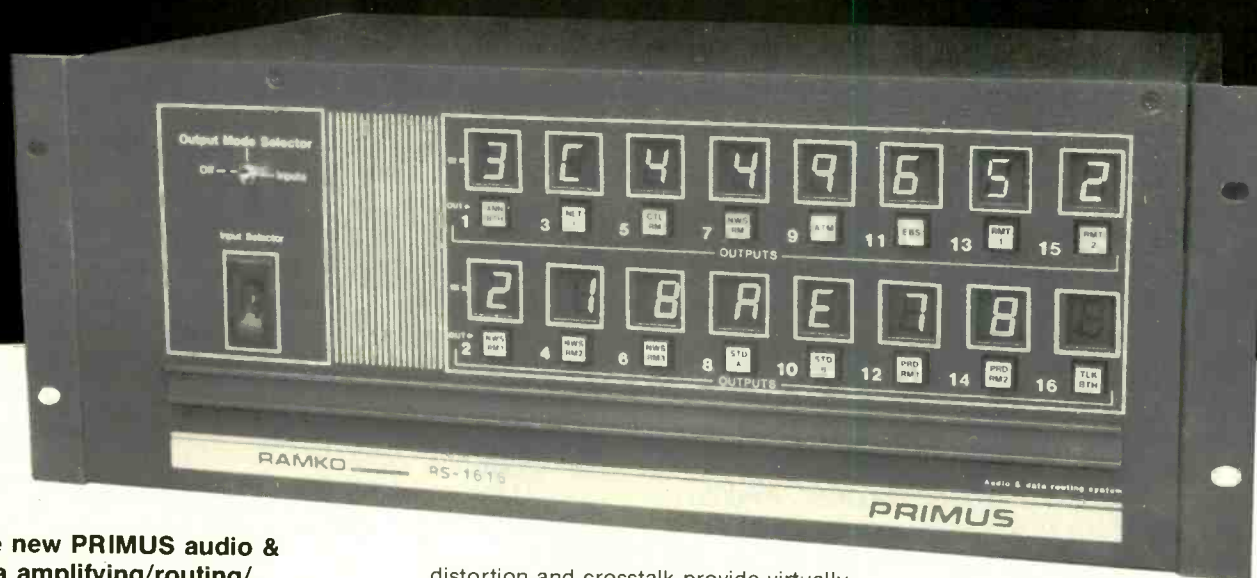

The new PRIMUS audio & data amplifying/routing/switching system.

You name it, this system will handle it. Audio, SMPTE, time code, DC, ultrasonics or modems. Expandable from 8 in X 2 out to 128 in X 64 out. Extremely low noise,

distortion and crosstalk provide virtually transparent operation, in both mono and stereo mode. In addition, the means of control (BCD, 3 wire party line, or RS-232 personal computer) are limited only by your imagination. Three year warranty with prices starting as low as \$920.

Call toll free (800) 821-2545 for details and the name of your nearest dealer.

RAMKO RESEARCH

11355-A Folsom Blvd., Rancho Cordova, CA 95670 (916) 635-3600 Telex: 176493 RAMKOSAC



Shure's new FP31 Mixer takes a big weight off your shoulders.

Introducing the most innovative field production mixer of its kind. Shure's FP31. You won't find another mixer this small with these features, dependability and ease of operation.

The FP31 measures only 6⁵/₁₆" x 5⁵/₁₆" x 1⁷/₈", and weighs just 2.2 pounds! Incredibly, it offers the same important features as much larger mixers. Plus, a few of its own.

Every channel has a mic/line level and a low-cut filter switch. And to prevent overload distortion, there's a built-in limiter with adjustable threshold.

The FP31 can be powered by two internal 9-volt batteries, or from an external 12-volt source. A green LED flashes to remind you that the mixer is on. Phantom and A-B power are also provided to operate lavalier and shotgun microphones.

A slate tone can be laid

down on the tape for locating specific takes, and there's also a built-in mic for voice slating.

The mixer also has two separate mic/line outputs for 2-camera shoots and a tape output to feed a cassette. For monitoring, there are two stereo headphone jacks—one 1/4-inch and one for miniplugs. The FP31's rugged nylon carrying case allows you easy access to every mixer function and lets you piggyback the mixer on your VCR or other equipment.

For ENG, EFP and film use, Shure's FP31 has everything you need to make your mix a perfect success. Coming from a mixer this small, that's quite an accomplishment.

For more information on Shure's FP31 Mixer, call or write Shure Brothers Inc., 222 Hartrey Ave., Evanston, IL 60204, (312) 866-2553.



SHURE®

THE SOUND OF THE PROFESSIONALS®...WORLDWIDE



“OUR NEWS IMAGE HAS NEVER BEEN BETTER.”

—David Choate, News Director WSVN-TV, Miami

“Ranked as a competitive activity, TV news would probably fall somewhere between rugby and wild boar wrestling in terms of fierceness. Which is why we’re constantly on the lookout for anything that might give us an edge.

“Our 6 Betacam camera-recorder systems are a good example. Their image quality is spectacular, so we look great on-air.

“But even better, the mobility Betacam offers is a real incentive to our photographers to go for that really dramatic, unusual shot. The kind you won’t see on every channel at 6 and 11. Because at least for the time being every station doesn’t have Betacam.”

“THE ABILITY TO SEND OUT MORE CREWS ON MORE STORIES IS WHAT I CALL GOOD NEWS.”

—Tom Kirby, VP/News WTCN-TV, Minneapolis

“Before coming here, I was with Gannett’s Denver station, KUSA, which was the



winner of the NPPA’s 1983 ‘Station of the Year’ award. And frankly, my goal here is to get to the finals again. A not unrealistic objective when you consider the talent we have, and the fact that we recently purchased 23 Betacams.

“After all, it seems obvious, the more people you have on the street, the better your chances are of coming up with a winner. Providing, of course, you give those people equipment that’s as performance-minded as they are.”

“WITH SO MUCH LESS EQUIPMENT TO LUG AROUND, WE’RE SEEING A LOT MORE EXCITING TAPE.”

—James Delmonico, President/General Manager WRGB-TV, Schenectady

“I don’t care how inspired or dedicated a photographer is, eight hours of hauling sixty-plus pounds of camera, recorder, lights,



and cable all over hell and gone is bound to have a stifling effect on someone’s creativity.

“That’s what initially got us interested in Betacam, and ultimately, why we made the decision to invest in it. The simple fact that you don’t have to be a gorilla to use it. The maneuverability of this system is tremendous. So naturally we’re seeing shots you just couldn’t get before. And, of course, the image quality itself is magnificent.

“In fact, I’d have to say from the looks of things, we’ll be adding more Betacam systems

HOW THE PEOPLE WHO LIVE AND DIE BY THE RATINGS RATE THE SONY BETACAM.™

before long. If for no other reason than to stop our crews from fighting over who gets to use the ones we currently have."

"THIS IS CLEARLY A SYSTEM BUILT FOR THE REAL WORLD."

*-Allan Howard, VP/General Manager
KXTV-TV, Sacramento*

"You rarely find news under ideal conditions. More likely you're getting jostled around by a huge crowd, buffeted by gale winds or caught in a very tense, fast-moving situation. All of which tend to play havoc with equipment life spans.

"Betacam, however, seems to have been designed especially for this environment. It's an extremely well-built, exceptionally rugged system, particularly for its weight. And the net result is that in the year we've had them, downtime has been virtually nil.

"Equally important, because Betacam is totally compatible with 3/4" systems, you can



move into this technology at your own pace. Which is another part of adapting to the real world, the world of equipment budgets."

These are just a few examples of the reports we're getting from stations that have made the move to Betacam. To hear more, or, better yet, to get a look at the system behind them, just give us a call. In the New York/New

Jersey area (201) 833-5350;

in the Northeast/Mid-Atlantic (201) 833-5375;
in the Midwest (312) 773-6045; in the Southeast
(404) 451-7671; in the Southwest (214) 659-3600;
in the West (213) 841-8711.

SONY
Broadcast

Sony Broadcast Products Company, 1600 Queen Anne Rd., Teaneck, New Jersey 07666. © 1984 Sony Corporation of America. Sony is a registered trademark and Betacam a trademark of Sony Corporation.

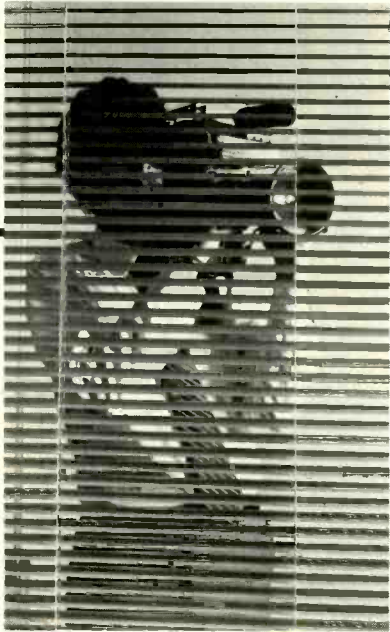

Undercover

Hidden cameras and concealed microphones can get stories that would be inaccessible by ordinary ENG techniques. What are the advantages—and drawbacks—to these covert newsgathering methods?

By Eva J. Blinder, Senior Editor

Hidden cameras: to many minds, they call up the image of Alan Funt's *Candid Camera*, or of commercials for laundry detergent. At television stations around the country, however, they provide an invaluable means for getting news stories that elude normal journalistic methods. The camera concealed in a suitcase or unmarked van, the microphone taped to a reporter's body, can capture the subject of a story in an unguarded moment that graphically backs up a news story's allegations.

At the same time, the hidden camera and concealed microphone carry with them legal and ethical questions largely absent from conventional ENG. The circumstances under which it is legally permissible to make a videotape or audio tape of a conversation or interaction without the knowledge and consent of all concerned vary widely from state to state, although Federal laws and regulations can give some general guidelines. The ethical and philosophical considerations, on the other hand, may vary from story to story, depending on the outlook of the producer or news director involved.

Undercover ENG an "essential tool"

Many television news directors look upon covert newsgathering methods as essential tools for getting difficult stories, to be used whenever circumstances warrant. Others, while basical-

ly endorsing the use of hidden cameras when necessary, express reservations about possible abuses of the technique. All whom *BM/E* spoke with were aware of the legal ramifications of making a tape without the subject's knowledge.

Radio news directors, on the other hand, were more often strongly opposed to covert recording. A typical comment: "We don't do that kind of work. I believe if you can't get it by regular methods, holding a microphone by someone's face, you shouldn't be doing the story." A news director of an all-news radio station suggested a further reason for the rarity of concealed microphone work in radio news: "With the overall low quality of such things, without the sight of the person actually being nabbed or whatever, you often end up with just a low-quality actuality." He and several others felt the absence of the visual component made hiding a microphone less exciting.

One apparently rare exception took place about three years ago at CBS O&O WCBS-AM, New York City, when investigative reporter Art Athens won a Peabody Award with a series on taxi overcharging at the city's airports. Posing as a French tourist who spoke no English, Athens taped taxi drivers who charged him \$20 to \$50 for a two-minute ride from one terminal to another at Kennedy airport, then edited the tapes into a 15-part report.

"I used a small Panasonic micro-cassette recorder and a small Sony electret mic," Athens recalls. "Since I was

wearing a suit, the recorder was in my suit jacket. The wire ran up my sleeve and the mic was taped to my wrist." The small recorder produced adequate sound quality for airing, according to Athens, and had an automatic gain control that helped suppress background noise. Athens found that smoking a cigarette made the mechanics of taping easier; he could turn on the recorder while reaching in his pocket for a cigarette, and by gesturing with the cigarette bring the microphone closer to the speaker. "It was almost like having a mic in your hand," he comments.

Athens cooperated on the story with local detectives, whom he encountered at the airport investigating the same allegations of taxi fare abuse. He differentiates this kind of cooperation with actually aiding the police in an investigation, however.

"I'm not a detective and I'm not going to do their work," he insists. "I would be compromising myself by being a journalist acting as a peace officer. But I have no qualms in working with the police on a story." He sounds a bit envious, though, when he describes law enforcement surveillance techniques generally unavailable to reporters because of their great cost. "They record in stereo," he says. "They can sweep the spectrum and center in on the voices they need." Athens does have one neat item, a belt buckle with a built-in microphone "that will pick up a whisper at 20 or 30 feet." Its sensitivity to background

ENG

noise is a drawback, however, and Athens has never used the device on a story. (Its sensitivity could create legal problems as well, as discussed below.)

Athens protects his tapes from possible subpoena by the simple expedient of erasing them when the story is completed (he jokingly cites the precedent of Richard Nixon). He explains, "I dub off material for the story from the tape, and if I feel I'm legally covered as to context I reuse the tape," thereby conforming to standard practice at radio stations.

Why, when the taxi series was so successful, hasn't Athens used the hidden mic since then? "It's a long, tedious process" to put together such a story, he comments; the taxi series took six months to put together and required lots of background digging. In addition to being time-consuming, such work is expensive and often risky (Athens was threatened by a gun-toting cabbie while working on the piece). Nevertheless, Athens remains interested in the technique and says he'll probably use it in the future.

Selective use

While radio seems reluctant to conceal microphones, hidden cameras are in fairly common use at television stations, particularly those with active investigative reporting teams. Still, television broadcasters tend to be choosy about when and where they will hide a camera.

"The only reason I would use a hidden camera is to verify some kind of information or allegation people have repeatedly made, but where I have only their word for it," says Robbie Gordon, documentary producer for Post-Newsweek Stations.

Gordon, who is based at PNS's WJXT in Jacksonville, FL, gives the following example: "I must have read 50 different articles in which experts on runaways said the kids get picked up in bus stations by pimps almost as soon as

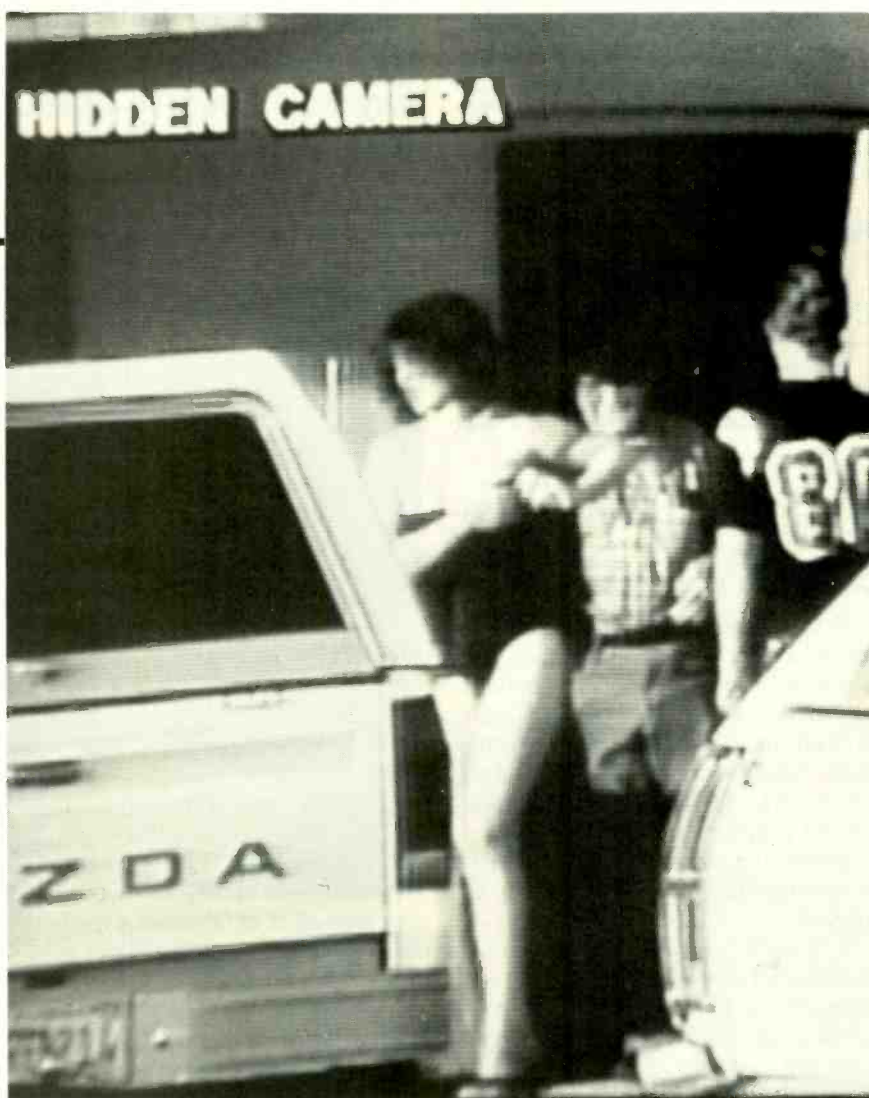

For her award-winning documentary, "Wards of the Street," WJXT-TV producer Robbie Gordon hid a camera in an unmarked van. Here, the hidden camera shows a young "lap dancer" leaving a booth with a client.

they arrive. We wanted to see how accurate that was." For the story, Gordon got in contact with a former runaway who had become a prostitute and was willing to pose as a decoy for the camera crew at the Orlando bus station. The station rented an unmarked van and modified it with one-way windows, then parked it 20 or 30 yards outside the bus station, which is glass-walled and very public. Photographer Windsor Bissel shot through the window of the van, while sound was picked up by a Vega RF mic taped to the decoy's body. The situation was perfect for compliance with Florida's laws on audio taping, which prohibit taping a conversation unless it takes place in a public area where passersby could reasonably be expected to overhear. In addition, the backup crew in the truck was ready to jump out at a moment's notice

if the decoy encountered a problem she couldn't handle alone.

"If she had a problem, she'd let me know, and I would jump out of the van and meet her at a place we'd previously arranged," Gordon recalls. "At one point she thought it was too dark in the bus station, so she steered the person she was talking to outside where the lights were brighter." Since the decoy was fully aware of what the camera crew was doing, she was able to position any alleged pimps with their backs to the camera but clearly visible, as Gordon had coached her.

The finished show, entitled "Wards of the Street," garnered a raft of honors for Gordon and PNS, including an Iris, four regional Emmys, a Freedom Foundation Valley Forge Award, and an Odyssey Award. It was also a finalist in the national Emmy awards and has



“The job of any credible journalistic organization is to pursue a good story in any way you need to pursue it.” Richard Moore, news director, WSOC-TV, Charlotte, NC.

been cleared by many markets in syndication.

Camera in a suitcase

More recently, Gordon used a camera in a suitcase for a story on the experiences of the poor in hospital emergency rooms. The suitcase, constructed for WJXT's news department by the station's engineers, contained an old Hitachi camera with a wide-angle lens set at infinity and aimed through a hole at the top. A Sony BVU-50 recorder was installed in the bottom of the suitcase.

To keep the story as public as possible, Gordon positioned herself and her photographer just outside the emergency room in a vestibule where people were smoking and relaxing. They explained the suitcase by saying they had come to pick up their mother and had brought her clothes. When Gordon would start talking to someone, the photographer would move the suitcase so that it pointed toward the subjects. Both Gordon and her production assistant wore wireless mics that were able to pick up the voice of a person next to them, but were inadequate if the subject was across the room. “With the two mics we were usually able to get usable audio,” Gordon says, “but when we aired the show we still used a character generator to let the audience see what was said.”

“In one sense I agree with people's objections to using hidden cameras,” Gordon muses. “I have less qualms with the pimp-type situation.... But I do have bigger qualms about going into an area where people are patients. You don't want to invade their privacy.”

According to Gordon, in most cases the emergency room patients were not recognizable because of the difficulty in positioning the suitcase and because

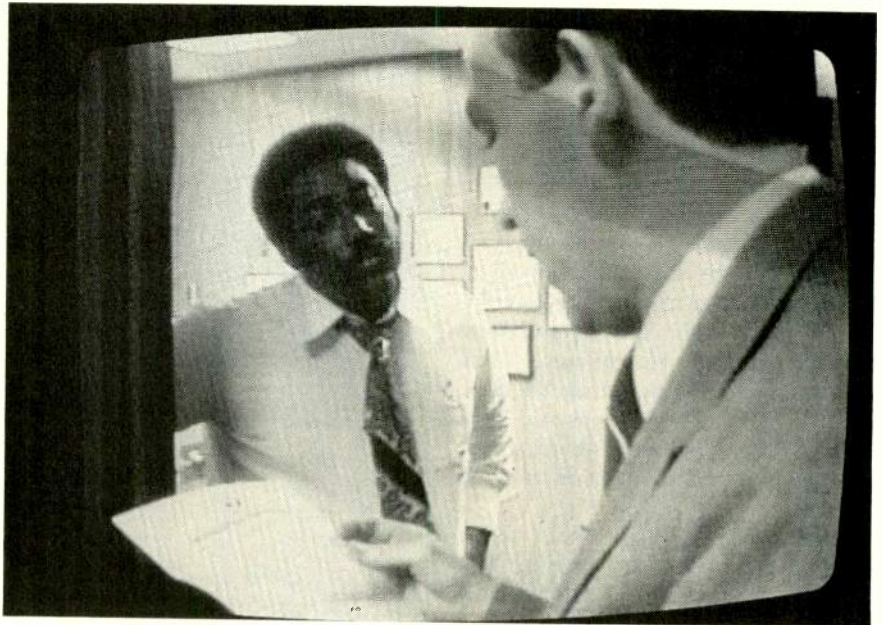

The then-chief of Charlotte's Park Police slams the door in the face of WSOC-TV investigative reporter Bruce Bowers. Bowers used a concealed camera to show the chief engaged in corrupt activities.

of ghosting in the picture. “Where they were really well defined we put a bar over their eyes,” she adds. “I try to use it (hidden camera) very judiciously and only when we think we can't do it any better in the usual way.”

Interestingly, one of those with strong reservations about hidden cameras is Mel Martin, news director at WJXT. “I think it's Big Brotherism,” he asserts. “People get outraged when the government spies on them. They should be equally outraged when broadcasters spy on them. I think in general it's not a good practice.”

Gordon is also very conscious of the need to stay on the right side of the law. “Whenever we do this, I'm on the phone a good 25 times to our lawyer. I never make a move without talking to him. A couple of times he's put the kibosh on a story idea, or we figure out a legal way around it. He's intricately involved in the process.”

Doing the right thing

A slightly different perspective is expressed by Richard Moore, news director of WSOC-TV, Charlotte, NC.

“We will use a concealed camera in a situation where the subject of the story is a fugitive and the presence of the camera would indicate that they are being watched, or in situations where the presence of a visible camera would make it impossible for us to get the story,” Moore explains. He adds, “You have to be aware of the right to privacy. We abide by established legal parameters. Occasionally we will consult with our lawyer if we're doing something out of the ordinary. But if we're operating pretty much within the law there's no need to consult an attorney.”

“In North Carolina we have a fairly liberal situation—we can record any telephone conversation as long as one party consents. We've used audio gathered on the telephone or by wireless microphone.... Implicit in what I'm telling you is that I believe we're doing the right thing or we wouldn't be doing it.... I happen to believe that it's part of what I perceive to be the job of any credible journalistic organization to pursue a good story in any way you need to pursue it.”

Moore makes relatively liberal use of

LISTEN TO THE DIFFERENCE



THE DELTA RCS-IV REMOTE CONTROL SYSTEM

A simple, yet sophisticated approach to AM, FM and TV Remote Control

SIMPLE

All parameters are displayed for the operator.

- Hands-off operation until an actual control function is required.
- Automatic logging option ends the nightmare of forgotten or incorrect log entries.

SOPHISTICATED

Features not found on other remote control systems:

- Modulation bargraph with peak flashers.
- Direct antenna monitor interface.
- Telephone coupler with speech synthesizer providing telephone interrogation.

The RCS-IV is designed to grow with your plant. Additional control, input, and alarm boards can be added to the systems, thereby meeting any new station requirements. In addition, the RCS-IV contains the fundamental building blocks for ATS, permitting conversion to a combination Remote Control/ATS System at a later date.

Write or call for a descriptive data sheet and pricing.

DELTA ELECTRONICS



5730 General Washington Drive, Alexandria, VA 22312 703-354-3350 TWX 710-832-0273

Circle 122 on Reader Service Card



"I think hidden cameras are Big Brotherism. People get outraged when the government spies on them. They should be equally outraged when broadcasters spy on them." Mel Martin, news director, WJXT, Jacksonville, FL.

the hidden camera, which has figured in perhaps half a dozen stories over the past year. A recent, successful use involved a story about the chief of the city park police, who was alleged to be receiving payments for outside work done by municipal employees on city time. According to reporter Bruce Bowers, who worked on the story, the station has an unmarked, undercover van with tinted windows in the back and movable black curtains inside. When the curtains are moved to one side and the Sony BVP-300 camera positioned on the other, the effect is to make the interior of the van seem entirely black from the outside, even to someone who walks right up to the van and looks in.

In order to get video of the suspect accepting illegal payments in the park, Bowers employed a clever subterfuge: He would put on jogging clothes, park the van near the park in sight of the suspect, and go jogging. While he was out, a photographer inside the van taped anything that happened outside. "No one ever suspected a thing," Bowers boasts. "Our only difficulty is that some of the footage was shot at 6:00 to 6:30 p.m. This was in the late fall, so it was starting to get dark at that time, and it was a problem with the tinted windows. A couple of times we had to open a window, but it was dark enough so it didn't draw attention."

Bowers used similar techniques for another recent story, this one about a federally protected witness who allegedly had become involved in a variety of illegal activities in the Charlotte area. The station ran a series on the man, using his story to illustrate the failures of the witness protection program.

Following the witness posed more problems than following the police chief, primarily because the witness



Anton/Bauer's Spy Cam system, designed for covert newsgathering, is a leather unisex shoulder bag containing (top to bottom) camera with Newvicon pickup tube and special pinhole lens; compact VHS recorder with special "auto record" mode and mini-monitor with 1.5-inch display; and Anton/Bauer battery and charger.

was being tailed by a variety of interests besides the station, including the police. "There were so many people following this guy that we'd all bump into each other," Bowers laughs. "He was so paranoid that after he'd seen the van once or twice he recognized it and we couldn't use it anymore." Among the other vehicles Bowers used was a station employee's Pontiac Trans Am sports car with tinted windows. "It worked fine, but it was a bit cramped," says Bowers. "The photographer had to lie down in the back."

Bowers was able to get some particularly rewarding footage one day when the witness was due for a court appearance. "I had been watching him for a while, so I knew his habits pretty well," Bowers recalls. "I thought I knew where he was likely to park, so we parked the van near there. Fortunately, I was right on the money." Although Bowers had kept the videotaping undercover, he had made the witness aware that the station was investigating him for a story, and had previously introduced himself to the witness. The witness, in turn, had promised to give Bowers an interview

on some allegations about police corruption, but was being coy about actually talking.

"I had wired myself with a Comrex wireless mic," says Bowers, "and I waited outside the van for him to get out of his car. When he did, he saw me, but turned around and pretended he hadn't noticed. I called to him, and then he turned around and came back to talk to me." Unaware he was being recorded on audio and videotape, the witness repeated to Bowers his charges against a particular police officer. At that moment, the district attorney appeared on the courthouse steps, and the WSOC photographer was able to record an angry confrontation between him and the witness.

The culmination of the story came after the witness had jumped bond (put up for him by his trusting landlady, who jeopardized her house to do so). Bowers had stayed in touch with the police on the case, and a deputy tipped him that the police had located the missing witness and invited him along to tape the arrest.

"We put the camera in the back of the sheriff's department van," Bowers

HGX Pro's most demanding role ever.

CONQUEST IN REMOTE



STARRING MOLECULAR FUSION BINDING AS THE OXIDE BOND THAT CONQUERED TIME.
PRODUCED WITH EPITAXIAL™ OXIDES FOR BRIGHTER CHROMA & ENHANCED
SIGNAL TO NOISE. PLAYED AND REPLAYED WITH NO SIGNAL LOSS.
AND CO-STARRING THE TOUGHEST SHELL IN THE BUSINESS.

ANOTHER MAJOR STUDIO RELEASE FROM

maxell®
PROFESSIONAL/INDUSTRIAL DIVISION

AVAILABLE IN VHS AND BETA FORMATS.

Maxell Corporation of America, 60 Oxford Drive, Moonachie, NJ 07074 201-440-8020

Circle 105 on Reader Service Card



"I'm not a detective and I'm not going to do their work. That would be compromising myself by being a journalist acting as a peace officer. But I have no qualms in working with the police on a story." Art Athens, WCBS-AM, New York.

says, noting that the more dilapidated van "blended into the scene better" than the spiffier station van. From behind the patterned, one-way windows, the station photographer was able to tape the entire dramatic arrest scene.

An especially successful story for Bowers grew out of his investigation of certain city building inspectors who were "goofing off" on the job, taking extra-long coffee and lunch breaks, doing personal errands on city time, and signing fraudulent time sheets. Bowers photographed the inspectors in coffee shops, at shopping centers, in supermarkets, and at home, all during working hours. To more fully document his accusations, Bowers sometimes held his wristwatch in front of the camera; for example, as one worker walked into a store on personal business and later when he walked out.

"It was the most boring, tedious assignment I've ever done, but it got a tremendous, vocal public reaction," Bowers says. His careful work led to several inspectors being reprimanded and/or suspended without pay, and contributed to a tightening up of work standards.

While Bowers is understandably enthusiastic about the use of hidden cameras, he does not endorse their indiscriminate use. As an example, he cites the time the station decided to investigate allegations that a worker at a local medical office was abusing female patients. Bowers fitted a woman decoy with an RF mic, and monitored her conversation with the suspect from a nearby restroom.

"Nothing happened," he states. "Later on I felt uncomfortable with that technique and discontinued it... I didn't want to be accused of setting someone up or enticing them to do something they might otherwise not have done. I'm not ruling out that tech-

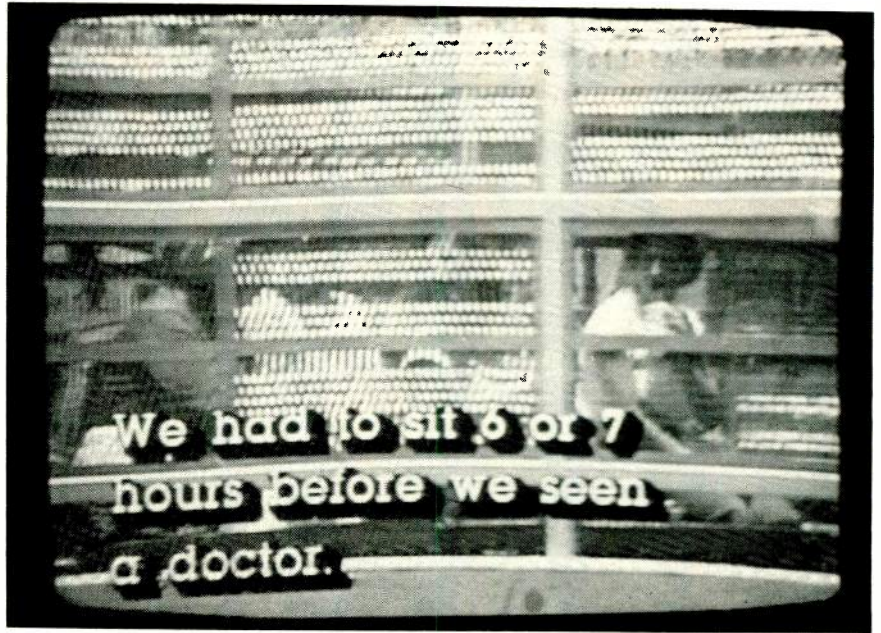

For WJXT's documentary on rising health costs, producer Gordon taped clients at a hospital emergency room with a camera and audio recorder hidden in a suitcase. Because audio quality was poor, the show was subtitled.

nique in the future, but it would have to be somewhat different from this case."

Sound solution

Covert newsgathering doesn't necessarily imply hidden cameras, even for a television station. WPTA, Fort Wayne, IN, is a good case in point. "We're a small shop," explains news director Jack Maurer. The staff of 23 full-time people puts together a half-hour of news four times a day, and generally has its hands too full to do investigative work. Nevertheless, it found time to look into complaints about a local discount meat market that was running a "bait and switch" operation, luring customers with unusually low prices, then inducing them to buy much more expensive meat.

WPTA worked in conjunction with the local Better Business Bureau, which had received numerous complaints about the market. Hidden cameras were out because the station's resources did not permit them, according to Maurer, so instead the station used a hidden RF microphone to record a conversation between a decoy and the

seller. The decoy, who was not a station employee but agreed to participate in the story for a small fee, was equipped with a small Sony wireless mic borrowed from the station's production department.

"We wired him and sent him into the market with \$200," Maurer explains. "The Better Business Bureau complaints said that the advertised specials weren't available and that people would get switched to other items costing more money. There was also a finance plan that would con people into spending much more money than they realized. We walked out of the market with 75 pounds of meat that butchered down to about 54 pounds, so that we paid \$5-6 for meat that would have cost \$2-3 retail... We took the meat itself to another butcher and had it appraised."

Because the taped material was all audio, Maurer needed a visual component for the four-part series. To supply this, he brought in the court artist whom the station uses and had her consult with the decoy shopper to produce sketches of the seller and the transaction.

Maurer notes ironically that just be-

**A DECADE OF
PROGRESS...
A DESIGN FOR
THE FUTURE**

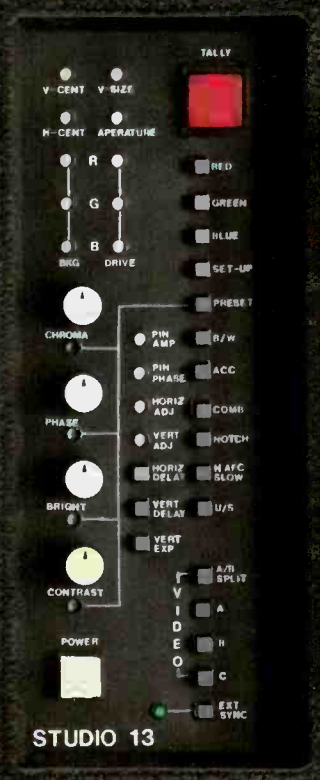

VIDEOTEK

Videotek, in only 10 years, has emerged as an industry leader on the strength of quality products, competitive pricing, and an unprecedented record of delivery and customer service.

The Studio 13 is the latest example of this Progress by Design, incorporating more features and a higher level of quality than any color monitor in its class.

Line Select and 1H/2H Mode highlight the 1984 refinements to the ever-popular TSM-5A Waveform Monitor and VSM-5A Vectorscope.

As we enter our second decade, our commitment to offer the best products, prices, delivery, and service remains an uncompromised goal.



THE FIRST 3-CHIP CCD CAMERA IS ON THE STREET.

NEC's 3-chip CCD camera is making news all over America.

In fact, it's making history.

SP-3 is the first ENG camera without pick-up tubes inside.

So it's the first to eliminate burn-in, retubing, and the hassle of re-registration.

With SP-3, NEC takes imaging quality out of your hands and puts it in the chips. To be precise, 3 solid state CCD chips.

Chips which give you more than 450 lines of beautiful color resolution. For any VTR: M-format, Beta™, ¼ and ⅜ inch.

Chips which eliminate comet tails, burn-ins, and sticking.

Chips which make the SP-3 so rugged, you could probably drop it on a sidewalk and still get the picture.

Yet, the SP-3 head weighs only 5.9 lbs. and draws a scant 12 watts of power. So it'll never be a drag on those long city blocks.

And the price? Perhaps the most newsworthy part of our story. \$16,900 for the camera without lens. To find out more, call NEC toll free at 1-800-323-6656.

Just remember. If you want reliability, it's in the chips. And on the streets.

NEC

IMAGINE WHAT WE'LL DO FOR YOU

NEC America, Inc. Broadcast Equipment Division
130 Martin Lane, Elk Grove Village, IL 60007
In Illinois 312-640-3792.

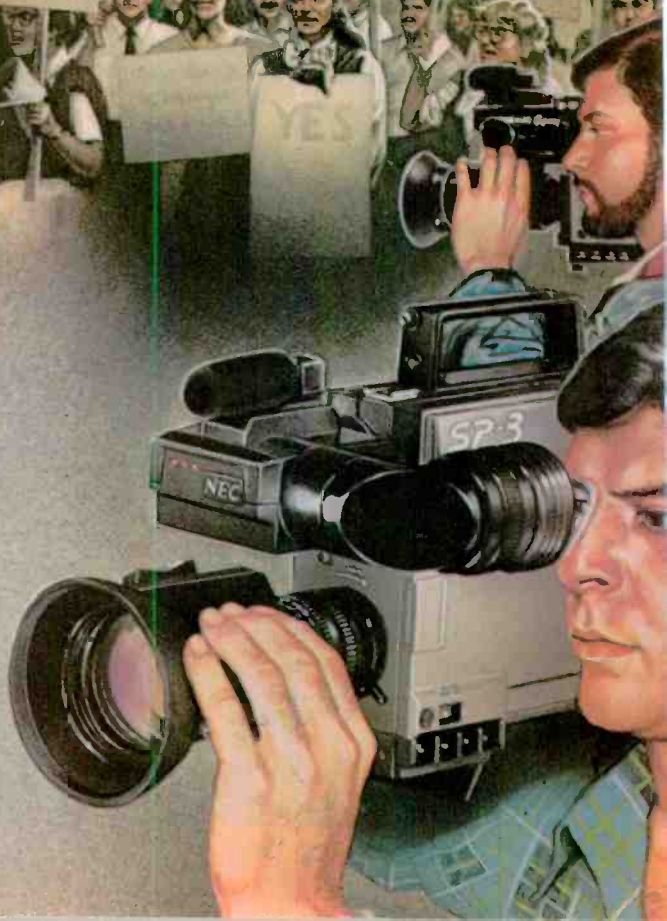

Introduced
at SMPTE
to the most
demanding
audience
in the world.

"Give me one good reason why
my next camera should be a CCD."



"SP-3A...
it's new
from NEC."

After 3-chip CCD cameras were introduced at NAB, NEC did extensive research to learn what you thought about CCD camera technology.

And quite frankly, you liked what you saw. But you weren't exactly ready to throw all your old ENG cameras down the tubes.

So our engineers went back and made a few major advances in CCD camera technology. Advances like a 30% increase in light

sensitivity. And a signal-to-noise ratio of 58 DB. Advances which make this NEC 3-chip the match of any ENG camera on the market.

We call it the SP-3A. And we think you'll call it a dream. Because it has all the features of the SP-3, such as no burn-ins, no retubing, no re-registration, and no comet tails.

No geometric distortion, no microphonics, and no light overloads. No magnetic disturbance,

no sticking, no gray scale degradation, and no pick-up tubes. And no blooming. Plus a signal-to-noise ratio and light sensitivity to meet even the most critical professional ENG requirements.

Oh yes, we did all of this and kept the price extremely attractive. So see the new SP-3A. We think you'll agree it's one of the most valuable and reliable ENG cameras on the street. For more than one good reason.

NEC

IMAGINE WHAT WE'LL DO FOR YOU

NEC America, Inc., Broadcast Equipment Division • 130 Martin Lane, Elk Grove Village, IL 60007 • (312) 640-3792

650-8433

Circle 125 on Reader Service Card

fore the station aired its story, which involved a three-month investigation, *20/20* did a piece on the company that ran the meat market, which allegedly was involved in unsavory business practices nationwide. "When our story aired a week later, people thought it had been prompted by the *20/20* piece," he recalls, "but in fact we'd been working on it for months."

The station had the satisfaction of seeing the local attorney general launch a consumer investigation of the meat market after its report aired. As a result

of the investigation, the operator was ordered to sign a statement agreeing to cease and desist from deceptive advertising practices. Shortly after signing the agreement, the market went out of business.

Despite the success of the meat market story, Maurer is not sold on the concept of I-teams. "I don't necessarily believe in those," he says. "They're always looking for something that is corrupt," and he is concerned they may find something that's not really there. The station does maintain a "trouble-

shooter reporter," however, whose job it is to investigate consumer complaints and problems, the results of which are aired as a weekly feature. In fact, it was troubleshooter reporter Jan Sherbin who got the lead about the meat market and investigated the story.

Package deal

While most stations use home-brew devices for undercover ENG, at least one company is providing a ready-made package for covert recording. The company is Anton/Bauer, and the product is called, appropriately, Spy-Cam. According to the company's Anton Wilson, Spy-Cam has been used by both CBS and ABC for investigative journalism with excellent results, and *20/20* reporter Geraldo Rivera recently used the package to shoot a spectacular episode on the opium trade in Pakistan, "Acres of Opium."

Spy-Cam consists of a camera, recorder, wireless mic receiver, and battery, all packaged into a shoulder bag. The shoulder bag is superior to the attaché case or suitcase for two reasons, Wilson says: first, the attaché looks totally out of place in many situations (for example, a Lower East Side drug den), and secondly, it is carried at knee level, forcing the user to point the camera up at an angle for an "up the nose" shot. The shoulder bag, on the other hand, can be carried higher and is more natural looking for both men and women.

As it is presently configured, Spy-Cam incorporates an Ikegami monochrome camera with a Newvicon tube and a pinhole lens that sees through a tiny hole at the top of the bag. The black-and-white camera offers several advantages, according to Wilson. It eliminates worry about color balance, gives higher picture resolution, and offers excellent sensitivity—all the way down to one-quarter footcandle. The camera has been modified to be fully automatic, including auto gain, so that it can go directly from bright light to dark interiors and still produce usable pictures.

The recorder is a modified Matsushita VHS deck with record time of up to eight hours. In addition, Spy-Cam has a Micron RF mic receiver that records sound directly onto the audio track of the VCR. Also built into the bag is a 1.5-inch monochrome monitor, which can be used for playback and verification or, under the right circumstances, as a viewfinder.

All this gear is powered by a single Anton/Bauer Pro Pac 90 battery (BP-90

THE VC-201 SYSTEM

Over 200 News Directors, Chief Engineers, Operations Managers, and Field Technicians helped us design this system. The VC-201 System lets you plan for today, and tomorrow. When the "rules" change, you can too.



As your needs change...the VC-201 System meets the challenge. It's comfortable...adaptable...efficient...affordable...durable...attractive...versatile...changeable...



WOLF COACH

7 "B" Street—Auburn Industrial Park—Auburn, MA 01501
Phone (617) 791-1950

type), which gives up to two hours' running time for the whole package. A silver battery offering six hours' running time is available as an option. Also available optionally are wireless and wired remote control. With its battery, Spy-Cam weighs in at around 20 pounds.

Legalities

It may make a great story, but is the hidden camera or concealed microphone actually legal? The answer varies widely depending on the circumstances and the locality, with many states having laws significantly stricter than federal restrictions. Following is a brief summary of applicable federal law, but stations considering using covert newsgathering techniques should consult their own lawyers beforehand and fully familiarize themselves with applicable local law.

Interestingly, federal law gives a much freer rein to the hidden camera than to the hidden microphone. In general, broadcasters may make a videotape with a hidden camera as long as the activity being recorded takes place in a public or semi-public place, if the recording is for the purposes of news or public affairs. (Different rules apply for entertainment or commercials.) This is based on the idea that in a public place, people assume that other people can see them. Stemming from this assumption is the caveat that the actions recorded should be clearly visible to a person in the vicinity.

Videotaping in a private place is on much shakier legal ground. Taping in the home, office, or hotel room, for example, of a station employee may be legal, although this is open to interpretation and challenge. If the premises belong to the subject, however, and the subject is unaware of being taped, he or she could sue for invasion of privacy.

In the case of audio taping, the public/private distinction also applies, but it is joined by stricter federal regulations. The FCC prohibits picking up a private conversation with a wireless microphone unless all parties to the conversation consent. If the conversation takes place in a public or semi-public place where it could reasonably be expected to be overheard, recording it with a wireless microphone is in compliance with the rules. To insure this, however, it is recommended that the microphone used be no more sensitive than the human ear. It is also a good idea to have a station employee within hearing range (if no station personnel

are taking part in the conversation) to insure that the conversation actually could be overheard.

Wired microphones may be used to record a conversation with the consent of only one of the parties involved (who may, of course, be the station's reporter), whether in a public or a private place. Once again, however, the caveat remains that in all cases, broadcasters should make themselves aware of applicable state and local laws, which in many cases are stricter than the federal regulations.

With proper care and legal counsel, therefore, broadcasters can find their way into otherwise elusive stories through the use of undercover ENG. The legal considerations vary from state to state; the ethical and philosophical considerations vary from story to story, and from station to station. But the news considerations—the ability to show misconduct as it happens—will continue to make hidden cameras and concealed microphones a valued technique of news directors around the country. **BM/E**

NEW!

BIG CLAIMS FROM THE SMALLEST CONTENDER

The HME System 82 Wireless Microphone!

Smallest professional body-pac transmitter made. Weighs only 2 1/2 oz., without battery. Easy to conceal, stays in place.

High-impact ABS plastic case molded-in color, paint to wear off, keeps its new look.

Detachable, radio belt clip — Allows antenna and microphone cables to be positioned either up or down without damage to kinking.

Color identification dot matches transmitter to receiver, prevents confusion in multi-system applications.

Dynamic Expansion II — Provides highest dynamic range of any wireless microphone today (over 115dB!)

Improved RF performance reduces multi-system interference. Over 20 systems can be used interchangeably.

Easy access battery compartment is separate from electronics enclosure. Prevents moisture and unauthorized fingers from damaging PC board.

Four pin microphone connector allows interchangeable use of dynamic, positive or negative-ground electret elements . . . no switching needed.





Rock-solid radio performance, sound quality that's indistinguishable from a cable and day-to-day reliability our competitors would rather not discuss. These are benefits our professional users have enjoyed for years. So how did HME improve the System 82 over the legendary System 22? We made it a delight to use. Look at the thoughtful convenience features above, starting with a transmitter package that's 9cc smaller than our closest competitor. We designed a belt clip that can quickly be added or removed, and which allows the transmitter to be mounted top-up or top-down for versatility. Color-coded dots match transmitters to receivers to prevent confusion in multiple-system applications; this is important since you can use up to twenty systems together now, thanks to advanced RF technology. Join the thousands of users who have put HME out in front in wireless microphone acceptance. The all-new HME System 82 is waiting for your evaluation . . . contact your nearest HME dealer or the factory for a demo.

HME also makes the world's most advanced wireless and cabled Intercom Systems.

h m e

HM ELECTRONICS, INC.

6151 Fairmount Ave., San Diego, CA 92120 Phone (619) 280-6050 Telex: 697-122

Circle 127 on Reader Service Card

antonbauer Pro Pac[®] 90

The *professional*
VTR battery.



Exclusive Features:

- **New printed circuit design**...greatly improves reliability compared to conventionally wired batteries.
- **New technology NiCad cell**...provides greater capacity, improved voltage plateau, more reliable fast charging, and virtually eliminates "memory" problems.
- **100% overcharge protection**...every cell is individually monitored during the Anton/Bauer Lifesaver[®] charging routine.
- **Triconn[™] connector**...includes cell monitor output for safe and dependable charging. (Patent Pending)
- **New cold temperature protection circuit**...eliminates danger of destroying a cold battery during charging.
- **100% computer tested**...a printout of test results is delivered with each battery.
- **Rugged design features**...new steel reinforced molded cable strain relief and high impact molded case.
- **Direct replacement for Sony BP-90 VTR battery.**

Call or write for our illustrated system brochure, price list and the name of your local dealer.

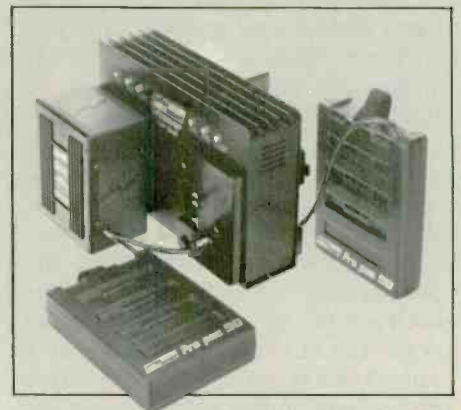

Lifesaver 8 Hour Quad, LSQ4, can charge any combination of up to 4 Pro Pac 90 VTR batteries or Snap-On[®] batteries. The Pro Pac 90 can also be safely charged in one hour with the Lifesaver Fast Charger, LSFC. The Lifesaver chargers prolong battery life and keep batteries fully topped indefinitely.

antonbauer

*The quality standard
of the video industry.*

Anton/Bauer, Inc. □ One Controls Drive, Shelton, CT 06484 □ 203-929-1100

Circle 128 on Reader Service Card

The Analog Component Dream

By Michael Greenhouse,
Associate Editor

Are we on the brink of a brave new analog component video world? It is probably safe to say we are. Activities by the SMPTE, product developments by manufacturers, and innovations by broadcasters and facility owners are paving the way for what could be the not-so-distant future of video: the "pure" all-component plant.

Quietly and methodically, a component revolution is taking place—a revolution which will culminate in the construction of the first analog component plant in the not-too-distant future, possibly by a DBS company such as Satellite Television Corporation. STC may follow the BBC's example in the U.K. and adopt a multiplexed analog component (MAC) delivery

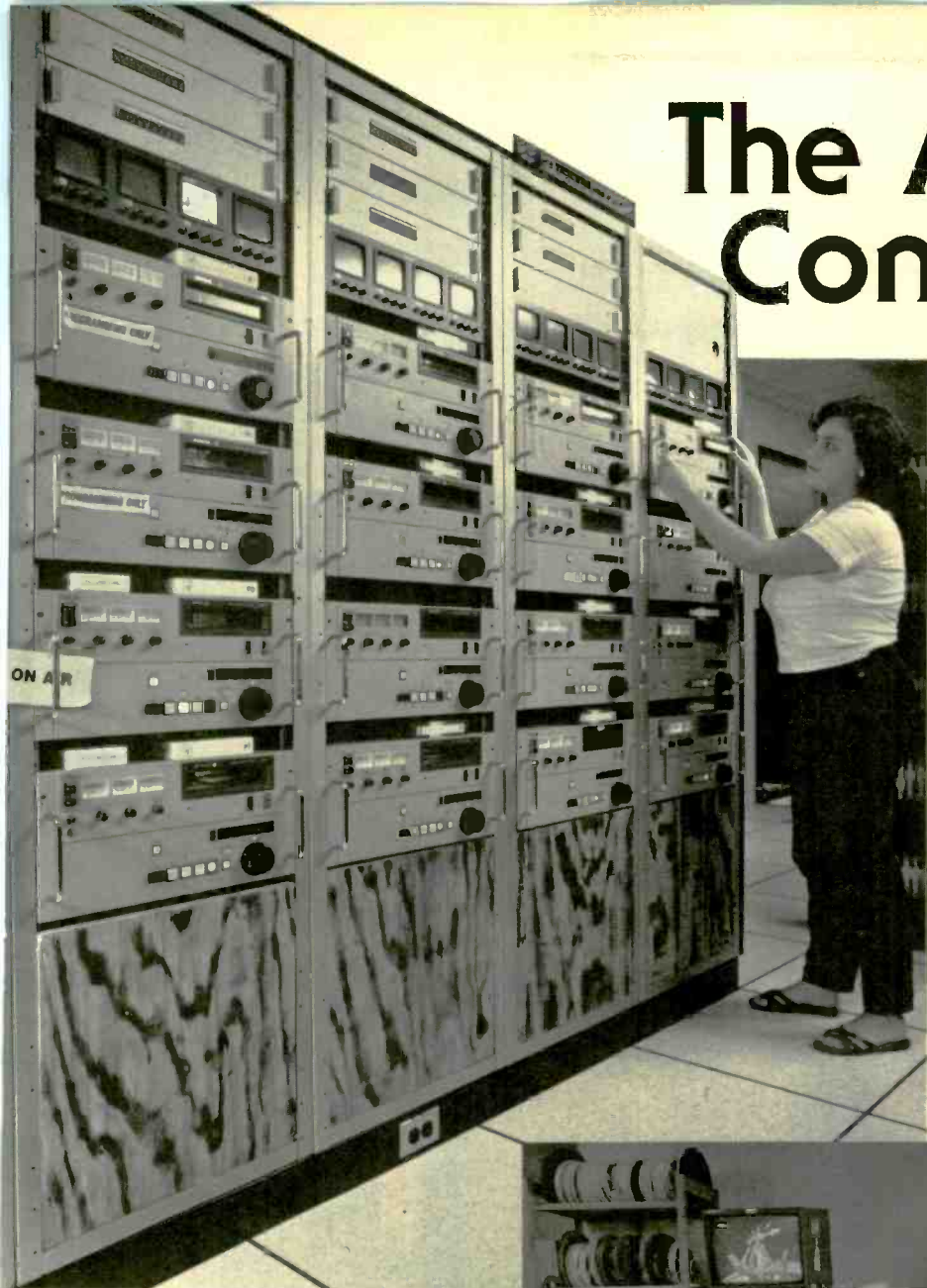

WNOL uses 16 Betacam decks to deliver 82 percent of its programming.



WNOL-TV transfers film to half-inch Betacam with its Rank Cintel, keeping the video in components.

If we can start out in components and stay in components all the way to the transmitter, we would have one very good looking picture," says Merrill Weiss, leading advocate of analog components. But what are the realities which must be realized for his dream to come true?

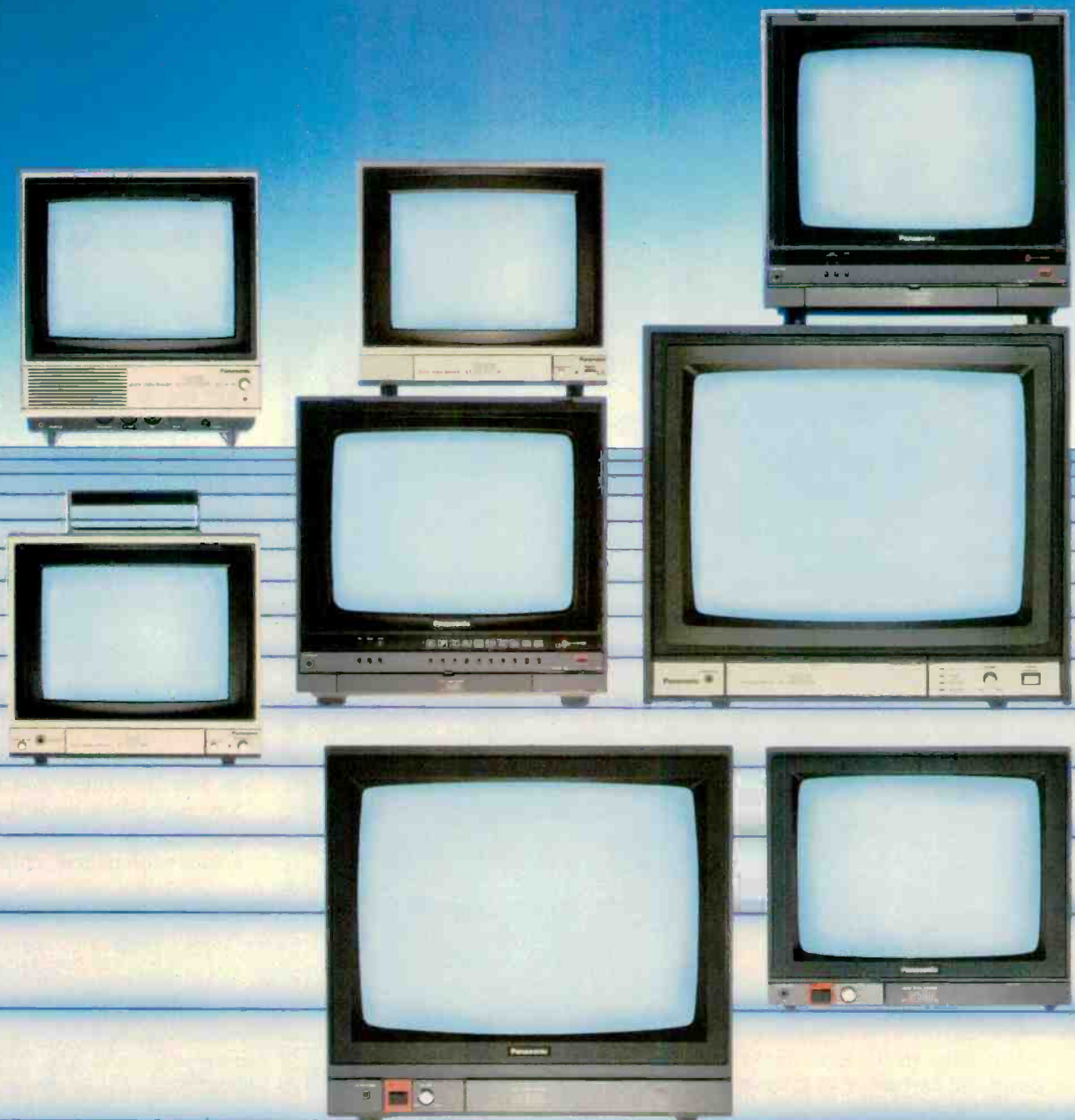

Panasonic® Industrial Monitors. Designed for teleproduction. Priced for any production.

When it comes to industrial monitors, it pays to come to Panasonic. Because Panasonic has just the right monitor for just about any application or specification you can think of. But don't think monitors good enough for teleproduction also have to be expensive. Take a good look at the Panasonic BT and CT series. What you'll see is outstanding picture quality

as well as a full complement of features and controls. What you won't see are high prices.

When you look at the BT-S1900N 19" monitor (all screen sizes measured diagonally), you'll see one of our most brilliant and best defined color pictures ever. One reason is our CompuFocus™ picture tube with OverLapping Field Lens gun. Another is

a switchable comb filter which increases definition for easy detection of signal flaws. Behind its push-open door lies a full array of operating controls. Like a normal/underscan switch, pulse cross, horizontal/vertical centering controls and blue-only for easy adjustment of chrominance and hue.

The 13" BT-S1300N has the same great picture,

controls and inputs. And our 7" BT-S700N is ideal for mobile units and outdoor production because it operates on AC or DC. It also features controls for normal/underscan, pulse cross, blue-only and much more.

The 7" BT-S701N is equipped with switchable line inputs and external sync terminals while the BT-S702 consists of two 701 monitors mounted in

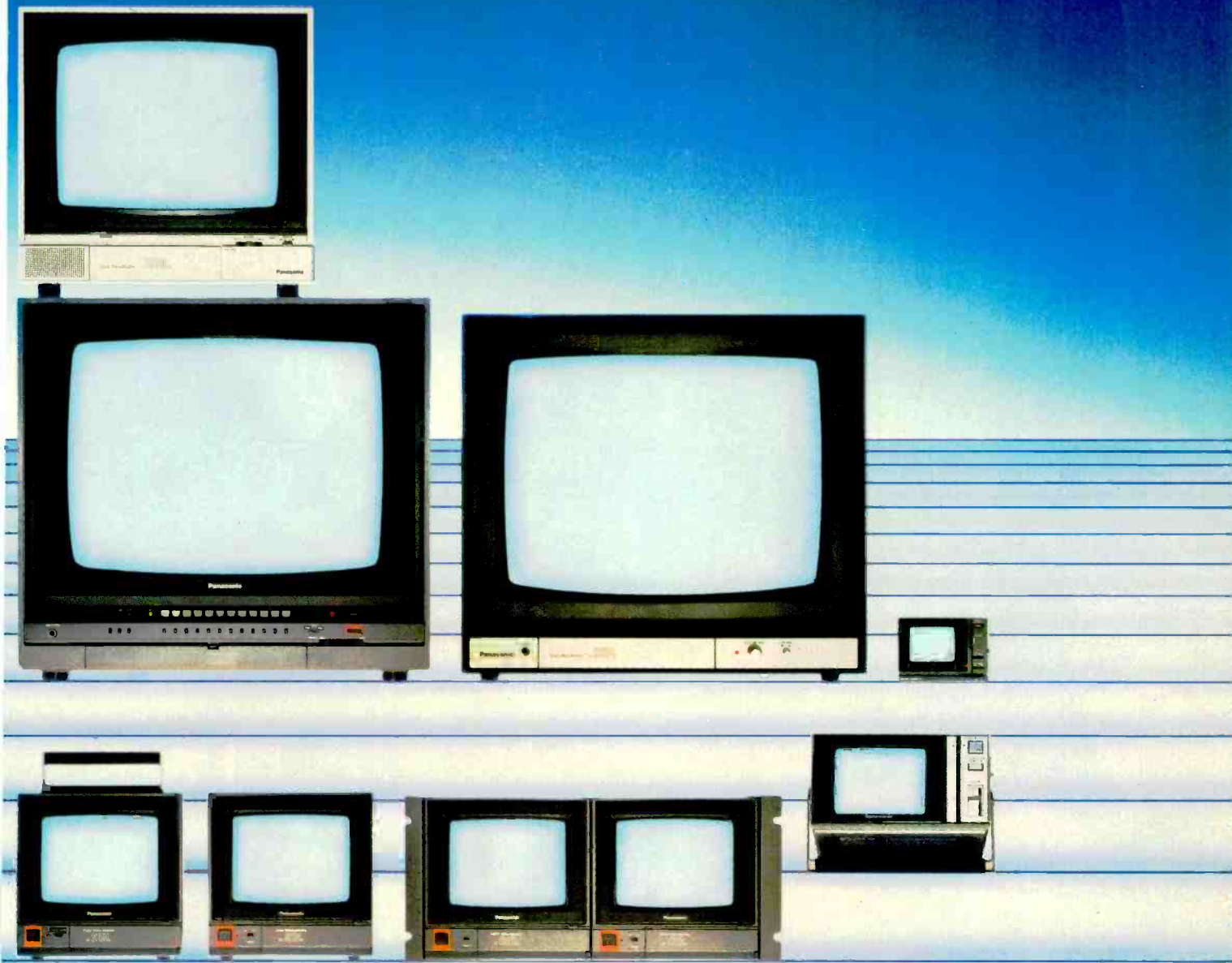

a dual rack adapter.

The Panasonic CT series will also show you a picture that's clear, well-defined and brilliant in color. Because both monitors have either CompuFocus or Quintrix II[®] picture tubes. And, of course, all models have 8-pin video input and output connectors as well as loop-through capability for easy system adaptation.

When portability and

light weight are important, choose from two AC/DC monitor/receivers: the 5" CT-500V, or the CT-300VT with its 2.6" screen—the world's smallest industrial color monitor.

There are also three 10" monitors for educational, industrial, computer, medical, and scientific applications. There's the CT-1330V monitor/receiver, the CT-1330M monitor, and

the CT-1350MG with NTSC composite and RGB inputs.

If you're big on 19" monitors, the CT series keeps you covered in a big way. Both our CT-1930V monitor/receiver and our CT-1920M have comb filters for increased picture definition, while the CT-2000M lets you switch from PAL to SECAM to either NTSC 3.58 or NTSC 4.43.

So, no matter what you

are looking for, you can't afford to overlook Panasonic Industrial Monitors.

To see the Panasonic BT or CT series call your regional Panasonic office:
 Northeast: (201) 348-7620
 Midwest: (312) 981-4826
 Southeast: (404) 925-6835
 Southwest: (214) 257-0763
 West: (714) 895-7200

Panasonic[®]
 AUDIO-VIDEO SYSTEMS DIVISION

THE "THIRD" TRACK

FEATURED ACTOR: A810 TC

TAPE FORMAT: 1/4"

AUDIO TRACKS: 2 (STEREO OR 2 TRACK)

CODE TRACK: THE "THIRD" TRACK

CODE FORMAT: SMPTE/EBU

CROSSTALK CODE-AUDIO: >90dB

OFFSET: ZERO

OFFSET COMPENSATION: μ P -

CONTROLLED DELAY LINE

COINCIDENCE: EXTREMELY PRECISE

Take One! Or take several. Studer's new A810-TC has established a new standard for stereo audio-for-video production. By placing time code on a center track between standard stereo audio tracks on 1/4" tape, the A810 lets you synchronize high quality stereo soundtracks with your VTRs. So you don't need a 4-track recorder using costly 1/2" tape. Two separate code heads and a microprocessor delay line add up to the best center track SMPTE system on the market.

In all respects, the A810 is the most advanced analog recorder available. With microprocessor control of transport, audio functions, and audio parameter settings. Digital memory storage of audio parameters for two tape formulations. Four speeds. Advanced phase compensation circuits for superior square wave response. Plus a serial interface option for external computer control. The list goes on.

Details on the A810 could fill a 20 page booklet. So we wrote one. Call or write today for your free copy.



A810-TC shown with Studer TLS4000 modular synchronizing system.

STUDER REVOX

Studer Revox America, Inc./1425 Elm Hill Pike/Nashville, TN 37210/(615) 254-5651

Circle 130 on Reader Service Card

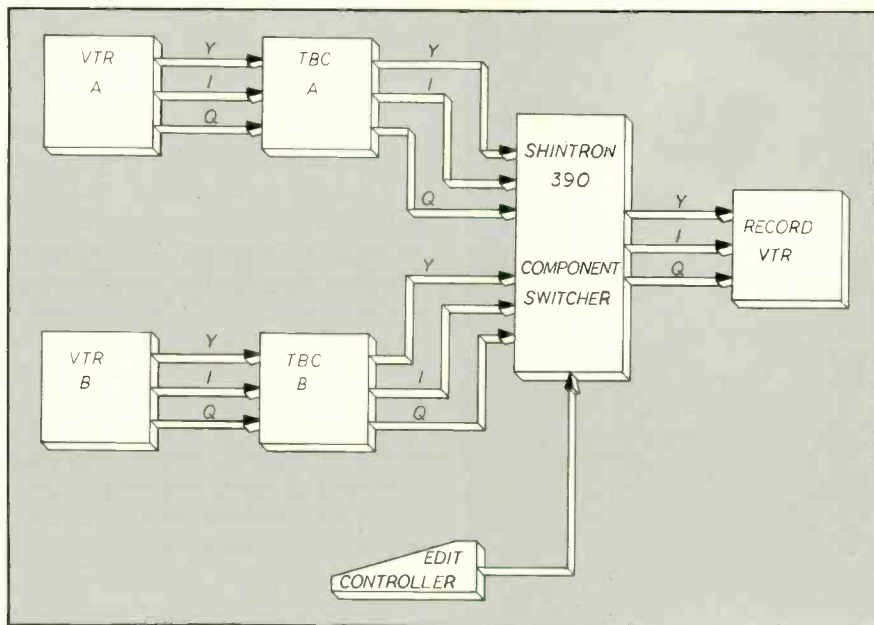

WNEV has configured its edit suites to keep the signal in components all the way to one-inch master or, sometimes, to the transmitter.

system for its DBS service; the company is "considering a plan to build a plant to originate the signal," according to a company official. The Canadian Broadcasting Company is also considering building a component plant.

What has spurred this revolutionary activity? Certainly, it has been fueled, in part, by a growing interest in small-format component camera/recorders. According to a survey of *BM/E* readers conducted by Tektronix and reported in *BM/E* last month, while only 13.5 percent are using component recording formats today, 31.7 percent say they will be producing with half-inch component gear by 1986.

But why the popularity? Why is component taking root? "The quality is far superior, both in terms of camera originals and multigeneration component format than it is in NTSC," says David Griffin, co-owner of Rock Solid Productions, Burbank, CA. "And when you get into things like graphics and titling and keys, they are much sharper in the component field than they are in NTSC."

Rock Solid, which shoots and post-produces much of its music-oriented programming on Betacam, is one of a number of production facilities and television stations that has moved into the forefront of the component revolution. Like other facilities, it has set up a closed component chain, or "island," to handle Betacam or M-format in the component domain.

Essentially, any cuts-only bay that

edits Betacam or M-format-shot material in the component domain is a component island. The setup only knows component, either Y,I,Q or Y,R-Y,B-Y, and the gear "speaks" along a three-cable, parallel interface. Usually, edited material is encoded to NTSC prior to transmission or when editing to another format.

Although it is a significant innovation, the cuts-only analog component

setup is only transitional —merely a step forward in the evolution. Eventually, STC or some other broadcasting entity will build a plant that will produce, post-produce, route, and completely process video in component. Unfortunately, that cannot be implemented practically now.

Transitional facilities

Exactly where are we on the evolutionary road to the component plant? What is being done at some of the "transitional" production facilities and component "islands" at TV stations? What needs to be accomplished to achieve the complete component plant? And how is the SMPTE involved in this area?

Rock Solid has gone beyond the cuts-only concept. At the end of July 1984, the company added a Grass Valley 1600 1X component video switcher (with E-MEM) to its Betacam edit suite. The switcher, the first delivered by Grass Valley and one of a handful the company has sold, is now in a suite along with two Sony BVW-10s and a BVW-40, an ISC edit controller, a Chyron character generator that outputs R,G,B (as well as NTSC), and R,G,B monitoring.

At the moment, introducing more than one component format into a chain creates the need for a matrix converter (also known as a translator). These con-



Karl Renwanz, WNEV's VP of engineering and operations, in one of the station's five component editing suites which feature M-format decks, Fortel TBCs, and R,G,B monitoring.

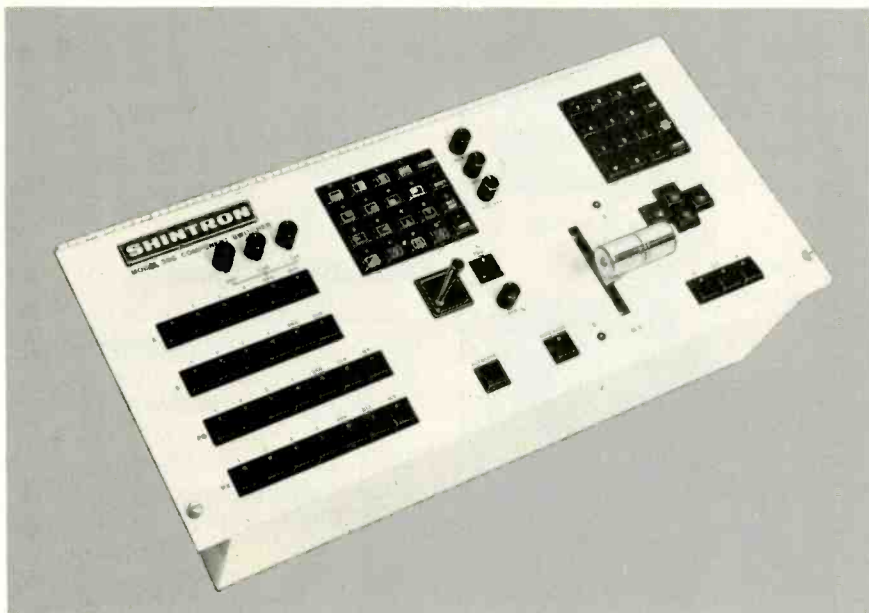

Shintron's Model 390 component switcher.

verters keep you in the component family; they allow you to move from, say, R,G,B to Y,R-Y, B-Y without degradation of the signal. At Rock Solid, matrix converters are used with the Grass Valley switcher so that an R,G,B input can be accepted into the chain, then continued in Y,R-Y,B-Y.

David Griffin says a number of his clients prefer a Betacam master, but some require an NTSC one-inch tape. In that case, the company uses its Asaca/Shibosoku NTSC encoder prior to laying off to its Sony BVH-2000 one-inch VTR.

Rock Solid has also extended its component operation to include film-to-tape transfers. According to Griffin, the company has a "sister relationship" with Image Transform, which has a Rank Cintel flying spot scanner, modified to output R,G,B. Rock Solid will occasionally shoot in film and have Image Transform transfer it to R,G,B, then matrix convert the signal to Y,R-Y,B-Y for editing. Rock Solid has also shot in Betacam and then transferred to film at Image Transform. "We've done some tests and the quality is phenomenal," says Griffin.

Component telecine

Ruxton, in Los Angeles, is also involved in component film-to-tape. The company, like Image Transform, has a Rank Cintel telecine modified to output R,G,B with a translator. In addition, Ruxton has modified the framestore in its telecine to output R,G,B. Also, the noise reducer, which follows the framestore in the telecine process, has been modified to output R,G,B (it al-

plunge is WNOL, a New Orleans independent station which has designed a unique system for handling and delivering programming, primarily in a component mode. The delivery system is based around a control system, built by Connolly Systems, Ltd., that is interfaced with 16 Betacam machines, two one-inch Sony BVH-2000s, and an auxiliary input for live programming. Eighty-two percent of the prerecorded broadcast day is programmed from the Beta machines; the balance is programmed from one-inch. No master control switcher is needed—the controller provides real time or sequential switching control, machine cueing, reel change, preview, preroll, next-up, and title verifications from its internal control logic.

WNOL's system is not "pure" component from source to transmission, but

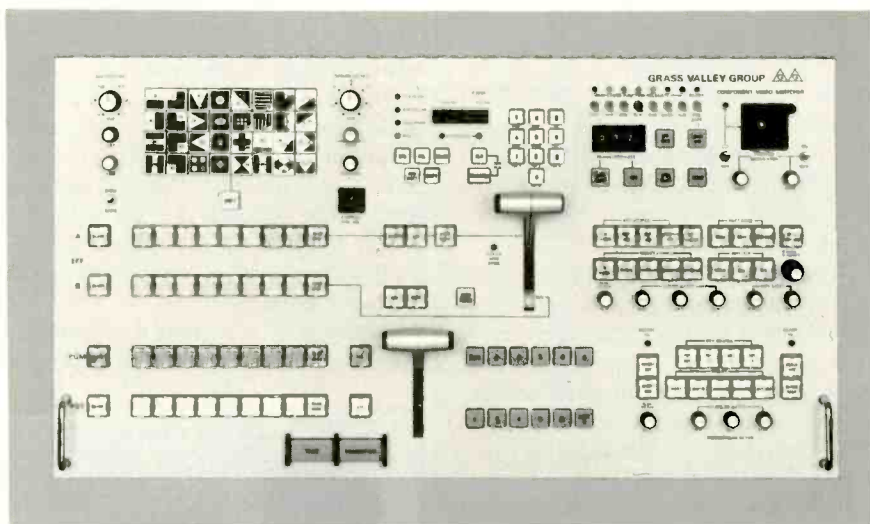

The Grass Valley 1600 1X component video switcher.

ready had an R,G,B input).

Ruxton has also added Ultimatte into its component chain—placed between the framestore and the noise reducer. To do that, the company had to modify the background input of the Ultimatte from composite to component (the foreground was already component).

Currently, Ruxton does not offer editing services—it is primarily a rental house that also provides film-to-tape transfers. However, the company is now designing a component edit bay, which will utilize Ruxton's BVW-40 recorder and a modified Grass Valley 1600 switcher. The bay will be configured to handle Betacam.

TV station experiences

Still another example of an operation which has taken the analog component

aspects of it come close. Any half-inch component source material—whether it's Betacam or M-format—remains in component, of course (with the aid of a matrix converter in the case of M-format). And its film source material is transferred to tape with a Rank component film-to-tape system. One-inch source material, however, goes through a decoding/encoding process. The material is dubbed directly to a Betacam deck (the decks have NTSC inputs), at which point the signal is decoded into its components, prior to encoding back to NTSC for transmission. The station also has two post suites, one of which is all Betacam. (The other suite contains the station's CDL NTSC switcher and effects.)

WNEV in Boston has an ambitious component post-production island.

THE WHEATSTONE SP-5 STEREO PRODUCTION CONSOLE

WHEATSTONE BROADCAST GROUP announces the SP-5 Stereo Production Console, the latest in a long line of high performance audio mixing systems from AUDIOARTS ENGINEERING, a company with an established reputation for technical excellence, quality production and product reliability.

Modular, and specifically designed for stereo broadcast production, the SP-5 offers true stereo subgrouping for mix-minus and stereo program work. Optional configurations allow mono subgroups and outputs, dual stereo line or mono mic/line inputs, and a wide variety of mainframe sizes accomodating 8 to 52 input modules.



 Wheatstone Broadcast Group

5 COLLINS ROAD, BETHANY, CT 06525 (203) 393-0887

Circle 131 on Reader Service Card

YOUR WORLD

The whole show builds to a series of quick cuts. But building those cuts isn't a quick process. So you take it back and forth...frame by frame...over and over. Through endless passes—and endless points of view. But in the end, what you really have to trust are your own eyes. And your instincts. And your tape.

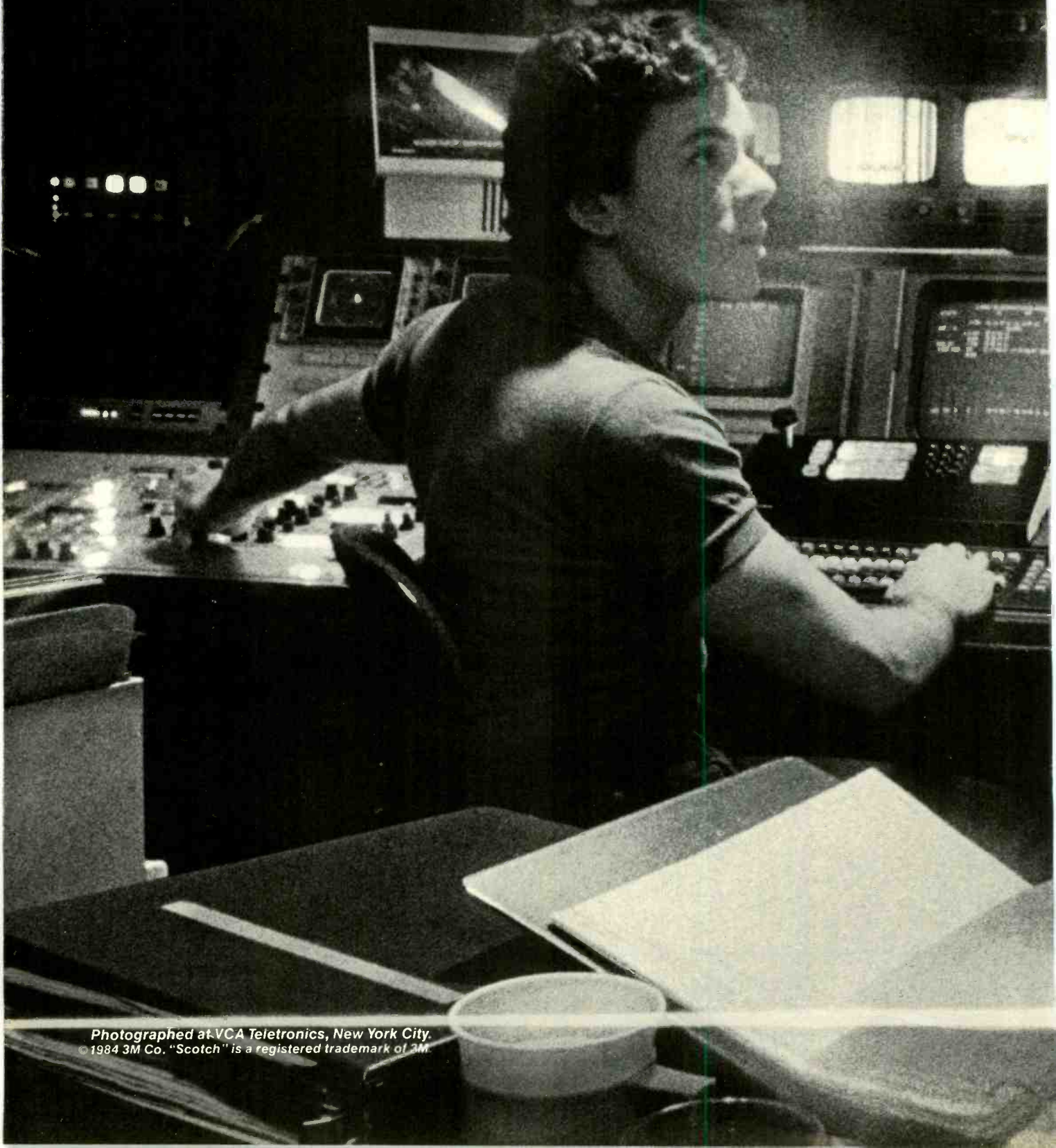

Photographed at VCA Teletronics, New York City.
©1984 3M Co. "Scotch" is a registered trademark of 3M.

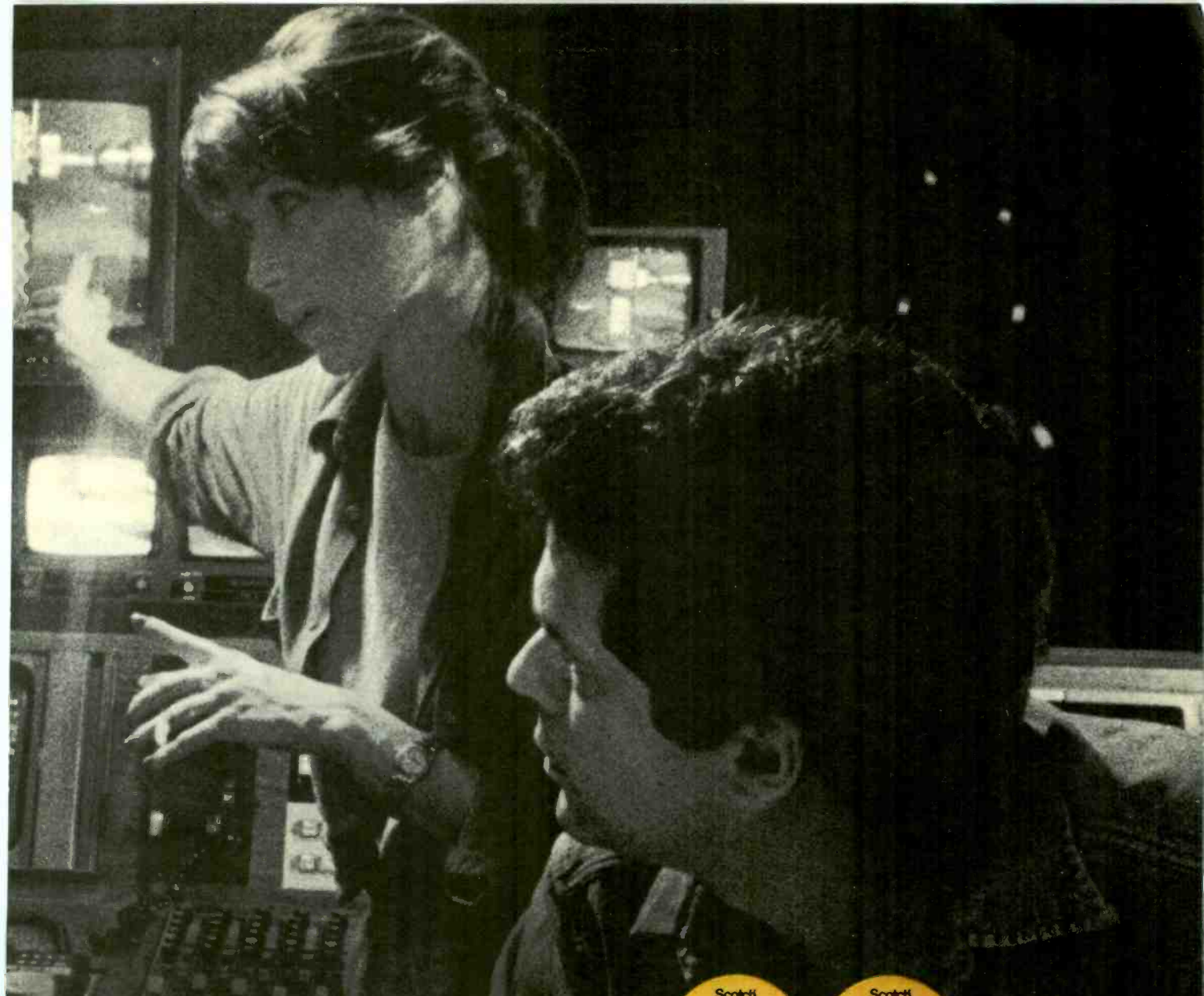

OUR TAPE



We know you need a videotape that can take the punishment of relentless editing. So we've taken the number one 1-inch tape in the world—our own Scotch® 479—and topped it. With



Scotch 480. With the same excellent electromagnetics as 479. The same superior dropout performance. And the same laser-tested consistency. But with 480, we've made a tape that's still more rugged—capable of retaining original picture quality even after 1000 edit passes from the same pre-roll point. With less than 1½

dB loss. Without stiction. And with the backing of Scotch engineers just a call away. Scotch 479 and 480. Two of the tapes that make us...number one in the world of the pro.

Scotch[®]
AUDIO & VIDEO TAPES

NUMBER ONE IN THE WORLD OF THE PRO

3M

THE TRUE MEASURE OF PERFORMANCE



ASACA/SHIBASOKU CD10A1 Color Decoder

The CD10A1 is the New World Standard Color Decoder for use with all systems to decode a composite signal to RGB.

- Switchable Comb Filter.
- Color is demodulated on the I & Q Axes.
- 2 signal inputs selectable from the front panel.
- Alarm indication when the signal is higher or lower than the rated value.
- Sync may be independently added to R,G,B, and Y output signals.
- 10 Output signals are available: RGB, Y, I,Q,R-Y,B-Y, Blanking, Burst Flag, Sync, Sub Carrier, and Y + Sync.
- Available in NTSC, PAL, SECAM.

Measure your performance with the best.

ASACA/SHIBASOKU CD10A1.
The color decoder with character.

For complete specifications, write:



ASACA/SHIBASOKU CORP.
OF AMERICA
12509 Beatrice Street, Los Angeles,
California 90066
Sales, Service:
(800) 423-6347 • (213) 827-7144

Circle 165 on Reader Service Card

Five three-machine edit bays with Panasonic M-format recorder/players all operate in the component mode using Fortel TBCs that were modified to include time base-corrected component output.

The station's Fortel TBCs play an important role in the way the final product is used at WNEV. In an edit suite, the TBC accepts the signal from the M-format machines in component form via a parallel interface—three cables in a multipin connector. All the time base correction is done internally as three separate signals. Then, it produces a component output.

The TBC can also encode the signal and produce NTSC, however, which is

very useful for final playback. As Brian Lay, engineering director, explains, "We take the edited master to our main videotape area and it plays back on a machine through another Fortel TBC, except this time we use the NTSC output. So it usually isn't turned into NTSC until it's actually played back on the air or integrated into another program."

WNEV's other component island, an elaborate "graphics creation center" (see *BM/E*'s September 1984 story on on-air graphics) ties Chyron IV graphics together with a Harris Iris still store through a custom-designed Shintron component switcher and an Asaca/Shibosoku monitor with Y,I,Q input.

WNEV Modifies its U-Matic-to-M-Format Dub Process

M-format is clearly the newsgathering system of the future at WNEV; the station plans to convert its entire operation to half-inch component in 1985. For now, however, WNEV is shooting and editing the majority of its news in 3/4-inch, and its tape library is, of course, primarily 3/4-inch.

The two formats certainly can live together comfortably at the station—if they are kept separate. But when 3/4-inch material is integrated into the half-inch post-production chain, an undesirable decoding/encoding process must take place. When 3/4-inch video is input into an M-format recorder, the NTSC signal is decoded—and, consequently, degraded.

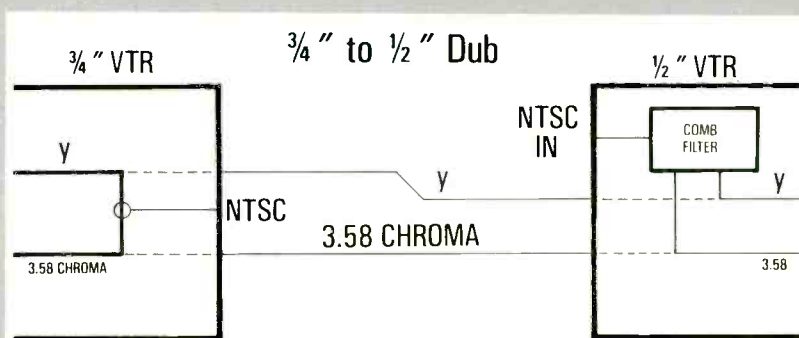

To improve this not-uncommon process (3/4-inch library material is often used in M-format-shot productions) the station set up a unique edit room with a modified Sony 5850 U-Matic machine interfaced with a Panasonic M-format AU-300 recorder. As Karl Renwanz, VP engineering and operations, explains, "What we've done is come out of the dub connector on a U-Matic machine and bypassed the input circuitry in the high-inch machine, and bypassed the comb filter. We then go in with a Y/C component directly from the 3/4-inch machine into the half-inch machine. By doing that, we maintain the highest transfer quality possible when integrating 3/4-inch library material into a half-inch edit situation."

Essentially, WNEV has added a second cable to carry the luminance and chrominance directly to the half-inch machine, bypassing the comb filter—a troublesome cause of degradation. The NTSC-encoded subcarrier portion of the signal is sent over on another cable, and then is decoded by the half-inch recorder. The dubbing process, then, is 50 percent "pure" component, while the rest requires decoding, as it did before the modifications were done.

Despite this "impure" dubbing process, the result, says engineering director Brian Lay, has been a significantly improved picture which has made the marriage of 3/4-inch and half-inch at WNEV more than palatable. The 3/4-inch-to-half-inch room is used daily, says Lay; for now, it has helped make the transition to an all half-inch component news operation a smooth one.

320.

The ProCam™ Video Camera
with Plumbicon* tubes at Saticon** price.

JVC's experience—and success—in designing the highest quality and reliability into compact video production cameras is unmatched. Now, continuing this tradition of high performance at an affordable price, JVC has brought a “high-end” teleproduction camera within the financial reach of production people often victimized by modest budgets. This time, it's ProCam 320.

What a package!

SENSITIVITY. ProCam 320 features three, 2/3" Plumbicon pick-up tubes for incomparable picture quality. A refined f/1.4 prism optics system provides horizontal resolution of better than 600 lines at center. A 2H vertical contour correction circuit further assures image clarity. And minimum illumination measures only 38 lux (3.6 fc) at f/1.7, permitting shooting even in limited or artificial light.

A video S/N ratio of 57 dB. Color framing output signal (RS-170A). A split field color bar generator for consistent color reference. A genlock circuit for maintaining a stable picture while switching or mixing with other signals locked on the same source.

EASY OPERATION. Several 8-bit data memory chips offer operator conveniences for quick set-up and consistent performance. These include: Auto centering, auto-black balance and auto-white balance, auto black level stabilization and auto beam control circuits. Matrix masking for true color reproduction and automatic protection for the pick-up tubes are a few of the many features standard on this new camera.

VERSATILITY. Easy portability. Outstanding performance in low-level

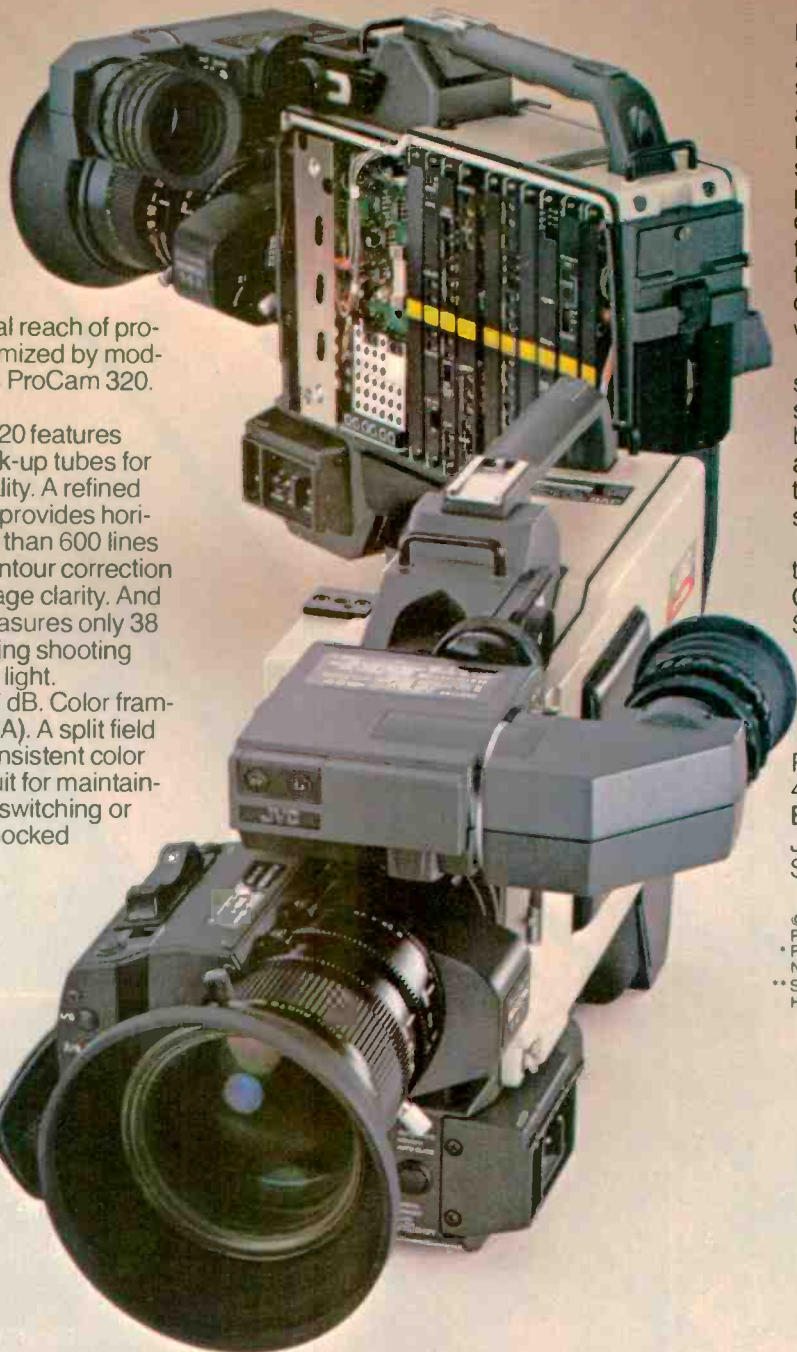

lighting. High degree of automation. An extensive selection of options and accessories combine to make the ProCam 320 suitable for both studio production, EFP, or ENG; or, indeed, to any application, anywhere, that calls for top quality video production while staying within a tight budget.

PROCAM TECHNICAL SUPPORT. Your ProCam sales representative will be happy to explain the availability and calibre of the ProCam technical support program.

For a demonstration of the ProCam 320 Video Camera, a 320 Spec Sheet, or JVC's complete catalog, call, toll-free:

1-800-JVC-5825

JVC Company of America
Professional Video Division
41 Slater Drive,
Elmwood Park, N.J. 07407
JVC CANADA,
Scarborough, Ont.

© 1984 JVC Company of America
ProCam is a trademark of US JVC CORP.
* Plumbicon is a registered trademark of
North American Philips Corp.
** Saticon is a registered trademark of
Hitachi Denshi, Ltd.



JVC
JVC COMPANY OF AMERICA
Professional Video Division

Circle 124 on Reader Service Card

TIME BASE CORRECTION RE-DEFINED

Introducing the first totally different approach to time base correction in 10 years.

Until now, the TBC has only been as good as its weakest link - the analog circuitry. So we have eliminated the input clock and introduced the industry's first totally digital sync separator in a TBC.

The DPS-103 single clock TBC uses component processing and an advanced interpolation technique to breakthrough to "picture perfect" video.

Designed to work with 3/4" heterodyne VTR's, the DPS-103 is the long-awaited solution to conventional time base correction. Only \$8950.

Features:

- Maintains lock through 40 times normal speed in forward and reverse
- Maintains color through 10 times play
- Velocity compensation
- 16 line window
- Auto color framing
- RS 170A output
- Internal test generator

DIGITAL DPS-103 COMPONENT TBC

Contact your local dealer to see "picture perfect" video - with the DPS-103 Component TBC. Write Digital Video Systems A subsidiary of Scientific-Atlanta 120 Middlefield Road Scarborough, Ont. M1S 4M6 or call Digital Video Systems (416) 299-6888

"It uses the Harris still store," says Lay, "so you can build layers and store them." Internally, the still store operates in Y,R-Y,B-Y. (It is not unusual for a digital device to operate in components internally, but to only have NTSC inputs.) It was converted to accept R,G,B signals (it already had R,G,B out) by bypassing the NTSC input and setting it up to receive the three components. The rest of the setup includes a camera on a graphics stand, from which R,G,B is extracted, and the Chyron. All of the outputs, which are R,G,B, are fed into the Shintron.

The station has also designed a color bar generator that sends house color bars in Y,I,Q.

All-component problems

WNEV's component chain is obviously quite extensive, yet analog component cannot be extended throughout the plant. Why? One reason is, not enough of the devices in a plant are able to accept and pass along a component signal. There are a number of devices—such as one-inch VTRs, digital video effects processors, and processing amplifiers—that "only know" NTSC, and to pass a signal through a chain that includes these devices generally necessitates going through a decoding process that seriously degrades the signal. As mentioned earlier, many devices—including ef-



Rock Solid Productions' on-line edit suite features a Grass Valley 1600 1X switcher, a Chyron CG with R,G,B output, an ISC edit controller, R,G,B monitoring, and Betacam recorders.

fects devices and still stores—are internally component and could be modified to bypass the NTSC input and accept component without first encoding to NTSC then decoding back to components, but what happens when you need to input an NTSC source? A decoder, at the moment, is still a necessary evil.

Also, there is a problem with rout-

ing. Right now, a small component chain can be interfaced using a three-cable parallel system for the three component signals, already fairly cumbersome. But in a large plant the wiring quickly gets out of hand with three cables, three sets of DAs, and a routing system with three levels of video.

Some of these problems will be overcome by the SMPTE Study Group on Component Studio Implementation, chaired by Merrill Weiss of Image X, Oakland, CA. Weiss's group is currently at work on a serial time-compressed analog component format. This format will accomplish a number of things: It is a one-cable system that, according to Lay of WNEV, "except for a wider bandwidth, is really going to look a lot like NTSC in terms of the sync pulses and pulse width and so on, so it's likely to pass through a lot of conventional video distribution amplifiers and routing switchers. In fact, you'll be able to look at it on a regular monochrome picture monitor. The picture may look a little funny, but you'll probably be able to use a lot of traditional monitoring equipment—waveform monitors, things like that."

The serial system, then, will not obsolete current routing switchers, DAs, and some monitoring gear; and because it is a one-cable system, the number of these devices will not have to be increased. The serial interface will also eliminate the need for matrix converters among component gear, and will



At WGRZ-TV, Buffalo, NY, cameramen edit their own footage on M-format machines. The station has six component edit rooms, with Fortel component TBCs.

make simpler the interfacing of equipment that is internally component.

The serial system will certainly go a long way toward making a plant conversion possible—but there are still a number of roadblocks. Bringing archival or other NTSC source material in and decoding it will still be a necessary evil that a serial format obviously cannot overcome. The one-inch and two-inch VTR, if used for more than just final mastering, will also create the

need for decoders. Also, a switcher that is not built for components would have to be modified, as would any place that a clamp is applied, or any place that sync has to be separated.

Says Weiss, "Wherever there is color separation equipment you would most likely end up bypassing it. For instance, in a proc amp, you separate out the chroma so you have separate gain control over it. It wouldn't work that way with analog components because

you don't have chroma interleaved into the same spectrum. It's in a different time slot."

As Weiss says, "It's possible to modify. You don't have to throw it all out." To this end, another SMPTE group, the Joint Ad Hoc Group on Component Studio Implementation, is working to establish what can be modified and what will have to be replaced during a plant conversion. The group, which is chaired by Birney Dayton, VP engineering of the Grass Valley Group, is actually a study group charged with supplying information to Merrill Weiss's group and to Stan Baron's Working Group on Digital Video Standards.

The Dayton group's charter, according to SMPTE, is to find methods by which existing facilities can be converted to components, and work out how future component plants might be structured. The group is also working to identify the optimum mix of analog and digital a future component plant should have. Digital component—in fact, the whole question of component studio interfacing and implementation—is an area Baron's and Weiss's groups have been collaborating on for some time.

According to Weiss, the ad hoc group will try to identify how many decoders will be necessary, and then indicate what the quality of those decoders must be in order to meet certain performance standards. The group will not, however, "get into how to design a better decoder," says Weiss. The ad hoc group will also consider what kind of performance is acceptable in an existing plant to be able to "drop in" components.

There's no way of predicting just when the first all-component plant will appear. Weiss predicts, however, that the first plant will probably be built from the ground up; the conversions will probably be done later, undoubtedly because of the modifications and potentially expensive equipment replacements that many NTSC environments would have to incur.

Judging from the progress that is being made by SMPTE (Weiss's group is now working up a rough draft of a serial waveform document), and by users and manufacturers, we can't be too far away from Weiss's dream: "If we can start out in components and manage to stay in components all the way to the transmitter, then convert to NTSC, we would have one very good looking NTSC picture." **BM/E**

Our consoles never die. They just keep fading away.

Built like a tank. Handle like a dream. Smooth, sure, responsive. And won't let you down.

That's LPB, for the air and production boards you see coast to coast—in local to network stations—from 100 watts to 100kw.

It isn't that we're all-solid-state, or that we make 5, 8 or 10 channel mixers, mono, stereo or both. It's simply because LPB consoles don't seem to break down. And that's on the record.

But features count, too. From pre-fader pushbutton cues to programmable muting logic, let's say if it's essential, we've got it!

If you're keeping current on consoles, get the specs on LPB equipment. Call 215-644-1123 or write LPB Inc., 28 Bacton Hill Road, Frazer, PA 19355. (Telex 703000.)

A lot of consoles will come and go in your time. But not if they're made by LPB.

Model M-8S



Model S-13C

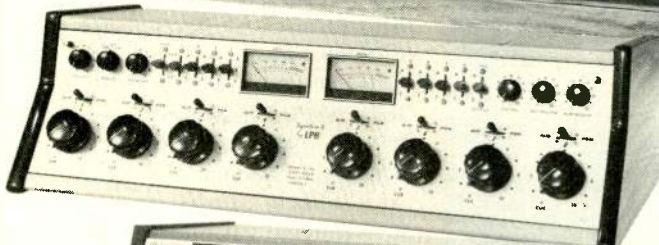

Model C-8S



LPB[®]

Our call letters make news 'round the world.

Circle 135 on Reader Service Card



sachtler

THE PERFECT HEADLINE

for your ENG- or EFP-camera

sachtler
camera supporting systems
offering

Dial-in – up to seven – steps of drag,
independently adjustable for pan and tilt,

built in compensation for center of
gravity displacements,

camera-adequate or dynamic counter-
balancing, adjustable on the spot
for all your possible requirements,

extreme positive, operational locks,
not effecting camera orientation
when operated,

a leak-proof by design fluid system
with guaranteed (for years) trouble free
operation,

an all-in-one piece unit for easy handling
and transport,

that is available when and where you need it
worldwide.

Its the Sachtler headline offering all
these features, dont ask for less!

Call on your nearest Sachtler dealer
or write to

Sachtler Corporation of America
400 Oser Avenue, Hauppauge NY 1178/8
Phone (516) 231 0033, Tx 140170,

a subsidiary of Sachtler GmbH
Dieselstr. 16
D-8046 Garching/München
Phone (89) 320 40 41, Telex 5 215 340

Circle 136 on Reader Service Card

Panorama

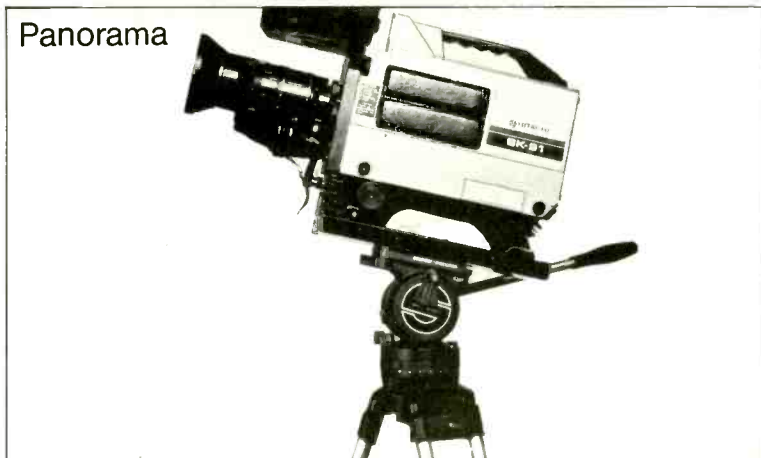

Video 20

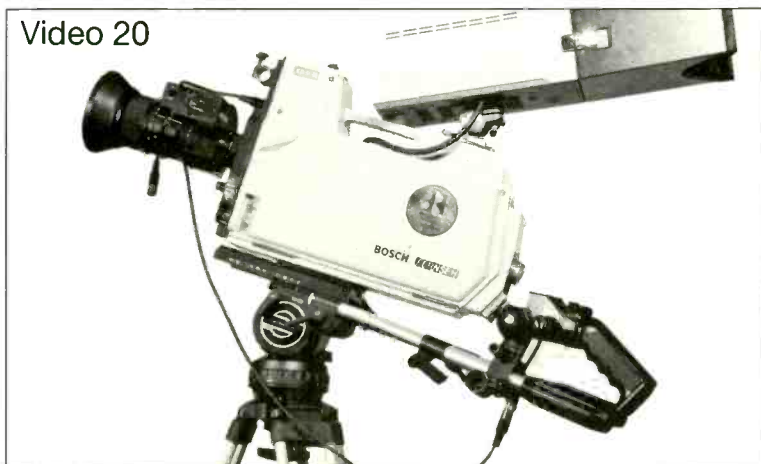

Video 25



Video 30



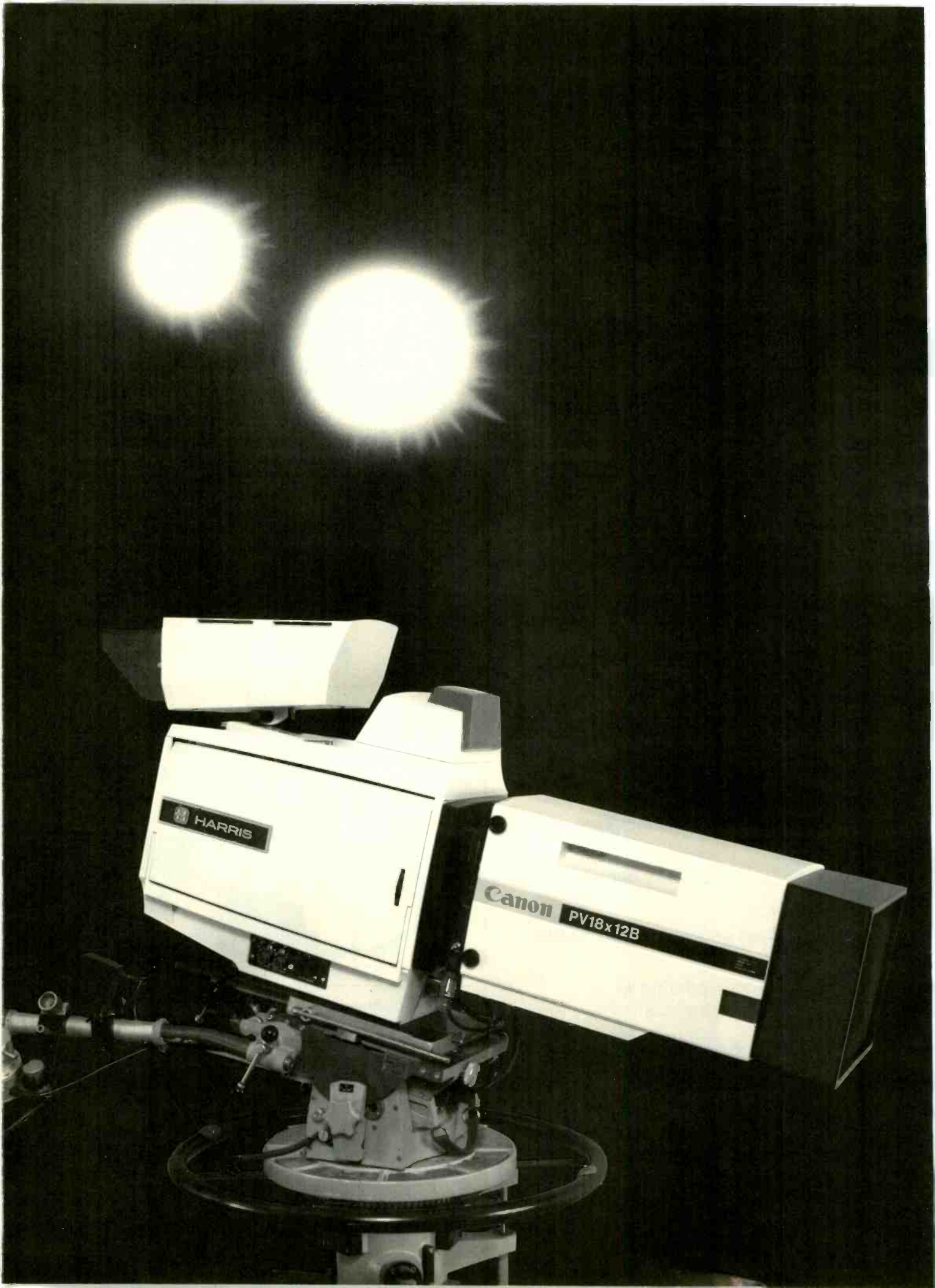

HARRIS

Canon PV18x12B

Which camera company offers a unique new process that sharpens your image without dulling the colors?



Now there's a special circuit in all Harris cameras that sharply defines the reds, *without darkening them*. Other cameras offer contouring on only one color at a time...Harris cameras provide contouring out of red and green simultaneously! This enhances picture clarity over a wide color spectrum, *with no loss of color fidelity*.

It's exclusive, and just one of the many advancements that make Harris cameras superb performers in the field and in the studio.

TC-90 ENG/EFP Cameras... Built for the Way You Use Them

Weighing about 8 pounds, the TC-90 is one of the smallest. But we deliberately made it a little bit bigger than it had to be to add balance and stability. A little longer to let the cameraperson grasp the lens in a natural, comfortable, controlled way. And we carefully shifted extra weight to the tail, so that the weight of the lens is counterbalanced.

Most cameras blind-side you to the right. Not the TC-90. Its low profile lets you see right over the top for total right-side visibility. And that low-profile body is constructed of a rugged graphite composite that is unaffected by the inevitable rough treatment in the field.

The TC-90 gives you auto white balance and auto black balance at the flick of a switch. With the addition of the exclusive Smart Package™, you also get computerized diagnostics, auto centering and encoder balance—plus microprocessor time code generation that lets you record SMPTE and VITC time codes as you shoot.

C Series Studio Cameras ...Picture Perfect

You expect top performance from a studio camera, and with Harris C Series models you get it! Color fidelity and picture integrity are the best in the industry. High resolution with low lag, high sensitivity, low noise, highlight handling and variable contrast control give you color as you really see it, and clean, sharp video even under the most severe lighting conditions.

If you want a full computer-controlled automatic setup camera, choose the TC-85C. Or, if you're on a tight budget now, the TC-80C is a manual setup camera with automatics that can be upgraded in the field later to full computer setup capability. Both feature a new viewfinder with electronic-generated safe title and safe action areas, and a variable rectangular window. It's tiltable and rotatable, too.

An impressive 48 operator func-

tions are controlled by the computer in the TC-85C, and adjusted according to preset parameters. Each camera has a built-in independent computer so that all cameras can be set up at the same time. Even by an inexperienced cameraperson. With just the touch of a button.

With the addition of a CRT and/or printer, which plug right into the TC-85C computer control unit, complete information on camera status becomes available on a hard-copy printout or on the CRT screen.

Manned 24-Hour Service

One of the real pleasures of owning a Harris camera is the secure feeling of knowing that it's backed by *manned*, 24-hours-a-day, 365-days-a-year emergency service. And by the best parts availability system in the industry.

Call or write for more information. Or, better yet, ask for a demonstration of the Harris camera of your choice. Harris Corporation, Studio Division, P.O. Box 4290, Quincy, IL 62305. 217/222-8200.



HARRIS

For your information, our name is Harris.

TV Monitors for

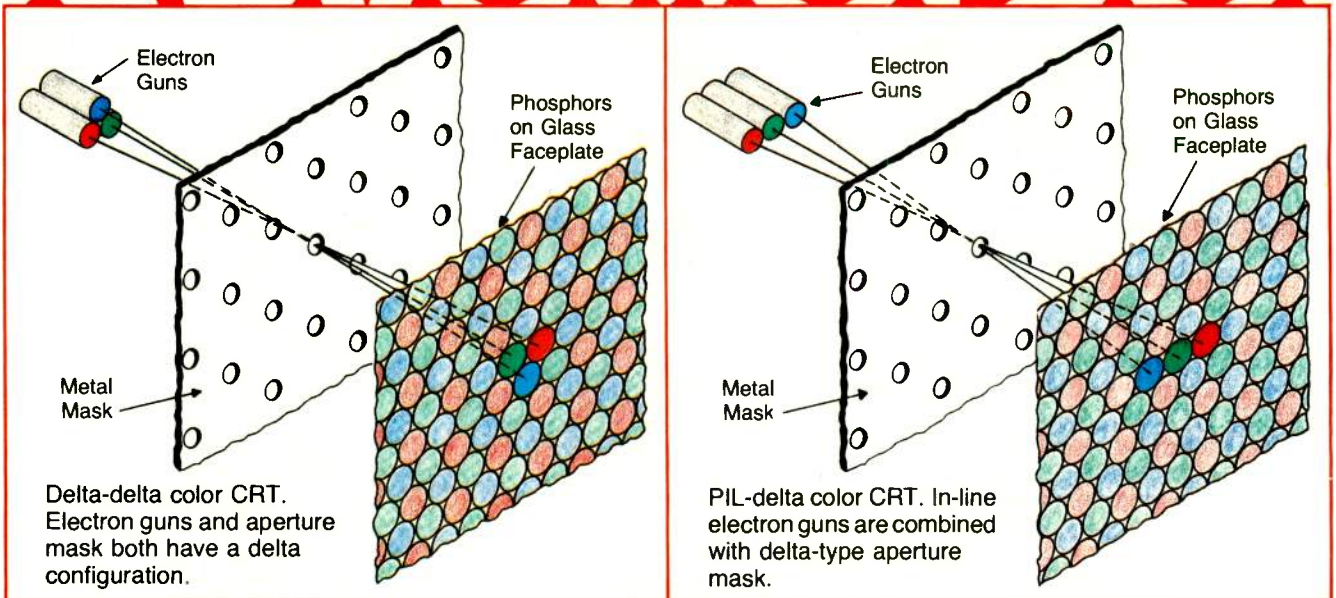

When talking about raster graphics, "resolution" is usually defined by the number of pixels stored in display memory and transmitted to the monitor during each frame-refresh cycle. The bandwidth of the interface, for example, must be capable of preserving the "system" resolution established by the number of pixel-to-pixel signal transitions which could occur while each raster line is scanned. The same bandwidth considerations apply to the monitor circuits which process the display signal and drive the electron gun (or guns) of the monitor CRT. It is entirely possible, however, that a severe degradation in the system resolution can occur at the final display stage—if individual pixels can no longer be readily perceived by the operator.

Display resolution is determined almost entirely by dimensional mathematics. A square raster with 512 raster lines and 512 pixels per line contains a total of 262,144 pixels. Each pixel area is, in effect, a square with sides measuring approximately 0.002 of the raster height or width. When displayed on a 19-inch monitor, the pixels would measure 0.54 mm on each side. The same pixels on a 13-inch monitor would have side dimensions of only 0.37 mm.

The pixel images on the display screen are not, however, square. Instead, they are formed by an electron beam with, at best, a circular or slightly oval shape (depending on the position of the beam relative to the center of the screen). Moreover, the luminance generated by the beam has a Gaussian distribution. It is inevitable, then, that a certain amount of overlapping between pixel images will occur, especially if a further requirement is that each pixel area is to be "filled" with display luminance.

Overlapping is a benefit when images consist of solid areas or subtly changing intensities or colors. A column of pixels can produce a relatively smooth luminous output

across a group of raster lines. But the Gaussian spread of the electron beam creates major problems when sharp image transitions are required—as in the extreme case when graphic elements are to be separated by a single pixel width. The Gaussian "skirts" of the pixels on each side would raise the luminance in the intervening area, reducing the contrast between image and background.

The loss of contrast from this effect is given a numerical value by the "modulation transfer function"—the ratio between maximum small-area (pixel, raster line) and large-area contrasts. If there is no loss of contrast due to overlapping, the MTF is 1.0, 100 percent or zero dB. A 50 percent contrast loss (16 dB) is normally considered to be the limit for adequate monitor performance. Larger losses in contrast would have the effect of reducing the display resolution because individual pixels would be difficult to distinguish—even on close inspection.

The MTF can be improved, of course, by reducing the spot size of the electron beam. But this lowers the overall luminance of the display and may make the raster lines *too* distinguishable. A compromise is therefore required. Spot sizes, measured at the diameter of 50 percent maximum luminance, are generally set to approximately the same dimension as the raster-line spacing—which would be on the order of 0.5 and 0.3 mm for the 19-inch and 13-inch monitors described above. Smaller monitors would require correspondingly smaller spot sizes to maintain an equivalent MTF, and this eventually sets one of the lower limits on the extent to which the screen size can be reduced and still produce a crisp, high-resolution display. With 0.2 mm as a practical lower limit on spot size, the minimum square-raster dimensions for a 512-by-512 display would be on the order of 100 mm. For a 1024-by-1024 display, the minimum would be

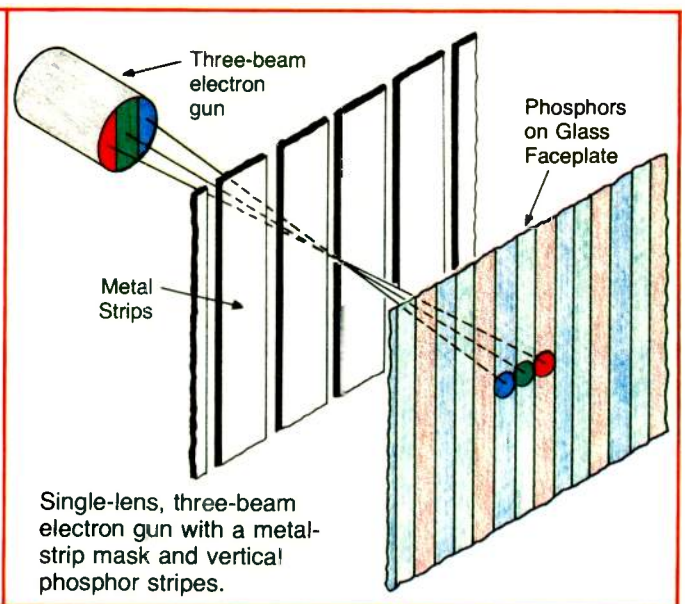
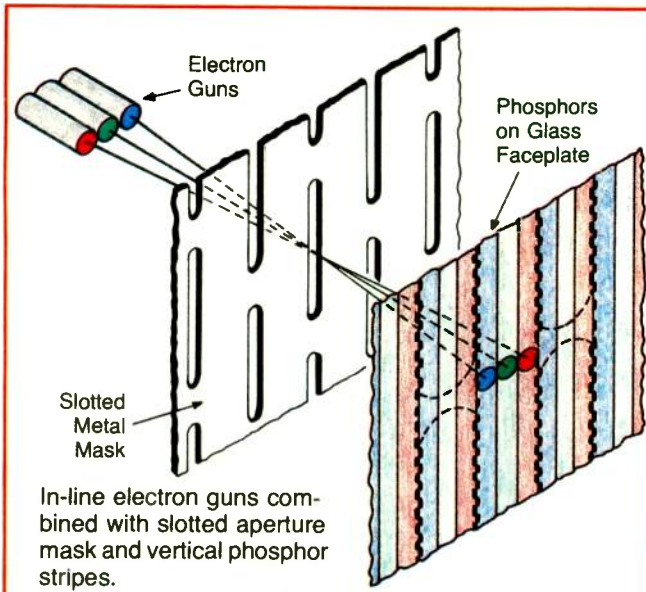

Video Graphics

Designers of computer graphics systems must pay special attention to the TV monitor selected for displaying the image. But there are also a host of factors which must be taken into account when choosing a picture monitor for any application.

200 mm—requiring at least a 13-inch monitor.

Contributing to the MTF loss—and the potential loss of display resolution—are the diffusing effects of secondary-electron emissions within the phosphor layer and the “halation” caused by reflections within the glass faceplate. Halation rings may form around each pixel location, again reducing the effective display contrast.

Fortunately, most of the steps taken to minimize the contrast-reducing effects of reflected ambient light—such as “etching” the faceplate or adding a filter—also lower the amount of contrast loss due to halation. Etching acts by diffusing the light at the glass-air interface. Normal practice is to bond a treated glass plate directly to the front surface of the CRT. The diffusing layer reduces the amount of light reflected back toward the phosphor. The displayed image is also slightly diffused, so etching represents a trade-off between two negative effects.

Filters, either laminated to the faceplate or mounted separately, act by simply absorbing a fraction of the light—both wanted and unwanted. Luminance generated by halation

tends to leave the surface at an oblique angle and therefore follows a longer path through the filter layer. The same would be true of oblique ambient light. In addition, reflected ambient light must pass through the filter twice and is consequently attenuated twice as much as light emitted by the phosphor layer. But again a trade-off is involved. Filters reduce the display luminance and can also affect the display resolution.

A variety of filtering materials and processes are commercially available, often combined with such anti-reflection measures as vacuum-deposited optical coatings. Polarizing layers have proved particularly effective. In one instance, the “filter” is actually an assembly of miniature louvres which shade the screen from overhead light sources.

Color resolution

The preceding paragraphs provide general guidelines on the effects that screen size, spot size, halation, and ambient light have on display resolution. In the case of aperture-mask color monitors, however, another major factor must be taken

ON YOUR SIDE ON TIME ON THE AIR!

Antek is on to something. A new alternative consulting system that provides a clear understanding of your market and all FCC regulations. Providing the answers you need in acquiring licensing. At less cost. In less time. And with greater efficiency.

Antek utilizes the most advanced software systems and a thorough knowledge of the industry to provide you the following:

- Location of transmitter sites.
- Frequency selection.
- Prediction of service area.
- Signal level calculation.
- Understanding the relationship between your potential site and existing sites.
- Necessary assistance in completing all required exhibits for FCC applications.

Antek will provide answers to all your questions concerning licensing. Project managers Jim Swayze and Kelley Stalder are accomplished experts, with over 10,000 applications accepted by the FCC. Combining the experience and knowledge to recognize your specific needs and to adapt their own capabilities to those needs.

Now is the time to consult Antek. With the establishment of the Docket 80-90 FM Drop-Ins, the FCC is authorizing over 1,000 new additions to the Table of Allocations. Antek is clearly your alternative to licensing and market consultation. Clearly on your side. And clearly capable of getting you on the air in the least amount of time.



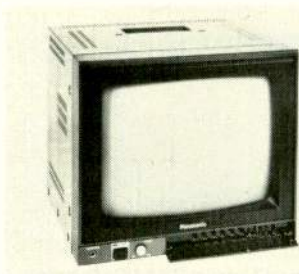

The Panasonic BT-S1300N color video monitor.

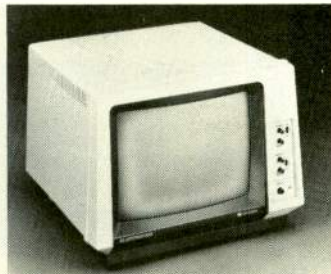

The 1301 color monitor from Electrohome.

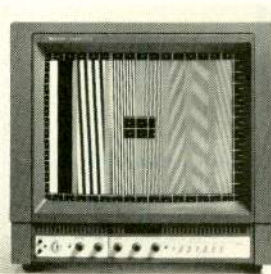

The 690 SR color monitor from Tektronix.



The Sharp 20J 580 color monitor.

into account: the "pitch" or distance between the aperture-mask holes or slots.

In principle, the resolution of a color monitor should equal that of the aperture openings (i.e., one pixel per aperture). Experience indicates, however, that significant improvements in the appearance of the display occur as the

The pitch of a standard-resolution delta mask ranges from 0.66 mm for large-screen CRT's (over 20 inches) to 0.42 mm for miniature CRT's (less than 5 inches). At mid-range, the distance from hole to hole is approximately 0.60 mm. Interlacing reduces the vertical distance between rows of holes to only half the pitch dimension. In terms of spot size,

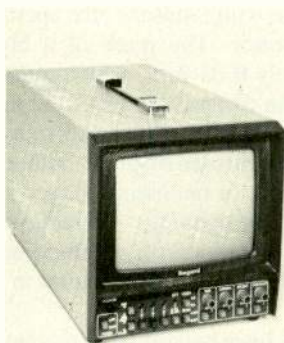

The Ikegami high-resolution nine-inch color monitor.



The JVC TM-R9U color monitor with nine-inch screen.

bandwidth of the monitor is increased far beyond the theoretical pixel-density limit set by the number of aperture openings. Other factors are at work, therefore, which need to be examined.

There is, for example, no synchronization (or registration) between the pixel locations and aperture-mask pattern. To avoid "missing" or low-luminance pixels it becomes necessary to increase the spot size so that at least two aperture openings are being continuously scanned. The result may be an electron-beam spot which is two or three times as large as the nominal pixel area.

The size of the aperture-mask pitch and the extent to which it potentially affects resolution are both functions of the type of color CRT. Four distinctly different types are now in use. The classical configuration is the delta-delta construction. The aperture holes in the metal mask form delta-shaped equilateral triangles, resulting in an interlaced pattern with offset holes in both the horizontal and vertical dimensions. The three electron guns are also mounted in a delta cluster. Ideally, the three beams converge and crossover at the plane of the aperture mask. The geometry is arranged so that each beam impinges on one of three colored-phosphor dots and is "shadowed" from the other two. The result is a cluster of primary-color dots with a perceived color established at normal viewing distances by the relative amplitudes of the three electron-beam currents. Less than 20 percent of the beam electrons pass through the holes; the balance are trapped by the metal mask. Very high beam currents are therefore required.

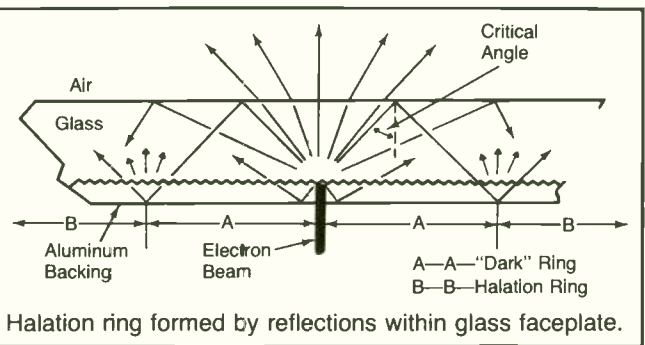

When YOU want NICKEL CADMIUM

PE 52
Lighting or
Camera

28.8 volt 4 AH
or
14.4 volt 8 AH
in one unit

dual belt
with/4 hr charger
built in



Versatile • Rugged • Economical

YOU want
PERROTT
a name you can depend on

7201 Lee Highway, Falls Church, Va. 22046 (703) 532-0700

Circle 139 on Reader Service Card

TELEVISION TECHNICIAN SAUDI ARABIA

The King Faisal Specialist Hospital and Research Centre has a current opening for a Television Technician in the Audio-Visual Department. The AV Department is responsible for the educational and television needs of the Hospital's employees and their dependents. The Hospital is a 250 bed acute care facility located in Riyadh, Saudi Arabia.

Requirements include an Associates degree in Electronics or 2 years trade school, 5 years experience including 2 or more years in maintenance and repair of TV and video systems. Experience in a Studio with working knowledge of PAL and NTCS formats is preferred.

Salary and benefits are attractive and include: 30 day annual leave, furnished housing, transportation, bonus pay and more. Contracts are single status. Persons interested in this position will have a contract with the Government of the Kingdom of Saudi Arabia.

For further information and/or to apply, please call our toll-free number, (800) 251-2561, or send your resume to: HCA International Company, Dept. BME-1184, P.O. Box 550, Nashville, TN 37202. HCA is an Equal Opportunity Employer.

HCA International Company

Circle 140 on Reader Service Card

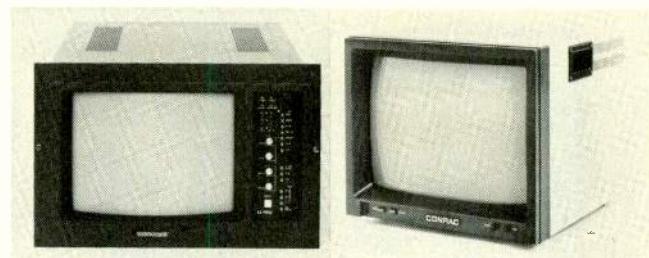

The Videotek VM-13 PRO color monitor.

The Conrac 7111C19 color monitor.

however, the controlling factor is the horizontal column-to-column gap which equals the pitch times the cosine of 30 degrees (0.7), or approximately 0.4 mm for an average monitor. The nominal spot size for the converging beams must therefore cover a diameter approaching 1.0 mm in order to assure full-luminance pixels.

One way to reduce the spot size would be to specify a "high-resolution" color monitor with four times the aperture density of a conventional monitor. The pitch of a high-resolution mask is approximately 0.31 mm, which reduces the horizontal column-to-column distance to only 0.22 mm. The spot size can thus be reduced to less than 0.5 mm—a value approaching that of a monochrome display—although the designer may choose, instead, to maintain a larger spot size—covering four or five aperture openings—to reduce the moiré effects which can occur when repetitive graphic-image patterns "beat" with the spatial frequency of the holes in the metal mask.

The high-resolution apertures have even smaller diameters than those of a conventional aperture mask. Even higher beam currents are therefore required to maintain display luminance. Convergence of the three beams must also be more precise.

Convergence problems created by the delta-delta arrangement can be reduced in turn, by using a precision in-line (PIL) electron-gun assembly instead of the conventional delta guns. The beams from the three in-line guns are "self-converging," eliminating the need for complex convergence circuits and adjustment procedures. The dot pattern produced by the converging beams is also different—forming a slightly elongated oval. The pitch of the aperture mask remains exactly the same, however, so there are no changes in the color resolution or the required spot diameters.

The in-line gun arrangement was first perfected for a different type of color CRT—fabricated with a slotted metal mask and vertical phosphor stripes on the CRT faceplate. The bridges between slots are required to give the mask structural stability, but are sufficiently small so that resolution in the vertical direction is theoretically unaffected. By contrast, the horizontal pitch is on the order of 0.7 to 1.0 mm, requiring very large spot sizes to avoid blanked-out pixels. Counterbalancing this negative attribute are the high luminances which can be achieved at moderate beam currents. The slotted mask traps less than half of the beam electrons, compared to the 80 percent blocked by a delta mask.

Similar advantages and disadvantages apply to the proprietary system in which the mask consists of stretched, end-supported metal strips, producing truly infinite vertical resolution. The horizontal pitch approaches 1.0 mm. The strips require the use of a cylindrical CRT faceplate. Another feature of the design is the "single-run" structure with a single large-diameter focusing "lens" for all three electron beams.

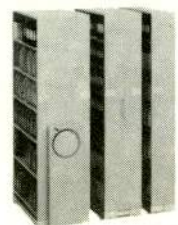

• HIGH CAPACITY SYSTEM

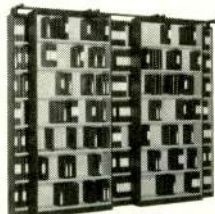

• SUPER DENSITY SYSTEM

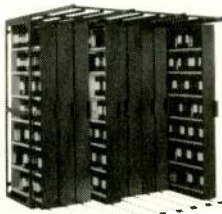

• PULL-OUT SYSTEM

Winsted®

space-saving tape or film MOVABLE STORAGE SYSTEMS

Organized, efficient storage for all types of film and videotape.

Sliding cabinets move effortlessly on low-profile tracks for easy access and maximum storage capacity in limited space.

Available in a variety of designs and sizes, with 5" to 36" depths, to suit your special storage needs. All steel construction.

For Free Full-color FULL LINE CATALOG
Write or call toll-free:

800-328-2962

THE WINSTED CORPORATION
9801 James Circle • Minneapolis, MN 55431

TELEX: 910-576-2740

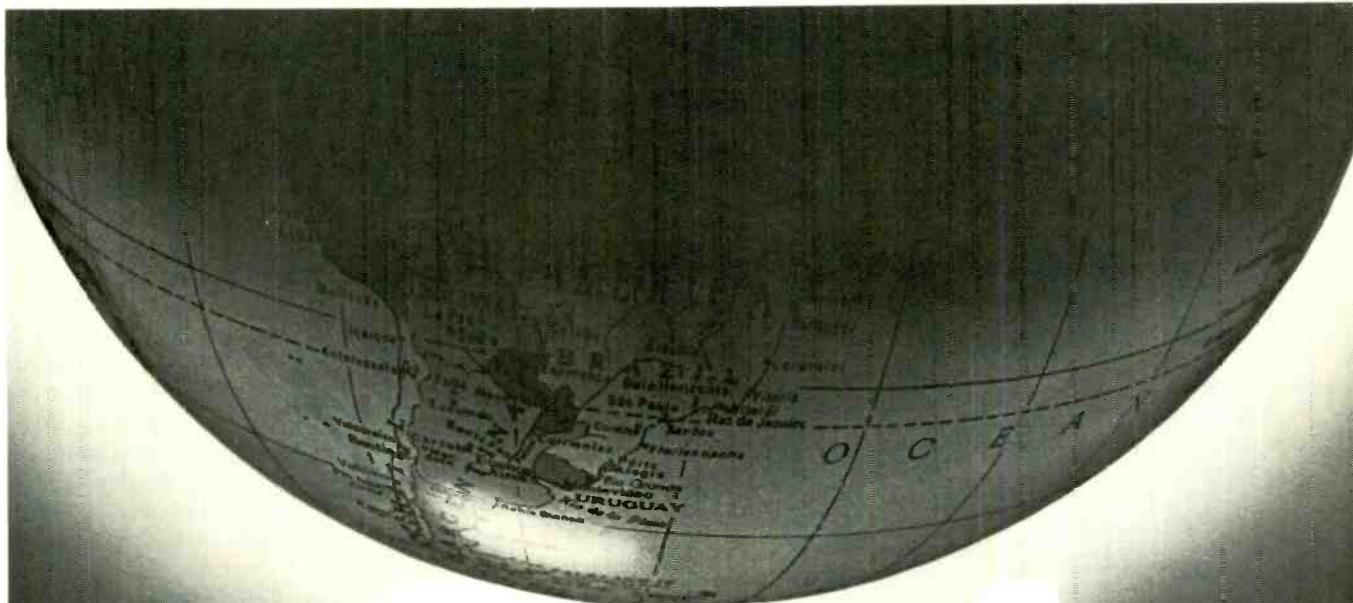

CFM TV NEWS

Equipment support for the broadcast news industry. Worldwide.

The Camera Mart, Inc.
456 W. 58th St., New York 10019 (212) 757-6977 / Telex: 1-2078
Sales • Service • Rentals

10 DC-8s Already SOLD!



\$69,950

Automatic Video Cart Machine

So SIMPLE anyone can learn to operate it in fifteen minutes. Runs commercials, music videos, programs....RELIABILITY and with GOOD PERFORMANCE.



BROADCAST SYSTEMS INC.
800/531-5232 800/252-9792 TX

Circle 143 on Reader Service Card

The Best Transmitter Test Package in the World!

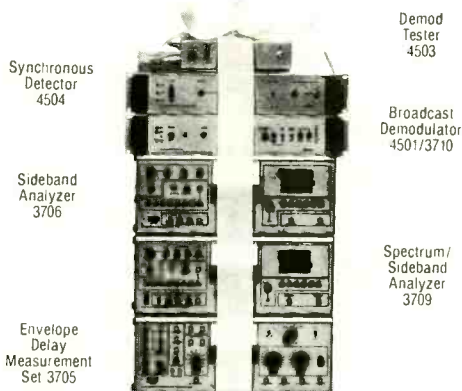

Synchronous
Detector
4504

Sideband
Analyzer
3706

Envelope
Delay
Measurement
Set 3705

Demod
Tester
4503

Broadcast
Demodulator
4501/3710

Spectrum/
Sideband
Analyzer
3709

The Telemet Transmitter Test Package provides accurate and reliable equipment, you need at a price you can afford.

Telemet

A Geotel Company

185 DIXON AVENUE, AMITYVILLE, L.I., N.Y. 11701
(516) 842-2300

Eastern Area Office—(914) 279-3231
Midwest Area Office—(312) 554-1121

Circle 144 on Reader Service Card



The Barco CM-33B high-resolution color monitor.

The PVM-8200 dual trinitron monitor unit from Sony.

Color-signal resolution

Reviewing these details, we can see that every type of aperture mask requires a spot size that is much larger than the theoretical dimensions of the pixels being displayed. How, then, can the eye perceive individual pixels? How can we explain, in fact, the definite improvement in display appearance that occurs when the monitor bandwidth is increased to support a pixel density that exceeds even the aperture-opening density?

The answer lies in the human visual system. The nerve structure behind the retina serves to "sharpen" images far beyond the limits set by the eye's optical apparatus. Moreover, the processed data is transmitted immediately to the brain and stored separately from the images that precede and follow the current image. In effect, then, the Gaussian spread of the electron-beam spot is narrowed by the eye to a much smaller-diameter dot.

Moreover, only one pixel color or intensity is on a display at a time—never simultaneously. The next pixel center is a measurable distance from the first, occurs at a later time, and is "stored" (remembered) as a separate image. No overlapping in the conventional sense occurs, therefore, and the perceived resolution can at least approximate the resolution (bandwidth) of the color signal itself.

There is, however, an upper limit established by the speed of the eye-brain system. Empirical evidence indicates that at bandwidths above 70 MHz, further improvements become marginal. Individual viewers and viewing conditions would affect the absolute limit—probably in the neighborhood of 100 MHz.

All of this assumes, of course, that the "resolution" of the color signal has been preserved by the monitor amplification circuits. An RGB monitor is essentially three monochrome monitors with shared synchronization circuits and CRT. All processing of the three color signals is performed in parallel, from the input connectors to the three CRT gun assemblies. Clearly the critical factor is the bandwidth of the amplifier or amplifiers which increase each display signal to the CRT-drive level, typically 10 to 50 volts. This bandwidth should be on the order of 20 MHz or more for most graphics applications.

A variety of ways are used to define this monitor specification. In addition to bandwidth, the manufacturer may state the minimum rise and fall times at the electron-gun interface—typically 20 to 40 nanoseconds—or the number of pixels which can be displayed along each raster line.

Equivalent specifications are rarely given for monitors designed to process encoded color signals. All of the color-encoding standards start with the requirement that the color information must be compressed within the limits imposed by the established broadcast channels. In the case of the NTSC standard, for example, the color information is used to modulate two subcarrier signals, one with a bandwidth of 1.3 MHz, the other with a bandwidth of 0.5 MHz. Most com-

DISCOUNT VIDEO WAREHOUSE

NEW LOW PRICES

Quantities Limited

All Prices Subject to Change

All Sales Final

TERMS:
Payment—In Advance
COD Cashiers
Shipping:
1000 Morton Grove, IL

★ NOVEMBER SPECIAL ★

More Free Scotch Video Tape!

Buy any of our 3 Specially Priced ENG Portable Systems and Receive 10 FREE TAPES



- SYSTEM I**
- JVC By-110UP 3-Tube Color Camera with 10X Lens
 - JVC AAC-11U AC/Charger
 - JVC DCC-11U Battery
 - JVC VC-511BU-2 VCR Cable
 - JVC BR-6200U Portable VHS Recorder
 - JVC AAP-26U AC/Charger
 - Portabrace C-6200 Case

Special System Price I \$4,469
Including 10 Free T-120 Tapes

- SYSTEM II**
- JVC KY-210UPL 3-Tube Color Camera
 - JVC HZ-512 12X Lens
 - JVC AAC-50U AC/Charger
 - JVC DCC-50U Battery
 - JVC VC-512BU VCR Cable
 - JVC CR-4900 3/4" Portable Recorder
 - JVC AAP-47U AC/Charger
 - Portabrace C-4700/HB-20 Case

Special System II Price \$9,350
Including 10 Free UCA-20's Tape

- SYSTEM III**
- Sony DXC-M3K 3-Tube Color Camera with 14X Lens
 - Sony VO-4800 3/4" Portable Recorder
 - (2) Sony BP-60 Battery
 - Sony CMA-7 AC Unit
 - Portabrace C-4800/HB20 Case

Special System III Price \$8,050
Including 10 Free UCA-20's Tape

SONY

NEW!

Sony FP-62 Video Projector \$1,645

NEW!

Sony FP-60 Video Projector w/built-in Betamax \$2,295

NEW!

Sony VPH-2020Q1 200" Universal Video Projector \$5,050

NEW!

Sony VO-6800 3/4" U-matic Portable Recorder, balanced audio, confidence head, 12.2 lbs
Introductory Sale—Call for Details

NEW!

Sony KV-4200 4" Color Profel Monitor \$395

MICROTIME

T-100 16 Line TBC \$5,199
T-120 16 Line TBC \$6,199

S-230 TBC/Frame Synchronizer \$10,560
T²E120 A/B Roll Effects System \$17,850

Sony VP-5000 3/4" Player \$1,345

Sony VO-5600 3/4" Recorder \$1,695

Sony VO-5800 3/4" Recorder "Feeder" \$3,250



Sony VO-5850 3/4" Editing Recorder \$5,225

Sony VO-5850 PAC Editing System Includes: VO-5850, VO-5800, RM-440 Controller; Cables \$9,495

Sony SLO-383 Editing Beta Recorder \$1,880

Sony CVM-1900 19" Color Monitor/TV \$835

Sony PVM-1220 Studio Color Monitor \$1,610

New Sony PVM-1910 19" Monitor \$666 \$475

Sony VPH-722Q/VPH-1020Q 72"/100" Ceiling/Floor Mount Wide-Screen Projection Unit \$4,585

Sony PVM-8000 8" Color Monitor (AC/DC) \$495

Sony CVM-1270 12" Color Monitor/TV \$610

KCS-10K \$10.91

KCS-20K \$12.53

KCA-30K \$14.39

KCA-60K \$21.06

KCS-20BRK \$14.07

KCS-30BRK \$16.89

KCA-60BRK \$23.74

JVC Editing System III CR-8250: CP-5550 & RM-86 \$7,295

JVC BP-5100 VHS Player \$498

JVC BR-6200 VHS Portable Recorder \$880

JVC BR-8600 Editing VHS Recorder \$2,195

JVC VHS Editing System II—(2) BR-8600 and RM-86 \$5,238

JVC-CR-4900 Portable 3/4" Recorder \$2,950

JVC TM-22 5" Color Monitor \$310

JVC C-2082UM 19" Color Monitor/TV \$665

JVC TM-R9U/RK-9U Dual (2) TMR9U Color Monitors in Rack Mount \$1,195

Sony VPH-722Q/VPH-1020Q 72"/100" Ceiling/Floor Mount Wide-Screen Projection Unit \$4,585

Sony PVM-8000 8" Color Monitor (AC/DC) \$495

Sony CVM-1270 12" Color Monitor/TV \$610

KCS-10K \$10.91

KCS-20K \$12.53

KCA-30K \$14.39

KCA-60K \$21.06

KCS-20BRK \$14.07

KCS-30BRK \$16.89

KCA-60BRK \$23.74

Sony BVU-110 Broadcast Portable 3/4" Recorder (U) \$4,395

Sony PVM-5300 Triple 5" Color Monitor (D) \$1,499

Barco CTVM 3/51 20" Studio Color Monitor (D) \$3,500

Star Overstock Case Clearance

Too Many Video, Audio and Utility Shipping Cases to List Them All—Listed Below Are Some Examples—Limited Quantities—First Come First Served! Call for Itemized List.

ATA Panasonic NV-8420 with Access \$149

ATA Panasonic PV-5200/Tuner/AC \$195

ATA JVC CR-4700 with AC and Charger \$169

ATA Hitachi VT-680 with AC \$149

ATA Rack Case 22 3/4" H-16" Deep \$249

ATA JVC BR-6200/AC, Access and Acme Tripod \$249

Tektronix 1420 Vectorscope \$2,330

Tektronix 528A Waveform Monitor \$1,895

JVC BR-8600 Editing VHS Recorder \$2,195

JVC VHS Editing System II—(2) BR-8600 and RM-86 \$5,238

JVC-CR-4900 Portable 3/4" Recorder \$2,950

JVC TM-22 5" Color Monitor \$310

JVC C-2082UM 19" Color Monitor/TV \$665

DEMO & USED

Misar Voice Activated 5-Camera Video Record System Includes:

5- B&W Cameras/Lens \$2,450

1- B&W Monitor \$4,608

1- Dissolve/Switcher Regular Price \$29,400

Demo Unit Price \$6,995

Videotek VM-12 PRO Studio 12" Color Monitor (U) \$849.95

Videotek RM-8 8" Receiver/Monitor \$525

Sony BVU-110 Broadcast Portable 3/4" Recorder (U) \$4,395

Sony PVM-5300 Triple 5" Color Monitor (D) \$1,499

Barco CTVM 3/51 20" Studio Color Monitor (D) \$3,500

JVC KY-1900 CHL10 3-Tube Color Camera with 10X Lens (U) \$2,450

JVC VE-92 Edit Controller with Fade-To-Black and Character Insert (D) \$4,608

SONY CVM-1250 12" Color Monitor/Receiver (U) \$359

JVC TM-22 5" Color Monitor (D) \$245

LENCO CCE-850 Color Encoder (D) \$1,325

ELECTROHOME EVM-1519 with P39 15" Monitor with P39 Phosphor (D) \$495

FUJINON TC V 75/80 Lens Teleconverter (D) \$795

WV-5352 Dual 8" B&W Monitor \$415

WV-5203B Triple B&W Monitor \$599

TR-932 Dual 9" Black and White Monitor \$291

WV-5410 14" Black and White Monitor \$254

WV-5490 19" Black and White Monitor \$392

QLH-7 Mini Fluid Head (10LB Cap.) \$246

QLH-7/QLT15 Mini Fluid Head and Husky Tripod \$338

QMT-3 Elevator Tripod \$257

QMH-17 Jr. Fluid Head (30LB Cap.) \$518

QHH-15 Hydro Head (40LB Cap.) \$779

QHH-23 Super Hydro Head (50LB Cap.) \$988

QuickSet

Panasonic WJ-5600 Built-in Colorizer and Chroma Keyer \$4,588 (AC/DC)

Panasonic WJ-5500B \$2,995

Panasonic WJ-4600B \$1,570

JVC KM-2000 Built-in Colorizer and Chroma Keyer \$3,995

Sony SEG-2000A Built-in Colorizer and Camera Setup (AC/DC) \$3,895

Sony Director 2000 System SEG-2000A; Wipe Generator; Chroma Keyer \$7,760

Sony WEX-2000A Wipe pattern extender, 84 wipe patterns \$1899

Panasonic NV-8420 with Access \$149

Panasonic PV-5200/Tuner/AC \$195

JVC CR-4700 with AC and Charger \$169

Hitachi VT-680 with AC \$149

Rack Case 22 3/4" H-16" Deep \$249

JVC BR-6200/AC, Access and Acme Tripod \$249

Tektronix 1420 Vectorscope \$2,330

Tektronix 528A Waveform Monitor \$1,895

JVC BR-8600 Editing VHS Recorder \$2,195

JVC VHS Editing System II—(2) BR-8600 and RM-86 \$5,238

JVC-CR-4900 Portable 3/4" Recorder \$2,950

JVC TM-22 5" Color Monitor \$310

JVC C-2082UM 19" Color Monitor/TV \$665

JVC TM-R9U/RK-9U Dual (2) TMR9U Color Monitors in Rack Mount \$1,195

Star Overstock Case Clearance

Too Many Video, Audio and Utility Shipping Cases to List Them All—Listed Below Are Some Examples—Limited Quantities—First Come First Served! Call for Itemized List.

ATA Panasonic NV-8420 with Access \$149

ATA Panasonic PV-5200/Tuner/AC \$195

ATA JVC CR-4700 with AC and Charger \$169

ATA Hitachi VT-680 with AC \$149

ATA Rack Case 22 3/4" H-16" Deep \$249

ATA JVC BR-6200/AC, Access and Acme Tripod \$249

Tektronix 1420 Vectorscope \$2,330

Tektronix 528A Waveform Monitor \$1,895

JVC BR-8600 Editing VHS Recorder \$2,195

JVC VHS Editing System II—(2) BR-8600 and RM-86 \$5,238

JVC-CR-4900 Portable 3/4" Recorder \$2,950

JVC TM-22 5" Color Monitor \$310

JVC C-2082UM 19" Color Monitor/TV \$665

JVC TM-R9U/RK-9U Dual (2) TMR9U Color Monitors in Rack Mount \$1,195

Star Overstock Case Clearance

Too Many Video, Audio and Utility Shipping Cases to List Them All—Listed Below Are Some Examples—Limited Quantities—First Come First Served! Call for Itemized List.

ATA Panasonic NV-8420 with Access \$149

ATA Panasonic PV-5200/Tuner/AC \$195

ATA JVC CR-4700 with AC and Charger \$169

ATA Hitachi VT-680 with AC \$149

ATA Rack Case 22 3/4" H-16" Deep \$249

ATA JVC BR-6200/AC, Access and Acme Tripod \$249

Tektronix 1420 Vectorscope \$2,330

Tektronix 528A Waveform Monitor \$1,895

JVC BR-8600 Editing VHS Recorder \$2,195

JVC VHS Editing System II—(2) BR-8600 and RM-86 \$5,238

JVC-CR-4900 Portable 3/4" Recorder \$2,950

JVC TM-22 5" Color Monitor \$310

JVC C-2082UM 19" Color Monitor/TV \$665

JVC TM-R9U/RK-9U Dual (2) TMR9U Color Monitors in Rack Mount \$1,195

Star Overstock Case Clearance

Too Many Video, Audio and Utility Shipping Cases to List Them All—Listed Below Are Some Examples—Limited Quantities—First Come First Served! Call for Itemized List.

ATA Panasonic NV-8420 with Access \$149

ATA Panasonic PV-5200/Tuner/AC \$195

ATA JVC CR-4700 with AC and Charger \$169

ATA Hitachi VT-680 with AC \$149

ATA Rack Case 22 3/4" H-16" Deep \$249

ATA JVC BR-6200/AC, Access and Acme Tripod \$249

Tektronix 1420 Vectorscope \$2,330

Tektronix 528A Waveform Monitor \$1,895

JVC BR-8600 Editing VHS Recorder \$2,195

JVC VHS Editing System II—(2) BR-8600 and RM-86 \$5,238

JVC-CR-4900 Portable 3/4" Recorder \$2,950

JVC TM-22 5" Color Monitor \$310

JVC C-2082UM 19" Color Monitor/TV \$665

JVC TM-R9U/RK-9U Dual (2) TMR9U Color Monitors in Rack Mount \$1,195

Star Overstock Case Clearance

Too Many Video, Audio and Utility Shipping Cases to List Them All—Listed Below Are Some Examples—Limited Quantities—First Come First Served! Call for Itemized List.

ATA Panasonic NV-8420 with Access \$149

ATA Panasonic PV-5200/Tuner/AC \$195

ATA JVC CR-4700 with AC and Charger \$169

ATA Hitachi VT-680 with AC \$149

ATA Rack Case 22 3/4" H-16" Deep \$249

ATA JVC BR-6200/AC, Access and Acme Tripod \$249

Tektronix 1420 Vectorscope \$2,330

Tektronix 528A Waveform Monitor \$1,895

JVC BR-8600 Editing VHS Recorder \$2,195

JVC VHS Editing System II—(2) BR-8600 and RM-86 \$5,238

JVC-CR-4900 Portable 3/4" Recorder \$2,950

JVC TM-22 5" Color Monitor \$310

JVC C-2082UM 19" Color Monitor/TV \$665

JVC TM-R9U/RK-9U Dual (2) TMR9U Color Monitors in Rack Mount \$1,195

Star Overstock Case Clearance

Too Many Video, Audio and Utility Shipping Cases to List Them All—Listed Below Are Some Examples—Limited Quantities—First Come First Served! Call for Itemized List.

ATA Panasonic NV-8420 with Access \$149

ATA Panasonic PV-5200/Tuner/AC \$195

ATA JVC CR-4700 with AC and Charger \$169

ATA Hitachi VT-680 with AC \$149

ATA Rack Case 22 3/4" H-16" Deep \$249

ATA JVC BR-6200/AC, Access and Acme Tripod \$249

Tektronix 1420 Vectorscope \$2,330

Tektronix 528A Waveform Monitor \$1,895

JVC BR-8600 Editing VHS Recorder \$2,195

JVC VHS Editing System II—(2) BR-8600 and RM-86 \$5,

mercial monitors process the combined signal to produce two derived signals with equal bandwidth on the order of 1.0 MHz.

The effect is both to spread a lower maximum number of pixels along the raster line and to "soften" the color transitions between pixels. Vertical resolution is limited by the number of lines per frame dictated by the color-encoding standard. In practical terms the maximum pixel-to-pixel color resolution of a color-encoded raster—of any size or aspect ratio—would be 150-horizontal by 480-vertical pixels.

Monitor enhancements

Both the CRT and the graphics-display CRT monitor are still evolving as commercial products. A variety of monitor enhancements should be evaluated, therefore, before a selection is made.

Many of these innovations relate to reliability and device life. The use of impregnated cathodes is an example. Every CRT will eventually "burn out," just like any other electron tube. A reserve supply of barium compound can continuously refresh the surface of a porous tungsten cathode, allowing the CRT to be driven at very high current densities and still give thousands of hours of service.

Other enhancements relate more directly to performance and should be considered within the context of a specific application. The conventional CRT electron gun, for example, "crosses over" the electron beam to give the focusing elements a point source. A parallel-flow design increases the number of electrons directed at the CRT faceplate without a corresponding increase in the cathode "loading factor."

Small spot sizes are somewhat more difficult to achieve, so the technique represents a trade-off between luminance and resolution.

Similar trade-offs apply to the choice of electrostatic or electromagnetic focusing and deflection. An all-electrostatic design would be preferred for systems requiring very fast scanning rates and modest resolution (spot size). An all-magnetic design reverses this order. Most raster-scan graphics monitors consequently use an electrostatic-focus, electromagnetic-deflection combination which represents a compromise between resolution and speed.

Manufacturers may also incorporate special circuitry into the design of the monitor itself. One example is a "beam-current feedback" circuit which maintains the black level of the display at a constant value despite CRT aging and component drift. The CRT beam current is sampled during each vertical retrace. Feedback adjustments are then made to the dc level of the display-signal amplifier to correct for any detected error.

CRT monitors are analog devices, subject to all the uncertainties which affect the performance of such devices. Enhancements like the beam-current feedback circuit help to make the monitor a stable dependable system component in the otherwise digital environment. **BM/E**

Note: Material in this story has been excerpted from Chapter 9 of the forthcoming Raster Graphics Handbook, Second Edition, to be published later this month by Van Nostrand Reinhold Company Inc., New York, NY.

© Copyright 1985, The Conrac Corporation.—Ed.



Record, play and dub complete sports events and full-length movies non-stop!

ME-238 Kit for Type-C VTRs

Extend record/play time to 3 hours on Ampex VPR-80, VPR-2, Marconi VTRs, Sony BVU 2000; 2 hrs. 40 min. on Sony BVU 1000/1100 recorders. Ideal for master playback when dubbing to small format machines or for automated programming.

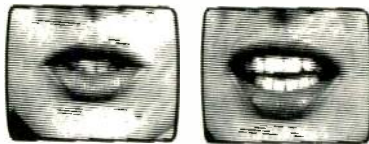

Restore lip sync to video transmission & processing



ME-278 Digital Frame Audio Delay

Correct audio-to-audio timing errors when programs are passed through framestores, standards converters, synchronizers or digital effects systems. Delay is selectable in frame or field increments using simple front panel control.

Remarkable Low-Cost PAL/NTSC Digital Image Processor

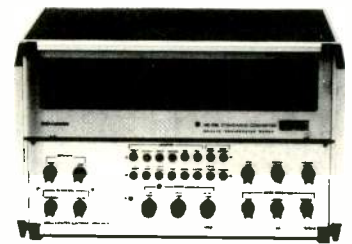

ME-288 Standards Converter

Unique in the field of digital video processing, the ME-288 combines TBC, noise reduction, color correction, synchronizer, field/frame store, H & V image enhancement plus NTSC to PAL/PAL to NTSC standard conversion in one integrated unit.

MERLIN ENGINEERING WORKS
1880 EMBARCADERO, PALO ALTO, CA 94303
(415) 856-0900 TWX 910-3731782



MERLIN

Merlin Engineering Works maintains complete design, engineering and fabricating capabilities for custom systems and special products. Call for further information

CALL TOLL FREE —
1-800-227-1980
(Calif. 415/856-0900 Collect)

THE ONE PIECE THAT SOLVES THE PUZZLE



THE ALL-NEW IKEGAMI HL-95 UNICAM®

If you're confused by the many tape formats and conflicting manufacturers claims, relax.

Ikegami's new HL-95 Unicam® is the only universal camera system that accepts all professional on-board VCR formats, 1/4-inch and 1/2-inch, and solves your buying puzzle by putting the picture you want into place.

Engineered to offer performance beyond the most rigid expectations, the HL-95 utilizes new 2/3-inch SM diode gun Plumbicons®, resulting in a camera with higher sensitivity and S/N ratio, greater resolution, lower operating power requirements and less registra-

tion error than previously possible in a camera of its size and weight.

The HL-95 is also available as a stand-alone ENG camera, and in systems configurations using Triax or Multi-core cable base stations, or with the ML-95 ENG Microwave Link. Once you examine the HL-95 Unicam®, you'll agree that the system flexibility and picture quality puts it in a class all by itself. The standard of excellence continues at Ikegami.

For a complete demonstration of Ikegami Cameras and Monitors, contact us or your local Ikegami dealer.

Ikegami HL-95 UNICAM®

Ikegami Electronics (U.S.A.), Inc., 37 Brook Avenue, Maywood, NJ 07607

■ East Coast: (201) 368-9171 ■ West Coast: (213) 534-0050 ■ Southeast: (813) 884-2046
■ Southwest: (713) 445-0100 ■ Midwest: (314) 878-6290

Why Beyer mics represent a viable alternative to the usual choices in Broadcast.



Beyer MCM Condenser System

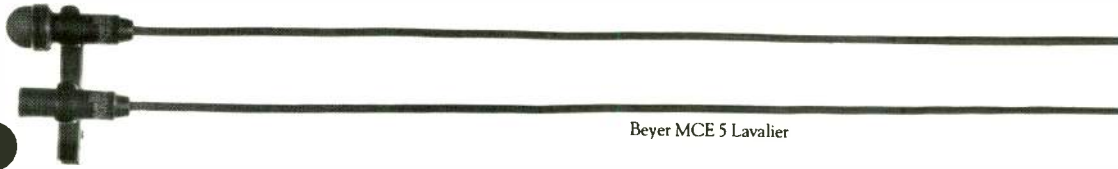

Beyer MCE 5 Lavalier



Beyer M 260

Now there's another high-tech German condenser system.



Until recently, film and broadcast engineers thought only Sennheiser and Neumann made high-quality condenser microphone systems. Now the Beyer MCM Series offers the same German excellence in design and construction, the same kinds of accessories (windscreens, pistol grips, shock mounts) and facilities for 12V and 48V "phantom" powering.

And since the MCM Series studio condenser mic is part of a system which combines power modules and different mic capsules (long shotgun, short shotgun, unidirectional, omnidirectional and figure eight), you get more microphone potential for dollar output.

Like all Beyer microphones, the MCM Series is a truly professional instrument system suited to the widest range of applications in Broadcast/Film and Video post-production.

With lavalier mics, small is not enough.



Electret condenser lavalier mics like SONY's ECM-50 have proven useful for on-camera miking situations because of their reduced size. And while many of these mics offer good performance in a compact size, the Beyer MCE5 also provides extended frequency response (20 to 20,000 Hz) and durability in an even smaller format (diameter: 7 mm / length: 23 mm).

To optimize its compatibility with a variety of broadcast and film applications, the tiny black MCE5 is available in different configurations for powering interface and includes a system with accessories like windscreens, expansion mounts etc.

At Beyer Dynamic's ultra-modern manufacturing facility in West Germany, we hand-build virtually all of our microphones in the most evolved state of fine German engineering.

There's more than one way to bring out the warmth in an announcer's voice.



Broadcast engineers choose the E-V RE20 for many vocal announcing situations because of its wide frequency response (45-18,000 Hz)* and smooth sound. Beyer Dynamic's M 260 also provides the extended frequency response (50-18,000 Hz) and warmth required for critical vocal applications with one distinct advantage: its reduced size. Its compact and efficient ribbon element captures the warmth traditionally provided by this type of mic. And because it is considerably smaller than a mic with a large moving-coil diaphragm, the M 260 provides a natural, balanced sound image in a portable format that won't obscure copy or take up valuable space in the studio.

The Beyer M 260 has its own custom-designed ribbon element to optimize the mic's performance based on its Broadcast applications.

The Dynamic Decision

beyerdynamic

*Extracted from competitive promotional literature or advertising.

*Documentation supporting specific comparative claims available upon request.

INDEXTRON: A New Beam-Index Picture Tube

Using beam indexing instead of a metal plate to focus the electron beam, this new picture tube development makes possible a picture 70 percent brighter than conventional tubes.

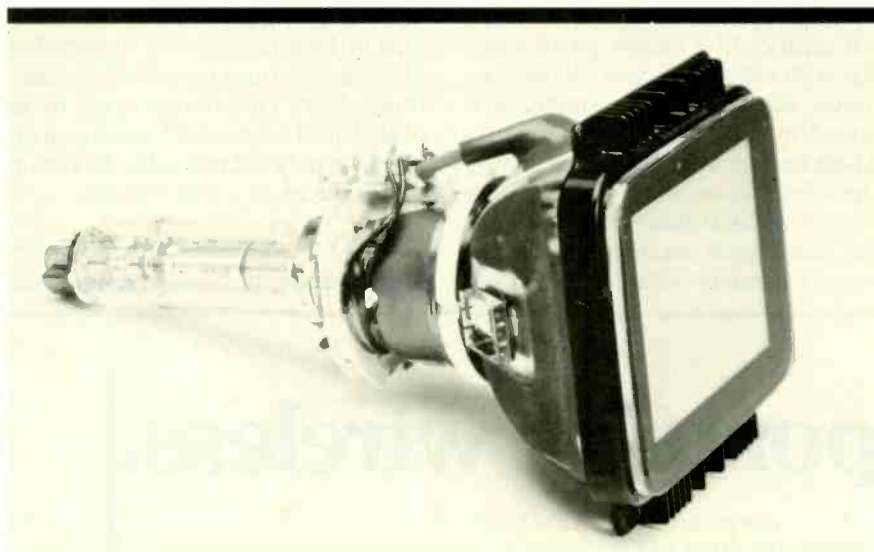

The newly developed Indextron beam-indexing picture tube.

By Robert Rivlin, Editor

When Sony engineers set out to design a high-brightness picture tube for the company's new Vidimagic video projector, they turned to an old idea: the beam index tube. This type of tube had never been mass-produced before. But by using the latest semiconductor technology, a newly-developed phosphor material, and several advanced manufacturing concepts, the engineering team developed Indextron—a beam index tube whose peak brightness, at 1600 footcandles, is six to eight times that of a standard tube.

In the conventional delta gun shadow mask TV picture tube [see the story on TV Tubes in Raster Graphics elsewhere in this issue], three electron guns (one each for red, green, and blue) are arranged in an equilateral delta pattern corresponding to the triangular arrange-

ment of phosphor dots on the front of the screen. As the electron beams from the three guns shoot towards the phosphor clusters, they pass through a shadow mask—a metal plate with extremely fine perforations (approximately 1.0 mm in diameter) spaced some 0.60 mm apart. The mask serves to focus the beams so that, theoretically, only one cluster of phosphors is illuminated by the three beams at a time, allowing the beam modulated by the red signal current to strike only the red-sensitive phosphors; the same occurs with the green and blue beams.

The problem with shadow mask technology, however, is that there is no one-to-one relationship between where the mask is placed during manufacturing and where the phosphor clusters are

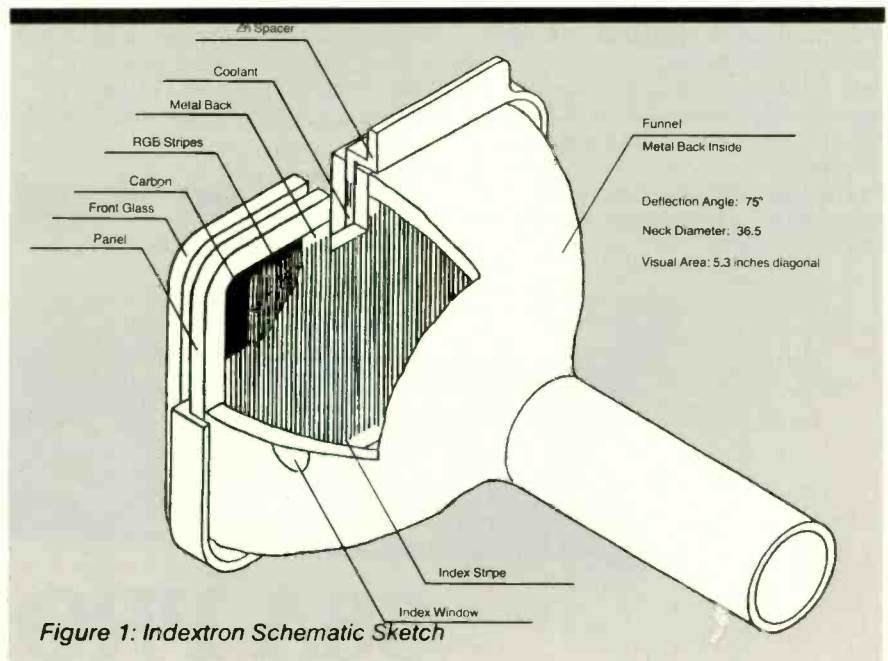

Figure 1: Indextron Schematic Sketch

deposited on the screen. This means that, in the worst case, it is possible for a mask to be completely out of phase with the phosphor clusters, thus totally blocking every other cluster and leaving it dark.

It is necessary, therefore, that the diameter of the beams must be increased so they illuminate at least two dot clusters at once, decreasing image resolution.

Another problem with the shadow mask is that it only permits some 20 percent of the electron energy from the guns to pass through the holes to the phosphors—meaning that huge beam currents are required to generate a usable picture, and that the mask absorbs a considerable amount of heat. In terms of image quality, the heat buildup causes deformation of the metal plate and its holes, leading to decreased resolution. Still another problem with the delta gun and shadow mask is the extremely precise registration needed to converge all three guns at the shadow mask plane.

The Indextron tube, on the other hand, completely does away with the metal shadow mask. The three beams of the standard picture tube (and the

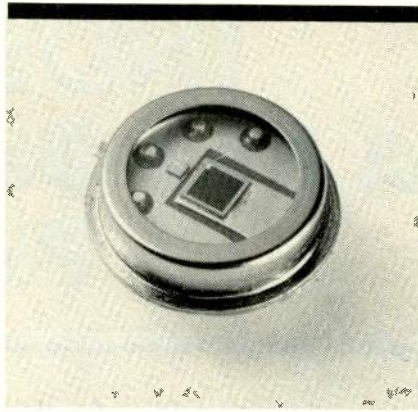

The new high-speed photodetector which makes beam indexing feasible.

three stripes of the Trinitron tube) are replaced by a single high-precision electron gun; and the phosphor dot clusters are replaced by vertical stripes of red, green, and blue phosphor material separated by narrow guard bands and with indexing stripes. As the gun moves along the raster pattern, it is sensed by a high-speed photodetector which instantaneously sends a control signal back to the gun causing it to advance to the next index position. Thus, the beam needs no focusing mechanism, but relies instead on semicon-

ductor technology in the control circuit to accurately position the beam to fall on successive phosphor stripes. The lack of a metal mask in Indextron leads to several key advantages. For one, it means that enormously high beam currents can be used without fear of warping the metal mask and causing loss of resolution. Higher beam current is also coupled with far greater efficiency: 78 percent of the beam current strikes the phosphor stripes as opposed to 20 percent in the shadow mask design. This leads to the 1600 fc peak brightness mentioned earlier—six to eight times that of a conventional tube.

Beam indexing also offers excellent resolution thanks to the extremely small electron beam size (it no longer has to be wide enough to accommodate two phosphor clusters at once). For the tube, Sony engineers designed a new type of high-performance unipotential electron gun with a triode cathode electronic lens. This design leads to an oval-shaped beam whose maximum diameter is only 0.2 mm at the maximum beam current of 2 milliamperes.

History of beam indexing

As mentioned, beam indexing is an

The best portable wireless.

The Model 66A PRO is the latest version of Cetec Vega's popular compact, battery-powered wireless microphone receiver. Features include:

- Lower power consumption for 8-10 hours continuous operation from four internal 9-V batteries.
- High signal-to-noise ratio and wide dynamic range (over 100 dB in Model 66A/DII with DYNEX® II audio processor).
- True helical-resonator front-end filter and multiple-pole crystal IF filter for superb selectivity.

- External power capability for field and portable use, from a 12-V camera belt pack or other +10.5 to +18 Vdc source.
 - Lightweight and compact (5.4 x 1.3 x 6.25 in.).
- Write or call for further information and location of your nearest dealer:
Cetec Vega, 9900 Baldwin Place,
EL Monte, CA 91731. (818) 442-0782.

 **Cetec Vega**
... the professional's wireless

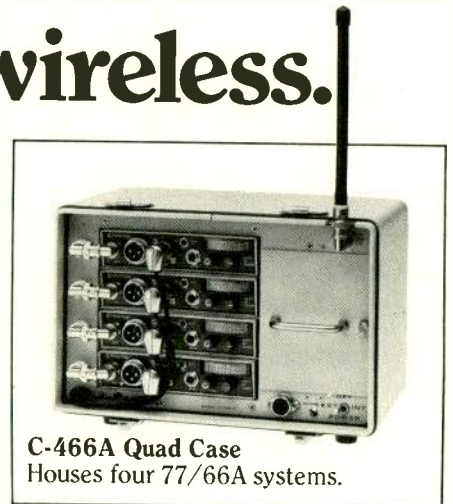

C-466A Quad Case
Houses four 77/66A systems.



66A PRO

old idea, and work on developing a beam index tube began simultaneously with the development of the shadow mask type. Philco, in fact, had an experimental beam indexing tube in the 1950s which used X-rays as the indexing mechanism.

In 1978, Matsushita developed a five-inch prototype beam indexing tube, eyeing the potential market for battery-powered home television receivers. But it never went through with plans to build the tubes or the sets.

More recently (1983), Hitachi began building a black-and-white version of the beam index tube for use in the viewfinders of its home video cameras—a design also incorporated in RCA's home video cameras. But the vertical stripe structure is considerably coarser than in Indextron, and would not suffice for picture viewing outside the viewfinder.

In 1981, Sony had developed an experimental 32-inch beam index tube using much of the same technology that was incorporated into Indextron, but with important differences, particularly in the structure of the indexing stripes. In the original tube, the pitch of the indexing stripes was approximately four

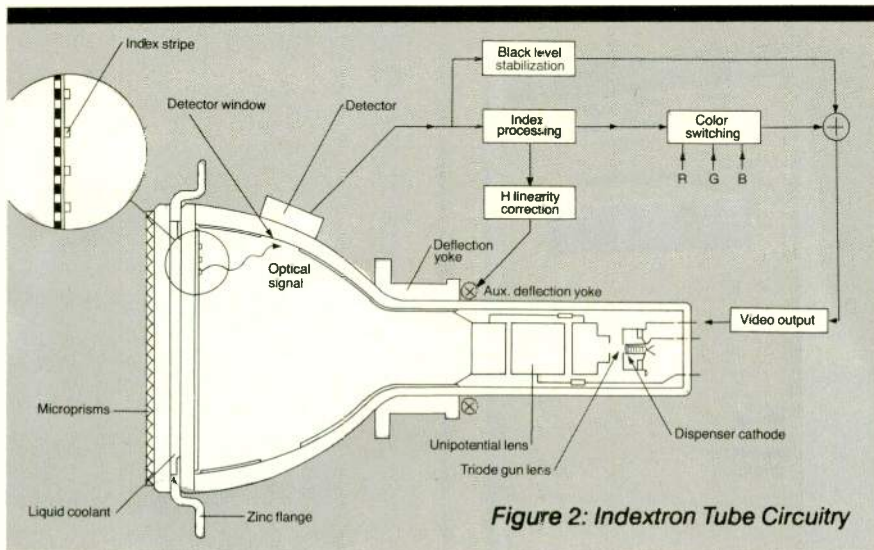

Figure 2: Indextron Tube Circuitry

times the pitch of the phosphor stripes. With the new technology, however, the pitch of the indexing stripes has been reduced to only two times that of the phosphor stripes, leading to more accurate positioning. Further, microprisms have been incorporated into the glass face plate of the tube to "fill in" areas in the picture occupied by the guard bands separating the phosphor stripes. In this way the apparent resolution of

Indextron, though it uses only 256 groups of vertical phosphor stripes, is considerably heightened, and the vertical stripe structure of the picture is not noticeable.

New cooling system

We have thus far mentioned both the high-efficiency electron beam and the high-speed photodetectors as crucial in the development of the new Indextron

Portable diversity wireless.

Cetec Vega's Model 67A PRO portable diversity receiver provides improved effective operating range and virtually eliminates signal dropouts caused by multipath conditions.

Features include:

- True dual-receiver diversity.
- Low power consumption; operates from four internal 9-V batteries.

- DYNEX® II audio processing for over 100 dB dynamic range and high signal-to-noise ratio.
- True helical-resonator front-end filter and multiple-pole crystal IF filter for superb selectivity.
- External power capability for field and portable use, from a 12-V camera belt pack or other +10.5 to +18 Vdc source.

- Lightweight and compact (6.95 x 1.4 x 7 in.).
- Write or call for further information and location of your nearest dealer:
Cetec Vega, 9900 Baldwin Place,
El Monte, CA 91731. (818) 442-0782.



67A PRO

Circle 149 on Reader Service Card

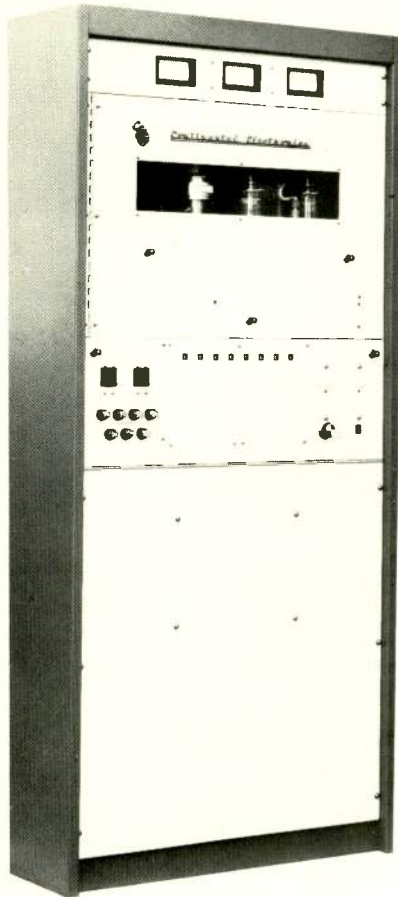

Continental's 1 kW AM Power Rock: a sound winner that's ready for AM stereo.

Tough market or not, the Power Rock is designed to give you the best signal around. Listen to the loud, clear signal, and you know you have a winner. The Power Rock is ready for AM Stereo and accepts sophisticated audio. Conservatively-rated components give you an extra margin of safety for steady and reliable on-air performance.

For information, call 214/381-7161
Continental Electronics Mfg. Co.
Box 270879 Dallas, TX 75227

Continental
Electronics 

Send me 1 kW AM Power Rock brochure
 Name _____
 Station _____
 Address _____
 City _____
 State/Zip _____
 Phone (____) _____
 © 1982 Continental Electronics Mfg. Co./4966

Circle 181 on Reader Service Card



The Indextron tube alongside Sony's new Vidimagic projector.

tube. There are several other technological advances as well which contribute to the new tube design.

The most important is a new liquid cooling system. Because there is no metal mask to absorb heat and deform, extremely high beam currents can be used. Average beam currents as high as 550 microamperes, accelerated to 31 kilovolts by the gun, can pump up to 17 W into the 5.25-inch faceplate. To handle this load, a layer of ethylene glycol and water is placed between the tube's faceplate and the cover glass, transferring the heat to zinc flanges from which it dissipates by convection.

Still another development in Indextron is a new green phosphor material, brighter and more responsive than what was previously available.

What all this means for video projection is that, for the first time, a single high-brightness tube with a single projection lens can be used, whereas before it was necessary to split the video image into three separate red, green, and blue pictures, display each on a small CRT separately, project all three images, then converge them on the screen. The equipment to do this is bulky. And moving the projector from one location to another almost always requires extensive re-alignment and re-focusing of the three separate projection lenses.

Using Indextron, the new Sony Vidimagic projector is light enough (weighing under 35 lbs. fully configured) and small enough (10 x 9 x 26

inches) to be transported in a canvas carrying case, and set up as easily as a movie projector. The operator simply points the lens at the screen, selects an image size from 30 to 200 inches diagonal, and focuses the single lens. Light output from Indextron is high enough so images can be projected onto a wall, and the projector small and light enough so it can be tilted up and the image projected onto the ceiling.

At present the projector is being marketed to industrial users for sales presentations, meetings, and so forth. Packaged with a 181-channel TV tuner, a built-in Beta format player/recorder, a remote controller, and a PA system, it is currently being sold for \$2995. A version without the Beta deck is available for \$2150. Future plans include the possible exploration of the home market; video software distributors could rent out the projector at the same time that they rent the cassettes, in the same way that many now rent out VCRs.

An even more interesting future potential, however, lies in the possibility of Sony developing a flat screen version of the beam index tube, for use in computer terminals and other displays. The current version of the tube is considered too bright for incorporation into standard TV monitors. But with the flat tube display, the high-efficiency beam can be put to excellent use. This large market could also serve to drive down the price of the beam indexing tube technology even lower than current levels.

BM/E

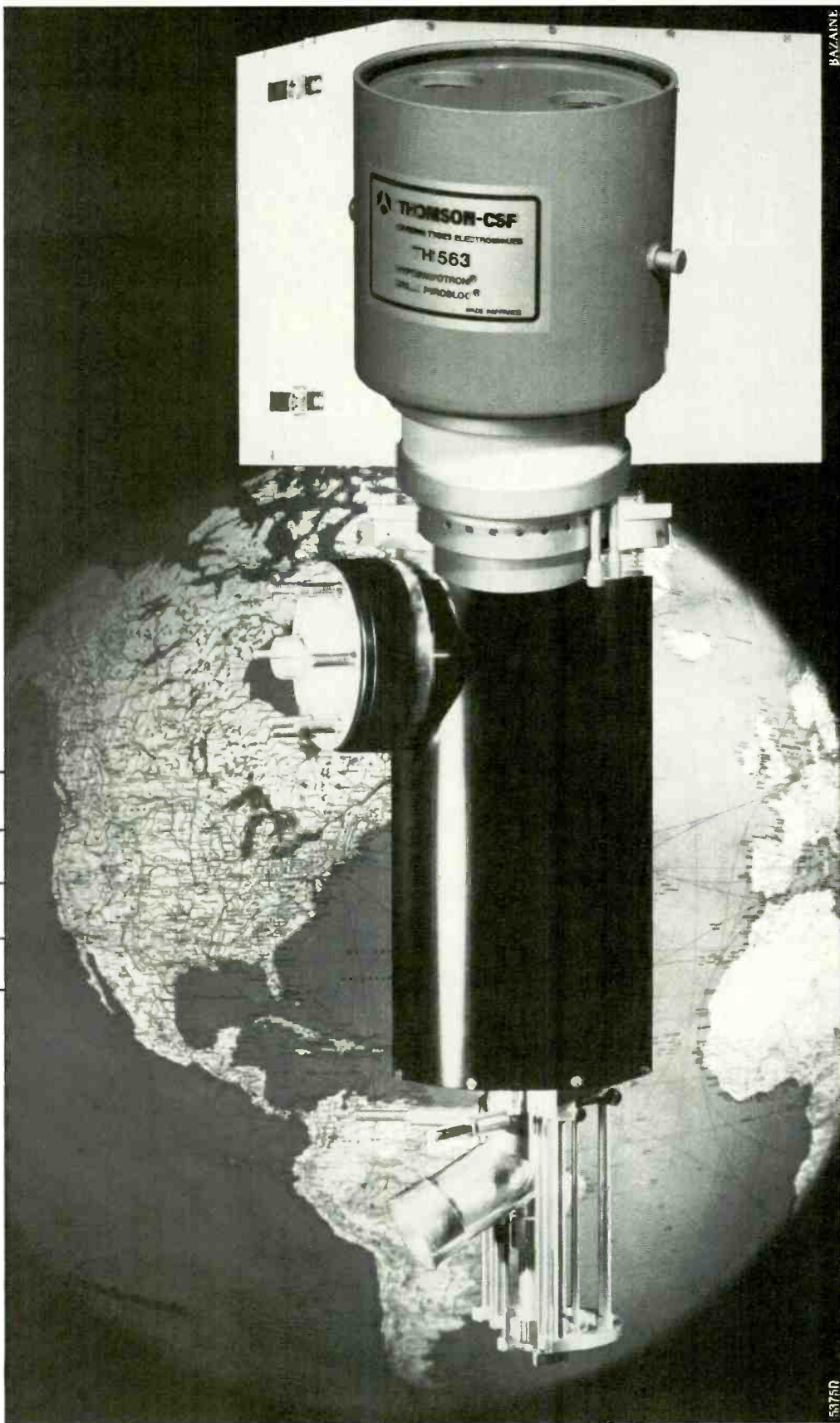

**70 YEARS
OF EXPERIENCE
IN POWER
GRID TUBES...**

*And still looking ahead!
That's your assurance of
world-class UHF-TV tetrodes
and coaxial-cavity circuits:*

- up to 50 kW output power,
- up to 17 dB typical gain.

*Incorporating decades of
innovation and experience with
Hypervapotron™ anode cooling
and Pyrobloc™ pyrolytic-
graphite grids.*

THOMSON-CSF
Components Corporation
Electron Tube Division
301 Route Seventeen North
RUTHERFORD, NEW JERSEY 07070
Tel. (1.201) 438.23.00
TWX: 710.989.7286.



**THOMSON
COMPONENTS**

ELECTRON TUBES

THE COMPONENTS OF SUCCESS

Brazil SAO-PAULO Tel. (11) 542 4 722	Canada OTTAWA Tel. (613) 236.36.28	France BOULOGNE-BILLANCOURT Tel. (11) 604 81 75	Germany MÜNCHEN Tel. (89) 78 79 D	United Kingdom BASINGSTOKI Tel. (256) 29.755	Italy ROMA Tel. (6) 638 14.58	Spain MADRID Tel. (1) 405 15 15	Sweden STOCKHOLM Tel. (08) 63 50.60	Japan TOKYO Tel. (3) 264 62 45
---	---	--	--	---	--	--	--	---

Life without a BMX can be
a real pain in the
Arbitrons*



*The New
BMX Series Three*

Frank. This is really serious. Can you do the programming and sales team a favor and find out what kind of on-air equipment that new station recently put on? Their sound is exciting and tight. They're doing things operationally that we can't figure out either — their morning team handles all those in-studio and telephone guests so smoothly. Are you sure you made the right decision to get us that budget console in "A"?

"Thanks, Frank. You're a good man. I know you'd help us out."

Ain't life a Birch? Just when you thought you'd be a hero to management, you saved all that money on that bargain BMX look-alike on-air board for studio A — the G.M. comes through the door and tells you the ratings are sinking fast. ■

Here's yet another sound reason why more #1 stations make the Pacific Recorders & Engineering BMX on-air console their #1 choice.

And the really good news for your station is that we've added new, useful features to our proven, ratings-building BMX, and kept the same performance and reliability that's made it, hands-down, the best on-air board you can buy, across-the-board.

Logically enough, we call it our BMX Series THREE.

Because we know you're anxious to hear what's new, here's the quick rundown on our latest console:

The BMX THREE has THREE main stereo mix buses, each with distribution line amplifiers. For increased flexibility for today's programming, we've built-in two telephone mix-minus feeds plus a telephone monitor mix. There's monitor facilities for two studios, not just one. Our system provides independent outputs for the console, host, co-host and guest telephone feeds. The stereo cue system has automatic headphone monitor switching.

So that everyone can know what's happening, we've included a multi-way intercommunication system for producer and external feeds.

For precise control, we've engineered each input on the microphone and line modules to have full and independent remote control logic. All BMX THREE's have multi-function metering with automatic cue and solo level display, a voice slating

system with a I.D. tone, and for easier performance check-outs, there's a built-in multi-frequency, low-distortion test oscillator.

The mainframes for the BMX Series THREE are available from 10 to 34 input positions, and we'll make 'em larger if you need. Naturally, they're fully prewired for all your present and future inputs, outputs, patch points and logic. Every BMX THREE comes with fully-regulated, independent power supplies for the audio, logic and microphone phantom power. Each module has its own on-board audio supply regulation too. Because many of you will be working with our new AMX and ABX production consoles, the audio and logic control systems are fully compatible — and the rear panel interconnections are clearly marked with silkscreened, functional designations.

There's not a lot of options to the BMX THREE, because we've built so much in. However, if you want, you can add two effects/foldback send mix buses, each with remote control logic. The only other option is stereo effects/reverb return, also with remote control logic.

Keeping to our tradition of keeping it simple, the BMX THREE is a clean, uncluttered design — making it easy to understand and operate.

There's a lot more to tell you about, including the impressive specs, but alas, we've run out of space.

Contact us now at 800-874-2172. In California, call 619-438-3911. We'll rush you a color brochure with all the details. While you're at it, feel free to ask about our other products, like the new Micromax, the Tomcat, and our other broadcast consoles that are geared to elegantly solve your toughest production problems.

And, by the way Frank, don't worry. You can probably unload that BMX look-alike, but you'd better hurry — it's not going to be easy after this ad is read. ■



Like Los Angeles ABC Radio Network affiliate KABC, more #1 stations have made the BMX Series consoles their #1 on-air choice.



Pacific Recorders & Engineering Corp.
2070 Las Palmas Drive
Carlsbad, California 92008
Telex: 181777

The Choice for More #1 Stations.

Harris All-Solid-State SX Transmitters

Bring Back Your AM Listeners!

Contrary to what you may have heard, your "average" listener has a better-than-average knack for finding stations with a quality, transparent sound—even on a crowded dial. The lower your sound quality, the higher your audience tune-out.

Bring back those listeners with a Harris SX Series all-solid-state AM transmitter. Harris' exclusive Polyphase PDM modulation system provides a *discernible difference in sound...* a crisp transparency that virtually eliminates listener fatigue and compares with the best FM has to offer. The specs will show you why. On the SX-5, for example, Intermodulation Distortion (IMD) is less than 1%!

SX Series transmitters (available in 1, 2.5 and 5 kW) also offer diagnostic capability through a microprocessor-based, pushbutton information center. You get instant readings on vital parameters.

Solid-state design means you'll save up to 46% more power than with other transmitters currently in use. That's a plus you'll see immediately in lower power bills.

And Harris has designed the SX Series transmitters for optimum AM Stereo performance. Strict AM Stereo compatibility was a major design goal right from the start—not an add-on or an after-thought.

Make the investment in quality sound that can build and hold your listening audience. For more information on Harris SX Series AM transmitters, contact Harris Corporation, Broadcast Group, P.O. Box 4290, Quincy, Illinois 62305-4290. 217-222-8200.

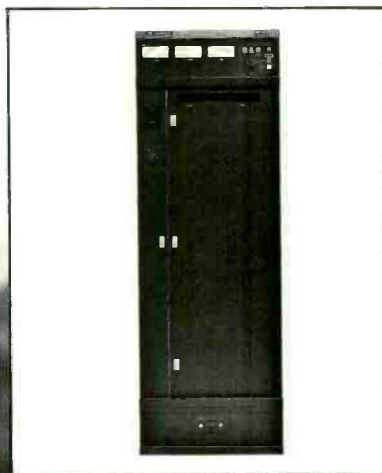



RTNDA:

Expansion and "How-to" Sessions in San Antonio

The thirty-ninth RTNDA conference, which will be held December 4-7, will equal, and most likely exceed, attendance and exhibition records set at last year's conference in Las Vegas, according to Lou Adler, the RTNDA's president-elect and the VP and news director of WOR Radio, New York. For this reason the conference has been shifted—for the first time—to a convention hall, the San Antonio Convention Center.

The show will feature more than 80 exhibitors and a full slate of panel discussions which, says Adler, will emphasize "how-to—such as how to handle increasing numbers of outside services, and how to work with talent agencies.

"Our members want nuts-and-bolts sessions," he continues, and that is what attendees should, for the most part, look forward to this year. Session topics will include: the role of radio news services in small and medium markets; coaching TV talent; career stress and family survival; talent agents; the role of media in society, with emphasis on libel, privacy, and coverage of criminal justice; and the televising of the New Bedford, MA, rape case.

This trial, which received national attention this year, will provide the basis for a panel discussion moderated by Ed Fouhy, the VP and Washington bureau chief of ABC News. According to Fouhy, this will not

be a how-to session; rather, the panel "will be looking for lessons from the trial in New Bedford." The issue of TV cameras in courtrooms is relatively new to the broadcast community, and as Fouhy says, "we think it needs exploring." This sort of exploration is what the RTNDA is all about for Fouhy: "The prime purpose of the conference is so we broadcast journalists can get together and discuss mutual problems and mutual concerns."

Other panelists at the conference will include Judge William G. Young, Superior Court of Massachusetts, who presided at the New Bedford trial; Ron Nessen, VP News, Mutual Broadcasting Company, and former press secretary to President Ford; Dr. Joyce Brothers; and Arthur Miller, professor of law at Harvard Law School.

There will also be an exciting lineup of guest speakers, including CBS News' Douglas Edwards, who will keynote the conference following welcoming remarks by San Antonio mayor Henry Cisneros; Lawrence Grossman, president, NBC News; and Sam Donaldson, ABC White House correspondent. Ralph Renick, VP of Wometco Enterprises and news director of WTVJ-TV, Miami, will receive the Paul White Award this year, and will speak at the Paul White Banquet at the conclusion of the show.



The city of San Antonio plays host to this year's RTNDA conference.



RTNDA PROGRAM



Newsroom systems will be extremely popular.



The Best Little Satellite Programmer on Earth

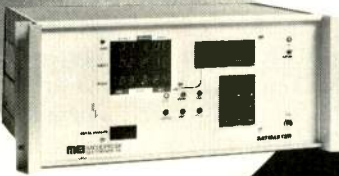

SATMASTER

Program the Satmaster to intermix a satellite signal with your local announcements and walk away!

The Satmaster will guard against silence, resync to satellite if something goes wrong and print a list of aired events . . . all at an astounding low cost!

MEI MICROPROBE ELECTRONICS INC

910 Sherwood Drive, #19
Lake Bluff, Illinois 60044
(312) 295-2606

Circle 152 on Reader Service Card

A 4 Lb. Microwave And 30-Mile Range On One Watt Of Power?

Call NEC Toll-Free 1-800-323-6656.

TVL-800-6F from NEC. A 7 Ghz microwave that needs only 10 watts of power to broadcast one watt. With advanced C-MOS and FET electronic components; 2 audio channels. Just call NEC toll-free. For big power in small packages.

NEC

IMAGINE WHAT WE'LL DO FOR YOU

NEC America, Inc., Broadcast Equipment Division
130 Martin Lane, Elk Grove Village, IL 60007
In Illinois 312-640-3792.

650-846

Tuesday, December 4

- a.m. Golf & tennis tournaments
- p.m. Welcoming reception

Wednesday, December 5

- 8:00 a.m. Business meeting breakfast
- 9:30 a.m. Welcome address by Henry Cisneros, mayor, San Antonio
- 9:45 a.m. Keynote address: Douglas Edwards, CBS News
- Noon Luncheon: address by Sam Donaldson, ABC News
- 2:00 p.m. Joint Workshop: Broadcasting and Marriage—Can They Coexist?
Chuck Wolf, KIKK Radio, Houston
Dr. Joyce Brothers
Dr. Harry Hoewischer
Merrilee Cox, ABC News
- 3:30 p.m. Joint Workshop: Order in the Court: The New Bedford Rape Case
Ed Fouhy, ABC News
David Layman, WLNE-TV, Providence
George Gray, WBSM Radio, New Bedford, MA
Ed Turner, CNN
Judge William G. Young, Superior Court of MA

Thursday, December 6

- 9:00 a.m. Radio Workshop: Radio News Services—Their Role in Small and Medium Markets
Steve Vogel, WJBC/WBNQ, Bloomington, IL
Ron Nessen, Mutual Broadcasting
James Hood, Associated Press
Bob Priddy, Missouri Network News Division

HOW DO YOU JUDGE A COMPUTER NEWS SYSTEM?

BY THE COMPANIES IT KEEPS.

BC NEWS • BBC-RADIO • CNN • BT
/OR-AM RADIO • BUSINESS TIMES
V-AM • KRLD-TV • ITN • RAI • KRON-TV
/FAA-TV • KRON-TV • BTQ-TV • NBC
HE MACNEIL/LEHRER NEWSHOU
NN HEADLINE NEWS • WOR-AM F
HANNEL TELEVISION • BBC-RADIO

From the largest to the smallest, they stake their reputation on Basys, the one computer news system designed by newsmen for newsmen. **NBC News** (USA): Selected Basys for its prime time and Nightly News special coverage of the U.S. Presidential Conventions. **CNN and CNN Headline News** (USA): Produce 24 hours of news every 24 hours with Basys. **ITN, Independent Television News** (Britain): Stays the independent alternative and ahead of the competition with Basys. **RAI, Radiotelevisione Italiana** (Italy): Operates the world's largest computer news facility with Basys. **WOR-AM Radio** (New York): Looks to Basys to help compete in the land of the network flagships. **BBC-Radio** (Britain): Chose Basys for all its nationwide radio news. **BTQ-TV** (Brisbane): Stays on top down under with Basys. They and **The MacNeil/Lehrer Newshour, Business Times, KRON-TV, WFAA-TV, KRLD-TV** all in the United States, and **TV-AM**, Britain's breakfast show, make Basys the most installed, fastest growing computer news system in the world. **Basys, the hard news software.**

BASYS

Basys Inc., 2685 Marine Way, Mountain View, California, 94043.
Tel: 415 969 9810, Telex 171604

Circle 153 on Reader Service Card

RTNDA PROGRAM

Bob Kimmel, Audio Features

Norm Woodruff, KFBK, Sacramento, CA

9:00 a.m. Radio Workshop: Women, Minorities, and Equal Opportunity in Large Radio Markets

David Lampel, WBLS, NY
Linda Santana, KSJL, San Antonio
Kris Krydell, WFYR, Chicago
James Rowe, WGCI, Chicago

Carol Karper, KUTE/KGFJ, Los Angeles

9:00 a.m. TV Workshop: How to Coach TV Talent
Spence Kinard, KSL-TV, Salt Lake City
Lynn Walker, KAUZ-TV, Wichita Falls, TX

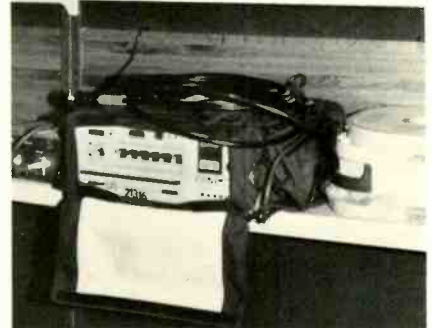

The Bosch Quartercam will be on display for the ultimate in lightweight ENG.

ALEXANDER
If You and Your Equipment Depend on Battery Power...
LET ALEXANDER HELP YOU BE FAST

Attach up to three 12-14.4 volt battery packs to the Alexander Triplex Charger. The Triplex will bring them all to full charge in less than two hours — automatically... without monitoring.



SMART, AND

With the Alexander Smart Sequential Charger you can charge up to six packs without buttons to push or lights to monitor. The consistent 2-amp charge means you'll get fresh packs with no worry about over-charging.

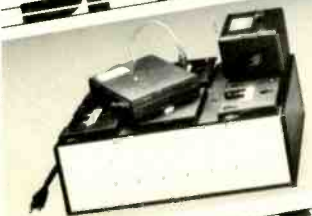

RELIABLE!

We're so proud of the reliability of our batteries that we urge our users to analyze them on a regular basis... with the TRI-ANALYZER. The Tri-Analyzer displays remaining capacity (in MAH) in a fully automatic operation that also dememorizes the cells.



ASK FOR THE NAME OF YOUR ALEXANDER BATTERY DISTRIBUTOR



1511 S. Garfield Pl/Box 1645/Mason City, IA 50401
515-423-8955

Circle 154 on Reader Service Card

Jim Topping, KTRK-TV, Houston
Lynne Wilford
Scarborough, Audience Research & Development
Eric Huguélet, Atkinson & Falder Research

9:00 a.m. TV Workshop: Talent Agents: The Most Important People in TV News Are Not in TV and Not in News
Jerome Nachman, WNBC-TV, NY

Richard Leibner and Carol Cooper, Leibner and Cooper
Jim Griffin, William Morris Agency
Alfred Geller, Geller Media Management

Noon Luncheon: address by Lawrence Grossman, president, NBC News
2:00 p.m. Business Meeting and Election

Friday, December 7

8:30 a.m. Media & Society Seminars
Morning Seminar: Libel
Noon Luncheon with Exhibitors
2:00 p.m. Afternoon Seminars: Coverage of Criminal Justice, and Privacy
6:30 p.m. Paul White Reception and Banquet; address by Paul White Award Winner Ralph Renick, VP, Wometco Enterprises, and news director, WTVJ-TV, Miami

Exhibition hall hours:

Tuesday: 6:00-8:00 p.m.
Wednesday & Thursday: 9:00 a.m.-6:30 p.m.
Friday: 7:00 a.m.-2:00 p.m.

Now . . . remote, automatic control
of your entire transmitting facility . . .



Harris 9100 Intelligent Remote Control System

In its various configurations, the Harris 9100 provides intelligent remote control; automatic transmitter control; automatic logging; plant protection through intrusion and fire alarms; and automatic control of tower lights and building temperature. It can even exercise your standby equipment...and operate up to three remote sites from a single location!

The Harris 9100 watches over your transmission system and physical plant. It makes decisions automatically, based on pre-programmed limits...with a minimum of operator intervention. Quite simply, it is the most intelligent re-

mote control system on the market.

Improve your manpower allocation. Increase plant protection. Maximize equipment life. The Harris 9100's automatic features are unmatched.

Whether you're AM, FM, TV or Satellite (or any combination), the Harris 9100 Intelligent Remote Control System is designed for you—for your security, efficiency *and* savings. For more information, contact Harris Corporation, Studio Division, P.O. Box 4290, Quincy, Illinois 62305-4290. 217-222-8200.



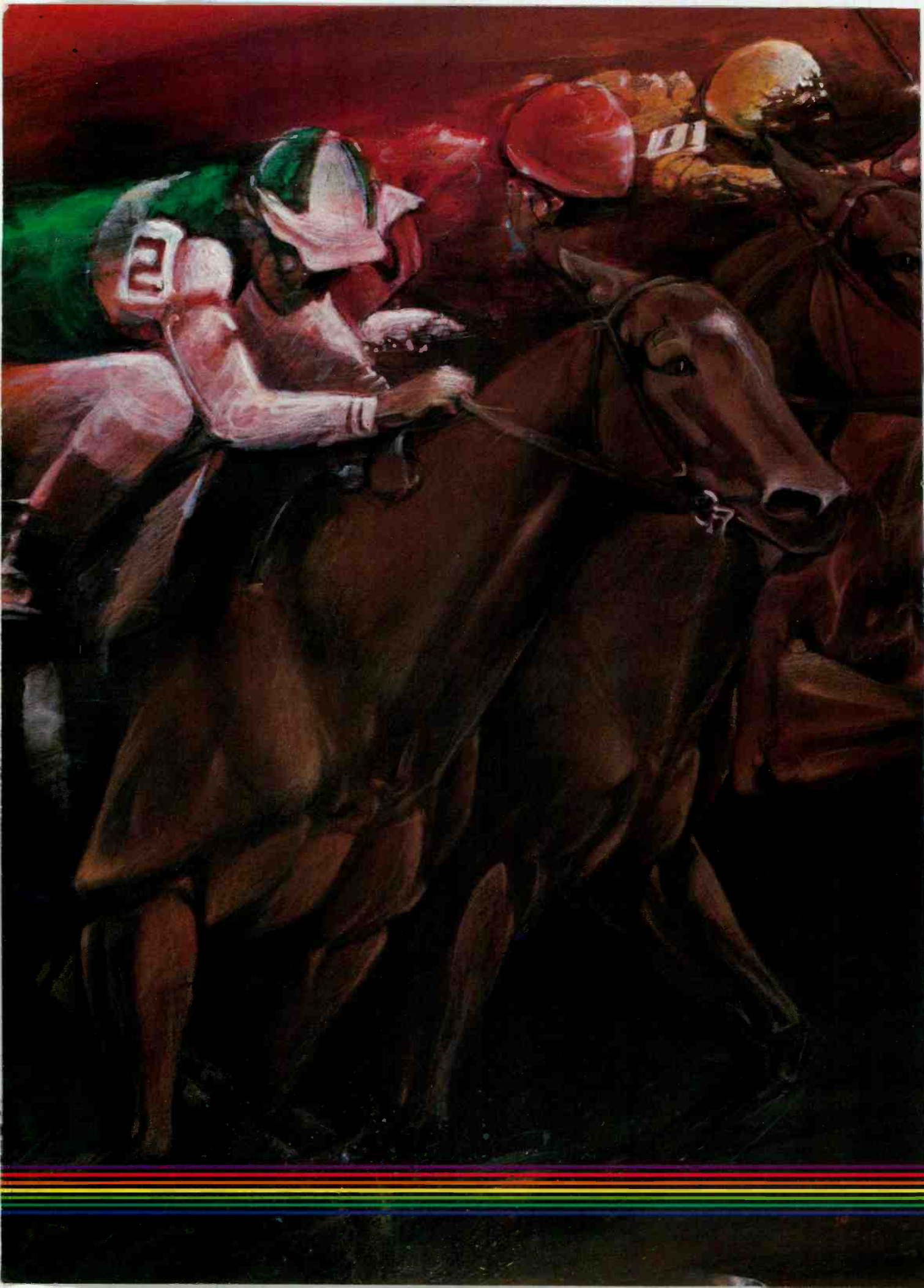



the race is on

News is a race — first getting it right, then reporting it first — airing it first — winning your share, then keeping it. You need all the help you can get.

There's another race in news—the newsroom computer race. It seems everybody's telling you they can do everything better than everybody else. But, only **QUANTANEWS™** has proven its networking, archiving, editing, and overall performance superiority under the toughest network conditions.



QNEWS is a winner. Check it out for yourself.

a decade of commitment



QUANTA®

Quanta Corporation • 2440 So. Progress Drive, Salt Lake City, Utah 84119 • (801) 974-0992 TWX 910-925-5684

Circle 156 on Reader Service Card



CONFERENCE EXHIBITORS

Exhibitor	Product or Service
Accu-Weather ADDA	Weather systems
Alcare	Still stores, graphics
Alden	News Features
Armed Forces Info.	Weather systems
Asaca	News service
AP	ENG systems
Audience Research	News service
Basys	Consulting
Beston	Newsroom computers
Bonneville	Newsroom computers
Bdcast. Microwave	Satellite services
	Microwave

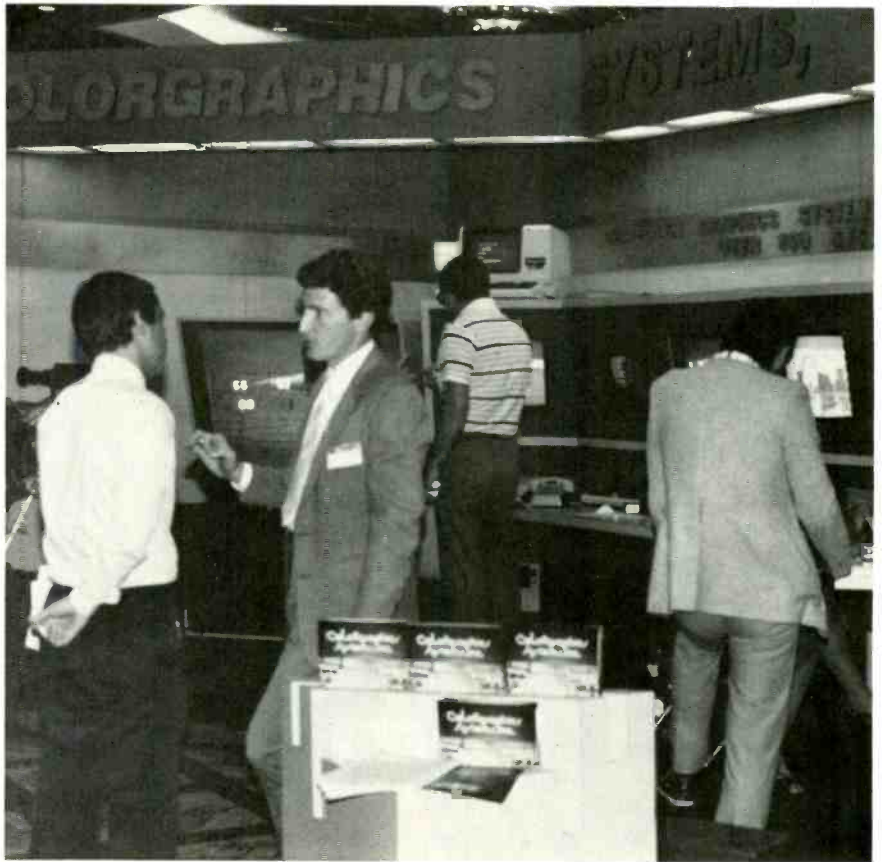

The Colorgraphics booth at last year's show.

NEW FROM AFA

Two superbly-equipped mini mobile units that every station can afford!

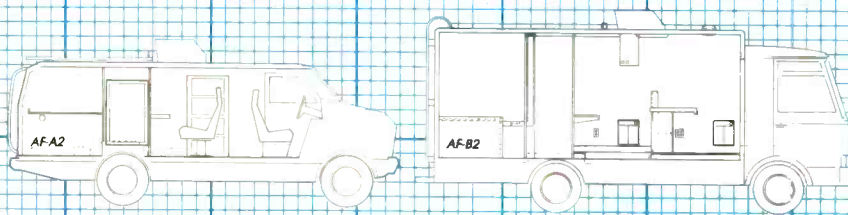

Each of these standard mobile units brings with it the combination of the nation's leading mobile system designer, broadcast-quality equipment and a brilliantly-engineered Wolf Coach vehicle.

The AF-A2 is a 19' 2-camera ENG/EFP unit that is equipped with your choice of broadcast-quality color cameras, a Grass Valley 100-N video switcher, two Sony BVU-50 portable 3/4" VCRs and a Yamaha audio console.

The AF-B2 is a 23' 2- to 4-camera EFP unit that features your choice of broadcast-quality color cameras, a Grass Valley

1600-1L production switcher, a Yamaha 8 input audio console and two Sony BVU-800 series VCRs.

Both units can be expanded to include 1" VTRs, character generators, editing facilities and more.

The low cost of these standard mobile video systems will surprise you. The high quality is exactly what leading broadcasters and production and post-production companies have come to expect as a matter of course from AFA. Call us for details: in the East at (201) 767-1000; in the West (213) 466-5066.



A.F. ASSOCIATES INC.

ADVANCED SYSTEMS AND PRODUCTS FOR THE VIDEO INDUSTRY
AFA SYSTEMS DIVISION 100 STONEHURST COURT NORTHVALE NJ 07647
1438 NORTH GOWER STREET HOLLYWOOD CA 90028

Exhibitor	Product or Service
Chyron	Graphics equip.
Colorgraphics	Weather systems, newsroom computers
Comrex	Audio production equip.
Conus	Satellite services
CQI/Sportsticker	News service
Crosspoint Latch	Production switchers
Data Communications	Newsroom computers
DWJ	Programming
Eastman Kodak	Videotape, film
ESD	Weather systems
Fujinon	Lenses



Alden will again exhibit its weather graphics displays.

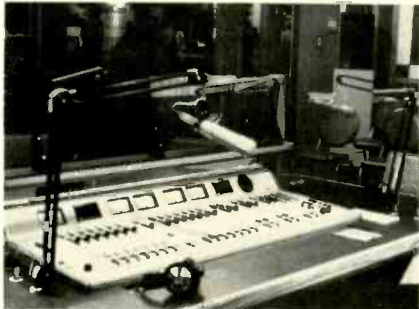

The Pacific Recorders setup for KSL Radio unveiled last year in Las Vegas.

Exhibitor	Product or Service
G&G Designs	Sets, graphics
G&M	Power and support
Graphic Express	Sets, graphics
Ivanhoe	Programming
Jefferson Data	Newsroom computers
JVC	Production equip.
Kavouras	Weather systems
Lexington	Personnel services
Listec	Teleprompters
LPN	Programming
Magid	Consulting
Major League Baseball	News features
Marti	Transmission, RPU
Mead Data	Newsroom computers
Media Computing	Newsroom computers
Mighty Minute	News features
Money/Pro News	News features
MZB	Mobile vans
Newslink	News service
PEP	Power supplies
Prijatel	Programming
Q-TV	Teleprompters
Quanta Corp.	Newsroom computers
RCA	Production equip.
Rip 'N Read	News service
RTI	Tape cleaners, evaluators
Scribe Recorders	ENG equip.
Sony	Production equip.
Station Program Resources	Programming
Telepak San Diego	Cases
Telepictures	News service
Telescript	Teleprompters
Telesound	Programming
Telesource	Newsroom computers
Terminal Systems	Production equip.
Thomson-CSF	Cameras
Turner Program	News service
Ultimate	Special effects
UPI	Programming
Viscom	Satellite services
Weatherbank	Weather systems
Winsted	Racks, cabinets
Westinghouse-Group W	News service
Wold	Satellite services
WSI	Weather systems

Telex Intercoms help you give your best performance.

When that moment is at hand, lighting and sound experts know that cue signals can be critical to the best performances. Behind the stage, on location or at the sidelines, things can happen fast, and when they do, the professional must take action. There's only one chance to do it right.

AUDIOCOM gives professionals the help they need. It's the closed circuit intercom system for large, small, portable or fixed installations from television to stage productions, stadiums to race tracks, or industrial to public safety applications. Belt packs or wall mounted stations deliver crystal-clear communications for up to five miles, and may be "daisy-chained" or directly wired to the power source. All components, including intercom stations with LED signalling, headsets, mics, cables, switchboards and remote battery packs, are completely compatible with other systems.

Audiocom — so each performance can be your best. For more information and detailed specifications, write to Telex Communications, Inc., 9600 Aldrich Ave. So., Minneapolis, MN 55420.

For quick information, call toll free **800-328-3771** or in Minnesota call (612) 887-5550.



TELEX®

ADVERTISER'S INDEX

Use Reader Service Card on Facing Page ►

Manufacturer	Page No.	Circle No.	Manufacturer	Page No.	Circle No.	Manufacturer	Page No.	Circle No.
A.F. Associates	98	157	U.S. JVC Corp.	65	124	Sony Broadcast	2-3	—
Alden Electronics	13	108					40-41	—
Alexander Manufacturing Co.	94	154				Studer Revox America, Inc.	58	130
Ampex AVSD	31-33	—	Leader Instruments	C-2	100			
Ampex MTD	106	123	LPB, Inc.	68	135	Tektronix, Inc.	15	109
Antek	74	138				Telemet	78	140
Anton/Bauer, Inc.	54	128				Telex Communications	29	116
Asaca Corp. of America	64	165					99	158
			3M/Magnetic Tape Div.	62-63	—	Thomson-CSF/DTE	87,114	161,172
			3M/Pro-AV	22	111			
Basys	93	153	Maxell Corp. of America	47	105	Videotek, Inc.	49	132
Belar Electronics Lab, Inc.	115	164	McCurdy Radio Industries	C-3	177	Vision Fund of America	117	176
Beyer Dynamic, Inc.	82	148	MCG Electronics	110	168			
Bourbon Street Assoc.	116	173	MCI/Quantel	25	113			
Broadcast Systems Inc.	78	143	Merlin Engineering	80	134	Ward-Beck Systems, Ltd.	C-4	178
Bryston Manufacturing Ltd.	6	104	Microprobe	92	152	Wheatstone Broadcast Group	61	131
			Midwest Corp.	8-9	106	Winsted Corp.	76	140
			Microtime, Inc.	111	169	WNEW	116	173
			Midwest Corp.	8-9	106	Wolf Coach	52	126
			Moseley Associates, Inc.	5	102			
Camera Mart, Inc.	77	142						
Canare Electric Co., Ltd.	6	103	NEC America, Inc.	50-51,	125			
Canon USA, Inc.	26-27	114		92	159			
Cetec Vega	84-85	149	Nurad, Inc.	103	155			
Christie Electric Corp.	30	117						
Cipher Digital	28	115						
Continental Electronics Mfg. Co.	86	181	Ok Electronic Industry, Ltd.	109	167			
Countryman Associates	115	163	Orban Associates, Inc.	7	180			
Crosspoint Latch Corp.	36	119						
Delta Electronics	45	122	Pacific Recorders & Engineering Corp.	88-89	150			
Digital Video Systems	66	133	Panasonic/Masushita	17-20,	110			
Discount Video	79	145		56-57,	129			
				104	162			
EECO, Inc.	116	174	Perrott Engineering	75	139			
EEV, Inc.	108	166	Potomac Instruments	24	112			
Fidelipac	37	179	QSI Systems, Inc.	117	175			
Fortel, Inc.	1	101	Quanta Corp.	96-97	156			
Harris Corp.	70-71	137	Ramko Research	38	120			
	95,90	147,151	RCA E/O	34	118			
Harrison Systems	11	107						
HCA	76	140	Sachtler GmbH	69	136			
Hitachi Denshi American Ltd.	112	170	Shure Bros., Inc.	39	121			
HM Electronics, Inc.	53	127						
Ikegami Electronics USA, Inc.	81	146						

SALES OFFICES



Broadcast Management/Engineering

295 Madison Ave.
New York, New York 10017
Telex: 64-4001
William McGorry, Publisher

Eastern & Central States

295 Madison Avenue
New York, New York 10017
212-685-5320
James C. Maywalt
Gene Kinsella

Western States

5015 Birch Street, Office One
Newport Beach, CA 92660
714-851-1461
408-720-0222
WALLY GILBERT

United Kingdom/Europe

28 Eaton Row
London SW1W 0JA, England
Telephone: 01 235 8431
Bronwyn Holmes
Derek Hopkins
Ruben Veksner

Japan/Far East

Eiraku Building
1-13-9, Ginza,
Chuo-Ku, Tokyo 104 Japan
03 562 4781
S. Yasui
K. Yamamoto
Y. Yozaki



SUPER POD™ (sōō' pər pod) *noun* 1. A microwave transmit/relay system used with ENG helicopters: enhances and extends the coverage capabilities of television news departments. 2. Nurad's advanced airborne ENG system featuring an automatically rotated transmit antenna; incorporates a sophisticated Loran C control system.

THE SUPER POD CONCEPT

The operational concept of the SUPER POD is sophisticated yet simple. As the helicopter changes direction, the Loran C interfaced control system constantly computes the helicopter position and automatically points the transmit antenna toward the receive site.

SUPER POD features a unique circularly polarized transmit antenna and a circularly polarized receive antenna (for relay operations) housed within a sleek, aerodynamically streamlined radome.

LOW PROFILE

The SUPER POD radome is only 8.75 inches in height for maximum ground clearance under the helicopter.

NOMINAL PERFORMANCE

FREQUENCY	2-2.7 GHz
GAIN*	16 dB
AZIMUTH HPBW	14°
ELEVATION HPBW	50°
SIDELOBES	13 dB

*Gain referenced to a like-polarized isotrope

NURAD

2165 Druid Park Drive Baltimore, MD 21211 Telephone (301)462-1700 TWX/Telex (710)234-1071

Circle 155 on Reader Service Card



Can the Panasonic® AK-30 stand head to head with the bestselling broadcast camera in the world?

You bet it can. In fact, when you compare picture quality, automatic features and price, you'll discover the Panasonic AK-30 is far and away your best bet.

Compare pictures. You'll notice the AK-30 produces a superrefined video image. The kind of image broadcasters love to see. But that's not surprising with these kinds of specifications: Horizontal resolution is 650 lines center. S/N is a very quiet 62dB (-6dB gain), the highest ratio in the industry. Digital registration is 0.05%, 0.1% and 0.25%. And illumination is a mere 24 lux at f1.4 (+18dB gain).

This high level of performance is

achieved with a unique combination of image-enhancing circuitry and high-focus-field Plumbicon* tubes.

You'll also appreciate the AK-30's automatic circuits. Like auto-white balance with memory for setting 2 color temperatures. Presettable black stretcher. Auto-black balance, and a knee circuit for variable dynamic range. Together, they let you customize the image you're shooting for.

Still, the AK-30 has plenty more going for it. Consider its dual outputs. One works with standard NTSC. The other lets you set new standards because it's compatible with component recording. That

means you can use it as part of our famous M-format Recam system.

The Panasonic AK-30. Compare it to the world's bestselling broadcast camera. And see why it stands out far ahead. *Plumbicon is a registered trademark of N.V. Philips for TV camera tubes

For more information call your nearest Panasonic regional office:

Northeast:	(201) 348-7336
Midwest:	(312) 981-4826
Southeast:	(404) 925-6835
Southwest:	(214) 257-0763
West:	(714) 895-7200

In Canada call: (416) 624-5010

Panasonic
Industrial Company

GREAT IDEA NOTEBOOK

Station-Run Weather Forecasting Service

By John Parks,
CE, WCNX Radio,
Middletown, CT

Two years ago WCNX saw the need for a weather forecasting service that our listeners could call without spending a toll call to a larger city or to the phone company-sponsored weather line, which charges for each call made to it.

At the time, we also were in the process of removing older model cart machines from service in our production studios; in this case, the RCA RT-7D rack-mount model. The accompanying circuit was our solution to using the cart machine to answer an incoming call and feed a weather forecast down the line to the caller.

A phone line stops ringing and seizes when a load of 600 ohms or thereabouts is placed across it, so the circuit does the following: K-1 and C-1 sense the ac ringing voltage on the line and provide

the closure to remote start the cart machine. C-1 is used to block the dc path to the phone line, or else the coil of K-1 would hold the line open all the time. K-2 is across the "start" lamp of the machine used; in our case a 24 V dc CP Clare relay works fine. When K-2 closes, the phone line is loaded by the output of the machine's output transformer. (If direct output machines are to be used, a standard phone company 11C coil can be inserted between the cart machine and the relay contacts.)

At the end of the cart, the start lamp goes out, relay K-2 drops out, and the phone line is released from the load, ready to go again immediately.

The advantages to using a surplus cart machine rather than a commercial answering machine are numerous. First, audio quality is increased; even if the machine is not up to on-air spec, it will sound great over the phone line even if it makes a 100-3K frequency response. You'd have to spend quite a bit to buy an answering machine built as ruggedly as most cart machines. Us-

ing standard carts lets us record the forecast in the production studio, so we have the option of reading a forecast, or dubbing a forecast from our weather service meteorologist. Announcers change the carts and update the forecast three times a day, and the sales department has a package that gives a sponsor a 10-second message before the forecast begins on the machine.

We use a commercially manufactured call counter as well, and can tell you that last year an average of 200-plus calls per day came into the service. In fact, it was so successful we just put a second service on line that gives callers a rundown on current arts/community events happening in the city.

So dust off those cart machines gathering dust on the shelf because they're too noisy or not up to spec for studio use. Although we utilize a separate phone number for each of our services, you could certainly put this idea to use on your main business numbers after hours, giving listeners and callers a little added service. **BM/E**

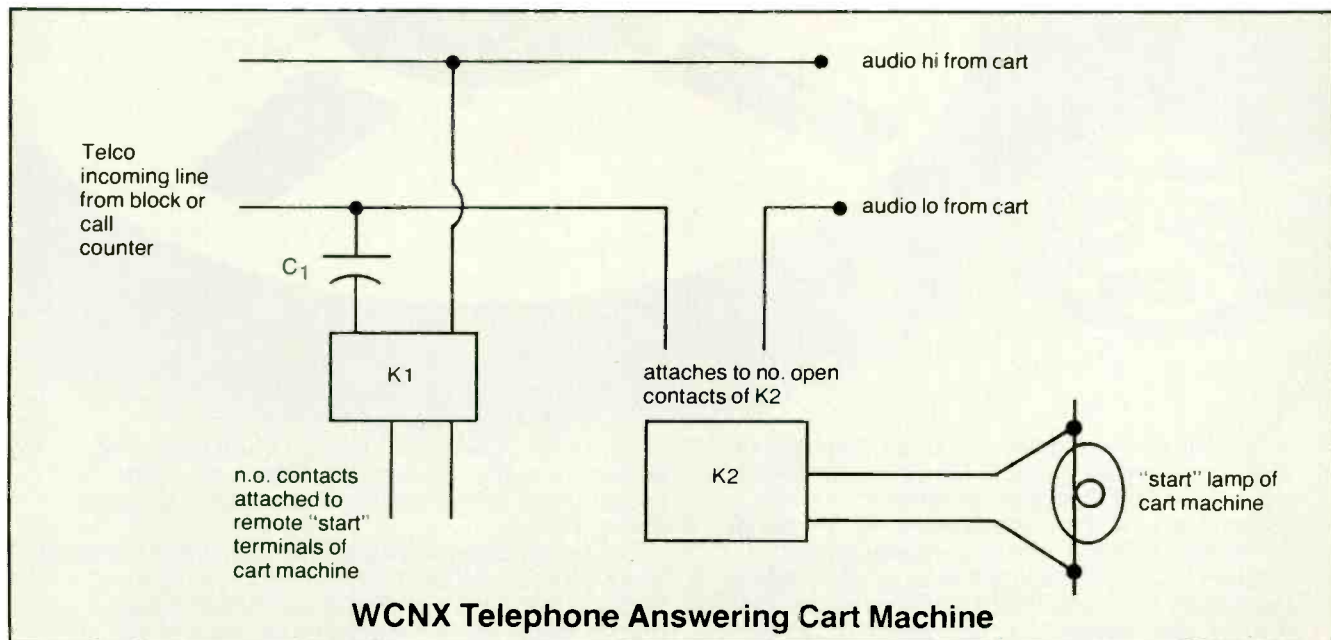

WCNX telephone-answering cart machine. Polarity of phone line does not matter. C1 is 10 μ F 50 V dc nonpolarized. K1 is 110 V ac (like CDE 104A0-120). K2 is selected to match voltage of start lamp on cart machine; for 24 V dc operation station uses C.P. Clare 354A 14A2C. Station also utilizes a call counter manufactured by Skutch Co. in Roseville, CA. The model T-8 is a four-digit counter that plugs in between the phone line and this circuit and sells for \$110.

Ampex Video Tape Scores a Perfect Ten



To capture the excitement of 8,000 hours of the Summer Games, ABC knew they'd need a video tape that was picture perfect.

That's why ABC chose Ampex 196 1" helical video tape and 197 3/4" videocassettes as the exclusive tapes to record the biggest events in the history of sports. It was an incredible honor for Ampex. One earned through years of consis-

tently crisp, clean performance. Reel after reel. Generation after generation. Even under the pressures of heavy editing and multiple generation dubbing.

So if you're looking for a video tape with a track record for reliability and quality, look to Ampex 196 and 197. ABC did. And their perfect performance made them the biggest winners of all.

AMPEX

Ampex Corporation • One of The Signal Companies

Ampex Corporation, Magnetic Tape Division, 401 Broadway, Redwood City, CA 94063, 415/367-3809

Circle 123 on Reader Service Card

interpreting the **FCC** rules & regulations

The New Window System: A Well-Intentioned Mistake?

by Harry Cole, FCC Counsel

The Nineteenth Century had its land rushes and its gold rushes. Now, if a recent Commission proposal is adopted, the Twentieth Century may have its own FM and TV frequency rushes. The result would be a new approach to the process of filing applications for new commercial stations in those services, an approach which could have a significant effect on strategies underlying decisions governing whether or not to file for new FM or TV stations.

The proposed system would replace the current system involving cutoff dates and cutoff lists. As you are probably aware, at present the Commission allocates FM and TV channels to specific communities. Once a channel is allocated, you are free to apply for it. There is no deadline for filing the first application, and there is technically no requirement at all that anyone ever file for any particular channel (although the Commission does assume in allocating each channel that at least one applicant will ultimately file for it). Once someone does file an acceptable application specifying a particular channel, that application is placed on an "A" cutoff list and assigned an "A" cutoff date. That cutoff date represents the deadline by which anyone interested in filing a mutually exclusive application must have his or her application on file. (It also represents the deadline for petitions to deny the listed application, although, in the context of the FCC's recent proposal, we need not dwell on that aspect here.)

Under the existing system, once the "A" cutoff date passes, the universe of competing applicants is fixed—i.e., if you don't have your application on file by the close of business on the "A" cutoff date, you're out of luck. Each application is then assigned a "B" cutoff date by which all minor amendments must be filed. Following the "B" cutoff date, the applications are ready for designation for hearing, a process which depends only on the availability of FCC staffers to review the applications and prepare the hearing designation orders. While this may seem rather simple on paper, in actual practice the overall process from the filing of the first application until designation for hearing can take two or more years.

Competing applications

This kind of backlog is an obvious source of concern. More troubling to the Commission, however, is the fact that placing an application on an "A" cutoff list makes it a sitting duck for competing applications. An "A" cutoff list acts like a red flag calling the world's attention to the fact that at least one applicant thinks that a new station in the specified community would be a good idea. Worse,

having called the world's attention to that fact, the "A" cutoff date affords all interested persons a 30-day period in which to prepare and file competing applications for themselves. The result is that even if the idea of filing for a particular community was unique to one applicant, that applicant is forced by the Commission to share the idea, and then to compete with everyone else who happens to agree that it's a good idea. And to make matters even worse, the Commission apparently believes that some of the applicants who file competing applications on the "A" cutoff date do not, in fact, want the station, but instead want only to blackmail the original applicant by standing in the way of a quick and simple grant. The idea, of course, is that the original applicant may be inclined to buy off the competing applicant in order to avoid the fuss (not to mention the expense) of a comparative hearing, and to get the grant that much sooner.

Not all of this situation is the FCC's fault. Back in the 1940s, in a case called *Ashbacker v. FCC*, 326 U.S. 327 (1945), the Supreme Court interpreted the Communications Act of 1934 as establishing a right to comparative consideration for competing applicants. In other words, the Court said that where two or more applications mutually exclusive with one another are filed, the Commission cannot simply grant one and deny the rest without first holding a comparative hearing involving all the applications. Thus, the FCC has been left to devise some system by which all potential mutually exclusive applicants are given an opportunity to get their applications on file before the universe of competing applications is fixed. The cutoff system is the most recent approach arrived at by the FCC to assure that everybody's *Ashbacker* rights are guaranteed.

The window approach

Because of the various problems inherent in the cutoff system, however, the Commission has now proposed a "window" approach akin to the manner in which cellular radio telephone applications are processed. The Commission has suggested that it designate a "window period" of 45 days during which applications for all allocated TV and FM channels could be filed. That means that if you had your eye on a particular channel in the FM or TV Tables of Allotments, you would have to file an application for that channel during the 45-day window period if you wanted to assure yourself of comparative consideration. Similarly, any future FM or TV channel allocation would include, as part of the action allocating the channel, a specified window period during which applications for that new channel would be permitted. If no one files for a particular

tube talk



P8160 P8460 P8462 Leddicons®

The complete family of 2/3" EEV Leddicon camera tubes.

EEV can now offer you a 2/3" tube for all your ENG/EP camera requirements.

These tubes are directly interchangeable with all existing lead oxide tubes.

Lowest lag and no blooming.

EEV Leddicons are rated the best for these image tube characteristics.

EEV 2/3" Leddicons meet the same high performance standards as the 1" and 30mm Leddicons, and are the newest extension to EEV's hallmark of high quality and reliability.

P8160 Standard 2/3"

P8460 Diode Gun 2/3"

P8462 Diode Gun L.O.C. 2/3"

EEV has the best 2/3" lead oxide tubes available TODAY.

Call or write today for complete details.

® Registered Trademark of EEV Lead Oxide Camera Tubes.

At EEV... your image is our business.



EEV, INC.

7 Westchester Plaza, Elmsford, NY 10523, 914-592-6050

EEV CANADA, LTD., Rexdale, Ontario, 416-745-9494

EEV, Chelmsford, Essex, England, 0245 261777

FCC RULES & REGULATIONS

numerous applications are going to be filed whether the FCC likes it or not, and that a window period approach will not necessarily discourage applicants. In fact, it appears that such an approach may trigger *more*, rather than fewer, applications, since it forces everyone who has even the slightest interest in a particular frequency to file applications in order to avoid being shut out from consideration.

Another aspect of this proposal which bears some discussion is the Commission's expressed concern about applicants who, according to the FCC, file applications "for the purposes of delay" and who may not be "seriously interested in providing better service." Obviously, applicants who fit this description are not desirable, and efforts to eliminate such filings should be pursued. But the question of an applicant's true intent is not an easy one to resolve. It is not always easy to tell from an application whether the applicant is really interested in obtaining the station, or whether the application was just filed for some other, inappropriate purpose (e.g., delay, blackmail, and so forth). This is especially true in light of the Commission's own massive effort to streamline the application form itself. That effort has led to an application form which requires virtually no time and effort, and very little money, to fill out and file.

More applications

What this means is that the FCC has removed virtually all the tediousness to filing applications. The obvious and inevitable result of that is going to be an increase in the number of applications filed, since there are certainly more people interested in trying to get a station if they don't have to do very much to get the application on file. In addition to this, the streamlining of the application form makes it difficult for the Commission to divine whether any particular applicant is or is not seriously intent upon building and operating a station. Further complicating this is the fact that, several years ago, the Congress and the Commission lifted the ban on profiting from the dismissal of an application. As a result, if you file an application now, and at some later time are offered a large sum of money to dismiss your application, you can accept that money even if it exceeds the amount that you have spent preparing and prosecuting your application. Even an applicant who is completely intent upon building and operating a station may have his or her mind changed if the right offer is made. But without the services of a mind reader, it is difficult to determine whether that applicant's mind was really changed, or whether he or she filed the application in the first place in order to be bought out.

The bottom line on this is that while the Commission's proposed window system is certainly a well-intentioned step, it may turn out to be more of a placebo than a panacea. And, ironically, it must be noted that some of the evils against which it is directed arise not so much from the existing cutoff process, but from the streamlined application forms which the Commission itself has developed. While we are loathe to suggest the reimposition of burdensome paperwork requirements in this enlightened age of deregulation, we might suggest that the effects of that streamlining be reconsidered in light of the perceived problems leading to the proposed window system. **BM/E**

Your Wings to the World's Airwaves



The World's Leading Portable TV Standards Converter Bar None

Professionals demand an uncommon level of picture quality and smooth image reproduction in TV standards conversion.

The LT1210 is the world's smallest converter able to handle NTSC, PAL and SECAM, with PAL-M conversion as an option.

The image enhancement function ensures a high-definition picture with outstanding image clarity. This converter is also a totally

integrated unit so no adaptor or changing of encoder/decoder modules is required for conversion between NTSC, PAL and SECAM. The cost-performance of the LT1210 is nothing less than outstanding. The LT1210. Check it out. Anywhere.

Oki also produces the high-end LT1015Σ Digital TV Standards Converter.

LT1210 Digital Television Standards Converter

In the U.S.A. and Canada, contact:

Oki America Inc. (Oki Telecom)
One University Plaza
Hackensack, New Jersey 07601
U.S.A.
Tel: (201) 646-0011-0015
Telex: (25) 710-990-5004 OKI ELEC HAK

In other areas, contact:

Head Office:
Overseas Marketing & Sales
10-3, Shibaura 4-chome,
Minato-ku, Tokyo 108, Japan
Tel: (03) 454-2111 Telex: J22527
Cable: OKIDENKI TOKYO



OKI

Oki Electric Industry Co., Ltd.
Tokyo 108, Japan

One **SPIKE** Can Cost **DOWNTIME!**

Overvoltage transients can bring the biggest installation down in a microsecond, or damage it cumulatively.

Surge-Master Heavy Duty Power Line Protectors give complete protection against all transients.

All audio and video transmission equipment is vulnerable to transients on AC power lines caused by heavy motors starting up (even elevators or testing your auxiliary power system), power company load adjustments—and of course, lightning. Even if your equipment operates from batteries charged by a UPS, you're not safe. If lightning knocked out your UFS, how long could you keep going?

The MCG Surge-Master offers two stage protection. The first reacts in nanoseconds to absorb lesser transients and the leading edges of major ones. The second stage absorbs the big ones, and has three modules on each line. So, in the unlikely event that one module should be knocked out, there are still two protecting you. And a system of indicator lights tells you not only when a fault has occurred, but exactly where it is. Modular construction (and the fact that Surge-Master is connected in parallel) makes replacement of damaged modules quick and easy. Initial installation requires minimal power interruption.

Available with capabilities from 100 to 3000 amps; for 120, 240 and 480 VAC; and for single, 3-phase, wye and delta power systems. MCG also manufactures smaller units for protecting individual pieces of equipment. To learn more, contact Department 31017 at 516/586-5133 or at the address below.

Protecting industry since 1967

MCG

ELECTRONICS, INC.
12 Burt Drive
Deer Park, N.Y. 11729

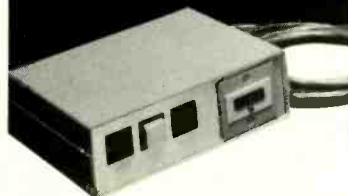

Circle 168 on Reader Service Card

FCC RULES & REGULATIONS

channel during the available window period, the first applicant filing for the channel after the close of the window period would automatically preclude any other application, and would thus be entitled to use of the frequency without the need for a comparative hearing. Applications for changes in existing stations would also be subject to the window period if the proposed changes would affect a vacant channel.

The Commission's idea, of course, is to give everyone the same notice as to the availability of FM and TV channels, and thus to satisfy the requirements of *Ash-backer* without creating any "sitting duck" situations. The Commission apparently thinks that the window system will somehow reduce the number of applications filed for FM and TV channels. The benefits which the FCC hopes to realize from this include reduction of both administrative delays and the costs incident to the application process. The FCC is also hoping that its window approach will discourage applicants who are not "seriously interested in providing better service."

As with many of its recent innovations—be they termed "regulatory," "deregulatory," "unregulatory" or whatever other term may be acceptable these days—the Commission's proposal here is not without merit. In the case of FM applications, there has long been a substantial backlog of applications which has been caused, in large measure, by the cutoff system. It should be pointed out, however, that the TV situation has suffered virtually no backlog problems, and the TV Branch has generally demonstrated an admirable ability to process new applications very quickly. Furthermore, anyone who has spent time, money, and energy in assembling an application, only to have numerous "claim jumpers" file competing applications on the "A" cutoff date, knows the frustration of having to sit back and wait while the FCC notifies the world of your application and invites everybody to file on top of you. The proposed system would theoretically eliminate that phenomenon, if only by forcing everyone to show their interest at the same time; in that way, no party could lay back in the bushes in order to check out everyone else's plans, and then pick and choose which channels to file for.

Conceptual flaws

However, as is often the case with these things, the FCC's proposal is not without its conceptual flaws. In particular, while the notion that a window system will reduce the numbers of applications to be filed is all well and good in theory, that notion is not borne out by the Commission's own experience. In cellular radio, where a variation on the window system has been in effect for several years, the FCC recently received approximately 150 or more applications for *each* of the markets in the fourth tier of cities (i.e., markets 90-120). Even in the most complicated FM cases it is unusual to find more than 20 applicants for a given frequency. And in the low-power television area, earlier this year the FCC tried to turn the cutoff system into a variation of the window approach by issuing a single cutoff list containing some 4000 applications; far from discouraging competing applications, this approach led to the filing of some 25,000 or more competing applications. The lesson, it would appear, is that

Perfect FIT™

Try our new T-220 Format Interchange TBC on for size

Introducing the next generation of Time Base Correctors from Microtime. The T-220 FIT is a component digital TBC that allows you input in one format and output in another. It transfers from 1/2" without loss of picture quality. T-220 FIT also provides jaggie-free and flicker-free freeze for use as an effect. Search to 40x and our exclusive VARI-TRAK™ DYNAMIC TRACKING® capabilities are standard features.

FIT Your EFP.

Use the new 1/2" recording cameras as input sources for your studio.

FIT Your Post Production.

Integrate 1/2" VTR source material into your 3/4" post production via "Dub."
Use NTSC output for 1" facilities.

FIT Your ENG.

Handle remote sources in your facility, synchronize and TBC remote VTRs.

FIT For \$14,900.

A PAL T-220 FIT version is available.

Contact Your Microtime Dealer or Region Manager



A Subsidiary of ANDERSEN GROUP

1280 Blue Hills Avenue
Bloomfield, Connecticut 06002

1-800-243-1570

Central	Northeast	Southeast	Southcentral	West
David Everett (312) 934-9191	Ray Bouchard (609) 896-3716	Jerry Rankin (404) 979-4437	Steve Krant (214) 644-0232	Gary Armour (619) 579-1344

FIT™ and VARI-TRAK™ are trademarks of Microtime, Inc.
DYNAMIC TRACKING® is a registered trademark of Sony Corp.

We designed-in features the competition couldn't.

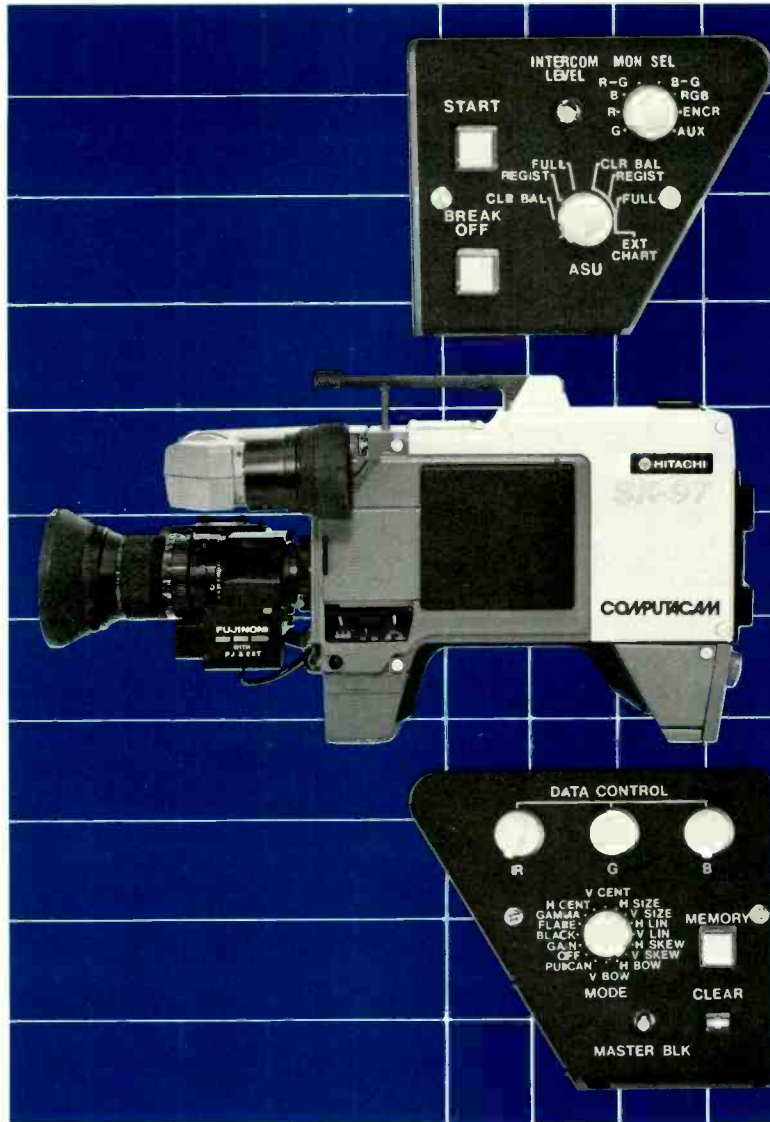

Get the competitive edge with our new family of field/studio cameras. The SK-97 and SK-970 combine on-board computers and advanced technology to provide the maximum flexibility and control available today.

No competitive video camera automatically sets up full color balance and full registration, including the green channel, in just two minutes.

No other video camera in its class has a full function, "smart" Remote Control Unit offering more capability in less space.

No other competitive video camera offers real time registration correction during lens zooming and focusing.

No other camera in its class offers automatic corner registration correction as part of its automatic registration set-up.

No other video camera has a prism heat sensor and pre-programmed ROM to ensure correct registration in real time.

Each camera contains an on-board computer that allows simultaneous set-up of up to 42 cameras within two minutes. Plus only one camera is affected in case of auto set-up failure.

Hitachi's SK-970 and SK-97 Computacams.



Our SK-970 and SK-97 Computacams offer superior noise-free video (59 dB signal-to-noise-ratio)

Combine all this with other advanced features such as 700 horizontal lines of resolution, high gain in 3 dB steps from 0-21 dB, completely interchangeable boards, and built-in auto diagnostics, and you can see why our SK-970 and SK-97 Computacams stand alone!

Get the features the competition couldn't design in. For descriptive literature, technical information, or a personal demonstration, contact Jack Breitenbucher, National Sales Manager, Hitachi Denshi America Ltd., Broadcast and Professional Division, 175 Crossways Park West, Woodbury, N.Y. 11797 (516) 921-7200 or (800) 645-7510.

 **HITACHI**

Circle 170 on Reader Service Card

broadcast EQUIPMENT

New Mixer/ Recorder from Tascam

The Ministudio Porta One is a portable, battery operated, four-channel mixer/recorder designed primarily for field recording. Significant features of this cassette recorder are its standard 1 7/8 ips speed allowing playback of standard stereo cassettes, the ability to assign one or all four channels to any track, and its switchable dbx noise reduction for wide dynamic range.

The Ministudio's input channel mute (OFF) switch permits you to bring channels into the mix without changing a setting. Each channel has a two-band EQ with center detent plus Pan for use during recording, overdubbing, and mixdown. Discrete four-track tape cue mix and separately adjustable headphone output level control enhance monitoring flexibility. It is possible to mix all four input channels and re-



corded tape tracks into an independently controlled headphone output to hear what is being recorded and overdubbed as it happens.

Off-speed recording is prevented by the Ministudio's flashing "low battery" power indicator LED. Positive settings and protection against damage or accidental control movements are ensured with low-profile, easy touch controls. Optional AC and auto battery adaptors complement the built-in battery supply.

**For More Information
Circle 235 on Reader Service Card**

New Lighting from Comprehensive Video



Comprehensive has introduced a new line of lights, modular mounts, and accessories. The V-10/6 focusing spotlight can be fitted with either 600- or 1000-watt lamps for domestic operation, or 1000 watts for 220/240-volt foreign operation. Similarly, the MF-10 floodlight can be fitted with 300-, 500-, 750-, and 1000-watt lamps for 220/240-volt foreign operation. The variety of accessories for these lights make them adaptable to all professional lighting applications.

The variable-focusing VM-300 can

be fitted with 12- or 30-volt battery operable lamps of 120- or 220-volt lamps for line operation. A "flip-up" accessory system, well-suited to TV news, enables the VM-300 to be equipped with a diffuser, dichroic filter or reflex plate, which can be left on the light and flipped into position as needed.

Comprehensive offers a choice of nine location kits. Most include a variety of useful location accessories to tailor the lights to the demands of the situation.

To make location rigging easy, Comprehensive has developed a new system of modular lighting mounts and controls. These new devices are compatible with most lightweight location lighting equipment currently on the market.

**For More Information
Circle 236 on Reader Service Card**

New SCA from CRL Audio

CRL has a new addition to its SCA family: the SCA 300A. The new "A" model, like the SCA 300, has an adjustable carrier frequency with no nulling

or balancing, and a low-distortion quartz crystal-controlled oscillator.

CRL has always guaranteed the finest SCA fidelity for music applications, and also guarantees no main channel interference. But now, with the SCA 300A, the company offers an SCA generator for just about any application: paging, music, data, and telemetry. The SCA 300A has an upgraded VCO response to accommodate a wide range of signals. The unit comes with both a standard "D" (RS232) connector, and a BNC connector for insertion of digital or FSK signals directly into the modulator. Linearity is excellent, and an advanced, digitally synthesized carrier is utilized.

**For More Information
Circle 237 on Reader Service Card**

Panasonic Introduces Recam Playback Adaptor and New Camera

Panasonic has introduced a new Recam playback adaptor, the AU-S220, for use with the Recam portable VCR. When the two are connected with a single cable, YIQ signals from the VCR are translated into broadcast format.

The AU-S220 has SC and ADV sync inputs for TBC interface. Waveform

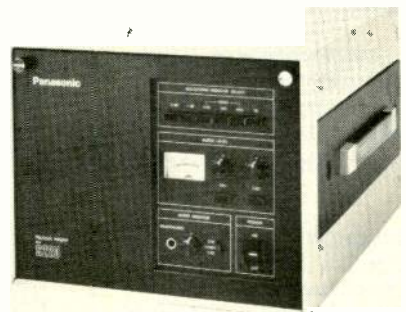

monitor outputs with front-panel controls are: C (I/Q), RF/Y, RF, TBC, TC, and EXT. The adaptor also has audio channel 1 and 2 outputs with switchable levels (4 dBm/22 dBm, 600 ohm balanced), with front-panel controls and meters.

For high-quality signals, the

50 KW
 OF FM POWER:
 JUST WHAT
 YOU'D EXPECT...

... from the inventor of
 — the Pyrobloc® grid
 — Hypervapotron® cooling
 Advanced technology as in all our FM-
 transmitter tubes, to guarantee their reliability.

THOMSON-CSF Components Corporation
 Electron Tube Division
 301 Route Seventeen North
 RUTHERFORD, NEW JERSEY 07070
 Tel. (1.201) 438.23.00
 TWX: 710989.7286.

 **THOMSON**
 COMPONENTS

ELECTRON TUBES

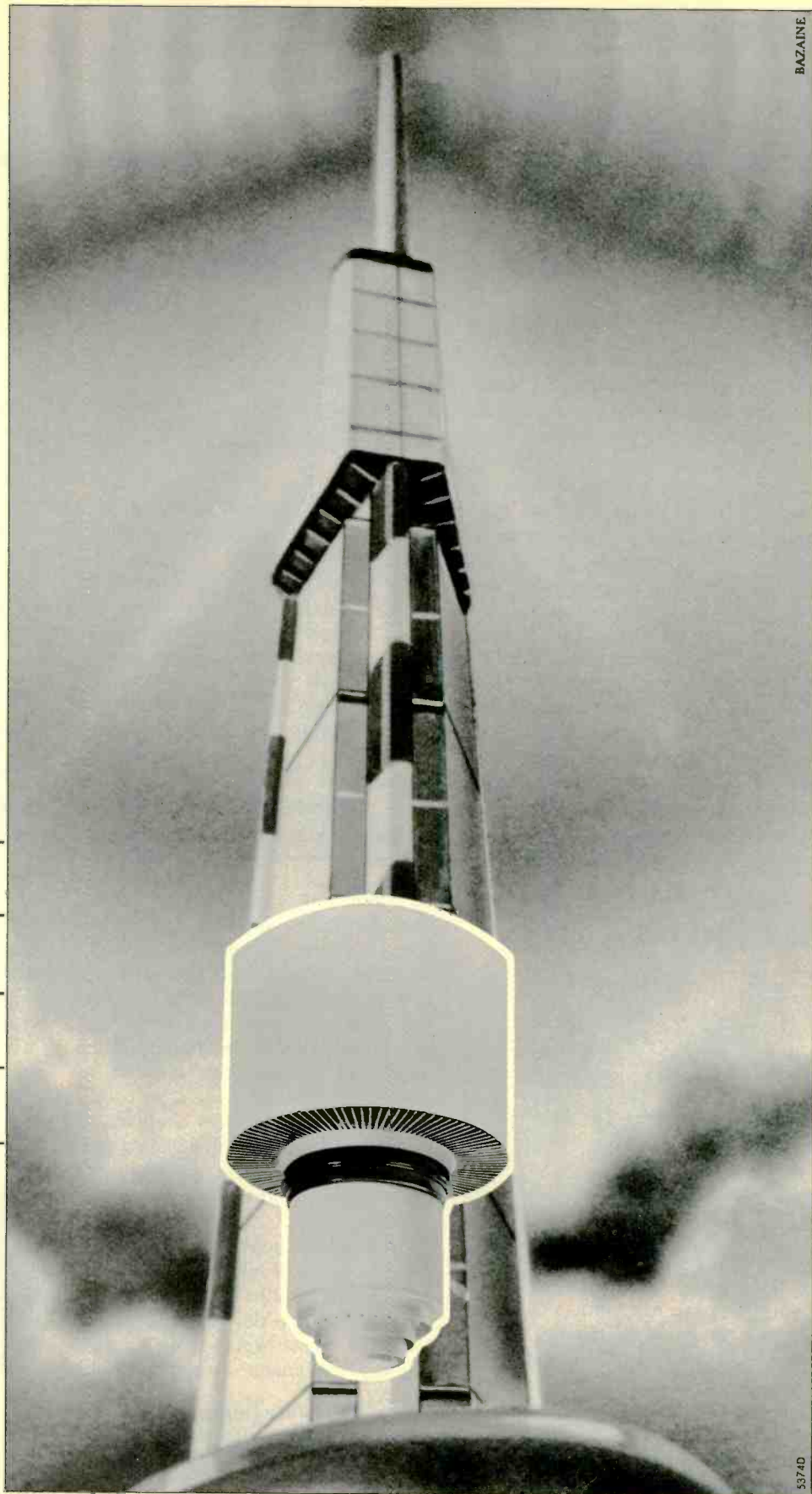

THE COMPONENTS OF SUCCESS

Brazil SAO PAULO Tel: (11) 542 4722	Canada OTTAWA Tel: (613) 236 3628	France BOULOGNE-BILLANCOURT Tel: (1) 604 8175	Germany MÜNCHEN Tel: (89) 78 79-0	United Kingdom BASINGSTOKE Tel: (256) 29-155	Italy ROMA Tel: (6) 638-14-58	Spain MADRID Tel: (1) 405-16-15	Sweden STOCKHOLM Tel: (08) 63 50 60	Japan TOKYO Tel: (3) 264-63-46
--	--	--	--	---	--	--	--	---

Circle 172 on Reader Service Card

EQUIPMENT

AU-S220 has YIQ DUB output. A dropout compensator is included. The adaptor provides power to both the camera and the VCR. AC voltage is selectable: 100, 120, 200, or 240.

The AK-30 is the newest three-tube camera from Panasonic. The camera employs Plumbicon tubes to generate a resolution of 650 lines. The signal-to-noise ratio is 62 dB (typical in a 6 dB mode), and the standard gain is 58 dB (typical in a 0 dB mode).

The AK-30 also features digital zone registration with memory, and automatic white balance for two color temperatures. For improved dynamic range, it has an automatic knee circuit. The iris is also automatic, with variable peak/average ratio.

The camera also has aural monitoring of incoming microphone, playback, and intercom. There is a warning tone for VTR malfunction. A triax adaptor is available as an option.

For More Information

Circle 238 on Reader Service Card

New Test Set from Hewlett-Packard

Hewlett-Packard has introduced a new noise-and-interference test set, which provides an accurate, easy-to-use method of simulating flat-fade and/or interference conditions on microwave radio links. Designed for operation in the IF section of a digital or FM microwave radio, the HP 3708A will add calibrated levels of white noise and/or interference signals to the radio IF carrier, thereby maintaining an operator-selected carrier-to-noise (C/N) or carrier-to-interference (C/I) ratio.

Use of a built-in IF power meter and microprocessor control enables the radio IF carrier power to be sampled continuously at the point of noise/interference-signal injection. The noise density/interference signal level is adjusted automatically to maintain a constant C/N or C/I ratio, even in the presence of receiver-carrier-level variations.

The HP 3708 is equipped with full HP-IB interface capability, and this facility has been fully utilized in the associated HP 3708S noise and interference measurement system. The price of the HP 3708A is \$13,400.

For More Information

Circle 239 on Reader Service Card

Hypercardioid Lavalier Microphone with Vibration Isolation

For TV news, remotes, lectures, documentaries, and live productions, there has never been anything like the Isomax TVH from Countryman.

Its superior side rejection allows it to go where no lavalier has gone before. For live stage and television productions, the TVH offers at least 6 dB more gain before feedback compared to other lavaliers. For news work, it brings in usable audio from even the noisiest remotes.



The Isomax TVH is the only hypercardioid lavalier microphone available today. And the TVH has something no other lavalier has: Vibration Isolation. Normally, directional microphones are 20 or 30 dB more sensitive to handling noise. Not the hypercardioid TVH. With its exclusive electronic vibration isolation it's even quieter than an omni!

Call or write for a free brochure or to arrange a demonstration.



COUNTRYMAN ASSOCIATES INC.

417 Stanford Avenue, Redwood City, California 94063 • (415) 364-9988

Circle 163 on Reader Service Card

BELAR IS THE BEST ... SUPERIOR PERFORMANCE AT A LOWER PRICE

For instance, our FM Stereo Monitors provide a signal to noise ratio of 90 dB, 0.01% distortion and 70 dB separation for 25% to 45% less money than our competition.

And they are reliable!

Call or write for more information on Belar AM, FM, Stereo, SCA and TV monitors.



BELAR
ELECTRONICS LABORATORY, INC.
LANCASTER AVENUE AT DORSET, DEVON, PA. 19333 • BOX 76 • (215) 687-5550
Where Accuracy Counts . . . Count on Belar

Circle 164 on Reader Service Card

**CONSISTENT
COLOR MONITOR
DISPLAY**
with IRT Visual
Color Comparator

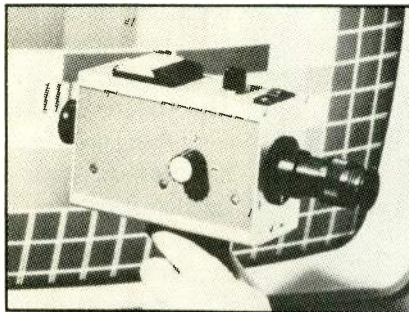

A battery-powered visual comparator for quick and precise color temperature adjustment and gray scale balance of color monitors to recommended world standard of D6500°K.

Over 12 years in service at TV networks and stations.

Bourbon Street Associates
Box 393, So. Salem, NY 105900393

914-763-8893 (In CA. 213-271-9570)

Circle 173 on Reader Service Card

TV Maintenance Engineer

FCC general radiotelephone license is required, or must be obtained within the first six months. EE degree desired. Should have three years experience maintaining video, and audio equipment including digital video effects and microprocessor based equipment, two component levels.

Send resume to:
W.D. KELLY

WNEW-TV
205 E. 67th St
New York, N.Y. 10021
Equal Opportunity Employer

Circle 171 on Reader Service Card

EQUIPMENT

New Comparator from Television Equipment Associates

The IRT color monitor comparator (designed and calibrated by IRT, Munich) is a battery-powered visual comparator for quick and precise color temperature adjustment and gray-scale balance of color monitors to the recommended world standard of D6500 degrees K, by direct color comparison of the TV kine.

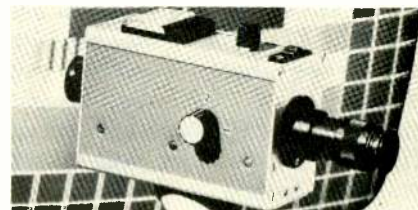

The comparator is presented to the face of the kine, on which is displayed a gray scale or full field white. The operator, looking through the device's ocular, observes a circular field where half of the area is a direct view of the kine face and the other half is the illuminant D reference. This reference is produced by the reflected light emitted from a specially selected bulb, which has been filtered through conversion filters and stabilized by a control-to-constant current. The operator adjusts the monitor's screen and gain controls so that the kine white balance will match with the comparator's in both highlights and lowlights.

For More Information
Circle 240 on Reader Service Card

WE WROTE THE BOOK ON TIME CODE

EECO designed the first practical time code editing system in 1967. We pioneered video editing by helping establish SMPTE/EBU time code standards and by engineering the first SMPTE/EBU time code generators and readers.

More recently, we contributed to the SMPTE/EBU recommended practice for vertical interval time code (VITC) and developed microprocessor-based editing equipment using VITC.

The industry leader, we offer a full line of precise and reliable time code generator and reader components. Easily interfaced to your studio equipment, all of our products are available from our Authorized Distributors.

And, when we say "we wrote the book on time code"—we mean it. For your FREE copy of our famous time code handbook, call our Video Products Customer Service

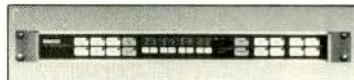

Department, (714) 835-6000 Ext. 419, or write EECO Incorporated, 1601 E. Chestnut Ave., Santa Ana, CA 92701-6391.

Ask for the time code book and the name of your nearest EECO Authorized Distributor.



EECO®

Computer Controls For Video Production

Circle 174 on Reader Service Card

Satellite TVRO System from Uniden

Uniden is now offering a complete line of C-band TVRO equipment. The UST 1000 receiver features detente tuning with lighted channel indicator and automatic polarity selection to provide crisper audio and cleaner video. Also featured is a signal strength meter, tunable audio, channel 3/4 modulator, horizontal/vertical indicators, channel scan indicators, and format switch.

The UST 3000 has all the features of the UST 1000 plus a digital LED display channel selector, a built-in satellite/TV selector and indicator, and both fixed and variable audio tuning. Both the UST 1000 and 3000 operate at 70 megahertz, and have 24-channel capability.

The UST 410 low-noise amplifier features weather-sealed housing, an in-

ternal voltage regulator, built-in lighting protection circuitry, and a one-year limited warranty. The UST 460 Unirotor is a mechanical feed system. Its probe rotates over a 180-degree pattern to select either horizontal or vertical polarity. The Unirotor features an in-line design and an adjustable scaler that ensures peak performance and simplifies installation. The unit interfaces with the UST 1000 and 3000 to change polarity from channel to channel automatically.

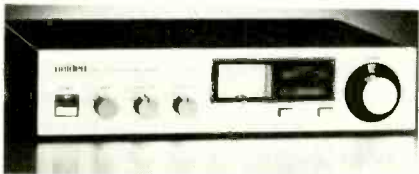

The UST 111 is an 11-foot aluminum mesh antenna featuring extruding supports and 24 panels. Two people can install it in two hours. It weighs only 158 pounds. Uniden also offers an eight-foot single-piece antenna. This antenna weighs just 64 pounds and can be installed in less than one hour.

For More Information
Circle 241 on Reader Service Card

JVC Introduces Super Beam Microphone

The MU-6200E is an extremely sensitive mic that boasts horizontal directivity that is seven times greater than conventional shotgun mics. Sensitivity measures 50 mV/Pa at 1 KHz with a frequency response from 50 to 15,000 Hz.

The microphone is intended for both studio and remote locations. Indoors or out, the MU-6200E is intended to capture subtlety. The mic features continuous variable directivity, and remote control of tone and directivity. The remote control unit and an AC power supply are optional.

Sound signal can be sent at line level by the built-in amplifier with 15 dB gain. The mic weighs 4.1 pounds and is 45 inches long.

For More Information
Circle 242 on Reader Service Card

No more camera tweaking

...for cable length. Phase three cameras automatically to insure phased chroma and sync at the switcher. New Automatic Blackburst Generator automatically compensates for differences in camera cable lengths.

Features

- Three auto-phased blackburst outputs
- Hi Z looping camera I/O
- Stand alone or genlock
- Use at distances up to 1000 feet

QSI Model AF-1000 Autophasing Blackburst Generator*

*patent pending

QSI systems, inc.
12 Linscott Road, P.O. Box 2176, Woburn, Massachusetts, 01888, 617-938-1403

Circle 175 on Reader Service Card

NEARLY 2,000,000 PEOPLE IN THE U.S. ARE VISUALLY IMPAIRED

The vast majority of them are partially sighted with remaining or residual vision that can be enhanced.

The Vision Fund of America (VFA) is an organization of concerned professionals and executives in the television and video industries dedicated to helping these partially-sighted people lead more useful, satisfying lives.

Your contributions will underwrite non-profit research into new optical, video, and related technologies and help apply those technologies to ways that benefit the partially sighted.

Many organizations raise money for the totally blind. VFA is the first to sponsor programs for the partially sighted.

HELP!

Send your tax-deductible contribution today, to:

THE VISION FUND OF AMERICA
Suite 1205, 136 East 57th Street, New York, N.Y. 10022
Telephone (212) 935-1840



The video industry helping the visually handicapped

Circle 176 on Reader Service Card

BUSINESS BRIEFS

Acrodyne Industries has reached an agreement with its parent company, Whittaker Corporation, for the purchase of a majority position in the company, to be headed by a group of investors which includes present Acrodyne management. The Whittaker Corporation will retain a minority equity interest. . . . **Picture Element Limited** has announced the installation of its Video Sequence Processor (VSP) in the new, video facility of Omnibus Computer Graphics in New York City.

. . . **Matsushita Electric Corporation of America**, in commemoration of its **twenty fifth anniversary**, has established a \$10 million foundation as a token of its gratitude to the American people. The foundation will be dedicated to funding educational programs in the U.S. . . . **Editel/NY** is doing all the post-production work for *The Bill Cosby Show*, a new TV series on NBC. Initial shooting is scheduled to wrap November 15, with editing continuing on into mid-December.

McDonnell-Douglas, in an effort to upgrade its single video remote truck, which has been used over the last year and a half to cover events such as this summer's Olympic Games in Los Angeles, and the 1984 All-Star baseball game, has purchased a 24-input Neve 5114 mixing console, which is specifically designed for television production needs. The 5144's features include a 4-band equalizer, full stereo capability, and comprehensive logic interfaces for microphones and muting. . . . **Montage Computer Corporation** has announced delivery of its **Montage Picture Processor** to Editel/Chicago, Editel/Los Angeles, Crawford Communications of Atlanta, and Pace International of Portland.

The United States Patent Office has issued a patent for the CompuSonics **DSP-2000** audio digital recording and playback system. . . . **Realtime Video Productions** has expanded to full one-inch editing capability with the addition of a second one-inch Sony BVH-2000 to its CMX suite.

The Robert Bosch Corporation, Video Equipment Division, recently shipped its new PAL format BCN VTR to Intercontinental Televideo, Inc., New York. ITI's BCN-51 VTR is one of only a few units in operation in the U.S. . . . Motion picture and video production and post-production organi-



The new transportable Elliptical Antenna from GEC McMichael. The British-based satellite communications manufacturer recently opened a new U.S. office in Scottsdale, AZ.

zation **Cinemasound, Ltd.**, has added a **new sound stage** to its facility in Washington, DC.

WFSB, Channel 3, Hartford, CT, has announced a major expansion of the station's broadcasting facilities, which include a new Harris TV-60L transmitter and circularly polarized antenna. The station also aired the **first stereo television broadcast** in New England on September 15. . . . **KTCA-TV**, Minneapolis-St. Paul, also aired a stereo TV broadcast in mid-September. Equipment was provided by **Modulation Sciences**.

Chyron Corporation has doubled the facilities of its Melville, NY, plant with the addition of a 26,000 square foot building. The building will become the new corporate headquarters, and will house the administrative, sales, and engineering departments. . . . **Hughes Communications Galaxy, Inc.** is offering part-time use of satellite capacity with a service called **Galaxy Video Timesharing Service**, which is available on Galaxy II positioned at 74 degrees west longitude. Hourly service rates are determined by two time-of-day classifications, prime-time and off-time.

Perrott Engineering Labs has added three new rep organizations. Innovative Concepts International, Long Beach, CA, will handle Western states; Henderson-Crowe, Inc., Atlanta, will handle the Southeast; and Omnivue, Inc. of New York will cover the East. . . . **GEC McMichael/Marconi Studio Systems** has announced the opening of a new U.S. office in Scottsdale, AZ. . . . British antenna company **C&S Antennas Ltd.** has opened an American-based company in Dover, DE, based on interest shown by the U.S. in CSA's military products which were used by British Forces in the **Falklands War**.

Among the personnel changes this month, **Modulation Sciences** has announced the appointment of Donald H. Haight as president and chief executive officer. . . . At **Robert Bosch**, Clifford Eggink has been named president of the Video Equipment Division, Salt Lake City, UT. . . . At **CMX**, Gary Schultz becomes manager, product management. Ed Bolger has been named Western regional manager, and Christen Hardman has been appointed product specialist within the product management department. . . . At **Chyron Corporation**, William Buynak has been elected vice president.

Harrison has announced the appointment of J. Eugene Harrison as president and CEO. . . . At **UPI**, Luis Nogales has been appointed president. . . . **TFT** has named Tony Bryan as North American broadcast sales manager. . . . **Altec Lansing** has promoted Gayle Campbell to national sales manager of commercial products.

SALES OFFICES

BM/E

Broadcast Management/Engineering

295 Madison Ave.
New York, New York 10017
Telex: 64-4001
William McGorry, Publisher

Eastern & Central States

295 Madison Avenue
New York, New York 10017
212-685-5320
James C. Jaywalt
Gene Kinsella

Western States

5015 Birch Street, Office One
Newport Beach, CA 92660
714-851-1461
408-720-0222
WALLY GILBERT

United Kingdom/Europe

28 Eaton Row
London SW1W 0JA, England
Telephone: 01 235 8431
Bronwyn Holmes
Derek Hopkins
Ruben Veksner

Japan/Far East

Eiraku Building
1-13-9, Ginza,
Chuo-Ku, Tokyo 104 Japan
03 562 4781
S. Yasui
K. Yamamoto
Y. Yozaki

SAY HELLO TO TOMORROW

McCurdy Radio's CS9400 Digitally Controlled Intercom

An advanced microprocessor system designed for today and tomorrow's complex communication requirements, the McCurdy CS9400 intercom offers unsurpassed quality and unique features:

- Totally balanced solid state switching
- Single pair control wiring
- Redundant single station architecture for ultimate reliability
- Alpha-numeric displays
- Assignment of keys locally or at central location
- Disc-based interface for storage
- Unique caller identification and reply system

- Ease of future expansion and reconfiguration
- Wide range of control panels and software options

The McCurdy CS9400 intercom system is already in use at major network and production facilities. The system offers total user flexibility as well as meeting complex production reconfiguration with ease.

The technology of tomorrow is here today with the McCurdy digitally controlled intercom system. Communicate with the best from the company known for its innovative design, dependable long life performance and solid customer service. So "Say hello to tomorrow" today!



McCurdy

McCurdy Radio Industries

108 Cambridge Road, Toronto, Ontario, Canada M4A 2L4 Tel: (416) 751-6262 Telex: 06-963533
1051 Clinton Street, Buffalo, New York 14206 Tel: (212) 772-0719

Circle 177 on Reader Service Card

Eloquent Audio!

Custom designed production facilities make a substantial contribution to overall program quality. This is particularly true with the CBC French network's new daily TV news magazine, "Le Point".

The ability to combine voice inputs from numerous local and remote locations with studio originated sound effects and "color" is essential to the program environment.

For this custom console, Ward-Beck collaborated with CBC engineers to design a producer's dream in which one operator controls 24 inputs with submasters on the left, while another handles the 8 effects inputs and submaster on the right. A centrally located illuminated 24 x 6 integral switch panel assures clean, unambiguous switching from either station.

The results speak for themselves.



First by Design.

Ward-Beck Systems Ltd.,
841 Progress Avenue, Scarborough,
Ontario Canada M1H 2X4.
Tel: (416) 436-6550. Telex: 065-25399.

