

APRIL 1981

\$3.00

BME

BROADCAST MANAGEMENT ENGINEERING

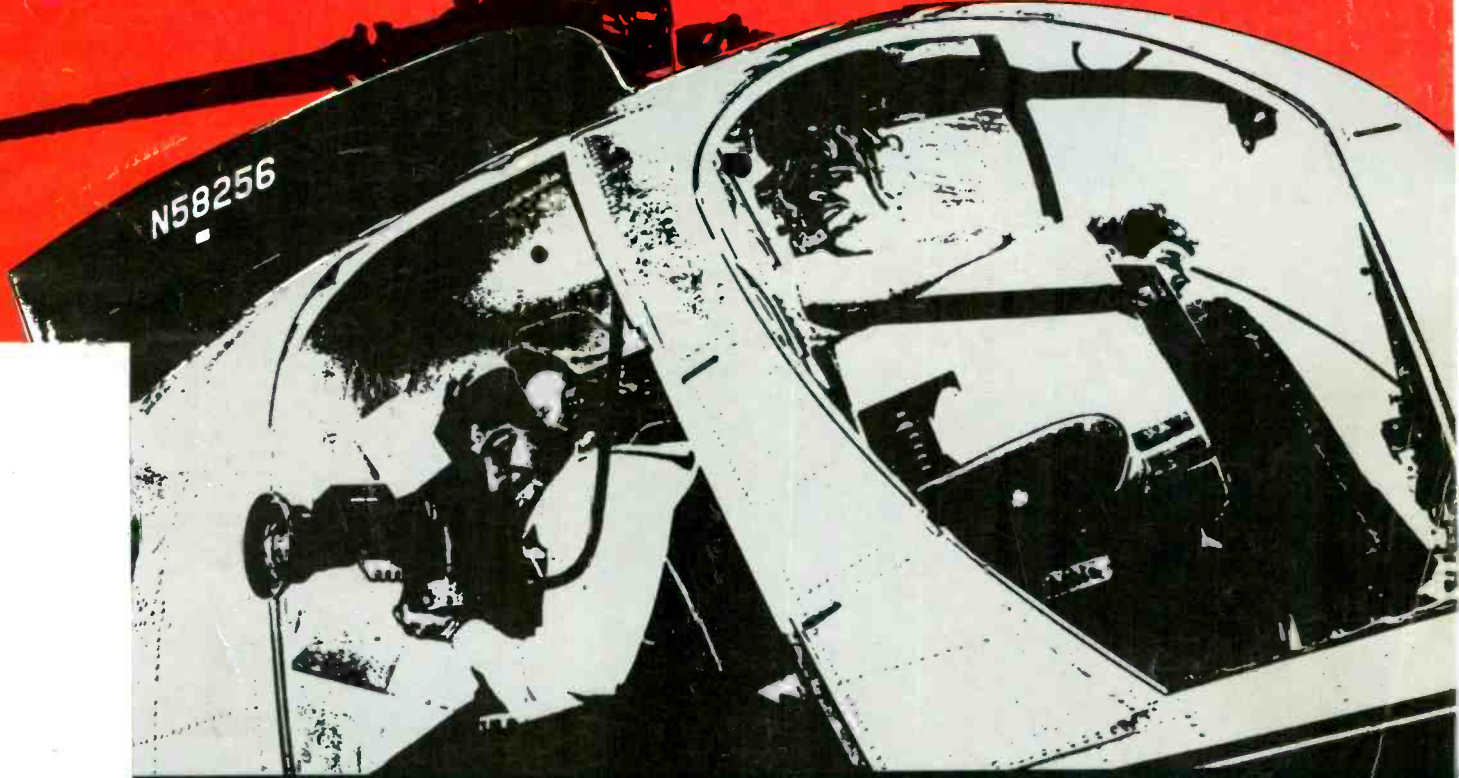

WFP A GROWING TECHNOLOGY MEETS THE DEMAND FOR GROWTH



WE'RE ON YOUR SIDE

**SPECIAL REPORT:
RETAIL COMMERCIALS**

ADM

Control the complete audio spectrum



See us at booth 1212-A

Our ADM 1600: modest but mighty

Although it's a desk-top model, our 1600 Series audio console offers a brilliant array of features and capabilities for handling the most demanding program material.

One of our new breed of consoles, the ADM® 1600 is available with up to 16 discrete inputs, 4 submaster and 2 master outputs. Combined with a host of pre-selector, buss selector and processor modules, the ADM 1600 creates perfect harmony with today's video. Like all ADM consoles, the 1600 is designed to exacting standards and manufactured to the most rigid tolerances. Each ADM console is backed by an exclusive 5-year warranty.

Make sure you control the entire audio spectrum. Contact ADM Technology, Inc., The Audio Company, 16005 Sturgeon, Roseville, MI 48066. Phone (313) 778-8400. TLX-23-1114. West Central Sales Representative, Gordon Peters. Phone (817) 467-2990.

ADDA's new VIP gives you infinite compression . . . and more.

For under \$40,000.



Now there's something really innovative in the broadcast equipment market . . . ADDA's new VIP Video Compressor.

A single-channel system, it provides low-cost infinite video compression and much more for news and commercial production facilities.

It's a powerful system.

With ADDA's microprocessor-controlled standard VIP system, you get a mainframe, an engineering remote, and an intelligent production remote. It has full frame synchronization and time base correction capabilities.

In addition, wiring is simplified. A single 75-ohm coaxial cable does away with complex wiring harnesses.

It doesn't skimp on quality.

Just the opposite. We developed an improved horizontal-vertical interpolation scheme which delivers unequalled excellence in picture quality. And that's not all. Our new method fixes the centroid of the picture during compression. No shifting problems.

It has the features most often used.

Infinite compression isn't the only valuable feature of our VIP. It has preset position and size

coordinates. Multiple presets. Justified positions. Electronic freeze frame. And 4:3 aspect ratio lock/unlock during zoom.

What's more, it has unity size and center position switches which will return either to center or full size. Also, an optional tracking color border generator is available.

It'll give you more than your money's worth in value.

We've found a better way to offer you affordable excellence. Interested in details on our new VIP? We'd like to tell you more. ADDA CORPORATION, 1671 Dell Avenue, Campbell, CA 95008, (408) 379-1500.

Sales Offices: Wakefield, MA (617) 245-4602; Brooklyn, NY (212) 375-4064; Reston, VA (703) 620-5449; Marietta, GA (404) 953-1500; Southfield, MI (313) 332-1500; Chicago, IL (312) 454-1251; Overland Park, KS (913) 631-1500; Dallas, TX (214) 343-0125; Seattle, WA (206) 721-0586; Portland, OR (503) 295-6458; San Jose, CA (408) 247-5553; Westminster, CA (714) 891-3364.

ADDA CORPORATION

Circle 100 on Reader Service Card

 **HITACHI**
Hitachi Denshi, Ltd.

HR-200



Hitachi-5 Competition-0

That's the score in one-inch VTR technology.

We've gone the first generation of TYPE C machines *five* better ...to help you get all the potential of one-inch out of your video installation. Here's what the competition *doesn't* give you.

1. Retracting Tape Guide

Retracts for unequalled ease of threading; repositions with one micron accuracy for up to two million threadings. Provides the reliability of a quad thread system in a one-inch format.

2. "PRO" Tape Path

The protective reverse oxide ("PRO") configuration of the tape path means *only* the video and audio heads touch the oxide surface. All other transport mechanisms guide the tape by its reverse side. Result: noticeably reduced dropouts; longer tape life.

3. Instant Head Replacement

Pre-aligned head design permits easy replacement of video heads in three minutes. No adaptors or jigs; no adjustments required.

4. Audio and Video Confidence

The others only let you *see* what you're taping. We let you *see* and *hear* everything being recorded...simultaneously.

5. Non-contact Tape Shuttle System

In shuttle and standby modes, tape rides on a cushion of air. Increases head and tape life immeasurably. Cuts frictional resistance, yielding shuttle times of only 80 seconds end to end.

We could go on. With impressive features like microprocessor control; broadcastable slow motion; one-touch shuttle and jog; front access circuit boards; audio spot erase; and on and on. But why run up the score, when it's already no contest? See the Hitachi HR-200, it's equally impressive portable HR-100 model, and companion TC-200 Time Base Corrector.

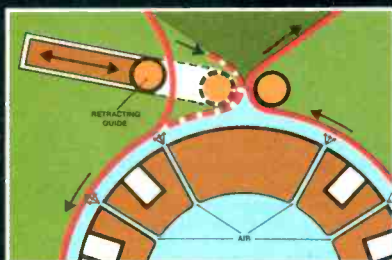

• Tape guide retracts for threading ease • Air drum eliminates head contact in shuttle/standby modes

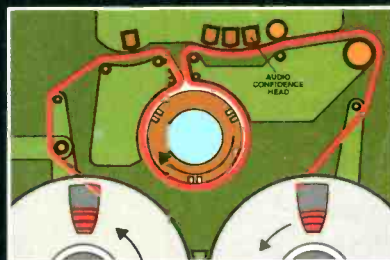

• Full audio and video confidence
• "PRO" tape path reduces dropouts



Tomorrow's Technology Today

175 Crossways Park West, Woodbury, N.Y. 11797 (516) 921-7200

• New York • Chicago • Los Angeles • Atlanta • Cincinnati • Dallas • Denver • Seattle • Washington, D.C.

Circle 101 on Reader Service Card

BM/E

BROADCAST MANAGEMENT/ENGINEERING

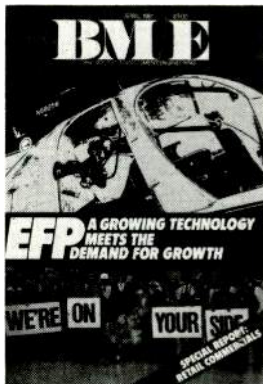

Electronic Field Production technology has enabled broadcasters not only to fulfill needs that have long thirsted for a local solution but also has given broadcasters the opportunity to explore new markets. Commercials are the catalyst for a new level of production at the local level.

Publisher
Charles C. Lenz, Jr.
Editorial Director
James A. Lipke

Editor
David Hawthorne
Senior Editor
Robin Lanier
Senior Editor
Stephen C. Miller
News Editor
Eva J. Blinder
Editorial Assistant
Doug Damoth

Assistant Publisher
Djuna Van Vort
Creative Director
Gus Sauter
Marketing Services Manager
Christine Bunish
Production Manager
David Rose
Advertising Production
Deborah Foley
Editorial Production
Heidi DeVos

Comptroller
Steven Abromowitz

FCC Counsel
**Lovett Ford and
Hennessey, P.C.**

APRIL 1981/VOLUME 17/NUMBER 4

8 Broadcast Industry News

FCC budget cuts spare minority division; Five-year TV license bill goes to Senate; Nets, public groups oppose "morality" boycott

19 Radio Programming & Production For Profit

Chamber music is up, and so is rock

20 BM/E's Program Marketplace

Profile of the FM 100 Plan

25 Television Programming & Production For Profit

INN: UHF's get a higher frequency of news

31 On The Road: Remote Vehicles

Television stations have come up with a variety of solutions for field production needs

37 Concert Programs For Radio Produced On Wheels: A Sharp Uptrend

The stories of three stations shed light on an attractive operation

44 January 20, 1981: A Remote To Remember

The return of the hostages complicated inaugural coverage

51 Field Production Of Sports And Events Is A Radio Profitmaker

Mobile studios have become central for many radio broadcasters

61 EFP: A Commercial, Sporty, Profitable Business

Though out of its infancy, EFP is still growing rapidly

73 Flexible Field Communications For ENG: A New Portable System

A new radio system quickly sets up communication lines

81 San Francisco: Bellwether Market For Commercial Production

The Bay Area is seeing a boom in television production

90 Quality Assurance And Control: You Can't Have One Without The Other — Part 2

How to apply the quality control loop in the broadcast station

101 DVTR Demo And SMPTE Television Conference Mark Watershed In Technology

Major understandings were reached at the February meeting

113 FCC Rules and Regulations

Court loosens diversification policy

117 Great Idea Contest

Win a calculator — enter the Great Idea Contest!

125 Broadcast Equipment

BM/E's survey of new products

BROADBAND INFORMATION SERVICES, INC.

295 Madison Ave., New York, N.Y. 10017, 212-685-5320, Telex: 644-001
Publishers: **BM/E—Broadcast Management Engineering**
BM/E's World Broadcast News



BM/E BROADCAST MANAGEMENT ENGINEERING (USPS 059280) is published monthly by Broadband Information Services Inc. All notices pertaining to undeliverable mail or subscriptions should be addressed to 295 Madison Ave., New York, NY 10017. BM/E is circulated without charge to those responsible for station operation and for specifying and authorizing the purchase of equipment used in broadcast facilities in the U.S. and Canada. These facilities include AM, FM and TV broadcast stations, CATV systems, ETV stations, networks and studios, audio and video recording studios consultants, etc. Subscription prices to others \$24.00 one year, \$36.00 two years, Foreign \$30.00 one year, \$48.00 two years. Air Mail rates on request. Copyright 1981 by Broadband Information Services, Inc., New York City. Second class postage paid N.Y., N.Y. and additional mailing offices.

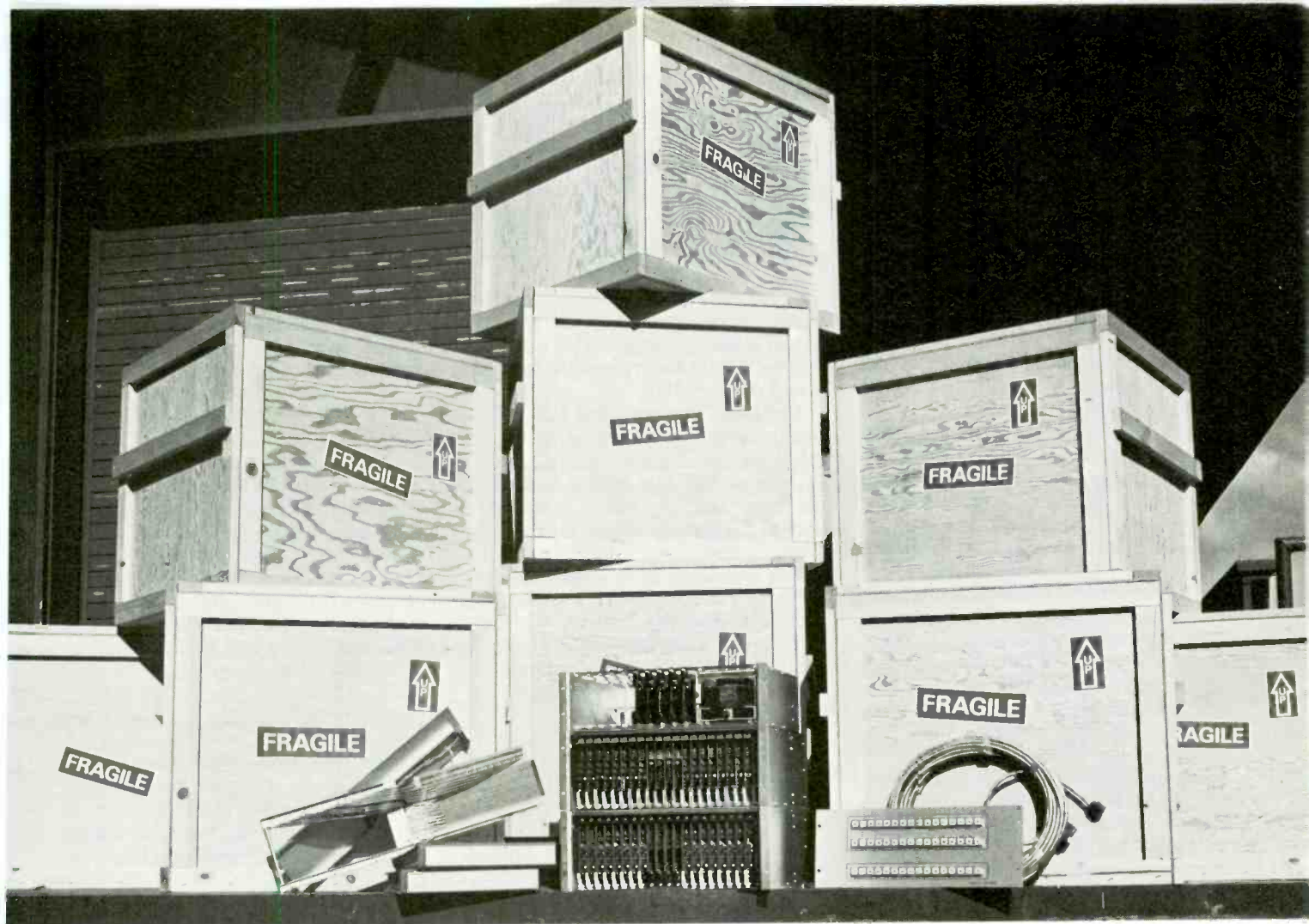

Special Offer!

For a limited time only, the Grass Valley Group is offering a complete 400-series 32x16 AFV routing switcher system at a very special price. This is your opportunity to own the same high quality routing switcher used in hundreds of installations around the world.

Now is the time to eliminate that conglomeration of patch panels and mechanical switchers you're using for VTR, framestore and ENG/microwave switching. Replace it all with world-famous Grass Valley Group equipment — at a most attractive price. If you're in a hurry, you'll be pleased to know that we're in a position to ship these packages in a matter of weeks!

Our special package includes the following:

- (One) 400 series 32x16 video matrix
- (One) 400 series 32x16 audio matrix
- (One) 400 series power supply
- (One) set interconnect cables
- (One) set module extenders
- (One) 400-201 X-Y control panel
- (One) 15 meter control cable
- (Two) instruction manuals

Interested? Don't delay, because this offer is good for a limited time only. Contact your Grass Valley Group representative now

THE GRASS VALLEY GROUP, INC.

P.O. BOX 1114 GRASS VALLEY CALIFORNIA 95945 USA • TEL: (916) 273-8421 TWX: 910-530-8280

A TEKTRONIX COMPANY

Grass Valley Group Field Offices: WEST: 4419 Van Nuys Blvd Ste 307, Sherman Oaks, CA 91403 (213) 990-6172 • SOUTHEAST: 1644 Tullie Cir NE, Atlanta, GA 33029 (404) 321-4318 • NORTH CENTRAL: 810 W Bristol St, Elkhart, IN 46514 (219) 264-0931 • NEW ENGLAND & MID ATLANTIC: Station Plaza East, Great Neck, NY 11021 (516) 487-1311 • SOUTHWEST: 2639 Walnut Hill Ln Ste 143, Dallas, TX 75229 (214) 358-4229 • MIDWEST: 3585 N I Exinator Ave Ste 374, Arden Hills, MN 55112 (612) 483-2594

Circle 102 on Reader Service Card

BROADCAST INDUSTRY NEWS

FCC Budget Cuts Spare Minority Division

Rejecting recommendations that would have eliminated the Minority Enterprises Division of its Office of Public Affairs, the FCC has voted across-the-board budget cuts in almost all areas of its operations. Over \$5 million dollars was slashed from the budget, with 169 jobs eliminated in the process.

Saved from the knife, however, were the Minority Enterprises Division and the Review Board, both recommended for demolition by the Commission's executive director's office. Commissioners Fogarty, Jones and Quello strongly opposed the elimination of the Minority Enterprises Division, with Fogarty issuing a sharply worded memo on the subject. The offices of Plans and Policy and Public Affairs will also be cut less severely than originally recommended, as will the Cable Television Bureau, which will lose six staff members, and the Private Radio Bureau, which will lose 22.

Both the Broadcast Bureau and the Common Carrier Bureau will shrink by 27 positions — a large jump from the more moderate cuts of 11 each originally recommended. Cuts in the Field Operations Bureau will result in the closing of eight to 10 field offices.

Five-Year TV License Bill Goes To Senate

Senator Barry Goldwater (R-Ariz.), chairman of the Senate Communications Subcommittee, has introduced a bill that would extend the license term

of television stations from three to five years. Other provisions of the bill would eliminate comparative renewals and institute a lottery system for contested new licenses.

Under the proposed new legislation, license renewal would be based on three criteria. Stations would have to show they had met public needs and interests, had operated in accordance with FCC rules and regulations and the Communications act, and had met the FCC's standard qualifications, outlined in Section 308 (b) of the act.

Several important sponsors, including Senators Packwood of Oregon (chairman of the Commerce Committee) and Cannon (D-NeV.), assure the bill broad support.

The TV move shortly followed hearings in the Senate on S-270, the radio deregulation bill. Support for the legislation was strong from Senators Goldwater and Packwood; Packwood took issue with testimony from the United Church of Christ's Everett Parker, calling Parker's anti-deregulation stand "ambiguous."

Nets, Public Groups Oppose "Morality" Boycott

An advertiser boycott proposed by the Coalition for Better TV has drawn fire from such (usually) divergent quarters as the major TV networks and public interest groups, such as Action for Children's Television.

The coalition, a conservative amalgam that claims 200 member groups, started three months of monitoring television programming March 1. It

plans to identify the sponsors of programs it finds offensively "violent, sexual, or profane" and ask for a one-year boycott of their products.

The networks were quick to oppose the boycott, which, in CBS's words, "amounts to censorship." ABC called the boycott idea "a totally unacceptable method of trying to influence programming." Negative reactions also came from Action for Children's Television (ACT) and the NOW Media Project. ACT president Peggy Charren, herself a frequent critic of television programming, said her group "doesn't think censorship and limiting options is the way to make a change."

The Coalition for Better TV is headed by Donald Wildmon, a minister from Tupelo, Miss. who organized the National Federation for Decency, a member group of the right-wing coalition. Jerry Falwell's Moral Majority is also active in the organization, which has not issued a membership list.

PBS Plans New Ad-Backed Net

The latest brainchild of the Public Broadcasting Service will bring subscribers programming from the nation's major cultural and educational institutions when it starts up in 1983, if all goes well. The Public Subscription Network, as the plan is titled, will be an advertising supported subscription network distributed by PBS's extensive satellite system. Local distribution will depend on what means are available; possibilities include CATV, MDS, STV, and LPTV.

One Piece Cam/VTR: A Dream Come True

Early last month, RCA announced its intention to introduce a one-piece combined camera/VTR unit at this month's NAB Convention. The unit is full broadcast-quality and claims a video recording signal better than current ¾-inch U-type recorders, though not up to one-inch quality.

Nevertheless, at under 22 pounds for the full unit (including batteries), the new RCA product, called "Hawkeye," halves the weight of existing camera and separate VTR packages. RCA will also introduce a full support system for the camera/VTR including editing.

The camera uses three ½-inch pickup tubes while the integrated recorder uses standard ½-inch VHS

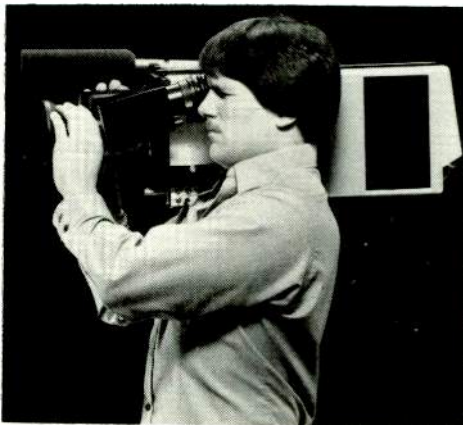

tape cassettes for the helical scan VTR section, manufactured by Matsushita Electric Co. Ltd. (Panasonic). The recorder uses new head design and recording circuitry to provide 20 minutes of recording time in the Hawkeye unit.

As *BM/E* went to press, it was learned that Matsushita, manufacturer of the recorder used in the RCA unit, will introduce a similar camera/VTR under its Panasonic label at NAB.

The Hawkeye broadcast-quality recording camera system was unveiled by RCA Broadcast Systems at the NAB convention in Las Vegas

MASTERFUL PERFORMANCE



ADM's DA16B/CH20B Audio Distribution System

You are assured of one masterful performance after another because the DA16B/CH20B provides audio distribution of unquestioned reliability. It offers a unique combination of features for exceptional versatility.

- Each amplifier is a one-input, six-output plug-in card.
- The input, and each output is individually transformer coupled.
- Input levels up to +27 dBv; output levels up to +27 dBm before clipping.

- Output amplifiers have individual, front accessed gain adjustment, and a test point.
- Each CH20B will house up to six DA16B cards, and has a complete set of redundant power supplies with automatic changeover.

But probably the most important feature of all is ADM's unexcelled built-in quality—quality backed by a five-year unconditional warranty.

Contact us today for the complete story about the unique DA16B/CH20B system.

ADM[®] The
Audio
Company

16005 Sturgeon • Roseville, Michigan 48066
Phone (313) 778-8400 • TLX 23-11
West Central Sales Represe
Gordon Peters • (817) 467

See us at booth 1212-A

News

Evening programming on PSN, as currently planned, will consist of "programming packages" featuring performing arts or documentary "centerpieces" surrounded by related shorts. A budget of \$36 million is forecasted for the evening productions during PSN's first year. Daytime offerings will include upper-level adult education and would be financed by institutional subscribers, who would pay a fee to record the programs for off-air use.

The net could reach 360,000 subscribers in its first year, according to PBS estimates. Subscribers would pay \$10 to \$13 a month for the service. Additional revenue would come from "institutional messages," loans, and grants. Another major source of funds would be the sale of videocassettes, videodiscs, and players to subscribers, as well as an arts magazine and discount tickets to cultural events. The network could be making money by its second year, PBS claimed.

Participating stations would contribute approximately \$20,000 each to

PSN initially, but would receive a share of the net's revenue.

Directors Charge Sexism In TV, Movies

Claiming "a pattern of discrimination against women," the Directors Guild of America filed charges of sex discrimination against the three major television networks, several large movie studios and a number of independent production companies late in February.

Although the suit involves only discrimination alleged to have taken place during the six months prior to the filing, the guild's women's committee previously released statistics showing a long pattern of such discrimination. According to the figures, since 1949 women have directed only 115 hours of prime-time television (35 by Ida Lupino) and only 23 women have directed prime-time shows.

Executives at the companies named in the DGA suit expressed surprise at the charges, many saying they were committed to trying to hire women. DGA, however, claimed that voluntary affirmative action programs were not working. Women make up approximately 11 percent of DGA membership.

Telidon Picked For Videotex Tests

Two major teletext trials, both starting late this year, will utilize the Canadian Telidon system. Time, Inc. will field a multi-channel, seven-day, 24-hour teletext service with information drawn from its editorial resources. Up to 20 "electronic magazines" will be available to users.

Telidon scored another coup with its choice by the Times Mirror Co. for a major videotex test to start next fall, with 200 terminals to be installed in homes in Los Angeles and Orange counties. The system will operate simultaneously over both telephone and two-way cable networks, offering data retrieval and transaction services.

Other major news on the teletext front is the formation of BVT (British Videotex and Teletext), a joint venture of Logica, Inc. and British Telecom. The company will provide a range of teletext and videotex systems as well as information on equipment and software.

Comsat Launches Fourth Comstar Bird

Comstar D-4, the fourth in Comsat General's communications satellite system, was launched successfully in late February by NASA from Cape Canaveral, Fla. Like its companions,

Announcing Model 909

9" Color For ENG

- Rugged/Compact/Portable
- In-line Slotmask CRT
- AC/DC Operation
- Pulse Cross Display
- EXT/INT Sync
- A/B Input
- Blue Only Display
- Black Calibration
- R-Y, B-Y Outputs For Vector-Scope
- Color/Monochrome Selector
- Twin Units For Rack Mount



SHINTRON
Worldwide

144 Rogers Street
Cambridge, MA 02142 USA
Phone (617) 491-8700
Telex 921497

Circle 103 on Reader Service Card

A professional Ikegami HK-357A video camera is shown mounted on a tripod. The camera is silver and black, with a large lens assembly on the right side. A control panel with the 'IKEGAMI' logo is visible on the front. A viewfinder is attached to the top. The camera is positioned on a tripod with a central column and three legs. The background is plain white.

Ikegami's third microprocessor-controlled camera reduces registration set-up time and cost

The ideal camera for field broadcast television assignments must meet three major criteria. It must be air-ready moments after arrival at the camera site. It must deliver pictures of studio-quality color, crispness, and clarity. And it must be consistently reliable.

The Ikegami HK-357A meets those criteria in the field and is equally suitable as a studio camera. And it allows the camera crew to concentrate on creative aspects of their assignment instead of on time-consuming set-up and readjustment tasks.

Once on-site, the HK-357A requires hook-up to only three cables and power source. Then, a push of the microprocessor activate button automatically cycles it

through a check and recheck of all set-up and registration adjustments. This takes approximately 45 seconds per camera (up to six cameras can be handled). No external registration and chip charts are necessary because a test pattern projector (diascope) is built into the lens. Camera distance from the compact base station can be nearly a mile with triax, or 2,000 feet with TV-81 multi-core cable.

Because the HK-357A optimizes the capabilities of the newly developed Diode Gun Plumbicon®, the picture output is of very high resolution, low lag, low noise and wide dynamic range. Dynamic Beam Stretch to reduce comet tailing; Geometric Correction for near-perfect registration; auto iris and auto white balance — all contribute to the superior color picture program output of this camera.

The HK-357A is notably versatile too. It offers selectable contrast compression levels; built-in chroma keyer; gen-lock to Sync and SC or VBS/BBS; and several other features, including an unusually compact CCU, optional RCU, tilttable and rotatable 7-inch high-resolution electronic viewfinder.

The performance record of Ikegami cameras at the major networks in the United States and around the world attests to their consistent reliability and long, trouble-free service life.

If you are upgrading, a demonstration may well reveal that the other cameras you've considered may already be obsolete when compared against the HK-357A.

Ikegami HK-357A

Broadcast Products Division, Ikegami Electronics (USA) Inc., 37 Brook Avenue, Maywood, N.J. 07607; (201) 368-9171. West Coast: 19164 Van Ness Ave., Torrance, CA 90501; (213) 328-2814; Southwest: 330 North Belt East, Suite 228, Houston, TX 77060; (713) 445-0100; Southeast: 522 So. Lee Street, Americus, GA 31709; (912) 924-0061.

Circle 104 on Reader Service Card

News

the new satellite's entire capacity is leased to the American Telegraph & Telephone Co. It is capable of relaying 18,000 simultaneous telephone calls or 24 television channels and will serve all 50 states and Puerto Rico. Hughes Aircraft Co. built the satellite, which is scheduled to go into service May 1.

In an unrelated move, Comsat announced that one of its subsidiaries, Comsat General Integrated Systems (CGIS), has acquired Comprehensive

Computing Systems and Services, Inc. (CCSS) of Austin, Texas. CCSS develops and markets computer software for the simulation and testing of complex digital electronic circuits. The move is intended to strengthen CGIS's move into the computer-aided design, manufacturing, and test industry, Comsat said.

M/A-Com, Philips Form Fiber Optic Venture

M/A-Com, Inc., N.V. Philips of the Netherlands, and Philips Optical

Communications Corp. of the U.S. have agreed in principle to form a joint venture company to develop, manufacture, and market optical fibers, optical fiber cable, associated hardware, and related systems.

Valtec Corp., a M/A-Com subsidiary, is a leading supplier of fiber optic equipment and its president, James R. Kanely, will act as president of the new venture, to be located initially at Valtec's West Boylston, Mass. facility. Valtec and Philips will share their technology in the 50-50 jointly owned operation.

M/A-Com also recently announced completion of its acquisitions of Alanthus Data Communications Corp. of Rockville, Md. and Microwave Power Devices, Inc. of Hauppauge, N.Y. Alanthus provides a broad range of data communications and computer terminal products and software to the data communications industry. MPD is a leading supplier of solid state RF and microwave power amps to the general telecommunications industry.

Canadians Attack Public Radio Plan

Private broadcasters in Canada are expressing opposition to a long-range plan of the publicly funded Canadian Broadcasting Corporation to increase its radio services. According to the Canadian Association of Broadcasters, which counts 345 private radio broadcasters among its members, the CBC's 20-year plan would severely limit the number of frequencies available to commercial broadcasters while bringing unclear advantages to the listening public.

As described by the CAB, the CBC proposal calls for the creation of four nationwide radio networks by the turn of the century — two services in French and two in English. Over 800 transmitters would be required, with many frequencies reserved for the public stations whether they were utilized or not. The expansion would be in the area of locally oriented programming in the CBC's monophonic services; CAB says that such expansion is unnecessary since the CBC already fulfills its legal mandate to provide such service. Besides, CAB asserts, such local programming is already amply provided by commercial stations. The association has requested public hearings on the proposal and has countered with its own recommendations for the future of the CBC, calling for amalgamation of public mono and FM services.

Philips, Du Pont Form Mag Tape Venture

The Du Pont Co. of Wilmington, Del. and N. V. Philips of the Netherlands

Go anywhere super-rugged SMPTE/EBU Edit Code Generator and Companion Reader that will give you an instant shot list.



The only portable SMPTE/EBU Edit Code Generators.

- Goes anywhere with your ENG crew. 2.0mA max. battery drain.
- Very light and rugged. It attaches to your VTR and produces accurate edit code as you shoot an important scene. More than 500 units in use worldwide.
- Model 640 for SMPTE, Model 641 for both SMPTE/EBU with LCD constant display and user code capability.



Model 644 Edit Code Reader plus off-line editing printer.

When Shintron builds a new product, we think of our customers' convenience first. Good Edit Code Readers are a dime a dozen today, but which one can generate an instant shot list? The only one is Model 644 Edit Code Reader/Raster Display and Shot List printer.



SHINTRON
Worldwide

Cambridge, MA 02142 USA
Telephone (617) 491-8700
Telex 921497

Circle 105 on Reader Service Card

Be where the news is happening at NAB. Visit the RCA exhibit and try out our lightweight new TK-86. It's a worthy successor to RCA's trusty TK-76, the ENG/EFP veteran that's served beyond the call of duty on newsfronts around the world. Through hell and high water.

It has the same basic electronics as the celebrated TK-76, but uses 33% less power. And there's the same ruggedness, reliability and serviceability. But shoulder the TK-86, and feel the difference.

With its form-fitting base, it nestles comfortably and securely on the shoulder. It's nicely balanced. And it can remain conveniently upright when you set it down.

It has an improved optical system, with a totally-sealed f/1.4 beam splitter. It's available with low-capacitance versions of the Saticon® or Plumbicon® tubes. And with a full range of remote control devices.

Of course, it's backed by incomparable RCA TechAlert service. See it at NAB or see your RCA Representative. RCA Broadcast Systems, Building 2-2, Camden, NJ 08102

NAB NEWSMAKER



Can you really afford less?

News

have formed a new joint venture company to manufacture and market magnetic tape and cassette products. The two firms predict that the new company, to be known as PD Magnetics B.V., will grow into a leading contender in the audio and videotape market.

Initial production of the tapes began in January at a plant in Oosterhout, the Netherlands, which PD Magnetics purchased from Philips.

News Briefs

Orion Broadcasting's **WMT-TV**, Cedar Rapids, Iowa, will be sold to Guy Gannett Broadcasting Services of Portland, Maine. The sale is required by the FCC since Orion is being purchased by Cosmos Broadcasting Corp. . . . Donrey Media Group of Fort Smith, Ark. will purchase **KEXO**, Grand Junction, Colo. from Century Broadcasting Co., subject to FCC approval . . . **Walter Cronkite**, stepping down (or up) after 30 years with

CBS News to take on new assignments, has been named honorary chairman of the Media Resource Service of the Scientists' Institute for Public Information. He also received that group's first "Excellence in Science Communication" award.

The FCC has voted to **establish an advisory committee** to assist preparations for the 1983 broadcast satellite planning conference (RARC). The committee will study technical issues, especially relating to DBS . . . Broadcast reaction to Satellite Television Corp.'s **DBS proposal** has been largely negative, with comments from the networks and NAB, among others, calling the plan hasty and wasteful of spectrum space. STC has responded by urging the FCC to approve the interim DBS service, saying the Commission has full authority to do so.

The NAB's Radio Board has passed a resolution **opposing a shift to 9 kHz AM channel spacing**. At the same meeting, the Radio Board reaffirmed its support for conversion of daytime-only stations into full-time facilities. The association has urged the FCC to name a single technical standard for AM stereo; such action is necessary before receiver manufacturers will build sets, NAB said . . . Small-market radio broadcasters are receiving **new services from NAB** this month. First offering is *Radiogram*, a bimonthly newsletter; other NAB services will include handbooks, a source guide, and a seasonal promotional merchandise service.

NBC's long-running *Meet the Press* news show has received the American Legion National Commander's **Public Relations Award** . . . KOCO-TV, Oklahoma City, anchor Mary Ruth Carleton has received a **President's Award** from the Oklahoma Wildlife Federation for a five-part series on a large timber operation in her state . . . Former White House advisor **Hamilton Jordan** has joined the staff of Cable News Network as an expert on government affairs and politics.

The **Concert Music Broadcasters Association** will meet May 6 through 9 at the Pontchartrain Hotel in Detroit. Contact Lee C. Hanson, program committee chairman, at (313) 833-6530 or 833-6105 . . . NAEB's 1981 **Executive Management Program** is scheduled for May 31 to June 13 at Boston's Parker House Hotel. Information is available from NAEB, 1346 Connecticut Ave. NW, Washington, D.C. 20036 . . . A conference on **"Teleconferencing and Interactive Media"** will convene May 7 and 8 at the Concourse Hotel, Madison, Wisc. Registration information is available from Registrations, Wisconsin Center, 702 Langdon St., Madison, Wisc. 53706.

"True Modularity with Plug-in Reed Relay Modules."



Another Reason Why MATRIX is the Leader in Coax Switching Systems.

MATRIX modular switching systems will never become obsolete. No matter how fast your requirements grow. Or how big.

There's a standard module to meet most every switching configuration. About all you need to do is plug it in. No expensive downtime or costly new designs!

And there's more. MATRIX modules use highly reliable, hermetically sealed reed

relays — with a life expectancy of 100 million operations. Repairs, if ever needed, can be made in minutes. Again, minimal downtime through modularity.

So check us out. See why modular MATRIX plug-in modules are the best solution to your coaxial and audio switching requirements.

Phone or write for details.



MATRIX
SYSTEMS CORPORATION

5177 NORTH DOUGLAS FIR ROAD • CALABASAS, CALIFORNIA 91302
(213) 992-6776 • TWX 910-494-4975

Circle 106 on Reader Service Card

"For the best national and local radar coverage, I depend on Weathermation."

Why does KSTP, one of the country's largest and best equipped weather facilities, count on WEATHERMATION Color Remote Radar? Perhaps it's because WEATHERMATION has the most far-reaching dial up system in the industry, with more digital transmitters at more sites than any other system. Perhaps it's because only WEATHERMATION provides simple telephone access to over 120 radar pictures. Or maybe it's because WEATHERMATION is the most cost-effective system on the market today; as new sites are added, they become available immediately to all WEATHERMATION owners, complete with map overlays at no extra charge.

At KSTP nine professional meteorologists work 24 hours a day, seven days a week to provide their radio and television audiences with over 200 weather reports a week. "Country Day," KSTP's syndicated early morning TV show broadcast by 30 stations reaching 13 states each day, relies heavily on WEATHERMATION for up-to-the-minute weather information.

So, when timely accurate weather news counts, take the word of the pros. WEATHERMATION.

See us at NAB Booth #1625

*Dennis Feltgen, Director
Eyewitness News Meteorology
KSTP Channel 5, Minneapolis*

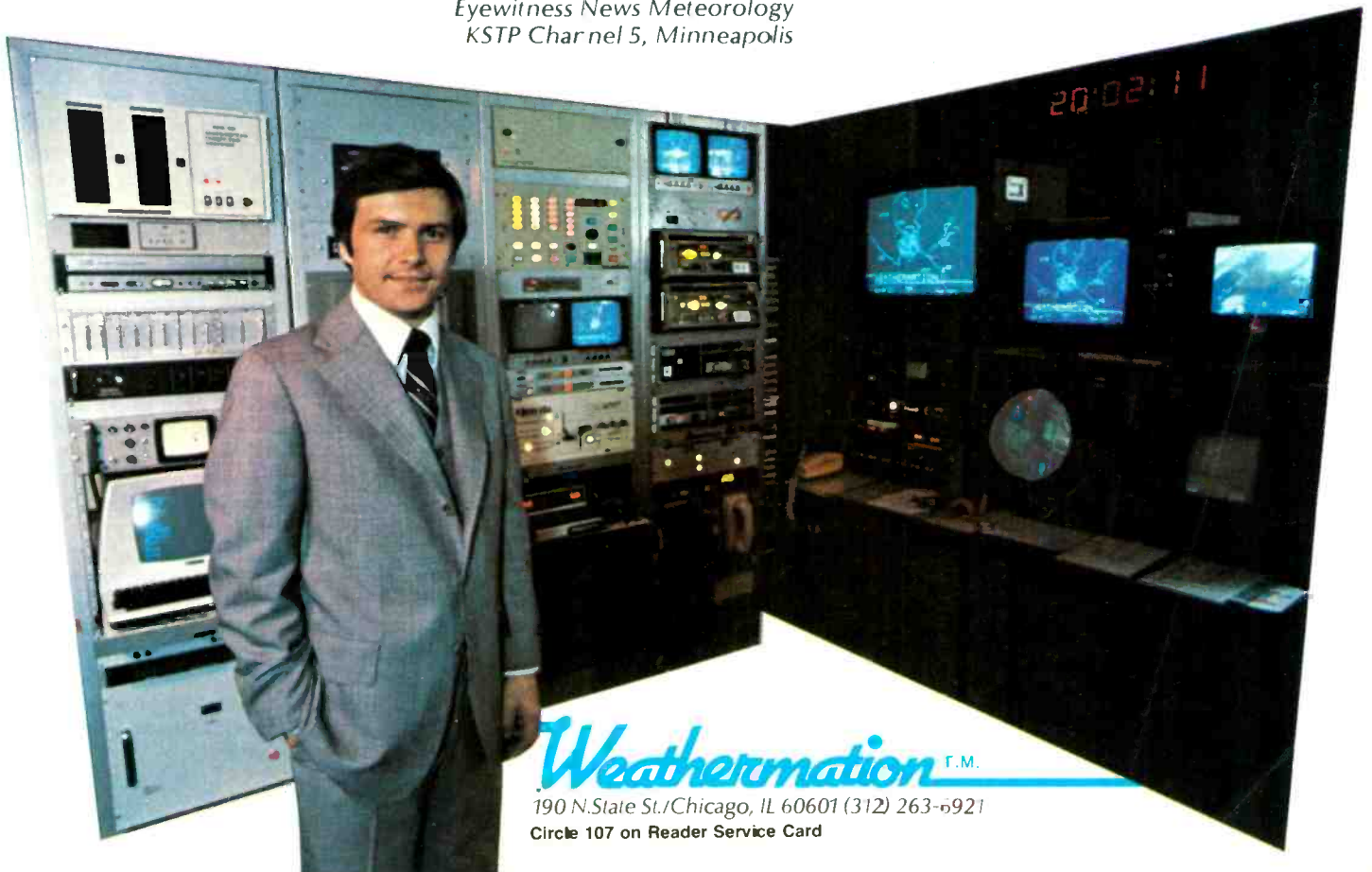

Weathermation T.M.

190 N. State St./Chicago, IL 60601 (312) 263-6921

Circle 107 on Reader Service Card

Business Briefs

Central Dynamics Ltd. has added over 20,000 square feet of manufacturing space to its plant and headquarters in Montreal in a \$1,100,000 expansion and modernization program **Fidelipac Corp.** has been appointed sole master distributor to the broadcast industry for the **Audio-Technica** ATP line of phono cartridges and replacement styli **dbx, Inc.**'s Professional Products Division has appointed Crescendo Associates of Miramar, Fla.

as manufacturer's rep for that state.

Ampex Corp. has delivered over 40 VPR-2B helical VTRs worth over \$3 million to Blairsat, Inc. television stations across the country. Another 12 VPR-2Bs and two SMC-100 slow motion controllers have been sold to Gaylord Broadcasting Co. for a total price of over \$1.2 million. KSBW-TV in Salinas, Calif. has ordered three VPR-2Bs and a VPR-20 portable VTR worth an estimated \$350,000 for production and post-production work. The company also reports three major videotape contracts, worth a grand total of \$12

million. Bell & Howell Video Systems Division, Teletronics Video Services, and U.S. Video Corp. will each be supplied with quadruplex and helical broadcast videotape as well as U-format, VHS, and Beta-format videocassettes for the production and duplication of movies and other programs for the home and industrial video markets The South African Broadcasting Corp. has ordered an estimated \$500,000 of videotape editing equipment from **Convergence Corp.** The contract covers 11 full ECS-103B editing systems with time code readers and other optional equipment for multi-source operations.

Broadway Video has purchased its second **Sony** BVE-5000 computerized editing system for its New York City post-production facility. On the other side of the country, KGO-TV, San Francisco's ABC O&O, has purchased 45 **Sony** WRT-27/WRR-27 wireless mic systems, 29 for the station's ENG crews and 16 for its film crews KRIV-TV, Houston, has ordered a TV-110U 110 kW UHF transmitter valued at \$960,000 from **Harris Corp.** The first NECAM II recording console in North America has been installed at Motown Recording Studios in Hollywood by **Rupert Neve, Inc.** KTTV and Metrotape West, the production division of Metromedia, have selected a Neve 24-channel 5315 console for their Los Angeles recording facilities.

WBRC-TV, Birmingham, Ala., has taken delivery on a **3M** model 40X series microprocessor-controlled routing switching system that accommodates 30 inputs and 20 outputs Knight-Ridder Broadcasting, Inc., headquartered in Providence, R.I., has ordered \$1.6 million of **RCA** videotape equipment, including eight TR-800 one-inch Type C VTRs and three TCR-100A VCRs. Ziff-Davis Broadcasting Co. will upgrade five of its TV stations with an equipment order that includes 10 TK-76C cameras and two TCR-100A VCRs **Valley People** is discontinuing the original Allison Research Kepex and Gain Brain signal processing equipment as of June 1 in favor of the new Kepex II and Gain Brain II **Wold Communications** provided satellite facilities to over 40 FM stations for a stereo simulcast of the Grammy Awards in late February. Approximately 20 more stations aired the awards on a tape delay basis.

R. Roger Watson has been named director of marketing for **Microtime, Inc.** William Park has been promoted to national sales manager for the Broadcast Division of **Sony Video Products Co.** Andrew V. Juettner has been appointed vice president of engineering for **Harris Corp.**'s Broadcast Products Division.

NEW!

A High Performance VIDEO DELAY D.A.!

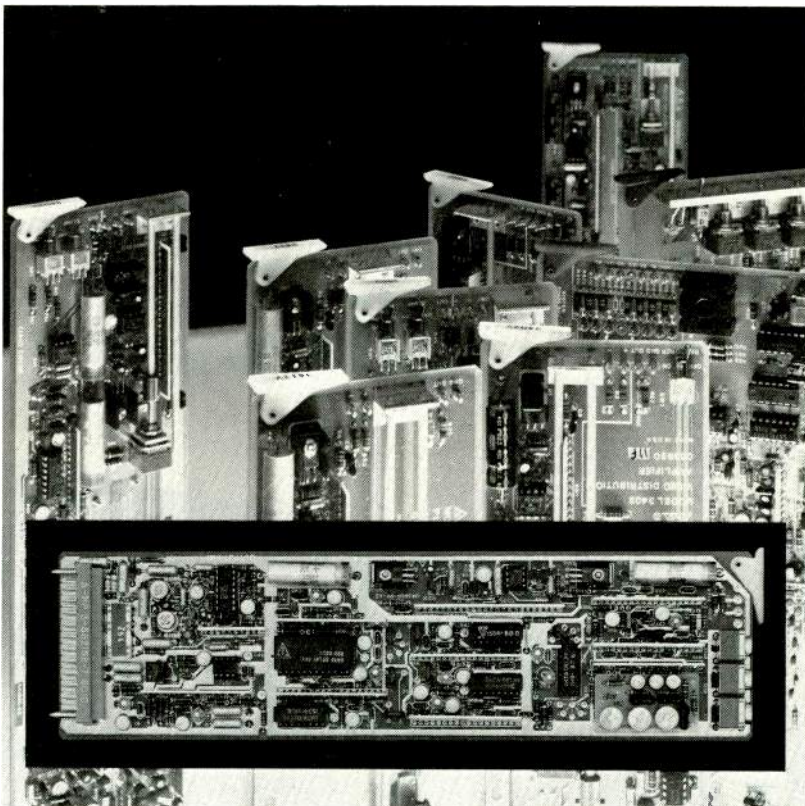

Introducing a GVG™ video distribution amplifier flexible enough to provide *adjustable delay from 65nsec to 550nsec!* Also; six outputs and optional cable equalization, all in
**ONE COMPACT PACKAGE,
THE MODEL 3430V!**

THE GRASS VALLEY GROUP, INC.®

P.O. BOX 1114 GRASS VALLEY CALIFORNIA 95945 USA

Circle 108 on Reader Service Card

Two Assignments

Canon J13x9B IE plus Canon J25x11.5B IE and your camera

Two assignments, one location. For example, get great action shots of a football game and also get player interviews at half-time. You can do it with one cameraman and *one camera*—like the one shown here—with Canon's amazing E.F.P. lenses. Here's how:

Mount our J25 x 11.5B IE on a tripod at your principal location. It's 2/3" system was designed specifically to work with ENG cameras, yet this lens provides a 25-to-1 zoom ratio, power zoom and focus, automatic iris and the image quality you'd expect from a Canon broadcast lens. Another choice is the Canon J20 x 8.5B IE, with a 20-to-1 zoom ratio. (Both these lenses have built-in extenders, too!) With your ENG camera attached, you've got full capability.

Detach your camera from the fixed lens, mount the famous

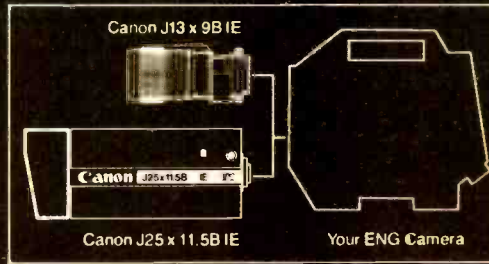

Canon J13 x 9B IE and head for the locker room!

You've got a 13X, f1.6 lens now and can move about freely for your interview shots.

The J13 x 9B IE is unsurpassed as an ENG lens, with Cable Drive and auto iris capabilities

plus built-in extenders and auxiliary wide-angle and telephoto accessories available as well.

Electronic Field Production is a reality. A practical reality because you don't have to send two crews or even two cameras to a single location if all you really need is one ENG camera and two Canon lenses. And, costs notwithstanding, sometimes you just don't have enough cameras to go around. Selecting the right combination of Canon lenses could actually double the utility of the ENG cameras you already own. And that's something even your accountant can appreciate!

Find out more. Use the coupon or write on your letterhead for the facts on the Canon J25 x 11.5B IE and J20 x 8.5B IE lenses, as well as our popular J13 x 9B IE. We'll also be happy to arrange a practical demonstration for you. A very practical demonstration!



Canon

Optics Division

Canon U.S.A. Inc. Head Office: One Canon Plaza, Lake Success, N.Y. 11042 (516) 430-5700

140 Industrial Drive, Elmhurst, Ill. 60126 (312) 833-3070 • 13 Paulatino Avenue East, Costa Mesa, Ca. 92626 (714) 979-6100

Canon Optics & Business Machines, Canada Ltd., 3245 American Drive, Mississauga, Ontario L4V1B8, Canada

Canon Amsterdam N.V., Industrial Products Division De Boelelaan 8, Amsterdam, Netherlands

© 1981 Canon U.S.A. Inc.

Circle 109 on Reader Service Card

The name to know in broadcasting.
Please send me information on Canon BCTV lenses and accessories.

Name _____ Title _____
Company/Organization _____ Phone (____) _____
St _____ City _____ State _____ Zip _____



Maxell gives you the professional advantage.

If your professional or business requirements call for the regular use of blank audio or video recording tape, you can't afford to lose production time because of inferior products. As a matter of fact, you need the kind of tape that consistently provides you with *all the advantages* of performance and durability you depend on for professional results. We call it *The Professional Advantage*, and at Maxell we are dedicated to giving you *just that*, with every audio and video tape we make.

Our magnetic tape products employ highly sophisticated formulations that reproduce original source material with exceptional accuracy, whatever the application. Our binder system and processing techniques assure that what you record, you keep—without dropouts, shedding, print-through or distortion.

Our superior cassette shell technology provides the precision necessary for smooth and quiet tape transport without slipping or jamming.

We make it our business to manufacture high quality products that give you every advantage. You'll get the professional results you demand, the first time and every time you use a Maxell audio or video tape. To discover more about Maxell's professional advantages, call one of our Regional Sales Offices: Eastern Office, Moonachie, NJ (201) 440-8020 ■ Midwestern Office, Glenelg, IL (312) 469-3615 ■ Western Office, San Jose, CA (408) 238-2900

maxell
PROFESSIONAL
INDUSTRIAL
PRODUCTS

The Professional Advantage

Maxell Corporation of America
60 Oxford Drive, Moonachie, NJ 07074

RADIO

PROGRAMMING & PRODUCTION FOR PROFIT

Chamber Music Is Up, And So Is Rock

ONE CULTURAL phenomenon of the past five to seven years is the ever-growing popularity of serious chamber music. There has always, of course, been a deeply committed audience for chamber music. What has been happening is the obvious expansion of this audience to many times its earlier size. Chamber music followers no longer constitute a microscopic fringe of the body politic. The near-universal sell-outs of the Chamber Music Society of Lincoln Center for a number of years are just one part of the evidence for this.

Now comes a radio program that can only add force to the trend, while deeply pleasing all those already attuned. It is called *St. Paul Sunday Morning* and will be produced every Sunday, as the name indicates, at station KSJN in Minneapolis, by Minnesota Public Radio. It is a 90-minute show that goes onto the National Public Radio net for use by any public station that wants to carry it. First airing was scheduled for March 22 (after this was written).

The programs will be based mainly on the St. Paul Chamber Orchestra, with other groups and soloists coming in from time to time. The St. Paul Chamber Orchestra is one of the most respected smaller groups in the country. The listing of material in the first few programs should make chamber-music devotees wave their arms in delight. Program One (we hope those already past will be repeated; everything is on tape) was all-Bach (for his birthday): Suite No. 3 in D Major; the Fourth Brandenburg Concerto; "Christ Lag In Todesbanden." Program Two will be a Handel Concerto Grosso; Vivaldi "Winter" from the "Four Seasons"; "Elegy" by Elliott Carter; Bach Suite for Flute in B Minor; Mozart Divertimento, K.138.

The programs that follow continue this very high level of attraction, with some of the guests being the Deller Consort with vocal music of the Renaissance and Dennis Davies, piano, and Charles Holland, tenor, with songs by great song writers from Grainger to Bartok, plus black spirituals.

A main feature of the programs, as stressed in the advance publicity, will be an informal, conversational tone added by conductor and host Bill McGlaughlin, who will interview musicians and composers, give back-

grounds for the music, and generally talk in a relaxed way about what is going on. This reassurance for the musically timid is aimed to gather more people in; more power to it.

Presently the programs are available only to nonprofit stations, but the producers may consider in the future a shift in contractual arrangements to make the programs available to both commercial and noncommercial stations. With literally hundreds of earth terminals going in for radio stations across the country, in another year or two there will be a couple of thousand stations that could, with minor additions to their equipment, get the NPR programs.

The programs will be technically superb, too. *BM/E* talked with Tom Voegeli, producer of the programs, who said the concerts will be taped in the new state-of-the-art studios of KSJN, in a room of about 55,000 cubic feet with advanced acoustic treatment. The studio is part of a 24-track recording facility, using MCI automated consoles and MCI and Studer tape machines. Every recording channel has Dolby noise reduction.

When asked about digital recording, Voegeli said that KSJN hoped to have it within a reasonable time. He has already made some experimental tapes with digital equipment. He said the early digital editors made his particular job difficult to do, and the prices of the equipment were very high too. But these impediments to the use of digital recording are in the process of removal and these concerts and others like them on the NPR satellite net will represent a source of magnificent music for radio stations with earth terminals.

The series has received support from a number of foundations — the Martha Baird Rockefeller Fund for Music, the Andrew W. Mellon Foundation, the Northwest Area Foundation — as well as from the Public Broadcasting System.

On discs: 25 years of rock

What might be called the Establishment history of rock and roll, which has been reissued every few years by Drake-Chenault, Los Angeles syndicator, has appeared again this spring. It has been completely redone by Drake-Chenault to celebrate the "25th Anniversary of Rock" and consists of 52 hours of music on 52 discs. Included



Bill McGlaughlin conducts orchestra in new live-music studio of KSJN, Minneapolis, for *St. Paul Sunday Morning*

is the Number One rock hit of each year, '56 through '81, and a lot of other material besides.

The 1981 "History" is narrated by Bill Drake, who did the first one some 13 years ago as well as all those since. Drake also wrote much of the continuity and was, of course, deeply involved in the choice of the music. As one of the founders of Drake-Chenault, Bill Drake has had a special relation to and understanding of rock music for many years.

The Drake-Chenault "History" has been an outstanding success in earlier years. Does the 1981 response of broadcasters indicate any falling off of interest in "standard" rock music? Although the program had just come on the market when this was written, Jim Kefford, just promoted from vice president to president of Drake-Chenault, told *BM/E* that sales were strong, indicating another full success.

We can speculate that the better early rock songs have become classics, or "standards," in pop music terms. The Drake-Chenault discs come right down to the moment. So the range is from Bill Haley and Fats Domino right up to the current kings and queens — Queen, for example.

Among the more topical items is an interview with John Lennon dating from a few days before his death. A large number of other current rock performers speak on the records in response to Bill Drake's questioning. Any radio programmer interested should call Jim Kefford at (213) 883-7400.

BM/E

Comrex Makes Low Frequency Extenders

An audio must. Broadcast quality on a standard dial telephone line. For networking, "first & last mile" satellite delivery, news, sports, weather, farm, stock market, religious or special interest programs.

Cue Systems

The ideal way to direct ENG field personnel. A 1 watt IFB system that allows ENG crew to hear both program and instructions in one pocket receiver. ALSO - TV Aural Monitors. Rugged pocket receivers fix-tuned to your TV channel for live off-air cueing. 50-550 MHZ.

Wireless Microphones

A new line of ENG gear.

Talk Show System

A studio/telephone interface system that permits on-air conferencing of two incoming telephone callers with studio host. The only complete, ready-to-go talk show system available.

For further information, call or write:

COMREX

18 Years in Broadcasting
P.O. Box 269
60 Union Avenue
Sudbury, Massachusetts 01776
TEL: (617)443-8811
TWX: 710 347-1049

Circle 111 on Reader Service Card

Program Marketplace

Syndicators For Radio

The FM 100 Plan
John Hancock Center
175 East Delaware Plaza
Chicago, Ill. 60611
Tel.: (312) 440-3100

WHEN THIS DEPARTMENT last reported on the FM 100 Plan in August, 1977, this syndication operation founded by Darrel Peters had grown from zero to about 90 subscribers in around 2½ years. FM 100 has kept up a fast pace ever since. Subscribers now number well beyond 100 and constitute a large syndication business. Market success is nearly universal among them.

Thus, a revisit to the FM 100 Plan should provide us with some benchmarks for movements and trends in radio programming. This seems especially interesting because FM 100 built success on, and is still totally committed to, Beautiful Music as a programming staple. From some quarters lately has come the observation, "Beautiful Music is beginning to fade."

Some cases seem to support this, but other factors are clearly involved since many of the syndicators truly successful with Beautiful Music over the years are still flourishing, along with their subscribers. One example is Radio Programming/Management, featured in the January issue of this magazine.

It also applies emphatically to the FM 100 Plan. Darrel Peters, president and founder, and Ray Lowy, sales manager, brought *BM/E* up to date in a recent interview. They cited numerous cases of stations jumping four, five, 10 places in the ratings after signing up with FM 100.

The basic factor seems to be Peters's sensitivity to movements in popular music and his ability to anticipate taste changes. These changes are in the particular character of Beautiful Music, but not away from a basic Beautiful Music format. Even three and a half years ago the FM 100 format was more "foreground," more lyric than Beautiful Music had traditionally been. Peters has continued to move his music toward what he perceives as the "next" thing the listener wants, where taste is going.

There are now three formats: *Beautiful Music*, the most popular; *Beautiful Country*; and *Beautiful Contemporary*. *Beautiful Country*, according to Lowy, is not the stereotypical twangy, stomping music that "Country" meant in the past. It is more lyric, softer, but still built on the "hot" country songs. This is the kind of Country large sections of the audience respond to today.

Beautiful Contemporary similarly

reflects Peters's perception of taste trends. It aims to be just in front of the listener preference movement, with a "forward" Beautiful Music treatment of popular tunes, using a good proportion of vocals.

Lowy points out that the FM 100 music works so well because Peters aims, not at the music people have been wanting in the past, but at the music they are going to want soon. This requires not only close study of the popular music field but also some instinct for what people are feeling and where that is leading.

FM 100 is in a particularly good stance to "customize" music because the firm is producing a large proportion of its music itself. Lowy says that FM 100 has recently invested more than \$300,000 in music production, mostly with musical groups in the Chicago area. This has given the company a library currently including more than 1500 cuts of the custom music, and more is being added steadily.

In his role as producer Peters can get just the quality he wants in the music. Arrangers, conductors, vocalists, and musicians are all closely directed.

This customizing originated, of course, as Peters's response to the scantiness of Beautiful Music on the American market, the drying up of this kind of music on American records noted in earlier articles here. Other Beautiful Music syndicators have gone abroad to produce music, as described here several times. FM 100 has used mostly American artists, with production in the Chicago area.

The necessity to produce his own music has given Peters the chance to get just the music he wants, as already noted. Lowy remarked that a number of recent subscribers have been stations that did their own Beautiful Music programming for long periods. "It's too tough for them out there today," he said. "Only a syndicator has the resources to get the music together."

FM 100 also supplies sales and promotion help to subscribers (as do a number of other syndicators). In this area Peters's long experience in station management, which parallels his programming efforts, comes into play. He is currently vice president and a leading mover and shaker of WLOO-FM in Chicago, where, in fact, the programming for the FM 100 Plan first came together under his guidance. This station is still using Beautiful Music as originated by Peters, and reputedly took in about \$6 million in 1980, a spectacular proof of the format's power.

FM 100 clearly has the advantage of personnel indoctrinated in the day-to-day necessities of station operation. And it has the crucial advantage of good instincts about the nature and direction of taste in popular music. **BM/E**

Introducing PR-99 The Broadcaster's Revox that Studer built.

As a broadcaster you know the value of Studer reliability — and the importance of Revox economy. Now both are built into the Revox PR 99. And what's more, it's designed specifically for *your* needs.

The PR 99 offers balanced inputs and outputs; XLR-type connections, with calibrated or uncalibrated levels; and ASA-VU metering with LED peak indicators.

The rugged die-cast chassis is designed for rack or console mounting. Reel capacity is 10.5 inches and tape speeds are selectable at 3.75, 7.5 or 15 ips with a vari-speed remote control option.

Complete editing facilities include dump editing, full head access and 2-way self-sync which help make the PR 99 the best machine in its class.

The Studer designed transport and die-cast head assembly block and tension arms provide instant smooth start-up and outstanding tape handling.

Here's traditional Studer quality built into the Revox PR 99. Perfect for broadcasters or any professional.

STUDER REVOX

Studer Revox America, Inc. 1425 Elm Hill Pike,
Nashville, TN 37210, (615) 254-5651 Offices: L.A. (213) 780-4234
N.Y. (212) 255-4462. Studer Revox Canada, Ltd.



**Now You Can Have Both.
Awesome Power.
Elegant Simplicity.**

Introducing the AVC Series Production Switchers from Ampex.

Microprocessor based. Unequaled multi-level video power. And a simplicity of operation that can only be called an incredible design achievement.

The AVC Series Switcher is the most advanced switcher available today.

Designed For The Operator.

Our new switcher delivers two important advantages. It vastly increases the operator's creative capabilities while actually reducing his workload.

So you can expect better results. Because the AVC Series features a logical, familiar A-B operation and a simple, compact control console.

Innovative Design That Offers More.

The AVC Series offers more capability than any competitive switcher on the market today.

For instance, unrestricted keying power from a very flexible keying system. Every video input, as well as two external inputs, can be key sources.

The switcher's standard key memory system can remember up to four separate and distinct key set-ups for each input. No key is restricted as to what type of key is introduced.

Another example of design innovation is the panel-oriented STAR Memory System. This provides increased capability because you can recall the entire switcher set-up or any desired part. It also allows the contents of the M/E's to be swapped with each other or transferred as required.

The Future Is Now.

The introduction of the AVC Series Switchers represents a strong commitment from Ampex to the state-of-the-art in switcher technology.

We invite you to take a closer look. Ampex has combined awesome power and elegant simplicity and the result is tomorrow's switcher today.

Call your Ampex representative soon.

Get the Ampex Edge.



Ampex Corporation, Audio/Video Systems Division
401 Broadway, Redwood City, CA 94063
415/367-2011

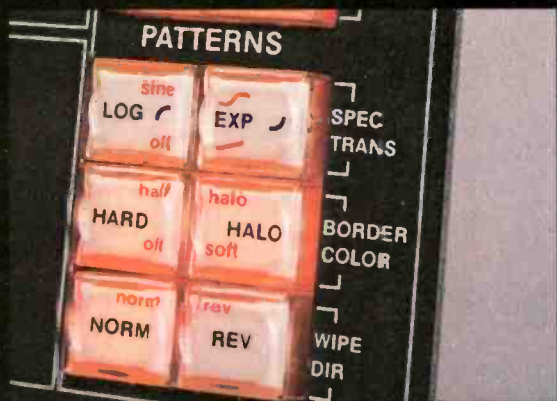

ADVANCED PATTERN CAPABILITY



SIMPLIFIED SET-UP & ADJUSTMENT

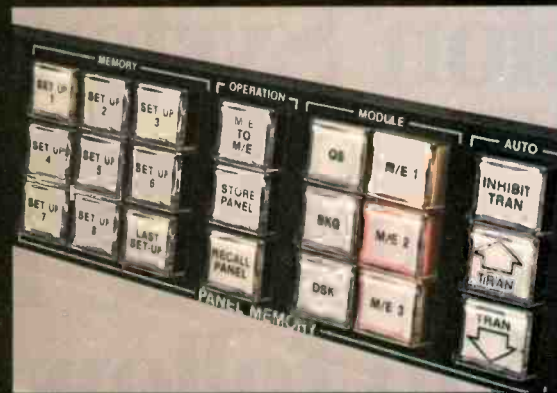

PANEL STAR™ MEMORY SYSTEM

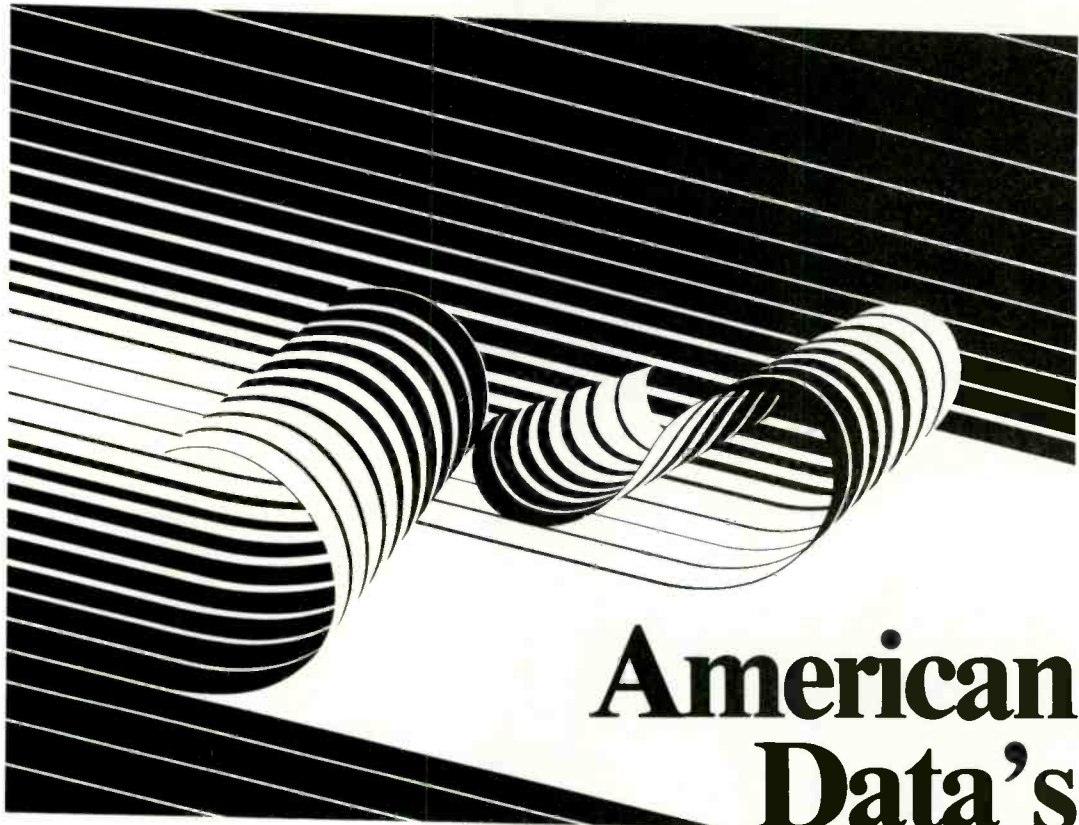

**American
Data's
"ACTS"**

**Automated Control
Television System
for Production
Switchers, the ACT
that is hard to follow.**



American Data

401 Wynn Drive • Research Park • Huntsville, Alabama 35805
(205) 837-5180 • TWX 810-726-2125

A North American Philips Company

Circle 114 on Reader Service Card

TELEVISION

PROGRAMMING & PRODUCTION FOR PROFIT

INN: UHF's Get A Higher Frequency Of News

JOHN CORPORON is one of those deceptive people that you meet now and then. He's tall, lean, and soft-spoken. Despite many years on the east coast, he's never quite managed to lose the mid-western inflections in his speech pattern. His hair is grey, but you just know that it ought to be straw-colored. And then you blink and the whole picture changes.

Corporon is not some hayseed from the sticks but one of the most innovative minds in broadcast journalism. Every time you bump into something new in news, you will probably discover that John Corporon had something to do with it.

In 1967 people were skeptical when independent WNEW-TV, New York, started a 10:00 p.m. newscast. Who would be crazy enough to put a news show up against the network prime-time offering? John Corporon.

The 10:00 news on WNEW-TV has become an institution in New York. It has an impressive record of doing serious journalism over the years. And the ratings have been more than respectable.

A lot of stations around the country were subscribers to TVN, the defunct news service. When TVN went out of business on short notice, many of the non-network affiliated stations could have been out in the cold for national and international stories. But the Independent Television News Association was formed to fill the vacuum. Who was the president and guiding force? John Corporon.



John Corporon, who seems to be in the middle of many news innovations, is executive producer of INN and news director at WPIX-TV, New York



Because of the shared facilities, the clutter and chaos that newspeople seem to need to function properly is doubled at WPIX and INN

WPIX-TV, New York was getting swallowed up in the ratings by the network O&Os when it tried to go head-to-head with its newscasts at 6:00 and 11:00. Then the times were switched to 7:30 and 10:00 p.m. The ratings went up. Last year, WPIX-TV's newscast won an Emmy as the best local newscast in New York. The best — beating out WABC, WCBS, WNBC, and its 10:00 rival WNEW. Is it necessary to say that the news director at WPIX-TV is John Corporon?

It would seem to some people that Corporon could put his feet up and bask in the sunshine of his works. But John Corporon wanted to start Independent Network News.

About a year ago, WPIX and co-owned WGN, Chicago, two of the founding members of ITNA, dropped out. Corporon and WPIX management wanted to form INN but continue as an ITNA member and use the ITNA material for the INN newscast. ITNA's position as a nonprofit cooperative was that it would not be right to make money off its material. The board also felt that only stations that had news departments could be part of the cooperative so that they could contribute stories to the other members. Corporon felt that the increased fees that would be paid to ITNA would offset the lack of material from the mostly UHF stations that would sign up with INN.

Most UHF stations have been struggling under the VHF shadow because of the superior signal strength of VHF. And because the VHF's have

been around a lot longer, they also have a superior monetary strength. In an age when the news department is the most expensive operation of stations, it makes it difficult for UHF stations to get in from the ground floor. It is estimated that a modest-size news department would cost \$500,000 to put together from scratch.

With lower ad rates and programming that consists of off-net reruns and old movies, a half million dollars is a sizable chunk out of a station's budget. For the most part, UHF stations have opted not to have news departments. There are some notable exceptions of course, but the majority felt that news was too expensive. A trend developed of having short headlines sprinkled throughout the broadcast day.

"A lot of stations," according to Corporon, "wanted to go into news but weren't ready to bite the bullet and crank up news. They were waiting, without knowing they were waiting, for an inexpensive way to get into a quality news operation." Corporon thinks that from most objective standards the newscast put on by INN is one that is of competitive quality. The judges at the New York TV Academy certainly thought it compared favorably to the news product of the network O&Os.

Independent Network News came along and offered the stations a full-blown newscast as counter-programming in prime time. And best of all, it's free. INN is offered as a barter deal. The station gets three minutes of commercial time for local spots and INN

THE TOWER

ROHN

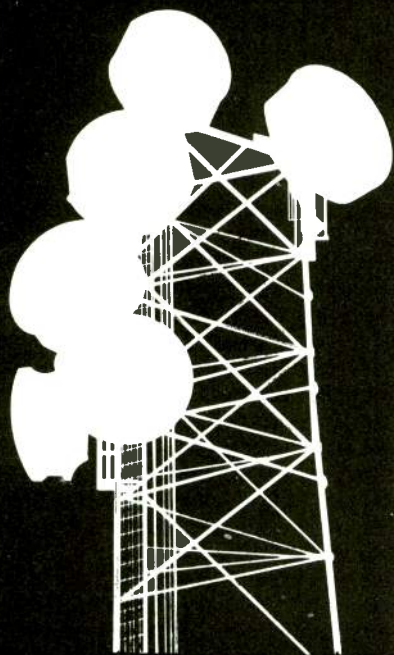

UNR-Rohn

Division of UNR Industries, Inc.
6718 West Plank Road, P.O. Box 2000
Peoria, Illinois 61656
U.S.A.

Circle 115 on Reader Service Card

TV Programming

sells three minutes to national sponsors.

John Corporon's vision notwithstanding, it is clear that INN would not exist if it wasn't for satellites. "The thing that gave birth to INN," explains Corporon, "was the development of satellite technology." He also feels that the public appetite for news has increased to an extent that stations would be foolish not to program to fill it.

Though even Corporon was surprised at the rapid growth of INN, he says, "We felt that there was a market out there but we didn't know that it would grow as fast as it did." When INN signed on last June there were 26 stations signed up. At that time the estimated audience for INN was 36 million. In early March there were 48 stations in the INN lineup with an estimated reach of 50 million viewers. That works out to about 64 percent of the households in the U.S. — quite a reach for a service that is less than a year old.

The INN newscast has three anchorpersons, Bill Jorgensen, Pat Harper, and Steve Bosh. Jorgensen is a veteran New York broadcaster who was the first anchorman for WNEW's 10:00 news. After a contract dispute he joined WPIX in 1979 as the co-anchor of the late news with Pat Harper. Pat Harper has been at WPIX for several years. When she began she co-anchored with her then husband Joe. Steve Bosh joined the station from WCBS where he co-anchored the 6:00 news. Why use three anchors on a half-hour newscast? "Because it works," says Corporon.

When INN was organized the staff was increased by about 30 people, bringing it to about 70. There is some overlap between the WPIX staff and the INN group. Corporon is the news director of WPIX but the executive producer of INN. Bill Littauer is the executive producer of news of WPIX and the senior producer of INN. There is a managing editor who has the same title for both organizations. The assignment editors are split for INN and WPIX except on the overnight when that editor works for both. The writers are separate. There are more writers working for WPIX because they produce more broadcasts. The reporters in New York report for all newscasts, but only for INN when the story has national implications.

INN also has its own bureau in Washington. Bureau chief Elvera Ruby has about a 15-person staff. Four reporters work out of the Washington bureau: Ford Rowan, formerly with NBC, Drew Scott, Charles Quinn, and John Aubuchon. The bureau covers all the major Washington stories. Rowan, as senior correspondent, tends to cover the White House and thus is on all the pres-



The Sony-equipped edit facilities are also shared by INN and WPIX, though it's first come, first served

idential trips.

A couple of things that are different about INN's newscast are that the show has a sportscaster, Jerry Girard, and a weatherman, Bob Harris. There is also a billboarded business report.

INN gets its foreign news from Visnews and UPITN. The domestic coverage, aside from the Washington news, comes from a variety of sources. Some of the larger stations like WGN in Chicago, KCOP in Los Angeles, and others have news departments and provide coverage of stories in their areas. For the most part no money changes hands, but if a story is not being covered by the station and INN wants it they will pay for out-of-pocket expenses and a modest amount over.

The INN newscast is now fed seven days a week on Westar 2. It's fed live at 9:30 eastern time, but most stations replay it at 10:00 p.m. There are, however, several stations that take the broadcast live. Most of those are in the west, where the newscast would come at 6:30 p.m.

The projected budget for INN's first year was about \$6 million, "and we've not been disappointed," adds Corporon with a smile. While not going into specifics, Corporon said that INN will exceed its budget, though there are indications that the year end will still see the new network at a profit. Slim maybe, but a profit nonetheless.

The market for a service like INN is substantial but not infinite. There are only so many independent stations and the saturation point can be reached quickly. Already the rate of growth of INN has slowed. But then, it already covers 64 percent of the television homes in America. How much more growth can there be? It seems reasonable to speculate that somehow, something will be added to cause another flurry of activity. We are, after all, dealing with John Corporon. **BM/E**

**A YEAR AGO
NOBODY BUT SHARP'S
ENGINEERS SWORE BY
THE XC-700.**



TODAY THE PROS

"WE DON'T SEE A \$27,000 DIFFERENCE BETWEEN SHARP'S XC-700 AND A \$44,000 CAMERA."

*—Larry Hatteberg, Chief Photographer
KAKE-TV (ABC's Wichita Affiliate).*

"My cameramen were pretty skeptical when Sharp® introduced the XC-700 last year.

Like a lot of pros, they just didn't believe that a \$12,000* camera could be any good. But we were looking for an economical way to go from film to tape, so we decided to give Sharp a shot.

We started using the XC-700 at the Democratic Convention last summer. And by the time we were covering the World Series, we were believers.

In fact, we've got seven XC-700's in our news department right now, and we're just one camera away from being an all Sharp operation.

So we've made the transition to tape long before I ever thought we could.

And we've done it with a minimum of compromise.

Of course, there will always be differences between an XC-700 and a \$44,000 camera. But reliability isn't one of them.

For day-in, day-out reporting, the XC-700 has held up as well as any camera we've ever used, even the most expensive ones.

It's also easy to handle. With the controls up front where a cameraman would expect to find them. And more features pound for pound than all the cameras I've seen in its class.

They say it was designed by cameramen, not engineers. But all I know is that the XC-700 has given our station a lot more for its money.

For \$44,000, we didn't just get a lot of camera. We got a lot of cameras."

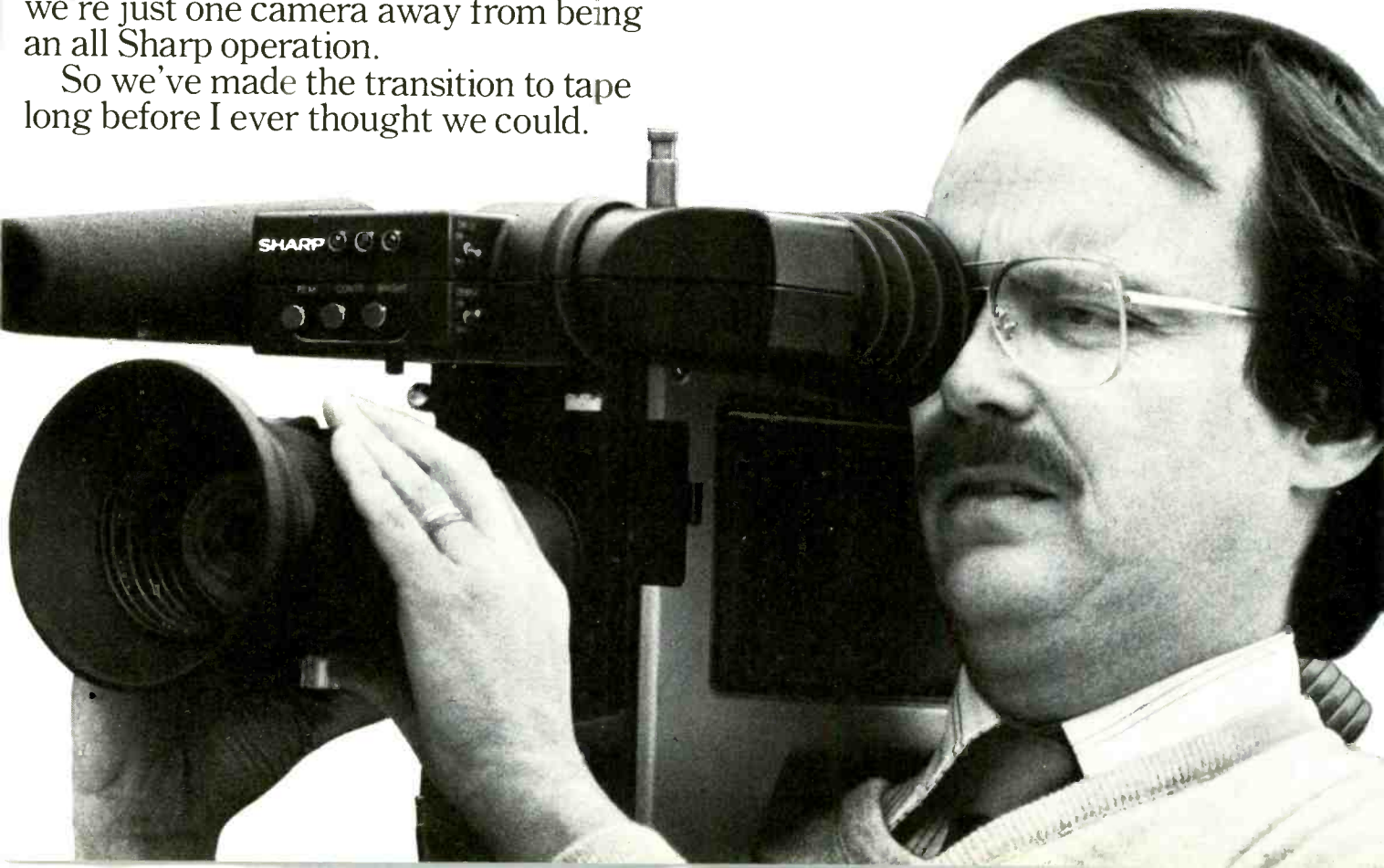

SWEAR BY IT TOO.



**“FOR SHOOTING IN LOW LIGHT,
SHARP’S XC-700 BEATS
ANYTHING IN ITS CLASS.”**

—*Sue Hartung, Chief Photographer
WLUK-TV (ABC’s Green Bay Affiliate).*

“Some of my best stories have been shot under the worst possible conditions. But with Sharp’s XC-700, the last thing I worry about is the light. I’ve covered warehouse fires and a bombing at night, with nothing but police lights or an occasional street light to shoot by. I’ve gotten shots of children touring a hospital, where the lights were kept low enough to read X-rays by. I’ve even photographed an operation for the removal of a brain tumor. And in every case, the Sharp® XC-700 really showed me something. It also surprised a few of my colleagues at the station, because we’ve all had bad experiences

with cheaper cameras in the past. So it’s refreshing to find a camera in the \$12,000 range* that’s loaded with features and that has one other important thing going for it. Dependability. In our business, that’s the name of the game. Because our territory is 20 counties and our average story is an hour away, so I only get one shot at stories I’ve worked on for hours. And if I don’t get it with the camera, I don’t get it on the air.”

For more information and more field reports from other working professionals, contact your local dealer or write: Sharp Electronics Corporation
Professional
Products
Dept. BME-4
10 Keystone Place
Paramus, New
Jersey 07652
**See the Sharp XC-700
at the NAB Show, Booth 1121.**

SHARP

*Manufacturer’s Suggested Retail Price \$12,600. Less Lens.

Circle 116 on Reader Service Card



Julius Barnathan, President
Broadcast Operations and Engineering
American Broadcasting Company

CHYRON® IV

OVERLAP ROLL

COLOR PALETTE
COLOR PALETTE

CAMERA COMPOSE

Italicize

DUAL CHANNEL

CRANL LIBRARY

PARTNERS IN PRODUCTION

The CHYRON® IV is a vital member of the ABC production team. For most of the leading TV stations and production houses, CHYRON has become their indispensable "canvas, brush and palette."

And, like Picasso, with these tools they create some of the most memorable graphics in the world...

Follow the Leaders with

CHYRON
TELESYSTEMS

A DIVISION OF CHYRON CORPORATION
265 Bethpage-Spagnoli Rd., Melville, N.Y. 11747
516-249-3296 • Telex: 144522 Chyron Melv

Circle 118 on Reader Service Card



ON THE ROAD: REMOTE VEHICLES

Everyone's field production needs are the same: production outside the studio. But the solutions for stations and production facilities are all different. This article takes a look at some of the answers.

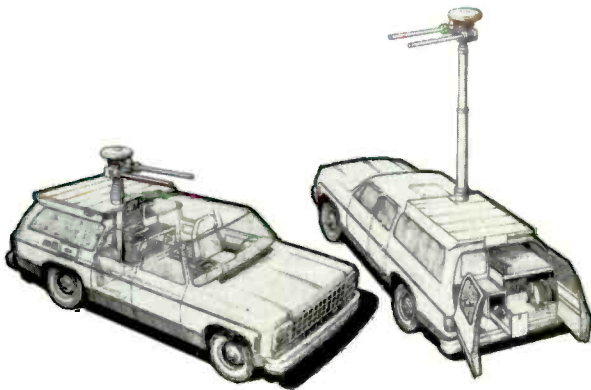

WXYZ's new microwave unit as envisioned by Wolf Coach. It contains everything for ENG in a small package

Part of WXYZ's current ENG fleet. Note the cover for the antenna to provide protection from harsh Michigan winters

KATV, LITTLE ROCK does a lot of field production. Much of it is sports — this season alone the station has telecast 27 University of Arkansas basketball games. And little needs to be said about the importance of college football in Arkansas and neighboring Oklahoma.

"Remotes have always been a big part of our operations," says Eric Nelson, operations manager at KATV. Because the station did a lot of remotes, the networks were always calling for various feeds. The station, however, never felt it really had the equipment that was needed for network productions because the setup was for their own use. But that changed two years ago.

"When the time came to upgrade our equipment for ourselves, we decided to see what the requirements of the





Bell Helicopter **TEXTRON**

**A Bell
JetRanger III
puts you
on top
of the
competition,
giving you
an edge in
audience
share.**

Get a big story on the early news instead of the late night edition and you have a tremendous competitive advantage. If the viewer watches the early telecast, you stand a good chance to hold him all evening. And that means rating points!

The best way to beat the competition is with a Bell JetRanger III. It gets you into otherwise inaccessible areas. It lets you transmit live up to 120 miles away, or tape and transmit enroute. The story can be on the air before you land.

Bell's JetRanger III is a superior ENG platform, offering low noise and vibration, so you get sharper pictures and cleaner audio. The large cabin allows shooting from either side through large sliding windows. And there's no need to clutter the space, because there's plenty of storage room in the baggage compartment, as well as in other accessible storage areas.

Bell's JetRanger III. Backed by the world's most extensive parts and service system.

Would you like to see what one can do for you?

For more information on Bell helicopters designed for the communications industry, contact Bell Helicopter Textron, Department 698, Box 482, Fort Worth, Texas 76101, or call 817/280-2117.

Remote Vehicles

network are for smaller regional feeds," explains Nelson. Since the station was an ABC affiliate and ABC does a lot of regional college football games, KATV went to ABC to find out what was needed in a remote unit. The specifications that came back listed a unit with four to six cameras, one-inch VTR, graphics, IFB, telephones, and support equipment. At that point the station had to decide what they needed in the new unit and how it could mesh with the needs of the network.

"We build trucks for us," explains Nelson, "because we want to keep them busy for us but make them available to the network. Fortunately we were able to strike a happy medium. It was a design that served our purposes very well but still fit the requirement the network had for regional football games."

Nelson feels that the station should be in the broadcasting business and not the remote business and that only using the facilities for outside work would not be profitable or wise. But the combination works well for all concerned.

Barbara Seipt, director of sports unit managers for

Video Recording Celebrates Silver Anniversary

This month it happens — the videotape recorder turns 25. The quarter-century mark finds the VTR at the very center of television station operation; today's television would be unthinkable without it. Its nonbroadcast uses, also, are myriad: education, medicine, industry, and sports are just a few of the areas the VTR has made its imprint on.

As many veteran readers no doubt remember (and younger ones also know, but have a harder time comprehending), the VTR was not always with us. The first practical VTR was demonstrated by Ampex Corp. at a meeting of CBS affiliates in Chicago on April 14, 1956. It had taken four years of work by a six-man team at Ampex to reach this triumphant moment, which was greeted by delighted cheers and shouts from the audience. Videotape recorders had been demonstrated earlier by both RCA and Bing Crosby Enterprises; these machines operated with fixed tape heads and very high tape speeds, however, so their commercial value was limited due to extremely high tape consumption (engineers at the BBC were also working on a machine of similar design).

Ampex took a different tack, however, going the route of rotating tape heads and two-inch wide (as opposed to quarter-inch) tape. This allowed a slower speed of 15 ips, which was very promising but hardly eliminated the problems of putting images onto magnetic tape. The research team, headed by Charles P. Ginsburg (still with Ampex as vice president, advanced technology planning), also included Ray Dolby, Charles Anderson, Alex Maxey, Fred Pfost, and Shelby Henderson.

Television stations were quick to recognize the advantages of video recording. The first videotape broadcast took place on November 30, 1956, when CBS taped a live news program in New York City and replayed it on tape for the West Coast.

Other videotape pioneers were not about to throw in the towel, however, although they soon switched to the rotary



CBS delegates at the Conrad Hilton hotel react with amazement to April, 1956 demonstration of Ampex's practical videotape recorder, center



CBS engineer adjusts Ampex VTR during the first tape broadcast in November, 1956. All three networks adopted videotape over the next few months

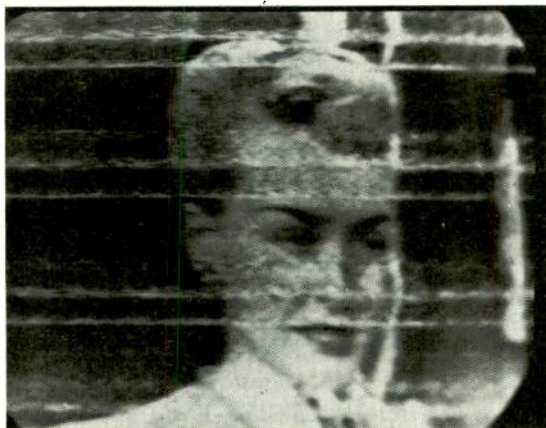

A prototype Ampex VTR produced this tape image in February, 1955. The "venetian blind" effect was removed within a month

head system. RCA introduced the first production model of a color VTR in 1957. The machine, model TRT-1AC, occupied six entire standard cabinet racks — a far cry from today's compact machines. Its tape speed was a sedate 15 ips. 3M was also busy, producing two-inch videotape in 1956 and selling its first commercial reel of Scotch brand videotape the following year. Also in 1957, tape compatibility among the different available VTRs was demonstrated.

As appropriate as this time may be for looking backwards, it is probably too much to expect the television industry to spend much time reminiscing. The rapid advance of the videotape recorder — from its basic, bulky beginnings to its present sleek, streamlined incarnation complete with bells and whistles — recapitulates the growth of the industry as a whole and no doubt foreshadows similar development to come. With the VTR apparently about to go digital (see SMPTE report on p. 101) who can tell what is in store?

Remote Vehicles

ABC, is responsible for securing facilities for the ABC telecasts. It is her staff's job to keep track of all the remote units around the country. "We're very demanding about the kind of units we use," she says. It is a measure of how well KATV managed to meet its own needs and the needs of the network that when asked for a list of large, first-rate units at local stations, Seipt listed KATV's van first. She mentioned co-owned KTUL in Tulsa in the same breath because the trucks are identical.

Actually, there are two remote units at each station — a large 40-foot Crown Coach and a smaller 27-foot GMC. Both units, except for the vehicle shell, were constructed by station personnel. The large unit is equipped with four RCA TK-46s, two TK-76s, and Ampex VPR-2s (the number varies from two to four depending on the event). The switcher is a Vital VIX 114 with 16 inputs. The audio console is an Audiotronics 16 by four. The unit is divided into four sections: a glass-enclosed audio booth, a production area, engineering, and videotape.

The large unit also has a service vehicle that travels with it — a Ford truck with a 20 by eight-foot box on the back. When the unit travels to a remote site the truck hauls cabling and ancillary equipment. At the site, it can act as practically anything. Nelson explains, "It's fully carpeted, air conditioned, indirect lighting, telephones, and has power outlets. Once it's on site it becomes an office or graphics area for the Vidifont Mark IV or an extra tape room for additional tape machines."

KATV's 27-foot GMC is set up for four TK-760s and either 3/4- or one-inch format. The switcher and the audio console are the same as in the larger unit.

Flexibility on a budget

WPSX is the PBS station licensed to The Pennsylvania State University. It is operated by the university's Division of Media and Learning Resources, which is responsible for servicing not only the needs of the university but also the broadcast needs of the viewers of public TV. As is the case with many PBS stations around the country, WPSX faces a constant flood of field productions that must be done on a shoestring. For its remote units it has to make full use of any and all equipment.

Not surprisingly, then, at WPSX the concept is multiple usage. The trick is to have a standard van (in this case the Wolf Coach Hippo) and customize it in such a way that it is easy to slip gear in and out as needed.

When the 18-foot box is fully operational it has three cameras, all configurable for both ENG and EFP. One of the cameras is a RCA TK-76 that has been retrofitted with a remote control interface; the other two are TK-760s with cut-down units that allow them to be used as ENG cameras.

Inside the van there is a rack-mounted Sony BVH 1100 with slow mo, TBC, and the test equipment. The whole thing can be removed and placed in the studio as an extra edit and playback machine. There is also a BVH 500 that is used for ENG recording but can be put in the truck and used as a second record machine or as the slow mo playback.

The switcher and the audio console are about the only things that always remain in the truck. The switcher is a Grass Valley IL and the audio console is a Rain Dirk with eight inputs and two outputs (though it's possible to move



The mobile unit at WPSX-TV gets a lot of field work covering everything from ballet to soccer

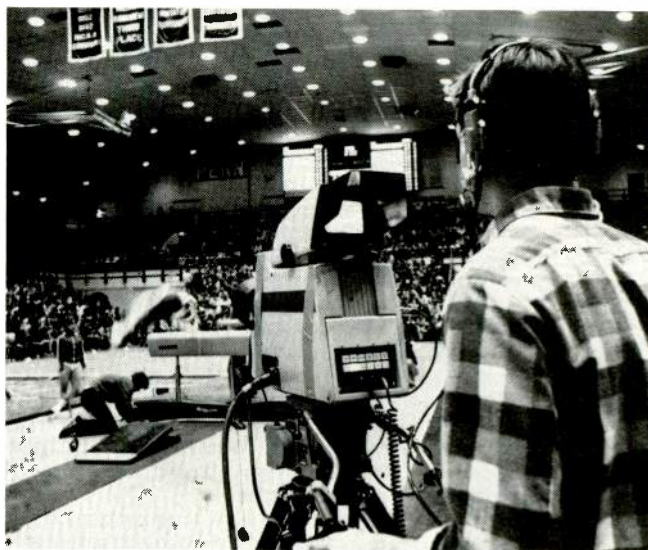

(Photo by H. Roger Kohn) At a recent women's gymnastic meet at Penn State, the flexibility of the unit was demonstrated. The RCA TK-760 can also be used as an ENG camera

the audio console without too much trouble).

Larry Johnston is assistant director of broadcasting in charge of operations for WPSX. "For people on our kind of budget it's an ideal situation," Johnston comments. "The bulk of your hardware cost can be constantly used rather than tied down to just being a mobile van."

ENG van: portable power in a small package

The trend in ENG vans for news departments is to move toward smaller vehicles but still maintain the kind of remote capability that exists in larger vans. Several manufacturers (Wolf Coach, ENG Corp., Midwest, and others) are offering the GMC Suburban as a microwave unit.

Until very recently, WXYZ-TV, Detroit, built all its news units in-house. The fact that the station was an ABC O&O didn't prevent the management from taking a hard look at what was needed in a microwave van for the Detroit market. The station decided to go with the Subur-



The production control room of the WPSX unit contains a Grass Valley IL switcher and a Rain Dirk audio console



Both Sony BVH recorders can be easily removed for ENG use in the case of the 500 and for studio use in the case of the 1100

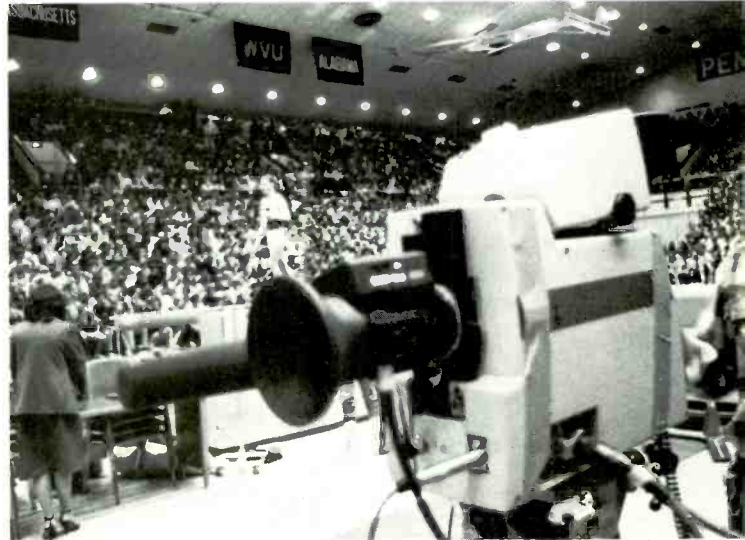

By means of a cut-down unit, it is easy for the WPSX-TV production staff to adapt for either ENG or EFP use with the 760s

ban, which was then packed with everything necessary for live and tape capability. WXYZ has seven microwave units; four are fully equipped microwave setups and the other three are equipped with portable microwave gear.

One of the ideas behind the units was that all equipment should be quickly replaceable. Therefore, all gear was stored on carpeted shelves and held down by removable clamping devices. This plan also allowed for the easy transference of the equipment in a building if the remote moved indoors.

The equipment in the WXYZ units is there to cover a variety of news situations. Each unit contains a Microwave Associates 2 GHz transmitter, a 13 GHz window transmitter, and a Will-Burt 50-foot telescoping mast with a pair of Nurad Goldenrod antennas with remote panner. On top of the mast is a TV receiving antenna so that off-air signals can be recorded and demodulated right in the truck with a rack-mounted demodulator.

Each unit has two portable tape machines, a Sony BVU 110 as main recorder and either a 100 or a 3800 as backup. The cameras are Ikegami HL 79As and 77s.

Even though the new unit that the station has ordered is coming from an outside vendor the concept is the same — flexibility. Mike Doback, manager of ENG operations for WXYZ-TV, went to an outsider vendor for the unit because the staff has grown so much in the past few years that most of the time is spent on news coverage and little is available for building vans. “When we first started,” he explains, “I used to be the one crawling around under the van wiring up stuff. I can’t do that anymore and neither can most of the staff. It made sense to go outside. My people are trained in electronics, not vehicle fabrication.”

Though most stations have the same objective — quality field production — the solutions vary widely. But the constant has been: look closely at alternatives and work out a plan that suits your station’s requirements. **BM/E**



Designed to
put vibration
and resonance
in their place.

In a professional quality turntable, you want musical vibrations, not mechanical ones. That's why our Professional Audio Division presents the Technics R&B Series SL-1015 turntable and EPA-500 interchangeable tonearms. They put vibration and resonance where they belong—out of the audible level.

The SL-1015 turntable system has a visco-elastic base that absorbs external and mechanical vibrations instead of transmitting them. The extra-heavy platter is damped 3 ways to help cancel platter resonance and acoustic feedback. A high-torque motor provides instant starts. And quartz-synthesized pitch lock with digital display precisely controls speed.

The EPA-500 tonearm system is a series of 5 independent, instantly interchangeable titanium nitride tonearms that let you match the correct tonearm mass to the correct cartridge compliance. The result is music in focus, with inaudible resonance.

The SL-1015 turntable and EPA-500 tonearms are available at select locations. For one near you, call 800-447-4700 (in Illinois, 800-322-4400). We challenge you to hear anything but the music.

Technics
R&B series



STUDIO QUALITY FOR RADIO VANS

New compact audio equipment of great refinement, top-grade distribution of programming via satellite, and strong growth in listener response to "live" music have combined to promote great expansion in the production of concert programs in vans. The stories of three stations shed some light on an operation sure to be attractive to many other radio stations.

AS ONE OF THE FIRST full-scale satellite nets in operation, the National Public Radio net is showing us some of the trends that very wide use of the satellites in radio, now rapidly coming in, will bring to radio broadcasting in general. As often noted recently, one large effect of the satellites is the prodding of radio broadcasters to upgrade their audio.

Another highly visible trend is expansion in both the supply of, and the demand for, high-quality music, par-

ticularly for live concerts, either direct broadcasts from the concert scene or first-generation stereo tapes made right at the scene for later broadcast.

A number of radio managements have found that the easiest and most efficient way to produce such programs is in vans fully equipped for multi-microphone pickup and mixdown to a finished tape or an air-ready program — often both simultaneously. In April, 1980, *BM/E* described a top-quality van designed for this purpose by the Canadian Broadcasting Corp. that immediately found wide use in the Canadian net's program origination. An update on the story of this van appears later in this article.

A van with the same design objectives was built more than a year ago at KUSC-FM, station of the University of Southern California at Los Angeles. KUSC is on the NPR satellite net and is, in fact, one of the regional uplink stations. The top-grade audio quality of the NPR satellite channels has encouraged member stations to ask for more and more live music, and all centers of production for the net are responding.

KUSC's response has consisted in the design and construction of the van and its use for production of a very large number of concert programs to be fed to the satellite net. The design was the work of Hugh R. Paul, director of engineering at KUSC. It is based on a 24-channel Audi-

Hugh Paul, left, director of engineering, KUSC, stands by Audi-tronics console in concert van. At right is W.W. Weide, president of Fleetwood, builder of interior

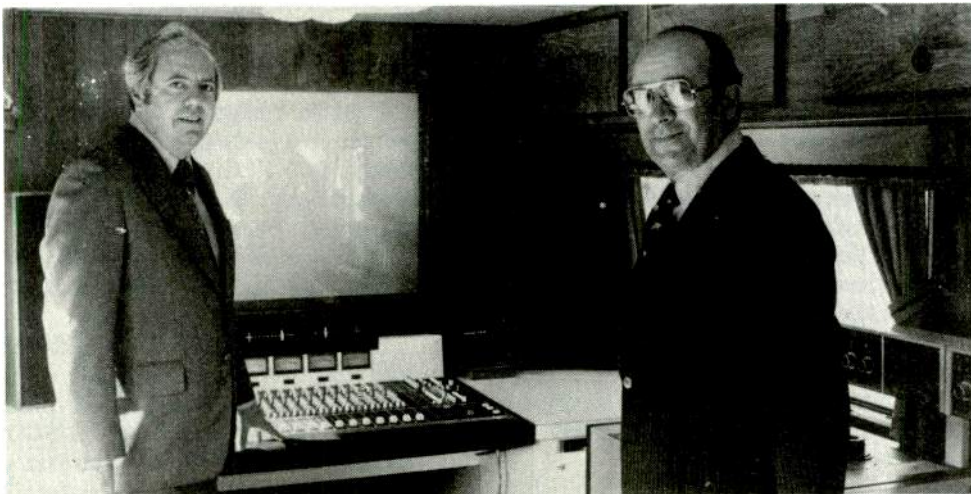

Studio Quality For Radio Vans



Operator position in concert van built by KPBS has multi-channel console on table, tape recorders left and right. Walls and ceiling have sound absorbing cover to improve acoustics for accurate monitoring

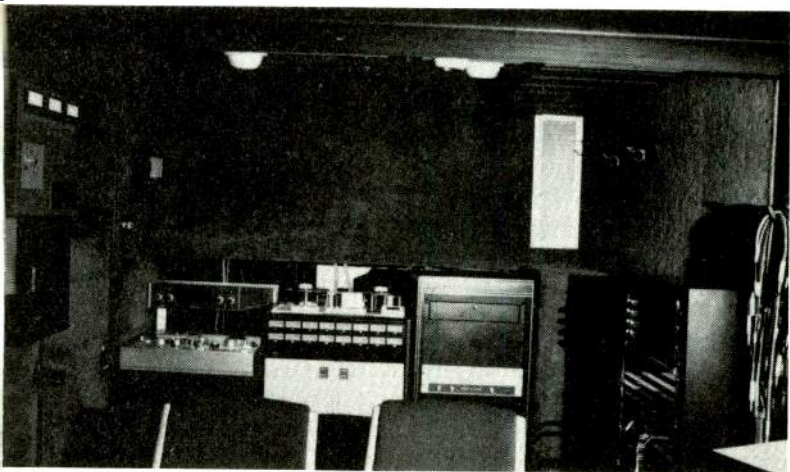

In rear of operator position in Canadian Broadcasting Corp. concert van are Ampex multi-channel recorder, Studer recorder, rack with electronic units. Reverb unit is on ceiling

tronics broadcast console, which provides the control and mixdown to two-channel and four-channel recording on a bank of Studer tape machines. The van boasts an array of audio processing units and top-grade stereo monitoring channels with JBL monitor speakers.

The interior has careful acoustic treatment so that the monitored sound will not suffer serious false balancing that would confuse the mixdown operator, who hears substantially what is going onto the tape and can control balances, reverb, and processing to get just the desired effect. Microphone inputs on the outside of the van make it easy to run as many microphones as needed into the concert hall or up onto the outdoor music platform.

This system, of course, puts heavy weight on the skill of the operator in making a live mixdown, a high art that takes considerable training. KUSC, according to Hugh Paul, has been successful in developing a corps of operators who do the job well, and the resulting quality has been extremely well-received by NPR station operators and listeners.

The van also has a separate booth, acoustically isolated

from the main operation area, equipped for announcements and on-the-spot interviews. Intermission commentary is one of the uses for the booth.

In about two years of use the van has carried a tremendous, increasing load, and is now to all intents and purposes booked solid. Paul told *BM/E* that he could easily use a duplicate van. Among the programs produced in the van for the NPR net have been all recent concerts of the Los Angeles Philharmonic Orchestra and all Los Angeles performances of the New York City Opera. The van has been sent to literally dozens of local music events—chamber music, local opera, jazz concerts, and many others — and has been as far afield as the Aspen Music Festival.

The van can send a program directly to the uplink transmitter at KUSC for immediate airing, while simultaneously producing the final tapes. The transmission to the KUSC studios is via a microwave system, with a collapsible microwave antenna on the van.

KUSC has also used the van occasionally to pick up the sound from a televised concert to supply the stereo program for simulcasts from public TV station KCET in Los Angeles.

Asked what advice he would give other radio broadcasters designing such a van, Paul said, "The most important factor in keeping costs reasonable is to find a body manufacturer who will sit down with you and discuss in detail what you want. You, for your part, must learn how the manufacturer makes the various parts, what the essentials of his usual design are, so you can adapt your plans to his construction capabilities. If you ask him to make something specially for you it is going to cost a great deal of money. For example, the side panels on most mobile homes are made on jigs that allow fast, closely duplicated production. If you ask for an entirely different panel a new jig will be needed — that is very expensive.

"It is also vital to total up the weight of what you will put in the truck and make sure the truck is designed to carry it with a good safety factor. A number of television vans built recently have been breaking down quite often simply because they are overloaded."

KPBS van does double duty

At KPBS-FM in San Diego, the management has developed a van not only for production of music programs on wheels but also for a wide range of public affairs and community events. The van is not primarily for hard news coverage, although it can be used for that; the station's programming does not emphasize such news, but does include a great many pickups of conferences, seminars, local public events of wide interest, celebrations, etc.

Thus the equipment in the van has a double character. For music it includes an Allen and Heath console with 10 inputs, two Revox A700 tape recorders, JBL monitor loudspeakers, and a complement of audio processing equipment. There is a battery of microphones of several types which can be run into the concert hall or auditorium. Again, the operator can make a final mixdown to stereo right in the van.

The music events covered with the van have included jazz and folk music concerts. A jazz festival, "Jazz Alive," was one recent program produced in the van. In many cases the tapes go to KUSC in Los Angeles for feeding onto the NPR net. The jazz concert and festival music has been extremely popular with NPR stations.



IF YOU'RE GOING TO DO IT ... DO IT RIGHT!

We "do it right" when designing and constructing mobile and fixed television facilities to insure superior technical/mechanical performance and human comfort.

Excellence in Telecommunication Systems Design and Engineering.

Circle 121 on Reader Service Card

 **Centro**
CORPORATION

COMMUNICATION ENGINEERS

San Diego, California • (714) 560-1578

CREATIVITY TAKES FLIGHT ON AMPEX VIDEO TAPE.



BROADCASTERS AND PRODUCTION COMPANIES DEPEND ON AMPEX TAPE.

From videotape equipment to the video tape itself, broadcasters and production companies throughout the world depend on Ampex. High quality, durability, reliability, and prompt service are just some of the reasons.

Ampex 175 Highband Quadruplex Video Tape has proven itself under every conceivable type of operating condition within every video standard. Excellent color performance, low drop-outs, and a tough durable formulation with low headwear are features which have contributed to this dependability.

And now Ampex 196 High Energy Broadcast Helical Video Tape has been specifically engineered to fill the increasing needs of a particularly demanding group of video professionals—those who have chosen one of the new broadcast helical VTRs.

No matter what your video tape needs are, there's an Ampex video tape for you. And, once you've tried Ampex tape, you'll see why broadcasters and production companies have grown to depend on Ampex.

AMPEX

REFLECTIONS OF REALITY. AND BEYOND.

Ampex Corporation, Magnetic Tape Division,
401 Broadway, Redwood City, CA 94063 415/367-4463

Circle 122 on Reader Service Card

Studio Quality For Radio Vans

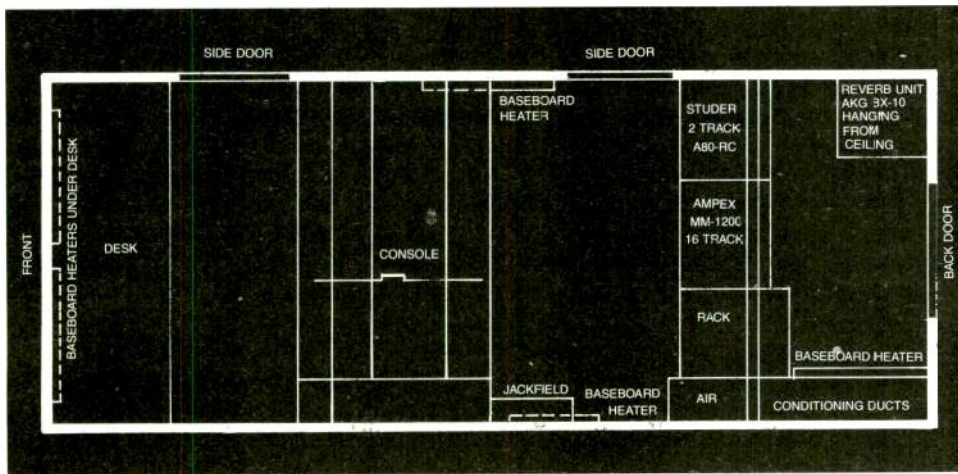

Floor plan of CBC van shows disposition of units for production of concert programs

The public-event side of the operation is built on the same equipment, with the addition of a complement of portable cassette recorders that allow operators to move into a crowd or a meeting for close-up interviews and descriptions. The cassette machines have been modified for improved quality, including modification for use with Electro-Voice RE50 microphones. Among them are Sony TC-142s and TC 1535Ds. Other microphones that can be fed into the van include RE11s and RE15s. There is also a Shure SE-10 compressor/mixer to improve the quality of voice pickups.

The programs produced in the van, whether music or talk, can be transmitted directly to the KPBS studios with a Marti UHF system. Because of the hilly terrain, which often puts the van in a "hole" that blocks the UHF path to the studio, KPBS has installed an automatic receiver on Mt. San Miguel, 1820 feet above average terrain. The receiver has a high-gain antenna on a rotor that can be controlled from the KPBS studio to optimize pickup from the van. The audio output of the remote receiver reaches the studio over an RCA TSL and the base station is wired directly into the console. Thus programs coming in from the van, whether directly or through the remote receiver, can go right on the air.

In addition to the Marti radio link, the van has complete interface for telco line hookup, with a block for a variety of telco input and output connections. The van has emergency power in the form of a Honda 1500 W generator.

Tom McManus, station manager, told *BM/E* that one virtue of the van easily overlooked is its efficiency in the use of station staff. He notes that he would be unable to cover nearly as many programs, whether of music or of public events, with his small staff without the van. With both pickup and final production of the programs right in the van, one or two persons in the field do a major part of the technical programming job.

A third production-on-wheels operation is also demonstrating the spectacular success of the "live concert" with today's radio audiences. The Canadian Broadcasting Corp. van described last April, with design by Don Reagh, director of engineering, is based at the CBC's Vancouver headquarters. It has a 32-input Ward-Beck console, Ampex MM1200 and Studer A80 tape machines, UREI equalizers, Eventide digital delay units, AKG reverb unit, JBL monitor speakers, Crown DC-300 monitor

amplifiers, and a battery of Neumann and Sennheiser microphones.

Like the other vans described here, it can be driven up to the concert hall; connectors are available for placement of as many microphones as are needed. Again, the entire production job is done in the truck — audio processing, balancing, mixdown to stereo. The interior has acoustic treatment to allow the most accurate monitoring of the signal so the operators engaged in the fast live mixdown will not be misled by the acoustic quirks of the listening area. The acoustic treatment includes a "sound trap" at the end opposite the monitor speakers to reduce coloration of the sound by strong bass reflections from the rear wall.

The van, built in 1977, by the next year was covering more than 300 concerts in 12 months. It was useful for everything, from opera and symphony to chamber music, recitals by soloists, rock bands from stadiums, jazz and pop from nightclubs, folk music.

In a recent *BM/E* interview Reagh reported that the CBC, faced with far more demand than the van could accommodate, has built a second one which is based in Toronto — and is already booked nearly solid. A third one is in the works and will be based in Winnipeg.

Like McManus at KPBS, Reagh stressed again the *efficiency* of concert production on wheels. Reagh reports studies that show the van bringing in a concert at lower cost than the usual alternatives. It avoids costly time spent in setting up electronics in the hall and does the job with fewer people than the hall job takes. Moreover, it avoids the very high cost of hiring two high-quality telco lines for stereo. It also opens up for top-grade pickup the large number of spots where such telco lines are not to be had, which includes an increasing number of locations even in larger cities. And, of course, the quality of the signal produced in such a van is far above that of other standard methods for getting a music program from a remote location.

Reagh also emphasized the *versatility* of having excellent audio equipment and the final mixdown to the program all in the truck. The operator has the ability to handle any kind of music, from rock bands in stadiums to pop singers in nightclubs to grand opera, all with the same excellent quality and each with full attention to its special requirements. This versatility is important in making the mobile music production studio such a success. The vans clearly have a great future.

BM/E

RCA CP ANTENNAS RUN CIRCLES AROUND

Outsell nearest competitor by 2 to 1. RCA CP antennas outsell the nearest competitor by more than 2 to 1 for good reason. And there are many more good reasons why RCA has sold 6 out of 10 of the CP antennas on order at the close of 1980. But the bottomline is customer trust and user confidence in RCA CP antennas...and the people who produce them. RCA developed and installed the first commercial CP antenna at WLS Chicago in 1973. Then, as now, RCA engineering, product performance, installation and service support run CP circles around the others.

Engineered like no others.

When you see the care and craftsmanship that go into each antenna at the RCA Antenna Engineering Center in Gibbsboro, N.J., you'll know why our CP's are as good as they are. They're engineered with experience unmatched anywhere,

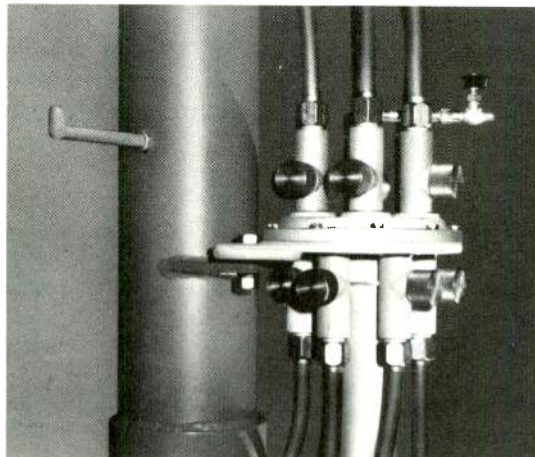

and built to last. For example, feed-line hardware is made from bronze, brass or stainless steel. Feedlines are firmly grounded to the antenna pole at multiple grounding points to eliminate arcing and protect against lightning.



Performance tested for sure results. We test our antennas on every channel for both horizontal and vertical polarization on giant turntables, with the results fed into computers. With this information we've built an enormous data bank from which we can reproduce characteristics for any type of antenna.

RCA Circularly-polarized antennas at these stations:

KCPQ (13), Tacoma, WA.
KCRA (3), Sacramento, CA.
KSTW (11), Tacoma, WA.
WABC (7), N.Y., N.Y.
WBNS (10), Columbus, OH.
WBTW (13), Florence, SC.

WCTI (12), New Bern, NC.
WFMY (2), Greensboro, NC.
WITN (7), Washington, NC.
WLS (7), Chicago, IL.
WNCT (9), Washington, NC.

WPBT (2), Miami, FL.
WRAL (5), Raleigh, NC.
WVTM (13), Birmingham, AL.
WTTV (4), Indianapolis, IN.
WTVD (11), Durham, NC.

XETV (6), Tijuana, MX.
Difusora (4), Sao Paulo, Brazil
Korean Broadcasting System (9), Seoul
TV Litoral (3), Buenos Aires, Argentina
TV Nacional (7), Santiago, CH.

THE OTHERS

Installation, service simplified.

We design our CP antennas for low windloading. That means you can install most of our antennas on your existing tower, probably without tower modifications. To further simplify installations on most types, there's only one feed line on each radiator, instead of the usual two. Fiberglass and steel pole steps are provided for climbing the antenna. We look after the installation to get you on-air properly, and provide incomparable RCA TechAlert service to keep you on.

We think RCA CP antennas are the best choice you can make. Their record in the field proves their superiority beyond question. For the details, call your local RCA Broadcast Representative. Or write RCA Broadcast Systems, Building 2-2, Camden, N.J. 08102.

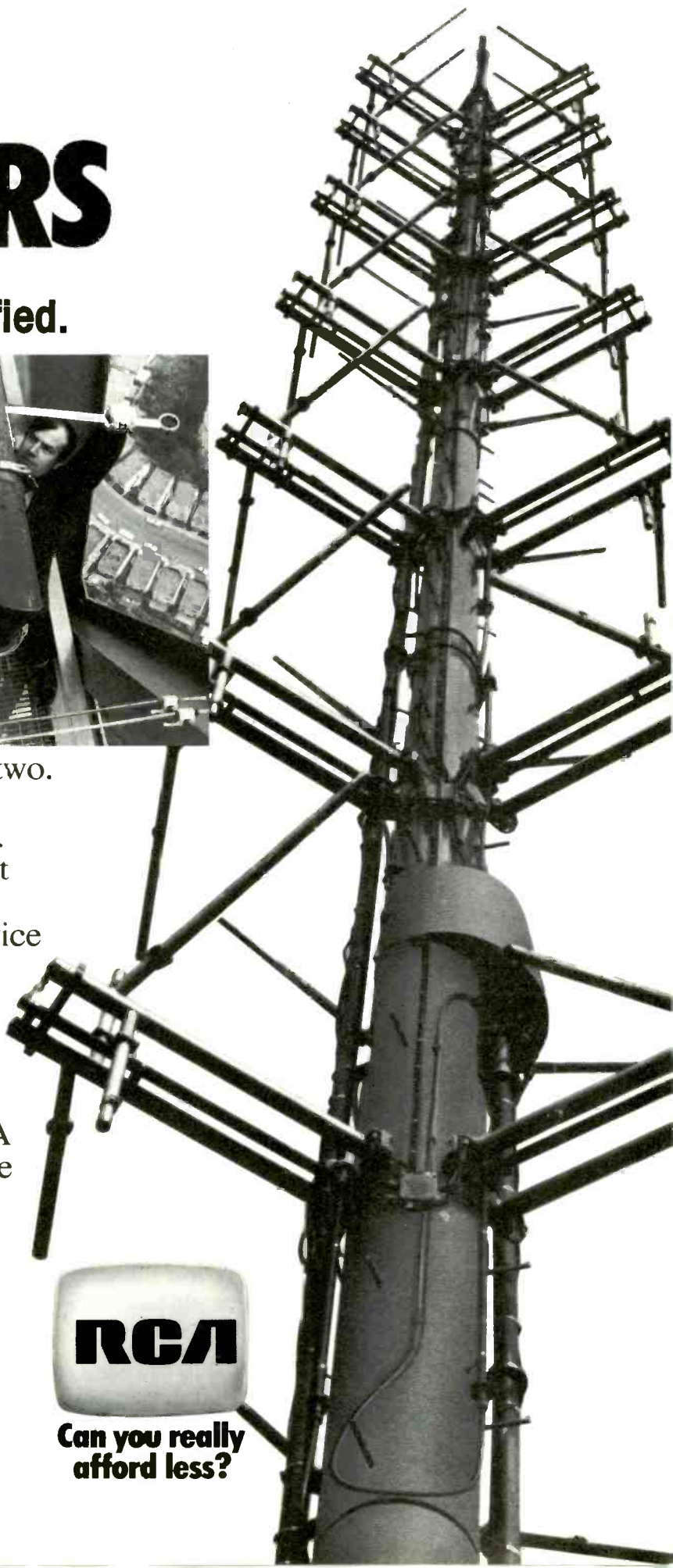
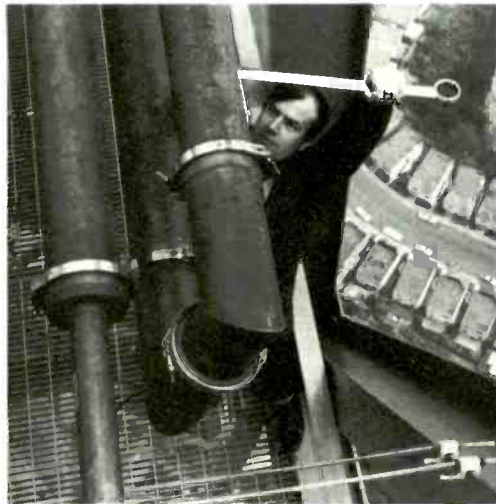

The RCA CP antenna line

Type TDM—Dual Mode, Top Mount, Lowband VHF—Ch. 2-6
Type TCL—Tetra Coil, Top Mount, Highband VHF—Ch. 7-13
Type TFU-CP—UHF Pylon, Top Mount—CH. 14-70
Type TBK—Quatrefoil, Side Mount, Lowband VHF—Ch. 2-6
Type TBJ—Panel, Top or Side Mount, Highband VHF—Ch. 7-13



**Can you really
afford less?**



JANUARY 20, 1981: A REMOTE TO REMEMBER

A planned remote like the Presidential inauguration is one thing, but add the unscheduled return from Iran of the U.S. embassy employees and you have a day that stretched many stations to the limit of their technical capabilities.

IT WAS A DAY that transcended even the most cynical view of media hype. It turned into a catharsis for America and a challenge for the technical wizardry of television. What made this story so different was that so many people were affected on a local level. The Iranian hostage release, for most stations, was a *local* story — but the definition of *local* had to be redefined. When Wiesbaden, West Germany becomes part of the ADI for Philadelphia, U.S.A., something extraordinary is happening.

At first, Alan Nesbitt, news director at WPVI in Philadelphia, didn't think that anything extraordinary in technical terms happened on January 20. "We were spread out, there is no question about that, but *extraordinary* means to me extremely difficult. What we did was not difficult; just testing."

He has a right to his viewpoint, but here is what WPVI did for its newscast on January 20, 1981: a remote in Wiesbaden for the hostage arrival, a remote in Washington for the inauguration, a remote in New Orleans for the Super Bowl (the Eagles were playing this year), and coverage of the hostages' families by various crews spread out over Pennsylvania and Delaware.

The Washington and New Orleans remotes were live. The only reason that the Wiesbaden remote wasn't live was because of conflicts on the satellite feed times — every news organization in the country was trying to get bird time. Even with the conflicts, the pictures were delayed only an hour on that Tuesday. The reporter in Wiesbaden did the narration live over the telephone. "I'm not anxious to see the phone bill for the month," laughed Nesbitt.

WPVI sent a reporter and crew and its own editing equipment to Germany. The material was fed via the ABC feed point in the Sheraton Hotel in Wiesbaden to ABC New York. Because all the lines were tied up between New York and Washington for the inaugural, WPVI sent

its helicopter to New York to pick up the tapes.

And if that wasn't complicated enough, the microwave van that was in Washington had to plug into a spare ABC loop that was being satellited to *Atlanta* and then to New York. WPVI picked up the signal at a downlink at WPHL-TV in Philadelphia. A WPVI microwave van at WPHL took the satellite signal and beamed it back live to the station.

There were four hostage families in the area; unfortunately, not in the immediate area. Two were in Scranton, which is 120 miles away, one was in Reading, about 75 miles away, and the other family was three hours south of Philadelphia in Wilmington, Del. The station hired a second helicopter to pick up the tapes from the crew in Delaware.

Finally, there was the remote in New Orleans. According to assistant news director Bob Feldman, that was no small feat either. "We sent a complete microwave van with a spare receiver. We placed the receiver on top of the tallest building in New Orleans so that we could be remote from anyplace in the city. We brought that signal into WVUE-TV, the ABC station in New Orleans, which gave us total cooperation and additional engineering help. The microwave signal from our remote in the French Quarter went to WVUE and then was fed by landline back to Philadelphia."

As a bonus to the station there were several live pickups into the morning talk show, *AM Philadelphia*. And as a favor, the WPVI truck was loaned to KGO-TV so that they could take a feed back to San Francisco.

"It was one of the busiest non-election news days we've ever had," concluded Feldman with some degree of understatement. When reminded of all the things that were going on that day Nesbitt finally conceded, "You know, it might have been extraordinary after all."

Pushing it through the funnel

Joel Albert didn't think that the coverage at WRC-TV, Washington was extraordinary either. He was too busy to think about it. As manager of news operations Albert is responsible for making sure all the technical and logistical arrangements are made. In addition he frequently acts as the coordinator of joint projects for the five NBC O&Os. This was one of those times.

"The only clear memory that I have of that day was being on the telephone with somebody in New Jersey



Beyond ENG

Born into ENG, the HL-79A adapts beautifully to EFP. The accepted leader in ENG, the HL-79A, reinforced its position as the preeminent portable camera at the 1980 Winter Olympics. Scores of HL-79A's covered the ski slopes, the bobsled and luge runs and the skating rinks for the ABC Network. Their performance brilliantly etched into the world's visual memory, is history. But the industry already knows about the HL-79A's capability.

Today, more and more broadcasters are learning that the HL-79A is a superior EFP color camera. Options such as 4½-inch electronic viewfinder with return video, program and intercom audio plus genlock — among other features —

transform it into the ideal camera for sports and special events, commercials and high quality production. Triax equipped, it ranges nearly a mile from its base station. Near-darkness is its frequent habitat; but it has knee control for brilliantly lit scenes too.

Of course, you may need some of its ENG flexibility for EFP too — like its shoulder action shape, 11.2 pound weight, 6-hour clip-on battery.

The specs and automatic features of the HL-79A are equally outstanding. They're yours, along with an eye-opening demonstration, at your Ikegami distributor. Or contact Ikegami Electronics (USA) Inc., 37 Brook Avenue, Maywood,

N.J. 07607, (201) 368-9171. West Coast: 19164 Van Ness Ave., Torrance, CA 90501 (213) 328-2814; Southwest: 330 North Belt East, Suite 228, Houston, TX 77060 (713) 445-0100; Southeast: 552 So. Lee St., Americus, GA 31709 (912) 924-0061.

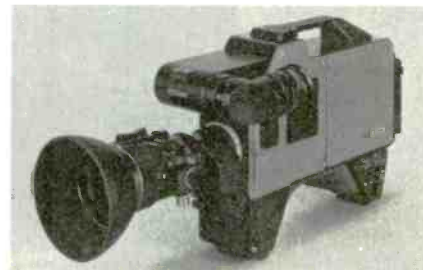

Ikegami HL-79A

A Remote To Remember

trying to arrange for all the telco lines that were going in and out of this place," Albert says. It may be his only clear memory, but something went on because every piece of microwave gear at the station and as much as could be begged, borrowed, or stolen from the network was in use.

The main problem with doing news that day in Washington was the inauguration. It's a big story for the local stations. There are so many events throughout the day and night that the local stations are hard-pressed to keep up with it under normal conditions. Toss in the fact that the Washington area had the largest concentration of hostage families (most of the hostages were career State Department officials, who tend to base in the Washington area) and you have a coverage problem that demands technical wizardry.

"I'm not sure that there was as much wizardry involved," explains Albert, "as there was sheer pushing it through the funnel and jumping up and down to make sure it got through. We just used everything we had to its limit." Albert concedes that he is fortunate in being in the same building with the network news bureau. Because of the network plan for the inaugural a lot of extra equipment was in place. There were also lots of contingency plans made just in case the hostages would be released that day.

"In the 10 years that I have been here," says Albert, "I think that the only thing that rivaled the inauguration for complexity has been the coverage of the Pope. Everything that you've got here is in use. You wind up with no spare



WPVI-TV fed live from Washington, D.C. during the inaugural with reporter Mariellen Gallagher

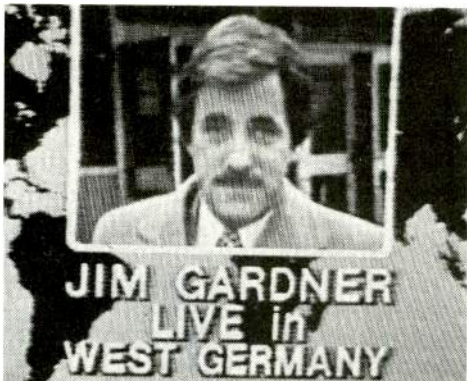

Reporter Jim Gardner was in Wiesbaden and did his narration live by telephone. The pictures were fed back on satellite but had to be delayed an hour



WNBC-TV built a mini-studio for its inaugural coverage and fed the signal back to New York by landline

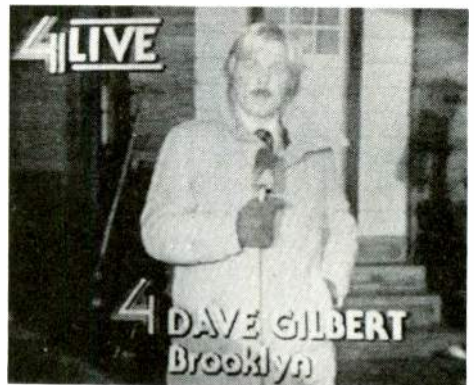

The family of returning hostage Barry Rosen was covered by microwave for live inserts into the WNBC-TV newscast

bodies to do anything. And there is no gear that gets unused in the course of things.

"How we got everything done that we wanted to get done? I don't know! There were times when I lost count of what we had out in the field. It was impossible to keep track of it." That may be so, but it didn't reflect on the air product. Somehow it all came together and there were few, if any, glitches on the air. Albert sums up doing the extraordinary this way: "You have good people and you send them out there with the right tools and let them do their jobs."

Covering the homecoming

Down in Atlanta there was a different problem. The news involved not only the inauguration and the hostages, but also the homecoming of the outgoing President. Despite his loss to Reagan, Georgians still hold a special affection for Jimmy Carter. He wasn't going off to live in New York or some beachfront mansion overlooking the Pacific Ocean, he was going home to Plains.

The Storer station in Atlanta, WAGA-TV, decided to focus a lot of attention on Jimmy Carter's homecoming. A couple of things helped enormously in that effort. One was that WAGA-TV has its own downlink. The second was that the Storer cable division was able to free up a remote truck and lend it to the station to help coordinate the coverage in Plains. The station also was fortunate enough to have one of the two telco lines coming out of Plains; the other was assigned to the network pool.

The station sent about 13 people just for the Plains remote. It was felt that whatever was happening in the rest of the world, Jimmy Carter's homecoming was the big local story. "The story was worth more from a Georgia

INNER VIEW 3: A closer look at Conrac Monitors

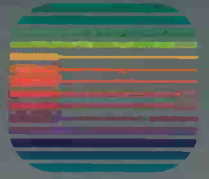

Comb Filter Separator: Resolution Solution at 3.58 MHz.

Conrac's Comb Filter Separator delivers the high resolution needed for today's high performance camera and taping equipment. It removes color information from the composite video signal without the luminance loss in the 3.58 MHz region produced by notch filters.

Conrac's Comb Filter takes advantage of spectrum interweaving to separate luminance from chroma, without reducing luminance bandwidth.

But the best part of Conrac's Comb Filter is that it gives you this improved picture clarity without the drawback of conventional comb filters. Because, unlike conventional comb filters which exhibit heavy dot patterns in the luminance path, Conrac utilizes non-linear techniques to virtually eliminate these patterns around vertical and horizontal transitions.

Conrac Quality: Computer-controlled for the 80's.

The implementation of a failure analysis documentation system has become an essential new tool in



1. Multiburst test signal with conventional bandpass and notch luminance/chrominance separator.



2. Multiburst test signal with Conrac's Comb Filter luminance/chrominance separator.

the quality factor. This system provides the capability of daily test analysis from four different product test and inspection areas. The net results are improvements in product quality and long term reliability.

Conrac Technology: Over 30 years of leadership.

Conrac's track record of technical innovations stretches back nearly three decades; and what we've learned since then goes into every monitor we make today. That is important to you because the more technology we pack into each monitor, the more performance you will receive from it.

Comb filter separator and computer-controlled quality are just two ways Conrac technology can save you time and money.

For the complete inner view of Conrac technology, call or write us today. Conrac Division, Conrac Corporation, 600 North Rimsdale Avenue, Covina, California 91722, Telephone (213) 966-3511, Telex: 67-0437.

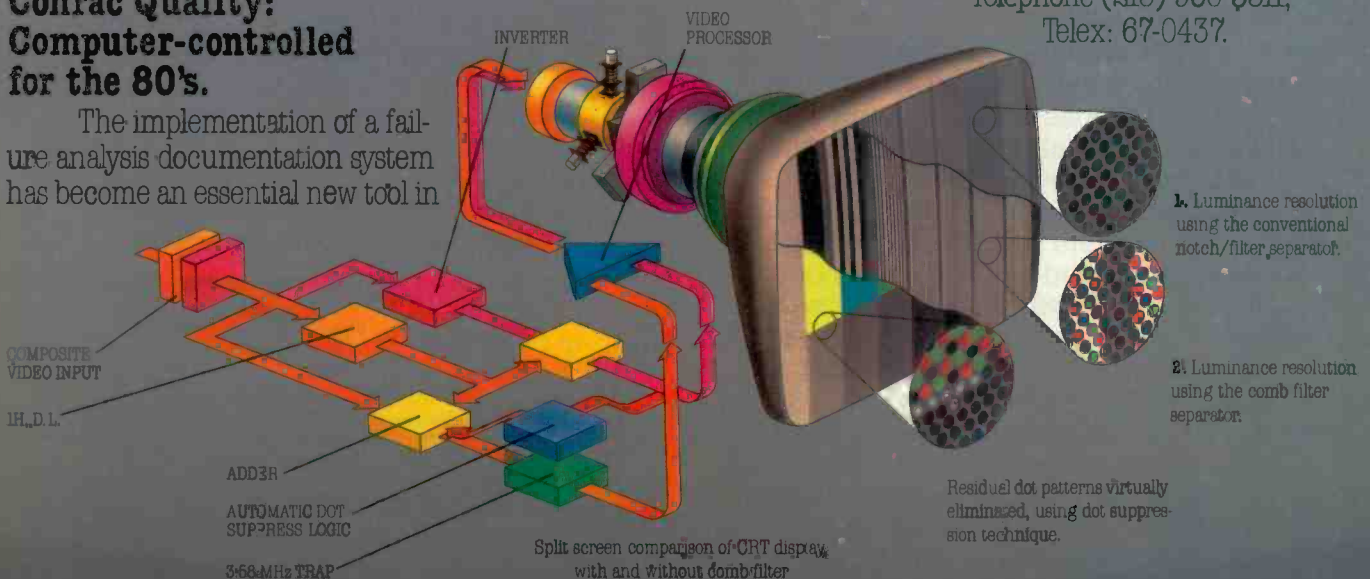

Quality you can take for granted.



Best Picture:
**SCOTCH ONE-INCH
VIDEO TAPE**

"Scotch" is a registered trademark of 3M.

For the second year in a row, Scotch® 479 won the award for the best picture of the year in a test of one-inch video tapes.

We scored well in all of the twelve categories tested, but especially well in the categories that commonly represent picture quality: color dropouts, high frequency dropouts, chroma noise, signal-to-noise ratio and stop motion.

These were scientific, quantitative tests, conducted as you would conduct them yourself, with no room for brand bias. The meters didn't play favorites. The standards were the same for every brand tested. And we tested every brand.

These kinds of test results don't surprise us. We pioneered the invention of video tape. And we've been setting the standard for quality ever since.

Our quality has always been consistent from the first replay to the

last. In fact, our sophisticated binder and oxide coating are more advanced than the binders and oxides on some quad tapes. They had to be advanced to meet the special durability demands of one-inch video production.

So choose Scotch 479 for your one-inch video production. You'll find it looks good from repeated mastering all the way through post production. And we've seen the test results to prove it.



3M

A Remote To Remember

perspective than from a national perspective," says Andy Fisher, news director of WAGA-TV. "That's why it was important for us to have our own line out of Plains." The networks were going to treat the Carter homecoming as a minor component in the overall coverage of the inauguration. The station needed to do more.

When the hostage story broke, the focus shifted. The station had sent a reporter and crew to Washington to do inaugural sidebars, but suddenly needed to cover the major breaking news story. Thanks to Storer's Washington bureau and an uplink, the story could be fed live to Atlanta via satellite to the station's downlink.

Another bonus: the reporter in Washington was able to get on the plane that was taking President Carter to Germany to greet the hostages. How that feed got back is another story because it didn't happen on January 20.

By the time the evening was over WAGA had done an hour's live special of Carter's arrival in Plains, several live cut-ins before the 6:00 p.m. news, updates throughout the evening, and some live reports out of Washington for the 11:00 p.m. newscast. Fisher has no doubts that the expense, time, and hassles involved were worth it.

That seemed to be the overriding reaction from stations around the country who went to the limit on that January day. There were stories of mishaps, close calls, dropped balls, and frayed nerves; but no one seemed to mind all the extra work. It was a chance for everyone to flex their technical muscles. "In fact, as I look back on it," says Alan Nesbitt, "it was fun." **BM/E**

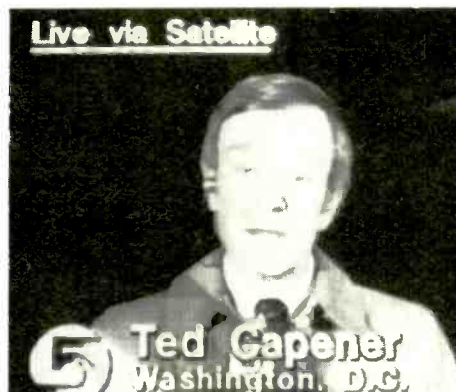

KSL-TV in Salt Lake City has its own earth station and almost routinely takes in feeds from around the world



WRC-TV co-anchor Merty Levin reported on the main inaugural ball at the Kennedy Center. It was one of several live remotes around Washington that night



The Original

The Total VTR Battery System

- Power-packed, higher performance Nicad Cells deliver more VTR running time, longer life, never need maintenance, fast charge in one hour.
- Exclusive electronic circuitry and quality construction provides the identical total reliability of Cine 60 Powerbelts... standard in the industry.
- "Total Charge Capability, anywhere..."
- On location, fast charge from any 12 Volt car system — unattended, in one hour, with our 3 lb. Car Fast Charger — no heavy inverter needed.
- From A.C., one hour fast charge with our 3 lb. Universal Model 9400 or 3P 2500.
- Fast Charge four batteries — automatically and unattended — with our new, multiple, High Frequency, Regulated Fast Charger, one per hour, four in 4 hours.
- Standard charge 2 batteries overnight, with our two channel, regular Charger.
- Directly replaces original VTR batteries — Sony BP-20, BP-20A, BP-50, BP-60, BP-80, BP-90 and JVC/Panasonic PBP-1.
- See your local authorized Cine 60 Dealer. Ask about the Total VTR Battery System you need.

There's Always Something New From Cine 60

CINE 60

630 Ninth Ave. New York, N.Y. 10036 (212) 586-8782
 6430 Sunset Blvd. Hollywood, Ca. 90028 (213) 481-3048
 TWX: 710-587; FLELEX: 645-647

See Us At Booth #1037 NAB.

Circle 125 on Reader Service Card

DEFLECTIONLESS.

**O'Connor Hydro-Ped.
Computer-designed for
maximum rigidity during
panning and tilting.**

VISUAL WHIPLASH.

The Hydro-Ped is the ultimate camera support, designed to replace the conventional tripod and correct the backlash problem inherent in its design.

Backlash often occurs at the end of a pan when the legs of the tripod tend to "unwind" slightly, jerking the camera the other direction. This backlash creates an image deflection subjecting audiences to a visual whiplash. The use of a telephoto lens will tremendously accelerate this problem.

LIGHTHOUSE EXPERIMENT.

An early experiment to solve the backlash problem included the filming of a lighthouse

through a telephoto lens from a mile away using a fluid head and a conventional tripod. The deflection of the image due to tripod backlash was 32 inches on a ten foot screen.

The Hydro-Ped was later put to the same test and the image proved to be virtually deflectionless.

SOLID AS A ROCK.

In torsion and bending,

the Hydro-Ped is four times as rigid as a conventional tripod which hinges at the top of its legs. The Hydro-Ped hinges near the ground and has short legs which lock hydraulically in both directions.

This design not only eliminates deflection, but also enables it to be used in the toughest terrain and tightest places.

SAVES LOTS OF PRIME TIME.

When minutes really count, the Hydro-Ped takes only seconds to position, level and lock.

To adjust camera height, the center column lifts 30 inches vertically with hydraulic assistance for the heavy camera.

BUILT TO TRAVEL.

The Hydro-Ped is made of a sturdy magnesium and aluminum construction weighing only 29 lbs. It folds to 30 inches long and 10 inches in diameter. A single centered handle with comfortable grip makes it easy to carry.

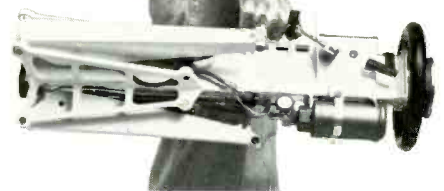

STUDIO PROVEN.

Although the Hydro-Ped is not ordinarily used to replace a studio pedestal, quick release wheels and casters are available and many enjoy its ease of use in the studio.

FLUID HEADS, TRIPODS AND MORE.

O'Connor makes the world's finest line of innovative camera support equipment.

If you're interested in learning more, let us know what camera you have and we'll let you know what we can do to support it.

O'Connor
FLUID CAMERA HEADS

O'Connor Engineering Labs., Inc., 100 Kalmus Drive, Costa Mesa, CA 92626 • Phone (714) 979-3993 • TELEX 685 641
O'Connor Engineering Ltd., 11 Rue des Moraines, 1227 Carouge, Geneva, Switzerland • Phone (022) 42 79 38 • TELEX 23 329

Circle 126 on Reader Service Card



RADIO'S EFP: A BETTER THAN SPORTING CHANCE FOR PROFIT

The efficiency of field production units for programming sports and other events has made mobile studios or transportable production equipment central for many radio broadcasters. The stories of four operations indicate that broadcasters can get into such field production on any level they choose.

ENTERPRISE RADIO, based in Avon, Conn., is a new kind of thing. It is supplying radio stations, via satellite, with 24 hours a day of sports programming, which includes not only live sports remotes but extensive background, interview, and comment, news of sports from around the world, and other material. Enterprise has its own uplink right at headquarters, as described in *BM/E* in January.

Thus Enterprise Radio is very different from a local radio broadcaster. But in the handling of live sports Enterprise most of the time has to operate very much as a broadcaster does. The problem is the same: to get the program from a sports location into a main studio where it can be controlled and directed as needed. Sometime in the future Enterprise Radio will use a portable satellite uplink transmitter for some pickups. At the present time, though, all remote programs are fed to the Avon studios. Enterprise is actively investigating portable uplink units and the installation of regional fixed-point uplinks for the operation. One difficulty pointed out to *BM/E* by Tony Masiello, director of operations, is that portable satellite uplinks have so far been designed almost entirely for video use, and the cost of using them is scaled to the cost of this design, much more complex than it would be for radio only.

Enterprise has aired a number of programs picked up by stringers and affiliated stations in this early period of operation, and these have come from many locations at great distances from the Avon center. Most depend on facilities available to the originator, and at a minimum consist of dial-up telephone lines with clip-on mic equipment.

In these cases no field production is involved, but the technical difficulties arise in the interface from the telco line to the Enterprise studio equipment. Various combinations of hybrids and mix-minus circuits are used. (See *BM/E*, March, 1981, for comprehensive discussion of these and other methods of interfacing telco lines.)

Enterprise is doing a growing volume of sports remotes with transportable equipment that does allow program production at the site. The operation is based on the Studer Model 069 outside-broadcasting console, which is designed specifically to allow every kind of command communication, insert, mic mixing, line mixing, telephone in or out connection, interpersonal communication, talk back, etc. at remote sites. Also in the equipment package is a battery of microphones, several Sony TC142 portable cassette recorders (noted for their excellent audio quality but unfortunately no longer marketed), two Nagra Model 4 portable tape machines, and a complement of headsets.

A broadcast-quality dedicated telco line is ordinarily connected into the array through the Studer console, which provides for this connection. Joe Ulrich, director of engineering for Enterprise, told *BM/E* that they recognize the essential nature of top audio quality for the operation in this era of satellite distribution with its superb audio. He said the technical operation would for some time be in a process of refinement as Enterprise explored various methods for handling signals.

The remote pickup package allows two operators to turn out a finished program with a primary narrative, with inserts of interviews picked up by the portable cassette machines or with the Nagra portables, inserts of taped material brought to the site, and mixing of mic channels fed directly into the Studer, which has three mixing channels. The program can go on the air directly with the telco line taking it to the Enterprise studios in Avon. It can also be recorded so that parts or all of it can be repeated at a later time.

The Enterprise operation is typical of a great many using transportable equipment for field production. It shows the outstanding virtues of doing it in the field: immediacy, making the program ready to air then and there; and efficiency, with two or three persons both originating and editing the program without using studio equipment or time. Bringing the raw materials back to the

Radio's EFP



Van used at WQOK for field production and remote pickups has equipment for multi-mic mix and recorded inserts. Exterior aids in station promotion campaigns



Operating position in field production van has two turntables for recorded program inserts, multi-channel mixer, and UHF radio for taking program to studio

studio means, first, that the program cannot be "live" on the air. And it means double work, with personnel tied to the program for a second time.

The transportable production package was used by Enterprise, for example, in covering the world championship skating contests in Hartford, Conn., completed just before this story was written. According to Massiello, all the equipment worked extremely well at the skating contests, and the Enterprise operators were able to turn out a finished program with a great deal of variety in the form of interviews, background discussion, and other material.

At WNDH-FM in Napoleon, Ohio (winner of *BM/E*'s 1980 Best Station Award for FM stations), field production is one of the essentials in a highly successful small-market radio operation. The in-studio programming, done in-house, is mostly Adult Easy Listening music from discs. As described in December's *BM/E*, WNDH also covers a very large number of sports events, community affairs, and local cultural events, especially the frequent polka festivals in the area. C. Richard McBroom, general manager, emphasized to *BM/E* that this attention to the community is a necessity for a station in a comparatively small market. The station could not get along without a lot of remotes.

The sports coverage brings in the whole state basketball competition, right up to the finals, as well as 50 or more football games. Every major sports event at nearby Ohio State University is covered.

The polka music has become one of the most important elements of the station's programming, highly successful with listeners. There are from 15 to 20 polka festivals in the area every year. WNDH goes to every one. In addition, a considerable part of every weekend's air time is given to the music.

For the polka festivals and for every kind of community political and cultural affair, WNDH has a package of transportable production equipment, functioning quite a bit like that of Enterprise Radio. The big difference is that WNDH uses a Marti UHF radio system to get the signal to the studio: this simplifies the matching problem at the studio.

The operation is based on an eight-channel console built by the station's engineering department — a necessary item for such operations to allow careful microphone placement for best pickup of the various elements of any event. For example, at a polka festival or any other event that includes live music, the musicians can be properly miked for a high-grade musical sound while other mics are used for narrative, interviews, commentary, and announcements. These elements are put together in the field so that the whole thing can go on the air live. McBroom noted that these live accounts of community affairs and entertainments have become a staple of the station's "presence" in the community and are now expected by listeners; the station's high standing depends on them to a large extent.

He noted that the station's operators have become adept at the "real-time editing" that this kind of remote pickup entails. They sometimes enlist the cooperation of the bands at the site; the musicians are usually quite willing to follow the radio operators' cues at certain points in the program to allow a smooth continuity of material. So a good relation with citizens in the community helps a radio station in some unsuspected ways.

At WFTW-AM and FM in Fort Walton Beach, Fla., a van allows the management to handle a very large load of local news and community affairs, including sports and local historical and cultural events. The van reaches the studio with Marti UHF radio. A Shure six-channel mixer provides control of multiple microphones. The equipment also has ready connection to send or receive telephone feeds. Recording can be done on cart machines or reel-to-reel machines brought into the van for the purpose. Also available for pickup are Superscope cassette recorders for greater range at public affairs.

Carl Shelenberger, technical director, described for *BM/E* a handy "one-board" complement of equipment that can be carried into the truck when needed. He has mounted on it the cart equipment, a mixer, and a complete connector block for instant hookup in the van. Thus the equipment can do double duty in studio or van.

The van seats seven people comfortably, for interviews and panel discussions. The operators can record everything right there to bring the tapes back to the studio or can develop a finished program that goes on the air directly through the Marti two-way radio.

The van is used for a regular "man-on-the-street" program, with sidewalk interviews and discussions of public topics in the van. It is used to cover every kind of local news and political event, coverage vital to the sta-

Happy 25th birthday to video tape
from the people who lit the first candle.



"Scotch" is a registered trademark of 3M.

Magnetic A/V Products Division

3M Hears You.

3M

Radio's EFP

tion's stance with listeners. There are, for example, 11 Gulf Coast newscasts in the course of the day. There is much beachfront and marine activity which the station's listeners want to know about as it happens, some involving the very large tuna fishing fleet harbored nearby.

Shelenberger described one of many community events that the station follows in close detail with the van. The "Billy Bowlegs Festival" is an annual combination of

historical pageant and Mardi Gras, with a crew of "pirates" under leadership of the legendary Billy Bowlegs arriving by sailing ship to try to "capture" the city. So far, the pirates have always won, and, somewhat paradoxically, this has led directly to a street festival of dancing, street markets, band concerts — a day of total "fun and frolic."

The WFTW van airs the whole festival, with description of every stage of the "invasion," the music in the street, the sounds of revelry, the reactions of people in the crowd. It has been one of the station's most popular events, with strong listener response.

Again, we see that the production of the programs on location allows for much more "live" coverage than would otherwise be possible.

The last operation in this survey is that of WQOK, another *BM/E* Best Station winner, at Greenville, S.C. This AM station is another that depends on highly mobile handling of local events to advance the goal of total community involvement. The station has two vans. One they call the "Q" cruiser; it is the locus for the remote program production. It carries a Micro-Trak stereo console with six channels, turntables, and dual-channel Marti UHF radio for getting into the studios.

One of the Marti channels is assigned to news pickup, the other to public affairs and community culture. Thus the van can return to the studio two programs simultaneously, and this has proven to be useful a number of times.

To give the remote operation the maximum in mobility, WQOK has installed an automatic repeater on the Marti frequency of 450 MHz on Paris Mountain, a peak just



Carol (Heiss) Jenkins, 1960 Gold Medalist in Olympic figure skating, goes on the air for Enterprise Radio at world championships in Hartford, Conn. She interviewed many contestants, described important contests "live" as they occurred

Beaveronics, Inc.

Write or phone for details.

8 Haven Avenue
Port Washington, New York 11050
Tel: (516) 883-4414

STUDIO PRODUCTION VIDEO SWITCHING SYSTEMS

(Also available in PAL and PAL-M versions)

FOR MODERATE SIZE FACILITIES MODEL B1-154

\$12,990.00



15-input, 4-bus mix/eff/key amp with downstream mix/key amp. Many optional features including DSK & quad-split, etc.

FOR SOPHISTICATED FACILITIES MODEL B1-156

\$21,795.00



15-input, 6-bus with two full mix/eff/key systems and dir. pgm and pre busses: many options available, DSK, quad, etc.

FOR REMOTE & SMALL PRODUCTION FACILITIES

MODEL J & D 712

\$7,400.00

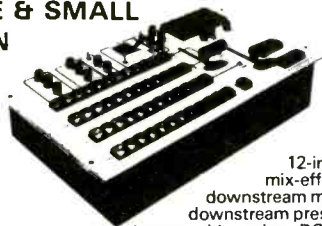

12-input, 4-output mix-effects amp with downstream mixer, includes downstream preset & program busses with cut bar, RGB chroma key

ENG Switcher Model J & D 705

\$7,990.00

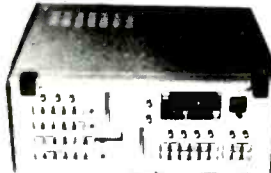

FEATURES:

- BUILT IN COLOR BLK AND BKG
- SELF CONTAINED SYNC GEN
- INDEPENDENT COLOR BLK OUTPUTS TO CAMS
- SELF CONTAINED CASE
- 5 INPUTS INCLUDING BLK AND BKG
- 32 PATTERN MIX/EFF/KEY WITH POSITIONER
- ADDITIONAL SEPARATE MIX BUSSES
- PREVIEW FEATURES
- FRONT PANEL ANGLE ADJUSTABLE

All Beaveronics Switching Equipment Carries a Two Year Warranty

OTHER ITEMS AVAILABLE FROM BEAVERONICS

FAYAG MASTER CLOCK SYSTEMS

Available with accuracy better than 1 second/yr.



- Master control switchers AFV with audio breakaway
- Routing switchers with AFV

- CHECK BEAVERONICS FOR:
- Specialized custom switchers
 - Selected terminal equipment

CLEAR THE AIR WITH THE **NEW** TRANSDYNAMIC PROCESSOR

THE SUPER CLEAN SOUND THAT WINS MORE LISTENERS.

VERSATILITY, RELIABILITY AND LOW DISTORTION. THAT'S WHAT THE TRANSDYNAMIC™ PROCESSOR IS ALL ABOUT. IT TEAMS WITH AUDIO & DESIGN'S EXPRESS OR COMPLEX LEVEL CONTROL AMPLIFIERS TO CREATE A SUPERIOR TRI-BAND SYSTEM. IT FEATURES:

- TWO INDEPENDENT* PROGRAM CHANNELS, FOR STEREO OR DUAL MONO PROCESSING.
- FIELD TUNABLE BAND-SPLITTING FILTERS (6 OR 12 dB PER OCTAVE PHASE COMPENSATED CURVES).
- SEPARATE CONTROL OF THE COMPRESSOR ATTACK, RELEASE AND RATIO FOR EACH BAND.
- WIDE BAND VCA LIMITER AT THE SYSTEM OUTPUT FOR ABSOLUTE OVERMODULATION PROTECTION.
- SELECTABLE 0, 25, 50 OR 75 μS PRE-EMPHASIS IN THE CONTROL CIRCUITS (NOT THE SIGNAL PATH) OF THE OUTPUT LIMITER.

- ADJUSTABLE PEAK MODULATION ASYMMETRY FOR AM OPERATIONS.
- SWITCHABLE HIGH AND LOW PASS FILTERS THAT ATTENUATE EXTRANEOUS INPUT SIGNALS AND CONTOUR THE SYSTEM BANDWIDTH.
- SENSIBLE SET-UP ADJUSTMENTS WITH LED BAR GRAPH PPM METERS.
- TAMPER-PROOF SOLID STATE AUDIO SWITCHING CIRCUITRY.
- NO MYSTERIOUS EPOXY "BRICKS" OR "SECRET PARTS".

NO MATTER WHAT YOUR FORMAT, THE TRANSDYNAMIC SYSTEM IS THE CLEAR CHOICE FOR YOUR SOUND.

AN ADDITION IS THE ONLY WAY TO FULLY APPRECIATE THE TRANSDYNAMIC. CALL TODAY, TOLL-FREE 800-426-6170 FOR FURTHER INFORMATION.

SYSTEM INSTALLATION BY FACTORY PROFESSIONALS IS ALSO AVAILABLE.

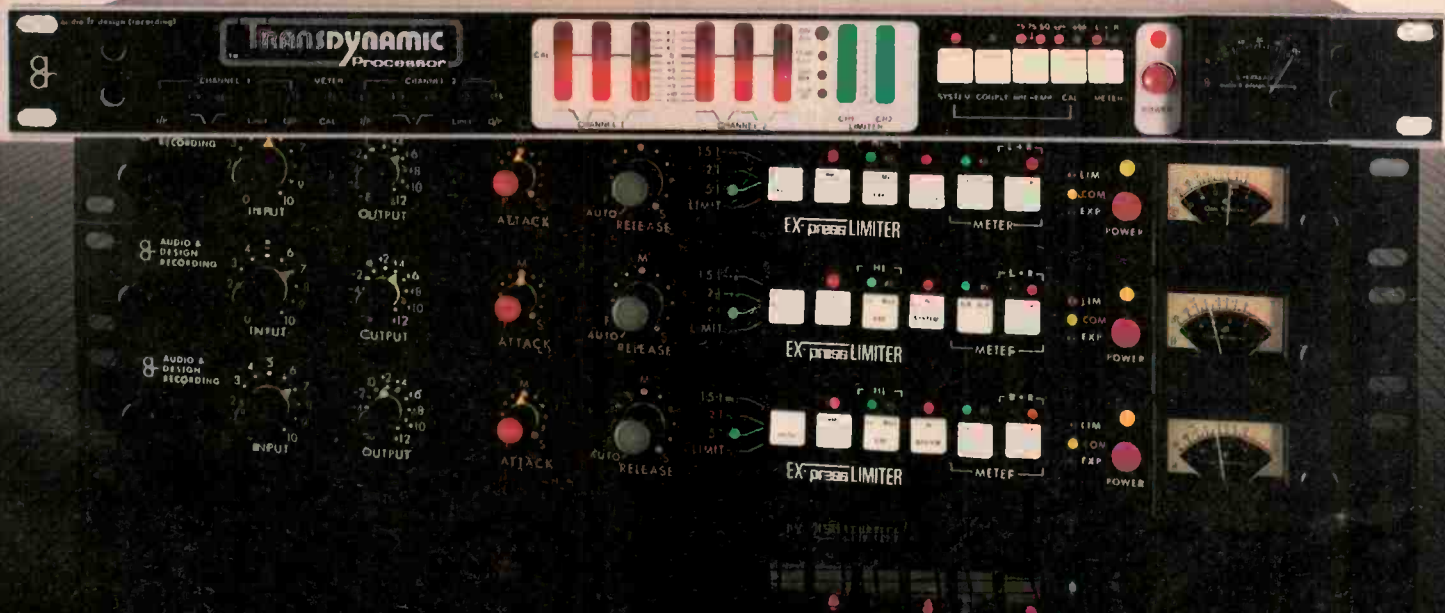

COME SEE US
AT THE NAB,
BOOTH 42A



Audio + Design

THE HIT SOUND IN BROADCAST SCIENCE.

CALL TOLL-FREE 800-426-6170
AUDIO & DESIGN RECORDING, INC. - P.O. BOX 786 - BREMERTON, WASHINGTON U.S.A. 98310 - TELEPHONE 206-275-5009 - TELEX 15-2426
AUDIO & DESIGN RECORDING, LTD., - NORTH STREET READING RG1 4 DA - BERKSHIRE, ENGLAND - TELEPHONE (0734) 53411 - U.K. TELEX 848722

Copyright 1981 by Audio & Design Recording, Inc.

Circle 129 on Reader Service Card

BANK ON US.

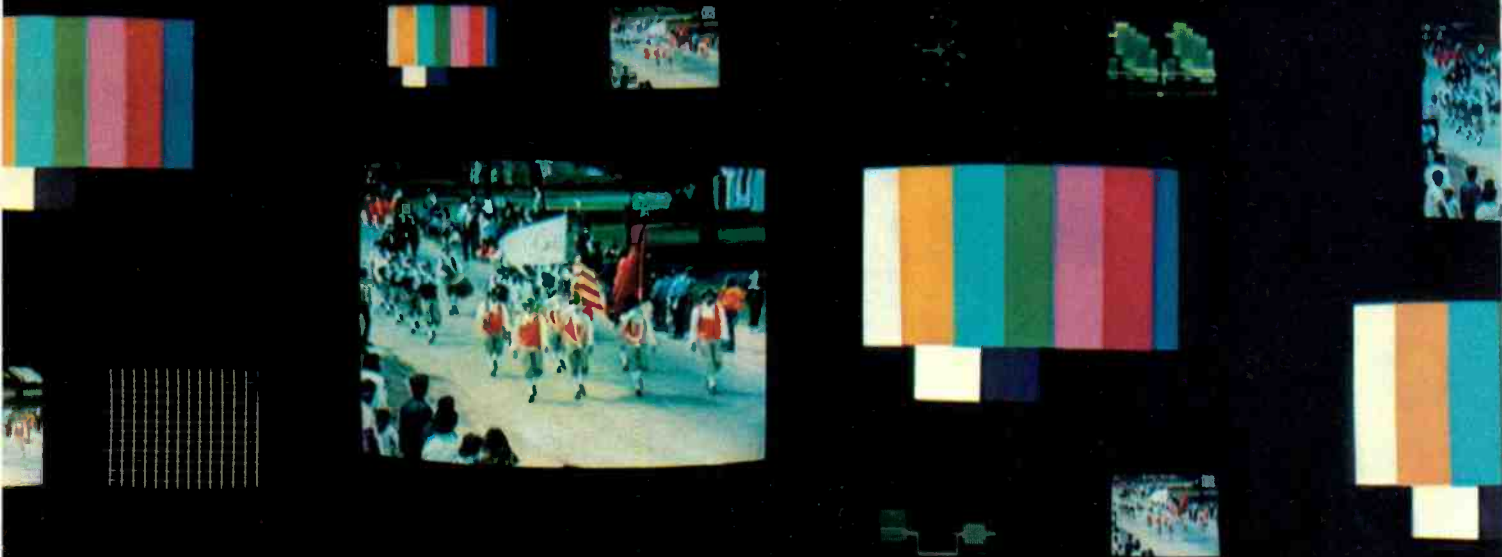

In the Rack or out of the Rack, Videotek products are a wise investment.

And for good reason. Videotek concentrates only on monitors; the most comprehensive line of rackmount and tabletop professional color monitors. In addition, Videotek is emerging as a leading manufacturer of Broadcast Test Equipment.

We are committed to provide quality products,

personalized service and excellence in field back-up. Large impersonal corporations sometimes forget the Human Factors in conducting customer relations on a day to day basis. We don't!

Videotek products represent a solid capital investment. One you can bank on year after year.



The same Videotek monitor bank whose color pictures are shown in the photograph above.



Videotek

125 North York Street, Pottstown, Pennsylvania 19464 • 215/327-2292
9625 North 21st Drive, Phoenix, Arizona 85021 • 602/997-7523

Circle 130 on Reader Service Card

Radio's EFP

north of the city. The automatic repeater has increased the range of the Marti system to about 60 miles in most directions.

John Francioni, chief engineer, told *BM/E* about the difficulty the station had in establishing the repeater channels. He said there were about 175 frequencies in the 450 MHz band already assigned to equipment on Paris Mountain. WQOK had originally wanted two separate channels up to the repeater, but had to settle for one channel with Simplex operation. In other words, when the mountain top repeater is in the return path, the system can handle two channels only on a "now I'll stop and you talk" basis.

The second van is the "Disco Van," designed primarily for promotional appearances at disco parties. It has a 1000 W audio system and loudspeakers on the roof so that music can be projected into the scene. However, the van also can carry a console and a Marti transmitter plus a complement of microphones, and can make an event pickup if needed for that.

Francioni, like all the others interviewed for this report, emphasized the flexibility and efficiency of events programming produced in the field. He said that keeping on top of everything of note happening in the area was "keeping the station alive." He noted that the station's average audience share went up from 5.1 to 5.6 after the mobile systems got into full operation. In a top-50 market with a host of competitors, this is a solid gain.

He also found that the audio characteristics of the program-pickup van were important in the success of the

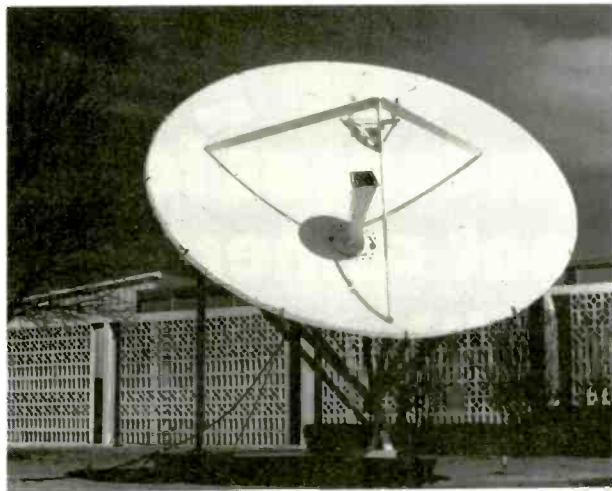

Ten-meter earth terminal antenna for both uplink and downlink used by Enterprise Radio at their Connecticut headquarters

operation. With a flat frequency response of 50 to 12,000 Hz, down only 3 dB at 15,000 Hz, the whole remote path from the program van to the studio has remarkable quality. Francioni said that nearly all the pickups sound as though they originated in the studio. Although the listener is fully aware of the location of the pickup, the studio-grade quality of the sound is definitely pleasing and gives the station a boost in the listeners' rating scheme.

The field operations in this survey are naturally a small fraction of those now underway. It seems most likely that virtually all demonstrate the power of field production to improve a station's community image, its profits, and its efficiency.

BM/E

THE 6112 IS SO ADVANCED IT SURPASSES ALL SWITCHERS IN ITS CLASS AND BEYOND

Two fully independent special effects generators each with double re-entry; downstream keyer.

Price N.T.S.C. \$7,345.

P.A.L. 8,345.

Encoded Chroma Keyer \$1,050.

Not Available in P.A.L.

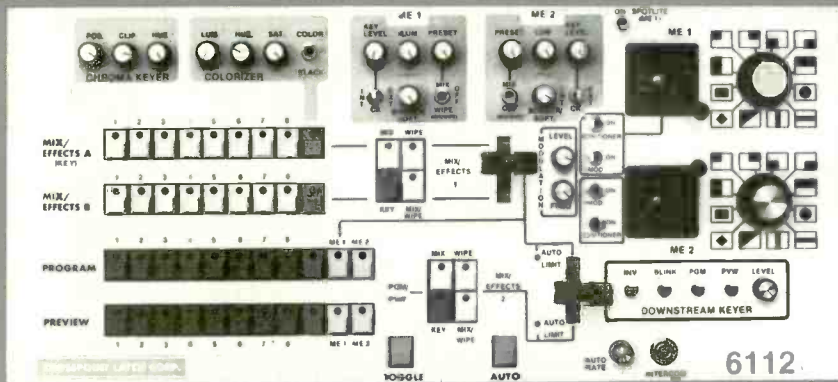

The production flexibility afforded by two fully independent mix-effects systems, each with its own keyer, has to be seen to be appreciated. The 6112 makes maximum use of its buses and controls. For instance, the preview bus is not tied up just to get an ME system into the program line. Ask your dealer for a demonstration.

The circuitry is rock stable — and we mean exactly that. Dual back porch clamps, patterns that snap into position, inherent timing accuracy with no lag or bounce, standardized interchangeable plug-in boards with gold fingered card edge connectors, all contribute to a sense of quality.

For further information on the 6112 or our other switcher products call or write for information.

CROSSPOINT LATCH CORP.

316 BROAD STREET

SUMMIT, N.J. 07901

(201) 273-1090

Zoom lenses for 1/2" format cameras...

The ultimate field zoom for 2/3" cameras...

High resolution lenses for electronic cinematography...

A full-featured, economical studio lens for 1" cameras...

**Some of the reasons to see
FUJINON at NAB, Booth 1117.**



New

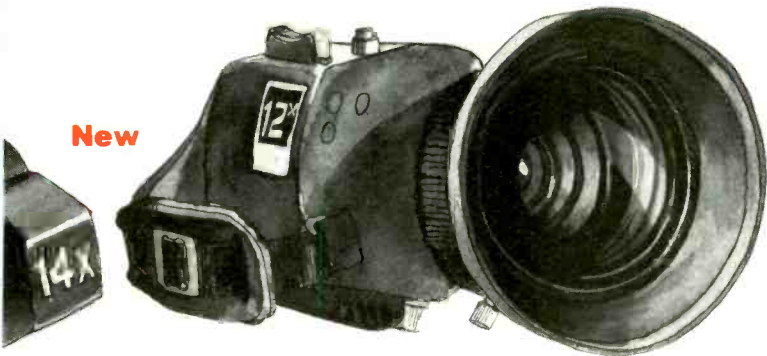

You'll see two new very lightweight zoom lenses for 1/2" format cameras. There's a 12x7 (7mm to 84mm) and 14x7 with built-in 2X extender (7mm to 196mm). Each offers F/1.4 speed, auto/manual iris, servo/manual zoom and focus. MOD is 0.8mm, weight 1.3kg.

Fujinon's first two lenses for electronic cinematography are fast, high resolution 14mm and 40mm fixed focal length models. Speed is F/1.4.

(You can be sure Fujinon will be doing for EC what it has done for ENG/EFP . . . and that's a big commitment.)

A new full-featured studio lens for 1" camera format is Fujinon's 14x14 with built-in 2X extender. Its F/1.6 aperture can be maintained out to 140mm. And at 200mm, it offers a very respectable F/2.0.

New

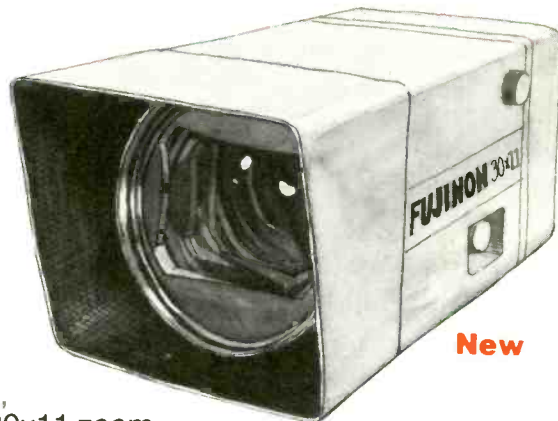

For field events, Fujinon's new 30x11 zoom with built-in 2X extender gives new range and flexibility to 2/3" format cameras. At maximum focal length of 660mm, it's the equivalent of 1,000mm on 1 1/4" format. Its F/1.6 aperture stays flat out to a 20X zoom. And at 30X, it gives you F/2.4. There isn't anything else in production that even comes close.

New



Another lens is a new, faster version of Fujinon's exclusive 3.5x6.5 wide angle ENG/EFP zoom. Now it gives you F/1.7 speed along with performance that is difficult to believe . . . even when you see it.

To see Fujinon for yourself at NAB, visit Booth 1117. Or just check out every camera on display. You'll soon see why the world sees itself more clearly through the eyes of Fujinon.

New



FUJINON

Fujinon Optical Inc. 
672 White Plains Road
Scarsdale, New York 10583
(914) 472-9800 Telex: 131-642

Fuji Optical Systems Inc., 4855 Atherton Avenue, San Jose, California (408) 866-5466

Fuji Optical Systems Inc., 118 Savarona Way, Carson, California 90746 (213) 532-2861

Circle 132 on Reader Service Card

CO-AX DIGITAL REMOTE CONTROL



Our new and exciting co-ax digital remote control system provides dependable, studio-like remote control to ENG/EFP cameras in the field *at a fraction of the cost of other systems!*

It is the most affordable and reliable remote control system available on the market today. Easily interfacing with a full range of professional ENG/EFP video cameras currently in use, such as Ikegami HL-77 and HL-79A, RCA TK-76B, NEC MNC-71 cameras, and many more.



Outstanding Features

- System consists of mini-CCU, analog-to-digital encoder, and digital-to-analog decoder.
- Permits control of all functions normally required in OB van, including genlock.
- Digital encoder (19" rack-mounted) designed to accommodate two mini-CCU's to control two cameras (each equipped with its own decoder).
- Lightweight, camera-mounted decoder features intercom capability.
- Digitally encoded control data relayed to camera-mounted decoder through a simple, lightweight and reliable coaxial cable.
- Eliminates the need for expensive, bulkier, multi-core or triax camera cable, and reduces to a minimum the risks normally associated with the use of such camera cables.
- Low-cost coaxial cable allows complete remote control and camera set-up functions from greater distances with greater safety and utmost reliability.
- System is ideal for all extended shooting situations such as sports events, live concerts, political rallies, etc.

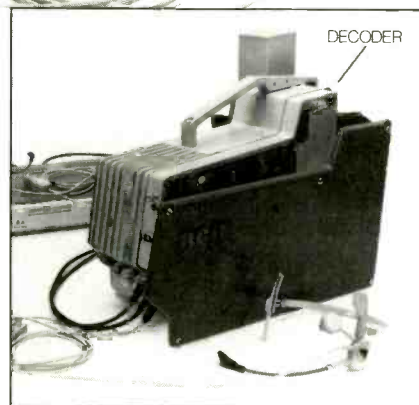

RCA TK-76B shown with decoder neatly "sandwiched" between camera body and door.

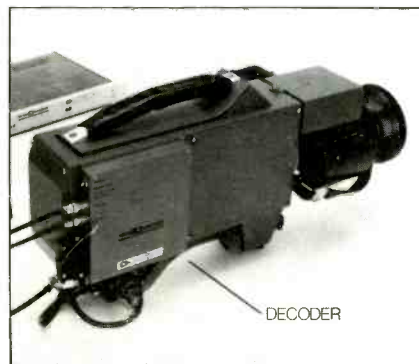

Ikegami HL-77 shown with side-mounted decoder.

For full details, call toll-free: 800-421-7468.

CINEMA E products
CORPORATION

Technology In The Service Of Creativity

2037 Granville Avenue, Los Angeles, California 90025
Telephone: (213) 478-0711 • (213) 477-1971 • Telex: 69-1339

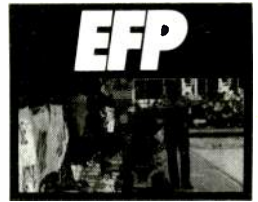

EFP: A COMMERCIAL, SPORTY, PROFITABLE BUSINESS

By Bob Paulson

Though out of its infancy, EFP is still growing rapidly in techniques and technology. Anyone biding time until field production reaches "maturity" is likely to be waiting a very long time.

IT STARTED WITH ENG. Electronic news gathering became a broadcast industry experimental activity in the late 1960s, with cumbersome two-piece cameras only an ex-NFL pro could handle gracefully (with the assistance of one or two lighter weight quarterbacks). By the late 1970s the optical and electrical components of an ENG camera had shrunk to a single package, easily balanced on the shoulder, weighing substantially under 20 pounds complete with battery pack.

In 1981, ENG activity has grown to maturity. Improvements in new cameras are measured in ounces, inches, and small increments of dBs and cycles. In this same period, EFP activity has become the rapidly growing tiger the industry is attempting to tame. Field shooting of videotape takes for other than breaking news requires the same meticulous monitoring and adjustment of camera performance as a studio shoot, and is far more difficult because lighting is often an uncontrollable variable.

Thus, by arbitrary definition, an EFP camera is again a two-piece system with its head and CCU connected by multi-core, triax, or fiber optics cables. The head, while only very infrequently operated from the shoulder, nevertheless must be compact, lightweight, and well balanced, truly portable until it begins to take pictures. The lens, prism optics, pickup tubes, and preamps must be meticulously designed as a subsystem which delivers 1 V, low-noise, wideband, sharp, geometrically precise, lag-free R, G, and B images to the CCU.

In the CCU, controls must be provided to adjust and maintain picture output within subjectively imperceptible tolerances in all the composite video signal parameters of gain, setup, linearity, gamma, and colorimetry. Many two-piece cameras cannot be adjusted this precisely and,

Bob Paulson is a television management and production consultant, writer, and producer.



WTVJ's fleet of mobile units increasingly respond to network sports production demands

further, are not stable over time and unpredictable changes in the shooting environment. These units really cannot merit the title of "EFP camera," even though they may operate perfectly acceptably in studio and stable location environment shooting.

EFP: out of its infancy and growing

That age of maturity and stability reached by ENG in a few short years will probably never be reached by EFP for at least three reasons. First, EFP has too many definitions: multi-camera sports and large audience event live pickups; multi-camera taping of live entertainment (concerts, sports, dramas, etc.) and EFP editing for DBs and syndication; ISO multi-cam taping for docu-dramas; single-camera ("film-style") taping of commercials, PSAs, promos, documentaries, soaps, talk-show inserts, et al. These offsprings of EFP, ranging from maturity to adolescence, are constantly shedding their old skins — updating not very old systems with new products and accessories.

Second, the techniques of EFP are constantly changing from two influences: more sophisticated products that can do more, made possible by incredible developments in microprocessors and storage devices from the computer industry; and new viewer groups, applications, and distribution means for programming that can only be created by EFP techniques. The "linear programming" we're used to on our television stations (continuous, not under viewer control) may well be as obsolete by the 1990s as big-band pop tunes on three-minute 78 rpm records. Its successor is already born — the "interactive programming" required

EFP: A Profitable Business

for maximum utilization of the laser-optical, frame-synchronous videodisc.

Broadcasters may not be interested in this specialized EFP/EPP technique — yet. But lots of old and brand-new production houses are, including many big ones that have so far derived 100 percent of their income and profits from broadcast-industry production.

Finally, EFP will continue to grow and evolve because of the constantly changing and broadening creativity of the people conceiving the programming ideas and then creating the footage using EFP equipment. These writers, directors, and editors, with backgrounds in film, theatre, journalism, recording, education, and training, will influence hardware designers to continue the products and features race.

Who's doing what in 1981?

ABC Television led the way into the 1980s with its "ultimate EFP" coverage of the Winter Olympics at Lake Placid last year (see *BM/E*, April, 1980). Inspired by the creative and technical operations expertise of Rooney Arledge and Julie Barnathan, ABC engineers, technicians, and EFP/EPP specialists masterminded the setup and operation of over 100 cameras to provide 100-percent live coverage of every event and ceremony during the two weeks of final training and competition.

On Whiteface Mountain, venue for all the downhill skiing events, the 100-percent coverage challenge was particularly arduous to meet. Philips LDK-5 triax cameras provided the answer. In a "battle plan" reminiscent of

General Patton's WW II Third Army activities, 18 cameras were helicoptered and snowcatted to 83 previously prepared locations during the skiing competition.

More than 60,000 feet of triax was laid in earlier months, to be covered up by snow and ice before the games started. Preplanning of switching points high up on the mountain, reachable only by snowcats or skis, replaced the conventional multicore cabling approach, which would have required over 100,000 feet of dedicated cable runs. Several of the top-of-the-mountain camera positions, about 20,000 feet away from the base camp, were operated through Philips-developed triax repeaters, which took operating power from the CCU in the van while relaying video, audio, and control signals and head, lens, and heater operating power to the exposed camera positions.

One of the several production trucks at Whiteface is usually operated in the more benevolent climates of the West Coast by owner Versatile Video, Inc., Sunnyvale, Calif. It is part of a fleet of large and small production and support vehicles that are in constant use producing a gamut of programming from location commercials shot single-camera "film-style" to multi-camera live pickups of the Stanford-Cal football game.

This camera is equipped with a cost- and shot-saving production accessory called the "Sportsfocuser," developed by Gary Gordon at Light Industries in close collaboration with technicians and creative people at VVI (see sidebar). Because this unit guarantees that a long-shot closeup camera will always be in focus, directors have a new dimension of creative versatility to play with, without the chance of airing bad pictures. And because wide to



The next best thing to the real thing

tight zooms will always be in focus, regardless of which way the action requires the camera to pan and tilt, the production setup can eliminate the need for a separate wide-shot camera as a production cover.

Wometco's WTVJ, Miami, has operated a fleet of EFP vehicles as a profit-making adjunct to its station business since 1956. The largest of these units, a 40-foot semi, has been rebuilt several times, most recently in 1979 with the installation of five Philips LDK-5 triax cameras. Field operations manager Spears Mallis reports that the truck has had few days off since then, rolling to locations throughout Florida and as far away as Nashville and Washington to originate pickups for ABC, CBS, NBC, and major private producers.

As this article was written, the van was on a three-week shoot of ABC's *Superstars* production in the Key Biscayne area. A check of the competitive event schedule shows the overwhelming advantages of triax cameras for multi-camera EFP sports production. Each of six cameras was moved three times a day to cover widely separated competition venues at the hotel, its beach, a nearby stadium, and a park. On the first day of competition, multi-camera coverage of back-to-back events included tennis (three cameras), swimming (six), basketball (five), and weightlifting (five). The next day the truck and all the cameras were moved to cover rowing, golf, track, bicycle racing, and soccer, and a third day found the system at the obstacle course.

A triax mobile unit must be used on shoots like these, according to Mallis. "Installing triax takes about half the time for installing multicore," he says, "and one-third the manpower to pull cables. There's also much less risk of

injury from jockeying heavy multicore cables around."

Preplanning for cabling and camera scheduling for this *Superstars* remote began a month ahead of the shoot, and installation and checkout took two days. Almost 30,000 feet of cable was used, including some 2000-foot runs which are left permanently installed and buried.

When it's convenient, a camera head is used to check out the cable. Most of the time a reflectometer is used, since simply checking continuity to the cable end verifies its state of health.

Mallis observes that when his system checkout procedure indicates that something is in trouble, the last item checked is the triax cable. In a multicore system, the cable and connectors are the first thing suspected when trouble appears.

"Another advantage of triax," says Mallis, "is that we know we can have a camera head up and making broadcast pictures in as little as 15 minutes, which eliminates the need for bringing extra camera heads to the site. Also, our cameras don't have to stay matched to their CCUs, and we can hopscotch the heads to cables of different lengths without allowing time for re-checking setup and adjustments."

These savings in numbers of cameras, setup time, crew size, and shooting schedule compression represent an enormous cost advantage to the quality-oriented producer who's working on a tight budget. Even with the top-of-the-line camera, VTR, editing, and audio equipment built into Wometco's Mobile Unit One, the cost of this van on a remote is price-competitive with lesser-equipped vans that can't match its quality, according to WTVJ executives.

is Scotch Color Plus.

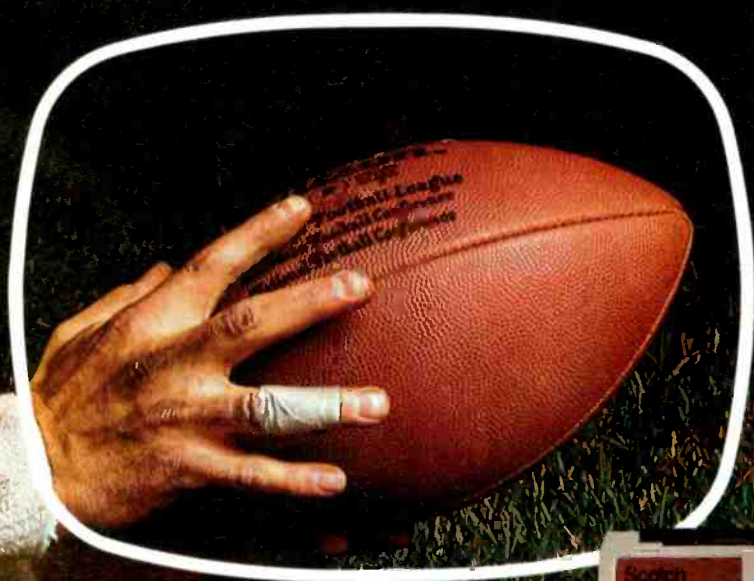

If you want real-life color and clarity from your 3/4 inch video tape masters or copies, use new Scotch® Color Plus. It gives you 2.5 dB more chroma signal-to-noise, 1.5 dB more signal-to-noise and 1.5 dB more RF output than standard U-Matic format videocassettes. That's equal to at least one generation of picture quality.

We put 25 years of video tape experience to work in developing Color Plus. And we manufacture it to the same precise standards as our 1" and quad mastering tapes.

As a result, you'll get the mastering, editing and duplicating characteristics you demand. Minimal drop cut levels. Improved runability. Reduced head wear. And stop motion durability for heavy editing work.

Color Plus is available in all Mini 3/4" video cassette and Master Broadcast (MBU) run lengths... plus extended play UCA 30s and the UCA 75. And every cassette is available with the exclusive Scotch Hanger System for compact storage at no extra charge.

Put some life into your next production with Scotch Color Plus. The real-life tape. Magnetic A/V Products Division/3M.



Scotch Color Plus.

3M Hears You.

3M

EYE-OPENERS

Just when everyone had their eyes wide open to the outstanding line of Ikegami broadcast and production color cameras, Ikegami introduced its color and B&W monitor line, engineered with the same innovative technology as its cameras. A great tradition of eye-opening continues with precision, quality and beautiful images.

The Ikegami color monitor line consists of the High Resolution Series RH Color Monitors and the High Performance Series 8 Color Monitors. The High Resolution Series RH Color Monitors are available in the 14" TM 14-2RHA and the 20" TM 20-8RH. Both provide precision color reproduction at 600 plus lines for professional studios, control rooms, remote vans, etc., and feature a high resolution CRT with High Density Dot Matrix, a switchable comb filter in the decoder, and the AFPC (Automatic Frequency Phase Control) system to maintain exceptional color reproduction. Both models are rack-mountable, with the TM

14-2RHA featuring plug-in circuit boards for easy maintenance.

The High Performance Series 8 Color Monitors are available in the 14" TM14-8RC, 20" TM20-8R and 25" TM25-8. The Series 8 monitors offer high quality color reproduction, a Shadow Mask Dot Matrix CRT, Pulse Cross Circuit, Active Convergence Circuit, low power consumption, and more.

The B&W Monitors are engineered to the same exacting Ikegami standards and are available in Triple 5", Dual 9", 5", 9", 12", 17" and 20" sizes.

Ikegami's Eye-Openers are available at most dealers. For details and additional information, contact: Ikegami Electronics (USA) Inc., 37 Brook Ave., Maywood, NJ 07607, (201) 368-9171; West Coast: 19164 Van Ness Ave., Torrance, CA 90501, (213) 328-2814; Southwest: 330 North Belt East, Suite 228, Houston, TX 77060, (713) 445-0100; Southeast: 522 So. Lee St., Americus, GA 31709, (912) 924-0061.



Video Products built to Ideal Standards

 **Ikegami**

Circle 134 on Reader Service Card

EFP: A Profitable Business



VVI's mobile units and support trucks have become a familiar site at sporting events

2/3-inch cameras in sports and entertainment EFP

When they were first introduced into ENG activities in the mid-1970s, 2/3-inch cameras won acceptance for their size, portability, and automatics, not their picture-making performance. What was "good enough" for recording on 3/4-inch U-Matics in the field, hasty editing, and playback on the 6:00 news was not deemed acceptable performance for either a studio or field camera used in program, commercial, and sports production.

Today that's no longer the case. Of the several thousand 2/3-inch cameras sold in recent years, several hundred to perhaps a thousand are used primarily in non-news shooting. Most of these units are loners (not loaners), traveling about in a station wagon or car trunk, operated by a two- or three-person crew carrying a portable 3/4-inch U-type or one-inch VTR, lights, spare batteries, and other standard field shooting accoutrements. A very few ride in style in compartments in their own custom-designed single-camera production vans or off-road RVs.

In the last few months the 2/3-inch multi-camera van has begun to proliferate. Economy-minded producers have turned them into "bandwagons" for a new generation of EFP programs for syndication — covering more major sports events featuring regionally popular competitors as well as more minor (less nationally acclaimed) sports events featuring world-renowned competitors. Program audience appeal is high, and production costs are low enough to attract syndicators focussing on special interest audiences. Most importantly for prime-time broadcast producers, these production advantages can generally be exploited without putting up with any loss in picture and sound quality.

Two of these new-wave multi-camera vans are operated out of Los Angeles and Reno, respectively, by the American Film Factory (AFF) and Electronic Location Productions (ELP). Both mobile units already have produced many hours of edited sports footage in their young lives, and are also being used for field shoots (exteriors and interiors) of both commercials and prime-time show-biz entertainment.

Electronic Location Productions president Ray Barp reports that his van was making money in five-camera coverage of the National Amateur Bowling finals spon-



Mounted cameras provide the stability required for long lenses while good grip equipment can provide the mobility



Sporting events often require a mix of hand-held and mounted cameras in order to provide a diversity of shots

sored by Miller Beer, produced by Miz Lou Television Sports, less than a week after its delivery. "No shake-down, no test productions, no test shoot giveaways, just a fast setup in the bowling alley and we were making perfect pictures," he says.

For this shoot, the van's three LDK-14s were studio-configured for behind-the-lanes and reverse coverage of the bowlers. Two additional units were hand-held, one producing some dramatic zoom shots following the ball down the alley at shoe-top level. The other was used for crowd reaction and scoreboard shots.

Barp points out that the client rarely attributes any significance to "2/3-inch tubes," but often recognizes the Philips brand name from earlier studio shoots. "One look at the picture quality," says Barp, "and he's assured that the small-format camera will give him the quality pictures he wants." Another important factor in choosing a field production camera, comments Barp, is the ease of converting from a two-piece unit to a single-piece shoulder-mount configuration. Field production situations often call for ENG-style coverage of a crowd scene or audience shot.

When you need microphones with "reach," reach for these!

CL42S Shotgun System

The CL42S reaches farther and rejects more ambient noise than any other shotgun of its size ever made. Our exclusive line bypass port makes it more directional at low frequencies so you won't have to sacrifice frequency response when you use it on a boom. Diffraction vanes maintain high-frequency directivity to preserve uniform frequency response if the "talent" gets a little off-mike.

Phantom or AB powered, the CL42S comes complete with windscreen, shock mount, carrying case and handle for hand-held applications. And it's rugged.

CH15S Hypercardioid System

The CH15S is actually more directional than a mini shotgun mike – in a package that's only 4 inches long that weighs less than 6 oz. Specially designed for boom and fishpole use in TV and motion picture studios, but equally at home wherever working space is small and you have need for a compact, highly directional microphone.

Compatible with phantom or AB power, the CH15S comes complete with windscreen, shock mount and carrying case. And, this microphone is rugged.

The Electro-Voice Warranty

Electro-Voice backs up these two microphones with the only unconditional warranty in the business: for two years we will replace or repair your CL42S or CH15S microphone, when returned to Electro-Voice for service,

at no charge – no matter what caused the damage!

We can do this because we build these microphones to meet our standards for performance, ruggedness and durability. We accept nothing less, and if you're a professional, buying a professional quality microphone, you shouldn't either.

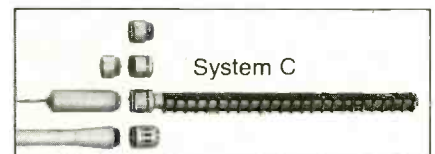

EV **Electro-Voice**[®]
a gulton company

600 Cecil Street, Buchanan, Michigan 49107

EFP: A Profitable Business

Barp cited the need, before the bowling tournament began, for ENG-style coverage of a Miller-sponsored contestants' reception in a nearby hotel. While pocket billiards wizards Steve Miserack and Don Carter entertained the crowd with their derring-do, the LDK-14 did its thing in light levels ranging from intense to available light on Miserack and Carter as they circled and shot.

This pool footage, the edited preliminary bowling matches, and full coverage of the finals — about 3½ hours of tape — are being edited to a one-hour syndicated show by Bill and Roger Schwing of Miz Lou.

Barp cites "big-van, one-inch camera production quality" as the third benefit of his new van. Following on the successful bowling tournament shoot in Reno, the ELP van, again with five cameras, was used by Roger Galloway's Caroge Productions to tape Donna Fargo, Lynn Anderson, and Lacy J. Dalton in a country special to be syndicated by showtime. On this remote the challenge to picture quality was low-level, dramatic theatrical light-



American Film Factory's 26-foot van provides a working environment nearly as comodus as any studio

Sports Focusing Goes Automatic

Focusing video cameras at major sporting events has always been a demanding task, aggravated by the large lenses, long focal lengths, and often minimal lighting that lead to shallow depth of field. Even an alert and knowledgeable camera operator risks losing focus during rapid and unpredictable plays.

It had to be just a matter of time before autofocus, widely available for cine cameras, came to television. A California company, Light Industries, has developed a unit, the Sportsfocuser, that plugs directly into the chamber under the lens, replacing the normal right-angle drive module. All necessary electrical and mechanical connections are supplied. The Sportsfocuser is presently compatible with Canon lenses, although a Fujinon model is planned.

The Sportsfocuser's principle of operation takes advantage of the fact that most sports events occur on level fields. It mathematically computes the slant distance from the elevated camera to the playing field. Sensors continuously measure where the camera is pointed and computation circuitry handles the trigonometry. A high-performance servo then does the actual lens positioning.

While the principle works well in application, it has some obvious limitations. It cannot be used on ground-level cameras, for instance. In addition, it will not autofocus on objects above the playing field, such as grandstands and scoreboards. For these less demanding shots, however, the camera operator can flip the Sportsfocuser off with a fingertip switch and focus manually. No adjustments are necessary when flipping the focuser back on.

Versatile Video, Inc., a California company offering network-quality remote pickups, has field-tested the Sportsfocuser for over a year, with over 25 camera operators, producers, and technical directors representing networks, independents, and local TV stations experiencing autofocus. Coverage included football, basketball, and baseball, the three major seasonal sports in the San Francisco Bay area.

Reactions from the camera operators varied and tended to be apprehensive at the outset, but were universally enthusiastic, according to Light Industries. The operators took an average of half an hour to become proficient with autofocus, some of that time spent gaining confidence that the technique worked and the rest practice-switching the focuser in and out. Before each game the focusers were calibrated for the particular stadium, a process taking a minute or two.



While the Sportsfocuser must be pointed down toward a flat playing field, it can be switched out of function quickly for other shots

Producers and TDs pointed out several benefits of the Sportsfocuser, including faster reaction to announcers' cues and faster setup of shots. A somewhat unexpected result was occasional better picture fidelity during night baseball and indoor basketball: lenses were run at wider than normal apertures, so the cameras generated less video noise, better color, and better dynamic resolution.

Light Industries, the manufacturer of the Sportsfocuser, is located at 21112 Bank Mill Road, Saratoga, Calif. 95070. The unit sells for under \$5000.

Winsted

**STACKED
VTRs**
For easy
operating
access!

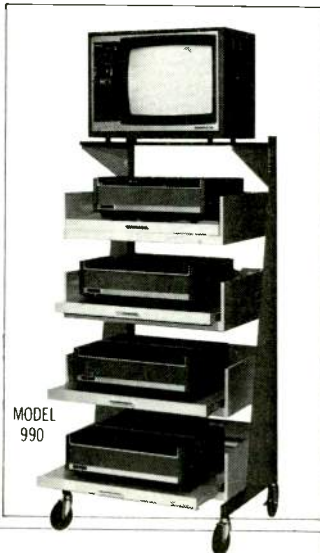

The console holds all sizes of 3/4" VTR equipment. An ideal setup for videotape duplicating. Shelves adjust on 1" increments. Sliding pullout shelves plus caster-mounted mobility for easy maintenance and total access to VTRs. Stack up to 5 VTR drawers on a single console. For full-line catalog of video consoles, tape and film trucks, film and videotape storage systems, call toll-free or write:

THE WINSTED CORPORATION 8127 Pleasant Ave. So., Minneapolis, MN 55420
(612) 888-1957 Toll Free Number (800) 328-2962

Winsted

Circle 136 on Reader Service Card



VM-13

COLOR MONITOR/RECEIVER

Two Modes of Operation for The Price of One

- Standard composite video/ 75 ohm term.
- Transformer isolated for safety.
- External audio input with control.
- Power Requirements: 117 VAC 60 Hz.
- VM-19, 19" diagonal screen, \$575.00.
- For professional, industrial, home video applications.

V.A.M.P. Inc.

P.O. BOX 29315 • LOS ANGELES, CA 90029 • (213) 466-5533

Circle 137 on Reader Service Card

EFP: A Profitable Business

ing. The challenge to profitability was getting all the footage needed for editing within one 8:00 a.m. to 5:30 p.m. shooting day, with equipment setup and strike starting after the previous day's last show and ending before the next day's first show. "The producers went away happy," Barp reports.

American Film Factory's van spent part of February in Tucson shooting 100 hours of film-style ISO footage from two cameras for Major League Baseball Productions. This material, featuring "big-league" players conducting clinics and demonstrations, will be syndicated as 13 half-hour *The Baseball Bunch* shows during the 1981 season. "Performance quality of our van was as big-league as the stars' performances," says Andy Maisner, AFF's founder and president. "And using it for electronic field production doesn't cost our clients a superstar's salary."

While triax has found a permanent home in field production, as evidenced by its availability as an option on most major field production cameras, it is only one of several technical tactics developed for field production applications. Multi-camera vans are becoming a routine part of the scenery at teleproduction facilities across the country. The goal clearly is to provide studio-grade equipment suitable to field environment at any location. The larger units mentioned in this article and those employed in other markets usually include a sophisticated studio recording audio board, multiple M/E bank and multi-camera switcher, graphics generator, and even slow motion controllers. These sophisticated field production units are often valued in excess of \$500,000.

The obvious question most broadcasters will ask when they spot a van with more production capability than they have in their own stations is, "How can you justify a capital outlay like that?" The answer is that a fundamental change is occurring in how programming is produced. Networks are no longer the only purveyors of prime-time, sports, or special events programming. Increasingly, advertisers faced with high national network prices are finding it economical to produce their own special programming directed to particular limited market objectives. Why buy the northeast when your market is the sunbelt? Networks themselves are a growing source of revenue for broadcaster-owned or independent production facilities. In an effort to control their own capital outlay, networks are making increasing use of independent teleproduction facilities. A large contingent of independent production resources worked on network payrolls during the recent inauguration in Washington, D.C. (see story on p. 44). Daytime soap operas have gone to the field to add reality to the usual studio settings, with location equipment provided by independent companies. In fact, even major network sports events commonly get some or all of their technical support from such independent sources. One major network recently contacted *BM/E* to enlist aid in conducting a census of location production capacity nationwide. Its purpose? To find out if sufficient network-quality production capacity existed in the independent sector to support network field productions. Add to this the pay TV specials, burgeoning industrial video program budgets, and the prospect of specialized programming for the CATV and videodisc markets, and one should begin to fathom how heavy investment in field production units can be justified.

BM/E

It's Here!

The
Saturn Series

NTSC / PAL

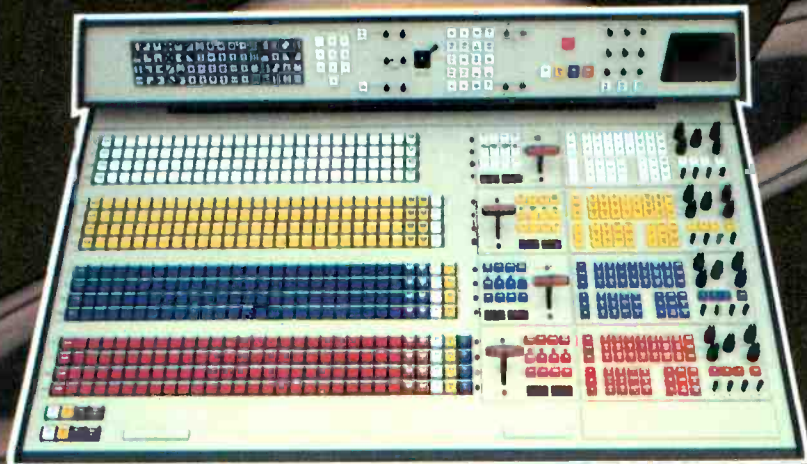

VITAL INDUSTRIES, INC.

3700 Northeast 53rd Avenue, Gainesville, Florida U.S.A. 32601
904-378-1581 • TWX 810-825-2370 • TLX 80-8572 VITAL-A-GAIN

Circle 138 on Reader Service Card

If we had set out to give you only
the features our competition gives you,
this is where we'd be today.



Most VTR units give you only a fraction of the features you might want from a video tape recorder. So we didn't stop where our competition did. We kept on adding features. Until we developed the most versatile 1" machine on the market.

Compare the 3M TT-7000 VTR and NTC-10 Time Base Corrector to the competition. Nobody puts together more of the features you want than 3M. And once you see our unit, we think you'll agree that buying anything else is like getting half a machine.

The 3M TT-7000 Video Tape Recorder gives you:

- Auto track following (ATF) ¼ reverse through 2x forward (optional).
- Video and sync confidence heads.
- Three channel audio confidence heads.
- Video sync channel.
- All DC motor and servo tape transport.
- 19" rack mountable with full dust cover.
- Front panel plug-in modules.
- Frame accurate insert and assemble editing.
- Dual tape timer with zero memory.
- Tape speed override on front panel.
- Stop tone and cue-up (0, 3, 5, 7 sec. preroll).
- Contact closure and TTL external interface.
- Variable speed forward/reverse shuttle.
- Still frame jog.
- Autochroma and color framing.
- Audio 3 record in play mode (built-in speaker).
- Instant stop action from play or slo-mo (with ATF option).
- Instant audio bias level adjust.
- Video level calibrate marker.
- Preset/Manual tracking select on front panel.
- Fixed precision rabbited drum tape guide.
- And low RF, high temperature and low voltage alarms.

Our Time Base Corrector comes complete with its own list of standard features:

- Sixteen line correction window.
- Ten bit quantizing.
- Four times subcarrier sampling.
- 65 dB signal-to-noise ratio.
- Velocity compensation.
- Digital one line drop out compensator.
- Compact size (8¾" high by 17½" deep by 18½" wide).
- 45 pounds total weight.
- Portable cabinet or rack mountable.
- And front panel plug-in modules.

Add it all up, and you've got the most complete VTR/TBC package on the



market. For a free demonstration, call (612) 733-7914 or write 3M/Mincom Division-Video Products, 223-5E 3M Center, St. Paul, MN 55144. In Canada contact 3M Canada, Inc., P.O. Box 5757, London, Ontario, N6A-4T1. In Alaska contact 3M Company, 5331 Minnesota Drive, Anchorage, AK 99502. Get the complete picture.

3M Hears You...

3M

The Quantel DPE 5000.



The digital effects system that will turn your head around.

Rotate it 360 degrees.

Manipulate it into an infinity of forms.

Flip it. Tumble it. Spin it.

But because not every broadcaster needs all these capabilities now, we've built the DPE 5000 to grow. Endlessly.

You can buy the basic single channel system and generate an array of optical quality digital effects. Infinite compression. Variable picture positioning. Freeze. Border generation. Position, size, and transition rate preselect. Horizontal and vertical squeeze. Key tracking.

Later, as your requirements change, you can add to your basic system.

Zoom expansion to four times picture size.

"No-Blank" noise reduction with blanking correction.

"Autosequence" effects recall system.

"Digiflip" flip, tumble, and spin.

"Autoflex" effects package for special shapes.

Picture rotation.

And up to four additional channels to give you effects on five pictures simultaneously.

All these options can be added to your basic DPE 5000 at any time. And this goes for any DPE 5000—all the way back to serial number 1. We want your digital effects system to grow, not become obsolete.

Even if you don't want your head turned around this year, who knows about next year?

Call your nearest MCI/Quantel representative. Or get in touch with us directly. Micro Consultants, Inc., P.O. Box 50810, Palo Alto, California 94303, 415/856-6226.



MCI/QUANTEL
The digital video people.

MCI/Quantel, "No-Blank," "Autosequence," "Digiflip," and "Autoflex" are trademarks of Micro Consultants, Inc.

Circle 140 on Reader Service Card

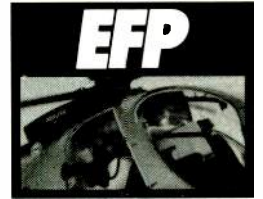

FLEXIBLE FIELD COMMUNICATIONS FOR ENG: A NEW PORTABLE SYSTEM

By Michael L. Locollo and Marc B. Wiskoff

ENG crews sent out to cover unexpected special events often need quickly set up lines of communication from unit to unit. A new portable radio system developed by the ABC RF Engineering Department and Motorola Corp. weighs 50 pounds, can be put on the air anywhere in a short time, and supplies a range of vital talk channels.

COVERING AN UNEXPECTED SPECIAL EVENT for radio is like a military operation in the sense that ENG field crews often need tactical communications. But in the past the equipment readily available often did not measure up to the need for really flexible inter-unit communications. If the base station radio equipment cannot be removed to a suitable transmission site and controlled from a designated operations center, there are likely to be talent mis-cues, vital messages not reaching news crews, and sometimes entire live spots lost because of unreliable, unintelligible, or totally missing communications.

Radio communications support for electronic news gathering and special events has rapidly and steadily grown over the last five years. Communication equipment has kept pace with this increased user growth by incorporating more medium and large-scale integrated solid state components, and more recently phase-locked loops to enable the generation of synthesized frequencies. This technology has allowed radios to become physically smaller, lighter, and more reliable. It was only natural to

take advantage of this equipment evolution when the ABC RF Systems Engineering Department was approached by ABC Network News and its Washington news bureau to design, build, and implement a completely field-portable communications system to alleviate many of the problems already identified in a remote pickup broadcast environment. The result was a unique field communications system that is completely portable and reliable.

What we wanted

Discussions between Andy Haas, Marc Drazin, and Bill Fowler of the ABC Washington news bureau and the ABC RF Systems Engineering Department fostered many desirable objectives for the field system. However, after refinement, final system objectives were formulated as follows:

- *Operational flexibility.* The portable field system must permit simplex communications between base operations and portable radios in the field as well and be capable of operating in a repeat mode in order to extend the effective range of portable-to-portable communications. Additionally, the equipment must be able to operate using either 117 V ac or 12 V dc power sources, have a nominal RF output power of at least 50 W in the simplex mode, be remotely controllable by a desk set or console, and provide an RF interface with the public switched telephone

Michael L. Locollo is an allocations and RF systems engineer with ABC and past chairman of both the 1980 Winter Olympics World Broadcasters RF Committee and the 1980 Political Conventions Frequency Coordination Committee. **Marc B. Wiskoff** is responsible for special market applications with Motorola Communications and Electronics.

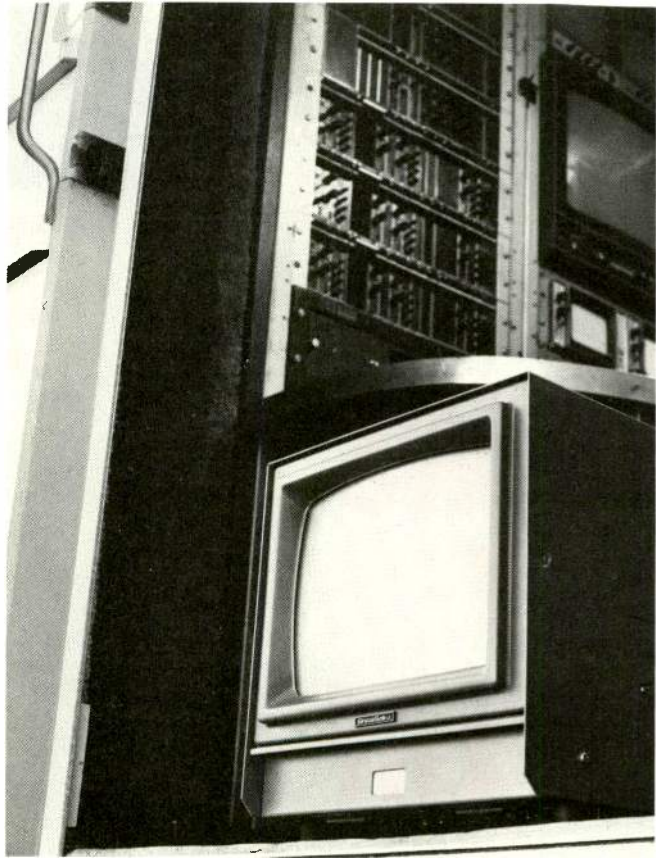

**Travel with
the compact
color monitor**

**that looks as good as your
studio's best.**

Asaca/ShibaSoku's 10-inch CMM 10-1 Color Monitor is one small way to be sure you have the best possible pictures you can get while on remotes. It's AC/DC, lightweight, and ready to travel. With its special high resolution in-line tube you'll be looking at pictures that match your studio's best monitor. Team it up with our ASW-100 Field Production System and you have a complete mobile broadcast studio with you. Just add the cameras.

The CMM 10-1 likes to travel. But it's still at home in your studio. Wherever it is, it's simply the best 10-inch monitor anywhere.



ASACA

ASACA/ShibaSoku
Corporation of America
1277 Rand Road, Des Plaines
Illinois 60016
(312) 298-4380

Flexible Field Communications

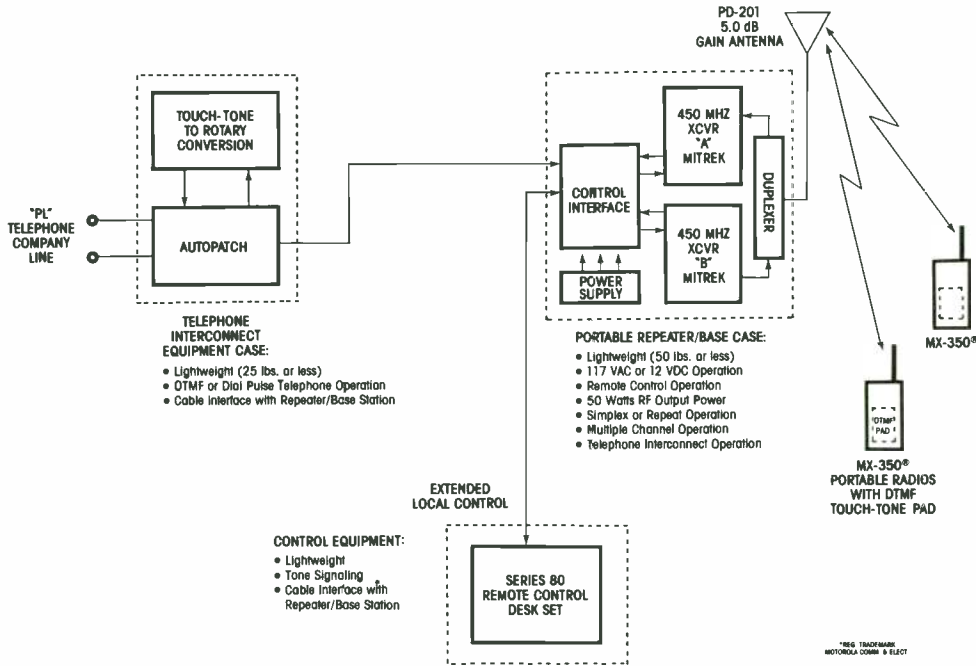

Fig. 1 (left) shows plan of first model for field communications. Great success led to plans for a second version (see below)

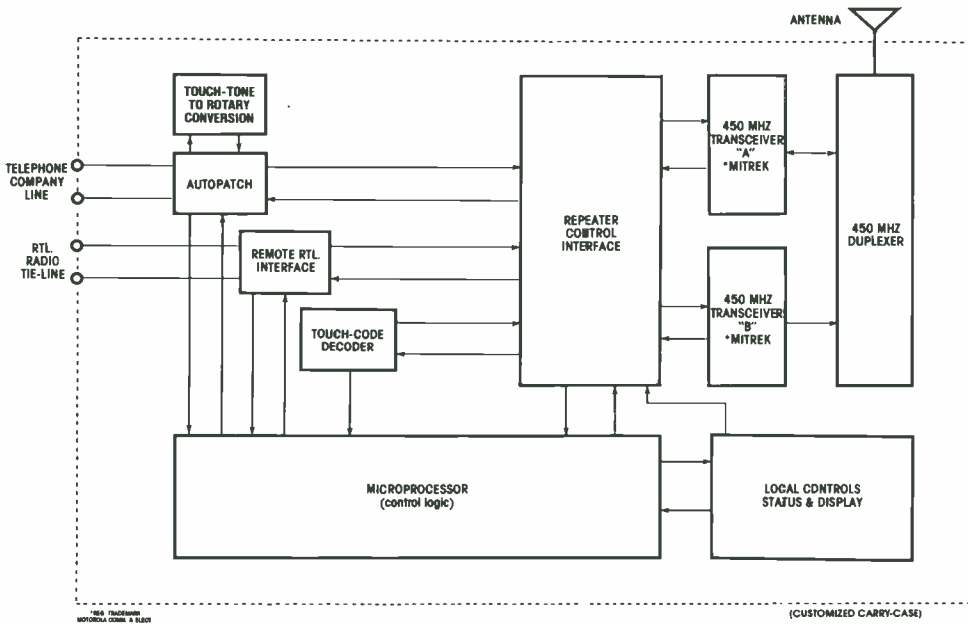

Fig. 2 is plan of PRB-II, second version of portable field communications system. Microprocessor controls all functions, substituting software for hard wiring

network to permit the placement and reception of telephone calls in the field.

- **Field portability.** The basic radio equipment (excluding antenna, transmission line, and remote control console) must be easily transportable, with an overall goal weight not exceeding 50 pounds. All other required equipment must be engineered for mounting into cases and connection to the radio equipment using short external cabling.

- **Minimum implementation time.** Equipment installation must be easy and fast, with total setup by one person to take less than one hour.

- **System compatibility.** The portable field system must be operationally compatible with the assigned frequencies and the tone codes of existing ABC Network News radio

systems in Washington, D.C. and New York City for news assignment, engineering, and production communications.

It was evident that the key feature to meet the above objectives was the development and deployment of a repeater/base station to perform the intended functions and still be light enough to be easily transportable. A thorough search of commercially manufactured two-way repeater radios indicated that equipment presently being offered could not satisfy our objectives.

At this time, ABC RF Systems Engineering and Motorola Communications began to discuss several approaches to the project. Ideas initially considered, but eventually discarded, included placing a fixed repeater station into a smaller cabinet with wheels and extended to

Flexible Field Communications

retrofitting a mobile repeater radio in a carry case and providing an external power supply. The plan we finally decided upon was to utilize lightweight Motorola Mitrek® mobile radios to form the nucleus of the repeater/base station and to design and build the required interface and telephone interconnect operation in one completely integrated package.

Once we chose this plan, the next step was to locate a company that would undertake the job of fabricating the repeater/base station in accordance with ABC and Motorola design requirements. Circuit Development Corp. of Brooklyn, New York (a division of ACS Communications, an authorized Motorola service shop) was selected because of its involvement with other large-scale projects for Motorola in the greater New York area broadcast market. Past experience showed the staff was knowledgeable and sensitive to the operating needs of the broadcast industry and was also completely accessible to both ABC and Motorola for frequent design review meetings. Stuart Nattboy headed the project for Circuit Development Corp. and was responsible for taking our design concepts and making them a reality — including packaging the individual components into the portable carry cases.

Figure 1 presents the final system plan, including the



Completed PRB-II weighs 45 pounds, is easily carried into field and set up to supply emergency communications. Pushbuttons control microprocessor

modular capability of adding the remote control and telephone interconnect equipment. The individual components for the plan were selected based on our defined functional and electrical interface requirements and integrated into a system as follows:

- **Repeater/base station.** This consists of two Mitrek® UHF mobile radios; interface circuitry to control frequency selection, simplex base station or duplex repeater station operation, tone signaling, and telephone interconnect operation; Phelps-Dodge PD-633-6 mobile duplexer; and an AC/DC Electronics RS series power supply — all mounted in a Zero-Halliburton carry case.
- **Telephone interconnect equipment.** This part of the system utilizes Data Signal, Inc.'s RAP-400 automatic radio telephone patch and DPC-221 dial pulse converter rack mounted into an A & J Manufacturing Co. travel case. A telephone company type-approved hybrid phone coupler is also included in the case to interface with a private line (PL) telephone circuit.
- **Remote control equipment.** A Motorola Series 80® remote control desk set was selected to interface with the repeater/base station through an external cable.

Total project time from initial concept, design, selecting of individual components, and building the repeater/base station and telephone interconnect equipment into the portable carry cases was nine months. The specifications for the repeater/base station appear in Table 1. As the next section indicates, the equipment was immediately placed into field duty with excellent performance results.

How it worked in the field

Setup in the field requires running suitable transmission line and mounting a lightweight UHF high-gain antenna, connecting the line to the antenna and portable repeater/base station, providing either a 117 V ac or 12 V dc battery power source, and interconnecting the remote control desk set. Andrew Corp. LDF4-50 transmission line and a Phelps-Dodge PD-201 5 dB stationmaster antenna are typically employed to obtain relatively low line loss and sufficient antenna gain to achieve a suitable level of effective radiated power. When required, the telephone

Portable Repeater/Base Specifications

GENERAL

Frequency band:	450-512 MHz
Number of channels:	3 simplex; 1 duplex repeat (4 total)
Temperature range:	-30° C to +60° C
Total package weight:	50 pounds
Construction type:	Completely solid state
Power requirements:	117 V ac or 12 V dc (switch selectable)
Power drain (maximum):	AC — 3.5 A transmit; 0.75 A receive DC — 20.0 A transmit; 1.8 A receive
Overall dimensions:	19½ x 22¼ x 14" (HWD)

TRANSMITTER

Power output:	50 W (simplex) 35 W (duplex repeat)
Deviation:	±5.0 kHz for 100% modulation
Spurious and harmonic emissions:	-85 dB
Output impedance:	50 ohms
Maximum frequency separation:	9.0 MHz

RECEIVER

20 dB quieting sensitivity:	0.5 V
Modulation acceptance bandwidth:	±7.0 kHz
Intermodulation rejection:	-85 dB
Selectivity (25 kHz adjacent channel):	-90 dB
Spurious response rejection:	-100 dB
Input impedance:	50 ohms
Audio output:	8.0 W
Maximum frequency separation:	2.0 MHz

DUPLEXER

Number of cavities:	3 transmit; 3 receive
Frequency separation:	5.0 MHz
Maximum input power:	50 W
Tx-Ant insertion loss:	1.4 dB
Rx-Ant insertion loss:	1.4 dB
Maximum VSWR:	1.3:1
Frequency stability:	1.5 ppm/°F

Sold!

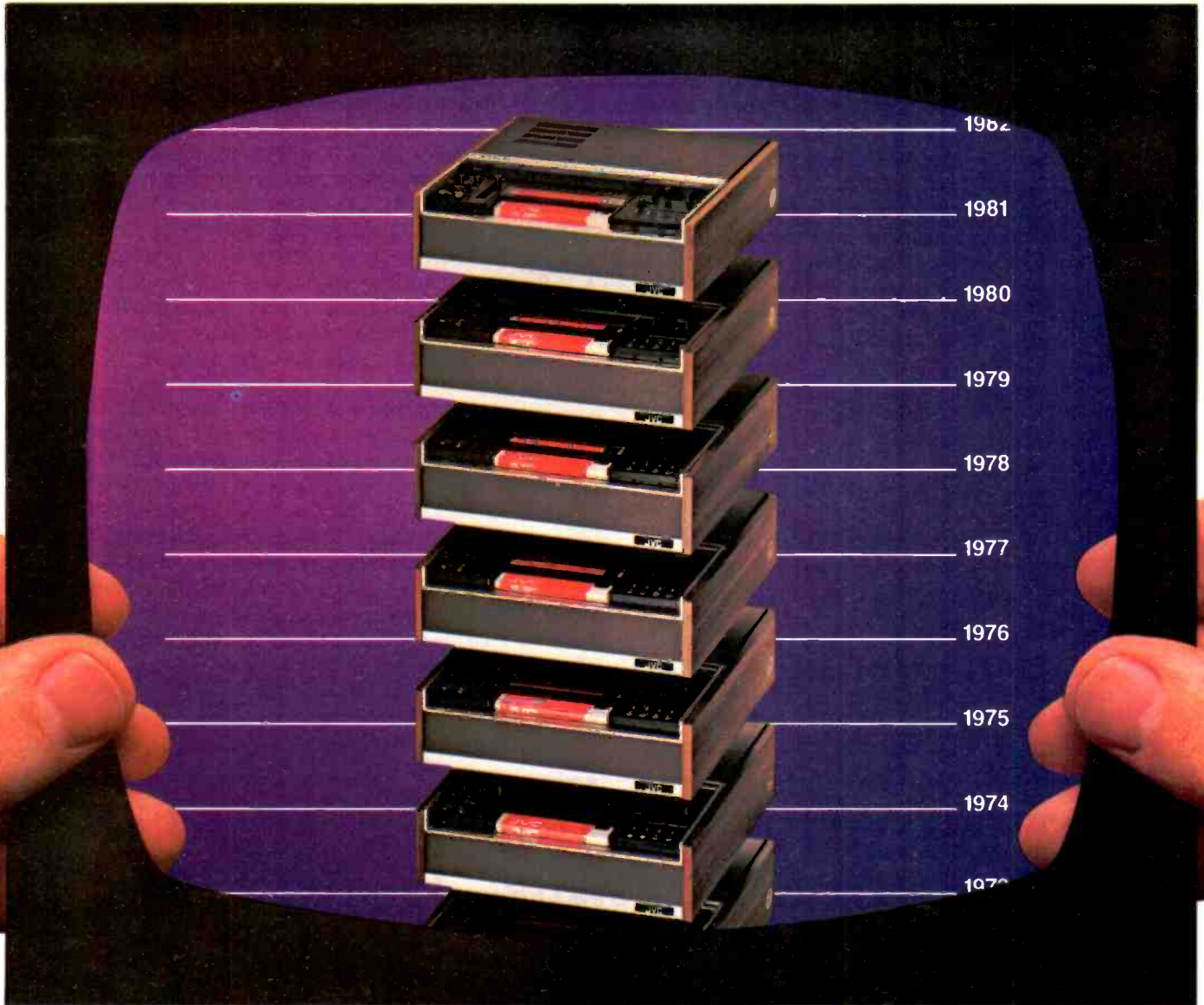

**Why thousands
of video users
are sold on JVC's**

CP 5000 U

Videocassette Player

CP 5200 U

Videocassette Player

CR 6060 U

Videocassette Recorder

Reliability. Quality. Economy.

Those are the reasons you see JVC's 3/4" Videocassette Recorders and Players working day-in and day-out, year-in and year-out, to bring the advantages of video to thousands of users in business and industry, science and medicine, broadcast studios, courtrooms... wherever you look.



The CP-5000U and its stop-action companion, the CP-5200U, are the real high quality workhorses of the professional video world. Packed with features, such as solenoid-operated controls, they're easy to use and hard to at use. The CR-6060U adds high-performance recording capability at an amazingly reasonable price.

Get full details on these time-tested products,
call toll-free 800-821-7700, Ext. 7005.
(In Missouri, 800-892-7655, Ext. 7005.)

Or write US JVC Corp., Dept.
41 Slater Drive, Elmwood Park, NJ 07407.
Available in Canada from JVC
Electronics of Canada, Ltd., Ontario.

**Your choice.
Now. JVC®**
US JVC CORP.

Circle 142 on Reader Service Card

Flexible Field Communications

interconnect package can be connected to provide telephone communications in the field; this only requires a private line telephone circuit at the equipment locations and interfacing the interconnect package to the line and repeater/base station. Total equipment setup can usually be performed by one person in less than an hour, with the possible exception of the antenna, which may require two people depending on its mounting location.

During the past year the field system was called upon to provide reliable communications coverage for many important news events, including the Papal visit in late 1979; the Iowa caucus that was a prelude to the Presidential primaries; the New Hampshire, Massachusetts, Florida, and Illinois primaries; the return of the hostages from Iran; and the President's many travels. As a firm rule, coordination of frequencies in each operating area was performed by the ABC Allocations and Licensing Department as required under Part 74 of the FCC rules and regulations prior to actual system operation.

In these operations, ABC News has found that the portable field system fully realizes the project's intended objectives of operational flexibility, field portability, fast implementation, and compatibility with their existing fixed radio systems.

The next generation

A piece of communications equipment with many field applications is obviously a major advantage in a remote pickup situation. With the success of the first project,

ABC News has initiated a second project which, when complete, will result in four additional systems. Again, ABC RF Systems Engineering Department, Motorola Communications, and Circuit Development Corp. are heading the project for ABC News to develop the next generation of portable repeater/base stations.

Unlike the original, which was hardwired, the PRB-II (portable repeater/base, Model 2) will incorporate microprocessor technology for increased control versatility and employ plug-in circuit boards interconnected with ribbon flex cabling throughout its design. As Figure 2 depicts, it will also be fabricated around the two Mitrek® mobile radios, mobile duplexer, and control interface but will include microprocessor control of all control and status functions. Additionally, the telephone interconnect equipment will be integrated into the case in the form of printed circuit boards rather than in a rack-mount configuration, eliminating the need for a second carry case. Increased performance features of this new design will include eight-channel operation out of a possible 64 combinations (programmed and user-selected via an internal DIP switch); remote channel changing using DTMF (dual tone multiple frequency) signaling over regular telephone control lines; an audible tone beacon to identify the channel presently selected for operation; and complete status indication of selected functions.

The next generation of the portable repeater/base station (PRB-II) will weigh about 45 pounds, five pounds less than the original. As a direct result of the ABC News success, Motorola Communications and Circuit Development Corp. will soon begin to offer this innovative radio to the broadcast industry. **BM/E**

COST EFFECTIVE CONTROL IN A MICROPROCESSOR-BASED SYSTEM



THE TCS-2A

- INDEPENDENT COMMAND, STATUS, AND TELEMTRY
- MICROPROCESSOR-BASED
- ONE-PERSON CALIBRATION
- MULTI-SITE CAPABILITY

The TCS-2A provides eight fully independent command, status, and telemetry functions. Utilizing microprocessor-based technology, the system combines reliability, speed, and economy with simplicity of operation. The TCS-2A consists of a command and a remote terminal and is designed to fill the needs of broadcasters, industrialists, ENG system users, and earth station operators. One-person calibration is afforded by a digital telemetry display at the remote terminal. The TCS-2A is expandable up to sixteen remote sites.

FOR FURTHER INFORMATION PLEASE CONTACT OUR MARKETING DEPARTMENT.



MOSELEY ASSOCIATES, INC.

A FLOW GENERAL COMPANY
SANTA BARBARA RESEARCH PARK, 111 CASTILIAN DRIVE • GOLETA, CA 93117
(805) 968-9621 • CABLE: MOSELEY • TELEX: 658-448

Circle 143 on Reader Service Card

**AUDIO COMPONENTS
FOR PA, RECORDING
& LIVE PERFORMANCE**

ADA-1
FOUR CHANNEL
ACTIVE AUDIO DA



LS-1

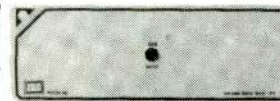

LINE
LEVEL
SPLITTER

STEREO
BALANCE
BOX:
FOR
PROPERLY
MATCHING TAPE RECORDERS
& OTHER EQUIPMENT



SB-1

Send For Your Free
Copy Of Our Catalog



SESCOM, INC. (702)384-0993
Professional Sound Division (800) 634-3457
1111 Las Vegas Blvd. North • TWX 910-397-6996
Las Vegas, NV 89101 U.S.A.

Circle 144 on Reader Service Card



Versatile Video Inc.

The Producer's Facilities

151 Gibraltar Court, Sunnyvale, CA 94086

(408) 734-5550

Come to Sunnyvale and let us show you why we're called "The Producer's Facilities." Whatever your needs, we provide a full range of video production services and equipment, including:

- Two spacious, fully-equipped studios
- Five remote trucks
- Philips LDK-5, 15, 25, and Ikegami HL79A color cameras
- Ampex 1" and 2" VTR's
- Mach One computer editing
- Rank Cintel Flying Spot Scanner
- Quantel DPE 5000 Digital Effects Generator

One look inside our complex and you'll see why we're the most complete video house in northern California. Versatile Video Inc. — we're worth a trip to Sunnyvale.

Circle 145 on Reader Service Card



Computer set-up and triax too

Today, broadcasters are classing computer setup and triax as necessities. Ikegami offers you a choice of two such cameras. Both are proven in the studio and field.

- The HK-312, with 1¼-inch pickup tubes, is a proven computer setup camera. More than 100 are in service throughout the ABC Network, at WGBH, and at other major stations.
- The HK-357A with 1" diode gun pickup tubes offers the same high standard of performance along with the convenience of field capability.

Both are extremely stable cameras that can be operated manually. And both accept computer control for automatic setup for on-air readiness in 45 seconds.

Both cameras can be used with multi-core cable. With triax the cameras can be a mile from their base station.

Of course, in colorimetry, automatics, circuitry excellence, and range of options, both are incomparable. But seeing is believing. Experience a demonstration soon at Ikegami Electronics (USA) Inc., 37 Brook Avenue, Maywood, N.J. 07607; (201) 368-9171. West Coast: 19164 Van Ness Ave., Torrance, CA 90501 (213) 328-2814; Southwest: 330 North Belt East, Suite 228, Houston, TX 77060 (713) 445-0100; Southeast: 522 South Lee St., Americus, GA 31709 (912) 924-0061.



Ikegami

SAN FRANCISCO: BELLWETHER MARKET FOR COMMERCIAL PRODUCTION

The San Francisco Bay area is going through a boom in television production that is likely to be repeated in medium and large markets across the country. Retail commercials, industrials, and the spectre of programs for broadcast and cable now sustain an impressive array of sophisticated teleproduction operations.



Commercial producers are often attracted to San Francisco's famous settings. Here, VVI Mobile Unit 1, using an HL-79A, shoots from its roof platform towards one of San Francisco's cable cars

AS THE FIFTH LARGEST television market in the country, San Francisco is atypical. It contains some 12 ADI counties with nearly two million television households. Its economy is varied, from the well-to-do Marin County to cosmopolitan San Francisco to rural Napa County. Per capita income is considerably higher than the national average. The area is also replete with some of the most beautiful scenery in America, not to mention the worldwide recognition owed to San Francisco's cable cars and breathtaking hills.

With all this going for it, San Francisco, until a few short years ago, had just one nationally recognized commercial production operation, Snazelle Films. Though the city could boast a healthy film and television production industry, most of the big budget work was being done in the city by Los Angeles-based studios, producers, and directors drawn to the city by its beauty or by the story lines of the show on which they worked. Commercials were a minor part of the scene. Los Angeles and New York dominated the commercial production scene in the minds of producers, if not in the absolute numbers of commercials produced.

San Francisco now boasts more than 50 companies whose principal activity is in the area of teleproduction. Many of the area's 12 commercial television licensees maintain strong commercial production arms, ranging

from the capacity to produce simple voice-over-slide spots to full-blown computer-posted spots with complicated sound tracks. The independent teleproduction companies range from simple U-type, inexpensive video operations that struggle to make it on videotaped business meetings and highly speculative CATV productions to network-grade production operations.

Three national trends sparked this explosion. Retail outlets discovered the power of television advertising, business and industry discovered the power of television for training and intracorporate communication, and technology advanced to make the power of television available to these constituencies. The impact of these trends is nationwide. A prediction by Outlet Broadcasting in 1979 stating that the company expected to see 60 percent of its stations' revenue derived from local sources by 1983 seems well ahead of schedule. (It should be noted that a contributing factor in this trend is the establishment of regional offices by major advertising agencies, which are now placing many spots locally that used to be placed as national spots.)

The San Francisco story

In researching this story, *BM/E* visited and/or spoke with a number of San Francisco Bay Area teleproduction operations. The four we will take a look at here represent



Master Control Automation™ takes the “excitement” out of Broadcasting. But it adds reliability.

From the people who brought you BIAS™ now comes Master Control Automation. It insures an accurate flow of event activity while simultaneously listing reports, reconciling aired spots, and preparing the log for subsequent billing.

And it's all possible through the most sophisticated software system on the market for on-air switching. Master Control Automation will control any on-air switcher regardless of manufacturer. It receives the program log and manages switching activity without

operator intervention. You monitor the entire process at one or more control terminals with a minimum of effort. And you know it's working right.

Master Control Automation™ is a part of the total system umbrella Network Control System™ Complete broadcast automation with BIAS™, BUY LINE™ (Avail Submission and Electronic Mail), Feature Film™ (Inventory and Amortization), and Financial Accounting Packages. Available together or separately. Call us today for a demonstration at (901) 345-3544.

The simplest, most efficient way to run a television station.



BROADCAST DIVISION

DATA COMMUNICATIONS CORPORATION
3000 DIRECTORS ROW
MEMPHIS, TENNESSEE 38131

Commercial Production



Many local producers report a resurgence of film activity among the sophisticated commercial user. Chronicle Productions has the only full Steadicam® rig for video and film in the market. Mike Elwell glides down 16-stairs here for an eight second shot

distinctly different styles of doing business and four distinctly different technical structures customized to meet the segment of the market they address. There is some overlap, and they do consider themselves competitors to a limited extent. Each of the operations is flourishing, a testimony to the vitality of the market as a whole.

KTVU, Oakland, is a Cox Broadcasting station. Its commercial production operation is known as Retail Services and is under the direction of Rich Hartwig. Set up seven years ago, Retail Services is the oldest of the operations reviewed here. The operation continues to grow at a spectacular rate and late last month it moved to brand new quarters.

Specifically, Retail Services' mission is to operate as an arm of the station's sales effort to assist in marketing and development. Commercials produced at KTVU are for use on KTVU's air, though the spots are also placed on the air of other stations.

According to Hartwig, about 98 percent of the production activity at KTVU is commercial production, with the remaining two percent divided among industrial and edu-

cational teleproduction done at the behest of existing clients or agencies with close ties to the station. The commercial production falls into two broad areas: introducing new clients to television and sustaining the commercial operations of existing clients.

Introducing clients to television is perhaps one of the most important functions of the Retail Services organization. New advertisers not only are brought to KTVU's air but, ultimately, become customers of other area stations as well, thereby boosting the overall level of market activity.

By any measure, KTVU's operation is a sophisticated one. The station's 12 local sales people benefit from a computer system that tracks market advertising in nearly all media. When retailers reach a certain level of advertising activity, KTVU sales representatives present them with an analysis of their advertising expenditures and show them how their dollars can be applied to television.

The sales rep is often accompanied by one of Retail Services' three account executives (they are also writer/producers), who analyze the client's budget and suggest commercial presentations. Generally, the budget for a KTVU-produced commercial will represent about 10 to 15 percent of the client's budget. According to Hartwig, "We are a non-profit organization" that produces commercials at cost for clients of KTVU's air.

The past seven years at KTVU have witnessed all the many stages of maturation that a broadcast-related commercial production operation can expect. Hartwig figures that when KTVU started Retail Services seven years ago, they were responsible for about 75 percent of retail commercial production in San Francisco. Now Hartwig places about 60 percent of retail commercial production in KTVU's arena. The absolute growth in numbers of retail commercials, however, has more than compensated for the decline in share of market.

The range of sophistication on the part of clients and their agencies covers the gamut from very simple to very flashy production. While Retail Services has worked out of "closets in a 22-year-old warehouse" in the past, it now works out of a \$23-million facility. This latest stage of development should eliminate the criticism that most of KTVU's competitors cite — that station-related commercial production operations often take the leftovers from station operation. While it is true that Retail Services used to do its production at off-hours utilizing technical support loaned to it by engineering, the new operation will have its own facilities, including a new 80- by 160-foot studio with a 25-foot cyc, a state-of-the-art control room with a GVG-300A switcher including digital special effects, a McCurdy 7800 audio console, Ampex VPR-2s, Ampex ATRs, ACR-25, RCA film chain, and three RCA computerized TK-47 cameras. Retail Services will also have its own CMX off-line editing suite. Hartwig confidently states that the new Retail Services production facility will have everything that any other commercial production facility in the area can offer, "if not more."

Currently, location production represents about half the shoots KTVU conducts. To accomplish these, Retail Services has both film and tape location capability. Its location unit is a one-inch equipped film-style video production unit with an Ikegami HL-79 camera. The truck carries lighting equipment, generator, and full video/audio facilities for EFP. It also has dressing room facilities. A second truck may be added in the near future.

Regarding trends in commercial production, Hartwig

Commercial Production

noted the increased use of 16 mm film for location production, as did a number of others in San Francisco. It is the more sophisticated commercial clients who are specifying film, primarily for its "look," said Hartwig, and it is the flying spot scanner that has made it practicable to work in film. The superior quality of transfers to tape made by flying spot scanners has allowed producers to transfer to tape for post-production, thereby taking advantage of the best of both worlds. Location film is easier to set up than video and somewhat less expensive, but video post-production is considerably faster and more certain than film post-production. According to Hartwig, after all things are considered an on-location film spot, posted in video, is about \$100 to \$200 cheaper than an all-video spot.

Chronicle Productions is a division of Chronicle Broadcasting Co., which operates San Francisco's KRON-TV. There is, however, no hierarchical relationship between KRON and Chronicle. Both are independent subsidiaries of the parent corporation.

Chronicle Productions, headed by Rich Hoffman, is a *facilities house*, according to account supervisor Ken Hobbs. It is distinct from the other operations reviewed here in that it primarily supports the commercial production operations of outside producers and directors. As such, it is geared to the higher-end retail spot and industrial video user.

The company was just a little more than a year old when its new facility went on line in December, 1980. According to Hobbs, Chronicle operates the area's most sophisticated film-style mobile unit, a 21-foot truck with camera platforms at the front, rear, and top. The truck sports hydraulic stabilizers and offers inverters and two 3 kW generators. Full lighting equipment is carried aboard the truck along with the audio and video equipment, which includes Sony BVH-500 and Ampex VPR-20 portable one-inch recorders. The camera is an Ikegami HL-79. Though Chronicle does not operate its own studio at present, it has on-going relationships with local stages. Its post-production operation includes the Harris Video Systems EPIC editor, three VPR-2s, an Otari eight-track audio recorder, and Grass Valley switching with the MCI/Quantel DPE-5000 for digital special effects. Automatic color correction, Compositor character generation, and Lexicon digital reverberation are among the special facilities offered by Chronicle.

Like KTVU, Chronicle is beginning to see substantial growth in the use of film by local commercial producers. Hobbs also attributes this to the advent of flying spot scanners and predicts that when more flying spot scanners are available in the market the trend will accelerate. There are now some 60 flying spot scanner installations in the country.

Chronicle includes among its high-end commercial users Macy's, Mervyn's and Emporium — a large California-based department store chain. Its high-end industrial users include Kaiser, Bechtel Corp., and others. Like others interviewed for this story, Hobbs says that his company is beginning to see an influx of commercial work coming into San Francisco from Los Angeles as the market expands its capacity for high-end television users.

The commercial style trends that Hobbs noted included more life style and corporate image style spots by the larger users of television commercial time, "We see a



KTVU Retail Services supplies everything from technical support to stylist



In addition to the usual equipment, KTVU has to make up a few things including their own wheeled production cabinet that carries monitoring and support equipment wherever the spot takes them



In-store spots are still an important feature of retail commercials. A KTVU client, here, uses the speed of television advertising to capitalize on seasonal buying. A quick video tag might give the user a leg-up on post Christmas sales

trend away from the in-store, single-product approach," said Hobbs. Advertisers and their agencies are beginning to be concerned with the commercial environment in which they compete with other commercials for the attention of the viewer. This implies a fairly sophisticated use of the medium that seeks to target a particular audience with good production values and an appeal to lifestyle-based psychographics.

Chronicle's staff of 14 people includes secretaries, maintenance, and technical support staff in addition to accounts people like Hobbs. There are, however, no full-time producer/directors on staff. With the level of client that Chronicle appeals to, the agency usually acquires the services of a producer/director either from the agency or selected from the community of established independents.

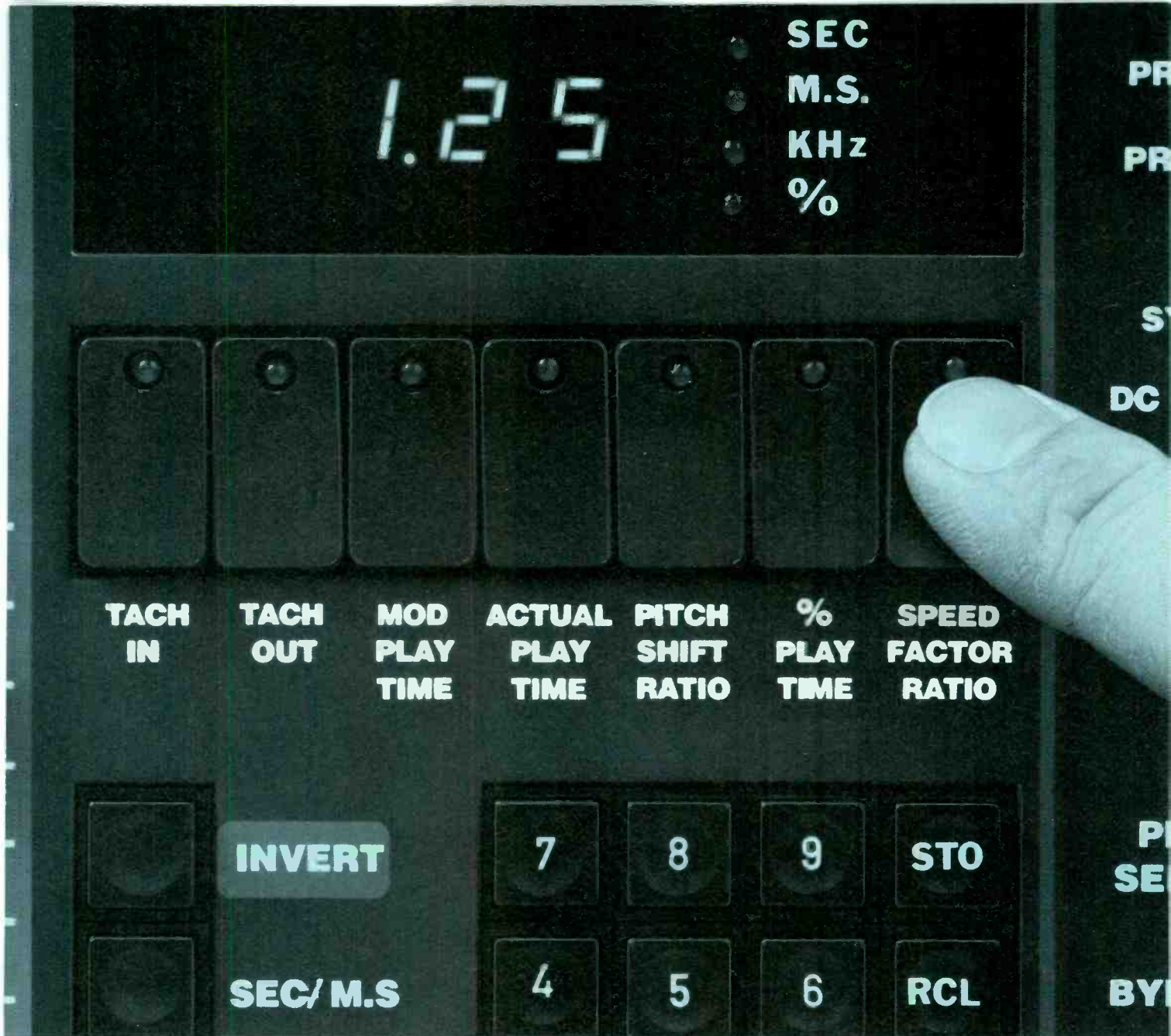

THERE'S A NEW PRODUCTION TOOL IN TOWN



lexicon

Model 1200 Audio Time Compressor automatically reduces or expands the play time of recorded material ... gives you "time-tailored" programming at the push of a button ... preserves original pitch and voice quality.

● With the remarkable new Lexicon Model 1200, you can now eliminate time-consuming retakes to fit commercials or other material into available time slots. For the first time, you can speed up tapes or slow them down — and get broadcast-quality sound free of distortion. ● You simply connect the 1200 with virtually any variable-speed tape recorder, set the timer for the on-air or play time you require, and you're in business. Material that runs too long can be compressed up to 25%. You can time edit to add tag lines or heighten the energy of the message. In TV applications, the Model 1200 can be teamed with a variable-speed film projector and/or a videotape recorder. ● The Model 1200 — a product of Lexicon's eight years of leadership in digital audio processing — marks a breakthrough in bringing time-processed audio to the level of quality necessary for radio and TV use. Based on sophisticated computer technology and proprietary intelligent digital processing techniques, the 1200 has been thoroughly field-tested in the production of nationally broadcast commercials by 19 of the top 20 advertising agencies. Write for detailed information and application notes.

60 Turner Street, Waltham MA 02154 USA (617) 891-6790 TELEX 923468
Export: Gotham Export Corporation, New York, NY 10014

Circle 148 on Reader Service Card

Introducing the first line of professional recorder care products. The Proformance Series.™ Designed and created exclusively for you, the professional. Who else but Nortronics could deliver products like these.

Nortronics, the undisputed world leader in magnetic heads. We make the heads others are compared with. Over 25 years of engineering skill and expertise are behind every head. Today, high quality and

technical innovation have become Nortronics' trademarks.

Now get that same expertise in recorder care products. The Proformance Series. We first pinpointed the industry's precise requirements. Designed to meet them. Established critical tolerances—tolerances that meet or exceed any requirement you may ever have. The key to everything is simplicity. In short, each product will exceed your highest

expectations. Because that's the way we do things—professionally.

Ask your distributor about the Proformance Series. Or call 1-800-328-5640 for the distributor nearest you. In Minnesota, call 612-545-0401.

PROFORMANCE SERIES™

BY NORTRONICS.

8101 Tenth Avenue North
Minneapolis, MN 55427 U.S.A.

Keep them as great as we've built them.



Circle 149 on Reader Service Card

Commercial Production

Hobbs states that San Francisco is a market of heavy television users and the local and regional spots produced at Chronicle reflect the rapidly growing sophistication of the market. This type of growth has led to a heavy reliance on post-production.

While Chronicle does its largest business in the production of commercials, it has also become involved in program production and industrial television. Both of these areas show current growth, while the much hoped for pay TV and cable-inspired program production remains miniscule. Nevertheless, Chronicle, like the other institutions involved in this story, see cable and pay TV as a real possibility. As Rich Hartwig of KTVU put it, "There's enough business out there that, while I don't want to say it's unlimited, it is!"

Hartwig's statement, while enthusiastic, seems nonetheless accurate. San Francisco's television production market now supports two of the nation's most sophisticated independent teleproduction houses, One Pass Video in San Francisco and Versatile Video, Inc. (VVI) in Sunnyvale.

One Pass sports CMX-340, EPIC, CMX-50, Sony BVE-500, and even CMX-600 lightpen editing. One Pass' technical operations manager, Tom Warner, has adapted CMX-600 software to apply this very powerful system to audio post-production as well as video. For field production One Pass operates two mobile units, a small film-style unit using the RCA TK-76 with either Sony BVU or BVH recorders and a multi-camera remote production unit using RCA TK-76, TKP-45, and Ikegami HL-79A cameras. Recording equipment in the larger truck is Sony one-inch or 3/4-inch machines. Ampex VPR-2s are available in post-production.

A full stage with 40- by 40- by 16-foot lighting grid is also available, as are a small insert stage and announce booth. Post-production switching is a DVE-equipped Grass Valley 1600. Viewing room, off-air recording, film-to-tape transfer via a flying spot scanner, and casting facilities are among some of the other services offered by One Pass.

One Pass started out in 1975 and has since gained a national reputation for its operation, producing not only commercials but taking on assignments for network programs like *Games People Play*, *Bill Moyer's Journal*, and entertainment specials like *Ann-Margret At Tahoe*. One Pass employs nearly 40 people, including gaffers, grips, producers, and directors. Larry Kingen, who heads sales for One Pass, expects this type of major program production to increase and states that San Francisco's post-production prices, which run about 20 percent less than Los Angeles, will encourage more producers to finish in San Francisco even if they shoot someplace else. To handle such major productions, One Pass has started a new company called Group One Productions.

While Kingen sees program production and post-production as an important growth area for One Pass, commercial production and industrial production still represent the bulk of the business. Right now, the quality of production offered has allowed One Pass to move into the national and regional commercial business as well as local. About 35 percent of the commercials produced are local, while national spots now represent about 10 percent.



Chronicle usually works with outside producer/directors for the "high-end" retail client. Here a national spot for Mervyn's, produced by Bambi Hamil, uses a fast snorkel lens on an RCA TK-76 to get dramatic angles on the Kangeroos Running Shoe product



Chronicle's list of extraordinary capabilities includes Northern California's only underwater camera housing for an Ikegami HL-79

One Pass is a signator to SAG and AFTRA contracts, but its other crafts are non-union. Kingen sees this as an advantage over Chronicle and KTVU. But Kingen is particularly proud of the role One Pass has played in educating television users. "We hold seminars for clients," said Kingen, to help them understand the complexity and power of the medium. Industrial users, he said, have been relatively unsophisticated to date, but the seminars and close cooperation that One Pass provides is helping them to get more out of their production dollars. Like the other groups, One Pass sees cable as having good potential but states that CATV and pay "are still pretty much in the talking stage."

One Pass' director of operations, Ed Sarmiento, points out that though San Francisco may not have the depth of talent that L.A. has, "the tools are the same and we make up for it with enthusiasm." Things are done differently in

Commercial Production



VVI's Mobile Unit 1, a film style video unit, works at the San Francisco Bay Wharf



VVI's CEI camera from Mobile Unit 1 is used here for a scene in a Northern California Datsun Dealers Assn. spot

San Francisco, he says, with very little carping between crafts and a general attitude of "let's get the job done right."

One Pass does work with outside producers and directors and provides post-production facilities to anyone who wants them. According to Sarmento, about half of One Pass' dollar volume right now is in post-production. "Our CMX 340 is operating two full shifts a day."

Versatile Video, Inc. is probably the biggest independent production operation in the market. VVI handles everything from major league sports to simple video tags. Its fleet of six mobile units (see EFP story elsewhere this issue) is suited to every type of field production requirement from single camera film-style video production to multi-camera (up to five) camera shoots.

While its credits include participation in ABC's Winter Olympic coverage last year and a host of other entertainment and sports program productions, like the other companies the bulk of its operation is commercial production. The key word for VVI is "versatile." The company provides an impressive array of field production capabilities using CEI cameras (Models 280, 290, and 310) and Philips LDK 5s and 14s. The multi-camera units include either a Ross 1600 14-input switcher or a Grass Valley 12-input switcher. Recording is on Ampex VPR and AVR systems. Audio boards on the trucks are Yamaha 16 by four and 12 by two mixers. Intercoms are RTS three-channel and four or 12 position IFBs. Full lighting and an Onan 45 KVA generator are available. Two of the VVI mobile units are tape trucks capable of one-inch, two-inch, and U-type recording. Electronic graphics are avail-

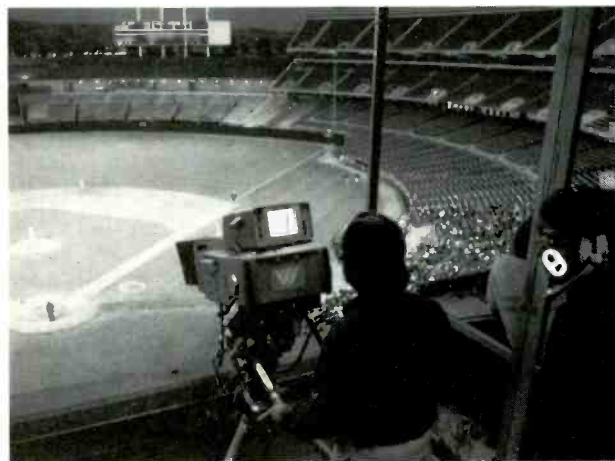

Mobile Unit 5 from VVI uses five Philips cameras for the more complex shot . . . including live sports coverage

able with a Vidifont Mark III or Datavision 4000 unit. A range of grip equipment is available including Vinten cranes, McAlister crab dollies, and ITE studio pedestals.

Studio facilities at VVI include two studios (40 by 50 feet and 30 by 30 feet). Studio cameras are LDK 25s. Audio facilities include a Yamaha PM-1600 16 by four mixer, Otari reel-to-reel recorders and Ampro cart machines. The same electronic graphics capability used in the mobile units is available in the studio.

Post-production at VVI is via the Fernseh Mach I editor for on-line and a CMX-50 system for off-line. The CMX-50 is programmed for audio post-production as well as video.

VVI offers, in addition to its production and post-production services, a host of film-to-tape and tape-to-film transfer services. Tape duplications and off-air recording services are also provided, giving VVI the definite scope of a "full-service house."

Added to the facilities described at the foregoing institutions are the facilities at other San Francisco Bay area television stations and independent production houses. We are looking at an enormous production capacity that would have been unthinkable a few short years ago. The San Francisco experience is not unique. While it may have arrived at this level of production in advance of some smaller markets, its growth is not unparalleled. Other markets are experiencing similar booms and there is no end in sight. Each of the companies mentioned here is struggling to keep pace with demand. Expansion is a part of their on-going plans. Will the process continue? All indicators say that it will. **BM/E**

DBX HELPS KMJQ WORK MAJIC.

Majic. It's a black format that's living up to its name in several markets across the country. And perhaps the biggest success story is Houston's KMJQ. Back in 1977, KMJQ adopted the Majic format and went from near bottom to #1 in just 2 short Arbitrons.



Yet KMJQ was the softest station on the dial.

"To achieve our goal," explains Chief Operator Leroy Dietrich, "we placed a lot of emphasis on the quality of the sound. By the day we started the Majic format, we had built a technical ability that we think is probably one of the best in the country.

"We hired an audio consultant to get us started," continues Dietrich. "He installed P 303 pre-amps and MC20 moving coil cartridges on SL-1100A turntables. Then he recommended dbx equipment for definition and dynamics."



KMJQ installed dbx tape noise reduction on all their cart machines. Not just for their program material, but for their commercials, too. "That keeps our advertisers happy because their commercials sound as clean as our music," says Dietrich. "And



we use a dbx Model 500 subharmonic synthesizer to restore the low end.

It makes the station sound especially well balanced. Even at low listening levels."

KMJQ also needed a compressor/limiter - but they didn't want to ruin the sound quality they had worked so

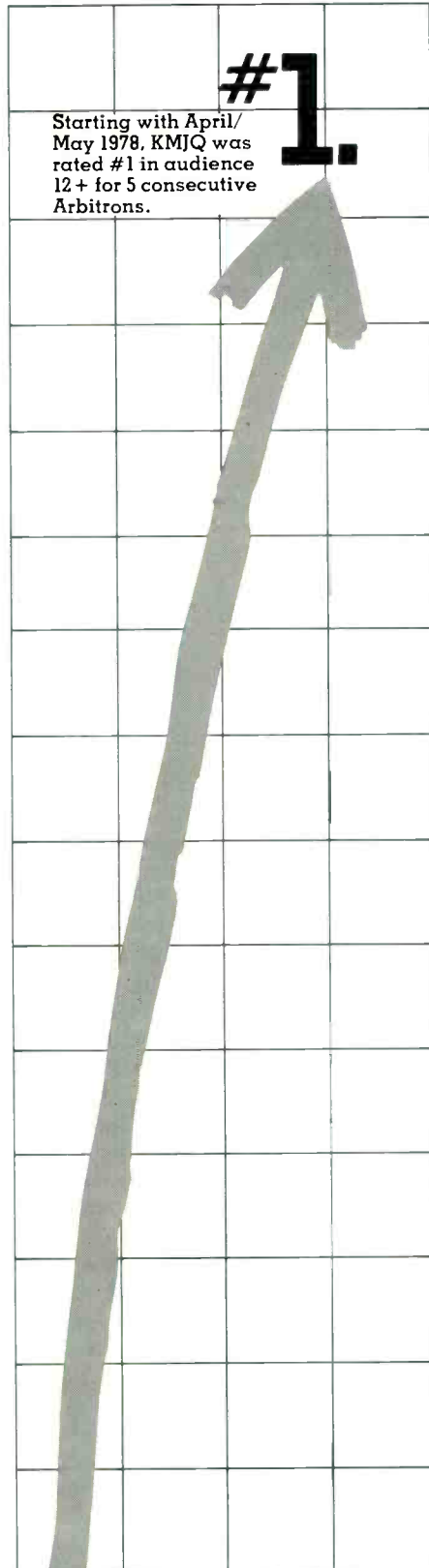

hard to get. "After hearing how smooth the dbx 165 compressor/limiter works, there is no doubt in my mind that it's the best limiter I've ever heard in my life. We use it on voices, and it gives us the control we need without sounding like we have any control."



As you'd expect, KMJQ has constantly been making subtle technical changes to maintain their leadership position. "Due to competitive forces in the market, we've had to crank our signal up louder. Without dbx tape noise reduction on our carts, the noise would have been cranked up, too. Now I'm happier than ever that we're fully dbx'ed," says Dietrich. "We not only get the sound we want, but the whole system is incredibly reliable - bulletproof."

Dietrich summarizes his feelings about KMJQ's technical product by saying, "A lot of this is subtle stuff, psycho-acoustics. But people comment to us that our station sounds more like the record they bought than the other stations do. A psychological thing, agreed. But it all adds up when you start reading the Arbitrons."



For more information on dbx's complete line of equipment for the broadcast industry, write Professional Products Division, dbx, Incorporated, 71 Chapel St., Newton, Mass., 02195, USA. Tel. (617) 964-3210. Telex: 92-2522. Distributed in Canada by BSR (Canada) Ltd., Rexdale, Ontario.

dbx[®]

QUALITY ASSURANCE AND CONTROL: YOU CAN'T HAVE ONE WITHOUT THE OTHER PART 2

By John M. Cummuta

In this second part of a series, the author describes the general principles of the quality control loop and tells how to apply them in broadcasting. The principles are essential to success in every part of the enterprise — sales, technical operation, programming, and promotion.

WHAT A MARVELOUSLY EXCITING business we're in. Broadcasting lives and breathes today, but always with one foot through the window of time, fiddling with the toys of tomorrow. Technologically speaking, Darth Vader and Luke Skywalker are indeed from a time "long, long ago" when compared to the effects available to today's professional communicator. All the synthesized computer graphics at the fingertips of the visual media notwithstanding, radio will never have to play creative second string.

However, there may be a danger in attributing messianic values to hardware. Listeners can't see the flawless, human-engineered wizardry of our new microcomputer-controlled, direct-coupled, infinitely isolated, bipolar, high energy signal twisterizer with an overhead cam, four barrels, and peak reading LEDs. All they know is what comes out the speaker, and if it's not what they need — it's punch-out time.

As I indicated in Part 1 of this article, we're going to borrow the industrial function of quality assurance to improve our level of customer (listener) acceptance. The defined purpose of a quality assurance program is to meet "the objective of establishing for the customer a satisfactory expectation that he will receive, from the producer of goods or services, the quality *he* has specified." Now the *he* in the preceding sentence might rub some broadcasters the wrong way — but *he* is the key to assuring quality.

If we exclude the customer (listener) from determining what the product (program material) will be and how it will be presented (quality standards), we run the risk of producing a finely honed white elephant. Even if the engineer hooks up all the processing equipment we ordered at the last show, the best we'll end up with is a green elephant. The point is that under all the technical coloration it's still an elephant, and if customers are in need of a

John Cummuta is operations manager and chief engineer at KNEI, Waukon, Iowa.



Quality assurance in radio starts with design that allows proper control of operation. In the well laid out studio above, control position and technical area have close eye contact for instant communication

water buffalo, they're going to tune in the water buffalo station across town.

If the station across town is just a pink elephant, we'll probably end up with a similar amount of dissatisfied listeners — depending on who's paying out the largest bribes at the moment. And even this wonderful state of equilibrium exists only until someone in the area offers water buffalos.

Today's radio market is the buyer's (listener's). We must supply the product that the listener desires — not only for survival, but for prosperity. Most industrial production businesses also operate in a buyer's market and hence must assure long-term customer satisfaction.

The concepts are not that different. Industry produces hardware; broadcasting produces a type of software. Both have products and consumers. Both can implement successful management concepts applicable to the other. Quality assurance is one such concept, but like any other program it relies heavily on management energy, flexibility, and commitment.

There is, however, one noteworthy dissimilarity between manufacturing and broadcasting. The customer, in the industrial scenario, generally defines the desired product in specific terms — including the imposition of process quality standards. Even if the industrial producer is manufacturing a product without direct customer prescribed parameters, it is still guided by the product's designed association with other manufactured articles or by a clearly defined user need.

The first 8-days-a-week logger.



The Dictaphone Veritrac SL.

Whether charting the hits or checking the spots, Dictaphone's new Veritrac SL voice communications recording system is practically indispensable. Here, in a package you can lease for as little as \$99 a month, is recorded testimony to what you've aired. Uninterrupted by tape changes. 24 hours a day.

What's more, the Veritrac SL is modular. It can be configured to meet your station's specific needs. Providing recording time of up to 8 days. And it has something else going for it. Dictaphone reliability and service.

 **Dictaphone**

A Pitney Bowes Company

Circle 151 on Reader Service Card

For more information on the
Dictaphone Veritrac SL system,
fill in the coupon or call toll-free:

800-431-1708

Except in Hawaii and Alaska
(in New York call 914-967-2249)

Name _____

Title _____ Phone _____

Station _____

Address _____

City _____ State _____ Zip _____

**Mail to: Dictaphone Corporation
105 Oak Street
Norwood, N.J. 07648**

Dictaphone and Veritrac
are trademarks of Dictaphone Corp., Rye, N.Y.

BME-4

Quality Assurance



Comfortable viewing room promotes quality assurance with monitoring and adjustment of all programs

Broadcasting is not quite so fortunate as to have the average listeners in our community regularly articulate their communicative needs. We have to go out there and find out what's requisite in their lives, discern which of those needs radio can best meet, and determine how the listener desires that material presented.

Radio finds out the things it needs to know about its potential and actual audience through research. Here we'll digress from the norm. Research commonly determines the characteristics of an audience already listening, monitors reaction to programming elements, or ascertains problems and needs in the service area.

Research, as necessary for the implementation of a quality assurance program, should serve just one purpose: to find out what the potential listener wants and needs from us. The answers we seek are very subjective and idiosyncratic, and designing a survey to secure valid, usable data is a challenge worthy of the most imaginative manager. In fact, imagination is a pivotal characteristic in making quality assurance work in broadcasting. We need to avoid predisposition or assumption and let the listeners tell us what *they* want from us.

I could spend the rest of this article (and a good part of another) on the subject of research alone. But I won't — because that would, in a sense, defeat my purpose. Rather than imposing my views on how to obtain the required audience needs and desires, I ask that we all take any notions like "that's not done in broadcasting," file them, and let our creative genius explore the universe of possibilities.

For those stations wishing to do their own research, or those desiring a broader understanding of the science before contracting it out, I highly recommend the following publications: *Why Do Research?*, *A Broadcast Research Primer*, and *Ascertainment of Community Needs*:

Suggestions for the Survey of the General Public. All are available at nominal cost from the National Association of Broadcasters, 1771 N St. NW, Washington, D.C. 20036. These booklets will help you understand what research is, what it can and can't do, and what types of research you may or may not be able to tackle on your own.

At this juncture, we're going to assume we've obtained and analyzed the results of our surveys, focus groups, crystal balls, and intestinal readouts and have determined what listener needs can best be met by our stations. You're shaking your head in Chicago, because the people would like your 50 kW to broadcast a half-hour Swap Shop. There you sit, comatose in Miami, considering bilingual newscasts on your rocker. The programmer in L.A. is dazedly contemplating a half-hour of uninterrupted "music to rollerskate to work by" during AM drive. While in Iowa's heartland, you're beginning to realize that you'd better powwow with the local Farm Bureau because all that wonderful agricultural material you've been running doesn't appear to be nearly enough — and what there is isn't totally relevant to farming in Iowa.

We have in our hands the focal point of a quality assurance program — the customer requirements. So how does it work? Let's open a cake factory and find out. The phone rings, and our first big order comes in: a chocolate cake. How can we assure the quality of our chocolate cake? We'll first make the not-giant leap in logic, that if we control the quality of all the elements that go into making a chocolate cake, we can confidently expect a quality chocolate cake when the buzzer sounds.

First let's examine that order a little more closely. Did the customer just ask for a chocolate cake, or was the need related more precisely as a nine-inch diameter, three-layer devil's food chocolate cake with white icing, saying "Happy Birthday Mildred" in red Early English script on

ALPHANUMERIC ROUTING SWITCHER CONTROLLER

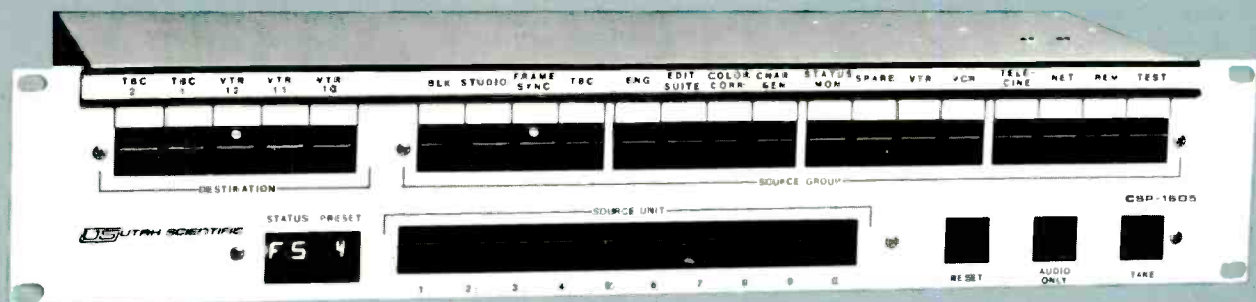

CSP-1605 FIVE-BUS ALPHANUMERIC PARTY LINE CONTROLLER - \$1,700

The CSP-1605 panel is one of a new series of routing switcher controllers from Utah Scientific. Each of these new models features alphanumeric **Preset/Status** displays with up to 1600 assignable name/number combinations to let your operator address sources by their actual name — VT14, CM 3, etc.

The CSP-1605 model pictured here can control five matrix busses and provides current status readout instantaneously as busses are addressed. Input selection is made by either one, two, or three keystrokes. Separate audio switching and statusing is standard and, as with all Utah Scientific party line panels, connection to the matrix is via a single coax.

ALPHANUMERIC DISPLAY — 1600 NAME/NUMBER — SINGLE COAX CONNECTION

TRY THAT ON YOUR GRASCOM FERNSAM DYNATEK SWITCHER!

US UTAH SCIENTIFIC
THE ROUTING SWITCHER PEOPLE.

2276 So. 2700 W. • Salt Lake City, UT 84119 • Phone 801-973-6840
TWX #910-925-4037

Circle 152 on Reader Service Card

Quality Assurance

Determining listener needs is first step in quality assurance program

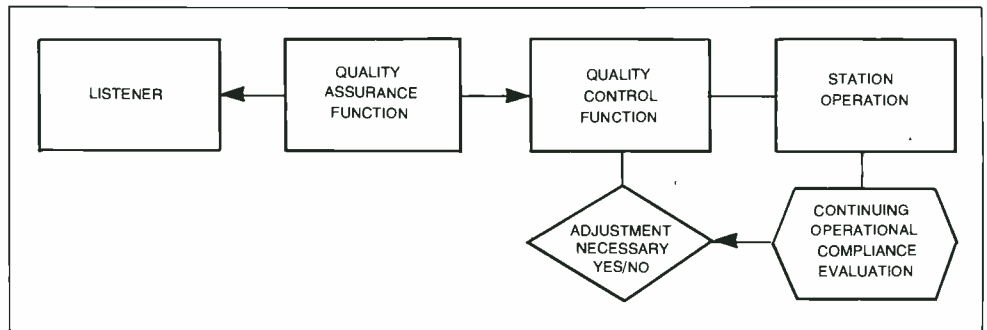

With listener requirements found, next steps in quality assurance are those shown in flow chart

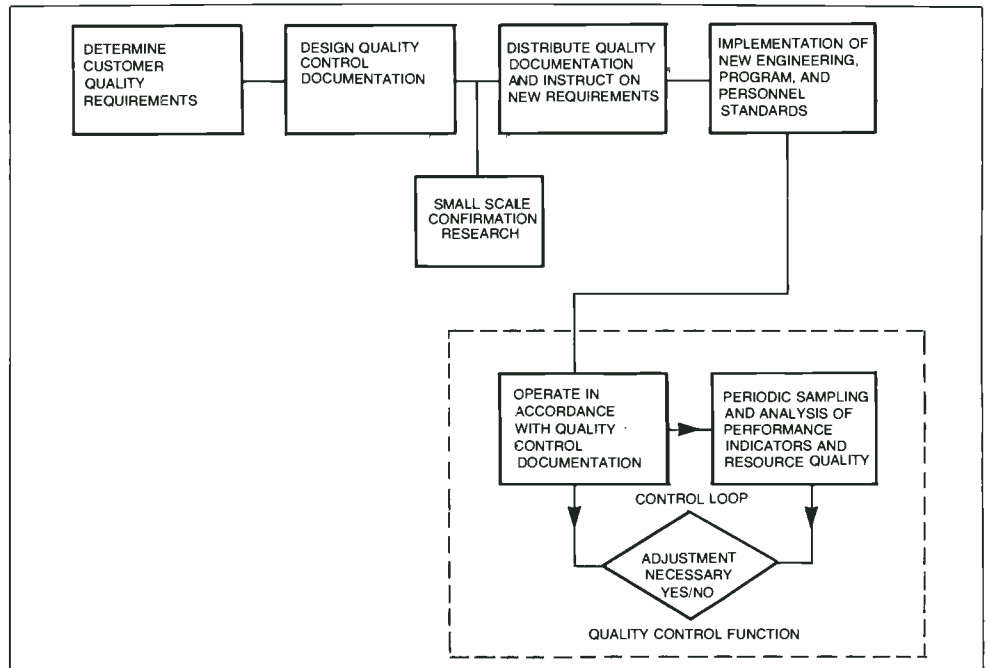

the top, delivered in a blue limo? The life's blood of a successful quality assurance program is a precise knowledge of what the customer expects us to provide.

Now that we know exactly what kind of cake we're producing and how it's to be presented, we have to identify all the controlling factors in the quality production thereof. We further must describe in writing (quality documentation) how the quality of each element will be judged and controlled; for example, "Only grade A eggs will be allowed." This quality documentation will henceforth control the quality of the incoming eggs. When we examine the egg supply each morning, anything other than grade A automatically stands rejected.

In like fashion, we'll delineate written qualifications for our chef. We shall, of course, write out explicit details for the preparation and presentation of the cake, and all pertinent instructions, diagrams, and guidelines will be made highly visible. Lastly, we will thoroughly train all the troops to minimize communications errors.

It should go without saying that our facility must be maintained in "spec sheet" operating condition.

Now that we've placed our cake factory in operation, someone in a management position will be assigned the critical responsibility of overseeing the quality control

function. Figure 1 shows the relationship of quality control (QC) to the rest of the operation. Notice that QC is insulated from the customer by the quality assurance (QA) function, and therefore plays a totally *inside* role.

QC discharges its responsibilities by periodically sampling various parameters or performance indicators, comparing the sample to the documented standards we designed above, and making any necessary adjustments to bring the ultimate product quality back within acceptable limits. Some elements QC might test in our cake factory could include the conformance of the chef to the written requirements, the control of oven operations according to manufacturer's instructions, periodic examination of the supplies, the clarity of written directions, and taste tests of the final product.

The sole purpose of QC is to continually monitor elements like these since deviation in any area would obviously have an adverse effect on cake quality. At the very least, if conformance in these areas is not controlled, any quality in the final product comes about by accident, not by management.

Figure 2 gives a more detailed indication of the whole quality assurance picture and quality control's part in it. Through our various methods of research, we determined

The Power Paradox:

The AC power your computer needs in order to operate is also a major cause of computer error, malfunction and damage.

The computers that control your operations (and therefore your profits) are designed to operate from a clean, steady supply of ac power.

This ac power *must* be kept within manufacturer-specified tolerances in order for the computers to operate properly and safely.

In fact, the U.S. Department of Commerce states that "if a computer's voltage exceeds 120% [of the rated voltage] for a duration as short as 1 to 10 milliseconds, the computer will make errors."¹ Unfortunately, interruptions and disturbances of this nature are commonplace occurrences within most computer facilities.

A comprehensive study of power line disturbances which affect sensitive computerized equipment was conducted by two IBM researchers. They concluded that such disturbances occur on an

average of 128 times each month.² For users of computer-based equipment, power disturbances can and do create a variety of costly problems.

Effects upon data processing computers.

When these power disturbances occur in your data processing center they can cause entry errors, program changes or loss, head crash, data loss, the generation of false or garbled data, the need to rerun programs, and computer downtime.

Effects upon computerized process control equipment.

Process control equipment is also vulnerable to power disturbances. Common problems created by these

disturbances include improper batch termination and even program changes. The program changes can result in the repetition of process errors and in downtime while equipment is being reprogrammed.

Effects upon energy management systems.

Most energy management systems use small computers to make energy-saving decisions, but their effectiveness can be offset by these same disturbances. Program changes and errors may prevent useful operation of these systems as energy savers.

Thus, the computers your company depends on to reduce operating costs actually may be increasing them.

Topaz power peripherals can protect all of your computers.

Topaz can provide the power peripherals specifically designed to keep your company's data processing, process control and energy management computers from making costly power-related errors.

And if you manufacture computers or computerized equipment, Topaz peripherals can make your product more reliable as well as reduce the requirements for needless service calls.

Immediate delivery and guaranteed solutions to power problems have made Topaz the leading computer power peripheral company in the world.

For more information about Topaz and its products:

1. Tear out this ad and mail it to us along with your business card; or
2. Circle the reader service card; or
3. Call us:

TOPAZ
ELECTRONICS DIV.

9192 Topaz Way
San Diego, CA 92123

References:

1. U.S. Department of Commerce, "The Effects of Electrical Power Variation Upon Computers: an Overview."
2. George W. Allen and Donald Segall, IBM Systems Development Div., "Monitoring of Computer Installations for Power Line Disturbances," presented to the IEEE Power Engineering Society.

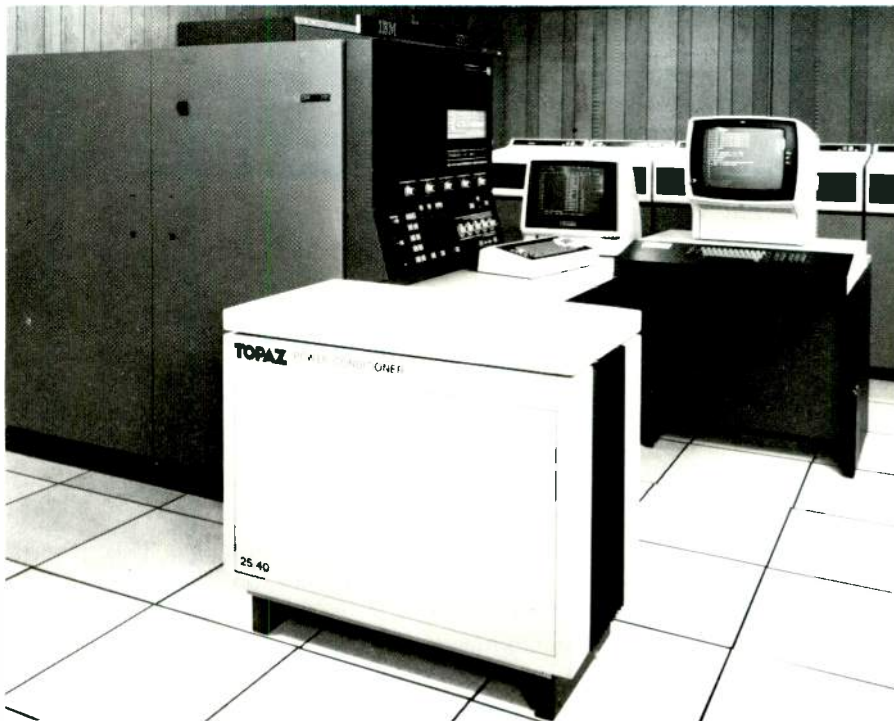

Topaz peripherals solve the power paradox by conditioning normal ac power for your computer and computer-based equipment.

Circle 153 on Reader Service Card

One Tube, 30KW FM Transmitter



Broadcast Electronics' FM-30. The Most Advanced FM Transmitter Ever.

FIRST: World's most powerful one-tube FM Broadcast Transmitter.

FIRST:*Folded half-wave output cavity. No plate blocking capacitor or sliding contacts for greater reliability.

FIRST: Microprocessor Control. Provides 127 status indications, two BCD line outputs for ATS or remote control.

Then there's the totally new synthesized 30-watt FX-30 Exciter with extremely low IM distortion.

And a conservative 30KW output provided by the Eimac 8990/4CX20,000A tetrode driven by four solid state IPA modules with 25% drive power reserve.

With its elegant appearance and outstanding design, the new FM-30 is engineered for top reliability and the finest FM sound.

For more information about BE's exciting new FM Transmitters write or call Joe Engle today. 217-224-9600

a **FILMWAYS** company



**BROADCAST
ELECTRONICS INC.**

*Patent Pending

4100 N. 24th STREET, P.O. BOX 3606, QUINCY, IL 62301. TELEX: 25-0142
Circle 154 on Reader Service Card

Quality Assurance

the customer's quality requirements. Next, we delineated in writing and diagrams the standards of quality and performance for our resources and personnel. Then we went operational and initiated quality control for the purpose of navigating our Good Ship Chocolate Cake to the port of customer satisfaction.

Wait — I hear a voice of someone crying in the wilderness, "I'm not planning on entering a baking contest — I run a radio station!" It's just as well — most of us are watching our waists anyway. Let's try our QA principles on a radio station. We've already determined what the customer (listener) wants, so we'll proceed directly to box two in Figure 2: "Design Quality Control Documentation."

A quick perspective on the whole program will get us off on the right foot. Figure 2 shows that we gather the program and quality requirements from the listener; design and write guidelines to direct station operation corresponding to the customer's desires; teach everyone the requirements of their part of the game plan; get it underway; and periodically sample the conformance of different areas of the operation to the written guidelines controlling them. If a sampled area proves to be noncompliant, an adjustment is made wherever necessary to correct the situation. If compliance is observed, a smile of satisfaction is all that's required.

That is the whole of operating a quality assurance program, but what fills those boxes in Figure 2 can be a bit more detailed than I made it sound above. With the possible exception of gathering the listener's needs and desires (research), the design of the quality documentation is the most crucial task inherent to the building of a successful

QA program. Let's see how we might construct the quality documentation for our station.

It's easy to relate to engineering quality documentation (Figure 3) — there's Part 73 of the FCC rules and regulations. But that's only the worst-case technical standards. A good chief engineer will want to design audio requirements that exceed FCC minimums in the direction of transparency. Other engineering quality documentation would include strictly enforced maintenance schedules, a documented discrepancy reporting procedure, and equipment history logs for everything more complex than a stylus.

The above examples give us a feel for what constitutes quality documentation, but let's start at the top: organization-wide documents for putting management in control of quality. Right at the top of the list is the operations manual. Yours should be adapted to your operation, and the requirements gleaned from your listener research, but seven inclusions I'd recommend are:

- A *station policy statement*. This is a philosophical declaration of what all the team players are striving for (prosperity is assumed; maybe this should be oriented toward community service).
- *Station rules and regulations*. These might suggest grooming standards, no visitors while working, no personal telephone calls while on the air, personal use of station equipment, record hop policy, and any other right/wrong or yes/no subjects.
- An *organization chart and chain of command*. For any enterprise to function smoothly, clearly defined lines of responsibility must be universally observed. It's extremely frustrating and counterproductive when employees aren't sure who their real bosses are.
- *Daypart audience descriptions*. Most stations' audiences change demographically during the course of the

Implementing quality program takes steps on flow chart shown at right

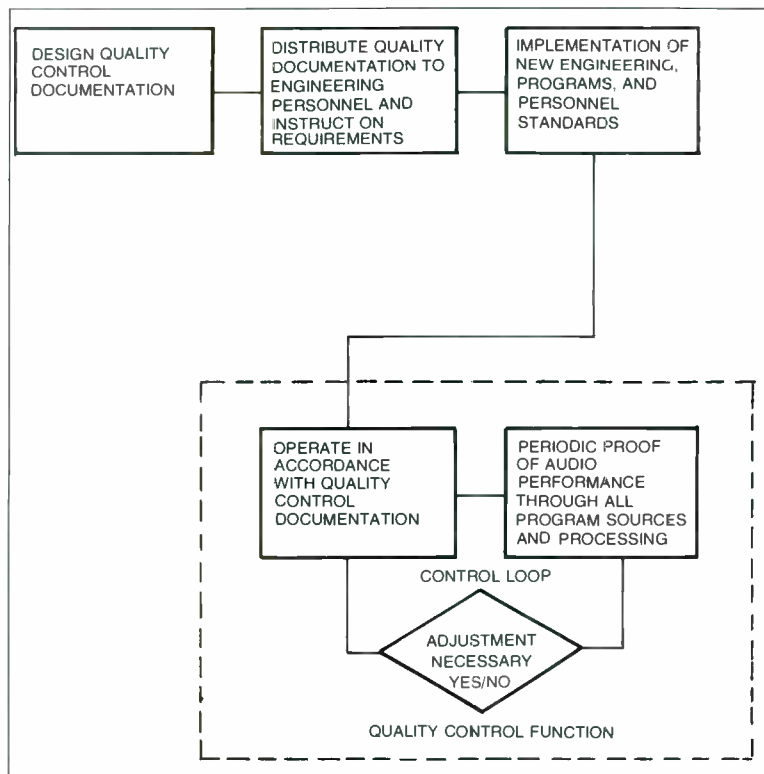

Quality Assurance

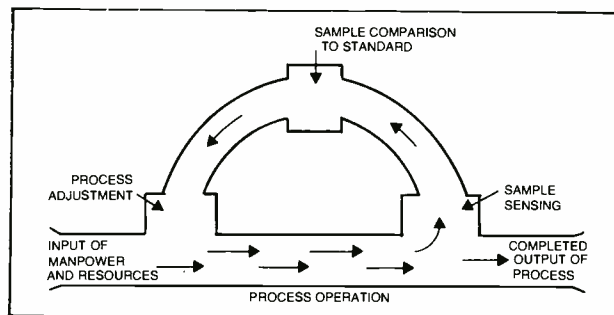

The quality control loop is shown in schematic form above. The sample sensing information goes back through standards comparison to process input, so adjustments in process can be made if needed

day. It helps air people to relate more naturally if they have a clear picture of who's sitting on the other side of the speaker.

- **Position or job descriptions** by job title and daypart (if relevant). These enumerations list both position qualifications and responsibilities.
- **Task Descriptions.** These documents control the performance of such areas as the various daypart airshows, production, copywriting, news writing, news delivery, and any other task requiring consistency and deserving control. Task descriptions can contain as much or as little detail as you see fit. Their purpose is to assure that the various functions are performed exactly the way management has determined they should be.
- **Proper log keeping.** This section should have clear examples of properly filled out log entries and accurate meter readings (include pictures or drawings of meter faces if necessary). The operations manual is something every employee should have, and it's something to give new employees instead of a baptism by fire.

A key area of our quality documentation is the format, and by now we should know precisely what the listener expects. The person on the air must have the same clear understanding of what's to be happening from minute to minute, in both conceptual and specific terms. Documentation here can include general instruction sheets on operating the format, hour clocks, different level music rotations, even pictures of the "typical listener." Format documentation should also describe the performance of individual format elements like weathercasts, sportscasts, newscasts, program intros and closes, and IDs. Management's goals here are control and program consistency.

However it's managed at your station, those discharging music control responsibilities will do a better job if they know what's expected. Written rules covering general station music policy to unacceptable lyric standards should be documented. Definite musical direction should have been discerned from the research.

Work schedules are part of quality documentation, and should include an airshift swapping (for time off) policy. You may not want any such practice, or you may allow it with management approval. In either case you control who might be on during critical dayparts.

With an arsenal of quality documentation, we boldly march into the control loop. Figure 4 demonstrates that the

control loop is a straightforward concept that can be applied to almost any process in our radio station. For the sake of clarity, a *process* is any operation or series of operations that bring together various resources such as materials, skills, time, and planned methods. The output is the product or result of that process.

Consider, for example, the production of commercial messages. Following the control loop in Figure 4, we see that the operation of producing commercials is the process. The input to this process includes the people performing the function, the materials (carts, music, copy, instructions, etc.), the equipment, and all other elements involved. Sample sensing, in this case, would be the random selection of the finished product showing up in the control room or a periodic observation of production being performed.

Flowing up the loop from the sample sense position, we arrive at comparison headquarters. At this stage we compare what we sampled to the written procedures and rules governing the *process*. These might include music selection as per instructions, the proper length cart for the number and length of commercials, the correct spacing between cuts, proper labeling, the required care of production studio equipment, the correct handling of any associated paperwork, and whatever else our quality documentation requires.

If comparison to the documentation controlling the process shows nonconformance, we proceed to *process adjustment*. This may only entail a discussion with the person making the error, or it may necessitate the rewriting of some of the controlling documentation. The degree of adjustment and where that adjustment takes place depends on the extent of nonconformance and the determined cause. The commercials we selected as samples, of course, go back into the flow for their assigned utilization.

We've just completed the implementation and initial operation of a quality assurance program at a radio station, and that would be that — except that the battle never ends. If we return to Figure 1 for a moment, we see that QA performs a type of straight-line control loop function by periodically sampling listener requirements to see if they've changed. If they have, an adjustment is made to the documentation QC uses to control process operations. These inputs to QA can come from further full-blown research, listener comments on the phone, or client comments to the sales people. A wonderful tool for QA is the tri-year scourge, ascertainment. Properly executed, this survey can put us in intimate contact with our community and its needs.

It's obvious that one of the byproducts of a quality assurance program is a peck of information about our listenership. These data should aid management in long-range planning, disclosing unforeseen cause/effect relationships and arming sales people with detailed demographic audience credentials. Information is management's most powerful tool, and a quality assurance program helps management use information to manage.

In the end, the heart of the quality assurance concept is the assuring of user satisfaction. All good station managers and sales managers counsel their sales people that if they really have their clients' best interests at heart and truly wish to meet their needs, success will automatically follow. Doesn't the same go for our station and its customers (the community)? If we concentrate on meeting their needs, won't loyalty, listenership, and success automatically follow?

BM/E



new SM85 PRO TECH™ SOUND

**brings a new dimension
to a hand-held
condenser microphone**

This new high technology Shure microphone will change the way people think of condenser microphones. The SM85 is designed especially for on-stage hand-held use. Its sound is unique—far more tailored to the special needs of the vocalist: sizzling highs and a scooped mid-range for superb vocal reproduction, and a gentle bass rolloff that minimizes handling noise and "boominess" associated with close-up use. Ultra-low distortion electronics make the SM85 highly immune to stray hum fields. An integral, dual-density foam windscreens provides built-in pop protection.

What's more, the SM85 Condenser Microphone must pass the same ruggedness and dependability tests required of Shure dynamic microphones. As a result, the SM85 sets a new standard of reliability for hand-held condenser microphones.

The SM85 is extremely lightweight, beautifully balanced—it feels good, looks good on-stage or camera, on-tour. Ask your dealer for a demonstration of the new SM85 PRO TECH Sound, or write us (ask for AL664) for full details.

The Sound of the Professionals®



Shure Brothers Inc., 222 Hartrey Ave., Evanston, IL 60204
In Canada: A. C. Simmonds & Sons Limited
Manufacturers of high fidelity components,
microphones, sound systems and related circuitry.

SM85
Cardioid Condenser
Hand-Held
Professional Microphone

IDENTIFY WITH QSI

Identify with these new source I.D.'s and this compact distribution amplifier. The CB7000, CB7300 and 6x1 DA really fit in with your ENG needs.

CB-7000 Color Bar Identifier

- Standard RS 189 NTSC color bars
- Eight programmable video characters
- Switchable and power down bypass
- 1000 Hz tone and mic. preamp.
- 115 VAC, 1¾" of rack



CB-7300 12VDC/115VAC Color Bar Identifier



- Switchable 12 VDC or 115 VAC
- Standard RS 189 NTSC color bars
- 1000 Hz tone and mic. preamp.
- 2" x 7½" x 19" portable
- Eight programmable video characters
- Switchable and power down bypass

6x1 DA Utility Video Distribution Amplifier



- Looped through video input
- Six isolated outputs
- Excellent transparency
- Front panel gain and equalization
- 5 W, 115 VAC, 4½" x 4½" x 2"

QSi systems, inc.

For more information on CB-7000, CB-7300, 6 x 1 DA Utility Video Distribution Amplifier or on QSI System's full line of broadcast equipment, call or write: QSI Systems, Inc., 993 Watertown St., West Newton, MA 02165, Phone: (617)969-7118

Circle 156 on Reader Service Card

DVTR Demo And SMPTE Television Conference Mark Watershed In Technology

WHILE THE BEST estimates still place the digital VTR as a practical reality at some 3½ to five years off, major understandings were reached in February following the SMPTE-sponsored DVTR demonstration and discussions that took place throughout SMPTE's fifteenth annual Television Conference in San Francisco. Commenting on the importance of the DVTR demonstrations, SMPTE president Charles Anderson of Ampex said, "This may be the most important event since NTSC [standards were set]." Joseph Flaherty, CBS vice president of engineering and development, called the demonstrations "... a monumental breakthrough."

Since the object of digital video recording research is to obtain high-quality pictures and to achieve an internationally compatible set of standards, SMPTE invited the EBU Bureau de la Commission Technique to view the demonstrations and meet jointly with SMPTE's Task Force to discuss a common approach. Following meetings held February 9, the SMPTE and EBU issued a joint statement. After restating the organizations' intention to arrive at a compatible standard, SMPTE announced its desire to settle on a sampling rate "in the vicinity" of 910 samples per line (14.3 MHz) while the EBU agreed to move from its previous position to a higher sampling rate of 832 samples per line (13.5 MHz). While a gap still exists, the joint statement expressed confidence that a compromise could be reached at future meetings. Both groups agreed on a quality level represented by a 4:2:2 orthogonal sampling system, that is, a sampling structure in which luminance is sampled at a frequency twice as great as the two color difference signals. Moreover, SMPTE maintained that sampling should be line-locked and sync-locked ($4 f_{sc}$), while the Europeans require only a line-locked approach.

What the demonstration showed

The demonstration, held at San Francisco's KPIX television facility, showed the impact of a variety of sampling frequencies and structures on picture quality under a number of operating conditions such as shuttle mode, picture expansion, and chroma key. Groups of interested parties were in-

vited to view the NTSC output under carefully controlled test conditions designed for the purpose of subjective analysis. Some 14 groups of about 30 individuals each viewed the demonstrations on February 2 and 3 and graded the quality of the pictures at proposed sampling rates (768, 864, and 912 samples per line) and at different quality levels (4:4:4, 4:2:2, 4:1:1, and 2:1:1).

The results of these subjective assessments were tabulated by computer and made available to members of the task force prior to their meeting with the EBU committee on February 9. The information gathered in these tests provided a statistical basis for evaluating

the impact of sampling rate and component sampling structure on NTSC-compatible output, processing of the picture, and recording of the signals.

Digital pot boils

Papers on digital video recording delivered by representatives of Ampex, Robert Bosch GmbH, and RCA clearly indicated that these major videotape recorder manufacturers had distinct reservations about the economics of DVTRs designed for higher bit rates and quality levels. The ongoing controversy, simply stated, was: "Do more bits mean more money?"

Joseph Flaherty, CBS, flatly stated



The digital component encoding demonstration. In the center of the room, the racks house the Dynair switcher, the VG zone plate generator, and various pieces of test equipment. To the left are the Ampex VTRs, in the back the Sony DVRs, and in the forefront the CCU for the RCA TK 47



Ken Davies, chairman of the Working Group on Digital Video Standards, monitors the demonstration procedure at the switcher control point. Merrill Weiss and Hal Grant, both of KPIX, helped with the daily presentations of this complex series of tests

Photo courtesy of SMPTE photographer Donna Foster-Roizen

Photo courtesy of SMPTE photographer Donna Foster-Roizen

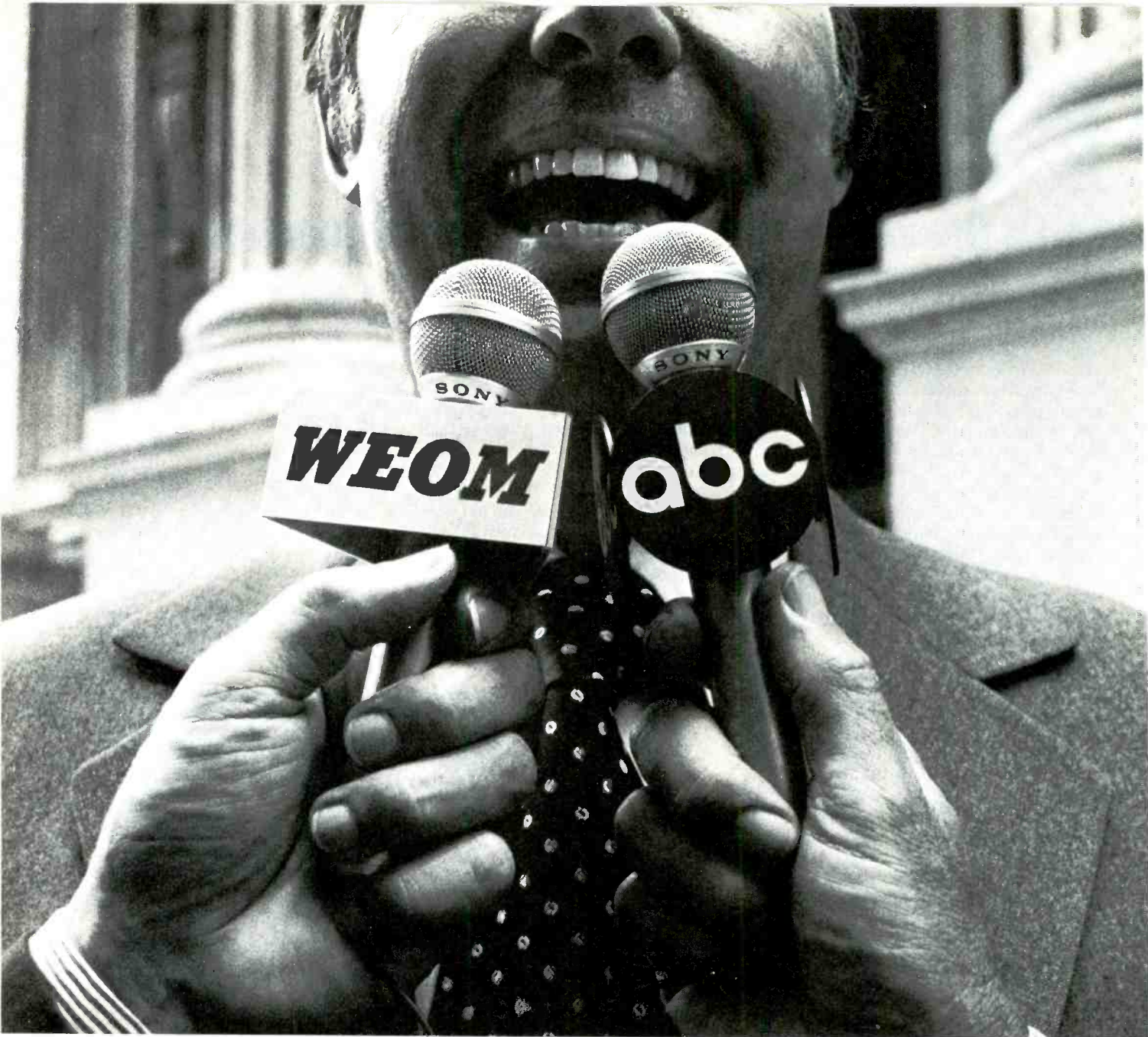

YOU DON'T HAVE TO BE THE NATION'S #1 NETWORK TO SOUND LIKE IT.

The Republican National Convention, the Democratic National Convention, the Winter Olympics—three of the most important and prestigious media events in the last four years were all covered by ABC with wireless microphone systems from Sony.

If you want your station to sound like a leader, take a tip from the Number One name in broadcasting.

Include a wireless system from the Number One name in electronics.

SONY

© 1980 Sony Industries, a Division of Sony Corporation of America, 9 West 57th Street, New York, N.Y. 10019.
Sony is a registered trademark of the Sony Corporation.



Circle 157 on Reader Service Card

WHERE TO FIND SONY WIRELESS SYSTEMS.

CALIFORNIA

AUDIO SERVICES CO.
N. Hollywood, CA
(213) 980-9891

HOFFMAN VIDEO SYSTEMS
Los Angeles, CA
(213) 749-3311

SOUND GENESIS
San Francisco, CA
(415) 285-8900

FLORIDA

HARRIS AUDIO SYSTEMS
N. Miami, FL
(305) 944-4448

ILLINOIS

ROSCOR CORP.
Morton Grove, IL
(312) 966-3010

MARYLAND

PIERCE PHELPS
Bethesda, MD
(301) 530-9580

TECHNIARTS
Silver Springs, MD
(301) 585-1118

MASSACHUSETTS

CRAMER VIDEO INC.
Needham Heights, MA
(617) 449-2100

MICHIGAN

GENERAL TV NETWORK
Oak Park, MI
(313) 548-2500

NEVADA

WESTERN MEDIA ENTERPRISES
Las Vegas, NV
(702) 871-4295

NEW YORK

ALTEL SOUND
New York, NY
(212) 889-9700

CAMERA MART
New York, NY
(212) 757-6977

MARTIN AUDIO VIDEO
New York, NY
(212) 541-5900

MASQUE SOUND RECORD SHOP
New York, NY
(212) 245-4623

PENNSYLVANIA

PIERCE PHELPS
Philadelphia, PA
(215) 879-7000

VIRGINIA

AVEC ELECTRONICS CORP.
Richmond, VA
(804) 359-6071

WASHINGTON

CUSTOM VIDEO SYSTEMS
Seattle, WA
(206) 365-5400

WISCONSIN

FULL COMPASS INC.
Madison, WI
(608) 271-1100

SONY

© 1981 Sony Corp. of America, 9 West 57th Street,
New York, N.Y. 10019. Sony is a registered trademark
of the Sony Corporation.

NEWS FEATURE



Digital panel discussants (left to right) SMPTE engineering VP Rollie Zavada, Charles Ginzberg of Ampex, Frank Davidoff, Ken Davies of CBC, William Connolly of CBS, and Steve Kerman of Tektronix



Packed hall listened to and questioned the discussants

after viewing the digital demonstration, "This should end the controversy once and for all. More bits do not mean more money." Nevertheless, the argument continued, but with the issue more clearly defined.

In the letter of invitation to the demonstrations sent by Robert Hopkins of RCA on behalf of the SMPTE Committee on New Technology, the purpose of the demonstrations was stated as "...to provide a factual basis for the specification of world-wide compatible digital coding parameters for digital television studios." Therefore, the issue of more bits versus more money can also be seen as an issue of more expensive recorders versus more expensive studios. In the opinion of many experts, higher bit rates will mean an increase in technical complexity for recorders (probably at greater cost) but a reduced technical complexity for all other studio systems (probably at reduced costs). The lower bit sampling rates will lead to more complex filtering problems at nearly all other non-recording points in a digital television system, according to the proponents of higher bit rates.

Sources close to the Task Force report that while none of the 52 members present for the Sunday morning (February 8) meeting voted against the endorsement of the 910/4:2:2 proposal,

that does not mean that all 52 voted for it. In a statement issued February 24, Charles Steinberg, executive vice president of Ampex Corp., said that his company maintains that "penalties in the form of an increase in cost of a digital videotape recorder, and an increase in the amount of tape used. . ." would result from a standard requiring bit rates above 200 Mbits/s. The proposed 910 line sampling rate is equivalent to a bit rate of more than 300 Mbits/s. The 912 samples per line demonstrated were equivalent to a data bit rate of 326.14 Mbits/s and achieved at a tape and head speed identical to current Type C standards.

Steinberg, however, continued to state, "It is my personal belief, as well as the official position of Ampex Corp., that a worldwide sampling standard for digital television, even if it involves a bit rate higher than 200 Mbits/s, should be our primary goal. It is now time for the necessary compromises to achieve this end."

The DVTR demonstrations were roundly acclaimed as a magnificent success (see sidebar). The French and German contingents of the EBU remain the most skeptical of the high bit rate, but as Joseph Flaherty pointed out, a worldwide standard goes beyond satisfying Europeans or North Americans and must include the concerns of

More than
400 RADIO
& TV
broadcast towers
have been guyed
with Phillystran®



Phillystran® HPTG installed
on WORL in Orlando.

Phillystran®:
the only field-proven,
flexible dielectric
guying system

- 1 simplifies installation of AM directionals, CP antennas and other broadcast towers.
- 2 eliminates EMI and RFI.
- 3 combines high strength with light weight and inherent flexibility.
- 4 improves antenna stability for AM directionals.
- 5 maintenance-free: non-conducting, non-corroding, nonmetallic. No insulators required. No white-noise arcing problems!

Plus...
High Performance
Phillystran® HPTG

with IMPROVED STRESS-ELONGATION PROPERTIES for "tension-once and walk-away" installations.

Call/write for new literature and proven solutions to your tower-guy problems.

PHILADELPHIA RESINS CORP.



20 Commerce Drive
Montgomeryville, PA 18936
(215) 855-8450
Telex 84-6342

Circle 158 on Reader Service Card

NEWS FEATURE

broadcasters in Africa, Asia, South America, and Eastern bloc countries as well. Moreover, a digital television system must also satisfy the quality demands of distribution systems other than broadcasting and should provide the quality headroom to meet greater demands of future technologies such as high definition television, another major hallmark noted at the fifteenth television conference.

Many decisions remain

Despite the progress made in selecting a sampling structure and line sampling rate for component digital video, a mechanical format for a DVTR remains to be proposed and there are still outstanding issues of channel coding, bit shuffling, error correction, and error concealment.

Two types of channel coding techniques have been shown thus far: 8/10 block coding such as used in the demonstration of the Sony DVTR, and a serial approach, Miller squared, backed by Ampex. Now, an 8/16 code has been proposed by Thomson-CSF's Max Artigas. According to Artigas's paper, the 8/16 code is easy to achieve and has the added advantages of zero dc words, a minimal length of transition between words for the same upper bandwidth, a maximum transition length for less sensitivity to low frequency distortion, and easy clock recovery and enhanced error correction and detection characteristics.

The research carried on in 8/16, however, has been directed toward a two-channel system with a data bit rate of 160 Mbit/s. Dieter Pohl of Robert Bosch GmbH said in his paper that both demonstrated channel coding techniques had shortcomings; specifically,

Miller squared suffers from an excess of energy in the low-frequency ranges and 8/10 block coding has too high an overhead bit rate. Pohl did not comment on 8/16.

Instead, he suggested that a segmented helical mode (like that used in Bosch's BCN design) offers some definite advantages, particularly in shuttle speeds. Ampex's M. Felix also suggested that the segmented helical scan approach offered operational advantages.

Felix said, however, that Miller squared channel coding is "the optimum" for a two-channel 160 Mbits/s machine using a segmented helical scan design. Such a machine would have the advantage of "an easily cassettable" 180 degree wrap versus the "360 degree" wrap of Type C designs and would use only eight heads instead of the 36 heads required by a six-channel field per scan system. Instead of flying erase heads, the design offered by Felix would use an overwrite approach, which suits it well since it has zero overhead. Fewer heads and smaller tape wrap would lead to greater reliability, reduced size and cost, and simplified automatic tracking functions.

The principle upon which Felix based his statements is that the highest packing density always occurs at the narrowest track width and that the limits for practicable track width are set not by simple read-write functions but by additional signal requirements in other modes. Such signal requirements could not be met economically, claimed Felix, by the multi-channel high bit rate field per scan systems.

RCA's C. Robert Thompson went along with Felix and Pohl on much of what they had to say, but stated RCA's position more forcefully. RCA settled squarely on a 4:2:2 luminance/chrominance sampling ratio, a 13.5 MHz sampling frequency (864 bits per line),

Digital Demo A Monumental Achievement

With less than a year to prepare, Ken Davies of the CBC and his fellow members of the SMPTE Committee on New Technology worked, with the help of various digital subcommittees, to mount what may come to be the landmark event in the new digital era.

Primarily under the auspices of the SMPTE Working Group on Digital Video Standards, headed by Davies, broadcasters and manufacturers from the U.S., Canada, Japan, the U.K., France, West Germany, and Belgium managed to bring an awesome measure of technical expertise and equipment to bear on this most important issue. Demonstration equipment

came from RCA, CBS Technology Center, Digital Video Systems, Sony, and Ampex. Support equipment was provided by Barco, Dynair, Ampex, RCA, Thomson-CSF, Tektronix, Ultimatt (VGR Corp), and Marconi.

KPIX provided the physical facilities for the demonstration, as well as the invaluable assistance of its engineering manager, Walt Nichol, and assistant engineering manager, Merrill Weiss. A team of no less than 50 engineers and technicians began setting up the demonstration system nearly a month prior to the event.

If the same level of enthusiasm and spirit of cooperation can be brought to bear on the outstanding problems related to digital television, the industry will boast of a truly superior television system capable of bringing great benefits to a worldwide audience.

Now film editors can enjoy editing video tape.



Thrilling Editing vs. Tedious Editing

As an editor, you know the thrill of creating a mood or changing the meaning of a scene. But if you're used to film, the thrill can be gone when you're editing video tape.

That's why we had editors who know film design the Z-6 Video Tape Editing System. It gives you frame-accurate editing, plus all the useful functions of the SMPTE time code *without* all the problems.

In addition, the Z-6 tracks SMPTE Drop Frame or Non-Drop Frame, 24-frame film rate, or any other time base. And, it "translates" codes for you — adding or subtracting real, decimal or mixed numbers for precise scene and program length computation.

Easy to Operate

With the Z-6, you edit pictures, not numbers, because edit point locations are loaded automatically. Microprocessor-based controls allow you to pick in or out points on-the-fly, maintain lip sync throughout the entire tape during all editing, and do A, B, C external rolls on one pass.

What's more, the Z-6 features auto edit, full look-ahead/behind logic, and random location of single frames on any tape in the system.

The Z-6 system is also simple to use and understand, because each key on the Z-6 system has a definite, single function. In no time at all, you're doing split edits and text editing, using animation and effects, and performing dissolves or wipes with ease. When you're finished editing, the Z-6 can even edit an exact duplicate tape. Automatically.

Easy to Own

Best of all, every Z-6 editing system is fully upgradable. There are several different Z-6 models available. You can start with a basic Mini-Z. Then, when you want more features (like multiple source, effects, or multi-event memory), you can order the Z-6 system that has them. All you'll pay is the *difference* between the price of the system you own and the price of the system you want.

For complete details on the entire Z-6 line, call or write today:

Videomedia
Professional Television Systems

250 North Wolfe Road
Sunnyvale, CA 94086
Telephone: 408-733-6500

NEWS FEATURE

two-channel encoding, and a non-segmented helical scan design utilizing three read/three write heads on a 240 degree tape wrap. Unlike the segmented scan systems, this would require no field store in order to achieve picture in shuttle.

In the face of this string of recommendations for lower bit rates and segmented scan formats, Howard Steele, head of Sony's U.K. operation, took



The small exhibit areas (23 exhibitors) gave delegates a first-hand look at some of the technology discussed at the conference



Professional Performance With A Bottomline Benefit.

The MX-5050B

The Otari MX-5050B. The 1/4" production machine that's earned the reputation of The New Workhorse. Because of quality that delivers unmatched reliability. Reliability that an engineer depends on. And accountability that makes your banker smile. Smiles, because it eases your production burdens while making a "return on investment." The 5050B offers the performance and features of machines which cost more than twice as much, and the "B" will keep on returning your investment long after it's written off.

Now, that's why we claim that dollars for dB's, it's the best you can own.

The New Workhorse

OTARI

Otari Corporation, 1559 Industrial Road
San Carlos, California 94070 (415) 552-8311 Telex: (910-376-4850)

the floor to suggest acerbically that the question of standards be postponed until other tape manufacturers had caught up in their design of heads able to achieve high bit rates. Despite the obvious disagreements voiced on Friday, February 6, it was clear after the Sunday, February 8, meeting of the SMPTE Task Force that RCA and Ampex would not resist the move to higher bit rates, though they would insist that the tradeoffs required to meet such bit rates would be expensive. The general impression of the Franco/German position was that while Europe is ready to compromise, its complete agreement was unlikely.

This leaves the digital recording question in treacherous territory. While everyone seems to be acknowledging a supreme concern for a truly international standard (one which, at the least, would minimize the difficulty of transfer between standards, though not making them absolutely interchangeable), the issue is a two-edged sword. RCA's desire for an 864-bit line sampling rate is similar to the new European position at 13.5 MHz and Ampex's position on a segmented scan system is attractive to the Franco/German constituency. Proponents of higher bit rates, on the other hand, suggest that the demand for 14.3 MHz and 910 bits per line is so concrete in North America that Europeans may find themselves paying a premium for equipment manufactured to the lower standard.

Sources close to the discussion state that the Europeans themselves are divided on the issue, with the British, Italians, Spanish, and Scandinavians less committed to 864/13.5 MHz than their Franco/German counterparts. Again, Europeans are more concerned with digital standards as they affect common carrier conditions than are Americans, who are more concerned with the production investment in picture quality.

Many American producers look at the issue much in the way they look at the differences in 16 mm, 35 mm, and 70 mm film. They want to achieve, at the least, quality comparable to 35 mm film so that production accomplished in

Circle 163 on Reader Service Card



You wanted precision video level control of multiple, random sources! Now you've got it! The Microtime 2525 SP system.

Only the Microtime 2525 SP insures precision alignment and solid stability of all proc amp controls for up to eight nonsynchronous video sources. When used in conjunction with the popular Microtime 2525 Video Signal Synchronizer, the programmable SP system can guarantee virtually perfect alignment of hue, set up, video and chroma gain for any video source. These sources are fed directly through the Microtime 2525 where they are time based corrected and synchronized.

Programmable features include:

- Complete processing amplifier for 8 independent video signals
- Time base correction or synchronization of any one of 8 signals with automatic optional mode selection
- Full control of image enhancement and noise reduction with the 2121 SP Video Image Processor option.

The 2525 SP also includes operator cues such as video confidence indicators human engineered to minimize inadvertent switching to idle channels. A digital control port is provided to interface the system with existing broadcast computers for station automation application. In

addition the light weight Engineering and Director's Control Panels may be located up to 1000 feet from the equipment area to permit installation in major broadcast system complexes.

The Microtime 2525 SP System and the companion 2121 SP provide significant cost savings over conventional processing equipment and conserve valuable rack space in tight operating conditions.

The 2525 SP—another intelligent application of framestore technology—from Microtime, a world leader in video processing technology.

For more information about the 2525 SP System or Microtime's wide range of broadcast products, contact your Microtime distributor or get in touch with us directly.



MICROTIME

MICROTIME, INC., 1280 Blue Hills Avenue, Bloomfield, CT 06002 • (203) 242-4242 • TWX 710-425-1165

MICROTIME INTERNATIONAL, INC., Rokin 9-15, Amsterdam, Netherlands 1012 KK • 020-23.07.34 • Telex 16354 MI NL

Circle 160 on Reader Service Card

NEWS FEATURE



NHK's live camera for their HD-TV demonstration provided 1600 lines resolution at center and 1200 lines at the edges

◀ After the papers describing HD-TV hundreds of delegates squeezed into the NHK demonstration room for a first-hand look

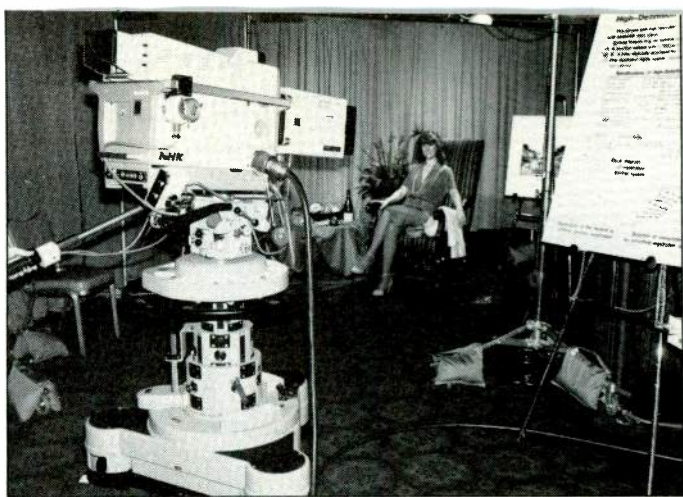

The Rackmount Monitor You've Always Wanted

3 clean audio watts from a -20dbm line • only 2 rack-units (3.5") height • transformer input • headphone disconnects 'speaker • input front & rear • smooth response.

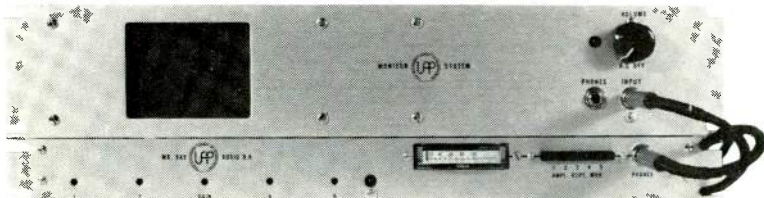

AM3 shown patched to monitor the outputs of the incredible **MR5x5** audio D.A. offering 5 5-output transformer-coupled line amplifiers (5x5) in but 1 rack-unit space.

Ultra Audio Products
A DIVISION OF AUDIO INTERNATIONAL, INC.

P.O. BOX 921 • BEVERLY HILLS
CA 90213 • 213/276-2726

Circle 161 on Reader Service Card

the present will have staying power over the years regardless of advances in distribution systems.

Galaxy of stars at conference

While the DVTR topic generated the most heat and light, it was not the only star in the galaxy of topics discussed in San Francisco. Multiplexed sound, camera improvements, high-definition television, and the all-digital studio — each garnered some of the glory. Digital audio appears ready, willing, and able to work together with digital video in any ultimate form. Though important, the advantages due digital audio are undisputed and virtually no voice was heard suggesting less than two channels of 15 kHz audio. Advances in camera design noted at the conference stemmed largely from the commitment to computer setup and improved designs suitable to higher resolution requirements. These advances should be apparent at NAB.

Several papers on the topic and the first-ever demonstration of the NHK system outside of Japan made high-definition television a major theme of the conference. What was clear from the presentations was that the analog domain is still capable of extraordinary development and that the future holds ever greater promise for new broadcast enterprise.

Three areas of concern were addressed at the conference regarding high-definition television (HDTV). Dr. Takashi Fujii addressed the technical development and experimental growth of the system in Japan and Joseph Polonsky of Thomson-CSF (France) discussed standards and marketability of HDTV, while Professor Broder Wendland of Dortmund University (FRG) addressed the issue of HDTV's compatibility with existing television broadcast transmission and reception.

Each area is of crucial importance to high-definition television, and the Japanese research and experiments are clearly a measure of the state of the art. Involved in HDTV research since 1970, NHK has now developed a nearly complete system including camera, processing, transmission, and a family

NEWEST AUDIO PROCESSORS AVAILABLE FOR DEMONSTRATION AND EVALUATION

Most brands in stock

We ship anywhere overnight

Factory service for warranty and repair



EXR Exciter SP-1



EXR Exciter EX-3



Audio & Design Limiter M-600



Eventide BD-955 Digital Delay Line



Lexicon 1200 Speech Compressor



Telex MC series Cart Machines



Telex Headsets



Otari MX-7800 Eight track



Otari 5050-B Half or full track



Otari ARS-1000 Automated tape deck

Signal Processors

Audio & Design
Recording
Ashly
dbx
Dolby
DeltaLab
EXR
Eventide
Inonovics
Lexicon
Marshall
Orban

Microphones

AKG
Crown/PZM
Electro-Voice
Neumann
PML
Sennheiser
Shure

Tape Machines

Eumig
Otari
Revox
Technics
Telex

Monitors

Auratone
JBL
Tannoy



Plus: **Acoustic design** and consultation services for your control room or production facility.

16055 Ventura Blvd., Suite 1001
Los Angeles, California 91436
Phone (213) 995-4175 • Tlx 651485



HAVE YOU MISSED
SOMETHING LATELY?
TRY SATELLITE ENG!
THE AFFORDABLE ALTERNATIVE TO TRANSMIT
YOUR NEXT HOT STORY HOME.

Our transportable earth stations can put you on the air quickly from almost anywhere; the heliport atop Cobo Hall in Detroit, a parking garage next to Madison Square Garden or a football field in the North Carolina hills. You tell us where and we'll bring your story home.

ABC, CBS, NBC, ITNA, SIN, Gannett, Bonneville, RDO, NPR and many more have all used our satellite transmission services.

Completely self contained, our satellite earth stations are ready to roll for your next assignment.

For details and rates call
Mark Wallhauser, Wold Communications,
(703) 442-8550.

WOLD COMMUNICATIONS®

*a division of
The Robert Wold Company*

NEW YORK

Empire State Building
New York, NY 10118
(212) 947-4475

LOS ANGELES

11661 San Vicente Blvd.
Los Angeles, CA 90049
(213) 820-2668

WASHINGTON, D.C.

8150 Leesburg Pike
Vienna, VA 22180
(703) 442-8550

The Perfect Companions

VSM-5, the latest in a series of professional test equipment from Videotek. A television Vectorscope which provides bright, sharp, easy-to-observe vector displays on a 5-inch CRT. Available as a separate unit, or rackmounted ... *The Perfect Companion* to our popular TSM-5 Waveform Monitor.



Quality Endures



Videotek, Inc.

125 North York Street, Pottstown, Pennsylvania 19464 / Telephone (215) 327-2292
9625 North 21st Drive, Phoenix, Arizona 85021 / Telephone (602) 997-7523

Circle 190 on Reader Service Card

Beyond P.L.



Broadcast Intercoms limited only by your creativity, Imagine:

- Live Remote P.L. and Cue Systems
- Battery Operated ENG/EFP Systems
- 4 Channel Studio and Post Production P.L. Systems
- Mobile Van P.L. Systems
- Cameraman's Headsets

All NEW from Clear-Com

Send for our catalog on more ideas and technical information.



Clear-Com
intercom systems

759 Harrison Street
San Francisco, CA 94107
(415) 989-1130
TWX: 910-372-1087

Circle 191 on Reader Service Card

of receivers. NHK's research has shown that a picture viewing area of 16,000 cm² produces the highest quality picture with a 2:1 interlace, 1125 scanning lines, and an aspect ratio of 5:3. A Y-C separate transmission system in which luminance and line sequential chrominance are transmitted through individual FM channels has been suggested for low-power, narrow bandwidth broadcasting as used in NTSC and HLO-PAL systems. Luminance bandwidth is at 20 MHz, with chrominance at 6.5 MHz. (For a full description of the NHK experiments see "High Definition Television," p. 95, *BM/E*, March, 1981.)

Joseph Polonsky of Thomson-CSF addressed the problem of arriving at standards. He said the industry could assume that 1200- to 1500-line digital systems would be available for professional use by the late 1980s, and that consumer HDTV will be available in the late 1990s (concurrent with satisfactory HDTV large screens being developed). Polonsky said that three major categories of research were necessary to usher in HDTV: marketing to determine how to start an HDTV public service, bandwidth compression, and compatibility with present-day TV.

Polonsky said that a four to six times increase in bandwidth might not be necessary if compression techniques that took into account picture redundancy were studied. Visual perception studies to reduce bandwidth and improve signal-to-noise ratios are called for, he said. Polonsky felt it was also necessary to study whether HDTV large screens would be integrated with audio-visual home systems that will evolve in the 1980s. The price of compatibility with existing standards should be studied, he urged.

Professor Wendland drew a great deal of attention to his proposal, which would make HDTV compatible with present standards. Improvements with today's standards are possible, he said, with the use of digital signal pre-processing at the transmitter and signal post-processing at the receiver. Wendland described a process that started with a picture source with increased lines but which used vertical filtering to decrease the cutoff frequency without aliasing. The post-processing network uses a reconstruction filter and a scan converter. Wendland said that vertical resolution is increased by a factor of 1.7 and that 25/30 Hz flicker can be removed. He also described how a system of offset sampling at 8 MHz on adjacent lines can be transmitted in the luminance channel, to improve horizontal resolution by a factor of two. **BM/E**

THE IMPOSSIBLE DREAM

Ever since $\frac{3}{4}$ " VTRs were invented, tele-producers have wanted a practical way to put $\frac{3}{4}$ " playback signals through a switcher/effects generator—the Impossible Dream. Too expensive, too costly.

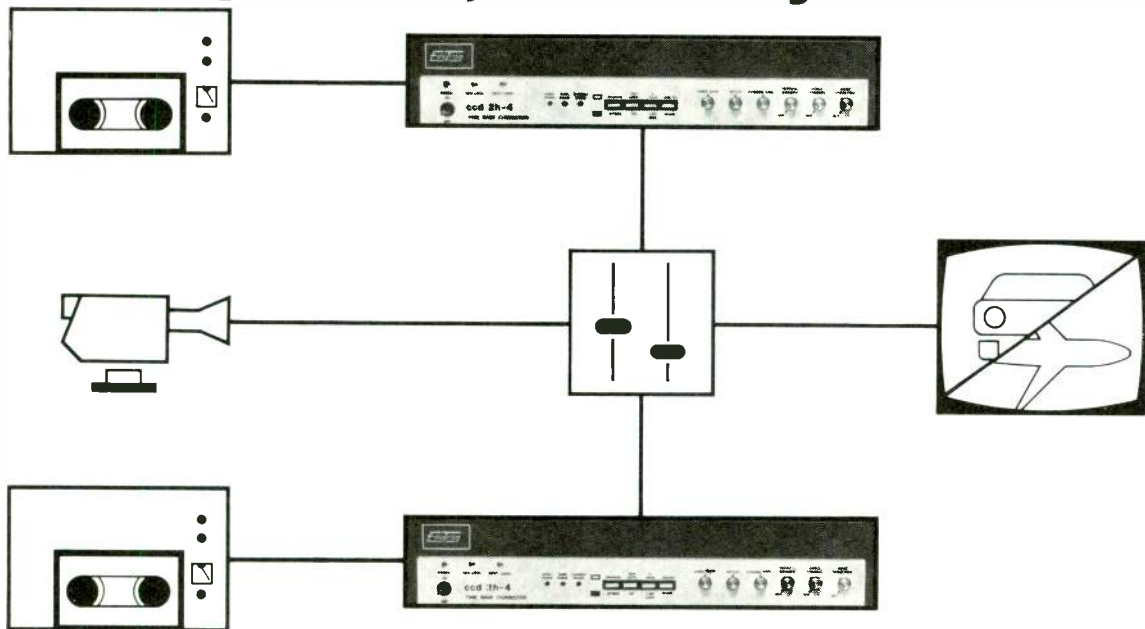

Now, using advanced technology in the Edutron ccd-2H TBC, any capstan servo $\frac{3}{4}$ " VTR can be locked to station sync to be processed through a switcher/effects unit just like a camera feed. To make the

signal look like a camera, noise reduction and detail improvement are included as standard features! Best of all, you can realize the impossible dream for only \$5950 or just twice that amount if you are in to AB rolls.

Call or write today to find out why Edutron TBC's are better by design!

Edutron

Edutron Inc.
11003 U.S. Highway 19
T.M. Roswell, Georgia 30075

The Video Electronics Company

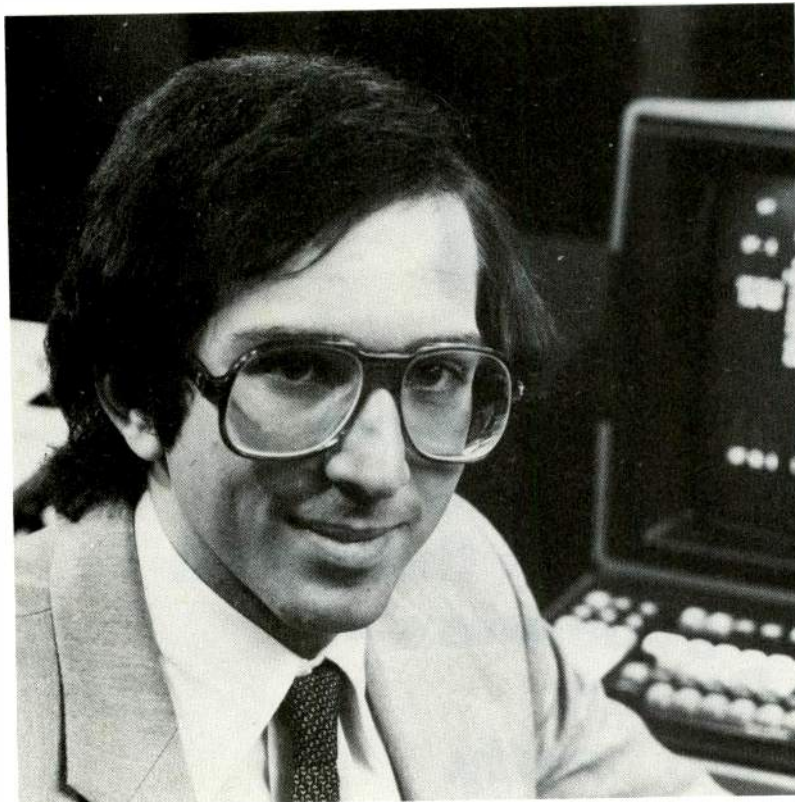

CREATIVE TECHNOLOGY ON CMX

Roger Berk, Jr.
President, Creative Technology, Inc.
Vice President, Group One Broadcasting, Inc.
Akron, Ohio

"We Designed Our System Around The 340X"

"When we at WAKR in Akron made plans to establish a separate production facility, our goal was to build an organization that was committed to excellence. Our proximity to Cleveland, Detroit, Pittsburgh, and the other large cities of the Midwest made our market area large and competitive. We decided to meet this challenge by offering a facility that not only provided a competent and creative staff but the very finest in technical equipment. We designed our system around the 340X.

"It is clearly the finest computer-assisted editor in the world today. And its versatile architecture assures its place as the leader in future

generations of equipment. With CMX's versatility we have interfaced everything from our computer-assisted production switcher, to our one-inch recorders, computer-assisted audio mixdown system, our multi-channel Squeezoom," and our computer-based animation and character generation system.

"This high level of interface, with the CMX 'talking' to the other computers in our control room allows us, with a minimum of multi-generational iterations, to perform dazzlingly complex effects involving up to nine levels of video and up to 18 tracks of audio on each frame-accurate edit.

"Here at Creative Technology, we're

saving time and money with our CMX; but of greater importance it allows us to produce more original and interesting material at a lower cost per spot than could be achieved using conventional techniques. Further, CMX always has one eye on the future, as the system is evolving and improving constantly. We've regularly added the latest software options as they have become available.

"The 340X is a many-faceted and unparalleled tool. It allows creativity to displace technical drudgery in high quality production. We can't wait to get our next one."

TM-Vital Industries



**CMX
ORROX**
The World Standard for Editing

Orrox Corporation, 3303 Scott Blvd., Santa Clara, CA 95050 (408) 988-2000 Telex 910-338-0554
Los Angeles (213) 980-7927 / Chicago (312) 325-8488 / New York (212) 371-1122

Circle 165 on Reader Service Card

INTERPRETING THE **FCC** RULES & REGULATIONS

Court Loosens Diversification Policy

By Frederick W. Ford and Lee G. Lovett; Lovett Ford and Hennessey, P.C., Washington, D.C.

IN A RECENT DECISION¹, the U.S. Court of Appeals has cast new light on the issue of diversification, the policy of maximizing the number of voices in the broadcast industry. The *Miner* case, which involved applicants for a Utah AM frequency, might well have substantial impact upon future comparative hearings involving multiple licensees. In particular, in light of last year's clear channel ruling², licensees of AM/FM combinations should take note. If the licensee owns a low-power, daytime-only AM station and wishes to change frequencies to increase power, it might not be necessarily prejudiced in a comparative hearing because of the companion FM station.

In this case, applicant Julie Miner owned an AM/FM combination in St. George, Utah, the only two stations licensed to the community. Miner applied to change frequencies for the AM in order to increase power. A newcomer, Albert Crain, filed a competing application for the new AM frequency. The FCC decided for newcomer Crain on the basis of a substantial preference on the criterion of diversification of media ownership. However, following an appeal by Miner, the Court of Appeals found that the assumptions made by the FCC in deciding the case were unsupported by the evidence.

If diversification of ownership of the media is a factor of primary importance in comparative hearings, the Court called for the Commission to pursue it in a way that is fair and does not "automatically" disadvantage existing licensees who have a record of service in favor of untried newcomers³.

This article examines the question of diversification as it applies to comparative broadcast hearings, specifically the *Miner* case. The article will also examine the possible consequences for future hearings.

The diversification criterion

The question of how to decide between mutually exclusive applicants has proven a continuing problem for the Commission. Prior to adoption of the *Policy Statement on*

Comparative Broadcast Hearings in 1965⁴, the FCC based its rulings on various preceding cases. The decision in the *Valdosta* case⁵ exemplified the position most often taken by the Commission on diversification in hearings involving circumstances similar to the *Miner* case. In the *Valdosta* case, the Commission held:

The Valdosta Broadcasting Company's application proposes the construction and operation of a new broadcast station which would provide new and additional service to the city of Valdosta as well as serve the rural areas proposed to be served by the other applicant WGOV [which had requested a change of facilities from a local Class IV to a regional Class III station]. Taken alone, the consideration of the establishment of an additional and competitive broadcast service would be persuasive of a grant to the Valdosta Broadcasting Co. However, we cannot accept this factor as controlling. Otherwise, an existing station seeking to improve its coverage by a change in frequency and increase in power would always be barred by a qualified applicant proposing to construct a new station on the operating assignment requested by the existing station.⁶

In the policy statement, the Commission sought to clarify its views on diversification and set priorities for governing the selection of applicants. The two primary objectives that emerge from this statement were, and still are, the best practical service to the public and a maximum diffusion of control of the communications media. The Commission stated, "since independence and individuality are elements of rendering good program service, the

¹*Miner v. FCC*, U.S. Court of Appeals, D.C., Circuit No. 78-1903, December 1, 1980, 48 RR 2d 1069.

²*Report and Order*, Docket No. 20642, In the Matter of Clear Channel Broadcasting in the AM Band, 78 FCC 2d 1345, 47 RR 2d 1099 (1980).

³*Miner, op. cit.*

⁴*Policy Statement on Comparative Broadcast Hearings*, 1 FCC 2d 393, 5 RR 2d 1901 (1965).

⁵*Valdosta Broadcasting Co.*, 11 FCC 796, 3 RR 619 (1946).

⁶*Id.*, 11 FCC at 733-74.

FCC Rules & Regulations

primary goals of good service and diversification of control are fully compatible."⁷

As an objective, diversification of control seems at first glance a very simple one to obtain. To apply this criterion to specific circumstances, however, is much more complicated. The diversification policy seeks to bring as many different voices as possible into the communications media. Consequently, when deciding between two applicants the Commission must take into account both common control as well as less than controlling interest in all media, that is, broadcast stations, cable television systems, and newspapers. (The latter two are governed by the Commission's crossownership policies, a variant of diversification of control of broadcast media.)

According to the 1965 policy statement:

Without indicating any order of priority, [the Commission] will consider interests in existing media of mass communications to be more significant in the degree that they are larger . . . and to the degree that the existing media are in, or close to, the community applied for; are significant in terms of regional or national coverage; and are significant with respect to other media in their respective localities.⁸

Nevertheless, the difficulty in obtaining this goal continually asserts itself.

Applying the diversification goal *Miner vs. FCC*

In the *Miner* case, the Court of Appeals reversed the decision of the FCC awarding the construction permit to Crain.

Miner owned and operated an existing AM in St. George plus a corresponding FM station. She had held the AM license since 1968. In November 1973, Miner applied to switch frequencies from 1450 kHz to 890 kHz so she could increase the power and improve station facilities. In January 1974, Crain filed a mutually exclusive application for the construction of a new radio station on the same frequency as Miner, 890 kHz. The mutually exclusive applications required a comparative hearing to determine the better qualified applicant in accordance with Section 309 of the Communications Act⁹ and the *Ashbacker* case.¹⁰

In his initial decision, the administrative law judge preferred Crain because of the factor of diversification. Since Miner operated the only AM and FM stations in St. George, the judge stated, ". . . at the threshold, a grant of the Crain application would provide a choice of programs and service from separately owned stations for the first time."¹¹ Even though Miner received a preference because of her better integration proposal, the judge felt that this was outweighed by the opportunity for a "new voice" in St. George. On an appeal to the Commission's Review Board, the panel heard arguments that Miner was the superior applicant because she had demonstrated her total commitment and dedication to the needs of the community. Miner also cited the *Valdosta* doctrine and the *Monocacy* case¹² as precedents for a favorable decision. However, on the basis of the comparative criteria of the 1965 policy statement, the board upheld the administrative law judge and decided for Crain. The Review Board noted:

The Commission's . . . enunciation of its views in the 1965 Policy Statement . . . leaves no room for doubt that current Commission policy on the various comparative

factors is different in emphasis. Thus, while *Valdosta* and its progeny are devoid of any substantial consideration of the public interest significance of diversifying control of broadcast interest, the 1965 Policy Statement and subsequent cases give this factor a strong independent significance.¹³

The Court of Appeals thought differently. It argued that the Review Board's ruling represented a change in the Commission's attitude towards diversification. This fact, combined with what the court considered a number of weak and unsubstantiated assumptions by the FCC, was the reason that the court reversed the FCC decision.

The court felt that both the administrative law judge and the Review Board assumed that Miner would continue to operate KDXU, the lower power AM, even if Crain was granted the new application. The decisions of the judge and the Review Board were based on this conclusion. However, the court specifically held that there was no support for such reasoning anywhere in the record. Therefore, the court found that it was unfair to resolve the comparative hearing on the issue of desired competition and diversification when in fact these might not actually result. In the words of the court:

Although a "maximum diffusion of the control of the media of mass communication" need be a commendable goal, what the Commission has done in this case creates the worst of both worlds — controlled competition without equal access to the marketplace. Here the FCC is not engaged in "reasoned decision making" because it has not taken a hard look at the "salient problem" of equitably fostering competition in the context of mutually exclusive applications such as those filed by Miner and Crain and because its findings are not "sufficient in number and substance to support the conclusion" reached.¹⁴

Significance to broadcasters

The court's reversal of the FCC ruling in this case seems to indicate that the diversification criterion will not be applied in a wooden way. Mass media diversification is important but will not be used as the *sole* determinant when granting an application.

Factors such as service to community needs, broadcast experience, local residence, participation in civic affairs, meritorious programming, and past broadcast records will be used to evaluate the competing applicant. The court also cautioned the Commission that it should base its decisions on previous ones like the *Valdosta* decision. If there is a departure from prior norms, the Commission must explain its decision.

Present and future broadcasters should note that this decision does not *necessarily* affect situations involving circumstances markedly different from those in the *Miner* case. Diversification of control of the media is still a primary goal of the Commission. However, the court might consider it to be an elastic consideration depending upon individual applications and cases. It might not outweigh all other considerations when evaluating applicants.

BM/E

⁷Policy Statement, *op. cit.*

⁸*Id.*, 5 RR 2d at 1909.

⁹47 U.S.C. §§309 (a) & (e) (1976).

¹⁰*Ashbacker Radio Corp. v. FCC*, 326 U.S. 327 (1945).

¹¹Initial decision cited in *Miner*, 48 RR 2d at 1070.

¹²*Monocacy Broadcasting Co.*, 28 FCC 301, 19 RR 137, *Recon. denied*, 29 FCC 171 (1960), *aff'd sub. nom.*, *The Price Broadcasters, Inc. v. FCC*, 11 U.S. App. D.C. 179, 295, F.2d 166 (1961).

¹³*Miner*, 48 RR at 1073.

¹⁴*Id.*, at 1975, citations omitted.

Why 4 out of 5 earth stations for TV broadcasting are from Scientific-Atlanta

Model 8010 7-Meter Antenna. Designed specifically for television broadcasting. Exceeds all broadcast earth station requirements.

Full geostationary satellite arc coverage.

Factory-installed de-icing systems available for severe weather conditions.

Highly reliable GaAs Fet low noise amplifier. Fully enclosed for weather protection.

Easy to install. Minimal space requirements.

Scientific-Atlanta has designed, built, and delivered more broadcast earth stations than any other company in the world. A lot more. Here are some reasons why.

SCIENTIFIC-ATLANTA MAKES THE ENTIRE SYSTEM

Scientific-Atlanta builds complete satellite earth station systems for the television industry. Our earth station packages give you everything you need to turn satellite signals into programming revenues. Antennas, receivers, low noise amplifiers, and installation and service.

THE RIGHT SYSTEM FOR YOUR NEEDS

As the industry's largest manufacturer, we offer a wider choice in complete system packages. And we have the practical, total systems experience to help you put together the earth station to fit your technical requirements. *And your budget.*

A broadcast earth station can be as simple as our Model 8501 Basic Receive-only system. It consists of an antenna assembly, a low-noise amplifier (LNA), and a video receiver.

This is the basic downlink system. It's perfect for operations such as taping satellite programming for future broadcast.

For added flexibility as well as improved reliability, many broadcasters choose our Model 8502 Receive-Only Earth Station. It includes a second set of electronics to give simultaneous reception on two different satellite channels—a significant increase in signal receiving ability.

What's more, the additional electronics serve as back-up units for the primary

set, giving full station redundancy.

Should a malfunction occur in your primary on-line components, protection switching devices are included in the Model 8502 package which will automatically switch those functions over to the redundant stand-by units without interrupting on-line reception.

SUPPLY YOUR OWN PROGRAMMING

Scientific-Atlanta has supplied 97% of all the satellite uplinks currently in use by commercial TV broadcasters.

When you buy a Scientific-Atlanta uplink, you get the entire package, from the initial site planning advice to the final proof of performance procedure.

If you prefer, the uplink package can include frequency coordination, FCC licensing, and supervision for pouring of the foundation (using local construction crews for minimum cost).

MORE SATELLITE COVERAGE MEANS MORE PROGRAMMING

Scientific-Atlanta broadcast earth stations are available with full geostation-

ary satellite arc coverage. Your system can "see" all current and future domestic communications satellites from anywhere in the continental United States.

No other antenna system offers more satellite coverage.

Pre-programmable motor-drive systems are available for 7- and 10-meter antennas. You can switch from one satellite to another in 60 seconds or less.

For example, by entering a simple two-digit code into our remote-control antenna positioning unit, your antenna can be switched to a different satellite during a commercial break.

WRITE OR CALL FOR INFORMATION

Clip this coupon for more information on the most advanced satellite earth station systems available for the television broadcast industry. Or call or write Ron Pearl at (404) 449-2064.

Scientific Atlanta Communications

Attn: Mr. Ron Pearl
3845 Pleasantdale Rd.
Atlanta, Georgia 30340

Please send more information on satellite earth stations for television broadcasting.

NAME _____

TITLE _____

COMPANY _____

ADDRESS _____

CITY _____

STATE _____ ZIP _____

BUSINESS TELEPHONE () _____

United States: One Technology Parkway, Box 105600, Atlanta, Georgia 30348. Telephone 404-441-4000. TWX 810-766-4912, Telex 0542898

Canada: 1640 Bonhill Road, Unit 6, Mississauga, Ontario L5T 1C8, Canada. Telephone 416-677-6555, Telex 06983600

Europe: Horton Manor, Stanwell Road, Horton, Slough SL3 9PA, England. Telephone Colnbrook (02182) 3211, Telex 849406

Circle 166 on Reader Service Card

AN EDIT CONTROLLER DESIGNED TO GROW?



The **EDITMASTER** is. Using the most advanced micro computer technology and serialized communications, **EDITMASTER** can start as a two machine system reading EBU/SMPTE time code and user bits or control track . . . add a dozen VTR's later. *Add on requirements?* Just a length of coax cable with BNC connectors! *Are there other elements for the system?* Sure! The **DATAVID** color graphics data crt that becomes a color video line monitor at the touch of a button. **TAGALONG** auto switcher and variable length dissolve. During search, it automatically switches your line monitor to the selected source. In either preview or edit perform, it switches the edit event and executes a programmed dissolve of up to 300 frames, including splits (We also control your programmable switcher). *An edit decision list?* **LISTMAKER** has a 5" mini floppy disc with over 1,000 event capacity and the ability to give a CMX 340 compatible list to another disc, hard copy printer, tape punch or becomes source for an on-line system. **EDITMASTER**. The *affordable* edit system. Whether your requirement is two VTR's with time code . . . or 14 VTR's, color data graphics, edit decision list and internal switcher ——**EDITMASTER** is *your* system.

EDITMASTER

Buy one system and grow with it!



UNEMCO INTERNATIONAL, INC.

MANUFACTURERS OF EMS PRODUCTS

2102 RINGWOOD AVENUE

SAN JOSE, CA 95131

(408) 946-5076

Circle 167 on Reader Service Card

GREAT IDEA CONTEST

Editor's Note: Before attempting to implement any Great Idea involving the modification of equipment, station personnel should check with the equipment manufacturer to insure that no violation of warranty will occur.

If the Great Idea involves any technical standards governed by the FCC, stations should make sure that the idea will in no way cause a violation of FCC rules.

VOTE FOR BEST IDEAS Ballot On Reader Service Card

12. Tower Light Control

*John Maxwell, Transmitter Supervisor
WTVM-TV, Cusseta, Ga.*

Problem: Servicing and troubleshooting tower light control system on 1749-foot WTVM/WRBL-TV tower.

Solution: All control systems were moved inside the

transmitter building for convenience. Relay was used to reduce current flow through 60 A mercury switch. P.E. cell and mercury switch are crouse hinds. A muffin fan is mounted over quarter-inch aluminum heat sink for cooling. The four solid state switches are SSAC FS155-30T. Breakers B1 and B2 are 40 A; all others are 20 A.

This system has performed satisfactorily for nine months.

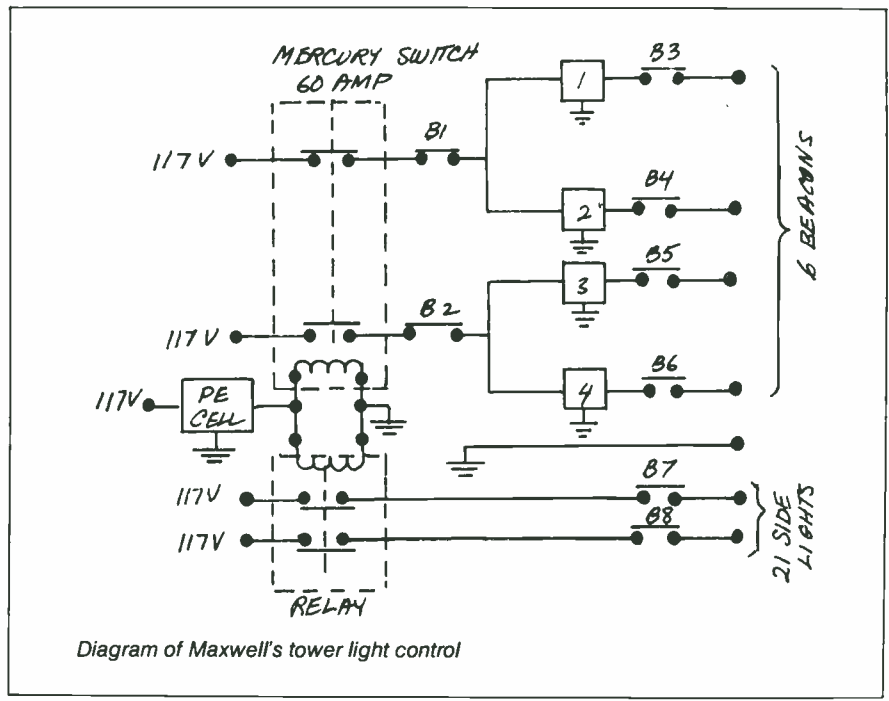

13. External Tally-Signal System

*Les Svoboda, Staff Engineer
KOLN-TV/KGIN-TV, Lincoln, Nebr.*

Problem: Often for remotes we add an additional RCA TK-76 to the system. By powering it at the camera location, we only need to run a single coaxial video cable plus an interphone line. The remote truck is then genlocked to this camera. We avoid running a regular camera cable as this camera is sometimes as far as 1800 feet away.

The camera operator, however, had to rely only on the director's commands to believe his camera was on-the-

air. There was no operable tally-light at the camera.

Solution: Since the required length of cable necessary for a separate tally circuit was not readily available, I decided I could "borrow a ride" along the existing interphone cable. We used mic cables or shielded audio pair because they were at hand.

Only two wires are needed for the interphone system (ours is a CBS type 1B), so we weren't using the shield. A note of caution: the shield should be lifted at both ends and not continue to ground or to any other circuits. An unused center conductor within this or other cables can replace the use of the shield.

The encoder produces a signal along one of the cable inner conductors and shield. This signal is above the

Great Ideas

audible range, so it produces no interference to the talk circuit. The relay is used because in our case the power supply that powers our "in-truck" tallies also powers the interphone system, so a means of isolation is necessary. The jumper over the 5.2K resistor from pin 3 of the 555 can be lifted for short runs of under 500 feet for line signal attenuation. The battery supply voltage could also be lowered. With the jumper in place, we have successful operation at 1800 feet.

The decoder could also be used to operate an audible device instead of the LED, if a "call" signal is desired. Because the current drain of the decoder circuit is minimal, we decided to use batteries rather than entering the camera to find a suitable power source. The 20 turn pot simplifies centering upon the received signal frequency. The LED at the end of the small diameter twisted wire pair is merely taped to the viewfinder screen.

The units operate in the neighborhood of 18 kHz to 38 kHz; we use 25 kHz. The bandwidth of the signal through 1000 feet of regular mic cable is around 800 Hz. We have not encountered problems which would make the system

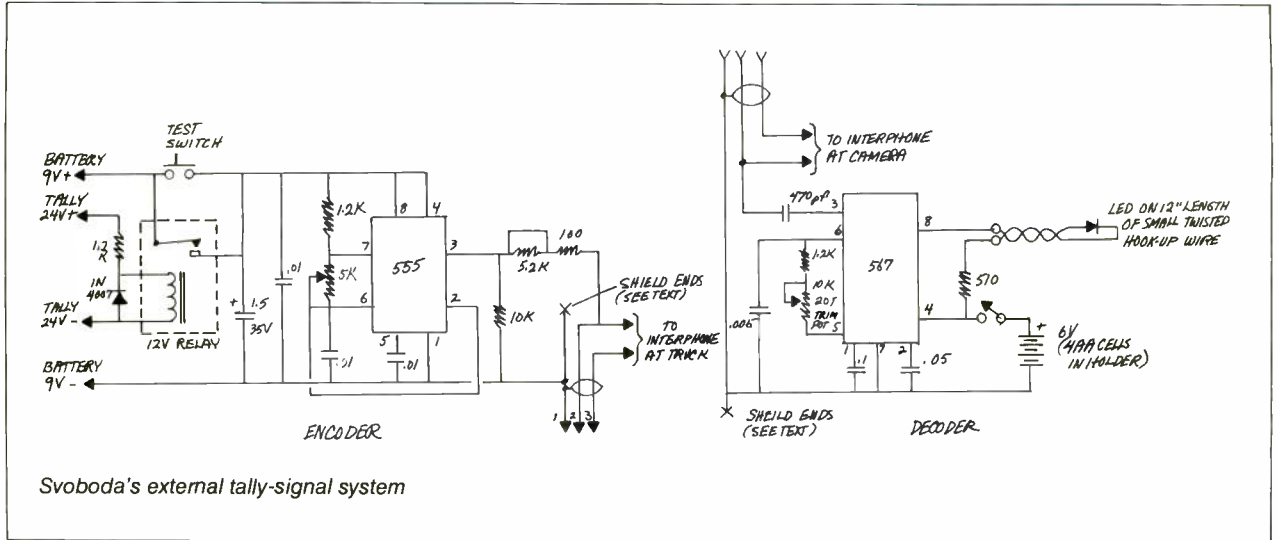

THE CASE FOR SURVIVAL.

Here's a custom case specifically engineered to protect your valuable equipment.

EXCALIBUR cases are

- Rugged—the case that can take it.
- Dependable—the case you can always count on.
- Strong—the case for the long haul.

Choose from the finest materials and hardware available. Built to your specs, or you may consult with our designers regarding your particular needs.

Write or call today for your EXCALIBUR Survival Kit.

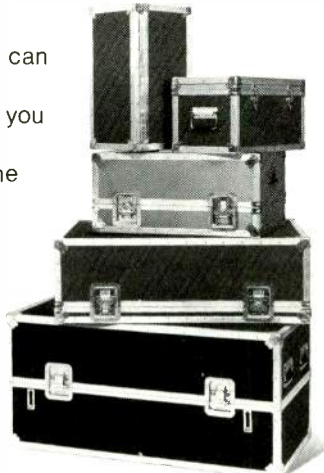

EXCALIBUR INDUSTRIES

12251 Foothill Blvd., Lake View Terrace, CA 91342 • (213) 899-2547

TWX: 910-494-1233

Circle 169 on Reader Service Card

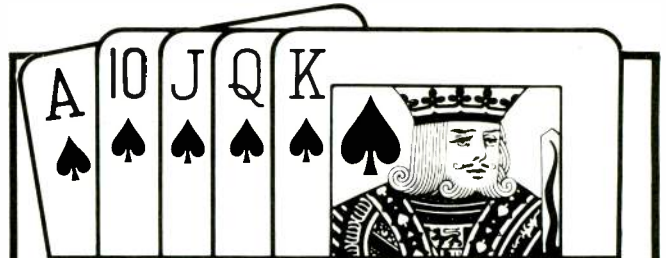

THE WINNER

When Purchasing/Renting/Leasing/Serviceing Video Communications Equipment In California, Mexico And Central America

We are the major distributor and factory authorized service centers for the most respected manufacturers:

SONY, PANASONIC, HITACHI DENSHI, SANYO, RCA, JVC, VICON, PELCO AND MANY OTHERS.

Four strategic locations fully staffed with the most qualified sales engineers, and video technicians.

INSTANT REPLAY EQUIPMENT CO.

LOS ANGELES (213) 870-9435 390-4417

5520 Westlawn Ave., L.A., Ca. 90066

CHATSWORTH (213) 998-4124 (805) 492-3513

9848 Desoto Ave., Chatsworth, Ca. 91311

ANAHEIM (714) 632-7744

1072 Kraemer Pl., Anaheim, Ca. 92806

MEXICO (905) 536-0607 536-0663 536-0245

San Francisco #1208, Col del Valle, Mexico 12, D.F.

Circle 168 on Reader Service Card

HITACHI

SK-91 ENG/EFP 3-Saticon Color Camera

- F1.4 Prism Optics
- 2 H Enhancer and ABO
- 9.7 Lbs +9 +18 db Gain
- Auto White and Black Balance
- 22 Watts

Includes 1.5 VF, camera cover, battery and charger, shoulder mount, 12:1-F1.7 9-108mm lens, auto iris servo zoom, tripod adaptor, carrying case, service manual, camera cable to VTR

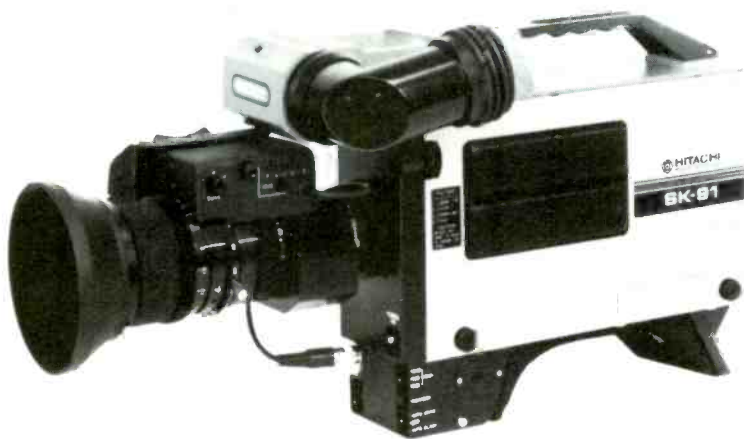

HR-100 Portable Type C 1" Helical VTR

- Conforms to all SMPTE standards
- features Video Confidence Head
- Sync Head, Built-in Time Code Generator, Back Space Editor
- Digital Servo System

Includes take-up reel, 1 hour 3M tape, battery and charger, operation/service manuals, set of extender cards



Both \$59,700 Includes Delivery, One Year Service, Parts and Labor 24 Hours a Day, Seven Days a Week.

(215) 223-8200

LERRO
ELECTRICAL CORPORATION
COMMUNICATIONS SYSTEMS DIVISION
3125 North Broad Street, Philadelphia, PA 19132

Ask for Fred Dorn
or Dick Murphy

Count the X's



THEIR SOLUTION.

\$XXXX.XX



YOUR SOLUTION.

\$ XXX.XX

VAC's Burst phase meter has one less digit in the \$ column and still provides more obvious accuracy where it really counts. The Burst phase meter is an easily visible method for detecting phase changes. Both Burst and H Phase errors can be more quickly observed and measured. The VAC Burst phase meter provides for 1/2 degree of accuracy while the typical vectorscope only offers the eye a 1 or 2 degree phase accuracy.

With the X's you save on one BPM you can afford to buy another.

VIDE  AIDS®
of colorado

1930 CENTRAL AVE., BOULDER, CO 80301
Phone (303) 443-4950

Send for Free Application Notes.

Circle 171 on Reader Service Card

Great Ideas

temperamental. I used common value components available at typical radio hobby-type parts stores. The circuits were housed in small plastic boxes. Connection to the line was made with mating connectors inserted between the cable ends where they join the interphone box at the camera and at the plug-in panel at the truck.

A frequency counter sets the encoder to the selected frequency. The decoder is then tuned with the 20 turn pot to light the LED.

It should be apparent that more than one of these systems can be placed along a common line to provide selected tally or calling to individual decoders, as long as different separated frequencies are selected.

14. Random Noise Generator

*Craig S. Butler, Chief Engineer
WVOJ Radio, Jacksonville, Fla.*

Problem: The value of random noise, white or pink, has been written about in many of our trade publications. It can be used to make test measurements quick and easy. My desire was to build an inexpensive, reliable generator which contained an internal battery supply for extensive use in the field.

Solution: The heart of this circuit is a small eight-pin IC, the MM5837 from National Semiconductor, or its equivalent from AMI, the S2688. These chips basically consist of a 17-stage shift register, some gates, and a clock. The output is random white noise. In order to get pink noise, the output is passed through a filter which reduces the signal amplitude by 3 dB per octave. A general design for that filter is given in Figure 1. However, at the time of construction for this device, I did not have some of the values listed in stock, so I used those that I had and found that the results were very good. A simple double pole switch allows insertion of the filter and determines the type of random noise generated.

After the switch, the generated noise is coupled through the 22 μ F capacitors and the 10K pot to a 353 dual opamp which is wired as a differential amplifier. This arrangement provides a balanced "transformerless" output with a signal level up to +4 dB, at 600 ohms.

Through experimentation, I found that the noise generator chip will run on an input voltage of +9 V. However, I noted that a more consistent output, particularly at low frequencies, resulted with an input voltage of +15 volts. (Note: the manufacturer's specs call for an input voltage of 14 volts, ± 1 volt.) To meet this requirement, as well as the opamp's need for a bipolar supply, I designed the simple battery power supply shown in the schematic.

Basically, each half of the supply consists of two 9 V transistor batteries wired in series to yield a total voltage of 18 V. This voltage is then passed through a 7815 voltage regulator which provides a constant, regulated 15 V output. In the bipolar configuration, the output of the 7815 is wired above ground potential for the positive supply, and reversed, below ground, for the negative supply. Note the wiring of pins 2 and 3 of the 7815s in the schematic. I must admit that four batteries are used in the generator; however, I am happy to report that this supply yields a very long battery life.

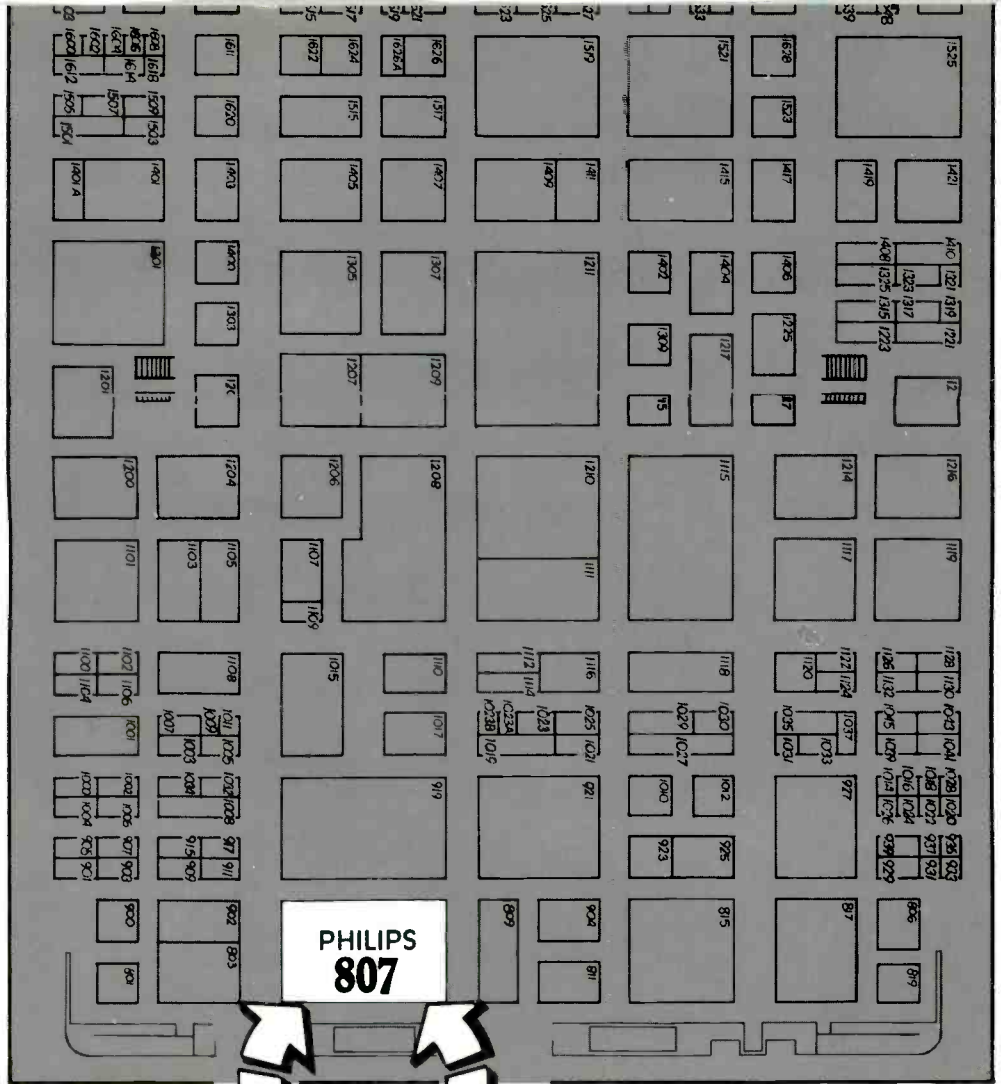

Entrance

Entrance Eastern Exhibit Hall

Profitable Production starts here!

Profitable production in the 80's requires efficient, cost-effective operation...which starts with cost-effective cameras. And Philips offers the greatest value in field and studio cameras today!

At NAB, Philips will combine live and taped demonstrations to focus on:

- New products, new features designed for the 80's.
- Demonstrations of production techniques used by some of

the most quality and cost-conscious broadcasters and production companies in the U.S. and Europe.

- How to increase bottom-line profits without sacrificing creativity or quality.
- Financing for equipment, van and studio.

It just may be one of the most profitable half hours you (and your Chief Financial Officer) spend at NAB. Don't miss it.

Profitable Production starts here!

PHILIPS

PHILIPS BROADCAST EQUIPMENT CORP.
A NORTH AMERICAN PHILIPS COMPANY
91 McKee Drive, Mahwah, N.J. 07430
(201) 529-3800

Circle 172 on Reader Service Card



Great Ideas

To date, the random noise generator has performed well. I have used it with frequency response meas-

urements on tape machines and for equalization of remote lines, just to name a few of its uses. The best part of this project is its cost for parts. I was able to get everything I needed from a local Radio Shack for under \$20. The total construction time was less than four hours.

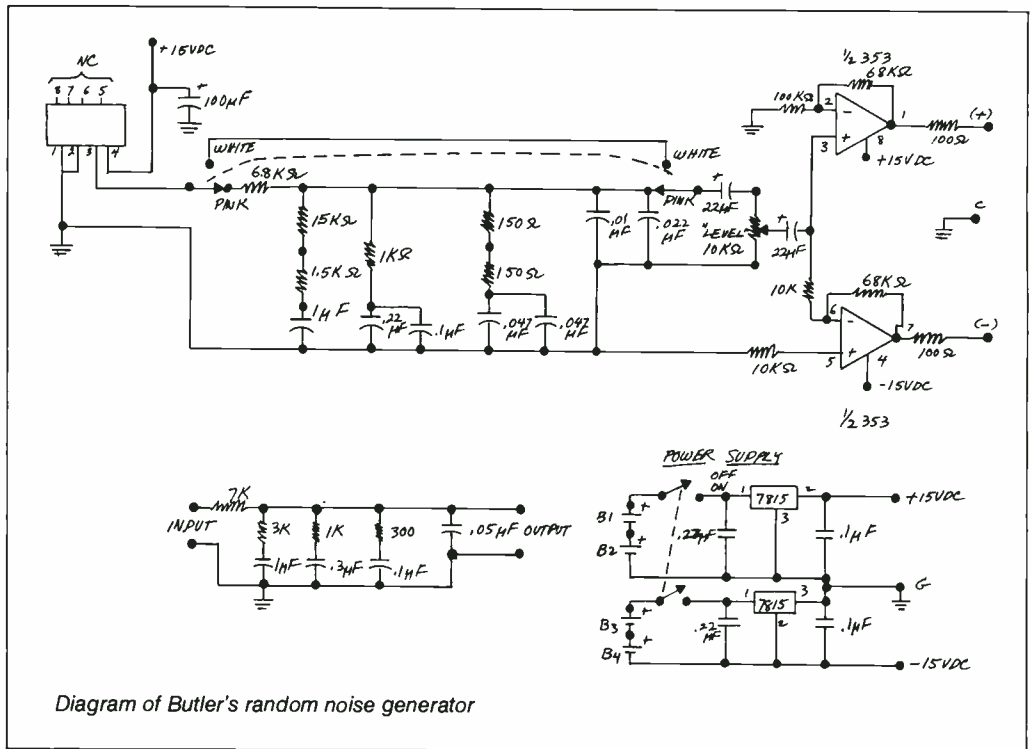

Rules for BM/E's 1981 Great Idea Contest

Mail to:
Editors, BM/E
295 Madison Avenue
New York, New York 10017

1981
Entry Form

Name _____ Title _____

Station Call Letters _____ City _____

State _____ Zip _____

Telephone No. _____

Licensee _____

Class of Station at which idea is used (check one)

TV _____ FM _____ AM _____

Category: Audio _____ RF _____ Video _____ Control _____

Objective or Problem: (In few words; use separate sheet for details)

Solution: (Use separate sheet—500 words max)

I assert that, to the best of my knowledge, the idea submitted is original with this station; and I hereby give BM/E permission to publish the material.

Signed _____ Date _____

1. Eligibility: All station personnel are eligible. Consultants to the industry may enter if the entry indicates the specific station or stations using the idea or concept. Manufacturers of equipment or their representatives are not eligible.

2. How to Enter: Use the Official Entry Form on this page or simply send BM/E a description of your work. State the objective or problem and your solution. Include diagrams, drawings, or glossy photos, as appropriate. Artwork must be legible but need not be directly reproducible and not exceeding three in number. Camera reproducible material is preferred. Length can vary, but should not exceed 500 words. BM/E reserves the right to edit material. Entry should include: Name, title, station affiliation, and the class of station—TV, FM, AM. Indicate if idea is completely original with you.

3. Material Accepted for Publication: BM/E editors will make all decisions regarding acceptability for publication. If duplicative or similar ideas are received, BM/E editors will judge which entry or entries to accept. A \$10 honorarium will be paid for each item published.

4. Voting: Every reader of BM/E is entitled to rank the ideas published. This can be done on the Reader Service Card in the magazine or by letters or cards sent to the BM/E office. To vote, readers should select the three ideas they like best and rank them 1, 2, or 3.

5. Winners: Top rated entries in the year-long tally will become winners in each of the three major categories (AM, FM, TV). Final winners will be picked in February, 1982, and announced in the March, 1982, issue of BM/E.

6. Prizes and Awards: Three top prizes will be awarded; a programmable electronic calculator will be awarded for the highest rated entry in the respective categories of AM, FM, and TV. Ten engineering slide rule calculators will be awarded as secondary prizes for the highest rated entries in the following additional categories (top three winners are not eligible for these prizes): audio (three prizes, one each in the AM, FM and TV categories); RF (three prizes, one each in the categories of AM, FM, TV); Control (three prizes, one each in the AM, FM and TV categories); Video (one prize in TV).

The end of the endless loop.

Eumig's new FL-1000 makes cassettes the broadcast medium.

The Eumig FL-1000, an extraordinary new cassette tape deck, has started a revolution in the world of broadcasting. We believe—and radio engineers agree—that it will soon make the cassette the standard tape format in the broadcast industry.

The FL-1000 is the world's first computer-inter-faceable cassette recorder. Up to sixteen FL-1000 decks can be controlled by any 8-bit computer. Some of the decks can be used for commercials; others for news and weather; still others for music and station ID's. And the location of every item on every cassette can be stored at the beginning of each tape and then in the computer, so any sequence can then be played back—automatically, with no human intervention, all day and all night long.

Watching a bank of FL-1000's working together

is an awesome experience. One deck is rewinding while another is playing, and still another is moving in fast-forward to locate the next selection. Meanwhile, other decks are copying from a network feed and recording an air check.

The technology of the FL-1000 is so advanced that half a dozen units can do the work of more than 100 individual cartridge players—plus several reel-to-reel recorders. And they do it better, at far less cost, with sound quality comparable to that of the finest open-reel equipment. And the Eumig FL-1000's have none of the mechanical problems that plague endless-loop broadcast cartridges.

To see the end of the endless loop, call Eumig about the new FL-1000. Once you see and hear this amazing new recorder in action you'll agree that this is the long-awaited deck that will make cassettes the standard medium in the broadcast industry.

eumig[®]

Eumig (USA) Inc., Lake Success Business Park, 225 Community Drive,
Great Neck, New York 11020, (516) 466-6533

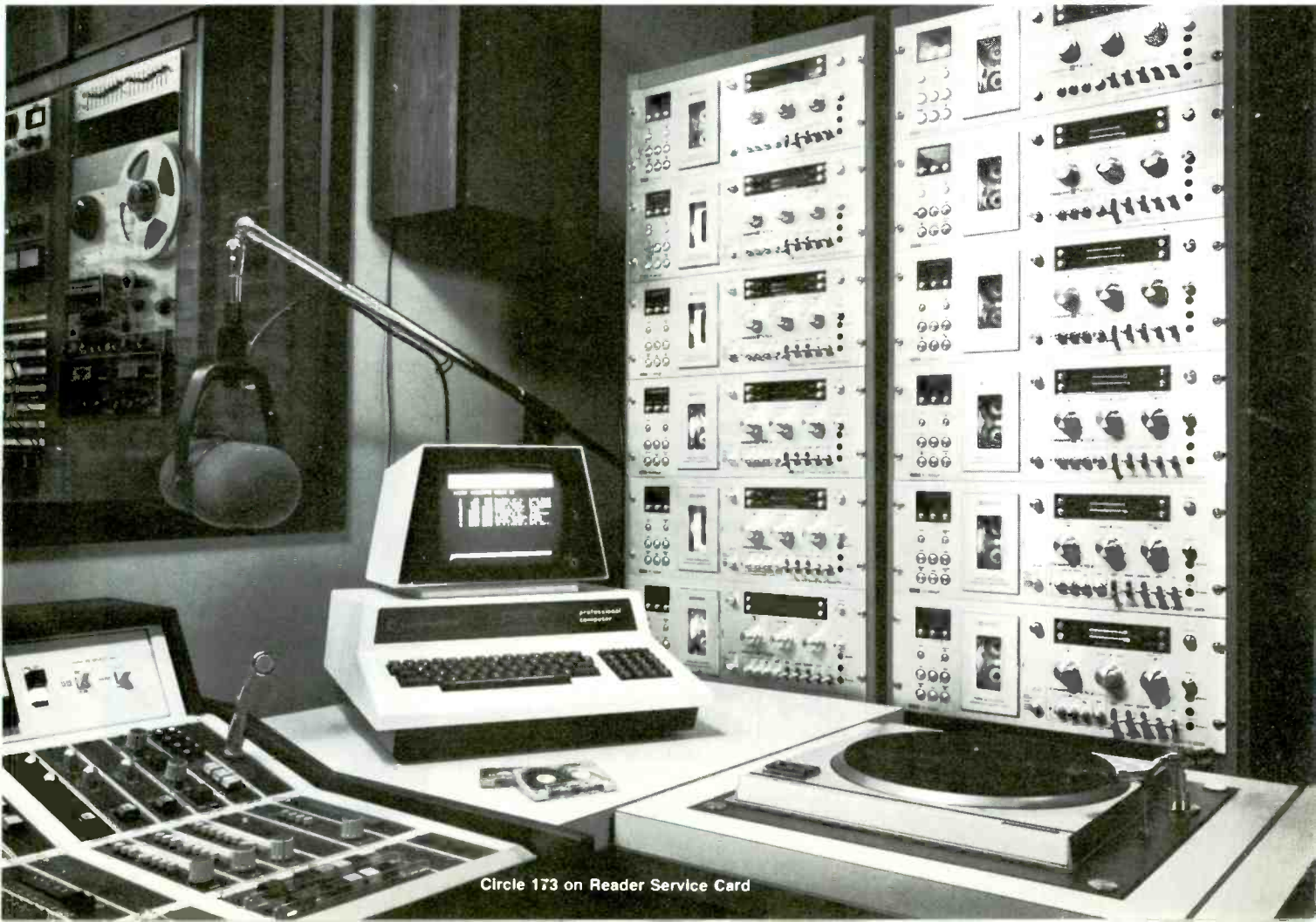

Electro-Voice's Greg Silsby talks about the Sentry 100 studio monitor

In all the years I spent in broadcast and related studio production work, my greatest frustration was the fact that no manufacturer of loudspeaker systems seemed to know or care enough about the real needs of broadcasters to design a sensible monitor speaker system that was also sensibly priced.

Moving to the other side of the console presented a unique opportunity to change that and E-V was more than willing to listen. When I first described to Electro-Voice engineers what I knew the Sentry 100 had to be, I felt like the proverbial "kid in a candy store." I told them that size was critical. Because working space in the broadcast environment is often limited, the Sentry 100 had to fit in a standard 19" rack, and it had to fit *from the front, not the back*. However, the mounting hardware had to be a separate item so that broadcasters who don't want to rack mount it won't have to pay for the mounting.

The Sentry 100 also had to be very efficient as well as very accurate. It had to be designed so it could be driven to sound pressure levels a rock 'n roll D.J. could be happy with by the low output available from a console's internal monitor amplifier.

In the next breath I told them the Sentry 100 had to have a tweeter that wouldn't go up in smoke the first time someone accidentally shifted into fast forward with the tape heads engaged and the monitor amp on. This meant high-frequency power handling capability on the order of five



Production Studio, WRBR-FM, South Bend, Indiana.

times that of conventional high frequency drivers.

Not only did it have to have a 3-dB-down point of 45 Hz, but the Sentry 100's response had to extend to 18,000 Hz with no more than a 3-dB variation.

And, since it's just not practical in the real world for the engineer to be directly on-axis of the tweeter, the Sentry 100 must have a uniform polar response. The engineer has to be able to hear exactly the same sound 30° off-axis as he does directly in front of the system.

Since I still had the floor, I decided to go all out and cover the nuisance items and other minor requirements that, when added together, amounted to a major improvement in functional monitor design. I wanted the Sentry 100 equipped with a high-frequency control that offered boost as well as cut, and it had to be mounted on the front of the loudspeaker where it not only could be seen but was accessible with the grille on or off.

I also didn't feel broadcasters should have to pay for form at the expense of function, so the walnut hi-fi cabinet was out. The Sentry 100 had to be attractive, but another furniture-styled cabinet with a fancy polyester or die-cut foam grille wasn't the answer to the broadcast industry's real needs.

And for a close I told E-V's engineers that a studio had to be able to purchase the Sentry 100 for essentially the same money as the current best-selling monitor system.

That was well over a year ago. Since that time I've spent many months listening critically to a parade of darn good prototypes, shaking my head and watching

some of the world's best speaker engineers disappear back into the lab to tweak and tune. And, I spent a lot of time on airplanes heading for places like Los Angeles, Grand Rapids, Charlotte and New York City with black boxes under my arm testing our designs on the ears of broadcast engineers.

The year was both frustrating yet enjoyable, not just for me but for Ray Newman and the other E-V engineers who were working on this project. At this year's NAB show it all turned out to be worth it. The Sentry 100's official rollout was universally accepted, and the pair of Sentry 100's at the Electro-Voice booth was complemented by another 20 Sentry 100's used by other manufacturers exhibiting their own products at the show.

What it all boiled down to when I first started the project was that I knew that the Sentry 100's most important characteristic had to be *sonic integrity*. I knew that if I wasn't happy, you wouldn't be happy. I'm happy.

Market Development Manager,
Professional Markets

 **Electro-Voice®**
a *gulton* company

600 Cecil Street, Buchanan, Michigan 49107

In Canada:
Electro-Voice, Div. of Gulton Industries (Canada) Ltd.,
345 Herbert St., Gananogue, Ontario K7G 2V1.



BROADCAST EQUIPMENT

Video Edit Controller

The Newsmaker, introduced at SMPTE, is a new-generation edit controller that can interface with a variety of VTRs. It features a color-coded keyboard for easy operation. Separate Digital Select Vari-Glide (DSVG) controls for both source and record side VTRs simplify tape shuttle and edit point location. The entire editing sequence may be accomplished rapidly with the operation of just five keys and the DSVG controls. Features include full GO TO function; settable, presettable, resettable displays; full VTR controls, clear key override; and others. The compact unit measures 20 by 4¾ by 20 inches and weighs about 20 pounds. CINEMA PRODUCTS CORP., 2037 Granville Ave., Los Angeles, Calif. 90025.

high-band videotape recording. It may be particularly useful for expressing weather probabilities, opinion poll results, and other statistical variables in graphic form, the manufacturer states. Employing a dual solid state memory, the ARS-170 remembers two complete

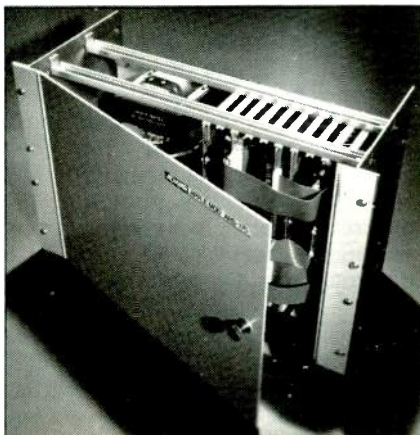

Apple frames, reading one out in full NTSC RS-170 type video standards while the next is being memorized. The unit is compatible with time base correctors and proc amps currently employed in broadcast-quality systems. ADWAR VIDEO.

26-Inch Color Monitor 250

VM-26P is a 26-inch diagonal professional color monitor. Standard features include A-B inputs, internal/external sync, RGB gun switches, RGB background and drive controls, raster size regulation, keyed back porch clamp-

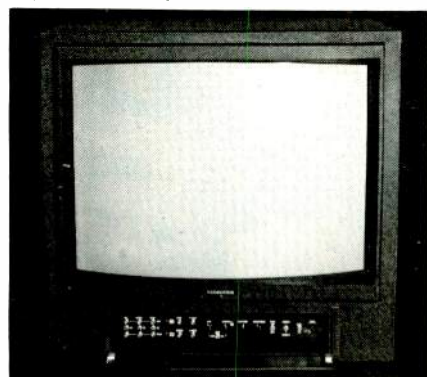

ing, dc restoration, dynamic focusing, velocity beam modulation for improved resolution, and preset adjustments for chroma, hue, brightness, and contrast. Pulse cross and underscan are available optionally. The unit measures 25 inches high by 26 inches wide by 23¾ inches deep and weighs 175 pounds. VID-EOTEK.

Computer Graphics Converter 251

Apple Mod (ARS-170) converts Apple computer graphics signals to RS-170 type NTSC broadcast standards, allowing the Apple to serve as an inexpensive video graphics generator for telecast or

Wideband Video Recorder 252

ME-248, introduced at SMPTE, is a wideband video recorder that can record high-definition television signals up to 14 MHz. Based on a standard Fernseh BCN-50 one-inch Type B VTR, the recorder uses the standard scanner, standard heads, and commercially available tape. The transport and servos are modified to run the scanner and tape at double speed; new signal system electronics are fitted and a bandwidth of 14 MHz at 45 dB S/N with a five percent response to a t/2 test pulse is achieved, according to the manufacturer. Up to an hour of recording is possible with 12-inch reels. The single-channel ME-248 can be adapted to a wide range of encoding standards for color recording. Since conversion is made at the module level, standard Fernseh modules can be replaced if desired to use the VTR in standard configuration. MERLIN ENGINEERING WORKS.

**For more information
circle bold face numbers
on reader service card.**

NOW! CONTINENTAL'S 1 KW AM



Pulse width modulation in an efficient 1 kW package; efficiency and reliability of a tube-powered final; clear, crisp sound of transformerless modulation; ready for AM stereo. Switch-mod system allows maximum modulation level at all power levels while providing cost-effective operation.

Write for brochure on 314R-1:
Continental Electronics Mfg. Co.
Box 270879 Dallas, TX 75227
(214) 381-7161

Continental 
Electronics

Circle 175 on Reader Service Card

Bring automated sound to life.

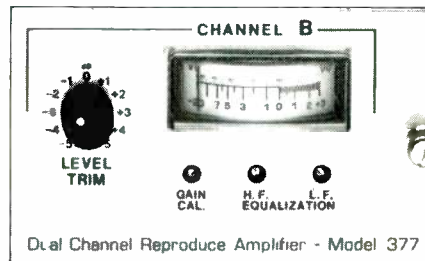

The Inovonics 377 Dual-Channel Tape Playback Pre-amp adds new life to radio automation system sound. You can expect high stability, low noise, and wide-range response — with new or existing installations.

Model 377 works with a variety of tape heads and transports, and is pin-compatible with older Ampex and Schafer equipment.

Bring automated sound to life. Call or write today for details.
Model 377 — \$395.

Inovonics Inc.
503-B Vandell Way
Campbell, CA 95008
(408) 374-8300



Circle 176 on Reader Service Card

FOBA

TRIPOD



Price:
\$625.00

The Foba all-metal professional motion picture tripod features a Pro Jr. flat-top plate which accepts Pro Jr., O'Conner C and 50, Miller F and Pro heads. Foba's unique tubular adjustable legs allow the tripod to be used in both standard and baby positions. Legs can be adjusted individually or simultaneously. Tripod comes complete with triangle-type leg locks and elevating riser plate. Foba was selected for use in filming the 21st Olympiad.

alan gordon enterprises inc.

1430 Cahuenga Blvd., Hollywood, CA 90028
Telephone: (213) 466-3561 • (213) 985-5500
TWX: 910-321-4526 • Cable: GORDENT

Circle 177 on Reader Service Card

NEW from LTM for PORTABLE VTRs

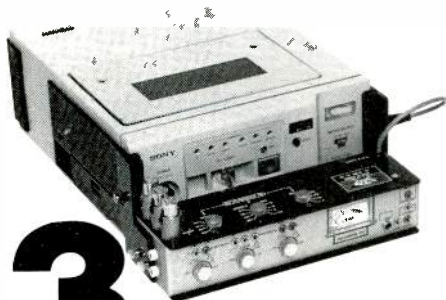

3 CHANNEL SOUND MIXER!

- ★ Quick, secure mount!
- ★ Weighs only 2½ lbs.!
- ★ Free access to all VTR controls!
- ★ 2 mics. plus line or 3 mics. input!

SEE AND TRY IT AT N.A.B.:
LTM—BOOTH NO. 1016



LTM CORP. OF AMERICA
1160 N. Las Palmas Avenue, Hollywood, CA 90038 • (213) 460-6166
LTM FRANCE: 104 Boulevard Saint-Denis • 92400 Courbevoie-France

Circle 178 on Reader Service Card

Broadcast Equipment

Video Production Switcher 253

Model 250 P/N, introduced at SMPTE, is a PAL/NTSC video production switching system with 10 inputs (including built-in color black and color background) and five levels of video: program, preset, and three keys, including mask and inverter capabilities and edger/shadow/outline. There are four output buses. The automation memory is capable of storing and recalling 100 transition configurations; four transition modes include mix, wipe, cut, and non-additive mix. Other features include automatic transition controller, preview potential, 32-pattern generator, two chroma keys, two matte generators, flip-flop mixer for program and preset buses, complete camera tally and non-sync input system, and camera monitor output. Editor access via serial RS-232 or SMPTE standard, composite-encoded chroma keyer, auxiliary switching matrix with remote control panels, and Squeeze-Zoom® interface are optional. VITAL INDUSTRIES.

Graphic Storage and Retrieval 254

The Electronic Still Processor (ESP) C Series is a new-generation digital graphic storage and retrieval system that stores up to 9000 graphic stills on standard computer-industry disk drives and retrieves any one of them in less than half a second. Dual channel memory permits preview selection of stills and last-minute editing of graphics prior to on-air use, or the creation of

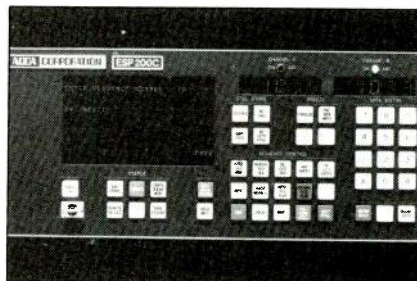

multi-layer visuals from conventional video sources or computer-assisted and enhanced graphic production systems. Sources may be synchronous or non-synchronous as the unit is fully frame-synchronized. A new control panel directs the user-machine interface with new software. System status and control information are displayed on the control panel by LED readout. Interrogation and instructions are displayed in alphanumeric language and arranged in logical order. Other new features include electronic storyboard, sequence

control and automatic sequence, SMPTE VTR time code interface, and optional computerized control system. ADDA CORP.

Professional Tonearm 255

RTA-120 is a professional tonearm constructed entirely of polished aluminum and chromed brass. It pivots on instrument ball bearing races and features easy and accurate adjustment of stylus pressure with calibrated weights.

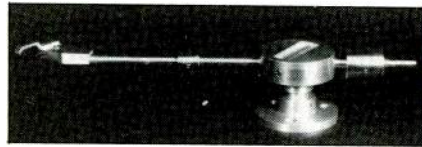

Widely spaced vertical jeweled pivots increase longevity. The head shell is an integral part of the tonearm, insuring solid shell plug connection. Tonearm is extra-wide to minimize the possibility of dropping the stylus on the turntable chassis. RUSSCO ELECTRONICS MANUFACTURING, INC.

Low-Cost Studio Camera 256

Model FP-50S is a compact, high-performance professional studio camera employing three 2/3-inch Saticons. It features f/1.4 prism optics and performs at 550 lines with an S/N of 53 dB. The CU-50 camera control unit, which

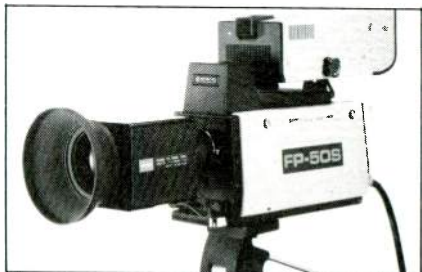

comes with the camera, permits remote operation at up to 1000 feet and includes RGB chroma key out, horizontal vertical drives or optional genlock, auto white, remote gain, built-in cable compensator, and other features. \$17,000 with CCU and five-inch viewfinder. HITACHI DENSHI AMERICA LTD.

Image Processing System 257

The GMR 275, introduced at SMPTE, is a full-color image processing system that generates a 512 by 512 resolution image display that is presented in a one-to-one aspect ratio. In its maximum configuration, the unit may contain five eight-bit image memory banks, allowing a 24-bit, full-color image to be stored in the display system

and processed into a 16-bit summation memory without the need for pumping image data back and forth across the computer interface. Data from the four independent graphic overlay memory planes is selectively superimposed on the displayed image, with selection of overlay display and assignment of colors under computer control. Other modules include the Interface Card, which provides a plug-compatible, bidirectional interface to most computer I/O cards; the Image Control Card, which controls the writing of data into the image memories and its read-back; and the Image Zoom and Pan Cards, which control individual memory banks and allow them to be individually panned and zoomed. GRINNELL SYSTEMS.

Tape Transport

258

The 3000 Series transport, a new addition to the Magnecord product line, is a three-motor unit that accepts reels up to 10½ inches with NAB type A or B hubs and fits standard equipment racks. It is available for 3.75 and 7.5 ips or 7.5 and 15 ips and in 120 V 60 Hz or 240 V 50 Hz versions. Compatible with the man-

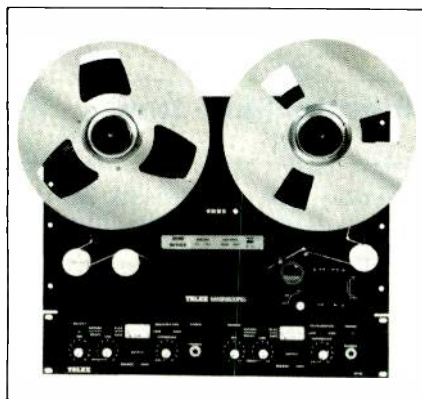

ufacturer's RP85 record/play preamplifier, it may be ordered as a complete recorder/reproducer package or as a separate item. One-, two-, and four-channel systems are available and include the transport, amplifier(s), cables, and rack-mount adapter. Features include transformer-isolated CMOS logic tape motion controls, automatic cycling, Automatic Cue Release (AQR), and a variety of interchangeable head configurations from half-track, single-channel to quarter-track, four-channel. A hinged rear panel provides quick access to plug-in PC boards and plug-in connectors. \$1950. TELEX COMMUNICATIONS, INC.

**For more information
circle bold face numbers
on reader service card.**

System 7000:

Now the broadcast automation champ has a new business automation partner!

The radio world knows all about Cetec's System 7000, the world champion in program automation.

It's the state-of-the-broadcast-art in fast, flexible, trouble-free automation. Plug-in expandable—up to 10,000 memory events, up to four CRT channels, up to 64 audio sources. Plain-English input and output. Cleanest, clearest audio specs in radio.

Cetec's 7000 is working 24 hours a day for winning broadcasters all around the world. (Ask us any time for names and addresses.)

Now Cetec offers the best of both worlds—System 7000 for award-winning program automation, and Cetec MAPS for cost-conscious, profit-prone business-side automation.

Ready to make some real progress? Call Cetec, the broadcast automation specialists.

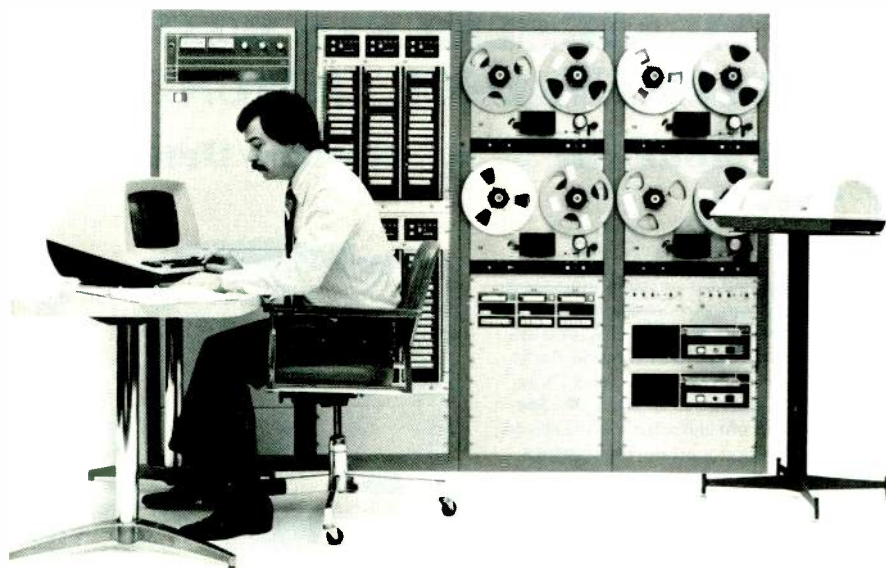

 **Cetec**

Cetec Broadcast Group of Cetec Corporation
1110 Mark Avenue, Carpinteria, CA 93013 (805)684-7686 Telex 658-461

Circle 179 on Reader Service Card

Introducing FM wireless intercom headphones!

Superb, interference free, intercom up to 150 yards! FCC certified and license free. 5 Channels available. Comfortable and lightweight...only 11 ozs. without std. 9v batteries. Soft, foam-filled, vinyl ear cushions provide excellent acoustic seal, reducing ambient noise. Interface capability with wired systems.



- TV & Film cameramen producers, directors.
 - Theatre crews.
 - Language translators.
 - Football coaches, assistants, spotters.
 - Tour directors.
 - Manufacturing personnel.
 - Security personnel.
- Request Bulletin-5T for TR-50 and other FM wireless models.*
INTERCOM MODEL TR-50 **\$297.**

INTERCOM

Manufactured by:

R-COLUMBIA PRODUCTS CO., INC.
2008 St. Johns Ave. Highland Park, IL 60035
(312) 432-7915 TWX: 910-692-2160

Circle 180 on Reader Service Card

ANTENNA IMPEDANCE MEASUREMENTS WITH INTERFERENCE IMMUNITY

The Model SD-31 Synthesizer/Detector Is...

... designed for antenna impedance measurements in presence of strong interference ■ High-level oscillator compatible with General Radio 916 Series, 1606 Series, and Delta OIB-1 Impedance Bridges ■ Special coherent detector circuit rejects interfering signals during measurements ■ Crystal controlled frequency, variable in 500 Hz steps from 100.0 kHz to 1999.5 kHz ■ Receiver for detector can be external or optional built-in RX-31 ■ Powered by rechargeable batteries ■ Self-contained portable package ■ Field proven ■ Versatile — can use as an RF signal generator for troubleshooting antenna systems; as a variable frequency oscillator for antenna site survey; or other applications requiring a precise frequency source



CONTACT US FOR DETAILS.

POTOMAC INSTRUMENTS
932 PHILADELPHIA AVE.
SILVER SPRING, MD. 20910
(301) 589-2662

Circle 181 on Reader Service Card

Broadcast Equipment

Portable Mixing Console

259

The 16:4:2 is the first in a new range of reportedly cost-effective high-quality portable mixing consoles for sound reinforcement and multi-track recording. Built directly into a heavy-duty PFP flight case, with slip-on PFP cover and integral carrying handle, the sys-

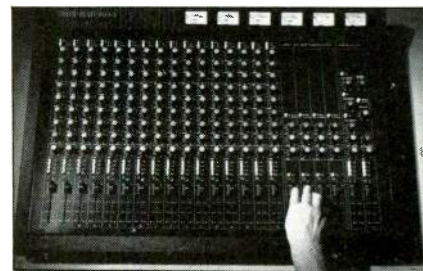

tem features 16 transformerless balanced XLR mic inputs/switchable quarter-inch jack line inputs; three-band sweepable EQ; three auxiliary channel sends; channel routing; long travel 90 mm faders; four subgroup/XLR direct outputs; two routable effects returns; auto PFL on all I/Ps; aux sends; subgroups; main outputs and effects returns. \$2300. ALLEN & HEATH BRENNELL.

All-Weather ENG/EFP Zoom

260

This new 15x9 zoom lens for 2/3-inch cameras has a continuous 15-to-one zoom range (9 to 135 mm). Its maximum aperture of f/1.5 is unsurpassed by any competitive lens, according to the manufacturer. In its standard version the lens comes with a built-in 2.5X range extender turret operated via a simple "flick-in" switch; it may be supplied without range extender if desired. A totally sealed unit with waterproof switches, the lens may be operated in any weather. Servo zoom operation is via rocker switch or pistol grip; servo iris and manual focusing are standard. Minimum focusing distance (without close-up attachment) is 31.5 inches. Options include tripod kit for remote zoom and focus and front-mounting retrozoom (wide angle) and tele attachments. Weight is 4.6 pounds with range extender and rocker switch zoom control and 4.2 pounds without. ANGENIEUX.

Station Management System

261

COMSYS[™] is a comprehensive, menu-based broadcasting station management system designed to automate many operations. Features include con-

tracts, logs, accounts receivable, auto-scheduling, availabilities, marketing and management reports, and invoicing. The system comes standard with word processing and BASIC, PASCAL, and LISP programming languages and has remote diagnostics and multiple terminal capability. Users can also access Arbitron's Programmer's Package for demographic data. Software options include payroll, general ledger with journals, accounts payable, and special reports of sales by region or product type. ECCSYS CORP.

VHF TV Transmitters

262

The TV-L line of low-band VHF TV transmitters, to be introduced at NAB, includes models for every need: single transmitters with 22.5 and 30 kW peak visual power for horizontally polarized applications and 45 and 60 kW parallel transmitters for circularly polarized applications. Typical of the line, the TV-30L 30 kW model features a new ultra-linear driver employing a broadband Class A solid state IPA and a conservatively rated tetrode to drive the final visual amplifier, resulting in maximum linearity and signal trans-



parency without complicated correction circuitry. The solid state IPA also reduces tuning requirements. Surface acoustic wave technology is applied to vestigial sideband filtering in the visual exciter. The transversal sideband (TSB) filter displays a nearly ideal bandpass function for systems M (FCC) and B bandwidths, according to the manufacturer. Other features include true low-level IF modulation, solid state visual and aural exciter/modulators, solid state control circuits, automatic power control, emergency multiplex option, interface with ATS and remote control systems, and easy installation and maintenance. HARRIS CORP.

**For more information
circle bold face numbers
on reader service card.**

OUR WIRELESS MICROPHONES ARE AS GOOD AS OUR MICROPHONES

You know how reliable our microphones are. And how nothing's ever come near the performance of our original Sennheiser wireless microphones. So just wait 'til you hear how good our new wireless systems are!



SENNHEISER

ELECTRONIC CORPORATION

10 West 37th Street, New York, NY 10018

(212) 239-0190

Manufacturing Plant: Bissendorf/Hannover, West Germany

© 1980, Sennheiser Electronic Corporation (N.Y.)

Circle 183 on Reader Service Card

COLOR PRODUCTION SWITCHERS

FOR MORE DETAILS
CALL OR WRITE

105 EAST 69th AVENUE
VANCOUVER, B.C.
CANADA V5X 2W9
PHONE (604) 327-9446
TELEX 04-508605



MODEL
1107

AC OR DC POWERED

ISCOUNT
INDUSTRIES Ltd

Circle 184 on Reader Service Card

Advertisers Index

ADDA Corp.	3
ADM Technology, Inc.	C2, 9
American Data Corp.	24
Ampex Corp. AVSD	22-23
Ampex Corp. MTD	40
Asaca Corp. of America	74
Audio & Design (Recording) Ltd.	55
Beaveronics	54
Belar Electronics Lab. Inc.	130
Bell Helicopter Textron	32
Broadcast Electronics Inc.	96
Canon USA Inc.	17
Centro Corp.	39
Cetec Corp.	127
Chyron Corp.	30
Cine 60 Inc.	49
Cinema Products Corp.	109
Clear-Corn Intercom Systems	110
CMX/Orrrox	112
Comrex	20
Conrac Corp.	47
Continental Electronics Mfg. Co.	125
Crosspoint Latch	57
Data Communications Corp.	82
dbx, Inc.	89
Dictaphone Corp.	91
Edutron, Inc.	111
Electro-Voice	66, 124
Eumig, USA Inc.	123
Everything Audio	108
Excalibur Industries	118
Fujinon Optical Inc.	58-59
Alan Gordon Enterprises Inc.	126
Grass Valley Group, Inc.	7, 16, 130
Hitachi Denshi American Ltd.	4-5
Ikegami Electronics USA Inc.	11, 45, 64, 80
Inovonics Inc.	125
Instant Replay	118
U.S. JVC Corp.	77
Lerro	119
Lexicon	85
LTM Corp.	126
3M/Magnetic Tape Div.	48, 53, 62-63

3M/Mincom-Video Products	70-71
Matrix Systems	14
McCurdy Radio Ind.	C3
Maxell Corp.	18
MCI/Quantel (Micro Consultants Inc.)	72
L. Matthew Miller	130
Microtime Inc.	107
Moseley Assoc. Inc.	78
Nortronics	86
O'Connor Engineering Labs Inc.	50
Otari Corp.	106
Philadelphia Resins Corp.	104
Philips Broadcast Equipment Corp.	121
Potomac Instruments	128
QSI Systems Inc.	100
RCA Broadcast Systems	13, 42-43
R-Columbia Products	128
Sennheiser	129
Scientific-Atlanta	115
Sescom	78
Sharp Electronics	27-29
Shintron	10, 12
Shure Bros. Inc.	99
Sony Corp. of America	102-103
Studer Revox America Inc.	21
Technics Recording & Broadcast	36
Topaz, Inc.	95
Ultra Audio Products	108
UNR-Rohn	26
Unemco Intl.	116
Utah Scientific Inc.	93
Vamp	68
Versatile Video	79
Video Aids Corp. of Colorado	120
Videomedia, Inc.	105
Videotek, Inc.	56, 110
Viscount Industries Ltd.	129
Vital Industries Inc.	69
Ward-Beck Systems Ltd.	C4
Weatheration Inc.	15
Winsted Corp.	68
Wold Communications	60

SALES OFFICES

BM/E

Broadcast Management/Engineering

295 Madison Ave.
New York, New York 10017
Telex: 64-4001

Eastern & Midwestern States

295 Madison Avenue
New York, New York 10017
212-685-5320
James C. Maywalt
Denis J. O'Malley

Western States

353 Sacramento Street
Suite 600
San Francisco, CA 94111
415-421-7330
William J. Healey
Rodger Wadley
3420 Ocean Park Blvd., Suite 3020
Santa Monica, CA 90405
213-450-7181
Bob Hubbard

United Kingdom/Europe

Chilberton House
Doods Road
Reigate, Surrey, England
Telephone: Reigate 43521
Bronwyn Holmes
Derek Hopkins

Japan/Far East

Eiraku Building
1-13-9, Ginza,
Chuo-Ku, Tokyo 104 Japan
03 (562) 4781
S. Yasui
K. Yamamoto

1" VTR to go

Rent Hitachi's HR-100 VTR from Miller.
It's lighter than you think.

Lighter on you

Pick up Hitachi's new HR 100. You'll be surprised so much 1" video recording reliability (meets SMPTE Type C standards) can be packed so compactly and weigh so little (less than 42 lbs.) Rugged enough for location

ENG/EFP use, low-power consumption, includes automatic assemble-edit, video confidence, built-in time code generator.

Lighter on your budget

Find out how little it costs to rent a new Hitachi HR 100 from Miller — the video specialists



L. MATTHEW MILLER Assoc. Ltd.

Suite 1316, 205 East 42nd Street, New York, NY 10017
Telephone: (212) 687-1168 • (800) 223-0620, Cable VIDEOUSA Telex 238917
VIDEO EQUIPMENT • RENTALS • SERVICE/REPAIRS • VIDEOTAPE • EDITING



Circle 185 on Reader Service Card

When accuracy counts... Count on Belar for AM/FM/TV MONITORS



BELAR
AM MODULATION MONITOR

BELAR CALL ARNO MEYER (215) 687-5550
ELECTRONICS LABORATORY, INC.
LANCASTER AVENUE AT DORSET, DEVON, PA. 19333 • BOX 826 • (215) 687-5550

Circle 186 on Reader Service Card

Field Service Engineers

The Grass Valley Group, Inc. a leading manufacturer of television broadcast equipment, is looking for people who want challenging professional positions PLUS the added attraction of working in a small town nestled in the Sierra foothills.

These challenging positions combine chances for U.S. travel plus marketing and engineering career opportunities. Individuals with experience designing and/or maintaining television broadcast systems are required to provide after-sales support for our wide variety of complex systems.

Interested and qualified candidates are invited to send a resume in confidence to Sylvia Smith, The Grass Valley Group, Inc., P.O. Box 1114, Grass Valley, CA 95945. An Equal Opportunity Employer M/F/H.

Grass Valley Group
A Tektronix Company

SS 8650

STEREO AUDIO CONSOLE



A new standard modular audio console offering full facilities, quality circuitry of proven reliability, comprehensive features and a range of standard, pre-wired options. A maximum of fourteen channels are available along with a convenient centrally-located script board and input and accessory modules to satisfy any requirement. Standardization allows these features to be incorporated into a well engineered, compact, functionally styled package at an unusually economical price.



McCURDY RADIO INDUSTRIES

TORONTO
[416] 751-6262

CHICAGO
[312] 640-7077

NEW YORK
[201] 327-0750

Ward-Beck ♥ NY!

Morning and evening,
major personalities and
events cover the nation
from ABC Television in
New York.

"Good Morning America"
and "20/20 News Magazine"
now originate from
ABC's new Studio TV2
featuring this highly
sophisticated Ward-Beck
console system.

Ward-Beck loves New York!

WBS

First by Design.

Ward-Beck Systems Ltd., 841 Progress Avenue, Scarborough, Ontario, Canada M1H 2X4.
Tel: (416) 438-6550.

Ward-Beck Systems Inc., 6900 East Camelback Road, Suite 1010, Scottsdale, Arizona 85251.