

# BROADCAST AN INTERTEC PUBLICATION July 1990/\$4.50 engineering

## Audio technology update



User's guide to  
TVRO performance  
p. 32

If you've been putting off doing stereo field remotes for fear of risking a fragile, expensive stereo mic, Shure's new VP88 is what you've been waiting for.

The VP88 is an advanced single point stereo condenser mic that not only recreates the sonic environment with extraordinary audio fidelity, but meets Shure's legendary standards for ruggedness and reliability.

The VP88 is built to withstand the punishment of field remotes. And, it comes at a price you'll find surprisingly affordable.

#### TRUE MS STEREO.

The VP88 features a forward facing Mid capsule, perpendicular Side capsule and built-in stereo matrix to assure a wide, natural, uncolored

response for stereo imaging. Yet, it's perfectly mono compatible.

To enable you to control the degree of stereo spread and ambience pick-up, the VP88 has three switch-selectable stereo modes

or direct mid and side output. And it's designed to provide the wide dynamic range and low noise you need for remote broadcasts.

#### THE FEATURES YOU NEED.

The VP88 can be powered by a self-contained battery or phantom power so you can go where the action takes you. It includes switchable low-frequency rolloff for reduced ambient noise and a built-in "pop" screen.

In addition to camera mounting, the VP88 can be used on a stand, fishpole, or boom. And the mic comes with a wide range of standard and optional accessories to accommodate your most challenging stereo miking requirements.

So whether you're just beginning to look at stereo miking, or you want to take your stereo to the next level — consider the advantages of the Shure VP88. It's making stereo miking an affordable proposition.

For the name of your nearest dealer and our free brochure, call or write Shure, 222 Hartrey Avenue, Evanston, IL 60202-3696. 1-800-257-4873. The Sound of the Professionals® ... Worldwide. **SHURE®**

Circle (1) on Reply Card

# Shure's New VP88 Stereo Microphone Offers A New Level Of Reliability And Affordability.

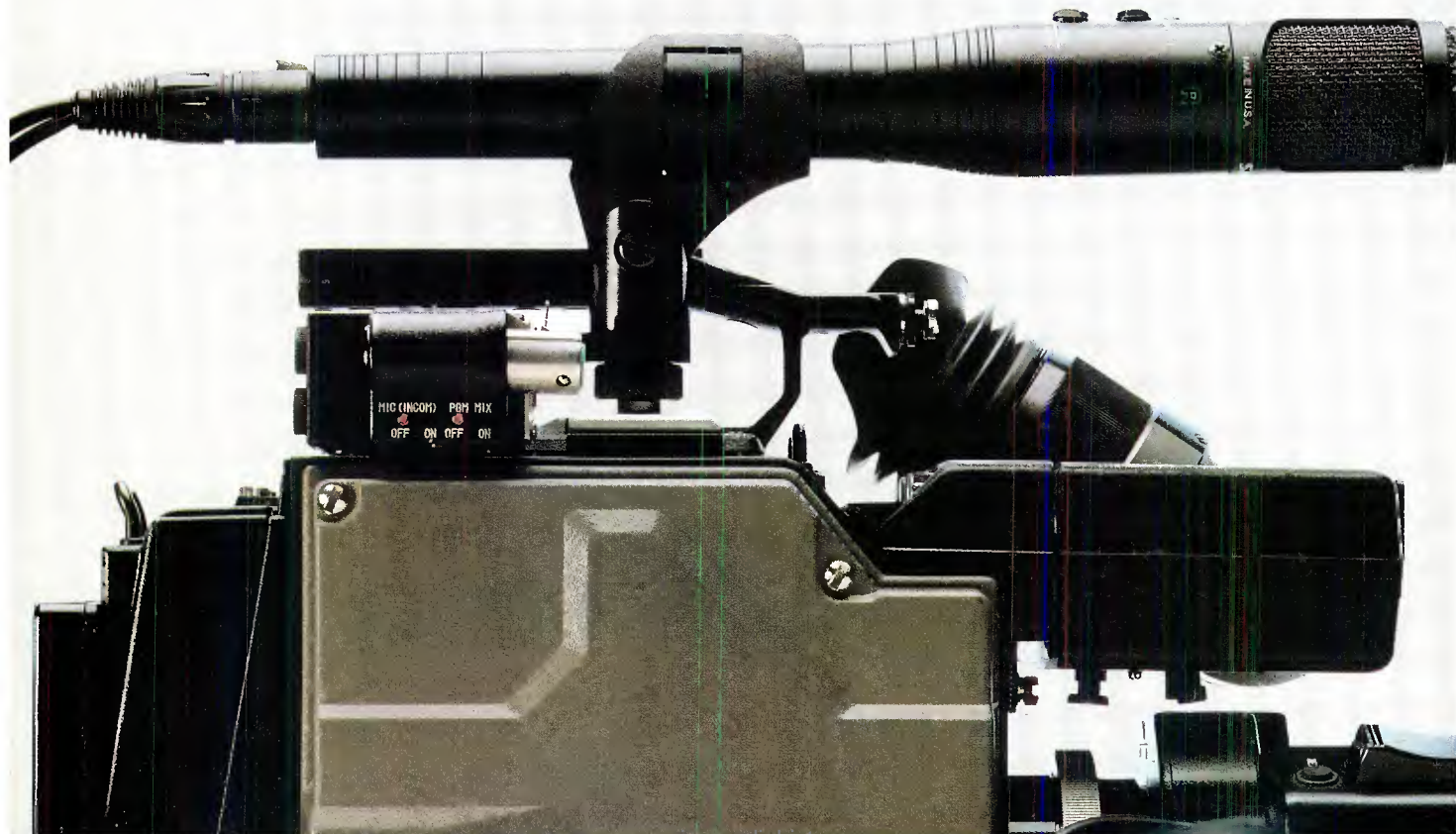

# The Whole is Greater Than the Sum of its Parts.

..... The Price is \$13,000 Less.

Starting with a Four-Field Wide Band Synchronizer for \$5,995.\*

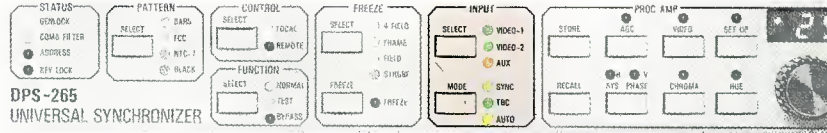

An infinite window TBC for \$4,995.\*

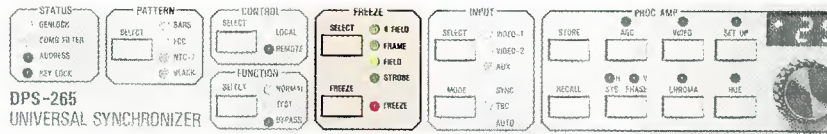

A Digital Proc Amp with AGC, Black/White Clip and 10 memory presets for \$2,580.\*

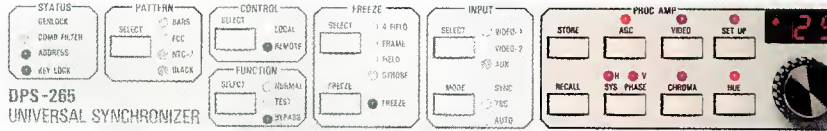

A 4-Pattern Digital Test Signal Generator with programmable VITS Inserter will set you back another \$4,995.\*

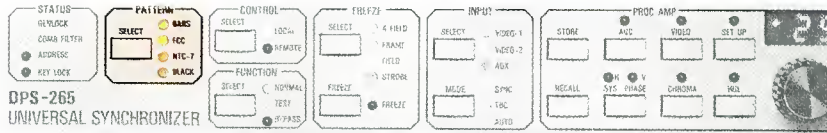

Add it all together and you've spent \$18,565.\*

But now you can have all these capabilities. And more. In a single unit. For a single low price.

The DPS-265 Universal Synchronizer TBC. Everything you need. And more. For \$13,000 less.

## Just \$5,495

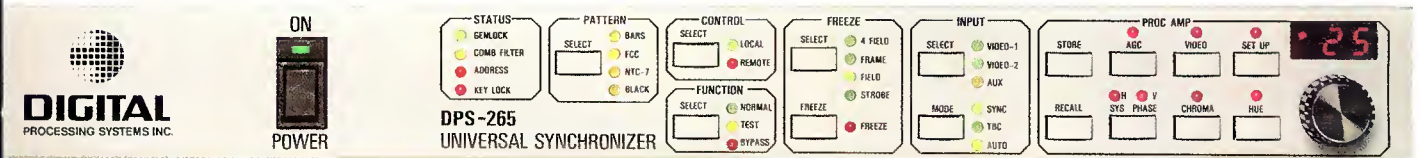

**DIGITAL**  
PROCESSING SYSTEMS INC.

ON  
POWER

DPS-265  
UNIVERSAL SYNCHRONIZER

the  
**SOURCE**

**MIDWEST**  
Communications Corp.

Circle (3) on Reply Card

\*Based on published list price of leading industry manufacturers.

www.americanradiohistory.com

One Sperti Drive  
Edgewood, KY 41017  
(606) 331-8990

# Contents

July 1990 • Volume 32 • Number 7

## BROADCAST engineering®

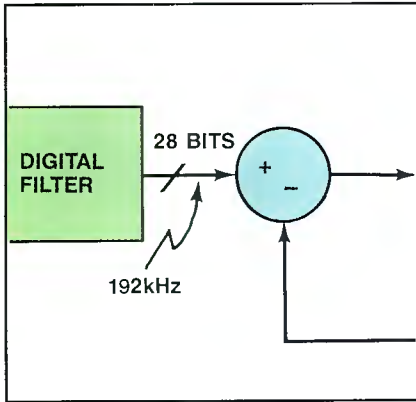

Page 26

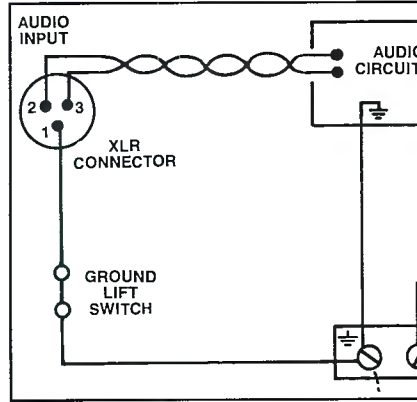

Page 48

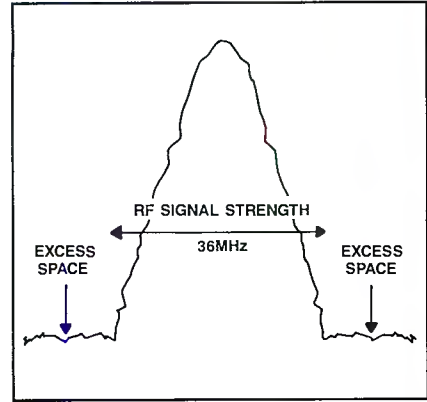

Page 66

### AUDIO TECHNOLOGY UPDATE:

The quality of broadcast audio has never been more important than it is today. As alternative delivery systems bring excellent technical audio into the home, broadcasters must ensure that their systems meet that challenge. This month, we examine three leading-edge technology issues: digital oversampling, how to interface today's high-performance equipment and TVRO performance guidelines.

### FEATURES:

#### 26 Performance Aspects of Digital Oversampling

By Richard Cabot, *Audio Precision*

Nothing is free, particularly with regard to digital oversampling. D/A and A/D conversion can affect other performance aspects of digital audio devices.

#### 48 Audio Interconnection

By Skip Pizzi, *radio technical editor*

Building bridges to better audio with modern interconnection.

#### 66 User's Guide to TVRO Performance

By Warren H. Davis Jr., *Standard Communications*

Tests and upgrades mean peak performance from satellite equipment.

### DEPARTMENTS

- 4 News
- 6 Editorial
- 8 FCC Update
- 10 Strictly TV
- 12 re: Radio
- 14 Uncommon Engineers
- 16 Circuits
- 18 Troubleshooting
- 20 Management for Engineers
- 82 New Products

### ON THE COVER

Broadcasters have always led the way in providing their audience with superior audio signals. Today's high-performance audio equipment makes that job easier. (Cover credit: Audio console supplied by Pacific recorders. Design by MediaScan.)



# One of Our CCD Cameras Should Be One of Yours

Presenting the Hitachi SK-F Series...  
A Line-up of Five High Performance  
Broadcast CCD Cameras.



Use the **SK-F700/710**  
for studio & field production  
work. A choice of RGB  
Triax, Composite Triax or  
Multicore gives you total  
system flexibility.

The **SK-F3** is our top-of-the-line EFP portable with 400,000 pixel FIT CCD's.

The **SK-F2** is our Broadcast ENG camera featuring IT CCD's with 700 lines of resolution.

The **SK-F1** is our ENG/EFP model that makes FIT technology affordable.

Hitachi Denshi America, Ltd

150 Crossways Park Drive, Woodbury, New York 11797 Tel: (516) 921-7200

## Interference problems threaten future of FM

The National Association of Broadcasters (NAB) told the Federal Communications Commission (FCC) that growing interference on the FM band, aggravated by directional antennas, threatens FM radio service nationwide.

In a joint filing with the Association of Broadcast Engineering Standards; du Treil, Lundin and Rackley, a consulting engineering company; Greater Media, a broadcast station group; and Mullaney Engineering, NAB said the use of FM directional antennas is "technically unsound" under today's FCC rules. It urged the FCC to reassess its 1988 decision allowing their use. NAB asserts the antennas do an inadequate job of preventing interference among FM stations closely positioned on the FM band.

NAB, which opposed the FCC guidelines in December 1988 that allowed the widespread use of FM directional antennas,

urged the commission to:

1. Thoroughly re-examine all technical data that led to the adoption of current federal rules on contour protection and their adequacy to accurately predict interference.
2. During this review, return to distance separation standards for allocation and assignment of FM stations.
3. Reinstate the case-by-case consideration of special waivers for distance separation requirements, consistent with past and present policy.
4. Revise immediately the FM antenna installation, filing and maintenance requirements.
5. Suspend the applications and use of contour protection rules adopted in December 1988.

## CableLabs and ATTC sign testing pact

The Advanced Television Test Center (ATTC) has agreed to allow Cable Televi-

sion Laboratories (CableLabs) to use its facilities in Alexandria, VA, for testing advanced TV (ATV) transmission systems. This testing is in support of the FCC's Advisory Committee on Advanced Television Service.

CableLabs will occupy office and laboratory space at the test center and will receive access to the technical infrastructure at the lab and to the staff necessary to provide technical support services. CableLabs will install and staff its own cable test system, a cable transmission impairment simulator, on site in early fall.

The two organizations have offered to undertake lab testing of the eight ATV transmissions system proposals pending before the FCC Advisory Committee. The tests include lab simulation of the broadcast and cable transmission environments, and objective measurements and some subjective assessments of the performance of each system in each medium. The two organizations also are working with Cana-

*Continued on page 82*

## BROADCAST engineering

Editorial and advertising correspondence should be addressed to: P.O. Box 12901, Overland Park, KS 66212-9981 (a suburb of Kansas City, MO); (913) 888-4664. Telex: 42-4156 Intertec OLPK. Circulation correspondence should be sent to the above address, under P.O. Box 12937. RAPIDFAX: (913) 541-6697.

### EDITORIAL

Brad Dick, *Editor*  
 Carl Bentz, *Technical and Special Projects Editor*  
 Rick Lehtinen, *Technical Editor*  
 Skip Pizzi, *Technical Editor*  
 Tom Cook, *Senior Managing Editor*  
 Dawn Hightower, *Senior Associate Editor*  
 Tim McNary, *Associate Editor*  
 Suzanne Oliver, *Editorial Assistant*  
 Pat Blanton, *Directory Editor*

### ART

Stephanie Chiles, *Graphic Designer*

### EDITORIAL CONSULTANTS

Fred Ampel, *Audio*  
 Nils Conrad Persson, *Electronics*  
 Ned Soseman, *Video*  
 Michael Heiss, *Consulting Editor*

### BUSINESS

Cameron Bishop, *Group Vice President*  
 Duane Hefner, *Group Publisher*  
 Jerry Whitaker, *Associate Publisher*  
 Evelyn Hornaday, *Promotions Manager*  
 Darren Sextro, *Promotions Coordinator*  
 Dee Unger, *Advertising Business Manager*  
 Mary Birnbaum, *Advertising Production Supervisor*  
 Sally Nickoley, *Advertising Coordinator*

### ADMINISTRATION

R.J. Hancock, *President*  
 Chuck Rash, *Corporate Circulation Director*  
 Sandra Stewart, *Circulation Director*  
 Doug Wilding, *Circulation Manager*  
 Customer Service: 913-541-6633  
 Kevin Callahan, *Creative Director*

### TECHNICAL CONSULTANTS

Eric Neil Angevine, *Broadcast Acoustics*  
 John H. Battison, *Antennas/Radiation*  
 Blair Benson, *TV Technology*  
 Dennis Ciapura, *Radio Technology*  
 Dane E. Ericksen, *Systems Design*  
 Howard T. Head, *European Correspondent*  
 Wallace Johnson, *FCC/Bdct. Engineering*  
 John Kean, *Subcarrier Technology*  
 Donald L. Markley, *Transmission Facilities*  
 Harry C. Martin, *Legal*  
 Robert J. Nissen, *Studio/Communications*  
 Hugh R. Paul, *International Engineering*  
 Art Schneider, *A.C.E., Post-production*  
 Elmer Smalling III, *Cable/Satellite Systems*  
 Vincent Wasilewski, *Communications Law*

### MEMBER ORGANIZATIONS

#### SUSTAINING MEMBERS OF:

- Acoustical Society of America
- Society of Broadcast Engineers
- Society of Motion Picture and TV Engineers

Member,  
 Association of Business Publishers

**ABP**

Member,  
 Business Publications  
 Audit of Circulation

**BPA**

BROADCAST ENGINEERING is edited for corporate management, engineers/technicians and other station management personnel at commercial and educational radio and TV stations, teleproduction studios, recording studios, CATV and CCTV facilities and government agencies. Qualified persons include consulting engineers and dealer/distributors of broadcast equipment.

BROADCAST ENGINEERING (ISSN 0007-1794) is published monthly (except in the fall, when two issues are published) and mailed free to qualified persons within the United States and Canada in occupations described here by Intertec Publishing Corporation, 9221 Quivira Road, Overland Park, KS 66215. Second-class postage paid at Shawnee Mission, KS, and additional mailing offices. POSTMASTER: Send address changes to **Broadcast Engineering**, P.O. Box 12960, Overland Park, KS 66212.

**SUBSCRIPTIONS:** Broadcast Engineering is mailed free to qualified persons in occupations described above. Others may subscribe at the following rates: United States, one year, \$50; all other countries (surface mail), one year, \$60. Rates include postage. Foreign air mail and Canadian First Class options are available at the annual subscription rate of \$115. Single copy price \$4.50, except for the annual Buyers' Guide/Spec Book back issues \$20. Adjustments necessitated by subscription termination at single copy rate. Allow six to eight weeks delivery for change of address or new subscription.

Photocopy rights: Permission to photocopy for internal or personal use is granted by Intertec Publishing Corporation for libraries and others registered with Copyright Clearance Center (CCC), provided the base fee of \$2.00 per copy of article is paid directly to CCC, 21 Congress St., Salem, MA 01970. Special request should be addressed to Cameron Bishop, group vice president. ISSN 0007-1794 \$2.00 + \$0.00.

©1990 by Intertec Publishing.  
 All rights reserved.

Advertising offices listed on page 94.

**INTERTEC**  
 PUBLISHING CORPORATION

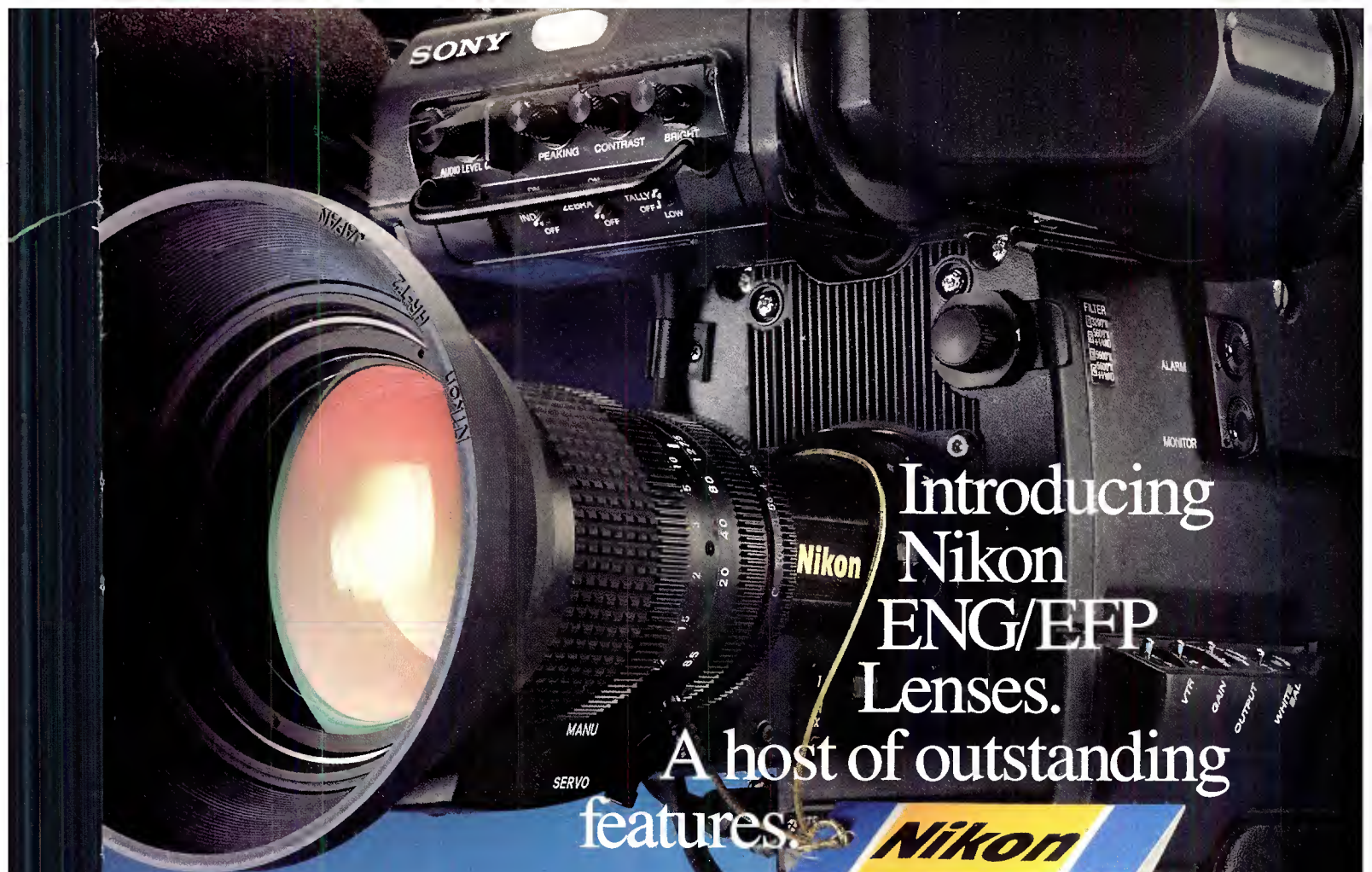

Introducing  
Nikon  
ENG/EFP  
Lenses.

A host of outstanding  
features.

And one you'll  
probably never use.

**Nikon**  
**EXPRESS  
LOANER  
SERVICE**

Selecting an ENG/EFP lens for your  $\frac{2}{3}$ " CCD camera is a creative decision. It should be lightweight, responsive and zoom smooth as silk at any speed. Its design should utilize Extra-low Dispersion Glass to minimize chromatic aberration. It should include an anti-reflection coating for improved spectrum transmission ratio. And it should have an advanced design that improves corner resolution and produces a high, flat MTF curve. In short, it should be a Nikon.

But selecting an ENG/EFP lens is also a business decision. And on that score we provide something almost as compelling as Nikon quality — our unique Express Loaner Service. Simply register the Warranty, then in the unlikely event your lens needs service we'll get you a loaner lens overnight. All your investment in equipment and crews is more secure than ever before.

A service like this is remarkable in itself. But not quite as remarkable as our lenses.

As with all Nikon products, our new ENG/EFP lenses have all our renowned quality, tradition and technology built right in. Our growing line is also fully accessorized, including adapters that allow the use of your entire arsenal of Nikkor 35mm SLR camera lenses for special effects.

To find out more, call or write for our complete brochure: Nikon Electronic Imaging, Dept. D1, 101 Cleveland Avenue, Bayshore, NY 11706, (516) 222-0200 Ext. 324. Or call 1-800-NIKON-US (645-6687) for the dealer nearest you.

**Nikon**  
**ELECTRONIC IMAGING**

© 1990 Nikon Inc.

Circle (4) on Reply Card

## Making order out of chaos

A guest editorial

It's been said that only two kinds of broadcasters exist; those who've been interfered with and those who will be. If you're in the latter group, don't brag, because you could be next.

Part of the problem is a continual increase in the number of broadcasters and non-broadcast organizations filing applications for auxiliary licenses. The rules permit common carriers, networks and cable companies to operate in the RPU and microwave bands. In many markets, these increased demands have pushed band capacity to the saturation point.



Auxiliary licenses granted by the FCC no longer restrict the user to any particular operating area, which compounds the problem. These licenses can be used anywhere at any time, provided local frequency coordination takes place. According to the FCC, any licensee has as much right to the channels in your local area as you do, as long as they coordinate.

Production companies and private operators that provide services to broadcasters add to the confusion. FCC rules allow any organization to operate on any of the auxiliary bands under the authority of a broadcaster's license.

Under the rules, these companies can transmit programming to the client stations using Part 74 RPU and microwave channels. In these instances, the broadcaster is ultimately responsible for frequency coordination and compliance with technical standards in the particular band. Therefore, anyone can enter your area and operate equipment in Part 74 bands if they meet the following three provisions:

1. They must be employed by an organization holding a valid license for the particular band in which they will be operating.
2. The frequencies must be used to provide service to a broadcast station or network entity.

3. The operator must coordinate these frequencies with the local coordinating committee.

Even then, your responsibility does not end. When you give permission to an unlicensed operator to broadcast in auxiliary bands, your station bears the legal responsibility for the actions taken by that company. If the company you hire does not coordinate its use of the band, your station is responsible for any interference generated.

If a company operating under your station's authority uses a transmitter that is not functioning properly, and creates interference that takes another station off the air, your station can be cited by the FCC. Your station license is at risk whenever you extend such privileges to another organization.

The FCC also requires that applicants for frequencies in auxiliary radio bands certify that they have contacted their area's local coordinating committee. They are required to enter the name and phone number of the coordinator they contacted on Form 313, line 16. The commission will deny any application that does not provide this information.

In most cases, the local frequency coordinator is affiliated with the SBE. If you need help finding the committee for your area, call the SBE office at 317-842-0836.

The most important thing to remember is that the auxiliary radio band consists of shared frequencies. No one has exclusive rights to any channel. Frequency coordination is the only means we have to maintain some semblance of order.

All broadcasters should become a part of their local coordinating committee. Frequency coordination is no longer an option. It is the law.

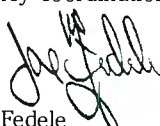
  
Joe Fedele  
Manager, Technical Operations and Chief Engineer  
WCBSTV  
New York



# An interview with "Orbie," the Orban Dalmatian.

**HOME:** San Francisco, California

**PROFESSION:** Orban Products spokes-dog.  
(Eat your heart out Spuds!)

**AGE:** 35 (that's 5 in human years).

**QUOTE:** "Orban has a passion for quality that is exceptional among companies today."

**PROFILE:** Reliable, versatile and technically outstanding (like Orban products).

**ON ORBAN:** "Orban maintains the highest technical standards and delivers the most thoughtfully engineered audio processors on the market. Reliable products, purpose-built and backed by great customer service. That's dogged perfection!"

**FAVORITE PRODUCTS:** "Compressor/Limiters, De-Essers, Stereo Synthesizers, Parametric Equalizers, Spatial Enhancers, Programmable Processors and of course, the OPTIMOD. The entire line is unsurpassed in quality."

**FAVORITE SONG:** "You Ain't Nothing but a Sound Dog."



## orban

a division of AKG Acoustics, Inc.

1525 Alvarado Street  
San Leandro, CA 94577 USA  
Tel: (1)415/351-3500  
FAX: (1)415/351-0500

### LISTEN TO THE DIFFERENCE.

Compressor/Limiters, De-Essers, Stereo Synthesizers, Parametric Equalizers, Transmission Processors

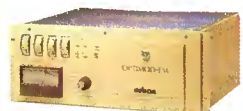

Circle (5) on Reply Card

[www.americanradiohistory.com](http://www.americanradiohistory.com)



## FCC adheres to fairness “corollaries”

By Harry C. Martin

Because 1990 is an election year, it is essential that broadcasters familiarize themselves with the FCC's political broadcast rules. These include rules that developed as corollaries to the fairness doctrine, even though the doctrine was abolished in 1987. The corollary rules are the *Personal Attack Rule* (47 C.F.R. 73.1930), the *Zapple Doctrine* (quasi-equal opportunities) and the *Cullman Doctrine* (free time to opposing views).

Under the Personal Attack Rule, if a station broadcasts an attack upon the honesty, character, integrity or like personal qualities of a person or group during the presentation of views on a controversial issue of public importance, such as a ballot issue, then the station must, within one week after the attack, notify the person or group attacked of the date, time and identification of the broadcast; provide a tape or script (or an accurate summary if a script or tape is not available) of the attack; and offer a reasonable opportunity to respond over the station's facilities. (Personal attacks made by legally qualified candidates or their authorized spokespersons are exempt from this rule.)

The *Political Editorializing Rule* is similar to the Personal Attack Rule in that when a broadcaster in an editorial endorses or opposes a legally qualified candidate, the broadcaster must, within 24 hours, provide opposing qualified candidates with notification of the date and time of the editorial; a script or tape of the editorial; and an opportunity to respond.

The Zapple Doctrine requires a station that sells time to supporters or spokespersons of a candidate during an election campaign to provide comparable time to the supporters or representatives of an opponent.

Finally, under the Cullman Doctrine, a station may not broadcast a sponsored spot for one side of a ballot issue and then refuse to broadcast an opposing viewpoint simply because no one would pay to sponsor that position. Therefore, if no paid sponsorship can be found, the station must afford free time to the other side.

All of these corollary rules are under at-

tack by major broadcast and news organizations that have urged the FCC to terminate its enforcement activities in all fairness-related areas. Congress, however, is pressing the commission to keep the rules. Although the rules will remain in place until the dispute is resolved, there have been no FCC actions taken against broadcasters for violations of the corollary rules since the fairness doctrine was abolished. Nevertheless, until the commission takes a definite position, broadcasters should play it safe and abide by the rules.

### Did you meet the NRSC-2 deadline?

All AM stations were required to comply with the NRSC-2 RF limitation standard by the end of last month.

In April 1989, the commission adopted the National Radio Systems Committee Emission limitation (NRSC-2) as a standard for AM broadcast stations. Compliance with the requirements can be achieved by one of two methods. A station could have installed NRSC-1 equipment by the deadline, or show compliance with NRSC-2 using a spectrum analyzer. (See FCC rules 73.44[a]&[b].) If the station installed NRSC-1 equipment, the commission will assume that the station is in compliance with the NRSC-2 standard until June 30, 1994.

### FCC air-hazard regulations

Although the FAA and FCC share regulatory jurisdiction over broadcast tower structures, the following FCC standards must always be met to keep licensees in good standing with that agency:

- When radio towers are taller than 200 feet and/or near an airport, the licensee must apply for FCC-issued obstruction marking and lighting specifications. During construction, temporary warning lights must be installed at the top of the structure, and at each level where permanent lights will be installed.
- Licensees should ensure that their towers are marked and lighted in accordance with the specifications in their permits. Daily inspections must be made to ensure the lights are on and operating properly.
- If a light outage occurs that cannot be corrected within 30 minutes, the local FAA Flight Service Station (FSS) must be contacted immediately. The FSS will issue a

warning to pilots. The FSS also must be notified when the lights are operational so the warning may be rescinded.

### FCC acts on abuses of process

As part of its effort to deter abuses of its processes, the FCC has adopted new rules and has proposed others dealing with comparative hearings and FM/TV allocation proceedings. The following are the most significant of the commission's initiatives:

- Limit settlement payments among applicants for construction permits to out-of-pocket expenses or, at some early stage of the hearing process, to 50% of out-of-pocket expenses.
- Limit the payments that can be made in exchange for the withdrawal of petitions to deny, or threats to file petitions to deny, in new licensing, modification, and transfer and assignment proceedings to the out-of-pocket expenses of the petitioner.
- Limit payments that could be made in exchange for the withdrawal of counterproposals in TV and FM allocation proceedings to the out-of-pocket expenses of the counterproponent.

The FCC is proposing to reform and streamline the comparative hearing process by the following procedures:

1. Require the payment of the \$6,760 hearing fee before the release of the hearing order.
2. Use new procedures to encourage settlements.
3. Permit merged applicants to take full advantage of any comparative upgrade that occurs as a result of the merger.
4. Overturn agency policies that permit settlements to extinguish integration and divestiture commitments made prior to hearing.
5. Eliminate the active investor/passive investor structure as a means of artificially maximizing comparative preferences.
6. Abolish the review board.
7. Require appeals from a law judge's decision to be decided within six months.
8. Limit the time for discovery to 60 days.
9. Rely more on written (as opposed to oral) testimony.
10. Eliminate oral argument on appeals except in extraordinary circumstances.

Martin is a partner with the legal firm of Reddy, Begley & Martin, Washington DC.

# More.



- *The familiar feel of the industry standard Model 100, with more power, more control and more features than ever.*
- *The extra quality of linear keying.*
- *10 E-MEM® Effects Memory registers at your fingertips for fast learn and recall of switcher effects.*
- *New KeyLink™ combines the Model 110 and DPM-100 Digital Picture Manipulator for more creative effects.*

**The new Model 110  
Production Switcher.  
GVG raises the  
standard for  
professional video  
and small studio  
production.**

**Again.**

Introducing the compact and affordable Model 110.

For the new, more powerful standard in professional video and small studio production, nobody supports you like GVG.®



*At the heart of Television*

## Interchannel timing in component systems

By Steve Talley

New technology never seems to rid itself of the problems of old technology; it just trades the old problems for new ones. Although component TV systems eliminated some objectionable chrominance-luminance interactions of NTSC, it produced a new set of problems. These problems are internal to component signal processing, and others relate to the interaction of component and NTSC systems.

### Component complexities

Interchannel timing is one of these problems. The signal events in all three channels are supposed to be simultaneous. When they are not, the consequences are significant. For instance, when the signal is routed on three separate cables in and out of one piece of gear after another, one of the signal components may be delayed in relation to the others. In NTSC, what had been mere signal delay problems now become color shifts, with hue, saturation or both taking on new and unwanted values.

To avoid this, you must be able to detect and measure the time delay between the Y channel and the two color-difference channels, B-Y and R-Y. Most of these principles also apply to GBR systems.

One way to measure interchannel delays is to use an ordinary component test signal and extract timing information from it using a special display mode on the measurement instruments (typically waveform monitors). Another way is to design a special signal for measuring and detecting interchannel timing problems using ordinary display modes. One method is to use ordinary component color bars and an ordinary oscilloscope. If you expand the display horizontally and vertically and find the midpoint of the green-magenta transition in both the Y and B-Y (or R-Y) components, you can see whether they occur at the same point. This is rather awkward because the transitions are not the same amplitude.

### Bowties and lightning

To speed these measurements, some waveform monitors are now equipped

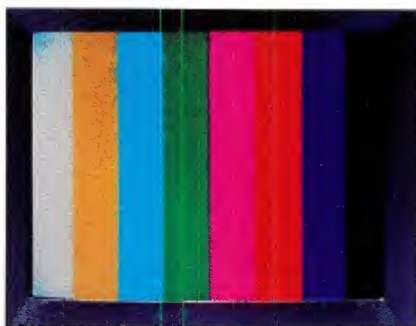

with a *Lightning* display. This display mode graphically portrays all of the color bar transitions so interchannel timing can be measured. This method does not require a special test signal (color bars are available everywhere), but it does need a special monitor.

Another system of measuring interchannel timing is with a special test signal known as the *Bowtie*. The Bowtie signal typically has a 500kHz sine wave packet on the Y channel and a 502kHz packet on the B-Y (and R-Y) channel. These sine waves are timed so that the center lobes are exactly in phase. Two sine waves of different frequencies cannot be continuously in phase. In the Bowtie, the sine waves are in phase at the center of the line and get progressively out of phase toward each end of the line. When you invert the B-Y component of the Bowtie and add it to the Y component, the center portions, which are now 180° out of phase, cancel. This cancellation is progressively less and less toward the left and right ends of the line, where the signals are not exactly in phase, and the resultant signal is a sine wave pinched in the middle, resembling a bow tie. (See Figure 1.)

If the timing between the two channels

is off, the null point moves right or left. A series of marker pulses in the last quarter of the field allows timing differences to be measured. For the frequencies mentioned, the markers typically signify 20ns delays. It is an easy matter to adjust the timing circuits of the equipment under test to get the null point to coincide with the center marker, which is larger than the rest. If the null point doesn't attain a complete null, this indicates an interchannel amplitude imbalance.

The Bowtie method has the advantage of working with any monitor capable of inverting one channel and adding the two signals in the display. Ordinary oscilloscopes can do this, as well as many new waveform monitors. It has the disadvantage that a signal generator with a Bowtie signal must be available.

Bowties also can be made at higher frequencies for even finer measurements of interchannel delay. A Bowtie made of 2,000kHz and 2,002kHz sine waves will display timing offsets at 5ns per marker.

**Editor's note:** The Lightning display and the Bowtie signal were developed and patented by Tektronix. The Bowtie has been released to the public domain.

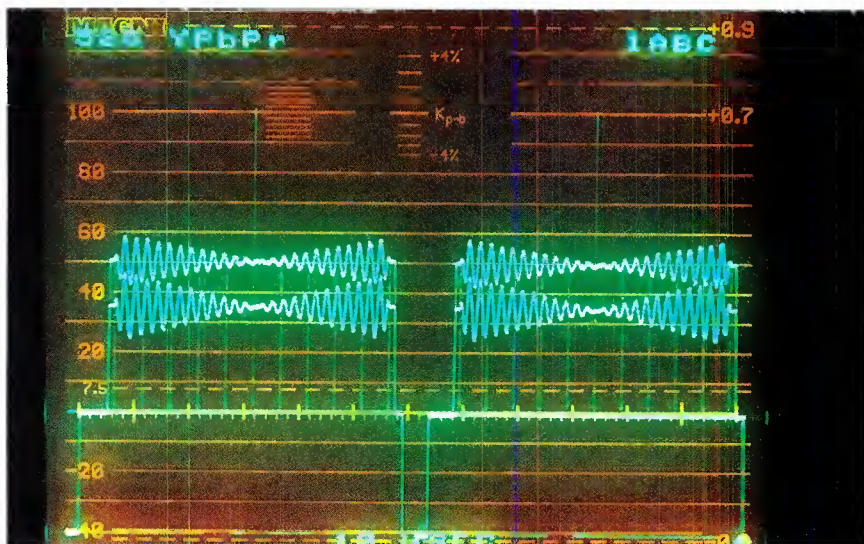
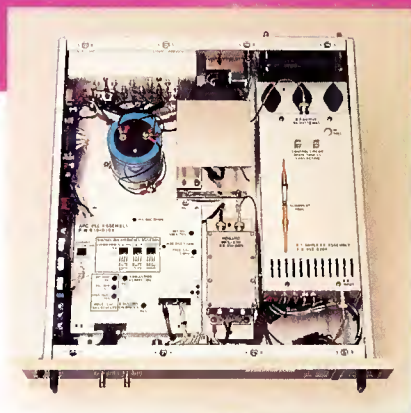

Figure 1. In this double Bowtie, the upper waveform has markers every 10ns; the lower waveform has markers every 20ns.

Talley is applications engineer for Magni Systems, Beaverton, OR.

# New FX 50 Exciter

Audio Performance That Rivals CD's



THD and IMD 0.003%, 93 dB S/N, 50 Watts

Broadcast Electronics introduces the ultimate FM Exciter - the new FX 50 - with performance even superior to the world standard FX 30.

#### **CD Sound**

The new FX 50 Exciter has the lowest distortion of any exciter available with THD and IMD of 0.003%.\*

#### **Move Up To CD Standards**

Every new "B" Series FM Transmitter incorporates the FX 50 for true CD transparency. And, the FX 50 is the ideal retrofit for your present exciter.

\*Typical

#### **CD Dynamic Range**

With a signal to noise ratio (S/N) of 93 dB\* the FX 50 can handle all of the nuances and power of compact discs.

#### **Set It And Forget It — 50 Watts**

Sophisticated automatic control systems assure stable reliable 50 watt MOSFET power output even under mismatch conditions.

For information on the FX 50 Exciter and on Broadcast Electronics' new "B" Series FM Transmitters which incorporate the new FX 50 Exciter, call Bill Harland or Russ Erickson at 217-224-9600.

**BE**®  
**BROADCAST  
ELECTRONICS INC.**

4100 N. 24th ST., P.O. BOX 3606, QUINCY, IL 62305, (217) 224-9600, TELEX: 250142, FAX: (217) 224-9607

Circle (7) on Reply Card  
[www.americanradiohistory.com](http://www.americanradiohistory.com)

## RF and the earth connection

By John Battison, P.E.

Last month, we discussed RF grounding at the transmitter site. Now let's consider how RF can affect a studio operation. The radiation from FM and TV stations does not cause as much of a hum and noise problem as do AM signals. FM and TV antennas generally are mounted some distance away from the studio and video and audio circuits. In addition, the radiation pattern from FM and TV antennas is modified by antenna design so less radiation comes from the ends (top and bottom) of the antenna than from the sides, or horizontally.

### Locate the source

If you experience noise on the audio lines, you first must identify its source. Detail identification methods are not necessary; listen to the audio, and trace video problems visually or aurally. The noise also may be caused by non-broadcast sources.

In a few cases, high-power radar in the immediate vicinity of broadcast stations has caused interference. From the station engineer's point of view, however, this interference occurs more in the listener's equipment than in studio equipment.

The fast rise-time pulses from radar transmitters can produce characteristic sounds that are identified easily. They often will appear every few seconds, as a pulsed beam swings around and illuminates the affected installations. This is a good indication of radar interference. Many hams will recall the "woodpecker" that was heard on the ham bands. Russians created that sound with over the horizon radar and propagation probes.

If noise and interference are coming from FM or TV transmissions, grounding and/or shielding is essential. The cure can be simple: Perhaps a termination was omitted, or an unshielded or ungrounded line may be the culprit. Despite every precaution, noise still can get into the system.

When the entry point for the interfering signal is found, it may be trapped with a series- or parallel-tuned trap. A piece of 300Ω twin lead with a sliding aluminum



foil short can be used as an effective, temporary and cheap trap. Ferrite beads also may help in cases where they can be applied without affecting operation.

### Noise from AM

RF interference from AM transmitters can be harder to eliminate than interference from FM and TV transmitters. The longer wavelengths have better penetrating power than many VHF and UHF signals. Today, many AM stations do not collocate the studios and transmitters. This is true especially with directional systems. For non-DA, co-located stations, however, eliminating the RF from studio equipment can be a challenge.

I've encountered stations in which hum and rectified RF appeared on most of the audio lines. The telephone systems usually were also affected. The new digital phone systems are more prone to RF interference than the old analog systems with carbon microphones. A capacitor across the microphones of the latter systems can cure much of the interference.

### Stick to the basics

Almost as many theories of grounding exist as there are broadcast engineers. Many engineers agree on the basic grounding principles, but everyone seems to differ on the best way to reduce hum and noise.

It is not always sufficient to rely on the building ground. The incoming power-line neutral wire is tied to the returns from all the third-pin outlet connections. This is the same point to which all the conduits and other electrical equipment are tied. This point should connect to a substantial ground such as a rod, or even a plate, and provide low resistance connection to the earth.

If the system load is unbalanced, however, a heavy current can flow in the neutral circuit. It also is possible for a high, or varying, resistance to develop at the "earthing point."

### Ohms law

Electricity has two important characteristics that can cause considerable grief if you aren't careful.

Two things occur when current flows in

a resistance. First is the development of localized heat immediately adjacent to the point of current flow and resistance; the second is a voltage drop across the resistance.

If the current is pure dc, the result may be impaired operation of the equipment being fed because of low voltage. Such a flow of dc alone through an "earthing" point probably would not produce any appreciable effect on the audio, provided that normal operation was not impaired because of low voltages. However, if enough heat is generated, it could cause a fire.

The changing resistance of the grounding point also could produce a sharp impulse noise, like "frying," if a high dc voltage was applied across the resistance path. This kind of noise, although not in "neutral," can occur in an automobile when the battery terminals are corroded. These sharp pulses can appear on remote pickup signals from such an automobile installation.

### ac-noise sources

Let's consider ac power flow in a ground point. Any corroded connection can act as a semiconductor, solid-state rectifier. If the ac is the regular 60Hz power supply, a spurious, wide-bandwidth RF signal can be generated with 60 cycle modulation. This signal easily can permeate a station's entire electrical system. Also, its modulating frequency need not be confined to 60Hz. The noise can include harmonically related frequencies and resulting beat signals, which means that a range of noise can come from one poor connection.

Such noise sources can be identified by successively removing loads from the line. Switch off individual branches of the system, or pull the power plugs on equipment.

Most engineers have encountered noisy pole transformers. Their signals can travel for miles along power lines and enter station equipment.

Eliminating external noise can be difficult. We'll continue our trek into this area next month when we examine ac effects, electrostatic shielding and magnetic shielding.

Battison, BE's consultant on antennas and radiation, owns John H. Battison and Associates, a consulting engineering company in Loudonville, near Columbus, OH.

# Dual Domain Audio Testing



## Analog and Digital

There are two worlds of audio... analog and digital. These two domains share many basic attributes but when it comes to audio testing, they're distinctly different. Until now custom hardware was needed to test digital audio devices in their own domain. Now the System One Dual Domain combines both analog and digital testing capability in one unit.

**ANALOG** audio testing with System One Dual Domain is even more comprehensive than before. Data acquired can be further analyzed using the Digital Signal Processor, which adds harmonic analysis, waveform display and FFT spectrum analysis to the already extensive list of System One's capabilities. New version system software supports color VGA graphics and on-screen cursor function with numeric readouts.

**DIGITAL** audio testing directly in the digital domain is available for the first time. System One Dual Domain provides signal generation, analysis and Input/Output capability and also mirrors familiar analog measurement techniques, now implemented digitally. The multiple-DSP architecture supports both AES/EBU serial and two-channel parallel inputs and outputs at a variety of sampling rates.

Integrated analog and digital domain audio testing... only from Audio Precision.

## System One

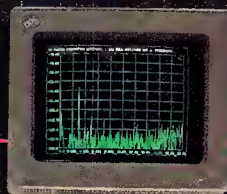

## Audio precision



P.O. Box 2209, Beaverton, OR 97075  
503/627-0832 1-800/231-7350  
FAX: 503/641-8906, TELEX: 283957 AUDIO UR  
Circle (8) on Reply Card

INTERNATIONAL DISTRIBUTORS Austria, Eastern Europe: ELSINCO elektron GmbH 222871751 Benelux: Trans European Music NV, Brussels (02) 4665010 Canada: Glentronix Ltd. (416) 4758494 China, Mainland: Harvest Scientific and Technology Company Ltd, Hong Kong 5-742983 Denmark: npr Elektronik ApS 86-57 15 11 Finland: into OY 0 755 7711 France: ETS Mesureur (1) 45 83 66 41 Germany, West: RTW GmbH 221709130 Hong Kong: TRP Consumer Electronics, Ltd 5-887 2008 Italy: Medea S.r.l. 24453828 Japan: TOYO Corporation 32790771 Korea: Myoung Corporation 784 9942 Mexico: VARI S.A. 250 7394 New Zealand: Audio & Video Wholesalers, Ltd. 7173414 Norway: Lydconsult (09) 19 03 81 Portugal: Acutron ELA 251 40 87 Singapore & Malaysia: TME Systems PTE Ltd 286 4608 Spain: Tely: [www.americanradiohistory.com](http://www.americanradiohistory.com)

## Charles Rhodes

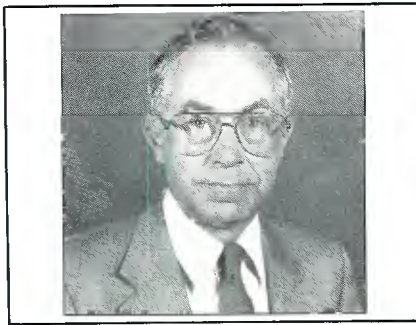

By Elmer Smalling III

Charles Rhodes developed an interest in electronics at an early age. As a young boy during World War II, he built crystal sets and, as a teen, he designed and built radios using war surplus equipment. During his last year of high school in Buffalo, NY, he watched WBEN-TV, the first TV station in western New York, being built, and realized that television was the natural extension of radio. He began to prepare for his future career in the industry.

### "Go West, young man..."

Rhodes took Horace Greeley's words to heart and moved to California, where he attended the University of California at Berkeley. During his college years, he designed and built a color receiver along with black and white units.

He graduated as an electrical engineer and joined the CBS receiver manufacturing division (the old Air King), where he served as a field engineer. CBS had hoped to use this company to build its sequential color receivers, but the RCA color system was adopted by the NTSC as the United States standard.

### Making choices

In 1956, Rhodes had to decide whether to join Ampex or Tektronix as a TV engineer. In order to fulfill his interest in all aspects of TV technology, he picked Tektronix in Beaverton, OR, because the company covered a broader spectrum of products. When Rhodes was hired, he was asked what he would like to do, and he expressed his interest in TV design.

Taking Rhodes at his word, Tektronix sent him to Los Angeles to learn the specific equipment needs of the networks. In 1954, only NBC was actively pursuing color. The only color-certifying devices available were synchronous detectors, which were phase-null boxes with many selector switches or crude vector display units made by Hazeltine and Crosby. These test devices were unstable. The most common service and measurement tool in television was the modified 7-inch RCA oscilloscope. Originally designed for black and white TV service personnel, it was too un-

### Profile

- Designed the Tektronix 526 vectorscope
- Designed the Tektronix 524 waveform monitor, which developed into the 527, 528 and 529.
- Designed the Tektronix 1450 TV demodulator
- Chief scientist of the Advanced Television Test Center (ATTC)
- Actively involved in developing tests for the ATV systems to be tested this fall
- Has 10 patents

stable for accurate color measurements.

### Fulfilling equipment needs

Rhodes immediately saw the use for new measurement and test equipment, so he returned to Beaverton and designed the model 526 vectorscope. The company already had established a reputation for its dc-coupled designs and small packaging. According to Rhodes, "I took the 526 prototype to Ampex where they were just putting the finishing touches on the VR1000-C color videotape recorder. Joe Roizen, one of the Ampex designers, let me hook up the 526 to the output of the 1000-C. The color vectors appeared as 120° arcs rather than dots." Rhodes asked tactfully for a color bar signal to check his vectorscope. After hooking up the color bar generator and attaching it to the vectorscope input, Rhodes said the vectors were "dots . . . just as they should have been."

Ampex realized that they had a stability problem, and they also realized the tremendous value of this new piece of equipment. They kept the prototype unit for a year. When the VR1000-C appeared at the next NAB show, it included Rhodes' Tektronix color demodulator circuit, which made its high-quality pictures the hit of the show.

### Setting standards

Rhodes continued designing equipment that would set world standards. The Tektronix 524 waveform monitor developed into the 527, 528 and 529. Using these new test tools, TV engineers could see all the parts of their signal and compare it to

FCC standards. Broadcasters began to put waveform monitors and vectorscopes in their control rooms, at their transmitter sites and in their editing suites. Video quality had become an important and competitive issue.

Rhodes then designed the model 140 test set. It provided color bars and color black signals while affording control of all the signal parameters via the front panel. "It was a great tool to teach NTSC video," he said. The Tektronix 1450 TV demodulator was another of Rhodes' projects. It provided more accurate information than the ubiquitous RCA diode demodulator and made accurate off-air signal measurements possible.

### Time to move on

In 1982, Tektronix turned its efforts toward computer peripherals and computer-oriented products and away from television. Rhodes then joined Scientific Atlanta as a corporate research scientist to work on the development of the B-MAC video encoding system. Imminent DBS satellite activity spurred the development of B-MAC as well as other encoding schemes.

The 1986 space shuttle disaster delayed the launch of many commercial satellites and set back the DBS business a number of years. In 1988, Rhodes got a call from ABC's Max Berry, asking him if he was interested in becoming the chief scientist of the network consortium — the Advanced Television Test Center (ATTC). Rhodes realized that his extensive background in TV test systems and his role in the development of color television made him an ideal candidate. He accepted the job and is actively involved in developing tests for the eight ATV systems that will be tested this fall.

With 10 patents to his credit, he is on the leading edge of TV technology and can reflect on his many contributions to the industry. When this uncommon engineer retires, he plans to write about his favorite subject — television.

Smalling, BE's consultant on cable/satellite systems, is president of Jenel Systems and Design, Dallas.



# Fortunately for us, most radio engineers look before they leap.

You've always been an analytical bunch, so we're sure you know that our MX-55NM 2-track not only gives you the features you need, but that it's also priced several thousand dollars below its nearest competitor.

We know you're not about to overlook *major* features, like HX-Pro™ bias optimization, or gapless seamless punch-in punch-out, or that famous Otari sound. However, here's some fine points to examine as you do your "apples-to-apples" with our competitors.

For example, the MX-55NM incorporates a printed-circuit capstan motor (like that used on our MX-80 multitrack machine).

This not only gives you low wow and flutter right out of the chute, but very fast start times.

It's also worth noting that EQ selection and Reference Fluxivity values can

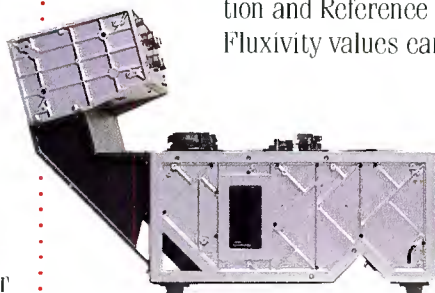

*A 15" cast alloy deckplate, plus cast side frames give the MX-55NM the rigidity and ruggedness you've come to expect from Otari. (Do our competitors show you the inside of their machines?)*

be changed with a flip of a switch. And as you put the deck



*Three cue locations and a zero memory can be accessed via the MX-55NM's built-in locator.*

through its paces, notice that the vari-speed control

provides 0.01% step resolution. This means you can make precise changes, and perhaps more importantly, you can repeat a change *exactly* when necessary.

For your convenience, an optional voice editing module maintains normal pitch at twice normal speed. And the meter-bridge keeps knobs and switches out of the way while you're editing.

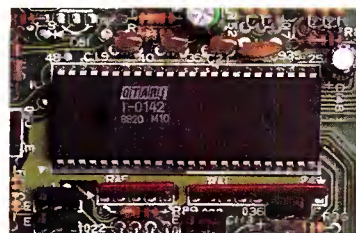

*Because we know how hard you use our machines, we use a double-sided glass epoxy transport circuit board, and we silkscreen both sides of our PCBs so you can locate the components easily.*

In the Otari tradition, we make the MX-55NM easy to service. Only four screws get you into the transport electronics. And when you get there, all servicing can take place with wiring intact. We also hinge all service panels, and use locking cable interconnects.

The specs? Why not call your nearest Otari dealer, or Otari at (415) 341-5900 and check them out. Like everything else, you'll find them "right on the money."



**OTARI**

Circle (9) on Reply Card

## Selecting Smith chart design components

By Gerry Kaufhold II

By using the Smith chart and graphical construction techniques, you can solve for the normalized values of reactance and susceptance in practical impedance-matching problems. In our example of the past few months, we are attempting to match an antenna to a transmission line using a low-pass filter. The line has characteristics  $R = 50\Omega$ ;  $XR = -j5.0\Omega$  (capacitive) at a center frequency of 50MHz. The antenna has characteristics  $R = 72\Omega$ ;  $XR = +j15.0\Omega$ . After being normalized for plotting on the Smith chart, these values become  $R = 1.0\Omega$ ;  $XR = -j0.1\Omega$  for the source; and  $R = 1.44\Omega$ ;  $XR = -j0.3\Omega$  for the load. By graphical constructions on the Smith chart and overlay, we obtained values needed to bridge the gap between these two points. The capacitive susceptance was  $+j0.62$  mhos and the inductive reactance was  $+j0.60\Omega$ . Now we need to

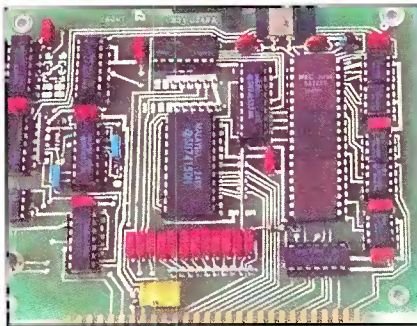

determine what values of components will give us a real-world embodiment of this design.

The value of capacitive susceptance must be changed back to a value of capacitive reactance. Do this by inverting the susceptance value to obtain the reactance:

$$(1 \div 0.62 \text{ mhos}) = 1.61\Omega.$$

All values now are reactances.

### Finding the component values

Next, denormalize capacitive and inductive reactance values, then convert them to component values required for the frequency of interest.

Recall that the original problem used the constant  $K = 50$  as the divisor for normalization. Multiply the normalized values by 50 to get true reactance values.

The capacitive reactance is  $(1.61 \times 50) = 80.5\Omega = XC$ .

The inductive reactance is  $(0.6 \times 50) = 30\Omega = XL$ .

The frequency of interest for this problem was 50MHz. Solve for actual component values by substituting into the standard equations for capacitive and inductive reactance:

$$C = 1 / (2\pi \times 50.000\text{MHz} \times XC) = 39\text{pF}.$$

$$L = XL / (2\pi \times 50.000\text{MHz}) = 0.095\mu\text{H} = 95\text{nH}.$$

These component values will provide the required impedance transformation between the output of the transmission line and the input to the antenna at 50MHz.

### Changing the frequency

The Smith chart provides solutions that are independent of frequency. After the matching network is defined from the Smith chart, therefore, it is easy to manipulate the results at different frequencies of interest.

Suppose the example of an impedance-matching network was used to connect a low-power TV transmitter to an antenna. We would solve the previous equations for C and L at the upper frequency of opera-

tion to test how our matching network performed across the full spectrum of the TV signal. For example, at the uppermost frequency of 56.000MHz,  $C = 35\text{pF}$  and  $L = 85\text{nH}$ .

Standard component values near 38pF for the capacitor and 90nH for the inductor would be suitable for providing an impedance match. Because most of a TV signal's energy is contained in the lower portion of its spectra, we would bias our choice of components toward the values obtained at 50MHz. Allowances for component values changing, because of self-heating, also would have to be considered before the design was finalized and a purchase decision was made.

### VSWR

We could create a circle for constant SWR by referring to the previous articles in this series.

First, plot the normalized complex conjugate of the source impedance on a Smith chart sheet. Construct the constant SWR circle with a compass using prime zero as the center of rotation. Measure down from the left-most tangent of this circle to the SWR scale to discover the standing wave ratio of the given network. You should get about 1.1:1.

Kaufhold is a market development engineer for SGS-Thomson Microelectronics, Phoenix.

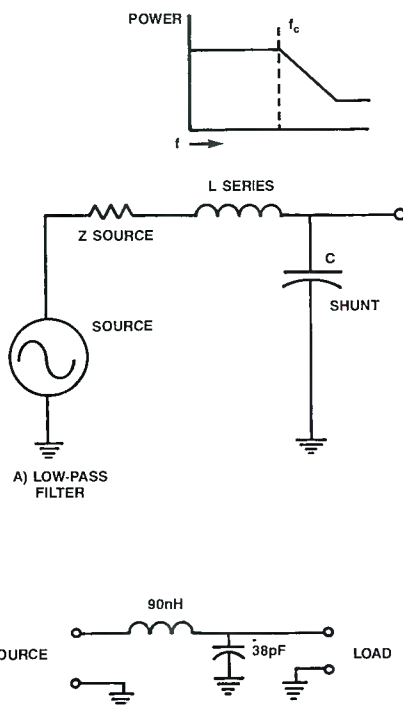

Figure 1. Equivalent circuit and real-world implementations of the Smith chart's solutions.

HE SAID,



*“You can write almost anything you want about this machine and put my name under it.”* SO WE DID.



THE DIGITAL SOUND EDITOR. STATIONS FROM BOSTON TO SAN DIEGO ARE MAKING IT THE HOTTEST BOX IN RADIO.

Dan McCoy was the first production director in radio to use the DSE 7000, and he saw it revolutionize the way production is done at

WZOU-FM,  one of the top stations in Boston. A spot that used to take an hour to produce now takes 20 minutes. Without tape.

Without razors. Without a single dB of generation loss. Even agency dubs now go right to the

DSE for levels, sound enhancement



and tags; then onto carts. Creativity has exploded, too. With the DSE's instant UNDO feature, the fear of trying new things is gone. You simply try another take, assemble a different edit, or test a new effect. If you don't like the results, UNDO it instantly. No wonder WZOU has

designed their production facility around the DSE.  And no wonder Dan McCoy calls this machine “the most impressive thing that's ever happened to radio.” His words, not ours.



1525 ALVARADO STREET, SAN LEANDRO, CALIFORNIA 94577, USA. (415) 351-3500. FAX: (415) 351-0500



DSE 7000 ♦ THE NEW SPEED OF SOUND



## Reviewing video basics

By Mark Everett

Last month we defined some basic terms. Now let's examine timing and phase relationships. The frequency and phase of many signals is the base of a functioning video system. If the frequency, or more likely the phase, is incorrect, you've set yourself up for a lot of trouble.

### System timing

TV production systems require vertical, horizontal, color-phase and color-subcarrier-to-horizontal-phase synchronization. What do these terms mean and how do they relate to a typical broadcast or editing system?

Imagine a TV picture that is split by a vertical line halfway through a horizontal wipe. Assume that the switcher is operating properly and that the two different pictures associated with the split screen are well-adjusted color camera feeds.

If the two cameras are not synchronous, the left side of the split will be clear and stable. The right side might be rolling vertically, tearing horizontally and even changing colors. Any or all of these undesirable things can happen. Each of these problems points to a different portion of synchronizing problems. The vertical rolling shows the lack of vertical synchronizing; the horizontal tearing shows the lack of horizontal synchronizing; and the color changing indicates the lack of color or burst synchronization.

Imagine that the right half of the picture is not moving, but the picture is out of position or simply the wrong color. The indications are that the two cameras are locked to the same synchronizing source but not phased together. *Phasing or timing* is the adjustment of electronics or cable length to assure that the two signals get to the switcher at the same time relative to vertical sync, horizontal sync and burst.

Misadjusted vertical phase will cause the right half of the picture to be vertically offset or moved up or down relative to the left half. Incorrect horizontal phase will cause the right half of the picture to be offset to the left or right relative to the left half. Incorrect burst or color phase will

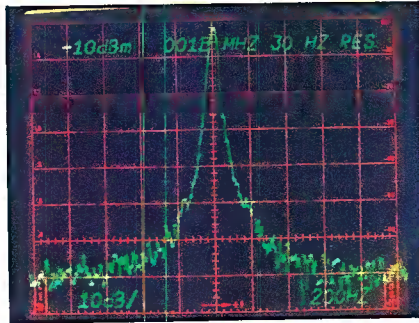

cause the left half to appear as the wrong color.

### Fix the problem

Now that you know what's wrong, how can you troubleshoot the system? The traditional way to time a system was to use one sync generator, a lot of distribution amplifiers, a whole lot of cable and more time than you could believe. The system was timed by calculating what source would be the last to arrive and then making all other sources arrive just as late.

The process was close, but not perfect. Completing the timing process was a tedious process of comparing source signals against the reference sync.

The waveform monitor and vectorscope are used to measure the timing differences. The horizontal sync pulses of both the reference generator and the source being tested are compared on the monitor and the timing difference measured. The color phase difference is measured by viewing those same two signals on two channels of a vectorscope and measuring the phase difference of the burst reference of the two signals.

With this information, it's possible to recalculate the needed line length. The coax can be lengthened or shortened and then remeasured. This method requires a tremendous amount of time. In a large facility, it requires days, not hours. This is not an effective way to time even a small system.

### Master synchronizing generator

Timing sources properly is only part of the battle; the tough part is knowing how to do it. Examine your system and decide what pulses you might need. Don't be too hasty to eliminate the horizontal and vertical syncs. They often are used by computer video devices.

Sync and subcarrier frequently are required by time base correctors, some production switchers and probably half of the digital effects products on the market. Blanking is less popular, but often is used in proc-amps and encoders. Blackburst probably is the most common sync signal used today, and it's not even a sync pulse signal. It is a composite video signal made

by the sync generator. It is developed from composite sync, composite blanking and a sample of subcarrier.

One option is *gen-lock*, which is the ability to lock the pulse output of one generator to another. If your system never interfaces with outside devices, you could get away without using some form of gen-lock. However, if your system ever has to lock to another source, you need gen-lock. Gen-lock seldom is the only choice, but it often can be the most efficient choice.

An SC/H gen-lock performs the internal timing to assure that all the output pulses are in phase with and timed from the same clock. Any timing drift will affect all pulses equally. The key is for the generators to gen-lock so that they will not destroy the phase relationships. The subcarrier phase adjustment of an SC/H-phased sync generator has to move the horizontal phase along with the subcarrier. The horizontal phase adjustment then moves the subcarrier in 360° steps. Think of them as course and fine adjustments.

The beginning reference point is on line 10 of color field 1. The subcarrier phase is observed at the leading edge of horizontal sync. At this point, it should be at a zero crossing and going positive.

### Hidden trap

If you assume that a system set up as described will operate properly, you may encounter a trap. Simply having a master sync generator that is SC/H-phased does not guarantee that the whole system is SC/H-phased. All distributed sync and subcarrier signals must have identical path lengths from the sync generator to the driven device. A path length difference will shift the relative phase of sync-to-subcarrier.

All devices driven by blackburst or any other composite signal must be SC/H-phased devices, or the input cannot be guaranteed over time. It is possible to set correctly the SC/H phase of a non-SC/H-phased device, but it most likely will drift and require constant monitoring and readjustment.

Everett is manager, corporate communications for Videotek, Pottstown, PA.

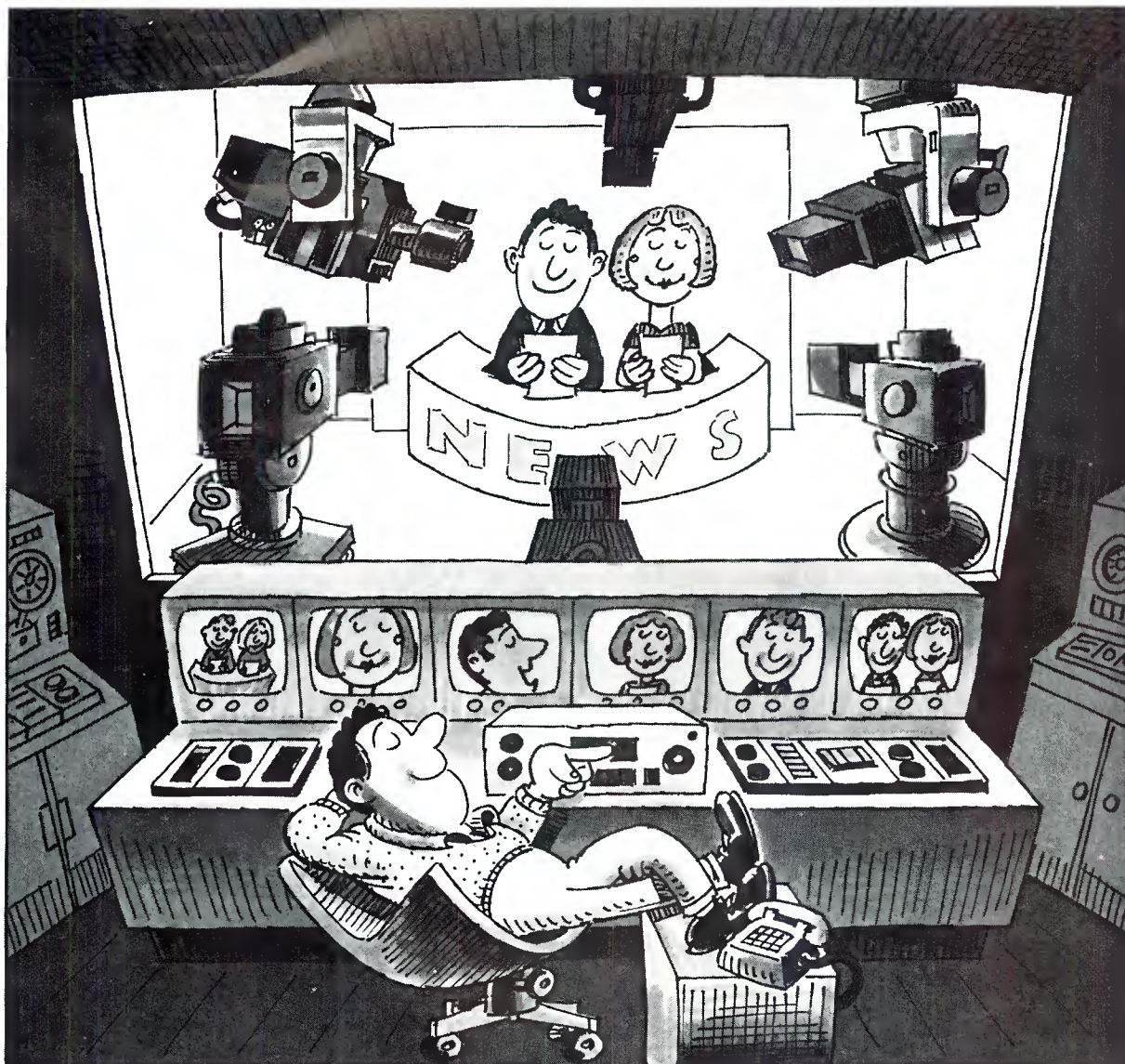

# MULTIPLE CAMERAS. ONE OPERATOR.

Impossible? Not if your news studio is equipped with the RADAMEC EPO ROBOTIC CAMERA CONTROL SYSTEM. —the system that is changing the way television stations, networks and cable systems are presenting their news.

- Up to 500 preprogrammed positions per camera, including control of pan, tilt, height, zoom, focus and iris and black levels
- Programmable fade modes that provide smooth transition from pre-programmed shots
- Ability to operate via telephone lines or microwave
- Pan and tilts heads for a wide range of cameras—from full studio to ENG types

It's flexible, affordable—and it is sold and serviced in the U.S. by A. F. Associates.

## NEW! THE AFA ROBOPED

Designed expressly for the Radamec EPO Camera Control System.

This laser positioned, free-roaming robotic pedestal glides smoothly and silently at up to 1.5 ft.-per-second anywhere in a studio without relying on a pre-determined path —without floor tapes, without target tiles. It's got a built-in intelligent collision-avoidance system that works faultlessly, and an incredibly simple manual override for special production needs.

## THE RADAMEC EPO CAMERA CONTROL SYSTEMS



### A.F. ASSOCIATES, INC.

ADVANCED SYSTEMS AND PRODUCTS FOR THE VIDEO INDUSTRY  
100 Stonehurst Court, Northvale, NJ 07647 (201) 767-1200;  
Western Region (619) 227-0291; Southern Region (404) 242-1661  
A Video Services Corporation Company.

# 1. Management for engineers

## Finances and today's engineer

By Brad Dick, editor

*If you always do what you've always done, you'll always get what you've always got.*

The process of budgeting is the financial solution to this dilemma. Budgeting forces you to break with tradition and plan ahead. We considered reasons to use budgets previously; now let's see how a budget is constructed.

The three phases of budgeting include *planning, preparation* and *control*. Each phase requires that specific steps be completed sequentially to build the total budget picture.

### The planning phase

The planning stage has five steps, which include the following:

1. *Set organizational goals and objectives that are consistent with the company mission.* They must be stated in such a way to direct activities toward meeting the company's mission.

An effective budget cannot be developed if the organization doesn't know what it wants to be and where it wants to go. For instance, "increasing the station's market share by 20% in the 18- to 34-year-old female demographic category within the next 12 months" is an effective goal statement. "Being Number 1" is not an effective goal statement. Before you can develop an engineering budget, you must understand the station's mission, goals and objectives.

2. *Develop a plan to accomplish the goals and objectives.* After you know where you want to go, you can develop a plan to get there. If you decide to purchase a transmitting antenna, you don't first select an antenna pattern and then hope it covers the needed areas. You see where the people are and then select an antenna with the pattern needed to reach them.

3. *Form a budget committee to direct the process.* This step often is not taken, especially in smaller stations. Even some large stations rely on key people to "come up with some figures." Involve your staff or the key department directors in the planning process. An effective committee is one whose members are in responsible positions and who understand the station's goals and mission.

4. *Establish a budget calendar.* The calendar sets time lines in the preparation and



control of the budget. The committee must be involved in setting the calendar. Each station will have unique conditions to consider. A deadline for the completion of the budget process can be determined in advance; however, it is best to allow those who must implement and follow the budget to have a say in the entire process.

5. *Assign accountability by a responsibility center.* This is a crucial area and one over which you may struggle. The accountability must be assigned by a responsibility center. This usually is by department and must be consistent with the chart of accounts. The engineering department must be in control of and responsible for engineering funds. If you don't have that authority, it's time to discuss the problem with your supervisor.

### Preparation phase

Now that the planning phase of the budget process is complete, the budget can be prepared. (See Figure 1.) After the company mission is known, the goals and objectives are made. Then, using revenue and expense subbudgets, the operating budget is developed.

The capital budget represents tangible items that have a useful life of more than one year. The items in this budget repre-

sent hardware and furnishings that are required to implement the goals and objectives stated in the planning phase.

The cash budget helps identify the cash balances that probably will exist in future periods. This budget traces the flow of funds through the station ahead of time, identifying likely revenue sources and likely expenditures. This is a crucial budget because it allows a station to plan rather than react to emerging situations.

The combination of all three budgets is the *balance sheet budget*. In financial terms, it can be represented by this equation:  $\text{assets} = \text{liabilities} + \text{equity}$ .

Assets represent cash on hand, accounts receivable, inventories, investments and the station's physical plant (land, buildings and equipment). Liabilities usually include accounts payable, mortgages and any outstanding bonds. Equity accounts include preferred and common stock and retained earnings.

### Control phase

The last, but ongoing budgeting phase, is the control phase, which involves four steps:

1. *Develop a solid responsibility-reporting system.* This relates to step 5 in the planning phase. Determine who will report on what areas of the budget. Record these facts for future reference.

2. *Analyze variances from the budget.* When the expenditures or revenue are reported to you, review them in light of the budgeted amounts. Ask yourself, "Are the expenses within budget, or do changes need to be made?"

3. *Investigate causes of variances.* If costs are higher or lower than expected, find out why. Don't wait until the end of the year to determine why predicted expenses or revenue don't meet your plans.

4. *Take corrective action.* It may simply be necessary to reallocate funds between your department's accounts. Serious overages should be reported and discussed with your supervisor or financial manager.

Developing a budget requires work. After the budgeting process is completed, however, you'll have a financial road map for success.

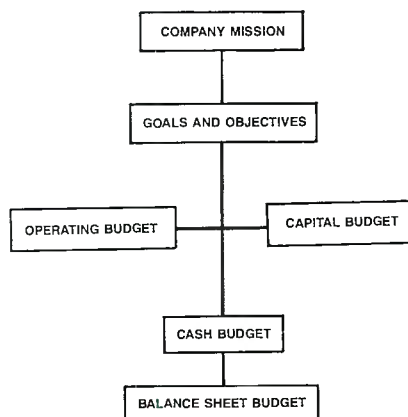

**Figure 1.** The budget is prepared by starting at the top and working down. Engineering usually is only concerned about one of the operating subbudgets and a portion of the capital budget.

MODEL 2000 SCT



## AUDIO CONSOLE PRODUCTS

Arrakis audio console products are designed by broadcast engineers for broadcasters at reasonable prices. Our products sell themselves. Study our features, specs., and prices. Compare and you will find what thousands have found — The Arrakis Advantage —

### TURBO FEATURES

- VCA Faders
- P & G Sliders
- .01% Distortion
- Solid Oak Trim
- 10 W/CH Monitor
- Remote Start
- Mix-Minus
- Modular Design
- Ultra-Reliable
- Mono Mixdowns
- Stereo Cue
- Full Muting
- Dimensions —
- 30" W x 17" D x 7" H
- Weight — 55 Lbs.

### MODELS

- 6 Channel Rotary (18 Inputs)
  - 150 SCT-6M \$2395
  - 150 SCT-6S \$2495
- 8 Channel Rotary (22 Inputs)
  - 500 SCT-8M \$3495
  - 500 SCT-8S \$3595
- 8 Channel Linear (22 Inputs)
  - 1500 SCT-8M \$4395
  - 1500 SCT-8S \$4495
- 12 Channel Linear (24 Inputs)
  - 2000 SCT-12M \$4895
  - 2000 SCT-12S \$4995
- 12 Channel Linear (34 Inputs)
  - 2100 SCT-12M \$5895
  - 2100 SCT-12S \$5995

**arrakis**  
SYSTEMS, INC.



2619 Midpoint Drive  
Fort Collins, Colorado  
80525

(303) 224-2248

Circle (13) on Reply Card

# Audio technology update

**Digital processing has changed the way we hear audio.**

I was in a consumer electronics store recently where the salesman was touting the quality of an integrated audio system with tape, CD and a receiver. "Once you get used to this kind of quality, you'll never go back to radio," he said. He was talking about a home unit, but the statement struck me as important.

Radio was king, before the early 1980s. Stations could get away with almost any on-air sound. The consumers weren't smart enough to know the difference between good and bad audio. Digital processing has changed that.

The CD player was introduced in 1983, and only 35,000 units were sold because they were expensive and few discs were available. In two years, more than one million CD players were purchased. Last year, almost 7 million CD players were sold. Today, the CD player has become the standard by which all audio is measured.

This means that a sizable, and growing, portion of your audience compares your station's audio to the sound of a CD every time they tune in. How will your station compare when this happens? Will it be obvious which source is live and which is recorded?

The CD isn't the only alternative medium by which your sound is compared. You have to contend with hi-fi stereo VCRs and DAT recorders. Don't forget that there are 2,200 more stations on the air than 10 years ago, and each of them is after your audience.

If your station's sound doesn't compare favorably with that from other sources (including the competition), you may lose audience shares, and that means lost revenue. Are you concerned yet?

It's the technical manager's job to

ensure that everything between the audio source and the listener's receiver is as clean as possible. To help you with that task, this month's issue is devoted to the audio portion of that link.

For a better understanding of how the digital process works, read "Performance Aspects of Digital Oversampling." Nothing is free, particularly with regard to digital oversampling. This article examines the tradeoffs and what they mean to you.

The backbone of any audio system is the interconnection system. Even the best CD player can sound like junk if it's not interfaced properly with the rest of the station. Don't make a mistake; read "Audio Interconnection" and learn how to connect your system together properly the first time.

Finally, satellite-delivered audio (and video) is a given for most stations. Although we often take these systems for granted, preventive maintenance can make a big difference in performance. Learn how to evaluate and improve the performance of your satellite system in "User's Guide to TVRO Performance."

Remember, you're the key to a quality-sounding station. Take advantage of the available technology to provide your audience the best in audio. You and your station will benefit.

- "Performance Aspects of Digital Oversampling" . . . page 26
- "Audio Interconnection" . . . . . 48
- "User's Guide to TVRO Performance" . . . . . 66



**Brad Dick,**  
editor





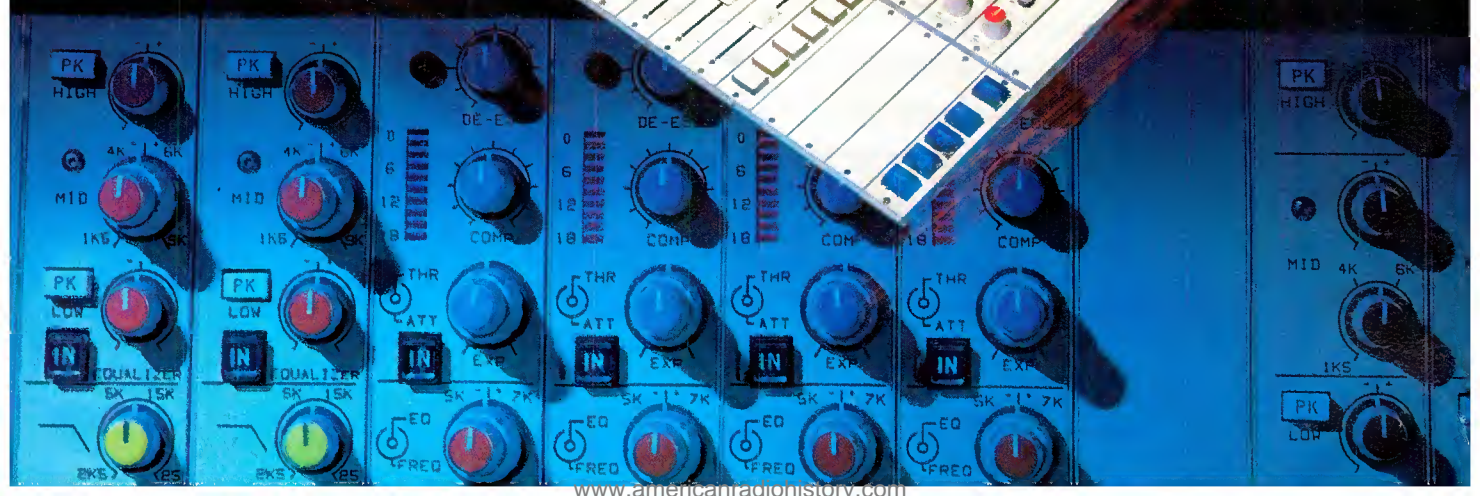
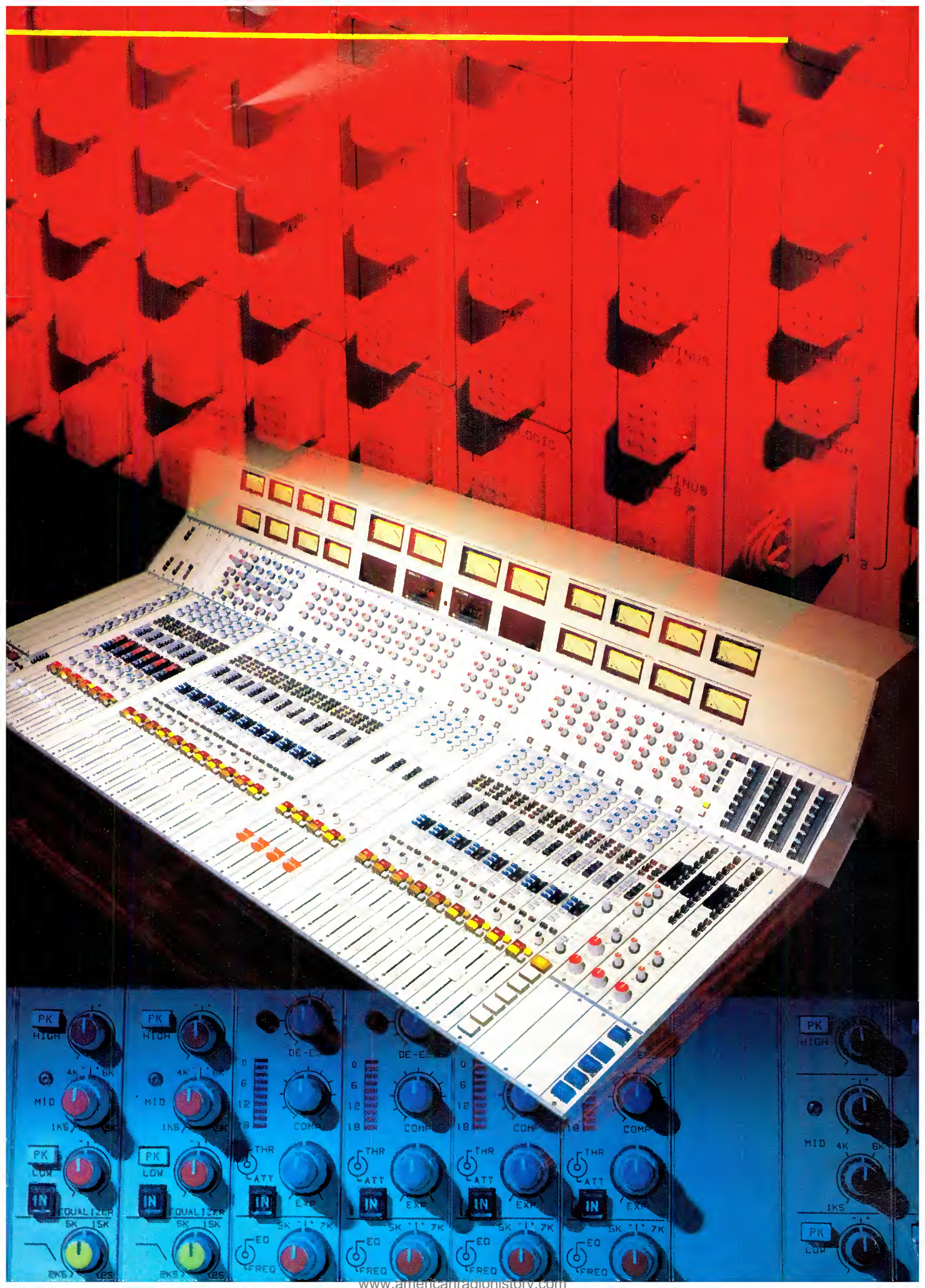

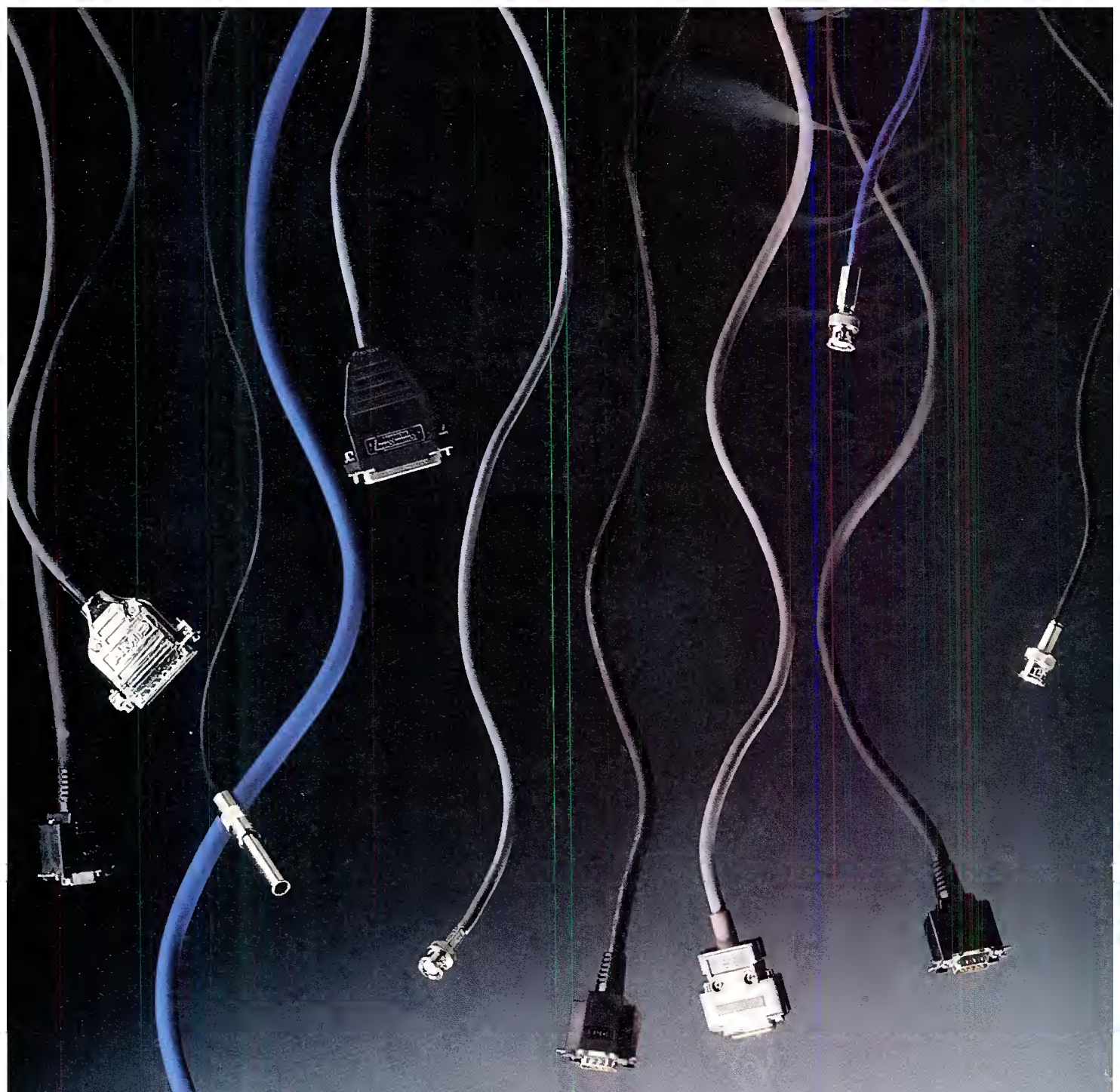

# Once you try our new edit yourself getting more

It's Sony's adaptable, expandable BVE-9000. And it offers you more choices than ever before available in an edit control system.

The BVE-9000 is designed to work with just about anything. It's compati-

ble with a vast range of hardware, which includes D-1, D-2, Betacam SP®, Type C 1-inch, and U-Matic SP® VTRs. And, of course, it can be hooked up to the entire line of



Sony switchers, digital effects devices, audio mixers, and audio tape recorders.

It's a system that adapts to you. The BVE-9000's fast, facile operation allows you the

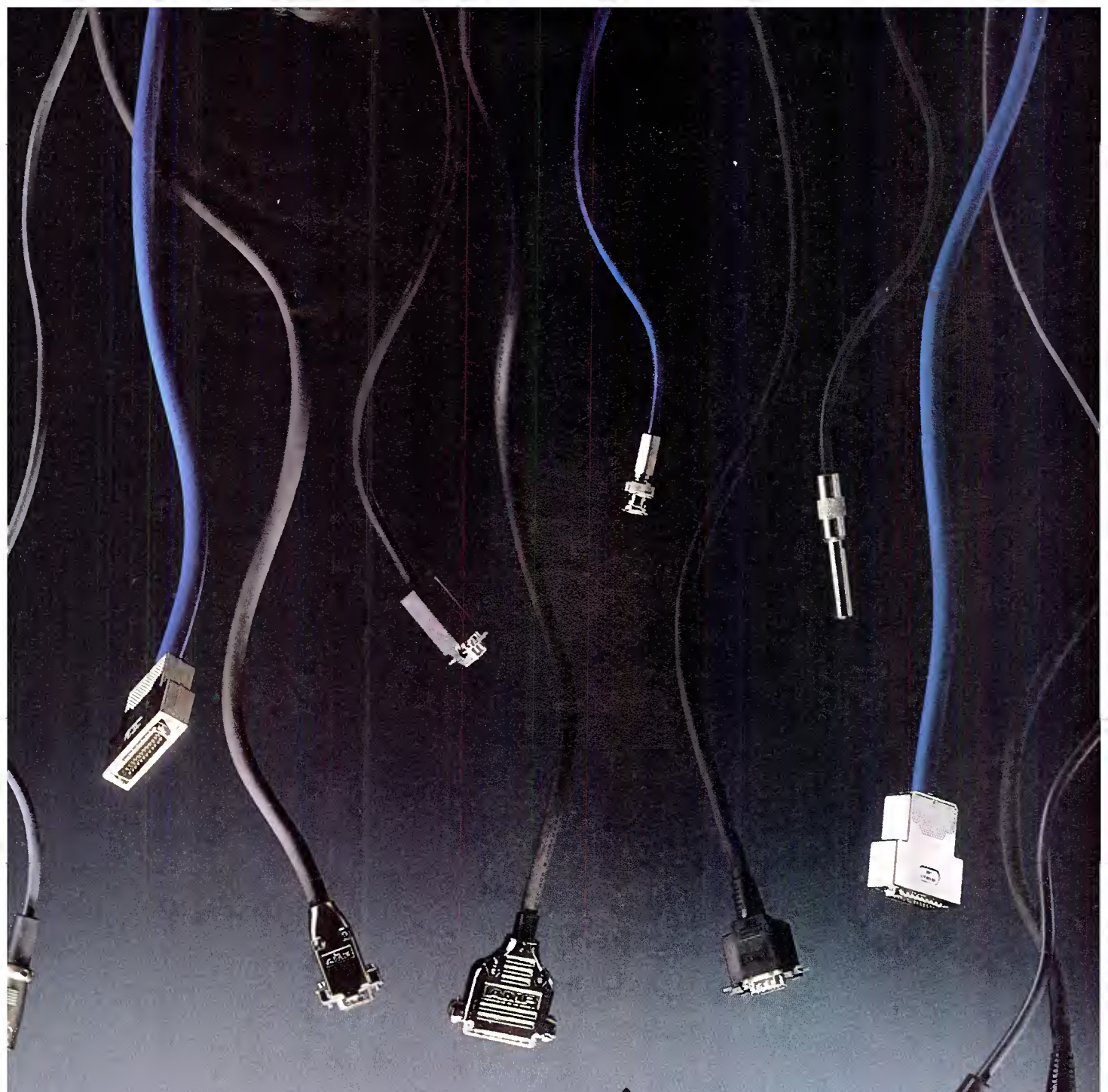

# control system, you'll find attached to it every day.

flexibility to customize both your screen and keyboard. You can also create powerful keystroke macros.

This is a system that will even adapt to your future. It can control anywhere from three to 28 VTRs,

and can be easily reconfigured to accommodate your changing needs.

And since it's designed to accept future product introductions, it's a system that will truly grow with you. To hook up with your own

BVE-9000 edit control system, call 1-800-635-SONY.

## SONY®

BROADCAST PRODUCTS

# Performance aspects of digital oversampling

By Richard Cabot

Nothing is free, particularly with regard to digital oversampling. D/A and A/D conversion can affect other performance aspects of digital audio devices.

As was the case with early applications of transistor technology to audio, many people did not understand the detailed tradeoffs inherent in digital-to-analog (D/A) and analog-to-digital (A/D) conversion technology. The drive for impressive numbers on the current buzzword specifications has resulted in serious degradations of other important specifications. As a result, commercially available digital devices differ significantly in audible and measurable performance.

## Signal conversion

A classic digital audio device is diagrammed in Figure 1. Circuitry at the input converts the audio signal to digital data. At the output, the data is converted back into an audio signal. The sample and hold section captures samples of the audio signal for conversion by the A/D. These samples are taken at least twice per cycle of the highest audio frequency in the signal. For example, to handle a 20kHz bandwidth, most professional audio equipment samples the audio 48,000 times per second (the sampling rate). Theoretically, a 48kHz sampling rate allows signals up to 24kHz to pass, but because of practical circuit complexity limitations, the highest frequency that can pass is typically about 22kHz.

The Nyquist frequency, named after the mathematician who derived the theory, represents a low-pass cutoff point equal to one-half the sampling rate. Input signals

above the Nyquist frequency cannot be converted properly and will create new signals in the audio band that were not present in the original signal. For example (assuming a 48kHz sample rate, therefore, a 24kHz Nyquist frequency), a 27kHz analog signal will appear in the digital output as 21kHz, and a 28kHz signal results in a 20kHz output.

These are alias components and are prevented by low-pass filtering at the input signal slightly below the Nyquist frequency. This low-pass filter must have flat response over the audio-frequency range of interest and must attenuate the frequencies above the Nyquist point by enough to put them into the noise floor. Some designers simplify these filters by not fully attenuating alias frequencies that ap-

pear in the digital signal above the range of hearing (usually 20kHz).

## Quantization error

The samples are converted to binary digital codes by the A/D converter. Although the original signal is continually changing, the output of the sample and hold is constant between samples. This allows the converter enough time to look at the analog voltage and come up with the digital code that represents it.

The process of converting an analog signal with an infinite number of possible voltages into a finite range of numbers (quantization) introduces an error signal that is dependent on the signal being sampled. This quantization error will be on the order of one least-significant bit (LSB) in

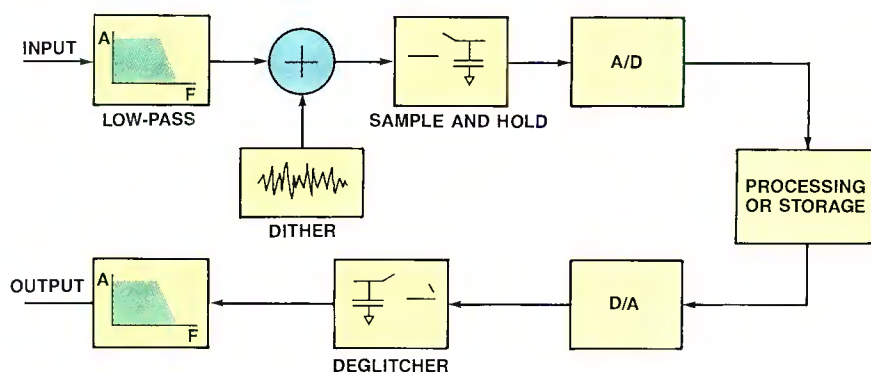

Figure 1. A basic digital audio system.

Cabot is principal engineer at Audio Precision, Beaverton, OR.

## "The beacons were blown out of their sockets, but our transmitter barely blinked."

**R**obert LaFore knows all about lightning. As Chief Engineer for WQPW-FM "Power 96" in Valdosta, Georgia, he'd better: His 600 foot tower



*Direct strike!*

WQPW'S 600 FT. TOWER TAKES THEM WHENEVER THERE'S LIGHTNING.

is the tallest object for miles around. "We've been hit so hard the tower beacons were blown out of their sockets," he told us recently, "and so often that the lightning rod looks like someone's been beating chunks out of it with a sledgehammer. But so far our new Harris HT 20FM transmitter barely blinks at lightning. Occasionally we get a PA Plate Overload message, but that's it."

Robert also knows something about Harris reliability: Until they received a power increase to 50,000 Watts last year, WQPW had been on the air with a 3.5 kW Harris transmitter for thirteen years. "That transmitter was very good to us," Robert reports.

"Still is, in fact—it's our back-up now. Basically, we shopped around enough to be sure Harris could match or top the competition in both price and features: Things like Automatic Power Control for simple remote operation. Then we ordered a 20 kW HT 20FM transmitter."

About 45 days later WQPW's transmitter arrived (meanwhile, Robert supervised construction of a new transmitter building, tower and antenna). "We just took it out of the box and put it right on the air," he says. "Even the tuning movements were small. The installation went so smoothly, I told the factory 'You've got to do something—this transmitter's boring.'"

After a number of months of service, WQPW's HT 20FM remains just as "boring." Robert has only shut it down for routine monthly maintenance. "Even that is minimal," he told us. "I vacuum the cabinet out, check tube cooling, make sure nothing's overheating, and that's about it. Two or three times a week I do a meter check and log the readings. They hardly ever

*Chief Engineer Robert LaFore*

WITH HIS NEW HARRIS HT 20FM 20 KW FM TRANSMITTER.

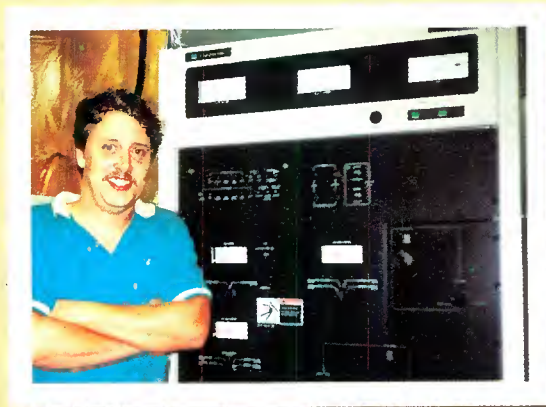

change. In fact, we're still using almost the same tuning numbers we got from the factory. And we're getting a very noticeable improvement in audio quality from our new Harris THE-1 exciter."

As you can tell, WQPW is very proud of their new transmitter. We're just as proud that



*Look south*  
FROM WQPW'S TOWER, AND YOU CAN SEE ALL THE WAY TO FLORIDA

our HT 20FM is living up to their confidence in Harris engineering. But then, we expected it do exactly that from the moment it took shape on the drawing board.

For more information on HT family FM transmitters from 1 to 35 kW, call toll-free (800) 4-HARRIS, Ext. 3022. Outside the continental US, fax us at (217) 224-2764. And for the widest selection of studio products, call Allied Broadcast Equipment toll-free at (800) 622-0022.



HARRIS BROADCAST DIVISION  
MARKETING DEPARTMENT  
P.O. BOX 4290 • QUINCY, IL USA 62035-4290

Circle (12) on Reply Card

amplitude, quite small compared to full-amplitude signals.

Full-amplitude distortion measurements, therefore, look respectable — possibly even impressive. However, when the sig-

nal gets smaller, the error becomes a larger percentage of the total signal. As the signal makes small changes in amplitude or frequency, this error will change radically. When the signal is removed, the er-

ror also will vanish, leaving a silent background.

This constantly changing error signal is a harsh, gritty noise that “breathes” during low-level passages in the program material. It is responsible for the early criticism of digital audio and for some of the continuing problems with specific models today.

### Dithering

To make the quantization error unrelated to the input signal, a noise-like, low-amplitude random signal is mixed with the input signal before conversion or sampling. This random signal is called *dither*, and the process of mixing it with the signal to be converted is called *dithering*. It is effective at changing what would be obnoxious distortion into benign background noise.

The op-amps and the anti-alias filter in many early digital systems created enough noise to provide an adequate dithering effect without its specific addition. Because of this, some designers have not understood the need for correct signal dithering and have produced undithered conversion hardware with low-noise front-ends. The result is a “non-musical” piece of equipment.

### D/A conversion

To re-create the analog signal from the digital data, the samples are fed to a D/A converter. This creates a staircase-looking waveform that changes value at each new sample. Because the converter often will create incorrect values (glitches) as it is changing from one sample to the next, the signal is processed by a deglitcher. This disconnects the D/A from the output while it settles to the new value. Deglitchers work similar to the sample-and-hold circuit at the input.

A low-pass filter is used to eliminate the staircase appearance and the harmonics that go with it. It rounds the sharp edges from the waveform and smoothly creates values between the samples. This is called a *reconstruction filter* because it reconstructs the analog waveform from the sample values.

### Analog filter tradeoffs

The anti-aliasing and reconstruction filters are similar in design requirements and performance. These performance limitations appear in all areas: frequency response, time domain response, distortion, noise and dynamic range. Completely filtering all alias products requires a complex filter that has more filtering stages. Each stage adds noise, distortion, phase shift and cost. Using more stages necessitates tighter control of component tolerances to keep the frequency response flat in the audio band.

Conventional analog filters introduce a

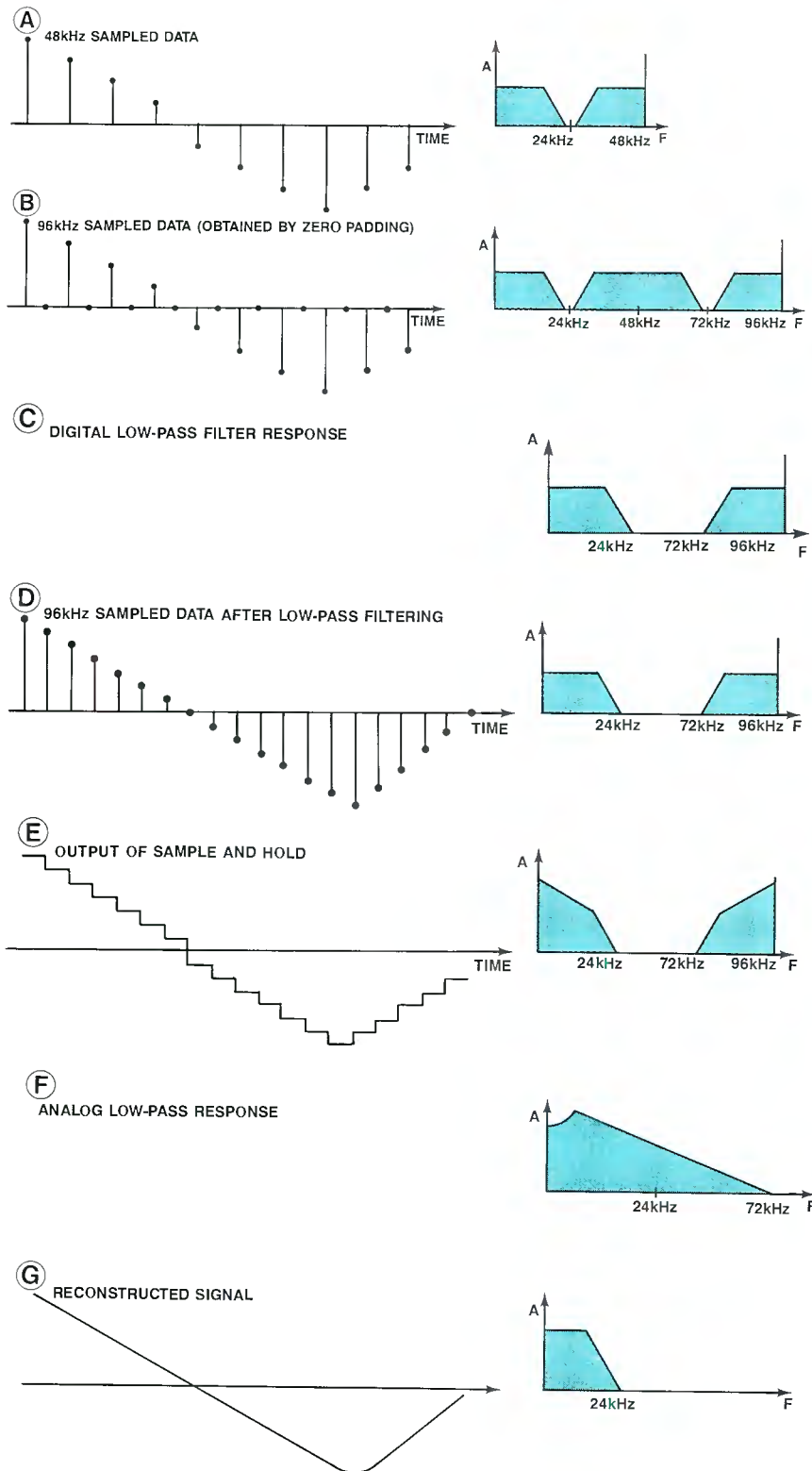

Figure 2. Illustration of 2X oversampling D/A operation.

# WHY YOU SHOULD PAY MORE FOR LESS.

**New Name-  
Same Great Cart!**  
The ITC Cart II Cartridge, formerly ScotchCart® II

*Less phase jitter caused by poorly tracking tape, because the naturally lubricated concave guides gently position the tape and allow the cartridge machine to perform critical guidance.*

*Less tape noise and signal loss with our 100% laser-inspected, high output, low noise tape which delivers better frequency response and keeps signal-to-noise ratio high, harmonic distortion low.*

*Less wow and flutter or stop cue overshoot, because there's no rotating hub to wear out, warp or rattle.*

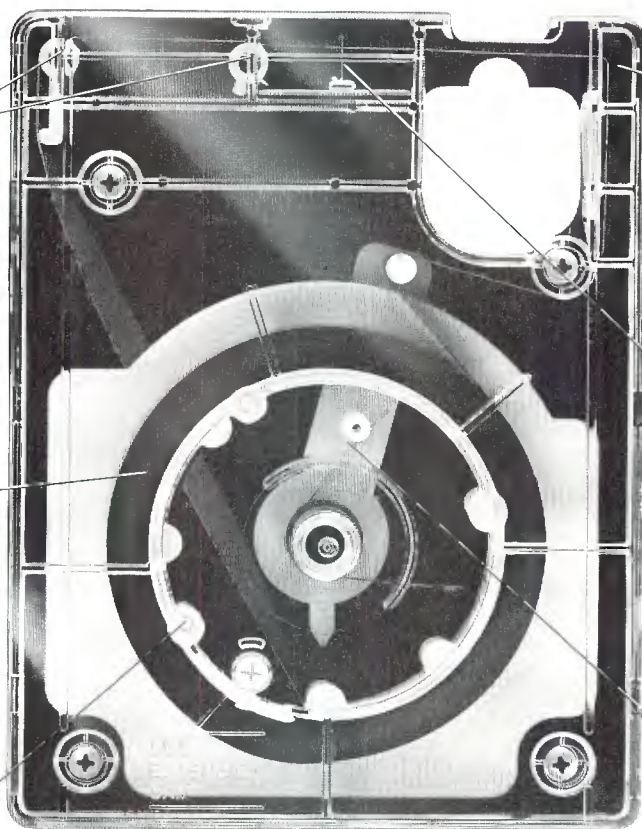

The ITC Cart II Cartridge, formerly ScotchCart® II

*Less chance of the cartridge cracking or breaking, because the tough polycarbonate cover withstands repeated use and abuse.*

*Less head wear, tape steering and modulation noise, because there aren't any pressure pads to add friction.*

*Less chance of tape destruction, because our patented dynamic tension control system ensures proper tape-to-head contact, and provides constant tension to control looping and prevent twisting.*

With broadcast cartridges, like everything else, you get what you pay for. With ITC Cart II cartridges, you get a revolutionary design that delivers trouble-free operation, superb sound quality and a life expectancy that's second to none.

We have renamed the cartridge due to trademark considerations, but only the name has changed, the cartridge and tape are the

same. New name, same great cartridge and performance.

For a complete listing of ITC Cart II dealers, call ITC toll-free at 800-447-0414 (in Illinois, call collect 309-828-1381.) Or write to ITC at P.O. Box 241, Bloomington, IL 61702-0241.

Because a cheaper cartridge may be more trouble than you can afford.

delay into the signal that is not constant with frequency. This shifts the phase of harmonics by a greater amount than the fundamental. Consequently, square waves applied to the filter come out looking non-square.

If the filter had a constant time delay for all frequencies (linear phase response), the square wave would be rounded at the edges, ringing on the top and bottom. The non-constant delay causes the waveform to ring substantially more on one edge than the other. It is possible to compensate partially for the frequency-dependent phase shift by adding more phase shift at lower frequencies as necessary. Phase-

corrected filters require additional analog stages to provide this phase shift, which increases cost.

Many companies manufacture analog low-pass filter modules for use in digital audio equipment. The most common design for the internal circuitry is a *ladder filter*, because the connection of inductors and capacitors resembles a ladder when drawn on paper. Most modern implementations replace the inductors with op-amp circuits called *frequency-dependent negative resistor* (FDNR) elements. These avoid the traditional inductor problems of distortion at low frequencies when the core saturates, and allow tighter control of

tolerances because capacitors are easier to manufacture accurately than inductors. The phase-correction stages, if included, also are most easily implemented with active filters.

Extremely sharp cutoff active filters, such as those required for digital audio, also have their share of problems. Sharper rolloff results in higher noise gain from the filter op-amps to the filter output. This requires the use of low-noise op-amps to achieve adequate performance. This also forces the use of high signal levels to maintain the signal-to-noise (S/N) performance of the digital system. The filter topology exposes the operational amplifiers to large

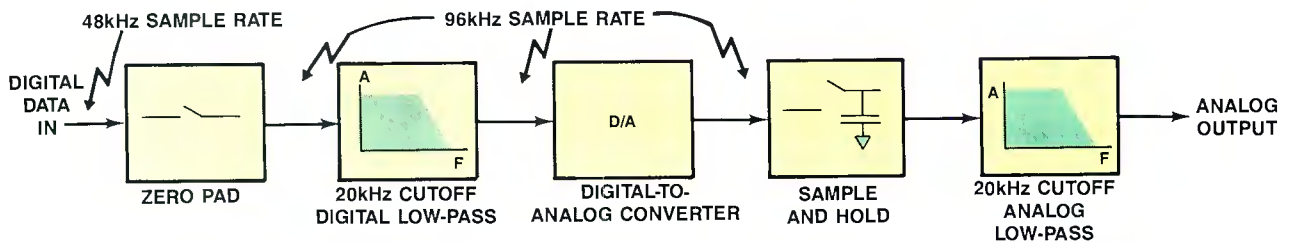
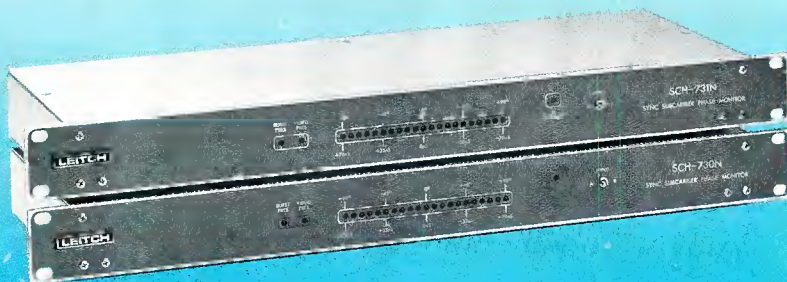

Figure 3. Block diagram of 2X oversampling D/A.

## Accurate SC/H\* phase... affordable at \$1350.-



# LEITCH®

Progressive Concepts in Television Technology

\* Sync/subcarrier phase relationship

### The SCH-730N

- Measures absolute and relative SC/H phase
- Certifies your SC/H phase reference
- Monitors all your picture sources
- H timing LED for perfect edits (SCH-731N)

For more information contact your local LEITCH dealer or call toll free:

In U.S.A.: 1-800-231-9673

or (804) 424-7920

In Canada: 1-800-387-0233



# ROY RATES LARCAN.

- "We've gotten virtually transparent performance since our LARCAN transmitter was installed last November.*
- "The straightforward design of the transmitter makes it easy to understand. They really avoided complexity for complexity's sake.*
- "In the 44kW model, it's like having the full redundancy of four transmitters. A failure in one doesn't affect the other three.*
- "LARCAN was very flexible about transmitter layout. We didn't have the space to line the cabinets up in a row; so, for us, they split the transmitter into two short rows which face each other.*
- "We had LARCAN do the physical installation and checkout; it was a big time saver. The transmitter was in place and wired in five days.*
- "Our relationship with LARCAN and LDL has been great. Their people are enthusiastic, cooperative, and easy to get hold of."*

Roy Trumbull  
Assistant Chief Engineer  
KRON-TV, San Francisco, CA

Testimonial after testimonial proves the point. LARCAN keeps moving ahead as the solid state leader in station acceptance and proven third generation performance.

Find out why. Call our RF experts at LDL. We'll send you all the reasons why LARCAN M Series 100% solid state VHF transmitters from 3 to 60 kW are your "best buy in the long run."

## **LDL COMMUNICATIONS, INC.**

14440 Cherry Lane Court, Laurel, MD 20707  
Telephone: (301) 498-2200. Fax: (301) 498-7952

## **LARCAN**

COMMUNICATIONS EQUIPMENT, INC.  
6520 Nartham Drive, Mississauga, Ontario, Canada L4V 1H9  
Tel: (416) 678-9970. Fax: (416) 678-9977. Telex: 06 968055.

MEMBERS OF THE LeBLANC COMMUNICATIONS GROUP.

 **LeBLANC**

Circle (16) on Reply Card

© 1990 LDL COMMUNICATIONS, INC.

[www.americanradiohistory.com](http://www.americanradiohistory.com)



# THE LEADER IS AT IT AGAIN!

## WE'VE ALREADY BUILT AND INSTALLED AN OPERATIONAL HDTV SYSTEM!

Just ask KBLR-TV39 in Las Vegas, Nevada. JAMPRO provided their antenna which permits the transmission of an HDTV signal.

State-of-the art technology and JAMPRO continue to grow together . . . we were on the leading edge when we developed the first circular polarized television antenna . . . and that tradition continues today.

### OUR SYSTEM PROVIDES

- Pattern stability
- Non-scanning characteristics
- A band width wide enough to provide the superior broadcasting of a high definition signal.

### FOR DETAILS

(916) 383-1177 • Telex: 377321  
FAX (916) 383-1182



6939 Power Inn Road  
Sacramento, CA 95828

Circle (17) on Reply Card

common-mode signals at high frequencies, a problem aggravated by the large signal levels. This can generate large amounts of distortion with many op-amps common in audio, especially FET-input types.

To keep power consumption and costs low, many manufacturers have used FET-input op-amps in their filter modules. The resulting distortion may not show up in THD measurements (because of the low-pass action of the filter), but, twin-tone IM measurements catch it nicely. This has created a large aftermarket for anti-alias filter and reconstruction filter upgrades in professional digital tape machines.

#### Oversampling D/A conversion

The complexity of the reconstruction filter is dictated by how close to the Nyquist frequency you want to reproduce signals. If the highest frequency to be output in a 16-bit, 48kHz sampled system is 20kHz, the low-pass filter must be flat to 20kHz and have more than 96dB attenuation at 28kHz. This is an extremely sharp filter. If the sampling rate is raised to 96kHz, the filter will only need to reach 96dB of attenuation at frequencies above 76kHz (the frequency above the Nyquist point that when folded over represents 20kHz).

With 96kHz sampling, filter design becomes simpler, cheaper and has lower noise, distortion and phase shift. However, to do so, the signal must be converted from a 48kHz sampling rate to a 96kHz sampling rate. Because the sampling rate is doubled, this technique is commonly called *2X oversampling*. If the rate is increased by four, raising the sample rate to 192kHz, it is called *4X oversampling*.

Interpolating is a more accurate term

than oversampling, because the process actually interpolates the additional samples from the existing sample values. Oversampling implies that the signal is sampled at a higher rate. However, by this point in the process, the signal is not available to be resampled. Despite these incongruities, the term oversampling has become widespread and will be used throughout this article.

The sample rate conversion process is illustrated in Figure 2. Let's start with a 48kHz sample. To change the rate to 96kHz requires that samples be taken twice as often. These extra samples must be computed from the existing samples. Because the value of the signal at the extra sample intervals is unknown, they are set to equal zero. The processor could be designed to assume that the new sample is the same as the previous sample, but this makes the processing more difficult. (See the related article, "Digital Filters for Oversampling Applications," page 93.)

The square edges created by the sampling process introduce harmonics of the original signal. By low-pass-filtering the signal with a digital low-pass filter, the harmonics between 24kHz and 72kHz may be removed. When viewed in the time domain, the digital low-pass filter "rings" on every sample pulse from the original signal and fills in the missing sample value.

The block diagram of the D/A conversion system now resembles Figure 3. The digital signal is padded with zeros and fed to a digital low-pass filter. This drives a D/A converter, which converts the digital words into analog samples. A deglitcher prevents transient errors while the bits go

*Continued on page 36*

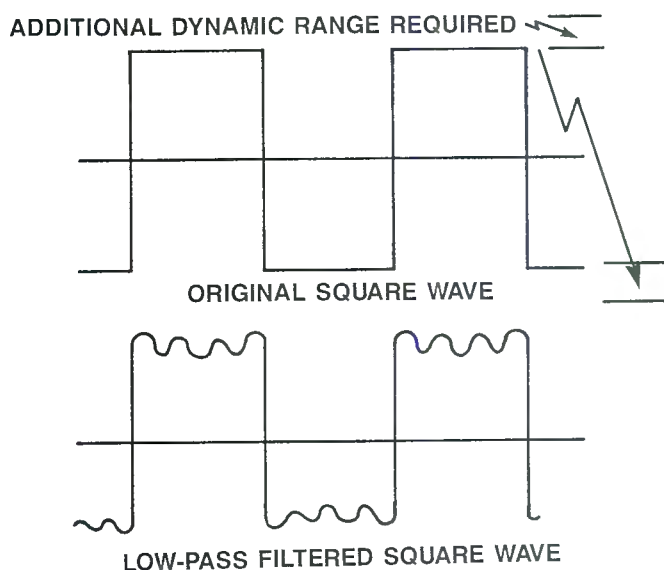

Figure 4. Overshoot in low-pass filters.

TVV	AI V	KOCO	WSOC	WXIA	WCMH	WDBJ
EVV	TVNZ	WITF	WTVH	KPIX	WVIZ	WVTV
ARK	CCTV	KJTV	KGBT	KSEE	WGAL	KVVU
ELO	VOK	WISN	KRGV	KRMA	KOAT	KPHO
CBS	TTV	WCVB	KTXS	WOFL	WUTR	WHMN
DVM	RAI	WAKA	WSLS	WATL	WCET	WAVY
TOL	KBC	KSTS	WHME	WHO	WSYX	WXEX
EHT	BTQ-7	WJCL	WJZY	WGN	WCAU	WOWK
BRZ						KBDI
MOX						KWHY
AIT						WTVT
NEM						WGNX
SLA						WAVE

## These stations had to pay us to get on this list.

ETK	STW-9	WIPB	WETK	WTVW	WNEP	WECT
LVI	BCV-8	WTVJ	KHJ	WPSD	WVIA	WMHT
ETK	KBS	KGUN	KARK	KPLC	WIS	KWTV
FCF	CSSR	KCOY	WYAH	WJZ	WSMV	KABY
FQC	BBC	WHCT	WTTV	KMOV	KCOS	WSAV
FMT	WABI	WMAZ	KFME	WFIE	KPRC	WBTV
BFT	WCCB	WBAL	KLTV	WHAS	KTRK	WFMY
ITV	WETM	WBFF	WSFA	KLFY	WWCP	WCPO
KVR	WXXI	KSPR	KPNX	WDSU	WYFF	WCIV
KVU	KEZI	WPTZ	KICU	WMAR	KBTX	KUTV
JOH	WTAE	WHYY	KSBW	WLOS	KFDM	KUSA
BUT	KSFY	KLRN	KCNC	WXII	KSAT	KXLY
IVM	WCFE	KTMD	WRC	WRGB	KVUE	KXAS
ISV-7	WTTW	KODE	WXEL	WBNS	KSL	KWCH

What we mean, of course, is that they all have purchased Ampex switchers, and we don't exactly give those things away. But what's more important is what the TDs and directors at stations like these are saying about our switchers...

"We can configure the switcher any way we choose, fast! Between live news and some spot breaks we have only 30 seconds to change TDs, directors, everything! With Century we can do it, with time for a sip of coffee to spare."

"Key clip level, gain level, etc., are all stored *per source* in the Century's key memory—we *never* have to adjust a key on-air."

"We store all of our switcher setups on the same disk where we store our program options. Then we can pop the disk

in and have our entire switcher ready, bingo, for the whole program...with all the panel memory setups...in 3 or 4 seconds!"

So if you're considering a switcher for your broadcast facility, get the full story before making a decision. Call **1-800-25AMPEX** for a poster and an information kit.

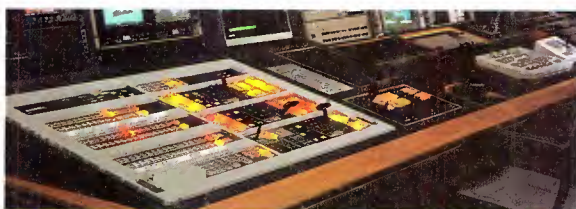

# AMPEX

# Panasonic Has Down To

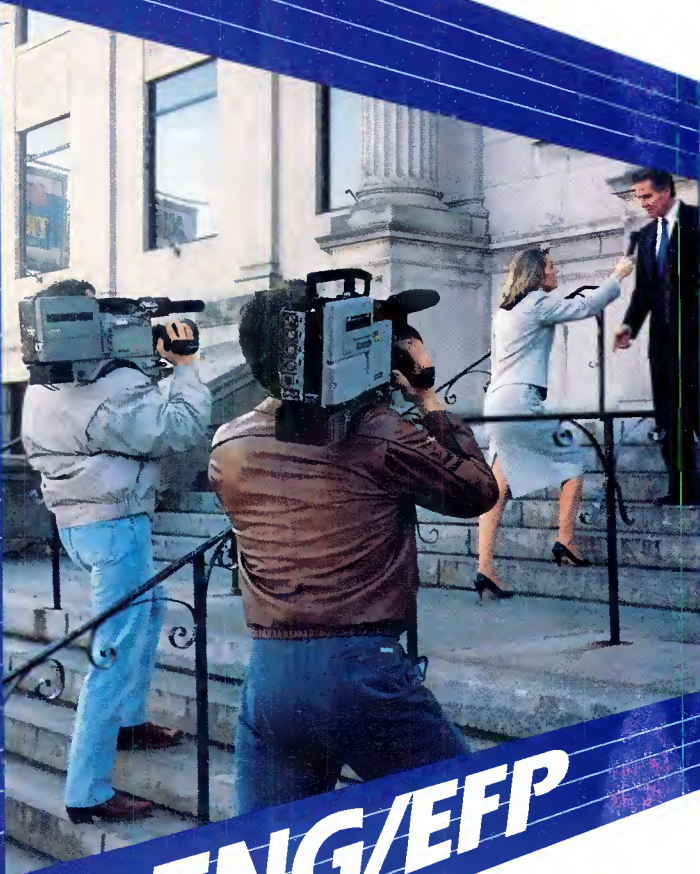

**ENG/EFP**



**STUDIO**

Selecting the most comprehensive video production system has never been easier. The Panasonic® Professional Video Production System is designed for total systems operation in the field, studio, editing suite and for virtually any playback operation.

The SVHS recording format is at the heart of Panasonic's comprehensive video production system. It provides a new level of high performance and cost efficiency across the spectrum of video recording and playback. One look at the numbers tells it all. Five generations of signal integrity, 400 lines of resolution and two-hour operation on a single cassette.

It is Panasonic performance you'll benefit from in the field. Panasonic's compact SVHS camcorders feature component signal technology and the efficiency of half inch cassettes. Including both

dockable and fully integrated one-piece units. And only Panasonic has SVHS camcorders available with three, two and single CCD image sensors. So you can specify the configuration that best satisfies your requirements. Panasonic lets you decide what's best for you.

Panasonic also captures all the details in the studio. With CCD cameras that feature component outputs to take full advantage of the SVHS recording format. And to make sure all the action you're recording looks its absolute best, Panasonic monitors allow you to easily analyze any video signal from any video source. A safeguard you'll appreciate during postproduction and final playback.

You can complement the performance of SVHS with the sophistication of Panasonic's MII recording format. The MII format delivers the operational characteristics you need for demanding broadcast

# Video Production A System.



## EDITING



## PLAYBACK

and postproduction applications. Like a luminance bandwidth of 4.5MHz, a K factor of 2% and a signal-to-noise ratio in excess of 50dB. It provides images that equal one inch VTRs with signal integrity that exceeds five generations of recording.

The integration of SVHS and MII video production components adds a new dimension to video system specialization. Because you can select the Panasonic components you need for the highest degree of performance and flexibility for specific system applications.

Panasonic SVHS and MII editing components provide a host of sophisticated features designed for virtually any application. From programmable 128 event A/B roll systems with time base correction to highly accurate insert and assembly systems. In addition, Panasonic speaks the industry's language with RS-422 VCR control interface components and video signal transcoders

for inter-format editing.

And for highly efficient playback operation, there's Panasonic's line of professional SVHS, MII and VHS VCRs, monitors and projection systems.

Make Panasonic your choice. After all, Panasonic has video production down to a system.

For more information and your local dealer,  
call your nearest regional office.

Eastern Zone: (201) 348-7620 • Central Zone: (708) 981-4826

Southern Zone:

Dallas Region: (817) 685-1117 • Atlanta Region: (404) 925-6841

Western Zone:

Seattle Region: (206) 285-8883 • Los Angeles Region: (714) 373-7275

**Panasonic**  
Professional/Industrial Video

Circle (18) on Reply Card

[www.americanradiohistory.com](http://www.americanradiohistory.com)

Continued from page 32

ing into the D/A are changing. The resulting signal is low-pass-filtered in the analog domain. This 2X oversampling system differs from a non-oversampled sample in that some of the filtering is done digitally, making the job of the analog filter easier.

It's not difficult to make linear phase digital filters, and they are relatively inexpensive because of the low manufacturing cost for digital-integrated circuits. However, this technique requires the D/A converter and deglitcher to operate at a higher speed than the original 48kHz approach. For a 4X oversampling system, the

converter must be four times faster than the original.

#### How much is too much?

The laws of physics dictate that high speed and high accuracy are difficult to achieve in the same circuit. The more the converter must output samples, the less time it has to settle to the true value of the sample. High-speed amplifier circuits tend to be less linear and have higher noise. This is similar to making a car handle well at high speed while producing a smooth ride.

Tradeoffs must be made and must keep reality in perspective. It does no good to

make a highly oversampled system to save on the analog filtering if the necessary converter is grossly non-linear.

The oversampling ratio has become a marketing buzzword. Manufacturers have been making equipment with 8X or higher oversampling, which have linearity errors and noise modulation of 6dB or more. The only inherent performance benefit of an oversampled system is the linear phase characteristic, and it may be achieved adequately by a 2X oversampler and possibly by a 4X oversampler. Once a 4X oversampling ratio is reached, the analog filter requirements may be filled by a single op-amp filter, making further in-

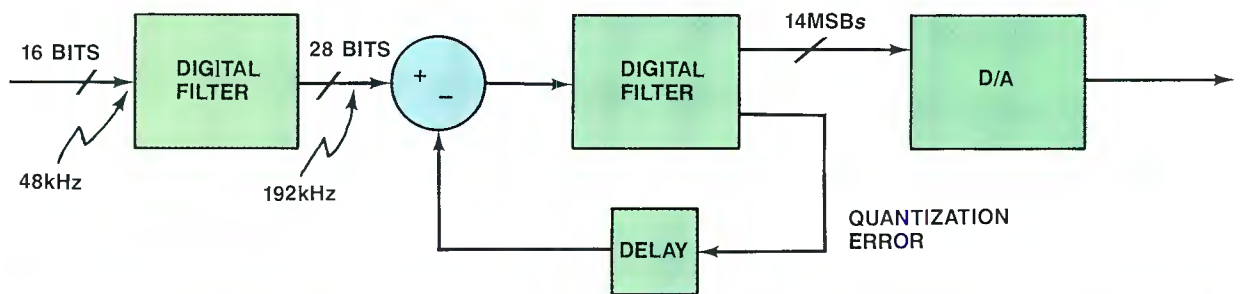

Figure 5. Noise-shaping D/A converter.

# INTRODUCING

SELECT

A	B	Y/C
BARS	BLACK	ALT

MODE

<input type="checkbox"/> SYNC	<input type="checkbox"/> AUTO	<input type="checkbox"/> HET	<input type="checkbox"/> SC
A	B		

DEFAULT

<input type="checkbox"/> OFF	<input type="checkbox"/> BLK	<input type="checkbox"/> BARS	<input type="checkbox"/> FRZ
<input type="checkbox"/> ALT	<input type="checkbox"/> A	<input type="checkbox"/> B	<input type="checkbox"/> Y/C

FREEZE

FRAME FLO 1	FLO 2
-------------	-------

VIDEO CHROMA HUE SETUP

H	V	C	S
NO	L		

FRAME SYNCHRONIZER  
TIME BASE CORRECTOR

novasync™ 2F

PRESET  
UNSTABLE

## PERFECT

## TIMING

**NOVA SYSTEMS, INC.**  
 50 Albany Turnpike, Canton, CT 06019  
 Tel (203) 693-0238 • Fax (203) 693-1497

THE CLEAR CHOICE IN VIDEO TECHNOLOGY

Circle (20) on Reply Card

# Your Next Cart Machine is **D**igital



Radio World called it The Talk Of The Atlanta NAB Show. Broadcast Engineering's panel selected it as one of their NAB "Pick Hits." And C.E.'s from everywhere proclaimed it a winning combination of digital performance and analog price.

## The Digital Cart for Broadcast

360 Systems presents the tool broadcasters have been asking for—the sonic excellence of CDs in a convenient user recordable for-

### COM P A R E

FEATURE	ANALOG	DIGICART
Random Access	No	<b>Yes</b>
Cue Title Display	No	<b>Yes</b>
Time Remain Display	No	<b>Yes</b>
Instant Cueing	No	<b>Yes</b>
Adjustments	10-20	<b>None</b>
HF Loss With Wear	Yes	<b>None</b>
Stereo Phase Error	Poor	<b>&lt;1°</b>
Wow & Flutter, %	.1-.3	<b>Zero</b>
Start Time, Sec.	.1-.3	<b>Zero</b>
Dynamic Range	58 dB	<b>92 dB</b>
Distortion	1.5%	<b>.005%</b>
Cost, R/P Stereo	\$3K-6K	<b>\$3,995.</b>

mat. DigiCart™ is a true digital audio cart machine. It looks and operates a lot like an analog cart; but under the surface, it's a powerful production tool that reshapes the quality and speed of broadcast operations.

Now you can store up to ten minutes of stereo at 15 kHz (or 40 minutes in mono at 10 kHz) on a rugged, removable magnetic disk cartridge. With true 16-bit linear encoding, fast access and an unlimited number of cuts per disk, DigiCart performs the daily tasks of broadcasting in a direct and reliable way.

## Random Access for Automation

If automation is part of your stations' business plan, DigiCart's serial control port can be the key to cost-effective operation.

Optional internal (and external) hard disks hold a full day's programming, and can be loaded at greater than ten times normal speed from the removable cartridges!

And since each cut has its own ID, cue lists can be created and stored within DigiCart to speed

production. It's even possible to cue up a second spot while the first one is playing on the same machine!



DigiCart uses rugged, removable Digital Audio Disks.

Call for a free brochure on how DigiCart can upgrade the quality of your station.

360 SYSTEMS  
18740 Oxnard Street, Tarzana, CA 91356  
Phone (818) 342-3127 • Fax (818) 342-4372

*360 Systems*

creases unnecessary.

Other advantages of an oversampled system — lower cost of digital integrated circuits and tighter control of frequency response — also peak around the 4X point. This is because the digital circuitry becomes more complex and the required tolerances on the digital filter coefficients tighten as the sampling ratio goes up.

As explained in "Digital Filters for Oversampling Applications," a digital filter uses

many multiples of sample values by fractional constants and adds the results of the multiples to obtain the output samples. The results of these calculations create numbers much larger than the original word size (usually 16 bits) that is input to the filter.

Quantizing noise is produced when the precision of the result is rounded to a smaller word size, which is usually the same as the input data. This quantization

is similar to that which occurs when converting the analog signal to a digital signal. Eliminating this source of distortion requires that the summation be dithered with a digital noise source at the LSB of the output word. Dithering the filtered signal makes the quantization noise independent of the audio signal. If dithering is not used, the output noise will contain 1/2-bit of quantizing distortion.

*Continued on page 42*

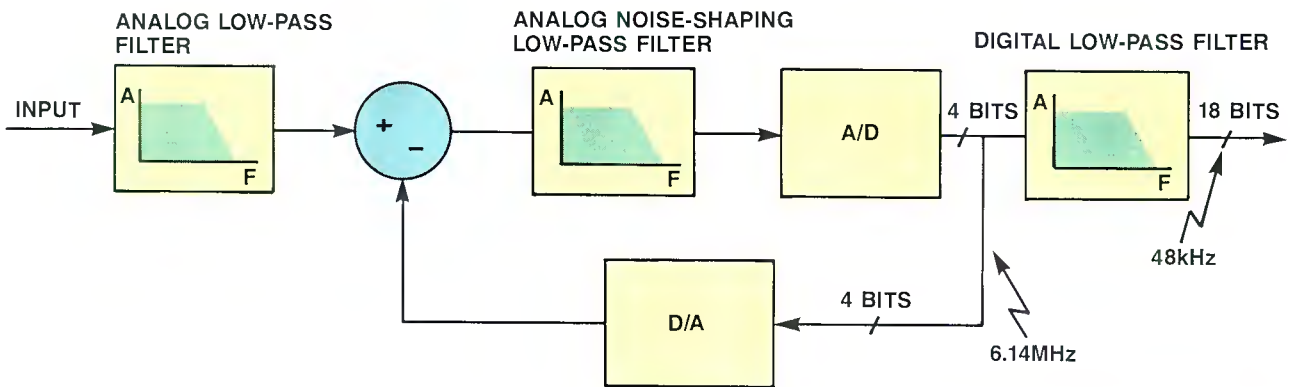
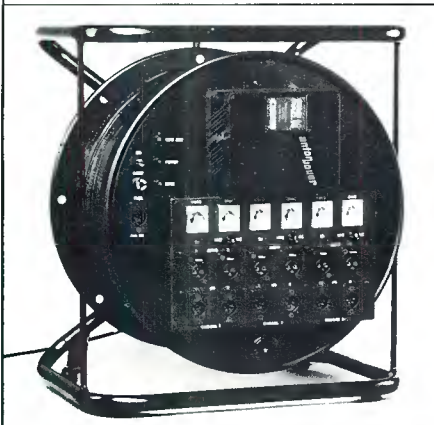

Figure 6. High-resolution oversampling A/D converter.

## SIDEWINDER E.N.G. VIDEO SYSTEM



RS-250B  
SHORT-HAUL  
PERFORMANCE

MILITARY  
TACTICAL  
OPTICAL CABLE  
up to 25,000 ft.

RECHARGEABLE  
NiCad BATTERY

FIBER OPTIC TRANSCEIVER FOR BROADCAST QUALITY  
REMOTE TRANSMISSION OF ANALOG VIDEO, AUDIO,  
INTERCOM AND SYNC SIGNALS.

# NATIONAL PHOTONICS

INCORPORATED

2965 E. Hillcrest Dr., Suite 304  
Thousand Oaks, CA 91362

805 494-4477  
FAX: 805 496-5379

Circle (21) on Reply Card

## New High Power Lightning Protection



7/8" to 3-1/8" EIA  
Hard line  
100 KA surge

208/240/277/480V  
3Ø  
Power Mains

For these and any of our other  
450 protectors and grounding systems contact

## PolyPhaser

P.O. Box 9000 • Minden, NV 89423-9000  
(800) 325-7170 or  
(702) 782-2511 FAX: (702) 782-4476

Circle (22) on Reply Card



# Nobody does it better



## **Vega Pro Plus Wireless, the Performance Standard**

Vega Pro Plus systems featuring the new R-42A receiver, have become the accepted standard for the most demanding applications from broadcast and film production to concerts and major live events.

Offering true-diversity operation, unparalleled RF selectivity, and resistance to overload, no other wireless system performs as well in severe RF environments. Usually, 25 or more systems may be used in one location. Pro Plus systems also feature third generation Dynex® III audio processing for the highest obtainable signal-to-noise ratio, lowest distortion, unequalled transient response and the widest dynamic range. When it comes to dependability, Vega is second to none. Major live events almost always use Vega systems because of their rock-solid reliability and exceptional performance. In other words, if you've got only one shot at it, you better have a complement of Vega Pro Plus systems.

The handheld transmitters are available with the new Electro-Voice concert vocal capsule, the N/D857, the popular N/D757A and a variety of Shure microphone elements. The bodypack transmitter offers flexible microphone biasing and interface, making it compatible with just about any lavalier microphone.

Nobody does wireless better than Vega. The Vega Pro Plus series, clearly the world's best wireless system.

For additional information, literature and technical assistance, please call James Stoffo at 1-800-877-1771.

 **Vega**  
a MARK IV company



SONY'S NEW UHF WIRELESS SYSTEM GIVES YOU EVERYTHING

A wireless system you can count on to do its job when your job is on the line. The new Sony WRT-28 UHF transmitter and WRR-28 UHF receiver utilize state-of-the-art surface mount technol-

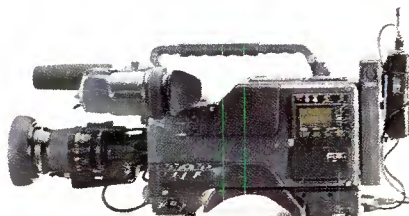

ogy for the ultimate in reliability and miniaturization.

Sony advances wireless technology to a new plateau with transparent sound quality and superior interference rejection. Plus the

YOU'D WANT FROM A WIRED MICROPHONE SYSTEM WITHOUT THE WIRE.



versatility of a switchable linear or compander mode.

Amazingly light and compact, the 28 Series UHF system goes anywhere, performing over a wide operational range. Powered by "AA"

batteries, available worldwide.  
The Sony UHF Wireless System.

**SONY**®

PROFESSIONAL AUDIO

It performs like a wired microphone. With no strings attached.

To find out more, call us at  
1-800-635-SONY.

Sony Communications Products Company, 1600 Queen Anne Rd., Teaneck, NJ 07666. © 1989 Sony Corporation of America. Sony is a registered trademark of Sony.

Continued from page 38

Whether or not dither is used, the noise floor will be increased. If the original data was 16 bits (with a  $1/2$ -LSB noise floor) and the output was limited to 16 bits, the noise would be increased by 3dB. To maintain the noise floor at the same level as the input signal requires a larger word at the filter output than the input. This is one reason why the 18-bit oversampling filters are becoming popular on consumer CD players.

This effect is analogous to the increased noise floor that exists when analog filters are used that have the same S/N ratio as the input signal. If you have an analog signal with a 90dB S/N ratio and pass it through a filter that has a 90dB S/N ratio, the result will be a ratio of 87dB. More specifically, a 16-bit filter output gives a 96dB noise floor. If it operates on an ideal 16-bit input signal, the result will be a signal with 93dB of dynamic range. Adding an extra bit of resolution (17 bits) to the output results in a filter with a S/N ratio of 102dB. Operating on an ideal 16-bit signal, this 17-bit output filter yields a -95dB noise floor.

#### Signal reconstruction

One aspect of the digital-to-analog con-

version process that is often overlooked by designers is shown in Figure 4. A low-pass-filtered square wave will overshoot on the leading corner, and a linear phase low-pass will overshoot on the leading and trailing corners. When a digital signal is reproduced using a D/A operating at the original sampling rate and an analog low-pass filter, all of the overshoot occurs in the analog domain. The extra headroom in the analog filter is usually easy to obtain and no clipping occurs.

In an oversampled system, most of the filtering is done digitally. The overshoot will appear at the output of the digital filter. If the digital filter is designed to have unity gain for sine wave signals, it will clip on the overshoot it creates on square waves. Handling this increased dynamic range requires an additional bit of headroom in the converter.

If a 16-bit signal is fed to the filter, a 17-bit D/A will be required to pass the output without clipping or attenuation. The filter gain must be arranged so that a full-scale sine wave into the filter only drives the D/A to one bit (6dB) below full scale. This extra bit becomes the headroom for signals from the filter. Commercially available 18-bit oversampling filters put both extra bits at the bottom of the digital word

(to reduce the noise increase effect described earlier), not one at the bottom and one at the top (providing additional headroom), where they belong.

#### Oversampling A/D conversion

The A/D conversion portion of the system has many similarities to the D/A portion. It is possible to trade off filtering in the analog domain for filtering in the digital domain. The function of the anti-alias filter is to prevent signals above the Nyquist frequency from entering the A/D converter and, ultimately, the audio band. Flat-frequency response in the audio band requires that the filter pass all components below 20kHz with no attenuation.

To prevent all alias components from entering a 16-bit digital signal, you would have to attenuate all signals above 24kHz by at least 96dB. However, if you just concern yourself with the *audio band* in the digital signal, only signals above 28kHz have to be attenuated by 96dB or more. As with the reconstruction filter, these requirements are tough to meet with an analog low-pass filter.

For example, if you sample the analog signal at 96kHz, the anti-alias filter only needs to eliminate signals above 76kHz,

# PERMANENT POWER.

Four new amplifiers from Carver Professional. The PM-120 (40+40W @ 8 $\Omega$ ), PM-300 (110+110W @ 8 $\Omega$ ), PM-600 (200+200W @ 8 $\Omega$ ), and PM-900 (350+350W @ 8 $\Omega$ ).

Each with features you've asked us for. Like barrier strip inputs

(along with TRS & XLR's) and 70 volt capability.

The new PM-600 and PM-900 also include remote/manual sequential power on/off and rear cover card slot for use with Carver add-in options such as our new FG2 Dual-Zone Fading Module.

Call toll-free, FAX, or write us for complete information including Architects' and Engineering Specs on the powerful, accurate, reliable solutions to permanent installation challenges.

## CARVER

PROFESSIONAL

TOLL-FREE 1-800-443-CAVR, FAX 206-778-9453  
P.O. Box 1237, Lynnwood, WA 98046

PM-120 PM-300 PM-600 PM-900



Circle (24) on Reply Card

# Reputation On the Line? Aphex Has the Solution ...

## for Audio Remote Control

The Aphex 150 audio remote control is simple to hook-up, easy to use and features unmatched sonic transparency. The 150 consists of two independent self-contained channels with the highest quality VCA—the Aphex VCA 1001. Each channel has servo-balanced inputs and outputs for problem free installation. All level settings are protected from power outages by a battery back-up. The fully independent control ports can be run independently, linked for stereo or for multiple channels.

An ordinary pot or switch is all that is needed for full remote control of audio signals in a wide variety of applications. The control port levels can be adjusted via analog sources (simple pot), ramp generators, or from Aphex digital remotes. The 150 also has a programmable MUTE level. One Model 150 supports up to 16 Model 175 digital remote controllers with bargraph display or 4 Model 176 digital remote controllers with numeric display, unlimited digital remotes without display.

## for Audio Distribution

The Model 120 is a one-in, one-through, four-out distribution amplifier. The servo-balanced input circuit provides excellent common-mode rejection, and its high input impedance allows several DAs to be driven from the same source. The four independently trimmed output amplifiers are very low impedance, allowing long lines and capacitive loads to be easily driven without loss of stability or frequency response. The electronically servo-balanced inputs and outputs provide all the benefits of transformers without degrading the audio.

The 120 was designed to provide outstanding audio performance with a flat response beyond 100kHz and a dynamic range 10 times better than 16 bit digital. A unique tri-color LED indicates power/level/clip. Rack mountable.

## for Audio Level Interface

A stereo, bi-directional interface for linking unbalanced equipment such as tape decks, VCR's, equalizers, CD players and electronic instruments with balanced equipment. Like all Aphex products, the Model 124 features superb audio performance. High level inputs and outputs are transformerless, servo-balanced for wide, flat frequency response and perfect square waves to preserve transients. Common mode noise rejection is very high while self noise and distortion are almost non-existent. Fits in a half rack space using optional Aphex rack mount kit.

Find out how you can protect your reputation ... and profit with Aphex quality products. Call or write today.



**APHEX**  
SYSTEMS

11068 Randall Street  
Sun Valley, CA 91352

(818) 767-2929

Circle (25) on Reply Card

if all you care about at the output are signals below 20kHz. This is a much easier analog filter to build because you have an additional 56kHz in which to reach the -96dB point. However, if the sample rate you want is 48kHz and you now have 96kHz, a sharp 20kHz low-pass that will roll off before 24kHz must be incorporated. After this filtering is done, all that is required to reduce the sample rate is to throw away the unnecessary samples. This reduction of sample rates is commonly called *decimation*.

With the FIR digital filter design described in "Digital Filters for Oversampling Applications," unnecessary samples do not need to be computed. This lightens the computational load substantially. The filter complexity, therefore, is determined by the output sample rate and the sharpness (number of taps) of the design.

The term *oversampling* is appropriate for this case; the original signal is sampled at a rate much higher than dictated by the Nyquist criteria.

The sample and hold and the A/D must function at a much higher rate in an oversampling system. As with the D/A portion, higher speed means lower accuracy. The tradeoff becomes one of anti-aliasing filter errors vs. conversion errors. The sam-

ple and hold must acquire the input signal in proportionately less time, and the A/D must convert this voltage to a binary word with a similar speed increase. This is more difficult for the A/D converter than for the D/A converter.

To understand why, consider the operation of a conventional A/D. Most A/D converters use a D/A internally in the form of a feedback loop to determine the binary output value. The D/A output is compared to the input signal and the bits are all set to zero. The most-significant bit (MSB) is then set to one, and the input is compared to the D/A output. If the signal is larger, the MSB is left at one. If the signal is smaller, the MSB is set back to zero. The second bit is set to one and the test repeated as with the MSB. This process is continued until all bits have been tested. The resulting bit pattern is the binary representation of the input.

This type of converter is called a *successive approximation converter* because the value is determined by successively testing each bit. For a 16-bit converter, this test must be performed 16 times, forcing the D/A to produce 16 new values during one input sample. Because the D/A is already running fast, making it faster is difficult. However, at least one A/D on the

market used in audio equipment yields 14-bit accuracy at sampling rates compatible with 4X oversampling.

#### **Error feedback conversion**

It is possible to use oversampling technology to reduce the required number of bits in the D/A converter — for a given number of bits of analog resolution at the output. This was done in some of the early CD players where 14-bit D/A converters were used in a 4X oversampling system to get 16-bit resolution. This technique is diagrammed in Figure 5. The idea is to use the bits below those fed to the D/A in a feedback loop to the input of the quantizer. These error bits are subtracted from the input signal to cause the error to average out to zero. This technique often is called *error feedback conversion*.

If a 4X oversampling is employed, the four 14-bit output samples can be designed into the filter to average to a value in between the 14-bit resolution of the words by having the four samples be different values. If three of the output samples are at zero and the other is at one, the average output will be 0.25. If two are at zero and two are at one, the average will be 0.5. The analog low-pass filter performs this averaging function because it cannot

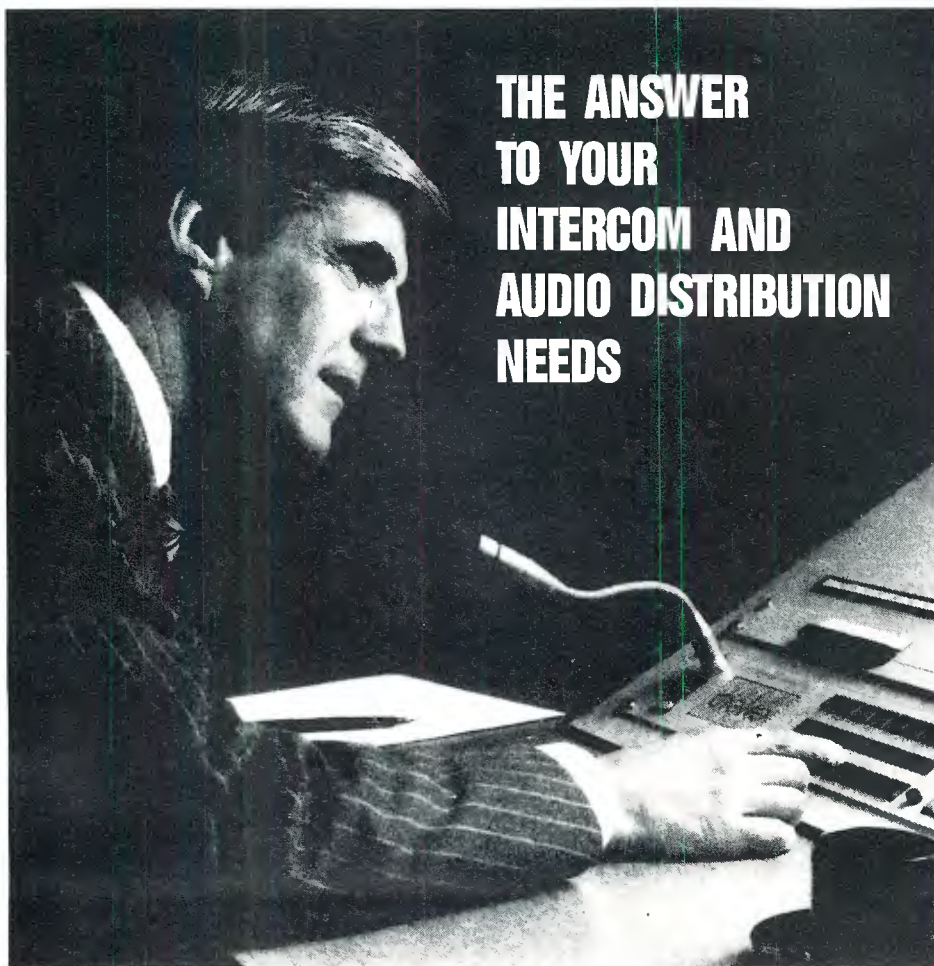

## **THE ANSWER TO YOUR INTERCOM AND AUDIO DISTRIBUTION NEEDS**

# **drake**

### **NOW YOU'RE TALKING**

Philip Drake Electronics Ltd.  
37 Broadwater Road  
Welwyn Garden City  
Hertfordshire AL73AX England  
Telephone: (0707) 333866  
Telex: 25415 DRAKE G  
Fax: 371266

USA Call Redwood Marketing  
(615) 254-7400

**9000 Series Video Audio  
Distribution modules.**

**6000 Series  
Microprocessor console,  
Talkback and Intercom  
system.**

**8000 Series Talkback  
including the definitive  
Compact range and  
Compact systems.**

**400 Series Radio  
Talkback modules.**

Circle (38) on Reply Card

# If you thought they were just for HDTV,



## think again:

Sure, our TSG 1000 Series Television Generators support the major proposed HDTV standards. But they're good for a lot more than high definition.

The fully programmable TSG 1001 and companion SDP 1000 Signal Development Program, for example, support signal generation in NTSC, Betacam®, MII and HDTV formats. With the PC-based SDP 1000, signals can be defined in arbitrary line and field rates.

FORMAT	TSG 1001	TSG 1050	TSG 1125	TSG 1250
525/59.94/2:1	•	•		
525/59.94/1:1	•	•		
787/59.94/1:1	•			
1050/59.94/2:1	•	•		
1050/59.94/1:1	•	•		
1125/60/2:1	•		•	
625/50/2:1	•			•
625/50/1:1	•			•
1250/50/2:1	•			•
1250/50/1:1	•			•
GBR	•	•	•	•
Y. PB. PR	•	•	•	•
Analog	•	•	•	•
Parallel Digital	•	•	•	•

The TSG 1050, TSG 1125 and TSG 1250 generate signals in HDTV as well as lower line rate interlaced formats.\* With an optional RAM or PROM board and the SDP 1000, signals can be generated in a wide range of line and field rates. Plus, a programmable zone plate generator is included in the TSG 1001 and is available as an option with the rest of the family.

All in all, once you get the full story from your nearest Tek representative, we think you *will* think again about looking anywhere else!

\*TSG 1125 excepted.

# NEWTON Equipment Racks

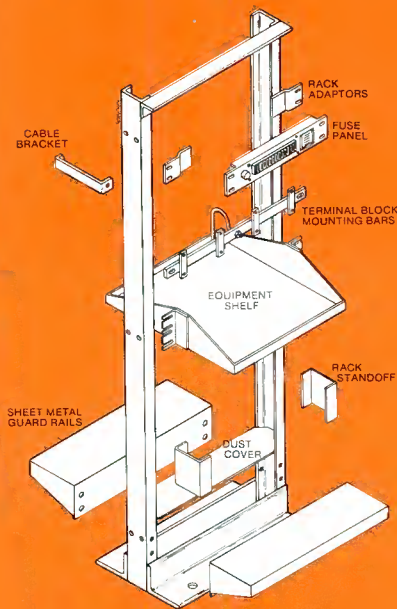

For versatility and ease of installation, Newton Equipment Racks are the first choice of many Central Office designers. They are backed up by a complete selection of accessories. And, Newton will custom tailor racks and components to meet your unusual needs. Here are some more reasons why you should specify Newton Racks in your design.

- all Central Office heights.
- wide inventory.
- available in aluminum or steel.
- interchangeable accessories.
- will custom design racks to your specifications.
- competitive prices.
- fast turn-around.

Newton also makes distribution frames, cable grid, cable rack, and all the hardware to go with each product.

*Write or call for a free catalog.*

## NEWTON INSTRUMENT COMPANY, INC.

111 EAST "A" ST. • BOX 727 • BUTNER, N.C. 27509  
PHONE (919) 575-6426 or FAX (919) 575-4708

*Newton Components—Engineered for Today and Tomorrow.*

Circle (27) on Reply Card

## Camera cable information from the company that knows best...Mohawk!

**Mohawk offers superior broadcast camera cable and a free, newly expanded camera cable and connectors information kit!**

If the job demands flawless broadcast transmission, order the best cable—Mohawk. Count on Mohawk's quick response to assembly orders and repairs to save you precious time.

Our expanded product line features:

- Ultra-flex VTR cable assemblies for Hitachi, Ikegami, Panasonic, Sony and others
- Slimline studio camera cables
- Waterproof, high strength three-piece connector design
- Customized lengths

Mohawk's entire team of engineers, technicians, and sales and service professionals are committed to providing product and service excellence. Our strict performance standards exceed even industry requirements.

Get your information from the reliable source! Mohawk's new edition of the TV camera cable and connectors information kit is available free. Just call or write Mohawk today!

### MOHAWK

Wire and Cable Corporation

9 Mohawk Drive • Leominster, MA 01453 • (508) 537-9961  
Toll free: 1-800-422-9961 • In MA: 1-800-642-9961

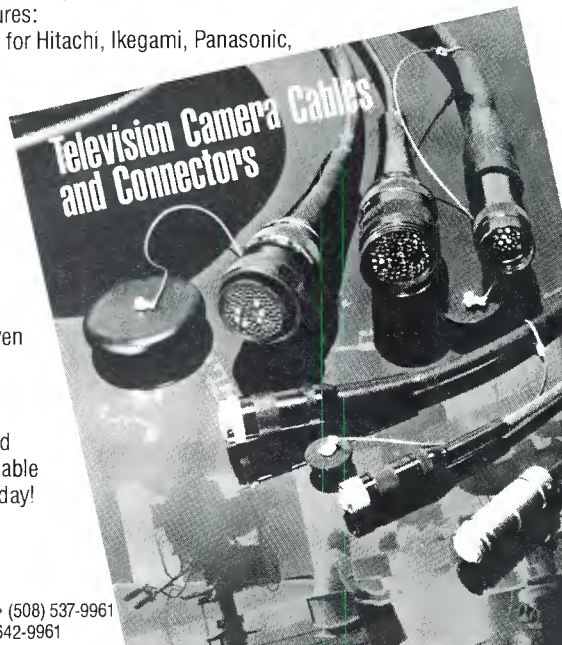

Circle (28) on Reply Card

change at the 192kHz rate.

By appropriate digital filtering of the quantizing error signal, its energy may be pushed to high frequencies above the audio range. This allows the analog low-pass to remove it and gives lower noise in the audio band, if the path from the oversampling filter to the quantization filter can avoid the noise floor increase.

When digital filtering is used to shape the background noise spectrum, it is called *noise-shaping* D/A conversion. Taken to the extreme, the D/A may be reduced to a single-bit converter while the sample rate is raised to the megahertz region.

### Converter accuracy

Oversampling A/D converters can benefit from the increased resolution offered by appropriate dither and filtering, as was discussed for the D/A. The performance benefits can be even more dramatic and more economically justifiable. The concept is to run a low-resolution A/D converter (which can, therefore, be faster) at a high sampling rate and to reduce the sampling rate with a digital filter. The extra resolution created by the large number of input samples averaged together for each output sample produces the needed resolution.

If the system merely raises the converter sample rate and then low-pass-filters the data to obtain the desired sample rate, the improvement is not dramatic. Decimation by two will give an extra bit of resolution; by four will give two bits and so on. However, the noise improvement is proportional to the square root of the bandwidth reduction, which means the noise floor only improves by 3dB (or 0.5 bits) per factor-of-2 reduction in sample rate.

This can be improved by dithering the A/D converter with noise that has most of its energy at high frequencies in the range that will be filtered out. This will allow the 1-bit-per-factor-of-2 in decimation to be achieved. Non-linearities in the system cause the high-frequency noise to intermodulate and create low-frequency noise, which will limit the ability to achieve even greater improvements in resolution for a given decimation ratio.

By making the A/D part of a feedback loop, greater improvements in resolution may be achieved for a given decimation ratio. The basic scheme is shown in Figure 6, and is used by several manufacturers in new converters. The input has a feedback signal subtracted from it and the error signal is converted by the A/D. It runs at a high sample rate, usually between 3MHz and 6MHz. The output of the A/D is converted back to analog voltage and subtracted from the input. Before driving the A/D, the error signal is filtered by a high-order low-pass filter. This has the effect of pushing the quantization noise up to high frequencies, where it will be

*Continued on page 93*



# LEXICON THE ART AND SCIENCE OF SOUND

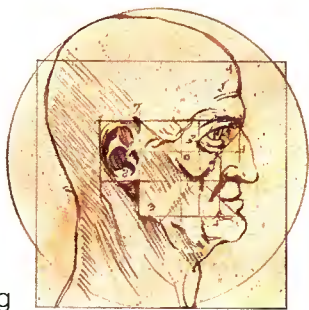

Leonardo Da Vinci was one of those rare individuals to whom both artistic and scientific excellence came easily. The concept of digitally reproducing and shaping analog sounds would have fascinated him.

Achieving excellence in digital audio technology requires a combination of scientific precision and artistic interpretation



that is as rare today as it was in Leonardo's time. It requires mastery of both the art and the science of sound.

Lexicon has devoted nearly two decades perfecting clean, natural digital audio sound without the quirks that digital technology is often accused of. It's called the **Lexicon Sound**, and you'll find it in every product we make.

When Lexicon introduced the world's first digital audio product in 1971, it was heralded as a major technological achievement, a breakthrough. We've built on that reputation with



other achievements, like reverberation and time compression/

expansion, that have earned us more than a dozen awards, including an Emmy.

Today Lexicon products serve more digital audio applications than ever before. There is

OPUS, the world's only fully integrated random access digital audio production system.

OPUS replaces a room full of equipment with a comfortable console and single equipment rack. Digital editing and mixing has never been smoother, more accurate, and more natural.

And everyone has a LARC. The Lexicon Alphanumeric Remote Console harnesses the power of the 480L Digital Effects System. The 480L produces a broad variety of superb effects from a growing library of software. It's no wonder you'll find LARC and the 480L in virtually every major recording studio throughout the world.

Lexicon's LXP-1 and LXP-5 effects processors provide a compact, economical way to include the Lexicon Sound in your productions. Each processor provides significant effects capability all by itself. But combined, the number and

breadth of their effects is astonishing.

The CP-1 Digital Audio Environment Processor extends the Lexicon Sound into the living rooms of America. It's been lauded as one of the truly great digital audio products of all time, and



*Stereophile* ranked it as "one of a handful of genuine advances in sound reproduction".

These are just a few samples of Lexicon's digital expertise. Our full range of products serves the needs of recording engineers, musicians, film and video producers, radio and television broadcasters, as well as discerning audiophiles. In each product we've merged



technical excellence and artistic elegance. The result is the Lexicon Sound.

For more information about Lexicon products or a demonstration of their complete capabilities, contact us at (617) 891-6790, FAX (617) 891-0340, or write Lexicon, Inc., 100 Beaver St., Waltham, MA 02154.

**Lexicon**  
The Art and Science of Sound

Circle (29) on Reply Card

www.americanradiohistory.com

# Audio Interconnection

By Skip Pizzi,  
radio technical editor

## Building bridges to better audio with modern interconnection techniques.

A carpenter who selects the finest wood to build a cabinet and then uses cheap glue and weak fasteners to hold it together would be accused of poor workmanship. Such practices result in a flawed product that fails to live up to its potential. The same goes for the aural quality of a broadcast facility. The best result is a combination of excellent audio equipment and state-of-the-art interconnection.

### Voltage-source design

Rip Van Winkle may be surprised about a lot of things when he wakes up more than 20 years after dozing, but one highlight in the broadcast world would be the absence of 600 $\Omega$  impedance on professional audio equipment inputs and outputs. The trend in recent years toward a *voltage-source* interconnection scheme yields a more flexible system.

Maximum power transfer, which an impedance-matched system provides, is no longer needed for simple audio connections in today's solid-state studios. Matching requires termination of all outputs, thereby creating a 6dB level difference between every output stage's loaded and unloaded conditions. If termination were not applied, an output stage could be operating without sufficient headroom because it would be 6dB closer to clipping.

Reconfiguring a studio can be an arduous task, and often severely limits what an operator can do at the patchbay. It also requires many expensive transformers, each of which adds audio degradation. A voltage-source method of interconnection has eliminated many of these difficulties. Now, a low-impedance output feeds a high-impedance input in a bridging fash-

ion. (See the related article, "Water Under the Bridge," p. 64.)

Bridging is the condition where an input's impedance is at least 10 times higher than the source impedance of the output that feeds it. Typically, the ratio is much higher than that, with modern audio output impedances under 100 $\Omega$  and input impedances of 10k $\Omega$  or more. This allows several inputs to be parallel-connected to a single output (via a simple patchbay "multiple") while maintaining a bridging condition. The output level of a device is not affected when it is connected or disconnected from the input of any downstream unit, and it can feed several hi-Z inputs without an intervening distribution amplifier. (A distribution amplifier is still a good idea because of the isolation it provides between inputs that it serves.)

This approach also possesses an ability to drive longer lines without significant high-frequency losses. For example, driving 1,000 feet of standard audio cable with a 600 $\Omega$  output, and feeding a bridging input results in a high-frequency cutoff of only 8kHz. Proper termination at the input will improve the response only to 16kHz, with a 6dB loss in level. Using a 60 $\Omega$  source and a bridging input with the same cable, however, provides an 84kHz cutoff and no level drop because of termination. This quintupling of interconnection bandwidth comes with the routing convenience of a bridging system. It also provides approximately 14dB lower noise pickup because of the lower interconnection impedance employed. Even if a 600 $\Omega$  load is applied to one of these outputs, the level drop will be less than 1dB. The characteristic impedance of today's audio

cable isn't 600 $\Omega$ , but falls around 80 $\Omega$  or 90 $\Omega$ .

Of course, this system does have some disadvantages. Power consumption is increased because of the higher output current required to pass these voltages through lower impedance lines. Conversion of a device to this method of interconnection often requires more than simply swapping resistors in its output stage. The current-drive capacity of the output amplifier also must be more than sufficient. DAs that are used must be able to continue satisfactory operation at this low impedance even when one of their outputs sees a short. Attention to proper grounding also is required, because the wide-bandwidth interconnection can be more susceptible to RF interference. Nevertheless, many of today's system designers consider these small prices to pay for the significant benefits reaped.

Each piece of equipment in an audio chain acts like a filter, with every unit's power bandwidth having an additive effect. Two pieces of hardware, each with 100kHz bandwidths, are down 6dB at 100kHz when chained together. Four pieces are down 12dB, eight pieces down 18dB, and so forth. It is not uncommon for audio routing to pass a signal through 12 or more devices, perhaps unwittingly creating a cumulative bandpass of less than 20kHz. It is important to minimize the additional band-limiting that interconnection can cause.

For cable runs of 3,000 feet or more, a terminating interconnection method is recommended that uses an impedance of 50 $\Omega$  to 75 $\Omega$ . Depending on the length and type of cable used, equalization may be

# PEOPLE WHO KNOW ROUTING SWITCHERS, CALL US FIRST.

- FIRST - 20 MHz solid state video switching system (NASA), 1963
- FIRST - 360 x 800 20 MHz switching system —world's largest (JPL), 1964
- FIRST - 30 MHz bandwidth switching system (USAF), 1965
- FIRST - 30 MHz equalizers for up to 200 feet of coaxial cable, 1967
- FIRST - 90 MHz video matrix (Satellite Tracking Center), 1969
- FIRST - 42 MHz bandwidth switching system (USAF), 1969
- FIRST - Use of laser-trimmed hybrid video circuits, 1978
- FIRST - Switching of high res computer generated graphics, 1980
- FIRST - 120 MHz switching system, 1987
- FIRST - 135 MHz switching system, 1987
- FIRST - 150 MHz video DA's, 1988
- FIRST - 40 MHz 2 RU V/A router, 1989

It only makes sense. When you want the most advanced routing and distribution systems, you come to the people who've set the standards. The people of DYN AIR.

Just consider what the list above means for you. Because while it details our technical milestones, there's another message coming through. One of experience. And reliability. Proven reliability. Like the DYN AIR switcher at NASA's Jet Propulsion Laboratory. It's been in continuous use since its installation—26 years ago.

26 years. Isn't that the kind of dependability you need when your job counts on it?

For reliable system routing and coax/fiber connectivity. For needs ranging from CCTV to high resolution graphics. For performance that's designed in, not tweaked in, dial 800-854-2831. We'll send you information on our full line of routing switchers and distribution systems. And you'll see why for 32 years, people have called DYN AIR. First.



**DYN AIR**  
Call us first. 800-854-2831

Circle (37) on Reply Card  
[www.americanradiohistory.com](http://www.americanradiohistory.com)



# PHILIPS

## Scope Buster Prices!

call

**800-882-NTSC**

Waveform monitors

**800-882-NTSC**

Vectorscopes

**800-882-NTSC**

Complete line

**800-882-NTSC**

Lowest prices...

**800-882-NTSC**

Anywhere

**800-882-NTSC**

Cash discount

**800-882-NTSC**

Immediate shipment

**800-882-NTSC**

Free 2nd day air

**800-882-NTSC**

Quality

**800-882-NTSC**

Who ya gonna call?

**800-882-NTSC**



TEST & MEASUREMENT INC.

7500 Six Forks Road  
Raleigh, NC 27615

Circle (32) on Reply Card

required to widen and flatten the pass-band. Telco lines fall into this category, but are established by the phone company typically as 600Ω circuits, and are equalized as such by the phone company. Because these long paths behave as transmission lines, with their characteristic reactive loading, it is critical for proper frequency response that the user's source and termination impedances also be 600Ω.

### **dB or not dB**

Any audio interconnection system must deal with a variety of audio levels. Although there are standard operating levels, how they are measured and codified often is unclear.

The unit dBm is referenced to 1mW, meaning that 0dBm = 1mW. The common definition of "1mW into 600Ω" is a misconception when dealing with dBm. Remember, decibel as originally defined is a unit of power measurement ( $\text{dB} = 10 \log P1/P2$ ), and a milliwatt is a milliwatt, whatever the load. The load becomes important when power is no longer the issue, but equivalent voltages are discussed. Across a 600Ω load, 1mW of power generates a voltage of 0.775V rms. Because voltage is the primary concern, a dB scale for voltage is used, following the formula  $\text{dB} = 20 \log V1/V2$ . This requires a reference voltage, and the dBm's is handy. If you are no longer operating in a fully 600Ω environment, the continued use of 0dBm to mean 0.775V is inappropriate. Another unit, the dBu (or dBv), is the proper term, with 0dBu referenced directly to 0.775V, regardless of the impedance encountered.

The most common reference level in use in professional audio systems is +4dBu (1.23V). Telco uses +8dBm (1.95V into 600Ω) as its reference level. VU meters must be calibrated properly so that a 0VU reading is given when the selected reference level is applied. It's a good idea to feed telco lines with +4dBm referenced signals, thereby gaining another 4dB of headroom (at the expense of signal-to-noise ratio) over the 10dB that most telco lines specify.

The proliferation of consumer equipment in the broadcast facility muddles things further. Referred to as "-10" gear, and equipped with RCA phono jacks, this hardware uses the interconnection specifications of the Institute for High Fidelity (IHF). The IHF uses another decibel scale for its measurements, the dBV, where 0dBV is referenced to 1V. Thus, -10dBV (0.316V) equals -7.78dBu, placing the pro/consumer reference differential at 11.78dB (not the 14dB that might be assumed). Any dBu value can be converted to dBV by subtracting 2.22.

### **Balanced vs. unbalanced**

To integrate IHF equipment into a professional audio environment properly,

active IHF/Pro interface boxes have been devised to deal with level differences and balanced-to-unbalanced conversion. Whenever ground is shared with a signal conductor, the possibility for noise pickup is greatly increased. Therefore, the use of unbalanced interconnection should be minimized, and always implemented with a conversion box.

Balanced circuits are less susceptible to induced (magnetically coupled) interference because of their differential signal condition. Sources of such interference are magnetic fields from ac-powered devices or power lines (when current is flowing through them) and RF radiation. The aural symptoms of these two interferences are different. Magnetically coupled ac interference is a smooth-sounding hum. RF radiation may cause actual demodulated audio signals to be mixed in with your audio, or may introduce carrier or subcarrier harmonics, usually characterized by a whine or buzz of varying intensity, spectral content or frequency.

The ability of a balanced line to reject induced noise is affected by two factors. First is the number of twists per inch in the cable, and the second is how well-trimmed the common-mode rejection of the input stage fed by the line is. Modern cable configurations, such as those found in the "star-quad" cable, further reduce induced pickup. This type of cable uses two highly twisted pairs that are twisted together. Each side of a balanced circuit is then connected to two conductors, one from each pair.

Splices or intermediate connectors in a line also can cause problems. Whenever possible, use one continuous piece of wire. Whenever a splice is made or a connector is installed, the signal leads are necessarily untwisted and spread apart, making them more susceptible to an unbalanced interference pickup. Physically moving the affected device or cable away from the source of interference also is a great help.

Meanwhile, capacitively coupled interferences can occur, which is characterized by a harmonically rich buzz. The latter is the result of the leakage through cable shields of electric fields from nearby hot conductors — whether or not current is flowing through them — or from ground loops. A balanced line's ability to treat shields and grounds separate from signal leads is a benefit.

The amount of audible annoyance that any interference will cause is a function of its level relative to the level of the desired audio signal in the conductor. Because mic-level signals are typically 1,000 times lower in voltage than line-level signals, they are more susceptible to interferences. For this reason, mic level signals should travel through as short a continuous cable run — in as well-balanced a con-

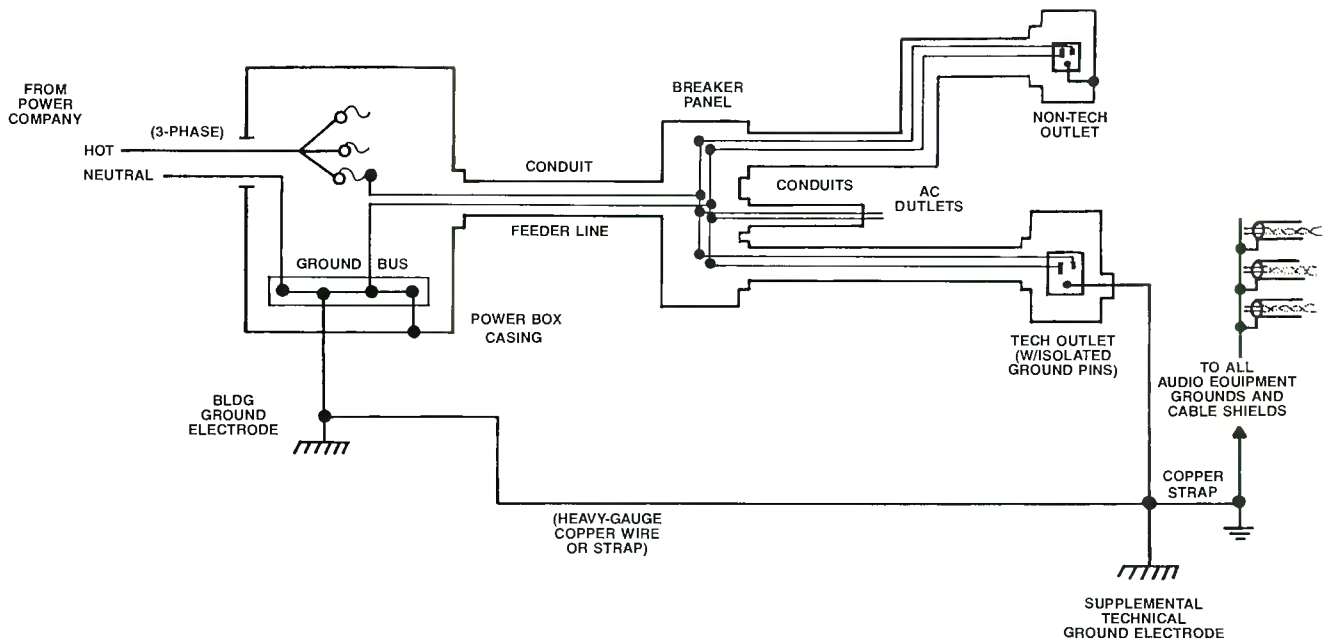

**Figure 1.** A facility ground system should have provisions for system, equipment and technical grounds. Electrical codes usually specify that the grounds all come together at one common point, generally the building ground electrode.

dition as possible — directly to a high-quality, high CMRR microphone pre-amp. Microphone signals should only be brought to a patchbay at a point downstream of the pre-amp. Proper system design should allow any patchbay output to drive any input (or reasonable group of inputs) without difficulty.

### Grounding and shielding

Proper grounding procedure is a complex and controversial subject. First, let's define some terms. *System ground* is the actual grounding network for the building where the power company's neutral is connected to the casing of the master power box, and the building ground point (cold water pipe or grounding rod system, preferably the latter). *Equipment ground* travels from the master power box to all distribution and subsequent breaker boxes via conduit (or a ground wire inside flexible conduit). Ground pins on standard outlet boxes are connected to the casing of the outlet box, and carried to system ground via the conduit. (See Figure 1.)

Audio installations should have a separate *technical ground* system, in which a separate star grounding network is used to tie all technical equipment grounds to a system ground via insulated copper wire. This reduces the chance of inadvertent grounding to conductive parts of the structure, and provides more than 100 times less resistant path to ground than conduit does at higher audio and RF frequencies.

The technical ground system should be connected to all audio cable shields, circuit grounds and chassis grounds, including the ground pin on iso-grounded or plastic ac outlet boxes. Non-audio hard-

ware can be grounded to the standard equipment ground.

Power to each technical area should be

routed via separate dedicated feeders from the main power entry. All technical equipment should be on the same phase. All



- Genuine Ampex replacement parts
- 35,000 different parts in stock
- Parts for out of production recorders
- For overnight delivery, call 1-800-227-8402

AND FOR AN EXCITING OFFER, TURN THE PAGE!

**AMPEX**

*Ampex Customer Support*

high-power switching (SCR dimmers and motors) should be kept off of these feeders. Audio cabling should be kept separate from ac power runs. Power in the floor and audio in the ceiling is one approach.

Problems can occur when the resistance to ground is significantly greater than  $0\Omega$  at the powering outlet, caused by poor or non-existent grounds. When two pieces of audio equipment that are not powered from the same outlet are interconnected, different resistances to ground between them create a voltage drop in the ground system. This causes current to flow, and the "ground-loop" buzz is heard. In these cases, the audio ground lift (disconnecting one end of the shield on the cable between the devices) can be helpful, removing that ground signal from the audio path by breaking the loop. This is preferred over breaking the loop by lifting the ground pin on the device's power cord, because this also lifts its low-resistance safety ground. (See Figure 2.)

Common-powering of all interconnected audio equipment is the best prevention against ground loops. This condition can be caused simply by the added resistance of a longer path to ac ground from one device than from another. In large, multistudio facilities where this is impractical,

supplemental technical ground electrodes distributed around the plant can help. A further aid is the use of "cascaded" gauges of technical ground wiring and busing, where ground conductors get heavier as the path works its way back from the outlet to the system ground point(s), forcing ground currents toward the lower impedance paths.

A related rule is to tie audio cable shields at the send end only during installation. This provides a ground reference for all cables back to their output devices only. Codes do not allow a completely separate technical ground system, meaning one that is tied to a separate earthing point from the system ground. For safety, all grounds must be referenced to the same potential, at a single, common ground point. Additional technical ground points are permitted as long as the system ground point is connected. Current codes also specify that technical ground wires must travel with the power conductors, inside the conduits. Many installations routinely violate this aspect of the code. The subject is under some scrutiny, and will possibly be liberalized in future codes.

**Transformers vs. active-balanced**  
Transformers offer a high degree of iso-

lation and are especially useful in unknown environments, such as remotes, where high common-mode voltages, dc or sudden overload conditions may be encountered. They also exhibit low-frequency, common-mode rejection superior to most active-balanced devices. Output transformers also are insensitive to being fed to an unbalanced input, tolerating either high or low sides being grounded. Impedances of input and output are a matter of the primary-to-secondary turns ratio.

Unfortunately, these are transducers, changing our electrical audio signals into roughly equivalent magnetic fields — and back — each time you go through one. This twofold change of state cannot occur with complete transparency. Insertion loss is inevitable as we trade voltage for current in the turns ratio, and deal with real-world imperfections in manufacturing. Various distortions also may be added, especially at low frequencies.

Magnetically coupled interference also may be picked up to a greater degree than it would be in the same circuit without a transformer. All of these problems can and have been minimized in reliable and well-known products through the use of Faraday shielding and excellence in design and

**NOW,  
ONE HEAD IS BETTER  
THAN TWO, THREE...**

- New Universal AST™ head fits Ampex VPR-80, VPR-6, VPR-3, and VPR-2
- Cuts your inventory costs and reduces maintenance errors
- Genuine Ampex heads—One year or 1000 hour warranty
- Call **1-800-227-8402** for fast delivery

**AMPEX**  
Ampex Customer Support

**FINALLY,  
A RACKMOUNT SLIDE KIT THAT WORKS**

FOR MORE INFORMATION... CALL **800-635-9297**  
**ERGO INDUSTRIES**

Circle (33) on Reply Card

**GELECO**  
We stock all tuning and matching components; coils, contactors, switchers, including Jennings Vacuum Contactors.  
*Call Us Today!*  
Phone (416)421-5631  
Fax (416) 421-5631  
#2 Thorncliffe Park Drive Unit 28  
Toronto, Canada M4H1H21

Circle (34) on Reply Card

**PRECISION MAGNETIC  
TEST TAPES**

Standard Tape Laboratory, Inc.  
26120 Eden Landing Road #5, Hayward, CA 94545  
(415) 786-3546

Circle (35) on Reply Card

# Digital Audio

with Audio Coder  
and Audio Decoder

# DCA DDA



"Munich Philharmonic Orchestra" at the philharmony of Gasteig

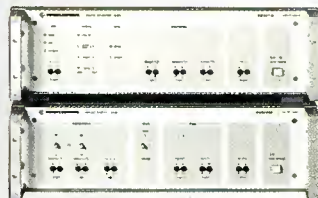

Digital sound broadcasting by satellite offers stereo programs with the same quality you experience in a concert hall or can hear from a compact disk. At the studio output Audio Coder DCA converts sound signals and auxiliary information into a digital DS1 data stream for high-quality audio transmission. For studio links via program lines or satellite (Euroradio), Audio Decoder DDA retrieves the signals from their DS1 format.

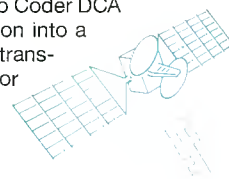

Ask for detailed information on Audio Coder DCA and Audio Decoder DDA

An independent concern, founded in 1933.  
5000 employees, represented in 80 countries.  
Design and turn-key installation  
of systems with software and servicing.  
Calibration, training and documentation.



## ROHDE & SCHWARZ

D-8000 München 80  
Postfach 80 14 69  
Telex 523 703 (r s d)  
Telefax (0 89) 41 29-21 64  
Tel. internat. +(49 89) 41 29-0

F-DCA/DDA/E

manufacturing, leaving one significant problem: cost. For some, this is simply the price of doing business. Others have pursued another course.

Op-amp technology also has progressed, bringing the potential of providing similar results at a lower price. The best of today's electronically balanced inputs and

outputs rival the top transformers in the area of common-mode performance above 100Hz. Although ac mains frequen-

*Continued on page 58*

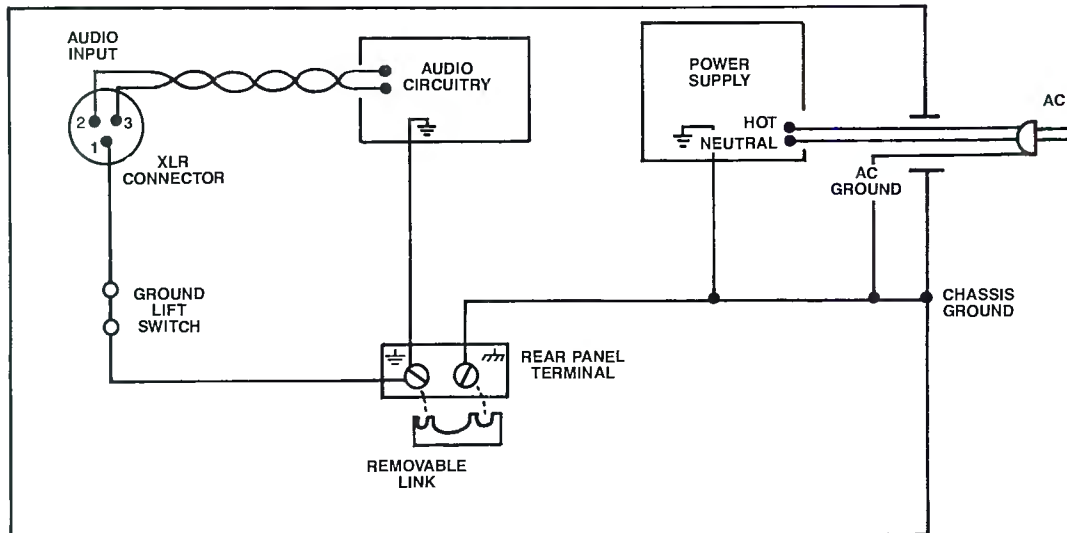

**Figure 2.** Do not lift the ground pin on a device's power cord, because this removes the low-resistance safety path to ground. Instead, use the audio ground lift switch found on professional audio equipment.



## AUDIO SERVICES CORPORATION



### Rycote

*Neither  
WIND nor RAIN  
nor dark of night  
will keep us from  
our appointed  
SOUNDS!*

#### Headquarters

10639 Riverside Drive  
North Hollywood, CA 91602  
(818) 980-9891 (800) 228-4429  
FAX (818) 980-9911

#### Topham Audio, Inc.

4403 Vineland Road Ste. B-3  
Orlando, FL 32811  
(407) 649-6444 (800) 486-6444  
FAX (407) 648-1352

**SALES SERVICE RENTAL ENGINEERING**



\$845  
MODEL  
CX-2

ONE-STEP

## COAXIAL CABLE STRIPPER

Fast consistent cable preparation is easy with the CX-2 Motorized Coaxial Cable Stripper. Prepares a 3-level strip in a single action for any connector configuration. Strips cables from .100 to .430" diameter. Twenty years proven use by leading networks and independent stations. Also available is the CX-1 hand-operated mechanical Co-ax stripper with similar capabilities. Call us for complete descriptive literature.

**WESTERN ELECTRONIC  
PRODUCTS CO.**

951-G Calleamanecer, San Clemente, Calif. 92672  
Telephone: (714) 492-4677

Circle (40) on Reply Card

Circle (41) on Reply Card



*Because it takes many cuts  
to make a gem . . .*



*VUES™ gives you sparkling simplicity  
in digital video editing.*

Fifty eight facets make a perfect diamond. In the editing business, you make as many cuts as you need to create a gem. VUES is a simple, economical editing system designed to make every cut look brilliant.

VUES is the first fully-integrated system for digital composite video editing. It makes dissolves and wipes as easy as cuts and offers high-powered features including infinite digital layering.

Engineered around NEC's RAM-based VSR-10 digital video sequence recorder, the VUES system uses a popular PC to let you control all video equipment with full-list management.

To provide all the capabilities of

a complex A-B-C-roll editing studio, VUES needs only a single source VTR of any format, plus one channel for digital video effects, and one channel for character generation. Forget about a costly production switcher, still-store and disk system. The VSR-10 incorporates

all their functions.

From any viewpoint, the VUES system offers outstanding economy. It uses less hardware, saves space, cuts power, shrinks cooling and maintenance costs. And VUES lets you achieve highly polished results with true economy of effort.

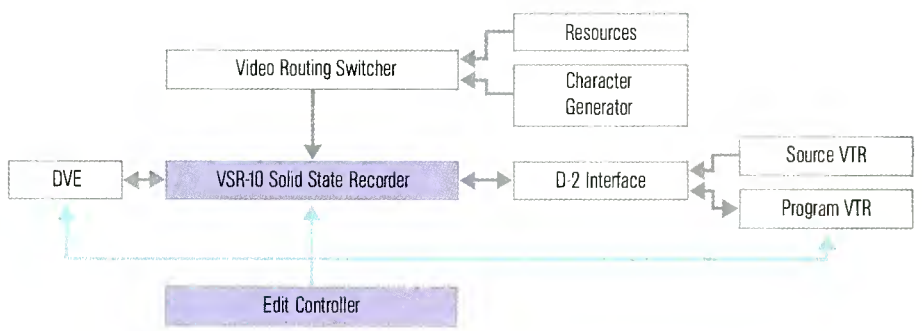

VUES is a product of NEC Corporation in coordination with Videofonics, Inc., U.S.A. VUES is a trademark of Videofonics, Inc.

**For further information, please contact:**

NEC America, Inc. Broadcast Equipment Division 383 Omni Drive, Richardson, TX 75080-3545, U.S.A.  
Tel: 214-907-4710. Fax: 214-907-4711.

NEC Corporation Overseas Department, Broadcast Business Promotion Division Morinaga Plaza Building, 33-1, Shiba 5-chome, Minato-ku, Tokyo 108, Japan. Tel: 03-798-6364. Telex: 22686.

Circle (42) on Reply Card



**Ampex D2.**  
**A better business machine . . .**  
**from the ground up!**

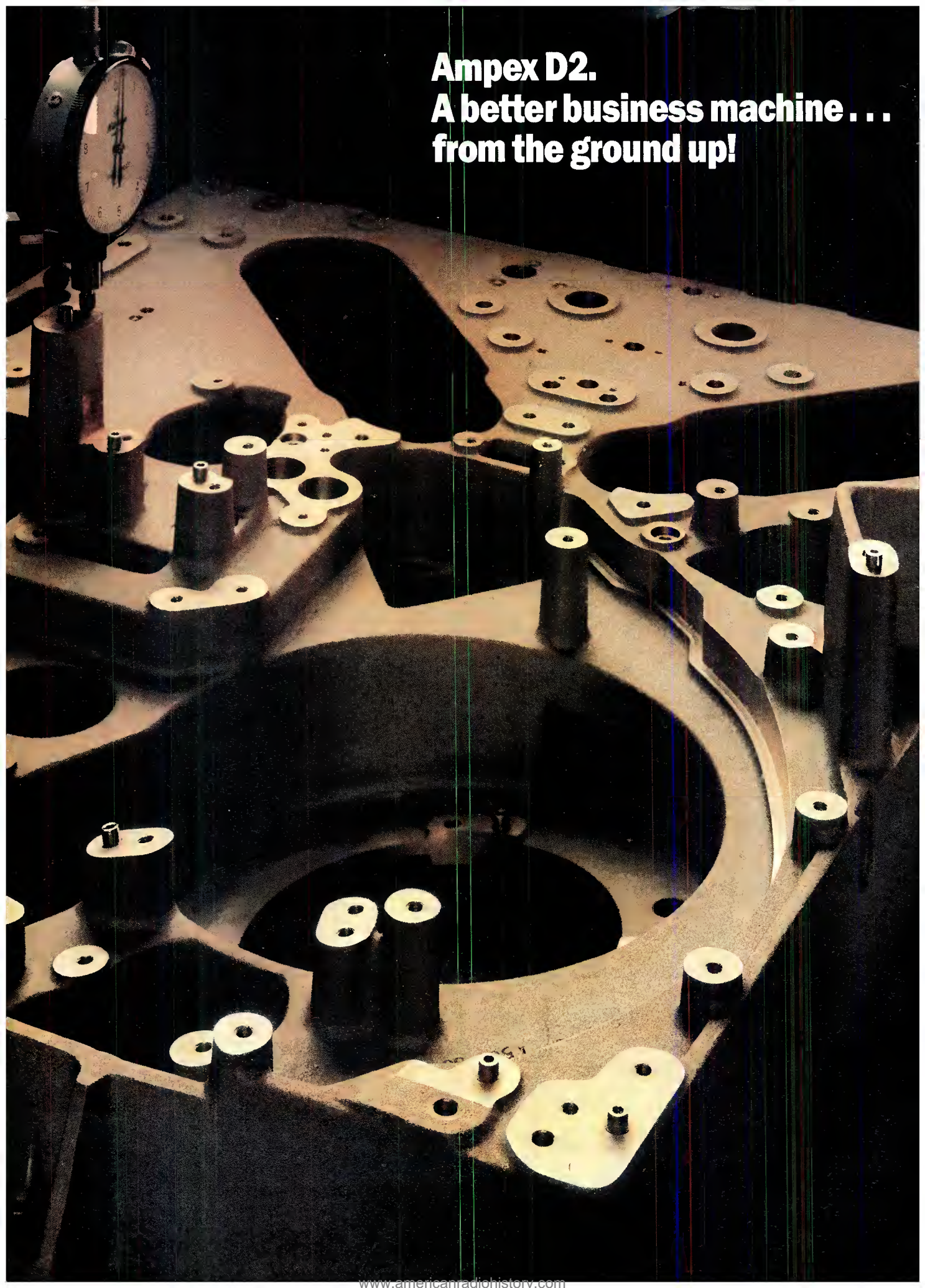



Yes, it's true that our new VPR-200 and VPR-250

D2 video recorders are designed and built specifically for broadcast operations. It's also true that they offer the broadcaster superior signal quality. But a much more important consideration is that these machines make *business sense*. Here's how.

You probably amortize your recorders over 5 or 7 years, but the "200" and "250" are built to be around a lot longer than that—you're not going to find any "bent metal" here! Precision-milled castings and pre-aligned guide assemblies not only give you dependable long life, but also low maintenance costs.



*Time-code information, error messages, even audio level bargraphs can be displayed over a separate video output. On-board speakers reduce equipment costs, save rack space, and make installation easier.*

Replaceable heads and easy access components reduce downtime.

We've given your operators some help, too.

For example, these are the only D2 machines designed specifically for broadcast

that make it easy to change program length. With *program compression*, your operators merely enter the program length required and the machine does the rest. You get no bounce, no blur video, and recovery



*Streamlined control functions reduce operator errors and cut training costs. All machine selections are clearly displayed and easily changed without cumbersome menus.*

of all four audio channels! And because all machine selections are clearly displayed and easily changed without cumbersome menus, operator training time and operator errors are significantly reduced.

Then there's virtually instant lock-up and 60 × shuttle speed to save you time and money,

*The VPR-200 mounts all 3 cassette sizes for flexibility from spots to movies. The VPR-250 handles small and medium size cassettes if that's all you need.*



plus air lubricated tape guides, and . . . but you get the idea.

You may not have thought of video recorders as "business machines" before, but we think your first VPR-200 or 250 will change your mind. Call **1-800-25AMPEX** for more information.

# AMPEX

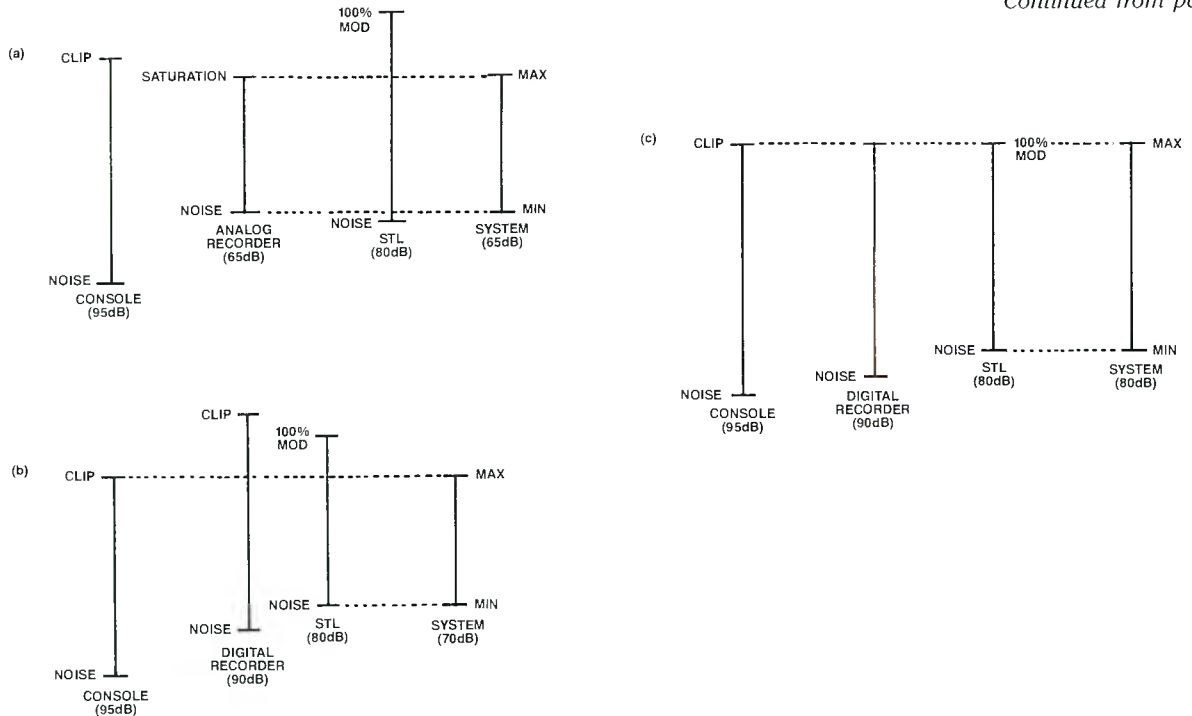
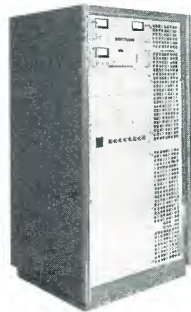

**Figure 3.** The dynamic ranges and noise floors of equipment should be roughly consistent throughout the audio chain. In (a), the console-to-STL misalignment is of no consequence, because the analog recorder defines the system dynamic range. But in (b), an equivalent misalignment between console and STL becomes problematic with a digital recorder. Now, the console clips before the STL reaches 100% modulation, and the STL noise defines the noise floor. System dynamic range is less than any of its component parts. In (c), all maximum levels are aligned, and the STL's full dynamic range defines the system limits.

## COMPLETE YOUR DEFINITION OF "CLASS A," CALL CONTINENTAL ELECTRONICS



500/1000W



3.8 kW



2.5 kW



5 kW

Continental Electronics is here to assist you with your new definition of "Class A." You can increase power, increase revenue base, and expand your listening audience by upgrading your transmitting facility.

Continental has engineered four transmitters to meet your needs. The 500/1000 Watt transmitter is single phase and is only 42 inches tall. This transmitter and the 3.8 kW are totally solid-state and designed for high efficiency and reliability.

The 2.5 kW and the 5 kW transmitters are single tube transmitters. All Continental FM transmitters include an internal harmonic filter and the Ultimate 802A Exciter.

For service after the sale, call the Continental 24-hour tech line. At Continental, service is an attitude, not a department.

So, call your Continental Sales Manager to get the complete definition of "Class A."

**varian**

continental electronics division

P.O. Box 270879 Dallas, Texas 75227  
Telephone: 214-381-7161 Fax: 214-381-4949 Telex: 73398



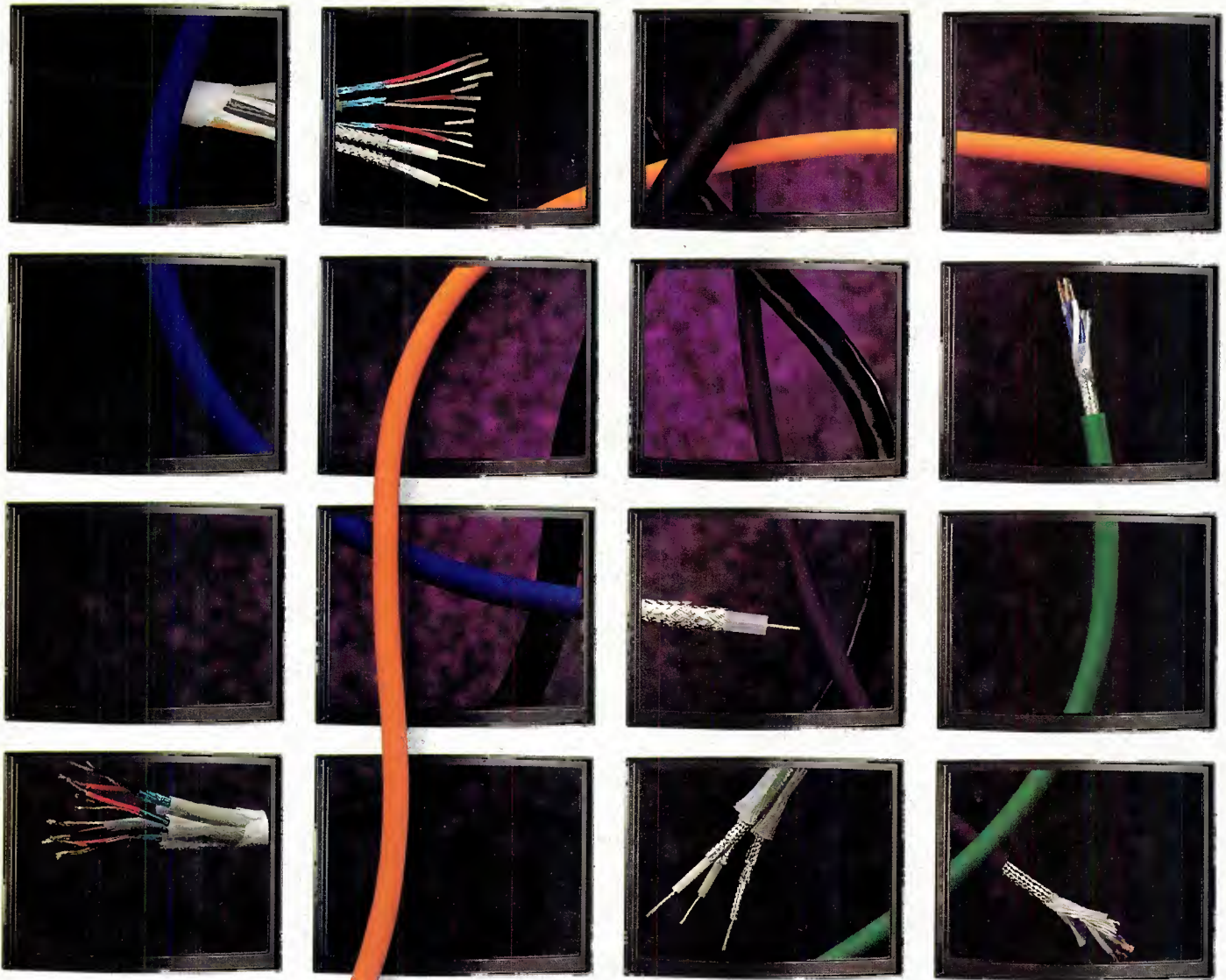

Just as no performer can stay on top without innovation, no company can retain its reputation for performance without product innovation. The standards we've set with our broadcast cables are a reflection of our commitment to product innovation - something that continues today with Brilliance®.

Named for the sound and picture brilliance obtainable through product innovation and improved signal integrity, Brilliance products range from exciting audio/video cable assemblies to the four new cable products below:

**Soft, flexible Microphone Cables.**

The debut of Belden's four-conductor microphone cable

# BELDEN BRINGS THE LIGHT OF INNOVATION TO BROADCAST CABLE

sets an industry standard. Featuring matte finish jackets in a wide range of colors, these new cables are designed to increase cable flexibility while enhancing performance.

**High-Flex and CL 2 Rated Precision Video Cables.**

To solve the problems of rack installations and CCTV systems, Belden has developed a

new 75 ohm precision video cable. High-Flex combines Belden® 8281 electrical performance with improved flexibility and longer flex life.

**Audio Snake Cables.**

Belden now offers a line of multi-pair snake cables. Featuring individually jacketed and shielded pairs, Belden snake cable provides maximum pro-

tection against signal loss. Features include loose tube construction and a non-reflecting black matte finish.

**Audio and Video Composite Cables.**

For systems combining audio and video, Belden has specifically designed cables for ENG and camera applications. They combine off-the-shelf availability with specialty design center technology and fiber/copper composition.

Call your local Belden distributor for our Broadcast Catalog, or contact us directly: BELDEN Wire and Cable P.O. Box 1980 Richmond, IN 47375

**1-800-BELDEN-4**  
(in Indiana, call 317-983-5200)

There is no equal.™



**BELDEN**

# Programmable electronic TIMERS

- Microprocessor-based
- Two to sixteen independent circuits control up to 15 Amps
- Ten (optionally 40) programs
- Cycle times from 2 seconds to 192 hours on each program
- Settable and accurate to the second
- Tamper-resistant locking keyboard
- Less than \$80 per circuit (16 circuit model)

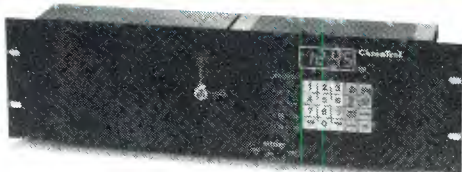

19" rack mount

There's no need to buy 10 different timers for 10 different jobs . . . one ChronTrol does it all! Now you can have precise, automatic control of all your broadcast equipment needs; tape recording, satellite feeds, equipment & signal switching — even remote control via ChronTrol's serial communications port. Field-proven and dependable, ChronTrol's easy operation simplifies your difficult timing jobs. See the latest ChronTrol catalog for full details on our various models.

**CALL FOR A  
FREE CATALOG TODAY—  
TOLL FREE  
(800) 854-1999**  
Outside CA

## ChronTrol®

ChronTrol Corporation  
9707 CANDIDA ST., SAN DIEGO, CA 92126  
(619) 566-5656

© 1990 ChronTrol Corp

Circle (45) on Reply Card

## The 21 Bit Stereo Audio DA

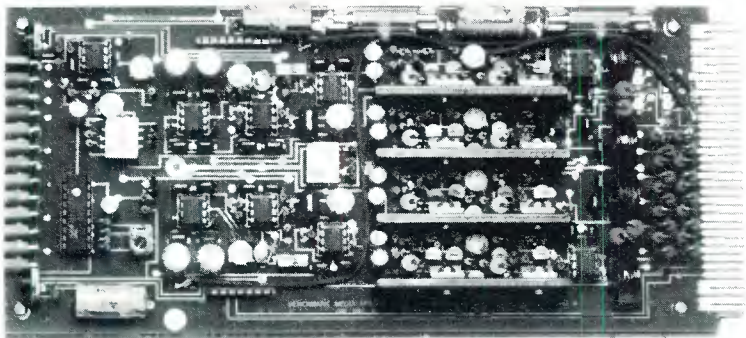

The application of the digital process to audio has been well received. Unfortunately, digital audio has been given a 1970s standard of 16 bits, with its 96 dB dynamic range. To improve upon this, some are using 18 bit converters with 16 bit data, to wring the last drop from an undersized pipe line. Even when an 18 bit standard comes, it's dynamic range will be limited to 108 dB.

Compare that with the spectacular DA-102, and its dynamic range of 130 dB, (21 bits +). That's 34 dB beyond current digital and 22 dB beyond a future 18 bit standard. With digital still in its infancy, the mature analog technology of the System 1000 is the safe long term investment. At an affordable price, you can have the finest today, and build confidently for the future.

Benchmark - anything less is 2 bit technology!

*Benchmark*  
...the measure of excellence™

Call 1-800-BNCHMRK (262-4675) Nationwide

**BENCHMARK MEDIA SYSTEMS, INC.**  
3817 Brewerton Rd. North Syracuse, NY 13212

Circle (46) on Reply Card

cy is below this, typical ac isolation problems are encountered at the second, third and fourth harmonics of the power-line frequency, in which case the two camps can perform equivalently, when at their respective bests.

Most active-balanced amplifiers have a finite tolerance for absolute input level that they can handle without damage, and may show deteriorating common-mode rejection performance as trim values drift over time. Transformers may be worthwhile where large spikes (lightning at an outdoor summer concert, for example) might be encountered, and their CMRR should remain uniform over time. Transformers looking at transformers in every studio interconnection causes unnecessary cost and audio degradation. Active-balanced inputs with well-trimmed and stable CMRR should be selected for these. Also look for the "smart" active systems that can handle high-level input signals and maintain reasonable SNR and CMRR, using active feedback loops or servo balancing techniques.

Servo or similar techniques are useful in active-balanced output stages, to sense when one side of the output is grounded, thereby feeding full level to the single-ended side, and shutting down the grounded leg. This sort of circuit is essential in any active DA.

Good active circuits are probably the best choice when there are many inputs and outputs, budget is finite, and quality is of ultimate concern. For remotes, such as mic-level splitter systems, telco-line interfacing and other potentially hostile environments where protection from the unknown is paramount, the transformer still reigns.

### High RF conditions

With foresight and time, practically every RFI problem can be solved. The foresight involves an RF survey of any potential site, using a variety of devices that are sensitive to magnetic and electric fields. An analog-tuned AM radio set between frequencies or a suction-cup-type telephone pickup coil plugged into a portable-powered speaker are a couple of simple devices. For example, many facilities are unknowingly built above the transformer vault of a high-rise building.

Some interconnection rules for the high-RF environment might also include rack-mounting of all equipment with heavy copper grounding strap connected in multiple locations, tying all open shields (receive end) to their respective chassis with a 0.01µF high-quality monolithic ceramic capacitor, and the use of only well-trimmed, true differential amplifier input stages. Although wide-bandwidth equipment and interconnection is encouraged, this may work to your disadvantage un-

*Continued on page 63*



# Both methods record incredible stereo. Crown's SASS-P makes it fast and easy.

Crown's new Stereo Ambient Sampling System™ (SASS™) and the DAT recorder combine to create a new generation of stereo recording. Unlike traditional recording methods, this powerful new combination is easy to use, more dependable and less expensive. The result is a system that records natural, beautifully imaged stereo just as your ears would hear it.

Crown's SASS-P\* eliminates traditional stereo recording compromises in sound quality, ease-of-use, and cost. No longer do you have to settle for weak low-end or off-axis coloration common to Midside, X-Y and near-coincident pair mics. Assembly and positioning time is also reduced significantly compared with conventional stereo micing techniques.

\*Also available as SASS-B for use with B & K 4003/4006 microphones (not supplied).

Lightweight and easy to set up, the SASS/DAT combination is a high-quality portable recording system that goes everywhere.

The SASS-P features switchable battery or phantom power and Crown's finest studio-grade PZM® capsules. You'll enjoy full ambience without coloration, excellent sum to mono, and extraordinary broad frequency response. With SASS's superb imaging capabilities, every sound is audibly reproduced in its precise position, resulting in a stereo experience of uncanny realism.

Readily adaptable to all common stands, the SASS includes a carrying case and accessories.

No matter what your stereo recording requirements—from sampling to electronic news gathering to remote recording of live events—you'll find the SASS-P the clear choice.

See your Crown representative for more information or call toll-free: 1-800-535-6289.

## SASS Sample CD!

Now you can hear for yourself just how great SASS sounds. This CD includes a wide selection of live and studio music, stereo sound effects and samples, including A-B comparisons with some of the best stereo mics available. The SASS CD is free, but we must charge \$4.95 for shipping and handling charges. Send check or money order to: Crown SASS CD, P. O. Box 1000, Elkhart, IN 46515-1000. Please allow 3-4 weeks for delivery.



Name \_\_\_\_\_  
 Title \_\_\_\_\_  
 Company \_\_\_\_\_  
 Street \_\_\_\_\_  
 City \_\_\_\_\_ State \_\_\_\_\_ ZIP \_\_\_\_\_  
 Phone \_\_\_\_\_



Crown International, Inc. • P.O. Box 1000  
 Elkhart, Indiana 46515-1000 • 219/294-8000

© 1990 Crown International  
 SASS and Stereo Ambient System are trademarks and  
 PZM a registered trademark of Crown International.

Circle (47) on Reply Card  
[www.americanradiohistory.com](http://www.americanradiohistory.com)

# Improve the Means to the End

Introducing Our New Extended Benefits Package:  
Model MCE325 Programmable User Station



Think of it...

a versatile Intercom user station with a wide range of operational and packaging formats.

Physical benefits include a five way modular packaging technique for permanent or portable applications. While headset operation comes standard, adding our MCS325 Speaker and a plug-in microphone supports an open-listening setting.

Operator benefits sport user-friendly software and hardware based programming; the MCE325 can be operationally and functionally configured to suit individual requirements.

As for the small print: the MCE325 works in conference-line or dedicated-line environments, with 2-channel split talk/listen or 4-channel combo talk/listen, in 2-wire or 4-wire line mode, or a combination of both. Also featured are two channels of IFB, two program inputs, and call signaling. Modular packaging includes: rack mount or portable headset station, rack mount or portable speaker station, or console mount headset station.

Please call or write for details.

The First Name In Intercommunications

Professional Intercommunications  
Professional Audio Products

1988 - 1989

Engineering  
Emmy Award



**RTS SYSTEMS**

A Telex Communications Company

1100 West Chestnut Street  
Burbank, California 91506  
Phone 818-566-6700  
Fax 818-843-7553

Circle (48) on Reply Card



Continued from page 60

der these conditions. RF filters, traps or chokes may be employed especially if the offending frequency is known. If multiple frequencies are involved, be sure to consider sum and (especially) difference products.

### The digital environment

In many ways, digital audio was the best thing that could have happened to analog, because digital forces analog to be at its best. The D/A hybrid studio environment puts stringent requirements on analog interconnections because noise floors are lower, and more revealing of formerly tolerable ground-fault noise. Ac power capacity and stability also become more important in the digitally equipped facility.

In order to get the most out of your systems, proper end-to-end gain structure also is important. When analog recorders were the limiting factor, it didn't matter whether reference levels of surrounding equipment weren't optimally aligned to the recorders' reference levels, as long as the clip point or noise floor of the other devices did not fall inside the dynamic range of the recorders. (See Figure 3a.) However, with digital recorders' dynamic range roughly equivalent to everything

else in the signal path, anything can be the limiting factor, and whatever device is most misaligned will be it. (See Figure 3b.) A careful review of each device's dynamic limits is required, with system gain structuring designed to have everything clip at approximately the same point. A reasonable reference level should then be decided upon and stuck to, with at least 15dB of headroom recommended. (See Figure 3c.)

Digital interconnection is still an open book, but, at present, standard low-capacitance cable will be sufficient for most applications, with coaxial cable used for multichannel, multiplexed links. Advantages include stereo feeds on a single cable, relative immunity to EMI pickup, and the inclusion of certain control parameters embedded in the audio data-stream, along with the obvious reduction in audio degradation inherent in the transmission of signals in the digital domain, through the avoidance of D/A conversion. Now there are "families" of hardware designed to be used with only digital intermediate interconnections, having analog interfaces only on the front and back ends of the chain.

On the other hand, digital audio paths have the potential to produce significant

EMI levels, so they should be kept separate from analog lines. Differences in channel formatting, connector types and termination also dictate such a segregation.

Optical interfaces seem to be in our future, mainly for long-line application. Optical interfaces are insensitive to it and produce none. Optical fiber can be run along analog audio or power conductors with impunity. However, fiber links do not allow distributed busing; each output can feed only one input, in a point-to-point method. Active splitting or regeneration is required for a distributed network.

Time will only tell regarding formats, but a safe bet for fully professional equipment is the AES/EBU digital audio interface standard, with its balanced, stereo-on-a-single-XLR configuration, and ability to use standard cable up to 100m lengths without equalization. With the frequencies involved (100kHz to 6MHz), we are back to a terminated system, this time using 250Ω. No more than four inputs should be fed from a single output.

Meanwhile, a proliferation of consumer digital audio interfaces exists, with the S/PDIF and IEC 958 Form II, Type I formats predominant, both using a single RCA phono cable for stereo signals. Although some interchange among the dig-

### Hardware Software Production Services

- Audio, Video and Broadcasting equipment
- Satellite TV
- Telecommunications
- A/V/B installation and servicing
- Audio and Video production
- Audio and Video post production
- TV networks
- Radio networks

**Pavilions:** 19-20-21-22  
**Open:** 9.30 a.m. - 6.00 p.m.

**Entrance reserved  
to trade operators**

**mem**

International Market of audio  
and video programmes and services

**18-22 October 1990**

**MILAN TRADE FAIR  
South Pavilion  
Milan/Lacchiarella  
Italy**

**IBTS**

**5TH INTERNATIONAL AUDIO, VIDEO,  
BROADCASTING AND  
TELECOMMUNICATIONS SHOW**

General Secretariat IBTS: Via Domenichino, 11 - 20149 Milan (Italy) • Tel. (02) 4815541 • Fax (02) 4980330 • Telex 313627 I

Circle (36) on Reply Card

ital formats is possible, control and program data may be corrupted or lost, even though audio may pass compatibly. During this transitional time, and perhaps even for the long term, an active digital format converter system may be advisable for many facilities. This device would be housed in a rack, adjacent to the patchfield.

A potential format for multichannel digital interconnection is multichannel audio digital interface (MADI). A single 75Ω, BNC-terminated coax carries 56 channels, for up to 50m lengths. Fiber may be used for longer MADI runs. Some time-base synchronization may be required, depend-

ing on the digital audio format(s) and hardware used. A house-sync generator and routing system will serve this purpose in much the same way as it does in a video production house. More sophisticated control methods also are possible, with the musical instrument digital interface (MIDI) format a likely candidate. It is already used in many production studios for a variety of applications. MIDI is an 8-bit, 31.25kb/s serial data format. Standard shielded, twisted pair cable is used, with standard 5-pin DIN male plugs on both ends. Pin 2 is ground (connected on one end only), and pins 4 and 5 carry data. Many digital audio devices are equipped with the MIDI

inputs, and their parameters can be controlled as software allows in preset and real-time modes. MIDI-to-SMPTE interfaces are available to interlock MIDI-controllable devices to SMPTE-striped multitrack tapes or clocks.

Interconnection in audio facilities is not a mastered skill. The lack of specific standards in the industry from technical grounding to audio signal polarity (pin 2 or 3 hot?) makes matters worse. Only attention to detail and a solid theoretical and practical understanding of the physics and formats involved will guarantee success — most of the time. As they say in show biz, connections are everything.

## Water under the bridge

One way to explain the operation of impedance-bridging distribution systems is with the waterflow analogy. (See Figure A.) Instantaneous changes in water pressure correspond to the voltage fluctuations of the input signal.

In (a), the source-pipe's diameter ( $Z_{out}$ ) is equal to the receive-pipe's ( $Z_{in}$ ) and maximum water (i.e. power) flows.

In (b), a wide pipe (lo- $Z$ ) feeds a narrower one (hi- $Z$ ), and pressure variations (i.e. voltage) are passed, without much water actually flowing.

In (c), a narrow source attempts to feed a wider one, and has insufficient water to do the job.

In (d), a wide source pipe is easily able to pass its pressure variations on to several narrower pipes, with water still to spare.

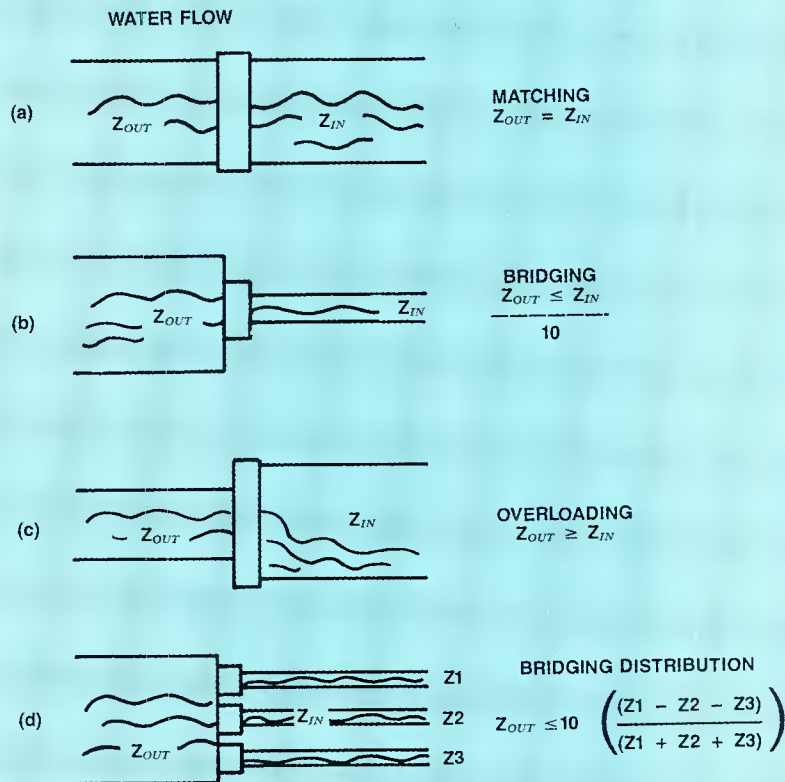

# INTERNATIONAL BROADCASTING CONVENTION

IBC90 will as in previous years, offer an ambitious Technical Programme covering all aspects of broadcast engineering and related subjects. Enhanced and High Definition television is expected to feature prominently in the papers, along with the problems of implementing new standards and services and their interaction with existing facilities.

The IBC Exhibition will reflect the leading edge of Broadcasting Technology, with the world's top manufacturers demonstrating their latest products. Also represented will be the increasing number of smaller specialist companies who play a vital role in the industry.

A comprehensive Social Programme will be arranged.  
The prestigious IBC Award for IBC90 will be presented at the Champagne Reception during the Convention.  
Further information can be obtained by contacting Adrienne Banks on 01-240 1871 Extension 346

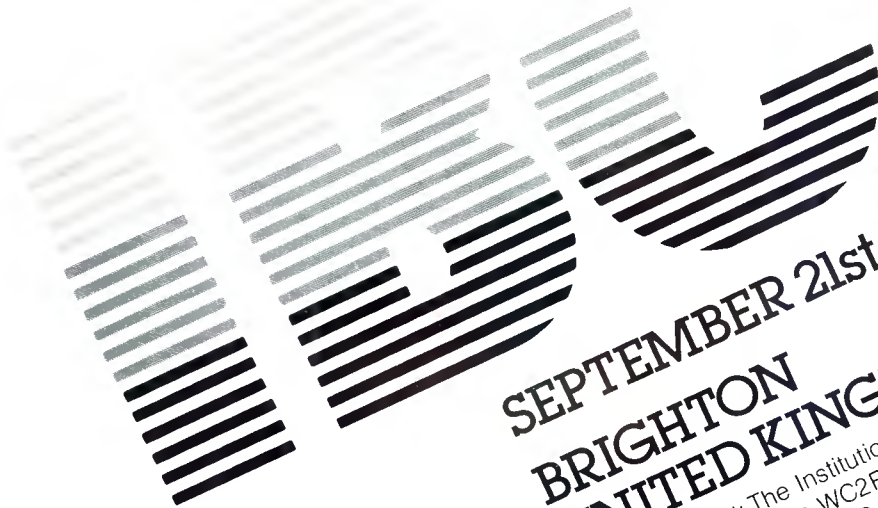

1990

SEPTEMBER 21st - 25th 1990  
BRIGHTON  
UNITED KINGDOM

IBC Secretariat: The Institution of Electrical Engineers,  
Savoy Place, London, WC2R 0BL Telephone: 01-240 1871  
Telex: 261176 IEE LDN G Fax: 01-240 7735

# User's guide to TVRO performance



By Warren H. Davis Jr.

## Tests and upgrades mean peak performance from satellite equipment.

Video and audio distribution via satellite has never been more important for broadcasting. In addition to being an established method of program transportation for sports and special events, commercial spots and syndicated programs are also carried in space. As newsgathering via satellite continues to expand, being "satellite capable" is virtually mandatory.

Achieving and maintaining broadcast-quality performance with a TVRO system can be rewarding and frustrating. Even though the system may be up and working, signal quality will degrade over time, and the pictures may look as if they have traveled 46,000 miles. Correcting satellite problems may be time-consuming and sometimes expensive, but it is usually an achievable goal.

Consider the physical methods by which you can improve the performance of satellite earth stations. Also, how can link-budget calculations provide the performance by which you can measure the effectiveness of maintenance efforts?

### Spring cleaning

We will begin by examining a 5-year-old, fixed, C-band 7m antenna, pointed at Telstar 301. As with similar installations, two C-band low-noise amplifiers (LNAs) are mounted on a focal point, dual-orthomode feed, with a 100-foot cable run to the studio. The dish has a 4-way passive splitter on each polarity. Power inserters on each of the two feedlines power the LNAs. There are four 4GHz satellite receivers, two of which are tuned to ABC, transponder 12-horizontal. The link-

budget for such a system is shown in Table 1.

With this link-budget performance, you expect the system to produce acceptable-quality video and audio. Table 2 shows the RS-250C satellite specification, which is considered broadcast quality. By comparing the two tables, you can see that the TVRO is not performing to design specifications. The video signal-to-noise (S/N) ratio is 51dB (lum wt.); the RF input level at the splitter is -69dB. A tune-up is in order.

### Begin at the antenna

Test the antenna for parabola shape and accuracy by placing a string across the center of the antenna from one side to another. Place another string 90° around the dish edge from the first, forming an "X," with four even antenna sections between the two strings. In a properly shaped dish, the strings should touch lightly at the center of the "X." If there is a gap, note its amount. If the strings are pulling on one

another, switch the strings so a gap is formed at the center of the "X." A gap between the strings indicates the antenna has sagged out of shape or was never structurally aligned in the first place. The antenna's gain efficiency is reduced because it was not fully maximizing the reflected RF signals to the feed point. Adjust the antenna's structural supports until there is no gap between the strings. (See Figure 1.)

Clean the entire feed assembly, especially inside the orthomode coupler. Check for corroded fittings on the LNAs and inspect the structural integrity of the feed assembly.

Begin repeaking the antenna using a power meter at the receiver's IF, making sure the receiver is tuned to an active transponder. Switch to a manual gain mode (to disable the AGC), and turn the AGC off to prevent the receiver from locking on any terrestrial interference that may be present. If a power meter is not available,

EIRP	34.0dBw	System Noise	126.6 DEG K
Antenna to LNBC loss	0.1dB	G/T system	26.0db/DEG K
Antenna gain	47.0dB	C/N ratio system	17.0dB
Ambient temp C	35.0 DEG	S/N ratio system	56.7dB
Antenna noise at elev	27.0 DEG	Audio S/N	66.1dB
Cable Loss	20.0dB	RF amplitude	-50.0dBm
LNA gain	55.0dB		
LNA noise temp K	90.0 DEG		
Receiver noise temp	13.0dB		
Receiver bandwidth	36.0MHz		
Free-space loss	196.0dB		
Video deviation	12.2MHz		
Video bandwidth	4.2MHz		

Davis is manager of product and technical operations for Standard Communications, Los Angeles.

Table 1. Existing system C-band link budget.

# Quick Terminations



## “Meet the Fastest Gun in the West”... Switchcraft

In a showdown, no other audio patch panel is “faster on the draw” than the APP Series from Switchcraft.

Bullet quick terminations are achieved with color-coded insulation displacement connectors (IDCs) that provide speedy wiring access of T, R, S, TN & RN termination points. One simple tool eliminates the need for wire stripping and makes connections fast and easy.

*Other sharp shooting features include:*

- **Versatile Configurations:** The APP can adapt to any installation as a full assembly, front panel only with 48 jacks installed and cabled to rear panel, or rear panel only.
- **Easy Wire Management:** Wiring guides and cable



support bar offer convenient wire routing.

- **Many Normalling Options:** Including top and bottom normals, half normals, and others.

Plus, Switchcraft manufactures a complete line of technologically advanced audio components, jacks, cords, connectors, plugs, and audio adapters.

You don't have to bite the bullet and put up with inferior audio products. Insist on genuine Switchcraft audio components "... from the fastest gun in the West."

## Switchcraft

A Raytheon Company

5555 N. Elston Avenue  
Chicago, Illinois 60630

For instant response to your questions or for more information, call our audio department at 312/792-2700 or FAX 312/792-2129.

Circle (61) on Reply Card

[www.americanradiohistory.com](http://www.americanradiohistory.com)

use a spectrum analyzer at 4GHz or the receiver's IF. When a spectrum analyzer is not available, reactivate the AGC and measure the AGC voltage change.

While adjusting the azimuth and elevation, don't stray onto a sidelobe. The wavefront from a satellite resembles the circular waves of a stone dropped in a pond. Only at dead center is there full am-

plitude, all the other waves are greatly attenuated. Enough signal might be present to yield an image, but it will be subject to increased noise and interference. The signal strength on a properly aimed dish will roll off rapidly when the dish is moved in any direction. A dish tuned to a sidelobe will show a gradual trail-off of energy in one axis. (See Figure 2.)

Next, adjust the antenna's feedpoint for correct polarization. This is accomplished by looking at a cross-polarized signal and tuning for minimum interference. Connect a power meter to the receiver's IF or use one of the other methods described previously. Tune the receiver to an occupied transponder of the opposite or wrong polarity. This may require temporarily

Amplitude response as a function of frequency:	0.7dB
Chrominance-luminance gain inequality:	4.0 IRE
Chrominance-luminance delay inequality:	26.0ns
Field time distortion:	3.0 IRE
Line time distortion:	1.0 IRE
Short time distortion:	2% SD
Luminance non-linearity:	6%
Differential gain (10-90%)	4%
Differential phase (10-90%)	1.5 DEG
Chrominance-to-luminance intermodulation:	2.0 IRE
Chrominance non-linear gain:	2%
Chrominance non-linear phase:	2.0 DEG
Chrominance non-linear intermodulation:	2%
Signal-to-noise ratio (lum. wt.):	54.0dB
Signal-to-low frequency noise ratio:	50.0dB
Signal-to-periodic-noise ratio:	63.0dB
Amplitude response as a function of frequency:	0.5dB
Total harmonic distortion:	0.5%
Audio S/N ratio:	58.0dB

Table 2. RS-250C satellite specifications.



# Wide Band

## Video Distribution +/- 0.75 dB @ 60 MHz!

### Model 220

- 1 input, 6 output
- high performance spec.
- +/- 3 dB gain

### Model 222

- Switchable Clamper
- Eq. to 1000' 8281 cable
- Slew rate > 250 V/μsec.



**di-tech**

Moderately Priced. Ideal for  
HDTV, RGB and all general uses

48 Jefryn Boulevard, Deer Park, NY 11729  
Tel: (516) 667-6300 • Fax: (516) 595-1012

Circle (62) on Reply Card

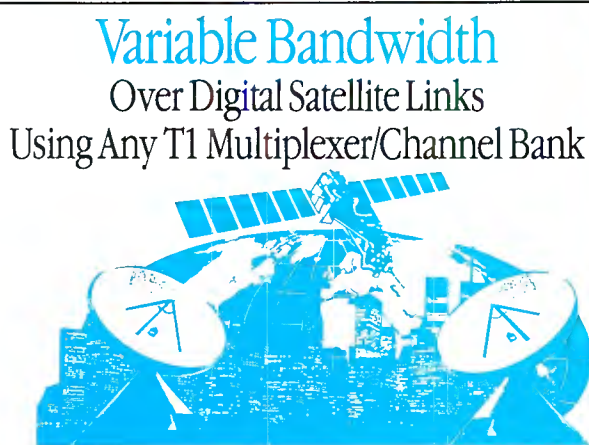

With Intraplex's  
DRR-1500 Digital Rate Reducer

- Conserve satellite bandwidth; lower your transmission costs
- Offer fractional T1 over satellite; free bandwidth for new users
- Link any T1 multiplexer or channel bank; compatible with your existing digital network
- Connect only the required DSO channels; adaptable to all of your traffic requirements



**Intraplex**

Intraplex, Incorporated, 59 Porter Rd., Littleton, MA 01460-3427  
TEL: (508) 486-3722 / FAX: (508) 486-0709

Circle (63) on Reply Card

# FLIPS AND TUMBLES

**A**LTA's new Pictoris EDE delivers first-class digital effects like flips, tumbles and curvilinear moves—all at a price that'll make you smile.

There's more—the EDE features 5.5 Mhz bandwidth in both composite and Y/C modes, a built-in keyer, auto transition keys and a bag full of effects including strobing, posterization and mosaic.

Create your own custom moves and



transitions, then store them in removable memory as small as a credit card.

Video quality? Shrink it down—way down. You'll like what you see. Images are crisp, clear—terrific. Try that with the other guys!

The EDE can be purchased as a stand-alone product, or as an upgrade—simply replace the keyboard on any existing Pictoris.

Like our other products, the Pictoris EDE is built to deliver reliability that our customers say is like money in the bank.

The Pictoris EDE from ALTA. Smart. Cost-effective. Easy. Check it out.

Call or fax us today for more information or to request our demo tape. Let us show you how to get flips and tumbles that won't leave you tossing and turning.

**1-800-677-ALTA or  
Fax 408-297-1206.**

**ALTA**  
GROUP, INC.

*Dynatech Broadcast Group*

535 Race Street  
San Jose, California 95126

**NEW**

# AT A PRICE THAT WON'T MAKE YOUR HEAD SPIN

Ask about another new ALTA product—the new Pegasus video production switcher.

Circle (49) on Reply Card

[www.americanradiohistory.com](http://www.americanradiohistory.com)

repatching or disabling the automatic-polarization switching relay system. Disable the AGC, and rotate the feed assembly until minimum signal power is achieved.

Never adjust antenna polarity by measuring peak power of a received signal of the correct polarity. The signal dip at the polarity "null point" is more than twice as deep as the signal peak at the "in-

phase" point is high. It is more accurate to tune for the dip. Restore all cabling to its proper position.

Examine the LNAs and feedline system. Connect a power inserter and 4GHz spectrum analyzer at the LNA's output. Measure the signal strength of the desired transponder Transponder 12 on the test antenna should measure approximately  $-30\text{dBm}$  before the cable run. To calculate your expected signal strength at the LNA output, work through the following loss budget equation:

$$(((\text{Transponder EIRP dBw} + 30\text{dB}) - \text{free-space loss dB}) + \text{antenna gain dB}) + \text{LNA gain dB} = \text{LNA transponder output level} - \text{dBm}$$

Example:

$$\begin{aligned} (\text{EIRP } 34\text{dBw} + 30\text{dB}) &= +64\text{dBm} \\ (+64\text{dBm} - 196\text{dB free-space loss}) &= -132\text{dBm} \\ (-132\text{dBm} + 47\text{dB antenna gain}) &= -85\text{dBm} \\ (-85\text{dBm} + 55\text{dB LNA gain}) &= -30\text{dBm} \end{aligned}$$

Reconnect the feedlines and measure the signal level at the input to the splitter at the back of the receivers. The decrease should equal the signal level at the LNA output minus the total calculated cable loss. In this case, 100 feet of RG214 at 4GHz is 20dB loss. The signal level for the test system should be  $-50\text{dBm}$  at the input of the splitter.

Connect the signal to the splitter and test each output port for signal level. In this test system there should be  $-57\text{dBm}$  at the splitter outputs, with not more than 0.5dB variance in output level per port. Check all connections from the splitter's outputs to the receiver's inputs.

In the TVRO of this example, the system check revealed the following irregularities:

1. The antenna's foundation had settled over time, causing antenna misalignment (approximately 1.5dB C/N increase).

2. There was only 15dB of cross-polarization isolation. This was corrected to 26dB isolation (approximately 1dB C/N increase).

3. The cable run had a bad connector at the LNA output causing the test polarity to have a 12dB reduction in signal level. This caused the connected receivers to be on the edge of input level sensitivity. When this was corrected, the receiver's S/N increased more than 2dB (lum wt.) because the receiver was not operating within its input level threshold.

The system parameters were re-measured following repairs and adjustments. This time the system showed a video S/N of 55 dB, which is close to the sys-

*Continued on page 74*

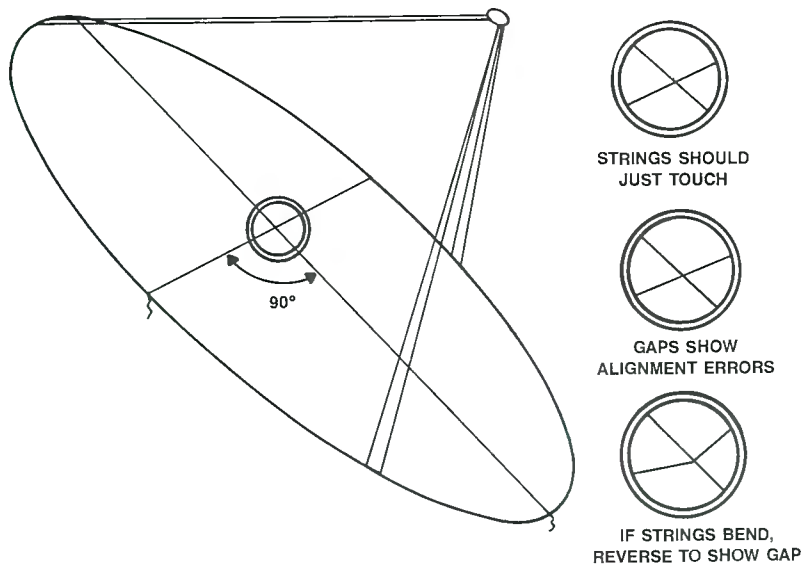

Figure 1. "Taut-line" test uses string to test dish alignment.

# THIN *and* LOUD

## AMPLIFIED STEREO MONITOR SPEAKER

Model 1020M - Amplified Monitor Speaker

- ▶ Only *one* rack space high
- ▶ Exceptional high (28w) output
- ▶ Full-range, high fidelity sound
- ▶ Magnetically shielded
- ▶ Includes LED peak level meters

For information & dealers call:  
TEL 415 527-6666

*"You have to hear it to believe it"*

**Clear-Com**  
SYSTEMS

Circle (52) on Reply Card





# ALL TETRODES ARE NOT CREATED EQUAL.

Beware. If it's not an original Thomson tetrode, you're not getting Thomson performance, reliability and longevity.

Isn't your station worth it? We carry a full stock of our tetrodes, so you can buy direct from the source.

Circle (65) on Reply Card

All tetrodes are available for immediate delivery. To order, simply contact us at the address below.

 **THOMSON ELECTRON TUBES  
AND DEVICES CORPORATION**

For additional information, mention code **TS**

40G Commerce Way - P.O. Box 540 - Totowa, New Jersey 07511 - Tel: ( 201 ) 812-9000 - Fax: ( 201 ) 812-9050

[www.americanradiohistory.com](http://www.americanradiohistory.com)



# ONE TAPE WON'T BREAK AT THE FINISH LINE.

To be a leader in video, you have to run in the fastest lane of all: The path over the tape heads. **LINE.** that keeps you on the leading edge of video production. So you're not just buying

Which is why the video leaders of TBS chase Sony professional videotape. editing, shuttling, juggling—and deadlines. In short, it's do or die. Alternatives

After all, leaders tend to recognize which demand a great support team. the world-class videotape company.

leaders. For example, at the Goodwill Games, the producers and engineers know you responsive sales representatives, Sony. The leader

Sony tape will endure constant still frame technical support and in-depth research video leaders follow.

**SONY**  
PROFESSIONAL VIDEOTAPE



# Make order out of your audio cabling chaos



Cannon MASSCON Connectors:  
up to 216 contacts per cable

Get rid of your audio cabling chaos once and for all. Get massive, single-cable connection with field-proven MASSCON circular connectors from Cannon. Originally developed for hostile environment applications, these rugged and versatile mating devices are manufactured in 122, 176 and 216 pin versions.

Cannon MASSCON connectors have hermaphroditic polarization: their self-mating design incorporates hooded, closed-entry contacts with rear insulators for positive retention. Cable repair is quick and simple; protective caps are provided for use when connectors are unmated. All contacts are gold plated.

End cabling chaos now. Get in touch with ITT Cannon today for the information you need about MASSCON.

ITT Cannon, Dept BE-90  
Four Cannon Court  
Whitby Ontario  
Canada L1N 5V8  
Phone (416) 668-8881  
Fax (416) 668-4152



**ITT Cannon**  
An ITT ElectroMechanical Components Worldwide Company  
*Discover our strengths.*

Circle (66) on Reply Card

Continued from page 70  
tem's theoretic of 56.7dB and only 0.4dB below RS-250C specification.

## About TI

At one time, each receive dish was licensed and qualified for protection from terrestrial interference (TI). For the past several years, most facilities have neglected the licensing step. As a result, terrestrial microwave systems operating in the 4GHz region will cause considerable interference to a TVRO facility, and the TVRO operator has no legal recourse against the interference source.

Several definite steps can be taken to conquer TI. These range from passive skirts around the antenna dish, which prevent the entry of off-axis radiation, to elaborate filtering systems that notch out the offending signals. Any time the performance of a TVRO is degraded, and the steps mentioned previously do not provide the desired improvement, check thoroughly to ensure you are not fighting a TI problem.

## On to Ku

Let's consider the task of upgrading this installation. Our goal will be to add Ku-band capability and to make the dish steerable by remote control. The system will be designed to achieve RS-250C specifications on all C-band 10.75MHz to 12.2MHz deviated signals and all Ku-band 9.1MHz to 13.8MHz deviated signals, full- and half-transponder. The weakest C-band EIRP for the test site will be 34dBw and the weakest Ku-band will be 39dBw at half-transponder.

The first step is to change some hardware. Instead of LNAs, the system will use four (950MHz-1,450MHz) low-noise block converters (LNBCs) for maximum C-/Ku-band flexibility. A new antenna will be required because the surface tolerance on the existing 7m dish is 0.0035rms, degrading its Ku-band gain efficiency to less than 40%.

Retrofitting the feed assembly for C-/Ku-band and the antenna mount to a steerable type would not be cost-effective. An AZ/EL-driven, computer-controlled-type antenna system with a 4-port C-/Ku-band rotating feed assembly will allow C- or Ku-band polarities to be received at once, and also permit redundant switching of LNBCs for critical feeds.

Because higher efficiencies are available in today's satellites and receivers, it may not be necessary to replace the 7m dish with a similar-sized unit. Based on the link budgets shown in Table 3, a 5m C-/Ku-band antenna would suffice.

The 4GHz satellite receivers will be replaced with a 950MHz-1,450MHz C-/Ku-band-compatible, computer-controlled, RS-250C performance-type receiver design.

## About channel splitting

The TVRO system will be built to receive all C-band and all Ku-band full-/half-transponder signals. The difference between C-band and Ku-band full-/half-transponder operation needs to be fully understood. The original system was designed for 24-channel operation on C-band Telstar 301. The receiver's main IF band-pass filter was optimized for ABC's video

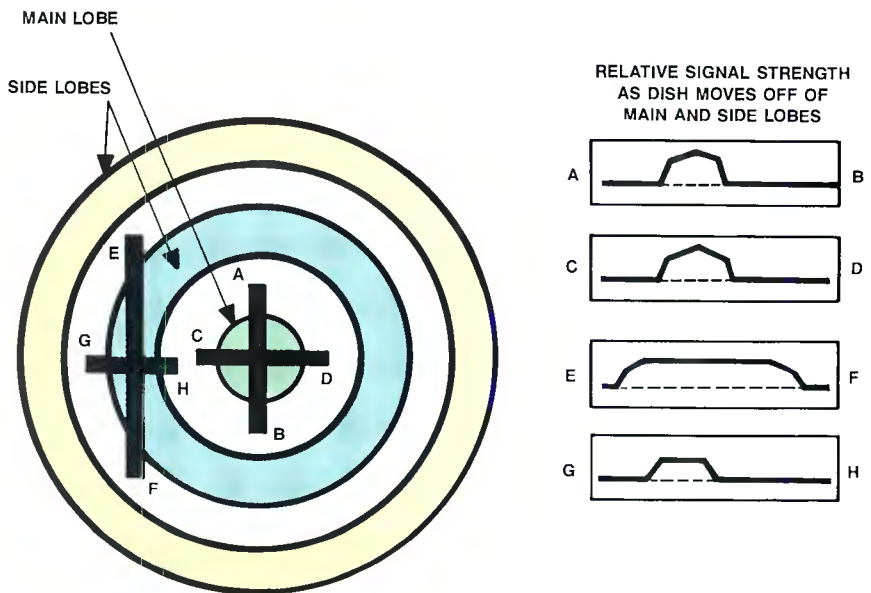
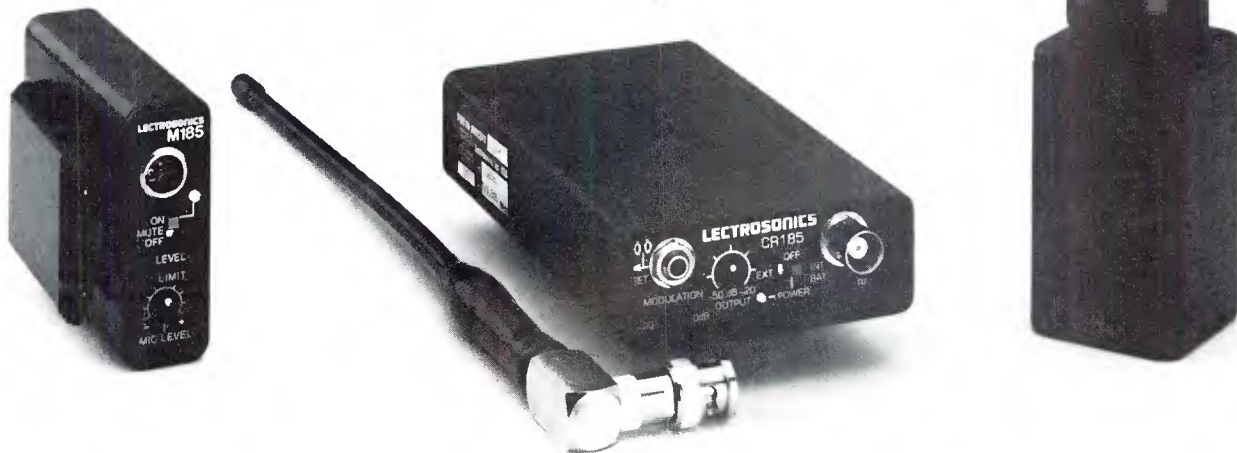

Figure 2. Relative signal strength as a function of dish-pointing accuracy.

# Who makes the best ENG wireless microphone system?



## The best mini-receiver . . .

The CR185 offers a six-pole helical resonator front-end, followed by narrow-band crystal IF filtering at 21.4 MHz. This provides unmatched selectivity and sensitivity, and minimizes drop-outs and interference. A balanced, XLR output interfaces with any professional camcorder.

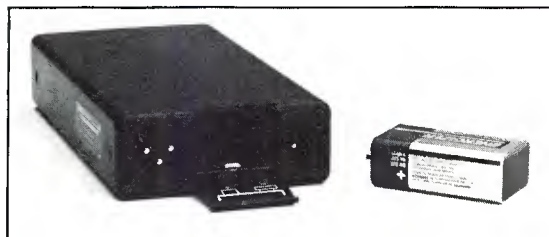

## The best belt-pack transmitter . . .

The M185 is a highly refined belt-pack transmitter. It matches any input requirement and provides "phantom power" for almost any lavalier microphone via a standard 5 pin jack. The belt-clip is constructed of machined aluminum and steel parts, spring-tensioned for a secure fit on any belt or fabric. Audio level LEDs are provided on the control panel for accurate level adjustment.

## The best "plug-on" transmitter . . .

The H185 introduces new flexibility to your ENG operations. It makes any hand-held or shotgun mic with an XLR connector wireless. The microphone body becomes part of the antenna circuit, forming a very efficient RF radiator. The audio input level is indicated by two LEDs next to the microphone coupler. These LEDs are clearly visible with the microphone attached for accurate level adjustment.



## The best construction . . .

All external parts are constructed of machined aluminum for ruggedness and durability. Shock-mounted crystals are used in the IF filtering and oscillators for reliable operation. The transmitters and receiver are built for the real world of hard knocks.

## The best factory support . . .

Whether it's frequency coordination or follow-up service, Lectrosonics will come through. Our commitment to the needs of broadcasters is second to none. Call us with questions, and you will get answers that make sense.

Call us toll-free to locate  
your nearest dealer:

**1-800-821-1121**



**LECTROSONICS, INC.**

P.O. Box 15900 • Rio Rancho, NM • 87174  
581 Laser Rd. NE • Rio Rancho, NM • 87124  
(505) 892-4501 • (800) 821-1121



# GLOBAL SUPPORT FOR GLOBAL COMMUNICATIONS

## C-Band, Ku-Band and D.B.S. High Power TWT Amplifier Systems

For Video, Voice and Digital Communications  
50-3000 Watt

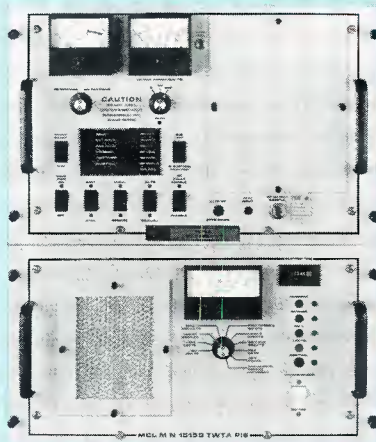
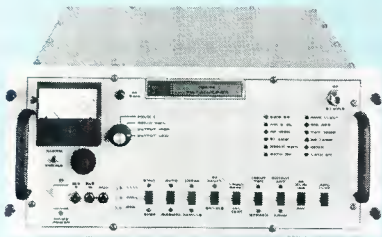

Designed exclusively for satellite earth station use, MCL's High Power TWT Amplifier Systems meet the demand and discriminating stringent requirements for maximum signal purity and uncompromising reliability. All MCL amplifiers share commonality in operation, design and mechanical layouts to facilitate interchangeability and to minimize maintenance and repair. MCL equipment is depended upon worldwide to operate at optimum efficiency . . . even in the most remote, unattended locations and under the most adverse conditions.

MCL offers a host of C-Band, Ku-Band, and D.B.S. High Power TWT Amplifier Systems featuring:

- Double Drawer Amplifiers (300 to 750 C, Ku and D.B.S. Band)
- Single Drawer Amplifiers (50-300W Ku; 75-700W C-Band)
- Single Cabinet Amplifiers (2.5K-Ku; 3KW-C-Band)
- Special Tube/Helix Protection Measures
- Amplifier Performance Readout/Control
- High Voltage Component Protection
- Build-in "Remote" Capability

Turn to MCL for high quality, competitively priced satellite communications equipment of truly *unequalled* performance . . . guaranteed.

Technical specifications and details on the complete line of MCL C-Band, Ku-Band, and D.B.S. High Power TWT Amplifier Systems may be obtained by writing or calling MCL today. Simply request your complimentary copy of MCL's New, comprehensive Brochure #6008.



# MCL

**MCL, INC.**  
501 S. Woodcreek Road  
Bolingbrook, IL 60439  
708-759-9500 TWX 910-683-1899  
FAX 708-759-5018

Manufacturers of TWT and Klystron Amplifiers for Satellite Communications.  
24-Hour Sales and Technical Support for Immediate Service Worldwide.

deviations of 12.2MHz (approximately 32MHz -3dB BPF). If these receivers were to be used for other C-band satellites they would need a second IF bandpass filter for general 10.75MHz deviated signals (approximately 30MHz -3dB BPF). A third and fourth could be required for half-transponder-reception.

The existing receivers could never be used on the Ku-band satellites because of their fixed IF bandwidth, 4GHz input and 24-channel C-band satellite format. The Ku-band 11.7GHz-12.2GHz RF downconversion standard is 950MHz-1,450MHz domestic and 950MHz-1,750MHz international. There is no real Ku-band transponder channel format standard like the 24-channel format C-band satellite follow. Almost all C-band satellites have 36MHz wide, 24-channel transponders. Ku-band satellites have from 10 to 24 transponders that vary in bandwidth from 27MHz to 104MHz. With wider bandwidth transponders and increased downlink power, Ku-band satellite transmissions are not

C-BAND TRANSPONDER DIAGRAM  
CENTER FREQUENCY

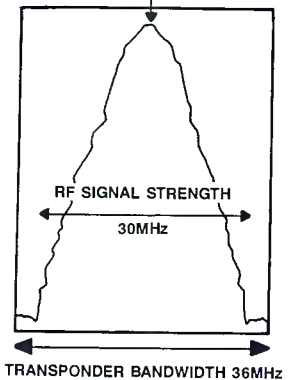

KU-BAND FULL-TRANSPONDER DIAGRAM  
CENTER FREQUENCY

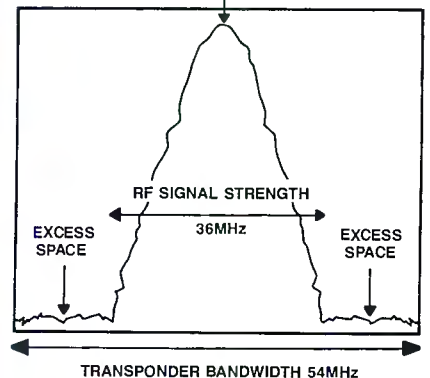

Figure 3. Full transponder C- and Ku-band signal bandwidths.

Circle (69) on Reply Card

# Innovation.



**Grass Valley Group<sup>®</sup>**

A TEKTRONIX COMPANY

*At the heart of Television*

For ideas that reshape the television industry, nobody supports you like GVG.<sup>®</sup>

NORTH AMERICA Grass Valley, CA (916) 478-3000

SOUTH AMERICA Miami, FL (305) 477-5488

EUROPE Basingstoke, Hampshire (0256) 817817

ASIA Hong Kong 7874118

Circle (70) on Reply Card

[www.americanradiohistory.com](http://www.americanradiohistory.com)

EIRP Antenna to LNBC loss Antenna gain Ambient temp C Antenna noise at elev Cable loss LNBC gain LNBC noise temp K Receiver noise temp Receiver bandwidth Free-space loss Video deviation Video bandwidth	34.0dBw 0.1dB 45.0dB 35.0 DEG 25.0 DEG 10.0dB 60.0dB 40.0 DEG 13.0dB 30.0MHz 196.0dB 10.75MHz 4.2MHz	System Noise G/T system C/N ratio system S/N ratio system Audio S/N RF amplitude	73.1 DEG K 26.4dB/DEG K 18.3dB 56.0dB 66.5dB -37dBm
EIRP Antenna to LNBC loss Antenna gain Ambient temp C Antenna noise at elev Cable loss LNBC gain LNBC noise temp K Receiver noise temp Receiver bandwidth Free-space loss Video deviation Video bandwidth	39.0dBw 0.1dB 54.0dB 35.0 DEG 30.0 DEG 10.0dB 60.0dB 80.0 DEG 13.0dB 25.0MHz 206.0dB 9.1MHz 4.2MHz	System noise G/T system C/N ratio system S/N ratio system Audio S/N RF amplitude	119.1 DEG K 33.2dB/DEG K 20.9dB 56.4dB 68.4dB -33dBm

Table 3. New system C-band link budget, and new system Ku-band link budget.

## ZERO LOSS VIDEO DELAY

### bvs DL 705 SERIES

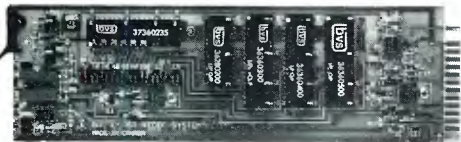

- Transparent video timing
- Delays from 10 ns to 1945 ns via jumpers and fine trim
- Up to 12 cards in 2 RU frame
- Looping input, 2 outputs per card
- Input and output return loss better than 40 db
- Flat response to 5.5 MHz
- Phase equalized
- Versions to plug directly into popular DA frames

### broadcast video systems ltd.

40 West Wilmot Street, Richmond Hill, Ontario L4B 1H8  
Telephone: (416) 764-1584 Telex: 06-964652 Fax: (416) 764-7438

Circle (71) on Reply Card

## Stamp Out SCR Buzz. Forever.

Diff amps may work – when far from SCR dimmers and RF transmitters. When you're up close, you'll need a good transformer.

### jensen transformers INCORPORATED

10735 Burbank Blvd. • North Hollywood, CA 91601  
FAX (818) 763-4574 Phone (213) 876-0059  
TELEX 6502919207 MCI UW

(Mon-Thurs, 9am-5pm Pacific time)

Circle (73) on Reply Card

### Free Catalog & Audio/Video Applications

Routing Switchers (St-A/V)  
(24,16,12,8,4,2 stations)

Mic, EO, Line, Tape, Phono, Osc, Trans., Video, ACN, Pwr. Supp.

Press Boxes 1-1/16" out

Video & Audio Dist. Amps. 2-in/24-out Audio

RGB-Sync Dist. Amps.

OPAMP LABS INC (213) 934-3566  
1033 N Sycamore Av LOS ANGELES CA, 90038

Circle (74) on Reply Card

## VIDEO SUPPLIES

CABLES • CONNECTORS • CHANIE • BELDEN • SWITCHCRAFT • D.A.s • TIES • BATTERIES • NEUTRIK • 50 INTERFACE BOXES • TAPE • 500 DIFF TAPE LABELS • GAFFERS TAPE • CASES • PATCH BAYS • LIGHTS • ACOUSTIC FOAM • FORMS • MICROPHONES • SONEK • STANDS • MOUNTS • WIND SCREENS • ZEPPELINS • FIBRE OPTICS • RACKS • DUCT • REELS • TESTERS • FILTERS • CHEMICALS • TOOLS • ON-AIR LIGHTS • DEGASSERS • INTERFACE DEVICES • HEADPHONES • CLIPS • SWITCHES • CAM & S-VHS CABLE

**FREE!** America's most unique catalog for audio and video!

MARKETEK VIDEO SUPPLY  
145 Ulster Ave., Saugerties, NY 12477 U.S.A.  
TOLL FREE 1-800-522-2025  
in NY: 914-246-3036

Circle (75) on Reply Card

Oh-Oh!

Call CORTANA

For Affordable Lightning Protection  
505-325-5336  
Box 2548, Farmington, NM 87499 • FAX 505-326-2337

Circle (76) on Reply Card

AS-101 AUDIO SWITCHER

10 Stereo In 1 Stereo Out

Remote Controls

NET RPU

- Illuminated and legendsble control buttons
- Instant or overlap switching
- Front panel accessible level controls
- Optional RS-232 Interface
- Optional relay follow switch outputs
- Plug-in screw-clamp terminals

CONEX ELECTRO SYSTEMS

P.O. Box 1342 Bellingham, WA 98227 (206) 734-4323

Circle (72) on Reply Card



# Small Monitor. Big Difference.



In the recording business, little things can often make big differences. Studio monitors, highly sophisticated critical listening devices, are certainly no exception. Our Control Series™ compact personal monitoring systems each provide the performance characteristics demanded in today's recording environments.

Take our Control 5™ for example. You get power handling capacity of 175 watts, outstanding dynamic range, smooth frequency response and excellent clarity and imaging. This high power, low distortion system is housed in a non-resonant polypropylene structural foam enclosure.

Today you can find Control 1's in home studios and midi workstations; Control 5's in major recording and teleproduction facilities; Control 10's in foreground and background systems, corporate boardrooms and teleconferencing facilities. And the two-way horn loaded Control 12SR, a logical extension of the technology, in sound reinforcement applications from supper



*Control Series. Compact high performance monitors designed to meet a broad range of fixed and mobile applications.*



clubs and discotheques to small tour sound systems. Control Series meets such diverse applications because they are, above all else, powerfully honest.

## **Versatility, the Other Advantage.**

Designed to accommodate a wide variety of specialized mounting brackets, Control Series monitors can go virtually anywhere. On the console, on the wall, on the ceiling, in a rack, on a tripod, keyboard or mic stand. Control 10's and 12SR's even come with a built-in handle so they travel like a seasoned professional.

Next time you're looking for a super compact high performance loudspeaker system, remember Control Series then go see your JBL dealer. Look at the specs, then listen to the big difference.



JBL Professional  
8500 Balboa Boulevard, Northridge, CA 91329 USA  
A Harman International Company

Circle (77) on Reply Card

locked to the center of the transponder's frequency range.

The transponder can be split into two halves, referred to as half-transponder or 2:1 mode operation. When used in this half-transponder configuration, the center frequency of the transponder is not used. Two RF frequency positions are created within the transponder, one in the upper section and one in the lower section. Figure 3 shows a typical full-bandwidth C-band transponder vs. a typical Ku-band satellite transponder for G.E. K1, K2 and

G-Star 1,2,3. Figure 4 shows the same Ku-band transponder if it were configured for half-transponder operation. Notice the reduction in the upper and lower RF total signal bandwidth, requiring the receiver to have a 25MHz IF bandpass filter.

A reduction in video deviation is required so both signals will fit within the 54MHz transponder bandwidth. The overall RF signal power is decreased in the half-transponder mode because it is necessary to back off the transmit power caused by the two different signals' being trans-

mitted within the one transponder. If both signals were transmitted at full power, the transponder would reach saturation and cause unwanted intermodulation products.

Additional tables are available that list the C-band and six Ku-band satellite formats, and can be used as a guideline for selecting a satellite transponder, transponder position, downlink frequency or 950MHz-1,450MHz IF frequency, video polarity, antenna polarity, receiver IF bandwidth and most common audio sub-carrier frequency.

Operators of steerable C-/Ku-band TVRO systems must keep track of all these parameters. To simplify this process, we chose a full-featured, C-/Ku-band, computer-controlled satellite receiver design. Such a system could eventually tie into the studio's master automation system. The receivers could be managed and assigned by the computer, allowing operators to enter a daily or weekly schedule. In the event of system maintenance or breakdown, the computer could rearrange receiver tasks based on equipment availability, and invoke alarm conditions if there were scheduling conflicts. (See Editor's note.)



- Eliminate ground-loop problems (hum, cross-talk, voltage differentials, etc.) on video and other wideband data lines.
- Insure outstanding signal transmission with over 120 dB attenuation of interference at power line frequencies.



For the ultra-wide bandwidth and low, flat insertion loss needed by broadcast or remote TV lines. For security, CCTV or Industrial Process Control systems. For high-speed Data Lines or Medical Imaging Equipment. Whatever your needs, there's a North Hills Isolation Transformer designed to meet them. Engineered for unmatched reliability. Standard insulated BNC connectors for easy installation. Backed by a 3-year warranty — it's the widest selection of Wideband Isolation Transformers available anywhere. And it's available now! Competitively priced! Right off the shelf!

**For details, dial: 516-671-5700. Or write for our new catalog.**

**North Hills Electronics, Inc.**

1 Alexander Place, Glen Cove, NY 11542-3796 (516) 671-5700 Telex: 46-6886 FAX 516-759-3327

Circle (78) on Reply Card

KU-BAND HALF-TRANSPONDER DIAGRAM

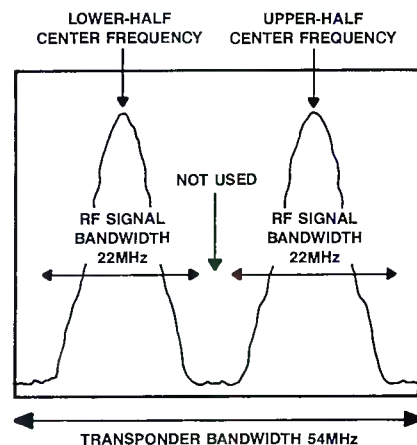

Figure 4. Ku-band half-transponder bandwidths.

#### Software available

In addition to the hands-on aspect of this example TVRO tune-up and upgrade, we have used the link budget and measurements to quantify the results of our activity. For a free copy of the satellite link-budget program used throughout this article, contact the SatCom division at Standard Communications at 800-243-1357. The program will be provided as a Lotus 123 .WKS file on a 5 1/4-inch floppy disk.

**Editor's note:** Contact Standard Communications, SatCom division, at 800-243-1357 for additional satellite formation information.





## “For Dependability and Quality, You Can’t Beat the Odetics Cart Machine...”

“Since we switched over to the Odetics TCS2000 Cart Machine, on-air discrepancies have dropped from about six per day to virtually none. And the quality has improved dramatically .

Our old machines were labor intensive. Too much time was spent daily pulling carts from storage and programming. We needed a machine that would do away with human effort...and human error.

I shopped and compared for over two years before I settled on the TCS2000. The other machines I researched didn’t have the Odetics level of automation, and they were not nearly as dependable.

I’ve been especially impressed with the Odetics machines ability to download from our traffic computer and generate a play list. Not only does that feature save time and effort, it eliminates

the error factor. And, of course, if we don’t have on-air failures, we don’t worry about makegoods.

The on-air appearance of the station is 100% better now. That’s a big morale booster for everyone here. And the machine has certainly made my job easier. I don’t miss those phone calls about our old machines problems at all hours of the night.

I didn’t know a lot about Odetics before I bought their equipment, so I asked for a factory tour and demonstration. After I saw the large-scale robotics work the company was doing for the space industry as well as the broadcast business, I knew Odetics had the automation expertise I needed. In fact, I would strongly recommend that any chief engineer looking at cart machines take that factory tour. Also, I knew

Odetics had already installed about 80 machines at other stations, so I called some of those chief engineers. I didn’t talk to anyone who wasn’t happy with the Odetics machine.

Most of the engineers I talked to emphasized the exceptional after-sale service and support Odetics provided. We found that out for ourselves when our new machine was installed. The training and support our operations people got was efficient, thorough and highly professional.

If you’d like to know about what the Odetics cart machine has done for KPHO, why not get some firsthand information? Feel free to give me a call at (602)264-1000.”

**Bill Strube, Director of Engineering  
KPHO, Phoenix**

## ***Odetics Broadcast***

1515 South Manchester Avenue, Anaheim, California 92802-2907 Phone (800) 243-2001 or (714)774-2200

Circle (81) on Reply Card  
[www.americanradiohistory.com](http://www.americanradiohistory.com)

da's Communications Research Centre, which will participate in additional subjective testing.

### SBE chapter addresses EBS issue

The New York SBE chapter recently held a statewide meeting on the emergency broadcast system (EBS). The meeting was organized by David Bialik, program director, to address perceived shortcomings with the state's emergency broadcast system.

Officials from the FCC, SBE and the New York state emergency communications committee discussed several proposed changes. Under the plan, participating New York stations would be interconnected by a satellite-based system. The assignment of common program control stations would be re-examined and the number of operational areas increased from 14 to 23.

The basic system would cost more than \$500,000. Five-year operational costs would be about the same. Plans are not complete. Additional information on how to organize a statewide meeting in your area is available from Bialik at

212-752-3322.

### Las Vegas is the venue for LPTV Conference

The third annual LPTV Conference and Exposition will be held Nov. 17-19 at the Riviera in Las Vegas. This is the only opportunity all year to meet with LPTV operators, CP holders and other interested parties. For more information, call 800-225-8183.

### SMPTE section created in Scandinavia

The Society of Motion Picture and Television Engineers (SMPTE) inaugurated the Nordic section on April 23 at the Film House in Stockholm, Sweden. The society now has 23 sections — 17 in the United States, three in Canada, one in Australia, one in Italy and one in Sweden. The Nordic section officers were elected at the opening meeting. They are chairman Svante Larsson (AB Film-Teknik), secretary/treasurer Mats Kullander (SF Bio AB), and managers Lars Jevbratt (Kodak AB), Otto Mikkela (Finnish Broadcasting), Kjell Van der Linden (Siv. Ing. Benum A.S.) and Poul Wachmann (Philips TV Test Equipment).

### PSI withdraws from HDTV process

Production Services (PSI) has withdrawn from the HDTV certification process because of the recently discovered public disclosure policies set for all proponents that are seeking to become the U.S. HDTV transmission standard.

Following a meeting of all proponents on May 1, PSI was informed that although full disclosure was not required to obtain pre-certification, it would be a requirement for full certification. PSI said full disclosure of its underlying technologies would compromise products scheduled for release this year.

PSI is continuing to develop its single-channel, simulcast HDTV transmission system. Other products that are based on the GENESYS technologies, are to be released this year.

||-X-||||

NEW

# How's your Audio?

## The PC3000 can tell you!

The new PC3000 Audio Analyser from Consultronics is the easiest way to test mono or stereo program channels, tape recorders, and other professional audio equipment. DSP circuitry, EL graphic display and easy to use menus make the PC3000 ideal for all your Audio testing needs today and tomorrow.

**Call today for more information...**

**Consultronics**  
533 Valley Way,  
Milpitas, CA 95035 USA  
Phone: 408-263-2600  
FAX: 408-263-8717

**Consultronics**  
160 Drumlin Circle  
Concord, ONT L4K 3E5 Canada  
Phone: 416-738-3741  
FAX: 416-738-3712

**Consultronics/Boyd**  
Third Avenue, Millbrook  
Southampton, SO1 0LE England  
Phone: 0703 705252  
FAX: 0703 705151

Circle (82) on Reply Card

AMEK  
BCII  
AMEK  
BCII  
AMEK  
BCII  
AMEK  
BCII  
**AMEK**  
**BCII**  
THE  
WORLD  
STANDARD  
COMPACT  
AUDIO  
MIXING  
SYSTEM

AMEK's BCII compact audio mixing system is the versatile problem-solver for a vast range of Broadcast, Edit Suite, and General Production applications from location recording to transfer suites.

Our large customer base – many with multiple BCII installations – includes such well-known names as the BBC, Central TV, Granada TV, NBC, Sony Corporation in Japan, Turner Broadcasting Systems, and ZDF in West Germany.

The 30mm wide modules can be housed in 16, 24 or 32 position frames which give formats as diverse as 6/1 and 24/4/2 with mono or stereo inputs and mono or stereo subgroups – with or without Dynamics – in most combinations. The frames are available in drop-through or tabletop formats with a variety of moving-coil meters including VUs, BBC-type PPMs and DIN-spec PPMs.

The SC Studio Chassis (illustrated) allows the basic audio system to be housed in a free-standing frame which can incorporate not only quarter-inch or TT jackfields but also many other custom features such as Audience Mixers and Bargraph meters.

All chassis are ruggedly built from steel and aluminium and afford a high degree of immunity from RF.

Input channels have a sophisticated and effective 3-band equalizer and 4 auxiliary send busses; the system has not only balanced inputs and outputs but also balanced mix busses. Several monitor modules cover all control room, studio and production gallery requirements.

The sophisticated ESM 32 AFV (Audio Follow Video) interface provides a simple package solution to problems of integrating a complete audio control system into a Video Edit environment. BCII/ESM32 provides quality audio – not 'video' audio – with monitoring and preview of audio sources. Audio can follow or be independent, and various cross-fade patterns are provided. The protocols support a vast range of equipment from major editor suppliers such as AMPEX, CMX, GRASS VALLEY, PALTEX and SONY. Standard AMEK-specified packages of desk and interface are readily available, but custom flexibility is catered for.

Pricing for a product of this quality is more than competitive and is yet another reason why AMEK BCII is the first choice of the world's leading broadcast and video production organizations.

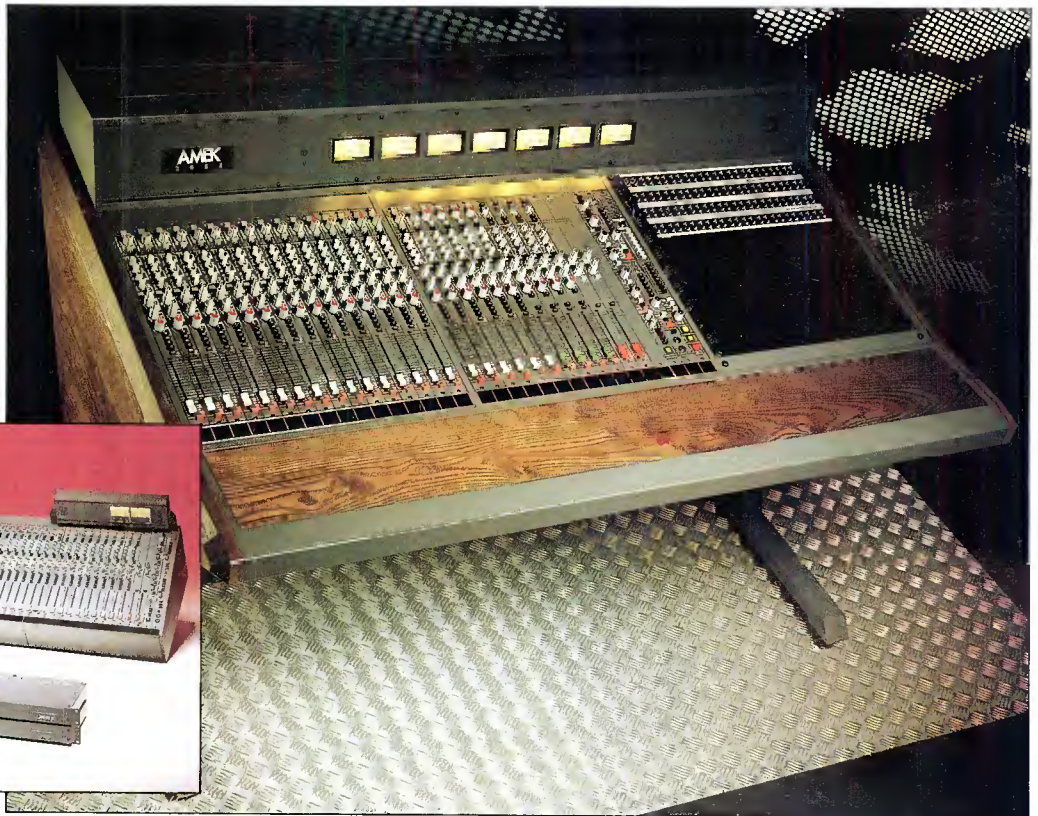

Head Office, Factory and Sales:  
AMEK Systems and Controls Ltd.,  
New Islington Mill, Regent Trading Estate,  
Oldfield Road, Salford M5 4SX, England.  
Telephone: 061-834 6747.  
Telex: 668127. Fax: 061-834 0593.

AMEK/TAC US Operations:  
10815 Burbank Blvd, North Hollywood,  
CA 91601. Telephone: 818/508 9788.  
Fax: 818/508 8619.

Circle (84) on Reply Card

[www.americanradiohistory.com](http://www.americanradiohistory.com)

AMEK  
BCII  
AMEK  
BCII  
AMEK  
BCII

# New products

## Lightning prevention

By United Systems

• **IDE-10PK series:** dissipation elements for lightning neutralization system; stainless steel and aluminum construction arrays remove built-up ionic charge from towers and buildings to keep lightning from striking.

Circle (369) on Reply Card

## Bulk eraser

By Wide Range Electronics



• **Model 7000:** media degausser designed for high-coercivity metal particle tape as well as standard oxide materials; manual operation produces 7,500G flux for reels to 2-inch widths and 16-inch diameters; also accepts audiocassettes, cartridges;

spindle adapter available for film-type reels; for 115Vac, 230Vac operation.

Circle (370) on Reply Card

## Broadcast console, intercom

By Philip Drake Electronics

• **Series 2000:** audio mixer in 36-into-12 format; modular construction design provides full stereo facilities.

• **Series 6000:** upgraded intercom, talk-back system; microprocessor-controlled product includes 32x32 matrix; interfacing for 16 external sources; permits multiple studio operation with networking of several series 6000 systems.

Circle (364) on Reply Card

## Multistandard VCR

By Instant Replay

• **World Traveler:** VHS-based videocassette player is capable of playing material in NTSC, PAL or SECAM for display on a television of the desired standard.

• **Caption Master:** VCR with captioning decoder; presents text on a black background; designed as an aid to teach reading.

Circle (359) on Reply Card

## Power conditioning

By Sola

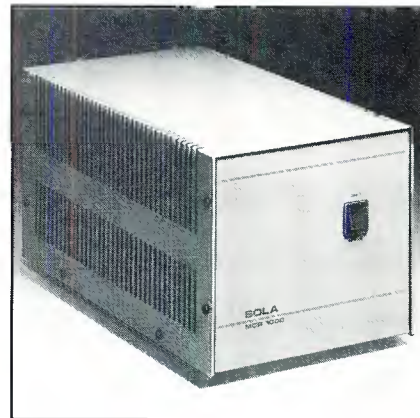

• **MCR series:** portable power-line regulators; ratings from 70VA to 3kVA;  $\pm 3\%$  regulation for +10%, -20% input line variation; for microprocessor equipment using switching-mode supplies; protects against spikes, surges, sags, brownout, overvoltage, common-mode and normal-mode transients; overload causes instant shutdown to protect equipment.

Circle (367) on Reply Card

## 64 CHANNELS. CABLE READY.

Sometimes it seems like you can't get there from here. You've got a thousand great ideas, and just about as many plugs in your hand. What you don't have is enough input channels.

Well, allow us to give you some input about a new way to solve your dilemma. It's a Tascam M3500 in-line mixing console. Choose either the 24 or 32-track mixer and by simply flipping a switch, you can double it to 48 or 64 mix positions.

And, with a suggested retail price of \$7,499 for 24 inputs or \$8,499 for 32, it won't take up a lot of your budget, either.

If you're planning to build a 24-track development studio, here's another advantage: The M3500 is the perfect match for the MSR-24, Tascam's one-inch 24-track recorder. Together, they make the most cost effective studio available.

It just may be that you don't need a huge console to enlarge your capabilities. The M3500 offers you a new, more effective approach to traditional mixing that is both compact and low cost. And when you need more inputs, all you'll have to do is switch channels. From 24 to 48. Or from 32 to 64.

# TASCAM®

© 1990 TEAC America, Inc., 7733 Telegraph Road, Montebello, CA 90640, 213/726-0303

Circle (87) on Reply Card

www.americanradiohistory.com

## Grounding system

By PolyPhaser

• **PolyRod ground:** chemical ground rod approach uses common chemical salts to enhance soil conductivity for better grounding of electronic equipment; copper-clad steel construction; may be hammered into place to avoid altering soil compacting; hose connection permits water to be added instead of depending upon natural precipitation; electrical interconnection between systems is possible.

Circle (366) on Reply Card

## Test generator enhancements

By Tektronix

• **TSG-1000 HD series:** an optional zone plate signal for multidimensional frequency response tests in 1050, 1125 and 1250 HDTV system.

• **TEK 1780R series:** may be upgraded with firmware and electronic graticules to display K-factor, short time distortion and ICPM measurements; two field-installable EPROMS.

• **CCS-3B Betacam, CCS-3M M-II:** com-

ponent/composite test systems combine the TSG-370 generator, WFM-300A waveform monitor and 1720 vectorscope packaged for easier signal monitoring and testing.

• **751 modulation monitor, Opt 1:** a 4.5MHz demod board.

Circle (450) on Reply Card

## Hands-free telephone

By VXI

• **Roamafone:** for hands-free, cordless duplex communications; Southwestern Bell Freedom Phone control unit, monaural or binaural headsets with noise-canceling mics and an ultralight headset; holster holds the wireless handset on the operator's belt, while the headset plugs into the handset to free the user's hands, full-dial facilities.

Circle (451) on Reply Card

## Gel/media protector

By Visual Departures

• **Gelly Roll:** keeps lighting gel sheets

protected from damage and dirt; media wrap around a hollow PVC tube, which stores in a nylon canvas bag, available for two sizes of media, the device accommodates 20 sheets of material.

Circle (452) on Reply Card

## Audio level matching unit

By Videoequip Research Ltd

• **LM-2 level matching system:** converts two XLR-balanced audio channels to RCA phono unbalanced signals; simultaneous change of two unbalanced RCA inputs to XLR-balanced channels; all level controls independent in the one-rack-unit package.

Circle (453) on Reply Card

## Servo-controlled pedestal

By Vinten Broadcast

• **Broadcast automation pedestal:** adds X-Y, servo height motion control to a Fulmar-type pneumatic pedestal; manual or automated control through a Microswift 800-shot memory; battery-powering simplifies cable management; alignment repeatability is specified at  $\pm 1\text{mm}$ .

Circle (454) on Reply Card

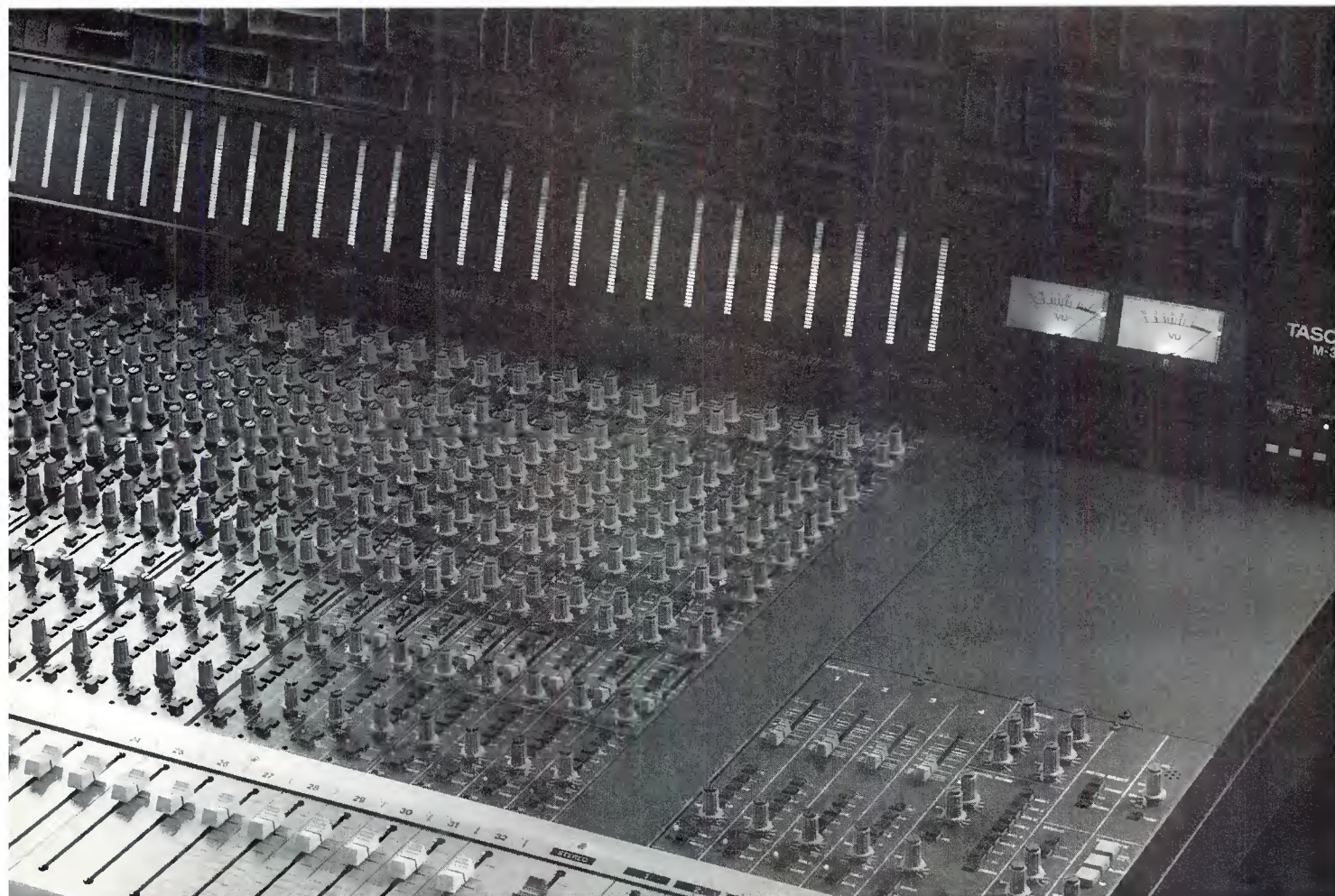

### Maintenance cleaners

By Chemtronics

- **Flux-Off Plus:** defluxant treatment removes rosin fluxes, ionic contaminants from printed circuit boards; contains no regulated CFC compounds.
- **E-series Ultrajet:** dust remover; pressurized 12 oz. cans contain EPA-exempt fluorocarbon to remove dust and particulates; push-button valve controls flow, extension tube for precise directional con-

trol; available as a reusable system.  
Circle (355) on Reply Card

### Service kit

By Jensen Tools

- **JTK-99 tool kit:** a collection of more than 80 basic tools needed for maintenance and repair of sound and video equipment; all items fit in removable pallets with additional space in the case

for test equipment and spare parts.  
Circle (361) on Reply Card

### Enclosure ventilation

By Equipto Electronics

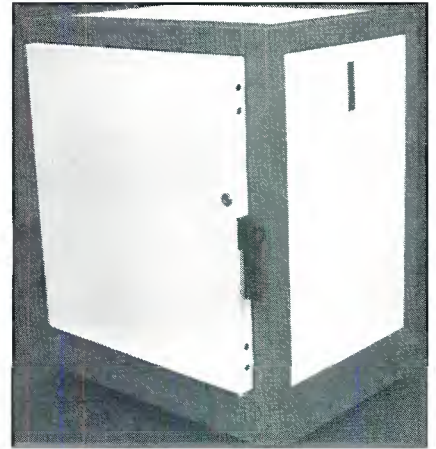

- **Fans and blowers:** a variety of 16 models of blowers, eight fans in catalog sizes, 200 custom sizes; various CFM ratings; options include filters, fan guards, adapters for special rack sizes; grills meet RFI specifications.

- **Extended doors:** option to heavy-duty vertical racks; adds 13/4-inch clearance to accommodate equipment that extends forward from typical front panels.  
Circle (357) on Reply Card

### Coaxial connections

By ITT Pomona Electronics



- **No. 5698 adapter kit:** includes BNC, TNC, SMA, N males, females; banana plugs, jacks; integral couplers permit various combinations between connector types to be created.  
Circle (360) on Reply Card

### Music library

By Musikos

- **Musikos CDs:** 12-disc set of custom-produced recordings; avoids cost of licensing; variety of music styles cover classi-



**Telex makes it fast, easy,  
and cost effective.**

The 6120 series from Telex proves that a high speed audio tape duplicator can feature easy one-button operation *and* an affordable modular design that grows along with your needs. As the leader in tape duplicators, Telex blends the quality and convenience of U.S. made products with production speed options that meet your special requirements. For complete details, write to Telex Communications, Inc., 9600 Aldrich Ave. So., Minneapolis, MN 55420.

© 1990 Telex Communications, Inc.

**TELEX**®

Circle (85) on Reply Card



cal to new age, country to big band; various orchestral sizes; slow to upbeat tempos with most being medium.  
**Circle (363) on Reply Card**

### Panel indicator replacements

By *Ledtronics*



- **Ever Glow 5SB:** LED lamps for telephone-type slide-in panel indicators; average life expectancy of 10 years as direct replacement 120PSB, T2-slide No. 5 base lamps; available in several colors, including a red-green bicolor unit for dual polarity indication; 1-, 2-, 4- and 6-chip versions cover voltages from 5Vdc to 48Vdc; with clear lens for 160° viewing angle and self-aligning contacts.

- **MFS476 series:** relampable pilot light units; with T1-3/4 base midget flange-type LED lamps; convex flutes on lens and 6-chip lamp units produce 270° visibility with twice the light output; available in seven LED colors.

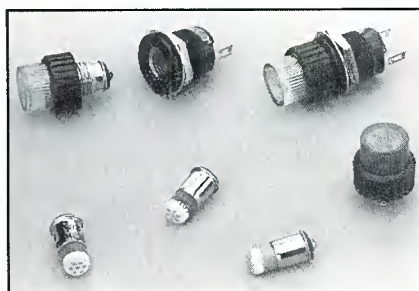

**Circle (362) on Reply Card**

### UHF power devices

By *Philips Components/Discrete Products*

- **PDC klystron:** 5-stage depressed collector design; achieves greater than 1.3 figure-of-merit; no intercepting grids for improved long-term operation; "recycles" approximately 75% of the beam power.

- **5-cavity klystron:** high-efficiency design using five tuned cavities; annular beam control feature uses no grid structures; 12MHz channel bandwidth, opera-

ble to 960MHz; excellent linearity and stability characteristics.

**Circle (365) on Reply Card**

### Tape compilers

By *T.E. Products*

- **TC-408, 408/7:** units prepare multiple program tapes from various source tapes; the TC-408 operates four source and four destination machines with 4x4 A-V

switching or optional stereo audio and SMPTE time code; various transports possible with TC-C machine-specific control cables; SMPTE code, frame count, park tones or AD EDIT 16-bit DTMF ID tones track tape positioning; the TC-408/7 offers keyboard selectibility of 1-7 source to 1-7 destination transports; adjuncts to AD VANTAGE series of random access and sequential commercial insertion systems.

**Circle (368) on Reply Card**

# FOR THE RIGHT HEADSET, USE YOUR HEAD

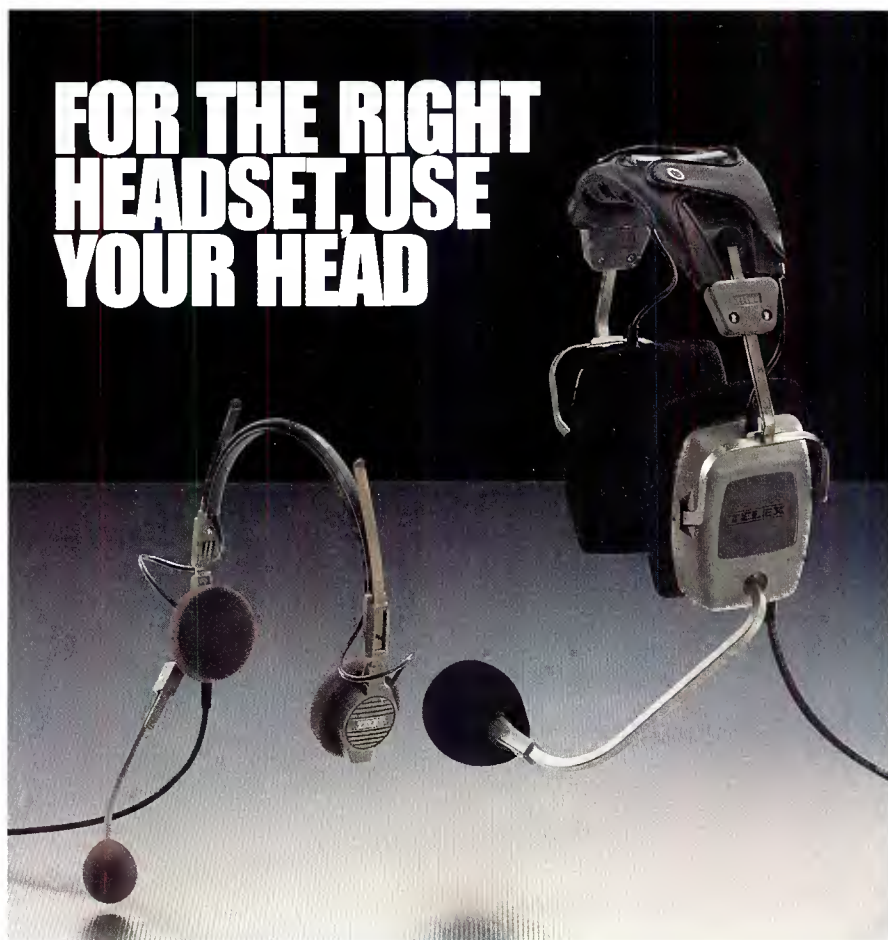

**Telex headsets.**  
**Feel the comfort, hear the quality.**

Discover what professional sportscasters in baseball, basketball, football, and golf already know. Telex has the best variety of top quality headsets on the market. You'll enjoy rich, natural sound whether you need full cushion isolation, lightweight comfort, or something in-between. There is a studio quality mic to fit your needs, too, from omnidirectional electrets to noise cancelling dynamics. For the complete story, write to Telex Communications, Inc., 9600 Aldrich Ave. So., Minneapolis, MN 55420.

© 1990 Telex Communications, Inc.

**TELEX**®

**Circle (86) on Reply Card**

# Winsted®

## Match your electronics with our EDITING CONSOLES

No matter what editing system you use, Winsted offers Editing Consoles to match your requirements! Our designs are based on consultations with professional users like yourself.

You've chosen your equipment carefully, to meet your specific needs. Now choose the Editing Consoles that fit your equipment—quality consoles from Winsted.

For our free full-color FULL-LINE CATALOG call us toll free:

**800-447-2257**

THE WINSTED CORPORATION  
10901 Hampshire Avenue So. • Minneapolis, MN 55438 • 612-944-8556

*Preferred by Professionals Worldwide*

FAX: 612-944-1546

Circle (88) on Reply Card

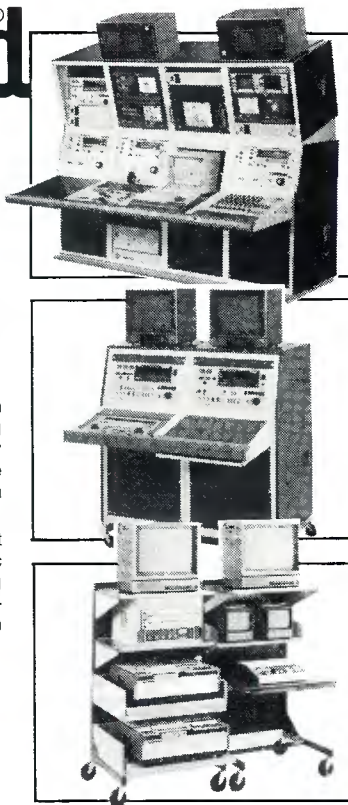

### Electrical testing

By A. W. Sperry Instruments

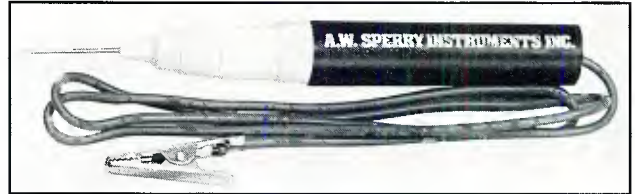

• **CT-101A tester:** checks continuity of non-energized circuits; long insulated lead to complete circuit; requires two AA cells for operation.

Circle (351) on Reply Card

### Aural image enhancement

By Audio Intervisual Design

• **Spatializer:** 3-D audio-processing system; "actionators" permit positioning of individual sound elements within 3-D space; once recorded, sound positions remain fixed; systems available with 8-, 16- and 24-position controllers.

Circle (352) on Reply Card

### Microphone demo

By Bruel & Kjaer Instruments

• **Series 4000 samples:** limited edition CD showcases music recorded with Series 4000 microphones; 69-minute disc includes 18 selections as well as a range of test times to check speaker response; available free upon written request on your letterhead to: Bruel & Kjaer, 185 Forest Street, Marlborough, MA 01752-3093; Attn. Adrian Weidmann.

### Feedline utility unit

By Environmental Technology



• **ADH-2 dehydrator:** automatic system uses 4-bit microprocessor control, monitoring for all pressurized waveguide, air-dielectric coaxial lines and other dry air applications; automatically regenerates desiccant for reduced maintenance requirements; integrated test and fault diagnostics, alarm relays, status indicators; 110Vac or 208Vac/240Vac operation.

Circle (356) on Reply Card

# CAPTURE IT ALL!



**SHURE®**

Introducing the new Shure VP88 Stereo Condenser Microphone that provides broadcast quality stereo from remote locations at a surprisingly affordable price. It's made for the field...rugged...durable...easy to use...made to capture it all!

**FREE T-SHIRT: 1-800-356-5844**

Free T-shirt with every Shure microphone and mixer purchased.

**HURRY! QUANTITIES LIMITED.**

Prices Too Low To Print



Audio Video Lights

Consultation 608-271-1100 • 5618 Odana Rd. • Madison, WI 53719

Circle (89) on Reply Card



## POPULAR PRODUCERS

Betacam is rapidly becoming one of the most popular production formats in both field and studio applications. And Ampex 198 Betacam and 298 Betacam SP videocassettes are popular professional choices for a full range of needs. When

you need high reliability in an ENG/EFP tape, the choice is Ampex 198. Or, when you need the ultimate in performance, the choice is Ampex 298, with its high-coercivity metal-particle formulation. Both offer you high-impact ABS plastic cassettes for rugged dependability and the unique Ampex labeling system for easy access and

storage. And all backed by the industry's most acclaimed service and support organization. No wonder they're so popular. They're from Ampex.

**AMPEX**  
THE PROFESSIONAL CHOICE

*Ampex Recording Media Corporation  
401 Broadway, Redwood City,  
CA 94063, (415) 367-3809*

Circle (90) on Reply Card

## Professional Time Code

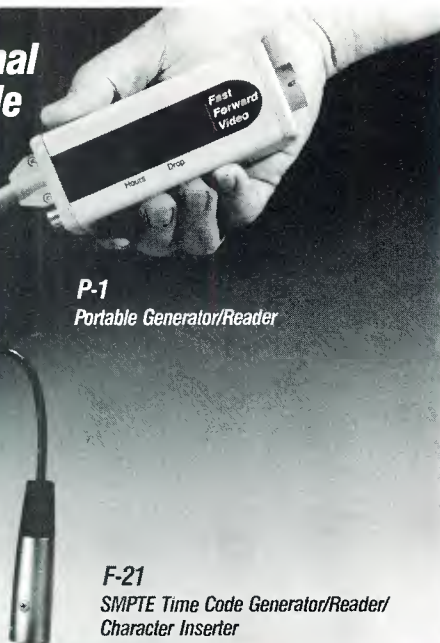

**P-1**  
Portable Generator/Reader

**F-21**  
SMPTE Time Code Generator/Reader/  
Character Inserter

Call your local dealer or contact us at (714) 852-8404

## Fast Forward Video

Circle (91) on Reply Card

## BUILDING QUALITY CASES SINCE 1952

A.T.A. heavy-duty shipping to lightweight carrying cases

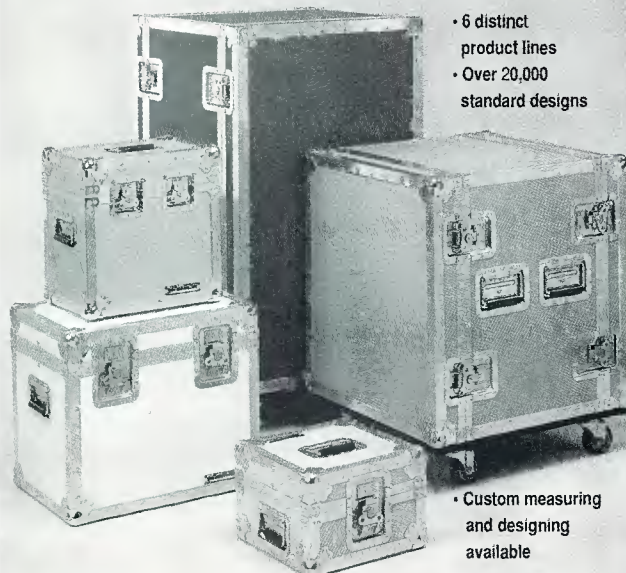

- 6 distinct product lines
- Over 20,000 standard designs

- Custom measuring and designing available

Call Today For More Information

**ANVIL CASES**  
UNIT OF ZERO CORPORATION

15650 Salt Lake Ave., City of Industry, CA 91745 • P.O. Box 1202, La Puente, CA 91747

(800) FLY-ANVIL (800) 359-2684

Circle (93) on Reply Card

## Equipment enclosures

By Cabtron Systems

• **Firstline series:** heavy-duty vertical rack cabinets; 12-gauge frames, 11-gauge mounting angles; tapped 10-32 mounting holes on front and rear angles; ventilation grills accept blower systems; available in plain or decorative trim models with removable side panels; accessories, casters.

Circle (354) on Reply Card

## System timing unit

By ICON Electronics

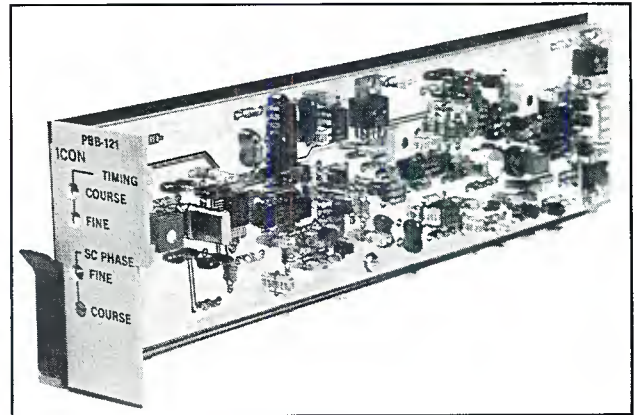

• **PBB-121 generator:** blackburst signal source with  $\pm 4.5\mu\text{s}$  timing range adjustment from the front panel for advance or delay; module fits in PGM-100 mounting frame with other Icon generator products; sync and subcarrier provided through frame motherboard for system lock; seven or eight timing modules per frame possible.

Circle (358) on Reply Card

[-:-:))]]]]

## Next month...

### VIDEO TECHNOLOGY UPDATE:

We will take a look at how stations can take advantage of different new systems to improve their competitiveness.

#### • Video: Technology on a Roll

The power of computers, coupled with innovative approaches to analog signal processing, have given users new opportunities and challenges. The biggest challenge is integrating the technologies into a cohesive and user-friendly system.

#### • Advanced Video Measurements

Repairing advanced video equipment requires sophisticated test devices. The key to reducing downtime is having the right test equipment.

#### • DAT in the Professional Environment

The DAT format is finally getting a foothold in the professional market. The new cost-effective recording and production techniques offer users many advantages over analog recorders.

#### • IBC Show Preview

Brighton, England, is the site for this year's major European broadcast trade show set for Sept. 21-26.



# Put Dolby SR before the cart

There's no doubt that compact discs and other digital audio sources have helped to raise broadcast audio quality to new heights. And to some degree, almost all broadcasters have embraced this new technology.

But you probably continue to use carts right along with these new formats. For on-air playback of your programming, as well as commer-

cials, spots, and jingles, carts are still tough to beat for convenience, ruggedness, and familiarity.

Carts do have one limitation, though: sound quality that doesn't measure up to today's high expectations. Dolby SR (spectral recording) overcomes that limitation. With Dolby SR, your carts can capture the full range of dynamics present in all your source

material, digital or analog. And using Dolby SR to produce spots and jingles ensures an outstanding finished product.

You've always had good reason to use carts. Now with Dolby SR there's a great one: sound quality updated for today's demanding broadcast environment.

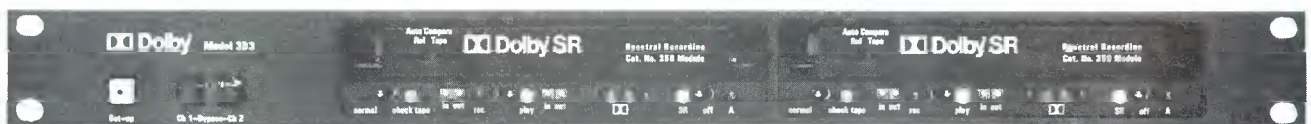

The Dolby Model 363 provides two channels of Dolby SR in a compact, reliable package ideally suited for both production and on-air playback.\*

**Dolby®**

Dolby Laboratories, Inc., 100 Potrero Avenue,  
San Francisco, CA 94103-4813, Telephone 415-558-0200,  
Telex 34409.

346 Clapham Road, London SW9 9AP,  
Telephone 01-720-1111, Telex 919109.

\*Broadcast units incorporating up to 12 channels of Dolby SR for use with multiple cart machines or open-reel recorders are also manufactured by Pacific Recorders & Engineering Corp., Carlsbad, CA.

"Dolby" and the double-D symbol are trademarks of  
Dolby Laboratories Licensing Corporation. S89/8689

# Professional services

**VIR JAMES P.C.**  
CONSULTING ENGINEERS  
Applications and Field Engineering  
Computerized Frequency Surveys  
3137 W. Kentucky Ave. — 80219  
(303) 937-1900  
**DENVER, COLORADO**  
Member AFCCE & NAB

\*\*\*\*\*  
**TNS**  
**TOWER NETWORK SERVICES**  
**STROBE LIGHT REPAIR**  
DISCOUNT RATES  
FLASH TECH / EG+G  
Tiner  
(305) 989-8703  
**NATIONWIDE SERVICE**

**EVANS ASSOCIATES**  
CONSULTING TELECOMMUNICATIONS ENGINEERS  
AM-FM-CATV-ITFS-CELLULAR  
216 N. Green Bay Road  
Thiensville, Wisconsin 53092  
Phone (414) 242-6000 Member AFCCE

  
• TERRAIN SHADOWING  
• POPULATION DENSITY  
• CONTOUR COVERAGE  
• SPECIALS  
(301) 652-8822 (800) 368-5754

**D. L. MARKLEY**  
& Associates, Inc.  
CONSULTING ENGINEERS  
2401 West Moss Ave.  
Peoria, Illinois 61604  
(309) 673-7511  
Member AFCCE

**K. BLAIR BENSON**  
Consultant  
Television Technology  
23 Park Lane  
Norwalk, CT 06854  
203-838-9049

**TEKNIMAX**  
TELECOMMUNICATIONS  
DENNIS R. CIAPURA  
PRESIDENT  
11385 FORESTVIEW LN.  
SAN DIEGO, CA 92131  
(619) 695-2429

**SMITH and POWSTENKO**  
Broadcasting and Telecommunications  
Consultants  
2033 M Street N.W., Suite 600  
Washington, D. C. 20036  
(202) 293-7742

Robert J. Nissen  
**THE NISSEN GROUP, INC.**  
Communications Technology Consultants  
32 Ridge Drive • Port Washington, New York 11050  
(516) 944-5477

  
**CHUCK JONES**  
ANTENNA SYSTEMS SPECIALIST  
618-564-2481  
**SOUTHERN ILLINOIS ANTENNAS**  
ROUTE 3 BOX 114  
METROPOLIS IL 62960

**ERIC NEIL ANGEVINE, P.E.**  
consultant in acoustics  
specializing in broadcast studio acoustics  
910 Lakeridge Drive Stillwater, OK 74075  
405-744-6444 405-372-3949

**Professional services**  
Why not run  
your Business  
Card here?  
It's a great way  
to promote  
your service  
and increase  
business, all for  
as low as \$110  
per insertion.

UNUSED CALL LETTERS  
MAILING LABELS  
AM • FM • TV  
**dataworld®**  
301-652-8822 800-368-5754

**PATCHPRINTS®** VIDEO TIE LINES  
In 1 2 3 4 Aux  
**Custom Patch Bay Labeling**  
By  
**PATCH BAY DESIGNATION COMPANY**  
Div. of Glendale Rubber Stamp & Printing Co., Inc.  
P.O. Box 6278, Glendale, CA 91205 Telephone (818) 241-5585  
4742 San Fernando Road FAX (818) 507-5050  
Glendale, CA 91204

Consulting Communications Engineers  
• FCC Data Bases  
• FCC Applications and Field Engineering  
• Frequency Searches and Coordination  
• AM-FM-CATV-ITFS-LPTV  
**OWL ENGINEERING, INC.**  
Consulting Communications Engineers  
1306 W. County Road F, St. Paul, MN 55112  
(612) 631-1338 "Member AFCCE"

**East Coast Video Systems**  
ON LINE IN TIME  
A full service  
company providing...  
• Consultation  
• Engineering & Design  
• Installations  
• Training  
Serving...  
• Cable Systems  
• Corporate Facilities  
• Broadcast Facilities  
• Teleproduction Facilities  
52 Ralph Street, Belleville, NJ 07109 (201) 751-5655

**NETCOM** (201)837-8424  
NETWORK COMMUNICATIONS CONSULTANTS  
931 TEANECK RD TEANECK, N.J. 07666  
STATE-OF-THE-ART ENGINEERING FOR AUDIO & VIDEO  
• FACILITY PLANNING  
• SYSTEM DESIGN  
• CAD SERVICES  
JAMES TRONOLONE  
ENGINEER

BROADCAST DATABASE  
**dataworld®**  
MAPS  
Coverage/Terrain Shadowing  
Allocation Studies • Directories  
P.O. Box 30730 301-652-8822  
Bethesda, MD 20814 800-368-5754

**JOHN H. BATTISON PE.**  
CONSULTING BROADCAST ENGINEER,  
FCC APPLICATIONS AM, FM, TV, LPTV  
Antenna Design, Proofs, Fieldwork  
2684 State Route 60 RD#1  
Londonville, OH 44842  
419-994-3849

  
MAILING LISTS  
AM FM TV  
Labels or Diskette  
**StationBase**  
(800) 359-2818

For information  
just call  
Renée  
Hambleton  
at  
(913) 888-4664

Continued from page 46

filtered out by the digital filter.

For small signals, the converter is operating with only the least-significant bit. This makes the converter perfectly linear at low levels because there can be no mismatches between sizes of the A/D bits. These mismatches, called *weighting errors*, are errors in the binary weighting of bits. The bits should each be larger than the last by a factor of two, for example, 1, 2, 4, 8 and so on. In practical A/D conversion, they might be 1, 1.995, 4.003, 8.011 and so on.

Converters of this type are often referred to as oversampling A/Ds, but the term *noise-shaping A/Ds* is more accurate. A simple oversampling technique cannot produce the dramatic accuracy improvements found in noise-shaping designs. Several other converters have appeared on the market recently using similar schemes but limiting the conversion hardware to one bit. This produces good linearity at all levels but limits the ultimate accuracy with today's technology to approximately 16 bits. In the next couple of years, this should improve to yield higher-accuracy converters.

## Oversampling pros and cons

- Oversampling can give more resolution.
- Oversampling A/Ds can provide freedom from low-level non-linearities.
- Digital filters can be linear-phase.
- Digital filters can be lower-distortion.
- Digital chips are usually cheaper to make.
- Digital filters give better control over response.
- Oversampling requires faster circuits, but faster circuits are less accurate.
- Oversampling D/As raise the noise floor unless more bits are used to suppress filter round-off.
- Oversampling D/As limit headroom unless an extra bit is used to handle overshoot.

## Digital filters for oversampling applications

The topology of a digital low-pass filter commonly used for oversampling applications is called a *non-recursive* filter or an FIR (finite impulse response) filter. The first name comes from the fact that previous filter output values never affect later output values. The second name comes from the fact that an impulse at the input will cause the output to ring for a finite time.

The input samples are fed into a long delay line composed of a series of single sample delays. The input and all of its delayed versions are multiplied by fractional constants and added to obtain the output. By adjusting these constants, the response may be controlled down to a lower limiting frequency of approximately the sample rate divided by the number of stages of delay. At frequencies below this, there will be less than a full cycle of input signal in the delay line and the filter can no longer differentiate between input frequencies. In practice, the frequency limit is several times higher than this if reasonably accurate control of response is desired.

If a sample is equal to zero, its product is zero, and there is no need to compute the product in the first place. This fact can greatly simplify the design of low-pass filters for oversampling D/A applications. By assuming the unknown samples to be zero, they do not need to

be used in computing the next output value. In a 2X oversampling application, for any given output sample, only half of the coefficient products need to be computed. Assuming the unknown output samples were the same as the previous samples would actually increase the computational overhead by two.

When used as a low-pass filter for oversampling A/D applications, the unused output samples do not need to be computed. Because, unlike recursive or FIR digital filters, the output values are not used in any later computations. The major drawback to FIR filters is that the delay line length becomes excessive if low-frequency filtering is required.

The multiplication of two binary numbers results in a number with its width being equal to the sum of the two number sizes. For example, if the samples are 16 bits and the constants are 16 bits, their product will be 32 bits. If two of these products are added, the result will be 33 bits long. Four products summed result in 34 bits, eight summed gives 35 bits and so forth. If the filter is 128 stages long, a common length in commercial ICs, an extra seven bits will be required to handle the summation without introducing any round-off errors. For the 16-bit data and 16-bit coefficient case, this gives 39 bits of data in the summation.

!-[=)]]]]

Classified advertising now available as Classified Display or By-the-word.

**Classified Display:** \$100 per column inch, per insertion, with frequency discounts available. 1 inch minimum, 10 inches maximum per ad. Blind ads \$40 additional. Reader Service number \$50 additional. Spot color available for \$150 (color determined by publisher).

**By-The-Word:** \$1.75 per word, per insertion. Initials and abbreviations count as full words. Blind ads \$40 additional. Minimum charge \$40 per insertion.

Contact Renée Hambleton, at (913) 888-4664, for information on frequency and pre-payment discounts. To place your classified ad send your order and materials to Broadcast Engineering, Classified Ad Mgr., P.O. Box 12901, Overland Park, KS 66212.

## HELP WANTED

### TELEVISION MAINTENANCE ENGINEER

Educational Television Association  
of Metropolitan Cleveland

(WVIZ-TV) seeks experienced Broadcast Television Maintenance Engineer to maintain (to component level) Cameras, One Inch Videotape Machines, Still Stores, Character Generators, Switchers, Digital Video Effects Generators, Editors, and other state of the art television studio equipment. Duties will be divided between our Remote facility and our Studio facility.

Studio duties will include recommending routine maintenance schedule, evaluating equipment for proper operation and for alignment within factory specs, working alone and with other engineers in performing routine and corrective maintenance.

Remote duties will include performing maintenance as above on remote equipment while the trucks are "in the barn", driving one of the Remote trucks to a shoot sight, helping with set up, and performing on sight maintenance as needed. Location remote duty sometimes requires being out of town for two or three days.

At least three years experience in maintaining a wide variety of television studio equipment to component level required. Graduation from college or technical school is desired. Also desired is an SBE "Broadcast Engineer" certificate or higher or an FCC "General Class" Radiotelephone license.

Send resume to Gary Bluhm  
WVIZ-TV, 4300 Brookpark Road  
Cleveland, Ohio 44134.

**MAINTENANCE ENGINEER TO:** Repair and Maintain Studio, Master Control, Production Control and ENG./EFP. equipment. Should be experienced in Sony 3/4", 1" and Beta format as well as MCR and PCR Switching Equipment. Knowledge of UHF beneficial. Degree and Prior Maintenance Experience Preferred. SEND RESUME TO: Chief Engineer, WETM-TV, Inc., PO Box 1207, Elmira, NY, 14902, EOE. 07-90-1t

### ENGINEERING MANAGER

Major satellite communications firm seeking experienced engineer to manage extensive transportable satellite network. Minimum of four years experience in satellite communications operation and maintenance. Thorough knowledge of video and C-band transmission system necessary. Component level maintenance experience. Experience with encryption a plus. Strong interpersonal and leadership skills essential. Travel involved. Only self-motivated individuals need apply. Competitive salary and benefits.

Send detailed resume with salary history and references to:

Helen Hunter, Telecom Broadcasting  
1930 S. Hill St., Suite 206,  
Oceanside, CA 92054. Fax #619-439-8838

### TV MAINTENANCE ENGINEER

needed for a national Christian studio post production satellite uplink facility. Three years component level maintenance experience. Ampex, AVC, ADO, VPR-3, Beta, Scientific Atlanta Uplink. Positions available in San Diego and Dallas. Competitive salary and benefits (Paid vacations, holidays, incentive programs, medical & dental insurance) with an exciting organization. Send resume to: Personnel Dept., Word of Faith, P.O. Box 819099, Dallas, TX 75381-9099

## HELP WANTED

### STUDIO TECHNICIAN

Heritage Cablevision has an opportunity for an experienced Studio Technician. Will report to Studio Engineer. Responsibilities include maintenance/repair of new Sony decks, chip cameras and all other production equipment. Previous TV production equipment maintenance experience and formal electronics training required.

Heritage serves 120,000 customers with two new studios, and daily live, 1/2 hour newscast, plus over 50 remote van events annually. Submit resumes to:

**Heritage Cablevision**  
Attention: Personnel Manager  
2215 N. DuPont Highway  
New Castle, DE 19720

EOE-Minorities & Females encouraged to apply. A condition of employment with Heritage is satisfactory completion of a pre-employment physical, which includes a drug screen.

**EXPERIENCED TELEVISION MAINTENANCE ENGINEER** for Houston, Texas network affiliate, UHF station. All new facilities, competitive salary and benefits. Advancement opportunities. KXLN-TV, 9440 Kirby Drive, Houston, TX 77054. ATTN: Personnel. 07-90-1t

## HELP WANTED

### TELEVISION SYSTEMS ENGINEER

Design, install and troubleshoot sophisticated new sports-related video facilities for a dynamic expanding and established television company. This individual should be knowledgeable in all of the new technologies and must possess strong managerial skills. Direct client contact and liaison with several existing facilities as well as all new installations is required.

Engineering degree, experience with sports-related remote operations, and satellite broadcast is a plus. Excellent salary & benefits. Send resume to:

### VPC

P. O. Box 840, New Hyde Park, NY 11040

**KCBA-TV IS SEEKING A MAINTENANCE ENGINEER** experienced with all video tape formats, grass routers and switchers, Beta Cart and UHF transmitter. FCC General or SBE certification required. Salary commensurate with experience. Send resume to: KCBA-TV; P.O. Box 3560; Salinas, CA 93912. EOE. 07-90-1t

**ATTENTION: POSTAL JOBS!** Start \$11.41/hour! For application info call (1) 602-838-8885, Ext. M-13464, 6am - 10pm, 7 days. 07-90-1t

## Advertising sales offices

### NEW YORK, NEW YORK

*Diane Gottlieb-Klusner*  
Telephone: (212) 332-0600  
Telefax: (212) 332-0663  
*Mike Trerotoli*  
Telephone: (212) 332-0600  
Telefax: (212) 332-0663  
888 7th Avenue, 38th Floor  
New York, NY 10106

### CHICAGO, ILLINOIS

*Vytas Urbanas*  
Telephone: (312) 435-2361  
Telefax: (312) 922-1408  
55 East Jackson  
Suite 1100  
Chicago, IL 60660

### SANTA MONICA, CALIFORNIA

*Herbert A. Schiff*  
Telephone: (213) 393-9285  
Telefax: (213) 393-2381  
*Jason Perlman*  
Telephone: (213) 458-9987  
Telefax: (213) 393-2381  
*Schiff & Associates*  
501 Santa Monica Blvd, Ste. 504.  
Santa Monica, CA 90401

### OXFORD, ENGLAND

*Nicholas McGeachin*  
Intertec Publishing Corp.  
Roseleigh House  
New Street  
Deddington  
Oxford OX5 4SP  
England  
Telephone: (0869) 38794  
Telefax: (0869) 38040  
Telex: 837469 BES G

### TOKYO, JAPAN

*Mashy Yoshikawa*  
Orient Echo, Inc.  
1101 Grand Maison  
Shimomiyabi-Cho 2-48  
Shinjuku-ku, Tokyo 162, Japan  
Telephone: (03) 235-5961  
Telex: J-33376 MYORIENT

### FREWVILLE, SOUTH AUSTRALIA

*John Williamson*  
Hastwell, Williamson, Rep. Pty. Ltd.  
109 Conyngham Street  
Frewville 5063  
South Australia  
Phone: 799-522  
FAX: 08 79 9522  
Telex: AA87113 HANDM

### CLASSIFIED ADVERTISING OVERLAND PARK, KANSAS

*Renée Hambleton*  
P.O. Box 12901  
Overland Park, KS 66212  
913-888-4664

## CUSTOMER SATISFACTION

### Service Engineers/Technical Trainers

When considering purchasing state-of-the-art equipment, people turn to SONY. Enjoying the number one position in the electronics industry has not relaxed our aggressiveness towards sales and marketing nor our deep dedication towards customer service and training.

SONY products are #1 not only for their quality but for the customer support that stands behind the name. Currently, SONY Operations and Technical Services has several positions available nationwide for dedicated engineering professionals in Customer Service, Field Service and Training.

We seek those rare individuals who can combine technical expertise with good communication skills and a dedication to customer satisfaction. The ideal candidates will have experience in the repair, maintenance and servicing of Professional Video, Professional Audio, or Broadcast Products equipment. An appropriate technical education (a BSEE or AAS) or equivalent experience is also preferred.

We offer you the challenge of working for an industry leader and the opportunity to develop your technical skills on state-of-the-art equipment. SONY offers a competitive salary, comprehensive benefits package and for some positions, a company car. If interested, please send your resume, indicating position of interest and geographic preferences, to: SONY CORPORATION OF AMERICA, Dept. BE, 677 River Oaks Parkway, San Jose, CA 95134. We are proud to be an EEO/AA employer, M/F/H/V. We also maintain a drug free workplace and perform pre-employment substance abuse testing.

# SONY®

Technology Never Looked So Good.



## HELP WANTED

### RF MAINTENANCE ENGINEER

KCPQ-TV FOX 13 is seeking an individual with a strong background in VHF-TV transmitters, microwave, and UHF-TV translators. Minimum requirements: three years full-time television maintenance experience, valid drivers license, and FCC general class license. Excellent pay and benefits package to successful applicant; moving expenses negotiable. RESUMES: Larry Brandt, Chief Engineer, KCPQ-TV, P.O. Box 98828, Tacoma, WA 98499. No phone inquiries. EQE.

**VIDEO PRODUCT MANAGER** A major international manufacturer of television broadcast equipment has an opening for an Audio/Video Routing Switcher Product Manager. This is a high visibility management position with considerable responsibility for guiding the product development plans of the company. An engineering and/or product management background in the television broadcast industry is mandatory. Sales or manufacturing experience would be helpful. Relocation to the company's U.S. headquarters is required, as well as domestic and international travel. A competitive compensation plan and an excellent benefit package will be offered to the successful candidate. Please respond with your resume to Human Resources, P.O. Box 14205, Huntsville, AL 35803 Equal Opportunity Employer. 07-90-1t

**ASSISTANT CHIEF ENGINEER** Independent UHF TV Station. Should have maintenance experience with Sony 1", 3/4" and Betacam, Beta Cart, Sony and Ikegam Cameras, Chyron IV Grass Valley Switcher and Comark Transmitter. Must have a FCC General Class License and/or SBE Certification. (Competitive Salary and Benefits) E.O.E. Send resume to: Station Manager, WHLL-TV, 27 Parker Road, Shrewbury, MA 01545. 07-90-1t

**STUDIO SUPERVISOR** WCIA is looking for an experienced technical supervisor. Applicants must have strong maintenance abilities on all aspects of studio equipment, microwave transmitters and receivers, satellite receivers and controllers, VHF and UHF transmitters. Must also have supervisory experience, scheduling both operating and maintenance personnel. Experience in Engineering budgeting also helpful. Must possess a FCC General Radio Telephone license and/or SBE certification. Send resumes to Engineering, WCIA, 509 South Neil Street, Champaign, Illinois 61824-0777. An equal opportunity employer. 07-90-1t

## FOR SALE

### FACTORY DIRECT



Request Catalogue 800-343-1433, 516-563-0633  
Island Cases, 1121-20 Lincoln Ave., Holbrook NY 11741

**MICROWAVE ASSOCIATES MA-12x2C** 12Ghz FM Video transmitter and companion receiver. \$1,750.00. Ideal for tripod or window ledge use. (305) 661-1595 Joe. 07-90-1t

### DEMO & USED EQUIPMENT BROKER

Hundreds of items listed up to 70% off!!

**MOBILE TRUCKS**—40 foot & 25 foot fully outfitted; 38 foot & 24 foot racked and ready. —\$OFFERS • **BETACAM/1" EDIT SUITE**—w/Scribe, NEC 10 DVE, more. —\$195,000 • **M2 A/B ROLL**—(Oemo system-2) Panasonic AU-620, AU-60, Paltext Elite editor w/status monitor & 35" disc for EDL & user key storage, Videotek Prodigy switcher w/ RGB chromakey & serial options. —\$62,035 • **U-MATIC A/B ROLL-2** VO-5800, VO-5850, ECS-203 editor, Echo SE-3 switcher, 2) TBC's. —\$20,000 • **1" VTR'S**—AMPEX VPR-2B/T8C-2B—\$15,000. • **SONY BVH-1100**—\$15,000 • **BETACAM & M-2**—BVW-40—\$13,000, JVC KR-M800 (OEMO)—\$6,150 • **CAMERAS**—IKEGAMI HL-95B EFP—\$13,000, SONY DXC-M7K (OEMO)—\$9,999 • **C.G.S.**—Chyron 4100EXB—\$38,000, Laird 150000—\$5,500 • **DVE'S**—Abekas A-52—\$16,500; Genesis/Act-1—\$9,000.

LET US SHOP FOR YOU!!  
PROVID SUPPLY CORP. ANDY TURNER (708) 215-9010

## FOR SALE

### CAPACITORS OVERNIGHT

- Power Supply—computer grade: up to 450VDC
- Transmitting - MICA — Sangamo, Cornell-Dubilier
- Oil Filled — Non-PCP Oval, Rectangular

Relays • Filters • Transistors  
Any Parts starting with 1N or 2N

1-800-323-0460 FAX 1-802-425-3664  
Kellner Electronics, Inc., Charlotte, VT 05445

**TRANSMITTERS** RCT-TT 25 DL Tx for sale, sideband filter, dummy loads, Harmonic Filter, etc. \$8,000 OBO. Also have AM 550 Tx BTA — 1m and 4 towers. Best Offer. Must sell immediately Call WCBT-TV 601-327-4444 07-90-1t

**USED**—16 mm & 35 mm telecine equipment. Lowest prices. Video Image—213-822-8872. 07-90-1t

### Portable Sound Panels



- Isolate specific areas
- Many sizes and options
- Panels start at \$19.95/ea. Complete w/foam

### Island Cases

Write for free catalog

1121-1 Lincoln Ave., Holbrook, N.Y. 11741  
800-343-1433 • In N.Y. 516-563-0633

**HIGHEST PRICES** for 112 Phase Monitors, vacuum capacitors and clean, one kw or greater powered AM and FM Transmitters. All duty and transportation paid. Surplus Equipment Sales, 2 Thorncliffe Park Dr., Unit 28, Toronto, Canada M4H 1H2, 416-421-5631. 6-89-tfn

**FOR SALE:** Tubes 3CX1500A7, 4CX250B, 4CX5000A, 4CX3000A, and more. We carry lg. inventory, all major brands (EIMAC, AMPEREX, RCA) Call Stew 1-800-842-1489. 01-90-12t

### Dcode TC-1 TIME CODE READER



- Reads Time Code from 1/50 - 50x speed
- Reshapes Time Code for copying
- 60 hz sync from 24 or 30 frame code

\$395

### DENECKE, INC.

5417-B Cahuenga Bl., No. Hollywood, CA 91601  
(818) 766-3525 • FAX (818) 766-0269

**SONY CAMERA BVP330** Low hour meter reading (125) Excellent condition Private \$14,000.00 (212) 468-2508, 9 a.m. to 5 p.m. 07-90-1t

**NEW 24' PRODUCTION TRUCK**, production switcher, 16 channel Tascam audio board, Sony monitors, 2 6.5Kw generators, Sigma distribution system 500, RTS comms, and much more. 305-893-6627. 07-90-1t

## COMPUTER SOFTWARE

**IBM PC AP/UIPI WIRE CAPTURE SOFTWARE.** Key features: Captures ANPA low/high speed wires. Sorts wire to DOS 3.2 or 3.3 directories. NETWORK Compatible Novel, 3COM, etc. Special directory viewing software, keyword SEARCHING, file archiving, translates data to ASCII format, compatible with wordprocessors, Eliminates need for printers, helps to automate the newsroom. Contact: Porter Communications, 579 DW. Highway, Merrimack, N.H. 03054. Tele: 603-424-4161. 05-90-12t

## EQUIPMENT WANTED

**WANTED: USED VIDEO EQUIPMENT.** Systems or components. **PRO VIDEO & FILM EQUIPMENT GROUP:** the largest USED equipment dealer in the U.S.A. (214) 869-0011. 04-90-tfn

## SERVICES

### WE PLACE TV MANAGEMENT, SALES & ENGINEERING PERSONNEL

America's Leading Source For A Decade  
For Information Phone or Write  
Mark Kornish



### key systems international, inc.

479 Northampton Street  
Kingston, PA 18704  
Phone (717) 283-1041  
Fax (717) 287-5889

Employer  
Paid Fees

**TRANSMITTER TUBE REBUILDING SINCE 1941:** 3CX2500, 4CX5000, 4CX15000 and many others. Write for details. **FREELAND PRODUCTS INC.,** 75412 Hwy. 25, Covington, LA 70433. (504) 893-1243 or (800) 624-7626. 6-79-tfn

**UHF KLYSTRON TUBE REBUILDING SAVE 50-76%** on External/Integral cavity Klystrons. New tube warranty. Major market stations use our services. **CALIFORNIA TUBE LABORATORY.** For full details (901) 324-4490 or (805) 995-1072. 04-90-6t



### Stainless, inc.

New Towers, Antenna Structures  
Engineering Studies, Modifications  
Inspections, Erection, Appraisals  
North Wales, PA 19454  
215-699-4871 FAX 699-9597

**NI-CAD BATTERY PACKS RE-BUILT.** All materials and workmanship warranted for one year. We also have new packs and inserts available for immediate shipment. Call Dave at Lowing Products, 616-245-2244. 04-90-4t

**TAPE TRANSFER SERVICE.** We transfer all obsolete video tape formats, one inch AMPEX, IVC, TYPE B, and SONY EV series. Also, all half inch black and white open reel formats, including PRE-EIAJ standard. No job too small. Call: TAPE TRANSFER SERVICE, PHILA., PA 19116 215-464-3158 05-90-3t

## TRAINING

**FCC GENERAL CLASS LICENSE.** Cassette recorded lessons with seminars in Washington, Newark, Philadelphia. Bob Johnson Telecommunications, Phone (213) 379-4461. 05-90-tfn

**NAPA VALLEY COLLEGE** offers a 2-year telecommunication program with emphasis in 1-inch "C" format, T.B.C.S., component and digital video. Call or write Gary Vann, 707-253-3258, Napa Valley College, Napa, California. 05-90-3t

# Use BE classified ads

# / Ad index /

	Page Number	Reader Service Number	Advertiser Hotline		Page Number	Reader Service Number	Advertiser Hotline
AKG Acoustics, Inc. ....	17		415/351-3500	JBL Professional .....	79	77	818/893-8411
A.F. Associates, Inc. ....	19	11	201/767-1201	Jensen Transformers, Inc. ....	78	73	213/876-0059
Alta Group, Inc. ....	69	49	408/297-2582	JVC Professional Products Co. 64A-D		50	800/582-5825
Amek Systems and Controls, Ltd. ..	83	84	818/508-9788	LDL Communications .....	31	16	301/498-2200
Ampex Corp. (AVSD) .....	33,51,52,56-57		415/367-2911	Lectrosonics, Inc. ....	75	68	800/821-1121
Ampex Recording Media .....	89	90	415/367-2911	Leitch Video of America, Inc. ....	30	15	804/424-7290
Anvil Cases, Inc. ....	90	93	818/575-8614	Lexicon, Inc. ....	47	29	617/891-6790
Aphex Systems Ltd. ....	43	25	818/765-2212	Markertek Video Supply .....	78	75	800/522-2025
Arrakis Systems, Inc. ....	21	13	303/224-2248	MCL, Inc. ....	76	69	708/759-9500
Audio Precision .....	13	8	800/231-7350	Midwest Corp. ....	1	3	606/331-8990
Audio Services Corp. ....	54	40	818/980-9891	Mohawk Wire & Cable .....	46	28	800/422-9961
Belden Wire and Cable .....	59	44	800/BEL-DEN4	National Photonics .....	38	21	805/494-4477
Benchmark Media Systems .....	60	46	800/BNC-HMRK	NEC, Corp. ....	55	42	214/907-4710
Broadcast Electronics, Inc. ....	11	7	217/224-9600	Newton Instruments .....	46	27	919/575-6426
Broadcast Video Systems, Ltd. ...	78	71	416/764-1584	Nikon Corporation .....	5	4	516/222-0200
Carver Corporation .....	42	24	800/443-CAVR	North Hills Electronics, Inc. ....	80	78	516/671-5700
Chronrol .....	60	45	800/854-1999	Nova Systems, Inc. ....	36	20	203/693-0238
Clear-Com Intercom Systems ...	70	52	415/527-6666	Odetics, Inc. ....	81	81	800/243-2001
Conex Electro Systems .....	78	72	206/734-4323	Opamp Labs Inc. ....	78	74	213/934-3566
Consultronics .....	82	82	416/738-3741	Orban, Div. of AKG Acoustics, Inc. ....	7	5	800/227-4498
Cortana Corporation .....	78	76	505/325-5336	Otari Corp. ....	15	9	415/341-5900
Crown International .....	61	47	219/294-8000	Panasonic Pro Industrial Video .....	34-35	18	800/553-7222
Di-Tech, Inc. ....	68	62	516/667-6300	Philips Components .....	50	32	800/882-NTSC
Dolby Labs, Inc. ....	91	92	415/558-0200	Polyphaser Corp. ....	38	22	800/325-7170
Drake Electronics Ltd. ....	44	38	615/254-7400	Rohde & Schwarz .....	53	39	
Dynair Electronics Inc. ....	49	37	619/263-7711	RTS Systems, Inc. ....	62	48	818/843-7022
Electro-Voice, Inc. ....	39	23	616/695-6831	Shure Brothers Inc. ....	IFC	1	708/866-2553
Ergo 90 .....	52	33	714/632-7045	Sony Communications Prod./ Broadcast Div. ....	24-25		800/635-SONY
Fast Forward Video .....	90	91	714/852-8404	Sony Communications Prod./ Audio Div. ....	40-41		800/635-SONY
Full Compass Systems .....	88	89	800/356-5844	Sony Pro Video Tape .....	72-73		201/930-7669
Geleco Electronics Ltd. ....	52	34	416/421-5631	Standard Tape Laboratory, Inc. ...	52	35	415/786-3546
Grass Valley Group, Inc. ....	9, 77	6, 70	916/478-3000	Switchcraft, Inc. ....	67	61	312/792-2700
Harris Corp. ....	27	12	800/4HA-RRIS	Tascam, Div. TEAC Corp. of America .....	84-85	87	213/726-0303
Hitachi Denshi America Ltd. ....	3		800/645-7510	Tektronix, Inc. ....	45	26	800/452-1877
IBTS-Milan .....	63	36		Telex Communications, Inc. ...	86,87	85, 86	612/887-5550
illbruck .....	IBC	2	804/358-3852	Thomson Tubes Electroniques ...	71	65	201/812-9000
International Broadcasting Convention .....	65	51		Varian, CED (Continental Electronics) .....	58	43	214/381-7161
Intraplex, Inc. ....	68	63	508/486-3722	Ward-Beck Systems, Ltd. ....	BC		416/438-6550
ITC-International Tapetronics Corporation .....	29	14	800/447-0414	Western Electronic Products, Co. ....	54	41	714/492-4677
ITT Canon/Canada .....	74	66	416/668-8881	Winsted Corp. ....	88	88	800/447-2257
Jampro Antennas Inc. ....	32	17	916/383-1177	360 Systems .....	37	64	818/342-3127





Place  
First Class  
Postage Stamp  
Here

# BROADCAST<sup>®</sup> engineering

*Circulation Department*  
P.O. BOX 12902  
OVERLAND PARK, KANSAS 66212-0902



# BROADCAST engineering ACTION CARD

New Subscription  Renewal  Address Change  Information Request

AFFIX LABEL HERE

Name _____
Title _____
Company _____
Address _____
City _____
State _____ Zip _____

Phone (\_\_\_\_\_) \_\_\_\_\_

## FASTER ACTION!

If you have immediate interest in any products in this issue, write in the number(s) below and check all the appropriate boxes.

I am interested in these items

#	Immediate Need	Have Sales-person Call	Name Nearest Dealer	Send Literature	For Future Reference				

## Circle reader service numbers below for more information

1	34	67	100	134	168	202	236	270	304	338	372	406	440	474	508	542	576
2	35	68	101	135	169	203	237	271	305	339	373	407	441	475	509	543	577
3	36	69	102	136	170	204	238	272	306	340	374	408	442	476	510	544	578
4	37	70	103	137	171	205	239	273	307	341	375	409	443	477	511	545	579
5	38	71	104	138	172	206	240	274	308	342	376	410	444	478	512	546	580
6	39	72	105	139	173	207	241	275	309	343	377	411	445	479	513	547	581
7	40	73	106	140	174	208	242	276	310	344	378	412	446	480	514	548	582
8	41	74	107	141	175	209	243	277	311	345	379	413	447	481	515	549	583
9	42	75	108	142	176	210	244	278	312	346	380	414	448	482	516	550	584
10	43	76	109	143	177	211	245	279	313	347	381	415	449	483	517	551	585
11	44	77	110	144	178	212	246	280	314	348	382	416	450	484	518	552	586
12	45	78	111	145	179	213	247	281	315	349	383	417	451	485	519	553	587
13	46	79	112	146	180	214	248	282	316	350	384	418	452	486	520	554	588
14	47	80	113	147	181	215	249	283	317	351	385	419	453	487	521	555	589
15	48	81	114	148	182	216	250	284	318	352	386	420	454	488	522	556	590
16	49	82	115	149	183	217	251	285	319	353	387	421	455	489	523	557	591
17	50	83	116	150	184	218	252	286	320	354	388	422	456	490	524	558	592
18	51	84	117	151	185	219	253	287	321	355	389	423	457	491	525	559	593
19	52	85	118	152	186	220	254	288	322	356	390	424	458	492	526	560	594
20	53	86	119	153	187	221	255	289	323	357	391	425	459	493	527	561	595
21	54	87	120	154	188	222	256	290	324	358	392	426	460	494	528	562	596
22	55	88	121	155	189	223	257	291	325	359	393	427	461	495	529	563	597
23	56	89	122	156	190	224	258	292	326	360	394	428	462	496	530	564	598
24	57	90	123	157	191	225	259	293	327	361	395	429	463	497	531	565	599
25	58	91	124	158	192	226	260	294	328	362	396	430	464	498	532	566	600
26	59	92	125	159	193	227	261	295	329	363	397	431	465	499	533	567	601
27	60	93	126	160	194	228	262	296	330	364	398	432	466	500	534	568	602
28	61	94	127	161	195	229	263	297	331	365	399	433	467	501	535	569	603
29	62	95	128	162	196	230	264	298	332	366	400	434	468	502	536	570	604
30	63	96	129	163	197	231	265	299	333	367	401	435	469	503	537	571	605
31	64	97	130	164	198	232	266	300	334	368	402	436	470	504	538	572	606
32	65	98	131	165	199	233	267	301	335	369	403	437	471	505	539	573	607
33	66	99	132	166	200	234	268	302	336	370	404	438	472	506	540	574	608
R7A	133	167	201	235	269	303	337	371	405	439	473	507	541	575	609		

FOR ISSUE OF JULY 1990  
USE UNTIL NOVEMBER 1990

(After this date, please contact supplier directly)

**1 IMPORTANT:** Do you wish to receive/continue to receive *Broadcast Engineering* FREE?  
 Yes  No

Signature required \_\_\_\_\_

Title \_\_\_\_\_

Date \_\_\_\_\_

**2** Please check the ONE type of facility or operation that best describes your business classification.

- 20  TV Station
- 21  AM Station
- 22  FM Station
- 23  AM & FM Station
- 24  TV & AM Station
- 25  TV & FM Station
- 26  TV, AM & FM Station
- 19  Low-Power TV Station
- 27  CATV Facility
- 28  Non-Broadcast TV including Closed-Circuit TV (CCTV)
- 29  Recording Studio
- 30  Teleproduction Facility
- 31  Microwave, Relay Station or Satellite Company
- 32  Government
- 33  Consultant (Engineering or Management)
- 34  Dealer, Distributor or Manufacturer
- 35  Other \_\_\_\_\_

(please specify)

**3** Which of the following best describes your title? Write the number in the box (select one number only):

- A  **Company Management**—(1) Chairman of the Board, (2) President, (3) Owner, (4) Partner, (5) Director, (6) Vice President, (7) General Manager (other than in charge of Engineering or Station Operations Mgt.), (8) Other Corp./Financial Officials
- B  **Technical Management & Engineering**—(9) Technical Director/Mgr., (10) Chief Engineer, (11) Other Engineering or Technical Titles
- C  **Operations & Station Management/Production & Programming**—(12) VP Operations, (13) Operation Mgr./Director, (14) Station Mgr., (15) Production Mgr., (16) Program Mgr., (17) News Director, (18) Other Operations Title
- D  **Other:** Specify \_\_\_\_\_

**4** If you checked 19 through 26 on question No. 2, which of the following best describes your over-the-air station? (check only one):

- A  Commercial
- B  Educational
- C  Religious
- D  Campus Low-Frequency
- E  Community
- F  Municipally Owned

**5** What is your annual budget for equipment purchases? (check only one):

- A  Less than \$25,000
- B  \$25,000 to \$49,999
- C  \$50,000 to \$99,999
- D  \$100,000 to \$250,000
- E  Over \$250,000

**6** What is the ADI rank of your station?

- A  Top 20
- B  21 to 50
- C  51 to 100
- D  Over 100

**7** Which statement best describes your role in the purchase of equipment, components and accessories?

- A  Make final decision to buy specific makes, models, services or programs
- B  Specify or make recommendations on makes, models, services or programs
- C  Have no part in specifying or buying



Place  
First Class  
Postage Stamp  
Here

# BROADCAST<sup>®</sup> ENGINEERING

*Circulation Department*

P.O. BOX 12902  
OVERLAND PARK, KANSAS 66212-0902



# THE MOST IMPORTANT AUDIO CONTROL EQUIPMENT WORKS FROM HERE TO HEAR

Keeping sound clean and accurate can make or break your audio projects. SONEX from illbruck ensures that you're getting the sound you want. Our complete line of acoustical materials gives you total control—in the studio, the control room, or wherever sound quality is critical. There's a reason SONEX continues to lead—nothing works better. Put the leader to work for you; call today for all our performance specs and application guides—800-662-0032.

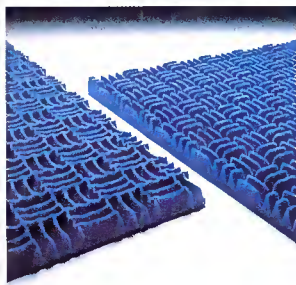

## SONEX

The only acoustical foam with the illbruck anechoic-wedge—over 400% more surface area than flat materials. Controls reverb, reflections, and resonances—beautifully. The proven performer.



## SONEX 1

The same unbeatable performance of SONEX but in materials that meet all Class 1 regulations. For demanding applications where heat or fire are factors. Safe for you but deadly for sound.



## SONEX CEILING

Suspended ceiling treatments that deliver new levels of acoustical performance. Unique, contemporary designs. Available in a variety of styles and colors.

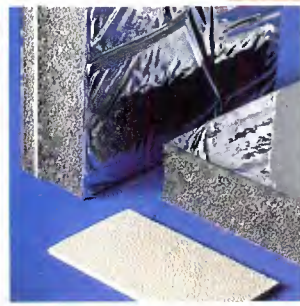

## BARRIERS & COMPOSITES

When the problem requires more than absorption, illbruck barriers deliver. Single layer vinyls to multi-level laminates. Lead performance without lead price or problems.

# illbruck

Sonex Acoustical Division  
5155 River Road N.E.  
Minneapolis, MN 55421  
1-800-662-0032  
In MN: 612-521-3555

Circle (2) on Reply Card

[www.americanradiohistory.com](http://www.americanradiohistory.com)

**More versatility!  
More important functions!**



**The D8212 Distribution  
Amplifier System just  
keeps on growing!**

All of Ward-Beck's substantial investment in R&D is directed towards one single objective ... to bring you the very best professional audio systems.

That's why other manufacturers, who try to satisfy a wider range of audio and video applications, simply cannot match the performance and quality of Ward-Beck audio products such as the proven D8212 DA System.

Now Ward-Beck is proud to announce the addition of new modules for the D8212 System. These include the M8200 transformerless, remote sensitivity microphone pre-amplifier, a stereo DA and a test oscillator.

We invite you to ask for details on these and other high-performance products in the expanding D8212 family.



**WARD-BECK SYSTEMS**

Ward-Beck Systems Ltd.  
841 Progress Avenue, Scarborough, Ontario, Canada M1H 2X4.  
Tel: (416) 438-6550. Fax: (416) 438-3865.