

BROADCAST[®] ENGINEERING

AN INTERTEC PUBLICATION

June 1988/\$3

NAB '88:
Another
record-
breaker



Cans for the 80s!
Minerals/Fossils

Pick hits
of NAB
p. 68

FIELD PRODUCTION

A special job demanding specialized products.



For your audio needs: a growing line of compact, easy-to-use FP amps and mixers.

Shure FP products are built specifically for ENG, EFP, film, and video work. They're not general audio products that "might" work on remotes. And no one offers as wide a selection with this kind of built-in ruggedness and reliability.

FP32



FP42



For Stereo Remotes. The FP32 Stereo Mixer is comparable in size and features to our famous FP31. Its stereo capability, light weight, easy-to-use controls and convenient shoulder harness make it the first choice of field crews. Our FP42 Stereo Mixer simplifies mic cueing, so important in situations like sports remotes. Plus it enables you to easily mix down stereo in your post production booth. It offers all the features of the popular M267 plus stereo capability and a stereo headphone amp.

FP31



FP16



The Industry Standards. The FP31 is Shure's original field production mixer. Thousands bet their audio on it worldwide. The FP16, a one-by-six distribution amp with transformer balancing and link jacks, outperforms all competition. It's also ideal as a portable press bridge.

FP11



FP12



For Long Yardage Situations. The FP11 Mic-to-Line Amp provides freedom from noise in long line situations, with up to 84 dB of gain in 15 6-dB steps. It converts any mic to line level and includes an invaluable limiter circuit. The FP12 Headphone Bridging Amp is a must for shotgun and boom operators. It keeps them on target without need for a return line. It's ideal for multiple headphone feeds, troubleshooting, and as an intercom.

FP51



The new FP51 gated compressor/mixer rides gain automatically. Once you set the compression level, the FP51 adjusts automatically to changing signal levels in critical remote-to-studio feeds to maximize signal output. As a result, your broadcast is quieter, smoother, better balanced and more natural sounding.

For more information on the entire FP line, call or write Shure Brothers Inc., 222 Hartrey Avenue, Evanston, IL 60202-3696. (312) 866-2553.

SHURE®

THE SOUND OF THE PROFESSIONALS...WORLDWIDE®

Circle (1) on Reply Card

the
SOURCE
*for Ikegami
Microwave Equipment*

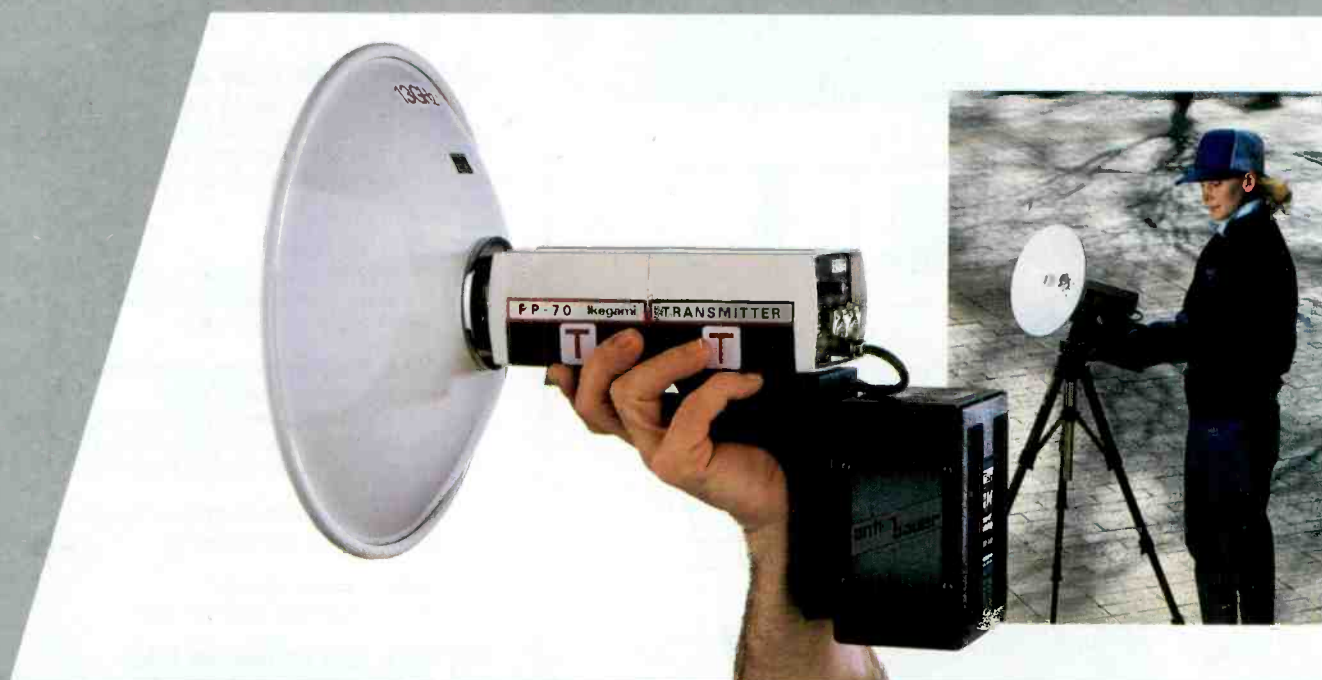

MIDWEST

As the nation's largest Ikegami dealer, Midwest offers you immediate delivery and dependable service on the full line of Ikegami products, including the PP-70 Portable Microwave.

Available in the 7 & 13 GHz frequency bands, the PP-70 is a compact high performance portable microwave link. This lightweight, battery operated unit (3 hours on a standard 4AH battery) is designed for convenient cable-free transmission of television video and audio signals. ENG and EFP production crews will find the PP-70 an operator-friendly addition to their production unit. The PP-70 is the only portable microwave unit with built-in features such as two audio channels (mike or line level), audio/video test signals, low battery indicators, LED bar graph/audible beeper for system path alignment, and LED SHF output indicator. Call your nearest Midwest office for a demonstration.

For all your RF Equipment needs, rely on the recognized leader. Midwest... the Source.

MIDWEST
Communications Corp.

One Sperti Drive/Edgewood, KY USA 41017
(606) 331-8990

Circle (3) on Reply Card

Contents

June 1988 • Volume 30 • Number 6



Page 24

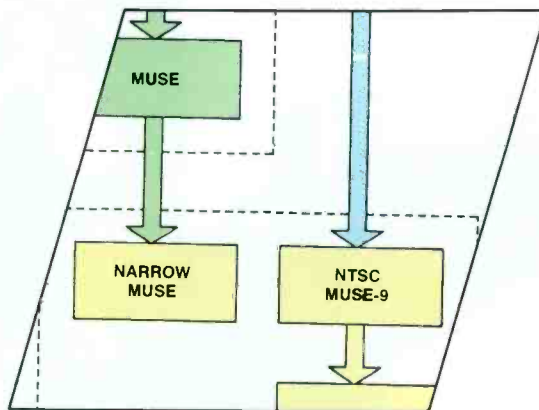

Page 28



Page 189

BROADCAST engineering

NAB '88 CONVENTION REPLAY:

The state-of-the-art is a moving target, and the annual NAB convention sets the pace for that target through major equipment introductions and company announcements. Our NAB show replay will highlight primary points of interest in the following articles:

22 NAB '88 Replay

By Jerry Whitaker, editorial director

If change makes you uncomfortable, it's time to start looking for a new job.

28 NAB Engineering Conference Report

By Brad Dick, technical editor

The engineering sessions brought high-tech answers for today's complex problems. Other session topics are covered in the following related articles:

•Electromagnetic Radiation Update

By Brad Dick, technical editor

•Fiber Optics Update

By Rick Lehtinen, technical editor

68 Pick Hits of the '88 NAB

By Rick Lehtinen, technical editor

BE's panel of independent experts shares its favorite new products from NAB.

80D Show of Shows

Coordinated by Carl Bentz, special projects editor

You probably didn't get around to all the exhibits at NAB. Here's a post-show tour your feet will love.

ON THE COVER

The NAB convention this year held something for everyone. Hundreds of new products were introduced, generating excitement in the broadcast and professional audio-video industries. This month we report on what happened in Las Vegas, and what it means to you. (Photo by Doug Schwartz.)

DEPARTMENTS

4	News	16	Circuits
6	Editorial	18	Troubleshooting
8	FCC Update	20	Management for Engineers
10	Strictly TV	182	SBE Update
12	re: Radio	192	Business
14	Satellite Technology	194	People

Still the Only Camera Better than the Z-31



Z31A

The Z-31A, Hitachi's newest member of the Computacam family, further enhances the performance, features and functions that have made the Z-31 so successful.

With newly developed Twist Field Saticon tubes and improved video processing, the Z-31A delivers 800 lines of resolution and 60dB signal to noise ratio.

We increased the power of the auto set-up system and cut the set-up time in half.

The price — it's as good as the specs.

Call the regional office nearest you and ask to see the camera that beats the Z-31... and every other camera in it's class.

 **HITACHI**

175 Crossways Park West
Woodbury, NY 11797

THE Z-31A... For Today's Bottom Line Broadcast Business

New York
516-921-7200

Atlanta
404-451-9453

Chicago
312-250-8050

Dallas
214-233-7623

Los Angeles
213-328-6116

Canada
416-299-5900

Circle (4) on Reply Card

Scientists review HDTV methods

State-of-the-art methods to assess the picture-quality improvements provided by high-definition television (HDTV) were analyzed at the recent NAB convention at a meeting of international scientists expert in psychophysics.

The Interim Working Party (IWP) 11/4 of the International Radio Consultative Committee (CCIR), met to discuss advanced methods for subjective assessment of TV picture quality.

In addition, the IWP 11/4 collected new information on subjective and objective measures of the major picture-quality impairments from using digital coding of TV signals for distribution. These results will be considered by CCIR IWP 11/6 (HDTV standards) and by a meeting of CCIR's study group II (TV broadcasting), devoted exclusively to HDTV, by May 1989 in an attempt to reach agreement on a single worldwide HDTV studio production standard.

By John Blau,
European correspondent

TV SAT-2 launch date moved forward

The Ariane 4 rocket, carrying the European direct broadcast satellite TV SAT-2, is to be launched half a year ahead of schedule. The rocket manufacturer, Arianespace, and the Bundespost agreed on a date sometime in "the middle of 1989." TV SAT-2 is to replace the unsuccessful TV SAT-1, which failed due to a defective solar panel. The date has been moved up to compete with the American rockets, Titan and Atlas-Centaur, and the Chinese "Long March."

WARC '88 to begin in August

The 1988 World Administrative Radio Conference (WARC) will take place in Geneva this summer. The main item on the agenda will be the allocation of new or-

bital positions for communications and broadcasting satellites. The conference opens on Aug. 29, and is expected to run for more than a month in order to sort out the scramble in Europe and North America for the best satellite positions for future broadcasting services.

German networks support Japanese HDTV standard

The two German public TV networks, ARD and ZDF, have publicly announced their support for the HDTV standard developed by Sony. The company has engineered a 1,150-line, 60Hz system to compete in the European marketplace.

The Sony HDTV standard still remains incompatible with existing European equipment. Despite Japan's lead in HDTV development, European efforts are centered largely on a 1,250-line, 50Hz system. A MAC decoder will be used for

Continued on page 181

BROADCAST engineering

Editorial and advertising correspondence should be addressed to: P.O. Box 12901, Overland Park, KS 66212-9981 (a suburb of Kansas City, MO); (913) 888-4664. Telex: 42-4156 Intertec OLPK. Circulation correspondence should be sent to the above address, under P.O. Box 12937. RAPIDFAX: 913-888-7243.

EDITORIAL

Jerry Whitaker, *Editorial Director*
Brad Dick, *Radio Technical Editor*
Carl Bentz, *Technical and Special Projects Editor*
Rick Lehtinen, *TV Technical Editor*
Paula Janicke, *Staff Editor*
Dawn Hightower, *Associate Editor*
Tom Cook, *Senior Managing Editor*
Kathy Mickelson, *Editorial Assistant*
James McWard, *Editorial Assltant*
Pat Blanton, *Directory Editor*

ART

Kristi Sherman, *Graphic Designer*

EDITORIAL CONSULTANTS

Fred Ampel, *Audio*
Nils Conrad Persson, *Electronics*
Ned Soseman, *Video*
Michael Heiss, *Consulting Editor*
Don McCroskey, *Consulting Editor*

BUSINESS

Cameron Bishop, *Group Vice President*
Duane N. Hefner, *Publisher*
Stephanie Hanaway, *Promotions Manager*
Cynthia Sedler, *Promotions Coordinator*
Dee Unger, *Advertising Supervisor*
Mary Birnbaum, *Advertising Coordinator*

ADMINISTRATION

R.J. Hancock, *President*
Doug Riemer, *Circulation Vice President*
Jane J. Powell, *Circulation Director*
JoAnn DeSmet, *Circulation Fulfillment Manager*
Barbara Clare, *Reader Correspondent*
Kevin Callahan, *Art Director*

TECHNICAL CONSULTANTS

Eric Neil Angevine, *Broadcast Acoustics*
John H. Baltison, *Antennas/Radiation*
Blair Benson, *TV Technology*
Dennis Ciapura, *Radio Technology*
Dane E. Ericksen, *Systems Design*
Howard T. Head, *Washington Correspondent*
Wallace Johnson, *FCC/Bdct. Engineering*
John Kean, *Subcarrier Technology*
Donald L. Markley, *Transmission Facilities*
Harry C. Martin, *Legal*
Robert J. Nissen, *Studio/Communications*
Hugh R. Paul, *International Engineering*
Art Schneider, *A.C.E., Post-production*
Elmer Smalling III, *Cable/Satellite Systems*
Vincent Wasilewski, *Communications Law*

MEMBER ORGANIZATIONS

SUSTAINING MEMBERS OF:

- Acoustical Society of America
- Society of Broadcast Engineers
- Society of Motion Picture and TV Engineers

Member,

Association of Business Publishers

ABP

Member,

Business Publications

VBPA

Audit of Circulation

BROADCAST ENGINEERING is edited for corporate management, engineers/technicians and other station management personnel at commercial and educational radio and TV stations, teleproduction studios, recording studios, CATV and CCTV facilities and government agencies. Qualified persons include consulting engineers and dealers/distributors of broadcast equipment.

BROADCAST ENGINEERING (ISSN 0007-1794) is published monthly (except in the fall, when two issues are published) and mailed free to qualified persons within the United States and Canada in occupations described here by Intertec Publishing Corporation, 9221 Quivira Road, Overland Park, KS 66215. Second-class postage paid at Shawnee Mission, KS, and additional mailing offices. POSTMASTER: Send address changes to Broadcast Engineering, P.O. Box 12960, Overland Park, KS 66212.

SUBSCRIPTIONS: Non-qualified persons may subscribe at the following rates: United States and Canada; one year, \$25.00. Qualified and non-qualified persons in all other countries; one year, \$30.00 (surface mail); \$108.00 (air mail). Back issue rates, \$5.00, except for the Buyers' Guide/Spec Book, which is \$20.00. Rates include postage. Adjustments necessitated by subscription termination at single copy rate. Allow 6-8 weeks for new subscriptions or for change of address.

Photocopy rights: Permission to photocopy for internal or personal use is granted by Intertec Publishing Corporation for libraries and others registered with Copyright Clearance Center (CCC), provided the base fee of \$2.00 per copy of article is paid directly to CCC, 21 Congress St., Salem, MA 01970. Special requests should be addressed to Cameron Bishop, group vice president. ISSN 0007-1794 \$2.00 + \$0.00.

© 1988. All rights reserved.

Advertising offices listed on page 199.

INTERTEC
PUBLISHING CORPORATION

LEADER

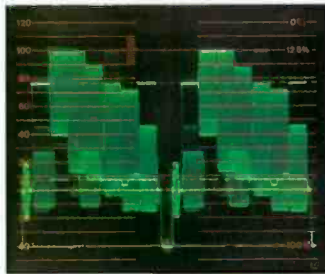

THREE.



IN ONE.

And only in the 5870 Vector/Waveform Monitor.

Only the 5870 gives you a unique numerical readout of SCH phase. And waveforms from 2 channels, plus vector information - appearing at the same time or separately. All this in one half-rack!

No compromises.

This unsurpassed unit performs like three superb instruments in one. **2-channel NTSC waveform monitor:** Features simultaneous or separate display of both channels, and dual filter display, plus a CRT readout of SCH phase, full 525-line select capability with a CRT readout of the line and field selected, memory

preset and recall of nine lines. Add to this the unit's remote control capability and extra-bright CRT, and you have a terrific waveform monitor.

Full-fledged NTSC vectorscope: Boxes for error limits of $\pm 2.5^\circ$ and ± 2.5 IRE units; $\pm 1^\circ$ differential phase and $\pm 1\%$ differential gain; internal Z-axis blanking for line selection and continuous phase adjustment. The 5870 is a great vectorscope, too!

Designed to go anywhere.

Operating from any 11-20 Vdc or 85-264 Vac (48-440 Hz) power source, this 12-lb, half-rack unit is ideal anywhere that size and weight are critical.

Call toll-free

1 800 645-5104

In NY State

516 231-6900

Ask for our full-line Catalog, an evaluation unit, and the address of your nearest Leader Distributor.

Leader Instruments Corporation
380 Oser Avenue, Hauppauge, New York 11788
Regional Offices:
Chicago, Dallas, Los Angeles, Boston, Atlanta
In Canada call Omnitronix Ltd. 416 828-6221

LEADER
FOR PROFESSIONALS WHO KNOW
THE DIFFERENCE

A curtain call for NAB

"Courage is virtue only in proportion as it is directed by prudence."
—Francois De Salignac De La Mothe Fenelon

We must compliment the National Association of Broadcasters for its courage. Plainly and simply, it takes guts to try something new, especially before an audience. This moxie was particularly evident at the 1988 NAB Annual Convention and International Exposition, held in April in Las Vegas. Among the gambles taken by the association: live HDTV coverage of President Reagan's visit to the convention, first-time use of a laser-based projection TV system, and use of the new 40GHz band to distribute the President's speech.

A basic rule applies to these operations, as with many other Las Vegas ventures: Sometimes you win; sometimes you lose. Some aspects of the proceedings went swimmingly, others thrashed around a bit. Aside from glitches, inconveniences and temporary setbacks, attendees walked away from the table richer than they had arrived, technically speaking at least.

The NAB plays its hand not only with new hardware, but also steers new technological proposals that potentially affect all broadcasters. A peek at the NAB's cards shows ideas on UHF efficiency, AM improvement, frequency coordination, signal propagation and the problems caused by electrical interference. The NAB also stands as an engineering watchdog, working to protect our industry from governmental rulemaking that may sometimes lack technical acuity.

Not every proposal espoused by the NAB can be said to be universally popular. The National Radio Systems Committee recommendations, for example, propose uniform bandwidth and pre-emphasis values for AM radio. With these standards in place, receiver manufacturers would feel confident about building high-quality radios that could sound good enough to compete with FM.

A small group, however, thinks that, although the proposals are a quantum leap from the chaotic situation of the present, they actually may *limit* the quality of AM to a point that FM would always be better. These critics also point out that, at one time, the NRSC recommendations were voluntary, but now the NAB is petitioning the FCC to make them law. It would be better, they say, for the recommendations to remain voluntary, allowing stations that want to stay technically abreast to do so, but leaving room for fine-tuning to fit local preferences.

The NAB also has put a lot of muscle into the advancement of HDTV, including the first on-air HDTV transmissions, reported last year. Few informed people can say honestly that there is no need for these advanced systems. Some critics, however, think the game was called before all the players were seated, and that it is too early to banter numbers such as 1125/60. The smart money is hedging, looking for an 1125/60, wide-aspect ratio *production* standard, and then relying on digital conversion to translate to whatever transmission standard has the most chips when the dealing's done.

As we at **Broadcast Engineering** can attest, technology is a moving target. Although we might not always be in complete agreement with what the NAB says, we certainly agree with what it does, in courageously advancing new technology. Congratulations, NAB, on a great show in 1988!

May NAB '89 be even better.

BLUE CHIP LEVEL CONTROL.



Orban's "Blue Chip" automatic level control units excel for one simple reason: They offer extraordinary transparency with a wide variety of program material. Whether being used in the production room, on mic channels, in the program line, or for videotape transfers, Orban compressor/limiters can be trusted to efficiently control levels and peaks while preserving dynamic integrity.

464A Co-Operator (Gated Leveler/Compressor/HF Limiter/Peak Clipper): A four-stage, system approach to level control and dynamics processing. Features quick set-up with straightforward front panel controls. Two channels in one rack space. Your "assistant operator" for a wide range of tasks. Astonishingly transparent and easy-to-use.

424A Gated Compressor/Limiter/De-Esser: A full featured, "hands-on" production tool. Designed to allow maximum user control of individual parameters such as compression ratio, and attack and release times. Contains an effective de-esser. Ideal for voice processing. Widely recognized for its smoothness.

412A/414A Compressor/Limiters: Orban's inexpensive compressor/limiters. Utilizes the same basic circuitry as the 424A, but does not include de-essing, nor gating. Offers a compressor THRESHOLD control. For cost-effective level control. Available in mono or dual-channel/stereo.

787A Programmable Mic Processor: Combines a 3-band parametric EQ, compressor, noise and compressor gates, and de-esser in a fully programmable package. Can be used to store up to 99 complete control setups for instantaneous recall. Mic or line-level inputs. MIDI, RS-232, and remote control interface options. Particularly advantageous for consistent DJ or TV newsroom mic processing and many other studio production tasks.

Security Covers: Attractive, acrylic security covers are available to fit any standard 19" rack-mount product—from one to four rack spaces, in opaque white, clear, and transparent blue.



Orban Associates Inc.

645 Bryant St., San Francisco, CA 94107 (415) 957-1067 Telex: 17-1480 FAX: (415) 957-1070

Circle (7) on Reply Card



Exploring the role of FM translators

By Harry C. Martin

The FCC has initiated a far-reaching inquiry to re-evaluate the proper role of FM translators in the radio broadcasting services. The commission is seeking to determine whether it would be appropriate to retain, eliminate, strengthen or relax its current restrictions on FM translator operations.

Among the areas of inquiry are: evaluation of the current functions of translators and possible alternatives to translator service; their effect on service provided by full-power FM stations; and the impact of possible rule relaxations on the commission's resources and enforcement activities.

The inquiry was initiated by a petition from the NAB seeking restrictions on current FM translator uses, as well as petitions by other parties, some of whom seek expansion of the service, including permission for programming origination, or "low-power FM." All indications are that the commission is inclined to relax, rather than tighten, its rules.

New rules for NCE-FM translators

In response to a request by Moody Bible Institute, the commission has amended its rules to allow non-commercial educational FM (NCE-FM) translators, assigned to reserved channels and owned and operated by their primary stations, to use alternative signal-delivery technologies such as satellite feeds and microwave links. Up until now, the rules have limited NCE-FM translators to rebroadcasting signals received directly over the air from their primary stations.

The commission claims that the new rules will allow improved service, but will not change the fundamental nature of the translator service. Non-commercial educational translators already are allowed outside the 1mV/m contour of their primary stations. They will continue to be restricted to the rebroadcast of their primary stations and will continue to be a secondary service. (That is, in a conflict with a full-service station, the translator operator must resolve the conflict or cease operating.)

The commission also has proposed to amend its rules to allow all non-commercial educational FM translators operating on reserved channels, whether owned by a primary station or a third party, to use alternative signal-delivery technologies. Additionally, it has proposed to allow the licensees of NCE-FM translators to use broadcast auxiliary facilities (intercity relay stations) to receive signals from their primary stations.

The commission is seeking comments on whether use of one or more broadcast auxiliary channels by non-commercial translators should be on a secondary basis to their use by full-service stations. (In other words, broadcast auxiliary stations that deliver signals to a full-service station could displace an existing intercity relay station used with a non-commercial FM translator.)

Freeze on FM translator applications

Pending action on its inquiry proceeding regarding the overall role of FM translators, the commission has imposed a general freeze on acceptance of applications for new FM translator stations and major changes to existing FM translator stations in the commercial FM band. However, the commission will make an exception to the general freeze for applications for new NCE-FM translators in the reserved non-commercial band. The commission said it would continue to process and to consider for grant any FM translator application already on file.

Cable systems subject to rate regulation

The commission has changed the conditions under which a local cable franchising authority may regulate cable TV rates, resulting in more cable systems being subject to local rate regulation.

The Cable Act requires that local rate regulation be permitted where cable systems do not meet the definition of "effective competition." Under commission rules, effective competition exists where three off-the-air broadcast signals: (a) cover all of the cable community or (b) are significantly viewed in the cable community. Previously, a broadcast signal would be considered available as long as

the signal placed a predicted grade B contour over any portion of the cable community. Complete coverage now is required. Also, the determination of significant viewing now must be based upon viewership data in the community, compared with the previous standard based on county data.

The commission also modified waiver procedures regarding the signal availability standard so that the losing party now is responsible for the cost of any engineering study that is necessary. Under its original waiver policy, the commission permitted parties to submit engineering studies and other evidence showing that the grade B contour and "significantly viewed" tests were not an accurate measure of actual signal availability in their communities. The commission says the new rule, which requires that the party that loses a waiver dispute bear the cost of engineering studies, will encourage parties to resolve disputes prior to formal engineering studies.

Further study of must-carry

The commission is requesting information concerning cable-system carriage of TV broadcast signals to assist it in preparing future policies in this area.

The must-carry rules were invalidated in "Quincy Cable TV vs. FCC." Subsequently, a different set of rules were adopted, but they also were invalidated by the court.

Now, in order to determine whether there is a need for such rules, the commission is requesting two types of information. First, it is interested to know whether TV stations that were eligible for signal carriage on cable systems under its initial rules are not being carried. Second, the commission is seeking to ascertain whether former must-carry broadcast signals now are being carried by cable systems on channels other than those on which they are available off the air.

The commission also is seeking information on the reasons cable systems may have dropped or added broadcast signals, as well as on the adverse effects on TV station audience levels and revenues caused by cable-system signal-carriage practices.

Martin is a partner with the legal firm of Reddy, Begley & Martin, Washington, DC.

Announcing Master-21™ from GVG.

Master control that's expansive. Without being expensive.



Introducing the new MASTER-21™ Master Control System from Grass Valley Group.

With its standard high performance features, available options, and built-in GVG quality, MASTER-21 packs more power than you've ever seen in any master control system.

Let alone in a *complete* system priced around \$17,000.

The MASTER-21 system is the first master control

system ever designed with a *keyed-in video status display*, so you can monitor *preset events and transitions*.

Plus a long list of standard features including *16 inputs, stereo audio, a keyer with matte generator, pre-roll, and RS-232/422 serial control of every active function on the panel.*

The new MASTER-21 Master Control System from GVG. The price/performance breakthrough you must see to appreciate.

For complete details, contact the Grass Valley Group office nearest you.

Grass Valley Group®

A TEKTRONIX COMPANY

THE GRASS VALLEY GROUP INC.

P. O. Box 1114, Grass Valley, CA 95945 USA
Telephone (916) 478-3000
TRT: 160432

OFFICES: New York (201) 845-7988; District of Columbia (301) 622-6313; Atlanta (404) 493-1255; Chicago (219) 264-0931; Minneapolis (612) 483-2594; Dallas/Fort Worth (817) 483-7447; Los Angeles (818) 999-2303; San Francisco (415) 968-6680; GVG International Ltd. (UK) +44-962-843939; Grass Valley Group Asia (HK) +852-3-7396632

Circle (8) on Reply Card

Good connectors prevent signal loss

By Robert Griffiths

In fiber-optic transmission, connectors and splices must be aligned closely to prevent serious loss of signal. Any type of misalignment of the fibers to be joined will cause light to escape from the cable (see Figure 1). The hairlike diameter of the fiber imposes strict tolerances on the connector. To keep losses to a minimum, a connector must meet the following criteria:

- It should be axially aligned by more than 95%.
- Ideally, the fibers should touch, but end separation of 0.001 to 0.005 can be tolerated.
- It should have no angular misalignment.
- The end surfaces of the fibers should be smooth, square and polished.
- The fiber ends should be parallel.

If the connector does not meet these requirements, the transmission of light through the fiber will be greatly attenuated.

Connectors can take many forms. Some resemble a small BNC or type F connector. Others are large assemblies with complex inner workings designed to hold the fibers dead straight. Some connectors use an index-matching gel to optically couple the light across the junction. Others use lenses that expand the beam to minimize the effects of minor misalignments. Some connectors are arrays of little troughs the size of the fibers to be joined. Still others squeeze fibers into the space between rods or hold them with elastic wedges.

Regardless of the type of connectors used, their installation calls for care and skill. It is important to wear eye protection and to keep track of loose ends. The fragments are not small curls of wire that can wisp away in the breeze. You are dealing with pieces of glass that can be as sharp as needles if they penetrate the skin, but they are nearly invisible, and they fragment easily.

Because their manufacture requires precision craftsmanship, connectors are quite expensive. However, as more streamlined methods of manufacture are

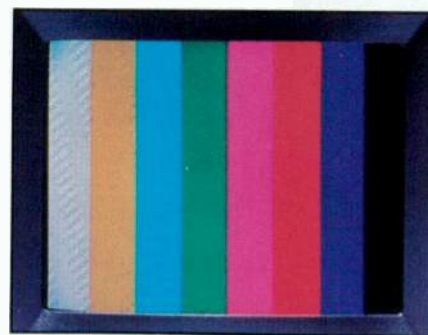

developed, the cost is expected to drop dramatically.

If a buried fiber-optic cable were to suffer a break, a device known as an OTDR (optical time-domain reflectometer) would be used to locate the rupture. Once iden-

tified, the broken portion of the cable could be dug up and spliced, either mechanically or with a fusion-splicing device.

For a mechanical splice, hardware mates the prepared fibers and holds them in position to transfer their light. Index-matching gel sometimes is applied to the ends to improve their transmission. The splice typically is sealed with adhesive, then packaged into an enclosure of some kind. The advantage of mechanical splicing is that it can be accomplished quickly in the field with a minimum of equipment. The disadvantages are that the fibers may experience more loss than they would with a fusion splice, and their characteristics may change over time.

With fusion splicing, the operator actually works on the glass. A fusion-splicer is similar to a tiny arc welder with a microscope attached. The operator inserts both ends of the fiber into the unit until the ends barely touch each other. At that point, a heat button is pressed, and the ends are annealed together. The entire process is monitored through the microscope. To be acceptable, the splice must be clean and bubble-free.

It is possible, of course, to temporarily "patch" a fiber using two connectors mated with a barrel, or a temporary mechanical splice, until a fusion splicer is available. Because of its cost and specialization, broadcasters typically contract for fusion splicing.

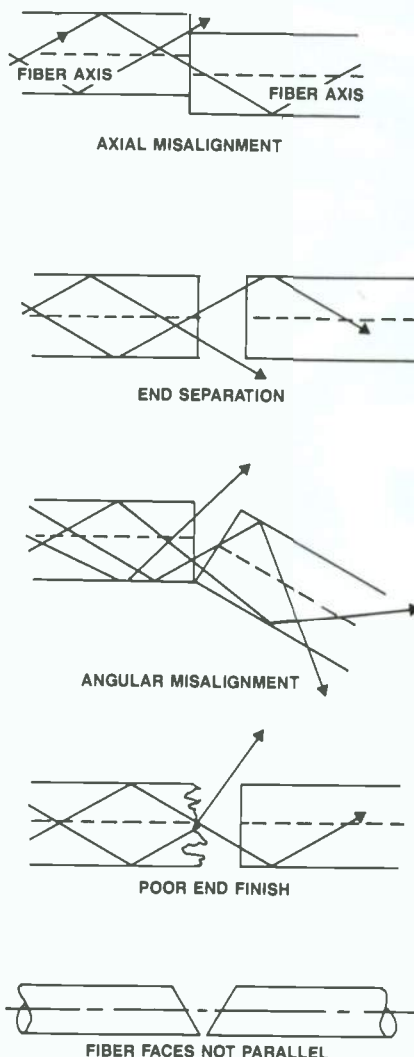

Figure 1. Any imperfection in the interface is a source of loss in a fiber-optic splice. Connectors are designed to minimize problems such as these. Even a "perfect" splice or connector suffers a typical loss that must be taken into account in the design of fiber-optic systems.

Griffiths is vice president of sales for Telemet, Amityville, N.Y.

They're here!



MAGNI

MAGNI SYSTEMS, INC.
9500 SW Gemini Drive
Beaverton, OR 97005 USA
(503) 626-8400
(800) 237-5964
FAX (503) 626-6225
TLX 650-2769743MCI

Circle (9) on Reply Card

Designing a parasitic array

By John Battison, P.E.

Engineers recognize that two vertical radiators, spaced 90° apart and properly driven with one tower leading the other by 90°, result in a cardioid pattern. This design produced what was probably one of the earliest intentionally created directional patterns. The technique may have been applied by an amateur in search of DX, or it may have been developed by one of the pioneer engineers. If an amateur was responsible for the technique, it was almost certainly achieved through use of a parasitic element. If a broadcast radio engineer came up with it, the design probably used a driven element.

Directional antenna use has become almost universal. The United States is undoubtedly the largest user of the DA. Without directional antennas, more than



half of U.S. AM radio stations would not be on the air.

As far as I know, no directional antennas in use today employ parasitic radiators. It is doubtful that any were intentionally built with parasitic elements. However, I have recollections of a station at which the DA started out as a conventional array with a driven element and ended up as an unintentional parasitic array.

Franklin antenna

The station was WWWE-AM, Cleveland, operating at 1,100kHz, DA-1 with 50kW of power. It was bought from NBC, and I was director of engineering for the new owner. As originally built, the transmitter used the tall tower of its sister TV station as a radiator. Because the tower height was ap-

proximately one wavelength of the AM frequency, the tower was built as a Franklin antenna. One vertical section of the tower was built above the other, as shown in Figure 1.

Because of a slight problem with excessive radiation toward Canada, the commission deemed it necessary to reduce radiation in the direction of Toronto. To achieve this reduction, a wire was dropped from a guy on the side toward Toronto, and a phaser was designed to drive this wire, which was close to the Franklin radiator.

The original plan was to drive the directional element. A transmission line was installed out to the tower base. As it turned out, driving the vertical wire did not accomplish the desired reduction in radiation toward Canada. The tower was then made parasitic by disconnecting the transmission line and substituting a resistor to ground to dissipate the undesired radiation. I do not recall whether the original base network was left in the circuit, but I think approximately 5kW was dissipated in the grounded resistor.

This vertical DA was monitored in much the same way as it would be today, with the antenna monitor reading phase and current in each of the vertical elements of the Franklin and in the base of the wire element. Continual problems were encountered because of the high voltages in the center of the Franklin antenna. Slight changes in weather conditions resulted in widely varying antenna-monitor readings. Stability was not one of the system's strong points.

Even so, the commission was finally persuaded that the transmitter was "within limits" as long as radiation toward Canada did not exceed a certain level. A monitor point was established in the appropriate direction, and this became the official checkpoint.

Sooner or later, the commission will accept parasitic antenna arrays in some specialized cases. However, I do not see this happening in situations in which a critical, or even mildly tight, tolerance exists. As far as I can tell, the rules do not prohibit parasitic arrays, but they do not specify how the desired radiation control is to be accomplished. [:(=)]

Battison, BE's consultant on antennas and radiation, owns John H. Battison & Associates, a consulting engineering company in Columbus, OH.

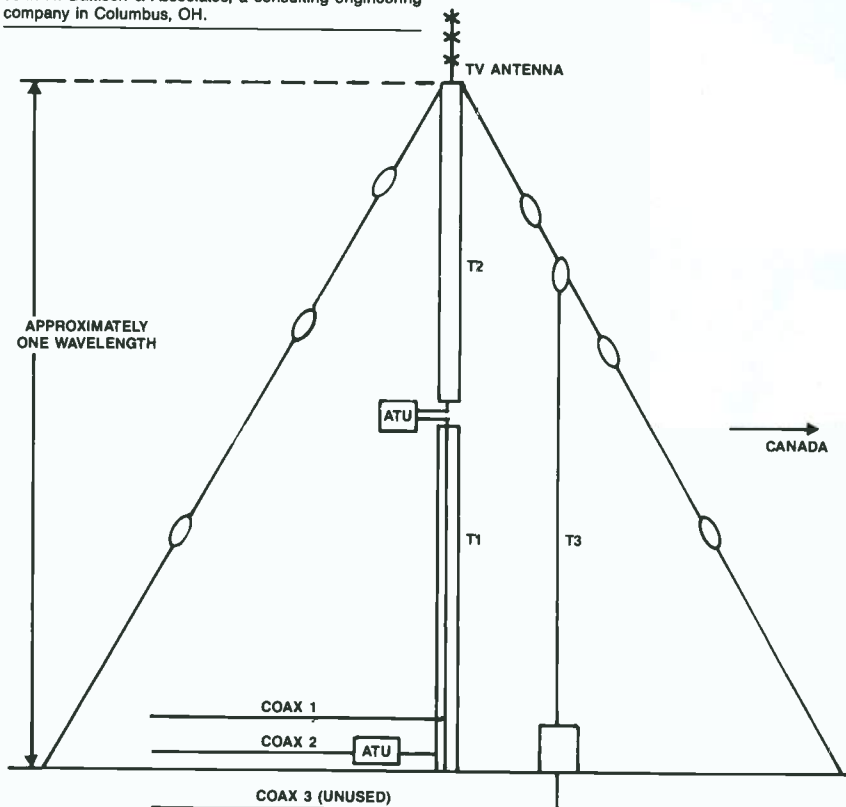

Figure 1. The original WWWE-AM Franklin antenna used a sectionalized, tall TV tower. Directional operation was first attempted by dropping a vertical wire from a guy and using it as a driven element.

Hot! from CRL



Digital Friendly Sound

FOR PROGRAMMERS:

Pictured above is the new FM processor from CRL, the SMP-850. It offers you a clean, open and transparent sound that will make you the winner on the FM dial. Here's why. Most audio processors get muddy sounding if you turn them up to get loud. Because of this fact, all kinds of add-on boxes are being used to "brighten" the sound. CRL has solved the problem by developing the variable transfer function pre-emphasis limiter, which will give you a LOUD clean signal that STAYS bright and open. That's why we call it "Digital Friendly".

But that's not all. We have "built in" a circuit that widens your stereo image. Sound Field Enhancement increases the separation between the left and right channels, but only on those recordings that need it. This means that YOUR stereo image is going to be more dramatic than your competition.

Also in the SMP-850 there is new input compressor that keeps the highs and lows in balance and gives you clean consistent bass that has punch and impact. All this for an affordable \$1950.

Yes, we know it sounds too good to be true. That's why we offer free auditions. Hearing is believing. Call CRL now, BEFORE your next ratings period starts.

Call 800-535-7648

FOR ENGINEERS:

INPUT (Ref. 0 dBm = 0.775 VRMS)

TYPE: Active balanced (differential)

IMPEDENCE: < 10 K ohms balanced bridging

TERMINATION: 600 ohms (selectable)

LEVEL: (adjustable): -10 TO +20 dBm

OUTPUT

TYPE: Active balanced (differential)

IMPEDENCE: 100 ohms (designed to drive 600 ohm load)

LEVEL: (adjustable): < -20 TO +20 dBm

FREQUENCY RESPONSE: 50 HZ TO 15 kHz: +/- 1 dB

HARMONIC DISTORTION

OPERATE MODE: < 0.15%, 50 Hz - 15 kHz typical

S + N/N: > 80 dB in operate mode, deemphasized

STEREO SEPARATION (minimum)

OPERATE MODE: > 60 dB, 50 Hz - 1 kHz 50 dB, 1 kHz - 10 kHz

INPUT COMPRESSION:

Input leveling G/R: selectable in 3 dB increments to 15 dB,

25 dB overall range

LIMITING: Selectable in 1 dB increments from 0 to +5 dB

TIME CONSTANTS: Program dependent

STEREO ENHANCE:

Threshold: Adjustable from 3 dB of program separation to infinite (off)

Enhance: Adjustable for 6 to 26 dB of enhancement (program controlled)

FRONT PANEL INDICATORS

Dual 10-Segment LED type input level meters with 22 dB (28 dB

with OV.D) dynamic range

TRANSFER FUNCTION LIMITER

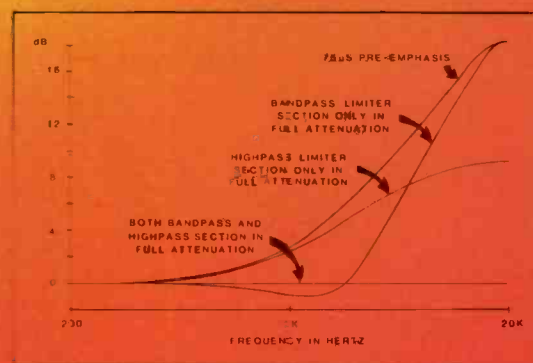

**THE
HOT
ONES**



CIRCUIT RESEARCH LABS INC.

TEMPE, ARIZONA

TELEX: 350464 CRL TMPE. UD.

602-438-0888

Circle (7) on Reply Card

Satellite internal electronics

By Elmer Smalling III

The average satellite used by broadcasters is equipped with 24 broadband communications transponders. To eliminate interference between adjacent transponders, the 12 even-numbered transponders are fed to an antenna that has opposite polarity to the one fed by the odd-numbered transponders. This cross-polarization reduces the interaction of adjacent transponder signals by as much as 35dB.

The satellite's communication antennas are steered, or focused, to cover a predetermined geographic area, or "footprint." The satellite operators adjust the satellite's signal over the footprint to guarantee access by all users. A diplexer is mounted in each antenna feed system to combine all 12 transponders.

Smalling, BE's consultant on cable/satellite systems, is president of Jenel Systems and Design, Dallas.

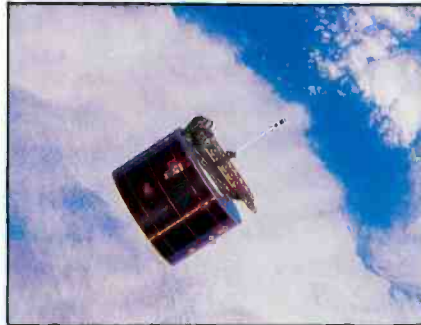

Uplinks, downlinks

Each transponder consists of a solid-state driver stage, a traveling-wave tube amplifier in the transmitter and a low-noise pre-amplifier and processor in the receiver. In the C-band, each transponder has an input frequency (uplink) between 5.925GHz and 6.425GHz and an output frequency (downlink) between 3.700GHz and 4.200GHz. At Ku-band frequencies, each transponder has an input frequency between 14GHz and 14.5GHz and an output frequency of 11.7GHz to 12.2GHz. All the electronics within the satellite are redundant and include automatic changeover and ground-control signal-routing mechanisms.

Most of the extensive cabling inside the satellite is waveguide or rigid low-loss coaxial cable, which will withstand the harsh environment of outer space. Where cavities and waveguide filters are required,

they are specially machined and treated to exhibit the lowest possible loss and VSWR.

Nerve center

The nerve center of a satellite is the telemetry and control section. Data is gathered from sensors mounted on and within the satellite. These sensors include earth and sun sensors, axis stability and positional transducers, thermal alarms and power-level detectors. This data is processed by the on-board telemetry and control computers, either directed by automatic housekeeping routines or by direct commands from ground stations. Telemetry and control data to and from the satellite is usually frequency-shift keyed at 4,800 baud.

Sun power

The solar arrays on 3-axis stabilized satellites occupy 80 to 100 square feet. These solar arrays, or sails, are directed at the sun by sun-sensor controls. The arrays produce the energy needed to power the satellite transponders, magnetic torque position-control systems, thruster control circuitry and the telemetry and control systems. An average communications satellite requires from 500W to 800W of power.

During periods of sun eclipse, however, on-board batteries are required. Rated to carry the spacecraft over the longest eclipse (more than 75 minutes) and to last for 10 or more years of satellite life, the battery packs weigh about 100 pounds and must be maintained at a rather warm 0°C. To accomplish this thermal regulation, the battery packs can be mounted so that they are exposed to just enough heat from the sun to maintain close-to-ideal temperatures.

All this electronic equipment is fitted cleverly into a lightweight, micrometeorite-proof, heat-resistant hull, which must last for at least 10 years in the extreme temperatures and near vacuum of space 22,500 miles above the earth. Future spacecraft, employing all-solid-state circuitry, larger antennas and solar collectors, will have quadruple the power and capacity of existing satellites and will allow for on-site repair and modification.

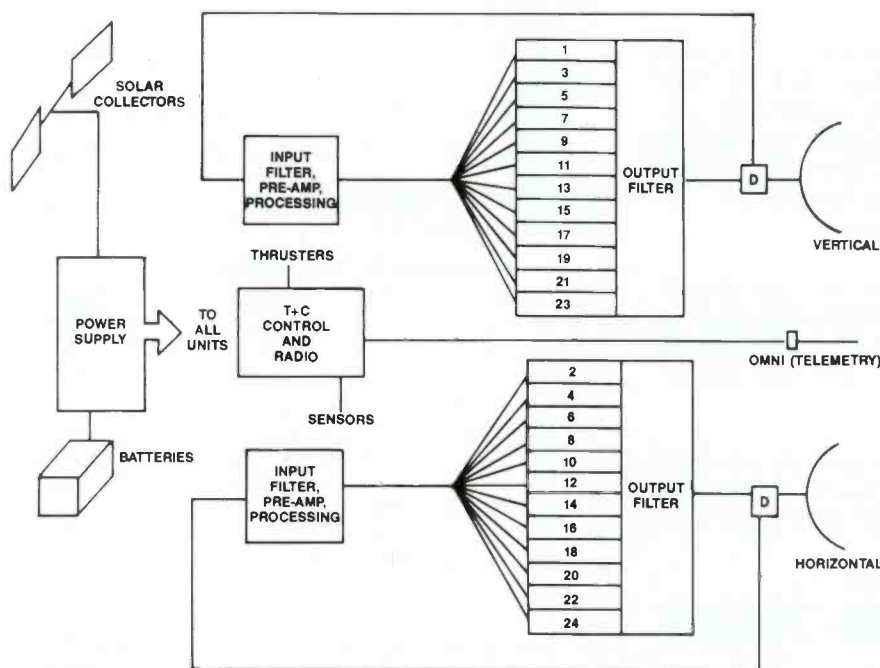

Figure 1. Basic functional diagram of a commercial satellite. Solar cells charge batteries to provide spacecraft power. The telemetry and control system is the spacecraft's "nerve center," monitoring spacecraft health and operating on-board systems on its own or by ground control. Cross-polarized antennas reduce the interaction of adjacent transponders. The diplexer combines transponder outputs into a single antenna.

INTRODUCING THE NEW MX-55



THE NEXT "WORKHORSE."

Before you take us to task for trying to improve the BII, a design that has become the "workhorse" standard for two-channel audio machines, consider what the new MX-55 offers:

An integral autolocator; a voice editing mode that allows 2X speed playback at normal pitch; a built-in cue speaker; GSPIPO (gapless, seamless, punch-in, punch-out),* and because you told us you wanted it, *all* adjustments are available through the front panel! These, and many more improvements will help make your job easier, and the results more creative.

And for those of you who still won't forgive us, we're keeping the BII in the line. So either way, you can get exactly what you need from Otari; Technology You Can Trust. Call Otari at (415) 341-5900 for information about the new MX-55.

OTARI

© Otari 1988 *Gapless, seamless, punch-in, punch-out is available only on some MX-55 models. (GSPIPO is a trademark of Otari Corporation)

Circle (11) on Reply Card

Improving accuracy of the A/D converter

By Gerry Kaufhold II

The simple 8-bit analog-to-digital (A/D) converter has many sources of error, mainly caused by component tolerances. If the number of precision components in the circuit could be reduced, accuracy would improve. One circuit with a reduced com-

Kaufhold is an independent consultant located in Tempe, AZ.

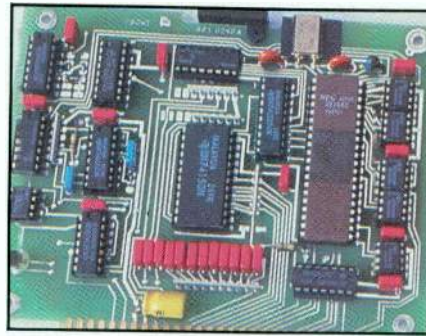

ponent count uses *dual-slope* conversion. Figure 1 illustrates the circuit and the waveforms for a dual-slope A/D converter.

The system master clock runs at several megahertz. Time can be measured accurately with this high-speed clock.

The single-pole, double-throw switch is controlled by the microprocessor. First, the

negative reference voltage is applied to the capacitor. The capacitor discharges through a precision resistor. The output of the comparator circuit goes high when the voltage on the capacitor equals 0V.

Now the circuit is ready to measure an unknown dc voltage. A counter, with the system master clock as its time base, is zeroed. The unknown positive voltage to be measured is then applied through a precision resistor to the positive plate of the low-leakage capacitor. The capacitor begins charging at a rate proportional to the applied voltage. A predetermined number of clock cycles later, the switch is automatically thrown, and the capacitor begins discharging toward the negative reference voltage. A counter inside the microprocessor measures the number of clock cycles as the capacitor discharges. As soon as the voltage on the capacitor equals zero, the output of the comparator goes high, and the measurement is complete.

The ratio of the first time period to the second time period is the same as the ratio of the applied voltage to the reference voltage.

An improvement over dual-slope measurements is the *quad-slope* method. In this method, one set of charge/discharge cycles is timed using analog ground as the input voltage to be measured. A second set of readings is taken using the unknown input voltage.

Through the use of four comparisons instead of two, the errors caused by input offset voltage and/or ground-line errors can be canceled, making quad-slope integration the most accurate of all methods.

Analog integration techniques require the voltage being measured to remain stable during the measurement process. Unfortunately, typical signals have some ac component due to noise. In addition to noise riding on the signal, changes may cause the impedance of a circuit to vary. An inexpensive way to isolate the analog integrator from the circuit under test is to use an analog switch and a low-leakage capacitor.

The capacitor that gets continually switched between the circuit under test and the measurement circuit is known as a *flying capacitor*. (See Figure 2.)

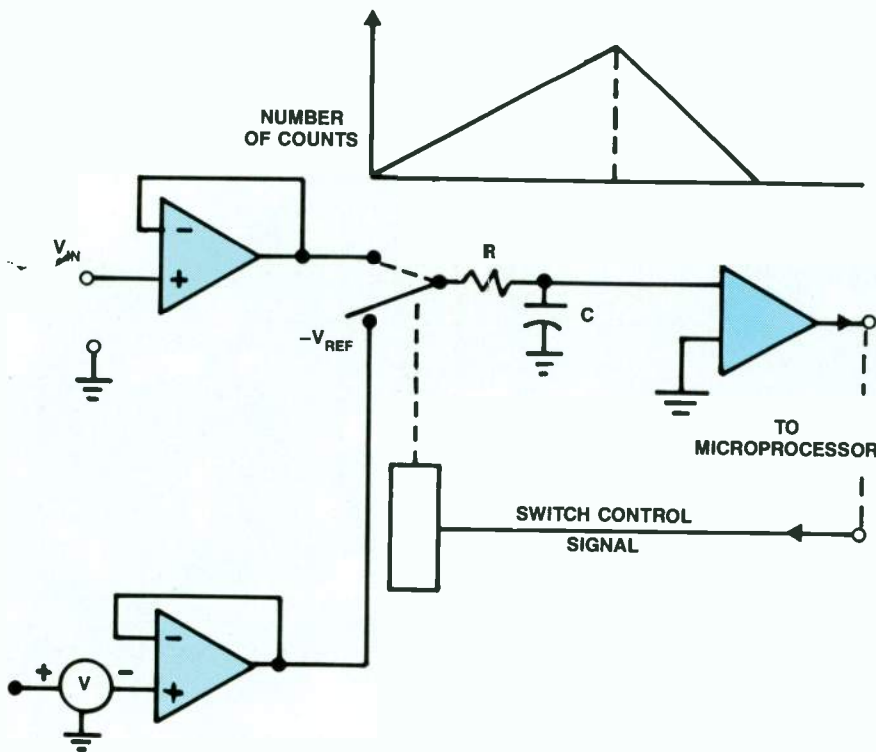

Figure 1. A dual-slope A/D converter. The waveform shows the voltage on the capacitor during one measurement cycle.

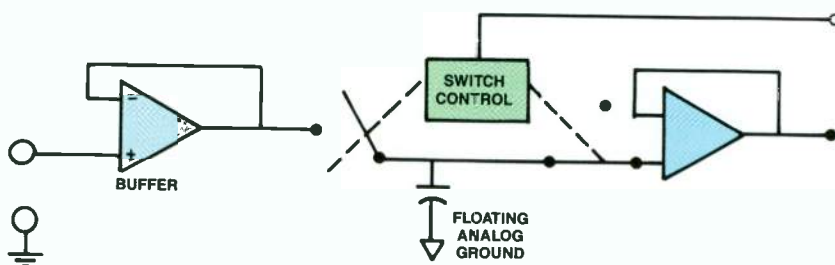

Figure 2. A flying capacitor circuit with isolated analog ground.

"We wanted the best sound in town—I think we were successful."

Martin Brandl, Chief Engineer
CJMF-FM, Quebec City, Canada
(Soft Rock)

"The automatic equalization and gently gain riding were just what we were looking for. And thank you for making your updates retrofittable."

Don Hobson, Engineering Manager
KJQY, San Diego, CA
(Light and Easy Music)

"I would highly recommend it to anyone—except my competitors!"

Ray Fisher, Program Director
WZIX, Columbus, MS
(Contemporary Hit Radio)

"Increased our punch and gave us a fuller sound. It's ultimately clean. In a competitive market, regardless of format, the cleaner sound gets (and keeps) the long-term listener. The added controls give us the advantage of tailoring our sound to the listener."

John Bortowski, Chief Engineer
WBMX, Chicago, IL
(Urban Contemporary)

"It's scary! Loud and dense, but not fatiguing. And it's consistent whether we're playing old LPs or a new Huey Lewis CD."

Duffy Egan, Chief Engineer
WPRO-FM, Providence, RI
(Contemporary Hit Radio)

"Clean and loud."

Barry Mishkind, Chief Engineer
KFXX, Tucson, AZ
(Contemporary Hit Radio)

"Clean and natural without being strident. It gives you lots of adjustment capabilities, and will fit almost any format. The manuals are very good as usual."

David Ficker, Chief Engineer
KHOO, Waco, TX
(Adult Contemporary)

"Voices sound clean and open, and the music sounds great."

John Buckhan, Chief Engineer
KITS, San Francisco, CA
(Modern Rock)

"Super! The most cost-effective change we've ever made."

Randy Wells, Chief Engineer
KREO, Santa Rosa, CA
(Adult Contemporary)

"It's the biggest bang for the buck—lets us customize our sound for our listeners."

Matt Conner, Chief Engineer
WASH, Washington, D.C.
(Adult Contemporary)

"Lethal."

Terry Carpenter, Chief Engineer
KJYY, Houston, TX
(Vocal Soft Rock)

"Gave us more punch and clarity without any increase in distortion."

Michael Fast, Chief Engineer
WPOC, Baltimore, MD
(Modern Country)

The OPTIMOD[®]-FM XT2 Processor: Everything they say is true.

Orban's XT2 Six-Band Limiter is an accessory chassis that works with any 8100-series OPTIMOD-FM. It gives you bass and high frequency equalizers, plus CLIPPING and DENSITY controls that let you customize the sound for your format and target audience. At \$2075*, it's probably the most cost-effective upgrade you can make to your audio.

For the details, see your Orban dealer, or contact us direct.

Orban Associates Inc.

645 Bryant St, San Francisco, CA 94107 USA
Phone (415) 957-1067 or (800) 227-4498
Telex 17-1480 FAX (415) 957-1070

* (suggested list)

orban

Circle (12) on Reply Card

CD player repair requires skill

By Brad Dick,
radio technical editor

In the past two columns, we've reviewed the basic circuits in a CD player. By now you should have a good idea of how the various CD servo systems work. Last month we examined the 3-beam pickup scheme used in many players. Let's look at the laser and focus circuits in more detail.

Be safe, not sorry

An important rule to remember when servicing CD players (or any device using lasers) is to carefully follow the manufacturer's directions with regard to laser safety. Because each player is slightly different, don't attempt repairs until you have a complete service manual showing you how to work safely near the laser.

The players are designed to operate without creating any hazard to the user. They can even be opened up to some extent without exposing the user to any danger. It is possible, however, to open the pickup assembly and expose yourself to the laser beam. Remember, the laser is pointing up because the CD information is on the bottom of the disk. If you were to bypass enough interlocks, press play and look down into the pickup assembly, you could expose yourself to the laser beam.

The laser is a beam of coherent light with a wavelength of approximately

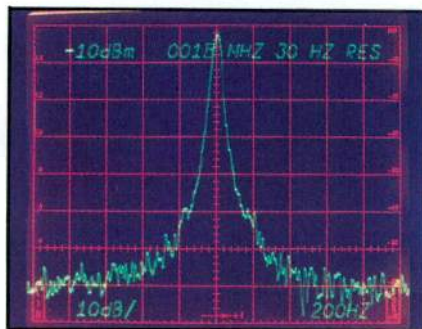

800nm, which places the light in the infrared band. This means the beam of light is invisible to the human eye. Never look directly into the path of the laser light to determine whether it is on.

In addition to the threat of laser burn, you also should be wary of problems that can be created by laser diodes. The diodes produce strong levels of electromagnetic radiation. Although the level is not harmful to humans, it can be disastrous to magnetic tape, some wrist watches or anything else that can be adversely affected by magnetic fields.

Fortunately, players often incorporate a set of safety interlocks, which *should* prevent the laser from coming on when exposure is possible. But we all know that engineers are notorious for finding ways to defeat interlocks. Being too ingenious can get you into trouble.

Laser diode adjustment

A typical failure mode is lack of audio. Let's walk through two simple checks you can make to resolve this problem.

After obtaining the service literature, determine if the laser is a likely source of the problem. Because the beam is invisible, the easiest way to "see" whether the laser is operating is through careful observation. A diffused laser beam usually is visible at the focus (objective) lens. When

the laser is on, the lens will appear to glow. If you apply power, observe the focus lens from the side and see a glow, you can assume the beam is operating properly.

If the beam does not appear to be on, first check for the proper command from the microprocessor. This signal may be indicated by LD ON or a similar term. This signal should turn on and off according to the commands from the front panel.

If the microprocessor output signal is correct, check the laser driver IC. A typical driver circuit is shown in Figure 1. Everything but the laser diode can be checked through tests on the circuit board.

Focus servo

Assuming the laser is working properly, check the functioning of the focus servo. After the laser comes on, the focus lens will move up and down at a rate of three to seven times per second as it attempts to focus on the CD surface. Because the movements are fine, they may be difficult to detect. An alternative method is to monitor the EFM (eight-to-fourteen modulation) signal with a scope. A CD will need to be loaded for this test. Presence of this signal means the pickup assembly is working properly.

Locate the FO ON (focus) signal test point. When play begins, the control system turns on the laser and outputs a focus control signal, which moves the focus lens up and down. If the IC focus control signal appears to be operating properly, check the driver IC to see whether it is outputting a signal to the focus coil. If the driver signal is present, and no focus adjustment takes place, measure the focus coil resistance. Focus coil resistance often ranges at about 20Ω.

Remember, the focus system relies on a feedback loop. If any element in the loop fails, the entire system may shut down. Follow the manufacturer's suggested troubleshooting procedure carefully or you may find yourself going in circles trying to locate the problem.

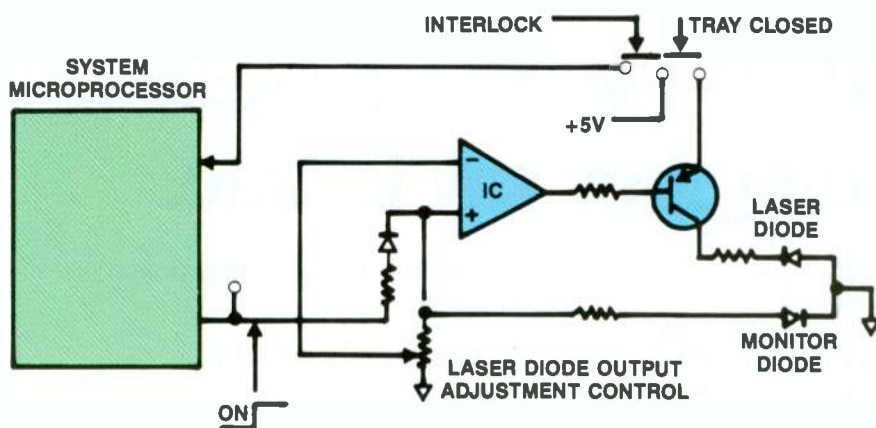

Figure 1. Several interlocks may need to be closed properly before the microprocessor can output the laser control signal. A secondary safety interlock usually is connected in series with the power-supply lead.

Acknowledgment: Background information on this topic was obtained from "Compact Disc Troubleshooting & Repair," by Neil Heller and Thomas Bentz, Howard W. Sams & Company.

Sachtler Hot Pod...fastest ENG tripod in the world.

Fast breaking news and the Hot Pod are made for each other.

Simply extend the legs and level your ENG camera on any surface. In just a few seconds you are shooting while others are still setting up. If you find yourself at the back of a crowd, simply raise the center column to as high as 6.5 feet and shoot over everyone else's head.

Don't be late with the late news. Use the lightweight, action tripod that is faster than fast breaking news. The Hot Pod is perfect for every ENG camera.

Sachtler is so confident of the performance of its equipment that it has extended the normal usage warranty from 1 to 3 years and guarantees its leak-proof fluid modules for 5 years. It's the best warranty in the business and comes only with the best camera support systems in the world.

Call or write today for more information and the location of your nearest Sachtler dealer for a hands-on demonstration.



sachtler[®]
corporation of america



Circle (13) on Reply Card

55 North Main Street
Freeport, NY 11520
Phone: (516) 867-4900

West coast:

3316 West Victory Blvd.
Burbank, CA 91595
Phone: (818) 845-4446

Management for engineers

Are you listening?

By Ernest Fair

One of the more difficult managerial tasks is communicating with employees who fail to pay careful attention. Unless the employee assumes a listening attitude, your instructions fall upon "closed" ears. And when this happens, communication (and understanding) does not take place.

Being certain that the other person really is listening prevents wasted effort and reduces mistakes that result from only half-understood instructions. The following suggestions may help assure you are being heard.

Tailor your approach

Put something in the employee's hands. The object will help the person focus on the subject you want to discuss. It can be a diagram, an instruction booklet or an outline of the discussion. Even a blank notepad will help if nothing else is available. The important thing is to help the employee to concentrate on something related to the topic you want to discuss.

Make certain that you talk loudly enough for the other person to hear with ease. Someone who's having a hard time hearing you may not make the extra effort to understand what you are trying to communicate. Reduce noisy distractions to a minimum. If your voice is competing with the sound from the VTR room, the employee must work harder to understand what you're saying.

However, don't let the volume of your voice get out of control. Talk at a level that is comfortable to the other person. Remember that hearing ability varies from person to person. Speaking in a loud voice to a person with sensitive hearing or talking so loudly as to draw the attention of co-workers can be just as disastrous as whispering to someone who is hard of hearing.

Involve the employee

Determine as quickly as possible the employee's level of interest in the subject under discussion. As you detect interest in what you are saying, play on it to increase the chance for continued



attentiveness.

Involving the employee in the conversation also helps you to be better heard and understood. A lengthy monologue kills the attention of even the most conscientious listener. An employee who becomes involved in a conversation with you will be more alert to what you are saying.

Occasionally ask a pertinent question about what you have presented. An employee who is listening for your next question will be more attentive and will remain more deeply involved in the conversation. Questions should be posed in such a way as to invite the employee's ideas or opinions. Be careful about simply asking the employee to repeat what you've said. This can be an offensive tactic.

When it is obvious that you're losing the employee's concentration, switch quickly to another point. Do so even if what you are discussing is important. You can return to it later, when the employee's attention has been regained.

Avoid confusion

Do not leave any idea, point or suggestion unclear in the employee's mind. If necessary, restate it in other terms. If the employee's questions are left unanswered early in the conversation, it may be impossible for you to make later issues or topics understood.

The employee will continue to think about an issue if it is unclear, even if you go on to another topic. That means that

the new material you're presenting also will be misunderstood because you don't have the full attention of the listener. The resulting confusion breaks down the communication process.

Again, asking questions allows you to determine whether the employee is comprehending the subject. Don't, however, let the other person dominate the conversation. If necessary, stop the dialogue, and go on to another topic.

Key issues

If you don't seem to be getting through, it may be because something is bothering the employee. Probe gently to find out whether another matter is making it difficult for the employee to concentrate on what you're saying, thereby competing with you for attention.

Weave a thread from one point to another during the conversation. Doing so stimulates anticipation for the next point.

Position the other person in such a way that you prevent distraction. If the employee easily can see something of interest other than you, communication may suffer.

When presenting suggestions, look directly at the other person as much as possible. This forces the employee to reciprocate, increasing the likelihood of attentiveness. Watch the other person's eyes while you talk for indications of the level of attention you're getting. They may warn you to readjust your presentation while there is still the chance to retain the employee's interest.

- Give the employee something to hold
- Speak clearly and loudly
- Involve the employee in the discussion
- Avoid confusion
- Look for distractions
- Watch the other person's eyes

Table 1. It is important to consider the communication process from the other person's perspective. Keep these issues in mind as you talk with your employees.

Fair is a consultant based in Clackamas, OR.

NEW FROM ARRAKIS SYSTEMS

5000 SERIES

The First No-Compromise
Modular Radio Console...



...At A Down-To-Earth Price: 16 Channels, Under \$10,000.

THE FEATURES YOU WANT —

- 16 Modular Stereo Channels.
- Program, Audition and Mono Mixdown Balanced Outputs.
- Telephone Mix-Minus Buss.
- Full Monitoring Facilities.
- Remote Equipment Start/Stop.
- Remote Module Control.
- Standard Digital Clock and Timer.
- Optional EQ and Effects Modules.

THE DEPENDABILITY YOU NEED —

- DC Controlled — No Audio On Pots.
- Rugged Modular Construction.
- Penny & Giles Slide Faders.
- ITT Schadow Switches.
- NE5532 IC Module Design.
- External Regulated Power Supply.
- Superb Audio Performance Specs.
- Most Important, Arrakis Systems Designed-in Ultra Reliability!

For features, performance, price and reliability,
NOBODY BUILDS CONSOLES LIKE ARRAKIS.

Call (303) 224-2248

Circle (14) on Reply Card

ARRAKIS SYSTEMS INC. 2609 RIVERBEND COURT FORT COLLINS, CO 80525





Las Vegas
CONVENTION
CENTER

NAB
BROADCASTERS

Gems for the 80s!
Minerals/Fossils

NAB '88 replay

By Jerry Whitaker, editorial director

If change makes you uncomfortable, it's time to start looking for a new job.

The NAB convention is the clock that drives the broadcast and post-production industries. Our show replay covers the primary points of interest to readers. The NAB '88 package includes the following reports:

- **NAB Engineering Conference Report** 28
The Engineering Conference is the industry's premier technical showcase.
- **Pick Hits of the '88 NAB** 65
Ten hot radio and 10 hot TV/video new products from the show were selected by our panel of independent industry experts.
- **Show of Shows** 80D
At a convention as large as NAB, no one can see all of the new products introduced. Let us help.

For the professional audio-video industry, the term "broadcast quality" is a moving target. The annual NAB convention sets the pace for that target, whether the product is a computer graphics work station, AM transmitter, EFP camera or anything else you might find at a radio/TV station or post-production facility.

Technical managers are generally of one of two mindsets as they approach the show. The first (for those with purchase orders in hand) is one of great interest and anticipation regarding the new products to be unveiled. The second (for the manager who spent a ton of money at *last year's* show) is one of dread. This fear has its roots in one undeniable fact: The state-of-the-art is a moving target. And these days it is moving faster than ever.

The NAB has become the annual event

for manufacturers to parade new products in front of the largest gathering of potential buyers in the world, and all under one roof. This year's show in Las Vegas didn't disappoint anyone.

Hit of the show

A favorite question of attendees and marketers alike at an event such as NAB is, "What's the *big news* of the convention?" Well, news is different things to different people. But here's my vote: *connectivity*.

Connectivity was the key word at this year's convention. For many years, farsighted broadcasters have wandered the show floor with the conviction that the overall efficiency of a station or facility could be improved greatly if the graphics equipment could communicate with the still store, and the still store could talk to the character generator, and all of them could talk to the disk recorder, and on and on. Questions raised on this topic with various manufacturers often were answered with, "Yes, that can be done," or "It's possible with existing technology," or "I don't see any reason that it wouldn't work."

But, as the computer industry discovered a long time ago, machine-to-machine communication often is easier said than done. This year's NAB, however, marked a milestone in connectivity among various black boxes, and among black boxes made by different manufacturers. The big news in Las Vegas was that not only are machines talking to each other, but also manufacturers—some of them competitors—are talking to each other.

The show floor was the scene of numerous demonstrations of various systems interfaced using one method or another to

Las Vegas is a city designed for just two things: gambling and conventions. Both were accomplished during the annual NAB show, April 8-12. (Photos by Doug Schwartz.)

provide a system for users that was greater than the sum of its parts. Perhaps this approach was most apparent in the field of newsroom computer systems.

Everybody has agreed, in principle, that a system could be devised that would tie a newsroom terminal into a still store, remote truck, graphics generator, news data service, videotape editor, robot-controlled camera and even live video. But, agreement in principle doesn't count if the ones and zeros of the digital bitstream don't match the right protocol, word length, sample rate or whatever.

At the NAB this year, things were dif-



Floor traffic was brisk for the 4-day run of the equipment exhibition. Most exhibitors said Sunday, the second day of the show, saw the greatest attendance.

ferent. To paraphrase Churchill, never have so many systems talked for so long about so much.

The connectivity theme, in this observer's opinion, was the big news of NAB '88. And connectivity is likely to become one of the key elements in the success of new products to be introduced at future shows. It is no longer enough to have a box that does something impressive. The box also must talk to other boxes to compete in today's broadcast/post-production marketplace.

Overall, a great show

Brisk business was reported at the convention by nearly every manufacturer the BE staff spoke with. Attendees, too, generally were more upbeat this year than at past shows. The hope was expressed more than once that this new-found enthusiasm and optimism was a sign that the broadcast equipment buying slump of the past few years finally has begun to turn around. Many companies reported record sales at the convention, certainly a good sign of the overall health of the industry.

The exhibit area this year included the Hilton Center, and the arrangement initially caused more than a little concern to exhibitors to be located there. Three years ago, when the Hilton Center was used for the first time, most exhibitors in that area were downright angry about the low level of traffic. This year, however, the NAB ef-



Because of the number of radio/TV crossover products, the exhibition hall was not divided into the strict radio/TV categories used in the past. Still, most radio exhibitors could be found in familiar spots on the floor.

fectively managed traffic flow to make it easy for attendees to visit the Hilton Center exhibits, including placing a registration area in the building.

Overall, there were few complaints from exhibitors. Nearly all were pleased with the way the new show manager, Rick Dobson, got things done.

New products to go

Some NAB conventions are more interesting than others. Usually, the level of excitement depends on the number and types of new products introduced. Based on these criteria, NAB '88 was a thrill and a half.

There was no shortage of new products for the attendees to examine. My vote for star product of the show was the D-2 format recorder, pushed by the broadcast industry's "Big 2"—Ampex and Sony. The show boasted plenty of other significant product developments, too, including:

- **Cameras:** The move to CCD designs for ENG/EFP applications continued at an ac-



This was the year of the videowall. They could be found everywhere.

celerated rate. Plus, there were significant introductions of CCD *studio* cameras. Improvements in CCD chips showed up as higher pixel counts, better high-speed shutter performance and improved resistance to vertical smear.

- **Transmitters:** The march of solid-state designs for both radio and television continued at a rapid pace. Improved efficiency was the name of the game for both radio and TV broadcasters, particularly UHF stations. Significant progress also was reported on the move of Klystrode-based transmitters into the field. (At press time, one was being installed at a station in Georgia.)

- **Video effects:** The videographics arena was characterized by products offering more features, faster speed, greater interface capabilities and lower cost. More graphics systems also were shown based on off-the-shelf computer platforms.



Go ahead, try it out! One of the best things about a trade show is that you're encouraged to kick the tires.

- **Robotic cameras:** This technology emerged at the convention as an important tool in the continuing drive for efficiency in station operation. Many engineers and technical managers got a first serious look at this technology.

- **Satellites:** New uplink and downlink equipment was shown, in addition to SNV trucks in all shapes and sizes. Despite all the talk about fiber-optics technology for terrestrial links, the satellite industry continues to prosper.

One major trend evident in many booths was the integration of personal computers into almost every corner of video, audio and RF systems. PCs could be found on the show floor controlling everything from antenna de-icers to video editors. PCs also were doing things that computers normally do, such as generating graphics, writing scripts and keeping the books.

NAB scorecard

A record 723 exhibitors participated in this year's convention. The exhibit floor space covered 383,400 square feet, includ-

Continued on page 175

Sony
Betacam SP.[®]
Bigger
than ever.

Now the Sony Betacam SP system is bigger than ever for the four essential areas of video operations: field acquisition, production, post production, and transmission. No other manufacturer sells a more complete line of products.

For the field a wide selection of advanced CCD and tube cameras handle the full scope of ENG and EFP applications. And the new single-piece BVW-200 sets a revolutionary standard for a compact, lightweight camcorder. Dockable VTRs, field portables and a host of peripherals, such as a color playback adaptor and wireless mic contribute to the unlimited flexibility of the Sony Betacam SP field acquisition system.

Whether in the field or in the edit suite, the Sony Betacam SP system provides unmatched versatility in video production; with features such as 4-channel



audio, component/composite editing as well as the capability to interface with every other Sony Broadcast VTR.

For transmission, Betacart,[®] Multicassette System, the standard of reliability, is now joined by the incredible 1000 cassette capacity Library Management System, which accommodates large and small cassettes for both program and commercial replay.

If you're looking for a system you can grow with, and a company that has demonstrated its commitment to that system, contact your Sony Broadcast representative. Or call Sony at 800-635-SONY.



SONY

Broadcast Products



Circle (16) on Reply Card

Engineering Conference report

The NAB engineering sessions brought high-tech answers for today's complex problems.

By Brad Dick, technical editor

The 1987 NAB convention was a hard act to follow. But this year's convention was so upbeat you could almost hear the band playing as exhibitors and attendees discussed not only technology, but also plenty of purchases. Exhibitor after exhibitor spoke of taking orders—and many said they sold equipment right off the show floor.

Compared with the moods of some previous NAB conventions, the optimism among attendees and exhibitors at this year's show was a great feeling. Virtually everyone seemed to have a positive outlook on the state of broadcasting and appeared to be looking forward to a good year.

The engineering sessions, filled to overflowing, echoed the auspicious tone of the exhibit floor. Engineers wanted to learn not only about the latest technology, but also how it could be applied in their stations. As if on cue, the NAB assembled panel after panel of experts who could answer just those types of questions. The theme was practical and available technology—the kind engineers like. If you were unable to attend the show, or could not make it to all of the sessions you would have liked to attend, the following review may help fill in the gaps.

Radio sessions

From sessions on AM technical improvements to the Zootube radio show, engineers were faced with an almost overwhelming number of radio engineering sessions. Deciding what sessions to attend was made more difficult by the high caliber of the presenters.

The radio technical sessions seemed to deal less with future technology and more

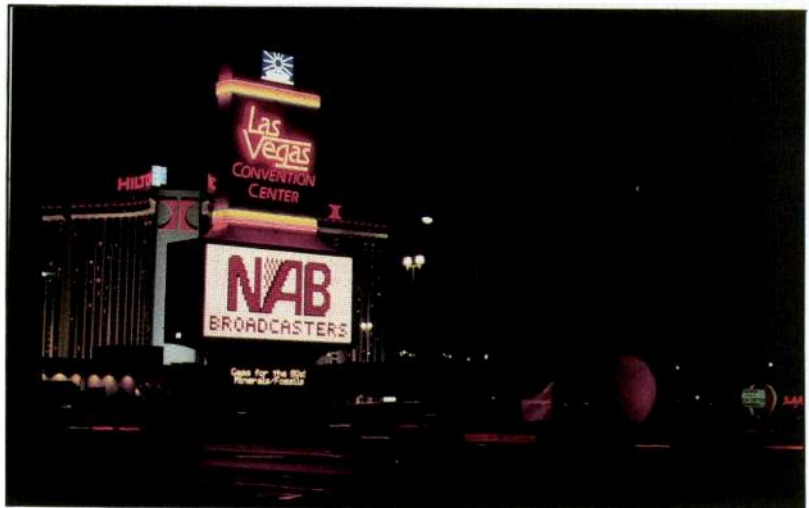

with today's how-to technology. Every link in the radio broadcast chain was addressed with sessions providing useful and practical information. The importance of discussing the everyday issues was confirmed by the high attendance at many of the sessions.

AM improvement

The Friday opening session on AM improvement began with a report by Harrison Klein, of Hammett and Edison, on the current state of AM technical standards. Hammett and Edison undertook a study of several technical areas, including atmospheric and manmade noise and maximum usable field strength, as part of its work for the NAB. Klein also discussed the FCC's Docket 87-267 Notice of Inquiry and reviewed technical criteria of AM stations.

Klein noted that adjacent-channel ratios, which generally have been ignored in the past, are inadequate. He said there is a great need to develop new methods of calculating night interference that would take into account adjacent-channel interference. The currently used RSS method does not consider adjacent-channel interference, he said, and does not give a realistic indication of actual interference conditions.

An important task yet to be completed is the development of an accurate way to predict E_{min} (minimum usable field strength). This is the field strength that produces the desired signal-to-noise ratio for a specified time in presence of noise. E_{min} can vary over a wide range.

Klein outlined the study on obtaining a 26dB-above-noise signal for specified percentages of time. Surprisingly low noise levels were encountered. In fact, in two cases, the noise figures rounded to zero. This means that a 0.1mV/m field strength would result in a 26dB noise ratio, even in business areas, under some circumstances. Klein noted that his work shows that the 0.1mV/m protection given to Class I stations is not entirely unreasonable. The report also showed that some areas require much more level, perhaps 1mV/m, to provide 26dB. The general indication of the study is that AM stations will need 1mV/m to 5mV/m signals to compete with FM station signals.

Interference monitor

A new AM monitor design, the splatter monitor, received a lot of interest from engineers who are concerned about signal quality. Although splatter has been a problem for AM for many years, it has wors-

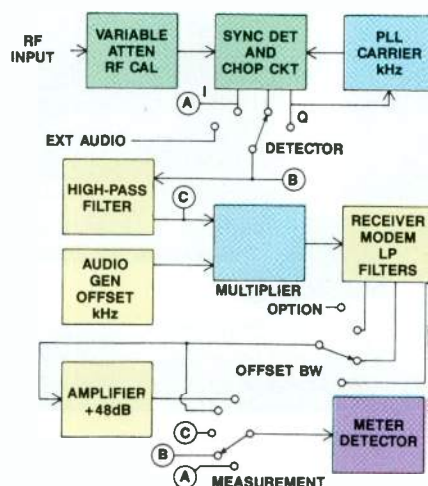
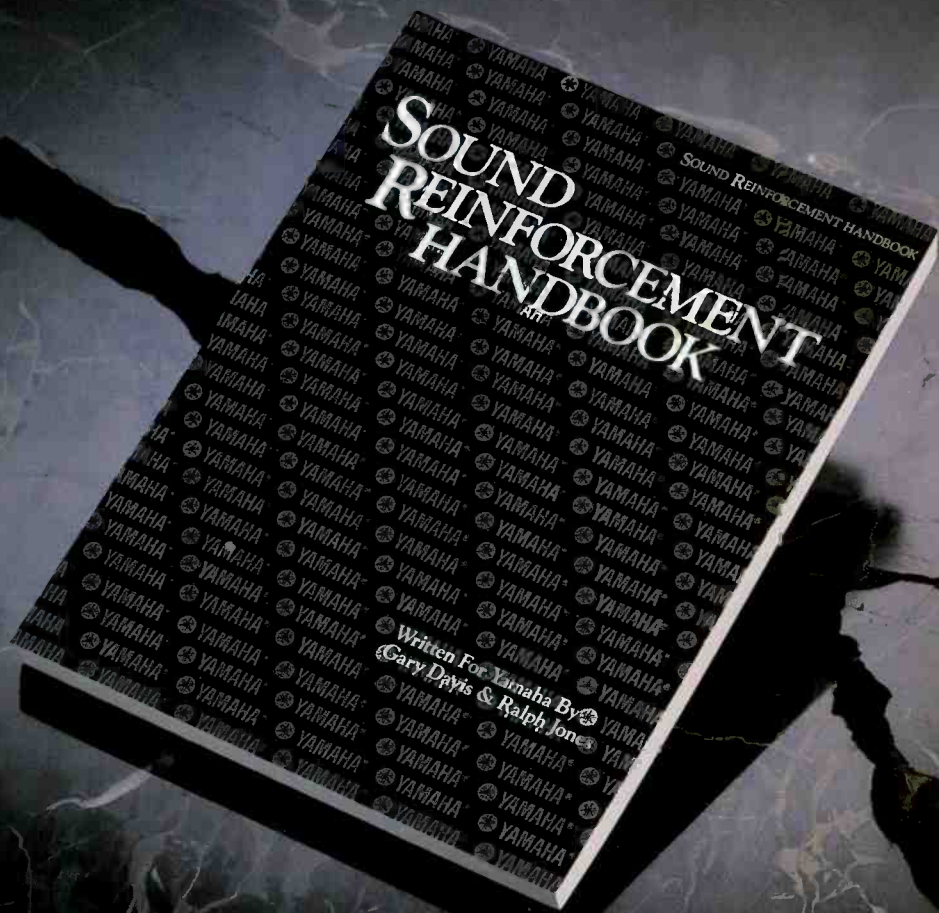

Figure 1. Simplified functional block diagram of the AM splatter monitor.



Here's the only plug you'll see on our new product.

At Yamaha, we've been putting all our sound reinforcement expertise into our equipment for years. Now we've put it all into words.

Presenting the Yamaha Sound Reinforcement Handbook. Without a doubt the only volume of its kind.

In it you'll find nearly 400 pages of explanations, definitions, diagrams and answers about sound. Covering everything from "What is a sound System?" to "Putting it all Together," plus every component and variable in between.

Which makes it perfect for the newcomer to audio. And a welcome refresher for the seasoned professional.

The Yamaha Sound Reinforcement Handbook. Available at your nearby Yamaha Professional Audio Dealer, college, university and technical bookstores. Published by Hal Leonard Publishing Corporation, P.O. Box 13819, Milwaukee WI 53213.

Pick one up today. It just may be the best source material you ever get to work with.

Yamaha Music Corporation, Professional Audio Division, P.O. Box 6600, Buena Park, CA 90622. In Canada, Yamaha Canada Music Ltd., 135 Milner Avenue, Scarborough, Ontario M1S 3R1.

YAMAHA
Engineering Imagination™

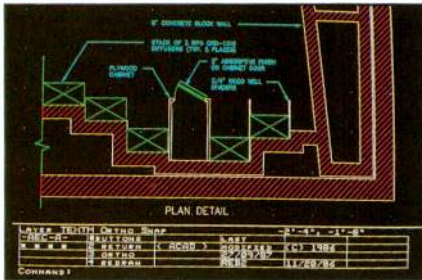

Design detail of the back wall of a control room using wideband diffusion techniques. The large red structure diffuses low frequencies. The green units scatter frequencies from 400Hz to 12kHz.

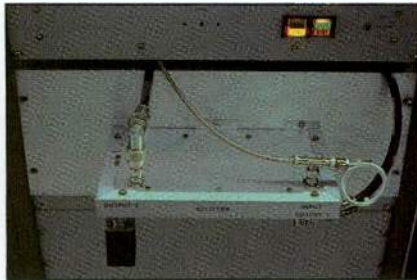

A 4-port, 90° hybrid splitter used to isolate the RF inputs to two parallel FM transmitters. Simpler splitting methods may result in phasing errors and incidental AM.

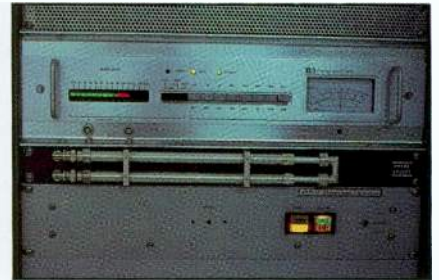

The trombone coaxial line section is adjustable, allowing precise phasing of two parallel FM transmitters. It is inserted at the input to the IPA of one of the transmitters.

ened with the implementation of heavy audio-processing techniques.

The primary causes of splatter are negative overmodulation and high-frequency signals. Thomas Wright, Delta Electronics, suggested that splatter actually is wasted modulation because the splatter sidebands are not audible to the station's listeners. His company's device helps monitor the problem, allowing a transmitter to be tuned for minimum splatter. A block diagram of the monitor is shown in Figure 1.

New antenna design

Skywave radiation has long been a problem (or a blessing, depending upon the class of station) for broadcasters. A lot of effort has gone into eradicating or reducing skywave radiation, and two new designs are being considered for testing by the NAB.

One new antenna design, the Corum antenna, received a lot of attention at the convention. The design was developed by Basil Pinzone and James Corum, Pinzone

Communications.

The antenna consists of a short vertical radiator, approximately 50 feet high, ringed by a contrawound helix. The two structures are fed in such a manner as to reduce high-angle radiation and to increase the groundwave. (See Figure 2.) The theory is too complex to describe in this short overview, but suffice it to say that the figures and data presented appear to support the presenter's contention that, based on scale modeling, the antenna does what it sets out to do.

AM directional-feed system

At previous NAB conventions, engineering papers on directional-antenna systems were as common as slot machines in Las Vegas. This year was an exception. Not to be completely forgotten, however, the topic was addressed by Kurt Gorman, Vector Technology, who presented a paper outlining the use of broadband transmission-line-matching transformers. His paper suggested that the use of such transformers

makes adjustments easier, improves the stability and broadens the bandwidth of AM directional systems.

Although transmission-line transformers have been used for more than 20 years, primarily in the HF and VHF ranges, they are uncommon in AM broadcast applications. These transformers differ from conventional transformers in that, at high frequencies, the energy from the input to output is coupled through the dielectric of the coiled transmission line wound on the core, not the core itself. Transmission-line transformers are categorized by their impedance transformation ratios, with 4:1 and 9:1 being most common.

In medium-frequency (MF) uses, transmission-line transformers may be treated as autotransformers, connected in a transmission-line configuration. This is a relatively new approach to MF DA design, and it may well be that more new phasers will use transmission-line transformers.

Improved receiver circuit

A paper addressing the need for improved receivers was a welcome addition to the sessions. The paper, "A Low-Cost, High-Performance AM Noise Blanker," by Oliver Richards, Sprague Electric Company, attracted a lot of interest.

His paper described an improved method of eliminating auto ignition, SCR and other noise sources. Briefly, it is an improvement on the familiar *Lamb* blanker. The processing of a noise pulse in a typical receiver is shown in Figure 3. Note that the noise pulse produces a long (and variable-length) audio pulse in the output. In the new design (shown in Figure 4), the noise is interrupted in the RF or IF stages.

Consequently, the noise is not amplified along with the desired signal. The receiver RF bandwidth determines the audio-gate detector timing. Because of this gate, and the sample-and-hold technique used, the sound or crackle produced by blanking is beyond the highest frequency that can be reproduced by the IF system. The resulting noise can be filtered out in the audio stages. The circuit is available on a monolithic IC using BiMos 4 processing in a 18-pin DIP.

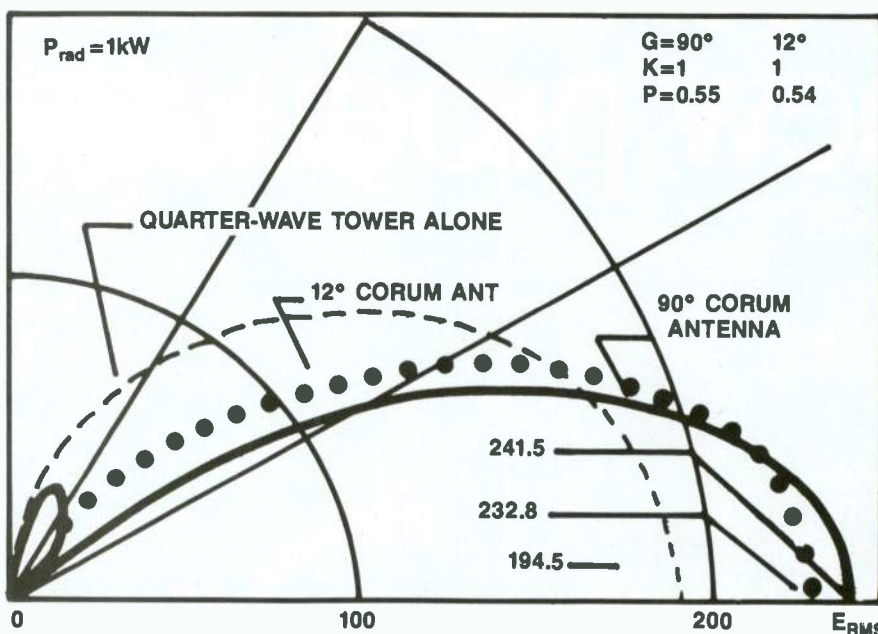

Figure 2. A comparison of the vertical radiation characteristics of a 1/4-wave tower and 12° and 90° Corum antennas.

The good news is...



Studio camera automation has arrived... *the HS-110P.*

The HS-110P automated pan/tilt head provides more effective utilization and distribution of production talent... *and at a surprisingly affordable price.*

- Our highly repeatable servos and stiff mechanical design provide the same feel and responsiveness of a manned camera... *absolutely essential for camera automation.*
- Four HS-110Ps, using our software driven Multi-Controller, provide a quality production with one operator. As an alternative, *the HS-110P Heads can be controlled directly by a News Room computer via MultiController's serial input.*
 - These features coupled with our Multi-Controller's "shot storage" and "motion learn" capability provide the director with complete and repeatable camera moves... with less staff and improved communications... *resulting in a more efficient production and a lower operating budget.*
- Automate for your future... now. Call us for a demo.



HS-110P features:

- Load capacity of 250 lbs.
- Max. velocity of 90°/Sec.
- Preset return accuracy of 18 arc seconds (0.03141" from 30 ft.)
- Highly responsive servo design.



TOTAL SPECTRUM MANUFACTURING INC.
 709 Executive Blvd., Valley Cottage, NY 10989
 914-268-0100 FAX: 914-268-0113

Courtesy of Patricia Dovas, CBS



This graphics studio provides broadcast designers the ergonomic support needed to develop a creative atmosphere as well as house the required equipment.

Courtesy of Don Miskowich, Symbolics



This graphic was created using behavior modeling techniques and a modern graphics system. Such techniques relieve the designer from executing minute motion details for every frame of video.

Courtesy of Don Miskowich, Symbolics

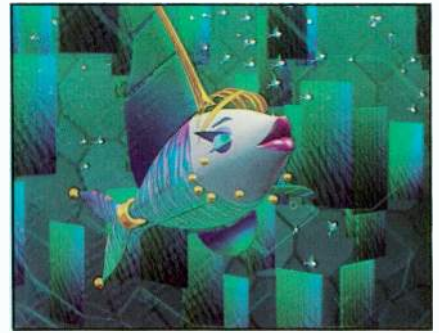

The productivity improvements provided by the modeling techniques, originally developed in CAD systems, provide the broadcast designer with the freedom to concentrate on animation—bringing images to life.

AM interference

The Friday afternoon panel discussed the broader question of eliminating AM interference at its source. One panel member, Richard Smith, FCC, noted that out of 55,813 complaints received by the commission, some 40,000 were about home entertainment equipment. The agency received about 6,000 complaints in regard to power-line and bell transformers. The panel said that additional noise is being generated because power companies have reduced their commitment to power-line maintenance.

Fortunately, the problem can be attacked with inexpensive test equipment. The panel suggested using a small battery-powered radio as a detector if you are faced with an unknown noise source. It may help you quickly identify the cause for the interference. However, because transformer-generated noise can be carried for miles along power lines, you may have to walk far to locate the source.

At one point, an audience member suggested that all AM stations convert to narrowband FM to eliminate all the noise problems. Because the audience was composed primarily of AM broadcasters, the suggestion was not greeted with great enthusiasm.

Mike Rau, NAB, suggested that a working draft on power-line interference be developed between the NAB and the power industry. By the time the session ended, the consensus seemed to be that a number of good suggestions had been made and that there was hope for some improvement.

AM antenna techniques

The topic of conventional AM antennas was not neglected at the engineering conference. Grant Bingham, Continental Electronics Division of Varian, described how grounding the top set of guy wires may reduce damage from static arcing and lightning. The technique creates a

grounded-guy antenna with no insulators in its top-level guy wires. (See Figure 5.) The hot guys carry a substantial amount of RF current and provide a dc path from the tower to ground. The configuration tends to produce an umbrella of protection from induced electrical storm voltages on the remaining guy wires. He indicated that the tower bandwidth also is increased.

Although the tower impedance changes significantly, Bingham said, it is possible to accommodate most designs. The technique is most effective for towers between 70° and 120° in electrical height. The vertical pattern is similar to that of an electrically short tower.

The success of FM stations has forced some AM stations to use towers designed for the needs of sister FM stations. Unfortunately, the height required by an FM station (greater than 0.8 of the AM station's wavelength) results in ineffective AM vertical patterns.

Ogden Prestholdt, A.D. Ring & Associates, discussed the use of electrically tall towers. He showed how to optimize a tall tower by sectionalizing it with insulators and/or inserting inductance or capacitance at the insulation points. The insulated section usually begins about two-thirds of the way up the tower. Some designs use a grounded base with the feed-point located a fraction of a wavelength up the tower.

Karl Lahm wrapped up the topic of AM broadcasting with a discussion of his study of 263 directional arrays using a computer program. Lahm maintained that the FCC antenna monitor tolerance is insufficient to maintain monitor points within limits for many situations. Because measured field intensity at specified monitor points can vary drastically with local conditions, he said, it may not accurately reflect the actual radiation pattern of the station. He said that many stations now classified as having *critical arrays* are being penalized unfairly.

After presenting statistical data to support his claim, Lahm suggested that each

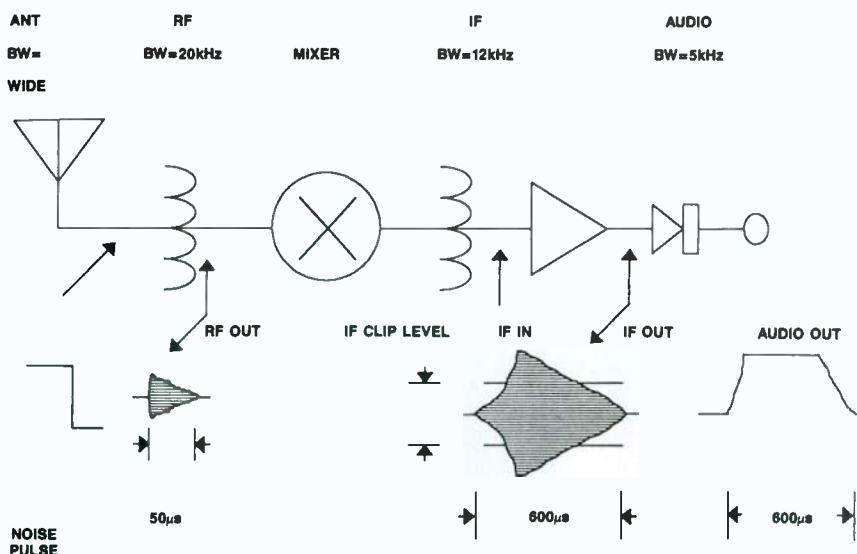

Figure 3. As a noise pulse travels through a typical AM receiver, it is not eliminated; rather, it is changed into an audible noise burst.

MORE radio studio, FASTER delivery, LOWER cost... That's the MAGIC of MODULINK.™

Don't let our MODULINK studio's classic good looks fool you. On the inside, MODULINK is really different. It's the first basic improvement in studio design in thirty years.

Designed and built by Arrakis Systems exclusively for Allied, MODULINK is a manufactured, modular radio studio system that can be custom-tailored to meet your exact specifications, yet its unique design allows your new facilities to be operational in days, not weeks or months.

Ideal for both new installations and renovations, MODULINK studio units come fully pre-wired with multi-pin connector "docking modules" which link all units and interconnect all equipment. We preassemble the furniture modules, install the electronics and test the entire package at our own facility. The units are then shipped to you by van. At your station, the fully-systemized MODULINK units are linked together, either by Allied installation crews, or by your own local people. Either way, the studio installation usually takes as little as a single day.

But MODULINK isn't just faster. It's better. The pre-wired, plug-in MODULINK modules offer greater electrical reliability than conventional point-to-point studio wiring methods. What's more, adding new equipment later on or troubleshooting an audio problem are so much easier with MODULINK.

Best of all, MODULINK's advanced design lets Allied give you more radio studio for lots less money. And that could be the difference between getting exactly the studio package you want, or settling for something less.

Before you start your next studio project, call the experts at Allied and let us show you how MODULINK can do it better, faster, for less.

CALL 714-752-6664

ALLIED 
Broadcast Systems

3901 MacArthur, Suite 200
Newport Beach, CA 92660
FAX: 714-752-0855

Circle (19) on Reply Card



 **arrakis**
SYSTEMS, INC.

station be given a particular tolerance for its antenna monitor that more realistically represents pattern maintenance. He advocated the elimination of routine monitor-point measurements.

Studio acoustics

Studio acoustics continues to be an important topic for radio and TV engineers. Because of format demands, many of today's studios must provide better acoustics than might be expected. Talk show studios and multitrack recording rooms demand

careful attention to room acoustics. Apparently, plenty of stations are interested in improved on-air sound; the Sunday evening workshop was standing room only. The audience heard from studio design experts Peter D'Antonio, Norman Phillips, Alfred D'Alessio, Stanley Ellington and David Schwind, who answered a broad range of audience questions on studio acoustics.

The panel agreed that although listeners may not be able to identify why a particular station sounds different, the fatigue

that they experience as a result of acoustical problems will cause them to tune away. Studio HVAC systems came under scrutiny early in the discussion. Suggestions for minimizing the problems from these systems included locating the units far from the sound-sensitive studio areas and mounting the compressors on shock-isolating feet. Fan noise can be reduced by proper duct sizing and routing and blower selection. Acoustically lined ducts with several bends and diameter changes reduce fan noise sufficiently in many situations. For more stubborn cases, prepackaged silencers may be necessary.

A design parameter that limits station construction is ceiling height. D'Alessio stressed the need for adequate ceiling heights in studios, noting that large HVAC ducts make it easy to quickly run out of headroom. One solution is to run a soffit around the room. It can be used for ductwork, and it can be designed to accommodate monitor-speaker mounting.

Modular studios

Studio renovation often is a nightmare for the entire staff. In many cases, an essential studio is either left "as is" or is haphazardly rebuilt over a weekend to minimize downtime. Either approach frequently produces disappointing results.

A relatively new solution is to construct a modular studio off-site to exact specifications and reassemble it within an existing room. Properly constructed, a modular studio is indistinguishable from a traditionally built one. Although this method may seem expensive, the costs of downtime and the extra engineering time involved in traditional renovation may make the modular approach price-competitive.

Room shape and acoustical treatment

The "keystone"-shaped control room was advocated almost universally for state-of-the-art performance. In this design, the front of the room is narrower than the back of the room. The flaring walls improve the monitoring environment. In addition, the ceiling should slope upward from the front of the room, rising at least a foot by the time it reaches the back of the room. This design is used extensively in recording studio control rooms.

Sound absorption is only one of three primary sound-conditioning treatments. The others are reflection and diffusion. Hard, flat surfaces reflect soundwaves, while rough or random surfaces diffuse the sound. Highly absorbent rooms require more monitoring power. Reflective rooms require less monitor volume, but can confuse the operator with distracting audio images. Diffusion preserves loudness, and by scattering the reflected sound, creates a more accurate and comfortable monitoring environment.

The panel reminded the audience that

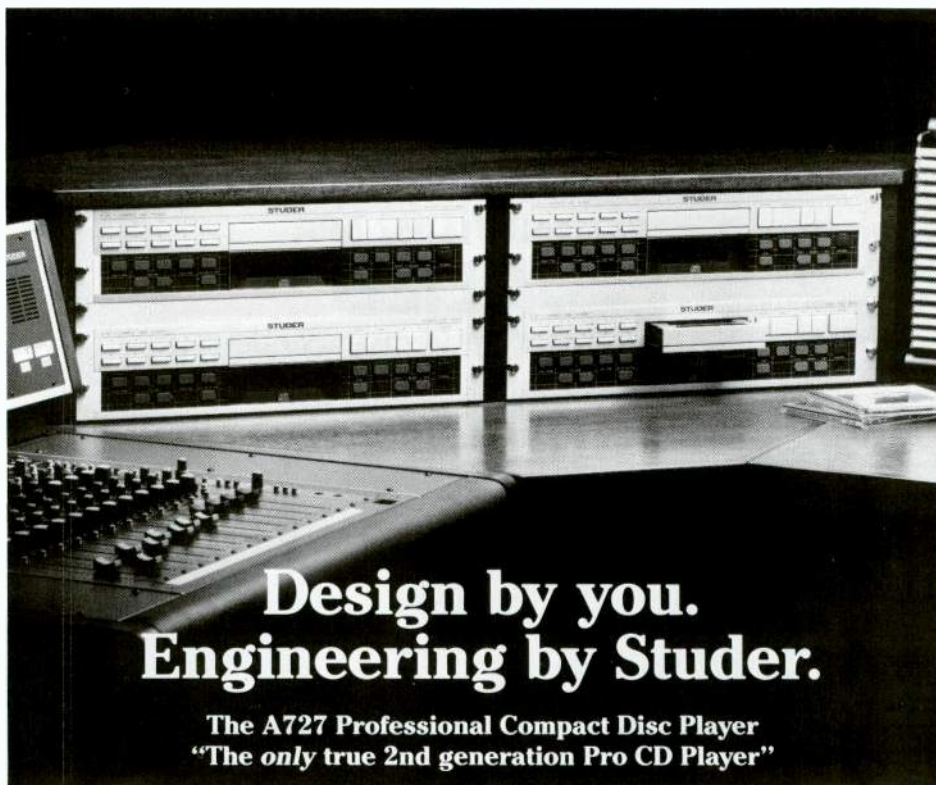

Design by you. Engineering by Studer.

The A727 Professional Compact Disc Player
"The only true 2nd generation Pro CD Player"

Listen to the A727... What you hear is Studer sonic quality: • separate 16-bit D/A converters • 4-times oversampling • proprietary Studer digital and analog filtering.

Use the features that professionals demanded: • very quick *direct* access to tracks *and* indexes • Auto Cue (aka, "cue to music") to find exact start of program material • Auto Stop to pause at end of any track • Start Review & End Review to allow quick checks of "in" and "out" cues • parallel remote with status tallies *and* fader start • bright self-illuminating display shows elapsed and remaining time for both track and disc • provision for RS 422 serial interface. I/O configurations: Analog—stereo balanced XLR, 2 sets of stereo unbalanced RCA (fixed level and variable level), *and* mono; Digital—balanced XLR, unbalanced RCA; Clock—input for vari-speed, output for synchronization.

If the A727 seems to be everything you need in a professional CD player, it's no accident. Studer engineered it that way.

Available from all Studer Revox Professional Products Dealers. Or contact Studer Revox America, Inc. 1425 Elm Hill Pike, Nashville, TN, 37210 (615) 254-5651.

STUDER REVOX

Circle (20) on Reply Card

The best of both worlds:

THE SOUND TECH 1510A AUDIO TEST SYSTEM

Until recently, most Audio Test Systems have been either manual stand-alone systems or external-computer driven automated systems.

Engineers have long enjoyed the portability, ease of operation and cost effectiveness associated with manual stand-alone systems. Unfortunately, these systems have always lacked speed and documentation capabilities.

On the other hand, the ideally configured external-computer driven test system can provide speed, data analysis, documentation, graphics and integration with other GPIB test systems. Unfortunately external-computer driven systems are designed for production testing and are not suitable for troubleshooting or field work.

However, Sound Technology has combined the Best of Both Worlds into a portable, intelligent stand-alone system with complete PC compatibility: the Model 1510A! The Model 1510A can be used as an intelligent stand-alone system, and when connected to an external computer it becomes the ideal Automated Test System.

The ST1510A as a Stand-alone System

- Built-in Intelligence
- Portable
- Semi-automatic and Manual Test modes for fast troubleshooting
- Built-In CRT/Graphics

The ST1510A as an Automated Test System

- Graphics
- Test Chaining/limit testing
- Industry-standard Computer Interface (GPIB)
- User Choice of PC
- Bundled software for IBM, HP
- Compatible with Automated Switchers
- Production Testing

Contact us now for full technical and applications information. Learn firsthand why the ST1510A is the only test system that combines the best of both worlds!

SOUND TECHNOLOGY

1400 Dell Avenue
Campbell, California 95008
(408) 378-6540 Telex: 357445



**Put The Best
To Test!**

Circle (21) on Reply Card

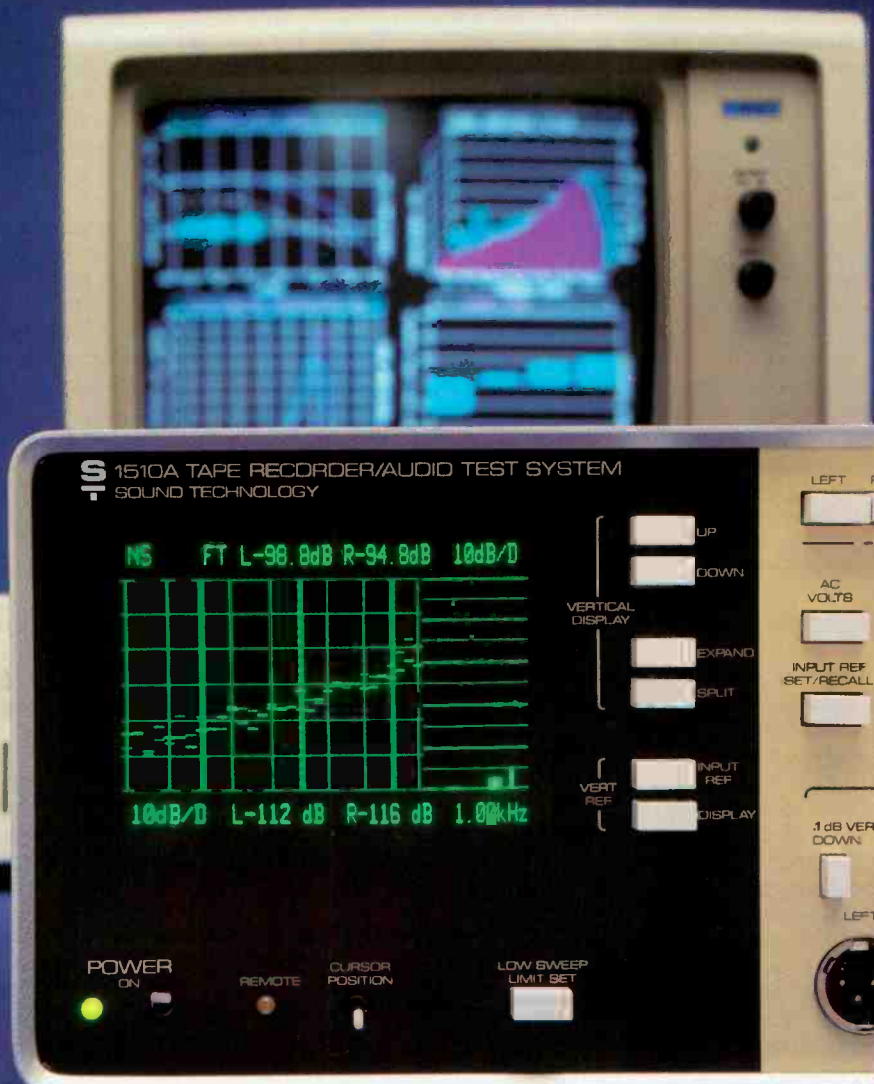

NEW



BP-1-11 Camcorder Battery

- *Direct replacement for NP-1.
- *Immediate delivery.
- *Reasonably priced.
- *Full warranty.
- *10 warehouses throughout U.S. and Canada.
- *Made in USA.



**Alexander
Batteries**

1-800-247-1821 or 515-423-8955

UNIQUE



Double Adjusting Battery Belt

- *Adjusts front and back to fit all sizes.
- *Shoulder strap for comfort.
- *All leather belt with no-crack, no-split, no-peel pockets.
- *Five models available.



**Alexander
Batteries**

1-800-247-1821 or 515-423-8955

many home audio sources compete for the attention of today's listeners and viewers. If stations are to compete effectively against better-sounding sources, many broadcasters will have to update their facilities.

New FM radio technology

If there had been a theme for this year's FM radio engineering papers, it would have been *Incidental amplitude modulation of FM transmitters and how it affects reception*. Three of the 14 papers presented in this radio session dealt with incidental AM. By far, the greatest audience response was to these three papers.

Geoff Mendenhall, Broadcast Electronics, presented an excellent summary of incidental AM, how to measure it and what techniques can be used to minimize it. Incidental AM comes in two forms: asynchronous, mostly from power-supply ripple and poor screen-voltage regulation; and synchronous, which is usually caused by limited bandwidth in the FM transmission system. The FCC requires only measurements of asynchronous AM, so it is more commonly understood by engineers. Synchronous AM measurements are more complicated because the station FM modulation monitor cannot be used to measure it with any confidence. Less common causes of incidental AM are limited bandwidth in antennas or multistation combiners.

Unless the transmitter has a serious design fault, incidental AM is controlled largely by proper transmitter tuning. Mendenhall said that, in most transmitters, minimum synchronous AM does not correspond to maximum output, best efficiency or other common indications of proper tuning. Parallel transmitters also must be closely phase-matched through a hybrid splitter and trombone section.

Mendenhall's measurement technique is shown in Figure 6. An RF sample is taken directly from the transmitter output using a directional coupler. This is fed through a 10dB pad to a precision envelope detector, to an RF filter network. The output is observed on an oscilloscope.

Another technique uses the dc output of a through-line wattmeter element to feed the RF filter and oscilloscope. This method seems simpler and less expensive and, judging from the audience response, is becoming popular. One attendee suggested listening to the amplified audio derived from the meter terminal of a through-line wattmeter and adjusting for minimum noise.

A display of either the passband or the AM waveform can be observed, depending on whether the scope is used in the X-Y or triggered mode. Mendenhall's paper, which is contained in the "1988 NAB Proceedings," describes methods for calculating the resulting synchronous AM

in decibels below carrier level.

An interesting perspective on FM reception problems was presented by Bert Goldman, Shamrock Broadcasting, Merriam, KS. Using a Texas station as an example, he described how the hot, humid climate of the South often causes temperature inversions. When this happens, FM and other VHF signals frequently are refracted, reducing the signal level in the station's service area. This is particularly true when the inversion layer is below the level of the transmitting antenna.

Figure 7 shows a record of temperature inversions during the spring of 1987 at the Texas location. To compensate for this phenomenon, the station uses two FM antennas mounted on a single tower. One antenna is located at 2,000 feet, and the other is located at 1,000 feet.

To monitor reception conditions, two receive antennas are located at similar heights. These antennas monitor another station operating at 1,000 feet 30 miles away. When the signal strength of the lower antenna exceeds that of the upper antenna, an alarm alerts the operator to switch to the lower transmitting antenna.

TV sessions

The TV sessions covered a wide range of topics, and most were well-attended. In fact, some were filled to capacity. Because engineers typically are concerned about effectively implementing new technology, the sessions were structured to meet that need.

New technology sessions ranged from new studio design techniques, to the ever-changing scene of graphics, to HDTV. Each area offered challenges to the engineer, especially in terms of understanding how rapidly changing technologies can fit into an existing broadcast facility.

TV studio production/facilities

This year's session provided a great deal of the information necessary to build a studio from scratch or, more appropriately, from a blank screen.

The papers covered topics on construction, control and physical planning and computer-project management. Program-signal systems and acoustical planning ideas also were presented. The session concluded with a presentation on the use of these techniques to construct a modern TV broadcast studio.

A good example of computer-aided planning was presented by Marvin Born, KRIS-TV, Corpus Christi, TX. He discussed several different planning techniques that can help keep projects on time and within budget. Through the critical path method (CPM), a project is divided into four planning areas designated as *strategic, tactical, management and evaluation*. Each of the areas addresses a specific need in controlling and managing the many individual

The Abekas A53-D Special Effects with Key Channel and WARP

The acclaimed A53-D digital 3-D effects system has added an optional Key Channel to meet even the most demanding key processing needs.

The Key Channel lets you do everything under the sun. Manipulate irregular-shaped objects in 3-D and key them over other pieces of video. Position key signals horizontally and

vertically. Freeze them independent of the video. Soften their edges and change polarity. And you can even generate drop shadows of any color or transparency, and position them wherever you want.

All A53-D features can be combined with the Key Channel in the key mode as well as the drop shadow mode.

WARP shapes—including page-turn, circle, cylinder, split, etc.—can now

have colorized and transparent drop shadows.

To overshadow your competition, add the A53-D Key Channel. For details, contact Abekas Video Systems, 101 Galveston Drive, Redwood City, CA 94063. (415) 369-5111.

Circle (23) on Reply Card

Abekas

Video Systems, Inc.

Now Anything is Possible.
SEE US AT ITS BOOTH #812

A53-D Key Channel casts a giant shadow

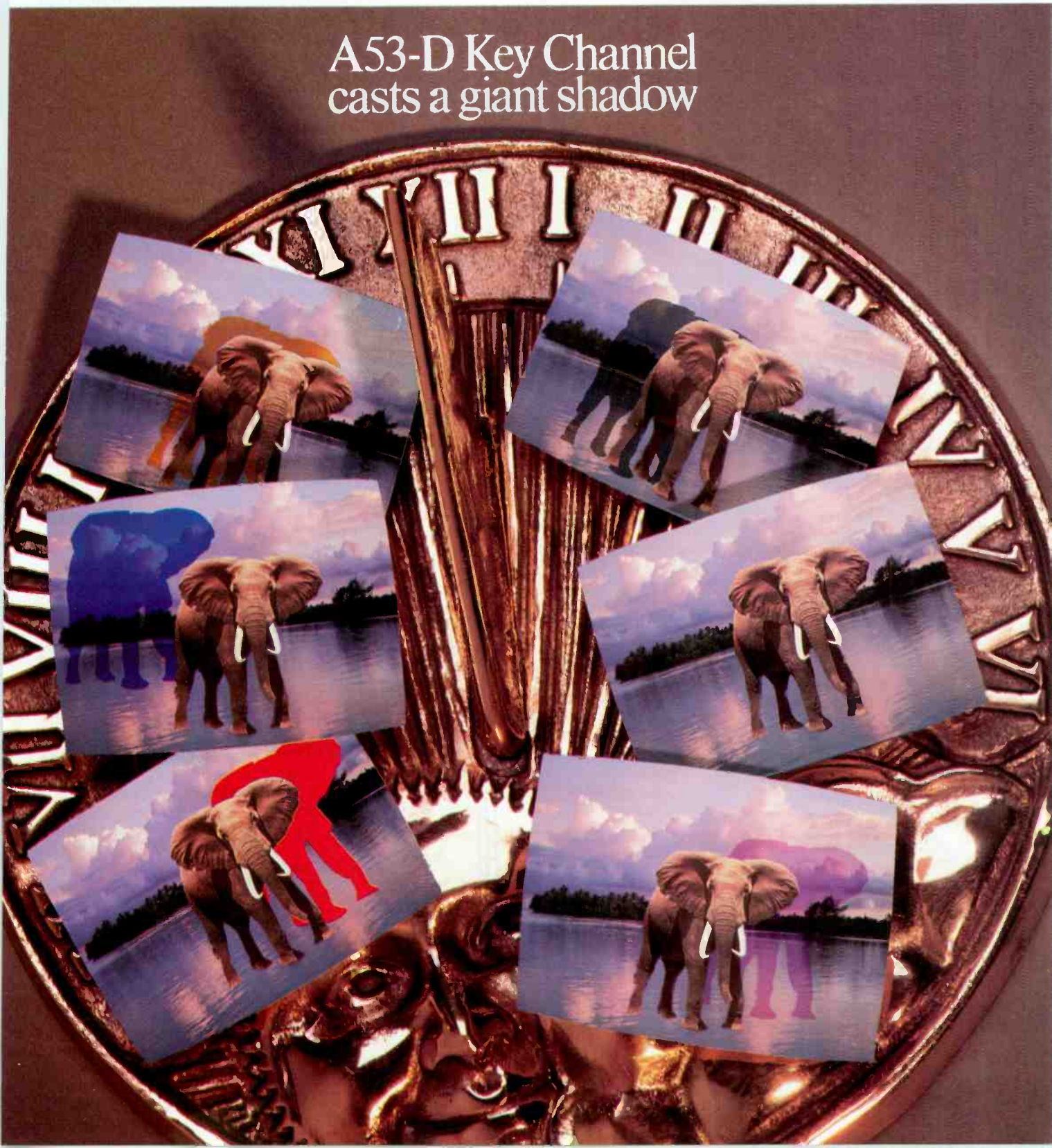

tasks that make up a project.

Strategic planning involves the "total picture" approach to project construction. Ask yourself these questions: *Is this a practical project? Does it meet the long- and short-term needs of my company?* Strategic

planning looks at the present and future needs of a company and defines how the planned construction will fill those needs.

Tactical planning is a detailed look at the individual aspects of a project. This might include job assignments from start to fin-

ish, names of those who will work the assignments, required resources for the tasks and how each task relates to the others.

Each task in the CPM chart is assigned a name, a beginning and ending date and resources. The computer indexes the tasks, using the dates as a reference, and draws a visual aid to show which assignment times are critical to completing the project on time.

The PERT (performance evaluation and review technique) chart, shown in Figure 8, is a visual aid with the tasks arranged on a time-referenced graph. As information is added to the data in the program, new charts are generated to reflect the changes. Movement along the PERT chart time axis shows how quickly the changes will affect the project's completion date. The real value in using computer-aided project management is the ability to make quick changes in your plan and see how they affect the project.

The final step in project management is evaluation. Stand back and look at what you have accomplished. Did you succeed? Were the costs what you expected? The evaluation stage helps prepare you for the next project.

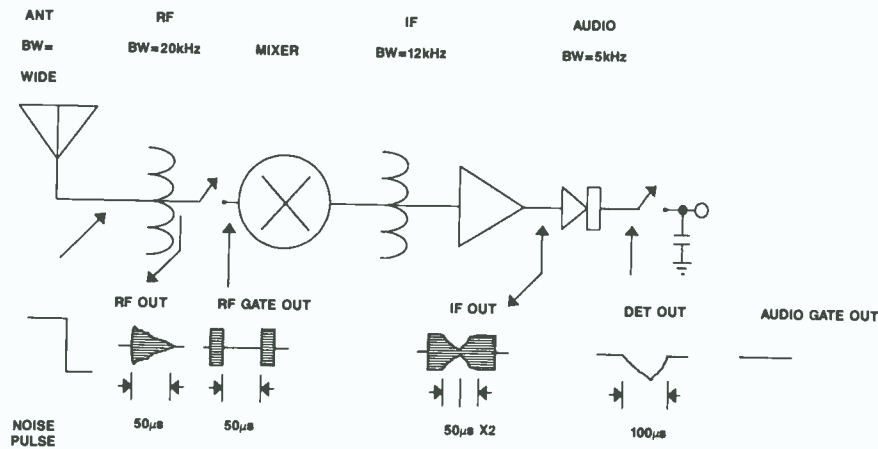

Figure 4. The improved noise-reduction circuit uses RF and audio switching to prevent the noise pulse from being coupled to the audio output.

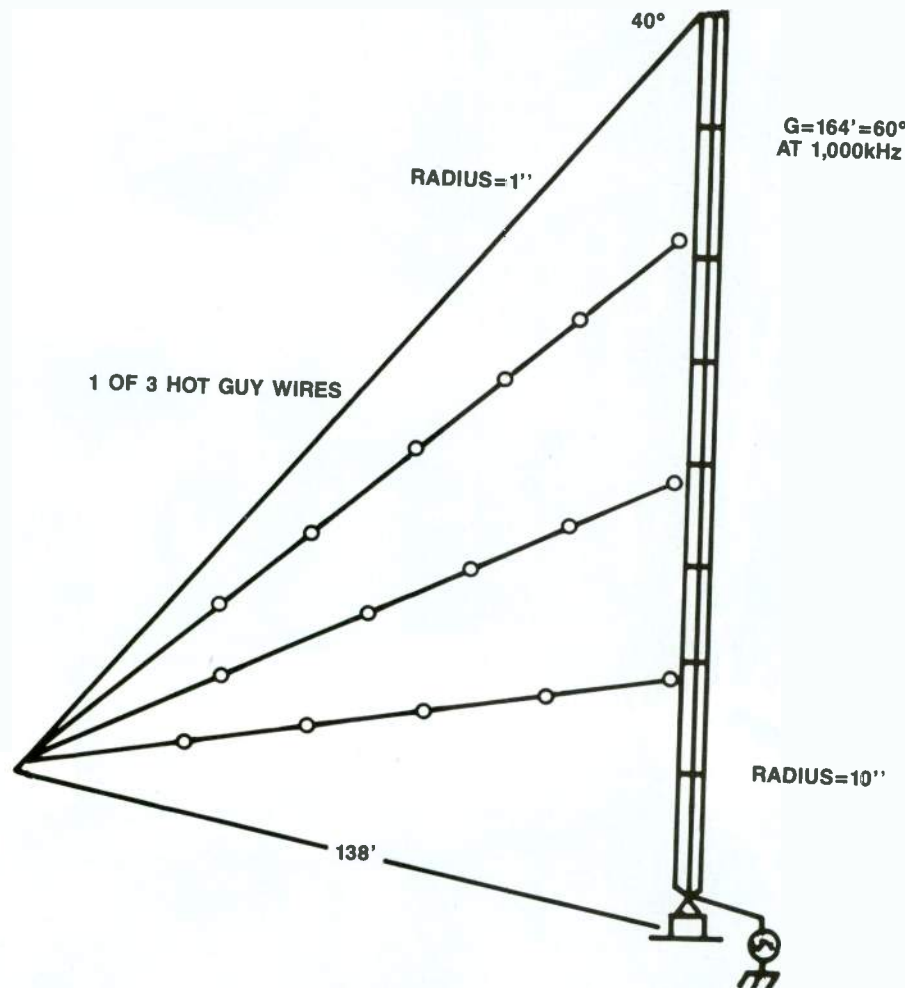

Figure 5. Hot guys carry a substantial amount of RF current and provide a dc path from the tower to ground. This configuration tends to produce an umbrella of protection from induced electrical storm voltages.

VITC vs. longitudinal

The advantages of using vertical interval time code (VITC) rather than longitudinal time code (LTC) were discussed by John W. Fullwood, The Fullwood Group. He likened the operation of VITC to devices added in-line to the video circuit. He pointed out that when video insert edits are made, VITC is erased. Consequently, it is impossible to re-edit to the same frame number.

LTC, using the same time-code numbers, is used at or near play speeds while VITC is used during slow motion. The advantages of VITC compared with LTC, beyond slow motion, include: match-frame calculations and preservation of the second-audio track for program material instead of time code.

With the proper modifications to a video-editing system, however, VITC can be used as the sole edit-control code. The modifications can be divided into two basic groups: feedback and non-feedback solutions.

One feedback solution requires that the VCR scanner be modified to permit it to provide the time-code address of the next frame to be erased by the flying erase head. The VITC is extracted from the pre-erase video output, and the feedback loop is completed when VITC is inserted into the record machine's video input during the recording of a video insert. A system block diagram is shown in Figure 9.

An alternative method involves modifying the AST head so that it is capable of scanning the track adjacent to the one

Continued on page 42

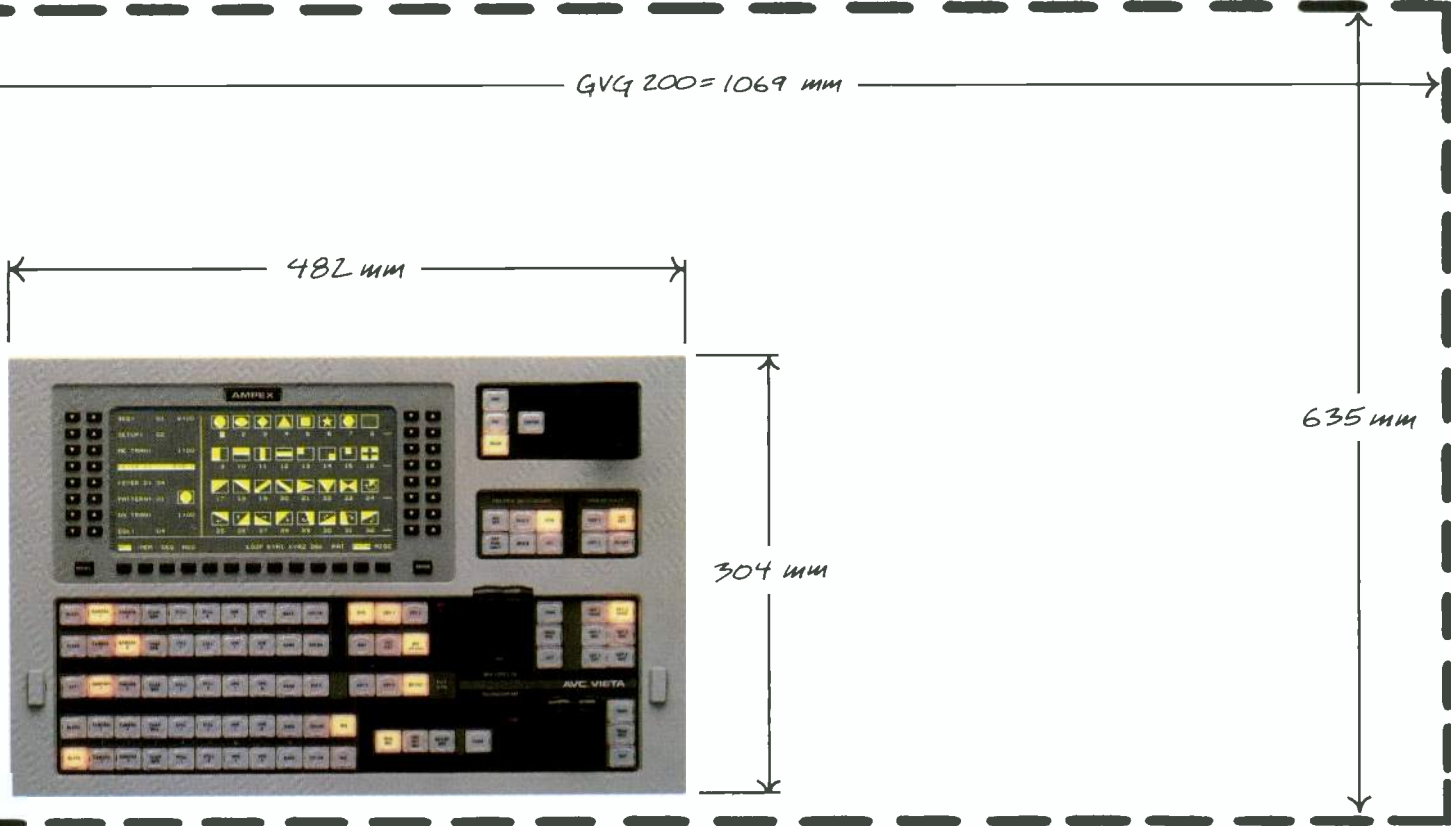

Introducing Vista.TM It will absolutely change the way you look at switchers.

The new Vista switcher gives you all the power and ease-of-use of a "big" switcher, in a third the space and at *half* the price.

Vista has four keyers and twelve buses with full program preset mix capability. So complex layering and sophisticated production are easy.

And since you don't have to make multiple passes, you'll have fewer generations and much cleaner pictures.

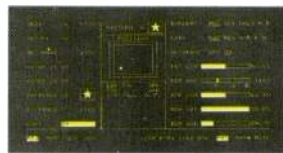

Electro-luminescent display

Revolutionary electro-luminescent display

A comprehensive display on the Vista control panel simplifies your most complicated production tasks. It provides all the information you need about operational status and memory setups, so you'll always know where you are.

And few switchers of *any* size have a memory like Vista. It stores 24 complete panel set-ups and 24 sequences for fast, easy recall of any combination of switcher operations.

Unprecedented digital effects control

When it comes to inserting and manipulating ADOTM or other digital effects, the Vista switcher virtually doubles your capability. Effects that take two M/Es with ordinary switchers require only one on Vista, thanks to our new DigiLoopTM effects circuit.

So compare. You'll find that big switcher power does not have to mean big size or a big expense.

For a descriptive brochure on the Vista switcher contact your nearest Ampex office today.

AMPEX

Atlanta (404) 491-7112 Chicago (312) 593-6000 Dallas (214) 960-1162 Los Angeles (818) 365-8627 New Jersey (201) 825-9600 (In New York (212) 947-8633)
San Francisco (415) 367-2202 Washington D.C. (301) 530-8800 Canada (416) 821 8840

Circle (24) on Reply Card

© Ampex 1987

You're only



1/2 INCH AWAY

**from the
highest
cost/performance
system
available...**

The Panasonic Pro Series



VHS — the recording format

behind Panasonic's Pro Series delivers both the high performance and economy demanded by today's professional video users. By combining the exceptional capabilities of component technology with the convenience and economy of 1/2 inch cassettes. In a complete systems configuration designed for field recording, post-production, studio operation and networking.

The Panasonic® Pro Series produces more than 400 lines of horizontal resolution in an affordable half-inch component system. For breathtaking detail and clarity throughout every phase of your video operation. And to preserve the definition of recorded images, the Pro Series boasts a signal to noise ratio of 47 dB. Which provides the perfect combination of high resolution and low noise.

To complement the high resolution of the system with brilliant, true to life colors, Y (luminance) and C (chrominance) signals originate from the Pro Series camera. Are maintained throughout the editing system. And viewed on Pro Series

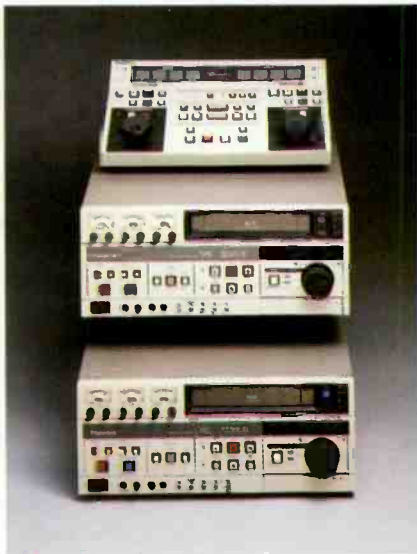

monitors. So the signals are free from cross color and dot interference, preserving the integrity of recorded images throughout the system.

The Pro Series also features two-hour record/playback operation on a single cassette. With professional quality Hi-Fi audio. To make the audio sound as great as the video looks. What's more, the Pro Series is upwardly compatible with standard VHS. So you can easily integrate it into your present video system. And utilize existing VHS programming.



But that's only half the story. Compared to a standard 3/4-inch system, the Panasonic Pro Series cost less to purchase and operate. Which means you can get higher performance at a lower cost.*

We also put a lot behind our product line. Like our broad network of Professional/Industrial dealers. And our own professionally staffed service and support network. With six key locations throughout the country. Who will help you select, maintain and upgrade the system configuration that's right for you.

For more information on the Panasonic Pro Series, call Panasonic Industrial Company at 1-800-553-7222. Or contact your local Panasonic Professional/Industrial Video dealer.

Panasonic

Professional/Industrial Video

*Based on a comparison of Panasonic edit machines.

Circle (25) on Reply Card

Continued from page 38

that is being scanned by the flying erase head. On the C-format VCR, the piezoelectric deformation would be toward the bottom of the scanner.

The non-feedback method has only one implementation scheme, which uses a fea-

ture unique to the C format. Video information is encoded on the long diagonal tracks located at the center of the tape. A 16-line segment of the vertical interval is recorded on the short diagonal track located on the lower portion of the tape, and it is labeled sync.

If the VITC is confined to the 10-line segment of the vertical interval between lines five and 14, it will appear only on the sync track. If the VITC is further limited to lines 10 through 14, the signal will not interfere with vertical retrace. To make a video insert, merely turn off the sync head in the same way that audio 3 is turned off during an edit in systems that use LTC as the edit control code.

TV engineering

Karl Renwanz, WNEV-TV, Boston, related his station's experience with component analog video equipment in both the M-format and Betacam SP products. Renwanz noted that a number of equipment "holes" remain in the component analog signal chain. He said there is still a need for more hardware, including component switchers, time base correctors, matrix converters, test signal generators and waveform and video monitors. Much of the equipment available is new and was developed in the past six years.

He indicated that most of the shortcomings of first-generation analog component hardware were addressed in the second-generation equipment. The new recorders have program-length capability, full on-board time-code facilities, dynamic motion control and improved NTSC encoding and decoding.

Renwanz reviewed some of the tests he performed on the Betacam SP products, noting that the new products show significant S/N improvements and multiple-generational capability compared with previous small-tape formats. The new generation of hardware does, however, place restrictions on the type of tape that can be used. At WNEV-TV, metal-particle tape is used throughout all operations because of the increased performance in both S/N and the number of cycles that a field tape can offer. Renwanz reported that the station has used the field tapes 12 times, and they are still in use.

D-1 and D-2 design criteria

The issue of D-1 vs. D-2 was a recurring topic of conversation at the convention. Many questions centered on the differences between the two formats and the ways they can be interfaced within a station.

The format you select depends upon the particular application. As shown in Table 1, each format offers a set of unique features and performance advantages. The D-1 format is well-suited to high-end production applications. The D-2 application, on the other hand, may find application in existing composite-based facilities.

Curtis Chan, Centro Corporation, discussed the importance of careful planning when interfacing component and composite digital-based technologies into existing analog, hybrid or all-digital teleproduction facilities.

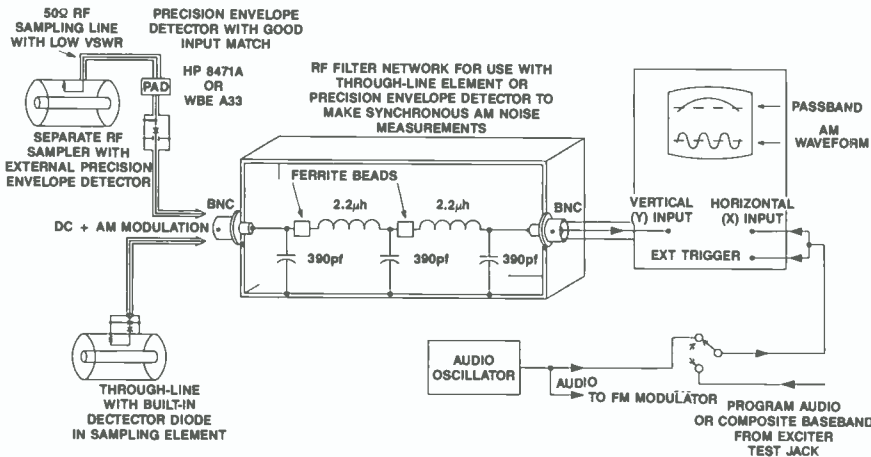

Figure 6. Suggested test equipment setup for making synchronous AM waveform measurements.

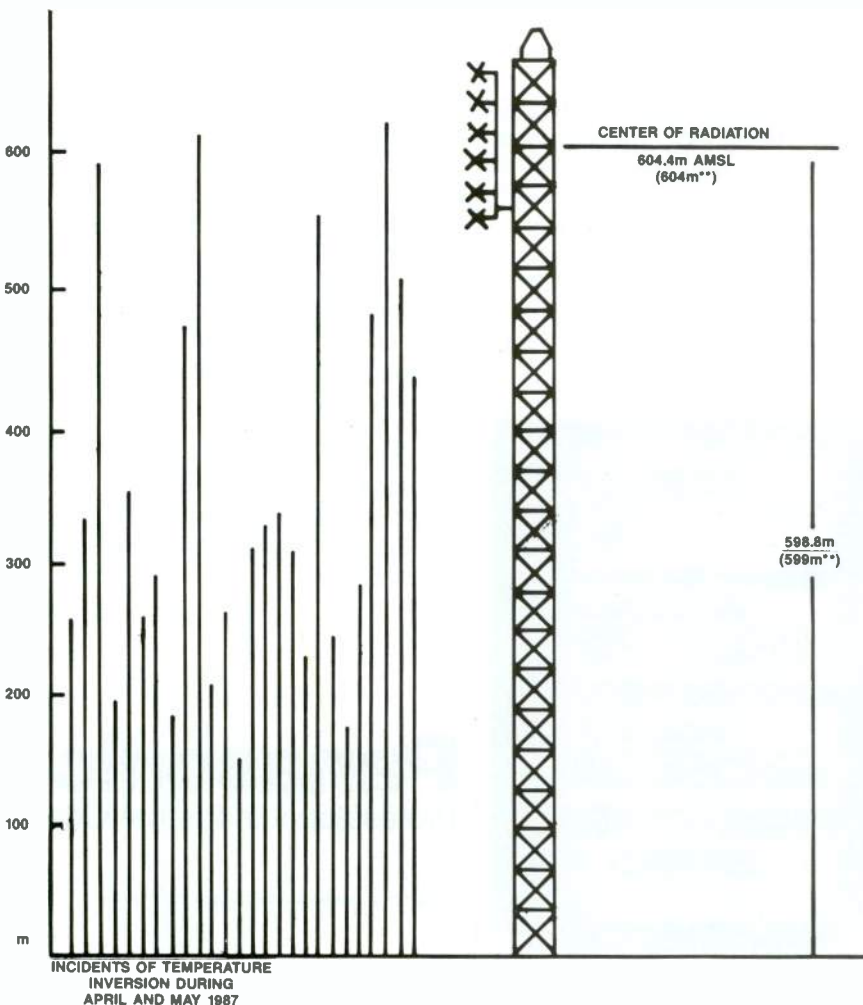

Figure 7. Record of temperature inversions at a southern Texas transmitter location. Such inversions may severely reduce a station's effective coverage area.

Panasonic® Pro Series Monitors.



Designed for production quality... With an eye on your budget.



Panasonic presents two very versatile, high-grade color monitors--the BT-D1910Y and the BT-M1310Y. Built for performance, these BT-Series monitors offer you the quality and reliability you've come to expect from Panasonic. Not to mention a wide array of features at an affordable price.

Our BT-Series provides you with the controls and connections necessary for studio applications--while serving a host of industrial, educational and professional video needs.

For maximum performance and versatility, both monitors offer complete, direct compatibility with the new S-VHS format--in addition to conventional signals. And video reproduction on the BT-Series is superb. As a matter of fact, the BT-M1310Y boasts a horizontal resolution of more than 560 lines, while the BT-D1910Y offers you greater than 550 lines.

What's more, each monitor provides you with a full set of front panel controls. Like Line A/B split, S-Video input connectors, Blue single-only switch, pulse-cross circuit, preset picture off/on, comb/trap filter selectable and normal/underscan switch, just to name a few.

So when you are looking for professional quality, but still need to keep an eye on your budget, look into the Panasonic BT-Series high-grade monitors. For more information, call Panasonic Industrial Company at 1-800-553-7222. Or contact your local Panasonic Professional/Industrial Video Dealer.

Panasonic

Professional/Industrial Video

Even though the all-digital facility is here, full implementation of the technology is many years away. As stations begin to use the new hardware, the technical differences between digital and analog systems require special attention.

A critical area is that of level and phase matching. In interformat systems, conversion of signals between composite- and component-based systems may result in mismatched levels and phase discrepancies. Operators and engineers need to be especially careful to monitor each signal before and after encoding or decoding. Until digital color-correcting systems become available, it may be necessary to convert the signal back to analog, perform

the color correction and again digitize the signal.

Component-level servicing

The complexity of today's broadcast system is creating problems for both manufacturers and broadcasters, according to Thomas Cavanagh, CBC. Cavanagh talked about the importance of proper maintenance in today's analog-digital production facilities. He said that it was important for manufacturers to understand that most equipment owners need not only emergency repair assistance, but also on-line, off-line and preventive maintenance assistance where faults are repaired to the component level.

Cavanagh identified three prerequisites for the achievement of high technical quality:

- The equipment must be inherently capable of delivering a quality signal.
- The equipment must be operated so as to take maximum advantage of its capabilities.
- The equipment must be adjusted and maintained to operate according to its specifications.

In the real world, the capabilities and operation of the equipment are beyond the control of the members of the maintenance staff. As technical specialists, however, they are more knowledgeable about the internal functions and, therefore, more

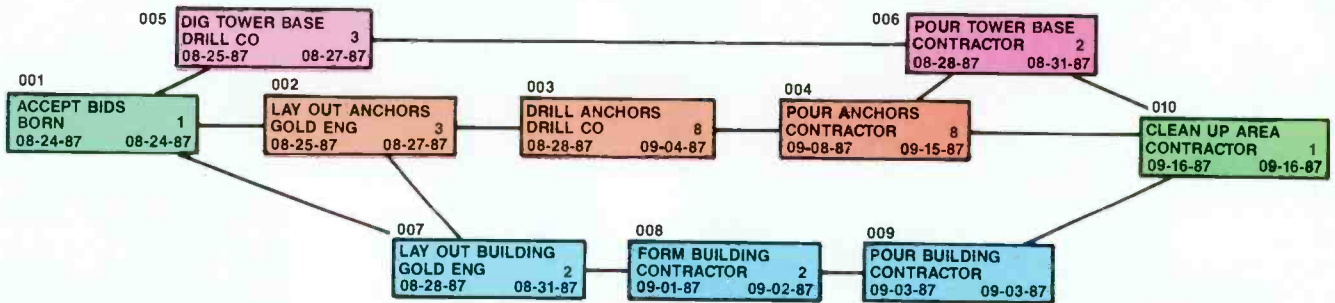

Figure 8. Performance evaluation and review technique (PERT) chart showing the various project elements and applicable critical dates. Such visual aids are helpful in tracking and successful completion of complex projects.

Portable Partnership

When you're on the scene, you're in the air—with a cellular phone and a Comrex. Our PLXmicro converts telephone quality to program quality around town or around the world.

The PLXmicro is the tiniest extender we've ever built. Just about pocket size, it stows-and goes-almost anywhere.

Yet despite its size, it's packed with features: the Comrex frequency extender is built in, along with interface for cellular telephone or standard dial line. There are

microphone and tape inputs and automatic send level control.

A monitor decoder, hybrid circuitry and headphone output allow full duplex operation.

Call or write for a demo tape of the difference that a Comrex can make.

COMREX®

Comrex Corporation, 65 Nonset Path, Acton, MA 01720.
617-263-1800 1-800-237-1776
Comrex UK, Ltd., 29 Kenilworth Road,
London W5 5PA UK 01-567-5128



IF YOU WANT THE BEST PRODUCTION 16 TRACK, YOU'LL HAVE TO SPEND A LITTLE LESS.

There's no getting around it. No one beats the 6016 on features. At any price.

Check it out. Two speeds without recalibrating each time you switch. Proprietary head technology so accurate that final EQing decisions can be made right in sync mode without rewind and repro verification. Gapless/seamless punch in/out with superior transparency. And unlike other 16s, the 6016 has built-in dbx professional Type-I.

The compact, rugged 6016 also gives you lightning fast lockup for use with synchronizers, incredibly precise spot erase, D-sub multi-connectors for faster setup with fewer cables and, oh yes, brilliant sound.

There simply is no finer 16 track available. Compare it with any other machine out there. Then compare the price. If money is an issue, you may have to settle for the best.



TASCAM

© 1988 TEAC Corporation of America, 7733 Telegraph Road, Montebello, CA 90640. 213/726-0303.

Circle (28) on Reply Card

aware of the implications of operational factors on technical quality. The success of any quality-assurance program is directly related to the ability of operators and production users to detect equipment failures. The maintenance technicians may be able to repair the equipment, but only if they are aware of its failure.

Cavanagh suggested that broadcasters request that manufacturers supply diagnostic documentation and sufficient training to permit a competent maintenance technician to quickly locate faults down to the component level. Although adequate diagnostics, documentation and training are not reality today, Cavanagh said, manufacturer cooperation will take place when users insist that these features and support services be included with the equipment.

TV audio and stereo

The TV audio session began with a standing-room-only crowd. However, the crowd didn't stay for the whole show. Randy Hoffner, NBC, described how surround sound has been used for years to enhance motion pictures. He went on to discuss the development of surround sound at length.

Although surround sound is not new to TV audio, the subject was unfamiliar to much of the audience. Hoffner said that NBC planned to begin surround-sound broadcasting at a later date, noting that several components in the transmission path have yet to be thoroughly tested. Comments from the crowd reflected relief that surround sound is not another complex audio format that must be accommodated right away.

A paper that seemed to generate a considerable amount of interest addressed what must be a TV engineer's major concern—routing mono, stereo and SAP audio throughout a broadcast facility. Rick Craig, WGN-TV, Chicago, described how his sta-

tion "reinvented the wheel" in terms of audio routing.

Craig pointed out that stereo conversion requires first dealing properly with the multitude of audio sources in the TV station. You must ask yourself questions such as: *How will out-of-polarity audio or reversed channels be corrected? What happens if a tape marked stereo is not really stereo, but rather, must be summed into a monaural signal prior to broadcast?* In addition, some sources also rely on matrixed stereo audio, which must be decoded prior to broadcast. Finally, determine how you will handle SAP. *Will there be silence on the SAP channel during commercials and at times when secondary audio is not available?*

Facing these and similar questions is crucial to successfully building a new audio distribution/switching system. Craig outlined how his station specified special features for new hardware. His station required that DA cards be capable of performing a variety of switching functions, in addition to amplification. To accomplish this task, the DA card relies on a daughter board that provides on-board audio switching, matrixing and dematrixing. The desired modes can be selected through a BCD logic signal.

After the sources have been controlled properly, it still is necessary to route the audio to the master control and station routing switchers. Figure 10 shows how this task is accomplished at WGN-TV. The completed system provides versatility as well as ease of control—desirable operating features for a station.

The remaining sessions were devoted to stereo-production techniques. After the presentation on stereo routing, the meeting room almost emptied. Apparently, TV engineers and managers are far more concerned with routing stereo audio than they are about producing it.

High-tech graphics systems

The graphics and animation session centered on the theme of cost-effective graphics systems. According to Steven Bonica, NBC, the current graphics and effects systems are capable broadcast tools, but they are only as good as the people who operate them.

The morning's first paper, "Weather & News Graphics Survey Results and Interpretations," was presented by Dr. Joel Meyers of ACCU-Weather. His survey of TV stations throughout the nation produced some interesting findings. Most large stations, for example, maintain their graphic style through top-of-the-line in-house gear and personnel. The luxury of a large design staff with access to still-stores and ¼-inch tape decks results in a greater variety of custom graphics.

Most small-market stations, many of which do not have weather computers, use outside sources for news, weather and sports graphics. These sources typically include a current-slide service and daily network feeds to augment a slide library. As expected, the capabilities and output of the graphics departments representing mid-size markets fell between these two quality/support extremes.

Meyers discussed the subtle, yet important, difference between news/sports graphics and weather graphics. In the case of the news and sports, one concise thought or idea usually is presented in picture form to support a story. In the case of weather, however, several concepts are presented at one time, and they themselves are the story.

The key, then, is to communicate accurate and up-to-date information in a crisp and obvious manner. The future, according to Meyers, lies in digital feeds, new radar systems, the ability to watch storms move in real time and clearer design and animations.

Election graphics

Steve Davis, WPRI-TV, Providence, RI, took the podium to address another area with specific challenges: election computer systems. He described election night as a competitive and challenging time, with only one shot at getting it right.

Early election display systems, highly customized and subject to degradation and breakdown, were limited in their speed, graphic design and display capabilities. PC software advances, however, have solved most of these problems and opened the door to new, affordable, available and configurable software packages.

Davis pointed out that current, popular character generators are the mainstay of graphic display devices. Most of these incorporate a serial data interface (RS-232 or RS-422) that can be connected to an election computer.

He offered several recommendations in

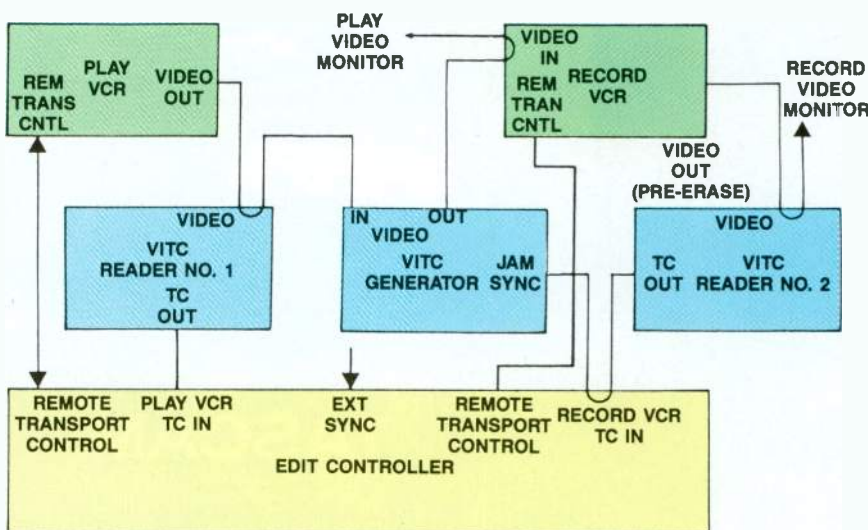

Figure 9. A VITC editing system using a modified VCR.

One tape consistently gets good reports.

When you've got to get the story in one take, you've got to get Ampex.

It's the tape professionals rely on to cover everything from four-alarm fires to world class sporting events.

That's because we designed it to withstand the tortures of heat, humidity and freezing cold.

And deliver fully saturated colors and rich, clean sound with minimal dropouts, tape after tape. Thanks to Ampex Process Management, our exclusive quality program.

So you can concentrate on great shots instead of worrying about your tape.

Another Ampex exclusive is our convenient labeling system which helps you keep detailed, accurate shot lists as you go.

And we always give you full technical support, immediate deliveries and the personal attention of your Ampex representative.

So when you've only got one shot at a story, cover it with Ampex. Anything less could be bad news.

AMPEX

It's your best shot.

Ampex Corporation
Magnetic Tape Division
4Cl Broadway
Redwood City, CA 94063
(415) 367-3809



Circle (29) on Reply Card

selecting an election computer system. Be sure that the prospective system is capable of handling a local data source such as a standard news wire, manual entries and dial-up data such as that provided by networks for their affiliates. Check to see that the system provides tabulations, percent-

ages, projections, the ability to customize and configure and, finally, backup and recover provisions.

Once the system is chosen and installed, Davis said, tests using realistic data, sufficient rehearsals and preliminary on-air tests are necessary to ensure the best pos-

sible election-night results.

Future graphics applications

Cathy Galvin, Ampex Video Systems Division, was the third speaker of the morning. Her paper focused on the practical, real-world integration of digital and analog equipment for today and tomorrow. The current operational and technical transitions are forcing people to learn new production methods. She noted that artists must learn to be creative in a technical medium in which engineers still are experiencing digital bugs. At the same time, advertisers and producers are calling for new and more attractive designs.

The near future is likely to see integration of composite digital and analog equipment alongside a "component island" of edit and/or graphic suites. She said integration will be helped by the CCIR 601 standard.

The past five years have brought a new wave of electronic designers who have made the jump from print. This transition, Galvin explained, transcends the boundaries of a paint system. And, as the learning curve matures, artists and designers will spend less time learning new technology and more time designing and producing better pictures. The ultimate "do-it-all"

Continued on page 52

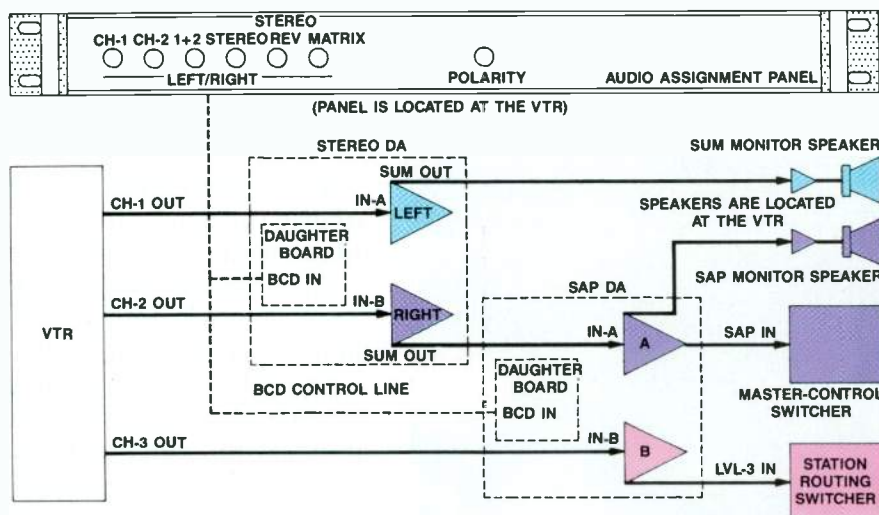

Figure 10. Signal and control flow for a typical 3-channel audio system within a TV station. The BCD-controllable DA cards located near the center of the drawing perform all audio switching prior to distribution.

Nothing sells an LPB[®] console like the station that bought one



We recently surveyed a group of radio station General Managers who purchased LPB audio consoles...

TX 100kw FM—"Delighted; it simply won't stop."

UT FM—"Love it; would certainly buy another. Best all-around console we've ever had."

NY AM—"Great board; our second LPB. Wouldn't buy anything else."

SC AM—"Best I've ever had. It was recommended by our consultant. Have anyone interested call us."

OH FM—"Our second LPB board, because we liked the first so well!!! Never had any problem with either."

WV 50kw FM—"Couldn't be happier with it. Certainly pleased with your rep's presentation."

CA AM/FM—Our operators love it. It's a solid console. The good layout made it easy to install."

What are you saying about your console?

Call your LPB Dealer or LPB

LPB[®] LPB Inc.
28 Bacton Hill Road
Frazer, PA 19355
(215) 644-1123

® is a registered trademark of LPB Inc.

Circle (30) on Reply Card

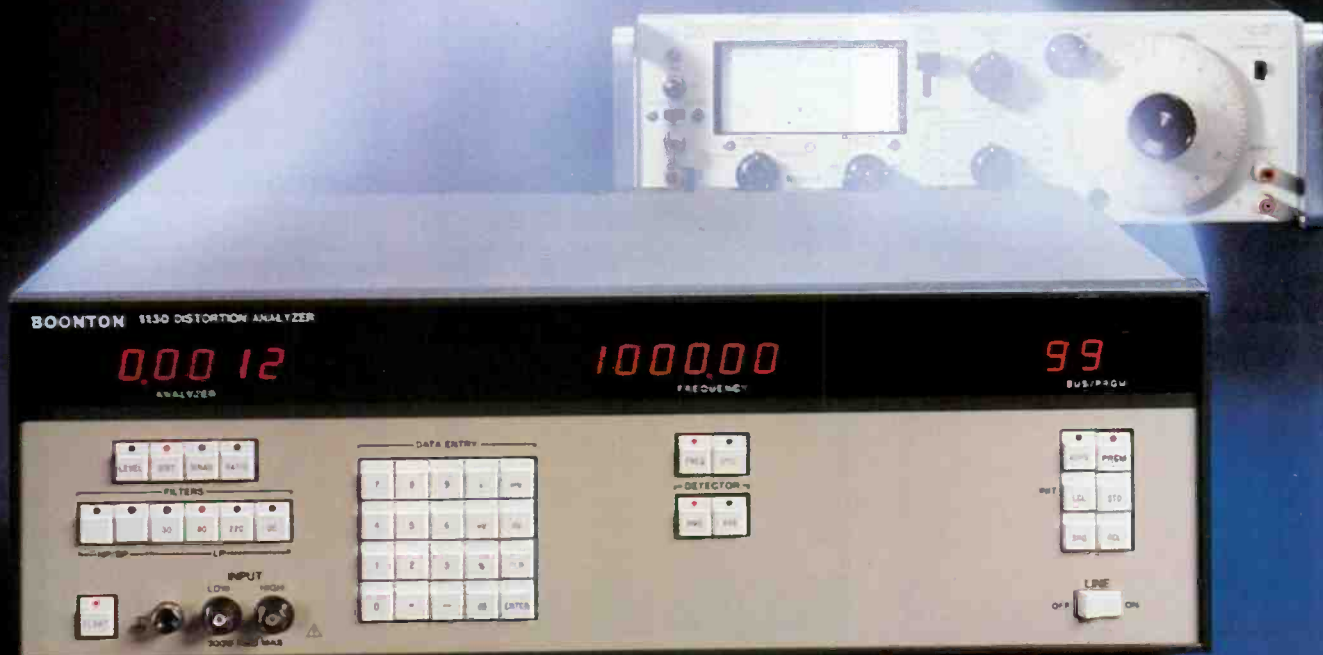

Want a distortion analyzer that's out-of-date...or up-to-date?

The new 1130 Distortion Analyzer from Boonton takes you out of the past and into the present with automatic and fast distortion measurements. Instead of the old, slow, manual-tuning method, the 1130 automatically displays total harmonic distortion, typically in less than 1 second.

In addition to fast distortion measurements, the versatile 1130 measures frequency from 5 Hz to 200 kHz, AC and DC levels to 300 V, and SINAD. And our selectable low-pass, high-pass, and weighted filters speed and simplify your testing.

But most important the model 1130 can improve your competitiveness:

- With its fast measurement rate. Automatic testing throughput is increased.
- With panel setups stored in memory. Redundant tests are duplicated quickly and consistently.
- With test repeatability. Interdepartment measurements are consistent.
- And with a very attractive price.

Standard Features:

- Distortion fundamental frequency range 10 Hz to 100 kHz.
- 10 mV sensitivity
- Residual distortion typically < 0.001%.
- Fully differential or single-ended input.
- Average or RMS detection.
- Non-volatile storage of 99 complete panel setups.
- Full function IEEE-488 bus interface, standard.

For immediate action, call or circle the appropriate response number.

BOONTON

Boonton Electronics Corp.
791 Route 10, Randolph, NJ 07869
Telephone (201) 584-1077
Fax (201) 584-3037

Signal Generators ■ Modulation Analyzers ■ RF Power Meters ■ RF Millivoltmeters ■ Capacitance Meters and Bridges ■ Audio Test Instruments

Circle (31) on Reply Card for a Demonstration

Circle (32) on Reply Card for Information

NOW ALL YOU NEED TO DO ALL THIS,

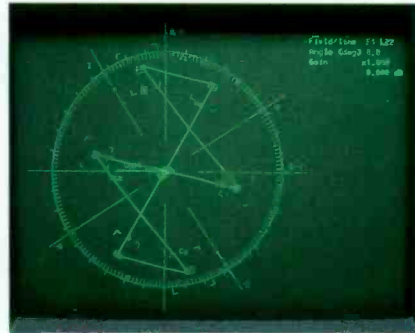
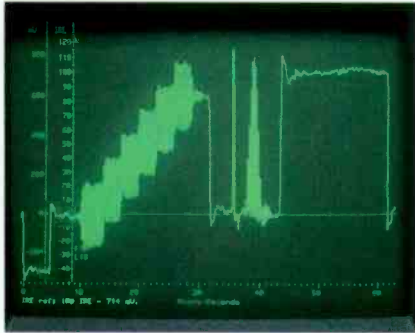

Video courtesy of KOIN-TV, Portland, OR.

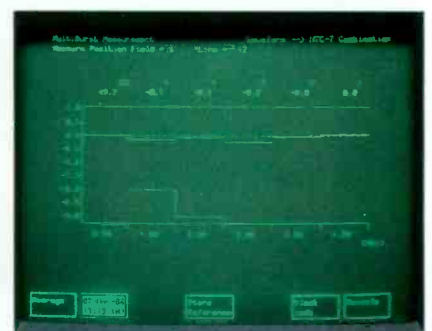
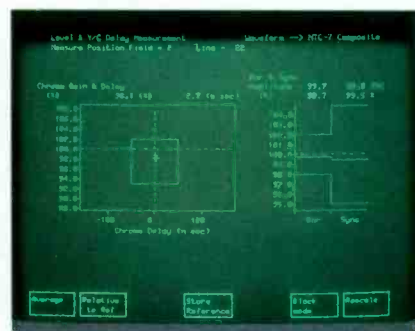
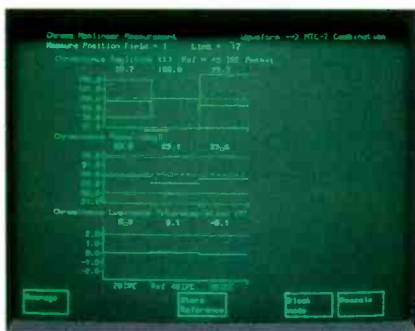
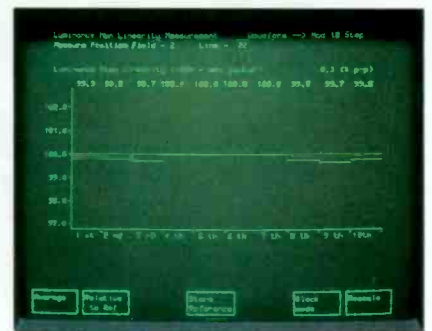
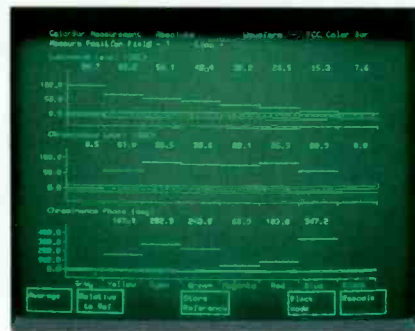
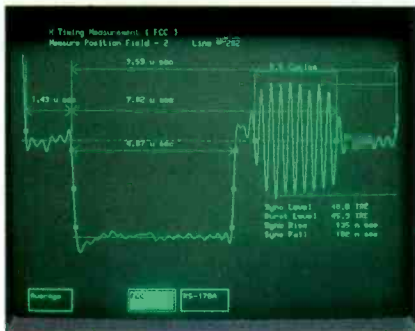
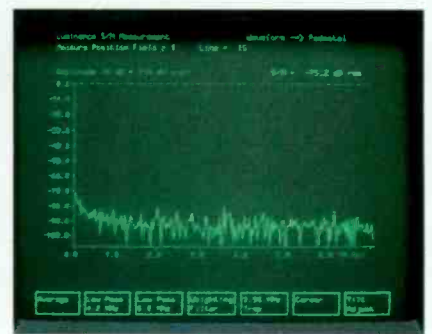
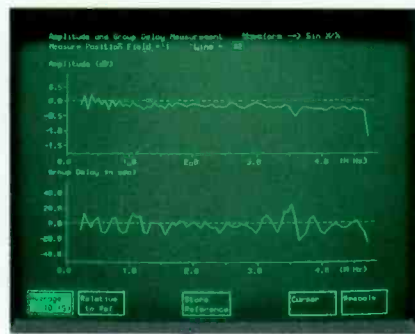
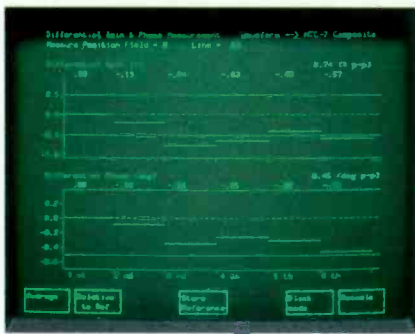

IS THIS,

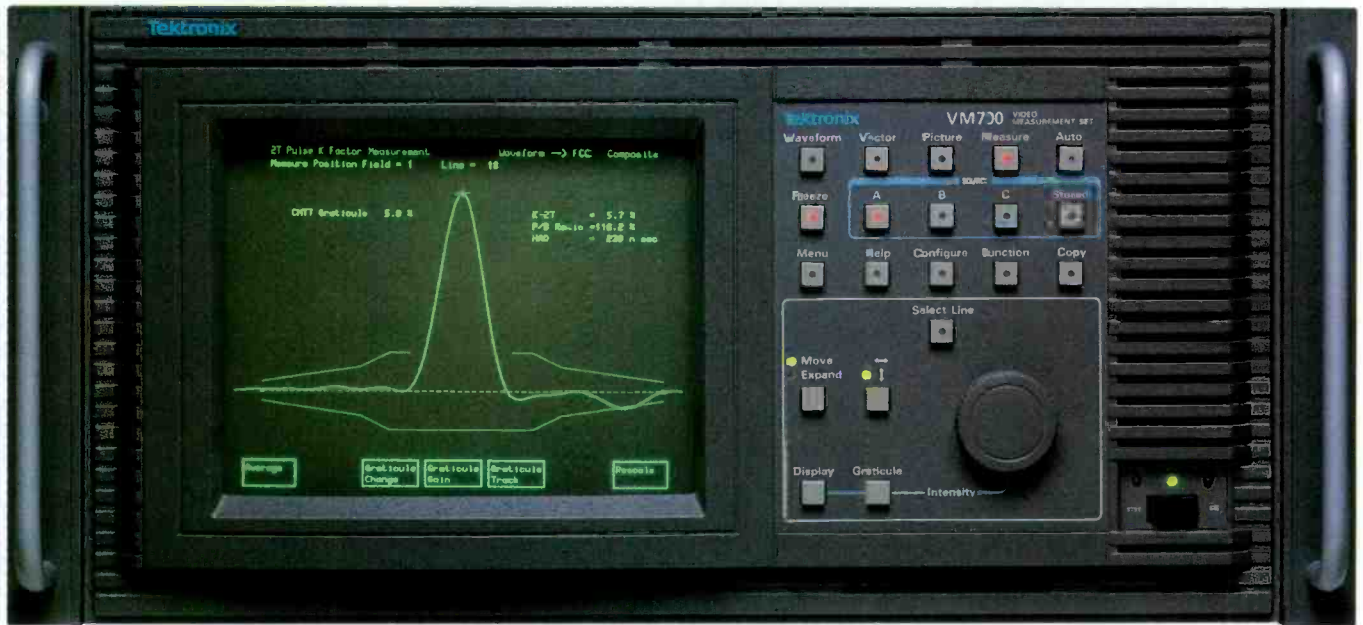

AND THIS.

The Tektronix VM700 Video Measurement Set puts complete digital monitoring and measurement at your fingertips. It offers more in performance and ease of use than you've ever had in a video measurement set.

All functions are controlled by a few simple, front-panel pushbuttons. Results are accurate and repeatable. And it's all done by one powerful package, at a very reasonable price.

The VM700 makes all standard television measurements automatically. It can compare them to limits you've defined and generate an alarm message if limits are exceeded.

To save even more time, you can define any sequence of operations as a function. Later, when you want them performed, the measurements will be made automatically—complete with printout.

Access to manual testing at the touch of a button. For detailed analysis, an actual signal can be displayed and additional measurements made manually. Waveform mode cursors ease the way to accurate time, frequency and amplitude measurements. And you can

expand any point of a waveform display vertically and horizontally just by touching the point on the screen.

To learn more, get in touch with Tek! Call your Tektronix representative to demonstrate the simplicity and power of the VM700. No other video measurement set provides so many capabilities in one easy-to-use instrument.

Tektronix
COMMITTED TO EXCELLENCE

Circle (33) on Reply Card

Continued from page 48

system, however, probably will never be built, because not everyone needs such a system. In fact, it's unlikely that anyone could agree on what "do-it-all" includes.

CBS graphics facility

Patricia Dovas, CBS News, discussed the explosive growth of computer graphics in broadcasting and its unabated progress in the 1980s. Her paper, "A Centralized Graphics Facility for the CBS Broadcast Center," described the network's growth from early CBS Laboratories character

generators to powerful 3-D animation systems, as well as the integration of artists into the editorial process.

To complete the expansion of the network's graphic capability, a joint planning committee—including representatives from the news, sports and engineering departments—began by first developing the system's goals. The controlled, creative environment required flexibility, visual contact among artists, proximity of equipment, compatibility with existing gear, ease of use and centralization of work.

Aesthetically, the ergonomic goal was

to make the work environment pleasing and functional. The result was clustered, modular work stations; half-height walls; track lights; a stereo; individual temperature controls; controlled traffic patterns; low noise levels; non-reflective, medium-tone walls; carpeting; and individual, adjustable work consoles.

Computer animation

Don Miskowich, Symbolics, discussed several points with respect to the state and future of computer animation. He said that rendering (the computer process of describing an object's attributes, such as size and reflectance capabilities) is being well-handled by today's hardware. In fact, he stated, the rendering "number-crunching" can now be sent out of house to independent rendering facilities.

Other major issues in computer animation, according to Miskowich, are its design and specifications. The detailed and time-consuming effort involved in designing each component detail, element by element and move by move, is a painstaking process.

Rule-based modeling and behavioral animation, however, are recent developments addressing this problem. These concepts are programs, or tools, to help animators quickly complete complicated designs. Although engineering rules such as these are common in computer-aided design (CAD) systems, they are just now migrating into modeling packages of animation systems.

In an example of flying birds in "Stanley & Stella in Breaking the Ice," the animator told the computer how fast and how slow the birds could fly, the turning radius to be used, that they could not run into each other or other objects in their physical environment, and that they should fly as close as possible to the flock's center.

The 80 animated birds and their 80 fish counterparts resulted in an excellent, complex and engrossing film that was probably well beyond the scope of what an animator could do without these tools. The payoff in human productivity is great; animators and artists are freed from tedious technical details to do what they do best.

Advanced TV systems

At 8:50 a.m., only a few seats were available in room 18 for the advanced TV transmission systems engineering session. The session started on time, and by 9 a.m., it was standing room only. Robert Hopkins, Advanced Television Systems Committee (ATSC), provided an update of the committee's work in sorting the various proposals and formats.

Later, Dr. James E. Carnes, the David Sarnoff Labs, fired several shots in what may prove to be a long and expensive battle between the Japanese manufacturers and U.S. terrestrial broadcasters. Carnes suggested that most of the proposed

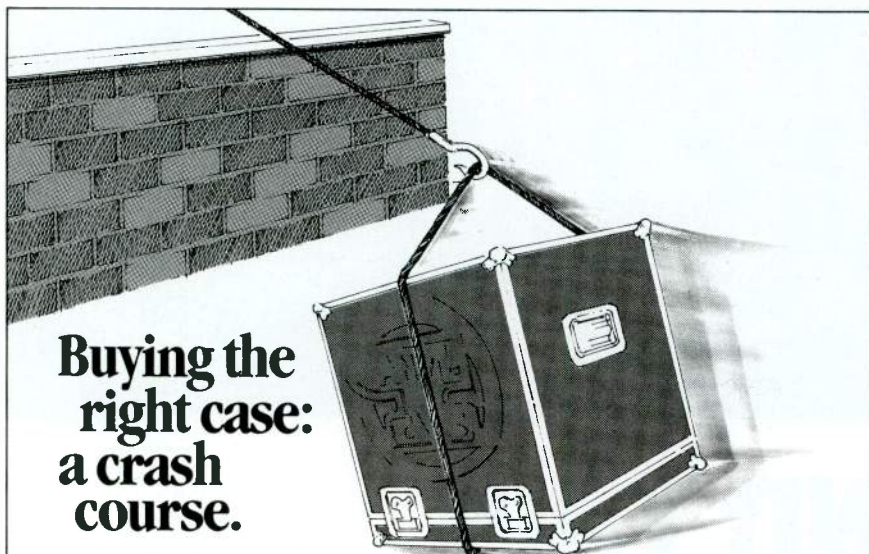

Buying the right case: a crash course.

1. **Plan for the worst.** We're talking real-life baggage handlers here. So take Murphy's Law, multiply by 2, and add a fudge factor.
2. **Get an expert evaluation.** ANVIL's ATA cases meet or surpass all the shock and vibration criteria in the Air Transport Association's Specification 300, Category 1—the industry's toughest standard for reusable shipping containers.
3. **Invest in durable quality.** With all you've got invested in your equipment already, isn't it worth the slight additional cost of a genuine ANVIL case, just for the peace of mind?
4. **Insist on ease and simplicity.** We have thousands of case designs you can order by your equipment's model number. And if we don't already have what you need, we'll make it for you.



800 / 423-4279

CA: 800 / 242-4466
818 / 575-8614

4128 Temple City Boulevard, Rosemead, CA 91770
©1988, ANVIL Cases

Circle (34) on Reply Card

THE FUTURE OF UHF TELEVISION HAS ARRIVED ...

KLYSTRODES

The future of UHF Television Transmitters is again brought to you by **COMARK**. After extensive research, product development and testing, the world's first Klystrode TV transmitter will be on the air this summer. From the very first moment that the Georgia Public Telecommunications Commission turns on its new Comark 120 kW Klystrode UHF Transmitter, they can look forward to **slashing their energy bills by \$50,000 or more a year . . . year after year!** Once again Comark has used groundbreaking technology to deliver tremendous bottom line savings for its customers, while the competition watched from the sidelines.

Best of all, these transmitters are in production now! Call your regional sales office for a firm price and delivery quotation.

Comark. Technology you can bank on.

 **COMARK**

Southeastern Sales Office
Byron E. Fisher
P.O. Box 179
Cropwell, AL 35054
(205) 525-5660

Northeastern Sales Office
Richard E. Fiore, Jr.
P.O. Box 616
Southwick, MA 01077
(413) 568-1808

Western Sales Office
Marty Jackson
P.O. Box 66507
Scotts Valley, CA 95066
(408) 438-4273

COMARK COMMUNICATIONS, INC.
A Thomson-CSF Company

P.O. Box 506, Route 309 & Advance Lane
Colmar, PA 18915 • (215) 822-0777 • Telex: 846075

Circle (35) on Reply Card



24 kW Transmitter shown.

HDTV systems pose serious problems for broadcasters because they require extra spectrum or are not compatible with existing NTSC receivers. Carnes also said that when HDTV images become available to the home viewer, NTSC images will appear (to the viewer) to be impaired. He

asserted that, in lieu of a practical approach for broadcasting advanced TV images to the home, terrestrial broadcast is likely to become the "AM radio of video." Carnes spoke strongly against the proposed NHK proposal, which he said would end more than 40 years of terrestrial

broadcasting in the United States and could result in the demise of 850 TV stations that serve local communities.

Richard Iredale, The Del Rey Group, proposed the HD-NTSC standard of HDTV, which produces a 6MHz compatible NTSC
Continued on page 58

APPLICATION	D-1 FORMAT	D-2 FORMAT
	LAYERING MULTI-EFFECTS EDITING MASTERING/REPLICATION FILM-TO-TAPE DATA STORAGE/ARCHIVE	PRESENT TYPE C APPLICATIONS
VIDEO I/O	RGB/Y, R-Y/B-Y/BETACAM/ RP - 125/EBU TECH-3246-E	COMPOSITE ANALOG RP-125X
AUDIO I/O	4-CHANNEL (AES/EBU)	4-CHANNEL (AES/EBU)
CASSETTE	19mm-S,M,L	19mm-S,M,L
PLAY TIME	16µm	13µm (TAPE)
SMALL	11 MIN	13 MIN
MEDIUM	34 MIN	41 MIN
LARGE	76 MIN	94 MIN
TAPE COATING	8500E METAL OXIDE	1,5000e METAL PARTICLE
TAPE SPEED	286mm/s	131.7mm/s

Table 1. Comparison of D-1 and D-2 applications and key parameters.

By the turn of the century there will be 12,500,000,000 more slides to file...

The image boom is coming... And you need to be prepared.

Computerize your slide library with the speed and efficiency you've grown to expect from today's workplace.

The best approach? The Gallery 2000 Automated Image Library from Rank Cintel. It's a database, still store, workstation network, graphics, and on-air production and transmission tool in one.

Gallery 2000 manages from 400 to millions of slides. And since it's 4:2:2 compatible it integrates with a range of digital studio devices — today and tomorrow.

Call for a free systems analysis of your company's image management needs:

312-426-2450

 Rank Cintel Inc.
Gallery 2000

704 Executive Boulevard, Valley Cottage, New York 10989, New York. Telephone: Sales — (914) 268-8911

Circle (36) on Reply Card



TOO MANY OF TODAY'S MICS ARE YESTERDAY'S NEWS.

When you're in the fast-paced business of news, why use outdated microphones? Time marches on, and old habits become bad habits if you don't keep up with the times.

The M 58, on the other hand, proudly benefits from new technical developments like a unique design employing a tiny, low mass diaphragm. Highly sensitive and accurate, its contoured upper frequency response produces unprece-

dentented intelligibility, even off axis.

A sophisticated modern internal shock-mount system reduces handling noise and vibration down to new levels. The 58 is scientifically "weight balanced" for greater comfort during lengthy interviews. Its slim, elegant profile and special "on-camera" finish look exceptional—in an understated way—on camera. The mic's thoroughly rugged and reliable construction

stands out in a world of "disposable" mics.

If your news microphone is old news, audition an M 58 at your authorized Beyer dealer and experience the sound of modern news mic technology. Or contact: **beyerdynamic U.S., 5-05 Burns Avenue, Hicksville, New York 11801, (516) 935-8000, FAX (516) 935-8018.**



ACCURACY IN AUDIO

beyerdynamic 

Canada: ELNOVA Ltd. 4190 Rue Sere, St. Laurent, Quebec H4T 1A6
Tel. (514) 3 41 69 33 Telex 5824086
Great Britain: beyerdynamic, Ltd., Unit 14, Cliffe Industrial Estate
Lewes, Sussex BN86JL Tel. 273 479 411

Australia: Hi-Phon Distributors Pty. Ltd., 356 A-358 Eastern Valley Way
Chatswood N.S.W. 2067 Tel: (02) 417 7088
Germany: Eugen Beyer Elektrotechnische Fabrik GmbH & Co., Theresienstrasse 8,
Postfach 13 20, D-7100 Heilbronn Tel: (07131) 617-0 Telex 728771

Circle (37) on Reply Card

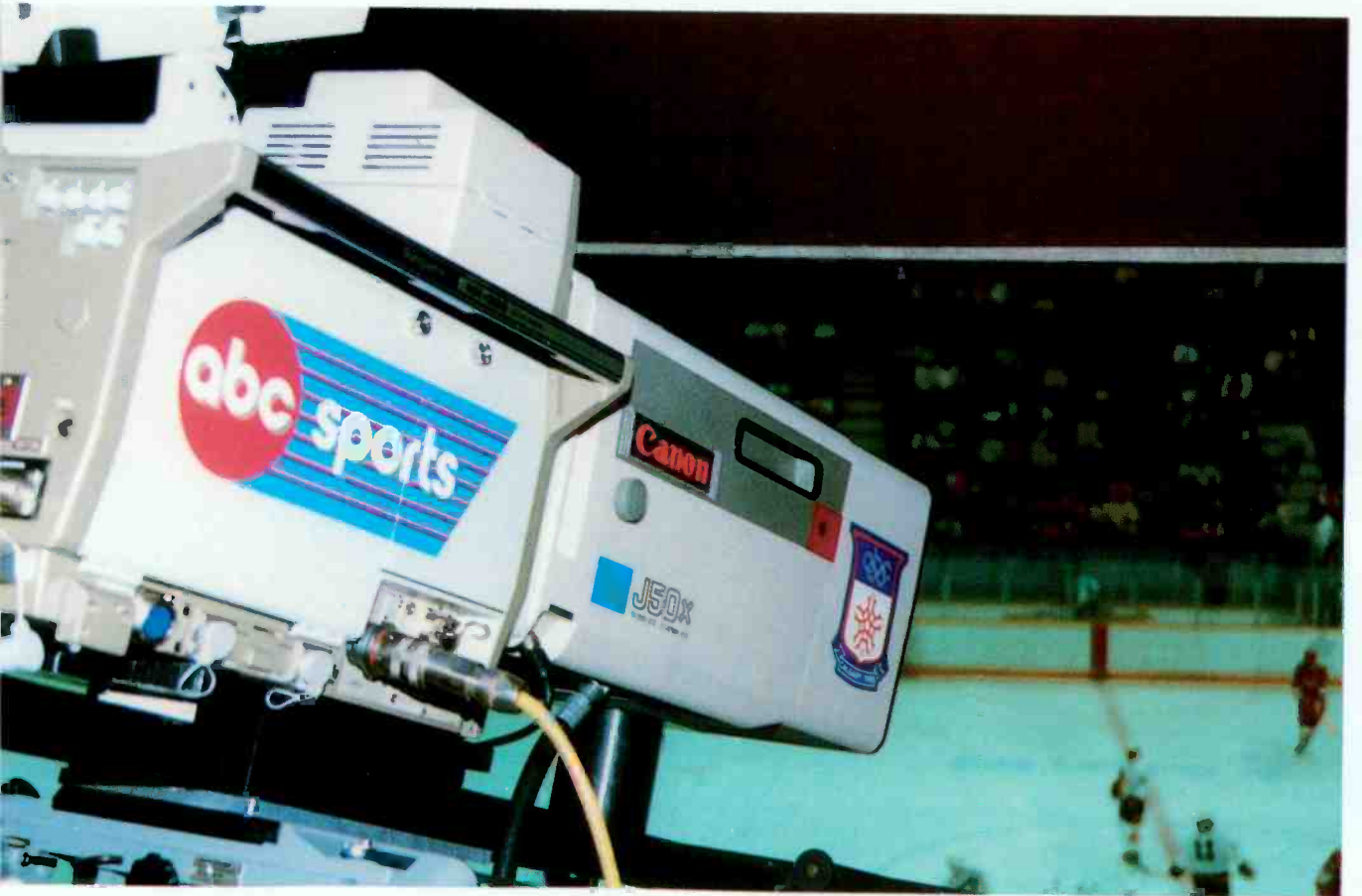
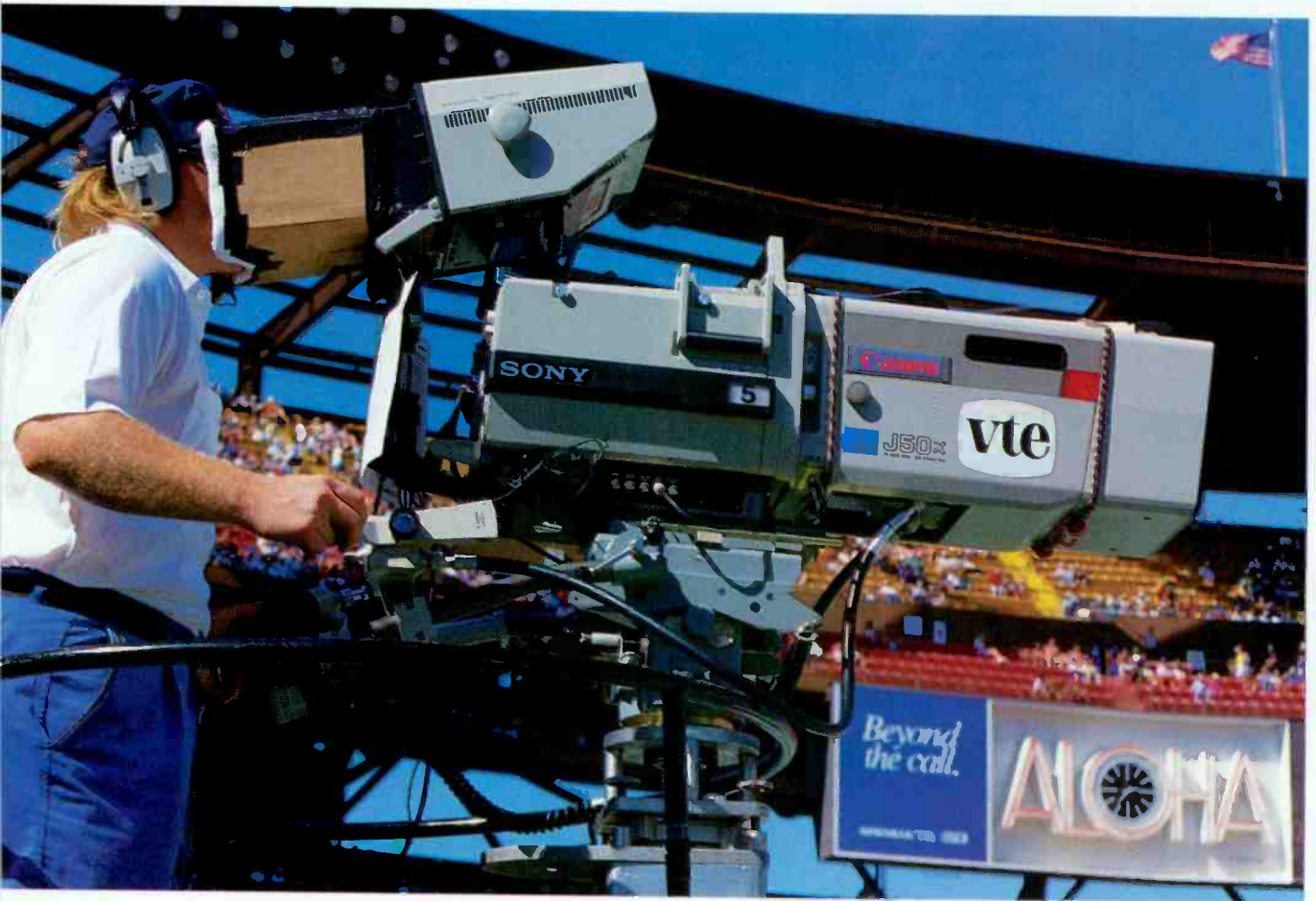



Canon Answers the Needs of the Broadcast Industry Once Again.

Introducing the Canon J50X9.5BIE.

Canon answers the demanding requirements of electronic field production with the sensational new J50X9.5BIE. The perfect lens for outdoor events like the Super Bowl and the Calgary Olympics where the J50X was put into action. Featuring a 50X zoom ratio, f1.4 maximum aperture, and an effective focal length of 9.5 to 950mm, thanks to its built-in 1.5X and 2X extenders. Any way you look at it, the J50X9.5 gives you incredible reach. Yet, it's great indoors too, with a minimum object distance of 7.2 feet and macrofocusing to 20 inches. Plus the usual high M.T.F., minimized distortion and chromatic aberration you've come to expect from Canon broadcast lenses.

An optional rotary shutter provides a choice of

1/1,000th, 1/500th and 1/250th sec. high shutter speeds and will interface with most major manufacturer's cameras.

The J50X9.5BIE is designed for outstanding performance on both 2/3" tube and CCD cameras. And with a weight of just 36 lbs., these credentials are even more impressive. Simply stated, the J50X represents the most advanced design in optical technology available to the broadcast industry today. There is no better lens to meet the tough professional standards of electronic field production. So the next time you need a broadcast lens with the reach of a 50X zoom and unsurpassed optical quality, choose Canon. Because no other lens measures up.

Canon

Canon USA, Inc., New York Office: One Jericho Plaza, Jericho, NY 11753 (516) 933-6300. Dallas Office: 3200 Regent Blvd., Irving, TX 75063 (214) 830-9600
Chicago Office: 100 Park Blvd., Itasca, IL 60143 (312) 250-6200. West Coast Office: 123 Paularino Avenue East, Costa Mesa, CA 92626 (714) 979-6000
Canon Canada, Inc., 6390 Dixie Road, Mississauga, Ontario L5T1P7, Canada (416) 678-2730

Circle (38) on Reply Card

Good Reasons To Call RTS When You Need A High-Performance Amplifier System.

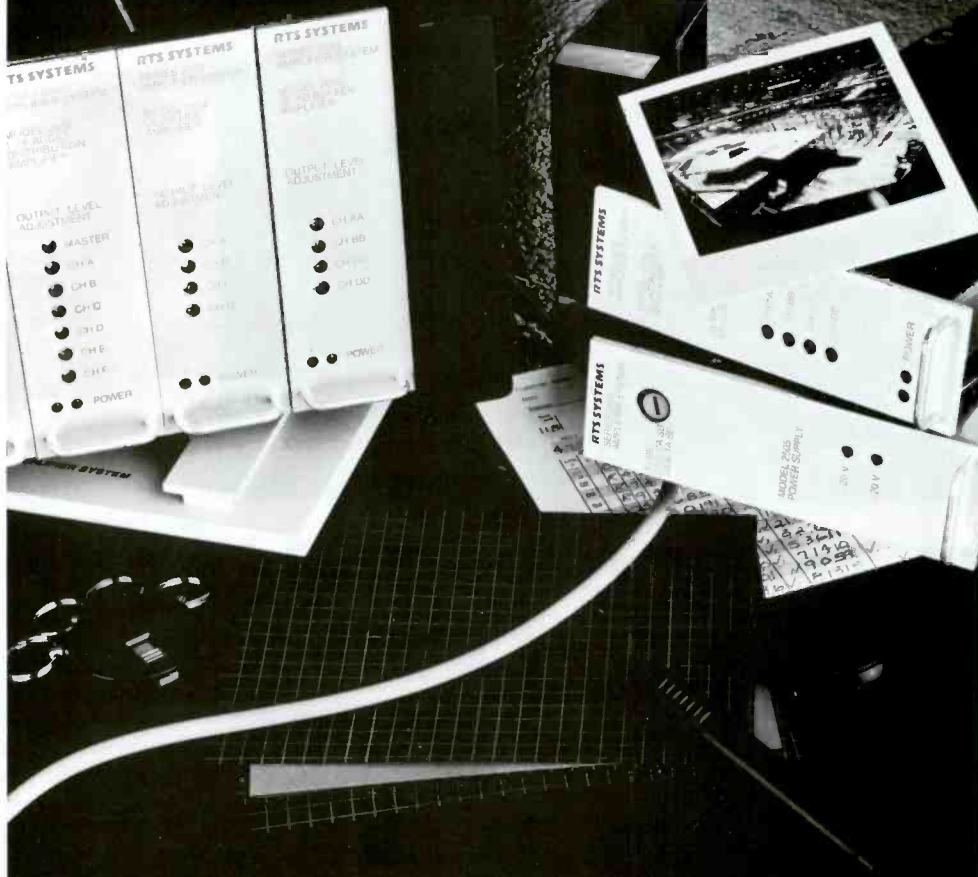

Our Series 2500 Amplifier System affords a broad range of amplifiers with top-rated specifications that sound great! For example, distribution amplifiers, line drivers, buffer amps, VCA circuits, and microphone preamps. Special products include a mix-minus matrix, summing switcher, multiple relays, and more.

We think you'll agree with our sound reasoning. Please call or write for detailed literature.

PROFESSIONAL INTERCOMMUNICATIONS • PROFESSIONAL AUDIO PRODUCTS

RTS SYSTEMS
INCORPORATED

1100 West Chestnut Street • Burbank, California 91506 • Telephone 818 840 7119 • Telex 194855 • Telefax 818 842 4921

Circle (39) on Reply Card

Continued from page 54

system. The Del Rey system includes doubling the current resolution, using a wide aspect ratio, removing NTSC artifacts and going to digital audio. The increased resolution would come from changing the shape of the screen pixels, allowing three times as many pixels to be placed in the same area on the display device.

Several other parameters would be changed with this system. The frame rate would be slowed to 10fps for stationary objects and to the normal 30fps for objects in motion. The pixels would be scanned sequentially, removing the flicker that would be expected from such a slow frame rate. Small bars added to the top and bottom of the picture would contain digital information such as audio and would make the 5:3 aspect ratio compatible with NTSC's 4:3.

The MUSE family of HDTV transmission systems was presented by Taiji Nishizawa, the Japan Broadcasting Corporation (NHK). The NHK HDTV system was tested last year in Washington, DC, using two contiguous UHF channels. Because there is a strong desire in the United States for an NTSC-compatible system using the current channel plan, NHK has proposed a series of plans using the MUSE standard (see Figure 11).

NHK is proposing adoption of the MUSE 1125/60 format for studio use because this standard already is being used in equipment currently on the market. NHK then suggested one of the other MUSE systems as the transmission standard if NTSC compatibility is absolutely necessary.

William E. Glenn presented a signal propagation and interference study for a compatible HDTV transmission system, developed at the New York Institute of Technology. The system, called VISTA, is a 1,125-line format. It operates by passing the HDTV signal through an encoder, which results in an NTSC-compatible signal that the station transmits in the normal manner. An augmentation signal also would be broadcast, conceivably by a UHF station. Consequently, the HDTV receivers would require separate tuners for the two frequencies.

Glenn also said that many of the proposed systems are using analog components with different time bases. He claimed that these differences may result in echo shift in a UHF/VHF broadcast system. Path differences may shift the position of echoes (stretch them out) in the display, resulting in the chroma and luminance having different echo positions on the screen. The VISTA system uses the same time base for all signals, so that if echoes result, they fall close in to the main image, as with the present NTSC signal. The system will be tested within the next year, and propagation studies will be conducted to verify some of the proposals.

LIGHT YEARS AHEAD...



Compare our systems capability... and discover how you can launch a complete, ultimate-quality intercom system providing all the functions you need. Whether you seek the latest in digitally-controlled beltpacks—full-duplex wireless transceivers—high-performance features such as microprocessor-controlled Station ISO—IFB/Program Interrupt—Clear-Com's far-reaching product line gives you more communications power and flexibility than ever before.

To go where no intercom has gone before... in any application where fast, easy, crystal-clear communication is vital:

- broadcast studios ■ mobile teleproduction units ■ post-production facilities ■ industrial/corporate systems ■ convention centers ■ performing arts/sports complexes ■ theatrical productions

As Clear-Com system applications and configurations continue to expand, one fact remains the same. Clear-Com provides complete engineering support, above and beyond all terrestrial expectations.

Explore the Clear-Com system. At a price that's down-to-earth—for performance that's **LIGHT YEARS AHEAD.**

Make contact with your Clear-Com dealer or write/call us for a free brochure.

1117 17th Street, San Francisco, CA 94107, Tel. (415) 861-6666



Clear-Com
Intercom Systems

Circle (40) on Reply Card

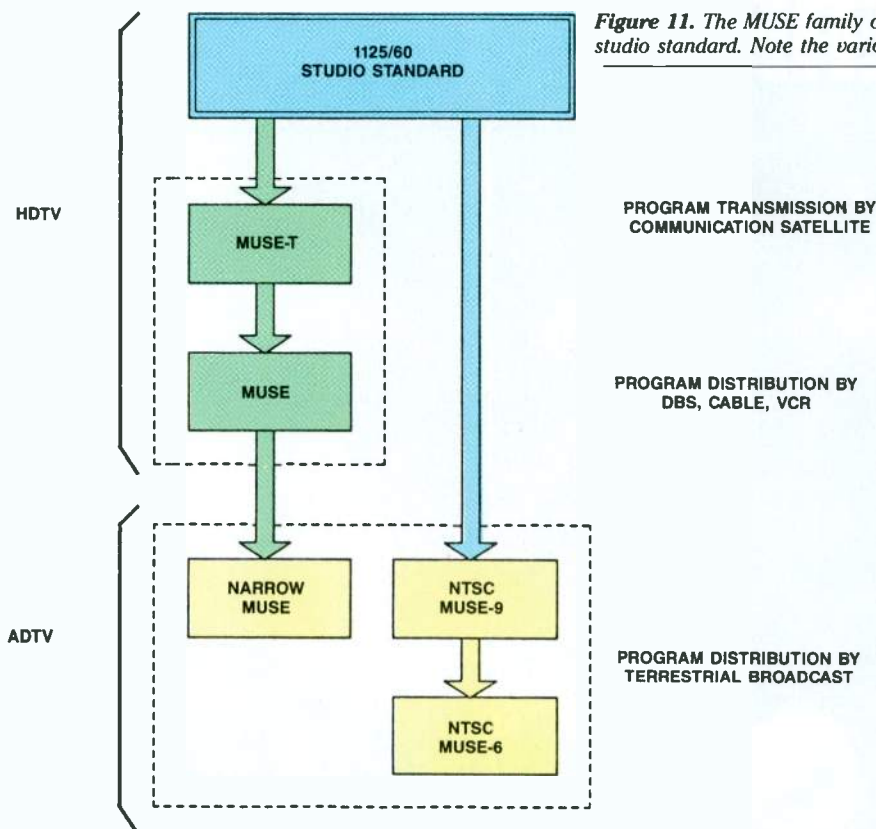

Figure 11. The MUSE family of HDTV systems is based on the 1125/60 HDTV studio standard. Note the various proposed distribution methods.

UHF transmission systems

The common thread running through all the papers in the UHF-TV transmission systems session was improved ac-to-RF efficiency. The improvement can come through more efficient transmitter operation or by placing radiated power where it will do the most good.

Harvey Arnold, University of North Carolina Center for Public Television, presented an informative paper on updating older transmitters with modern technology. Arnold argued that upgrading existing hardware, rather than purchasing a new transmitter, can be effective in some situations. He made seven suggestions for equipment upgrading:

- Replace the high-voltage contactor. Although this may not directly affect efficiency, it can have a significant effect on system reliability.
- Replace the heat exchanger. Water-cooled klystron transmitters will benefit from improved cooling capacity as well as better temperature regulation.
- Replace the filterplexer with a modern notch diplexer. This will reduce insertion

Splatter matters.

Splatter is a form of radio interference that can drive listeners away from AM radio. It creates distortion in your signal, wastes transmitter power on undesired sidebands and interferes with other stations. Even with an NRSC audio filter, misadjustment of the transmitter or audio processing equipment can still produce an RF spectrum that can exceed NRSC or FCC limitations.

That's why routine monitoring of your station's RF spectrum is a must. But it doesn't mean you'll have to bust your budget on a spectrum analyzer. It just means you need the rugged SM-1 AM Splatter Monitor from Delta Electronics.

For just \$2,150 you can now accurately measure your transmitter's spectral output, monitor transmitter IPM levels and make adjustments to improve clarity. An external audio input helps identify splatter sources.

The Splatter Monitor's unique offset feature tunes spectral segments for closer examination 10 kHz to

100 kHz away from the carrier. Unlike a spectrum analyzer, you can listen to the front panel speaker or your own headphones as you measure splatter levels on the front panel meter. The Splatter Monitor also has an alarm output to drive your remote control.

In this day and age where splatter matters, monitoring it doesn't have to cost you a fortune.

To find out more about the new Delta Splatter Monitor, call (703) 354-3350, or write Delta Electronics, Inc., 5730 General Washington Drive, P.O. Box 11268, Alexandria, VA 22312.

The Above Standard
Industry Standard.

DELTA ELECTRONICS



©1988 Delta Electronics, Inc.

Circle (41) on Reply Card

Here is the World's Only Universal TV Signal Analyzer With:

- **High Speed** — 40 parameters in only 3 sec. — nothing else comes close.
- **High Precision** — Accurate and repeatable 0.01 resolution.
- **Multi Waveforms** — VITS, full field and selective field measurements for all applications.
- **Signal Subtraction** — Local and remote subtraction of input errors.

PLUS...

- **10 Video Inputs Standard** — Expandable to 64.
- **Limits Comparison** — Urgent, caution and acceptance limits for all parameters.
- **Remote Control** — GPIB and RS232-C as standard.
- **Hard Copy** — Screen dump or user definable printouts.
- **Search and Recognition Mode** — Allows VITS to be found and measured.
- **Multi Standard** — One instrument measures 525 and 625.

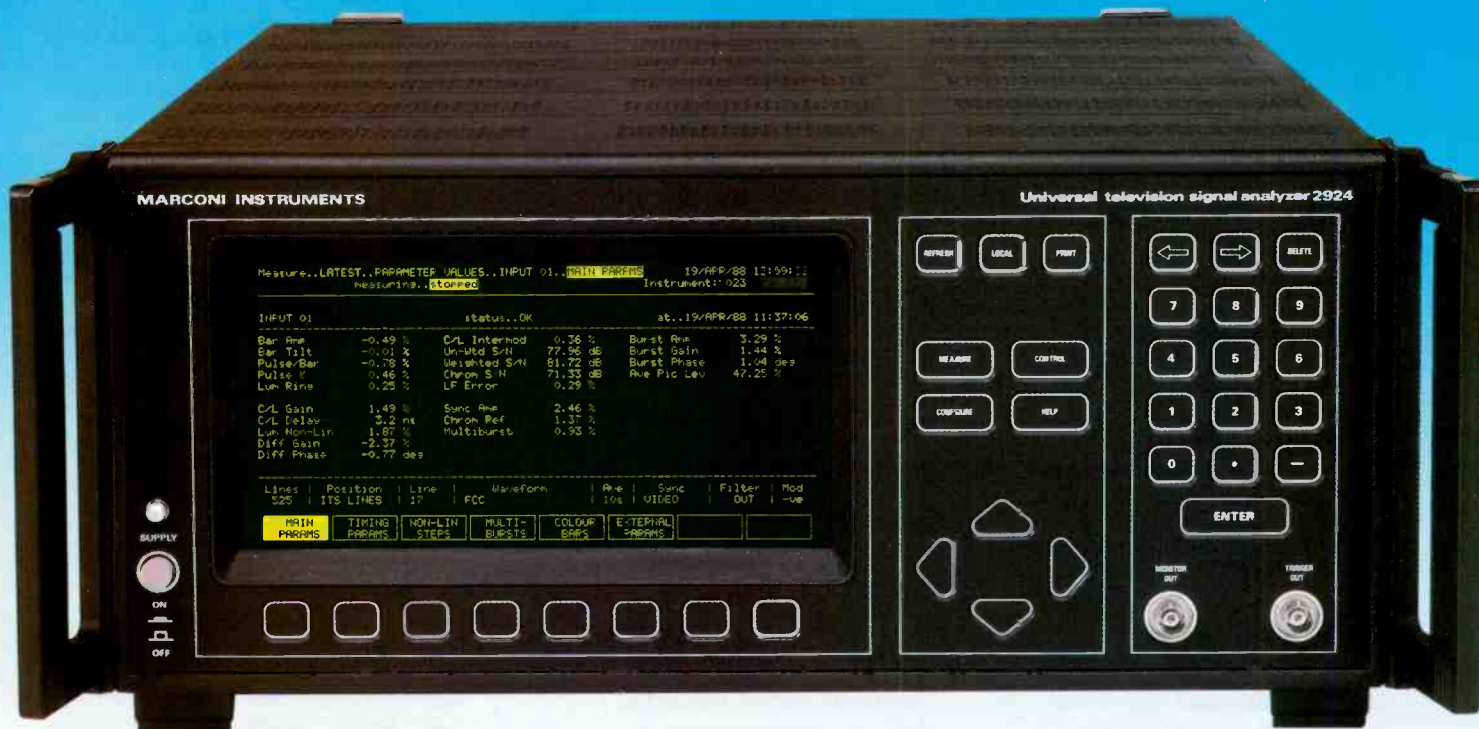

This one instrument, Model 2924, satisfies all video assessment applications... for users and manufacturers of studio, links, transmitters, satellites, switches, cable TV...

For detailed literature...or a Demo...

**CALL TOLL FREE
1-800-233-2955**

Marconi
Instruments

3 Pearl Court, Allendale, New Jersey 07401
(201) 934-9050 • (800) 233-2955
FAX: (201) 934-9229 • TWX: 710-991-9752

Circle (42) on Reply Card

- loss allowing easier power upgrade and conversion to MTS stereo.
- Replace the exciter and IPA. A new exciter sets the stage for other upgrades such as stereo or pulser operation. Additionally, a new exciter allows wider video precorrection, multiplex capability and the elimination of high-power vestigial sideband filters.
- Install a pulser. Although difficult, this can be one of the most cost-beneficial of all upgrades. The savings in decreased power bills may quickly pay for this change.

- Replace the beam supply. Today's supplies are rugged, reliable and do not contain PCBs. Mounting such a supply outside the building also can reduce air-conditioning load.
- Replace the antenna. Antenna replacement can improve and tailor power distribution to provide a better signal over desired population areas. A new antenna may provide additional effective radiated power and greater reliability and eliminate the need for de-icers. The total cost for these improvements, including the antenna, can total approxi-

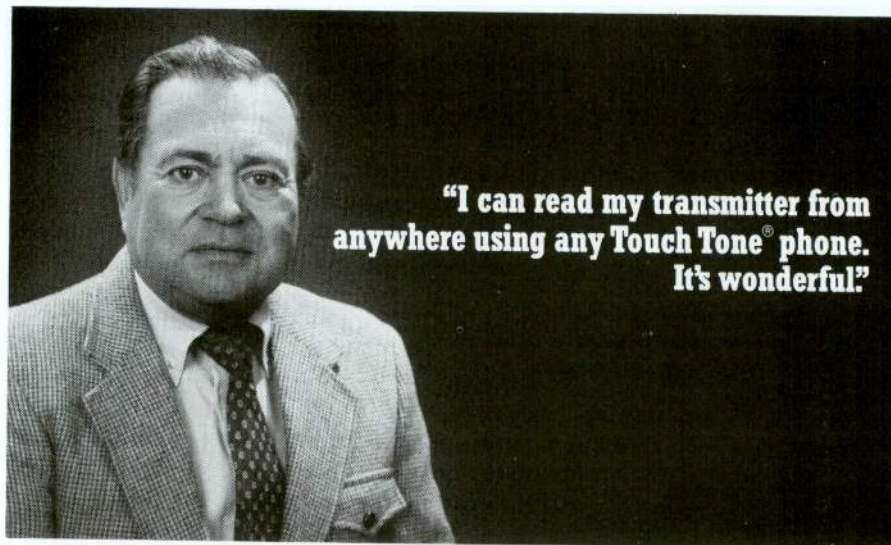

Ben Enochs - WDXL Lexington, Tennessee

"With Gentner's VRC-1000, I'm troubleshooting AM/FM, plus EBS, from my house, from the studio, from almost anywhere. Our transmitters get read at least a dozen times a night, it's the most control I've had keeping up the transmitter since 1954.

Now my transmitter can alert me to problems by phone, anywhere, any time. The preprogrammed synthesized voice gives me the parameters, I make the adjustments. All at the touch of a button.

And, I don't have to think like a microprocessor to work with the VRC-1000. Nothing could be simpler or more dependable.

**Gentner's VRC-1000
Will Put You
in Total Control.**

Stop baby-sitting your transmitter. For complete product information or specifications on the VRC-1000 Remote Control, I recommend you give Gentner a call today."

GENTNER
RF PRODUCTS DIVISION

PO Box 32550, San Jose, CA 95152 • (408) 926-3400 • FAX (408) 926-6699

© 1988 - Gentner Electronics Corporation

Circle (43) on Reply Card

26 Broadcast Engineering June 1988

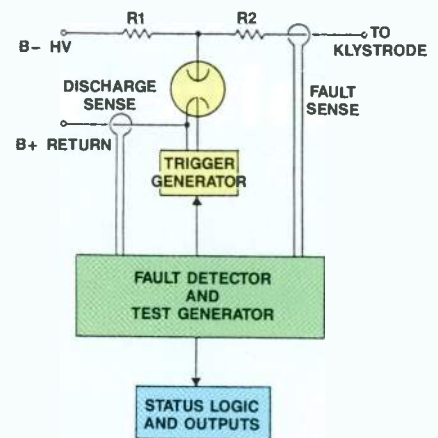

Figure 12. Block diagram of a Klystrode grid-protection circuit, which can trip at 50A in less than 10 μ s and handle a peak current of 3,000A.

mately \$425,000, which may be less than a new 60kW transmitter. One drawback to these upgrades is that your engineering department will have to spend many hours planning and executing the changes.

Klystrons, Klystrodes and transistors

The final report on the multistage depressed-collector klystron (MSDC), by Earl McCune and Glen Huffman, Varian Associates, covered the project started by Varian in 1984. The MSDC project was initiated jointly by funding from NASA, NAB and PBS in an effort to increase the operating efficiency of klystrons.

The tube, now designated VKP-7555S, was tested at 60kW peak sync power at 850MHz. Tube construction is essentially identical to that of any other klystron, with the exception of the collector assembly. On the MSDC tube, the collector is comprised of four stages and shaped to distribute current as RF drive levels change. The tube has 40dB of gain, an 8MHz bandwidth and a 1.316 figure of merit. Test results are termed as "encouraging" and compare closely with predicted values.

Klystrode

Merrald Shrader, Varian Eimac division, presented a paper updating the latest in Klystrode technology. In 1985, Klystrodes could produce 30kW at 72% efficiency. Currently, Varian is producing a 60kW Klystrode operating at Class B with 80% efficiency. The tube's double-tuned output cavities are used to obtain the required bandwidth, and the antenna is coupled into the second cavity.

The tube demonstrated its ruggedness during developmental testing when the system load opened up. The tube continued to operate with no damage, according to Shrader. Although the operating situation is not recommended, the test indicates the Klystrode's capability to withstand unusual conditions.

Introducing The most innovative pair of STLs on the market.



- **Frequency Agile**
- **Excellent Selectivity**
- **Switchable Monaural/Composite Operation**
- **Comprehensive Metering**
- **Built-in Receiver Transfer Circuitry**

The PCL 6020 and 6030 Studio-Transmitter Links blend technology and innovative design to provide a reliable, high-performance alternative to leased telephone lines.

The PCL 6000 Series STLs feature transparent audio, excellent selectivity, built-in receiver transfer circuitry, extensive front-panel metering, and frequency agility.

Now, you can select monaural or composite operation from a single system in the field. Receiver IF bandwidth can be set in the field or in the factory for 100 to 500 kHz channel spacing.

PCL 6010 Transmitter

The 6010 Transmitter is common to the 6020 and 6030 systems, and uses direct modulation techniques. FM frequency modulation is converted to final output through an up converter mixer. For long STL paths, a 15-watt transmitter power output is available as an option.

PCL 6020 System

The dual conversion PCL 6020 Receiver uses an FM quadrature detector to provide maximum fidelity. Use the PCL 6020 to replace an older STL, such as the PCL-505 for a 10 dB improvement in SNR and stereo separation.

PCL 6030 System

The PCL 6030 system offers the highest performance in hostile RF environments. The triple conversion PCL 6030 Receiver uses a digital pulse counting discriminator to provide the transparent audio necessary with aggressive processing techniques.

Call Moseley Marketing for more information, and for all your STL needs.

Moseley

111 Castilian Drive
Santa Barbara, CA 93117
805 968 9621
FAX: 805 685 9638

The design of even more powerful Klystrodes has been spurred on by space defense research. Varian is proposing a superpower Klystrode capable of 50kW average power and peak power of 500kW. In the next phase of the project, a tube will be developed with an average power of 500kW and peak power in the megawatt range.

Klystrode transmitter

Nat Ostroff presented a paper on Comark's new line of Klystrode transmitters. The principle design advantages are simplicity and efficiency. A Klystrode design has an inherent need for more drive, about 600W for 60kW operation. But operation in Class B results in a total plant power consumption of 83kW for 60kW RF output. This figure compares with 140kW total plant input for the same 60kW RF out with some other designs.

The transmitter has some unique power-

supply requirements, including a sophisticated crowbar circuit that will shut down a 50A trip in 10 μ s (see Figure 12).

Solid-state UHF transmitters

Solid-state power amplifiers have reached the UHF broadcaster. Joe Engle, NEC, discussed the American debut of a solid-state UHF-TV transmitter. Each power-amplifier module develops 800W of RF and, like Klystrodes, draws power only while being modulated. The transmitter provides redundant operation with two 800W RF modules, each of which are powered by a separate power supply. Any module can be removed while the transmitter is on the air, allowing for on-the-air replacement.

The highest power-supply voltage is 28V; consequently, other than ac supply-line voltage, no high voltage is present within the transmitter. Because there are no filaments to warm up, the transmitter

is an effective instant-on device. Total transmitter efficiency is 88%.

The offerings at this year's NAB engineering conference were bountiful. In fact, there were far more sessions than you could ever hope to attend.

The 566-page "Proceedings," available from the NAB, contains many of the papers presented at the convention, as well as many of the visuals used with them. So, if you were unable to attend all the sessions that interested you, or if you simply couldn't make it to NAB this year, the "Proceedings" will be a good reference guide.

Bibliography

"1988 Broadcast Engineering Conference Proceedings," NAB, Washington, DC.

Acknowledgment: The following people contributed information for this report: John Battison, Battison & Associates, Columbus, OH; Karl Renwanz, WNEV-TV, Boston; Douglas W. Fearn, D.W. Fearn & Associates, West Chester, PA; Gary Krohe, KTKA-TV, Topeka, KS; Marvin Born, KRIS-TV, Corpus Christi, TX; Mike Berry, Dallas-Post Productions, Dallas.

Fiber-optics update

By Rick Lehtinen, TV technical editor

Fiber optics was the topic of two speeches at this year's NAB convention. Richard O. Claus, of the Fiber and Electro-Optics Research Center of Virginia Tech, Blacksburg, VA, spoke on "The How and Why of Fiber Transmission Systems." Robert Blackburn, of Bell Communications Research, Morristown, NJ, reported on the use of fiber as a means for telcos to transmit customer signals.

Light propagation in optical fibers

Claus described an optical fiber as a series of concentric, cylindrical layers of dielectric material (glass or plastic), about the thickness of a human hair. The fiber is covered with buffers and jacketing to make it durable, and several fibers may be bundled together with strain-relieving material to form a cable.

Light rays travel down the core of an optical fiber in about the same way a bullet would travel down a long pipe. It would bounce from side to side, and a number of different trajectories would be possible. It could go straight down the middle, ricochet from side to side, or maybe even corkscrew. The same is true of light traveling by way of fiber.

A path with few bounces most quickly gets the light to where it's going; a heavily reflected ray will lag. This is one cause of distortion in fibers. Also, current optical emitters have broad spectrum outputs, and light of different frequencies travels down the pipe in various trajectories, causing similar distortion problems. Consequently, there is a practical limit to how long a fiber can carry a signal before retransmission is necessary. Although the distortion in

optical fiber is minimal compared with that in copper conductors, it is, nonetheless, a factor in system design.

In spite of this, fiber has fantastic potential applications in broadcasting. An optical-fiber communication system can be thought of as a radio system with a carrier frequency of 100THz (100,000GHz), about a million times the frequency of current TV transmitters. Theoretically, this means a potential for about a million times the modulation bandwidth of current television. Today's fiber systems have about 1,000 times the bandwidth of copper systems. Although this is more bandwidth than is needed at present, the fibers have the facility to accommodate future systems expansion.

Fibers are made of dielectric materials. This means they don't conduct, they don't radiate and they don't crosstalk. They also don't pick up hum currents from stray electromagnetic fields, as copper can, which makes them immune to EMI, RFI and EMP, or electromagnetic pulse from nuclear explosions. (Fiber is affected by radiation, however, through the radiation's effects on impurities in the glass. When the radiation is removed, the fiber returns to near normal.) Because a fiber transmission system resembles a long opto-isolator, there are no ground loops. And no voltage flows, so fibers can't make sparks, which makes them safe in most environments.

Fibers are small and lightweight, saving conduit space and loading. They can conserve radio spectrum in point-to-point applications, and, because they are difficult to tap, they are secure. Finally, the cost of fiber-optic equipment and cable has declined dramatically over the

past decade. There may be a higher front-end cost, but long-term cost/performance trade-offs also should be considered.

Fiber also can be used for remote illumination and sensing. With proper coupling, external stimuli can affect the way fiber transmits light, changing its intensity, phase and polarization. This means that a broadcaster could use fiber optics to monitor electric current and temperature and to detect fire or intruders.

Networks of tomorrow

According to Blackburn, customer-controllable terrestrial 45Mb/s (DS3) distribution networks using optical fibers or microwaves may be available in the future. Such networks could serve as an alternate or supplement to existing satellite distribution systems.

Video-rate coders, necessary for conversion of video signals into the digital format of DS3, are available and have been used in broadcast applications. Unfortunately, standards allowing interchange between coders of different manufacturers have yet to be developed, hindering large-scale use of the systems.

Nevertheless, designers envision the development of terrestrial networks having the same autonomous control (ability to switch and reconfigure the network at will) that broadcasters have become accustomed to with satellites. Satellites would back up this network, and vice versa. Five TV networks, four interexchange carriers (long-distance carriers) and 12 equipment suppliers are slated to participate in an 8-city test of this type of distribution network next year.

HERE'S YOUR JVC TELEVISION SYSTEMS DIVISION PRODUCT DIGEST...

If someone already
beat you to it, circle the
Reader Service number
below...or call:

1-800-JVC-5825 ext. 101

JVC[®]

**ALWAYS A STEP AHEAD...
TO KEEP YOU A STEP AHEAD.**



JVC[®]

Television Systems Division

WHAT ONE COMPANY

- Developed **VHS**
- Developed **SVHS**
- Co-developed 3/4" **U**
- Continues to develop new products for **MII**
- Continues to develop products for multi-format integration
- Continues to service and support all four VCR formats...

ONLY ONE COMPANY...

JVC[®]

**ALWAYS A STEP AHEAD...
TO KEEP YOU A STEP AHEAD.**

For literature or product demonstrations
call TOLL FREE 1-800-JVC-5825
or write JVC PROFESSIONAL PRODUCTS COMPANY
41 Slater Drive, Elmwood Park, New Jersey 07407



Electromagnetic radiation update

By Brad Dick, technical editor

Environmental concerns continue to haunt broadcasters. As evidence were the sessions dealing with PCBs and RF radiation problems, where attendees learned of recent attempts to deal with both issues. On a day-to-day basis, the FCC RF exposure guidelines seem to create the most problems.

Many broadcast engineers find it difficult to perform their work while conforming to the commission's regulations on RF exposure. This is especially true at powerful AM stations. At least one company is working on the problem by developing remote antenna meters. As outlined in the session, the problems associated with reading AM base currents from remote locations are not solved easily.

Another difficulty centers on the high-RF fields generated in antenna tuning units (ATUs), which occasionally must be adjusted or repaired. Unfortunately, engineers are notorious for working on these devices with RF applied. Richard Tell, Richard Tell Associates, presented evidence from his research showing the intense magnetic fields that are possible, especially around the coils in high-power AM installations. By the time Tell finished, at least some of the attendees may have decided to mend their ways.

The key to operator safety lies in conforming to the regulations with respect to RF exposure. In an effort to protect both the public and station operators, the commission released an ominous-sounding document entitled "Evaluating Compliance With FCC-Specified Guidelines for Human Exposure to Radio-Frequency Radiation," otherwise known as OST 65. Although the bulletin is "not designed to establish mandatory procedures," you can bet your station had better meet the guidelines if you want to stay in business.

ANSI protection guidelines

The guidelines are based on the radiation protection recommendations issued by the American National Standards Institute (ANSI) in 1982, titled C96.1-1982, "American National Standard Safety Levels With Respect to Human Exposure

to Radio-Frequency Electromagnetic Fields, 300kHz to 100GHz." Effective Jan. 1, 1986, all broadcast stations were required to meet the exposure levels specified in these guidelines.

However, because the guidelines are complex, the commission developed tables, figures, equations and other helpful information for stations to use in determining compliance, and this data was issued in OST 65. This bulletin is the key to finding out whether you meet the requirements.

So what?

Broadcasters are required to certify that their facilities meet the exposure in two general forms: license renewal and construction permit applications. If the application or renewal form asks the question: "Is commission grant of this application a major action under Section 1.1305 of the FCC rules?" then you have to determine your station's compliance. You want to be able to answer this question with a "no." Otherwise, you must attach a narrative describing the facility. The commission would weigh the information, and perhaps call for an environmental impact statement, which might require modification of the proposed or existing facilities.

Fortunately, most stations will be able to truthfully answer no to the question. However, before you can, you must assess the current RF exposure levels around your transmitter and tower site. This is where a copy of OST 65 is required.

Determining compliance

Three determination methods, ranging from simple to complex, are described in the bulletin. The easiest compliance-determination method relies on printed tables and figures. Many broadcasters will be able to determine that their facility is in compliance simply by using these tables and figures. A table of worst-case situations was developed by the NAB and can be used as a guideline (see Table 1). However, do not use the table in determining actual compliance for your station. Instead, use the

data and methods contained in OST 65.

If the bulletin's tables and figures do not indicate that your station is in compliance, try to determine compliance through the calculation methods listed.

The last determination method relies on RF measurements. The procedures are complex and probably should not be undertaken by stations without outside expertise. Community antenna, multi-antenna or other complex RF situations also are likely to require measurements. Again, the decision to make these measurements should not be taken lightly. The measurement procedures are complex, and specialized equipment is needed. You'll be glad you obtained specialized expertise if your measurement data is challenged later.

Operator safety

Although it is often easy to bring a transmitter site into compliance as far as the public is concerned, through fencing or other restrictive tactics, maintaining a safe RF environment for your staff may be more difficult. Maintenance personnel often must work close to high-RF potentials. A change in work habits may be required if maintenance or adjustments make it necessary for an employee to be near high-power transmitters, ATUs and antennas.

Train your operators to follow safe practices when working near high-power RF components. Don't be shy about telling the station manager that the station needs to leave the air for maintenance or that power must be reduced while adjustments are made.

Finally, do not allow contractors to work in or near your facility without providing them adequate protection. For example, many stations no longer will be able to maintain normal operations during tower lamp replacement. In a case such as this, either switch to another antenna, reduce power or leave the air when workers are near excessive RF levels. In today's litigation-minded society, you don't want to be responsible for someone being hurt because the transmitter power was not reduced sufficiently while they went about their jobs.

AM STATIONS

ANSI LIMIT = 100mW/cm²

ERP	DISTANCE (FT)
1kW	10
5kW	17
10kW	23
25kW	30
50kW	40

TV STATIONS

ANSI LIMITS:

VHF = 1mW/cm²

CH. 14 = 1.58mW/cm²

CH. 69 = 2.68mW/cm²

ERP	DISTANCE (FT)	ERP	DISTANCE (FT)
VHF 100kW	150	VHF 316kW	266
UHF 1,000kW	378	CH. 14 292	CH. 69 25kW
2,000kW	532	414	50kW
5,000kW	840	653	100kW

FM STATIONS WITH CIRCULAR POLARIZATION

ANSI LIMIT = 1mW/m²

ERP	DISTANCE (FT)
1kW	28
3kW	46
10kW	78
25kW	129
50kW	187
100kW	269

Table 1. The values shown represent "worst-case" examples in terms of power output and distance from the antenna. Complete details are available in FCC bulletin OST 65.

**Wouldn't it be great
if somebody built a
fully integrated
station automation
system that could
handle all on-air
operations, with
off-the-shelf hardware,
and backed by a
ten-year warranty?**

Somebody does.

The SAS-2 from Utah Scientific—part of a growing line of integrated automation systems. Machine control, cart control, business service interface, off-line recording—complete systems from a single source. And all backed by the industry's only ten-year warranty.

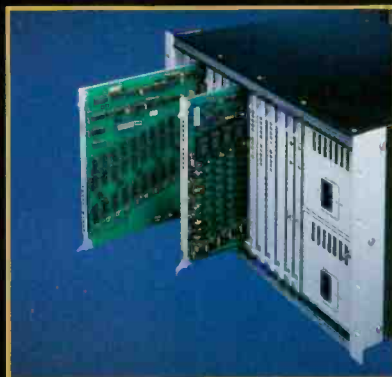
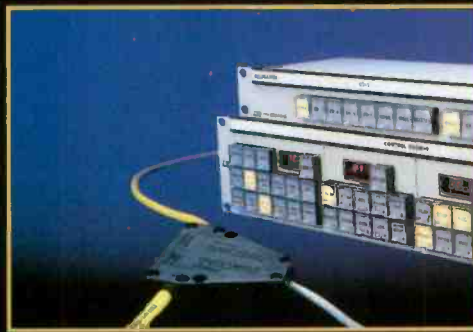
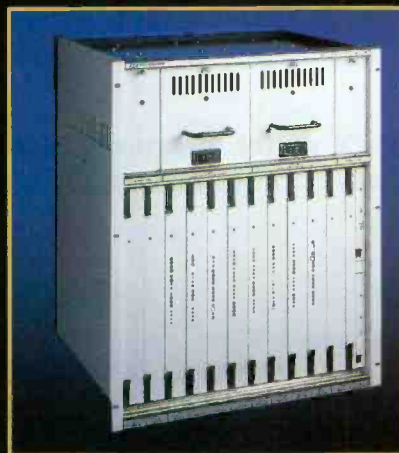

US UTAH
SCIENTIFIC
DYNATECH Broadcast Group

1685 West 2200 South, Salt Lake City, Utah 84119
(801) 973-6840 • Call Toll Free (800) 453-8782 • TLX: 269-916 • FAX: (801) 973-0255

Circle (45) on Reply Card

Pick hits of the '88 NAB



BE's panel of independent experts shares its favorite new products from NAB '88.

By Brad Dick, radio technical editor,
and Rick Lehtinen, TV technical editor

W elcome back to Las Vegas!

With the NAB banner planted firmly in the Vegas venue (for two years, at least), the granddame of broadcast equipment shows opened to record crowds. And to the delight of vendors, this year's crowds were in a buying mood. It was a "really big show" for the exhibitors and the attendees.

Of course, BE was there. Our 32 associates combed each booth and attended dozens of press conferences, briefings, booth tours, demonstrations and hospitality suites, gathering far more data than could ever fit into this issue. We knew that much of what we learned would have to wait for later publication, because to print it all would fill several volumes.

To make sure that the information that did see print was most in line with the needs of today's broadcasters, we organized the fourth annual BE "Pick Hits" panel, 10 independent experts who agreed to take some time out of their NAB schedules to tell us what products they found new and interesting. They set out to select 10 radio and 10 TV products.

As always, the judges looked for products that are new, that have been designed to offer unique solutions to everyday broadcast problems, and that do the job at a fair price to the end-user. Obviously, not every new offering could be included on the pick hits list, so be sure to see "Show of Shows," page 80D, for descriptions of all the new products we could find at the show.

TV pick hits



•Ampex Corporation: ACE-25 editor

The ACE-25 is a unified, integrated, computer-based editor, designed for the newsroom, off-line suite or the small post-

production facility. The system controls up to four VTRs (three source, one record) and three GPIs. A modular product, the editor's standard chassis provides slots for an optional internal 6-input composite or component switcher and a 6-input audio mixer with equalization. Two RS-422 ports allow interface to external switchers (such as the Ampex Vista and Penguin and Grass Valley Group's GVG-100).

The unit has a 1,000-line SMPTE EDL and can perform cuts, wipes, dissolves and keys in either audio-follow-video or split audio and video modes. A key feature is the multifunction rotary knob, which con-

The rules

BE's panel of judges followed these basic guidelines to select products as pick hits:

1. **They must be new products,** not shown at a previous NAB. In cases in which it was difficult to distinguish a "new" product from a modified old product, they considered a new product to be one with a new model number or designation.

2. **They must have some positive impact on the everyday work of the user.** The judges searched for equipment that would be used on a regular basis at a station. They looked for equipment that provided a new solution to a common problem.

3. **They must offer a substantial improvement in current technology.** Although the equipment didn't have to feature unique circuit architecture, the panel was alert for some new ideas on applying current technology.

4. **The product's price must be within reach of the intended users.** The judges sought products marketed to a wide spectrum of broadcasters.

5. **The products must be available for purchase.** Equipment must have been displayed on the convention floor, be in production (or nearly so), and have delivery dates scheduled for within the year. Products demonstrated in private showings did not qualify.

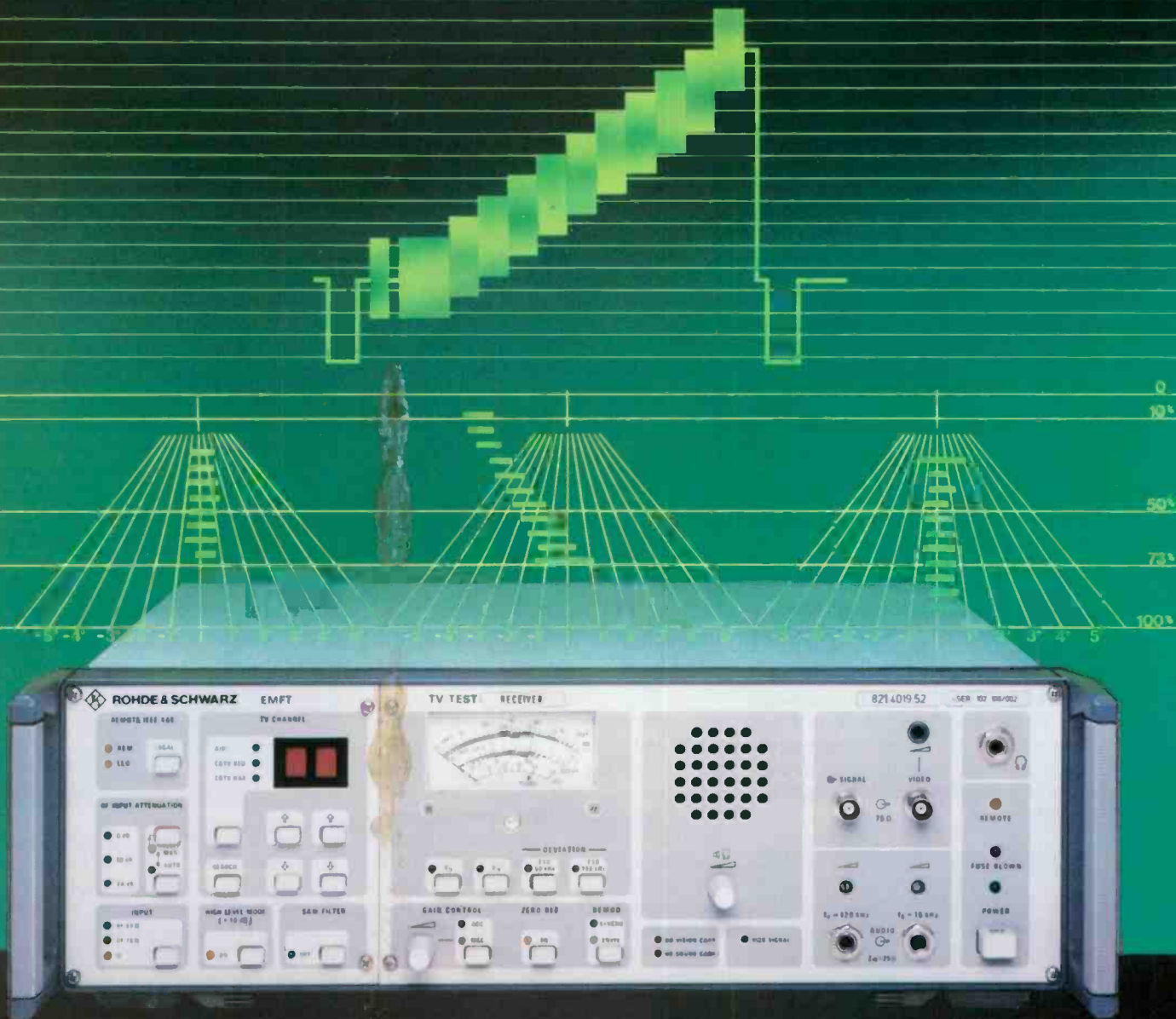

A SUPERIOR TV DEMODULATOR NEEDN'T COST AN ARM AND A LEG!

At Rohde & Schwarz we've been selling high performance TV demodulators for years . . . and saving our customers thousands of dollars over competitive units. Our latest EMF series features envelope and synchronous detection. There's a Q signal output for ICPM measurements and an internal zero reference pulse for accurate modulation measurements.

The EMF series also provides a wide-band (120 kHz) aural output.

Three feature-packed models to choose from:

Model EMFT. Synthesized all-channel receiver including CATV to 550 MHz. (Frequency is selected by channel number ± 100 kHz AFC). Switchable SAW filter for adjacent channel requirements.

Model EMFK. Single channel crystal-controlled receiver with a sensitive and selective front end for off air reception.

Model EMFD. The precision TV demodulator for every transmitter site.

Check with us to arrange for a demonstration . . . and keep your arm and leg!



If you are willing to pass up Q-signal outputs, the EKF2 series offers synchronous demodulation and optional wide-band aural output at 1/3 less cost.



ROHDE & SCHWARZ

4425 Nicole Drive, Lanham, MD 20706
Telephone (301) 459-8800

Outside USA contact:
Rohde & Schwarz Headquarters;
D-8000 München 80, Muhlendorfstr. 15,
Fed. Rep. of Germany
Tel.: (089) 41 29-0

trols all audio input levels, output levels, monitor levels and equalization parameters. For the internal video switcher, the knob sets fader position, video mix levels and key clip levels. It controls basic transport functions and also scrolls the EDL.

The ACE-25 is available in NTSC, PAL and PAL-M versions.

•**Ampex Corporation: VPR-300 D-2 videotape recorder**

(Shared award with Sony DVR-10 D-2 VTR)

The judges were taken with the arrival of D-2 machinery. Two offerings in particular caught their eyes. As a result, the Ampex VPR-300 and the Sony DVR-10 (see page 74) share honors as one of the pick hits of the show.

The VPR-300 is a high-performance D-2 (digital composite) format VTR. Patterned after the performance characteristics of a VPR-3 with Zeus, the VPR-300 delivers all the performance features that users of 1-inch have become accustomed to, plus some. It can shuttle forward and backward at up to 60 times play speed, in color. Because it is digital, the recorder can provide 20 transparent generations of dubbing and redubbing, which is important in editing.



The VTR accommodates all three cassette sizes supported by the D-2 format. Using the largest cassette, the machine could record for nearly three and a half hours. The VPR-300 is gentle with tape as well, employing air guides and a pinchrollerless capstan. It also comes with an exceptional diagnostic package.

Perhaps the biggest plus is that it is compatible with the existing wiring in most broadcast facilities. A roll-out/roll-in replacement for any component system, the recorder is available in NTSC and PAL.

•**BTS: LDK-900 studio CCD camera**

The BTS LDK-900 is a compact studio and field-production camera with high-resolution frame transfer CCD sensors. The camera uses a CCD/shutter combina-



tion, with picture elements of 610x492 in NTSC and 604x576 in PAL. Sensitivity is 1,750lx at f/5.4, S/N 58dB (NTSC) at normal gain.

The camera may operate self-contained or with full RGB triax remote control capable of up to 2,000-meter cable runs. For use in stand-alone modes without a CCU, a small, optional local control panel allows painting by the camera's side. The LDK-900 consumes little power—170W, including a 70VA utility power outlet. It weighs less than 40 pounds. The unit is wrapped in a unique circular carrying handle. Other features include 7-inch viewfinder, microprocessor control, electronic exposure control, teleprompter channel, program-quality audio channel and intercom.

•**Eventide: BD-1000 video/audio delay unit**

The Eventide BD-1000 digital video delay was cited for its ease of use. Similar to the companion audio delays that have protected call-in radio shows for years, the video delay now makes it possible to delay video out of a control room for one to 20



seconds. If someone says a "no-no," the producer can hit a dump button, and the program will return to real time. The BD-1000 will gradually remake the delay, invisibly "catching up" and automatically re-establishing the delay protection, without having to interrupt the program. The unit is RAM-based, and there are no moving recorder parts.

•**Innovision: endoscopic lenses**

The novel Innovision lenses will most likely find application in documentary work and other uses requiring hard-to-get shots (such as photographing the inside of a beehive). These lenses consist of a series of glass optic relays that run down the center of a stainless steel tube. Outside the optics, but still inside the tube, are bundles of fiber optics that shine out of the front



of the lens to illuminate the subject. Light from the 250W, 5,600°K illumination source is fed to the fiber optics at the camera end from a special saline-filled "Liquid Light" flexible cable. The lens couples to the camera body with an adapter that includes the focus ring. The lenses have an angle of view of approximately 60° and various angles of view depending on the lens choice. Most can rotate 350° around the long axis without having to move the camera.

•**Larcan: solid-state TV transmitter**

The Larcan solid-state VHF-TV transmitter, dubbed the "M" series, is modular;



adding more power is a matter of dropping in more cards. The highest voltage used (other than the PC power) is 55V, so all the problems and dangers associated with vacuum-tube power supplies are

Continued on page 74

Your next news story could be on any satellite, in any format.

With MAT, you'll have it in seconds.

MAT gives you unprecedented access to any satellite, at any time. So if you want to monitor an uplink from anywhere in the country, you can do it.

With MAT, once your system has been pre-programmed, all you do is punch in your chosen name for the feed—MAT takes care of the rest: antenna position, frequency, polarity, C- or Ku-band, full/half transponder, and other parameters. So whether it's a feed you receive regularly, or a new one you need to pick up with just a few minutes notice, MAT saves you valuable time.

You can schedule MAT in advance to automatically recall pre-named set-ups, including contact closures that activate ancillary equipment.

MAT can also be located away from your station to avoid C-band interference, and controlled remotely through a computer dumb terminal via phone line or STL link.

Meets tough broadcast specs.

MAT was designed for use in the professional broadcast environment, so it meets or exceeds all RS 250B specs. And in addition to a normal

video output, MAT provides an AGC'd output that maintains a constant level, regardless of source deviation.

There are a number of options with MAT, including terrestrial interference traps that can be programmed for use on just those channels that demand it, and your choice of a 3.66, 5, or 7 meter antenna, with either a motor-driven el/az or polar mount. And as always, we'll be happy to work with you to meet any special requirement you may have.

Turn-keyed by Microdyne.

Each MAT system is installed, calibrated, and serviced by Microdyne, so you're assured of a dependable

system that will deliver the reliability and performance we're known for, backed by one of the most responsive service departments in the industry.

Call us today for more information on the most flexible downlink system available anywhere—the only system that can guarantee access to any commercial satellite, at any time.



MAT is quickly and easily controlled through its front panel keypad or remote terminal.



Microdyne Corporation

P.O. Box 7213, Ocala, FL 32672
(904) 687-4633 • TWX: 810-858-0307

Circle (47) on Reply Card

ENERGY SAVERS

MSDC

MULTI-STAGE DEPRESSED COLLECTOR

Varian's Microwave Tube Division now offers UHF-TV broadcasters two new devices that can significantly reduce their power bills. These devices are the Multi-Stage Depressed Collector (MSDC) Klystrons and Integral Cavity Klystrons with Annular Control Electrode (ACE) guns.

The photo on the left is the new 60 KW VKP-7995 integral cavity MSDC klystron. This MSDC prototype was developed at the Varian Microwave Tube Division with support from NASA, PBS, NAB and various UHF-TV transmitter manufacturers. This new MSDC klystron will provide a figure of merit of up to 131 and will require approximately 50% of the power required by klystrons of equal power ratings with figures of merit of 65 to 70.

In addition to the integral cavity MSDC klystron, Varian will have its wideband external cavity MSDC klystron in full production by 1989.

Varian Microwave Tube Division
611 Hansen Way
Palo Alto, CA 94303
Telephone: (415) 424-5678

VKP-7995

varian 

Circle (150) on Reply Card

FROM VARIAN

ACE

ANNULAR CONTROL ELECTRODE

ACE Klystrons

Varian has incorporated an Annular Control Electrode ("ACE") to provide low voltage pulsing capability and efficiency enhancement in our "S" Series UHF-TV klystrons.* In conjunction with the improved linearity correction available from most original equipment manufacturers, these klystrons can provide the highest efficiency available in the world today, with a figure of merit approaching 85. The improved efficiency is coupled with the added reliability inherent in low voltage pulsing systems and the documented life of five cavity klystrons.

ACE Klystron Retrofits

These klystrons are now available from Varian for new transmitter applications and can be readily retrofitted into existing transmitters with kits available from OEMs. Contact Varian for recommendations on retrofits.

*VKP-7553S VKP-7554S and VKP-7555S

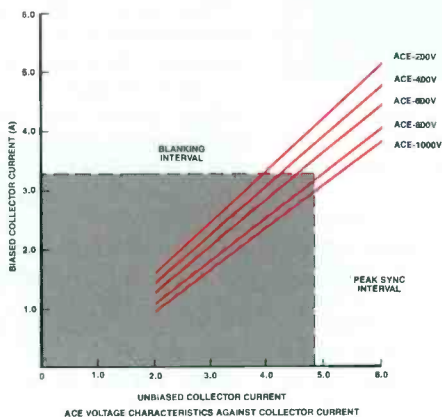

Circle (151) on Reply Card

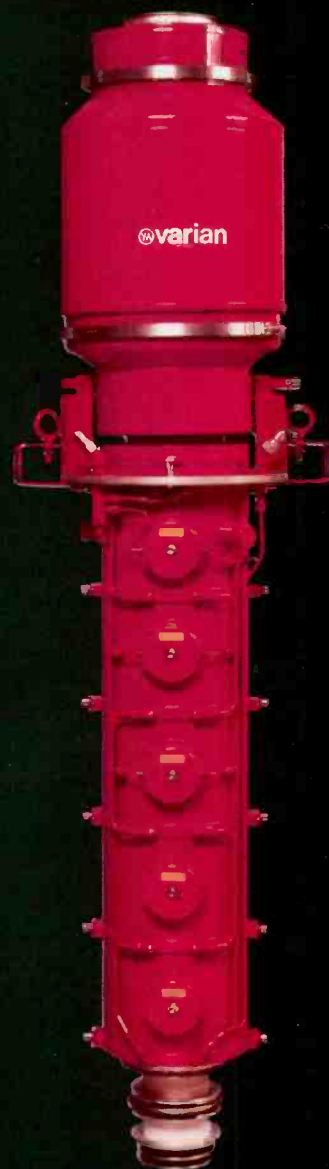

VKP-7553-ACE

Continued from page 70

eliminated. Units can be ganged together until desired power is reached. Amplifiers slide in and out of the unit and require no tuning. Control and metering are greatly simplified: the transmitter is either on or off—elaborate control logic is not required. Abundant monitoring is available. The Larcam Tek-IV exciter is solid-state and can provide TV stereo, SAP and pro channel.

•Magni Systems: 560 component/composite waveform monitor and vectorscope

The Magni Systems WFM560 waveform monitor provides six video inputs, enabling you to run two complete signal sets



in the same component format or to tailor combinations of two standards (including composite) for your particular requirements. Switching among formats (SMPTE, composite, Betacam, M-II and RGB) and displays (alternate, parade, A-B and component vector) is accomplished from the front panel, as is memory storage of up to 18 switch positions for later recall. Readouts provide an on-screen display of such parameters as input format, line selection and sweep speed. Cursors simplify measurements of time (reading out in time or as cycles of subcarrier), voltage (reading out as IRE, volts or percentages of predetermined amplitude) and rise times.

An on-board transcoder converts Y/Pb/Pr, Beta or M-II standards into standard RGB for use on a picture monitor or any other application.

•Nikon Corporation: TV-Nikkor ENG/EFP lenses

Although they were included in another pick-hit item, the Nikon series of lightweight ENG lenses deserved special mention on their own merits. The two lenses, the S15x8.5B, weighing in at just 2.7 pounds, and the S13x9B, which weighs 2.4 pounds, are made of extra-low-dispersion glass. The front lens group, accounting for 60% of the lens weight, uses a newly developed lightweight optical glass. The lens shapes also were redesigned to reduce size. The lens barrel and servo sections are made primarily of lightweight magnesium alloy, and the servo section is integrated with the extender,



enabling better balance during operation. The result is a high-quality lens, small in profile, and extremely lightweight.

Additionally, the lenses are optimized for CCD cameras. Special antireflective coatings are used in the lenses' 20-plus elements to minimize internal reflections. This is important because a CCD camera often is used to shoot strongly backlit scenes with the light source in the frame, being that the CCDs are immune to "burn-in." Chromatic aberration is held extremely low, because a CCD camera has no provision to adjust for it. The lenses exhibit a high, flat, modulated transfer function, even to the edge of the picture frame.

•Sony Corporation: BVW-200 camcorder

Weighing in at just 15 pounds, 3 ounces, the Sony BVW-200 Betacam SP VTR-in-camera combination unit consumes only 19W of power and can be operated for an hour with a single NP-1A battery. The manufacturer achieved small profile and low weight by miniaturizing the transport



mechanism, shrinking the drum assembly and doing away with the main wiring harness. The unit uses newly developed ICs to further reduce weight.

A movable shoulder pad allows the camera to bend to fit the operator, not vice versa, and simplified controls make the unit easy to operate. A 3-chip CCD device yields sensitivity of $f/5.6$ at 2,000lx, and 550 TV lines of resolution with no image burn-in or lag. VU meters, tape timers,

time-code and user-bit information and warnings are shown on an LCD display. The unit provides two longitudinal audio tracks (equipped with Dolby-C), as well as two high-fidelity AFM tracks. A phantom power supply operates external microphones. The camera's own microphone is detached easily and can be used as an interview mic if the optional extension cord is installed.

When the return video switch on the lens is pressed in the *rec pause* mode, the tape rewinds up to 10s and plays back the last scene, stopping in position to continue recording.

•Sony Corporation: DVR-10 D-2 videotape recorder

(Shared with Ampex VPR-300 D-2 VTR)

Two manufacturers shared honors for introducing D-2 machines. The Sony DVR-10 joined the Ampex VPR-300, in the opinion of the judges, as a fine embodiment of this new standard.

The DVR-10 is compact, about the size of a Betacam studio VTR, and weighs 103 pounds. It accepts the M or S size cassettes, for a maximum play time of 94 minutes. Cassette size is identified



automatically within the unit. The recorder can reproduce a recognizable color picture from tape shuttling at up to 40 times play speed. The control systems of the DVR-10 will interface directly with the 1-inch, Betacam and U-matic lines of Sony machines.

Operator prompts for the DVR-10 appear on a 640x200-dot electroluminescent panel. The panel also indicates tape direction and run time and provides audio metering.

One aspect of the D-2 format demonstrated by Sony probably deserves comment. Both pick hit manufacturers' D-2 products have the capability to read before write, and because of the multigenerational capability of the D-2 format, it is possible to do limited editing, say the insertion of supers, on a single machine. Although this is risky (the original video is erased), the judges were intrigued by the possibilities.

•Tektronix: VM-700 video measurement set

The VM700 is a complete video

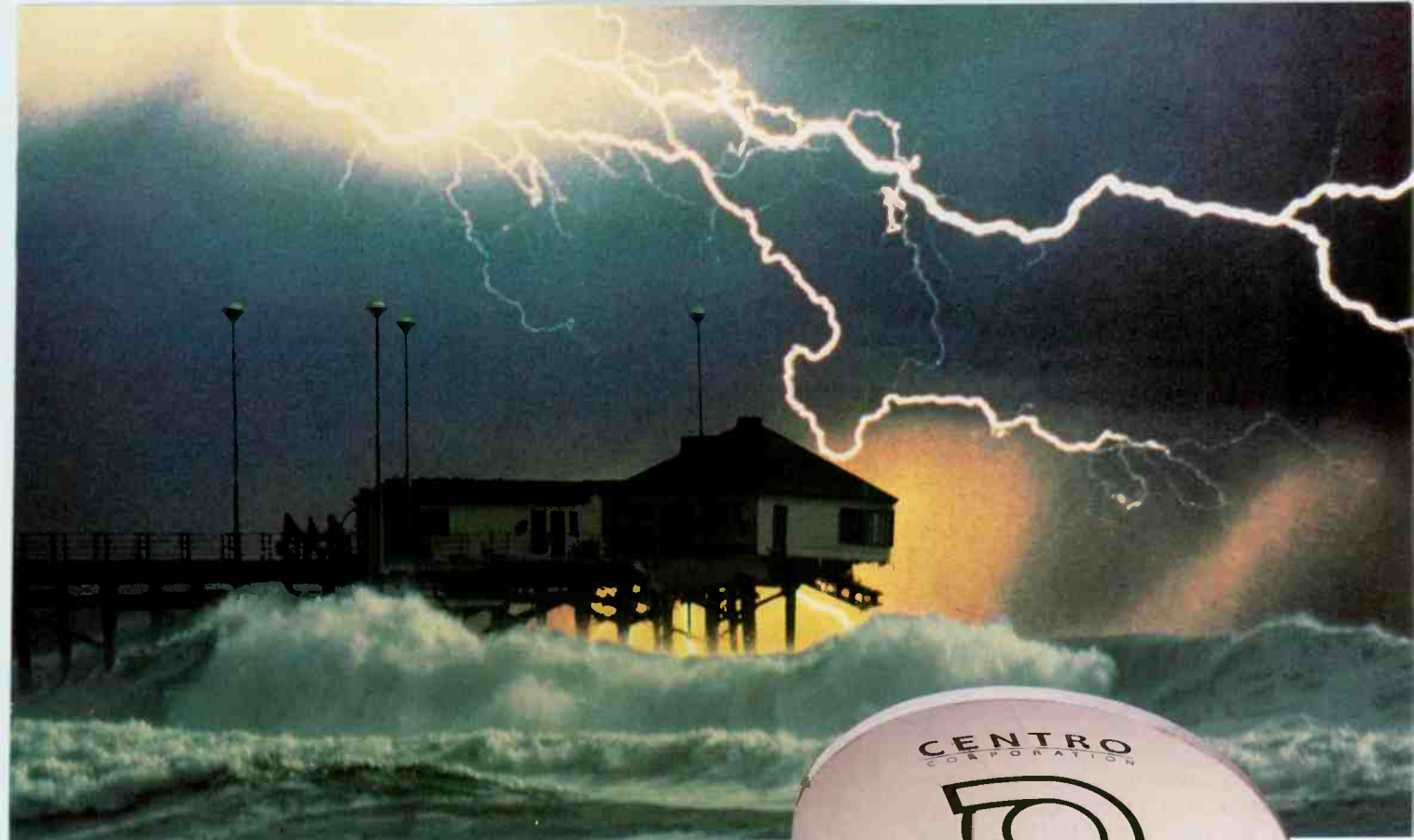

...or high water.

Don't get stuck with a fair weather truck. Neither rain, nor snow, nor 40 mph winds with gusts to 60 mph, will keep Centro's Satellite Networker™ from getting your signal through. This sleek, low profile, high performance SNV can turn any story into more than a remote possibility, and link you instantly to the rest of the world.

Centro is building everything from single thread uplink only utility trucks, to fully redundant SNV's with microwave capability, full compliment of production gear, and complete communications packages. And, Centro can build exactly the truck you need. Just the way you want it. On time, and within budget.

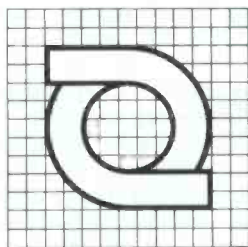

CENTRO
CORPORATION

369 Billy Mitchell Road, Salt Lake City, Utah 84116 (801) 537-7779

© 1987 - Centro Corporation

Please call me. I'm interested. Circle (49) on Reply Card.
Please send literature. Circle (50) on Reply Card.

monitoring and measuring instrument that can make automatic, as well as manual, measurements. In the automatic mode, measurements are compared with user-definable limits, and if there is a discrepancy, an alarm message is generated. In manual mode, cursors aid in measuring time, frequency and amplitude.



The waveform can be expanded to about any point both horizontally and vertically, and the axes expand so that the units are correct as displayed. All the information on the screen, as well as the results of automatic measurements, can be dumped to a printer via a standard RS-232C port. A picture mode allows the user to see the signal under test and, using the cursors, to select a line off the picture for waveform or vectorscope display.

New products

Hundreds of new products were introduced at the NAB convention in Las Vegas. The BE "Show of Shows" feature (see page 80D) provides a comprehensive summary of all the new products unveiled at the convention. Reader service numbers are provided so that you may receive additional information on the products of a particular company.

Because the NAB convention is the major new product showcase for the broadcast industry, keep this reference issue on hand as a guide to the latest information on new equipment and engineering trends. Whether or not you attended the convention, the BE "Show of Shows" summary can be an important element in any new product purchase decision.

With a show as large as the NAB, you can't tell the players without a scorecard. Use ours.

Radio pick hits

•CompuSonics: disk storage and editing system

Cost-effective digital audio storage and expanded editing capabilities made the EXD module and Mac/PC editing software a pick hit for the 1988 panelists. The expansion module provides storage capacity for up to four 380Mbyte drives. Each drive holds 1.75 hours of stereo audio at a 32kHz sampling rate, and up to six hard disk drives can be connected to the DSP controller.



The application software provides either a PC-compatible or Apple Macintosh-compatible graphic user interface. The system provides a simple, friendly, mouse-driven digital audio work station that can "cut and paste" digital audio much like a word processor.

•Delta Electronics: splatter monitor

The SM-1 AM splatter monitor provides AM broadcast engineers with a means of accurately and easily measuring off-channel emissions (splatter) to ensure compliance with the FCC regulations or the more stringent recommendations of the NRSC.

The monitor measures both the I (in-phase) and the Q (quadrature) modulation components. An adjustable frequency offset permits measurement of splatter in 1kHz steps beginning 10kHz away from



the carrier. The monitor also can be powered from an external battery for portable operation. An adjustable alarm output permits remote-control monitoring of the selected parameters. A front-panel speaker permits monitoring of the meter-selected interference.

•Design Radio Labs: ACM-1 noise meter

The ACM-1 is a precise AM noise meter

that provides an LED-graphic display of AM noise on an FM transmitter or TV aural carrier. An LED display with 20dB of range indicates AM noise to aid in

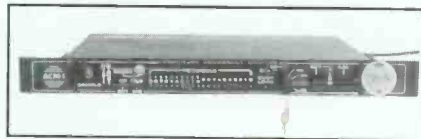

precise transmitter tuning. The ACM-1 also provides a remote-control output so data can be read at the studio. An adjustable-threshold alarm can signal the operator when AM noise has increased beyond a predetermined level.

A front-panel jack provides a scope display signal, which can be used to assist in identifying AM noise components. Both audio and data outputs are available on the rear panel.

•Gentner Electronics Corporation: routing distribution amplifier

The routing distribution amplifier (RDA) combines the features of both a routing switcher and distribution amplifier. It provides eight inputs and 28 outputs, where any input or any combination of inputs can be routed to any output. An 8-position



dip switch for each output selects the combination of inputs to be directed to that output.

Input levels are adjusted while monitoring a bicolor LED display. This allows the proper ratio of input to output gain, and assures that one adjustment isn't fighting the other. Coarse audio level adjustment is accomplished through a 4-position dip switch, and fine audio level adjustments are made with the trimmer level control. All trimmers and dip switches are located behind a removable front panel.

•Gentner Electronics Corporation: 3-line digital frequency extender

The EFT-3000 is a 3-line digital frequency extender providing a frequency response of 50Hz to 7.5kHz. The EFT-3000 also can operate over one or two lines, with reduced program bandwidth.

The unit provides totally automatic setup, including: auto-dialing, auto-answering, automatic encode/decode, group delay adjustment, phase correction

NEED A COMPACT INTERCOM?

The innovative CS9500 is ideal for radio and television stations, production facilities and mobile vans where a totally programmable and high performance digital intercom is required. System features include:

- Very compact: only 3 Rack Units (5 1/4") high!
- Totally field expandable up to 50 x 50 matrix
- Innovative microprocessor-based architecture
- Dual redundant switch-mode power supply

In addition to Point-to-Point communications, other capabilities include:

- Party Lines
- Fully programmable control panels
- IFB's or Program Interrupt
- 2/4-wire interface
- 2-way radio interface
- Telephone interface

The CS9500 is a high performance, space saving and cost effective solution to your intercom needs.

McCurdy Radio Industries

McCurdy

WE'RE ON YOUR WAVE LENGTH

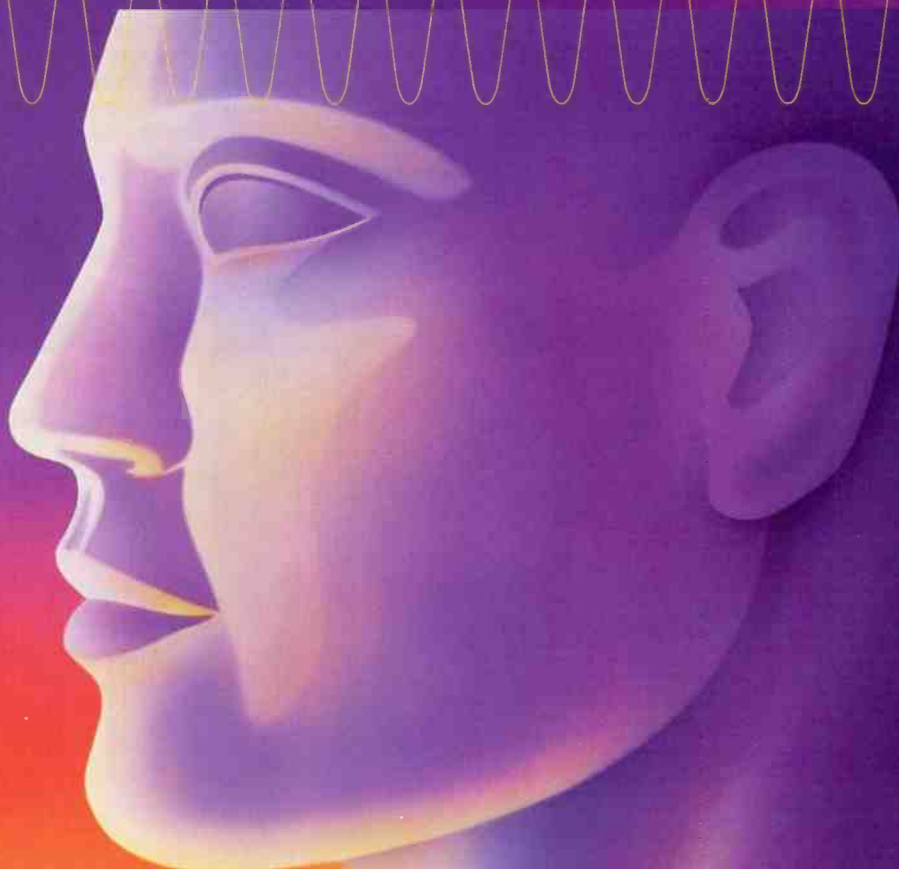
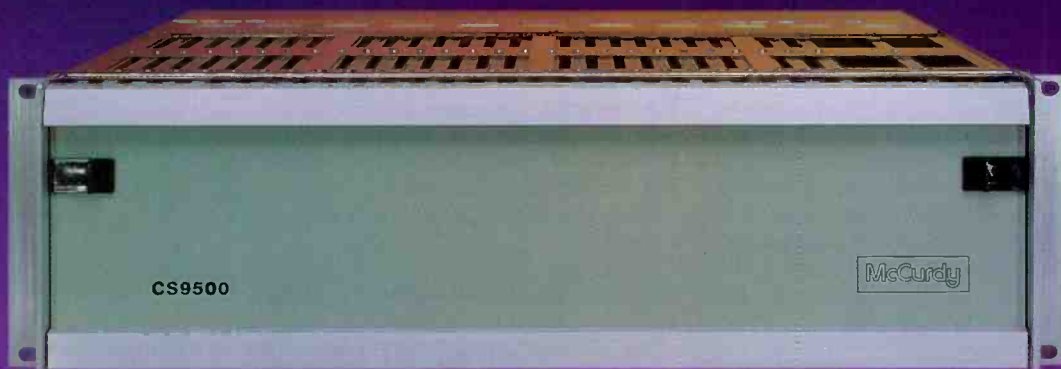

40
YEARS OF EXCELLENCE

McCurdy Radio Industries
108 Carnforth Road
Toronto, Ontario
Canada M4A 2L4
Tel. (416) 751-6262
Telefax (416) 751-6455
Telex 06-963533

1051 Clinton Street
Buffalo, N.Y. 14026
Tel. (212) 772-3719

Circle (51) on Reply Card



and equalization using digital signal processing. Noise reduction in the unit occurs in the digital domain through the use of a special noise-reduction algorithm. An internal routing switcher configures the three lines automatically for low-, medium- and high-frequency shift. Once the lines are established, the automatic level calibration and equalization take approximately 10s. Remote cuing with built-in microphone and headset amplifier is a standard feature.

•**Henry Engineering differential summing amplifier**

The Henry Engineering MixMinus Plus is designed to add a *mix-minus* output to a broadcast console. This output is typically used to feed the *send* input of a telephone hybrid device. The MixMinus Plus has two inputs and one output. One input is fed with the console program output. The second input is fed from the hybrid receive audio, tapped after the phone-channel console fader.



The MixMinus Plus subtracts the hybrid receive signal from the program output, creating a program mix-minus in the receive (caller) audio. The front-panel null adjustment provides approximately 40dB of caller audio rejection (30Hz-3kHz). The inputs and outputs can be balanced or unbalanced. The unit provides a gain of unity, and the output stage will drive a 600Ω load to +26dBm.

•**Moseley RPL remote programming system**

The Moseley RPL 4000 remote programming system consists of an RPL 4010 transmitter and RPL 4020 receiver. The transmitter is fully synthesized for operation from 450MHz to 456MHz. Maximum RF output is 20W. The RPL has one line/mic input and one additional microphone input. Audio bandwidths from 5kHz to 15kHz are possible. The system can operate on 25kHz, 50kHz and 100kHz



channels.

Encoding and decoding for repeater and noise-reduction companding are available. The receiver provides dual-frequency operation with remote-control selection. The receiver has a subaudible decoder and an optional DTMF decoder. Optional variable IF and channel selection also are available.

•**Pinzone Communications Products antiskywave AM antenna**

The Pinzone Corum antenna provides a new technique for controlling the elevation plane pattern of AM broadcast antennas. The structure is a low-profile, slow-wave, vertically polarized, self-resonant, omnidirectional radiator with a substantial feedpoint impedance.

The antenna offers several advantages: it employs near-ground construction, it

can be used to retrofit most existing arrays, and each element of the phased array has a much narrower elevation plane pattern. The arrays of concentric Corum elements may be used to tailor a pattern that other designs may not be able to provide. The antenna's low-profile radiators may be usable in situations in which traditional antennas are impractical.

•**Potomac Instruments programmable controller**

Intelligent, user-programmable remote control is featured in the Potomac Instruments 1500 PC programmable controller. The system uses an 8085 microprocessor and can operate as a stand-alone intelligent controller. It may



be linked via landline or radio to the optional 1510 studio terminal for automatic remote-control applications.

The 1500 PC is provided with the necessary I/O interface hardware and software for autologging, external video display and telephone interrogation. System programming is accomplished via front-panel controls and menu selection

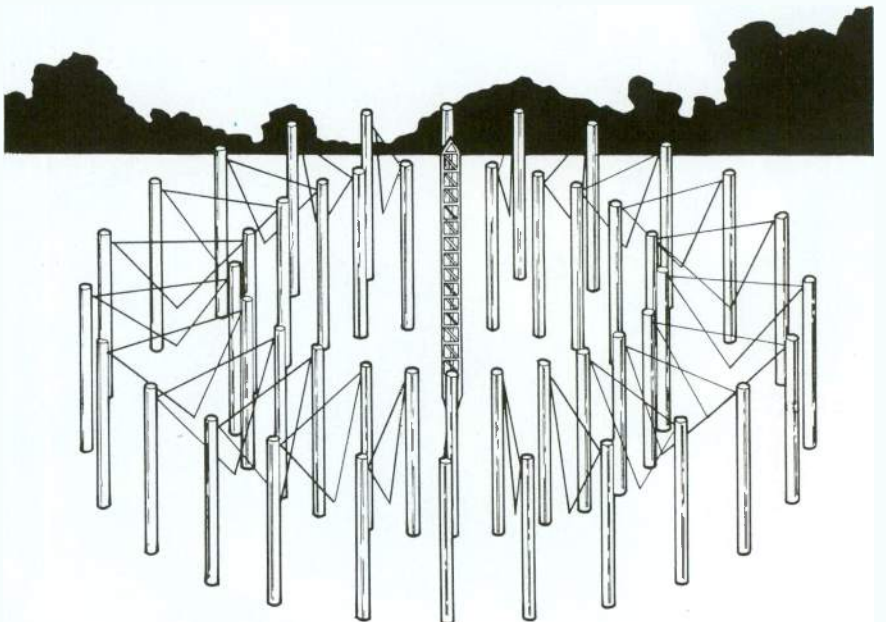



20 gets you 40. 40 inputs plus 8 subs for tracking, overdubbing or mix down means flexibility and control without re-patching at every step. Thanks to the flexibility of the WR-T820B, you can use the monitor section during mixdown to gain 20 extra inputs—over and above the WR-T820B's 20 input modules. So 20 really does get you 40!

The WR-T820B's performance and construction quality are every bit as remarkable as its design. Premium, high-speed IC's in the gain stages give it an open sound that does full justice to all those incoming signals. And our faders are rated at 300,000 operations—20 times the life of a typical carbon fader. Just *two* examples of RAMSA's integrity in design and component selection.

See your RAMSA dealer for a complete demo. Or contact us for further information at: 6550 Katella Ave., Cypress, CA 90630, 714/895-7200.

RAMSA

Panasonic
Industrial Company

Circle (52) on Reply Card

FREE!

TV CAMERA CABLE AND CONNECTORS INFORMATION KIT



Your
one-stop source for
broadcast-quality
camera cable

- Ultra-Flex VTR Cable Assemblies for Sony, Ikegami, Hitachi, & Others
- Slimline studio camera cables
- Waterproof, three-piece high strength connector design
- Customized lengths
- Chassis Mounts
- Quick response to all assembly orders
- Quick repair turn around

Call or write today for your free order kit.

MOHAWK
WIRE & CABLE CORPORATION

9 Mohawk Drive
Leominster, MA 01453
1-800-422-9961
In Massachusetts, 1-800-642-9961

Circle (118) on Reply Card

Do You Want
To 'Talk' Audio?

GO **AESNET**

ON COMPUSERVE

John Hoffman
Net Administrator
76703, 1036

on the CRT screen. The basic configuration includes up to 16 operating modes, each with 16 telemetry, status and control channels.

•TFT remote pickup unit

The TFT model 8888 RPU system provides 50Hz to 15kHz audio response for ± 10 kHz and ± 35 kHz deviation. The transmitter provides up to 25W of power with frequency-agile operation. Two preset frequencies are selectable from the front panel. The transmitter provides three audio inputs, two microphone channels and one line-level channel, which minimize the need for an external mixer. A built-in limiter prevents overmodulation. A built-in headphone amplifier permits the operator to monitor the mix.

An on-board microprocessor is an integral part of the receiver's IF section, enabling frequency-agile operation. The operating channel can be selected from the front panel or by DTMF remote control.

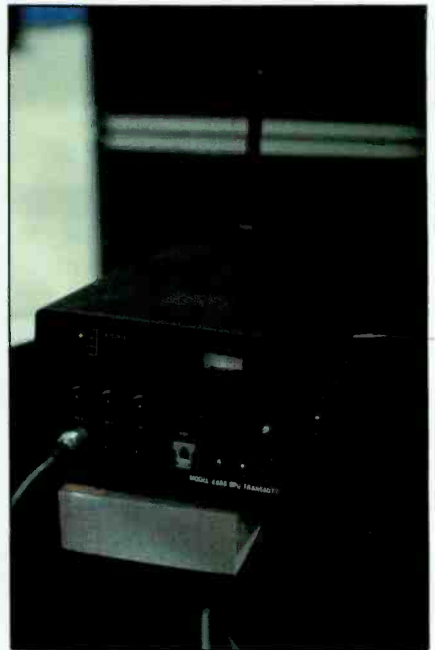

The judges

We selected 10 well-known and respected independent industry experts to act as our panel of judges. Five judges selected radio products, and five selected TV products. Those experts who served on our 1988 panel were the following:

For Radio:

John Battison

BE's consultant on antennas/radiation
Owner, Battison and Associates
Columbus, OH

John Dehnel

Chief engineer, KSL-AM
Salt Lake City

Tom McGinley

Director of engineering, Cook Inlet
Radio Partners
(formerly First Media Radio Group)
Washington, DC

Andy Laird

Vice president of engineering,
Radio Group
Heritage Media Corporation
Los Angeles

Ed Treese

Contract radio engineer
Merriam, KS

For Television:

Tal Ball

Chief studio engineer, KSL-TV
Salt Lake City

Robert Hess

Director of engineering, KOVR-TV
Sacramento, CA

Chuck Morris

Director of engineering, KIRO-TV
Seattle

Karl Renwanz

Vice president of engineering
and operations, WNEV-TV
Boston

Steven A. Smith

President, Broadcast Technology
Consultants
Overland Park, KS

Alternate (Both TV and Radio):

Marvin Born

Vice president of engineering
Gulf Coast Broadcasting
Corpus Christi, TX

1:7(=)111

Focus on your future

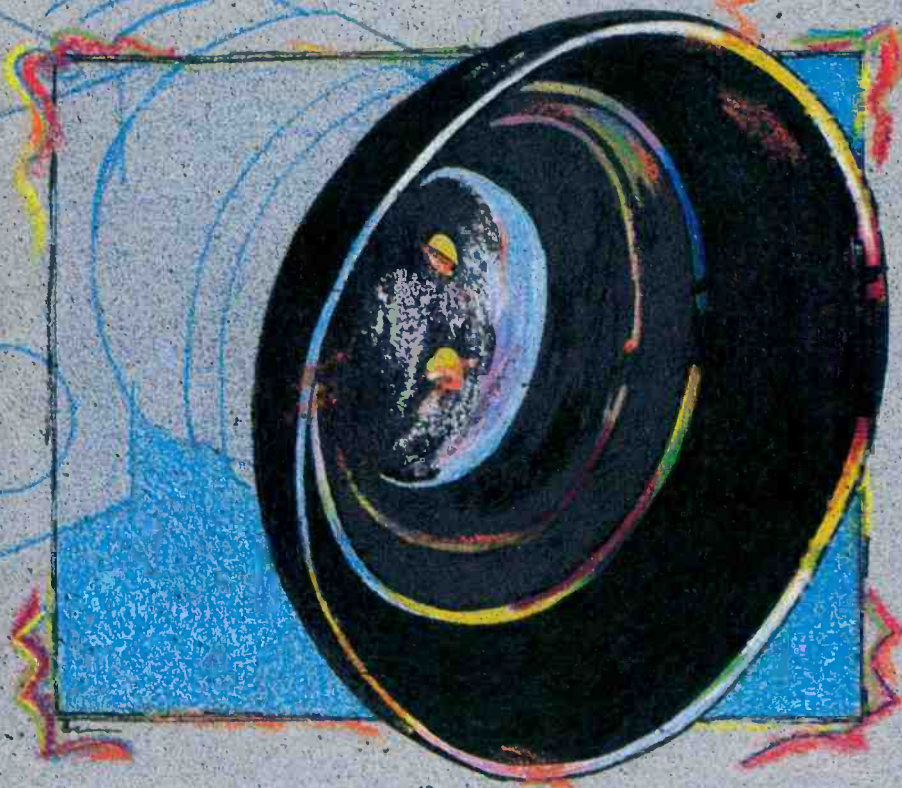

The need for technical expertise has never been greater, and the competition has never been tougher. Focus on your future by attending the 1988 SBE National Convention and *Broadcast Engineering Conference*, September 22-25 in Denver. Examine the latest broadcast equipment from leading manufacturers. Attend technical sessions that provide practical answers to today's problems.

This year's convention will provide more exhibit hours and more technical papers than ever before.

Keep an eye on your future. Attend the SBE National Convention and *Broadcast Engineering Conference*.

**Denver Convention Complex
Denver, CO
September 22-25**



NATIONAL CONVENTION

BROADCAST
engineering
CONFERENCE

Co-located with the Rocky Mountain Film and Video Expo and ITVA Region 8 Conference

It pays for itself... The Panasonic MII Cart



Panasonic
MII

Official Video Equipment Of
The 1988 Olympic Games



Title 36 United States Code Section 380

automatically. Machine. Available now.

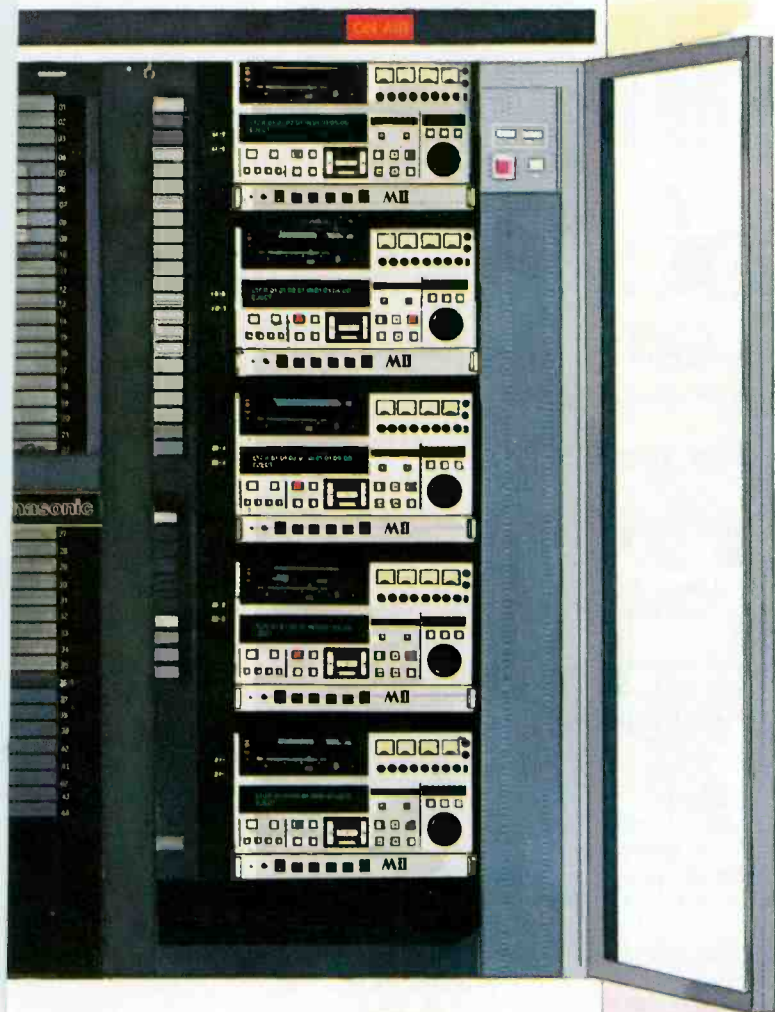

Now our most technologically advanced cart machine is also one of the most versatile. Presenting the Panasonic MII cart machine.

- From 10-second spots back to back, continuously, to two months of 24-hour automatic program airing.
- Uses 10-, 20-, 30-, 60- or 90-minute cassettes in any desired mix.
- Capable of record and playback of single or multiple events on the same cassette.
- Uses up to 5 standard MII studio VTR's plus 3 optional outside sources.
- Modular design—various configurations to suit user's needs and budget.
- Expandable—from 120 cassettes up to 3 rotary libraries that can hold over 1,150 cassettes.
- User-friendly software and hardware tailored to customer needs.
- Cost-effective operation and ease of maintenance and access.
- Backed by Panasonic MII 24-hour service support system.

MII

MII Panasonic
Broadcast Systems Company

Call our field offices now:

Northeast: One Panasonic Way,
Secaucus, NJ 07094; (201) 348-7671.

Washington, D.C.; (703) 759-6900.

Southeast: 1854 Shackleford Court,
Suite 250, Norcross, GA 30093;
(404) 925-6772.

Midwest: 425 E. Algonquin Road,
Arlington Heights, IL 60005;
(312) 981-7325/(317) 852-3715.

Southwest: 4500 Amon Carter Blvd.,
Fort Worth, TX 76155; (817) 685-1132.

Western: 6550 Katella Avenue,
Cypress, CA 90630; (714) 895-7209.

Northwest: (408) 866-7974.

Circle (53) on Reply Card

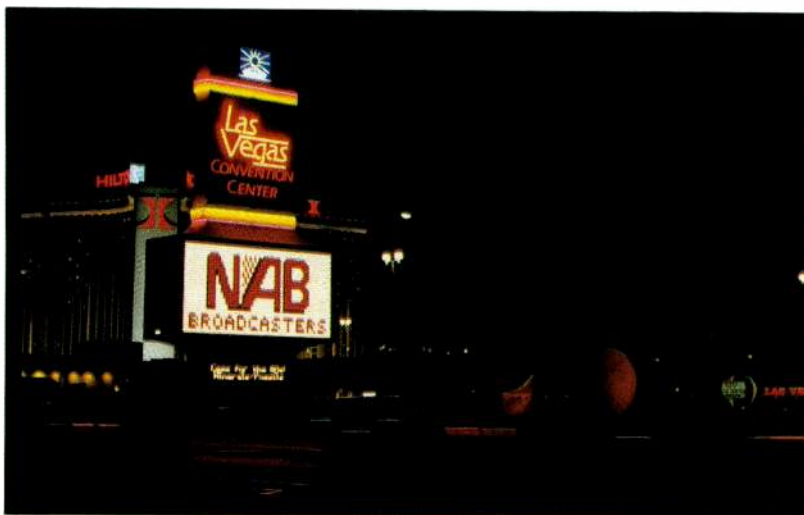

Show of shows

Let's face it. You probably didn't get to all the exhibits at NAB. Here's a post-show tour your feet will love.

Coordinated by Carl Bentz, special projects editor

There are two primary reasons for going to the NAB convention: to learn more about the broadcast industry from the many technical seminars and to find out what's new (for the next capital budget wish list). If you're like most attendees, you probably didn't see half of what was there. So, for those of you who wish you'd made it to more exhibits, or if you were unable to attend the convention, the following new product wrap-up will help you keep abreast of this year's bells and whistles, nuts and bolts.

Products from 723 manufacturers were displayed to more than 46,000 attendees. The tally of new, upgraded and enhanced products comes out to about 2,000—not bad for an industry that has experienced less-than-favorable economics in the past few years.

In "Show of Shows," the new products are described briefly, and each is accompanied by a reader service number to help you get more information from the manufacturer. The list consists of four major divisions: audio, RF, support and video products. Each is subdivided into several categories of products that fall under that general topic. The breakdown of categories is shown in the following outline. It's worth your time to thumb through the entire list, but if you're in a hurry to read about a particular kind of equipment, page numbers indicate where each subdivision begins.

Group A—Audio Products

- A1 (84): Mixers (on-air, portable, production, recording; studio automation).
- A2 (86): Processors (compressors,

limiters; delays, effects; noise reduction; telephone hybrids).

- A3 (90): Recording (analog, digital; audio editing; recording accessories; transport synchronizers).
- A4 (94): Sources, monitors (CD players, phono; headphones, headsets, intercoms; speakers, monitor amplifiers; wired, wireless mics).

Group R—RF Products

- R1 (100): Transmission (antennas, towers; radio, TV transmitters; transmission line).
- R2 (108): Microwave (antennas, electronics; ITFS, OFS, STL, radar RF, MDS, MMDS).
- R3 (110): Amplifiers (grid power tubes, klystrons; assemblies, cavities).
- R4 (112): Receiving (demodulators, modulation monitors; receivers).
- R5 (112): Generation (exciters, generators, subcarrier systems, stereo FM, TV, paging).
- R6 (116): Satellite (antennas, controllers, electronics).

Group S—Support Products

- S1 (118): Automation (hardware, software; business, traffic, newsroom, on-air; remote-control systems; clocks, timers; 2-way radio, paging, data transmission).
- S2 (124): Wire, cable (audio, video, coax; connectors; fiber optics; patchbays, panels, cords; power distribution).
- S3 (126): Storage and studio (equipment cases, bags; racks, consoles; acoustical material; studio fixtures).
- S4 (128): Recording media (audio, video, data; reel, cassette, disk; analog digital formulas; cleaners, conditioners, degaussers; shippers).

- S5 (130): Distribution (A-V, data distribution amps, routing switchers).

- S6 (134): Test equipment (delay lines, filters; signal generators, monitors, meters; RF loads; tools; UPS, power conditioning, power transformers, voltage regulators).
- S7 (140): Facilities (design, construction, consultants; studio, mobile; equipment leasing, rental).
- S8 (140): Programming (distribution services, effects, music libraries; production services; satellite time brokers).

Group V—Video Products

- V1 (142): Cameras (EFP, ENG, studio; camera tubes, CCDs; lens systems; pan/tilt heads, pedestals, tripods; control, robotic systems).
- V2 (148): Recording (analog, digital, editing, animation; time-code equipment; transport synchronizers).
- V3 (156): Film cine (video-for-film, telecine, film-to-tape transfer, film editing equipment, cleaning, inspection equipment).
- V4 (157): dc power, light (batteries, packs, belts, chargers, reconditioners; lighting instruments, controls, lamps).
- V5 (159): Effects, graphics (production titlers, digital effects, graphics systems; prompters; video production systems).
- V6 (168): Switchers (master control, video production).
- V7 (168): Processing (compositors, keyers; encoders, decoders, signal correction; standards, format converters; sync generators, VBI IDs; TBCs, synchronizers).
- V8 (173): Displays (video monitors, projection systems).

Continued on page 84

The inside story on *Flexwell* is performance



Flexwell Transmission lines offer low RF loss, smooth impedance coefficient, and conservatively rated power handling capability.

Flexwell utilizes a copper corrugated outer conductor, solid or corrugated inner conductor (depending on size), and a tough, durable, corrosion resistant polyethylene jacket suitable for burial and prolonged life. A low loss foam version called Cellflex is also available in $\frac{1}{2}$ " , $\frac{7}{8}$ " , $1\frac{1}{4}$ " and $1\frac{5}{8}$ " sizes.

Air dielectric Flexwell in smaller diameters ($\frac{1}{2}$ " and $\frac{7}{8}$ ") offer a field proven, fixed helix design called Spirafil II, a single, continuous extrusion which locks the center conductor coaxially within the outer conductor, resulting in a linear impedance coefficient throughout the entire length of line.

Larger diameter air dielectric Flexwell Cables, ($1\frac{5}{8}$ " , 3" , $3\frac{1}{2}$ " and $4\frac{1}{2}$ ") feature a unique vertebra helix design to achieve optimum crush and tensile strength. Its "pillar effect" , using less volume of

dielectric, provides lower loss and higher average power handling capability due to the more rapid dissipation of heat from the center conductor.

Flexwell has it all: low loss, low VSWR, high power handling, smooth impedance coefficient, and rugged, long dependable life. Cablewave System's Flexwell is type accepted for sampling systems in accordance with FCC Part 73.68.

For complete details contact Cablewave Systems, 60 Dodge Ave., North Haven, CT 06473. Tel: 203-239-3311



Cablewave Systems

DIVISION OF RADIO FREQUENCY SYSTEMS, INC.
60 Dodge Ave., North Haven, CT 06473 • (203) 239-3311

Circle (54) on Reply Card

With low key lighting, differential lag can be a problem. Amperex Plumbicon tubes with built in bias light increase the speed of response of the layer, and lag is virtually eliminated.



Comet tailing and loss of detail in highlights are minimized by using the Amperex patented Diode Gun or anti-comet tail (ACT) tube. Both solve this problem by providing high beam current to stabilize highlights.



High audio levels can produce the annoying problem of microphonics. Amperex attacked this at its source, and all Amperex Plumbicon tubes have a unique mesh designed to prevent the build-up of mesh vibrations—not just to dampen them.



Six of TV's toughest shots and how

The problem of image retention. By reexamining layer physics and semiconductor properties Amperex developed a new extended red layer. Now you can include brilliant reds in your scene without concern for image retention.

Low output capacitance Amperex Plumbicon tubes help maintain high signal to noise performance. This helps prevent loss of detail and increased video noise in low light areas of high contrast scenes.

Because of special photoconductive layers for each color and an optimized electron optics design, the Amperex Plumbicon tubes provide the highest resolution for each image format. This resolution is measurably higher than earlier tubes.



Amperex Plumbicon® camera tubes handle them.

Ordinary pick up tubes can handle ordinary TV shots. But when you have to contend with low light levels and bright highlights... the glare of reds and the glare of trumpets... you need the extended performance of Amperex Plumbicon® TV Camera Tubes.

Amperex invented and refined the pick up tube technology that makes it possible to handle the 6 toughest shots in TV. Since the original Plumbicon cameras were introduced, your business has become more competitive, more demanding. Camera designs have become more complex. That's why we continued to invest in improving the performance of the Plumbicon tubes. That's why we offer today's range of extended performance Plumbicon tubes.

Today, virtually every TV camera system—domestic or imported—is designed to use the Plumbicon tube. And that makes the handling of the toughest shots in TV very easy. Simply specify Amperex Plumbicon TV camera tubes.

Made in Rhode Island, U.S.A. Delivered to you in twenty-four hours or less.

For more information call or write Imaging Products Group, Amperex Electronic Corporation, Slatersville, Rhode Island 02876. (401) 762-3800. A North American Philips Company. Outside the U.S.A. contact: Philips Electronic Components and Materials Division, 5600 MD Eindhoven, The Netherlands.

Amperex®
Amperex Imaging Products
... we see things your way.

Circle (55) on Reply Card

Audio Products

A1: Mixers

- On-air, portable
- Production, recording
- Studio automation

Allen & Heath

Phantom series: 8-/16-bus multitrack recording console; 24, 32, 40 inputs; standard μ P muting control.

Circle (889)

AMEK Consoles

ESM1000: edit suite control; serial, parallel interfaces for BC-II range of broadcast consoles; Esam I, Esam II protocols.

G2520 automation: options for 40-/56-input multitrack master recording console include Audio Kinetics *Mastermix*, GML *Moving Fader System* and Digital Creations *Disk Mix*.

Circle (533)

AMS/Calrec

LOGIC 1: automated digital audio mixer; integrates with AMS Audiofile disk recorder; moving fader; Logicator touch-sensitive controls; 32-bit architecture; internal dynamic range >1500dB; level indicators integral to knobs.

Circle (538)

Audio Developments

AD066-10: mic splitter; 1-in \times 4-out; \pm 0.5dB, 20Hz-20kHz.

AD150: mic/line module; transformer-balanced mic input, electronically balanced line; 48V phantom, 12V Tonader/AB powering; phase switch; EQ, high pass filter; overload indicator.

AD062-7: edit mixer; 8-16 input system.

AD145-E: edit mixer in 4-, 6- or 8-input configurations.

AD110: digital edit mixer.

Circle (1181)

Audio Kinetics

REFLEX: centrally controlled VCA faders, muting, auxiliary switching automation system; retrofits to mixing console without modification.

Circle (565)

Autogram

AC/IC console modules: upgrade kits including IA input amplifier, MXA-2 mix amp, LA-3 line amp, MPA-2A mic pre-amp.

Circle (572)

Broadcast Electronics

Mixtrak-90: modular mixer for on-air work; 12-/18-input models; stereo capability; sequencing to setup of entire station break for automatic performance, including equipment starts.

Circle (607)

Digital Creations

DISKMIX: console automation storage, editing system; SMPTE, MIDI timing interfaces; operates with ARMS, JH-50 console computer systems for enhanced functions.

ARMS-II automation: VCA fader retro system; integrates with console; Super Group input sub-grouping, solo-mute, optimized VCA fader modules.

Moving Faders: for DISKMIX automation; multiple μ P, 10-bit data conversion, P&G faders.

Circle (703)

Dorrough Electronics

Model 700: dual-channel on-air console; 7-position, 15-line, 3-mic inputs; loudness meter option.

Circle (713)

FORA

AS-740: audio-follow mixer; operates with FA-740 TBC/EC-740 editing controller.

Circle (767) See ad page 155

Gentner Electronics

Combination remote mixer: four mic inputs, headset amps; each headset monitors its input or master channel.

Circle (779) See ad page 62

Grass Valley Group

AMX-170S: automated mixer; integrates with editing controller; eight VCA inputs route to four program outputs; E-MEM setup of faders.

Circle (788) See ad page 9

Harrison Systems

AIR-790: on-air console; mono mic, stereo line, remote line inputs; logical control avoids source on air and audition simultaneously.

PRO-790: general purpose production console; mono mic, line and stereo line inputs; levels and mutes controlled by fader/switches, VCA fader groups or proprietary video switcher, editor interface.

Circle (798)

Logitek

Stereo Pre-10: mixer input expander.

Circle (867)

Neotek

Essence audio console: multitrack effects layout, ADR, Foley recording, post-production assembly, synthesizer sampling and assembly.

Elite, Elan: multitrack recording consoles.

Circle (928)

Rupert Neve

V60 console: post-production, film, music mixer; Necam 96 moving fader automation; in-channel dynamics with external side chain control, advanced mix-cue, variable balance of overdub tracks, 4-band FSE EQ.

Prism series: rack-mount audio consoles; FSE formant spectrum EQ; mic amp, compressor, limiter, gate, expander functions; powered from console or separate supply.

DTC-1: digital transfer console; total digital mixing, processing chain to prepare master tapes for CD manufacture; compatible with AES/EBU and Sony 1610/1630 formats; automated with 250 snapshot memories.

Circle (930) See ad page 133

Orion Research

NewsMaker console: Remem Recall memory; universal input modules; upgrade software based on AMU system; additional features for TV applications.

Circle (947)

Panasonic/Ramsa

WV-8119: surround module for WR-842B post-production console.

WR-T820B: 8-bus recording console.

Circle (956) See ad page 79

Radio Design Labs

Audio consoles.

Circle (1275)

RAM Broadcast

SX-18: on-air console; stereo.

Circle (985) See ad page 176

Shure Brothers

FP51: portable gated compressor-mixer.

Circle (1027) See ad on Inside Front Cover

Solid State Logic

G Series: SSL mixing system; an integrated working environment; based on SSL master studio system with computer hardware, on-board memory, high capacity disk cartridge storage, optional remote keyboard.

G series computer: hardware with on-board memory, high capacity disk cartridges; optional remote keyboard.

Circle (1034)

Sony Professional Audio

MXP-3036 enhancements: software upgrade, wild fader option; vacuum fluorescent light meters; ADS-3000 hard disk automation system with Version 2.0 software.

Circle (1039)

Soundcraft Electronics

SAC 2000: on-air desk; range of module options; opto-isolated universal logic interfaces enable console to communicate with outboard ancillary equipment.

TS-12 automation: exclusive for TS-12 console. *6000 console: split-bus architecture; configurations to 24-bus, expandable to 32-track monitoring.

*200BV/E: 8-input model of series 200B console; for video editing room.

Circle (1043)

Soundtracs

FM range: updated, modular mixing consoles; six mainframes, 11 modules configure for production, dubbing, sweetening, matrix, sound reinforcement.

Circle (1045)

UREI

7510B mixer: upgrade to 7510A system with Background Threshold Trim, preset threshold adjustments; 2-mainframes link to create 48 channels.

Circle (1127)

Ward-Beck Systems

RP2200: radio production console; multitrack interface to existing WBS radio consoles; mono, stereo inline EQ.

Circle (1153) See ad on Back Cover

Wheatstone Broadcast Group

TV-500: MTS master control console; four stereo subgroup, two separate stereo master buses; mono bus for SAP, sum outputs; also foldback, mix minus, special effects.

Model A-20: radio on-air console; 10-input; mono-mic, stereo-line, control room, studio, full function machine modules.

Circle (1160)

Whirlwind

US-M-5: 5-channel stereo rack-mount mixer.

Circle (1162)

Yamaha Music

MV422: multisource mixer for production, edit suites, remote vehicles; four mic, two line source inputs; XLR, 1/4" connectors; 2-band EQ on mics; effects send; L/R master, composite monaural outputs.

DMP7: mixing processor; 8x2 console with

The wireless mic you asked for.



True-diversity systems with the professional quality you expect from Cetec Vega, at unusually attractive prices.

PRO 2 Series Cetec Vega's PRO 2 dual-receiver true-diversity wireless-microphone systems are far superior to phase-diversity and all other diversity systems for eliminating dropouts caused by multipath (reflected-signal) conditions. Configured around the technically advanced Model R-32 true-diversity wireless receiver, the systems are extremely reliable and provide crisp, clean, clear, solid audio.

The ruggedly constructed R-32 diversity receiver features Cetec Vega's advanced DYNEX®II audio-processing system for superior signal-to-noise ratio and widest dynamic range.

A PRO 2 true-diversity wireless system, built with typical Cetec Vega professional quality, normally would be expected to cost more than other systems. However, through innovative

design and advanced manufacturing techniques, the systems are available at unusually attractive prices.

Contact your Cetec Vega dealer (or factory representative) for more information.

All Cetec Vega products are made with pride in the USA

PRO 1 Series...



...for applications not requiring diversity. Configured around the Model R-31B receiver.

Cetec Vega

Division of Cetec Corporation

9900 Baldwin Place
El Monte, California 91731-2204
Telephone: (818) 442-0782
Toll-free: 800-877-1771
Telex II: 910-587-3539
FAX: (818) 444-1342

digital EQ, three integral digital effects processors, moving fader memory.

Sound Reinforcement Handbook: illustrated source book answers numerous often-asked questions.

Stereo MC-series consoles: 8, 12, 16 inputs; 3 aux sends, headphone cue system.

Monaural EM powered mixers: 4, 6, 8 inputs; 150W 4Ω, two aux sends, integral reverb.

Circle (1170)

See ad page 29

Audio Products

A2: Processors

- Compressors, limiters
- Delays, effects
- Noise reduction
- Telephone hybrids

AKG Acoustics

ADR 68K V4.00: software enhancement to reverb/effects processor; hall/DDL, hall/hall, hall/chorus, plate/plate splits; MIDI parameter control; enhanced sampling in effects; expanded presets, help screens.

Circle (518)

ANT Telecommunications

E-413: Telcom C-4 24-channel noise reduction system.

Circle (544)

Aphex Systems

Model 124: 10/4 audio level interface; converts -10dB unbalanced lines to servo-balanced +4dB, +8dB outputs; simplifies connecting

VCRs, cassette decks, CD players, IHF equipment in the studio.

Model 612: 2-channel expander, gate, ducker; attack, hold, release, ratio, depth controls; high, low-pass filter; instant attack time without clicks.

Circle (548)

Bradley Broadcast Sales

Telos 100: digital telephone interface.

SoundSpace: digital multitrack recording, editing system.

Circle (602)

Broadcast Supply West

Orban 222A: spatial enhancer audio processor.

Circle (614)

Bryston

N/R Portability Pac: encode/decode noise reduction in on-location analog recording; compatible with Dolby SR-280, Dolby A, DBX (K9-22 card) and Telcom C4.

Circle (612)

Circuit Research Labs/CRL

BAP-2000: broadcast audio processor; mono FM limiter for LPTV; sync filter for TV use with jumper that must be removed for radio operation; input AGC circuit.

Circle (681)

See ad page 13

dbx

Model 153: P graphic equalizer.

Circle (696)

Delta Electronics

Z4 processor: stereo multi-band design; connects to external EQ I/O ports of Eliminator;

4-band digital control; all parameters individually adjustable; by Armadillo Audio.

Eliminator: stereo signal processor; digitally controlled differential input AGC; intelligent expander; peak limiter, clipper; by Armadillo Audio.

AMP-1 processor: AM stereo tri-band system; complements ASE-1 AM stereo exciter, other C-QUAM systems; broadband AGC, slow attack, release; processing in L+R/L-R matrix mode.

Circle (697)

See ad page 60

Energy-Onyx

AM Protector-Enhancer: use with existing limiter; switchable audio pre-emphasis circuit, integral 10kHz filter; 10dBm headroom; <0.1% distortion; meets NRSC recommendations.

Circle (745)

Eventide

H3000, H3000B Ultra-Harmonizers: pitch change, audio effects processor; *3000B* version includes 50 radio-relevant audio effects, automatic stereo time compression.

BD1000 digital video delay: TV counterpart of 7s audio delay; 1-20s delay available; Dump button deletes offensive audio/video section, then catch-up feature rebuilds A/V delay to re-establish protection.

Circle (750)

Fairlight Instruments

Series III: music, sound production computer; create, edit, synchronize music, sound effects; 16 channels, expands to 80.

MFX Music Effects: post-production system; Cue-List of instructions coordinates sound effects, music; Series III CPU with SMPTE, MIDI

Continued on page 90

100% SOLID STATE VHF TO 44 KW!

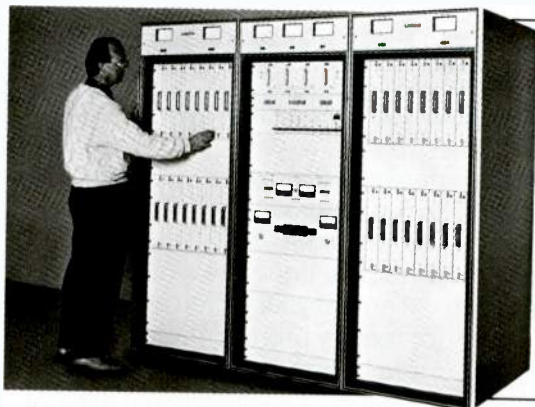

While the others
are delivering promises
LARCAN is delivering
TRANSMITTERS.

While other manufacturers are promising no-tube high power transmitters sometime down the road, LARCAN is delivering our advanced M-line 100% Solid State transmitters to KFVE, Honolulu HI; WLBT, Jackson MS; KMSB, Tucson AZ. In fact, the list of stations choosing LARCAN's advanced, field-proven 100% Solid State technology is growing every month.

These stations are making solid transmitter decisions based on solid facts. And solid savings that go on and on: No more ongoing expensive tube replacements. Broadband amplifiers eliminate tuning adjustments and reduce maintenance. Redundant, modular "fail-safe" circuitry

virtually eliminates lost airtime. Plus LARCAN delivers unparalleled performance and ease of operation.

Superior service from the RF experts at LDL Communications, LARCAN's sales and service subsidiary, is also part of the package.

Let us show you how LARCAN 100% Solid State VHF transmitters are eliminating tube replacement costs, vastly lowering maintenance requirements, increasing reliability and providing remarkable operational simplicity, *right now*. Just pick up the phone and call LDL Communications at 301-498-2200. We've got a solid lead over our competition, and so can you!

LARCAN The best choice for the long run.

Circle (57) on Reply Card

LDL Communications Inc.
14440 Cherry Lane Ct., Suite 201, Laurel MD 20707

UHF BROADCASTERS

YOUR HDTV/STEREO FUTURE MAY DEPEND ON YOUR READING THIS LETTER

BOGNER

Subject: Competing with cable for
HDTV & Stereo

Dear UHF TV Broadcaster,

We are TV broadcasters as well as antenna manufacturers, and as such we have come upon a major problem which could impede the efforts of all of us to compete with other HDTV & Stereo delivery methods. We have found that certain types of TV transmitting antennas can cause large reductions in effective bandwidth, and in aural levels, which could result in terrestrial broadcasting being seriously blocked from advanced uses of the TV spectrum. Therefore we are urging all stations to make a few simple measurements to permit determination of the extent of this problem. It is especially important to do so if your antenna is a bottom fed coaxial or waveguide slot array. Contact your consultant or chief engineer.

An easy procedure for determining if your antenna is contributing to the problem is enclosed, as well as an article describing the theory, and a summary of measured results to date, indicating some severe degradation of reception. *

If an HDTV system is chosen that critically depends on use of the full 6 MHz channel width, which now appears likely, the condition we have found will have a particularly deleterious effect on broadcasting, but would probably not be apparent until it is too late for many stations to correct it. Therefore performing the recommended tests at this time could be of considerable value to the future of the broadcast industry.

We would appreciate being informed of the results, and we will provide any assistance we can. Please do not hesitate to contact us.

Yours very truly,
Bogner Broadcast Equipment Corp.

R. D. Bogner
Richard D. Bogner
Technical Director

RDB/ch
Enclosure

*** CONTACT US FOR
THIS MATERIAL IF YOU
MISSED THE COPY THAT
WAS SENT TO YOU!**

BOGNER[®]

Broadcast Equipment Corp.

603 Cantiague Rock Road, Westbury, NY 11590

Tel: (516) 997-7800 • Fax: (516) 997-7721

Pick up a new Sony ED Beta and get better

It's the kind of definition that gets second looks from everybody.

The kind you've always wanted.

Because the new Sony ED Beta™ VCR format (E for extended, D for definition) produces a picture of incredible clarity.

A picture that could only result by shifting from 5.6 MHz to an astounding 9.3 MHz in the luminance carrier signal. A signal-to-noise ratio improved by 3 db over SuperBeta.™ And an eye-opening 500 lines of horizontal resolution.

Making it a picture unsurpassed for home off-air recording. Vivid, lifelike and highly detailed. Like you're used to seeing in a broadcast booth.

Besides improving what you see, the ED Beta VCR improves what you hear. With Beta Hi-Fi® sound. A dynamic range of more than 90 db. And a frequency response of 20 to 20,000 KHz.

What's more, to insure what you record has the best possible video and audio, ED Beta uses our newly developed, metal particle tape. Which allows for extremely high-density recording.

In short, ED Beta is a format best appreciated by those of you with a very well-developed sense of video.

The machine made for home workouts.

Everything we mentioned above and more is packed into the new Sony EDV-9500 ED Betamax® Professional Editing VCR.

It has our exclusive tape stabilizer system, so time-base error can be reduced significantly.

And editing features unavailable for home use

until now. Like pre-roll editing accurate to within ± 3 frames. An 8-segment programmable assemble edit with random sequence capability. And a direct Jog/Shuttle dial with digital freeze-frame for joggling the tape while in play.

We've also included dual Flying Erase™ heads. An on-screen linear time & frame counter. 2 S Video inputs and outputs. And 2 sets of Video/Audio inputs and outputs for easier editing and use with any camcorder.

There's only one format like ED Beta. Which means there's only one machine like the EDV-9500 ED Beta VCR.

And only one place you'll find it. Call 1-201-930-7669 for the ED Beta dealer nearest you.

Ask for the Sony ED Beta. The ½" VCR with muscles. **ED Beta**

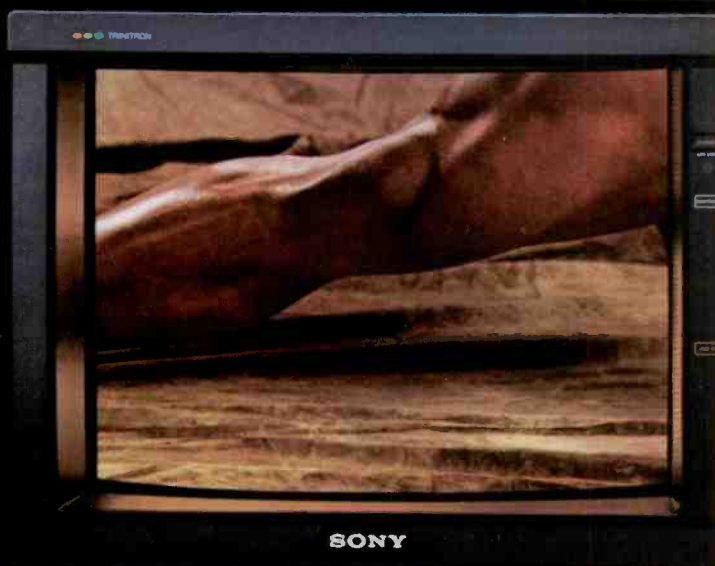
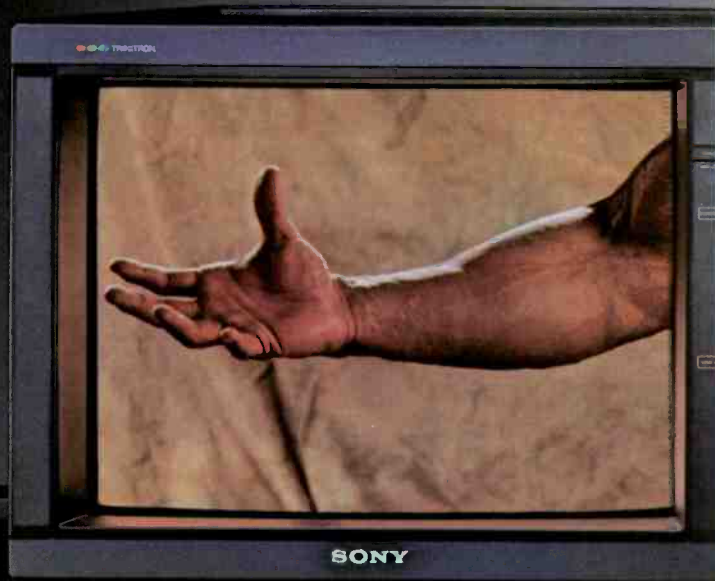

definition instantly.



SONY



SONY



SONY

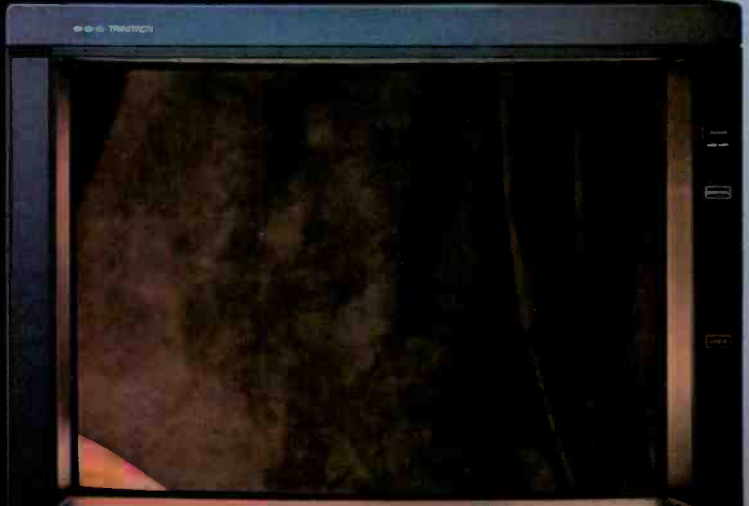

SONY



SONY



SONY
THE ONE AND ONLY.

SONY

Continued from page 86
equipment control.
Circle (753)

Gentner Electronics

Hybrid coupler: send, caller capability makes 2-wire circuit into 4-wire system.

Auto coupler: auto answer, disconnect with send, caller capabilities.

Silence sensor: detects presence, loss of audio; programmable timeout from 1s to 99 min.

Handset interface: provides telephone interface for EFT equipment via telephone handset.

EFT-100 frequency extender: 2-way system for use with existing hybrid; requires single telephone line.

EFT-900A extender: single-line, 2-way device; integral coupler; mic, headset amplifiers.

EFT-1000A: 2-line frequency extender; auto answer; auto encode, decode; two couplers, integral mic, headset amps.

EFT-3000: digital frequency extender; 3-line with digital processing for 7.5kHz bandwidth on all three lines; auto answer, EQ, phase correction, group delay alignment.

EFT battery pack: 4-hour dc power for EFT products when ac is not available.

Remote systems: complete packaged systems to simplify setup and operation for telephone remotes; all equipment pre-wired in single travel-approved case.

Circle (779) See ad page 62

Howe Technologies

2300A PhaseChaser: detects, corrects inter-channel time delays in stereo program; maintains mono compatibility, improves stereo imaging; auto fill-in capability, polarity reversal correction.

Circle (807)

IMC/International Music

SMX007: battery-backed sampler-expander; 10-sample non-volatile memory.

Circle (815)

Inovonics

**222:* NRSC processor; complies with AM improvement program; adaptive pre-emphasis characteristic, enhances signal intelligibility and presence.

Circle (819)

Kintek

KT-904 mono-stereo converters: /S for TV broadcast; /Post for post-production; /Plus2 includes Monogard, correlation monitor.

Circle (844)

Lexicon

Model 2400 compressor, expander: stereo capability; no dedicated machine control interface to run Master mode; slaves to variable speed playback with Timecode Follow interface.

CP-1 digital environment processor: 12-program set generates reverb, ambience, panorama, surround; enhances home listening with stereo or to six additional speakers.

LXP-1: multiple effects processing; VLSI circuitry creates hall, room, plate, gate, inverse reverb, delay, chorus effects; 16 presets, 128 user memory registers.

Circle (862)

Rupert Neve

Neve Prism: rack-mount units derived from Series V consoles; powered from existing console; Formant Spectrum EQ, mic amp/dynamics modules.

Circle (930) See ad page 133

Orban Associates

**642B parametric filter:* switchable 4-band dual, 8-band mono parametric EQ/notch filtering; 12dB/octave Automatic Sliding Besselworth LP filter, 18dB/octave HP filter and vernier-tuned notching.

**787A programmable mic processor:* parametric EQ, compressor, de-esser, noise gate; 99 control setups; MIDI, RS-232 control interfaces available.

222A stereo spatial enhancer: detects, enhances psychoacoustic directional cues in stereo material; increases brightness, clarity, spatial/transient definition.

9105A Optimod-SW: processor for international shortwave AM and SSB broadcast; 3-4dB greater loudness than standard system compensates for noise, interference.

ACC-204 composite isolation transformer: improves S/N, prevents ground loops between stereo generator; installs at exciter, presents generator composite output with balanced floating load.

Circle (946) See ad pages 7, 17

Pinzone Communications

AA-280 audio interface: for unbalanced-to-balanced 600Ω audio.

Circle (969)

RAM Broadcast

E-413: Telcom C-4 24-channel noise reduction system; by ANT Telecommunications.

Circle (985) See ad page 176

Studio Technologies

ISS system: modular, integrated simulator system, mono-stereo recognition for MTS broadcasting.

Mic-PreEminence: 2-channel mic pre-amp.

Circle (1060)

Texar

LAZER: FM stereo generator, limiter; L/R channel inputs, composite output; RF shielding; FMX option; modular construction.

Circle (1093)

UREI

7110: limiter/compressor; program material dependent Smart-Slope compression adjusts from 1.5:1 to infinity; auto preset engages program dependent variable attack/release; fixes compression ratio, average/peak blend.

**7110 compressor/limiter:* complete control over threshold, attack, release time and output level; single rack unit.

Circle (1127)

Valley International

Digital Dynamics Processor: multiband processor; 16-bit linear PCM for on-air; configure as 3-, 5-, 8-band; phase coherent FIR digital filter; compression, phase correction, L+R/L-R matrix, pre-emphasis, fast peak limit.

Circle (1131)

WaveFrame

Digital Signal Processor DSP: module for AudioFrame workstation; 24-bit EQ, pan, gain, effects, reverb, delay.

Circle (1155)

Yamaha Music

REX50: compact digital effects processor.

DEQ7: digital EQ; 44.1kHz sampling, 16-bit conversion, 32-bit processing; graphic, parametric configurations; shelving, notch, dynamic sweep filters; 60 user-programmable memories; MIDI interface.

FMCI: dual-channel/stereo digital format con-

verter from Yamaha proprietary format to unbalanced SDIF-2 (Sony), CD/DAT (S/P) and AES/EBU; 44.1kHz, 48kHz sampling switchable.

REV5: digital reverb; LSI design for enhanced reverb algorithms, increased bandwidth; 44.1kHz sampling, 16-bit quantization; 20Hz-20kHz bandwidth; >84dB dynamic range.

Circle (1170)

See ad page 29

Audio Products

A3: Recording

- Analog, digital
- Audio editing systems
- Recording accessories
- Transport synchronizers

Alpha Audio

BOSS keyboard: editing system accessory; all keys assignable through programming; jog knob for search, jog.

Circle (527)

See ad page 175

AMS/Calrec

AMS Audiofile update: software with cut/paste, scrub edit, other features; interface to video editing controllers.

Circle (538)

ASACA/Shibasoku

AAM-700: IC card audio file; S-RAM storage of 12.2s per card; maximum of 30 cards for 360s of monaural audio; six independent output channels; message sequencing; RS-422 remote control; DPCM coding.

Circle (555)

Audio Broadcast Group

Revox C270: 2-track audio recorder.

Circle (564)

Audio Kinetics

ES Eclipse: 16-machine controller for audio post-production; ESbus controller.

Circle (565)

Broadcast Electronics

PT90-RPS: companion record/play deck to PT90-PS play-only cart system; continuous auto phase correction; learn mode detects type of tape in use for EQ adjustment.

Circle (607)

Broadcast Supply West

Sony PCM-2500: pro R-Dat recorder.

Otari MX55: reel-to-reel recorder.

Circle (614)

Columbine Systems

New England Digital: Synclavier and Direct-to-Disk digital multitrack recorder.

Circle (652)

CompuSonics

Editing enhancement: cut-and-paste edit on DSP-1500 recorder, program sequencing with serial data or MacSonics software option on Macintosh computer.

PC/Sonic: front-end software for DSO-1500 cartridge recorder/editor.

MacDJ: software to control one or more DSP-1200 or -1202 units.

EXD-760: hard disk storage expander; 760Mbyte rack-mount attaches to DSP1500 with 210 minutes stereo recording capacity; may be used for direct playback or allows audio

Prodigy™

Experience the
genius of Videotek.

You're burning the midnight oil.... Final edit's due at 8 a.m.

Be glad you have a Prodigy—the new switcher with more brain-power in a smaller package.

Forget about old two mix/effect systems.

A reliable video switching and special effects system follows the new industry standard—multi-level effects with look-ahead preview. Much more than just another clone, Prodigy raises the standard—offering features no one else does, even on their most expensive systems. Prodigy includes stereo audio-follow-video, editor interface and effects memory—a complete

system for less than \$10,000!

Have it your way.

Modify Prodigy to suit your style of operation and create memorable performances. Program up to 99 events into Prodigy's 68000 microcomputer, then preview the results instantly. Ten programmable sequences link 80 on-line memory registers, and ten learned operator transitions track your actions over time. With Videotek's exclusive Times Six Plus black burst generator, system timing is virtually automatic.

Who says the grass is greener?

Equally at home in the post-production facility, newsroom or

studio—Prodigy rack-mounts in minutes and its software talks to a wide range of popular editing controllers.

Get your hands on a Prodigy and let the performance begin! For more information or the name of your nearest Prodigy dealer, call Videotek today.



VIDEOTEK INC.

Designed for real needs.
Priced for real budgets.

243 Shoemaker Road, Pottstown,
Pennsylvania 19464 • (215) 327-2292
TWX 710-653-0125 • FAX (215) 327-9295

to be transferred to cartridge disks.
DSP-1202: dual digital audio cartridge player.
Circle (662) [See ad page 165](#)

DHK Group

Audisk: digital recording, playback, editing of encoded audio; 14.5kHz stereo bandwidth; for radio automation, basic system has 105 minutes of hard disk storage.
Circle (1220)

Digital Audio Research

SoundStation II: multichannel digital recorder, production workstation; direct-access sound editing, 20-bit processing; keyboard, touch-screen control.
Circle (702)

Fidelipac

Remote control: all functions for DYNAMAX CTR-100 series NAB cart machines.
Circle (760)

FOR-A

Sirius-100: digital audio memory; multiple feature storage system.
Circle (767) [See ad page 155](#)

Fostex

R-DAT: digital recorder/player; locks to video with SMPTE time code for editing.
Circle (770)

Harris Broadcast

XD-001UH: digital tape recorder, player; rack-mount; start ID, program numbers assist in fast cue, music search; remote control option; by AIWA.
Circle (796)

Image Video

AES-2000: digital audio editing system.
Circle (814)

IMC/International Music

DR1200: 12-track digital recorder; PCM design, 44.1K/48k sampling; 17-minute record time on Video 8 cartridge; 16-bit resolution.
Hard disk interface: for S900 sampler to most hard-disk drives.
Circle (815)

IMS/Integrated Media Systems

Dyaxis: disk-based digital recording, editing system; format conversion with SMPTE synchronization; Macintosh with Maxmix software; disk capacity options to 1.2Gbyte.
Circle (816)

Mitsubishi Pro Audio Group

X-86HS: 2-channel digital recorder; samples at 44.1kHz, 48kHz, 88.2kHz, 96kHz; response to 40kHz possible at higher sample rates.
X-86C: 2-channel, dual-format digital recorder; compatible with X-80 format tapes.
Circle (904)

Nagra Magnetic Recorders

TA-Box: connects to T-Audio time code in twin recorder mode with TA-RSA on Sony-2 protocol; for 2-machine audio/video editing.
TA-RSA: RS-422 adapter for T-Audio; allows double system editing on single recorder editors; use with T-Audio machine fitted with TACA-TC2 keyboard.
Circle (921)

New England Digital

Graphics workstation: Macintosh II controls Synclavier and Direct-to-Disk digital audio systems; 18 color graphics screens,

multitasking.

PostPro: digital audio post-production system; 8-track Direct-to-Disk recording, editing; direct transfer from digital tape through PRODIGI standard; AES/EBU, DASH interfaces planned.
Time Compression: for PostPro 8-track Direct-to-Disk digital multitrack recorder; expands, contracts length of program while retaining fidelity of speech, music.
PostPro enhancement: waveform editing; word alignment; dynamic output allocation; time compression; direct digital transfer module.
Circle (931)

Otari

MTR-100A: 24-track master recorder; pinch-rollerless; auto alignment of record, reproduce parameters; analog recording with digital control from alphanumeric keypad, LCD display.
MX-55 2-track series: table-top recorders; over-bridge, time-code overbridge versions; Dolby HX-Pro dynamic record bias linearization; gapless, seamless punch-in/out; mini-locator, cue speaker; optional VEM double speed voice editing
MX-50 prototype: 2-track professional recorder, reproducer; mini-locator, independent reel size selection for supply, takeup; other standard Otari features.
MX-55 prototype: 30IPS version of 1/2" recorder; including EQ section, machine control software; no changes in head or motor required.
T-700 TMD: high-speed video duplicator; Thermal Magnetic Duplication at speeds to 150x normal play; tape bin loop design.
Circle (949) [See ad pages 15, 127](#)

Pacific Recorders & Engineering

Dolby Spectral Recording: Maxtrax format cart machine, performance equivalent to 16-bit linear PCM digital audio recording; 92dB dynamic range, improved headroom, reduced distortion.
Circle (951)

Panasonic/Ramsa

SV-250: portable R-DAT recorder; balanced XL inputs; 2.2-hour record time from NiCad batteries; dual MASH multistage noise shaping A/D converters, 64x oversampling digital filtering.
SV-3500: rack-mount, ac-powered R-DAT machine; remote control; XL-inputs, outputs; fast access; multiple repeat mode; 32kHz, 48kHz record sampling; 32kHz, 44.1kHz, 48kHz playback sampling; IEC interface for direct digital transfers.
Circle (956) [See ad page 79](#)

Quantel

HarrySound: digital audio editor system; controlled from Harry with tablet, pen; six audio record/play "reels" with control of cut, crossfade, offset, gain profile, mix; by SSL.
Circle (979) [See ad page 131](#)

Sharp Electronics

SX-D100: pro R-DAT recorder; 44.1kHz, 48kHz sampling; infrared remote control; hour, minute, second tape counter; play, record timer function; audible cue, review.
Circle (1024)

Solid State Logic

01 Digital Production Centre: signal processor, storage, mixer, editor functions in a single system; features of 8-channel analog mixer with digital quality; integral A/D conversions.
HarrySound: digital audio editor; extends capability of Quantel Harry video editor;

analog to digital inputs or direct AES/EBU digital interface; random access to edit points; no generation losses.
Circle (1034)

Sony Professional Audio

PCM-2500 pro R-DAT recorder: SDIF-2, AES/EBU connectors interface 32, 44.1, 48kHz sampled signals for digital dubs to, from CD mastering system and DASH recorders.
DAE-3000 digital editor: CD master tape production system with editing resolution to 23µs; improved crossfade; 16-bit digital gain fader; edit setup menus.
Circle (1039)

Soundmaster

EBU/SMPTE bus interface: for machines using this protocol.
Soundmaster system: integrated audio, video editor control with Synchro distributed processing, Smart Sync varispeed machine synchronizer.
Shuttle Goto Interface: varies speed of reel motors rather than FFW, REW commands; interfaces for many video machines, as well as Sony, MCI, Studer.
SHUTL: remote control; shuttle, jog modes for audio, video decks; 13 programmable user keys permit 79 keystrokes per key.
CMX Download: permits Soundmaster system to clean video edits, auto conform the EDL list; all EDL functions included.
Circle (1044)

Stanton Magnetics

Disco Starter kit: everything the DJ needs to get started.
DP5107AL: 3-stylus pack.
Circle (1049)

Studer Revox America

Enhanced A820-8: 8-channel 1" A820 series multichannel recorder.
A807 VUK series: floor console recorders; HS high speed 1/4" 2-track; 4-1/2" 4-track 1/2"; 3-speed, dc-servo capstan motor, MDAC electronics, Dolby HX Pro; RS-232 remote control.
C274, C278: compact 4-track 1/4", 8-track 1/2" recorders; 15/32-15ips; LED-peak, VU graph meters; remote port; internal time, date code generator, reader; Dolby HX Pro Headroom Extension; SMPTE center track LTC.
C270: compact 2-track 1/4" recorder; 3-speed and variable; monitor speaker, headphone output; Autolocator with Zero and Address cuing.
Circle (1059) [See ad pages 34, 171](#)

TASCAM

PRO DAT DA-50: digital cassette recorder; 32kHz record/play, 48kHz record/play, 44.1kHz play sampling; oversampling digital filter; intelligent disk-top hard-wired remote control.
ATR-80 recorder: 24-track 2" system.
**238 Syncassette*: 8-track cassette recorder.
ES-50: transport synchronizer, with ES-51 controller.
MTS-30: MIDI tape synchronizer.
ATR-6016: 16-track format recorder; 1" tape.
Circle (1075) [See ad page 45](#)

WaveFrame

SoundStore: 90-900Mbyte hard disk sample sound storage; for AudioFrame system; database, query provides fast location of individual sounds.
Memory expansion: 6Mbyte, 28Mbyte modules extend recording time of AudioFrame Sampling Synthesizer to 69s, 370s.
AudioFrame: audio workstation; produces

Get in sync with Videotek's versatile team of timing devices.

No matter what your application, Videotek has a range of feature-rich timing devices to suit it—and your budget.

Take our new VDP-8000 Frame Store/Synchronizer with independent Freeze Field capability. Our two blackburst generators—each with individual horizontal and sub-carrier timing correction for up to six sources. The Times Six Plus model offers manual or automatic operation and automatically compensates for cable length and equipment drift.

Our new drift-free VSG-201 digital sync generator with six isolated blackburst outputs, audio test tone and "textbook" SMPTE color bar outputs can drive the whole show. And all units feature front-panel gen lock input loss/presence indicators.

Don't waste a try time! See your Videotek dealer for details!



VIDEOTEK INC.
Designed for real needs
Priced for real budgets.

243 Shoemaker Road Pottstown,
Pennsylvania 19464 • (215) 327-2292
TWX 710-653-0725 • FAX (215) 327-9295

Circle 51 on Reply Card

finished tracks within digital domain.
SoundProcessor: software for AudioFrame; user interface, cut/paste editing, stereo sampling, AudioTrigger for track replacement.
ADC8 module: 8-channel A/D converter for AudioFrame for multichannel mixing, recording.
VITC synchronization: for AudioFrame to align pictures and sound in video post-production; part of Studio Control Processor module.
Circle (1155)

Audio Products

A4: Sources, monitors

- CD players, phono
- Headphones, headsets
- Intercoms, speakers
- Monitor amplifiers
- Wired, wireless mics

AKG Acoustics

C-562: natural response, shock-isolated boundary mic, windscreen.
C-522 ENG mic: electret capsule in hand-held, boom type; *M-S* or *X-Y* stereo configurations.
C-414BULS: FET condenser mic; large diaphragm, ultra-linear response; 4-pattern selection.
Circle (518)

Allied Broadcast

Denon DN950F: CD cart player; special cartridge stores CD, is inserted into the player, similar to cart tape; front panel LED data display.
Audiometrics AMCD5 1000A: 100-disc CD multipley; up to nine random selections or play all tracks, all discs in sequence.
Circle (524)

Alpha Video & Electronics/AVEC

News Connection: IFB system; reporters page director from remote locations for confidential communications; director access to five separate lines simultaneously with audio cues to one or all locations; expands to 25 lines.
Circle (528) [See ad page 122](#)

Arrakis Systems

Modules: utility units for the studio; DAs, phono pre-amp, others; designed on Series 10,000 console concepts.
Circle (552) [See ad pages 21, 33](#)

ATI/Audio Technologies

M11 mic amp: low-noise, high CMR direct balanced input instrumentation amplifier; distortion-free, transformer isolated line output; variable gain in; switchable limiter; low-cut filter; 48Vdc phantom power; output phase reversal.
Circle (560)

Audio Broadcast Group

Studer A727: CD player.
Circle (564)

Audio Engineering Associates

MS380TX: two mic pre-amps; full-function, dual-mode MS matrix, high level stereo line driver.
Circle (1231)

Audio-Technica

Model AT4071: externally polarized, transformerless line-gradient mic; lightweight, low-noise, high output.
Model AT4073: short version of AT4071; slightly wider acceptance angle.
Model AT8506: 48V 4-microphone phantom supply; ac-powered.
Model AT4031: cardioid studio/field production capacitor mic.
900 series: studionphones *ATH909*, *AT911* open-back; *ATH910* closed-back; 96dB sensitivity; 4-24Ω matching impedance; 20Hz-20kHz (to 25kHz for -91).
Circle (567)

Benchmark Media Systems

Interface amplifiers: balanced, unbalanced inputs, outputs; mixing balanced outputs; headphone amps; custom configurations; 1-RU rack-mount.
Circle (589)

Beyer Dynamic

MCE10 mic: miniature hypercardioid.
MPC60: cardioid or hypercardioid acoustical boundary mic.
Pre-amp: for MCE 5 omni, MC10 supercardioid condenser lavalier mics; allows battery or phantom power from 12V-48V.
MCE86 mic: short shotgun for studio, on-location; on-camera, fishpole boom, hand-held; 95g weight; condenser element, hypercardioid pattern; response 50Hz-18kHz; phantom power 12V-48V.
MCE81 mic: shock-mounted supercardioid.
M58 mic: ENG/EFP sports, news interviews; internal shock-mount reduces handling noise; extended response, weight-balanced, no-glare matte black finish.

MPC40: omnidirectional acoustical boundary mic.

Circle (590) [See ad page 55](#)

Bradley Broadcast Sales

Tannoy PGM-6.5: reference audio monitor.
Circle (602)

Bryston

BP-1 phono pre-amp: within 0.1dB of RIAA curve from 20Hz-20kHz; balanced outputs on XLR connector; distortion <0.005%.
DAC power amplifiers: balanced inputs (unbalanced option); remote gain control; available on 2B-LP, 3B and 4B monitors.
Circle (612)

Cetec Vega

Ranger 2: wireless mics; 2-B T-93 bodypack, 2-BM LM-206X mini omni electret, 2-HA T-96 hand-held, 2-HV T-94 Vega K4 condenser; CVX audio processing; R-98 true-diversity receiver.
Q Plus: wireless intercom; full duplex operation, programmable interface.
R-33 ProPlus: miniature wireless mic receiver for ENG.
PRO 2: wireless mics; 2-B T-37 bodypack, 2-HE T-36 EV BK-1 condenser, 2-HS T-39 handheld Shure SM96 condenser element; R-32 true-diversity receiver.
Circle (637) [See ad page 85](#)

Clear-Com Intercom Systems

TWC-10 adapter: two standard Clear-Com channels (on separate cables) to single standard 3-pin microphone cable.
WBS/STR wireless intercom: WBS-6 base, WTR-1 portable transceivers; accessories; full duplex, dynamic companding; low noise, good dynamic range.
TW option: converts 6-pin cable, 2-channel intercom to single 3-pin cable, 2-channel operation.
ISO-4000: station isolate system; establish private, isolated 2-way communications between Clear-Com stations in conference line intercom system; expands to isolate 16 stations from multiple control points.
RMK-1 control: remote kill function; shuts off live intercom mics to cancel noise; for series 500 belt, main or remote stations.
Circle (646) [See ad page 59](#)

Comprehensive Video

Production Music Library: 5-CD collection, in stereo.
Circle (658)

<p>The NEWS from PERROTT</p>  <p>You know our quality compare our price</p>	<p>The "441" discharger/charger for NPI's and NPJA's</p>  <p>4 independent units in one</p> <p>Weights 5 3/4 lbs. total</p> <p>115/230 AC</p>	<p>THE onboard "14" with FREE minicharger built in</p>  <p>eliminates extra costs all metal casing</p> <p>115/230V AC</p>	<p>Micro Minicharger® for 4 AH Nicads</p>  <ul style="list-style-type: none"> • BP90s • On Boards (14.4V to 12V) • Belts (14.4V to 12V) • Pocket Sized • 115/230V AC <p>PE 383</p>
<p>•SINCE 1957• For information, call or write: PERROTT Engineering Labs, Inc. 7201 Lee Highway, Falls Church, VA 22046 (703) 532-0700 (703) 528-5861</p>			

Circle (62) on Reply Card



25000J
FM Transmitter

300J
FM Transmitter

Model X
FM Exciter

Silverline UHF
TV Transmitter

Silverline UHF
TV Transmitter

1000W UHF
TV Transmitter

100W UHF
TV Transmitter

FOR BROADCASTING EXCELLENCE... SOLID, POWERFUL, TELEVISION AND RADIO EQUIPMENT

High Power UHF TV Transmitters

TTC's Silverline UHF TV Transmitters provide the ultimate in picture quality, reliability and efficiency. These transmitters are designed that way, without compromise.

All new state-of-the-art design utilizes CMOS logic for control functions. Silverline multiple klystron transmitters maximize reliability by offering total redundancy. Each multiple klystron transmitter includes two or more amplifier cabinets, control circuits, high voltage contactors, beam supplies, cooling systems and exciters.

Low Power Transmitters

TTC offers a full line of outstanding VHF and UHF translator-transmitters, with an ultra-stable design that assures high quality and trouble-free operation.

For both VHF and UHF TV up to the 100W level, TTC offers solid state translator-transmitters designed for worry-free unattended operation in remote and hostile environments.

The 1000 Watt TTC XL1000 has become the best selling UHF transmitter in the world. Long-term reliability, performance, advanced capabilities, and versatility for use with UHF, VHF, satellite, or video inputs provide you with assurance of lasting quality.

FM and AM Radio Transmitters

TTC has established a longstanding track record for producing highly reliable and durable FM and AM radio transmitters—combining unsurpassed value and performance.

A complete line of transmitters is manufactured including units with a power output of as low as 30 Watts and ranging upward to 50,000 Watts.

Featuring our clean, uncomplicated designs incorporating refinements developed from over twenty years of proven performance in radio stations worldwide, today's TTC radio transmitters provide unmatched price-performance value and quality.

If you missed us at NAB, call or write us at our new location:

TELEVISION TECHNOLOGY CORPORATION
P.O. BOX 1385 • BROOMFIELD, COLORADO 80020 USA • (303) 665-8000 • TWX: 910-938-0396 TTC COLO

Circle (63) on Reply Card

ComTek Communications

MR-180: miniature wireless mic receiver for use on video cameras.

Phase Right +1: active, dual summation, gated antenna system.

Circle (669)

Countryman Associates

ISOMAX TVH: enhanced hypercardioid lavalier mic; reduces room noise, reverb from 6dB to 15dB; less phase cancellation in multiple mic systems.

Circle (680)

Electro-Voice

RE45N/D: Cardiline N/DYM handheld shotgun; adaptor for stand, boom mount; light weight; high-flux neodymium magnet reduces size; background noise attenuation; cardioid pattern; accessories.

Circle (738)

See ad page 181

Farrtronics

M86 series: rack-frame, power supply, M86-AMP-IC universal (intercom) amplifier, M86-IFB module.

Circle (755)

Gentner Electronics

6x amplifier: 2W/channel headset, speaker amp; individual, master level controls.

Remotable amplifier: 35W/channel; dual mic, line level inputs; remote speaker level control.

Circle (779)

See ad page 62

Alan Gordon Enterprises

Sonic 312/307: Sonic mic booms, boom holders.

Circle (784)

HEDCO

HPA-100: HEDLine audio power amplifier.

Circle (799)

HM Electronics

EM43 mic: omnidirectional electret lavalier; includes clip, windscreens, case; for broadcast, entertainment, church, theatre.

RX520: switching diversity receiver for System 50, 55 mics; with NRX-11 noise reduction.

System 50: 2-channel wireless bodypack mic. *System 55*: wireless handheld mic.

RP733 power station: rack-mount; for 700-series cabled intercoms and other 3-wire systems; operate up to 100 BH720 beltpacks.

DN100: antenna distribution system; operate four RX520 receivers from two antennas.

Circle (803)

See ad page 121

IGM Communications

CD-240: multidisc CD player.

Circle (811)

JBL Professional

Control 5: studio monitor; 2-way for nearfield broadcast, recording, sound reinforcement, foreground monitoring.

Energizer 6210/6211: power amps convert Series 4400 or other 8Ω speakers into self-contained sound system; 40W output to 8Ω, low TIM.

Circle (827)

Lectrosonics

PRO mini: miniature wireless mic for field production; XLR receiver output.

PRO 4-channel: wireless mic for studio, ENG.

H-185: hand-held wireless mic transmitter.

QUAD mini: miniature 4-channel wireless mic

system; field, ENG production.

Circle (856)

Logitek

MON-S/2: stereo monitor, multirange meter; 6W speaker; fits standard TEK 1/2-rack unit.

Circle (867)

McCurdy Radio Industries

CS-9400+: digital intercom; point-point, dynamic party line, interrupted foldback, radio/telephone interface, 2-wire beltpacks; expandable 640x640 matrix; programmable with standard PC.

CS-9500: digital intercom; 4-wire central matrix; 3RU frame holds 25 50x2 crosspoint cards, controller card, optional redundant power supply; 50-inx50-out configuration; additional input per card for IFB.

Circle (887)

See ad page 77

McMartin Industries

LT-502/6D, LT-1002/6D: 50W, 100W universal audio amps; bass, treble, gain controls; two mic, two line inputs; ±1dB, 20Hz-20kHz; <0.5% IMD.

MS series: commercial sound universal, power, mixer/line amps.

LT-1000D, LT-3500D: 100W, 350W power amps; <1% distortion 30Hz-20kHz; hum, noise <-80dB below rated output; unbalanced, balanced inputs, outputs.

Circle (890)

Micron Audio

CNS-500 series: wireless systems; hand-held, pocket type transmitters; portable and modular

Continued on page 100

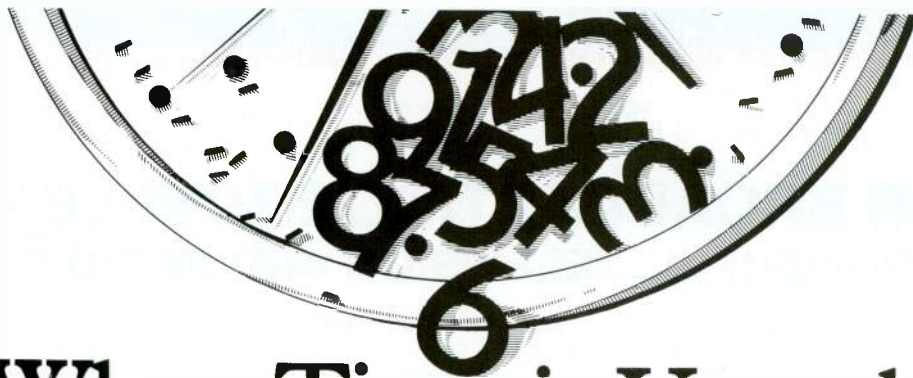

When Time is Unreal, You Need Real-Time.

Quanta presents a very practical solution to crunch time: the new anti-aliased, free-form Delta I™ character generator with real-time operation. *Real-time* as in instant sizing by character, instant rendering, and instant digital compositing.

And with features like flash digitizing and dual frame buffers, Delta I is the perfect solution to your production pressures.

The new Delta I character generator from Quanta. Real-time for the next time you're in a squeeze.

We Liberate the Imagination.

QUANTA®

DYNATECH Broadcast Group

Quanta Corporation • 2440 South Progress Drive • Salt Lake City, Utah 84119 • (801) 974-0992

Circle (64) on Reply Card

Alone At The Top!

IKEGAMI'S TELECINE SYSTEM
STANDS ALONE AS THE BEST

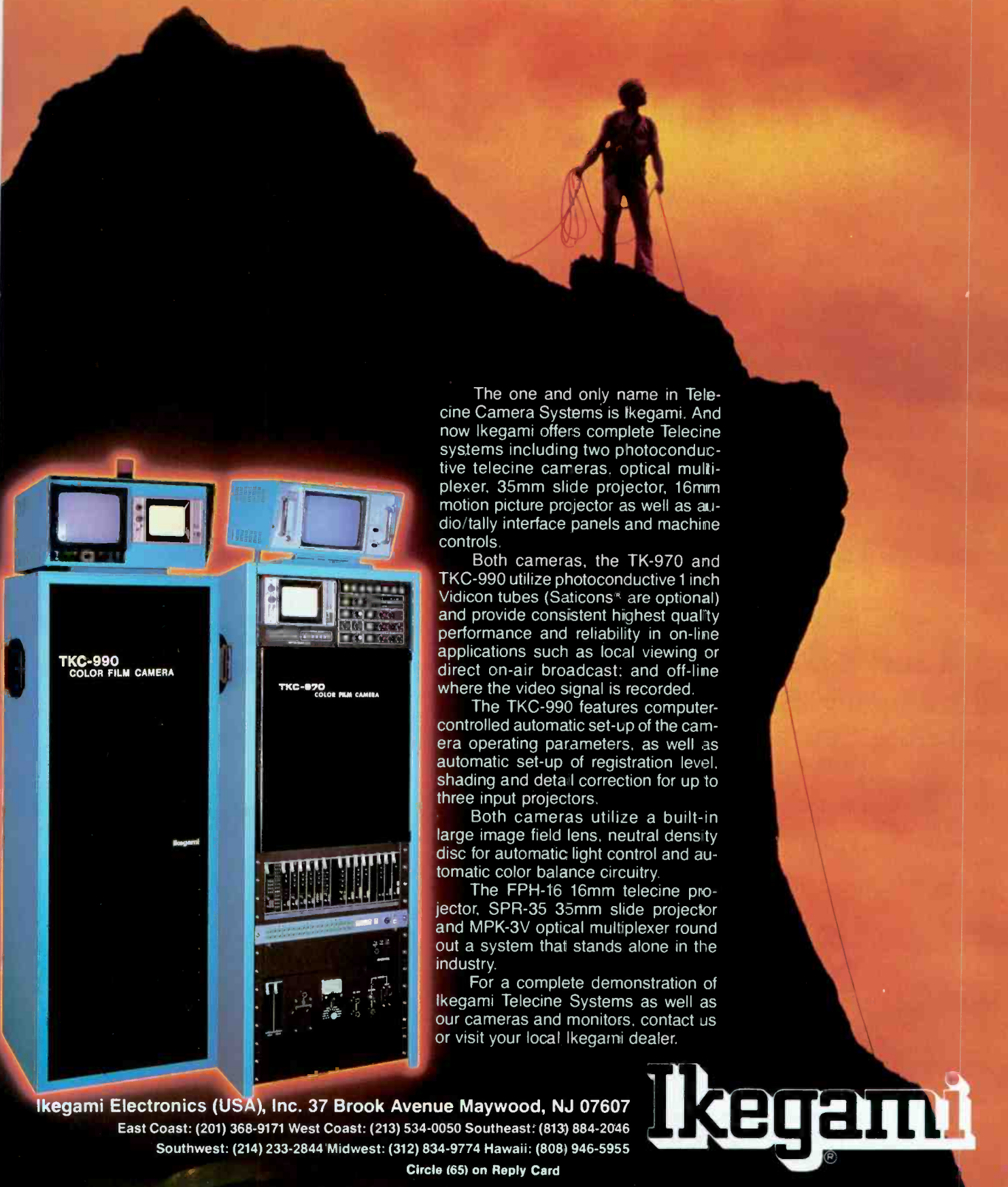

The one and only name in Telecine Camera Systems is Ikegami. And now Ikegami offers complete Telecine systems including two photoconductive telecine cameras, optical multiplexer, 35mm slide projector, 16mm motion picture projector as well as audio/tally interface panels and machine controls.

Both cameras, the TK-970 and TKC-990 utilize photoconductive 1 inch Vidicon tubes (Saticons[®] are optional) and provide consistent highest quality performance and reliability in on-line applications such as local viewing or direct on-air broadcast; and off-line where the video signal is recorded.

The TKC-990 features computer-controlled automatic set-up of the camera operating parameters, as well as automatic set-up of registration level, shading and detail correction for up to three input projectors.

Both cameras utilize a built-in large image field lens, neutral density disc for automatic light control and automatic color balance circuitry.

The FPH-16 16mm telecine projector, SPR-35 35mm slide projector and MPK-3V optical multiplexer round out a system that stands alone in the industry.

For a complete demonstration of Ikegami Telecine Systems as well as our cameras and monitors, contact us or visit your local Ikegami dealer.



Ikegami Electronics (USA), Inc. 37 Brook Avenue Maywood, NJ 07607

East Coast: (201) 368-9171 West Coast: (213) 534-0050 Southeast: (813) 884-2046

Southwest: (214) 233-2844 Midwest: (312) 834-9774 Hawaii: (808) 946-5955

Circle (65) on Reply Card

Ikegami[®]

Here's a far out way



and a down to earth

Introducing the Cycle Sat Satellite Courier System.

With the dramatic increase in the number of spot commercials and the revenues they generate, your television station faces a critical need for a dependable, fast, accurate system for receiving network quality spots and traffic instructions on time.

Any commercials OR traffic instructions that are misplaced or damaged due to land or air courier error can mean financial loss to your station or the inconvenience of "make-goods."

Now there's the *Cycle Sat Satellite Courier System*. Cycle Sat can provide you with network quality spots AND traffic information – including updates in a timely fashion, allowing you more scheduling time. Changes in trafficking can now be instantaneous instead of late or lost.

Cyclecypher downlinks fast!

Cycle Sat's proprietary Cyclecypher®, when installed in your station, is capable of automatically recording **only** those spot commercials



to deliver TV spots...

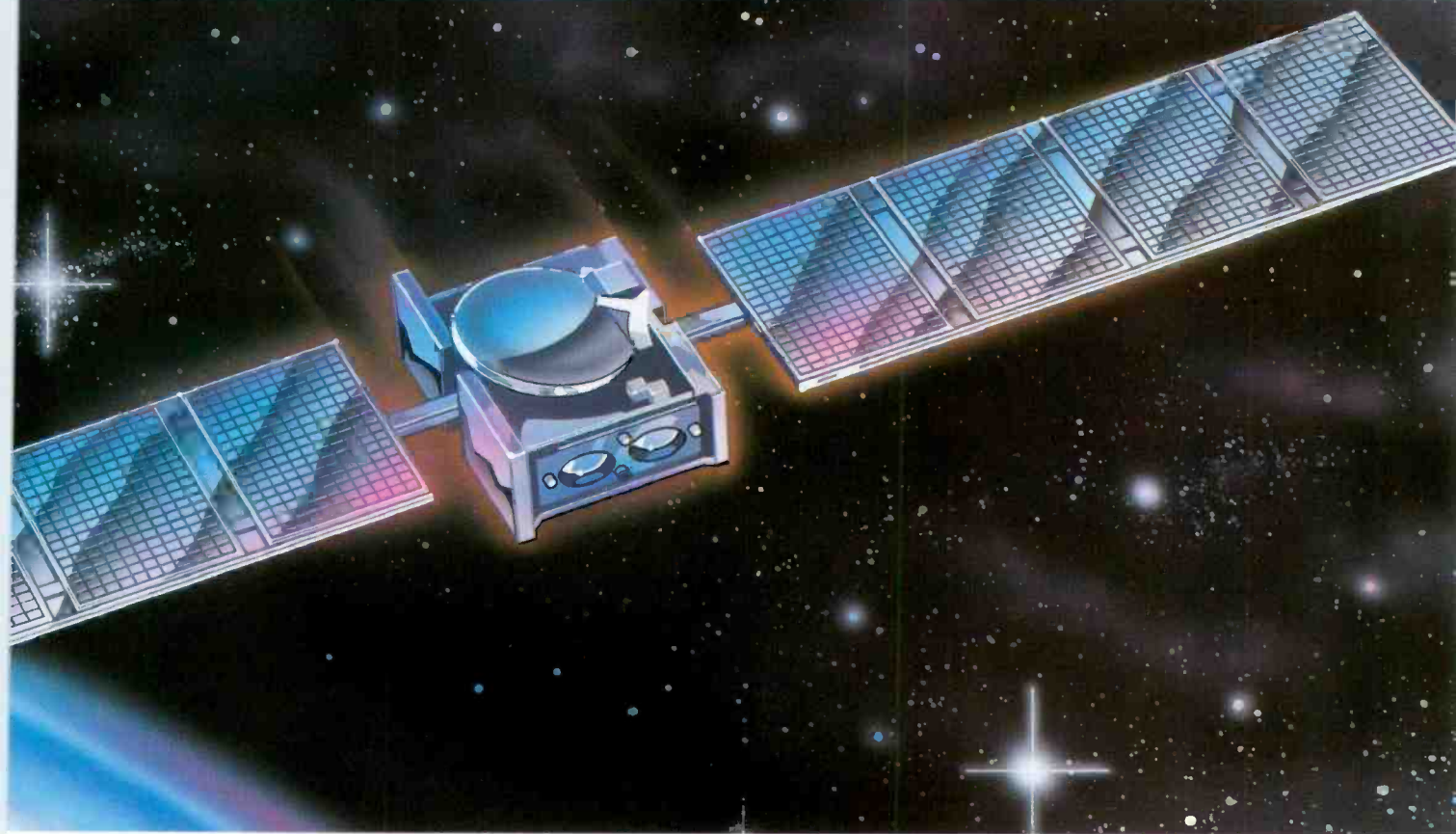

way to receive them.

intended for your station. What's more, they may be recorded in off-peak time periods.

With reception of either Ku-band or C-band, our nightly transmission schedules reduce your recording equipment conflicts by allowing you to receive all scheduled commercials during a **single** feed. By the use of the Cyclecypher system, you can reduce operation time and store commercials in just 25% of the space required to store a similar number by conventional means.

The Cycle Sat Package.

When you sign-up for the *Cycle Sat Satellite Courier*, you will receive the Cycle Sat package, which includes: a Cyclecypher, Ku-band/C-band satellite data decoder/receiver, a high-speed Cycle Sat printer, a remote record indicator, two interface cable packs, and \$100 to help cover your installation costs.

For consistent clear picture quality, reliability, timely delivery and scheduling of spot TV, call toll-free 1-800-622-1865.



CYCLE • SAT
SATELLITE COURIERS

DELIVERS CLEAR SOLUTIONS

A subsidiary of Winnebago Industries Inc.
119 Willowglen Drive
Forest City, Iowa 50436

Offices in Los Angeles, Chicago and New York

Continued from page 96
space diversity receivers.
Circle (897)

Microset

Digicom 50: digital loop intercom; supervisory station supports 50 keypanels, program feeds, telco lines, paging speakers, 2-way radios; multiline display shows system setup.
Circle (1221)

Nady Systems

101VHF wireless: 1-channel receiver; 101HT hand-held or 101GT bodypack transmitter; 170-216MHz spectrum.

Nady 1200VHF: wireless; diversity receiving; HT hand-held, GT bodypack, LT instrument mic transmitters.

Nady 201VHF: wireless mic with diversity receiving; 201HT hand-held or 201GT bodypack transmitters; 170-216MHz.
Circle (920)

Panasonic/Ramsa

SL-4300: single-tray CD player; broadcast, production, sweetening, on-air; 10-key pad for direct access to any track; preset play sequences for 20 track selections; automated playback with multiple units.

SL-4700: CD player with removable 6-disk magazine; 36-step programmability for one disk or tracks across all six disks; 4x oversampling digital filter.
Circle (956)

See ad page 79

Peerless Sales

**040-815-02 Radial Cube*: mounts speakers up to 75 lbs on wall, ceiling; directional H/V axes adjustments.
Circle (958)

R-Columbia Products

52/XT: headphone/microphone for the telephones.

6058/T: ENG/IFB "hands free" telephone; tone dialing; mic mute switch; incoming call volume control; aux mic input for ENG, aux out for IFB.
52/700: amplified camera operator headphone; lightweight; phantom-powered amplifier, noise-canceling mic; standard PJ-051 plug.

TR-50/PRO: 2-way wireless intercom headphones; 2-channel; channel selector allows operation on either of 2 non-interfering networks in the same area.

TR-50/B: wireless-to-wired base station interface for TV camera intercoms; full, partial duplex.
Circle (988)

RF Technology

RF-101B/104B: 950MHz diversity wireless mic; OB/field use.
Circle (995)

See ad page 184

ROH

**303PS*: portable party-line supply; phantom power 12-15 PL headset stations, beltpacks; user programmable.
Circle (999)

See ad page 191

RTS Systems

BP317: portable single-channel headset user station; TW or Series 17 intercom component.
CC62/CPK62: intercom user station mini circuit card/assembly; TW intercom component.
CIF612: camera-iso interface; TW intercom component.

**848A*: 24-channel programmable matrix intercom station; series 800 component.

DC848: data concentrator; for 848A systems.

**2524*: dual 8x1 audio summing amplifier; series 2500 component.

BP325: portable 2-channel programmable headset user station; TW intercom system component.

Circle (1008)

See ad page 58

Sanken Microphones

CMS-9 MS microphone: portable MS-stereo instrument; outputs normal stereo signals as input to DAT machine equipped with L-R and 48V phantom power; 108dB dynamic range; nearly flat response.
Circle (1012)

Sennheiser Electric

MKH 30 P48U3: figure-8 condenser mic; symmetrical capsule, for M-S recording; transformerless.

RS-2012 Six Pack: wireless multichannel receiver; six SK2012 VHF bodypack transmitters; six EK2012 VHF receivers; common dc power supply, antenna diplexer.

MKE 4032: stage vocal mic; metal body, double-screen basket; supercardioid pattern reduces feedback.

HD-480, HD-450: headphones; neodymium iron magnets; 70Ω impedance; -450 20Hz-20kHz; -480 18Hz-22kHz.
Circle (1021)

SESCOM

Rack products: line-level active combiner and monitor amp, speaker.

Mic-line drivers.

Mixers: mini-console systems for audio, video production studios.
Circle (1022)

Shure Brothers

SM15: headworn condenser microphone.

W15HT/87, W15HT/58: hand-held wireless mics.

PDPI000: pro CD player for broadcast use.

SM84: supercardioid condenser lavalier mic.
Circle (1027)

See ad on Inside Front Cover

Sony Professional Audio

VHF 400: wireless mic system; *WRT-410* hand-held, *WRT-420* bodypack transmitter with ECM-77B lavalier; *WRR-410* receiver, *WRR-420* diversity receiver.
Circle (1039)

Sound Genesis

Master Sampler Collection: computer/keyboard-based virtual instruments; with ScoreKeeper selection, audition of instruments.
Circle (1279)

Stanton Magnetics

SRS-215, -225, -245, -265: pro headphones.

ST-PRO, ST-4: pro headphones.
Circle (1049)

Studer Revox America

A730 Pro CD player: direct access to track, index; autocue finds start, end of modulation; non-volatile memory for 100 CDs; three start cues per CD; accepts 3" CD without adapter; cue speaker; parallel remotes with RS-232, 422, tallies.
Circle (1059)

See ad pages 34, 171

Swintek Enterprises

Mark 200DP: lightweight, full-duplex transceiver; integral antennas; compatible with standard headsets.
Circle (1062)

Symetrix

SX-201: parametric EQ/pre-amp.

SX-202: dual mic pre-amp.

SX-203: single-line telephone interface.

SX-204: headphone amplifier.

Hybrid: automatic telephone interface.
Circle (1067)

Tannoy North America

PBM 6.5, PBM 8: playback reference monitors.

SR140, SR-740: high-current, MOSFET amplifiers.
Circle (1073)

Telex Communications

HT-400: 2-channel wireless mic, transmitter.

LM-300: unidirectional lapel mic system.

WT-400: 2-channel wireless mic transmitter.

FMR-4: 4-channel wireless receiver.

ENG-4: 4-channel wireless receiver.
Circle (1090)

See ad pages 135, 145, 187

TV Equipment Associates

Drake intercoms: μ P-controlled matrices, talkback features.
Circle (1089)

Ward-Beck Systems

MicroCOM-II: μ P-controlled TV plant intercom; bidirectional data transfer on single audio pair, assignable key functions, alpha/numeric readouts, central salvo reprogramming.
Circle (1153)

See ad on Back Cover

Whirlwind

US-A audio power amp: 40W stereo.

PHMAS: headphone amplifier system.
Circle (1162)

Yamaha Music

S110H/S115H: Club series speakers; 10" or 15" with horn tweeter; 200W program power capability.

SM10H/SM15H: 10" or 15" Club series speaker with horn tweeter; slant-front floor monitor; 150W or 200W program power capability.

S115MT: Club series speaker includes 1-15"; 1-6.5" mid-range, 1-3.2" bullet tweeter with 200W program capability.

MZ203Be: dynamic vocal mic; wide response with laminated beryllium diaphragm.

MZ106S: dynamic mic; high quality with Off/On switch.

MZ204, MZ205e: percussion mics for drum pickup; multiple axis stand mount; 90° XLR connector; -205e for higher frequency transient response; -204 for low frequency sources; 250Ω impedance; -77dB/ μ bar output at 1kHz.

NS40M Studio: audio monitor; 3-way system for close-field monitoring; white-cone woofers, soft-dome mid-range driver, soft-dome tweeter; 100W capacity; 50Hz-20kHz.
Circle (1170)

See ad page 29

RF Products

R1: Transmission

- Antennas, towers
- Radio, TV transmitters
- Transmission line

Acrodyne Industries

Freedom Line TR series: internally diplexed 5-20kW VHF, 30kW UHF transmitters; tetrode visual PAs, solid-state drivers; stereo ready.

GO FOR THE GOLD WITH FUJINON



Clean Sweep

For every one of their new cameras, CTV Television Network, Ltd., host broadcasters for the '88 Winter Olympics, selected Fujinon — more than 18 lenses in all. In the strongest domination of the games, all the action captured by CTV cameras — from the widest panoramas to the longest, tightest close ups on the slopes — will be through Fujinon lenses.

Covering the downhill like it's never been covered before, Fujinon is providing a new secret weapon... the longest focal length lens ever used in broadcast television. Watch the races and see the difference.

Twenty-eight new CTV cameras will be equipped with the industry-proven A44X9.5ESM. From a wide 9.5mm out to 420mm and an F1.4 maximum aperture flat to 240mm (F2.5 at 420mm), the 44X takes first place for the best ramping characteristics in the long focal length competition!



Fujinon's brand new 13kg A34X10ESM will be on 10 new CTV cameras. No larger than the lens it replaces (the A30X11ESM), its coverage is wider and longer. From 10mm to 340mm with an F1.6 that's flat to 229mm. Naturally, it has a built-in 2X extender.

In the handheld competition, Fujinon wins hands down with 28 new CTV cameras equipped with the A14X9ERM, 7 cameras with the A8.5X5.5ERM ultrawide zoom, and five cameras with the A18X8.5ERM. All three compact, lightweight, weatherized lenses have built-in extenders.

Long the industry's favorite ENG lens, the A14X9ERM zooms from 9mm to 126mm while the maximum aperture is F1.7 out to 103mm. For events demanding wider and longer coverage, the 18X provides 8.5mm to



153mm range with an F1.7 aperture constant from 8.5mm to 116mm (F2.3 at 153mm). And for wide angle abilities, nothing beats the A8.5X5.5ERM. It's an F1.7 that zooms from 5.5mm to 47mm. And even with its 1.7X extender in position, it provides a familiar 9.4mm wide angle.

In addition to the CTV cameras, most of the production companies supporting the coverage will be bringing Fujinon equipped cameras. And, naturally, Fujinon will be on hand to provide field support. After all, one reason Fujinon lenses are so widely used is Fujinon service — it's as good as gold, too.

To learn more about the lenses that scored a clean sweep, you'll get more information or a demonstration by calling the Fujinon location nearest you.



Circle (67) on Reply Card

FUJINON INC. 10 High Point Drive, Wayne, N.J. 07470
SOUTHERN 2101 Midway, Suite 350, Carrollton, Texas 75006
MIDWESTERN 3 N. 125 Springvale, West Chicago, Ill. 60185
WEST 129 Savarona Way, Carson, Calif. 90746

(201) 633-5600 Telex 68 18115
 (214) 385-8902
 (312) 231-7888
 (213) 532-2861 Telex 194978



FUJINON

10 High Point Drive, Wayne, N.J. 07470

Freedom Line TL series: 1W-1kW UHF, VHF TV transmitters, transmitters; broadband solid-state amplifiers.

Freedom Line TCV VHF: VHF TV exciter; front panel selector for mono, MTS sound; TXCO oscillator; all solid-state design; meets FCC, CCIR spec.

Freedom Line FL series: VHF transmitters; Bands I, III; 1kW to 60kW; solid-state aural PA; 1-tetrode visual PA 20kW and up; external diplexing; driven by TCV VHF exciter; MOV power supply protection.

Freedom Line FL series: UHF transmitters; FL/5KU, FL/10KU, FL/30KU; 1-tetrode visual PA, air-cooled to 10kW; solid-state aural PA; optional Marconi B7500 exciter, dual channel for stereo.

Marconi B7540 series: UHF TV transmitters; 10kW to 60kW; for G/I/M/N systems with NTSC, PAL, SECAM color; dual sound; external cavity klystrons.

Circle (506)

Andrew

Waveguide antenna: high-power UHF TV TRASAR antenna; capable of powers greater than 220kW; custom azimuth, elevation patterns.

Pressurization equipment.

MACX series: bellows construction rigid transmission line, eliminates sliding contacts and resultant copper shavings; 3-1/8" through 5-1/8"; 50Ω, 75Ω.

HJ12-50: 2-1/4" air-dielectric Heliac; for class B 25kW FM transmission.

ACW series: circular waveguide for high power transmissions.

Ground straps: applicable to all Heliac products.

GUIDELINE GLW series: high power waveguide

for UHF TV; handles more than 110kW; single-polarized operation; lower wind load than elliptical, truncated or rectangular.

Circle (541)

Broadcast Electronics

FM-20A: 20kW FM broadcast transmitter; λ/2 output cavity, auto power control; μP video diagnostic system.

FM-1A: 1kW FM transmitter; direct RF drive output from FX exciter to single tube PA; folded λ/2 output cavity; auto power control; 7-LED diagnostic indicators.

Circle (607)

Browning Labs

VHF k-Line: TV transmitters; TVT-5k/V 5kW, TVT-10k/V 10kW, TVT-20kV 20kW; tube-type PAs; CMOS logic controller; IF diplexed; BTS or dual carrier stereo option.

Circle (1222)

Cablewave Systems

HCC 7/8" Air Flexwell: tubular center conductor coaxial cable; 50Ω impedance; high velocity propagation for medium power signals to 5GHz.

Circle (616)

See ad page 81

Comad Communications

TEM Sync/FM: synchronized FM broadcasting for FM booster operation in the same frequency; eliminates retuning auto receivers when moving from main transmitter coverage area to booster coverage area.

Circle (653)

Comark Communications/Thomson

CCT-U-25MX: 25kW klystron transmitter;

operates in multiplex mode.

CTT-U-60SK: 60kW Klystron UHF TV transmitter; NTSC and CCIR versions; IF modulator; switchable ED corrector, VSB saw filter; solid-state parallel redundant driver; also available for 120kW and 240kW.

CCT-U-2MX: 2kW T-series UHF transmitter; tetrode PA design; powers from 2kW to 10kW ratings.

Circle (654)

See ad page 53

Cortana

Lightning prevention: static eliminators, folded unipole antennas, detuning kits.

Circle (1201)

Dielectric Communications

UHF CP pylon: full circular polarization or partial vertical component; 90° phase quadrature between polarizations throughout vertical radiation pattern; maintains axial ratio when depression angle is increased.

Circle (700)

Energy-Onyx

Solid-state line: new FM series; 20W-500W range.

MK series: FM transmitters; 12kW, 15kW.

Transmitter controller: for 1.5kW to 40kW systems; maintains output with varying line voltage; auto, manual modes; fold-back VSWR; full interlock status without transmitter energized.

40kW FM transmitter: based on tetrode PA stage; full modulation with 800W drive.

Circle (745)

Continued on page 106

**Before
The Phantom**
These Two Weren't Speaking

But now, the video editing system communicates beautifully with the ATR, thus eliminating the need for an expensive audio suite. And all the credit goes to the unique, new PHANTOM from Cipher Digital.

Technically speaking, the PHANTOM is a VTR Emulator that allows video editing systems control of audio transports. It accepts information from virtually any video editing system via the RS-422 interface and provides parallel information to the audio transport. Designed around a high speed microprocessor, the PHANTOM has the capability to provide control of up to four events and will even interface U-Matic type VCR's with video editing systems designed for 1" VTR's.

To get the conversation going in your editing suite, contact Cipher Digital today!
Call (800) 331-9066

cipher digital, inc.
P. O. BOX 1701/FREDERICK, MD 21701
(301) 695-0200 TELEX: 272065

Timely today, consistent with tomorrow.

Circle (68) on Reply Card

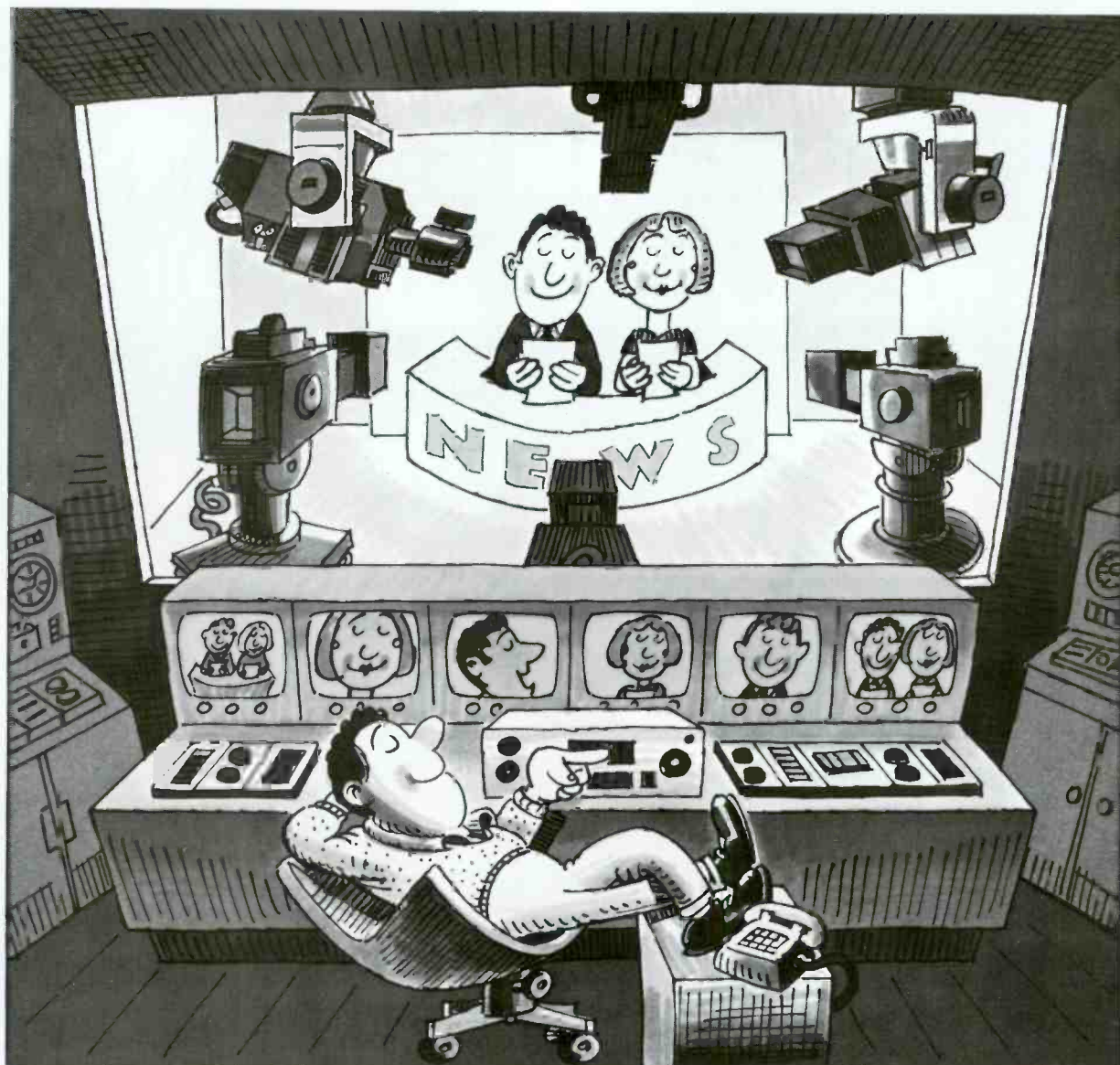

MULTIPLE CAMERAS. ONE OPERATOR.

Impossible? Not if your cameras are mounted on EPO Servo-Controlled pan and tilt heads. These extraordinary, labor-saving devices, which first found favor in legislatures where remote-controlled, unobtrusive coverage was a key factor, are now the basis for complete remote-controlled news studios.

Just look at these outstanding features:

- Up to 500 preprogrammed positions per camera, including control of iris and black levels
- Programmable fade modes that provide smooth transition from preprogrammed shots
- Ability to zoom and focus
- Unobtrusive
- Can be operated via telephone lines or microwave in a remote studio away from the main studio location
- Wide range of pan and tilt heads, for full studio cameras with teleprompters to ENG type cameras
- Wide range of control options, from panels with multiple-shot memories to simple joy stick remote controls.

It's flexible, affordable—and it's sold and serviced exclusively in the U.S.A. by A.F. Associates.

THE RADAMEC EPO REMOTE CAMERA CONTROL SYSTEMS

Your news show's bottom line will never look so good.



A.F. ASSOCIATES INC.

ADVANCED SYSTEMS AND PRODUCTS FOR THE VIDEO INDUSTRY
100 STONEHURST COURT NORTHVALE NJ 07647 (201) 767-1000
10650 SCRIPPS RANCH BLVD SUITE 200 SAN DIEGO CA (619) 530-2970

Circle (69) on Reply Card

GE IS THE LIGHT THAT TAKES THE HEAT OFF THE PERFORMERS.



GE Lighting lights up the night while generating 35% less heat than ordinary stage and studio lights.

The pace is frantic. Five minutes to airtime. Late breaking news has just been handed in. As the countdown begins...the lights go on.



For the performers, ordinary stage and studio lights can be torturous, because they generate so much heat. That's why GE invented the GE Watt-Miser Quartzline[®] lamp. This Quartzline lamp, with a revolutionary infrared reflecting coating, delivers 90% of the



light of ordinary stage and studio lights while using up to 35% less wattage. It generates less heat, which means more comfortable working conditions for the people onstage and the people backstage. It also reduces the load on the air conditioning system and fits existing fixtures.

With features like these, it's not surprising that more and more people are using them. Because when what's onstage is hot, GE Lighting keeps it cool.

GE is Light.



GE Lighting

Circle (70) on Reply Card

Continued from page 102

Express Tower

EXCO towers: for radio, TV, microwave; range 250-1,480 feet; designed, fabricated to EIA-222D standards; faces to 144".
Circle (1223)

Flash Technology

FTB 205A: ElectroFlash beacon; FTB 205A white flashing light; SC 110 controller; meets FAA tall structure marking requirements and Transport Canada, CSA approved.
Circle (764)

Graves & Graves

Tower services: construction, maintenance on communications towers.
Circle (1224)

Harris Broadcast

Training courses: AM, FM, RF circuitry covered in technical training program at Quincy, IL.
SX-5A: single-phase 5kW AM transmitter.
DX-25: 25kW digital solid-state AM transmitter; better ac-to-RF efficiency; reduced audio overshoot, tilt, ringing; redundant RF PA design.
HT-10FM: 10kW FM transmitter; single 4CX7500A PA tube in $\lambda/4$ cavity; broadband tuning; auto VSWR foldback; 50 Ω interstage impedance permits bypassing of IPA, PA for low power operation.
FM-20K2: 20kW FM transmitter; single 4CX20000A tetrode in wideband $\lambda/4$ cavity; requires 31kW input power; FlexPatch feature allows pre-amp, IPA or PA to be bypassed for continued operation at low power.
FM-20K2, FM-25K2 enhancement: improved cooling system reduces overall ac power consumption for greater efficiency.
FM-30K: 30kW FM transmitter; single tetrode design requires 46kW input power; auto VSWR foldback circuitry; FlexPatch feature.
Circle (796)

Hughey & Phillips

Guy guards: 2-piece guard fits over base of guy to protect against ice damage.
Circle (1225)

Itelco

T100/300 series: Band I, III VHF TV transmitters in serial, parallel configurations; ratings from 1W to 40kW; external, internal diplexed; 1-tetrode or solid-state visual PA, solid-state aural PA designs.
Circle (824)

ITS

ITS-220: 100W UHF LPTV transmitter.
ITS-1610C: ITFS, MMDS television transmitter.
ITS-1658C: ITFS, MMDS television amplifier.
Circle (825)

Jampro Antennas

JBBP series 1, 2: balanced, omnidirectional circular polarized FM antenna; more symmetrical pattern, less frequency sensitive, improved axial ratio; can be top-mounted.
JSDP: FM cavity antenna; virtual unity gain; for single and multiple frequency applications.
JSM, JSH "EP" slot TV antenna: elliptical polarization; new application of existing technology for better market saturation.
UHF shunt corner reflector: high gain over wide range of power levels; flexible to produce various patterns.
Circle (826)

Kintronic Labs

RF contactor: for switching of low power AM

signals.

Circle (845)

LDL Communications

30kW: FM broadcast transmitter.
TTS-6M: Larcen 6kW solid-state VHF TV transmitter.
60kW: VHF TV transmitter; M-series; solid-state.
TTS-22M: Larcen 22kW solid-state VHF TV transmitter.
TTC-50LH: Larcen 50kW VHF TV transmitter.
TC-TP: circular-polarized, top-mounted VHF TV antennas.
Circle (853)

See ad page 86

Magnum Tower

Towers & installation: radio, TV, microwave triangular, guyed, self-supporting, pre-welded and knock-down types.
Circle (876)

Marconi Communication Systems

B7500 series (UHF): high performance 60/120kW TV transmitters.
B7540 series: UHF TV transmitters, rated 10kW to 60kW; for G/I/M/N systems with NTSC, PAL, SECAM color; dual sound facilities; external cavity klystrons.
B8880 series: complete range of feeder components.
Circle (879)

McMartin Industries

BA series: AM broadcast transmitters; power range from 1kW to 50kW; also available for shortwave.
BF series: FM broadcast transmitters; 400W-30kW; translator systems also available.
Circle (890)

Micro Communications

**55000:* VHF TV switchless combiner; hot switching for visual and aural transmitters without lost air-time.
**55070:* UHF TV switchless combiner; hot switching of aural or medium power visual signals.
**55090:* 180kW switchless combiner; system for operation of three visual transmitters.
**90000:* UHF high-power waveguide antenna; improved efficiency and reliability with higher power capacity.
TTL circuitry: μ P-controller for MCI motor-driven equipment; requires only momentary closures for operation.
Circle (894)

Midwest Communications

TX60S: 60kW UHF TV transmitter; standard and redundant configurations; series includes 30kW, 120kW and 240kW rated systems; by Technalogix.
Circle (901)

See ad page 1

Nautel

AMPFET ND10: 10kW solid-state AM transmitter; 10% more headroom than AMPFET 10; <5% square wave tilt, IMD <1%, IQM >35dB; includes main/standby exciters; modular redundancy with eight 1.25kW subsystems.
Circle (925)

Omega International

Synchronous repeater: locks FM transmitter and repeater to same frequency, in phase; reduces degrading of signals in overlap areas.
Circle (1264)

See ad page 178

Pinzone Communications

Corum AM antenna: anti-skywave, anti-fade

system; low profile nearly equal to a 190° tower (835 feet at 620kHz).

Circle (969)

QEI

FMQ-series: FM transmitters; field upgradable models from 3.5kW to 30k; with 695 exciter; single, ground-grid triode PA.
Circle (975)

See ad page 183

Rapid Deployment Towers

RapUp: transportable tower; non-telescoping design; 70-300 feet, deploy at 10 feet/s.
Circle (1226)

ROHN

7500 SR: guyed tower with 7'6" face, suitable to heights of 2,000 feet.
Circle (1001)

Singer Products

CCA FM500G: FM transmitter; ground grid 3CX800A7 PA to produce 500W output; auto overload, recycle, optional SWR protection; FM20G 20W exciter.
AM-15000FHF: broadcast, short wave transmitter covering HF band from 1.5-10MHz; 15kW rms output; for A3 and A0 (CW) emission; PA 4CX15000A, modulators 4CX5000A, IPA 4-400A.
Circle (1030)

SWR

WR1150, -1400, -1500, -1800: rectangular waveguide for UHF TV; includes "R" flange.
Circle (1064)

See ad page 190

Tennaplex Systems

OMEGA: full-band multistation FM antenna.
Panel antennas: triangular mast mounting for VHF TV, FM radio.
ALPHA: high-power, multistation combiner.
Hardware: Spinner coaxial, waveguide accessories.
Circle (1091)

Thomson-LGT

Series 8000 VHF: VHF TV transmitters; solid-state 1W-30kW, single-tube 5kW-30kW; for all TV standards; capable of MTS sound operation.
Series 8000 UHF: TV transmitters; solid-state 2W-2kW, single-tube 1kW-20kW, klystron 20kW-30kW; ICPM $\leq 3^\circ$; all TV standards.
EUHF 2000S: UHF TV transmitter with IF modulation; single-tube design; 2kW output visual rating; for all TV standards.
EUHF high power: 20kW, 30kW, 60kW UHF TV transmitters; 2-klystron systems with EEV or Valvo devices; aural PA may be tetrode; water or vapor cooling.
EVHF 10000S: 10kW VHF TV transmitter; solid-state aural, single ceramic tetrode visual PA in grounded-grid configuration; 24kW power consumption.
VHF, UHF transposers: 2W-2kW repeater systems; applicable to all TV standards; solid-state designs except single-tube models for 1kW, 2kW UHF.
RAMSES series: FM transmitter; output powers from 100W to 5kW; solid-state design; mono, stereo, SCA, RDS signals; compact, redundancy.
Circle (1102)

TMD/Will-Burt

Telescoping mast: 30 feet extended, nests to 6 feet.
**7-42-357/367:* telescoping mast; black anodized finish; 42-ft height.
Circle (1107)



Beat the traffic.

M/A-COM opens up a new lane for broadcasters with our new 18GHz microwave system.

If you've been looking for an open frequency at 7 or 13GHz, you're not alone. In many areas, they simply aren't available: there's too much traffic and not enough spectrum.

M/A-COM's new 18GHz microwave system gives you another option: a wide-open band which the FCC has assigned to broadcast. It gives you 50% better link availability (or 40% longer range) than 23 GHz, and none of the congestion of the lower frequencies.

The MA-18CC is a fully-featured microwave system, designed to meet or exceed all RS-250B short-haul performance

specifications. It is field tunable, and a single gunn oscillator covers a wide selection of frequencies so spare parts can be kept to a minimum.

For over 20 years M/A-COM MAC has specialized in providing microwave radio equipment to broadcasters. Every unit with our name on it is built in our own factory, so we not only control the quality, but we know how to service it.

For more information on how you can streamline your microwave needs, contact M/A-COM MAC, Inc., 5 Omni Way, Chelmsford, MA 01824, (617) 272-3100.



Circle (71) on Reply Card

TTC/Television Technology

UHF 10MA: Klystron, air-cooled TV transmitter; 10kW rating, multiplexed system; Intermod Compensation, Vector IF Corrector circuits.
FM-300J: 300W solid-state FM transmitter; regulated beam power supply.
XL300MU: 300W solid-state UHF TV transmitter.
Circle (1117) [See ad page 95](#)

TWR Lighting

L-866: FAA-approved medium intensity strobe light.
Circle (1119)

Valmont Industries

AM Unipole/monopole: improves AM radio coverage, audio reception; requires no guys or base insulators.
Circle (1132)

Varian TVT

LDM series FM transmitters: 2kW, 5kW rated solid-state systems; redundant modular power amplifier for reliability; power foldback for adverse VSWR conditions.
Circle (1289)

Varian/Continental Electronic

317C-3 upgrade: solid-state RF driver replaces 4-400C tube in 50kW AM broadcast transmitter.
XL-301: 1kW solid-state AM transmitter; pulse width modulation; meets NRSC proposals; five power modules allow variable output.
816R series upgrade: solid-state driver module for 21.5kW, 25kW, 27.5kW and 35kW single-ended transmitters and combined versions.
814C: 3.8kW FM transmitter; 802A solid-state exciter; broadband modular design requires no tuning; self-protected power modules add redundancy.
Circle (1134)

Vector Technology

FMT-3: 3.5kW FM transmitter; 3CX3000A7 grounded-grid amplifier at >70% efficiency; PLL exciter design, Auto-Matic power control, integral remote, VSWR overload/power foldback modules.
40kW FM: single-tube, single-cabinet FM broadcast transmitter.
Line transformer: impedance matching device allows wideband signal matching for phasor system.
Circle (1136)

RF Products

R2: Microwave

- Antennas, electronics
- ITFS, OFS, STL
- Radar RF systems
- MDS, MMDS

BEXT

RXG/STL: programmable composite receiver; for use with TXG/STL to create a directly programmable composite STL.
Circle (1266)

Communication Microwave

Response transmitter: 4-channel.
Transmitter control center: for frequency-agile system control.
Solid-state transmitters: models for 50W and 100W rating.
Circle (856)

Conifer

QL-1010: wireless cable/MMDS block downconverter; 31-channel capacity; processes all or some channels in ITFS/OFS groups, 2500-2686MHz.
PT-2528: 4' ITFS receive antenna; 1-piece perforated Al reflector; matched feed assembly; mounts to 2" to 4-1/2" OD mast.
QL-3010: integrated dual-band MMDS block downconverter; common input, common output; for MDS channels 1, 2 and all ITFS/OFS channels; Interdigital Filter for improved image, out-of-band rejection; SMD technology.
QL-3030: integrated dual MMDS block downconverter; separate inputs with common output; Interdigital Filter.
Circle (671)

EMCEE

MC2127 downconverter: for 2.15-2.7 GHz MMDS, ITFS; broadband design; output bandwidth 100-400MHz; conversion gain 25dB minimum.
Circle (742)

Enterprise Electronics

LARS-88 Baby Radar: Doppler weather radar; lightweight, X-band; options of remote display/control, color printers, 30Mbyte image store disk.
DWSR-88, -88CTV: Doppler radar systems for weather, weather surveillance; intensity, velocity, color display modes; improved clutter reduction.
R²D²P-8800: color remote radar data display processor.
Circle (746)

GE Comband

Proband/Comband: addressable bandwidth compression, scrambling system for use on MDS, MMDS, ITFS, OFS services.
Circle (778)

Graham-Patten Systems

VAMP II system: puts two PCM audio channels above video on TV STL system.
Circle (787) [See ad page 112](#)

Harris Farinon Video

FMT-40, FMR-40: video transmission equipment; dc-coupled video circuitry, sync-gated modulator; IF heterodyne or baseband radio relay for STL.
Heterodyne microwave upgrades: FET power amplifiers for 1.7GHz to 13.25GHz transmitters, receivers.
Circle (1227)

Ikegami

PP-80: ENG microwave equipment; high-power 2GHz and 7GHz; complements lower power PP-70 series.
Circle (812) [See ad page 97](#)

Mark Antenna

P-21A72KG-2: 6' diameter compact grid-type microwave antenna; also available in 4-, 8-, 10-, 12-foot sizes.
Circle (1228)

Micro Controls

TSL 2001: 450MHz transmitter-to-studio link.
Circle (895)

Microwave Radio

Model 2A20: ProStar ENG antenna.
MR, MRC: ProStar receivers.
Model 2T2: ProStar portable microwave

transmitter.
Circle (900)

Moseley Associates

PCL-6000 series: STL system with -6010 transmitter and 6020, 6030 receivers; 15kHz monaural or wideband composite stereo by change of jumpers; dual configuration with no measurable crosstalk.
RPL 4010, 4020: remote programming link; portable transmitter, receiver; synthesized, extensive metering; high rejection characteristic in crowded UHF bands.
Circle (914) [See ad page 63](#)

Nurad

230HP2L: 23GHz parabolic antenna in 4-series systems; fiberglass, removable radome, rotatable feed, universal pipe mount bracket.
130CP1S, 130CP2S: 13GHz compact parabolic antennas; 12", 24" diameters; quick-connect attachment; circular polarization.
70CP1S, 70CP2S: parabolic antennas, compact design for 7GHz; 12", 24" diameters; circular polarization; quick-connect attachments.
20PTI-10: 2.5GHz portable ENG transmitter with 40dBm output; quick-connect antenna mount; PT-series includes 2GHz units.
Circle (937)

Radiation Systems

Hardware series: various waveguide, coax, hangers and accessories.
Satcom Tech #240AT: transportable 2.4m uplink trailer system; #240KV antenna system; 3-axis pedestal with auto stow/deploy, digital position display; dual generators; collapsible feed support boom.
Circle (982)

RF Technology

RF-200LC: ultra-portable receiver; operates with UPL series transmitters in 1.7-2.7GHz range.
RF-203B: ultra-portable transmitter; 1.7-2.7GHz, frequency agile; two audio channels with mic/line switching; 500mW output.
RF-FLP: colinear omnidirectional antennas for helicopter, central receiver and wireless camera receivers.
RF-CD: automatic tracking antenna system for wireless camera; 1.7-13GHz applications.
RF-SCP: low-profile antennas for boat, racecar, backpack wireless camera operation.
Circle (995) [See ad page 184](#)

Rockwell International

DVS-1000: digital video system; video, stereo audio; DS3 interface to 44.736 Mb/s asynchronous; for NTSC/system M video; complies with FCC part 15 subpart J.
Circle (998)

TFT

Model 8888, 8889: remote pickup transmitter, receiver; 25W; frequency agile; selectable deviation, receiver bandwidth; cue, remote control with DTMF signals; front panel metering for diagnostics.
Model 8700: TSL transmitter-studio link; optional 4-channel TDDM time division data multiplex allows four users to share TSL system with DTMF address codes; operates in 450MHz P channels.
Circle (1094) [See ad page 141](#)

Thomson Video Equipment

Vidiplex TTV 7552: coder, decoder allows two interlaced, synchronous images of same standard on single transmission channel.
Circle (1101) [See ad page 167](#)

DALSAT DELIVERS RATINGS

Dalsat's SNG-12 produces outstanding market share with live coverage.

- o **Baby Jessica's Rescue** 50 SHARE
(WFAA TV - Dallas)
- o **1988 Calgary Olympics** 27 SHARE
(ABC)
- o **Delta 191 Crash** 53 SHARE
(WFAA TV - Dallas)

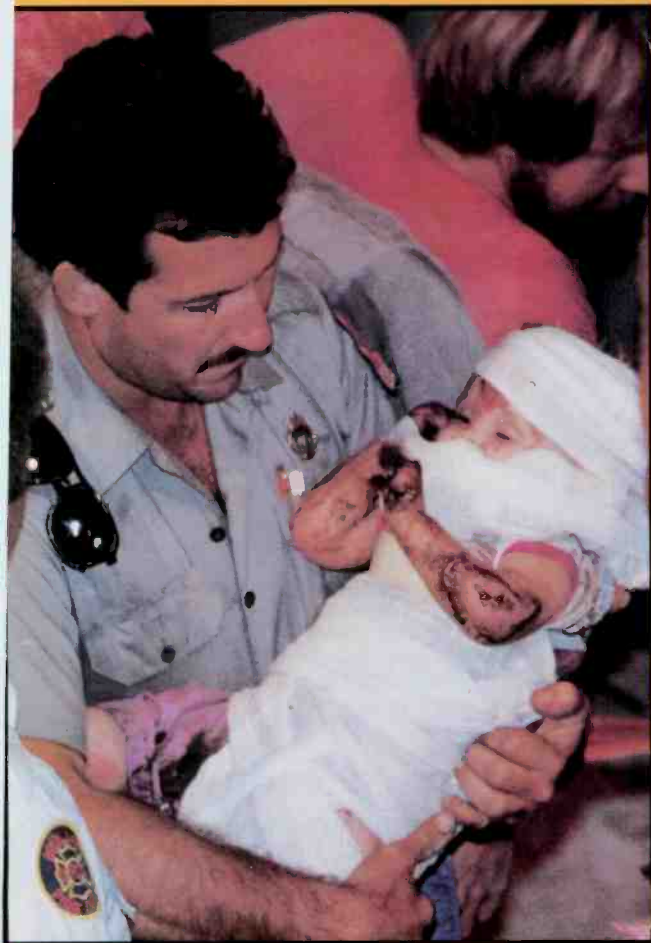

DALSAT

1701 SUMMIT AVENUE, PLANO, TEXAS 75074

(214) 578-7561

Circle (72) on Reply Card

BRING 'EM BACK TO LIFE.



How many thousands of dollars have you buried in the past couple of years?

Here's good news. Henceforth, this money goes back in your pocket. Because Christie's CASP® brings dead NiCads back to life.

Our exclusive charging method actually reverses electrochemical deterioration!

And Christie's microprocessor-based CASP handles every type of rechargeable battery. Gives each exactly the type and amount of current it needs for a cool, fast, properly balanced charge.

Operates unattended, too. All you do is load and off-load batteries.

CASP comes in two models. The user-programmable CASP/2000 delivers everything your battery can possibly need for peak performance and long life.

The economy CASP/1000 is a user-friendly GO/NO GO system, pre-programmed for all the most popular types of batteries.

So save your valuable NiCads from an early grave. Get full information from Mike Diamond at Christie Electric Corp., Torrance, CA 90509-2872. Phone (213) 320-0808. FAX (213) 618-8368.



CHRISTIE
RAISING THE DEAD

© Copyright 1988 by Christie. All rights reserved.

Circle (73) on Reply Card

The TOTAL SOLUTION to Automated Audio Measurements

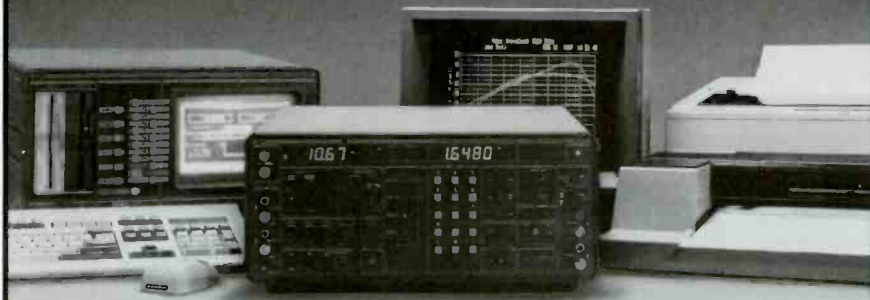

Amber offers the full package for automated audio tests: high performance GPIB hardware and easy to use, comprehensive software. At home both in the lab and the production line, the Amber 5500 Audio Measurement System and the PC-based AudioCheck software package gives you *instant, complete and accurate* results. Simple menu driven, self-running software lets you easily define complex tests with outputs as simple as PASS/FAIL tickets to comprehensive full color graphs and custom multi-page test reports.

State-of-the-art measurements with balanced or unbalanced interface, distortion below 0.001%, noise below -120dBV qualifies the latest digital or analog systems in broadcast, telecommunications and consumer audio applications.

Find out how easy audio testing can be. Call us today.

amber

Amber Electro Design Inc.
3391 Griffith Street
St. Laurent, QC, Canada H4T 1W5
Telephone (514) 735 4105
US Toll Free 800 361 3697

Circle (74) on Reply Card

RF Products R3: Amplifiers

- Grid power tubes
- Klystrons
- Assemblies, cavities

Amperex Electronic

#9021: power tetrodes for UHF/VHF TV and FM broadcasting.

YL1750: UHF power tetrode.

YK1270: air-cooled klystron.

Circle (535)

See ad page 82-3

Econco Broadcast Service

4CX3500A: rebuilt tetrode power tube.

Circle (726)

EEV

K3936L24: air-cooled C-band satellite uplink klystron.

K3153BCD: 15kW air-cooled UHF TV klystron;

K4153 circuit assembly.

K3773BCD: 70kW wideband UHF TV klystron with K4653 series circuit assemblies.

Circle (731)

See ad page 125

Hipotronics

dc beam supplies: for transmitters.

Circle (801)

Keltec Florida

R60-300Ku: medium power Ku-band TWT amplifier.

R90: high power TWT amplifier.

R50-125C: low power C-band TWT amplifier.

H60-300Ku: hub-mount TWT amplifier.

Circle (839)

MCL

#10906: 300W Ku-band hub-mounted TWT amplifier.

#10890: 500W Ku-band phase-combined hub-mount ABSAT TWT amplifier.

Circle (888)

See ad page 179

Richardson Electronics

Siemens YDI381, YDI275: planar triodes for TV translators.

Circle (996)

Stantel Components

W2MC12H, W2MC16K: TWT C-/Ku-band power devices, rated 300W for earth station HPAs.

Circle (1298)

Thomson Electron Tubes/Device

TH-3694: 450W TWT for DBS uplink earth stations operating at 18GHz; for forced air cooling; current control anode counteracts tube aging.

TH-2426: 2kW earth station klystron; 14GHz operation, minimum gain of 37dB with instantaneous bandwidth greater than 85MHz, forced air cooling, permanent magnet beam confinement.

Circle (1099)

Varian Associates

X2254: air-cooled Klystrode, rated 15kW.

ACE retrofit: for use with VKP 7553-4-5 annular control electrodes; reduced energy costs, increased efficiency (to 85% figure of merit) for integral-cavity transmitter; includes pulser, exciter, visual drive amp.

VKP-7990: external cavity klystron, multistage depressed collector design.

PT-5093 ACE: high efficiency, external cavity

TO LAST IN THIS BUSINESS, YOU'VE GOT TO MAKE WAVES

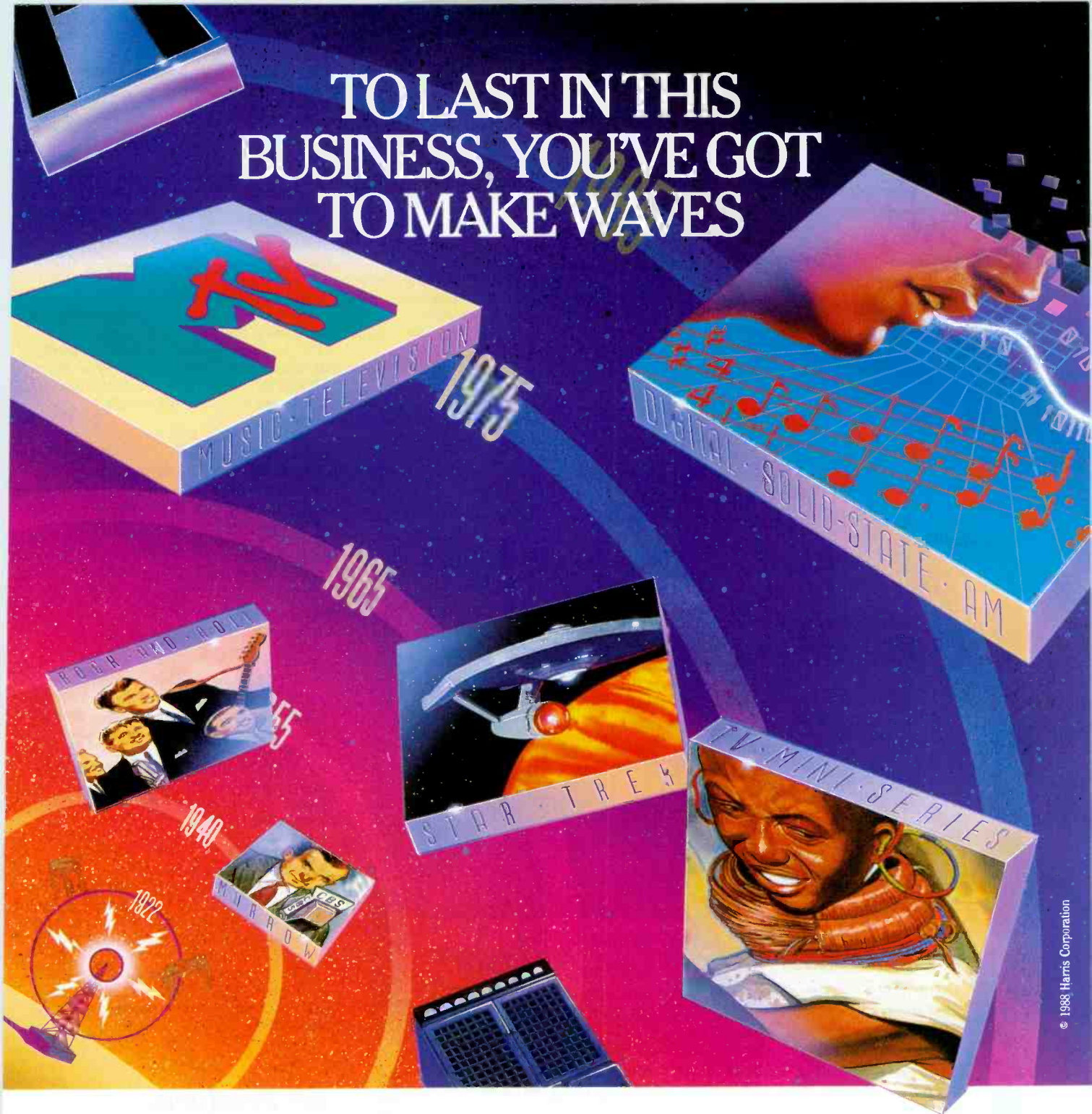

© 1988 Harris Corporation

While Ed Murrow invented broadcast journalism to report a world war, Harris supplied the radio equipment that carried the word.

As Mr. Spock sailed the galaxy, Harris introduced the first VHF television transmitter with I.F. modulation.

And when TV miniseries first glued viewers to their chairs night after night, Harris put the broadcast industry's largest field service team on call 24 hours a day. Seven days a week!

Now, as MTV, Talknet, and L.A. Law set the pace for programming, Harris is leading the way with digital

and solid-state systems that are revolutionizing radio and TV technology.

Harris started making waves in 1922. Since then we've introduced over 50 industry *firsts*. From the transcription turntable. To the digital, solid-state AM transmitter.

And we're the only manufacturer with a Technical Training Center. Not just for Harris hardware. But to teach your staff how to operate and maintain any transmission system on the market.

In our business, you either make history. Or you become history.

That's why programs like Star Trek became classics. And that's why Harris is still America's only full line broadcast equipment manufacturer.

Find out how Harris is leading broadcast manufacturing into a new century. Call TOLL FREE:

1-800-4-HARRIS
Extension 3011

The U.S.S. Enterprise™ and © 1988 by Paramount Pictures Corporation. All Rights Reserved.

 **HARRIS**

Circle (75) on Reply Card

klystron for UHF TV; 64kW wideband; efficiency rating to 54% peak sync; from Thorn EMI division.

PT5096: 75kW UHF external cavity klystron; typical efficiencies of 50%; replaces K3773BCD: from Thorn EMI division.

VKP-7995: integral cavity klystron with multi-stage depressed collector.

YU-148: power amplifier tube for 10kW FM transmitters.

Circle (1133)

See ad pages 72-3

•Modulation monitors

•Receivers

BEXT

RXG/FM: programmable composite receiver for translator, booster systems; with programmable modular transmitter, creates a programmable translator/booster with synthesized inputs/outputs.

Circle (1266)

DX Communications

DSA-676: C/Ku-band remote control receiver;

RS-250B spec for full and half transponder use.

DHA-530: CATV channel processor.

DSA-646: C/Ku-band receivers, for exact transponder frequencies.

DSA-525: very low noise Ku-band LNB block

converter.

DSA-656: C/Ku-band receivers; for full, half transponders.

Circle (715)

Emergency Alert Receivers

EBS tone-alert receivers.

Fixed frequency FM: crystal-controlled, dual ceramic filters; 5" Alnico speakers.

Model 80 SCA receivers: dual FET front end; 41kHz, 67kHz, 91kHz subchannels; 3-trap, 3-tuned circuits.

Circle (744)

Gorman-Redlich

CEB encoder, decoder: complete 2-frequency EBS system per FCC requirements.

CRW weather receiver: 0.28 μ V sensitivity; MOSFET RF amp, crystal-ceramic IF filters; 1,050Hz tone triggers relay to enable receiver output, alarm, recorded message.

Circle (785)

McMartin Industries

Super S series: SCA encoder, generator/modulation monitor, SCA tuner, decoder module for 3, 4 or 5 SCA subchannels on an FM broadcast signal.

Circle (890)

Motorola-AM Stereo

MCI3024/13022: C-Quam low and medium voltage AM stereo receivers.

Circle (915)

Telemet

4504-B1 BTSC synchronous detector: operates with various non-stereo demodulators for determination of ICPM; integral low-pass filter for quadrature output; integral demo tester.

Pro channel demod: allows remote/field crews to receive Pro BTSC channel for communications purposes.

Tunable demod: all TV channel capability.

Circle (1084)

Wegener Communications

Series 1800 receiver: for audio, data subcarriers above video or FM \times 2 broadcast transmission on C/Ku-band; remote transponder selection, subcarrier tuning, authorization; multiple channels of data, audio.

SDM2000: Dolby digital audio transmission system; for C-/Ku-band networks; compatible with FM \times 2 subcarriers above video and SCPC.

Circle (1158)

RF Products

R5: Generation

- Exciters, generators
- Subcarrier systems
- Stereo, FM, TV
- Paging

Acrodyne Industries

Marconi B7500: UHF exciter and drive system.

Circle (506)

AEG Bayly

RDSC 3237: radio data system encoder; for addition of supplementary information to multiplex signal for FM broadcast transmitters.

Circle (514)

Continued on page 116

When There's No Room For Compromise...

We have the Solution...



AN AUTOMATED AUDIO MIXER WITH A TRACK RECORD FOR RELIABILITY AND COMPATIBILITY.

The Model 608 Edit Suite Audio Mixer incorporates the features of our larger mixers into a smaller package, at a significant cost savings, without sacrificing quality or ease of operation.

Audio sources are controlled with the 608 in much the same way as video sources are controlled using a production switcher. This concept allows you to edit audio quickly, along with video or separately, using the same editing system.

Our proven editor interface, supported by most major edit system manufacturers*, allows hands-free control of audio mixing right from the editor. Yet, at any time the mixer may be operated manually or with a combination of manual and editor control.

The Model 608 has eight inputs, each with its own fader, with separate inputs for the record VTR and tone. Outputs are stereo for both the program channels and built-in preview switcher.

Call us for a complete brochure.

* mixers are currently in use worldwide with the following editing systems: Ampex Ace, CMX, Calaway, Convergence, Grass Valley Group, PALTEX, and other systems capable of operating a video switcher.



GRAHAM-PATTEN SYSTEMS, INC.

P.O. Box 1960, Grass Valley, CA 95945

Inside CA: (800) 422-6662 • Outside CA: (800) 547-2489

TWX 910-333-6065 • FAX: 916-273-7458

Circle (76) on Reply Card

To get a bigger slice of your video patching business, we borrowed an idea from the experts.



Quick delivery.

Whether it's a pepperoni pizza or a patchbay, nobody likes waiting for deliveries. And when you order video products from ADC Telecommunications, you don't have to. Because unlike other manufacturers, we sell through a nationwide network of

video distributors. So instead of waiting weeks for delivery from a

factory a thousand miles away, you simply call the

ADC distributor in your area.

We offer toppings the others can't match, too. Our video jacks come in gold or nickel finish, terminating or non-terminating and phase compensated as well.

But you don't have to order an extra-large with everything to get fast delivery. We'll give you the same service even if you just need a few patchcords. Because we know if we offer a broad range of quality products at fair prices, and deliver them faster than the competition, we'll get a bigger slice of your business.

We call it the "Domino Theory."

For the name of your local ADC stocking distributor, call **612-893-3126** east of the Mississippi, or call **612-893-3119** west of the Mississippi.

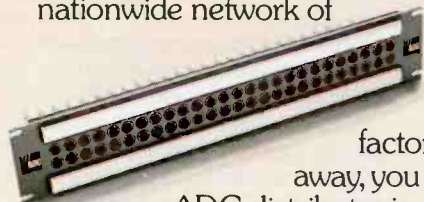

ADC Telecommunications
"Where Quality Runs Full Circuit."

Circle (77) on Reply Card

4900 West 78th Street. Minneapolis, MN 55435

News events cha so can M

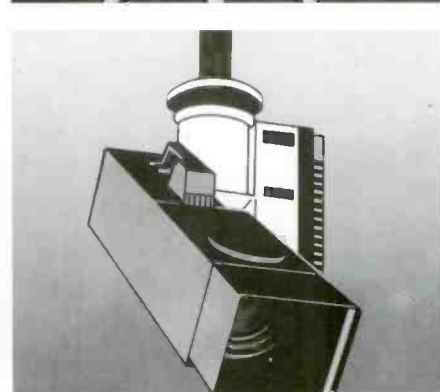
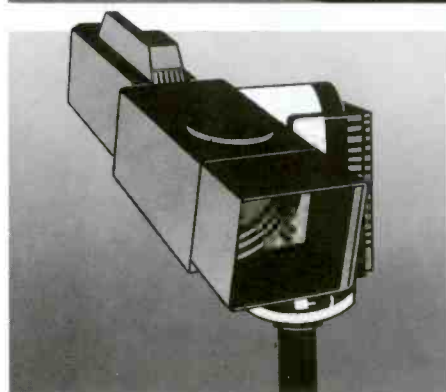
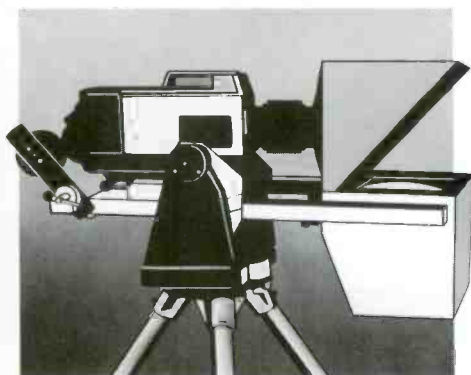
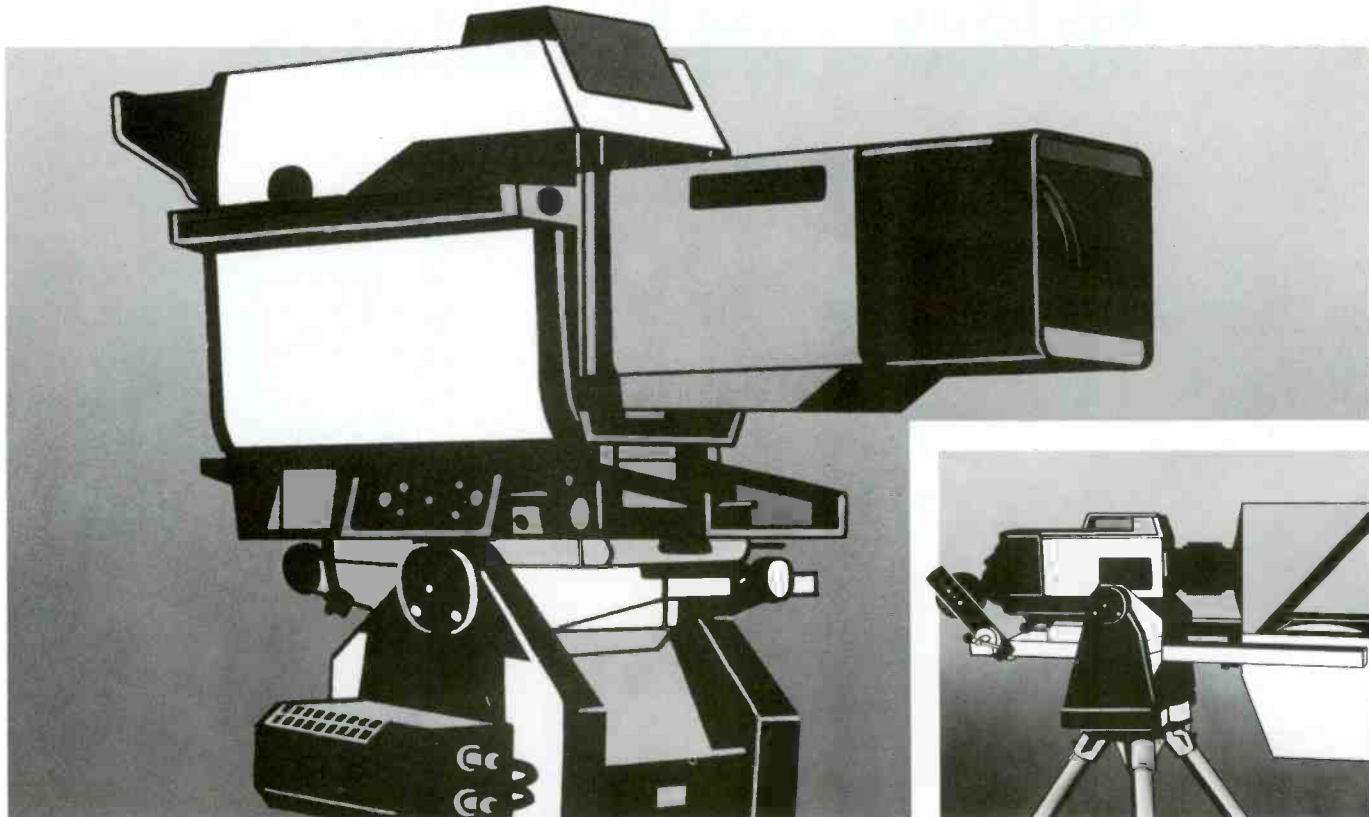

The remote camera control system.



Experience the freedom of movement that MicroSwift gives you.

No other remote camera control system in the world feels like it or moves like it.

MicroSwift's unique servo-control system automatically puts you in a better position. The servo-controlled pedestal allows the operator to raise and lower the camera from 24 to 58 inches as well as control the pan and tilt, zoom, focus, and camera functions.

Smooth, silent, accurate and repeatable. The quality and versatility of MicroSwift's digital control is equally impressive.

age by the second, croSwift.

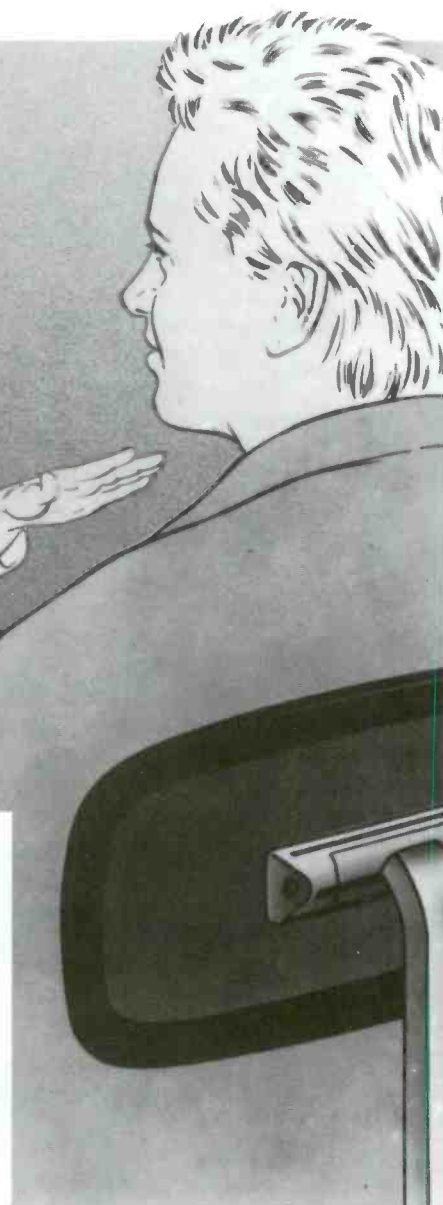

Television studios. Legislatures. Conferences. Wherever manual camera operation is impractical, unacceptable or prohibitively expensive MicroSwift is precise, articulate and impressively cost effective.

The unique MicroSwift system offers the dual advantage of exceptionally rapid subject finding through automatically selected pre-programmed shots with full operator override.

MicroSwift also has a superb memory for camera positions. It can store up to 1500 with a repeatability accuracy to 0.03 degrees.

Sophisticated inside, simple outside. MicroSwift is very easy to operate, even when several cameras are linked into the

system, and for a totally automated environment MicroSwift offers machine control capability.

The standard MicroSwift range also includes a choice of control panels depending on the complexity of the proposed application. From single camera to complex multi-camera use.

And from Vinten, the world's leading producer of camera mounting systems you're assured of reliable, remotely controlled on-air movement wherever cameras are located.

Innovative design. Superbly engineered. Whatever your angle MicroSwift will cover it. Contact Vinten at one of the following addresses:

Vinten

Vinten Equipment Inc.
275-C Marcus Boulevard Hauppauge
New York 11788-2001
Telephone (516) 273-9750 Telex 640470
Telefax (516) 273-9759

Vinten Equipment Inc.
8115-B Clybourn Avenue Sun Valley
California 91352-4022
Telephone (818) 767-0306 Telex 182686
Telefax (818) 767-0772

MicroSwift
Repeatably the best.

Continued from page 112

DX Communications

DSM-150: CATV modulator, channels 14 to 78.

DSM-332: FM stereo modulator.

DSM-160: CATV modulator for channels 2-YY;

BTSC stereo capable.

Circle (715)

Harris Broadcast

THE-1: 3-15W or 3-55W solid-state FM exciter; direct carrier modulated oscillator; two composite, two SCA inputs; broadband design requires no tuning.

Circle (796)

Inovonics

*705: FM stereo generator; FMX option available; low-pass filter, transmission pre-emphasis; digitally synthesized pilot(s), subcarriers(s); overshoot control.

Circle (819)

Marconi Communication Systems

B7500: UHF exciter and driver system.

Circle (879)

Marti Electronics

SCG-10, SCD-10: subcarrier generator, demodulator; stand-alone components for subcarrier link service on microwave systems; audio processing options for selection of pre-emphasis, encode/decode boards; ac/dc operation, auto mute.

Circle (881)

Micro Controls

ULX 2001: FM Uniphase exciter.

Model 51: 88-108MHz scan subcarrier pager; alpha-numeric display.

Model 88: pager/telephone compilar.

Model 57: 57kHz subcarrier pager generator.

Circle (895)

Modulation Sciences

FM ModMinder: FM radio status panel for use with any FM demod or high quality receiver. *ModMinder:* TV audio modulation status panel; wideband TV demod gives total metered modulation at a glance; peak indicator, status of all subcarriers.

Circle (909)

Motorola-AM Stereo

Model 1400: C-Quam AM stereo exciter.

Model 1400: C-Quam AM stereo generator.

Circle (915)

Philips T&MI/Pro TV

PM 5687: TV digital sound modulator.

Circle (965)

QEI

Model 695: FM broadcast exciter; distortion <0.025%; Automod automatic modulation control; modulation metering, peak counter; broadband PLL design; 5-20W output; spectrum output for Bessel-null calibration.

Circle (975) See ad page 183

Rohde & Schwarz

DMC.05 data coder: RDS (radio data service) device, modulates 57kHz FM auxiliary carrier with data to tune automotive radio while driving in areas between main and booster transmitters; under test in West Germany.

Circle (1000) See ad page 69

SCA Data Systems

Music 4: 4-channel SCA generator, receiver systems; high quality 10kHz and low distortion

5kHz channels; meets FCC standards for recording; audio material not receivable with existing receivers.

9600 bps: complete FM SCA data system; generator, compatible receivers; 1-way communications to 30 mile radius from FM station; integral error detection, correction; auto scanning; asynchronous, synchronous operation. *Data 4:* allows single FM subcarrier (67kHz, 92kHz) to support four independent data channels; data rates from 0-1,800 b/s with 5kHz bandwidth per Data 4 channel.

Circle (1276) See ad page 173

TFT

Model 884: FM modulation monitor; baseband and stereo; frequency agile with Peak Modulation Duration Differentiator PMDD circuit.

Circle (1094) See ad page 141

TTC/Television Technology

XD-20UA: Silverline UHF TV exciter; correction circuitry and pulser system.

Circle (1117) See ad page 95

RF Products

R6: Satellite

- Antennas, controllers
- Electronics

Acrodyne Industries

Marconi Transat 37, 56: road-transportable satellite earth station; elliptical antennas of 3.7m and 5.6m; mounted on trailer, flat-bed or semi-trailer; electronics in separate container.

Circle (506)

Advent Communications

Upconverters: Ku-band *AUC 314I*; C-band *AUC 306I*.

AVE 214I: Ku-band broadcast uplink video exciter; exceeds RS-250B, CCIR R567-1 requirements; switchable for PAL, NTSC, SECAM, all MAC formats; clamped AFC system; four audio subcarriers; remote control.

Portable uplinks: antenna, electronics fit into two shipping cases for easy transportation.

AVE 206I: C-band uplink video exciter.

Circle (1192)

Andrew

4.5 ESA: 4-port C/Ku Cherry-Picker system.

C/Ku upgrade: 5-, 6-port uplink kit.

Uplink upgrade: prepares 7.3m antenna systems for transmitting.

7.3 ESA: Cherry-Picker TVRO antenna system for lower EIRP regions; motorized, dual band C/Ku, dual polarization; 4-port feed system; APC-100 programmable antenna controller; ASR-300 video receiver, ASC-1000 ESA system controller options.

Circle (541)

AVCOM of VA

SCPC demods, downconverters.

SCS-200: tunable satellite audio receiver; wide-band with high-stability downconverter, frequency agile demodulator; presets for 4 frequencies; AVPAND-A processing.

Circle (574)

BMS/Broadcast Microwave

BMT-14GR: Ku-band uplink exciter; solid-state; full or half transponder operation; SCPC input standard; CW video switch; exceeds RS-250B,

meets INTELSAT requirements; tunes 1MHz steps.

Circle (597)

Comtech Antenna

EC6 antenna controller: 64-position satellite memory; LCD display shows position, visual prompts during installation; program pack is removable software cartridge, accessible from rear, for simplified updating or customizing; RS-232 ports.

Circle (668)

Dalsat

SNG-12: Ku-band transportable system; 3.7m TRI-FOLD antenna, electronics, electrically driven azimuth movement; Volvo GM F6-13 cab-over diesel truck.

Circle (667) See ad page 109

Harris Farinon Video

VE-14 enhancement: Ku-band exciter upgrade with four tunable subcarriers, switchable IF bandwidth assembly.

Circle (1227)

Keltec Florida

H60-300Ku: hub-mount TWT amplifier.

R40-50Ku: 50W Ku-band TWT amplifier.

R60-300Ku: medium power Ku-band TWT amplifier.

SF60-300Ku: 300W Ku-band TWT fly-away amplifier in a single flight case.

R90-600Ku: high power TWT amplifier.

R50-125C: low power C-band TWT amplifier.

Circle (839)

Marconi Communication Systems

Transat 37, 56: road-transportable satellite earth station; elliptical antennas of 3.7m and 5.6m; mounted on trailer, flat-bed or semi-trailer; electronics in separate container.

Newshawk: flyaway earth station.

Circle (879)

MCL

*20076: 5W Ku-band communications adapter, transmitter.

Circle (888)

See ad page 179

Microdyne

Newslock: satellite video/audio encryption system for news gathering backhaul.

M.A.T.: Microdyne automated satellite terminal; includes 1100 BKR(M) broadcast receiver, meets RS-250B.

1100BKR: broadcast satellite receiver; agile in Ku-/C-bands; meets RS-250B.

Circle (896)

See ad page 71

Microtek Computer Consultants

MAC-I: antenna controller; features receiver control, remote access and networking capabilities.

Circle (1260)

Midwest Communications

S-18 Mobile: news gathering system; 4-port antenna, communications adapter; 1.8m DMK antenna by Vertex; Ford E-350 cargo van; meets 2° spacing.

S-2 Flyaway: Vertex 1.8m segmented antenna; azimuth, elevation assembly; redundant electronics available.

Video Scamp: Vertex 4.6m or 6.1m Ku-band antenna; hub-mounted electronics; remote computer control.

RC-8097B: auto satellite locator; includes antenna controller with auto pointing of mobile Ku-band antenna; uses Loran-C signals to deter-

Auditronics 'because they work well and they're so easy to use'

“**T**hat's what I tell colleagues from other stations when they ask why I prefer Auditronics consoles,” says Jon Book, Engineering Manager, Studio Systems for WOC-KIHK in Davenport, Iowa.

“We have about 15 people working the boards between our AM and FM operations so ease of use is very important to us. Our five Auditronics consoles in on-air and production let our people air a highly professional product on both our programming and the commercials we produce.”

Call us now to find out more about why Jon Book buys Auditronics consoles for on-air and production, **toll free 800-638-0977.**

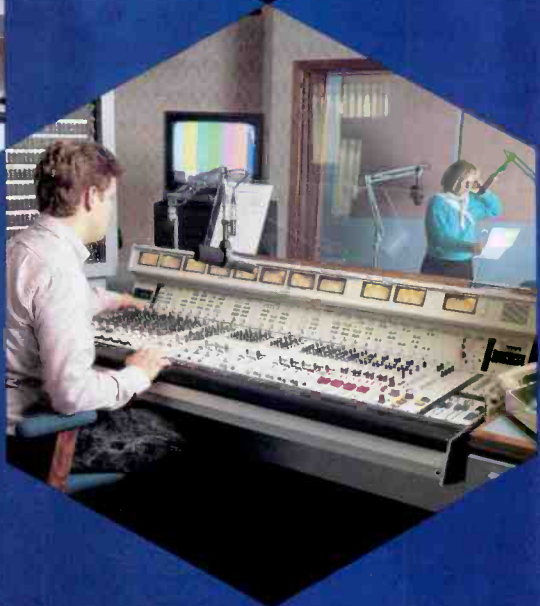

 **auditronics, inc.**

3750 Old Getwell Road, Memphis, TN 38118 • 901-362-1350

Circle (79) on Reply Card

mine location of up-link truck.

Circle (901)

See ad page 1

Pinzone Communications

MAC-1 controller: receiver control, remote access, networking capabilities; time-programmable satellite antenna control unit.
Model 9270: all-format C/Ku-band receiver with Comtech, Vertex antennas; stereo audio, eight subcarrier presets, auto offset for 1/2-transponder operation; covers 36 current satellite formats.

Circle (969)

Scientific Atlanta

7670 controller: total centralized control of earth station from on-site or remote (via modem) with multitasking PC-based system; preconfigured, reconfigurable menus, screens; hardcopy of all system component parameters; allows prescheduled automation.

Circle (1019)

Standard Communications

LNBC-12C: HEMT GaAs FET Ku-band, low-noise amplifier, block downconverter; available for various ITU frequencies.

Agile Omni International: video/audio satellite receiver for all ITU frequencies and satellite formats; applicable for NTSC, PAL, SECAM and MAC transmission standards.

Agile Omni Pro: RS250B video/audio satellite receiver, full feature.

LNBC-4B: HEMT GaAs FET C-band low-noise amplifier, block downconverter.

Circle (1048)

SureShot Satellite Network

Transportable uplink facilities: outfitted for C-

/Ku-band; available on lease for networking; transponder brokers.

Circle (1281)

Thomson-LGT

RSA series antennas: 2m antennas for use with Telecom 1 (RSA 31 AG) or Eutelsat/Intelsat (RSA 30 AG) satellite signals.

Transposer: satellite-to-terrestrial repeater system; power output range 0.3W to 100W UHF or VHF; input 900-1700MHz; 12-24Vdc power by coaxial cable for LNC.

Circle (1102)

Toshiba

Mt-3 Scoop System: portable satellite news gathering system; collapsible to 3-case package; offset parabolic antenna; 1.8m reflector; exciter, HPA.

Circle (1109)

Varian Microwave Equipment

VSTAR: small terminal amplifier; 50kW rated TWT module, power supply, P-controlled CMOS logic module; antenna-mounted.

KSRP: klystron service replacement program; purchase replacement klystron in advance at discount; device stored at depot and delivered when needed.

Circle (1288)

WATCO

8606A transmitter: 300W TWT amplifier; 14-14.5GHz; compact HPA for ground fixed, mobile, flyaway package; digital metering for functions, status; rack-mounted.

8702 transmitter: 300W, Ku-band; antenna-mounted.

8711 transmitter: 400W, Ku-band, rack-

mounted.

8712 transmitter: 500W, Ku-band, rack-mounted.

8713 transmitter: 600W, Ku-band, rack-mounted.

8705: power combiner, redundancy switch; rated 2kW at Ku-band.

8803: uplink transmitter remote control system.
8804 transmitter: 300W, Ku-band, environmental unit.

Circle (1154)

Support Products

S1: Automation

- Hardware, software
- Business, traffic
- Newsroom, on-air
- Remote control systems
- Clocks, timers
- 2-way radio, paging
- Data transmission

Adrienne Electronics

PC-207M interface: links IBM PC/XT/AT to SMPTE 207M machine control bus.

Circle (511)

Advanced Micro-Dynamics

ARC-16: expanded transmitter remote control; modular features for multiple site, walk-away applications; includes phone lines, subcarrier, dial-up comm. options with computer control.

Circle (513)

Betacam® With Triax Control

Live broadcasting with ENG cameras began with Telemetrics control systems.

Controls • Video • Audio • Genlock • Power
Telemetrics—for over 20 years the innovators of camera control multiplexing systems.



Circle (80) on Reply Card

Telemetrics Inc.

7 Valley St. Hawthorne, N.J. 07506
For Information Call (201) 423-0347

*Ask for info on Pan/Tilt Systems.



IS MUSIC TO OUR EARS AND EYES.

Any way you look at it, this was no easy assignment for National Video Center Recording Studios: two nights of Carly Simon in concert had to be edited down to a one-hour HBO special. The schedule was tight; there was no room for error. That's why EASTMAN EVT-2000 Broadcast Video Tape was chosen for this assignment by senior colorist Bill Willig and editor Chris Hengeveld.

Bill: "The hard part was matching colors. The concert was filmed at dusk, with big arc lights for keys. And we had lots of reds, the toughest color in video. But our Eastman tape held up fine. Actually, we went to four generations with this tape. Film transfer, editing, master, then dubbing. The quality was amazing. A technical person might see the generation differences. But you couldn't see it on the broadcast."

Chris: "Some tapes have tremendous dropouts. Especially saturated color. But when we use Eastman tape for a job, we never have those problems. Our clients love the color."

Bill: "We were really pushing to get it done. HBO was running promos, and actually had it in the program guide before it was shot. That kind of schedule called for Eastman tape reliability."

Chris: "We've been using it for two years for a lot of different jobs. It's one of the many tapes we use that's never let us down. We trust it."

Find out how EASTMAN EVT-2000 Broadcast Video Tape can star in your next production. For information call 1 800 44KODAK, Ext 814 (1 800 445-6325, Ext 814).



Senior colorist Bill Willig (left) and editor Chris Hengeveld.



AF Associates

Cue Computer: centralized management, controls for caption generators, video mixers, VTRs, lighting control; data tablet operation; by Radamec EPO.

Circle (515)

See ad page 103

Alamar USA

M-II, S-VHS interfaces: transport controllers; integral in MC-1055 master sequencer, Auto-Cart, Copy-Cart and News-Cue.

News-Cue: auto tape deck control for news department; VCR automatically rolls tape, reads, reports tape ID, title, then cues for pre-roll.

RCMP-5 remote control panel: uses ESBUS network to operate any five devices currently on line on any SC-2000 controller.

Traffic System: IBM PC-based traffic management program for sales, accounting, programming, equipment scheduling, inventory management.

Circle (519)

AMX

ATP: LCD control panel.

SX-DCU: data control unit for serial and infrared-controlled equipment.

Circle (540)

ASACA/Shibasoku

ACL-5000, 5100: auto random access cart playback system; available for 48 or 300 cassettes; -5000 for M-II, -5100 for Betacam, Betacam SP; barcode, SMPTE time code for ID; minimum playback time, 15s.

Circle (555)

Automated Business Concepts

MAPS: radio business system, runs on IBM-AT or AT compatibles; accounting, sales, management, programming software.

Circle (573)

BAI/Broadcast Automation

Live Assist: 24-programmable event automation; 10-position thumbwheel switches for programming; 8-input channel mixer, L/R, mono outputs; 20Hz-20kHz response.

Automation: remanufactured systems.

Circle (605)

BASYS

Archive 1: integrated multiple user newsroom archiving software; on-line, information storage/retrieval; addressing capability to more than six million stories.

Release 9: newsroom software enhancements; auto display refresh, variable split screen, call/capture.

ANGIS interface to Media Computing: automated news graphics interface system software; links with Chyron or Aston 4 character generators to integrate graphics; also links to ANGIS election reporting system.

TIMESLOT: personnel scheduling software; to track and control complex scheduling of personnel under unit and non-union contract conditions.

B.I.T. Function: stand-alone Betacart control system.

NEXIS interface: to on-line information service system from Media Data Central.

Media Touch interface: touch-screen access to news, weather, sports copy, wire service capture; includes OpLOG, OmniPLAY station business systems.

Circle (581)

Brite Voice Systems

Information Hotline Computers: advertiser-supported, telephone information systems; free to callers.

Circle (570)

Broadcast Electronics

MVDS remote control: μ P video diagnostic system for any A-series FM transmitter from Broadcast Electronics; control the transmitter via modem from your personal computer via telco line or STL/SCA; multitransmitter interface option.

Circle (607)

Broadcast Management Plus

J-Plus: software venture with Jefferson Data Services; combines data storage capacity of series 1 with the PC; improves electronic interface between station and rep firm.

Circle (608)

Broadcast Video Systems

VIC900: VBI data transmission system.

Circle (610)

See ad page 192

CBSI/Custom Business Systems

System interface: links radio automation system to broadcast business computer.

Circle (630)

Channematic

Li'l Ben: clock controller; 7-day programmability; 8-outputs individually programmable with 100 switches; 4-key pad program interface; EPROM program storage, RAM parameter storage.

ADCART: random access commercial insertion system.

8-BALL: instrument grade monitor switcher; audio, video sections; vertical interval switching.

Broadcaster II: automatic videocassette changer; random access of 15 cassettes; 7-day programming, 100 events/day; auto duplication mode with external video source and record deck; for 3/4" cassettes.

Circle (638)

Colorado Video

**240/*241:* vertical blanking interval freeze-frame video transmission system.

Circle (651)

Columbine Systems

Columbine/Salmon Sales Management: system for IBM PC or PS/2.

Columbine/Finance: new financial management application software.

Enhancements: sales, traffic, billing software upgrades.

Columbine/Music: software.

Prompter interface: links Columbine/News Management software to Q-TV Tewsprompter 1.

Circle (652)

Connolly Systems

CATS: computer aided transmission system; automatic control of all sources, presentation mixer according to prearranged schedule; manual override; hardcopy printout of stored schedules.

VTS-100: VTR sequencer, switcher controller; allows control of 16 machines, auto program recognition, time code cuing and replay; extendable to other transmission equipment.

Circle (673)

Cubicomp

Network Link: Ethernet direct transfer of im-

age files and data from PictureMaker 3-D animation system to Vertigo computer graphics systems.

Circle (685)

Cycle-Sat

Satellite Courier system: automated delivery system, operated with GE American Communications; uses addressable equipment at TV stations to record commercials during off-hours.

Cyclecypher: data decoder, receiver; activates a designated VTR at station when commercial or other material is directed to the station; equipment lease plan.

Circle (687)

See ad pages 98-9

Data Center Management

DCM election reporting system: electronic newsroom equipment, with electronic prompting, generic CG/titler interface; stand-alone or part of newsroom system.

Circle (690)

Digital Equipment/DEC

VAX family: computers with VMS software architecture; Ethernet/DECnet networking tools; for newsroom, programming, accounting, traffic, operations.

Circle (704)

DKW Systems

CABS: computer-aided broadcasting software; CABS/PS programming, scheduling; CABS/LA live-assist; CABS/LA+ live-assist with full automation.

Circle (711)

See ad page 195

DSI Communications

CC101: computer with Bars'n'Tone test signal generator.

STATUSSystem family: remote monitor control, automation systems; broadcast, video.

Circle (919)

Dynamic Technology

VICAT: vertical interval control, transmission system; enter data through RS-232 link for transmission in VBI over cable, microwave, satellite; encoder, decoder operates on NTSC, PAL, SECAM.

Circle (717)

Dynatech NewStar

APS robotic camera interface: option for NewStar systems; communicates camera shot sequence to Total Spectrum Manufacturing camera controller.

PC NewStar: terminal for newsroom systems; operates on PC/AT or PC/386 systems; requires 640K RAM, supports monochrome, color monitors; one floppy drive required.

LEADER: newsroom election system; PC/AT MS-DOS based; supports titlers from BTS, Chyron, Quanta; producer's screen for monitoring multiple races.

Circle (721)

Edit Line

Edit Line TTA 2000: automation system based on Amiga 2000 computer, up to six machine controllers; 8x1 A/V switcher; bus controller, two machine control units with integral time code readers; for CATV LO.

Circle (1243)

EEG Enterprises

VBI data distribution system: allows new revenue source by offering data service providers a point to multipoint transmission network; 5.7272Mb/s instantaneous data rate, for-

Introducing the New Generation of Wireless Microphones from HME.



All New RF Link. All New Switching Diversity. All New Packaging. And *Unbeatable* Sound.

HME's new Series 50 is so advanced that anything else is a compromise.

Here's just a few highlights:

A completely new RF link greatly improves the capture ratio for dropout-free performance under the most demanding conditions. Our new state-of-the-art noise-free switching diversity system has broken the price/performance barrier.

There's a new, rugged ABS body on the hand-held models, along with an advanced internal antenna with superb radiation characteristics. The new dual-frequency body pacs give you top

performance under physical as well as electrical abuse.

HME's new NRX II™ noise reduction system has to be heard to be believed. It's the only noise reduction system designed *expressly* for wireless microphones. And it's available only in HME's New Generation Series 50, both hand-held and body pac.

See your HME dealer for the final shock:

You'll find HME's Series 50 price *below* every other professional system. That's because we're sure every thinking professional will standardize on it.

And why not. There's nothing even close.



HME ELECTRONICS, INC.

6675 Mesa Ridge Road
San Diego, CA 92121
(619) 535-6060

**HME's New Series 50 Wireless Microphone—with NRX II™
No Equal. Nothing Close.**

Circle (82) on Reply Card

ward error correction process for 9,600 baud throughput.

Circle (729)

Enterprise Systems Group

Electronic Tie-in: direct link between station business computer and various computer-based agency systems.

Betacart interface: links cartridge playback equipment to station business system.

Circle (747)

Evertz Microsystems

Model 120, 125: time, data displays; 2" characters viewable from 100 feet or more; matrix-based numbers, characters; time code, serial RS-232/422 data inputs.

Circle (751)

Gentner RF Products

VRC setup software: use IBM PC/compatible with modem to setup VRC-1000 system; menu-driven.

Radio version firmware: for remote operation with VRC-1000 on radio link or dial telephone circuits.

Version 3.0 firmware: for VRC-1000 remote control; expands, enhances auto time-based command capability; selective calling for alarms.

Antenna monitor interface: links VRC-1000 to directional array phase monitor; remote system checks all parameters of array.

DC amplifier: interface VRC-1000 to metering samples to 1000V above ground.

Temperature sensor: VRC-1000 accessory; self-calibrated; measures four different temperatures from -50°F to 250°F.

Circle (780)

HEDCO

RSC-100: remote serial control card used for switchers using RSP-100 control panel.

Circle (799)

IGM Communications

PC logging system.

Circle (811)

Innovative Automation

Di-Trol software: for Apple II; control 23 stereo sources for totally automated radio station.

Di-Trol Jr.: automation software for Apple II as controller; controls 39 devices, 1,440 events/day; log to disk for later printout.

Micro Di-Trol automation: software for Apple IIe controller; memory for 1,440 events (60/hr), disk capacity to 10,080 events/week; 4-source control, three with random selection.

Circle (1250)

Jefferson-Pilot Data

BIAS Program Decision: film management, amortization system.

JDS AutoSelect III: radio music rotation system.

Electronic Contract: rep to station electronic orders.

Electronic Invoice: station to agency electronic affidavits.

MEDIA LINE: media planning, buying, paying, billing.

Circle (828)

Kinematics/Truetime

VTI: video time inserter.

Circle (842)

LaKart

MiniKart: cable insertion system; plays tapes;

switches frame accurately using SMPTE time code; tape ID stored in user bits; memory for 330,000 events; system controls six transports.

ALS automated library system: cassette capacity for 500, 1,000 or 1,500 for unmodified Beta SP, M-II, D-2, U-Matic or S-VHS transports; 10s throughput with four transports; robotic system for random access of cassettes.

Circle (1256)

Leitch Video

3000RA: remote control assignment unit; bi-directional, 8-pole, 8-position relay switching unit; thumb-wheel selection; switches eight data lines, such as RS-232/-422/-485 or other serial ports.

Circle (859)

See ad on Inside Back Cover

Lexicon

MRC MIDI remote controller: expands LXP-1 processor through MIDI System Exclusive; accesses hidden parameters of LXP-1; allows analog-style patch to Yamaha 6-operator FM synthesizer; 24-character LCD display; modifies ADSR envelopes.

Circle (862)

MAX³ Inc

MacToolkit Version 3.0: software for scheduling, budgeting with Macintosh computers.

Circle (1257)

Media Computing

NCI interface: links newsroom computer system and character generator to supplement ANGIS election system.

Circle (891)

ALPHATIZED TYPE 6

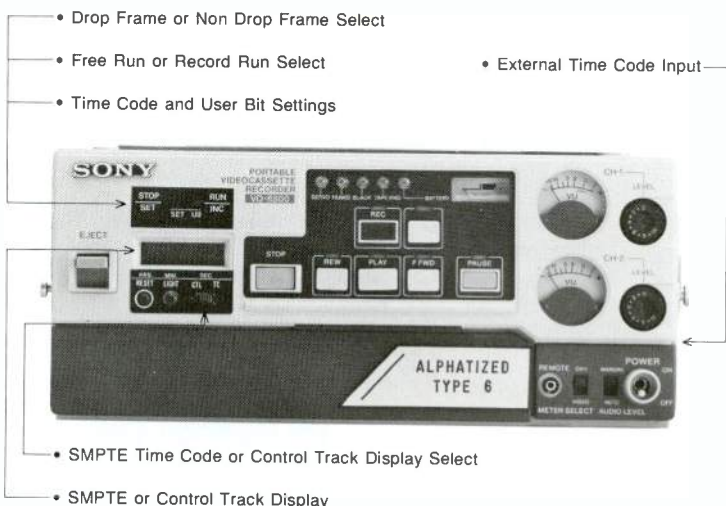

AVC

Alpha Video & Electronics Co.

200 Keystone Drive, Carnegie, PA 15106, (412) 429-2000, FAX: (412) 429-2015

Video Distribution Amplifier in a Chip



VBB-1

A low-cost solution to video distribution. VBB-1 is a high performance hybrid video amplifier/line driver with two outputs. Its specifications are outstanding and it is easy to use. Two of these and you have a 1 IN, 4 OUT DA. Excellent for component video.

Call or write:

415-792-8684

415-361-1253 Message Ctr.

AVA

ADVANCED VIDEO ASSOCIATES

400 Walnut St., Ste. 101, Redwood City, CA 94063

Circle (84) on Reply Card

THE WORLD'S STANDARD IN ACCURACY AND RELIABILITY ...NARDA

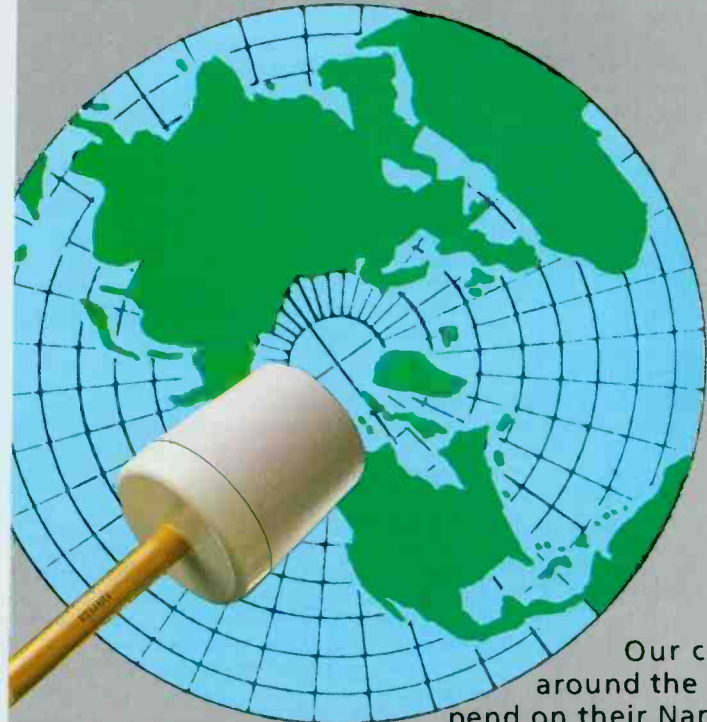

Our customers around the world depend on their Narda instruments because they know our products meet their needs for reliability and accuracy.

Or, it could be our comprehensive product line consisting of the popular 8600 series with the new 8500 or 8700 series monitors.

Or, maybe it's our new model 8696 Averaging Module that performs complex time or spacial averaging, even while immersed in the worst of RF environments.

Or, it's our fully automated calibration reminder service that provides Narda customers with fast turnaround times and MIL-45662 compliance.

Whatever the reasons are, Narda has the product to meet your needs, with a world of experience behind us. To find out more about the world leader contact:

Whatever the reasons are, Narda has the product to meet your needs, with a world of experience behind us. To find out more about our exclusive line of Radiation Hazard equipment contact: Narda Microwave Corporation, 435 Moreland Road, Hauppauge, New York, 11788, (516) 231-1700. TWX: 510-221-1867. FAX: 516-231-1711. CABLE: NARDACORP HAUPPAUGE NEW YORK.



Model 8615



Model 8654



Model 8660



Model 8616



Model 8716



Model 8696



Model 8520



Model 8520



Model 8512



Model 8699

narda

A Subsidiary of LORAL

Circle (85) on Reply Card

Media Data Central

NEXIS/LEXIS database: information service, available by subscription; on-line library of wide range of subject matters; assist in substantiating news stories.

Circle (1258)

Merlin Engineering

ME-980, ME-990: data acquisition system units, inserts data into active video for recording. *Bar-Keeper, Play-lister:* software for Sony Betacart system.

Circle (893)

3M/Broadcast-Related

RS-422 3M machine control system.

Circle (907)

Moseley Associates

MRC-2 software: real-time telemetry updates allow operator's knowledge of system status; adjustment of out-of-tolerance parameter happens as the operator moves the setting at the terminal.

MRC PC: emulates MRC-2 or MRC-1600 control terminal with CRT and automatic logging; multitasking system stores logging data to hard disk if other programs are in operation.

Circle (914)

See ad page 63

Motorola

Saber Handie-Talkie: portable FM radios for VHF (6W) or UHF (5W) operation; MC68HC11 μ P control.

MTX800: trunked portable radios; μ P-controlled automatic functions for Special Mobile Radio (SMR) service.

Circle (915)

Odetics

CWS500 workstation/recorder: make recordings, update database, download from traffic, edit play lists, delete spots; on-line with Cart Machine through Novelle network; AT-type computer and other hardware and software. *XR800 external interface:* enables cart machine to control and switch external recorders, players and other program sources; two with RS-422, one with parallel dry contact.

TCA3000: on-air automation cart system; play, record events under control of a real time interactive station automation system.

T1700: advanced traffic/station automation interfacing; fully automates play list and "as run" log information exchange with TCS2000 or TCA3000

TCS2000: expanded line includes M-II (release 5 software) and Betacam SP transports (BVW-75/-70/-60).

Circle (940)

See ad page 129

On-Air Systems

Tape Delay System: 80386 computer controls M-II, Beta, Beta-SP, U-Matic SP, S-VHS formats; complete automated tape delay center; operator enters record start time and delayed playback time.

Betacart+Beta-SP: machine control system; 80286 computer, keyboard, EGA graphics with NEC multisync display; intermix Betacart cassettes with Beta-SP and 1" VTRs from one playlist.

OAS label making database system: keeps entire media inventory through standard Sony Barcode labels; userbit IDs.

Circle (1266)

Offbeat Systems

Streamline Scoring System: musicians, composers tools to match music to picture; software

for IBM AT/compatible.

Circle (1264)

Pinzone Communications

Timeslot Schedulers: Microtek Facilities, Personnel software; for all IBM and compatible PCs; 640K RAM, 10Mbyte hard disk suggested.

VISCAS: encodes voice, data, talkback, foldback onto one line in the vertical interval.

Circle (969)

Potomac Instruments

1500 PC: programmable remote control system, 8085 μ P-based; link via telco, radio to 1510ST studio terminal for automatic remote control; front panel controls, menus on integral CRT; key-lock for security.

Circle (973)

See ad page 132

Radamec EPO

Cue Computer: centralized management, controls for caption generators, video mixers, VTRs, lighting control; data tablet operation.

Circle (1274)

Reach Electronics

21TYE1: Liaison dial access paging terminal; with voice storage capability; configurations for Liaison, tone only, tone and voice paging; optional voice storage with repeat message.

Circle (989)

Rohde & Schwarz

DGF/EGF data coder/decoder: video program system uses data lines to include program origin (station), program postponement; decoder can be used with programmable VCR to record only selected programs.

Circle (1000)

See ad page 69

SCA Data Systems

PG 57-2 Paging Generator: digital signal processing; error correction, data regeneration; auto squelch on invalid data; RS-232 compatible with EBU RDS spec.

PGC-001 Paging Combiner: intelligent insertion of local pages into national paging system; conforms to Swedish Public Radio paging standard; local-only fall back mode if national input fails; RS-232 connections.

Circle (1276)

Sony Broadcast

DVC-1000 LMS Library Management System: for Betacam and D-2 formats; standard storage capacity to 1,000 cassettes; modular expansion to 4,000; auto replay of programming, spots, commercials.

Multi-segment software: for Betacart; allows integration and playback of commercials, programs longer than 30 minutes from any of four external VTRs; NEWS Network Engineering WorkStation.

Circle (1037)

See ad pages 25-7

Sony Corporation of America

RDSS radio determination satellite system; vehicle hardware, operations center mapping software; through Geostar satellite service and Loran-C navigation network.

Circle (1278)

Systemation

Station software: traffic, billing packages to drive automation; sales management program. *Infoline call-handling:* callers ask for specific information by selecting numbers on tone-dial telephones; recorded voice announces available choices.

Touch-screen option: point-n-shoot control for

radio automation.

Circle (1069)

Telesource Communications

Newsroom applications: Sportscap; Stockscap; Wire service management; Weathercap; PSA/Report; interfaces to various standard titler systems; newsroom systems; still stores. *PC Election system:* complete tested equipment, interfaces to wire services; producer's Status Program; customized display formats from existing titler.

Circle (1207)

Townsend Broadcast System

DC-80: automatic videocassette commercial playback system; available for SP, S-VHS, M-II, Betacam formats.

DC-800: multiple channel automatic playback system; for programs, commercials, PSAs, IDs; *DC-800A* walk-away automation.

DC-80DL: auto program delay from four minutes to more than two hours without intervention; enhanced video processing, stereo audio; allows record-only, play-only, push-pull schedule adjustments.

Circle (1111)

Twentier Systems

Genesis: electronic newsroom system for small radio, TV stations; from 4 to 10 terminals.

Circle (1205)

Utah Scientific

TAS-I: total on-air automation; full-featured, intelligent machine control; open architecture; Unix-type Regulus operating system.

RAS-I: real-time switcher control; computer-based scheduling of time referenced events for routing switchers and machine control systems.

Circle (723)

See ad pages 66-7

VG Electronics

**1075:* data encoder for use with FM radio transmitters.

Circle (1137)

Video Design Pro

VidPAD/AudPAD: video and audio paper-aided design, when a computer isn't available for CAD.

VidCAD for MAC: VidCAD, AudCAD and TC+CAD for MAC computers.

VidCAD 2.9: combines versions 1.4 and 1.8 with drawings for more effective use of pull-down menus in AutoCAD release 9.

VidCAD On-Line: 24-hour information, support service on national AutoCAD Echo BBS.

TC+CAD: teleconference, multimedia and AV/V library for VidCAD; components, tools for design including large screen computer display facilities.

Circle (1142)

Support Products

S2: Wire, cable

- Audio, video, coax
- Connectors
- Fiber optics
- Patchbays, panels, cords
- Power distribution

Abbott & Co./Brintec

Safety Lock power distribution system; entrance

EEV KLYSTRONS SO MUCH MORE TO OFFER

*The most comprehensive range of
External Cavity UHF TV Klystrons*

	Transmitter output power	Frequency range	Typical Sync efficiency
WIDEBAND SERIES			
K3773BCD	60-70 kW	470-860 MHz	44% to 48%
K3673BCD	55-60 kW	470-860 MHz	44% to 48%
K3573BCD	40-55 kW	470-860 MHz	43% to 46%
K3672BCD	55-60 kW	470-810 MHz	44% to 48%
K3572BCD	40-55 kW	470-810 MHz	43% to 46%
K3271BCD	15-30 kW	470-860 MHz	42% to 47%
K3270BCD	5-15 kW	470-860 MHz	42% to 47%

STANDARD SERIES

Low Band			
K3276HBCD	40-55 kW	470-596 MHz	38% to 43%
K3382BCD	40-55 kW	470-590 MHz	38% to 42%
K3217HBCD	30-45 kW	470-590 MHz	40% to 42%
K3230BCD	10-30 kW	470-596 MHz	40% to 42%
K376L	10-30 kW	470-610 MHz	34% to 40%
K370/W series	5-10 kW	470-606 MHz	29% to 35%
Mid Band			
K3277HBCD	40-55 kW	590-710 MHz	38% to 43%
K3383BCD	40-55 kW	590-702 MHz	38% to 42%
K3218HBCD	30-45 kW	590-702 MHz	40% to 42%
K3231BCD	10-30 kW	590-704 MHz	40% to 42%
K377L	10-30 kW	590-720 MHz	38% to 45%
K371/W series	5-10 kW	606-742 MHz	32% to 35%
High Band			
K3278HBCD	40-55 kW	702-860 MHz	38% to 43%
K3384BCD	40-55 kW	702-860 MHz	38% to 42%
K3219HBCD	30-45 kW	702-860 MHz	40% to 42%
K372/W series	5-10 kW	740-860 MHz	32% to 35%

EEV Klystrons

AVAILABLE TODAY

Circle (86) on Reply Card

USA: EEV Inc, 4 Westchester Plaza, Elmsford, NY 10523 Telephone: (914) 592 6050 Telex: 6818096 Fax: (914) 682 8922
 CANADA: EEV Canada Ltd, 67 Westmore Drive, Rexdale, Ontario M9V 3Y6 Telephone: (416) 745 9494 Telex: 06 989363 Fax: (416) 745 0618
 UK: EEV, Waterhouse Lane, Chelmsford, Essex CM1 2QU, England Telephone: (0245) 493493 Telex: 99103 Fax: (0245) 492492

service box/company switch.

Circle (501)

ADC Telecommunications

S-9 PatchMate: SMPTE 9-pin patching system.
I.C.O.N. IJF: jackfield with 24-pair cable for termination of inputs/outputs to the bay.

Circle (508) [See ad page 113](#)

Alpha Wire

Mic cable: extra flexibility; Starquad design for reduced hum, noise; PVC or rubber jacket.
RG coax: plenum-rated, passes UL VW-1 flame test; does not require conduit; for data logging, local net, CRT, VDU, CCTV uses.

Precision video cable: 75Ω; structural return loss of -30dB to 300MHz; for indoor, outdoor, plenum installations.

Circle (1229)

Artel Communications

T3080: fiber optic transmitter operates at 1,550nm; for Series 3070 receivers on single-mode fiber link; meets EIA-250B short-haul spec; 45km range; compatible with T3100 series audio/data subcarrier modules.

Wave Division Multiplexer: signal combiner allows T3070 1,300nm and T3080 1,550nm transmitters in dual unidirectional or bidirectional transmission; T3080/WDM system can be bridged to existing fiber link using 1,300nm equipment.

FiberWay 802.3 Bridge: links entire Ethernet networks to 100Mbit/s FiberWay fiber optic LAN.

Circle (554)

Audio Accessories, Inc.

Patching products: panels, bays; prewired, custom audio panels; patch cords.

Circle (563) [See ad page 178](#)

Belden Wire & Cable

Brilliance: flexible microphone cable.

Snake cable: individually packeted.

Circle (587)

Cam-Lok

EO400 series: Posi-Lok power distribution panel; 400A, 500V; meets NEC spec; special polarization, interlock design assures ground contacts are made first; avoids cross phasing.

EO315 series: Posi-Lok power distribution panel; 600V; NEC spec; polarization interlock design makes ground contacts first; avoids cross phasing.

Circle (620)

Cambridge Products

Fastfit: BNC connectors; twist-on, crimp-on series of cable plugs and jacks; field installable; includes right-angles, terminators.

Circle (621)

Canare Cable

L-2E5: miniature microphone cable.

V-series: video component cable.

A2SP: ENG/EFP remote snake system.

A2V1: camera remote cable; one video, two audio circuits.

GS-4: miniature high-Z cable.

BCP-C3: BNC connectors, in-line type; 75Ω.

BCJ-R: 75Ω BNC recessed receptacle.

Circle (623)

Catel Telecommunications

**3100:* synthesized fiber material.

Modulator/demodulator: infra-red fiber optic system; synthesized.

Circle (628)

Chester Cable div/Alcatel

Component video cable: meets SMPTE component standards; type with individual and multiple coax cables in a common jacket.

Circle (639)

Comlux

System 2000: modular, open-architecture, fiber-optic transmission system; digital main channel rate of 140Mb/s; for broadcast video, program audio, RS-232 data, T1 data, packet-switched data.

Models 2507, 2508: 9-bit linear encoding video codec; meets RS-250B short haul spec; simultaneous transmission of digital program audio, and other data protocols.

Circle (655)

Connectronics

J-BAY: uses printed circuit 1/4" standard jack sockets, 2-/3-pole; normalized, semi-normalized; cards fitted with single 3-pole jack on back, two 2-pole jack on front.

X-BAY patchbay: enables different types of connectors to be mounted on the same unit; a maximum of 32 channels; order preassembled or in components.

Circle (672)

Dynair Electronics

Fiber optic link: wideband, for HDTV.

Circle (716)

Gentner Electronics

Flexiblock FB-100: wire termination; double density for four wires/terminal with two connection points per terminal; for stranded or solid wire.

Versapatch FB-1: 48 TRS jacks, offset for stereo patching; normals to rear for easy access; FB-100 Flexiblock terminations.

EasyTerm/FB-1: rack-mount termination, 320 punch-down terminals in 3.5" rack space; 4 wires per circuit, stranded or solid; hinged panel for easy access.

Circle (779)

[See ad page 62](#)

H. L. Dalis

Distributors: wire, connectors, wiring tools, patch/power cords, shrink tubing; batteries, tape, test equipment.

Circle (1247)

IMC/International Music

PG1000: universal patchbay programmer with 12" RGB monitor.

DP3200: 32 in/out audio patchbay.

DP2000: 16 in/out audio and video patchbay.

Circle (815)

LEMO USA

Service: custom cable assemblies.

Circle (860)

Neutrik USA

Speakon: loudspeaker, amplifier connectors; 4-contact series for frequently connected, disconnected high power audio systems.

Weatherproof XLRs: rustproof, splashproof, corrosion proof; NC3FX-HD female, rubber boot; NC3MX-HD make, stainless steel.

NA, NM series: custom adapters, connectors from modular system; create the required device from XLR, RCA, BNC styles; can include transformers and other devices.

Circle (1219)

OptiVideo

Twenty-Twenty: optical routing system with

crosspoint matrix switching flexibility.

Circle (1267)

Pyce-National/Brintec

Multipin environmental power and control connectors; liquid tight strain reliefs; indicator lights.

Circle (1273)

Switchcraft

EI11L: 1/4" locking jack.

Audio patch panel: assembled, fully shielded, 19" rack-mount; IDC insulation displacement connectors on inside of back panel; 48 3-circuit jacks.

A3FS/A3MS: small diameter Q.C. cable clamp.

A3FBAU/A3MBAU: black/gold Q.G. connectors.

Circle (1063)

[See ad page 139](#)

Union Connector

Model 2P&G: 20A floating pins; *2P&GMC* make cable plug, *2P&GFC* female cable receptacle; body of molded phenolic, contacts of solid brass.

Patch panels: various types including single pin patch, hanging cord.

Circle (1121)

VEAM/Litton

Mic Snake: transmit 52 audio channels through a single optical fiber; balanced mic inputs, 2mV; separation, 90dB; 44.2kHz channel sample rate; distance to 0.5km.

Circle (1135)

Wireworks

CF Extra Flexible: 2-conductor mic cable; 60-strand 40AWG annealed copper with high density braided shield; low hum, noise, interference.

CQ series/Star Quad: 4-conductor configuration with high shield density for reduced hum, handling noise; low capacitance with polyethylene dielectric insulation.

Circle (1165)

Support Products

S3: Storage & studio

- Equipment cases, bags
- Racks, consoles
- Acoustic material
- Studio fixtures

Alpha Audio

Acoustic materials: 24"×24"×2" lay-in tiles of Sonex, Soundtex, Acoustilead, Sonex 1; compatible with standard suspension grids; five motifs available..

Circle (527)

[See ad page 175](#)

AMCO Engineering

Control desk centers: improved styling; conforming to FCC EMI standards.

Circle (532)

Anvil Cases

M.I.C.S.: modular interlocking case system.

Circle (546)

[See ad page 52](#)

Arben Design

Display kiosks: for interactive videodisc or other programming displays.

Studio sets: new line of flats for traditional wall or room settings.

Circle (550)

FOR NEWS EDITING, ON-AIR, AND PRODUCTION



RADIO'S TOP TEN!

© Otari 1987

For news editing, on-air, or in the production studio, Otari has exactly the equipment and features to fit any application, or budget.

When you are ready for a multitrack recorder, you can choose from our BQII, MKIII/4, MKIII/8, MTR-10, or the MX-70 with 8 or 16 tracks. Need a 2-track? Choose our famous "workhorse" MX5050 BII, MKIII/2, or the brand new MX-55! Looking for top-end performance? The MTR-10 has all the features you need to stay ahead in the competitive world of broadcast. We also offer three models of our CTM-10 cart machine, and if yours is an automated radio station, our ARS-1000 reproducer is the most popular in the world.

So you see, whatever you need for today, or for the future, Otari can provide it from a complete line of high quality, ultra-reliable tape recorders. Call your nearest Otari dealer today, or contact Otari at (415) 341-5900 for "Technology You Can Trust".

OTARI

Circle (87) on Reply Card

Arrakis Systems

Modulux: factory prewired studio systems; pedestals include connectors ready to plug in; standard configurations with Arrakis consoles, custom designs; available through Allied Broadcast.

Circle (552) See ad pages 21, 33

Audio Broadcast Group

Rolling Radco: mobile studio completely ready for remote broadcast; includes console, RPU equipment.

Circle (564)

BC Inc.

Custom containers: reusable shipping, storage containers per ATA 300 Cat I, Mil Spec 810D.

Circle (1234)

Calzone Case

Convoy: ABS plastic molded cases; 1/8" material; for lightweight equipment.

Proline: lighter duty version of Escort series; for local, regional equipment transport.

Escort: equipment cases; maximum protection design exceeds ATA spec.

Circle (619)

Centro

RM-1: 19" rack-mountable enclosure; 1RU to 4RU high; aluminum with removable front, rear, top panels.

CRK-1: collapsible rack kit; gangs for multiple bay rack; 12-outlet isolated power strip with junction box; 19" EIA standard; 1/2"x1/2" square tubular material.

Circle (634) See ad page 75

Duggan Manufacturing

Hardware: for equipment cases.

Circle (1242)

Ergo Industries

Tilt slides and computer furniture.

Circle (1244)

Ferno Washington

**293 Freelancer*: audio-video equipment transporter with gimbal battery holder; shelf; light support pole.

Circle (757)

Alan Gordon Enterprises

Special effects: acrylic devices; ice cubes, spills, pours, bubbles, smoke bombs.

Circle (784)

Karl Heitz

Kiwi Rhino bags: six sizes, partitioned; high impact padding for safe transporting of video, computer, lighting equipment.

Circle (800)

Kangaroo Video Products

Case/raincover: for Sony Betacam SP and Panasonic M-II camera/recorder models.

Cases: for Panasonic AG-7400, AU-500, AU-400 recorders.

Case: for portable TV monitor.

Waist-belt production pack.

Raincover: for field use of the Sony BVP-360 studio camera.

Camera case: new design case with viewfinder support for Sony Betacam SP and Panasonic M-II cameras.

Circle (836)

K&H Products/PortaBrace

Producer-Director: compact briefcase.

Circle (841) See ad page 192

Kintronic Labs

SER series: standard equipment racks; unique features and decor.

Circle (845)

Lucasey Manufacturing

Mounting systems: wall, ceiling, VCR, pedestal mounting devices for monitors.

Circle (1211)

Luxor Corporation

OHT 50: overhead projector cart.

TVP 44: cart for 35" TV monitors.

Circle (871)

Matthews Studio Equipment

Triple Riser C: combines steel legs with aluminum risers.

Circle (883) See ad page 190

Morton Hi-Tek Furnishing

Avonite consoles: different colors available.

Circle (913)

Nalpak Video Sales

TP-1248: expanded line of TriPak tubular tripod cases.

SP-9948: soft tripod case.

Circle (923)

Penn Fabrications

Hardware: for equipment cases, speaker enclosures; rack-mount equipment; Par 64, 56 lighting cans; mic stands.

Circle (959)

Rosco Laboratories

Studio floor tiles: 3'x3'; gray, white, black.

Circle (1002)

RPG Diffusor Systems

Complete acoustical treatment: expanded line of broad-bandwidth sound QRD diffusors, Ab-fusor absorbers and Triffusor variable acoustics modules.

Circle (1005)

Star Case

SuperStar case: premium ATA 1/4" plywood, fiberglass lamination, recessed step-down hardware, extra deep groove valance.

UltraStar case: heavy duty ATA 1/2" plywood, fiberglass lamination, recessed step-down hardware, extra deep groove valance.

ATA Star case: ATA approved 1/4" plywood, fiberglass lamination, recessed step-down hardware; available in 11 colors.

CarryStar case: lightweight 1/8" plywood, fiberglass lamination, exterior hardware; available in black, pink, gray, aqua.

Circle (1051)

Storeel

CD-160: storage system for CD media; accommodates 160 CDs.

Circle (1055)

Telepak San Diego

T-80: case for EVM-8010, BVM-8021, PVM-8020 monitors.

T-84: Panasonic NV-8420 case.

T-Rain IV: raincover for Panasonic AG-150-55-60.

T-UCP: universal camera case; styled as carry-on luggage.

T-80 HC: shipper case for EVM-8010, BVM-8021, PVM-8020.

Circle (1086)

Uni-Set

DBS cabinets: storage for the downlink business TV network equipment.

Studio staging: 3-ft modular set pieces.

Circle (1122)

William Bal

Attache case: various metallic colors.

Custom made cases for electronic equipment.

Circle (577)

Winsted

Cassette storage: for Beta, VHS, M-II cassettes.

Custom wood consoles.

Vertical equipment racks.

30° Slope: modular console series.

Circle (1164) See ad page 195

Support Products S4: Recording media

- Audio, video, data
- Reel, cassette, disk
- Analog, digital formulas
- Cleaners, conditioners
- Degaussers, shippers

Agfa-Gevaert

PEV-162 SDX-TB: thin base VHS tape in pancake packaging; up to 167 minutes; 16µm thick base material.

Broadcast Pro Betacam: low dropout video cassette; static resistant tape coating, extra durable shell of ABS plastic; hard-box case.

Circle (516)

Ampex MTD

Tape storage system: flame-retardant storage rail; 10 four-foot rails holds 280 U-Matic or 300 Betacam cassette shippers with hanger feature.

Ampex 219 D-1 tape: 19mm digital videotape for 4:2:2 component recorders; cassette sizes for 34 and 76 minute play times; 850 Oe cobalt gamma-ferric oxide formulation.

Ampex 198: improved 1/2" Betacam tape with smaller cobalt particles in formulation for greater RF output; play lengths of 5, 10, 20, 30, 60 and 90 minutes; anti-stat shells.

1"×14": flame retardant, water-resistant shipper; integral turntable to avoid tape cinch during transit.

Ampex 319 D-2 tape: metal particle digital video tape; three cassette sizes for maximum play times of 32, 90 and 208 minutes; 1,500 Oe; ABS antistatic housings.

Packaging systems: anti-static plastics in #187 broadcast and #197 master broadcast U-matic cassettes.

Circle (537) See ad page 47

Audico

Videocassette loader: reloads, unloads, rewinds, cycles, length verification for all 1/2", 3/4", 19mm and 1" formats.

Circle (561)

Audiopak

Audio media: broadcast cartridges, lubricated tape.

Circle (1232)

Carpel Video

Blank videotape: quality, evaluated 3/4", 1", 2" media; wholesale.

Circle (1238)

If you think all cart machines are created equal...

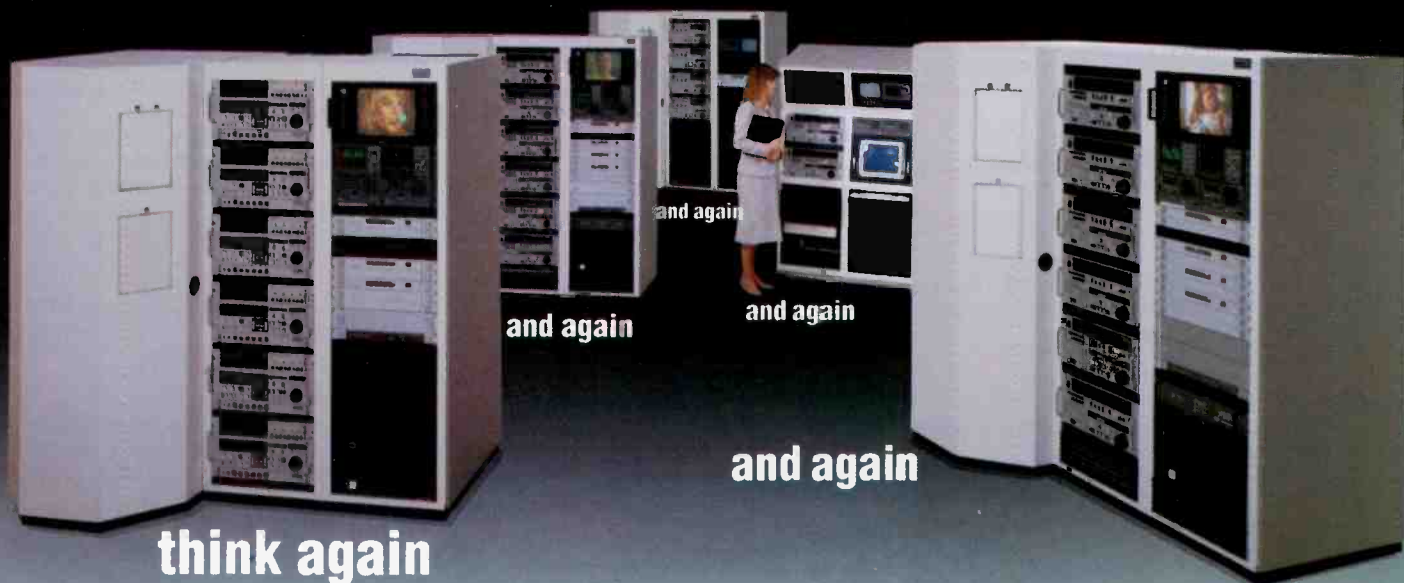

We have the industry's broadest selection of cart systems.

While our competitors deliver promises, we deliver:

- Integrated record/play cart systems
- Play-only cart systems
- Cart work stations
- Traffic interface sets
- External VTR controllers
- On-air automation cart systems
- Choice of formats including M II and SP

Odetics Broadcast

We're changing the way you think about cart machines.

1515 South Manchester Avenue, Anaheim, California 92802-2907

Phone 800-243-2001 ☐ 714-774-2200

Circle (88) on Reply Card

CMC Technology

Service: full, partial refurbishing of Sony BVH1100/2000 PAL, NTSC upper drums.

Circle (647)

Collins Automatic Tape Joiners

CAT system: magnetic tape splicer; cassette of 350 adhesive joining tabs; self-sharpening guillotines are machined anti-magnetic steel; ends to be joined are held automatically.

Lynx splicer: automatic system of anti-magnetic steel; self-sharpening blades; hand-held; one touch dispenses a pre-cut splicing tab to make a join.

Circle (1239)

Eastman Kodak

Production Pack: contains 10 Eastman Pro Format II cassettes for Betacam format.

Pro Format SP: broadcast video cassettes for Betacam SP.

Image Master MHG: broadcast master VHS videocassettes; durable for editing, dubbing.

Circle (724) See ad page 119

Fidelipac

Dynamax series 1000: cobalt formulation tape; for fidelity nearly equal to the source.

Circle (760)

Fife-Pearce

2PT5: tape degausser, conveyor design; automatic, continuous operation; approved by National Security Agency.

Circle (761)

Fuji Photo Film

D-2 digital prototype: for digital composite systems; 30, 90 minute lengths.

Pro-S S-VHS: 30, 60, 120 minute cassettes for S-VHS; 20-minute for S-VHS-C; -Beridox formulation.

H321E L preview: videocassettes for Betacam/SP; 60, 90 minute play times.

M321P prototype: Betacam SP metal formulation.

H321E Betacam S cassette: oxide video recording media for Betacam and Betacam SP; 5 to 30 minutes play times.

Circle (772)

Garner Industries

Eliminator 4000: high-energy videotape degausser; 3,900 Oe force requires 18s for -75dB analog audio track depth of erasure on 1,500 Oe media.

Circle (775)

3M Magnetic Media

SP series: 3/4" cassettes for broadcast; 1,500 Oe metal tape; 5, 20, 30, 60, 90 minute play length cassettes.

MM series: Master Broadcast M-II videocassette media; 1,500 Oe metal formulation; cassettes for 10, 20, 30, 60, 90 minutes.

SnapCap: cassette hanger system for 3/4" U-matic videocassettes.

ST series: S-VHS videocassettes.

PB series: Master broadcast Betacam SP videocassettes; 60- and 90-minute Betacam cassettes; 700 Oe formulation.

Circle (906) See ad pages 162-3

Maxell

TF20-5000F/4400GN: pancake VHS duplication packs; -4400GN contains 14,436 feet; improved base film increases performance, strength.

Video floppy disk: 2" media for electronic still cameras; metal particle formulation allows 50

images per disk.

R-120DM: digital audiotape for R-DAT systems. *Duplication pancakes:* VHS media; TF20-5000F, stronger base film; TF20-4400GN also in lengths to 14,436 feet.

Circle (885)

Panasonic/Ramsa

Pro DAT tape: high-coercivity metal particle media for DAT recording systems; 60, 90, 120-minute lengths.

Circle (956)

See ad page 79

Quantum Audio Labs

BTE 18, 80, 90B degaussers: for 400 Oe, 750 Oe, 770 Oe recording media; single reel systems; by Weircliffe.

BTE 1900 series degaussers: -1905 S-VHS, VHS, 8mm, BetaMini; -1910 M-II, Betacam SP, VHS, S-VHS, 8mm; -1915 for D-1, D-2, U-Matic; -1925 for all formats of high energy metal tape.

Circle (980)

RTI/Research Technology

Model 6120: 1" videotape evaluator/cleaner; high-speed operation.

Tapechek 4150: 1/2" videotape pancake evaluator; identifies magnetic and physical defects in new tape at 20x play speed.

TapeChek 4150: videotape evaluators for 3/4", Betacam, M formats; CRT graphic display of problems identified on tape, detailed dropout reports; printer recaps tape condition report on hard copy.

Model D-II: dropout analyzer; allows dual size dropout counting.

VRS Data V90: high energy degausser; 5,000 gauss erasing power for 90dB erasure on center tracks of 1" tape, complete erasure of 1/2" oxide and metal tapes with coercivity of 1,500 Oe.

Circle (1007)

Sony Professional Tape

D-1 tape: available in 12, 22 minute medium cassettes; 94 minutes in large cassette.

D-2 tape: metal tape formulation for digital composite format.

D-1/4, D-1/2, DAU, DAT tape: cassettes and open reel tape for digital audio recorders; D-1/4 for 1, 2, 3 hours; D-1/2 for 1/2, 1 hour; DAU for 30, 60, 75 minutes; DAT for 60, 90, 120 minutes.

Betacam-SP, Betacam BCT-series: now available in 5, 10, 20, 30, 60, 90 minute lengths.

Circle (1038) See ad pages 88-9

Taber/AVSC

Taperaser 1500M: automatic controlled erasure of metal tape; multiformat for M-II, Beta-SP, 1" reels, VHS, U-matic; switchable for 700 Oe, 1500 Oe.

Circle (1070)

TDK Electronics

B455 series: videocassettes for M-II format; super high density formulation.

B415 series: Betacam SP videocassettes; ultrafine metal particle formulation for high S/N characteristics.

B410 series: Betacam cassettes for news gathering; ultrafine Avilyn magnetic particles.

B1650-series: for D-1 4:2:2 format DVRs; 13µm thickness for extended play.

ZST Super VHS: S-VHS videocassettes for 425-line horizontal resolution in home recordings.

Circle (1076)

Zonal

920, 960 series: 75µm and 125µm polyester

magnetic sound recording film; improved mechanical characteristics with electro-acoustic performance of 900/950 series.

Voice logging tape: full range of logging tapes, compatible to most communications recorders. *830 series:* broadcast audiotape; formulated for EBU standards for improved distortion, noise and HF response characteristics.

Circle (1173)

Support Products

S5: Distribution

- A/V distribution amps
- A/V/data routing switchers

A.C.E.

VX164 routing switcher: 16x14 video matrix; µP control system; dc-restore, VBI switching; remote with X-Y or single bus connection.

DV410 routing switcher: 8-inx4-out; serial control to standard S series panels.

VD110 digital video distributor: 2-channel, 5-output/channel; for parallel interconnection per EBU 3246; drives cables to 150mm lengths; optional input EQ.

Circle (586)

Adrienne Electronics

AEC-1: 10x1 video/stereo audio router; 30MHz video bandwidth.

Circle (511)

Allen Avionics

1000A series DAs: video, pulse distribution units; to six outputs per amplifier; 10 modules fit ZLR-1 rack unit; response ± 0.1dB to 30MHz; noise, hum -70dB.

Circle (523)

AMX

ASW-500: audio, video switcher.

Circle (540)

AVA/Advanced Video Products

DAS-10 distribution amplifiers: self-powered amplifiers for audio, video; bridging; long-line drivers; data distribution.

Circle (1233)

Brabury Porta-Pattern

CFT175 series: portable Eurocard housings for signal modules distribution in ENG, EFP, desktop systems.

CFT190: 1-RU Eurocard housings hold three DA modules; appropriate read-panel terminations.

ADT557: audio DAs; 10 electronically balanced outputs with transformer-coupled balanced input; on-board regulator; front-panel gain adjustment.

T518 series: video, pulse DAs; high-density packaging 6-output distribution equipment; plug-in cable-length EQ, HF/LF gain adjustment.

Circle (972)

BSM Systems

Cluster series: rack-mounted audio, video amplifiers; series of 30+ types of modules in addition to A/V DAs.

Circle (613)

BTS Broadcast Television Systems

TVS/TAS-2001: A/V distribution switcher; user configurable control panels; can expand existing systems.

BVS/BAS 350: 10x1 or 20x1 HDTV video,

ENCORE

encore

*The all digital
digital effects system*

Quantel's Encore is a very, very effective effects system, the *crème de la crème*. Every year it gets better and better, with more and more unique features. Like the brilliant accuracy of Corner Pinning which no-one but no-one else can do. From the four sets of axes through true through-point movement to the smoothest, soothing curves. And Flash, Sparkle, Caterpillar and Montage, just a few of Encore's brilliant track and trail effects. All in addition to the most magnificent swoops, tumbles, turns and other picture effects. All in real real-time.

What's more, Encore's operating system is going up and up in reputation: the Floating Viewpoint Control and Spacetraks give pinpoint positioning you can never, never get from a joystick.

For real broadcast-quality quality, Encore stands alone as a standalone effects system, equally at home in broadcasting or post-production. And, as an evolutionary part of Quantel's Digital Production Future, it will go on and on, for ever and ever. Well, almost.

So we'll say it again: Encore, the very, very effective all-digital digital effects system. See it for yourself yourself.

*ENCORE -
for very, very effective effects*

QUANTEL

Quantel Inc.,
655 Washington Boulevard,
Stamford, Connecticut, CT 06901
Tel: (203) 348 4104 Fax: (203) 356 9021

Now with corner pinning

Circle (89) on Reply Card

stereo audio switcher; 30MHz bandwidth video. *BSX-350V, BSX-350A*: compact video, audio routing switchers; 10x10 matrix. Circle (615)

CEL Electronics

P172: 16x8 video routing switcher. Circle (631)

Datatek

D-2400: audio-video routing switchers; wide-band for HDTV, MAC signals; 8-level control, integral RS-232/422; 20x10 matrix, 10-bus output amps; 160x20x1 to 42x20x4 configurations.

D-870: multilevel control; provides D-2000 compatible control for 10x1 switching system; RS-232-422 control; plugs into audio or video 10x1 module.

D-800 series: 10x1 audio, video switching modules; mount in universal frames to form multilevel routing system; configurable for S-VHS, M-II and traditional systems; RS-232/422 ports; 30MHz bandwidth. Circle (693)

Di-Tech

Model 9002: virtual matrix control system; software map of every input/output connection to routing switcher; allows any combination of routing switchers for integration into an 8-level master grid.

Model 6700, 6701: 64x16 X-Y matrix or 16 isolated 64x1 switches; use #672 64x1 tally relay cards; DIP switching on cards set output, input address range, control level being tallied.

Model 5865: video combiner; expands video switching systems from 64 inputs to 256.

Model 5863: RS-422 data routing switcher; ex-

pandable from 32x32 matrix; to allocate serial controlled devices into A/V matrix.

Circle (710)

Dynair Electronics

Mini control panel: for Dynasty switchers; full-featured.

Modular DA series: mix/match coax and fiber optic inputs/outputs.

Switcher controller: includes multiple bus, multiple level display.

Modular DAs: mix/match coax and fiber optic inputs, outputs.

DYNASTAR: controls for routing switchers; 8-system controller packages.

StarPak system manager: new features for routing switchers; source restriction, passcode protected destination lock, alphanumeric operation for source, destination.

Switcher controller: multiple bus, level display. *MiniStar control panel*: single-bus or full matrix control; firmware option provides memory for single-button operation. Circle (716)

Dynamic Technology

Series 3900: μ P-controlled A/V routers; cross point inhibit lock, soft-patch, salvo-take features; alphanumeric source, destination labels; video, audio, time code, RS-422, relay levels. Circle (717)

ESE

ES247 VDA: four independent 1-inx6-out video amplifiers; gain, dc level, line EQ controls. Circle (749)

See ad page 193

FOR-A

VRS-2000/ARS-2000: video/audio router; expandable 16x16 matrix system. Circle (767)

See ad page 155

Future Productions

AVD-12S: A/V distribution amp for S-VHS; 12-output. Circle (774)

Gentner Electronics

Routing DA: 8-inx28-out; individual input/output level control. Circle (779)

See ad page 62

Grass Valley Group

Enhancements: to HORIZON and TEN-20/20-TEN routing switchers.

DHX-532 routing system: parallel, digital configuration operates as one level or extends a level of the Horizon routing system; 8-in/8-out blocks for 8x8 to 32x32 matrix; 10-bit system complies with international standards.

HX-GPEM, HX-GP200: interfaces to link Horizon routing switcher to Series 200/300 production switchers; expands input capability of the production switcher.

20-TEN upgrade: relay matrix for switching two hard-wire data paths; joystick override for European installations for source selection from remote camera control unit.

DDA-101: digital distribution of 8-, 10-bit data; 1-in, 4-out; auto cable EQ to 500 feet; data reclocking. Circle (788)

See ad page 9

James L. Grunder & Associates

CEL P172: 16x8 video routing switcher. Circle (793)

This new QuantAural™ QA-100 Audio Program Analyzer gives you the advantage in competitive broadcasting

Simply put, the QA-100 quantifies what you hear. Your station sound can now be electronically monitored the way you hear it. Exactly. And, you can monitor the competition too!

Real time analysis of any audio signal. From a receiver, tape recorder, or processing equipment. You see the measurements as you hear the sound. Changes in processing or variations in system performance are immediately shown on the QA-100 panel meter or bargraph display—using program material as the signal source.

The QA-100 hears like a program director and talks like an engineer. With it you can monitor maximum peak level (relative peak modulation), overall

processing effectiveness (average level), tightness of sound and processing control (peak density), tonal balance, consistency and preemphasis (four band real time analyzer), stereo image width (L + R to L - R ratio) and "punch" (special "aural intensity" measurement).

Interested? To learn more about how the QA-100 will help your station compete, call Potomac Instruments today.

QuantAural is a registered trademark.



POTOMAC INSTRUMENTS

932 PHILADELPHIA AVE. SILVER SPRING MD 20910
(301) 589-2662

Circle (90) on Reply Card

Withstanding The Test of Time



Like the proud, serene monuments of another age, Neve stands alone as manufacturers of the most enduring, reliable broadcast recording consoles in the industry. It takes the same kind of ingenuity, vision and advanced technology to be the architects of a line of products that range from 8 input stereo remote consoles to 96 input, 48 bus production consoles, standard and custom designed. And all with the same pristine performance.

Unique Formant Spectrum Equalization and comprehensive Dynamics, together with the acclaimed sound of Neve, produces the facilities and benefits for the finest broadcast consoles around the world.

Neve . . . Wonder of the World of Sound

 **Neve**

Rupert Neve Inc.
A Siemens Company

RUPERT NEVE INC., BERKSHIRE INDUSTRIAL PARK, BETHEL, CONNECTICUT 06801, U.S.A.
TELEPHONE: (203) 744-6230. TELEX: 96 9683. FACSIMILE: (203) 792-7863.
NY: TEL. (212) 956-6464 • CA: TEL. (213) 874-8124 FACSIMILE: (213) 874-1406 • TN: TEL. (615) 385-2727 TELEX: 78 6569
NEVE ELECTRONICS INTERNATIONAL LIMITED, MELBOURN, ROYSTON, HERTS SG8 6AU, ENGLAND
TELEPHONE: ROYSTON (0763) 60776. TELEX: 81381. CABLES: NEVE CAMBRIDGE. FACSIMILE (0763) 61886

Circle (91) on Reply Card

Harrison Systems

ARS-9/14: audio routing switcher; transformerless, differential in, out; maximum matrix 128x128; 80C31- μ C with Macintosh or Mac II controller.
Circle (798)

HEDCO

TWS-100, TWS-200: 12x1 video and stereo audio routing switchers.
HDI600 switcher: 16x16 video router with RS-232 serial controller.
Circle (799)

Ikegami

TSW-series: video signal source selectors for use with projection systems.
Circle (812) See ad page 97

Image Video

**9521*: 20x10 dual-audio routing switcher; requires 1-rack unit space; RS-232/422 interface; use with *9520 with full breakaway capability.
**9520*: 20x10 video routing switcher; 1-rack unit required; RS-232/422 serial interface;
VDA-160: 16-channel, 3-rack unit video DA package.
Circle (814)

J-Lab

Routing switcher: 5x1 matrix.
Video DA: battery powered device.
Circle (830)

Key Video

AVS-4001-2, 4001-3: video only router; -3 for RGB with sync.
SRS-1000: serially controlled A/V routing switchers; RS-422 control with 8-bit Z8 μ P.
AVS-1014-1, -1020-1: 10x14 and 10x20 video only routing switchers.
AVS-1004-6, 1005-1: A/V routing switchers in 10x4 multipurpose and custom configurations.
AVS-100 series: A/V switching systems; 10x1 crosspoint boards; 10x20 matrix with line drivers in two rack frames.
Circle (1175)

Leitch Video

PDS-624: program distribution system; video, stereo audio configuration; ADA-816 audio, VDA-680 video, VEA-680 video EQ modules, 664PS power supply.
DAD 6000: digital-to-analog converters; from CCIR-601 signals to RGB, YIQ, Y/R-Y/B-Y, M-II.
DDA 6000: digital equalizing 4x1 distribution amps; for CCIR-601 signals; four reclocked outputs with 10-bit data path.
ADA-816: audio distribution amplifier; 1-inx16-out low impedance; 95dB S/N; +17dBV maximum output level.
Circle (859) See ad on Inside Back Cover

Lenco

Starflex distribution: modular DA system for audio, subcarrier, regenerated sync, black burst, video and pulse signals.
Circle (861)

McCurdy Radio Industries

ADS-800: audio distribution system; 12-module system, each with six actively balanced outputs and one direct output for split expansion; 36dB gain; VCA option for remote control.
ADS-500 audio DAs: 10 modules per FRA-500 rack; six actively balanced outputs per module; 36dB gain, noise -121dB below maximum output.
ADA-700: audio DA, 1x16 mono, dual 1x8 stereo; -6dB, +28dB gain; noise -121dB below

maximum output; 0, -0.2dB 20Hz-20kHz.
Circle (867) See ad page 77

3M/Broadcast-Related

Routing switchers: audio, video systems.
Circle (907)

Moseley Associates

ARS-256 PC: PC control/scheduling option for audio routing switcher.
Circle (914) See ad page 63

Rupert Neve

Siemens Crossmatic D: audio routing system; SMD technology; 16/32 bit μ P control for single user systems; 6-level switching of analog, digital signals.
Circle (930) See ad page 133

Omicron Video

Model 330: digital component video DA.
Circle (943)

Patch Bay Designations

PatchPrints: custom patchbay designation labels.
Film inserts: for rear-illuminated button switches; color-coding, adhesive backing available.
Circle (957)

Penny & Giles

Noise-free jackfields: prewired, custom, standard configurations; noise-free operation; palladium contacts, self-cleaning; audio jack sockets, audio/video jackfields.
Circle (960)

Pinzone Communications

10x1 switchers: video VA-400; stereo audio AA-294; passive video/audio VA-379.
VA-366, AA-367: 25-output video, audio DAs; \pm 3dB gain.
Circle (969)

ROH

**7000*: audio routing switcher; summing crossbar design assigns any or all inputs to any or all outputs; specs exceed broadcast requirements.
Circle (999) See ad page 191

Siemens AG

Crossmatic D: audio routing switcher; 68000 μ P control; high density SMD; switching times <3ms; applicable to analog and digital signals; crosstalk between any two channels \leq -100dB at 15kHz.
Circle (1277)

Sierra Video Systems

Series 5: new design component video 5x1 router; for all component formats; optional remote control; vertical interval switching.
Series 8/16: 8x8 audio, video matrix and 16x4 video, 16x8 audio matrix; expandable; 20MHz video, 100kHz audio bandwidth.
Series 42 data router: for RS-422 signals; 16-/32-/64-port based on 16x16 matrix; control from keypad or serial RS-232.
Circle (1028)

Sigma Electronics

SVC-212/SVC-213: component switchers; 10x1 routing units with 20MHz bandwidth; for SMPTE, Beta, M-II, RGB, S-VHS signals; 2, 3-level systems.
VDA-202/203: 2, 3-channel component video DAs.
Series 210: 10x1 routing switcher; video,

video/audio, stereo audio configurations.
Circle (1029) See ad page 177

H. A. Solutech

SOL 5532: stereo audio DA.
Circle (1035)

Telmac

Primebridge Vision modules: PVA-1 video DA 1x3.
Circle (1190)

Thomson Video Equipment

Video switchers: digital distribution routing with TTV 5775 10x4 and TTV 5790 30x15 or 30x30 configurations.
TTV 7160: digital video DA; modular 1-inx4-out.
TTV 5780: video routing grid/switcher; 525/625-line, RGB, component, MAC signals; 68000 μ P control; RS-422/SMPTE multiple control point interfaces, RS-232 for associated audio; power failure memory.
Circle (1101) See ad page 167

Utah Scientific

AVS-101: 10x1 video plus dual audio single-bus switchers; 30MHz bandwidth; RS-232/422 control option; 3-level breakaway; expands to 19x1, 28x1.
DVS-1: digital video routing switcher; for parallel CCIR-601 signals; fully compatible with existing Utah Scientific A/V routing control systems; 32x16 matrix expands to 128x128; 10-bit architecture.
Circle (723) See ad pages 66-7

Video Accessory

VDA-3PC: video DA with clamping; 1-inx6-out; adjustable gain, wide bandwidth.
Circle (1138) See ad page 194

Videotek

RS-103, -103A: 10x1 routing switcher; RS-422 control interface; bandwidth to 40MHz; interconnection with twisted telephone pair; expandable to 40x1 or 30x10; -A has three audio inputs/channel with audio or video breakaway.
Circle (1147) See ad pages 91, 93

Vortex Communications

Video DAs: wide bandwidth, high stability.
GC-16x16: expandable routing switcher systems; four levels of master, multislave switching; for video, RGB, YUV, digital, HDTV, audio or control RS-422/232 signals.
GC-5x1: RGB/component routing switcher; loop-through inputs; equivalent of 15 DAs.
Circle (1151)

Support Products

S6: Test equipment

- Delay lines, filters
- Signal generators
- Monitors, meters
- RF loads, tools, UPS
- Power conditioning
- Power transformers
- Voltage regulators

Allen Avionics

AV225A/B video attenuators: variable with eight attenuators selected in binary switch sequence; 0-25.5dB range; usable to 200MHz; 50 Ω and 75 Ω models.

TELEX WIRELESS. Exceeding Professional Broadcast Standards.

HT-400
Handheld
Mic/Transmitter



POWER

175.000
FREQUENCY IN MEGAHERTZ

CHANNEL

A
B
C
D

AF dB -20 -10 -7 -5 -3 -1 0 +1 +2 +3
RF 1 2 3 4 5 6 7 8 9 10

AUX OUTPUT
8 Ω
3K Ω
300 Ω

TELEX FMR-

FMR-4
4 Channel
Rack Mount
Receiver

WT-400
2 Channel
Transmitter

ENG-4
Compact 4-Ch.
Receiver

At Telex, we've always believed it to be wiser to exceed a standard than to meet it. We've been providing product to the professional broadcast and production industries for over fifty years and we know what it takes.

Our wireless microphone

systems have been designed to stand up to the rigors of difficult remote ENG news assignments as well as the daily abuse of studio use. Call or write for detailed information. Telex Communications,

TELEX

Inc., 9600 Aldrich Ave. S.,
Minneapolis, MN 55420

ZL series: zero-loss video delay lines; models with continuous adjustment range 0-2,270ns; 10 units fit in ZLR-1 rack with power supply.
Circle (523)

Allsop

VCR maintenance products: cleaning cassette for 3/4", 1/2" cassette decks; uses cleaning solution for removal of contaminants; non-abrasive.
Circle (526)

Altronic Research

***6735:** 35kW air-cooled RF coaxial dummy load resistor.
Circle (530)

Amber Electro Design

AudioCheck revision: software update for multistep test procedure using Amber 5500 programmable audio measurement system and IBM PC/XT/AT or compatible controller.
System *5500 options: wow, flutter measurements per NAB, JIS, DIN, ANSI, CCIR, IEEE; relative phase measurements between two inputs or between input and generator output.
Split site system: split versions of *5500 including 5100 programmable audio generator, 5200 programmable ac level/noise/frequency meter and 5300 programmable audio analyzer.
Circle (531) [See ad page 110](#)

Anritsu

MG6301A/B/C, MS6301B/C/K/L: digital video generator and signal analyzer system; more than 100 signals available in all standards; Y/C/Sync separation by 10/10/8-bit DAs; 3.5" floppy disk storage; optional printer.
MS2061A: portable spectrum analyzer; synthesized local oscillator for 10kHz-2.2GHz frequency range; 1Hz resolution; auto calibration; measurement parameters displayed on CRT.
Circle (543)

ASACA/Shibasoku

TG-7 generator modules: U711A1 high resolution monoscope test pattern (525-line); U711A2 high resolution monoscope test pattern (625-line); U730A1 high resolution color pattern (NTSC), PAL available.
TG-8A signal generator: color bar, step-form wave, sin² pulse/bar, multiburst signals simultaneously, independently; integral sync generator with gen-lock; for systems M(NTSC), B/G, I, D(PAL).

TG56A: digital TV test signal source; 16 types of signals selectable from front panel; 10-bit conversion from 12-bit internal processing; remote control available; for NTSC, PAL, SECAM.
Circle (555)

ATI Audio Technologies
Micro-Meters VU200/VU400/VU600/VU800: monitors, displays 1, 2, 3, 4 stereo signal pairs on 2-color vacuum fluorescent bar-graph indicators with peak storage; balanced adjustable gain.
Circle (560)

ATI Audio Technologies

Micro-Meters VU200/VU400/VU600/VU800: monitors, displays 1, 2, 3, 4 stereo signal pairs on 2-color vacuum fluorescent bar-graph indicators with peak storage; balanced adjustable gain.
Circle (560)

Audio Precision

PCI-3: interface to IBM PS/2 computer family.
Software: for automated alignment of Studer A820, 821, 810, 807 record/reproduce electronics using existing reference tapes.
Circle (566) [See ad page 159](#)

Audio-Video Engineering

HSC-1, -2: video hum-stop coils.
Circle (568)

AVCOM of VA

PSA-35A: portable spectrum analyzer, satellite test equipment.
Circle (574)

B&B Systems

AM2HR series: 1/2-rack format X-Y audio signal monitor scopes; available with Lissajous or patented ImageScope display; integral audio power amp allows engineer to hear signal as well as view phase condition.
Circle (582)

Belar Electronics Lab

SCM-2: SCA modulation monitor.
TVM-100: TV aural modulation monitor; mono, stereo compatible.
FMM-4: digital FM frequency meter.
Circle (585) [See ad page 180](#)

Bird Electronic

***8891-400 series:** TERMALINE wattmeters for hybrids and other balanced networks; 2.5kW, 5kW ratings; temperature compensated elements for accuracy.
Circle (594)

Bradley Broadcast Sales

SA-3050A: industrial real-time analyzer; by Audio Control.
Circle (602)

Broadcast Video Systems

FASTIME: BAL smart video delay system.
Digiview: test system for CCIR R601 4:2:2 digital component video signals; module fits PC and compatibles.
Circle (610) [See ad page 192](#)

BTS Broadcast Television Systems

TEST D7 pattern generator: 4:2:2 digital line repetitive, color area, full/split screen and zoneplate signals; H/V interval signal insertion.
Circle (615)

Cal Switch

Fluke: multimeters.
Circle (617)

Coaxial Dynamics

Meters-line sections: appropriate elements included with 4-1/16" and 6-1/8" products.
***7510 frequency counter/wattmeter:** "peak power" readout capability.
Circle (649)

Control Concepts

Islatron Plus: power line protection for microprocessor-based equipment; protection begins within $\pm 2V$ of preset level, response time < 5ns; BC-105, 120Vac to 5A; BC-115, 120Vac to 15A.
Circle (675)

Current Technology

Power Server Line: power condition, distribution to serve digital equipment.
Circle (686)

Peter W. Dahl

Custom: high voltage power supply for TV klystrons.
High level: modulation transformers, reactors for 1-50kW transmitters; 1-50kW plate transformers.
Circle (688)

Delta Electronics

Splatter monitor: measures out-of-band AM radio emissions; remote output adjustment; in-

terfaces to remote control equipment; frequency agile, 12Vdc; optional loop antenna for field measurements from vehicle.

TCA-Jr: RF ammeter; measures low power common point, antenna base currents; use with J-Plug or Delta MJ-50 meter jack for quick insertion of meter only when values must be measured.

Circle (697)

[See ad page 60](#)

Digital Audio & Video

2362 audio level monitor: stereo with meters, LED; CRT display shows L&R phase, amplitude, time code, sync reference.

Circle (708)

Electro Impulse Lab

DPTC-75KFM: improved model; dry, forced air-cooled FM dummy load; replaces DPTC-65KFM.

Circle (737)

Grass Valley Group

CBM-85N: SMPTE color bar generator for 8500 series frame.

Circle (788)

[See ad page 9](#)

HEDCO

PTS-100: portable test signal generator; 10 digitally derived signals with 400Hz, 1kHz audio; removable PROMs permit change of signals.

HTG-100: HEDLine audio tone generator.

Circle (799)

Hipotronics

Peschel: automatic voltage regulator.

Circle (801)

Holiday Industries

HI-5000-SX: RF exposure measurement system; determine compliance with ANSI RF standards.
HI-3600: VDT video display terminal radiation monitor.

Circle (805)

Jensen Tools

JTK-11: broadcast engineer's tool kit.

Circle (829)

Kay Industries

Phasemaster T-series: 1 ϕ -3 ϕ power converters; range of 1kW to 50kW; integral lightning protection; buffers line transients; reduced cost from 3 ϕ power.

Circle (838)

Kintek

KT-932: dynamic audio phase meter.

KT-960: correlation monitor and polarity corrector.

Circle (844)

Kintronic Labs

MP-TCA: meter plug-in for Delta Electronics metering system.

Circle (845)

LEA Dynatech

PT-series transient suppressor: clamps impulse voltages to a safe level; installs at distribution panel or just ahead of studio equipment; single, split, three-phase systems.

PH-series voltage surge suppressor: diverts lightning-induced surge current and high-voltage impulses to utility common point earth ground; single, split, three-phase.

Circle (720)



Announcing EP-3: The first CCD camera designed for field production

Tube cameras used to be the favorite for electronic field production. Now there's a new star in the field: the EP-3 from NEC.

This sharp new CCD camera offers 700-line horizontal resolution and 62dB S/N ratio. So it goes head-to-head with tubes in picture quality. And when it comes to freezing fast action, the EP-3 gives you far greater clarity than tube cameras. Because it has a 7-speed electronic shutter, with a top speed of 1/1500 second.

Operation is worry-free. Forget about smear, burn-in and comet-tailing.



The EP-3 outperforms tube cameras under difficult lighting conditions.

Make your own scorecard. You'll see that the EP-3 is the first CCD camera that challenges tubes in field production and comes out the overall winner. To find out how our latest CCD camera can meet your EFP goals, call NEC today.

NEC America, Inc.
Broadcast Equipment Division,
1255 Michael Drive, Wood Dale, Illinois 60191.
Tel: 312-860-7600. Fax: 312-860-2978.
Twix: 910-222-5991.

Circle (93) on Reply Card

NEC

Leader Instruments

Model 411: synthesized sync/test signal generator with source ID; 18 signals with 10-bit digital resolution.

LCG-412B: portable pattern generator; precision source for field adjustment of VTRs, monitors, receivers.

LSN-9044A: video noise level meter.

LCG-413: EFP test signal generator with source ID.

**5870:* combo waveform-vector monitor with SCH-phase error indicator on CRT.

**5854:* hand-held ENG/EFP vectorscope; dc-powered portable unit.

LVM-9042A: automatic video level meter.

Circle (855) [See ad page 5](#)

Leitch Video

SPG-1510, SCH-710/711: SC/H phase meters.

2600TG: component test signal generator modules; for use with SPG-1300N sync generator or MTG-2600 multiformat generator.

Circle (859) [See ad on Inside Back Cover](#)

Logitek

MAS-OSC: tone generator module for Audio Accessory System.

Circle (867)

Magni Systems

4004/4005: converts output of Amiga PC to broadcast video.

Model 2021: programmable signal generator. *1510A/1510S option:* composite digital output for signal test generators.

125AD/125DA: CAV/digital 4:2:2 signal transcoders.

1517: component test signal generator; 24 625-line CAV signals; optional component digital output.

WFM-530/VS-530: component, composite waveform monitor, vectorscope; supports NTSC, PAL, SECAM.

1515: component and composite test signal generator; supports NTSC, RGB, Beta, M-II, SMPTE/EBU, S-VHS; component digital output option.

Circle (875) [See ad page 11](#)

Marconi Instruments

**2924:* universal television signal analyzer; preprocesses signals prior to sampling; user defines type, line location of waveform to be analyzed; for NTC-7, CCIR, EBU, NTSC, PAL, SECAM.

**2926:* television generator, inserter; NTC-7/FCC VITS, VIRS test signals and complement of color bars; 60Hz, 250Hz square wave, 75% saturation red bar, 2T reflection signal, four external inputs; digital generation.

Circle (880) [See ad page 61](#)

Matthey Electronics

Video filters: battery-powered, zero-loss filter; phase equalized low pass filter for TV picture signals; package accepts any Matthey filter type; cutoff frequencies from 200kHz to 30MHz.

Audio anti-aliasing filters: low pass for 48kHz sampled digital audio; turn-over frequency at 20kHz; stopband attenuation > 60dB.

Brickwalls: low pass video filters; flat to 4.2Mz, -40dB at 4.5MHz; phase equalized to 92.6% of passband; sharpness to 1.07.

Circle (884)

Microsonics

Glass delay lines and 1H, 2H video delay modules.

Circle (898)

Minolta

CS-100: non-contact colorimeter.

LS-100: luminance meter.

TVCA: low threshold, high-sensitivity measurement range CRT display analyzer.

Circle (903)

Nalpak Video Sales

EF-AC: monitor detects ac/dc voltage without a connection.

Circle (923)

Narda Microwave

Series 8700: RF meter (8716); probes (8721) for 0.3-40GHz, (8761) for 0.3-1000MHz.

Model 8520: combination E-H field monitor, 50-220MHz.

Model 8696: radiation monitor averaging module; time or spatial averaging of potentially hazardous non-ionizing radiation; for use with 8616 electromagnetic radiation monitor.

Circle (924)

Odetics

TIA 3100: time interval analyzer; evaluates faults in digital videotape recorders including D-1 systems; measurements to 100ps; CRT display; from KODE division.

Circle (940)

Penny & Giles

Audio transformers: input, output, impedance, mic matching devices by Systel.

Circle (960)

Phillips T&M/Pro TV

PM-5640: TV test signal generator; full-field, VITS functions; more than 150 standard signals, patterns; non-volatile memory; nine front-panel set-ups, customized signals; sinewave frequencies to 20MHz; zone plate signals to 13.5MHz.

Circle (965)

QSI Systems

408, 416, 424: NTSC, SMPTE color bar generators with black burst; 8, 16 and 24-character alphanumeric IDs flashing or constantly displayed; 1kHz tone.

**3440 multiburst generator:* stores 40 different 24-character messages or IDs in non-volatile memory; companion to CB-2440 bar generator.

Circle (976)

Quality Video Supply

UT-CX1: 3-blade coax cable stripping tool.

Circle (978)

Radio Design Labs

Noise monitors for AM radio.

Attenuators, transformers.

Circle (1275)

RAM Broadcast Systems

PS-1000: audio phascope.

Circle (985) [See ad page 176](#)

RF Technology

Faraday filters: range of video, aliasing filters, delay lines.

Circle (995) [See ad page 184](#)

Rohde & Schwarz

EMF TV test system: precision measurements with continuous tuning on *EMFT* for use with receiving antennas, CATV systems; *EMFD* modulator; *EMFK* channel-specific relay receiver for feeders, headends; synchronous, envelope detection; Q output.

VMS: automatic video measuring system; checks selectable parameters from up to 100

channels computer selected by IEC/IEEE bus from VSF video selector and analyzed by UVF video analyzer; modem allows remote control. *ODF digitizing waveform monitor:* 525/625-line and HDTV; displays, measures, drives external plotter; supports R&S group-delay meter, side-band analyzer; Q-mode shows carrier phase; TALIS trigger after line select and D2MAC triggers.

Circle (1000)

[See ad page 69](#)

SESCOM

ASG-1 upgrade: push-button frequency selection; adjustable output range -60dBm, +10dBm in 1dB steps.

SC-3: includes transformer-balanced line inputs.

CT-5: cable tester with F and 3.5mm stereo jacks.

TEST-1: all-in-one audio test system; AF oscillator, DMM, frequency counter, acV/dcV, ohms, dB, distortion analyzer; includes 3" oscilloscope.

Circle (1022)

Sierra Video Systems

DELTA CBG: component video color bar generator; RGB or Y/R-Y/B-Y forms available.

Circle (1028)

Sigma Electronics

CTG-100A: component video test signal generator.

SVM-100: allows conventional WFM to display, measure component signals.

TSG-370A, 375A: enhanced test signal, sync generators; 24 test signals, 20-character ID, countdown clock.

Circle (1029)

[See ad page 177](#)

Singer Products

WHR series regulators: electromechanical voltage regulation equipment; systems for 1 ϕ and 3 ϕ to 1600kVA.

Circle (1030)

H. A. Solutec

SOL-20/20: inserts stereo audio level meter in video image as three bar graphs; VU or PPM display; L/R or L-R/L+R; center bar shows out-of-phase condition.

Circle (1035)

Sound Technology

MP300M: audio test software for ST Model 3000 audio test system and IBM or compatible computer.

3200B: audio analyzer with graphic output for dot-matrix printers.

Circle (1042)

[See ad page 35](#)

Techni-Tool

Wrist straps: adjust to conform to any wrist size; for continuous protection from static charges when working with solid-state equipment.

Workstat 1000: eliminates excess static charge in the work area; benchtop ionization system generates positive and negative ions for a balanced environment.

Ultrasonic cleaners: various models available; portable to extra large, with heaters, digital timers.

SMD kit: for soldering surface-mounted components; standard Soldermaster iron, assortment of 12 tip sizes; adapters.

Smoke absorber: activated carbon filter absorbs lead fumes during soldering.

Circle (1283)

[See ad page 196](#)

Tektronix

DP-100: digital video probe; high-speed data ac-

EVOLUTION

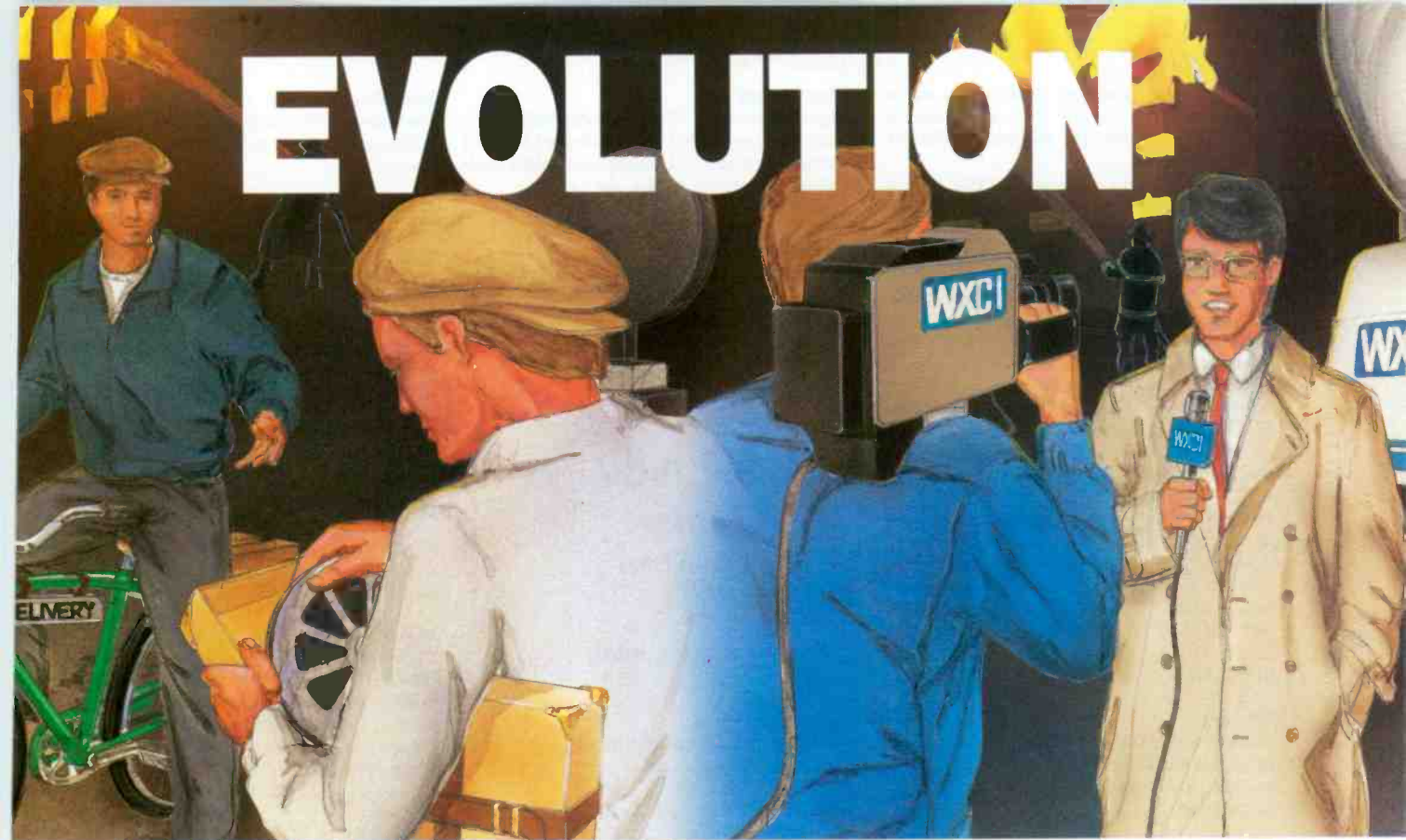

REEL NEWS

Early newsreel makers were hungry for news. Studio cameramen were responsible for developing their own leads, and they aggressively sought exclusive footage to scoop their competition. As fast as the film was shot, it was taken to the lab, developed, and distributed to theaters. Sometimes, as in the case of a presidential election, these pioneers of the broadcasting industry would produce two endings for timely viewing. The newsreel producers' wizardry probably culminated during a parade of WWII soldiers in New York City, when audiences were able to see the event before it had ended!

Today's broadcasters still rely on speed to deliver up-to-the-minute coverage. News crews travel in sophisticated SNV's and broadcast live from the field. Their ability to communicate instantly to almost anywhere in the world has diminished the once-phenomenal feats of their earlier counterparts.

SWITCHCRAFT ARRIVES ON THE SCENE

As the broadcasting industry continues to evolve, there remains a need for reliable communications equipment. From the start, Switchcraft was there to meet that

need. For over 40 years, Switchcraft supplied broadcast engineers with quality audio components—phone jacks and plugs, patch panels, power cords, and audio adapters. Switchcraft offered the industry a product line of over 6,000 parts, to provide the right part at the right time. And Switchcraft's staff of design engineers followed through by tailoring their quality products to broadcasting engineers' custom applications.

A MARKET LEADER EVOLVES

Today, Switchcraft is the most asked-for name in audio and broadcasting components. Switchcraft is synonymous with quality,

dependability, and rugged durability. It's no wonder we're proud to broadcast our role as an industry leader and how we got there.

HERE'S THE SCOOP

You rely on your equipment to "out-scoop" your competition. Switchcraft can be counted on for delivering consistently superior performance. Specify Switchcraft—the natural selection in quality broadcasting components.

Send me information on your quality components:

- Please have a representative contact me.
- Please send me your General Line Catalog
- My area(s) of interest is:
 - Switches Connectors Power Cords
 - EAC Receptacles Jacks/Plugs
 - Molded Cable Assemblies Patch Panels

My application is Current
 Future (date) _____

Name _____

Company _____

Title _____

Address _____

City _____ State _____ Zip _____

Telephone (_____) _____

Mail To: Marketing Communications Dept.,
Switchcraft, Inc.,
5555 N. Elston Ave.,
Chicago, IL 60630

BE 6-88



Switchcraft

A Raytheon Company

5555 N. Elston Ave.
Chicago, IL 60630
(312) 792-2700

Circle (94) on Reply Card

quisition, D/A converter; displays data signal in analog form on any picture, waveform monitor or vectorscope; module for *TM500*, *TM5000* frames.

SPG-271: PAL sync generator; digital design with 12-bit DAC; conforms to EBU D23/D25 statements; SC/H phased outputs.

VM700 option 01: enhanced monitoring, measurement functions to Video Measurement Set; functions include digital waveform monitor, vectorscope, noise measurement, group delay measurement, automated monitoring, measurements.

#1730HD: high definition waveform monitor; selectable 625/50, 525/60, 1125/60 and other HDTV standards; 30MHz bandwidth; tri-level sync; two sets of 3-channel inputs; parade, overlay displays.

TSG-170D generator: digital composite NTSC TV signal source; 10-bit D/A conversion for signal accuracy; 23-character ID, tape leader count-down, remote control; 17 standard test signals. *TSG-100*: test signal generator; dc-operated for bench, mobile, field portable use; 8-pattern set includes SMPTE color bars, convergence, multiburst.

Circle (1083) See ad pages 50-51

Telemet

Stereo broadcast demod upgrade: improved S/N ratio; input change to 50Ω only; demod tester module improvements.

Circle (1084)

Tennaplex Systems

MKF-48: all-channel radio-TV field strength meter.

Circle (1091)

Tentel

T2-H15-SLC: Tentelometer for Sony Type 7, 9 U-matic.

TQ-1800: dial torque gauges for U-matic VCRs.

TQ-300: dial torque gauges for Betacam.

T2-H5-UMC: Tentelometer for M-II.

T.E.S.T. cassette: evaluates extremes of back tension servo operating system.

Circle (1092) See ad page 185

Titan Electronics

Practel Video Isolator: isolates points of differing ac/dc potential, reduces hum problems for video systems; not standards conscious.

Circle (1285)

TV Equipment Associates

Brickwalls: low pass video filters; flat to 4.2Mz, -40dB at 4.5MHz; phase equalized to 92.6% of passband; sharpness to 1.07; by Matthey.

Audio anti-aliasing filters: low pass for 48kHz sampled digital audio; turn-over frequency at 20kHz; stopband attenuation >60dB; by Matthey.

Racal headsets: lightweight types; high-noise environment types.

Video filters: battery-powered, zero-loss filter; phase equalized low pass filter for TV picture signals; package accepts any Matthey filter type; cutoff frequencies from 200kHz to 30MHz.

Circle (1089)

Video Accessory

PG-3PC color bar generator: RS-170A, genlockable signal source; SMPTE bars, black burst outputs; frequency trim, subcarrier phase, H-phase adjustment.

Circle (1138) See ad page 194

Viewtronics Ltd

Digiview: card for IBM PC/compatible computers; accepts digital TV signals per CCIR 656 parallel interface, 601 sampling; displays component waveform, vector, data tables.

Circle (1291)

Vistek Electronics

Model 2015: YUV test generator; for test with analog component camera recorder systems; firmware-based signals changed by installing different EPROM device.

Circle (1292)

Support Products S7: Facilities

- Design, construction
- Studio, mobile
- Consultants
- Equipment lease, rental

Acoustic Systems

BB-440: prefabricated, acoustically engineered, voice-over booth.

SD-47: acoustic door.

Circle (505)

Alpha Video & Electronics/AVEC

Safety Raiser: device mounted atop ENG mast detects the presence of overhead power lines; two coils in quadrature sense magnetic fields, sounds alarm; GPI interface to mast function control.

Circle (528) See ad page 122

B&B Systems

Facility designs and construction; for audio, video, broadcast.

Circle (582)

BAF Communications

BAF 450-B, 435-B: SNV satellite news vehicles; 6-rack models.

Circle (576)

Camera Mart

Rental special: video production packages.

Circle (622)

Centro

Networker II: 2nd generation Networker SNV vehicle; 4-equipment racks; generator, HVAC, power system; Satcom Technologies 2.4m Ku-band antenna, optional microwave antennas; heavy duty air suspension.

EFP-1: electronic field production truck; 22' length; 1/2", 3/4", 1" tape capability; Ford E-350 chassis.

Circle (634) See ad page 75

Dalsat

RoadRunner: transportable uplink with 2.3m antenna on Ford Econoline E350 chassis; 4-port feed; antenna folds down within roof-line for clearance; Ku-band operation; 15kVA multitap transformer ties to shore power.

Circle (667) See ad page 109

Electronic Media Consultants

Boom Box: mobile radio studio resembles giant portable radio.

Circle (781)

Fort Worth Tower

Enclosures: mobile communications equipment buildings; optional roof-mounted tower.

Circle (788)

Gray Communications Consultants

Custom systems: studio, post-production facilities; mobile production vehicles.

Circle (789)

Lake Systems

Custom: video production facility design, construction.

Circle (850)

Maze Broadcast

Services: appraisals, dispositions, liquidations, auctions.

Circle (886)

Media Concepts

Equipment broker: for used broadcast products.

Circle (1204)

Midwest Communications

S-23F Mobile: satellite news gathering system with Vertex 2.6m DMK antenna and flyaway system with 1.8m antenna; common electronics; for regional and greater remote distance requirements.

Circle (901) See ad page 1

Roscor

STARFLEET 25: satellite news vehicle; Iveco-450 chassis, 20kW generator, custom A/C, large storage, production areas; antenna mast and electronics rack combined in rigid-rack support system.

Circle (1003)

Shook Electronics USA

Mobile TV production vehicles.

Circle (1026)

Television Engineering Corp

Mobile units: new designs in electronic news gathering vehicles.

Circle (1088)

Video Financial/Riviera Leasing

Factoring: business improvement plan to ease cash flow; immediate cash for accounts receivables.

Circle (1143)

Video Protection

Live Guard tape: plastic tape with station logo, call letters; keeps curious onlookers back at a safe, quiet distance; helps prevent accidents, stolen equipment; high visibility yellow, black lettering; rolls of 1,000 feet.

Media tactical jacket: protective wear for unusual remote assignments.

Circle (1290)

Support Products S8: Programming

- Distribution service
- Effects, music libraries
- Production services
- Satellite time brokers

Associated Production Music

Original music: by Richard Honoroff; Sonoton

Of 400 TV Stations who broadcast stereo,

*The TFT 850
BTSC TV
Stereo Monitor.*



300 of them rely on this monitor to do it right.

The TFT Model 850 is the only precision BTSC TV Stereo Monitor that permits comprehensive performance testing of 20 parameters from RF to composite. It features easy-to-read, conventional meters, an optional Multifunction Digital Audio Analyzer for fast and easy analysis of stereo performance and best of all, it doesn't tie-up or require additional, expensive video equipment to operate.

Make sure your station is broadcasting the best stereo signal it can. Contact us now for complete details on the 850, the BTSC Monitoring Standard. We'll also send you our free Engineering Guide—**BTSC STEREO: TV Aural Proof-of-Performance Guide.**

TFT INC

*... Where New Things
Are Happening!!!*

□ 3090 Oakmead Village Drive P.O. Box 58088 □ Santa Clara, California 95052-8088 □ (408) 727-7272 TWX: 910 338-0584 FAX: (408) 727-5942
Circle (95) on Reply Card

music library; *Broadcast One* CD music library.
Circle (557)

BAF Communications

Transponders: Ku-, C-band satellite service sales, marketing.
Circle (576)

COMSAT ISS

CTVS: COMSAT International TV Scheduling service.
Circle (666)

GE American Communications

Ku-/C-band services: Atlantic, Pacific region Intelsat access; domestic connectivity.
Circle (776)

Gefen Systems

McIntosh software: program BBC sound effects library.
Sound effects: hardware, software interface for effects, production libraries.
Circle (1246)

GTE Spacenet

Transmission services: satellite relay, distribution, news gathering; voice, data, video.
Circle (794)

Media General Broadcast

Lazer: production music library.
Circle (892)

NPR Satellite Services

Services: networking, transportable uplinking, SCPC audio transmission; uses Westar IV, Satcom 1R, Galaxy II satellites.
Circle (936)

Omnimusic

Professional Broadcast: 400 10s, 30s, 60s CD music beds; original, copyright-cleared.
Circle (944)

TPC Communications/Channel 1

Services: full post-production, 35mm-16mm film transfers.
Circle (1286)

Video Products

V1: Cameras

- EFP, ENG, studio
- Camera tubes, CCDs
- Lens systems
- Pan/tilt heads
- Pedestals, tripods
- Control, robotic systems

AF Associates

Radamec EPO System 90: full robotic control of camera, lens positioning; 500 preprogrammed camera positions; variable fade times between positions; serial data link; simultaneous control of eight cameras.

Radamec EPO remote system 10: smooth movement of pan, tilt, zoom, focus; 10-99 preset positions; multiple camera control from single panel; serial data, expandable to 32 ON/OFF functions, 24 analog functions.

Robotic Systems: robotic pedestal, X-Y tracking, video tracking, camera positioning; station computer interface; by Radamec EPO.
Circle (515) See ad page 103

Ampere Electronic

FT-CCD: high resolution frame-transfer CCD imager.

89XQ: high definition Plumbicon; tetrode gun, electrostatic deflection.

Circle (535)

See ad pages 82-3

Ampex AVSD

CVR-200: integrated camera with Betacam SP recorder; 550-line resolution from 3-CCD design; dynamic range extended by 600%; 30-minute cassette record time; for metal or oxide media; AFM and standard audio tracks.

CVC-7: CCD color camera; HADS interline transfer devices produce 700-line resolution; six electronic shutter speeds; linear matrix for color matching with Plumbicon cameras.

CVC-50: 3-chip CCD camera for sports, ENG, EFP; frame interline transfer design, switchable electronic shutter; studio, camcorder configurations.

Circle (536)

See ad page 39

Angenieux

14x series updates: for 2/3" camera formats; Fluorophosphate glass with high efficiency coatings for f/1.6 on 14x8, 14x9 models.

Model 20x8.5: lens for Sony BVP-360.

40x14 lens: 1" format; f/1.9 14-285mm, f/2 370mm, f/3 560mm; 0m MOD; μ P control; 2.1x extender standard, 1.45x optional; 43 lbs.

14x 1/2" series: 6-84mm, 7-98mm, 2x extenders; f/1.4; MOD 0.8m; macro focus; weight less than 4.2 lbs.

40x9.5 lens: 2/3" format zoom; f/1.3 9.5-195mm, f/1.4 255mm, f/2.1 380mm; 0m MOD; μ P control; 2.1x extender; 1.45x available; 43 lbs.

Internal shutter: option for any Angenieux μ P-controlled 1", 2/3" lens; 3,600rpm for 60Hz camera for 1/250th second exposure.

Circle (542)

Arriflex

ARRI geared head: full-swing/tilt, geared head for film or video cameras; $\pm 90^\circ$ tilt with wedge plate.

Circle (553)

Bencher

Model 330-01: copy stand for lightweight video or film cameras; 36" column; 3200°K or incandescent photo flood lighting.

Model 430-02: table-top copy stand; 6.75"x10" camera mounting plate, adjustments center camera lens over working area; rack/pinion carriage with positive brake; 3200°K or 5000°K color lighting.

Circle (588)

Bogen Photo

Video camera support: aluminum frame with Neoprene padding; double ball joint head with camera platform; leaves both hands free; weighs 2.6 lbs.

Professional Cine/Video tripod: 100mm diameter claw-ball leveler; variable leg angles, two click stop positions; lever leg locks; stainless steel fittings, enameled castings; tandem legs, retractable spike tips.

Circle (598)

BTS Broadcast TV Systems

LDK-900: studio CCD camera with triax to 2km; extended intercom facilities, utility 70W power output; HiFi audio channel; SMPTE/EBU VTR connector; optional teleprompter channel; NTSC or PAL versions.

LDK-90 Triax: companion to LDK-900 with remote control of camera on cable lengths to

6,560 feet; full bandwidth RGB signals at base station.

KCB-590: LDK-90 Frame Transfer CCD camera, BCB-5 Betacam SP VCR.

KCH-1000 HDTV camera: flexible standard capability supports all currently proposed HDTV systems without hardware modification.

COACH: remote control, monitoring system for LDK-6 camera family; RS-232 asynchronous data channel connects to IBM/compatible computer; menu, window, keyboard selection or mouse operation.

KCM-138 camera: portable companion to KCM-125; automatic setup with storage and recall of every function; multicore or triax operation.

Circle (615)

Burle Tube Products

FPS vidicons: focus projection scanning tubes; 1" format with sulfide or silicon diode target; electrostatic deflection with H-V plates printed on the wall of the tube.

Circle (987)

Camera Mart

InnoVision lenses.

Circle (622)

Canon

Ci-20 series: CCD video camera modules; 1/2" sensor with 380,000 pixels; various lenses; RGB stripe color, monochrome, infrared systems.

U-4 pan/tilt: portable, multipurpose remote control system for Sony BVP-5 with J15x9.5B KSS or J18x8.5B ISS; operational control panel allows tilt speeds of 0.3°-5.3°/s and pan from 0.5°-8°/s.

RE-550 video visualizer: video copy stand with single CCD color camera using stripe filter color separation; 780Hx490V pixel; NTSC output; additional video inputs with selector; lighting, microphone circuit.

RC-760/701: still video camera; 600,000-pixel 2/3" CCD; stores images in 2" disk; field, frame modes; 6-mode auto, manual exposure.

J15x9.5B IRS: zoom lens for 2/3" cameras using CCD devices; integral 2x extender; 9.5-143mm, 19-286mm; aperture from f/1.8-2.1 without extender.

J15x9.5B IRS-HP: dynamic zoom time, <2s, >15s end to end; rain-proof drive; positional focus servo control; 2x extender; zoom shot box.

J50x9.5B IE: zoom lens with integral rotary shutter; driven by vertical drive signal from camera; shutter rotation speed 1,800rpm NTSC; exposures of approximately 1/250, 1/500, 1/1000.

Circle (624)

See ad pages 56-7

Century Precision Optics

Nikon-to-Sony: optical relay adapter for Nikon lens to mount on video camera.

DupLikin III: 35m slide-to-video transfer attachment; for Ikegami HL-79, -95 cameras.

C-to-Sony adapter: optical relay device; allows use of C-mount lens on video camera.

Circle (636)

Comprehensive Video

Geocam Universal Matte Box: allows camera, format change without changing matte box; modular filter stages for 4" square, 4-1/2" round filters.

Circle (658)

Eastman Kodak

SV5035 slide-video transfer: converts 35mm positive slides image from Kodak 80-slide

"All You Need To Know About Abner, In 00:00:30:00."



Abner, from Paltex, is durable and dependable. Very economical. Frame accurate. A true A/B roll 3 machine editor.

Abner gets the job done the world over, in on-line and off-line areas producing commercials, news programming, corporate sales and training materials, and music videos.

Abner is well built, able to withstand the daily pressures of a busy edit suite, even the bumps and jolts of a production truck. And, Abner is simple to install with any 3/4" or 1/2" VTR, in any combination. Hook up the cable and you're editing. No complex interfaces with Abner, they're all built in.

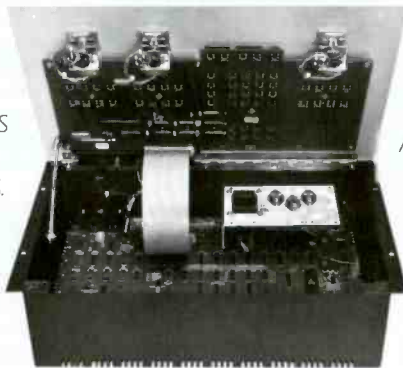

Abner is easy to operate. Transport functions for each machine are linked to dedicated rotary controls, no "time-sharing" with Abner. If you've used a two machine controller, you'll find Abner extremely easy to use. You get full A/B roll editing that lets you focus on your work, not the technology.

Well, our 00:00:30:00 are about up. All that remains to be said is that there are Paltex dealers around the world, including one in your area ready to give you a personal demo. For Abner literature and dealer information, just give us a call or write and we'll give you all the time you need.

PALTEX
Editing Systems

NTSC • 2752 Walnut Avenue • Tustin, CA 92680 • TEL (714) 838-8833 • TWX (910) 333-8535 • FAX (714) 838-9619
PAL/SECAM • 948 Great West Road • Brentford, Middlesex TW8 9ES • England • TEL 01-847-5011 • TLX 94011067 • FAX 01-847-0215

© 1988 PALTEX

Circle (96) on Reply Card

Carousel to video signals; motorized zoom, scan; random access.
Circle (724) [See ad page 119](#)

EEV
P8454/5: 30mm Leddicon camera tube for TK47 updates.
Circle (731) [See ad page 125](#)

Elicon
FACETRACKER: IR-transponder system; allows camera to track talent or objects within a studio environment.
roboGlide: automatic guided vehicle; moving platform for dolly, pedestal or other camera support device.
Circle (741)

FOR-A
HMC-1000: Multicam high definition still camera; produces 1,125-line stills; RGB outputs; switchable TV formats.
Circle (767) [See ad page 155](#)

Fujinon
1-1/4" HDTV lenses: fixed focal lengths of 13mm, 25mm, 70mm; f/1.4 aperture; servo or manual focus, iris control.
HP5x16SD zoom: HDTV lens for 1-1/4" format; f/1.4 aperture over entire 16-80mm focal length; servo or manual control of iris, focus, zoom; 14.5kg.
A34x20.5ESM zoom: maximum 1,400mm focal length from 20.5-700mm f/2.4 lens with 2x extender; MOD is 5m; compatible with CCD and tube cameras.

1" HDTV lens: 18mm fixed focal length; f/1.2 with 42°21' horizontal field angle; MOD 0.65m; 5kg.

HR22x18SD zoom: 1" format with 18-400mm focal length; f/1.8 to 350mm, f/2 at 400mm; servo iris, focus, zoom; MOD 5.5m; 24kg.

R34x29.5ESM zoom: 29.5-1000mm with 2x extender; f/3.5 to 700mm, f/5 at 1000mm; integral test pattern projector; for 1" format camera; direct access to adjustments without removing shroud; 26.5kg.

HR11x11SD zoom: 11-121mm focal length for HDTV; constant f/1.8 aperture to 110mm; f/2 at 121mm; manual, servo control; MOD 1.2m; 8.5kg.

A34x10ESM zoom: f/1.8 aperture over 10-229mm, f/2 at 340mm; 2x extender; optional pattern projector; MOD 1.8m, 13.6kg; for 2/3" format.

EPT series: remotely controlled pan/tilt heads for ENG, EFP cameras; analog servo drives; 270° pan range at maximum 30°/s; stopping accuracy within ±2°; noise level is 30dB at 20°/s.

EOP series: operating panels for EPT series pan/tilt systems; series includes multiple shot memories, camera monitor, multiple camera and remote via modem configurations.
Circle (773) [See ad page 101](#)

Future Productions

MCU-400 camera CCU: multiple camera operation for Ikegami HL-79/95-379, ITC-730, Sony BVP series; full remote functions; compensate cable to 1,000 ft; sync/sc phase adjust; intercom/tally, monitor; PS-400 power supply.

PS-400: power supply for MCU-400; powers four cameras up to 300 feet away.

S-VHS modification: creates Y/C S-VHS output from HL-79 A/D/E, HL-59.

Circle (774)

Alan Gordon Enterprises

REVPOD: product shot turntable.

Argus Compact: dolly with mini-jib.
Circle (784)

Karl Heitz

Gitzo tilt attachment: for #480, #580, #680 100% fluid heads; weights to 100 lbs; 90° front, rear tilts.

Gitzo tripod: Inter Pro Studex, 3-section, lightweight, for cameras to 30 lbs; interchangeable leveling ball; sliding or cremalliere gearlift column.

Gitzo monopods: 4-section to 8 feet, 6-section to 12 feet; for added camera if standing on ladder, chair; taking pictures over fences; holding lights in elevated positions.

Circle (800)

Hitachi Denshi

SK-971: auto setup 2/3" Computacam; wide-band RGB over triax, ac utility power at camera head; three LOC DG Plumbicons, f/1.2 prism; μ P system includes normal, lens, temperature, scene data files; rain protection built in.

DK-8000: 1,049 scan line camera; 20MHz bandwidth achieves resolution to 800 lines horizontal, 700 vertical; small size allows mounting on microscope or other optical applications.

Z-31SX camera: auto setup system for ENG/EFP; twist-field LOC MS Saticons for improved overall resolution; horizontal resolution, 850 lines; S/N 61dB NTSC; encoder outputs for Beta, M-II, S-VHS.

Circle (802)

[See ad page 3](#)

Ikegami

HL-791: EFP camera; dockable version of HL-79E.

ITC-735: economical ENG/EFP camera; full feature.

Chip cameras: HL-379A, CCD-770; production versions.

CCD-870 prototype: 3-chip ENG camera; interline sensor for > 600 TVL resolution; S/N > 56dB; H/V dual-edged detail correction; auto functions; camera head weighs 9.3 lbs.

MKC-300: medical FT CCD camera; f/1.2 optical system with 2,000 lux sensitivity; > 60dB S/N, 600 TVL; compatible with S-VHS, ED-Beta VCRs; electronic shutter, variable speed.

HK-355P: 3-FIT CCD EFP camera; low fixed pattern noise; electronic shutter; 700 TVL resolution; compatible with HK-323(P) accessories, various VCRs; weight 7.7 lbs with viewfinder.

ITC-735 teleconferencing system: camera with TCU-735 control unit for four cameras; SU-500PZ pan/tilt remote unit; PC-100 preset controller for lens zoom, focus and camera pan, tilt adjustments.

HL-55: CCD ENG camera; FIT device has low fixed pattern noise; S/N > 62dB at 700 TVL; +24dB gain available; 6.8 lbs with viewfinder.

EC-1125: HiVision HDTV camera; 1125/60 system with 16:9 aspect ratio; 1-1/4" MS Plumbicon; numerous auto functions; expanded dynamic range for film look; improved sensitivity.

HL-87M: CCD with image intensifying micro-channel plate; minimum sensitivity to 0.02 lux; S/N to 57dB; compatible with HK-323P cable extension equipment; resolution > 300 TVL.

HC-230: compact CCD camera; 1/2" format for 580 TVL resolution, 2,000 lux f/4.5, S/N 58dB; S-VHS, component VCR, docking VCR or RGB signals; weighs 8.37 lbs complete.

Circle (812)

[See ad page 97](#)

Image Devices

Rental: film, video cameras, accessories; lights; underwater and land applications.

Circle (1249)

InnoVision Optics

Specialty lens: direct, 45°, 90°, 110° views; integral light source; allows camera to fly over, under, around, through objects; for 16mm, 35mm, video cameras.

Circle (1251)

ITE/Innovative TV Equipment

T48/H48: ENG/EFP tripod/fluid head for cameras under 25 lbs.

T55 series: tripod family for camera loads to 30 lbs.

P9 pedestal: pneumatic operation; load capacity of 110 lbs.

P6L: low-boy P6 studio pedestal; minimum height at 23.5".

H90 head: fluid system for studio, OB cameras; capacity to 165 lbs.

T17/H17: ENG tripod/fluid head for CCD cameras.

Circle (823)

J-Lab

Gen-lock CCU: for HL-79 camera; component adaptor; standard CCU controls.

Circle (830)

JVC Professional

KY-15: 3-CCD camera; S-VHS, M-II, studio, mobile configurations; 1/2" IT-CCDs; 500 TVL resolution with 58dB S/N; 3-speed electronic shutter; 1/2" bayonet lens mount; automatics; stereo audio circuit.

BY-10: 2/3" single IT CCD camera; S-VHS camcorder with BR-S410U recorder; 11x, 16x C-mount zoom lenses; 450 TVL resolution; self-diagnostic warnings; NTSC, RGB, Y/C outputs; weighs 5 lbs.

BR-S200U: 2/3" CCD camcorder S-VHS; 450 TVL from camera, 400 TVL from VCR; 4-speed electronic shutter; date/time record function; TCL image sensing auto-focus; VCR input selection from camera or external source.

KY-20: 3-CCD camera; S-VHS, M-II, studio, mobile configurations; 2/3" IT-CCDs; 500 TVL resolution with 58dB S/N; 3-speed electronic shutter; 2/3" bayonet lens mount; automatics; stereo audio circuit.

Circle (833)

[See ad pages 64A-J](#)

Landy Associates

Ikegami cameras: HK-323, HL-379, CCD-770.

Circle (851)

Merlin Engineering

ME-08 auto camera tracking system: digital remote servo-controlled mount for ENG, EFP cameras; balanced cradle with capacity to 150 lbs; ±160° pan, ±30° tilt; can accommodate small prompter units; multiple unit control possible.

Circle (893)

Miller Fluid Heads

**352*: lightweight System 40 "ENG Special."

**340*: lightweight system 20 "Special."

**355*: System 80 EFP field support system.

Circle (902)

NEC America

Industrial cameras: CCD-based systems with variable speed electronic shutters.

EP-3 CCD camera: high-resolution camera for EFP, studio; 3-IFT CCDs with 360,000 pixel arrays; 700 TVL, 62dB S/N; 2,000 lux sensitivity at f/5.6; electronic, 7-speed shutter; auto functions, setup.

Circle (926)

[See ad page 137](#)

Today's tougher audio requirements demand a new choice

Telex *Pro Series* 6120 XLP

A new duplicator with 8X speed and tougher specs.

Improved frequency response plus less distortion and crosstalk are just a few of the technical gains achieved in the new Telex Pro Series duplicator. This means that you'll make duplicates that are **true to the master** than with any comparable tape duplicator on the market today.

Yes, here's a system with all the advantages of the famous 6120 high speed duplicator plus enhanced specifications. Features that made the 6120 popular such as compact size, unlimited expandability, track select, audio level monitors and easy one-button operation remain distinct Telex advantages. But, by developing the 6120XLP with 8X speed, Telex gives you the advantage of improvements in many **important professional specifications** such as distortion, frequency response, speed accuracy and crosstalk. And, the new cassette transport speed allows you to duplicate directly from 15 ips open reel masters for the ultimate in quality and convenience.

The Pro Series 6120 uses a newly developed, highly effi-



New XL LIFE cassette head.

cient **XL LIFE™** cassette head featuring ultra-hard physical characteristics for **extra long life (10X normal)** plus a satin smooth surface that resists excessive oxide build-up preventing the need for frequent maintenance. Its advanced engineering, precision design and painstaking manufacturing techniques contribute immensely to the Pro Series improved specs including an **unmatched frequency range** of 50 to 13KHz. For further technical details and the name of your nearest 6120 dealer, call or write Telex Commu-

nications, Inc., 9600 Aldrich Ave. So., Minneapolis, MN 55420.

Up to 12 months to pay with no interest!

The entire Telex 6120 duplicator series is available with special **NO INTEREST** financing through participating Telex dealers. Yes, with only 10% down and up to 12 months to pay, you could be eligible for special **NO INTEREST** financing. Think of it! You could pay for your 6120 out of the savings or income generated.



TELEX®

Call Toll Free in U.S. 800-828-6107 • In Minnesota Call (612) 887-5531

DIAL-UP

Touch-Tone® Remote Control Systems

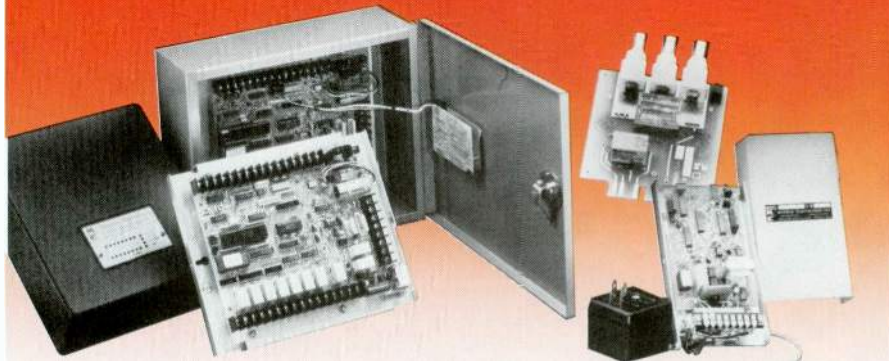

For versatile, cost-effective control and monitoring of unattended sites, using DTMF commands. Accessible from any Touch-Tone® telephone, microwave or two-way radio. Multiple options permit expandability for diverse control applications.

■ Remote Control Systems ■ Functional Building Blocks ■ Telephone Couplers

Part of the complete line of state-of-the-art remote control systems from Monroe Electronics.

M **MONROE ELECTRONICS, INC.**
E 100 Housel Avenue, Lyndonville, NY 14098
 Phone: 716-765-2254 • FAX: 716-765-9330 • Telex: 75-6662

Circle (98) on Reply Card

NEW SMPTE-EBU Time Code Analyzer Model TCA-143

If your edit problems are SMPTE Time Code related, Gray Engineering's new Time Code Analyzer pinpoints the error, displays code faults and corrects for phase and amplitude error.



Code Conditions at a Glance

- Phase Error/Display
- Sync Word Error
- Bit Count Error
- Sequential Count Error
- Color Sync Frame
- Code Level
- Flag Bits
- Video Sync Loss
- Code Loss

When a time code error occurs, a front panel light is illuminated, and an audible alarm is activated.

3 Output Modes

- :BY-PASS—(E to E)
- :RESTORE (restores amplitude and reshapes) (DUB)
- :REPHASE (rephases, restores amplitude and reshapes)

List Price \$2595.00
 5-Year Warranty—
 Parts & Labor

GRAY ENGINEERING LABORATORIES

INCORPORATED

504-P W. Chapman Avenue • Orange, CA 92668 714-997-4151

Circle (99) on Reply Card

Nikon

HDTV Fixed: RF15A-HD2 15mm, 5.2 lb; RF50A-HD2, 50mm 4.1 lb; fixed focal lengths; f/1.2; cover 16mm diagonal picture format.

HDTV Zoom: R.5×12.5A-HD2 TV-Nikkor ED 12.5-70mm, 15.4 lb; R7×12A-HD2 TV-Nikkor 12-84mm, 11 lb; f/1.8 maximum aperture; cover a 16mm diagonal picture format; with macro feature.

2/3" ENG/EPF Zoom: S15×8.5B 8.5-127.5mm, 2.7 lb; S13×9B 8-117m, 2.4 lb; f/1.7 aperture; integral 2× extender; antireflection coatings; for CCD cameras.

Circle (1216)

O'Connor Engineering Lab

Model 127: pneumatic studio pedestal.

Model 35: quick-release ENG tripod.

Circle (939)

Panasonic Industrial

WV-200CLE: 3-CCD camera; NTSC composite, Y/C S-VHS component; 600-TVL, >56dB S/N ratio; 2.5 fc minimum sensitivity; color match matrix for multicamera systems; two memories, three position auto-white balance; detail control.

AG-450: integrated camera, S-VHS recorder; 10× power zoom lens; manual iris, Piezo TTL auto focus; variable shutter speeds; 2-hour recording, flying erase head.

WV-300CLE: 3-CCD camera with S-VHS, composite outputs; f/1.4 prism; >700 TVL, >60dB S/N; 4-speed electronic shutter; minimum illumination to 2.5 fc.

Circle (922)

See ad pages 40-1, 43, 80B-C

Pannonia

S-105: S-drag adjustment hydrohead; quick-release sliding plate.

S115: 150mm ball-based hydrohead for camera loads to 100 lbs.

Circle (1269)

Photographic Equipment Service

Hammerhead: pan/tilt, zoom, focus head; controlled by animation computer to permit interlocking of stage action with artwork on animation stand.

Circle (966)

Quickset

QRTH-1: Rainbow pro fluid system; 20lb fluid head, 100lb capacity tripod.

QST-5: Samson 3/4-size tripod with column; collapses to 21" height.

Husky QKTH-30: fluid-damped pan/tilt; 2-section legs; camera plate with safety lock; tubular legs; anodized, scratch resistant; 3-12 lb load capacity.

QRH-7: cam-balanced, fluid head; 40-lb capacity; ±45° tilt; 360° pan; 100mm claw ball.

QRH-10, QSH-10: spring counterbalance, fluid drag; fluid head with 30-lb load capacity; 100mm claw ball base.

Circle (981)

See ad page 194

Radamec EPO

Robotic Systems: robotic pedestal, X-Y tracking, video tracking, camera positioning; station computer interface.

System 90: full robotic control of camera, lens positioning; 500 preprogrammed camera positions; variable fade times between positions; serial data link; simultaneous control of eight cameras.

Remote Control System 10: smooth movement of pan, tilt, zoom, focus; 10-99 preset positions; multiple camera control from single panel; serial data, expandable to 32 ON/OFF func-

Natural Evolution...

RVS-210A

RVS-216A

*with
Distinction*

RVS-416

16 video inputs,
rotary, spin, and
matrix wipes,
linear keys,
4 mask generators,
4 key busses,
key interchange...

ROSS VIDEO LIMITED

ROSS[®]

tions, 24 analog functions.
Circle (1274)

Sachtler

Video 10: dolly, tripod, integral spreader, elevation column, compact fluid head; weighs approximately 11 lbs; for CCD cameras.
OB2, ENG2, EFP2: elevator column, 2-stage tripods; 100mm, 150mm bowl for fluid heads; carbon fibre or Dural hardened aluminum.
Circle (1009) See ad page 19

Schneider

TV-80 enhanced: 17x8.5mm wide angle zoom lens for studio use; integral diascope, range extender.
TV-64: 14.5x13mm studio zoom lens; integral range extender, optional diascope; for Ikegami HK-323 1" camera.
B+W filters: coated optical filter products for color correction, neutral density, b/w film image contrast enhancement, polarization, infrared material, trick/effects; lens hoods, adapter rings.
Circle (1017)

Schwem Technology

GX-3: mini image stabilizer; integrated CCD camera with lens in 4" diameter 10" cylinder; based on Hitachi VK-C150 camera with 350-line resolution; 12.5-75mm f/1.8 lens, 2x extender.
Circle (1018)

Sony Broadcast

BVP-50: CCD EFP/ENG camera; vertical smear eliminated, electronic shutter, larger S/N ratio.
HDVS system: camera *HDC-300* f/4.5 at 2,000 lux, 1,200 lines H resolution; *HDCO-300* CCU with multiscene setup memory; *HDCS-300* signal processor; *HDM-3830* monitor; *HDL-2000* videodisc recorder.
CCU-355: triax camera control for BVP-350 EFP camera; interface at camera is *CA-3511*; compatible with BVP-360 cameras; allows optional use of four video remote operation panels.
Circle (1037) See ad pages 25-7

Sony Professional Video

DXC-750 camera: interline transfer CCD unit with 700 lines H resolution, 60dB S/N; variable speed electronic shutter; up to 330 feet of cable to CCU.
DXC-M7 production camera: based on three 768 interline transfer CCD; 700 line resolution with 60dB S/N; variable speed electronic shutter; dynamic contrast control; cables to 1,000 feet with CCU-M7 control unit.
DXC-3000A: 3-CCD camera; enhanced to include 1/2" Y/C recorder formats including ED-Beta.
Circle (1040) See ad page 189

Telemetrics

Remote camera pan/tilt, zoom/focus tracking system.
Microprobe: for video cameras.
Triax camera control: for Ampex CVC 5 CCD camera.
Miniature system: pan/tilt for single chip cameras.
Triax camera control: for Hitachi CIH camera.
IR controller: for pan, tilt, zoom and focus.
Pan/tilt heads: remote computer-control systems.
Circle (1085) See ad page 118

Thomson Electron Tubes/Device

TH-7866: 550 pixel/line frame-transfer CCD; compatible to NTSC/RS-170 and 2/3" optics; antiblooming gate, controllable integration

equal to 3 diaphragm stops; 30dB S/N at 40mlux illumination; TH-7864 for 50/625 line systems.

TH-X898: HDTV camera tube; 1" Primicon photoconductive layer; electrostatic deflection, magnetic focus, bias lamp; output target capacitance less than 5pF; limiting resolution 1800 pixels per line.
Circle (1099)

Thomson Video Equipment

TTV 1530, 1532: EFP, OB cameras; 2/3" format; automatic setup based on 182 picture zones; talkback channel, teleprompter circuit on triax system; camera head ID uses pilot tone.
TTV 1640: production models of 2/3" 3-CCD camera; interline transfer sensors; white compression, auto knee, contour correction; compatible with TTV 1624, 1530, 1532 cameras, accessories.
TTV 1525C enhancement: contours out-of-red, diagnostics, memory, status display unit for automatic camera.
TTV 1624 upgrade: 3-Plumbicon camera with modular interfaces for ENG or other VTRs or other Thomson camera accessories.
Circle (1101) See ad page 167

Tiffen Mfg.

Video presentation: "Which filter should I use?" explains filter use for image improvement, creative effects, etc.; available for purchase.
Air Can: compressed air canister; chrome valve assembly, filter, 4" nozzle, 36" hose for hard-to-reach places.
#934 filter case: holds 24 series-9, 3x3 or 3x4 filters in any combination; fine-texture lining; reinforced aluminum, safety latch, key lock.
#456 filter case: holds 18 series 4x4, 4-1/2 round, 4x5, 4x5.650/Panavision or 4x6 filters in any combination; reinforced aluminum, safety latch, key lock.
Circle (1103)

Toshiba

IK series CCD cameras: single 1/2" CCD color cameras; electronic shutter; external sync capability, NTSC interlaced video output.
SC821: CCD color camera; 3-FIT CCD design; diagnostics, status in viewfinder; ENG system with variable speed electronic shutter; 700 TVL resolution; adapters allow various applications.
Circle (1109)

Total Spectrum Manufacturing

ENG camera accessories.
Teleconference equipment: remote control products, including VS-200M pan/tilt, UNI-11-SND unipler.
AutoTrack: allows camera to track specified talent on set.
Controller: software-based, for HS-110P, HS-105P servo pan/tilt systems; touch screen input with menus; interfaces to newsroom computer; camera equipment maneuvers can be edited.
AutoCam: camera control system with *ACP-8000* touch screen controller; *SP-200* servo pedestal with optional X-Y base; multitasking system controls truck, dolly, pan/tilt, zoom/focus for eight cameras.
Circle (1110) See ad page 31

Ultimate

Memory Head: remote control camera mount; ac/dc operation; moves stored on 3.5" diskette; precision positioning repeatability; one diskette holds two minutes of motion information on 4-axis basis.
Circle (1120)

Vinten Equipment

Vision 5 system: tripod, spreader, foam-lined case with fluid pan/tilt head; $\pm 85^\circ$ tilt angle; for cameras to 15 lbs.
Shot recall: prompter interface accepts ASCII text with MicroSwift shot codes embedded in prompter copy; translated codes cause a specified camera to move to the requested shot.
Tracking base: dual wheel design for standard, narrow gauge track, straight or curved and off-track on land surfaces; PTFE, Duthane wheels for smooth, quiet movement; tiller for crab steering.
Circle (1149) See ad pages 114-5, 149

Video Products

V2: Recording

- Analog, digital
- Editing, animation
- Time code equipment
- Transport synchronizers

Abekas Video

D-2 interface: option for Abekas digital disk recorders and effects systems; enables direct connection to D-2 VTRs.
Circle (502) See ad page 37

Adams-Smith

ZETA~Remote: autolocator, remote controller for Zeta~Three system.
ZETA~THREE: combines transport synchronization, time code functions, MIDI-to-time code synchronization.
2600 A/V: audio for video editor with C:Sound visual audio waveform editing; synchronization of 10 transports; RS-232/-422 serial I/O; 20 function keys; 24 GPI triggers.
Circle (507)

Adrienne Electronics

PC-TIMECODE: time code reader card; for IBM PC/XT/AT.
Circle (511)

Alpha Video & Electronics/AVEC

TCGR: integral time code generator, reader for VO-6800.
Type 5SP: SP retrofit for Type 5 VCRs.
EI-9: editor interface for Type 9 VCRs.
Circle (528) See ad page 122

Amberst Electronic Instrument

AM21000: combines machine control functions of CTX-1000 with infinite-window TBC, color field sequencer, manual or computer-controlled proc-amp and auto gen-lock circuitry.
ESP video editing software: IBM PC/AT or compatible based; menu operated, context-sensitive help screens; monitors hardware connected to system and provides information and status on entire system.
CTX-1000: universal machine control interface; interfaces to two serial or parallel devices, communications bi-directionally with upper level editing system; daisy chains together for centrally controlled multiprocessor system.
Circle (1230)

Ampex AVSD

Betacam SP: CVR-70 studio recorder; CVR-65 studio player with AST; CVR-60 studio player.
VPR-300: D-2 composite digital studio VTR; plug compatible with existing composite



VISION 5

We put our heads together to give you a smaller one!

Fast set-up and breath-taking smoothness of action. These are two major benefits Vinten's new Vision 5 head offers.

Vision 5 is the smallest and lightest head in the remarkable Vision family. It shares the same unique, patented technology.

For use with the smaller ENG and new generation CCD cameras, the quality of movement will astonish you.

This is because unlike any other type of head Vision 5 is perfectly balanced at any increment of tilt through 160 degrees of movement.

Achieved with the unique, adjustable system common to the range, making the camera effortlessly easy to manipulate.

Vision 5 is available with a single stage or the acclaimed two stage tripod.

And if the performance sounds unbelievable, wait till you see its low price. If you've got five. You've got Vision.

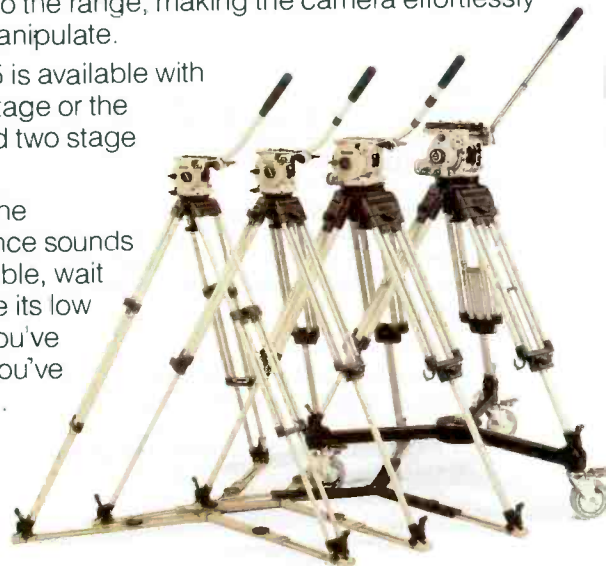

Vinten

Vinten Equipment Inc.
275-C Marcus Boulevard Hauppauge
New York 11788-2001 Telephone (516) 273-9750
Telex 640470 Telefax (516) 273-9759

Vinten Equipment Inc.
8115-B Clybourn Avenue Sun Valley
California 91352-4022 Telephone (818) 767-0306
Telex 182686 Telefax (818) 767-0772

Circle (101) on Reply Card

June 1988 *Broadcast Engineering* 149

systems; for 32, 94, 208-minute 19mm digital cassette; 4-channel digital audio; assemble, insert, animate editing modes.

ESS upgrades: Still Auto Sequencing; List-N-List playlist management; component analog or digital inputs and outputs; standard on new systems, upgrade option for existing systems. **ACE-25:** low-cost edit controller for ENG, corporate-industrial, off-line; 4-VTR interfaces, three GPIs, 3.5" disk; optional internal composite/component video or audio switchers; 1,000-line SMPTE EDL, CMX-340 EDL compatible.

CVR-22: Betacam SP play-only; integral time code reader; two AFM, two standard audio tracks with Dolby C noise reduction; plays standard and SP Betacam cassettes; wired or wireless remote control.

ACR-225: automated cassette recorder; 256 32-minute cassette capacity; allows 7s spots back-to-back; analog or encoded digital NTSC, PAL inputs, outputs; operational multitasking. **Circle (536)**

See ad page 39

ASACA/Shibasoku

ADS-200 floppy disk still store: 25 color still frames per 5-1/4" disk; editing, trim, position, dissolve, push effects; hard disk available; use with AIP-1300/1320 image pickup station to transfer slides or graphics to disk.

ADS-6000: HDTV still store; 1,200 frame capacity of 1125/60 HDTV frames; expandable to 9,600 with additional magneto optical disks; 64.8MHz 8-bit RGB component digital coding. **ADR-5500:** magneto optical videodisc recorder; 4:2:2 system with color video, audio storage of 10 minutes or 72,000 still images; rewritable disk technology.

ADS-5000: still store with audio; magneto optical disk technology; 2,250 frames of still picture commercials with two image fields, 15s audio; expandable to 18,000 with additional drives.

Circle (555)

Audio Kinetics

ES SSU: system services unit; provides EBus with auxiliary features required within a machine control network; event, system relays, time code source for external equipment; distributes sync source, time code throughout the system.

ES 1.11 synchronizer: open architecture machine control system; 1-machine chase to control of entire multiroom complex; based on EBus system.

Circle (565)

BHP Inc/TouchVision Editing

TouchVision: non-linear, film-style videotape editing controller system.

Circle (592)

Broadcast Electronic Services

BetaBox: interface box for direct editing capability between Beta and U-Matic VCRs; switches all player elements without patching. **Circle (1235)**

BTS

BCB 65: studio Betacam SP VTR; dynamic tracking; **BCB-65-N** for NTSC; integral TBC, time code reader.

BCB-60-N/BCB-70-N: Betacam SP studio player and player/recorder/editor; integral TBC, time code equipment; NTSC standard.

BCB-22 VCR: field player; Betacam SP format; for office, field use.

BCB-35 VCR: portable field recorder, player; Betacam SP; 19.2 lbs with battery, cassette.

DCR-100 DVTR: D-1 digital video recorder; exchangeable scanner, modular construction; accepts all three cassette sizes; coders, decoders to integration into existing systems.

BCB-65 VCR: studio player with Dynamic Tracking; Betacam SP.

BCB-75 VCR: studio recorder, player; editing system in Betacam SP format.

Circle (615)

Calaway Engineering

CED enhancements: software for videotape editing controllers handles six RS-422 protocol VTRs/VCRs.

Circle (718)

Camera Mart

ADX system: time code monitor.

Circle (622)

Canon

RR-450 still video recorder: 350-line resolution; 50 field images stored on 2" floppy disk; frame or field recording; playback forward or reverse, adjustable interval display times, looping; wireless remote controller.

RT-611, RT-971: still video transmitter, transceiver; displays images from floppy disk and transmits them via standard telephone lines; direct connection or acoustic coupler available.

Circle (624)

See ad pages 56-7

CEL Electronics

ERIC enhancement: triple time code reader, generator; time code calculator available through touch screen menu of P158 system controller.

Circle (631)

Cipher Digital

CDI-4835 Shadowpad-Maxi: gives control of Shadow II information display; displays status, operation of synchronizer and transports connected to it.

CDI-4825 Shadowpad-Mini: enter, recall, modify offset register and system register information of Shadow II transport synchronizer.

CDI-4810 Phantom Emulator: interfaces video editing system to audio transports through RS-422; parallel information to audio transport; control U-matic VCRs with systems designed for 1" VTRs.

Softouch-PC: software, hardware; one keyboard for EDL, annotating; second keyboard for actual editing session operation; speeds audio editing process.

Circle (645)

See ad page 102

CMX

CMX 100 enhancements: editing suite in a box with Match Cut Calculate, Trigger Mark, Match Back, Printer Port features.

CMX 3100 enhancements: Version 300 software for advanced switcher control, pre-cue auto assembly, text editing, mark files, fetch EDL time codes features.

CMX 3600 enhancements: expanded save, GPI and switcher memory configurations; keyboard assigns audio, video switcher crosspoints, selects time code, tape timer, user bits; expanded learn keys.

A/V switcher: for 330A, 330S, 3100, 3400A, 3600 editing controllers; cuts, dissolves, fade-to-black from A/B/C source machines.

CMX 6000 videodisc player: dual-head design reduces number of videodiscs for random access editing system.

MC Matched Computer Cut: software generates negative cutter's list and CMX edit decision list

with CMX 6000 system.

EDL Optimizer II: for increased speed; 500-event EDL cleaned in 30s; 4-channel audio control; 8-character real IDs; 3-1/2" EDL disk compatibility in CMX or MS-DOS formats.

EDL Optimizer: Superclean, Lookback, text editing, sorting, speed assembly and disk utilities for edit decision list management; NTSC/SMPTE, PAL/EBU.

Multi-Cam option: multiple camera random access editing on CMX 6000 laserdisc editing system; view several film cameras or VTRs shot from varying angles in the same time code. **Circle (648)**

Colorado Video

#941 system: digital image storage unit.

Circle (651)

Comprehensive Video

Edit Master: frame-accurate edit controller software, IBM/PC compatible base; list management, cleaning; auto assembly; 900-event memory; upgradable to A/B roll.

Circle (658)

Cubicomp

V2300 animation: stand-alone graphics using Silicon Graphics 4D/70 Superworkstation; video in/out and tape control handled by Cubicomp V32 intelligent frame buffer, codec analog converter.

Circle (685)

Digital Services/DSC

DiSC: real-time digital disc recorder; 200s record time; composite digital conforming to CCIR 601X, compatible with D-2 VTR; simultaneous record, playback for multilayering; three foregrounds over background with priority.

Circle (707)

Dubner Computer Systems

DSS-4 still store: 4-field video capture, storage, retrieval system; program, preview output channels; 20Mbyte lomega disk cartridges, 100Mbyte fixed disk; full paint system; graphic tools.

Circle (714)

Dwight Cavendish

Videocassette duplicator: computer-controlled system.

Circle (629)

Edit Line

ELC series: edit list compiler; complete EDL management including translation between different list formats; output list to printer, store on disk, upload, download via serial link to on-line editing system.

Circle (1243)

EECO/Convergence Video Products

Improved EMME: added features include color coded, editor compatible keyboard, joystick for improved tactile control over tape movement; added versatility for different editing styles.

900 PLUS: A/B roll video edit controller; programmable slow motion for multiple serial VTRs; 1,000 line internal edit list memory; full VTR assignment; time code through serial cables from VTRs or direct to integral readers. **Circle (677)**

ESE

ES956: multiple speed bidirectional time code reader with 2" displays; for 1/30-20x play

A REVOLUTIONARY INTERCOM:



PROCOM INTERCOM WITH SINGLE-BUTTON SELECTION

DILESS ProCom is a new kind of intercom, with convenient single-button selection. Every kind of connection possible: station-to-station, station-to-all, all-to-all, or any combination, up to 11 simultaneous calls. You hear no unnecessary messages – only those which concern you directly.

No line can be busy, so your message will always reach the other party.

ProCom is also compatible with other systems currently in use.

That's why we call ProCom a revolution. What would you call it?

For further information, contact

DILESS

Melkonkatu 16 A, SF-00210 HELSINKI,
FINLAND
Phone: +358-0-679 271
Facsimile: +358-0-671 910
Telex: 1001825 /Attn: DILESS

Circle (102) on Reply Card



speed operation.

ES453/ES452: play-speed time code readers; -452 unit includes two BNC video outputs with time code characters inserted.

ES456/ES455: multispeed, bidirectional time code readers; -455 includes inserter.

ES461: time code generator; jam sync and user bits features.

ES263: portable SMPTE time code generator; presettable 8-digit time; internal GelCell battery for 10-hour operation per charge.

Circle (749)

See ad page 193

Evertz Microsystems

e² interface: intelligent device upgrades VHS, S-VHS VCRs to communicate with edit controller or computer; VITC/LTC option for frame accurate editing, autolocation; complete transport control at all speeds.

Circle (751)

FloriCal Systems

TimeShifter: videotape delay system; may be used as video obscenity delay; automate continuing net delays; computer, A/V switcher, tape controller, software, manuals; uses three VTRs during actual delays.

Circle (765)

FOR-A

TGR-2000: time code generator, reader; LTC format.

EC-740: edit controller; operates with FA-740 parallel effects TBC in A/B roll system.

Circle (767)

See ad page 155

Fostex

**4011*: video character inserter, VITC time code generator.

Circle (770)

Future Productions

MMC-100 (MMC-500): monitor main control; selects output of 96 (or 504) different VCRs in duplication system to A/V monitoring equipment.

Circle (774)

G&M Power Products

Color video assist: full color video tap with CCD camera; record, playback system adaptable to motion picture camera; mounts on video tap port of camera; by General Camera.

Circle (782)

Grass Valley Group

VPE-141: low-cost editing controller; LSI-11/73 CPU with RS-422 communications; 13 serial ports for 7 VTRs, switchers, peripherals; battery-backed CMOS operating system memory; Super Edit software, JOG-PAD.

VPE-151 edit control: single-board computer design; JOG-PAD and keyboard include All-Stop, Record, Gang functions; version 4.1 Super Edit software; dedicated keys eliminates several setup menus; Trace, XEDL, modem EDL transfers; EDL management.

Circle (788)

See ad page 9

Gray Engineering Laboratories

CC-244 code comparator: 16 discrete relay contacts; programmable to open or close at specified time code; RS-232 serial interface for computer control of unit.

DT-104FC: SMPTE LTC and control code transmitter; interface to telecine as a master time code generator with transport tracking features; locked count based on film frames.

Circle (790)

See ad page 146

Harris Video Systems

Vus video workstation: 32-bit architecture; multifunctions for image management, processing, storage, retrieval; Winchester drive stores software and 200 fields or 100 frames; expandable with Winchester or optical disks.

IRIS II PLUS: upgrade still store system based on *422 frame buffer, synchronizer; 4:2:2 CCIR-601/RP-125 digital, RGB and NTSC or PAL inputs, outputs; compatible with IMAC system for multiple disk storage library.

Circle (797)

Hitachi Denshi

HF-3100, HF-3200: HF digital color disc recorders; write-once optical disc technology; 170 pictures per optical disc plus hard disk.

VG-SI: S-VHS portable VCR; integral TBC, independent playback, record heads; 400-line resolution, S-VHS mode; 240-lines, VHS mode; 45dB S/N; Dolby NR; 12Vdc, weight 10 lbs.

D-2 VTR: component digital recorder; plug-for-plug replacement for Type C systems; 208 minute maximum record time.

Circle (802)

See ad page 3

Interactive Motion Control

REMOT head: keyboard, plasma display, jog box in single unit; control animation table up to 4000 feet from IMC 3565 power/driver; hires graphic display, RGB output available; increased speed of movement.

2x2 animation stand: two feet of X-Y motion, 360° rotation.

Slide system: attachment for 2x2 system; gives X-Y motion, rotation, zoom, focus functions with 2-1/4" or 35mm transparency artwork.

Circle (820)

James L. Grunder & Associates

CEL ERIC enhancement: triple time code reader, generator; time code calculator available through touch screen menu of P158 system controller.

Circle (793)

JVC Professional

BR-S410: portable S-VHS recorder; docking system design; auto assemble editing; Dolby NR; for use with KY-20U, KY-15U, BY-10U cameras; four audio channels with meters, level controls; camera, line, Y/C input switching.

BR-S810: S-VHS editing recorder; Y/C in/out, Y/C 629 dub mode; 400 TVL resolution; jog, dial search; use with *RM-G810U* edit controller; 54dB S/N video, 44dB S/N audio without Dolby NR.

RM-G410U: simple editor for use with BR-S410U portable S-VHS VCR and BR-S810U editing S-VHS recorder.

BR-S610: S-VHS recorder, player; Y/C dub; SMPTE in/out terminals; sync input for external sync or TBC; jog control; Dolby NR; use with *RM-G810U* edit controller.

Circle (833)

See ad pages 64A-J

Landy Associates

Interformat editing: console with Paltex Elite editor; may use mix of 3/4", Beta SP, M-II and 1" VTRs.

Circle (851)

Leitch Video

DSF-3100N: digital still-file enhancements; digital transitions, keying; over the shoulder still presentations; 1,500 stills, expandable to 10,000; random access retrieval <0.6s.

Circle (859)

See ad on Inside Back Cover

Lyon Lamb Video Animation

VASystem-1: links computer graphic workstation with NTSC video; controls frame-by-frame recording of RS-170A video on VTR with RS-232 control.

VASystem-2: adds image capture, storage from various inputs to base system; Ethernet data transfer; VTR control functions.

VASystem-3: enhances VASystem-2 with video paint functions, 2-D graphics manipulations; digitizing tablet, RGB monitor.

Symbolics S-Record: links paint, animation system through MiniVAS to control VTRs, disk recorders, Sony HDV-1000, BVH-3000.

MiniVAS interface: links Wavefront Technologies graphics for VTR control.

Circle (873)

Merlin Engineering

Tape delay system: automation hardware, software package, controls 3-4 VTRs for constant fixed video delay; 45s to maximum of recorder play time.

ROADMAP imager: 32-frame solid-state video storage system; designed for medical use; cycle through frames for review; enhance controls; uses conventional monitors and VTRs for direct viewing, archival purposes.

Circle (893)

Montage Group

System II Picture Processor: enhanced non-linear, random access, editing system; 17 SuperBeta HiFi VCRs with intelligent interface, time code reader; integral switcher, effects generator, two TBCs.

Circle (912)

Multi-Track Magnetics

Rangertone 192: studio processor, counter; intelligent counter computes data in feet, meters, time; time code reader, generator; multitransport autolocator; resolver for transports; 68008 μ P.

Circle (917)

NEC America

VSR 10: solid-state recorder with low-level control from Macintosh computer; allows customized editing control.

VSR 10 control panels: allow multitasking applications of solid-state recorder with DVE System 10 effects for post-production, fixed or variable delay and video looping.

Circle (926)

See ad page 137

Odetics

TCPI000: play-only cart machine; operation complemented by CWS500 workstation.

Circle (940)

See ad page 129

Optical Disc

RLV Mk II: recordable laser videodisc; Laser-Vision compatible; 54,000 frames for 60 min CLV or 30 min CAV video; S/N 45dB unwt'd; NTSC, PAL compatible; 5MHz NTSC, 5.7MHz PAL.

Circle (945)

Paltex

ES/D 6/12: 6-machine editing system with slow motion capability; 12 VTR interfaces, any mix; 500-event non-volatile EDL; multiple record; learn mode; FFW/RWD speed set; FIT expansion, compression.

Esprit Plus 8/16: new range of videotape editing systems including 8-machine roll Esprit Plus; 16 VTR interfaces; 700-event EDL; audio mixer interface; 10 user-defined keys; 10 SFC/event in EDL.

HOW TO PROTECT YOUR IMAGE



Scrambled



Descrambled



S-234



The Microtime S-134 and S-234 will protect your video image with the most advanced capabilities for synchronizing and correcting remote feeds. And, with video scrambling, you ensure the security of your video image. Features include:

- Four field memory with four field freeze
- Composite digital sampling for transparent video processing
- Sophisticated "hot cut" performance to correct incoming signals
- High level of noise immunity to synchronize poor quality signals without freezing
- Selectable response to fading signals
- Audio steering output to correct lip sync problems
- Complete proc amp controls and optional remote control
- Available in NTSC, PAL-B or PAL-M standards

S-234 Four Field Synchronizer/TBC

The S-234, available in NTSC only, has all of the features of the S-134 and in addition, includes an infinite window NTSC TBC. You can operate the S-234 with or without advanced sync to a heterodyne VTR. A 3.58 sub-carrier output is provided for wideband TBC operation. Auto mode circuitry selects TBC mode or synchronizer mode based on the video output.

Scrambler Option

If you are concerned about the theft of your video signal, use the scrambler option to turn the S-134 or S-234 into a scrambler/descrambler system. All you need is a scrambler at the transmit location and a descrambler at the receive location.

- 4,300,000,000 user selectable key codes
- Random line-to-line scrambling
- Random code changes during transmission
- Scrambled video can be recorded by VTR for time delayed de-scrambling

For more information, call Microtime.

 **MICROTIME**

A Subsidiary of ANDERSEN GROUP

Microtime, Inc., 1280 Blue Hills Avenue, Bloomfield, CT 06002 USA
Telephone: (203) 242-4242 • 1-800-243-1570 • Telex: 4938290 MCRO UI • Telefax: (203) 242-9876

Circle (103) on Reply Card

ELAN 4/12: 4-machine editing system with SpeedScan; 12 VTR interfaces; 5 SFC/event, 326-event EDL memory; Freezescan programmable freeze; ListTrac, auto list match; slow play with speed set.

ELITE 3/12: 3-machine edits, keyboard assignable; six VTR interfaces mixing 1", 3/4", 1/2"; 250-event EDL, non-volatile; Varascan shuttle; A/V sync frame bump.

SID, R-SID: parallel to RS-422 serial, serial to parallel control interfaces for editing system interconnections; SID adds time code to RS-422 serial line with integral time code reader.

Circle (954)

See ad page 143

Panasonic Broadcast

AU-X80: M-II studio editing VCR; low-cost for editing, dubbing; 12-pin connector for CTCM/component switching; 7-pin connector for Y/C to S-VHS; insert, assemble, with V/A1/A2; 17-step shuttle speed dial; use with AU-A65 controller.

Field Edit Package: two AU-550 editing recorders; AU-A50 edit controller; AU-MX-50 audio mixer; AU-TB50 TBC; compact to fit in station wagon or other vehicles.

AU-620: M-II studio player; compatible with video cart installation; integral TBC with 32-line correction; VITC/LTC reader; $\pm 10\%$ speed trim key; two AFM and two longitudinal audio channels; b/w pictures at $\pm 32\times$ play.

AU-630: studio play-only M-II VCR; auto-tracking from $-1\times$ to $2\times$; 32-line TBC; VITC/LTC/UB reader; 4-field color framing; two FM, two longitudinal audio channels; tape speed override; parallel, RS-422 remote interfaces.

AU-660PE: studio M-II editing VCR; integral 9-bit TBC; amorphous video heads; control panel detaches for remote operation; insert, assemble, split editing; play speed override; integral time code reader, generator; parallel, serial remote interfaces.

AU-640: M-II VCR; studio recorder, player; integral TBC, VITC/LTC reader, generator; 4-field color framing; Dolby C on two longitudinal audio channels; two AFM audio channels; play speed adjustment, $32\times$ jog; parallel, serial remote control.

Circle (955)

Panasonic Industrial

WJ-MX10 digital AV mixer: editing capabilities with integral frame synchronizer, frame memory, freeze frame with mosaics, adjustable paint, 17 wipe patterns; joystick image positioner; optional WV-KB12A titling generator; 4-input audio mixer.

AG-A800: multiple event editing controller.

AG-7800: Pro series S-VHS VCR; Y/C signal system with >400 TVL resolution, Hi-Fi audio; also standard VHS mode; integral serial remove receiver allows up to 500 VCRs connected in duplication system; 4-channel audio with 90dB dynamic range.

AG-7300 player/-7100A recorder: S-VHS VCRs; 400-line resolution, 46dB S/N ratio; comb filter design; 14-step dial search; 2-channel audio with Dolby noise reduction.

IPF-44: S-VHS to RM-440 interface adapter.

AG-560: VHS VCR with integral 10" diagonal color monitor; 300-line resolution; 10-key wireless remote control; Super 4-head system, Double Super slow motion, double speed play, still, still advance; tuner.

Circle (922)

See ad pages 40-1, 43, 80B-C

PEP

InterFormat edit control emulator: translates control signals between S-VHS deck, Sony

RM-440 edit controller or BVU-800 edit VCR; PA800S for Panasonic VCRs, JV800S for JVC systems.

Circle (961)

Pioneer Electronics

LD-W1 LaserDisc player: double disc play capability allows CLV extended play or CAV standard play without turning the disk over; 8-bit digital field memory for remote controlled effects.

Circle (1271)

Quantel

DLS 6031: component video storage capability for DLS-6000 family of digital image library systems.

Harry LP: increased on-line image storage to 3,360 frames NTSC or 3,024 frames PAL; E-Motion included as a standard item.

Carousel Ramcorder: DRAM solid-state recorder controlled from Paintbox pen and tablet; CCIR R-601 ports, 4:2:2 interfaces, internal processing; random access.

Circle (979)

See ad page 131

Recortec

EPA-500: extended play adapter for VHS recorders; for record and immediate playback of uninterrupted segments or sequences to 150 hours in SSL mode; external synchronized transport for handling large reels of 1/2" tape, houses standard VHS player.

Circle (990)

Sharp Electronics

XA-2500S: Super-VHS VCR; jog/shuttle dial, flying erase, advanced digital effects, stereo hi-fi audio; 20MV97P color monitor with S-VHS input, Linytron Plus CRT.

Circle (1024)

Skotel

TCR-111c: time code reader with RS-232/422 interface; LTC type code for speed range from 1/40 to $80\times$ play; large green LED readout; μP control.

TCR-132 reader: for VITC, LTC time code; LTC range 1/40 \times to $80\times$, VITC range $\pm 50\times$; four character heights; simultaneously displays time, user bits.

AV TC-20 VI: portable VITC, LTC reader with character inserter; auto priority selection of VITC, LTC, CTL; automatically identifies 24, 25, 30 f/s.

AV TC-20: portable time code generator, reader; 24, 25, 30 f/s free running or locked to video; jam sync; numeric touchpad for presetting time, user bit information; integral time code calculator.

TCG-80N-FT: film-to-tape time code generator; film tachometer interface; 3/2 pull-down recognition; character inserter; VITC output option.

Circle (1031)

Sony Broadcast

BVW-507, BVW-550: Betacam SP camcorders; camera for -507 is BVP-7 with Interline Transfer CCD with electronic shutter; camera for -550 is BVP-50 with Frame Interline Transfer CCD. **DVR-10 D-2 digital VTR:** composite digital video recorder.

BVW-22: Betacam SP office player; long playing time, metal tape option, 4-channel audio, self diagnostics; optionally superimposes time base data on monitor image.

Betacam-SP series: playback only BVW-60 for on-air or edit suite; BVW-65 playback with Dynamic Tracking; BVW-70 play/record deck

without DT.

BVW-200: integrated Betacam SP recorder with CCD camera; camera based on 510 Interline Transfer CCD; integrated motherboard for camera, VCR links four μP s for system diagnostics.

Circle (1037)

See ad pages 25-7

Sony Professional Video

RM-450: editing control unit for 2-machine editing; 33-pin, 9-pin remote interfaces; for VO-5850/5800, BVU-800/900 U-matic, Betacam, Betamax VCRs; fixed speed dynamic playback of 9-pin editing VTRs.

BVE-600: A/B editing controller; serial control system with optional switcher boards **BKE-611/621** to integrate controller into edit suite; split A/V edits; slow/fast motion with DT VTRs.

BVU-900 U-matic SP: integral time code editing with optional TBC, digital noise reducer.

Circle (1040)

See ad page 189

Spectra Image

Spectra System: post-production system with laserdisc technology; electronic editing, sound syncing/editing, special effects, auto assembly.

Circle (1280)

Steady-Film

Animation desk: portable attache desk and studio disc; top, bottom bars calibrated and slide East-West for scene planning; bar lock down; removable Acme pegs; clear, diffuse inserts. **MANIPULATOR:** servo-controlled, joystick operation, 4-axis motion control with 3 levels of hardware, software for animation table.

Video-Cue: computer-controlled, time-code related video cuing device for post sync, language overdubbing; for PAL or NTSC, to 15,000 cue points.

Circle (1053)

Tamron Industries

11-100 FOTOVIX editor: framing to preselected sizes, aspect ratios with two joysticks; control tone of marginal areas; pointer highlights specific parts of image.

Slide film feeder: single frame, continuous frame, step, jog advance.

Circle (1072)

TEAC

LV-250H: high resolution monochrome laser videodisc recorder; 550 TVL resolution; one disc holds 54,000 frames; 6-digit ID codes recorded with image for faster retrieval; RS-232C interface standard; variable speed playback.

Circle (1077)

Telcom Research

TCR680, T6020: time code reader/inserter systems; T-6020 is rack-mount unit.

PC 600: time code reader card for IBM PC.

T800, T900: LTC to VITC, VITC to LTC translators.

T6010: high speed time code reader, character generator; drop frame, 25, 30 frame modes; 0.8" LED display; character inserter; color framing.

T-7000A: portable time code generator, reader; jam sync; 25, 30, drop frame modes; EBU/SMPTE standards; 40-hour operation from AA cells; keyboard entry of time, user bits data; for ENG, remote operation.

T5010: SMPTE/EBU time code reader/generator; 4-field NTSC, 8-field PAL color framing; all standards; LTC only; with character generator, keyer.

Time Base Correction: The Third Dimension

Time Base Correction has taken on a whole new dimension with the introduction of the FOR-A FA-740 Parallel Effects TBC. A/B roll *plus* Program Output all in a single package. Three simultaneous outputs!

It's a powerful full-frame dual-channel time base corrector with independent channel freeze plus an impressive array of special effects on the program output channel. The FA-740 gives you reliable time base corrected outputs on channels A and B while simultaneously

generating your mixes, mosaics, paints, wipes, cuts, dissolves and more on the program output. With unparalleled reliability and performance.

Perfect for A/B roll editing in post production suites, the FA-740 handles both $\frac{3}{4}$ " and $\frac{1}{2}$ " VTRs with or without external sync output. And the proven FOR-A analog component processing gives you the very best picture possible. Also part of this powerful

package—dropout compensation, program memory capability (10 events/10 pages), and RS-422 and GPI ports for remote editing and external control.

For less than \$12,000, you'll have the power of *two independent TBCs plus effects* in a single compact unit. Put it to the most important test. Your own. Enter The Third Dimension with a call to your FOR-A Dealer now.

FA-740
PARALLEL EFFECTS . . .
UNPARALLELED PERFORMANCE



FOR-A[®]
INNOVATIONS IN VIDEO
and AUDIO TECHNOLOGY

FOR-A CORPORATION OF AMERICA Nonantum Office Park, 320 Nevada Street, Newton, MA 02160
Boston (617) 244-3223 / Chicago (312) 250-8833 / Los Angeles (714) 894-3311

Circle (104) on Reply Card

Model T7800A: time code reader/generator. **TCG 550, TCR 660:** ac/dc operated time code generator, reader units; table-top packaging; operates on all four EBU/SMPTE standards with NTSC, PAL color framing. **Circle (1284)**

Thomson Video Equipement

TTV 3962: edit controller for use with TTV 3500 series VCRs and other VTRs for editing suites.

TTV-3505: Betacam SP VCR for use with TTV-1624, -1640 tube or CCD cameras.

TTV 3560 VCR: studio recorder player; Betacam SP format; TTV 3565 includes dynamic tracking.

ANDI: still store image archive with WORM OPTIMEM digital optical disc recorder; 2,400 frame capacity per 12" disc; 5-1/4" optical disc also available; SACADO library software.

TTV 3535 VCR: Betacam SP portable recorder, player; remotely controllable from studio recorder for editing.

TTV 3522 VCR: playback unit only; Betacam SP format.

TTV 3570 VCR: studio recorder player; Betacam SP format; TTV 3575 includes dynamic tracking.

Circle (1101)

See ad page 167

TimeLine

LYNX System Supervisor: accepts generalized serial commands from external control computers and transmits device-specific commands to the appropriate Lynx module or other serially controlled device; RS-422, ESBUS.

LYNX Film Module: integrates sprocketed film transport controlled from biphasic bus with tape transports and other parts of editing system.

LYNX keyboard control: comprehensive, programmable machine control for multiple tape, film transports and other devices; connects to System Supervisor via RS-422 serial cable with ESBUS protocol when possible.

Circle (1104)

Toshiba

TVR-1000, TTB-1000: 1" HDTV video recorder; 90-minute record time with 14-inch reels; Y/Cw/Cn, RGB video; three audio channels; 41dB S/N ratio video; optional TBC available.

Circle (1109)

United Media

Multitasking series: editing controllers allow frame-accurate, multiple editing functions simultaneously; MT-30, MT-60, MT-90 3, 6, 9 VTR systems; include monitor, disk drive, time code generator, RS-232/422 control ports; 5-channel audio console.

Model 505: time code generator, reader, character generator with rephasing capability.

Circle (1124)

Videolab

Time code retrofits: TCR-5 Sony Type 5; TCR-6 for Sony VO-6800; TCR-9 for Sony Type 9; kit available for BVU-200.

Circle (1145)

Videomedia

PC-Link: allows IBM PC control of Mickey editing systems; mouse or manual operation; event-by-event comment structure; on-line menus; convert to/from CMX compatible file; 999-event list memory; pull-down windows.

Mickey Version 2: software upgrade for editing systems; adds jog, shuttle, non-volatile memory, field upgradable options and software assignable VTR features.

V-MAX system: V-LAN distributed intelligence; upgrades from Mickey, Eagle, Magnum systems; interface to PC-Link; control 32 devices; video dissolve, 20-channel AFV; 4-machine sync roll; multilevel transition, key control; animation. **Circle (1146)**

Voodoo Technology

EDL Maker: hand-held system to create EDL list, 250-event memory; calculates time code in any mode; sort events; search list; transfer list to editing system with RS-232 port; add, delete edits.

TiComp: hand-held time code, film edge number calculator.

Circle (1182)

Video Products

V3: Film, cine

- Video-for-film equipment
- Telecine systems
- Film-tape transfer
- Film editing equipment
- Cleaning, inspection

AF Associates

B3410-03: digital line-array CCD telecine, with options; switchable between 625/50, 525/60; auto vision, sound lamp changeover; still frame color correction; digital aperture correction with coring.

Circle (515)

See ad page 103

Apollo Audio Visual

Audio-visual equipment: film-strip, motion picture, overhead projectors, projection lamps.

Circle (549)

Arriflex

16SR On-Board Walkman adaptation: sound system for 16SR-2 film camera with Sennheiser MKH416T mic, Sony WM-D6C Pro Walkman. **16SR-2 time code generator:** TC generator runs internal or external time code; also available for 35BL, 35-3 cameras.

Circle (553)

BTS Broadcast TV Systems

FDL-60 enhancements: Print Look simulates transfer characteristic of high contrast print film; ESO 35mm, 16mm horizontal, vertical stabilizers; optical blocks for 35mm, Super 35mm and Super 16mm with X-Y zoom; 35mm 3-perf or 4-perf system.

FDL-60 ESO: electronic steadiness optimizer for 35mm, 16mm film; real-time H/V steadiness telecine enhancement.

4:2:2 output: optional digital encoder for FDL-60 telecine; analog component outputs also available.

Image manipulation: telecine image sizing, repositioning with frame-by-frame programming with high quality component digital signal processor.

Circle (615)

Cinema Products

Moviecam: motion picture film camera system; improved sound isolation system for silent operation; precision film plane positioning.

Circle (643)

Digital Audio & Video

FGR-1 film grain reducer: digital processing for

Rank Cintel Digi IV telecine; operates in all standards.

Circle (708)

J&R Film/Moviola

Model 600 LOKBOX: hard-lock synchronizer; locks film sound and negative to edited videotape picture/production track.

Circle (832)

Lipsner-Smith

Ultrasonic: film cleaner system.

Circle (865)

Marconi Communication Systems

B3410-03: digital line-array CCD telecine, complete with working options; switchable between 625/50, 525/60 standards with options; auto vision, sound lamp changeover; still frame color correction; digital aperture correction with coring.

Circle (879)

Multi-Track Magnetics

Rangertone HP-1635: high-speed holoscope projection system; for 16mm, 35mm; 24-sided prism eliminates the Geneva intermittent and image flicker; variable speed available; optional Xenon sound lamp, magnetic/optical playback.

SP-1635 projector: high-speed 16mm, 35mm studio projector; μ P-controlled electronic intermittent pulldown; servo drive system.

Circle (917)

Polaroid

UL-544 FreezeFrame accessories: 4x5 and 8x10 film backs; foot switch control.

Circle (971)

Rank Cintel

3-Perf/4-Perf gate: for 35mm film with enhanced MkIII-C Digiscan III and 4:2:2 telecine with Varispeed, X-Y zoom; auto sensing of film perf type.

ADS-IC telecine: new generation CCD linear array; improved black level sensitivity in blue, anti-bloom capability, aliasing control, low light levels; reduced spike content; dirt, scratch concealment.

Circle (986)

See ad page 54

RTI/Research Technology

TV-2000: high-speed TV film editor.

Circle (1007)

Steady-Film

Peterson film cleaner: full immersion system; rotary buffer; automatically recovers solvent fluids; sprocketless film transport with speeds to 300 ft/min.

TE190X2 CRT: magnetic focus/deflection CRT for Rank Cintel Mk III telecine; phosphor matches persistence of RGB channels with 3x light output in blue channel; by Tube Enhancement.

Turbo-Telecine: Digiscan III/IV, variable speed; 3-perf capability; scan track; Festival shading/burn circuitry; XYZoom control; by Unimedia.

Peterson video immersion system: adapts to Mk III telecine, forward, reverse high speed shuttle; wet/dry transferring with one head; film fully immersed at aperture.

Notch Guide: accessory for Rank Cintel Mk III telecine; reduces interference caused by notched 35mm film.

Unimedia X-Y-Zoom: for Mk IIIB telecine; frame time base; scan track; auto scan protection; compatible with Digi-I, II.

Festival enhancement kit: for Cintel Mk III;

replaces shading, burn correction/blinking boards for improved RGB shading, burn correction, contrast ratio, S/N, low noise head amps.

High speed lens: doubles light transmission of standard Rank lens; equivalent color, resolution; greater S/N ratio, longer tube life, reduced burn.

Peterson RSG-Gate: for Mk III telecine; reduced film weave; quick change 3-perf adapter, sound sprocket assembly; compatible optics with standard gate; 16mm, 35mm.

Circle (1053)

Steenbeck

ST-701: 35mm flatbed film editing table; 6-plate, 1-picture, two magnetic sound track; film-to-tape transfer capability.

ST ADR: computer-controlled automatic dialogue replacement system.

ST-921: 16mm flatbed editing table; 8-plate, 2-picture, two magnetic sound tracks.

Circle (1054)

Thomson Video Equipment

TTV 2715 slide scanner: enhanced color shading with correction per component and smaller zones in image; improved S/N, dynamic range, automation and remote commands.

Circle (1101)

See ad page 167

Video Products

V4: dc power, light

•Batteries, packs, belts

•Chargers, reconditioners

•Lighting instruments

•Lighting control, lamps

Alexander Batteries

BP-1-11 analyzer: revitalizes batteries while determining condition.

BP-1-11 battery: direct replacement NP-1, NP-1A.

BP-1-11 charger: μ P-controller determines full charge.

Circle (521)

See ad page 36

Anton/Bauer

LOGIC Series: battery, charger technology; μ P-based system with multisensor network and Microcode program module in each battery through Data-Link interface.

PROBE: programmed battery evaluator; accessory for Lifesave MP-4, MP-8 μ P fast chargers; performs diagnostic, calibration, revitalization functions; LCD display, RS-232 printer port.

Lifesaver: μ P-controlled 4-, 8-position chargers.

Gold battery mount: compatible with all equipment using Anton/Bauer mounting system; integral 10A output connector; 6-pin Logic Series connector; cam-action latch for battery loading, removal.

Circle (545)

Arriflex

Fresnel kits: 300W, 650W Fresnels in kits; packaged in heavy duty shipping cases.

ARRI Obie: lightweight on-camera lights; variable illumination over 2 f/stops; no variation in color temperature.

ARRI Grip: production tool kit for grips, gaffers;

complete set of lighting and grip accessories.

Circle (553)

Brabury Porta-Pattern

T115/123: script lighting units; adjustable light beam easily directed onto control desks for reduced light scatter on nearby monitors.

Circle (972)

Christie Electric

NiCad battery series.

CASP/1000: battery reconditioning, recognition, analysis, charging; ReFLEX charging technique; analysis data on hard copy.

Circle (640)

See ad page 110

Cine 60

Hitch-Hiker Master: overnight charger; 12-14 hr charger; safe, cool charging of Cine 60 H12, H13, H14 Hitch-Hiker camera batteries.

KFC Lifeguard: batteries with integral 2-rate charger; no heat buildup or voltage depression if left connected to ac.

Overnite charger: 14-hour charge for 30V to 60V NiCad batteries; auto adjustment to battery impedance and voltage; reconditioning, equalizing.

DM-1214A dememorizer: constant discharge circuit, timer; used with C10 battery charger restores battery capacity after overcharge and shallow discharge.

Circle (642)

Cinemills

Silver Bullet: 12kW HMI lighting system.

Camera filters: resin material; for color correction, diffusion, effects.

To celebrate our 15th year, we'll give you a \$1,500.00 gift with the purchase of a system 12 or System 16 Stereo Audio Console. Choose any two: Equalized Stereo Mixer; BA-235 Monitor Amplifier; or SERIES IV Custom Upgrade. Offer ends September 15, so call Broadcast Audio, or your authorized BAC representative today! Sorry — offer is limited to 15 consoles per customer.

HAPPY BIRTHDAY!



**BROADCAST
AUDIO** CORPORATION

11306 SUNCO DR., RANCHO CORDOVA, CA 95742 (916) 635-1048

Circle (105) on Reply Card

Color filters: 3 mil polyester film, heat resistant; available in rolls or sheets.
Harrison & Harrison filters: glass material for light regulation, effects.
PARGEL: available in 10"×25' rolls.
Dedolight: wide focus range possible with special meniscus lens; 12V halogen lamp; use with auto battery or have three color temperatures with control unit.
Circle (644)

Desisti Lighting

2400 series: stainless steel HMI fixtures.
DesiPak: portable dimmer packs; 2.4kW, 6kW, 12kW.
Botticelli: quartz-halogen studio softlights.
Inciso: 2kW quartz-halogen pattern projector.
Circle (698)

Domke Lighting

Light panels: for reflective, diffusion of lighting; lightweight fiberglass frames, clamps, panels; lighting control for photographers.
Flexi-Grip: table-top stand for easy positioning of props, reflectors; for still-life photography.
Circle (727)

Frezzolini Electronics/PAG

MC2 Mastercharger: 2-wire system fast charges four batteries sequentially, slow charges four batteries simultaneously; auto mains select, cell balancing, maintenance charge; for NiCads of any manufacture.
Models 9537, 9418: PAG Speedcharge 6000+ sequencer; for sequential charge of eight batteries, revitalize NiCad batteries 10V to 30V.
Mini-Fill series: On-Board lights, accessories.
MicroMaster 9526, 9529: ac, mobile dc μ P-controlled NiCad chargers.
PAG-LOK series: NiCad batteries, brackets.
UPS-14: On-Board uninterruptible power supply; allows batteries to be changed without shutting down camera, VCR.
Circle (771)

General Electric

GEMI lamps: metallic iodide multivapor for 5600°K daylight color temperature; 200W to 12kW; color-rendering index 90+; for standard fixtures, ballasts, igniters.
Circle (777) [See ad pages 104-5](#)

The Great American Market

LightWiz: remote control electric yoke; pan 400°, tilt 100°; 0-10Vdc control; for various popular fixtures.
Scenic projector: 2.5kW rating HMI light.
GamColor: deep-dyed polyester color lighting filters; extended life.
Circle (791)

ILC Technology

DayMax HMI: metal halide lamps (5600°K); 200W, 757W, 1.2kW, 2.5kW, 4kW, 6kW, 12kW ratings.
Circle (813)

Kintek Custom Products

Mobilizer 3: recharges VHS C-format 9.6V NiCad minicam battery from 12Vdc vehicular battery through lighter connection.
Circle (1255)

Kliegl Brothers

CCT Minuette series: 500W rated Fresnel and Profile spotlight fixtures; C-clamp, safety cable, color frame and connector included.
Performer IV: computerized lighting control console.
Circle (846)

Lee Colortran

Motorized luminaires: multipurpose 2.5/5kW Fresnel spot, soft light; motorized control of pan, tilt, focus, barn-door rotation and flaps.
Daylight Fresnels: spotlights from 575W to 12kW.

HMI line of flicker-free ballasts.

The Rack/Dimension 192: up to 192 1.2kW or 2.4kW dimmers in one rack; independent cooling from ambient air; plug-in module design.
Lee filters: color-effect, correction, diffusion materials; resin camera filters; polyester photographic filters.

192 Wall Pack: terminal package with Plug-in dimmer, electronic control modules; lockable door, electrostatic filter; analog or digital control signals.

Baby Fresnels: 2kW, 5kW ratings, stand or pole operated models.

Prestige 3000: Version 4.0 software; Alpha-Patch 5-character names assigned to dimmers; four effects submasters; controlled rate of effect step; Park Dimmers; programmable remote switches.
100-500 series: 1kW, 2kW TV Fresnels instruments.
Circle (857)

Lighting Methods

L86 dimmer packs: plug-in system for 3-100A, 6-50A, 12-20A or 24-10A modules; multiple format control capability with analog or digital signals; 1 ϕ -3 ϕ input configurations.

L86 portable dimmer racks: plug-in modular design, 1.2kW, 2.4kW, 6kW, 12kW ratings; digital or analog control; optional CRT status panel; various configurations for 24 or 48 dimmers.
Circle (863)

LTM

The Blue Torch: 270W HMI battery-powered SunGun.

HMI system: 220Vac 19" 6kW Fresnel instrument.

220V: 12kW HMI mini ballast.

Cinepar: 200W light.

Pepper Pot: 3-channel dimmer system.

Circle (870)

Matthews Studio Equipment

MatthPacks: Snap-in, articulating arm, Mini-Matth boom, medium kit stand, gaffer grip, Light Lift, light/heavy stand, C-boom clamps.
White Bobbinet, 1/4-Stop Silk: reduce light intensity by approximately 1/2 of a stop.

Super Sky Mote.

Gobo arms: 20", 40" stainless steel; rust resistant; resist twisting, bending.

Mini-Meat Axe, Flag: clamp with extension and flag; quickly attaches to overhead grid in limited space restrictions.

Stainless steel stands.

Matthflector: soft, expendable reflector material; available bulk or 6×6, 12×12, 20×20 precut reflectors.

GOBOBALLS: styrofoam balls, safety feature for the ends of Gobo arms.
Circle (883) [See ad page 190](#)

Maxell

NiCad batteries: for portable VCRs and ReCam power packs.
Circle (885)

Modulite/Bardwell-McAlister

Electralift: stand to lift lights to a maximum of 12 feet; capacity to 300 lbs.

Circle (910)

Mole-Richardson

575W HMI: Solar-Arc Solarspot.
Type 6308: 12kW ballast, ac or dc operation.
Type 4821: Tweenie II Solarspot, 650W.
Circle (911)

Musco Mobile Lighting

Lightbar: in-door lighting unit; four light heads for metal halide, incandescent or 1200W HMI lamps; prewired, pre-assembled.
Circle (918)

L. E. Nelson

MID series: 200W to 12kW daylight (5600°K) linear lamps.

FMR: 600W lamp for Colortran ellipsoidal instruments.

FGM/FGN: 1kW PAR64 daylight lamp (5600°K); rated for 800-hour.
Circle (927)

Olesen

6-1200 dimmer: portable, remote control dimmer system; six 1.2kW units are individually fused; master fader, individual bump buttons.
Circle (942)

Osram

Metallogen HMI 1200W PAR: metal halide lamp for stage, studio; GS gap-shortened for higher luminance; 30% increase in efficiency.
Circle (948)

Paco Electronics USA

DP-11: NiCad battery pack; 13.2V, 1.9AH; equivalent to Sony NP-1.
Circle (952)

PEP

UMC: Universal MicroCharger; applicable to all ENG batteries.
Circle (961)

Perrott Engineering Labs

PE124: 4AH dual fast charger with 3rd-pin technology; for field use, charges two 12, 13, 14V 4AH packs in about 4 hours; dual circuits operate independently.
Circle (962) [See ad page 94](#)

Pro Battery

PRO 500 charger: μ P-control; four ports operate independently, charge simultaneously; charge time readouts; auto trickle at full charge; 120/230Vac input; 14-16 hour typical charge; for most common battery types.
Circle (974)

Rosco Laboratories

Model 1500: fog, smoke machine.
Video paint: TV black, TV white for improved contrasts.
Circle (1002)

Strand Lighting

Lightboard M: studio lighting control system.
Circle (1057)

Sylvania Lighting/GTE

STTV lamp: 10kW DTY studio lamp; 120V, 3200°K; ceramic, mogul bipost base; replaces 10KG96/1, 10MQ/4CL.
Circle (1065)

Synergistic Batteries

SB-90L, SOB-13L: disposable lithium technology batteries; 3.5× capacity of similar NiCad batteries used at 2A rate, 75°F; 13V under load; Cicolac ABS case.
Circle (1282)

Teatronics

GLX-1212: dimmer system.
Dimming system: high density, modular.
Comstar Genesis: lighting control system.
Circle (1078)

Tekno

Multitube system.
Galaxy: modular soft-light system.
Circle (1081)

Theatre Service/Supply

OMEGA: μ P-based lighting control system; up to 960 dimmers with 72 or more control channels; non-volatile memory for 900 cues.
Circle (1095)

Theatre Vision

Lycian SuperStar 1.2: model 1275 1.2kW metal halide followspot; medium to long throw; 5600°K color temperature; 3-legged base; brakes for pan/tilt; adjustable trim shutters, douser; snap action color boom with rolling color and instant change.
Circle (1096)

Times Square Lighting

Q145: 1kW, focusing, long throw scoop instrument.
L2200: set light instrument.
Microstar II: memory lighting control system.
Circle (1105)

Ushio America

Halogen stage, studio lighting products.
Circle (1208)

Video Products

V5: Effects, graphics

- Production titlers
- Digital effects systems
- Digital graphics systems
- Prompting systems
- Video production systems

Abekas Video

A72: digital character generator; instant font sizing, full color logos; single, dual channel configurations.
Circle (502) [See ad page 37](#)

Accu-Weather

Satellite Delivery: all weather data circuits including DIFAX via satellite.

Accu-Data: advanced database; all forecasts, data plus AMPS Advanced Map Plotting System; color displays include DIFAX.

Graphics: more than 1,200 images per day including color, 3-D satellite, radar imaging and RadarPlus.

Forecasting WeatherShow, WeatherBreak: combines voice-over of Accu-Weather broadcast meteorologist with Accu-Graphics for complete 15-60s self-contained information service.

Front Door 750: PC-based hardware, software to receive, display, archive satellite delivered weather graphics.
Circle (504)

Advanced Designs

Doprad II enhancements: LPATS, LLP lightning displays simultaneous with Doppler weather radar.

WDDS: IBM PC/AT-based weather data display;

TAPE MACHINE TESTING AND LOTS MORE!

Tape machine testing is just part of Audio Precision System One's repertoire. For tape, System One does:

- response on stereo machines—or multi-tracks to 192 tracks
- distortion across the entire spectrum
- wow and flutter, rotational and scrape
- MOL
- SOL
- separation (worst-case crosstalk on multi-tracks)
- azimuth adjustments
- phase vs frequency
- gap scatter on multi-tracks
- spectral analysis of noise

ANALOG TAPE: System One tests VTRs, ATRs, reel-to-reel, cart, cassette formats—two or three head—using tapes you make or standard reference tapes, even with voice between tones.

DIGITAL TAPE: System One's -100 dB (0.001%) distortion levels make it the selection of the leading manufacturers of digital recording systems. Try measuring the -85 to -90 dB distortion 16-bit PCM systems with a test set with -75 dB residuals!

AND LOTS MORE: Audio Precision's System One tests all audio equipment in your inventory—compact disc players, consoles, power amps, distribution amplifiers, switchers, transmitters. Even acoustical tests on loudspeakers and microphones.

Features such as:

- three forms of imd including transient
- complete, automatic custom test procedures created without knowledge of programming languages
- fast on-screen graphic or tabular results
- low-cost graphic hard copy via dot matrix printers

make System One the most powerful choice in audio testing.

Call or write Audio Precision today for complete technical data and prices on System One.

Audio precision

P.O. Box 2209, Beaverton, OR 97075
503/627-0832 1-800/231-735C

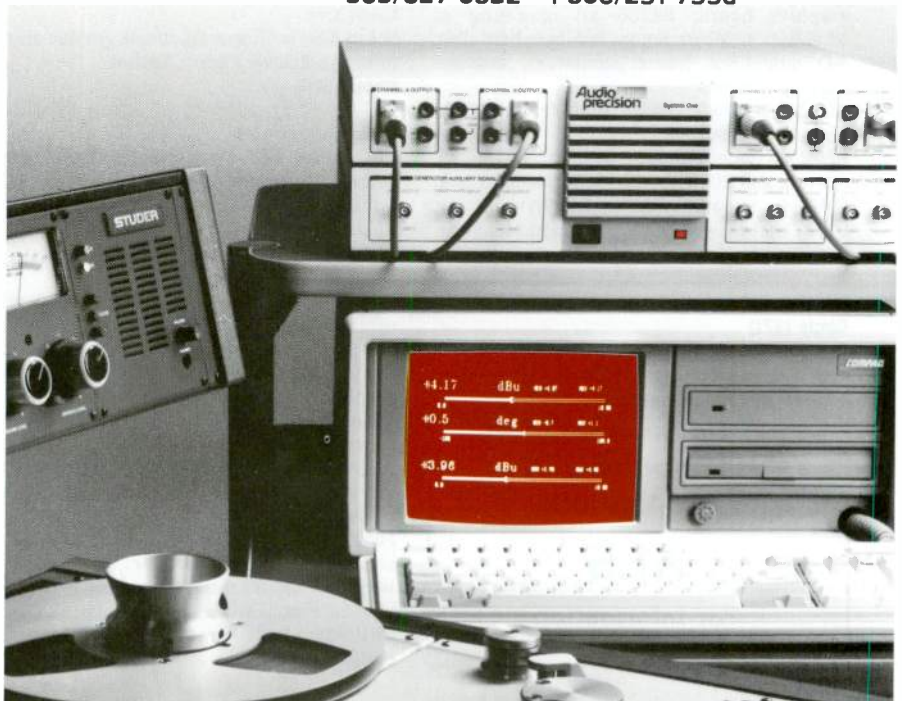

Circle (106) on Reply Card

graphics generation, satellite data acquisition.
Circle (512)

Alden Electronics

C2000R/S: weather radar and graphics/satellite imagery.

C2000M: weather radar designed for radio station operations.

C2000R: weather radar composites, displays echoes from 10 radar units.

Circle (520)

Ampex AVSD

ADO: upgraded keyboard, expanded software, off-line effects management; available as upgrade package for existing systems.

AVA-3 art enhancements: 4:2:2 component digital input/output with digital key I/O; analog composite, analog RGB, Y/R-Y/B-Y I/O; studio; conforms to CCIR-601; upgrades available for existing systems.

Circle (536)

See ad page 39

Associated Computer Services

Station Manager graphics: modular software for graphics, weather, animation, titling, prompting, library, program scheduling and tape editing.

Circle (556)

Aston Electronics

Spectra background generator: color gradations; initiate from any direction; can push image off screen; disk memory; compatible with many title generators; 2-level keying, auto tracking.

Caption: full feature character generator; software anti-aliasing; two independent text display planes; integral LogoMaster; 20Mbyte hard disk; variety of licensed typefaces.

Circle (558)

AT&T

TOPAS 2.2: 3-D object processing, animation software; uses Truevision TARGA and VISTA videographics boards; includes modeler and animator modules.

Circle (559)

Aurora Systems

AU/225: videographic systems; Truevision Vista graphics board; 80286 μ P operating at 12.5MHz; 1.2Mbyte floppy, 80Mbyte hard disk; 3-D modelling, frame animation, weather package options.

AU/220 upgrade: frame grab feature, PAL, SECAM compatibility.

AU/250: videographics system; 80386 μ P operating at 20MHz; 145-435Mbyte hard disk; 60Mbyte streaming tape, 1.2Mbyte floppy; 80387 math coprocessor for added manipulation speed.

Au/75 enhancement: Accu-Weather service interface.

Circle (571)

BASYS

CUEWORD: teleprompting system; variable fonts, fully integrated to BASYS running order. *Graphics interface* to Rank Cintel/Logica Gallery 2000; access 4:2:2 graphics, stills from the newsroom system.

Circle (581)

Broadcast Video Systems

CI-200: clock, message generator, inserter.

Circle (610)

See ad page 192

BTS Broadcast TV Systems

Font, Logo Compose: full screen capture, auto tiling onto characters for full screen display, animation; integral resizing, scaling, slanting, italicizing; compatibility to 1,500-face Bitstreams library.

Pixelerator: high-speed rendering for ERIC graphics network; renders animations from FGS graphics; combines variable resolution, CCIR-601 digital in/output, machine control. *Vidifont Viditext II*: graduated backgrounds on third plane; third channel RS-232 interface; timed rolls.

GraphicStore: paint, still store; high-resolution with picture capture, save, recall, create, montage; 4,096 colors; 4-frame buffer system.

Vidivote: election reporting package; instantaneous, automatic updating, retabulation of Vidivote database; special graphics package of candidate pictures, screen page formats; 900-race capability.

Vidilink: software for IBM PC/compatible links VidiVote system to AP election data service; auto entry for national, state, regional, local returns.

EPIC: Expandable Performance Image Computer; high-speed graphics platform; comprehensive software tools; video, animation, color electronic press, medical, scientific applications.

Circle (615)

Byte-by-Byte

Sculpt-Animate 3-D: interactive 3-D for Commodore Amiga 2000 computer animation with ray tracing; real-time wireframe playback preview; store as compressed animation file playable from RAM or record on tape.

Circle (1237)

CASCOM

Select Effects VI: special effects graphic animation; syndicated library format.

Circle (626)

CEL Electronics

PI64 series: TBC, synchronizer, digital effects systems; meets 8-bit CCIR-601, 4:2:2 requirements.

Circle (631)

Chyron

Scribe Jr: compact version of Scribe graphic titler; full anti-aliasing; 32 on-screen colors from palette of 16.7 million; 3" floppy disk with 2Mbyte storage; compatible with any Scribe graphic display; font compose, subtitle.

Super Scribe: on-line font conversion with Advanced Font Utilities; multitasking allows font conversions in background with normal message compose functions; multi-user operations.

High Definition Scribe: HDTV version of character/graphics generator; 1125/60 system with 16:9 aspect ratio; 0.84ns resolution; Advanced Font Utilities I, II; Logo Compose; Bitstream font library; networking, other options.

Auxiliary entry: Scribe enhancement; off-line entry via PCs and ASCII terminals; perform on-line graphics composition while Scribe renders fonts, graphics off-line; off-line, computer interface operate simultaneously.

Advanced Font Utility packages: for Scribe; glows, bevels, chiseling, embossing, 3-D texture maps, neon effects; camera capture, business graphics; auxiliary entry package for off-line/election reporting interfaces; IOMEGA mass storage.

Circle (641)

Circuit Studios

Velocity 3-D: Version 2.0 of motion control and video animation system; real-time manipulation of solid, shaded 3-D shapes; Megatek 9115 graphics engine base; 8,000 line resolution.

Circle (1180)

CMX

CMX-330S: post-production system; integral A/V switcher for cuts, dissolves, fade-to-black for A/B/C VTR, non-TBC mode without TBC; off-line, on-line operation with many features.

Circle (648)

ColorGraphics System

LiveLine 5: 32-bit 68020- μ P weather graphics presentation system; 24-bit and 8-bit graphics capabilities with MXR digital video mixer; supports WSI, ESD, Weather Central, Accu-Weather services; 2-plane animation; satellite loops; paint, text.

DP-4:2:2: graphic paint/animation equipment; Ethernet link to other equipment; NTSC or PAL encoding output; 4:2:2 external interface, 4:4:4 internal processing; RGB-to-digital; mix effects; object, raster-based.

Circle (719)

Commodore Business Machines

Amiga 2000: graphics-oriented personal computer with Byte-by-Byte Sculpt Animate 3-D software.

Circle (1248)

Comprehensive Video

PC-2 Fonts-Plus: titler module adds seven font styles, graphics, allows storage, retrieval from disk; integral Font/Logo Compose feature; mix 32 type styles, sizes per page.

TCSM: time code sync monitor; aids in locating timing, phasing errors before they become serious editing problems; on-screen display of time code condition.

Circle (658)

Comprompter

ENR-Electronic NewsRoom: software expanded to run on IBM PS/2 as well as on XT/AT systems; based on MS-DOS.

TotaPrompter-PC: an electronic production, prompting system; producer's desk feature for cut-past editing; calculates script length with tape insert lengths; prompting hardware also available.

Circle (659)

Computer Prompting Services

CPS standard: IBM AT/compatible-based custom graphics board, software; multiple workstation configurations possible; drives b/w, color monitors, handheld electronic cue cards.

Circle (1202)

Computer Prompting

CPC-2500/-3000: IBM PC prompters; simultaneous scroll/edit, closed captioning

Continued on page 164

Grow
Professionally!
Join &
Participate in

AES

For Information
Call: 212-661-8528

AV & Broadcast China '88

The 2nd International Audio-Visual, Broadcasting,
Professional Photographic and Theatre Technology
and Equipment Exhibition For China

China International Exhibition Centre,
Beijing, The People's Republic of China

December 2-7, 1988

Range of Exhibits:

TV, Video and Broadcasting Equipment
Audio Equipment

TV Lighting Equipment • Cinematographic Equipment
Theatre and Stage Lighting Equipment
Photographic & Processing Equipment

Sponsors: **Ministry of Film, Radio and TV**
China Central Television
Ministry of Commerce

Organisers: **Business & Industrial Trade Fairs Ltd., H.K.**
CIEC Exhibition Company (H.K) Ltd

A
B&I
EXHIBITION

AV & BROADCAST CHINA '88

Yes, we are interested in participating and need more details

Name: _____

Position: _____

Company: _____

Address: _____

Tel.: _____ Telex: _____

Please fill in and return to:

BUSINESS & INDUSTRIAL TRADE FAIRS LTD.

4/F, China Underwriters Centre, 88 Gloucester Road, Wanchai, Hong Kong.

Tel.: 5-756333 Telex: 64882 ASIEX HX

AV10-88/BE



3M

MBR 20s
Master Broadcast
Videocassette

Scotch™
Color Plus



Hi-matic MADE IN USA

With
Exclusive
Anti-Stat
Treatment

One Tape for a True Picture.

In the field, in a factory...the worse the conditions you're shooting in, the better the tape you need. That's why we've made the 3M 3/4" MBR™ Videocassette—created to exceed even our widely acclaimed MBU Videocassette. Designed with our exclusive Anti-Stat™ System—to reduce its static charge and help prevent the dust buildup that causes dropouts. To give you a true picture.

TO THOSE WHO MAKE THEIR MANAGEMENT LOOK GOOD, ONE TAPE IS TRUE.



One Tape Stands True.

Just as your business is to make your management look good, ours is to make you look good. And that's been our business since we invented videotape 30 years ago.

That's why we stand by you—with the largest support force in the field.

And we stand behind you—with some of the most advanced research in the industry. All to keep our standing—as number one in the world of the pro. See your authorized 3M distributor for more information.

NUMBER ONE IN THE WORLD OF THE PRO

3M

Worldwide Sponsor
1988 Olympic Games



Continued from page 160
features; -3000 for newsroom systems.
CPC-500: closed captioning system.
CPC-1250 teleprompter: with simultaneous scroll/edit feature.
CPC-1500/-1750: teleprompters for electronic newsroom use; -1750 includes simultaneous scroll/edit.
Circle (664)

Contel ASC/Gov't Network Div.
NOAA weather wire service: proposed service to replace existing teletype-based weather service; user receives reports with 30" diameter satellite antenna.
Circle (1241)

Cubicomp
Version 8.0: enhanced software for V2000 3-D graphics products; refractive mapping, soft-edge shadows, lighting features, motion control, faster operation.
Ray tracing: enhancement to RACE render accelerator board of PictureMaker 3-D animation systems in Version 3.0 software.
Model 522-00: high-resolution image output to film recorders for RACE boards with PictureMaker systems.
Circle (685)

Digital Arts
DGS FX: updated version of special effects software; includes animated water pattern; starfield generation; edge/motion blur; controlled chroma removal.
Expanded fonts: additional 38 fonts to DGS 2.1 software.
DGS 2.1: PC-based 3-D animation; 2-D modeler with auto-trace; 3-D modeler shapes logos, typefaces; spline-based models; Scenes motion scripter; Render module.
DGS CSM: Constructive Solid Modeler; creates models with 3-D Boolean processes; to 3,500 vertices each; Boolean union, intersection, difference creates third model from two 3-D models.
Frame buffer drivers: for Truevision Targa 16, Vista frame buffers.
Circle (701)

Digital F/X
DF/X 200 video production system: digital effects with real-time perspective, full color paint, titler, digital library; ASIC circuitry for increased processing speed.
Circle (705)

Digital Services/DSC
Collage: D-2 digital compositor; 5-source, 3-key external signals; composite three foreground videos over background, controls priorities of two videos; output direct to D-2 tape or disc recorders; interface option includes A/D, D/A convertors.
Eclipse upgrade: optical digital effects enhanced with 68020 32-bit μ P; wave, curtain pull, slide through page turn and scroll, 16-level posterization.
Illusion update: software enhancements for optical digital effects system; repertoire of 280 preprogrammed effects; moving crop, alternate line split image, double image with axis offset, expansion, compression, mosaics; bubble memory.
Circle (707)

Dubner Computer Systems
20 KEL election computer: assembles, analyzes voting data, compiles running totals; inserts data into video signal from 20-K

character/background generator; full-featured titler system.
K-PNT option: paint software for 10-K, 20-K titlers; includes tablet, stylus, paint mode and font-compose software.
Graphics Factory: modular approach to video graphics workstation; operates in D-1 digital component format; standard outputs in RGB or NTSC component analog, optional as PAL and CCIR-601 digital signals; GF-30 character generator, paint, animation.
K-DIG digitizer: hardware, software accessory for 10-K, 20-K titlers; grabs logos, creates fonts, captures full-screen backgrounds from b/w images; assigns colors to captured signals.
Circle (714)

Dynatech NewStar
Closed captioning: Advanced Performance Software APS Version 4.0; add-on software, hardware for NewStar equipment; uses EEG Enterprises encoder.
Circle (721)

Edit Line
Edit Line TTA 500: video/graphics display automation; Amiga 500 computer; 3.5" disk, color monitor; interface to VHS transport; mix graphics, taped videos on in-house, CATV systems.
Circle (1243)

ESP Electronic Script Prompting
IBM-based prompter: 14,000 line capacity for six hours non-stop prompting; slaved back-up prompting; search feature, macro keys; laser printer support; rental, sales.
Circle (1245)

Fairlight Instruments
Video Producer: effects, draw, paint features; image input from camera, tape, laserdisc, tuner; operates from pushbutton slide faders, digitizing touch pad.
CVI-LINK Amiga: software places CVI, CVI PLUS under control of an Amiga Computer.
Video Entertainer: digital effects; trails, colorization, pixelation, titling; foot switch for hands-free operation.
CVI PLUS: low cost effects, graphics generator based on CVI Computer Video Instrument; 7-font, 108-brush, 108-texture, 100-title library, large sequence memory; full-screen frame store.
Circle (753)

FOR-A
MF-2000: Multiflex digital image processor; optional dual channel controller; full 2-D effects, many additional features.
VTW-210H: adds b/w titles to HDTV system; RGB interface.
VTG-12H timer: for HDTV system; displays month, day, year, hours, minutes, seconds.
VTW-240 titler: four downloadable fonts can be used on any one page; anti-aliased; 3.5" floppy disk; 1,600 page disk storage.
TG-170 titler: character display generator interfaces through RS-232C for remote control.
Circle (767) See ad page 155

Genigraphics
Imaging system: Masterpiece film recorder; SCODL graphics description language, interface to IBM PC/AT, DEC VAX, PDP-11 computers.
Design Plus Scanner: flatbed input device; imports transparency or print; variable resolution to 300dpi.
PowerPoint graphics: color transparencies,

prints, presentation graphic formats; Genigraphics, Microsoft venture.
Circle (1203)

GML America
X-Calibre II: digital video effects system.
Circle (783)

Grass Valley Group
Graphics option: Kaleidoscope enhancement, allows off-line creation of effects as wire-frame outlines of transformations; 5-channel manipulation simultaneously for complex multiple channel effects.
IPS-100: model 100 switcher; edit controller; AMX-170 audio mixer; complete desk-top production system in 4-VTR configuration; optional Dubner titler board; two carrying cases; E-MEM storage of audio effects.
Circle (788) See ad page 9

Intelligent Light
Rendering software: version 2.1; interactive user interface with mouse, 3-D multiview graphics editor; bump, texture, reflection mapped rendering; field-rate rendering.
Framestore-32: NTSC, PAL full-color frame buffer; based on Truevision VISTA for Apollo Personal Workstations; image capture, display and image output to VTR or film recorder.
Geotrans: translates SDRC I-deas Geomode database solids for animation.
10-series: high-performance rendering computer; parallel multiprocessor architecture capable of 60MIPS performance; for 3-/4-/5-series 3-D animation workstations.
GW-series graphic workstations: 3-D animation equipment.
Circle (1215)

Intelliprompt
Intelliprompter II: MS-DOS and IBM PC, XT, AT, PS/2 compatible; accepts any ASCII text file; on-line context sensitive help files.
Circle (1252)

James L. Grunder & Associates
CEL P164 series: TBC, synchronizer, digital effects systems; meets 8-bit CCIR-601, 4:2:2 requirements.
Circle (793)

JDK Images
Pro Video Plus: character generator software for Commodore Amiga computer; 20 internal fonts; 2,600 pages, 4,096 colors; proportional spacing, kerning; background generations.
Circle (1254)

JVC Professional
IWS Image Work Station: paint system includes 2-D, 3-D rendering, animation; 16.7 million colors; bit-pad, keyboard control.
Circle (833) See ad pages 64A-J

Kavouras
4D Satellite: weather display showing heights, widths, lengths with movement and direction.
Circle (837)

Knox Video
Model K20: high resolution, full-color character generator with keyboard.
Circle (502)

L. Greenburg Electronic Teleprompting
LG series prompters: computer-based; -100 console workstation; -50 Porta-prompter; -300

Why record on Cart Disks?

"Because the audio quality is what I expect from digital. Also, it's practical and affordable for our radio stations."

- Andy Laird

Vice President

Director of Engineering, Radio Group

Heritage Media Corporation

**The CompuSonics DSP 1500:
reproduces, records, edits.**

Circle (109) on Reply Card



CompuSonics

First in audio computers since 1983

2345 Yale St., Palo Alto, CA 94306

415-494-1184

camera package; -400 executive prompter; -25 micro prompter.
Circle (1214)

Laird Telemedia

CG-7000 Y/C: titling generator with integral Y/C encoder.

#1540: electronic paint system; option for 1500 titler; plug-in PC board and software for 35ns resolution; 1506H×483V pixel display of 65 thousand colors in a single graphic.

Circle (849)

Listec Video

A-2009 portable prompter: 9" monitor with collapsible mirror frame, soft draw-string hood; 10 lb system separates to two components for transportation.

Circle (866)

3M/Broadcast-Related

Silver: video work station.

Panther: graphics generator.

Specter: 3-D animation system.

Circle (907)

NEC America

DVE System 10 upgrade: hardware/Version 4.0 software option for range of compression effects providing 3-D simulation; soft key selection menu to manipulate size/line length, offset/skew, non-linear compression.

Circle (926)

[See ad page 137](#)

NETG Tech Graphics

Tech Graphics II: presentation system; 80286 CPU; MS-DOS; 40Mbyte hard disk, 640K RAM; 1024×1024 resolution; Harvard Graphics business software, vector, raster fonts; compatible to ArtStar paint, animation system.

Tech Graphics 386: presentation system based on 80386 CPU; design, software, hardware features of Tech Graphics II.

Circle (1262)

Norpak

TDS3 data delivery module: NABTS asynchronous cyclic encoder; for fixed format information distribution systems; where rapid data update is necessary.

Circle (933)

Numark Electronics

VAM-2000: digital video, audio mixer; perform fades, wipes, strobos, video beat freeze, scene cuts, various audio mixes without TBCs.; interface to external titler.

Circle (1263)

Pan Am Weather Systems

Advantage graphics: IBM compatible CPU, 40-280Mbyte hard disk; 4,096 colors; 32-bit paint, full color frame grab; still store; NTSC encoder; supports Accu-Weather, ESD, WSI, Weather Central; Collins radar interface or RRWDS Dial-Up; 3-D modeling.

Circle (1268)

PESA Electronica

CG-4711: video production character generator/titler system.

Circle (963)

[See ad page 191](#)

Philadelphia Video Lab

Hard copy printer: Commodore Amiga-based system creates slides, prints with 485×1000 line resolution, 16 million colors.

Circle (1270)

Pinnacle Systems

SV-1000: super V-1000 desktop video workstation; cuts-only editing gives look of A/B roll; capacity to 100 stills.

Series 3000 Graphics Workstation: 768 pixel/line accelerated graphics processor and paint system.

PRIZM: z-axis manipulator; curvilinear, rotation, perspective effects.

Circle (968)

Progressive Image Technology

SuperGen: RS-170A video from Amiga computer RGB signals; dissolves between Amiga and external video; key output.

Text-Droid: video information delivery system; IBM PC/compatible base; standard text files, multiple fonts, colors; shadowing; PC PaintPlus Pictor images; optional Cable-Droid controls 4-VTRs for program, commercial insertion.

Circle (1210)

Q-TV

On-Camera II: lightweight, on-camera display prompter unit.

ScriptNet: expandable network of script preparation terminals.

QCP captioning module: add-on for IBM-PC based QCP Mark I computer prompting software; allows concurrent teleprompting and closed captioning functions.

NPI Newsprompter One: 68000 μ P-based prompter; simultaneous scroll, edit, run order management, captioning and communications with newsroom computer; interfaces to four serial devices; text, backgrounds in eight colors.

Circle (977)

QSI Systems

#2048 message crawler: on-air advisories, promos, disclaimers in lower third crawls without tying up production titler.

Circle (976)

Quality Video Supply

PSS-912: video production slate.

VAM-2000D: digital video, audio mixer; by Numark Electronics.

Circle (978)

Quanta

Orion titler: 68000- μ P base; 16-level anti-aliasing, effective 5ns resolution; auto kerning, 256 levels of transparency; 16 million colors; five type faces in 40 on-line fonts.

ARTISTA: full-color paint, 3-D modeling, animation includes key-frame with path and tension; five anti-aliased fonts standard with edging, drop shadow; business graphics; dual frame buffer.

Delta I: anti-aliased, free-form titler; real-time operations; multiple on-line fonts; high-speed rendering, compositing, dual frame buffers; texture mapping, 4.6ns effective resolution; kerning.

QUANTAPAIN 32: 32-bit paint system based on TI 34010 processor; 756×486-pixel resolution NTSC; 16.7 million colors; menu selections from graphics tablet; 14 drawing tools, text mode, grab for images, textures.

Circle (722)

[See ad page 96](#)

Quantel

Cypher Sports: live character generator, multichannel 3-D capability and background still store on an integrated unit; 4:4:4 processing, 256 levels, Multitrack motion control, Autoscure.

Starlight: production models of lighting, shading package for Mirage; six light sources

independently controllable for orientation, intensity, color, style, reflective quality; real-time 3-D illusions.

Encore HUD: Head-Up Design digital effects control; motion and effects parameter in logical on-screen menus; control via trackball, joystick or pen/tablet.

Paintbox ProStyle: improved artist's interface with Paintbox; Pro 4 software with smudge, stamp, smear features; interfacing for Harry or CCIR 601 option.

Harry E-Motion: serial transport control for three VTRs from Harry's pen, tablet, menus; Profile speed control of stretches and dissolves; Chroma Mix for flexibility in keying.

Graphic Paintbox: electronic graphic system creativity combined with print quality output.

Circle (979)

[See ad page 131](#)

R-Scan

LDIS: Lightning Data & Information Systems; graphics display system; supports Advanced Designs, EDS, Kavours systems; data via satellite by Zephyr, Siscorp, Pan Am Weather, WSI, Weatherbank.

Circle (1006)

Rank Cintel

Digital interface: links Gallery 2000 still library with BASYS newsroom automation; accesses ADS-80 digital slide scanner, Art File/Slide-File components and still storage from Winchester or optical disc all in a 4:2:2 environment.

Circle (986)

[See ad page 54](#)

Shima Seiki

Paint system: high resolution with animation, digital effects; options of 3-D polygon system to render wireframes before key frames are designated.

Prototype texture mapping unit: renders at 50,000 polygons/s; ray tracing; input from video or scanner; output video or high resolution thermal printer.

Circle (1206)

Symbolics

4.0 software: S-Render, S-Dynamics, S-Geometry, S-Paint, compositing; 2k×2k pixel resolution; EFT rendering generates 2-D Fourier fractals for effects, textures; unlimited layers of compositing with transparent, translucent objects.

Print Input/Output: send computer images in digital form to electronic prepress system for output as color separations; 9-track data tape system; 2000×2000-pixel resolution.

Real-Time S-Paint: software for use with APROC 110 32-bit array processor; faster paint capability; pressure-sensitive pen similar to painting with air brush.

HDTV graphics: 2-D, 3-D animation, paint capabilities in HDTV format; supports NTSC, PAL, film resolutions; 32-bit frame buffer with alpha channel for mattes.

Circle (1066)

Telescript

Computer prompter: 8-color display, four font sizes including upper, lower case.

Circle (1087)

Time Arts

Graphics equipment: Lumena systems; Targa 8/16/32-bit architecture; Crystal 3-D modeler,

animator; Lumena/DVI with graphics board by David Sarnoff Research Center.

Circle (1297)

Toko America

DRAM frame memories: store moving image

ENTER
THE 4.2.2. WORLD



“LE STUDIO NUMERIQUE”[®] WE DEVELOPED IT FIRST. WE MADE IT FIRST. AND NOW WE DELIVER IT.

Our latest success: “Le studio numérique”[®]. The world’s first fully operational Serial Component Digital switcher. The digital switcher that’s available now.

Digital - for impeccable production quality. Even with multiple generations Thomson is making you an offer you can’t refuse with their Digital switcher “Le studio numérique”[®].

Component Digital - avoid unnecessary coding and decoding; the Component Digital switcher is your only choice.

Serial Component Digital - picture source and other peripheral devices are easily connected. All you need is standard coaxial cable.

The Serial Component Digital Switcher. Get the picture? You will with Thomson - every time.



THE ALL DIGITAL STUDIO

*“LE STUDIO NUMERIQUE” is a registered trade mark of Thomson.

 **THOMSON VIDEO EQUIPEMENT**

Circle (110) on Reply Card

sequences; MP3000 for 525/625 line NTSC, PAL, RGB, YIQ or other inputs; MP5000 1125-line RGB, Y/P_B /P_R; various sampling frequencies.
Circle (1177)

Total Spectrum Manufacturing

FCS-20, FCS-30C: title or color art stands.
Circle (1110) See ad page 31

Wavefront

Ardent Titan: graphics supercomputer; operates at 60MFLOPS/s with Wavefront 3-D Dynamic Imaging System software.

Rendering, recording: software enhancement for increased 3-D animation quality, motion with rendering speeds to 60 frames/s.

Circle (1156)

Weather Connect

WC-1000: turnkey weather graphics work station; pull-down menus, point/click, quick-read icons; based on Motorola 68020 32-bit architecture; maps, camera zoom/pan; integral weather symbols; autoplot frontal boundaries; animated air masses.

Circle (1295)

WeatherBank

WeatherCheck-2: satellite-delivered weather information; full color display from 24" earth station; PC-based, 20Mbyte hard disk storage; user defined menus.

Circle (1157)

WeatherConnect

WC-1000: high resolution TV weather graphics workstation; 68020 μ P; 32-bit data at 14MHz; multitasking for graphics editing, animation while receiving data from meteorological data base.

Circle (1295)

WSI

ASTROdata: weather data service via satellite; PC-based system receives, sorts, stores user-specified weather information; data available instantly for printing or screen viewing.

SOFTfax: option to ASTROfax official National Weather Service facsimile maps, charts.

PREview: preview option to ASTROgraphics, a comprehensive selection of on-air weather graphics.

Circle (1169)

Zenith Electronics

TE-521: EEG Electronics line-21 caption to World Systems teletext transcoder.

MET-2000: Metaphor Developments line-21 caption to World System teletext transcoder.

TV receiver/monitors: various models with World System Teletext decoders.

Circle (1172)

Video Products

V6: Switchers

- Master control
- Video production

A.C.E. (Abekas Cox)

T8 switcher.

Circle (586)

Ampex AVSD

AVC Vista: 18-input production switcher; graphics oriented display; two linear keyers

with full-length independent key switching buses; DSK with optional Spectrakey; ADO interface.

Circle (536)

See ad page 39

Broadcast Video Systems

BB-500C: passive 5x1 component/RGB-sync switcher.

Circle (610)

See ad page 192

BSM Systems

Master control switcher: desk-mounted units; machine control option; 8-, 16-, 24-input two and three bus systems; insert key and DSK options; PAL, NTSC; μ P control.

Circle (613)

Crosspoint Latch

6129AHK: 8-input, post-production switcher; 3-bus; RGB chroma keyer standard; 2-M/E system architecture, shared 32-pattern generator; three colorizers, DSK, auto ramps, 100 4-event sequences; 5-level keying.

6129BHK: 16-input version.

8200C: 6-input, 2-bus switcher; two TBCs with full bandwidth Y-C inputs, outputs, switchable to composite; digital effects, 22-level keying, AFV, breakaway, auto transitions.

Circle (682)

ECHOLab

DV-5: programmable switcher, Archetect II with improved specs, construction and functions.

Circle (725)

FOR-A

CVM-series switchers: component video systems with complete transcoding interfaces; CVM-600 12-input, CVM-1000 16-/24-input with two M/E systems.

PVM-600 enhancements: 12-input production mixer; full-feature switcher with DSK, edge generator.

Circle (767)

See ad page 155

Grass Valley Group

MASTER-21: master control switcher; stand-alone system; control panel, dedicated matrix, interface to routing switcher expands inputs; 16 video/16+4 stereo audio inputs; 4-input accumulative keyer; Transition Status Display with graphics; more.

DPP-1 KADENZA: digital picture processor; integrates effects with mix, wipe, chromakey switcher functions; interfaces to Kaleidoscope effects processor using 10-bit architecture.

MASTER-21: master control switcher; stand-alone system with functional control panel, dedicated matrix; interface to routing switchers for input expansion; 16 video, 20 stereo audio inputs; 4-input accumulative keyer, matte generator.

Model 300 E-DISK II+: optional effects storage for production switchers; 3.5" floppy disk drives; 50 complete switcher E-MEM setups per disk.

Circle (788)

See ad page 9

Intergroup Technologies

Series 9500: production switcher; 12-, 24-input, down-sized from 9600; M4 keying system, Pattern attribute memory system, REFEX reprogrammable effects store, recall; six simultaneous key sources displayed in seven levels of the switcher.

Model 9608S: 9600 accessory; serial control audio follow unit.

REFEX II: 9600 switcher enhancement software; reprogrammable effects.

Model 9629: 9600 series accessory; extended

wipe-pattern generator.

Series 8600: master control switcher.

Circle (821)

International Datacasting

Supreme SFX: multiple level effects generator. Model 694, STRATA-10: video production switchers.

CD-400LE, CD-600LE: production switchers; 16x6 input matrix; SFX extended effects generator; encoded, RGB key options; title select bus; DSK; auto transitions.

Circle (632)

Omicron Video

#507-15: master control switcher; 15-input system.

Circle (943)

Panasonic Industrial

WJ-MX10: digital audio-video mixer; integral frame synchronizer, frame memory; mosaics, adjustable paint, wipe patterns; joystick; 2-input and key camera; optional WV-KB12A titling generator; four audio inputs, metering.

Circle (922) See ad pages 40-1, 43, 80B-C

Prime Image

Component S-Switcher: Y/C, Y/688, composite inputs and outputs; transcoding between video sources.

Circle (1272)

Ross Video

RVS 416: 16-input production switcher; two MLE effects amps, optional rotary/matrix wipes; simultaneous use of 4 keys, 3 backgrounds.

Circle (1004)

See ad page 147

Telmak

PVS-1 video switcher: 3-in, 1-out; by Primebridge Vision.

Circle (1190)

Thomson Video Equipment

TTV 5645: component vision mixer; modular configuration; analog, digital inputs, outputs; provides transition to fully digital studio.

TTV 5650, 5655: component digital vision mixers; serial and parallel digital input/output configurations meet CCIR-601, -656 recommendations; correction, modification of recorded pictures, multiple generations, editing in digital domain.

Circle (1101)

See ad page 167

Toshiba

DSW-4220: digital component video switcher; EL display status panel; 4:2:2 digital in/out, 10-bit internal processing; 10 inputs; outputs in analog composite, analog component and 4:2:2; editor interface available.

Circle (1109)

Videotek

Prodigy: production switcher; multilevel effects, look-ahead preview; 100-event memory; integral stereo AFV; three RS-422 ports for edit controllers or other intelligent devices; eight primary inputs, 24 wipes, hard/soft edges, pattern memory.

Circle (1147)

See ad pages 91, 93

Video Products

V7: Processing

- Compositors, keyers

- Encoders, decoders
- Signal correction
- Standards, format converters
- Sync generators, VBI IDs
- TBCs, synchronizers

Accom

DIE 125: digital image enhancer; removes film grain in film-tape transfers; reduces random noise in video; 4:2:2 component signal conforms to CCIR-601/RP-125; frame-based recursive architecture.

Circle (503)

A.C.E.

204P PAL encoder: RGB, YRGB, Y/R-Y/B-Y inputs; multiformat color bar generator; 525 PAL-M, 625 PAL-N versions available; 6-output; sync timing, subcarrier adjustment.

DV210 encoder, DV220 decoder: RGB or YUV inputs, outputs; 525 or 625 line versions; EBU/SMPTE or Betacam component levels; encoder provides three outputs; decoder has integral pattern generator.

600TC color corrector: enhanced with RS-232 port, enables download of data from RAM to disk storage on IBM/compatible PC; store, recall settings via menu prompts.

Circle (586)

AF Associates

B2022: PAL frame synchronizer; 9-bit 3x3Fc processing; tolerant to asynchronous inputs; two full field picture store; cuts to black on input failure.

Circle (515)

See ad page 103

ALTA Group

Centaurus: dual TBC/switcher with still store and Y/C inputs and outputs.

Pyxis-E: dual TBC/switcher with dual-channel freeze.

Celeris: Y/C-3.58 or Y/C-688 inputs; conversion to composite, Y/C-3.58 or Y/C-688 outputs.

Pictoris: video image compressor; composite, S-VHS inputs, outputs; live backgrounds, color borders/mattes, variable crop, position; programmable presets; GPI control; auto zoom in/out, freeze.

Circle (529)

Ampex AVSD

TBC-7: extended performance TBC includes many features of Zeus processor, variable speed playback, time modification without picture bounce/blur, digital velocity compensation, eliminates picture shift of non-color-framed edits.

Zeus Port: interface links type C VTRs to D-2 composite digital recorder; eliminates additional A/D, D/A conversions; available for all Zeus processors in NTSC, PAL, PAL-M standards.

Circle (536)

See ad page 39

AMX

ATS-550: S-VHS TBC.

Circle (540)

Brabury Porta-Pattern

CMT599: analog-component matrix module; converts between RGB and Y/R-Y/B-Y signals; matrixing accuracy >0.05dB.

Circle (972)

Broadcast Systems Design

BSD 501 TBC: for Y/688, Y/629, S-VHS and NTSC or PAL video; white balance; 58dB S/N; 16.11MHz sampling, 8-bit; ± 8 line correction; luminance to 6.4MHz.

Circle (1236)

Broadcast Video Systems

**204:* Cox NTSC encoder.

MASTERKEY: composite down-stream keyer.

Circle (610)

See ad page 192

BTS Broadcast TV Systems

HCN-5C decoder: comb-filter design; composite to RGB conversion.

HDTV noise reducer: full HDTV component and composite capability.

CD-7, DC-7: encoder, decoder for signal conversion between RGB, Y/P_R /P_B analog components and 4:2:2 digital components; remote control by serial data line.

DNR7 noise reducer: for 4:2:2 digital signals with studio bandwidth; processes composite or analog components through A/D, D/A converters.

CNR7 VTR noise reducer: includes TBC function for 3/4" or VHS VCR with external sync.

HCN-5CF 64A: comb filter decoder, composite signals to RGB.

SMAC D7: A/D, D/A conversion of digital 4:2:2 signals to S-MAC format.

Circle (615)

Corporate Communications

Triton: scene-to-scene computer-controlled color correction system; 6-vector control of hue, saturation, luminance; controls for master video, black, black/white gammas, overall

Replacement Cathode Ray Tubes

New Instant On — Low Power — Dark Glass — Direct Etch All the latest technology to update your equipment — or an exact replacement — **Color or Monochrome.**

Almost every conceivable application. We stock 100,000 tubes 3500 types.

Your window on the world of information & entertainment is your Cathode Ray Tube! We do windows.

Call **1-800-241-5005** or **404-938-2080**



Video Display Corporation

5530 E. Ponce de Leon Ave.
Stone Mountain, GA 30086

phase/saturation.

Circle (679)

Digital Processing Systems

DPS-270: TBC for U-matic, S-VHS VCRs; Y/C, composite in/out; 58dB S/N; 5.5MHz bandwidth; 16-line correction; viewable picture in shuttle, jog modes; remote control possible.

Circle (706)

Faroudja Laboratories

VHP-N, VHP-P: Vertical, horizontal detail processor for SuperNTSC; also available for PAL/SECAM; improves visibility of small detail without overenhancing large outlines.

CTE-K: key signal delay board for SuperNTSC encoder; option creates separate delay path for fourth input signal for color keying; 16-position

key delay switch.

CTE-DP: SuperNTSC detail processor option; improves visibility of small detail in V/H domain with excessive enhancement of large outlines.

CTE-N NTSC encoder: SuperNTSC device; prefilters luminance, chrominance to avoid spectral overlay and artifacts; eliminates cross color, cross luminance.

FTC-N: flesh tone corrector for SuperNTSC system; automatically re-establishes proper skin tone without affecting other colors.

CTE-Y transcoder: option for CTE-N encoder; provides Y/R-Y/B-Y inputs for encoder from Betacam or M-II VCRs.

SuperNTSC CTC transcoder: Betacam, M-II to RGB, RGB to Betacam, M-II; gen-lock sync generator with blanking processor, sync

reinsertion; color correction; proc-amp controls.

SuperNTSC CFD-N: NTSC to RGB comb filter decoder; eliminates ringing and loss of chroma bandwidth; RGB, combed chroma/luminance, color difference, sync outputs from standard NTSC input signal.

Circle (754)

FloriCal Systems

ChroMatte: matte unit; multiple layer mattes without NTSC, PAL encoding; natural edges, shadows, reflections.

CT-600: component transcoder; for Y/C composite, component formats, including Y/C358 S-VHS.

FA-740 enhancement: independent A/B channels on parallel effects/TBC with C channel effects output.

FA-300: digital TBC with Y/C-3.58 S-VHS input/output interfaces and Y/R-Y/B-Y component outputs.

CCS-4360: color corrector system, includes gen-lock, black stretch.

Circle (767)

Fortel

Interpreter: universal interformat transcoder; RGB, Y/R-Y/B-Y, Y/688, Y/629, Y-3.58, NTSC outputs from any component input signal format.

SuperPro 200: multiformat video processor; for 3/4", 1/2" VCR formats; infinite window TBC, frame freeze, interformat transcoding, picture enhancement, dynamic tracking/shuttle processing.

SuperPro: TBC for S-VHS, 3/4" VCRs; 5.5MHz video bandwidth; 4x Fsc sampling; full proc-amp controls.

Circle (769)

Graham-Patten Systems

Model 1237: component video keying system; RGB in, out; optional sync input; key clip, gain; key mix, fade-to-black.

Circle (787)

See ad page 112

Grass Valley Group

**7510 (receive)*: proc-amp cleans up incoming telco or other feeds; adjustments include relay bypass, AGC, chroma level, phase, video gain.

ADC-120: translates CAV to component digital RP-1125 or EBU 3246-E signal.

CV-95N sync generator: color black reference generates all standard pulses and GVG encoded SC; fits CV-20 module.

Model 7510: modular video processing amplifier; gain, phase adjustments possible from remote location; cable EQ; four outputs per module.

DAC-110: CCIR-601 digital to component analog video signal translator; auto selection of 525/625-line operation; outputs switched for RGB, Betacam or M-II formats.

Circle (788)

See ad page 9

James L. Grunder & Associates

YEM ENC-3000: gen-lock color encoder; integral RS-170A color bar generator; meets EBU/NTSC specifications; four encoded outputs.

YEM CVS-950: real-time scan conversion develops NTSC, PAL from computer RGB outputs; 1280x1024-pixel 64kHz scan converted without data omission.

YEM CVS-801: real-time scan converter; handles rates to 38kHz; 704x704 resolution, flicker elimination.

YEM CVS-900: scan converter; 38kHz analog input; 704x704 8-bit pixel resolution; 16.7

TAKE IT ON THE ROAD. SEE WHAT IT WILL DO.



Shok-Stop™ cases are tough. Hit the road with them once, and you'll know exactly what we're talking about.

Built like no other, Shok-Stop cases can take a beating that would turn other cases into so much scrap metal and sawdust. The Shok-Stop's rugged high density polyethylene shell, with its unique ribbed design, absorbs virtually all impact shock. The little remaining vibration reaching the interior is instantly overcome by the high density custom fitted foam. And, your very valuable extremely sensitive broadcast equipment is left totally unharmed.

Shok-Stop cases are water tight, scuff resistant and are the only field repairable cases on the market today. They can be ordered with optional EMI/RFI shielding and pressure release valves.

So, the next time you hit the road for one of those knock-down drag-out sessions, remember to pack it all in the toughest transit cases made.

The Shok-Stop from Thermodyne.

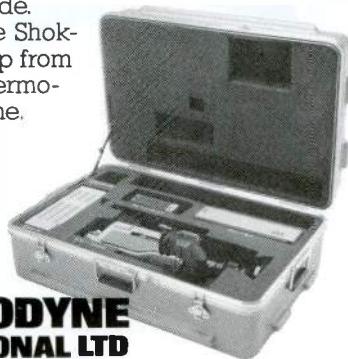

**THERMODYNE
INTERNATIONAL LTD**

20850 Alameda St, Long Beach, CA 90810 (213) 603-1976

Circle (112) on Reply Card

million colors.

Circle (793)

Harris Video Systems

#634: digital noise reduction system with independent chroma, luma noise control to improve picture quality.

Circle (797)

HEDCO

HSG-100: NTSC source sync pulse generator.

Circle (799)

Hotronic

AF71: TBC, frame synchronizer; freeze field, frame feature.

AG81: slow mode TBC with still store; video scratch pad function for loops; two channel; video capture triggered by time code; 128 frame memory for capture, editing, playback in random order.

AF72: 16-bit frame synchronizer; auto matching of digital stereo, mono audio delay; cleans noisy satellite feeds; 2-frame, 4-field freeze.

AE61: TBC, Y/C inputs, outputs.

Circle (806)

Ikegami

ENC-750/DSC-750: digital encoder/decoder; encodes NTSC RGB signals to wideband composite; 12MHz bandwidth for 450TVL vertical, 750TVL horizontal resolution in 525-line non-interlaced output signal.

DSC-1050: digital scan converter; 450TVL vertical, 525TVL horizontal resolution; converts from 525 to 525- or 1,050-line progressive scanning with 4.25 or 30MHz bandwidths, respectively.

Circle (812)

See ad page 97

Intelvideo

Model IV-3: enhanced NTSC color encoder; switchable 3-line anti-alias comb filters; digital color modulation; full image enhancement; reduced interline flicker, cross-luminance, cross-color.

IV2 TR, IV2 RC: transmitter, receiver of FM TV Link Optimizer; dynamic optimization of NTSC color signal to take advantage of STL power, channel bandwidth; increases video power on link; receiver reduces power at transmitter site.

Circle (1253)

J-Lab

Color corrector: for component video signals.
4-channel equalizer: for component system cables to 300 feet; powered from cable.

Circle (830)

JVC Professional

SA-T400U: S-VHS TBC; Y/C 3.58 in/out; composite in/out; Y/R-Y/B-Y output; TBC range 1-frame, 2-field; Y/C delay adjustment.

SA-T300U: TBC for M-II signals; CTCM signal format; composite and Y/R-Y/B-Y component output, component input; 32-line correction; 8-bit sampling at $858 \times F_H$; single rack unit.

Circle (833)

See ad pages 64A-J

Laird Telemedia

1032 Y/C: Y/C to NTSC encoder; R-Y/B-Y axis single-chip encoder circuit; S-VHS compatible.

Circle (849)

Lenco

PGE-843 graphics encoder: combines RS-170A sync generator with RGB input NTSC video encoder.

800-series: sync generators; -813 basic unit; -823 with black burst; -833 with black burst, color

bars; RS-170A, gen-lock.

Starflex 4500: TBC, frame synchronizer module; frame freeze; 8-bit sampling at $4 \times F_{sc}$; for any composite VTR; S/N 55dB; luminance bandwidth to 3MHz.

Circle (861)

Lyon Lamb Video Animation

HRC: high resolution conversion from RS-343 1280x1024 60Hz non-interlaced RGB video to RS-170A NTSC video or low-resolution 525-line RGB without loss of graphic information.

Circle (873)

Marconi Communication Systems

B4002: NTSC comb-filter decoder.

B2022: PAL frame synchronizer; 9-bit $3 \times F_{sc}$ processing; tolerant to asynchronous inputs;

two full field picture store; cuts to black on input failure.

Circle (879)

See ad page 125

Media Management

BSD-130: RGB-NTSC encoder; luminance bandwidth to 15MHz; 800-line horizontal resolution, 480 vertical; includes Y/C, Y/688 and Y/629 outputs with RS-170A NTSC.

Circle (1259)

Merlin Engineering

Progressive Scan Converter: extends ROADMAP system with 1,000-line or 525-line progressive scanning with conversion to reduce motion artifacts in cine angiography.

Circle (893)

Stereo and Mono: A MIXER TO MATCH



Every input on the Studer Revox C279 mixer is a stereo input . . . and a mono input.

Line level stereo, balanced mono and balanced microphone, each with a separate input position. Mix them or match them with all six channels of the C279.

Built to strict Studer Revox standards, the C279 makes no compromises in durability or sonic performance. No "small mixer" short cuts here.

If you're looking for a compact mixer built like the big boards, the compact C279 mixer is tough to match.

Details available from your Studer Revox Professional Products Dealer, or contact Studer Revox America, Inc., 1425 Elm Hill Pike, Nashville, TN 37210. (615) 254-5651.

STUDER REVOX

Circle (113) on Reply Card

Merlin Snell & Wilcox

ME-8500: unidirectional standards converter, digital image processor; for any two standards PAL, SECAM, NTSC; supports M-II, S-VHS, ED-Beta; digital color bar source; framestore, TBC, synchronizer functions.

ME-890: NTSC to PAL-M transcoder; transparent processing through all comb filter design.

ME-8700: triple standard converter digital image processing; NTSC comb filter allows framestore, TBC function; 8-bit multidirectional conversions between NTSC, PAL, SECAM; supports ED-Beta, M-II, S-VHS.

Circle (893)

Microtime

S-134 synchronizer: NTSC or PAL 4-field; eliminates picture shift of 2-field memory; optional video scrambling function.

S-234 TBC/synchronizer: S-134 with integrated TBC; time-shared applications with auto selection mode; NTSC only.

ImagePlus Graphics: paint, 3-D modeling, animation; multiple light sources; RGB frame grab; RS-422 VTR controller; 2,000, 4,000 line film outputs for 35mm, 4x5 transparencies in Matrix QCR/PCR camera.

Tx4 TBC: for S-VHS and other component formats; full-frame memory, field/frame freeze; DOC, proc-amp; key output; variable picture position with 1/4-size image; mosaic tiles, H/V blinds; posterizing, solarizing; pull-push, wipes.

RP-1 3-D effects upgrades: keyframe programmable H/V twists, internal re-entry effects; mosaic tiles, posterization, solarization, solar colors.

Circle (899)

See ad page 153

Midwest Communications

DPS-270: TBC for U-matic, S-VHS VCRs; Y/C, composite in/out; 58dB S/N; 5.5MHz bandwidth; 16-line correction; viewable picture in shuttle, jog modes; remote control possible; from Digital Processing Systems.

Circle (901)

See ad page 1

Nova Systems

NOVA 700S: S-VHS and standard heterodyne TBC processing; 8-bit, 14.3MHz sampling; factory upgrade for current 700 TBCs.

NOVASync: frame synchronizer; full bandwidth with A/B inputs; auto default, video AGC, input switching, black source, color bars, proc-amp; 8-bit 14.3MHz sampling.

NOVA 620S: full-frame TBC, framestore; S-VHS, composite processing in heterodyne and VTR-SC operating modes.

Circle (935)

Oki Electric

LT1250TSC: portable standards converter; NTSC, NTSC-4.43, PAL (SECAM, PAL-M options); TBC, image enhancement, picture freeze, frame synchronizer.

Circle (941)

Panasonic Industrial

TBC-200: TBC with chroma enhancement circuitry.

UTB-1: universal signal transcoder; RGB, Y/R-Y/B-Y, Y-688, Y-629, Y-3.58 input, output.

Circle (922)

See ad pages 40-1, 43, 80B-C

Philips T&M/Pro TV

PM 5638: component color coder unit; integral SPG; jumper selects input component type; output for NTSC, PAL-G/M/N; can operate as slave SPG/encoder.

Circle (965)

Photron

Scan conversion: CAD/CAM to NTSC systems.

Circle (967)

Pinzone Communications

VA-361: video gain, cable equalizer; 5-unit package with two dc-coupled outputs per unit; front panel gain, EQ adjustment.

VA380: auto video equalizer; maintains luminance level, frequency response of video coax cable circuits.

Circle (969)

Prime Image

S-series TBCs: S-video and composite inputs, outputs; systems with, without digital effects.

Circle (1272)

Progressive Image Technology

Video Charley encoder: attaches to EGA display card, synchronizes IBM PC compatible graphics to external video; RGB encoder.

Circle (1210)

QSI Systems

**5700 switchover*: auto video switching to second source or integral color bar pattern; station ID can appear over second source if desired; returns to primary video signal when it is restored.

Model 5500: video processor; full sync regeneration, replacement; black burst on loss of signal; auto bypass on loss of lock; line-by-line process in VBI; proc-amp controls.

Circle (976)

Quality Video Supply

KCP-180: computer RGB to NTSC composite video; by Kramer.

TEL-ENC2: RGB to composite video converter.

TEL-2000: computer video combiner.

Circle (978)

Quantel

Satin 601: direct conversion from 525/60 to 625/50 within the digital domain; RGB/YUV component conversions; external coders, decoders for Laser Frame, Overscan features, integral diagnostics; optional remote panel.

Circle (979)

See ad page 131

Sierra Video Systems

CVCC: component video color corrector; available for RGB, Y/R-Y/B-Y, HDTV; remote controls.

Circle (1028)

Sony Broadcast

BVX-100: digital PAL/NTSC decoder; develops video component signals for Betacam SP, 4:2:2 DVTRs or other component products.

DFX-1200, *DFX-2100*: sample rate converters between 4:2:2 D-1 format and 4x4:4:4 D-2 format.

Circle (1037)

See ad pages 25-7

Sony Still Imaging Systems

SFU-1000: still frame transceiver; data compression with error correction for transmission of color, b/w images over telco lines; for Pro-Mavica line.

Circle (1278)

Technov Industries

CSG-300: RS-170A color sync generator; oven-stabilized crystal, gen-lock, split-field color bars, tone generator, blackburst output, rack-mount.

Circle (1080)

Telmak

Neriki Image Master: gen-lock system allows Commodore Amiga graphics integration into video production; available for PAL, NTSC; supports S-VHS, M-II, Betacam, composite, RGB analog inputs.

Primebridge Vision modules: PVW-1 video wiper 2-in, 1-out; PVK-1 video keyer, 3-in, 1-out, switchable key source; PVM-1 video mixer 2-in, 1-out.

Circle (1190)

Thomson Video Equipment

Serializing/deserializing chip: transformations between 4:2:2 parallel video and 243Mb/s serial signal.

Digital converters: TTV 7650 A/D, TTV7660 D/A; TTV 7655, 7645 serializer, deserializer units; meet CCIR-601, -656.

Circle (1101)

See ad page 167

Toshiba

Motion Stabilizer: image vibration corrector; NTSC composite signals; 4-mode of detection; minimum motion detection 0.06% of field horizontal, 0.05% of field vertical.

MUSE encoder, decoder: high definition transmission system; 4-channel sound; audio encoder, decoder optional.

Circle (1109)

Transimage International

RCU/VU-102: remote control unit; deluxe model including individual audio level controls, master audio fader, fade-to-black, stereo headphone output with level; VU metering, switchable dot-bar mode.

CTS-102: component time sharer module for TS-102 TBC time sharer system; switches 3/4" dub signals; NTSC, PAL/SECAM (CCIR-L, -H); level controls for Y and C signals.

Circle (1112)

Ultimatte

U-300: video-compositing keyer with digital memory; μ P system analyzes, controls matte parameters for best composite image.

Circle (1120)

Video Accessory

Model 200 sync: RS-170A color with gen-lock; black burst, H/V drive, blanking, subcarrier, sync, burst flag outputs; frequency trim, subcarrier phase, H-phase adjustment.

Circle (1138)

See ad page 194

Video Associates Labs

MicroKey Mark 10 modules: Fade smoothly from one segment to another (A/V); RGB module converts input video to analog RGB, combines it with RGB graphics from MicroKey Mark 10; RGB/Fade module, combines the two functions.

MicroKey Mark 10: PAL/NTSC single-slot EGA text, graphics overlay card for PC/AT and compatibles; videodisc control hardware for interactive video.

Circle (1139)

Video International Development

DTC-4500: 4-field standards converter system.

Circle (1144)

Videotek

VDP-8000: frame store, synchronizer for satellite, microwave, ENG, remote signals; composite 8-bit sampling at 14.31818Hz; Freeze Field stores two different fields or one field without interruption of live video operation; 3-line digital comb filter.

VSG-201: color sync generator; integral SMPTE bars, audio tone generator.

Circle (1147) See ad pages 91, 93

Vistek Electronics

V4020, V4030: Varicomb PAL, NTSC encoders, decoders; proprietary comb filter technique to minimize cross-color; available for all NTSC, PAL variations.

V2030 component split screen unit: for RGB/YUV, Y/C or PAL/NTSC signals; A-B inputs with key processor; Key 1 mode for key drive from graphics or other video source; Key 2 mode for self-fill key signal on B input.

V3020-series: component video multiplexer, demultiplexer; for interfacing 4:2:2 digital equipment with existing analog systems; applicable to S-MAC, ACLE (analog component link equipment) microwave, ENG.

Circle (1292)

Vortex Communications

VTR clock: anti-aliased video ID program generator.

Sync generator: high stability SPG; multiple blackburst outputs, multiple test patterns; component or encoded video outputs.

Circle (1151)

VTE Digital Video

4:2:2 interface: one digital video input, two outputs with memory-mapped framestore memory; software drivers available for most graphic workstations; complies with CCIR 601, SMPTE 125.

Circle (1293)

Yamashita Engineering/YEM

CVS-801: real-time scan converter; handles rates

to 38kHz; 704x704 resolution, flicker elimination.

ENC-3000: gen-lock color encoder; integral RS-170A color bar generator; meets EBU/NTSC specifications; four encoded outputs.

CVS-950: real-time scan conversion develops NTSC, PAL from computer RGB outputs; 1280x1024-pixel 64kHz scan converted without data omission.

CVS-900: scan converter; 38kHz analog input; 704x704 8-bit pixel resolution; 16.7 million colors.

Circle (1171)

Video Products

V8: Displays

- Video monitors
- Projection systems

Barco Industries

CVM broadcast monitor: μ P-controlled, auto setup; 100 fL output; high stability, resolution; AKB auto kine bias maintains color temperature with aging and temperature variation; modular, membrane keypad; 14", 20" diagonal CRTs.

Circle (579)

Eidophor/Gretag

Model 5177 multistandard: HDTV color video projector; 3,300 lumen output for 40-foot wide images on regular motion picture screens.

Circle (733)

FOR-A

MV-40C: color multiviewer; one-fourth compression of video signals for four complete images on screen simultaneously.

Circle (767) See ad page 155

Hitachi Denshi

CM-150/210: high performance color monitor; added functions for broadcast with RGB, Y/C separate inputs and S terminal; FS type in-line CRT, comb filter design; 450, 500 TVL resolution, respectively.

HDTV projectors: large screen systems; C110-5000R 110" 4:3 or 5:3, C58-1500R 58", C54-3500R 54" 16:9, 120fL; NTSC composite, RGB, HDTV-1125/60 inputs.

Circle (802) See ad page 3

Hoodman

H1114: universal computer monitor hood, reduces glare.

H789: collapsible sun shades for TVs, monitors.

Circle (1248)

Ikegami

TPP-1000 projector: HiVision system for 1,000 line rear, front screen use; 9" CRTs; 29-65kHz horizontal, 40-100Hz vertical scan rates.

TPP-50HLB: 50" rear-screen video production system; autolock, multisync from 15-34kHz horizontal, 40-80Hz vertical; liquid-cooled CRTs.

TPP-700 projectors: front or rear screen system; multisync, autolock for RGB video or TTL graphics inputs.

Circle (812) See ad page 97

Information Display

Eidophor 5177 multistandard: HDTV color

MUSIC 4[®]

Four-Channel SCA Generator and Receiver

SCA DATA SYSTEMS, INC.
THE LATEST INNOVATIONS FOR
THE SCA INDUSTRY



© Music 4 is a registered trademark of SCA Data Systems, Inc.

The MUSIC 4 system represents the latest technology in SCA audio transmission. Four 5 KHz (or two 10 KHz) channels can be placed on a single 67 or 92 KHz subcarrier.

Superior channel bandwidth and distortion characteristics are achieved using the patented MUSIC 4 ISB subcarrier modulation.

- Superior S/N ratio when compared to conventional FM subcarrier systems.
- Advanced generator design eliminates subcarrier interference with main stereo channel.
- Generator incorporates off-the-air audio and injection monitoring.
- DATA 4 option available.

S.C.A. Data Systems Inc.

3000 Ocean Park Blvd. #3002
Santa Monica, CA 90405
(213) 452-2506 • Fax: (213) 450-5307

Circle (114) on Reply Card

HIGH ENERGY CORP
CERAMIC RF CAPACITORS
CORNELL-DUBILIER
MICA RF CAPACITORS



FL JENNINGS
VACUUM CAPACITORS
VACUUM RELAYS

SURCOM ASSOCIATES, INC.

2215 Faraday Avenue, Suite A
 Carlsbad, California 92008
 TEL (619) 438-4420
 FAX (619) 438-4759

Circle (115) on Reply Card

**IF YOU NEED
 ATTENUATORS
 YOU NEED THIS
 CATALOG!**



**AUDIO AND RF ATTENUATORS
 TO MEET ANY REQUIREMENT**

Here in one compact and informative 24 page booklet is all the data you need to select a Precision Audio and RF Attenuator for your application.

Reference Charts, Circuit Diagrams, Types and Uses, Current and Voltage Ratio Tables, Ratings, Etc., make this a handy and invaluable reference.

SEND FOR YOUR FREE COPY TODAY.

TECH LABS, INC.

Bergen & Edsall Blvds.
 Palisades Park, N.J. 07650
 Tel.: (201) 944-2221

Circle (116) on Reply Card

video projector; 3,300 lumen output for 40-foot wide images on regular motion picture screens.
Circle (818)

Leitch Video

DTD-5230: digital time display; μ P-based units accept SMPTE/EBU time code; 4-digit, 7-segment displays of time of day; 12 or 24 hour format; 4" high characters.
Circle (859) [See ad on Inside Back Cover](#)

Listec Video

A-2015: on-camera prompter monitor.
A-5500 Scroll Box: prompter accepts ASCII text files, serial or parallel; creates prompting text output; battery driven.
A-5000: computer prompting display.
Circle (866)

Mitsubishi Electric

VS1200, -2020: video/RGB projection systems; 675-lumen output from composite, RGB analog, S-VHS inputs; 1000-line resolution from RGB inputs.
AM-3501R: 35" diagonal autoscanner color video monitor; auto variable scanning from 15-35kHz; VCR in/out, RGB TTL/analog, monochrome TTL video inputs; three audio inputs; 33-function remote control keypad.
CP-100U copy processor: autoscanner color video product produces 640-dot \times 614-line print from any source with 64-color gradation; integral character generation; on-screen menu operation; selectable frame, field.
P-61U, -65U, -71U: monochrome video printers; high resolution hardcopy prints with autoscanner from various video sources.
Circle (1261)

Nytone Electronics

Pan/Zoom: with roll, tilt, invert; computer controlled; programmable, all-electronic option available for VSS-1, VSS-2.
VSS-1: sequential color slide scanner; with tray, test slides, mounting rails, extender card.
VSS-2: random access color slide scanner, with microprocessor slide control, digital remote control box RA-2, tray, test slides, mounting hardware, extender card.
Circle (938)

Panasonic Industrial

PT-105 Datamaster: S-VHS compatible video data projection system; 550 peak lumens, 650 TVL resolution with video, 1,100-line resolution RGB; floor or ceiling versions; auto scan for RGB, TTL RGB, NTSC, NTSC-4.43, PAL, SECAM; integral audio system.
BT-D1910Y/-M1310Y: Pro series S-VHS monitors; 19", 13" diagonal with optional Y/R-Y/B-Y input modules; 550-line resolution; blue-gun test, pulse-cross, underscan; line/VTR input selector.
WJ-450 Digital Quad system: displays four pictures on one monitor; for the editing suite or other multiple signal monitoring requirements; individual or quad mode selectable.
Circle (922) [See ad pages 40-1, 43, 80B-C](#)

Sharp Electronics

GZ-P21 video printer: color system compatible with S-VHS signals; 64-step color gradation; 600H \times 480V dot format; disposable yellow, magenta, cyan developing paper; also for NTSC, RGB inputs.
QA-50: LCD computer projection panel; portable; used with overhead display projects data from computer terminal onto screen.
Circle (1024)

Sony Broadcast

BVM-1912: 19" video monitor; super high resolution CRT, automatic setup; auto convergence, geometry correction.
Circle (1037) [See ad pages 25-7](#)

Telex Communications

MagnaByte 5220-I: electronic imager with color display.
Circle (1090)

Toshiba

32HD01: 32" high definition color monitor; 1,125/60 system; optional mode for operation on non-interlaced NTSC signals.
TPJ-110HD: HiVision projection system; 1,000TVL resolution minimum at center; frontal projection; 230 peak lumen minimum.
Circle (1109)

Triuniplex Display Systems

Model 536: infinitely variable, single lens projection system; three 5" CRTs with liquid lens image combiner; 800 lumen peak white (NTSC); 1500-line resolution; 30MHz RGB video amplifiers.
Circle (1287)

Videotek

AVM-19S: 19" professional color monitor; integral audio system.
Circle (1147) [See ad pages 91, 93](#)

Vistek Electronics

GM7200 series: grade 2 color monitors; RGB and encoded inputs; multistandard decoder option; EBU phosphor available; blue only, cross pulse, over/underscan; split screen; 6.5", 10" screen sizes.
GM7100 series: grade 1 color monitors; RGB, encoded inputs; 525/60, 625/50 systems; normal/overscan; 14", 20" diagonal CRTs.
Circle (1292)

Visulux/Visual Information

LASAR 1000: large screen, high definition projection system; laser light sources in RGB wavelengths.
Circle (1294)

||:~::~)))))

**Want To Talk
 Broadcasting?**

GO **BPFORUM**
 ON COMPUSERVE

John Hoffman
 Net Administrator
 76703, 1036



Many companies sported new booth designs. The return to Las Vegas provided a good opportunity to change things around.

Continued from page 24

ing the Hilton Center exhibit area (an increase over last year of about 18%). Attendance figures broke all records at more than 46,000. Attendees included scores of distinguished guests, including 41 members of Congress, three FCC commissioners and the following luminaries:

- President Reagan.
- Entertainers Lucille Ball, Milton Berle, Rich Little, Roy Acuff, Frankie Valli & the Four Seasons and the Four Tops.
- FCC chairman, Dennis Patrick.
- Former FCC chairman Mark Fowler.
- NBC News president, Lawrence Grossman.
- The "McLaughlin Group."

All aboard the HDTV express

The award for the greatest amount of talk on a single topic at this year's NAB goes to high-definition television. No surprises there. Everybody went to Las Vegas expecting HDTV to grab the headlines, and it did.

A special section of the convention center was set aside for demonstrations concerning high definition. Much of the equipment on display operated on the NHK 1125/60 HDTV system. However, a number of different systems were shown that could be used to transmit *studio quality* HDTV to consumers, at varying degrees of degradation and compatibility. The HDTV demonstration area was the largest and most ambitious undertaking of this type at any NAB. In all, 33 companies provided hardware for the exhibit, and eight others supplied programming.

At present, four different types of "high definition" video signals are being discussed:

- **Advanced television (ATV):** This broad term covers just about anything better than what is on the market today. A wide range of improvements has been proposed. Probably the best known is ACTV (advanced compatible television), developed for NBC by the SRI Sarnoff Research Center.
- **Improved-definition television (IDTV or improved NTSC):** These terms refer to



The outdoor exhibit area was located between the convention center and the Hilton Center, providing easy access to the satellite trucks and other displays.

changes to the current system that would not make existing receivers and other equipment obsolete. They are sometimes called *compatible improvements*.

- **Enhanced-definition television (EDTV):** A classification for improvements that are not compatible with today's receivers, although some elements of the basic system are retained.

- **High-definition television (HDTV):** This is probably the most precise of these terms. It means, among other things, a TV system with more than twice the resolution of NTSC and a wider picture with 1,125 scanning lines.

The purpose of the NAB's demonstration room was to give attendees a closer look at the advanced TV systems available today, as well as those currently under development. There were three demonstration areas in the room:

- production and post-production equipment.
- broadcast transmission systems.
- home viewing equipment.

The production and post-production demonstration area was properly called "high definition." The 1125/60 systems on display were designed to produce programs with a technical quality equal to that of 35mm film. Some of the equipment was on loan from production companies doing just that, such as Rebo High Definition Studio and 1125 Productions.

Generating the greatest interest, however, were the broadcast transmission demonstrations. There was no shortage of systems on display, and each offered something different. Participants included:

- The Compatible Video Consortium (Marina Del Rey, CA).
- Faroudja Laboratories (Sunnyvale, CA).
- NBC/RCA/Sarnoff Research Center (New York).
- NHK (Japan Broadcasting Corporation).
- New York Institute of Technology (Dania, FL).

A pointed attack on noise.



SONEX

SONEX acoustic foam wages a two-front war on noise.

First, the patented SONEX wedge traps, deflects, and scatters noise. The wedge's depth and angle carry noise waves down into the lowest point of each anechoic foam valley. Most of it doesn't have the energy to come back up.

Then the foam itself converts sound energy to silent kinetic energy. Sound literally gets lost within the open cell pores of this special foam. What the wedge doesn't dissipate, the acoustic foam converts to silence. Together this two-pronged attack kills background noise every time. Call or write us for all the facts and prices.

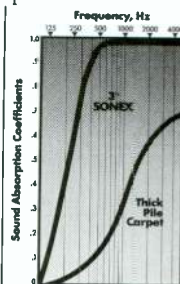

According to testing performed in strict accordance with ASTM C423-77 procedures, at 500 Hz 3" SONEX has a weighted noise reduction coefficient (NRC) of almost 0.98, while thick carpeting is 0.15.

Alpha Audio Acoustics

2049 West Broad Street
Richmond, Virginia 23220 USA (804) 358-3852
Telex: 489037 (ALPHAUD C) FAX: (804) 358-9496
Acoustic Products for the Audio Industry



SONEX is manufactured by Illbruck and distributed exclusively to the pro sound industry by Alpha Audio.

Circle (117) on Reply Card

The peacock shows off

Clearly, the transmission system that made the biggest waves at NAB was the David Sarnoff Research Center (DSRC) advanced compatible TV system, developed in association with NBC and RCA. Much of the interest centered on a new twist announced at the show: ACTV-II, a system designed to let broadcasters have their high-definition cake and eat it later.

ACTV in its current form has been discussed and demonstrated previously. However, the new system takes the NTSC-com-

patible ACTV signal and provides an *augmentation channel* that, when combined at the consumer receiver, delivers what was described as "studio-quality HDTV."

The 2-phase system allows broadcasters and consumers to enjoy the benefits of improved-definition television, with a wide aspect ratio by using ACTV, and later upgrade to higher-resolution pictures when, and if, the FCC grants additional spectrum to TV broadcasters. (Enter ACTV-II.)

The new system was unveiled at a joint news conference featuring the technical

managers of DSRC, NBC-TV and Thomson Consumer Electronics. This impressive show of force left little doubt that ACTV would be transmitted before too long, and that TV sets would be available for purchase by consumers to receive those improved pictures.

Michael Sherlock, president, Operations and Technical Services, NBC, told those at the news conference that "advanced compatible television can now provide broadcasters, as well as cable operators, with both short-term and long-term strategies

Silence is Golden and less work with telcom c4 for RADIO and TV.

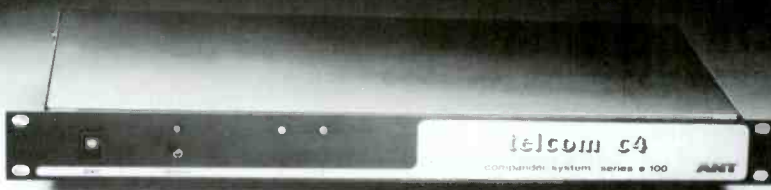

The NR system you just set and forget.

- A product of ANT Telecommunications, Inc.
- No overshooting.
- No pre or post echo.
- Applications:
 - Cartridge machines
 - STL
 - RPU
 - Reel-to-reels
 - Cassettes
- No wasting time with lining up — not even for tape exchanges.
- Up to 118dB dynamic range — the widest dynamic range available in any noise reduction system today.
- Over 15,000 channels in use worldwide.
- No breathing or pumping.

telcom c4
Silence by Design

Distributed by:

RAM BROADCAST SYSTEMS INC.

346 W. Colfax Street, Palatine, IL. 60067

New York (516) 832-8080

Chicago (312) 358-3330

Tennessee (615) 689-3030

Circle (153) on Reply Card

The connectivity theme was, in this observer's opinion, the big news of NAB '88.

to enable them to maintain their competitive postures in the television/broadcasting business."

The ACTV specifications look like this:

- 1,050 lines per frame, 29.97fps.
- Aspect ratio of 5:3 (or 16:9).
- Luminance resolution—ACTV-I: 410 horizontal, 480 vertical; ACTV-II: 650 horizontal, 800 vertical.
- Chrominance resolution—ACTV-I: horizontal, same as NTSC; ACTV-II: horizontal, double NTSC.

Key benefits of ACTV-I and -II are that the 2-phase system provides for a gradual introduction of improved video for consumers, allows consumers to continue use of their old TV sets until they decide to purchase a new ACTV receiver, and includes provisions for upgrading in the future if additional spectrum becomes available.

View from the couch

A key element in any discussion of services aimed for the consumer is the receiver: Is it technically practical to build such a box, and can it be made affordable to the viewer? Dr. Joseph Donahue, the vice president and senior scientist for Thomson Consumer Electronics, representing the RCA and GE brands of consumer electronics, told reporters at the NAB that ACTV receivers would meet both requirements. According to Donahue, prototypes already are being built at the Thomson facility in Indianapolis.

Donahue, who worked on the development of color picture tubes for the original NTSC system, urged that an industry consensus be formed to provide for an orderly implementation of high-definition technology. He said that the absence of industry agreement on a common direction "will result in the expenditure of large

sums of money, along with wasted technological resources and valuable time, with the prospect of the U.S. market falling behind the rest of the world in offering the public advanced TV features and performance. . . . We really cannot wait for the consumer or the marketplace to decide an issue that requires active participation now by all broadcasters and cable operators, as well as TV receiver manufacturers."

Citing the example of stereo television, which has been established quickly as an important feature in both the broadcast and home receiver industry, Donahue told reporters, "Once broadcasters, TV set manufacturers and others pursued one specific direction, this enhanced service reached the public in relatively short order. In contrast, AM stereo radio is still a developing service with a variety of technical approaches under active consideration."

He warned that failure to reach an industry consensus on transmitting high-definition signals could place over-the-air broadcasters in a precarious position. "In our industry's 42-year history, a common thread of success has been consistency in the technology that we have offered to the public," he said. "When there was conflict in the type of systems that were offered,



Jules Cohen (right) receives the NAB Engineering Achievement Award from NAB vice president, Michael Rau (center). The award is the association's highest honor for technical achievement.

the public invariably backed away from making a choice."

Donahue added that the consumer's appetite for new technology is significant, but not unlimited. "Consumers, in our opinion, will tolerate change, but only on a gradual, evolving basis that allows them to decide when they want to upgrade their TV receivers to new technology."

Equipment demonstrations of the Sarnoff ACTV system, held continuously during the show, were in meeting rooms at the Riviera Hotel a few blocks away.

Don't give up on NTSC

The Faroudja Laboratories demonstration of improved-quality NTSC drew a steady flow of interested attendees. Yves Faroudja, the champion of improved NTSC, demonstrated further enhancements that promised to breathe new life into the veteran format.

Known as SuperNTSC, the Faroudja system is fully compatible with current-generation NTSC receivers. To fully take advantage of the resolution possible with SuperNTSC requires a line-doubling receiver. Such receivers are expected to reach the consumer market within a year.

MUSE and its brothers

The MUSE (multiple sub-Nyquist sampling and encoding) system has been discussed often as a means to transmit HDTV signals to consumer receivers. MUSE, in its original form, is a bandwidth-compression system developed by NHK for satellite broadcast of HDTV and for consumer disc and tape equipment. It is a sophisticated system that reduces the bandwidth required for HDTV from more than 20MHz to 8.1MHz. The latter, however, is still twice the video bandwidth of NTSC. MUSE also includes up to four channels of digital audio.

Several variations of MUSE have been

ANY FORMAT, ANY BUDGET, ANY SYSTEM



COMPONENT



CONVENTIONAL



PARADE/OVERLAY

Beginning a New Chapter

If you are beginning to integrate component equipment into your system, you're probably looking for ways to hold down the cost. Sigma offers a smart way to do this.

The SVM-100 lets you use your conventional W.F.M. to display both component and composite video signals. It is easy to use, easy to install and easy to afford!

To get started . . . Specify Sigma



SIGMA ELECTRONICS INC.
1184 Enterprise Road, P.O. Box 448
East Petersburg, PA 17520-0448
Telephone (717) 569-2681 FAX (717) 569-4056

IMPROVE YOUR FM SIGNAL

Last year, the F.C.C. created new rules which provide a practical means for many FM Broadcasters to dramatically improve their signals.

Now, OMEGA INTERNATIONAL has developed a system which allows you to take full advantage of these new rules. If your FM station suffers from multi-path, terrain shielding or other coverage problems within your licensed contours, we can help.

OMEGA INTERNATIONAL's unique solution is a proprietary FM Synchronous Repeater system. It's new, it's flexible, it's sensible, and it works.

We don't have to tell you that improving your coverage will probably bring new listeners and new sponsors. But, we should tell you that OMEGA's complete solutions probably cost less than you think. Let's talk about it. Call or write for all the details.

Call the Original... Call the Leader in Systems Engineering.



OMEGA INTERNATIONAL

2691 Richter, Suite 116

Irvine, CA 92714 USA

(714) 553-0564 Telex: 678641 CORP HQ

Circle (120) on Reply Card

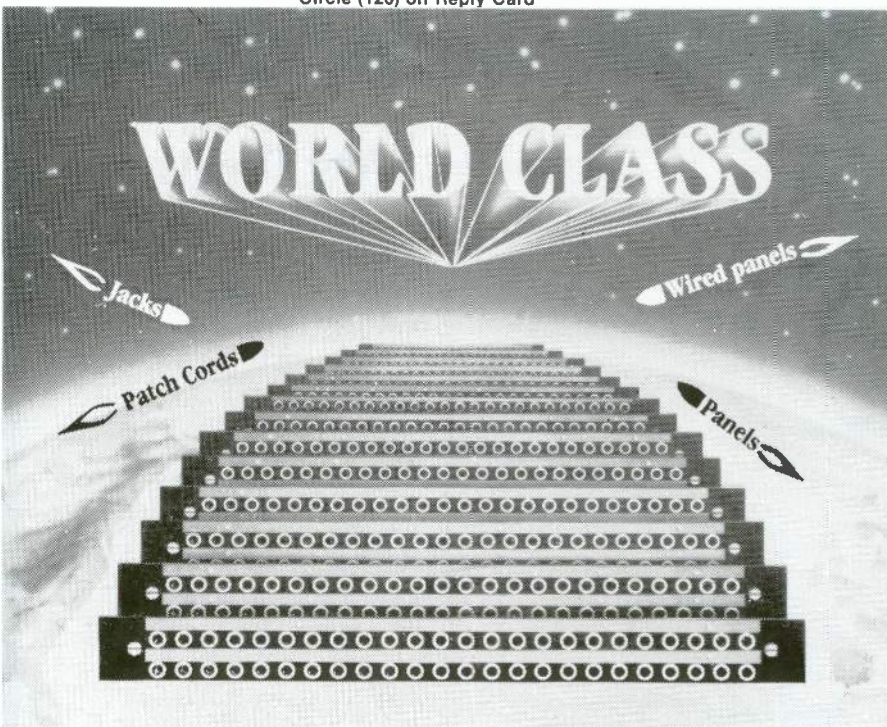

Call or write for information on these and other Audio-Line products.

audio accessories
audio line

AUDIO ACCESSORIES, INC., MILL STREET, MARLOW, NH 03456 (603)446-3335

Circle (121) on Reply Card

proposed and demonstrated. Broadcast tests of the MUSE system were carried out in Washington, DC, last January employing two UHF-TV channels, demonstrating the viability of the system for use in terrestrial HDTV broadcasting. The tests showed that the use of two contiguous channels offers the best quality for terrestrial broadcasting.

Because of the obvious spectrum allocation problems that implementation of

My vote for the star product of the show was the D-2 format recorder.

MUSE would involve, the NAB and the Association of Maximum Service Telecasters (AMST) asked NHK to consider a terrestrial system that is compatible with the NTSC system and can operate on one, or one and a half, conventional channels. Several such systems were demonstrated in Las Vegas at the special HDTV exhibit area. Systems on display included:

- **Narrow-MUSE:** A system compatible with NTSC only insofar as the 6MHz bandwidth is concerned. Narrow-MUSE offers a significant improvement in picture quality because there are no restrictions on compatibility with the NTSC system. Compatibility with an NTSC receiver can be achieved using a low-cost downconverter. The narrow-MUSE system offers transmission of digital audio.

- **NTSC/MUSE-9:** A dual-channel approach incorporating one channel that is compatible with current NTSC receivers.

Personal computers were integrated into almost every corner of video, audio and RF systems.

A 3MHz augmentation channel can be used for improving both static and moving resolution for the top-bottom mask method, and for expanding the aspect ratio for the side-picture method. The NTSC/MUSE-9 system gives twice the static resolution of NTSC.

For best performance, the augmentation channel should be contiguous with the main channel. Use of non-contiguous

channels decreases picture-quality improvement because of differences in propagation and receiver characteristics. Transmission of digital sound is provided on the augmentation channel.

- **NTSC/MUSE-6:** A system compatible with the NTSC system, occupying 6MHz bandwidth. Limited picture-quality improvement is realized. The NTSC/MUSE-6 system provides one and a half to two times the resolution of a conventional NTSC system with the top-bottom mask method, and two times the improvement

ACTV-II is designed to let broadcasters have their high-definition cake, and eat it later.

with the side-picture method. The higher-resolution systems tend to introduce more impairment on NTSC receivers, resulting in lower compatibility.

To add to all the talk about HDTV at the convention, the NAB organized a post-convention meeting of representatives of 13 of the 36 countries using the NTSC system to discuss advanced TV issues. The group reached consensus on the following points:

- There is a growing interest on the part of broadcasters and consumers regarding advanced-definition television.
- An international HDTV studio production standard is desirable because it would provide for easier program exchange among countries and lower the cost of program production equipment.
- It is essential that whatever advanced TV system finally is adopted be implemented in an orderly and economical way to offer the viewing public the highest-quality television as quickly as possible.

Like it or not, we all need to keep a close eye on what's going on in consumerland.

But wait, there's more

A couple of weeks after the convention, Philips Laboratories demonstrated to the press what was described as an "early implementation of NTSC-compatible HDTV for North America. The system, called HDS-NA (high-definition system for North



GLOBAL SUPPORT FOR GLOBAL COMMUNICATIONS

C-Band and Ku-Band High Power TWT Amplifier Systems

For Video, Voice
and Digital
Communications
50-3000 Watt



To meet expanding needs of the video, voice and data markets, MCL offers a host of C-Band and Ku-Band High Power TWT Amplifier Systems, 50-3000 Watt, with flexibility in configuration and consistently reliable power output. MCL is dedicated to manufacturing amplifiers of the highest quality, yet at competitive prices. The amplifiers are recognized and accepted worldwide for incomparable performance. They are designed to withstand interference from EMI-radiation/RFI-susceptibility, electrical (power source), mechanical stress, environment (temperature/humidity), or general maintenance and transportation.

MCL's C-Band and Ku-Band High Power TWT Amplifier Systems are designed with state-of-the-art engineering concepts, and options are available for customized applications. The C-Band units (5.850-6.425 GHz) operate at 50-3000 Watt power levels; and the Ku-Band units (14.0-14.5 GHz) operate at 50-2500 Watt power levels.

MCL is a primary source of amplifiers and allied equipment for satellite communications worldwide. Commonality in operation, design, and mechanical layout of all MCL equipment provides for interchangeability and keeps maintenance and repair time at a minimum, performance at a maximum.

Write for your FREE copy of MCL's New Brochure #6008 for additional details and technical specifications on the complete line of MCL High Power TWT Amplifier Systems.



MCL, INC.
501 S. Woodcreek Road
Bolingbrook, IL 60439
312-759-9500 TWX 910-683-1899

Manufacturers of TWT and Klystron Amplifiers for Satellite Communications.
24-Hour Sales and Technical Support for Immediate Service Worldwide.

You can measure... with the best monitor and the most accurate test set.

The FMM-2/FMS-2 series monitors provide an even greater degree of precision measurement than ever before... **You can measure S/N below 90 dB, You can measure crosstalk below 85 dB, You can measure separations of better than 70 dB, You can measure frequency response to better than 0.25 dB, You can measure distortions to lower than 0.01%, and much more...** Our uncluttered panels and autoranging voltmeters make these measurements a dream.

BELAR CALL ARNO MEYER (215) 687-5550
ELECTRONICS LABORATORY, INC.
 LANCASTER AVENUE AT DORSET, DEVON, PENNSYLVANIA 19333
 Call or write for more information on Belar AM, FM, Stereo, SCA and TV monitors.

Circle (123) on Reply Card

Slap it in the rack and forget about it!



But your accountant won't. Because the **BIC Model 1000 SCA Generator** is designed and built to be worry free with a low, low price. And **simultaneous dual channels**. Call today for specifications and information 303/641-5503.

BIC

BROADCAST TECHNOLOGY OF COLORADO
 322 EAST DENVER AVENUE • P.O. BOX 13105
 GUNNISON, COLORADO 81230 • 303/641-5503

Circle (124) on Reply Card

FREE 44pg Catalog & 80 Audio/Video Applic.

PHONO, MIC, TRANS. ACN, TAPE, VIDEO, LINE OSC. / PRESS BOXES

1-in 18-out Video Audio
 2-in 18-out Audio
 2-in 24-out Audio
 4-in 1-out Mixer

Stereo Mono Pwr Ampl. Video & Audio Dist. Amps. RGB-Sync Dist. Amps. Routing Switchers

OPAMP LABS INC (213) 934-3566
 1033 N Sycamore Av LOS ANGELES CA, 90038

Circle (125) on Reply Card

PRECISION MAGNETIC TEST TAPES

STL

Standard Tape Laboratory, Inc.
 26120 Eden Landing Road #5, Hayward, CA 94545
 (415) 786-3546

Circle (126) on Reply Card

Want more information on advertised products? Use the Reader Service Card.

America), is designed to be equal in quality to HDTV systems currently being proposed. Philips says the system will be usable on an equal basis by terrestrial broadcast, cable TV and direct broadcast satellite delivery systems.

The HDS-NA system consists of two signals. One is a satellite feeder signal, called HDMAC-60, designed to relay program material to terrestrial broadcast stations and CATV head-ends, and for transmission of DBS programming to consumers. The second transmission format, HDNTSC, is a signal suitable for terrestrial delivery (broadcast or CATV). HDNTSC uses a 2-channel scheme in which normal NTSC occupies the first (standard) TV channel. An augmentation signal of about 3MHz bandwidth provides the additional information needed to implement HDTV reception.

HDMAC-60 is designed to be "NTSC-friendly" in that the parameters of the relay signal permit easy transcoding to NTSC and HDNTSC.

Transmission of HDTV signals is only one component of the improved viewing picture for consumers. Unveiled at the same Philips news conference was a new digital improved-definition (IDTV) receiver, fully compatible with NTSC. The IDTV system, developed by the Philips Consumer Electronics division, based in Knoxville, TN, provides significant picture improvement through the use of non-interlace scanning, field memory-based noise reduction and field comb filtering.

The company described its IDTV receiver as "the first giant step available today toward the evolution of high-definition television using the existing NTSC system." Through non-interlaced scanning, the IDTV system doubles the number of scan lines from the standard 262.5 per field to 525 per field. As a result, an apparent improvement in vertical resolution of 40% is realized. Also, two viewer-selectable levels of digital noise reduction provide up to 10dB-12dB reduction in extraneous video noise for sharper picture reproduction.

Developments such as this receiver clearly show a significant movement toward maximizing NTSC in its present form. What broadcasters transmit is, of course, only half of the equation in delivery of programming to consumers. The receiving equipment is just as important as the studio and transmission gear.

Like it or not, we all need to keep a close eye on what's going on in consumerland.

Format fever

We've heard for a couple of years now that the D-2 digital composite videotape format was on the way. It was heralded as the upcoming replacement for 1-inch. Well, we in the magazine business hear a lot of things. Not all of them come to

Continued on page 184

News

Continued from page 4

transmission.

ARD and ZDF are likely to be followed by several other public networks dissatisfied with the direction of HDTV research in Europe.

Private TV approved in Spain

After making several modifications, Spain's Senate finally approved a change in the country's law regarding private ownership of public broadcasting stations. Private groups can now acquire up to 25% of any public broadcasting station. Previously, only a 15% ownership was possible. The push for change came from Spain's newspaper publishers, who were looking for ways to expand in the electronic media.

Spanish TV transmitted via London

Spain's first private TV station, Canal 10, is being transmitted from London via Intelsat VA. Canal 10 is owned by a Spanish film production company and the French TV station Canal plus. Both Canal 10 and Canal plus are pay TV operations. Spain holds a great deal of potential for satellite broadcasting, with few cable networks and a rapidly growing number of private satellite receivers. New terrestrial frequencies, however, are not expected to go into effect until next year.

English-language cable attracts more viewers

English-language cable station Super Channel is received by 10 million European households. When it was launched more than a year ago, the count stood at 6.5 million cabled households in 15 countries. The Netherlands makes up a third of the total, and more than 40% of potential Super Channel viewers live in Germany, Austria and Switzerland.

No new private TV stations for Austria

The Austrian Broadcasting Corporation (ORF) and the Association of Austrian Newspaper Publishers (VOZ) agreed to no new private TV stations in Austria for the foreseeable future. The publishers can, however, participate in local radio.

| : ? =)))))

We come in like this.



We go out like this.



That's what the Electro-Voice unconditional warranty means to us broadcast microphones.

It's tough being a broadcast microphone. You get dropped, smacked into walls, rain-soaked, sunbaked, bumped by gesturing hands, and flung unceremoniously into equipment cases. Bruises, scrapes, and contusions are all in the day's work.

The EV Warranty: New life for broken microphones:

Those of us who are Electro-Voice broadcast mics can at least look forward to some T.L.C. applied by the skilled hands of EV service experts – at no cost whatever, if we're less than two years old.

And, whatever our age, EV mics are protected against acoustic system malfunctions due to workmanship or material defects – with a few qualifications, of course.

But what if you're **not** an Electro-Voice microphone? Well, tough, pal. And better luck in your next recycling.

The incomparable EV loan-for-trial policy

Another great thing about being an EV broadcast microphone: we get frequent auditions for new, challenging roles. Any qualified user or buyer of professional microphones can take us out – from an EV professional dealer – to see how we perform. Without charge or obligation.

Is it any wonder we Electro-Voice broadcast mics are so popular? We give you peace of mind, backed by the industry's strongest warranty. Plus risk-free trial. Can you blame us for feeling a bit, ah, superior?



EV Electro-Voice®
a MARK IV company

BROADCAST/PRODUCTION MICROPHONES
Quality-made in the U.S.A. since 1927

Circle (149) on Reply Card

June 1988 *Broadcast Engineering* 181

New version of database program released

By Bob Van Buhler

Version 2.8 of the National Frequency Coordination Council-approved database program for BAS/CARS record keeping has been released. According to Gerry Dalton, the editor of the program, the software has been tested extensively for use with most DOS clones. The new version should operate successfully on any computer that runs common MS-DOS benchmark programs.

The computer system must provide a minimum of 640kbytes RAM (400kbytes of RAM available after loading memory-resident programs). Another hardware requirement is two floppy drives. Because the program speed is limited by floppy drives, a hard disk is recommended.

Printers used for the coordination software should be capable of printing 132 columns, either by accepting 14-inch-wide paper or by compressing type. The software disk supplied includes a list of printers that can accept the proper form feed commands used by the NFCC software.

Color monitors are supported by the software, and a color specification file is supplied on the disk to determine and record the selected options. New version features include color monitor setup menu, distance and bearing calculations, acceptance of coordinates in seconds and a sort procedure to list by frequency. Version 2.8 also provides additional data security.

An EDIT bug in V2.70 was repaired, and the software is now OPUS-compatible. More printout format choices are available in this version than in past ones, and the data exchange between floppies is improved.

The NFCC and the SBE originally intended to make the software dBase III Plus-compatible. Unfortunately, the specialized program functions needed would require unacceptable compromises in processing speed.

Any software problems or questions should be directed to: Gerry Dalton, engineering manager, KKDA Radio, P.O. Box 530860, Grand Prairie, TX 75053.

Dalton also can be reached by MCI Mail

Van Buhler is chief engineer for WBAL-AM and WYYY-FM, Baltimore.



(GDALTON), CompuServe Easyplex (75026, 1055) or at 214-647-0670. Requests for copies of the software should be directed to the SBE national office, Suite 216, 7002 Graham Road, Indianapolis 46220. These requests will be forwarded to Richard Rudman, current national frequency coordinator. The software also is available by downloading from the Broadcast Professionals Forum (BPFORUM) on CompuServe. Look for the latest version.

Lost grandfathers

The national office has discovered that a small number of engineers who applied for certification through the original grandfathering provisions in 1976 may have been inadvertently denied proper consideration. The certification committee wants to correct this unintentional omission.

If you applied for grandfathered certification before Dec. 31, 1976, and your application was not acknowledged, you may be part of the group that was omitted. If you have retained your documentation, such as a dated copy of your application, please forward it to the certification committee in Indianapolis for reconsideration.

Certification news

Cayuga Community College in Auburn, NY, has become officially accredited. On behalf of the national certification committee, John Soergel of Chapter 22, Syracuse, presented the accreditation certificate to Dr. Lawrence Poole, Cayuga president, at a meeting in February. Hugh Cleland, a former member of the national board of directors, joined in the presentation. A member of Chapter 22, Cleland is a telecommunications lecturer at Cayuga.

Cayuga's 2-year radio and TV technology graduates now are automatically certified as broadcast technologists. The Cayuga Community College telecommunications program is 15 years old, and the school is the first 2-year institution in New York state to receive the accreditation.

More scholarship awards

The Harold E. Ennes Educational Foundation has awarded two more Alpha Ep-

silon Rho scholarships for 1988. Gregory Glenn, a junior at Ohio University, Athens, OH, will receive \$1,000 to continue his work toward a Bachelor of Science degree. Glenn is a student engineer at WOUB-TV and has worked with remote news crews at KYW-TV, Philadelphia. He holds amateur call sign KH2KWTW.

Paul A. Meyer, a maintenance engineer at WMSN-TV in Madison, WI, will receive a \$500 grant to continue his education in TV RF engineering at Harris Technical School.

Kevin Bosak of Worthington, OH, a National Merit Scholar, will receive an Ennes scholarship fund grant of \$1,500 to pursue his Bachelor of Science degree at Ohio University. Los Angeles member Kenneth Meades will receive \$750 toward his Bachelor of Arts degree in electronic technology at California State University. He has been in the program since September 1986.

Convention news

The SBE convention and **Broadcast Engineering** conference will be enhanced by the participation of the Rocky Mountain Film and Video Expo, a group that convenes annually in Denver.

Another addition this year will be the International Television Association (ITVA) seminars, to be offered concurrently with the SBE convention and **BE** conference. The ITVA seminars, generally geared toward video production, lighting and sound techniques, will be available to convention attendees at an extra cost. Other seminar programs will be conducted by the Colorado Film and Video Association and the International Interactive Communications Society, which will offer hands-on demonstrations of interactive video projects and programs.

Because many of the exhibitors also will be participating in the NAB Radio '88 convention in Washington, DC, special air freight arrangements are available to them. Air freight service will be provided through American Airlines Air Freight at a 25% discount to exhibitors shipping materials to the convention in Denver. Exhibitors should contact Eddie Barker Associates at 214-631-1278 for more information. [:-? :~)]

WATTS UP?



3.5KW

5KW

10KW

When-and-if you're ready to UP your transmitting power, will your FM transmitter be ready too? If it's one of the QEI "New Reliables" FMQ series, the answer is YES!

Our new 3.5KW, 5KW and 10KW transmitters were designed to give you a clear upgrade path to higher power. In just a few hours, your 3.5KW or 5KW QEI FM transmitter can be upgraded to a factory-equivalent 5KW or 10KW unit, right in the field. QEI's unique modular solid state drivers and interchangeable P.A. assembly make these power upgrades easy...and very economical.

If you're shopping for a 10KW unit in the first place, the QEI FMQ-10000 has lots to recommend it. No other FM transmitter packs this much power, reliability and performance into a single 24" wide rack cabinet. And the FMQ-10000 is designed to operate on single-phase power, so there's no need to pay for installing new three-phase electric service.

What's more, for upgrades to power levels beyond 10KW, each of these FMQ series

transmitters can serve as the driver section for QEI's 20, 30 or 60KW transmitters, again resulting in major cost savings.

Every QEI "New Reliables" FM transmitter is built to deliver ultra-dependability and performance. So—whether your station is thinking of upping its power down the road, or if the power you start with is the power you stay with—you'll be glad you chose QEI. Call us toll-free at (800) 334-9154 for the full story.

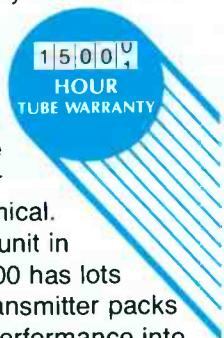

CORPORATION

The New Reliables

One Airport Drive, P.O. Box D
Williamstown, NJ, 08094 (609) 728-2020

Continued from page 180
pass. This one did.

After the second day of the show, first-time attendees and seasoned veterans alike were singing the praises of D-2. Both Ampex and Sony were prominently showing D-2 recorders in various configurations. Another player also moved to carve out a slice of the D-2 pie. Hitachi-Denshi displayed a prototype D-2 recorder that is scheduled for shipment in about a year.

Broadcasters and post-production operators responded to the new format with checkbooks. Ampex, for one, announced at the convention that it had booked orders for more than 300 D-2 units worth an estimated \$30 million. Sony also reported strong sales at NAB. Even Ampex, developer of the format, was surprised by the way users flocked to embrace D-2.

Major sales for the Ampex VPR-300 D-2 unit included the Canadian Broadcasting Corporation, AME, (a Burbank, CA, post-production house), the Post Group (a Hollywood post house) and the British Broadcasting Corporation. There was, by the way, keen interest in D-2 on the part of European broadcasters. Ampex reported orders for 70 PAL D-2 systems.

The purchase of D-2 equipment by AME and the Post Group is a significant first step in winning over the important video post-

production community to the new format.

Some digital products on display answered questions before they were asked, such as parallel-to-serial converters and a product that converts D-1 to D-2, or vice versa.

A flood of new digital video products is still to come. Next year, look for more sup-

porters. Each side had significant product and sales announcements at, or just after, the convention.

Panasonic Broadcast Systems reported at the show that NBC had purchased approximately 20 MARC-II cart machines. The sale, estimated at \$10 million, marked the first major placement of the M-II-based system.

Many of the units will be used at the network's New York headquarters for broadcast of all network programming and commercial material to the four time zones. According to Michael Sherlock, president, Operations and Technical services at NBC, "This will mark a milestone achievement in broadcast automation."

Two other major sales for Panasonic's M-II line also were announced at NAB, the Public Broadcasting Service (PBS) and KCRA-TV (Sacramento, CA).

On the Betacam front, Sony reported at the show that it had sold 250 pieces of equipment to various stations and facilities. One deal involved London Weekend Television (LWT), a major program producer in the United Kingdom.

Also at NAB, Sony and Ampex announced an enhanced Betacam agreement. Calling for cooperative product development and reciprocal manufacturing, Ampex is expanding its capacity to

*After the second day
of the show, first-time
attendees and
seasoned veterans
alike were singing the
praises of D-2.*

port boxes to take advantage of the inherent strength of the digital formats: multiple generations.

Beta vs. M-II, round three

There was no shortage of developments at NAB on the analog videotape format front. The battle continues between M-II proponents and Betacam (and Beta-SP)



...almost too good for words.

WE'RE RACECAM. The UPL Series is the world's most compact video system for live wireless camera applications from Grand Prix race cars to Americas Cup yacht racing.

WE'RE ENG. Our RPL-200 Series provides cost effective ENG and EJ systems with up to 12 watts of RF output in the band 1.7-2.7 GHz.

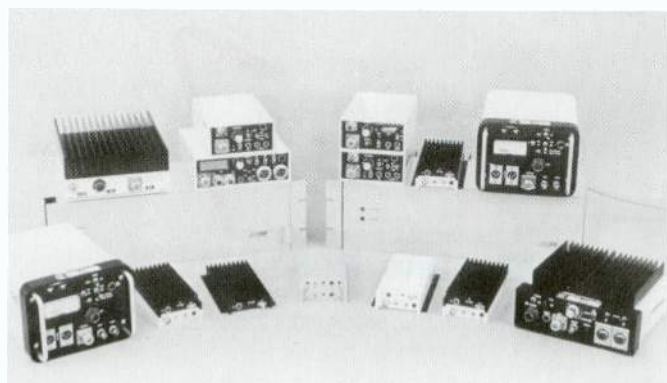

WE'RE PORTABLE. Our 400/1500 Series provide portable microwave systems for all field and emergency restoration applications in any band from 4-15 GHz.

WE'RE FIXED. The RFL Series of fixed microwave is available in any configuration for applications ranging from studio to transmitter links to long haul intercity interconnections.

WE'RE ACCESSORIES. Low profile/rod/parabolic antennas, low noise and RF power amplifiers.

WE'RE COST EFFECTIVE. High quality for the best price available anywhere.

WE'RE RELIABILITY. 2 years parts and labor warranty on all systems both fixed and portable.

WE'RE RF TECHNOLOGY.

WE'RE TOO GOOD FOR WORDS!

 **RF TECHNOLOGY INC.**

16 TESTA PLACE SO. NORWALK, CT 06854 203-866-4283
TELEX: 3722030 RFTECH FAX: 203-853-3513

Circle (128) on Reply Card

enable manufacturing of products for Sony. Each company will focus on manufacturing a part of the Betacam-SP product line for sale by both companies. The Ampex factory in Hong Kong is currently in production of Betacam-SP products.

At last year's show, S-VHS machines were well-hidden. But this year, they were front and center. The S-VHS docking machines look just like baby M-II decks. Editing decks are here, TBCs are available from a number of sources and cross-format transcoders were displayed. If nothing else, all of the S-VHS equipment validated the format for at least some professional applications.

Radio technology moves ahead

Developments on the radio front were a mixture of the old and the new. With the NAB claiming moderate success in implementing the NRSC standard, phase two of the effort was announced at the convention. For FM stations, the news about FMX

was encouraging.

The big boost for FMX actually came a couple of weeks before the convention with an announcement from CBS that it plans to install FMX at all 11 of its FM radio

The next hurdle for FMX to overcome concerns receiver manufacturers.

stations. FMX co-developer Emil Torick stated at an engineering conference presentation that all of the pieces were in place for widespread implementation of FMX.

With some early bugs now worked out, Torick pronounced the system ready for implementation. He said broadcasters can

expect FMX to provide quieter stereo reception within present listening areas as well as an expanded stereo reception area for a given signal-to-noise ratio.

In strong signal areas, Torick stated, multipath noise and distortion levels in automobile receivers should be close to those of monophonic reception. In weak signal areas, FMX radios should continue to provide good stereo separation. Conventional automobile receivers blend to mono in weak signal areas.

The next hurdle for FMX to overcome concerns receiver manufacturers. Torick said he was confident that the promise of improved FM performance, and subsequent consumer demand, would be sufficient to convince receiver manufacturers to implement FMX in current and future designs. He said that he hoped to have 100 stations on the air using FMX by the end of this year.

The National Radio Systems Committee (NRSC) proposed at the convention a sec-

TENTEL® MAKES IT EASY TO DIAGNOSE VCR MECHANICS

With NEW Gauges for 1" Type "C", MII, Betacam, and U-Matic

Tentel manufactures a complete line of gauges for U-Matic, 1" Type "C," Betacam and other recorders, too. If you've suffered the frustration of having a master tape ruined, or if you are responsible for maintaining and repairing VCRs— There's no faster, easier method to test the various mechanics that make VCRs work properly. Call our technical engineering department for details. We've been helping customers for years and want to help you too— your satisfaction is guaranteed.

TENTEL® CORP.

1506 Dell Ave.

Campbell, CA 95008

Circle (129) on Reply Card

(408) 379-1881

800 538-6894 (Not in Calif.)

Reconfirm
your involvement in
the broadcast industry!

**Renew
your subscription
today.**

SUBCARRIERS

AVAILABLE

- Major Satellite
- Low Monthly Rates
- Quality Owner
- SCPC or Backhaul
- 24 Hours Daily
- Brokers Welcomed
- 15 Khz & 7.5 Khz

Call (804) 845-4146

Circle (130) on Reply Card

ond voluntary national standard (designated NRSC-2) for AM radio transmission. The standard is designed to help AM broadcasters further control interference to their signals for better audience reception.

NRSC-2 is known as an *RF mask*, and developed in parallel with this recommended practice was a new technology

to monitor AM splatter. The new monitor permits economical and accurate measurements of AM interference.

The NRSC released its first voluntary national standard to control the amount of audio pre-emphasis (and, therefore, the bandwidth of AM stations) last year. According to the NAB, more than 700 sta-

tions in the United States and Canada had converted to the NRSC standard by the end of March 1988. The NAB has petitioned the FCC to make the transmission portions of the standard mandatory. AM stations would have until Jan. 1, 1990, to comply with the requirements.

The NAB Office of Science and Technol-

State of the industry according to Fritts

The opening ceremony of the NAB convention is a golden opportunity for making speeches. This show was no exception. NAB President, Eddie Fritts, gave his annual state-of-the-industry address on the opening day of the show, warning broadcasters to plan for the long term, or face an uncertain future. Following are selected excerpts:

"Broadcasters established and maintained the definition of the phrase 'broadcast quality' as standing for state-of-the-art, the highest technical standards.

(HDTV)...can mean opportunity—or it could mean disaster for television broadcasters.

"In the past decade, for example, stereo FM has swept into dominance. Stereo AM and stereo television have been introduced. Minicams, satellite news gathering, compact discs, digital audio and the new standards for AM transmission and reception have all come into being.

"But the kind of technology I mean is not these improvements. It is much more revolutionary. Its arrival can mean opportunity—or it could mean disaster for television broadcasters.

"Of course, I am speaking about high definition, or advanced television. For the first time in the history of television, we are at the threshold of a system which is not unique to broadcasters.

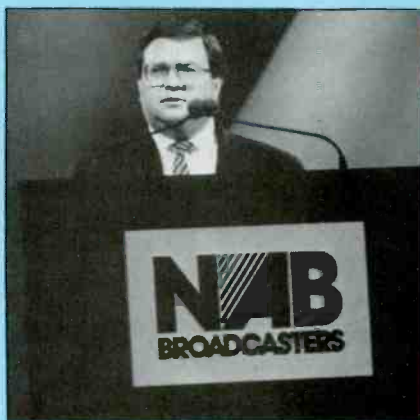

NAB president, Eddie Fritts, presents his state-of-the-industry address during the opening ceremonies.

HDTV will be in the American marketplace—via cable, VCRs, probably DBS in the early 1990s and, possibly, fiber optics from the telephone companies. And as this new form of television moves into American homes, broadcasters must be sure they are competitive.

"NAB has joined hands with other industry groups to make sure that as technology advances we are well-positioned to take advantage of its full potential. It is a complex and difficult area, and the NAB advanced-television task force is providing a steady hand on the tiller in working with the FCC blue ribbon advisory panel and in reviewing options to assure our position for the future.

"Because of the complexities of the issues, we strongly urge the FCC not to foreclose any options by prematurely reallocating UHF spectrum, which may,

in fact, be needed for broadcasters to compete with other media. At this convention there are numerous panels and workshops on the subject, and a number of exhibitors are displaying advanced television equipment.

"It is abundantly clear that changing technologies and various competing delivery systems will all merge at the consumer's location. If we are smart, we will coordinate the merging of these delivery systems so each will be competitive and compatible with the next generation of receivers.

"This, of course, means that broad-

Broadcasting...is a national resource that is worth protecting and preserving.

casters, cable operators, satellite distributors, fiber-optic systems and manufacturers need to work together to develop a marketplace of opportunities for all, rather than a marketplace of chaos. If we are successful—and I believe that we will be—the American consumer will continue to enjoy the finest system of television in the world for many generations to come.

"Our system of free, over-the-air community broadcasting is unique in providing many...benefits to the public. Our system of broadcasting...is a national resource that is worth protecting and preserving. It is, by far, the finest devised anywhere in the world. We will do whatever necessary to ensure its continued strength and viability."

ogy provided a special exhibit on the convention floor (just outside the Engineering Conference session halls) to demonstrate use of the NRSC standard by AM stations and AM receiver manufacturers. Six prototype receivers were on display. Comparisons were made between NRSC and non-NRSC audio processing on present and future AM radios.

The NRSC-2 standard is intended to characterize the RF emissions of AM stations that use the first set of parameters. It specifies the RF signals that leave a station's transmitter and antenna system. The RF mask consists of a limit on out-of-band emissions and accompanying measurement procedures.

Engineering Achievement Award

The annual NAB Engineering Conference luncheon is the cornerstone of the technical side of the convention. Presentation of the Engineering Achievement Award is the centerpiece of the luncheon. The prestigious award was given this year to Jules Cohen, a Washington, DC-based engineering consultant.

Michael Rau, NAB vice president and head of the Science and Technology department, praised Cohen as an engineer who refused to compromise on technical matters. Cohen recently retired as president of Jules Cohen and Associates after 42 years in the broadcast industry.

In accepting the award, Cohen reviewed the current state of broadcast technology. "Television, not surprisingly, generates the greatest excitement and creates the greatest challenges," he said. "We are seeing in our homes better picture quality than was hardly dreamed of 20 years ago. Even better is still to come.

"For someone like myself, devoted to the concept of local television available to all who can afford even the least expensive of television sets (and that really encompasses just about everyone), the major consideration is the survival of a healthy terrestrial television broadcasting service. Competing media without the spectrum restraints of terrestrial broadcasters seem to be better positioned to take advantage of the new television developments. But the current population of some 140 million NTSC television receivers in this country alone must be reckoned with. . . .

"Some terrestrial broadcasters may have come only recently to the realization of the threat from other media, but some voices have been crying in the wilderness for a decade or more. The surge of effort now under way is encouraging, and I feel confident that broadcasters will meet the challenge."

(See related articles, next page)

Contributors to this article include Ned Soseman, editor of *Video Systems* magazine, and Michael Heiss, BE consulting editor.

Telex, a broadcast headset in perfect balance.

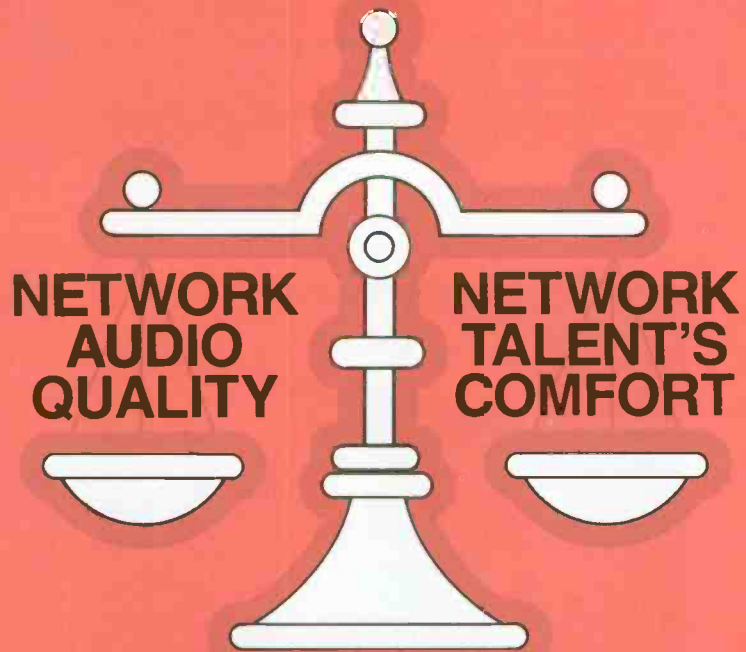

Telex satisfies the comfort needs of network sports announcers while meeting high network audio standards. For years Telex has worked diligently with network audio engineers and network talent—searching for the ideal combination of sound and comfort. The PH-24 and PH-25 lightweight Sportscaster headsets offer the perfect balance of both needs. **Two of the three major networks have already adopted it as their standard for all sports events where excessive crowd noise is not prevalent.**

Ideal for golf, tennis, baseball and football in most stadiums, these professional headsets deliver the ultimate in sound and comfort. The same microphone quality is available in the PH-91 and PH-92 full ear-encompassing, noise attenuating headsets designed for noisy stadiums, basketball arenas or auto races.



PH-24 (Monaural) and PH-25 (Binaural) Lightweight Professional Headsets



Charlie Jones, network sports announcer says that since using the PH series headset from Telex his old problem of "halftime headaches" has disappeared.



PH-91 (300 ohm) and PH-92 (6000 ohm) binaural Professional Headsets

TELEX®

TELEX COMMUNICATIONS, INC.

9600 Aldrich Ave. So., Minneapolis, MN 55420 U.S.A.

Circle (132) on Reply Card

NAB slice of life

A convention often brings out some strange characters. No report on the NAB would be complete without some mention of the folks and things that help make the show something to talk about.



Who is this man, and what was he doing on the roof of the Hilton? He gets my vote for the "nut of the year" award.



Here is the inside version of the giant boom box. Either the speakers are turned off or the people in this picture are deaf.

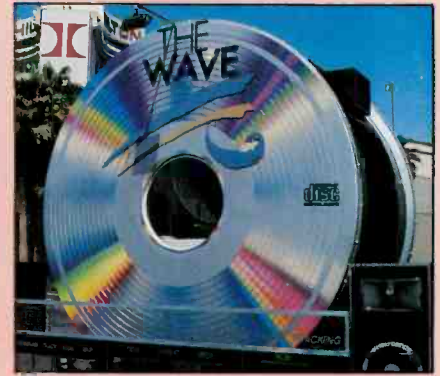

Didn't you just love the boom boxes on wheels? They were great. When they cranked up the volume you could hear them in Reno.

Fowler: gone but not forgotten



Mark Fowler, former FCC chairman, recipient of the NAB Distinguished Service Award.

Mark Fowler, the architect of deregulation of the broadcast industry, was honored at the convention with the NAB Distinguished Service Award. The presentation to the former chairman of the FCC was made at the opening

ceremonies of the show.

Fowler's remarks were a mixture of humor and hope. He reminded his audience what he had done for them, and what they need to do for themselves:

"The freedom you enjoy is no small matter. Look around you, and you will see a front line of competing technologies. Whether it's cable television, videocassette recorders, fiber-optic systems offered by telephone companies, or satellite services, they all have one thing in common, one thing you don't have: freedom from government content control. But you're getting there. And I say, more power to you.

"In the midst of all this, we sometimes forget that broadcasting is made up of people. Some have snazzy expense accounts and show great generosity at events like this. Others have snazzy expense accounts and get hand cramps when the check comes. Some are from the great corporations of America. Others are 1-person operations, selling accounts from the kitchen table.

"But all of us here today feel that special feeling because we love broadcasting. Everyone can remember who gave them that first job, who showed kindness when the rat race looked like the rats were winning. Each of us has watched some special series on television or listened to a moving moment on

radio, and we could say, "Yes, I'm a part of that. I helped make that happen."

"Maybe it's because broadcasting is part public service and part show business. Public service calls forth our altruism, show business our competitive instincts.

"Broadcasting, despite all the hoopla about new technologies, remains America's favorite pastime. You're not facing the sunset of its years. Oh, no. It's going forth into the next decade with the strongest, freest and most responsive system devised by humankind to communicate.

"Broadcasters are optimists by profession. We expect television sets to get brighter, bigger and cheaper. Somehow they do. We expect programs to take us to new corners of the human mind or return us to old favorites, and they do. We expect to master the unexpected—a transmitting tower gets thrown to the ground in a hurricane or a political hurricane calls for on-the-spot reporting. And you take care of it.

"Broadcasters are like Americans generally: optimists.

"I guess it took optimism for me to see that broadcasters could be freer, that government officials, including the chairman of the FCC, could discard the robes of the censor. I'm glad for that bit of old-fashioned American optimism."



Last year in Dallas we had the CD-head man. This year, in keeping with advancements in technology, it was the R-DAT man. He didn't say much, but just danced around and waved a lot.



This fellow's perfectly executed robotic movements drew crowds of onlookers curious to know whether he was a human or a robot. He turned out to be a talented human being.



You know you're in Las Vegas when you see women with tinsel hair handing out pamphlets. Some things never change.

The wireless system that will never leave you speechless.

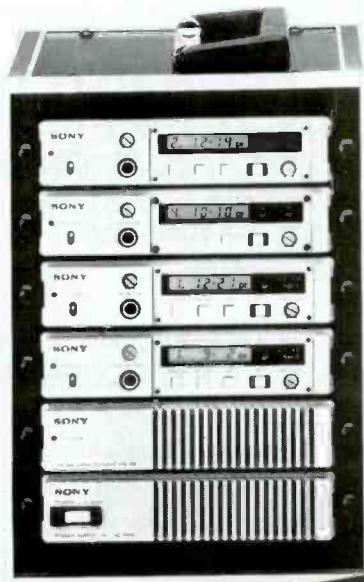

If this has ever happened to you, you weren't using a Sony VHF wireless microphone.

Rather than a mere one, two or ten channels, the Sony wireless system gives you up to 168. So no matter where you are, no matter how cluttered the airwaves, the signal will come through loud and clear. And with so many open channels to choose from, multi-microphone setups are a snap.

For added insurance, Sony wireless arms you with true space diversity reception. Twin tuners constantly compare incoming signals for the strongest, clearest signal. sparing you the echoes, dead spots and other horrors that plague lesser systems.

So, if you're looking for a wireless system you can have faith in—any time, any place—contact your Sony Professional Audio representative. Or call Sony at 800-635-SONY.

SONY

Professional Audio

President Reagan steals the show

Although President Reagan's speech at the NAB only touched on issues strictly relating to broadcasting, it added a definite sense of excitement to the convention. The 1-day stopover also gave HDTV proponents a good opportunity to show off the capabilities of their systems.

Attendees began lining up at 8 a.m. on Sunday, a full three hours before the President was to speak, to get a seat in the hall. In all, 4,500 packed the Hilton Center to hear Reagan, and an estimated 1,000 watched in an overflow room equipped with a high-definition TV projection screen. Still others saw the talk on a huge screen set up in the parking lot of the Hilton.

The President's talk dealt primarily with foreign policy, but he did touch on several topics of particular interest to broadcasters:

"It was back in 1923 that Warren Harding became the first President to speak over that new-fangled piece of equipment, the radio. In 1946 Harry Truman became the first President to speak by way of television, followed by Dwight Eisenhower who, in 1955, became the first President to be seen on color television.



President Reagan's presence brought a sense of excitement to the convention. He was awarded the first Ronald Reagan Broadcasting Award after his Sunday morning speech.

"Today, just six short decades after Warren Harding first spoke over the radio, these remarks of mine are being recorded on HDTV. I am told that HDTV represents an advance as dramatic as that from black and white to color, a

new and powerful manifestation of the broadcasting industry.

"This technological creativity—from primitive, early radio to HDTV and satellite transmission, during my own lifetime—has, of course, transformed American life.

"To be sure, no revolution in our time is more striking, far reaching and profound than the revolution in technology and communications. The semiconductor and countless other breakthroughs have ushered in a new burst of economic creativity; we have products today—the lap-top computer, for example—that were quite literally undreamed-of just a decade ago.

"Instantaneous communications have made possible the growing integration of world markets. And, yes, the new communications technologies have made it harder and harder for totalitarian states to control the information that reaches their peoples."

President Reagan was awarded by the NAB the first Ronald Reagan Broadcasting Award for "a lifetime of achievement and leadership through the effective use of the broadcast media." The presentation was made following Mr. Reagan's address.

MATTH PACKS

PAGE 80

MATTHEWS CATALOG

CALL OR WRITE



2405 Empire Avenue
Burbank, California 91504
(818) 843-6715

"THE REEL THING"

Circle (134) on Reply Card

**ERASE
IT!**



Nothing erases audio, video or computer tape better than Audiolab degaussers.

For information call: 916/485-0500

**AUDIOLAB
ELECTRONICS**

3725 Esperanza Drive, Sacramento, CA 95664

Circle (135) on Reply Card

**S.W.R.
INC.**

**SYSTEMS WITH
RELIABILITY**

MANUFACTURER OF:
COAX TRANSMISSION LINE,
WAVEGUIDE SYSTEMS,
AND UHF/VHF/FM
ANTENNAS

FOR ALL YOUR
BROADCAST EQUIPMENT
NEEDS
CONTACT:
MIKE COMITO
OR
DOUG ROSS

S.W.R. Inc.
RD 3
ROUTE 77
NO. WEARE, NH 03281
603-529-2500

Circle (136) on Reply Card

Sanders leaves Ampex

Mark Sanders, a 19-year veteran of Ampex and the driving force behind the D-2 digital recorder, left the company on May 23. Sanders' resignation as vice president and general manager of the Recording Systems Division occurred less than six weeks after a highly successful showing of D-2 products at the NAB convention.

Sanders told *BE* that he left because of a difference in management approaches between himself and the Sherborne Group (headquartered in New York), which purchased Ampex in May 1987. Sanders said he had discussed his concerns with Max Mitchell, president and CEO of Ampex. Early this year, he had made known his desire to leave.

Mitchell told *BE* the departure was regrettable but an unavoidable part of the business world: "Unfortunately, change is inevitable in all of our lives and our businesses. This is one of those changes."

Mitchell said he is evaluating internal candidates for a successor to Sanders, and that an executive search firm has been engaged to look outside the company. In the interim, Mitchell will serve as acting division manager.

Sanders' tenure with Ampex was long

and distinguished. He joined the company in 1969 and served in various management positions, including vice president and general manager of the Data Systems Division, VP/GM of Marketing and New Technology and VP/GM of AVSD, a position he held from 1983 to 1986. Sanders also served as general manager of the videotape recorder group, product manager of helical video products and manager of professional audio products.

He was instrumental in the development of the D-2 recorder format and the Ampex-Sony Betacam manufacturing agreement. Mitchell said, however, that the changes will not affect either product line. "There was no disagreement on strategy, only how to implement the strategy," he said. "We intend to continue along the path that we've been on. The division is healthy, it is making money...and we're shipping more products than ever before."

Sanders expressed confidence that the D-2 format he championed was off to a good start. "My main thrust at Ampex has always been in magnetic recording. D-2 has been a 5-year struggle...but it is clearly going to be a success."

Another year, another NAB

The Order of the Iron Test Pattern held its annual meeting during the NAB convention. Created out of whole cloth just prior to the 1979 NAB convention, the Order has filled a real need for television's technical slaves—recognition for their contributions.

The first annual meeting during NAB '80 honored the longest sufferers of the lot and started a tradition that was scheduled to last five years, or forever, whichever came first.

The Order currently has more than 2400 members in 23 countries and is growing like a well-fertilized flower.

The order makes awards to deserving members who have proved that they have done anything longer than anyone else. It is important to note that the association honors tenacity, not ability.

At this year's annual meeting, Al Leon, Leon, Inc., became the first recipient of the Al Leon Print Communicator award. The Al Leon award is a perpetual one that will be given annually to members of the print communications industry who support television.

**Want To Talk
Broadcasting?**

**SBENET
ON
COMPUSERVE**

**John Hoffman
Net
Administrator
76703, 1036**

Now Customer Programmable

The SWAT Plus



The SWAT Plus - A Unique Product

• Automatic monitoring of all Sync/Blanking Parameters

GET THE DETAILS FROM PESA NOW!



PESA

Pesa America Inc., 6073 N.W. 167 Street,
Suite C-4, Miami, Florida 33015
Telephone (305) 556-9638 Telex 6712435 Fax (305) 556 5536

Circle (138) on Reply Card

June 1988 *Broadcast Engineering* 191

PORTA-BRACE QUICK DRAW

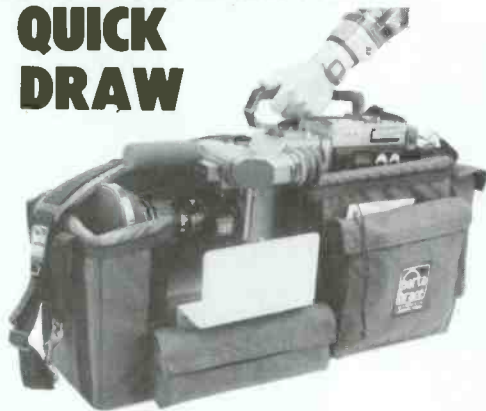

► This professional case is a convenient way to carry and protect your camera on the ground, in your car and in the air. With its hard shell construction and aluminum viewfinder guard, this padded nylon case means lightweight security for your camera. Call or write for information.



K&H Products, Ltd.

Box 246
North Bennington
Vermont 05257
802-442-8171

Circle (139) on Reply Card

LET'S TALK KEYERS



VK-900

MIX TO KEY IN EITHER
INTERNAL OR EXTERNAL MODE
PLUS A/B ADDITIVE MIX.



DK-400

SAME FEATURES AS
VK-900 PLUS KEY
PREVIEW AND MASTER
FADE TO BLACK.



OPTIONAL FOUR SPEED AUTO MIX
MAY BE ADDED TO EITHER KEYER.

THE ECONOMICAL SOLUTION TO
ADDING EXTRA MIX/KEY LEVELS
TO EXISTING SYSTEMS.

broadcast video systems Ltd.

40 West Wilmot Street, Richmond Hill, Ontario L4B 1H8
Telephone: (416) 764-1584 Telex: 06-964652 Fax: (416) 764-7438

Circle (140) on Reply Card

Aurora enters agreement with Chyron

Aurora Systems, Redwood City, CA, has signed a letter of intent for the sale of warrants to Chyron. The agreement provides for an immediate advance of \$2.1 million by Chyron and allows Aurora access to Chyron's customer-financing plan. The agreement also provides for the purchase, over a 5-year period, of the current venture capital interest in Aurora, giving Chyron the majority interest in the company.

Clear-Com moves to new quarters

Clear-Com Intercom Systems, San Francisco, has relocated its operations to a new facility in Berkeley, CA. The company has purchased a 24,000-square-foot building, which more than doubles the manufacturing capability and accommodates future expansion. The address is: 945 Camelia St., Berkeley, CA 94701; telephone: 415-527-6666.

Columbine moves to larger facilities

Columbine Systems, Golden, CO, has moved its headquarters to the Denver West Office Park, where it occupies 60,000 square feet of office space. The address is 1707 Cole Blvd., Golden, CO 80401; telephone: 303-237-4000.

Abekas Cox enters U.S. broadcast video market

Abekas Cox, Feltham, England, sister company of Abekas Video Systems, has established marketing, sales and service operations in the United States for its line of broadcast video equipment. It also has adopted a name change to A.C.E. in order to establish an independent identity in the market.

BTS and Thomson Video Equipment reach new technology agreement

BTS Broadcast Television Systems GmbH, Darmstadt, Germany, and Thomson Video Equipment SA, Cergy, France, have reached an agreement on cooperation in the development of new technologies. This will strengthen their positions in digital and high-definition TV systems in the international market.

Chyron's ownership of DSC increases

Chyron, Melville, NY, has acquired all outstanding shares of Digital Services Corporation, Gainesville, FL, from its founders, John T. Davis, president, and James M. Seipp, vice president, as well as options from other key employees of DSC. The shares were acquired for an undisclosed cash consideration based on the net income of DSC as defined over a 7-year period that began July 1, 1987. No management changes are contemplated. Both Davis and Seipp will continue in their present positions under employment agreements that extend beyond the 7-year pay-out period.

Gentner acquires Microprobe Electronics

Gentner Electronics, Salt Lake City, has acquired Microprobe Electronics (MEI), Lake Forest, IL. MEI manufactures broadcast automation equipment and digital audio storage products. Its line has been integrated into Gentner's Salt Lake City facility, and all MEI products will be sold under the Gentner name.

Harman acquires Soundcraft Electronics

Harman International Industries, Northridge, CA, has acquired Soundcraft Electronics, United Kingdom. The JBL Professional division of Harman International had been the exclusive distributor of Soundcraft products for the United States and Mexico since January 1986.

Clark-Teknik purchases two companies

Clark-Teknik Electronics, Farmingdale, NY, has purchased Celco Inc., U.S. distributor for Celco Ltd., and several other lighting equipment manufacturers. Celco's products are sold and

serviced from the U.S. offices of Klark-Teknik in Farmingdale.

Klark-Teknik also has purchased certain assets of Midas Audio Systems, a British manufacturer of live mixing consoles. Midas products are sold and serviced by Klark-Teknik from its U.S. offices.

Lexicon relocates West Coast sales office

Lexicon, Waltham, MA, has relocated its West Coast sales office to larger quarters at: 2323 Corinth Ave., Suite 201, West Los Angeles, CA 90064; telephone: 213-479-2771.

New England Digital expands into broadcast radio market

New England Digital, White River Junction, VT, has expanded into the broadcast radio marketplace with the signing of a remarketing agreement with Columbine Systems, Golden, CO. Columbine will distribute the Synclavier Digital Audio System and direct-to-disk digital multitrack recorder to Columbine's domestic and Canadian radio stations.

New England Digital also has installed broadcast radio systems at KIIS-FM, Los Angeles, and at Gannett affiliate WGCI-AM/FM, Chicago.

Neve opens two facilities

Neve, Bethel, CT, has opened facilities in New York and Nashville. The New York office is located at 260 W. 52nd St., Suite 25E, New York, NY 10019; telephone: 212-956-6464. The Nashville facility is located at 1221 16th Ave. South, Nashville, TN 37212; telephone: 615-329-9584. Both facilities are staffed by technical service engineers to assist customer service and sales.

Thorn and Varian plan organizational changes

Varian Associates, Palo Alto, CA, and *Thorn EMI Electronics*, Hayes, United Kingdom, are planning organizational changes in their joint venture to allow improved service to the U.S. UHF-TV market. The manufacture of the Thorn EMI-Varian (TEV) UHF-TV product line has been transferred from the Hayes facility to Varian's microwave tube division. This will include the PT-5090 and the PT-5093 ACE wideband external-cavity klystron. As of June 1, Varian's microwave tube division assumed marketing responsibility for UHF-TV klystrons in all world markets. In a concurrent realignment, Varian's U.K. subsidiary, Varian Associates, assumed responsibility for all marketing and support of the company's tube products in the United Kingdom. These activities are handled by the TEV joint venture.

Richardson Electronics and Panasonic enter marketing agreement

Richardson Electronics, LaFox, IL, and *Panasonic*, Secaucus, NJ, have entered into a marketing agreement that delegates Richardson as a stocking distributor for Panasonic cathode ray tubes. The move also enhances Richardson's CRT program, which concentrates on the maintenance and repair of equipment.

Stellar forms software vendor agreements

Stellar, Boston, has made an agreement with a wide range of application software vendors to market scientific and engineering applications on the Stellar Graphics Supercomputer. It also has announced the availability of more than 30 leading applications packages.

Stellar has signed a joint marketing relationship with Neo-Visuals for CAD-related applications, scientific research, presentation graphics and computer-aided styling.

Stellar also has signed a value-added reseller agreement with Bechtel Software. Bechtel will sell the Stellar Graphics Supercomputers.

||:~>)))

Perfect Timing

CLOCKS AND TIMERS

FROM \$183



TO \$495



(213) 322-2136

142 Sierra Street, El Segundo, CA 90245

Circle (141) on Reply Card

June 1988 *Broadcast Engineering* 193

TWO HEADS ARE BETTER THAN ONE.

Sometimes.

QuickSet's new PRO 1030 Fluid Head combines the counterbalancing provided by a traditional spring head with the smooth movement of an expensive "Broadcast" style fluid head. The best of both systems at one affordable price.

Sometimes, one head is better than two.



QUICKSET

3650 Woodhead Drive, Northbrook IL. 60062
800/247-6563 Illinois 312/ 498-0700

Circle (142) on Reply Card

Good things come in small packages(part II) . . .

VAC's new RS-170A color bar/sync generator provides SMPTE bars. This quarter rack wide unit is also a stable genlocking or free running color sync source with subcarrier, sync, blanking, burst flag, field one ID flag, and black burst outputs.

Introductory price: \$1095.



To meet our entire family of distribution amplifiers, line isolators, pattern generators, sync generators, signal presence detectors, and alarms please call or write for the dealer nearest you.



VIDEO ACCESSORY CORPORATION

2450 Central Ave. Suite H Boulder, CO 80301
(800) 821-0426 (303) 443-4950

Circle (143) on Reply Card

People

Bill Greene has been appointed technical sales representative for Agfa-Gevaert, magnetic tape division, Ridgefield Park, NJ. He covers territory in the Southeast with responsibilities for all magnetic tape products.

Spence Burton has joined Alpha Audio, Richmond, VA, as technical manager, concentrating his efforts in the automation systems division. He is responsible for coordinating the delivery and installation of the division's BOSS automated audio editor, and for all production and technical support documentation, including the preparation of user manuals.

Sue Jones has been promoted to operations manager for Amek/TAC U.S. operations, North Hollywood, CA. She is responsible for overall operation of the company, ranging from personnel to systems coordination.

Robert L. Wilson and **Marty Blanchard** have been appointed to positions with Ampex, Redwood City, CA. Wilson is general manager of the worldwide marketing, sales and service organization. Blanchard has been promoted to senior market research and planning analyst at the magnetic tape division. She is responsible for the coordination of strategic long-range planning, as well as for tracking industry activity and trends. She also is chairperson of the International Tape/Disc Association's blank tape statistics committee.

Piet Lesage has been appointed national sales and marketing manager, broadcast and graphics products for Barco Industries, Nashua, NH. He will divide his efforts between the East Coast and West Coast sales offices.

Gilbert Housewright and **Russell Erickson** have been promoted to new positions at Broadcast Electronics, Quincy, IL. Housewright is senior service engineer in the customer service department. Erickson is manager of RF products. He is responsible for providing the technical support in all RF product sales.

Adrian Weidmann, international manager with Bruel & Kjaer Pro Audio Group, Marlborough, MA, has moved to the United States, where he will spend the next year opening up the American market. He also will coordinate a series of educational seminars on the series 4000 professional microphones. While in the United States, he will continue to oversee the company's international operation.

Don C. Klick is vice president of operations for Centro, Salt Lake City.

Steve Sloane has been promoted to vice president of international sales for the tele systems and video products line for Chyron, Melville, NY. He is responsible for sales in Europe, Africa, South America, the Middle East, the Far East and Australia.

Lawrence Weiland has been elected president, chief operating officer and director of CMX, Los Gatos, CA. **Alfred O.P. Leubert**, chairman and chief executive officer of Chyron, assumes the duties of chairman of CMX. **Richard Sirinsky** is vice president and director of marketing and sales for CMX.

Walter Rice has been appointed director of domestic sales for Continental Electronics, Dallas.

Laura Tyson has been appointed sales engineer, broadcast division, for Denon America, Parsippany, NJ.

William van Rassel has been appointed head of engineering for Digital Processing Systems, Ontario, Canada. He is re-

sponsible for overseeing engineering activities, and is in charge of research and development and the engineering of new products.

Peter Werp, Shane Dickey, Jason Danielson and David Brack have been appointed to positions with Digital F/X, Santa Clara, CA. Werp is vice president of manufacturing and is responsible for all manufacturing, materials, quality assurance, manufacturing engineering and testing of the DF/X 200 digital video production system and future products. Dickey is vice president of engineering and is in charge of all product development and the engineering department. Danielson is product marketing manager of the DF/X 200 digital video production system and is responsible for all strategic product and marketing efforts, as well as for product marketing communications and sales support and training. Brack is regional sales manager and is involved in the sales of the DF/X 200 and in setting up field engineering and sales centers in New York and Orlando, FL.

Marko Hayes has been appointed general manager of Stairless Construction Company, North Wales, PA.

John William Park has been appointed national sales manager for DSC, Gainesville, FL. He is responsible for six regional U.S. sales offices as well as the nationwide dealer network.

Brad Friedrich has been promoted to director of marketing for the Magnetic Products Division of Fuji Photo Film U.S.A., Elmsford, NY. He is responsible for all facets of the marketing function for audiotape and consumer and professional videotape products. Areas of responsibility include the development

Winsted®

FREE CATALOG



Video Furniture Systems

Big, full color catalog includes complete descriptions, pricing and ordering information on:

- Editing Consoles
- Video Consoles
- Equipment Cabinets
- Micro Computer Stations
- Tape & Film Storage Systems

Winsted Systems ... *the Perfect Match*
for all professional Video Equipment

THE WINSTED CORPORATION

10901 Hampshire Ave. So. • Minneapolis, MN 55438
TELEX: 510-601-0887

Call for your nearest dealer
Phone Toll Free (800) 447-2257

FAX: 612-944-1546

Circle (144) on Reply Card

TOOLS AND TOOL KITS



Techni-Tool's complete line of tool kits serve every need in the industry. Standard and customized kits and our exclusive design-a-kit system all feature the finest tools and cases available. Call or write for our complete **FREE CATALOG**.

TECHNI-TOOL inc.

5 Apollo Road, Box 368
Plymouth Meeting, PA 19462 USA
(215) 825-4990 Telex 83-4763
FAX 215-828-5623

Circle (145) on Reply Card

Live Assist and more!

CABS delivers an integrated Computer Aided Broadcasting System from Library Maintenance to Analysis of Aired Events.

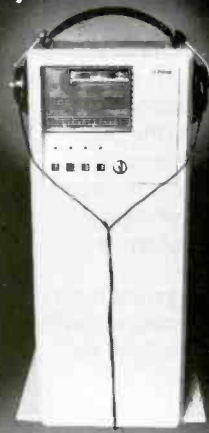

- Music and commercial library management
- Sophisticated programming and scheduling criteria
- Live assist with full control of audio peripherals

- Announcer information, live tags and schedule enquiry
- Analysis of formats, aired events and their relationship to station ratings.

DKW SYSTEMS INC.

#730, 9919-105 Street
Edmonton, Alberta Canada T5K 1B1
(403) 426-1551

Circle (146) on Reply Card

MIC SALE Mania!

Bigger
Better
Cheaper

AKG
Audio-Technica
Beyer-Dynamic
Crown
Countryman
Electro-Voice
HME
Nady
Ramson
Samsen
Sennheiser
Shure
Sony
Stewart
Teac
Telex
Tram
Toa
Vega
Williams

UNBEATABLE
PRICES

200 Product Lines for the Professional

FULL COMPASS SYSTEMS

6729 SEYBOLD RD., MADISON, WI 53719-1393

All 50 States
TOLL FREE
800-356-5844
In WI: 800-362-5445
(608)271-1100

Circle (147) on Reply Card

Shively FM Antennas

A good antenna is crucial to quality broadcasting. An antenna that is merely adequate will compromise the performance of even the best studio equipment and transmitter.

Shively regularly includes standard features that other companies either provide only as options or simply do not offer.

At Shively, we design and build antennas of uncompromising technical quality and performance. And, we build them to last.

Shively Labs

A Division of Howell Laboratories, Inc

36 Harrison Road Bridgton, ME 04009 (207) 647-3327
TWX 710-223-8910 SHIVELY BRGT FAX (207) 647-8273

Circle (148) on Reply Card

of long- and short-term business plans as well as the direction of the marketing, product management, advertising and promotion functions of the division.

Frank Blaha has been named sales and marketing manager of satellite communications products for the microwave equipment division of Varian Associates, Santa Clara, CA. He oversees worldwide sales and marketing of commercial satellite communications products, including high-power amplifiers using traveling-wave and klystron tubes.

Andrew Murray has been appointed field sales engineer for QSC Audio Products, Costa Mesa, CA. He is responsible for product training and overall product support in the field, and will act as a technical liaison.

Michael Brunsky has been appointed to the national sales team with Aston Electronics, Olathe, KS, as part of the company's stepped-up marketing program in the United States.

Bill Hall has been appointed engineering product manager for Graham-Patten Systems, Grass Valley, CA. He is responsible for CAD operation and the implementation of an MRP system.

Eric S. Hass and **E.L. Corujo** have joined Harris, Melbourne, FL. Hass is vice president in charge of the video systems operation, located in Mountain View, CA. Corujo is distribution manager for the international sales department, broadcast division. He is responsible for strengthening international distribution channels, identification of special sales opportunities and assistance with strategic planning for international sales.

Michael Popadiuk is sales manager for the Canadian office in Toronto for LTM, Sun Valley, CA.

J. Michael Hughes has been elected vice president of marketing for HM Electronics, San Diego, CA. He is responsible for coordinating all sales activities, marketing programs and customer-service functions.

Nigel W. Spratling has been appointed national sales manager for Microtime, Bloomfield, CT.

Peter Flicker has been appointed to the board of directors of Neve, Bethel, CT. He also is vice chairman of the board.

Richard Zabel has been appointed national sales manager for Nova Systems, Canton, CT.

Paul Insko has been named Midwest area sales manager for Pinnacle Systems, Santa Clara, CA.

William A. Wohl has rejoined Radio Systems, Edgemont, PA, as custom projects manager. He oversees the sales and coordination of all projects involving custom cabinetry, RF and studio turnkey installations and custom engineering projects.

Fred Ekins has been appointed manager of research and development for RAM Broadcast Systems, Palatine, IL.

Russell Dahl has been named product manager for the cathode ray tube product line for Richardson Electronics, LaFox, IL. He is responsible for defining and redefining the CRT product line, setting price structure and inventory levels, developing relationships with new and existing vendors and customers, and offering technical assistance.

[:(-:))]]

Professional services

VIR JAMES P.C. CONSULTING ENGINEERS

Applications and Field Engineering
Computerized Frequency Surveys

3137 W. Kentucky Ave. — 80219
(303) 937-1900

DENVER, COLORADO
Member AFCCE & NAB

PRO VIDEO & FILM EQUIPMENT GROUP

SPECIALISTS IN USED & NEW
WE BUY-SELL-TRADE-CONSIGN
FREE CATALOG ON REQUEST
(214) 869-0011 DALLAS

EVANS ASSOCIATES

CONSULTING TELECOMMUNICATIONS ENGINEERS
AM-FM-TV-CATV-ITFS-LPTV SATELLITE
216 N. Green Bay Road
Thiensville, Wisconsin 53092
Phone: (414) 242-6000 Member AFCCE

FCC ON-LINE DATABASE dataworld®

Allocation Terrain Studies
AM • FM • TV • LPTV • ITFS
P.O. Box 30730
Bethesda MD 20814
(301) 652-8822 1-800-368-5754

D. L. MARKLEY

& Associates, Inc.
CONSULTING ENGINEERS

2401 West Moss Ave.
Peoria, Illinois 61604
(309) 673-7511
Member AFCCE

BLAIR BENSON

Engineering Consultant
TV Systems Design and Operation

23 Park Lane
Norwalk, CT 06854
203-838-9049

TEKNIMAX

TELECOMMUNICATIONS

DENNIS R. CIAPURA
PRESIDENT

11385 FORESTVIEW LN
SAN DIEGO CA 92131 (619) 695-2429

SMITH and POWSTENKO

Broadcasting and Telecommunications
Consultants

2033 M Street N.W., Suite 600
Washington, D. C. 20036
(202) 293-7742

Robert J. Nissen

THE NISSEN GROUP, INC.

Communications Technology Consultants

32 Ridge Drive • Port Washington, New York 11050
(516) 944-5477



COMMUNICATIONS INC

- Radio and Television System Design
- Transmitter and Studio Installation
- Microwave and Satellite Engineering and Installation

201-746-9307

12 North Willow St.
Montclair, NJ 07042

JOHN H. BATTISON PE. CONSULTING BROADCAST ENGINEER, FCC APPLICATIONS AM, FM, TV, LPTV

Antenna Design, Proofs, Fieldwork
890 Clubview Blvd. North
Columbus, Ohio 43085
614/888-3364

ERIC NEIL ANGEVINE, P.E.

consultant in acoustics

specializing in broadcast studio acoustics

910 Lakeridge Drive Stillwater, OK 74075
405-624-6043 405-372-3949

MAILING LABELS

AM, FM & TV
CALL

dataworld®
1-800-368-5754

PATCHPRINTS

Video Tie Lines
In 1 2 Aux 1 2 Mon A B

Custom Patch Bay Labeling for the Audio/Video Industries

By
PATCH BAY DESIGNATION COMPANY
Div. of Hildebrand Rubber, Stamp & Printing Co., Inc.

CHARLIE SCHUFER

P.O. Box 6278, Glendale, CA 91205
4742 San Fernando Road
Glendale, CA 91204 Telephone
(818) 241-5585



AMERICAN LASER SYSTEMS, INC.

751 S. Kellogg Ave.
GOLETA, CA 93117 USA

ENG • STL LINKS • SPORTING EVENTS
Solutions to LICENSE-FREE, short range
video/audio transmissions via infrared
atmospheric links

LORRAINE SHALLENBERGER
MARKETING MANAGER

805/967-0423
FAX 805/683-4382

East Coast Video Systems

ON-LINE... IN TIME

A full service
company providing...

- Consultation
- Engineering & Design
- Installations
- Training

Serving...

- Cable Systems
- Corporate Facilities
- Broadcast Facilities
- Teleproduction Facilities

178 Casterline Road • Denville, NJ 07834 • (212) 431-7453

Consultation Services

Lightning • Power Conditioning • Grounding
Over 40 years experience, work guaranteed

Roy Carpenter
President

Lightning Eliminators and Consultants
13007 Lakeland Rd. Santa Fe Springs, CA 90670
213/946-6886 TWX 910/946-1361

Franklyn R. Beemish & Co.

Engineering for the Video, Motion Picture & Recording Industries

VIDEO POST, BROADCASTING, CONFERENCE CTRS, THEATERS, RECORDING

FACILITIES AND SYSTEMS DESIGN & IMPLEMENTATION
ANALOG & DIGITAL VIDEO AUDIO HDTV

ARCHITECTURAL ENGINEERING
ELECTRICAL, HVAC, ACOUSTICAL

574 Sunrise Highway, Baldwin, NY 11510 516/867-8510

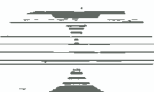

CHUCK JONES
ANTENNA SYSTEMS
SPECIALIST
618-564-2481

SOUTHERN ILLINOIS ANTENNAS

UNUSED
CALL LETTERS
CALL
dataworld®
1-800-368-5754

BROADCASTING CONSULTANTS AND ENGINEERS

- FCC Applications and Field Engineering
- Frequency Searches and Coordination
- Tower Erection and Maintenance
- Facility Design and Construction

Contact:
KENNETH W. HOEHN
23400 Michigan Avenue
Dearborn, MI 48124

Telatech, Inc.
(313) 562-6873

340 WEST 55TH ST., NEW YORK, NY 10019 (212) 769-4660



System Design
Studio Planning
Teleconferencing

**IDEA
DIMENSIONS
ORGANIZATION LTD.**

Broadcast Engineering Consultants

Hall Electronics Broadcast Equipment & Components

- We sell quality used radio broadcast equipment with 30 day warranties & economical prices.
 - We buy used equipment.
 - SEND FOR FREE FLYER!
- P.O. Box 7732
Charlottesville, Va. 22906
(804) 973-8697

PRO/INDUSTRIAL VIDEO REPAIR

- RAPID TURNAROUND OF VO5850's AND VO5800's
- GUARANTEED REPAIRS
- UPS PU/DEL DAILY ON SITE PREVENTIVE MAINTENANCE SERVICES IN NORTHERN CA. AREA

(415) 391-2640

VIDEO TECHNICAL SERVICES

511 Sir Francis Drake Blvd., Greenbrae, CA 94904

Classified

SAVE
TIME

For fast, accurate service, please remove the peel off label used to address your magazine, and attach it to the Reader Service Card, the Address Change Card or to any correspondence you send us regarding your subscription.

Advertising rates in Classified Section are \$1.50 per word, each insertion, and must be accompanied by payment to insure publication.

Each initial or abbreviation counts a full word. Minimum classified charge, \$35.00.

For ads on which replies are sent to us for forwarding (blind ads), there is an additional charge of \$40.00 per insertion, to cover department number, processing of replies, and mailing costs.

Classified columns are not open to advertising of any products regularly produced by manufacturers unless used and no longer owned by the manufacturer or distributor.

TRAINING

FCC GENERAL RADIOTELEPHONE operators license through cassette recorded lessons at home plus one week seminar in Boston, Washington, Detroit or Philadelphia. Our twentieth year teaching FCC license courses. Bob Johnson Radio License Preparation, 1201 Ninth, Manhattan Beach, Calif. 90266. Telephone (213) 379-4461. 8-81-1fn

NAPA VALLEY COMMUNITY COLLEGE: After High School or military Tech school, learn television studio equipment repair. Napa, CA. 94558 (707) 253-3000. 6-88-3f

SERVICES

AUDIO AUTOMATION: Computer controlled, 8-CD changers, music and commercial program software, hard disc for commercials. Complete: \$6900. BGM INTERNATIONAL, (904) 438-8054. 7-71-1fn

TRANSMITTER TUBE REBUILDING SINCE 1941: 3CX2500, 4CX5000, 4CX15000 and many others. Write for details. FREELAND PRODUCTS INC., Rt. 7, Box 628, Covington, LA 70433. (504) 893-1243 or (800) 624-7626. 6-79-1fn

BATTERIES—ALL TYPES RECONDITIONED, REBUILT. Buy dead batteries, sell rebuilds. SATISFACTION GUARANTEED. THE ENERGY SOURCE, 1105 North Aviation Blvd., Manhattan Beach, CA 90266 (213) 546-2572. 6-88-1f

FOR SALE

FREE TCR100 and SPU with purchase of 2000 varying length TCR carts. Also available: 1 Quantel 5000 + two channel DVE, 2 RCA TK27 film chains, 1 RCA TR70B or C (your choice) quad machine, and 1 RCA TS4A switcher system. Please call Tom Bentsen at (301) 338-6455 for details. 6-88-2f

BROADCAST CRYSTALS: Save a bundle on guaranteed T12A or BH8 types in stock, tradeins taken. Also new crystals for oven holders for AM, FM and TV transmitters. 52 years in business! Eidson Electronic Co. (817) 773-3901. 6-88-1f

CHANNEL 3 ANTENNA. 5 bay Superturnstile, RCA-TF5CL. On ground ready to ship. Will need feedlines and sails. Negotiable. WPSX-TV, Penn State University, (814) 865-1423. 6-88-1f

HALL ELECTRONICS has several ITC cart machines from \$395-\$1,695. All equipment guaranteed. Much more available! We buy used equipment. Send for flyer. Hall Electronics, P.O. Box 7732, Charlottesville, Va. 22901 (804) 973-8697. 6-88-1f

CONRAC MONITORS, Model 5411-RS-19, 19 inch rack mount. Industries best at half the price. New condition. Will warranty, ship and insure. \$950.00 per unit, 17 in stock, call (907) 563-8588. 6-88-1f

WANTED TO BUY

HIGHEST PRICES for 112 Phase Monitors, vacuum capacitors and clean, one kw or greater powered AM and FM Transmitters. All duty and transportation paid. Surplus Equipment Sales, 2 Throncliffe Park Dr., Unit 28, Toronto, Canada M4H 1H2, 416-421-5631. 3-86-1fn

POSITION WANTED

E.N.G. MAINTENANCE ENGINEER/SUPERVISOR Sony trained on Umatic and Betacam format's. Experienced in analog, digital and RF. Contactable: P.O. Box 641242, Kenner, LA 70064. 6-88-1f

SEEKING MAINTENANCE SUPERVISOR, instructor, chief position, 12 years broadcast/education maintenance and production experience. M.A. higher education administration. FCC General Class. SBE certified. Contact: C.D.P., P.O. Box 6264, Surfside, FL 33154. 5-88-2f

CAREER OPPORTUNITIES

WE PLACE ENGINEERS

CHIEFS, ASST. CHIEFS, MAINTENANCE TECHNICIANS, EDITORS, GRAPHICS

America's Leading Source for a Decade

ITV STATIONS, PRODUCTION FACILITIES, CORP. TV., MFG.

For information phone or write Mark Kornish



KEY SYSTEMS

479 Northampton Street
Kingston, PA 18704

Employer
Paid Fees

(717) 283-1041

HELP WANTED

TELEPORT CONTROL TECHNICIAN New Orleans Teleport looking for fast thinking, creative, intelligent individual for Master Control Operations. Broadcast Master Control experience necessary. Electronics a plus but not necessary. Responsibilities include on air operations, light tape machine maintenance, control of "on air" satellite delivered video, voice, data, international traffic. Resume and salary history to: New Orleans Teleport, 1047 World Trade Center, NOLA 70130, Attn: Director of Engineering. 6-88-3f

MAINTENANCE ENGINEER New Orleans Teleport looking for bright, creative, intelligent individual to fill position as Maintenance Engineer. Will be responsible for Maintenance, Repair and Installation of Equipment. Knowledge of Ku-Band, C-Band technology, as well as broadcast facility operations and Repair of Broadcast Equipment necessary. Uplink-Downlink experience also necessary. Resume and Salary history to: New Orleans Teleport, Inc., 1047 World Trade Center, New Orleans, LA 70130, Attn: Director of Engineering. 6-88-3f

TV MAINTENANCE ENGINEER. Ever thought about working in Alaska? We are seeking a studio/ENG maintenance engineer with strong background in U-Matic, 1" VTR's, studio, ENG cameras. Send resume, references, salary history to: KTVA, 1007 W. 32nd Ave., Anchorage, AK 99503, Attn: Chief Engineer. EOE. 6-88-2f

HANDS ON CHIEF ENGINEER needed for AM & FM in Tallahassee, FL. Prefer 5 years minimum experience, SBE certification and strong technical background. FM soon to upgrade to 1400' tower facility. Send resume to: Bruce Timm, P.O. Box 1874, Tallahassee, FL 32302. 6-88-2f

TRANSTAR, the nation's leading satellite network, has openings for highly motivated individuals in our Engineering Department. Openings for studio engineer in Los Angeles, and an affiliate engineer with good communications skills in Colorado Springs. If working on the challenging leading edge of satellite and studio technology interests you, rush your resume to Larry Wilson, VP/Engineering, TRANSTAR Radio Network, 660 Southpointe, Ct., Ste. 200, Colorado Springs, CO 80906. M/F EOE. No calls, please. 6-88-1f

Classified

ABEKAS VIDEO SYSTEMS RESEARCH AND DEVELOPMENT ENGINEER—Strong interest in hardware and software for advanced digital video products. Ability and enthusiasm a must. Track record in digital video hardware or control software in "C" a plus. **TECHNICAL SUPPORT ENGINEER**—Based in Redwood City, CA. Responsible for providing technical support and troubleshooting assistance for our customers over the telephone. Applicants must have prior electronics work experience and knowledge of digital video products. **PRODUCT ENGINEER (Manufacturing)**—Responsible for taking prototype from engineering into manufacturing. Provide technical interface between engineering, marketing, technical support and manufacturing. Must have prior electronics work experience and knowledge of digital video products. Applicants: Send resume with cover letter explaining position desired to: **ABEKAS VIDEO SYSTEMS/Mail Stop 60/P.O. Box 3659/Redwood City, CA 94064.** 6-88-11

TRANSMITTER MAINTENANCE SUPERVISOR Minimum 10 years experience maintaining and operating VHF and/or UHF Transmitters and related microwave equipment. Familiar with the installation and maintenance of translator equipment helpful. Send resumes to: **Ralph Lee/Chief Engineer, KSTP-TV ENGINEERING DEPT., 3415 University Ave., Minneapolis, MN 55416.** Equal Opportunity Employer M/F. 6-88-11

MAINTENANCE ENGINEER—PBS The Public Broadcasting Service has an immediate opening for a person to service, maintain and troubleshoot broadcast electronic equipment down to the component level. Qualifications are: A.A.S. degree in Electronics Technology, or equivalent training; minimum two years full-time successful work experience in electronic maintenance of broadcast equipment. Must be current and competent in the operation, troubleshooting, general repair, and installation/construction of state-of-the-art broadcast equipment. Must have experience with 1 inch tape machines: VPR-3 or BVH-2000. Other areas of responsibilities: Sony VTRs 800, 200, 5600; Editors ACE, BVE 5000, 800; Bosch router, automation systems, and production switchers. PBS offers a salary commensurate with experience and an excellent benefits package. Please send letter of interest, resume, and salary requirements to: **PBS, Attn: Carla A. Gibson, 1320 Braddock Place, Alexandria, VA 22314.** EOE/AA 6-88-11

VIDEO ENGINEER Growing customer base requires us to increase our technical staff. Minimum requirements: 2 year maintenance experience in broadcast and industrial video systems and 2 year electronic degree. Suburban Chicago location. All replies confidential. Send resumes to: **Video Images, 1121 West Tower Lane, Bensonville, IL 60106.** Attention: **Horace Dawson.** 6-88-11

CHIEF ENGINEER: A staff position providing strong consultancy duties to top management. Included in these duties will be the development of engineering policies and the promulgation of technical planning for the network; the establishment of guidelines for equipment purchases; the evaluation and recommendation of management systems for the technical operations of the network (i.e., air, production, maintenance, distribution); and providing representation and leadership for the network at the state and national levels. Bachelor's degree in Electrical Engineering preferred plus a minimum of five years' experience at high supervisory level in a production/broadcast facility comparable to KET. DOE. Send resume to the following: **Ray Sullivan, Personnel Administrator, KET, 600 Cooper Drive, Lexington, KY 40502, (606) 233-3000, ext. 330.** 6-88-11

TV TRANSMITTER MAINTENANCE ENGINEER Fox Television, KRIV in Houston is seeking a qualified transmitter maintenance engineer with strong background in RF. Previous experience with Harris TV-110U UHF transmitter preferred. Modern well equipped facility. Please send resume to **KRIV-TV, P.O. Box 22810, Houston, Texas 77227, Attn: V/P Chief Engineer.** No phone calls. E.O.E. 6-88-11

MAINTENANCE ENGINEER: Northern California TV station needs hands on person with state of the art systems knowledge including UHF transmitters. Must be a self starter. Chance for advancement. Send resume and salary requirements to **Director of Engineering, Broadcast Engineering, P.O. Box 12901, Overland Park, KS 66212, Dept. 698.** 6-88-11

MAINTENANCE ENGINEER FOR ORAL ROBERTS TELEVISION PRODUCTIONS needed. Experience in repair of broadcast video and audio equipment required. Satellite uplink and microwave experience a plus. Please send resumes to: **Bill Lee, P.O. Box 2187, Oral Roberts TV Production, Tulsa, OK 74171** EOE. 6-88-21



REPRINTS

Interested in ordering article reprints out of this or another issue? * Reprints can be excellent learning tools for your technical staff and great marketing tools for your sales staff. Call or write **Cynthia Sedler at Intertec Publishing Corp., P.O. Box 12901, Overland Park, KS 66212; (913) 888-4664.**

*Minimum order 1,000 copies

Advertising sales offices

CHICAGO, ILLINOIS

Tora Nilsen
Telephone: (312) 435-2361
Telefax: (312) 922-1408
55 East Jackson
Ste. 1100
Chicago, IL 60604

SANTA MONICA, CALIFORNIA

Herbert A. Schiff
Telephone: (213) 393-9285
Telefax: 213/393-2381
Jason Perlman
Telephone: (213) 458-9987
Telefax: 213/393-2381
Chris Woodbury-Leonard
Telephone: (213) 451-8695
Telefax: 213/393-2381
Schiff & Associates
501 Santa Monica Blvd., Ste. 504
Santa Monica, CA 90401

TOKYO, JAPAN

Masuyoshi Yoshikawa
Orient Echo, Inc.
1101 Grand Maison
Shimomiyabi-Cho, 2-18
Shinjuku-ku, Tokyo 162, Japan
Telephone: (03) 235-5961
Telex: J-33376 MYORIENT

NEW YORK, NEW YORK

Diane Gattlieb-Klusner
Telephone: (212) 702-3404
Telefax: (212) 702-7802
David W. Frankel
Telephone: (212) 702-3405
Telefax: (212) 702-7802
866 Third Ave.
New York, NY 10022

OXFORD, ENGLAND

Nicholas McGeachin
Intertec Publishing Corp.
Roseleigh House
New Street
Deddington
Oxford OX5 4SP
England
Telephone: (0869) 38794
Telefax: (0869) 38040
Telex: 837469 BES G

FREWVILLE, AUSTRALIA

John Williamson
Hastwell, Williamson, Rep. Pty. Ltd.
409 Conyngham Street
Frewville 5063
South Australia
Phone: 799-522
FAX: 08 79 9735
Telex: AA87113 HANDM



© 1988. All rights reserved.

Ad index

	Page Number	Reader Service Number	Advertiser Hotline		Page Number	Reader Service Number	Advertiser Hotline
A.F. Associates Inc.	103	69	213/466-5066	Monroe Electronics, Inc.	146	98	716/765-2254
A/V Broadcast China	161	107		Moseley Associates Inc.	63	44	806/968-9621
Abekas Video Systems	37	23	415/571-1711	Narda Microwave	123	85	516/231-1700
ADC Telecommunications, Inc.	113	77	612/893-3010	NEC America Inc.	137	93	312/860-7600
Advanced Video Associates	122	84	415/792-8684	Odetics, Inc.	129	88	800/243-2001
Alexander Mfg. Co.	36	22	800/247-1821	Omega International	178	120	714/553-0564
Alpha Audio	175	117	804-358-3852	Opamp Labs Inc.	180	125	213/934-3566
Amber Electro Design Inc.	110	74	800/361-3697	Orban Associates Inc.	7	7	800/227-4498
Amperelex Electronic Corp.	82-83	55	401/762-3800	Orban Associates Inc.	17	12	800/227-4498
Ampex Corp. (AVSD)	39	24	415/367-2911	Otari Corp.	15	11	415/592-8311
Ampex Corp. (MTD)	47	29	415/367-2911	Otari Corp.	127	87	415/592-8311
Anvil Cases, Inc.	52	34	818/575-8614	Paltex Inc.	143	96	714/838-8833
Arrakis Systems, Inc.	33	19	303/224-2248	Panasonic Industrial Div.	80B-80C	53	201/348-7671
Arrakis Systems, Inc.	21	14	303/224-2248	Panasonic Pro Industrial Video	40-41	25	201/348-7671
Audio Accessories, Inc.	178	121	603/446-3335	Panasonic Pro Industrial Video	43	26	201/348-7671
Audio Precision	159	106	800/231-7350	Perrott Engineering	94	62	702/532-0700
Audiolab Electronics	190	135	916/485-0500	Pesa Electronica S.A.	191	138	800/872-7372
Auditronics, Inc.	117	79	901/362-1350	Potomac Instruments	132	90	301/589-2662
AVEC	122		412/923-2070	QEI	183	127	800/334-9154
Belar Electronics Laboratory Inc.	180	123	215/687-5550	Quanta Corp.	96	64	801/974-0992
Beyer Dynamic Inc.	55	37	516/935-8000	Quantel Ltd.	131	89	415/856-6226
Bogner Broadcast Equipment Corp.	87	58	516/997-7800	Quickset International, Inc.	194	142	800/247-6563
Boonton Electronics Corp.	49	31,32	201/584-1077	Ram Broadcast Systems Inc.	176	153	516/832-8080
Broadcast Audio Corp.	157	105	916/635-1048	Ramsa/Panasonic	79	52	714/895-7277
Broadcast Technology of Colorado	180	124	303/641-5503	Rank Cintel Inc.	54	36	312/426-2450
Broadcast Video Systems Ltd.	192	140	416/764-1584	RF Technology	184	128	203/866-4283
Cablewave	81	54	203/239-3311	ROH	191	137	800/262-4671
Canon USA Inc., Broadcast Lens	56-57	38	516/488-6700	Rhode & Schwarz, Inc.	69	46	301/459-8800
Centro Corp.	75	49,50	619/560-1578	Ross Video Ltd.	147	100	613/652-4886
Cetec Vega	85	56	818/442-0782	RTS Systems, Inc.	58	39	818/843-7022
Christie Electric Corp.	110	73	213/320-0808	Rupert Neve, Inc.	133	91	203/744-6230
Cipher Digital, Inc.	102	68	301/645-0200	S.C.A. Data Systems Inc.	173	114	213/452-2506
Circuit Research Labs, Inc.	13	10	800/535-7648	S.W.R. Inc.	190	136	603/529-2500
Clear-Com Intercom Systems	59	40	415/861-6666	Sachtler Corp. of America	19	13	516/867-4900
Comark	53	35	215/822-0777	Shively Labs	196	148	207/747-3327
Compusonics	165	109	415/494-1184	Shure Brothers Inc.	IFC	1	312/866-2553
Comrex Corp.	44	27	617/443-8811	Sigma Electronics Inc.	177	119	717/569-2681
Cycle Sat.	98-99	66	800/622-1865	Sony Corp of America (A/V & Pro Aud)	189	133	800/662-SONY
Dalsat	109	72	214/548-7561	Sony Corp of America (Broadcast)	26-27	16	800/662-SONY
Delta Electronics	60	41	703/354-3350	Sony Corp. of America (Broadcast)	25		800/662-SONY
Diless International	151	102		Sony Mag. Tape Div.	88-89	59	201/930-7669
DKW Systems Inc.	195	146	403/426-1551	Sound Technology	35	21	408/378-6540
E E V, Inc.	125	86	914/592-6050	Standard Tape Laboratory, Inc.	180	126	415/786-3546
Eastman Kodak Co.	119	81	212/930-7500	Studer Revox America Inc.	34	20	615/254-5651
Electro-Voice	181	149	616/695-6831	Studer Revox America Inc.	171	113	615/254-5651
ESE	193	141	914/592-6050	Surcom Associates Inc.	174	115	619/722-6162
For-A Corp. of America	155	104	213/402-5391	Switchcraft Inc.	139	94	312/792-2700
Fujinon Inc.	101	67	201/633-5600	Tascam Div. Teac Corp. of America	45	28	213/726-0303
Full Compass Systems	196	147	800/356-5844	Tech Labs, Inc.	174	116	201/944-2221
GE Commercial Indust'l Light	104-105	70		Techni-Tool, Inc.	195	145	215/825-4990
Gentner	62	43	801/268-1117	Tektronix Inc.	50-51	33	800/452-1877
Graham-Patten Systems Inc.	112	76	800/547-2489	Telemetrics Inc.	118	80	201/427-0347
Grass Valley Group, Inc.	9	8	916/273-8421	Television Technology Corp.	95	63	303/665-8000
Gray Engineering Laboratories	146	99	912/883-2121	Telex Communications, Inc.	187	132	612/887-5550
Harris Corp.	111	75	800/442-7747	Telex Communications, Inc.	135	92	612/887-5550
Hitachi Denshi America Ltd.	3	4	800/645-7510	Telex Communications, Inc.	145	97	612/887-5550
HM Electronics	121	82	619/578-8300	Tentel	185	129	800/538-6894
Ikegami Electronics Inc.	97	65	201/368-9171	TFT, Inc.	141	95	408/727-7272
JVC Company of America	64A-64J	200	800/582-5825	Thermodyne International Ltd.	170	112	213/603-1976
K&H Products Ltd.	192	139	802/442-8171	Thomson Video Equipment	167	110	203/324-1320
LDL Communications	86	57	301/498-2200	Total Spectrum Manufacturing, Inc.	31	18	914/268-0100
Leader Instruments Corp.	5	5,6	800/645-5104	Utah Scientific Inc.	66-67	45	800/453-8782
Leitch Video of America, Inc.	IBC	2	804/424-7290	Varian	72-73	150,151	415/592-1221
Liberty Broadcast Network	185	130	804/845-4146	Video Accessory Corp.	194	143	303/443-4950
LPB Inc.	48	30	215/644-1123	Video Display Corp.	169	111	800/241-5005
3M Magnetic Media Div.	162-163	108	800/328-1684	Videotek, Inc.	91	60	602/997-7523
M/A-Com Mac Inc.	107	71	617/272-3100	Videotek, Inc.	93	61	602/997-7523
Magni Systems, Inc.	11	9	503/626-8400	Vinten Equipment Inc.	149	101	516/273-9750
Marconi Instruments	61	42	800/233-2955	Vinten, W. Ltd.	114-115	78	818/767-0306
Matthews Studio Equipment	190	134	818/843-6715	Ward-Beck Systems Ltd.	BC		416/438-6550
McCurdy Radio Industries	77	51	416/751-6262	Winsted Corp.	195	144	800/447-2257
MCL, Inc.	179	122	312/759-9500	Yamaha International Corp.	29	17	
Microdyne Corp.	71	47	904/687-4633				
Microtime, Inc.	153	103	800/243-1570				
Midwest Communications Corp.	1	3	800/543-1584				
Mohawk Wire & Cable	80	118	800/422-9961				

STILLS AT WILL



STILL MANAGEMENT AT YOUR FINGERTIPS

Discover the marvels of
Leitch Video's new **STILL FILE**

Capable of storing up to 10,000 stills, retrievable in a FLASH, this flexible video still store delivers powerful still management at your fingertips. Ease of operation is ensured with a compact control panel, single key functions and on-line help. Stills can be individually compressed, repositioned and bordered. Furthermore, multiple STILL FILE systems can exchange stills over a data network, and a complete tape backup and restore system allows stills and their descriptions to be archived conveniently.

All this with Leitch high quality video specifications. For a versatile production tool that gets the picture every time – look into a STILL FILE today!



LEITCH



STILL FILETM

Leitch Video International Inc., 10 Dyas Rd., Don Mills, Ont., Canada M3B 1V5 – Tel: (800) 387-0233 Fax: (416) 445-0595 Telex: 06-986241
Leitch Video of America, Inc., 825K Greenbrier Circle, Chesapeake, VA 23320 – Tel: (804) 424-7920 or (800) 231-9673 Fax: (804) 424-0639

Circle (2) on Reply Card

WBS
MicroCOM II
Communications System

- 1... Create or Edit a Matrix Index file.
- 2... Create or Edit a Terminal Assignment file..
- 3... Create or Edit a Terminal Group file.
- 4...
- 5... Create or Edit a Block file.
- 6... Create or Edit an IPR file.
- 7... System Utilities.
- 8... Transfer files to system.
- 9... Read files from system.
- 0... Help documentation.

To select, enter the number of the desired item from the menu and press ENTER.



MicroCOM II ... Clearly the industry's most advanced Communications System ...

With its superior design and advanced PC based software, MicroCOM II moves communications technology a whole generation forward, outperforming all the rest by a significant margin.

While some of its qualities are readily apparent, the full scope of its capabilities are best appreciated in actual operation . . .

- * Dot matrix alpha-numeric multi-colored readouts identify functions
- * All keys are programmable from both the PC and the terminals
- * Unique tactile switches enhance simple rapid operation
- * Reconfiguring does not interrupt system communications
- * Menu-driven program is simple to operate
- * On-line system operation is totally independent of the computer
- * Ultra high speed microcontrollers provide faster response
- * Matrix is expandable to 960 x 960 and beyond
- * Self-initializing system operates without power backups.

But this is just the tip of the iceberg . . . talk to us . . . we'll be glad to reveal the additional power of features still beneath the surface!



WARD-BECK SYSTEMS

Ward-Beck Systems Ltd., 841 Progress Avenue, Scarborough, Ontario, Canada M1H 2X4.
Tel: (416) 438-6550. Fax: (416) 438-3865. Tlx: 065-25399.