

BROADCAST[®] engineering

September, 1979/\$10.00

1979 BUYERS' GUIDE ISSUE

*The broadcast industry's
comprehensive product directory*

331550 272 800 0007 27
016 R MEYERS C004
UNITED RADIO NETWORK PRES
4700 SW 75 AVE
MIAMI FL 33155

Wherever reliability, transparency, power and size conservation are of critical importance, NEC's Television Routing Switcher takes first place honors. The TKA-105 is capable of behind the scene operation in any 60X60 matrix or larger application, from fixed station to Olympic coverage.

All audio signals are digitized in the TKA-105, with provisions for up to 4 discrete audio channels for each video input. Major design advancements include 8X1 crosspoint chips,

1980 Olympics

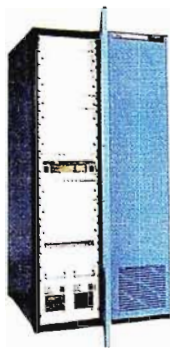

1X6 video distribution amplifier chips, and full micro-processor logic in every controller. Optional NTC-7 VITS signals may be added asynchronously to

each input for automatic signal verification. Controllers are available in a variety of styles including touch-pad with the ability to select any of the four audio channels and perform A/B comparisons.

The TKA-105 Switcher offers performance specifications far superior to the equipment signals it routes, and is capable of outside data interface, permitting computer,

mini-computer, or microcomputer switching commands plus switch station feedback loops. Whatever events you want to cover you can "make the scene" thanks to LSI technology, from NEC, the world's leading manufacturer of semi-conductors.

Call Toll Free 800-323-6656 24 hours a day. In Illinois call 312-640-3792.

NEC

Nippon Electric Co., Ltd.

NEC America, Inc.

Broadcast Equipment Division

130 Martin Lane

Elk Grove Village, Illinois 60007

Circle (1) on Reply Card

NBC will be using the TKA-105 in their coverage of the Moscow Olympic Games in 1980.

THE SCENE MAKER





Jane Kaelber
Drum Alignment
5 years



Velma Cowan
Tip Winding
8 years



Bill Townsend
Contour
5 years



Bob White
Tip Inspection
6 years



Virginia Jensen
Marketing
Administration
5 years



Pat Ladaga
Assembly
6 years

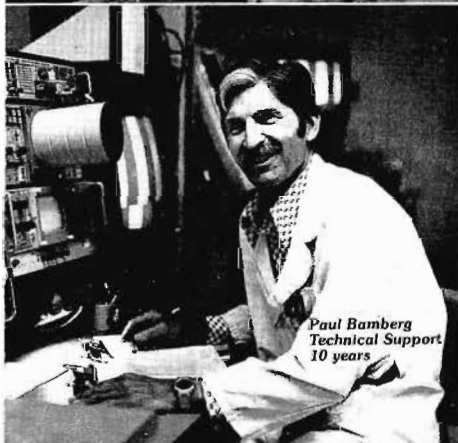

Paul Bamberg
Technical Support
10 years



Rose Underwood
Preliminary
Quota
10 years

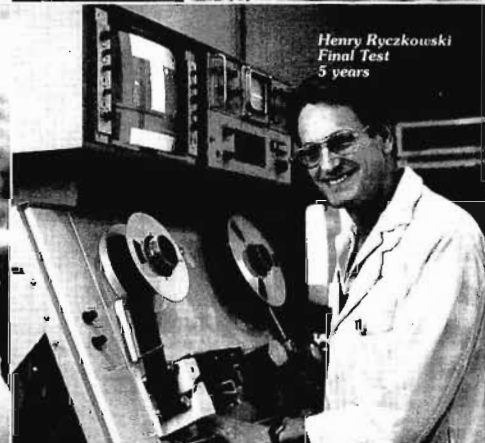

Henry Ryzkowski
Final Test
5 years

Put your heads in the most capable hands in the industry.

Our Years of Technical Expertise Have Made Us The World's Largest Independent Head Refurbisher

Over 10 years and 18,000 video heads ago, we decided we were going to be the leading independent in quad head refurbishing. To accomplish this, we knew we had to do things better than Ampex and RCA. Our location in the center of U.S. video technology made it possible for us to put together a marvelous marriage of people and technology. It also made it possible for us to achieve our goals.

Many of our technical experts and production people have been with us from the beginning. It's people like this, with their special skills, who put their heads together to provide over 1,000 customers all over the world with the most technically perfect refurbished video heads and the finest service support anyone could possibly ask for.

To learn how our experience can help you keep your quads in top shape, write or call, VIDEOMAX, 3303 Scott Boulevard, Santa Clara, CA 95050, (408) 988-2000, Telex: 910-338-0554. Los Angeles (213) 980-7927, New York (212) 947-8031, Atlanta (404) 992-4490.

Sales and service representatives in Canada, Australia, Hong Kong, Argentina, Mexico, Japan and Germany

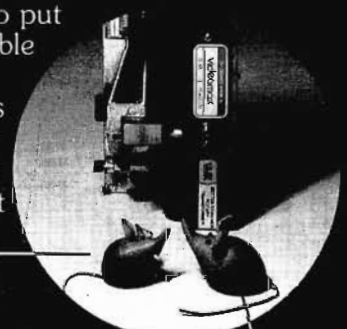

Max:
"My goodness,
all those people
to do just
one job?"

Maxine:
"That's only
a small part.
There are
nearly fifty
altogether."

videomax[®] ORROX

Circle (4) on Reply Card

BROADCAST engineering

The journal of broadcast technology

September, 1979 □ Volume 21 □ No. 9

- 8 Feedback
- 12 Industry news
- 32 Business news

Association news

- 48 National Association of Broadcasters
- 52 National Radio Broadcasters Association
- 58 American Society of Television Cameramen
- 62 State broadcasting organizations and other associations

- 68 People in the news
- 78 Meetings, events and seminars

BROADCAST ENGINEERING ANNUAL BUYERS' GUIDE

- 181 Introduction
- 182 Product Directory
- 228 Broadcast Product Manufacturers' Addresses
- 242 Broadcast Product Dealer/Distributors

- 86 World Administrative Radio Conference: Ten decisive weeks for the future of broadcasting / telecommunications
- 96 Technical achievements in producing Live from Lincoln Center
By Donald W. Redall, Broadcast Engineering correspondent
- 110 Introductory digital circuits, Part 2: Logic circuits and simplification
By Dr. Ron Jetton, Bradley University, Peoria, IL
- 122 National Radio Broadcasters Association 6th Annual Conference & Exposition
- 130 Circular polarization (CP) field tests
By Bill Loveless, chief engineer, Bonneville International

STATION-TO-STATION

- 134 Tape recorder air-checks programming
By John Shepler, chief engineer, WROK / WZOK, Rockford, IL
- 134 Back in action with improvised horn feed
By Steve Flyte, ENG engineer, KATU, Portland, OR
- 138 2-tone attention signal broadcasting system
By Patrick Bryant, studio / theater engineer, ABC, Hollywood, CA
- 139 Building a digital lock
By John Linebarger, WREG-TV, Memphis, TN
- 140 An improved digital logic probe
By Edward P. Alciatore, III, weekend supervisor, WCKT-TV, Miami
- 144 The 150 Hz / 8kHz tone detector for cartridge machines
By Tom M. Cupp, broadcast operations engineer, WCTE-TV, Cookeville, TN
- 146 Transmission line pulser
By Victor Castens, KOAM-TV, Pittsburg, KS
- 147 Electret condenser mics
By Ian M. Evans, news director, KRCR-TV, Redding, CA

Hardware report.....	149	Classified ads.....	249
New literature.....	152	Advertisers' index.....	248
New products.....	159	Sales offices.....	249

Copyright, 1979, by Intertec Publishing Corporation. All rights reserved. Material may not be reproduced or photocopied in any form without written permission of publisher.



THE COVER

The 1979 Broadcast Engineering Buyers' Guide cover reflects the two major markets for manufacturers of broadcast equipment: television and radio.

Counter-clockwise from upper right, the cover depicts

- a simulated TV news studio as demonstrated at NAB'79 in Dallas (Photograph by Christopher Cave, One to One Photography, Dallas, TX);
- the Mt. Sutro transmitting tower which dominates the San Francisco skyline (Photograph by Don Lincoln, KPIX, San Francisco, CA);
- the WABC/Radio studios in New York (Photograph by Robert Deitsch, WABC/Radio, New York, NY); and
- a directional antenna array for radio (Photograph by Harris Corporation, Quincy, IL).

NEXT MONTH

- Preview of SMPTE and AES meetings
- TV automation: Case study of KOMO
- Audio processing: Keeping the sound clear and punchy
- Audio processing: Technology trends

Best In The Field

HITACHI SK-90

Outside the studio, the remarkable Hitachi SK-90 does it all. For EFP, it sports a studio style 5" viewfinder. All key functions can be controlled with your choice of Remote Operating Unit (ROU) or Digital Command Unit (DCU). For ENG, slip off the SK-90's studio viewfinder, slip on the 1.5" viewfinder and shoulder mount. Your SK-90 is now a compact, lightweight self-contained portable!

ENG with EFP image quality. And EFP with total remote control. SK-90 has the field covered!

**Hitachi...
Tomorrow's
technology
today.**

7 Regional Centers for 24-Hour
Parts and Field Service

- New York (516) 921-7200
- Chicago (312) 344-4020
- Los Angeles (213) 328-2110
- Atlanta (404) 451-9453
- Dallas (214) 233-7623
- Denver (303) 344-3156
- Seattle (206) 575-1680



HITACHI

Hitachi Denshi America, Ltd.

175 Crossways Park West
Woodbury, New York 11797

Circle (5) on Reply Card



Hitachi SK-90: portable ENG mode



Digital Command Unit (with coax/triax option)



Remote Operating Unit (features RGB out)

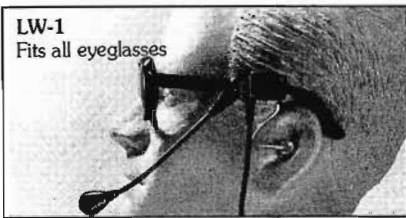

LW-1
Fits all eyeglasses

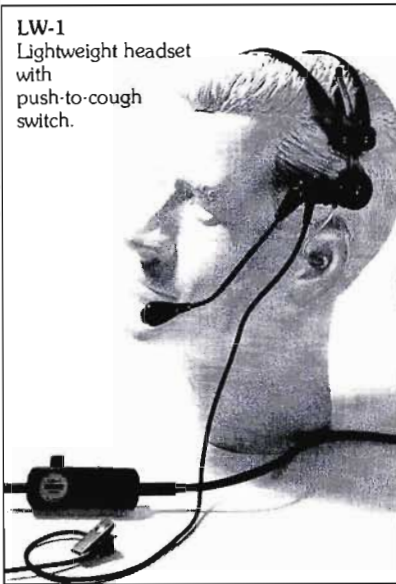

LW-1
Lightweight headset with push-to-cough switch.

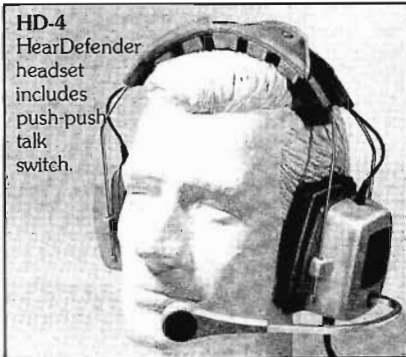

HD-4
HearDefender headset includes push-push talk switch.

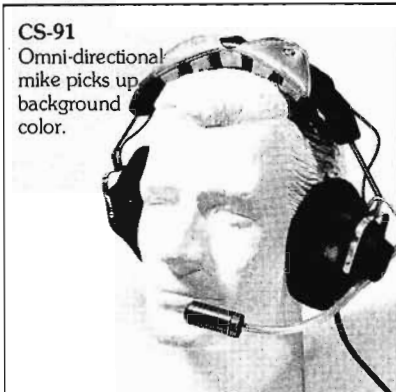

CS-91
Omni-directional mike picks up background color.

Play by play, Color or Interview... Sportscaster Headsets cover them all.

Sportscaster Headset CS-91

Perfect for booth, track or field or whenever you want background color and the excitement of a crowd added to the clear sound of an announcer's voice. Omni-directional dynamic mike. Binaural headphones receive cues and monitor program while screening out ambient noise. Equipped with "push-to-cough" switch.

Sportscaster HearDefender™ HD-4

For interviews in a speedway pit or play-by-play on the sideline, the announcer's voice cuts through the din with this noise cancelling electret mike. High noise attenuating monaural receivers deliver clear cues, monitor the program and eliminate the tendency to shout over the noise. His voice sounds crisp, clear and natural. Equipped with push-push talk switch.

Sportscaster Headset LW-1

In an open broadcast booth or in the hush on a tennis court, the announcer's natural voice is transmitted crystal clear with a close-talking, noise cancelling electret mike. Unobtrusive even on camera, this super lightweight single side receiver headset is worn with headband or clips to eyeglass bows. Unmatched for comfort and equipped with push-to-cough switch.

In the booth or in the crowd, on track, field or court, Telex Sportscaster headsets cover it all. Write for free information.

Quality Products for the Audio Professional



TELEX

9600 ALDRICH AVE. SO., MINNEAPOLIS, MN 55420 U.S.A.

Telephone: 612-884-4051, telex: 29-7053

EUROPE: 22, rue de la Légion-d'Honneur, 93200 St. Denis, France, Téléphone: 820-98-46, telex: 63-0013

CANADA: Telak Electronics, Ltd., 100 Midwest Road, Scarborough, Ontario M1P3B1, Telephone: 416-752-8575

Circle (6) on Reply Card

4 Broadcast Engineering September 1979

BROADCAST engineering

Editorial, advertising and circulation correspondence should be addressed to P.O. Box 12901, Overland Park, KS 66212 (a suburb of Kansas City, MO); (913) 888-4664.

EDITORIAL

Bill Rhodes, *Editorial Director*
John Williszowski, *Video Editor*
Cindy Nelson, *Managing Editor*
Joan Jackson, *Editorial Assistant*
JoAnn Vella, *Editorial Assistant*
Pat Blanton, *Directory Editor*

ART

Dudley Rose, *Art Director*
Joy Viscek, *Graphic Designer*

TECHNICAL CONSULTANTS

Howard T. Head, *FCC Rules*
Harold L. Kassens, *FCC Rules*
Carl Babcoke, *Technical*
Donald L. Markley, *Facilities*
Art Schneider, A.C.E., *Post-production*

CORRESPONDING ASSOCIATIONS

American Society of Television
Cameramen
National Association of Broadcasters
National Radio Broadcasters
Association

CIRCULATION

John C. Arnst, *Director*
Evelyn Rogers, *Manager*

ADMINISTRATION

George H. Seferovich, *President*
George Laughead, *Publisher*

ADVERTISING

Cameron Bishop, *Marketing Director*
Jan Winters, *Production Manager*

Regional advertising sales offices listed near the Advertiser's Index.



Member,
American Business Press



Member,
Business Publications
Audit of Circulation

BROADCAST ENGINEERING (USPS 338-130) is published monthly by Intertec Publishing Corporation, 9221 Quivira Road, P.O. Box 12901, Overland Park, KS 66212. Postmaster, return from 3579 to the above address.

BROADCAST ENGINEERING is edited for corporate management, engineers/technicians and other station management personnel at commercial and educational radio and TV stations, teleproduction studios, recording studios, CATV and CCTV facilities, and government agencies. Qualified persons also include consulting engineers and dealer/distributors of broadcast equipment.

SUBSCRIPTIONS: BROADCAST ENGINEERING is mailed free to qualified persons in occupations described above. Non-qualified persons may subscribe at the following rates: U.S., one year, \$20; all other countries, one year, \$26. Back issue rates, \$3, except for the September Buyers' Guide issue, which is \$10. Rates include postage. Adjustments necessitated by subscription termination at single copy rate. Allow 6-8 weeks for new subscriptions or for change of address. Controlled circulation postage paid at Kansas City, MO.



INTERTEC PUBLISHING CORP.

RECORTREC

777 PALOMAR AVENUE
SUNNYVALE, CA 94086
PHONE (408) 735-8821

NO, NO, NO!
WHEN I SAID "QUAD QUALITY"
I MEANT "TAKE THE HBU"



HBU-4400



You don't need a "gorilla" to carry the portable HBU-4400. It weighs only 22 lbs. without the battery and provides 10 full minutes of recording time per cassette. Cassettes are preferred for portable applications because you don't have to monkey around with reel-to-reel tape. High band "quad"

quality is achieved by tripling the head-to-tape speed of the U-format recorder and adding Recortec electronics to a transport with proven interchangeability. For reliability reasons the capstan and scanner speed increase is achieved without any change in motor rpm and, of course, all bearings are still well within their design limits.

And when you need a studio machine for playback and editing there is the HBU-2860 that will faithfully reproduce your high quality HBU tapes. We kept the 2860 remote control interface unchanged so it can work

HBU-2860



with your computerized editing system.

The HBU format is economical to own and economical to use. The HBU costs less than a third of machines of other formats with the same video quality. Tape costs are lower too. **CONCLUSION:** Buy the HBU and donate your "gorilla" to the zoo.

Other products from Recortec are: Video Tape Conditioners and Video Tape Evaluators for all tape widths, Video Cassette Evaluators, Video Tape Timers and Reel Servo Modifications (R-MODs) for quad recorders and Video Tape Addressors which record time code on two-inch tape at high speed.

Circle (7) on Reply Card

How can we convince is really a total

Perhaps we should begin by telling you that the Arvin-Echo Slo/Mo-1 is one of the best investments you can make.

It's a great investment because it will allow your staff to offer production techniques that add up to increased business. And increased business means Slo/Mo-1 will pay for itself in a short period of time!

Regardless of your activities—Sports, News, or Commercials—Slo/Mo-1 can make a big difference.

A difference like Animation! Imagine being able to incorporate Animation from any source into your productions!

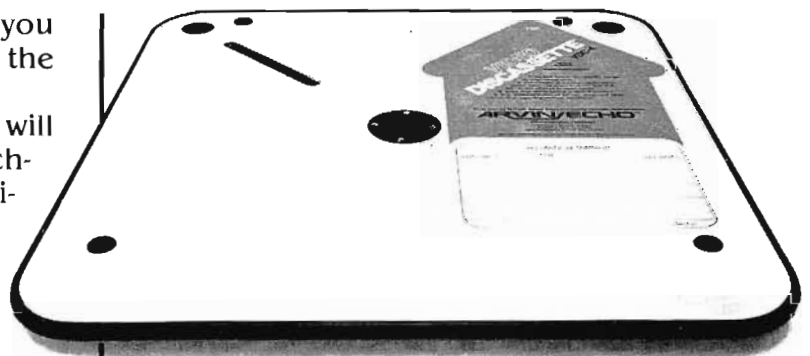

If that's not enough, let's add the fact that Slo/Mo-1 uses our unique Discassette[®] rather than a hard disc or 1" tape. Because it is a disc, it operates equally well in either forward or reverse. And that means even the most difficult editing job can be greatly simplified!

So add complete editing to Slo/Mo and Animation!

We don't call Slo/Mo-1 a production tool without good reason!

We set out to design the best Slo/Mo possible. And we built in the features that will make your productions stand out from the competition!

Features like *Field/Frame Select*, *Time Lapse Recording*, *Digital Comb Filter*, *High Band Color*. And configured to be so *small, rugged, and portable* that two men can easily transport it to almost any location. Plus Slo/Mo-1



Don't get wrapped up with 1!"

you that our Slo/Mo-1™ production tool?

is *expandable* to meet your system requirements!

So how can we convince you?

In addition to owning one of the best Slo/Mo's on the market, you'll be able to provide services, either in your studio or on location, that will make you Number One with viewers and customers.

Yet, now that we think about it, there's really only one way to convince you.

Give us a call today for a complete, no obligation demonstration and quotation on a lease or buy program!

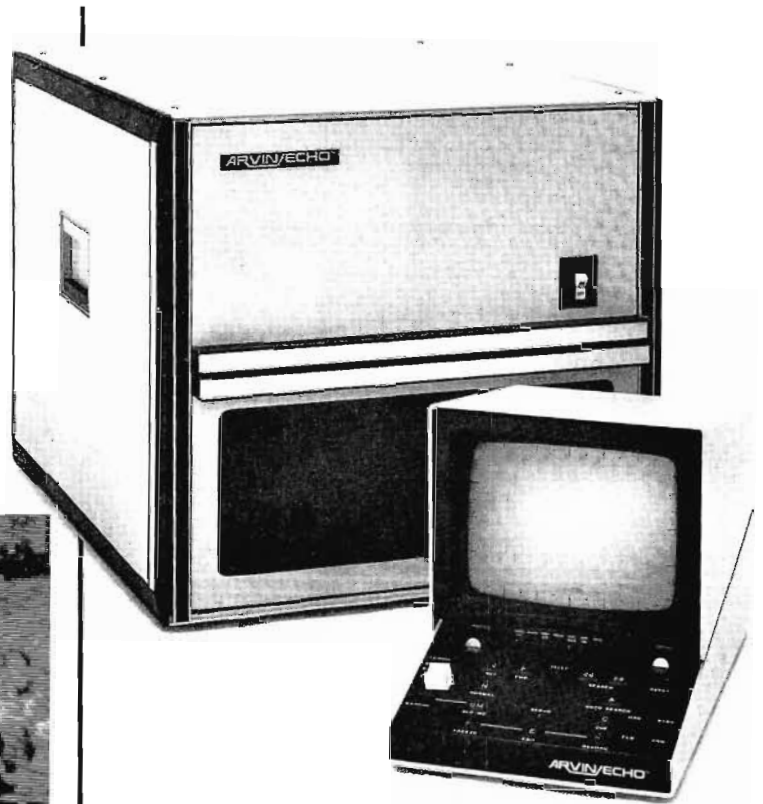

ask for the Disc Marketing Team

ARVIN/ECHO™

ECHO SCIENCE CORPORATION
an ARVIN company

485 E. Middlefield Road
Mountain View, California 94043

Tel: (415) 961-7145 TWX: 910-379-6499

Circle (8) on Reply Card

Feedback

Letters from readers, technical & miscellaneous notes, station & plant visits

Address letters to go in this column to Feedback Editor, P.O. Box 12901, Overland Park, KS 66212.

AM stereo: Which system?

I hope you have information on the situation of AM stereo broadcasting. KEZY Radio, licensee of KEZY/AM, would like to go to the stereo mode of transmission the day it is approved. To do so, we need advanced knowledge on the subject of which system or combination of systems the FCC is favoring, based on performance and technical compatibility with existing receivers.

I would really appreciate obtaining any papers or other literature at your immediate disposal.

Mark R. Mocerì
KEZY Radio
Anaheim, CA

Editor's note: Mark, the whole industry would like to know which way the FCC will rule. We will just have to wait and see. There are five systems being considered, and any one might get the FCC nod.

From Ontario

I was interested in the article in the February 1979 issue of **Broadcast Engineering** dealing with "FM antenna and line measurements."

The techniques and equipment setups described also have been successfully used in cable television. We have used the techniques on FM broadcast antennas as well. Recently we purchased a new HP

8568A spectrum analyzer system with controlling computer, digital plotter and printer and have found that it facilitates the measurements described. The excellent calibration and stability of modern electronic instruments remove the needs for the comparator setups described.

I. Switzer
Switzer Engineering Services
Mississauga, Ontario

"Doc" Herrold's station

The radio pioneer section in your May issue was of great interest.

You show the picture of Dr. Charles D. Herrold's pioneer station located on the roof of State Bank Building in San Jose. I turned that picture over to CBS along with the complete history of KQW-San Jose that was established by Dr. Herrold.

I pioneered KFWM in Oakland, CA, going on the air in February 1925, and in 1926 Dr. Herrold went to work for us at KFWM, having sold KQW at San Jose.

I organized, in 1927, the first network of stations to carry a coast-to-coast program from the West Coast. There were 300 stations carrying it in the United States, nine in Canada and four international shortwave.

Dr. Herrold successfully completed a microwave in

Well, Alex...

If Alexander Graham Bell had to choose between his own great invention and Moseley's new Telemetry Return Link, he might have a tough time. Bell, like many great inventors, was always open to new ideas. Moseley's reputation is built on new ideas and the TRL-1 is the most recent example.

Even if you are currently using an STL with a remote control system, you may still depend on either a phone line or your transmitter carrier for return telemetry.

Moseley's alternative, the

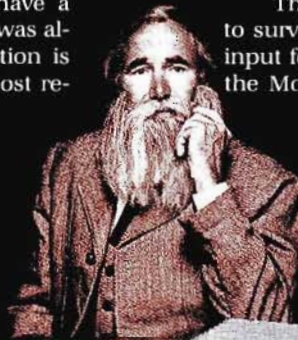

Model TRL-1, allows you to transmit telemetry data back to your control point on the 450 MHz band Remote Pick-up Link frequencies. No more dependence on phone lines and no more worries if your broadcast carrier goes down.

The TRL-1 even has an optional battery pack to survive loss of AC power and a separate MIC input for voice communication. Installation with the Models PCL-505/C, PCL-505 or PCL-101 STL systems and the new Model MRC-1 Microprocessor Remote Control provides an unbeatable, totally independent wireless combination.

Sound like a good idea? Alex would have thought so!

Pending FCC type acceptance.



MOSELEY ASSOCIATES, INC.

A Flow General Company

Santa Barbara Research Park, 111 Castillian Drive • Goleta • CA • 93017

(805) 968-9621 • Cable: MOSELEY • Telex: 658-448

See us at NRBA,
Booth 413-15.

Circle (240) on Reply Card



Model 1701A
Designed for lowest-distortion
Measurements (.0009% or > 100 dB)



Model 1710A
Designed for use
in strong RF fields



Model 1700B
Designed for general
measurement applications

When you need to know about distortion, pick from the analyzers that are easier, faster, and tell you more

The performance leader

When you talk to Sound Tech, you're talking to the firm that introduced a new era in improved distortion measurements with its 1700 Distortion Analyzer.

Now you can choose from three separate Sound Tech analyzers plus several options.

In Sound Tech Analyzers you can get conveniences that simply aren't available elsewhere—conveniences like these:

- **RMS, peak, and average-responding meter circuits.** Different standards require different type meter circuits

- **Higher sensitivity** — measure distortion as low as .0009%
- **Faster and more repeatable** — pushbutton frequency selection measures in 5 seconds
- **Balanced and bridging VM for measuring from 30 μ V to 300 V even on floating circuits**
- **Very-low distortion internal test oscillator with high output level of +26 dBm—adjustable down to -90 dBm in 0.1 dB steps**
- **Balanced, floating, center-tapped but transformerless output for low distortion**
- **Intermodulation distortion measuring option**

- **150-ohm and 600-ohm outputs**
- **Two-year parts and labor warranty**

See about our new easy purchase plan

We also have both an easy purchase plan and a lease plan that can help when budgets are running low.

So contact Mike Hogue/Larry Maguire now. Arrange for a demo and see how useful these analyzers are — not just for measuring distortion but as high-sensitivity balanced voltmeters and as low-distortion signal sources.

Call today.



SOUND TECHNOLOGY

1400 DELL AVENUE
CAMPBELL, CALIFORNIA 95008

In Toronto: The Pringle Group

Circle (9) on Reply Card

location lighting

Colortran's location lights are designed for ENG and film production. Their lightweight construction and compact design delivers maximum illumination for your production needs. Fill lights and variable focus spots are available in wattages from 500 to 1000 watts. 120, 220, and 240 volt lamps are available for all fixtures. Need location lighting? — Fill out the coupon for more information.

Berkey Colortran

Headquarters
1015 CHESTNUT STREET
BURBANK, CALIFORNIA 91502

International
P.O. BOX 5, BURRELL WAY
THETFORD, NORFOLK
ENGLAND IP24 3RB

DIVISION OF
Berkey
Photo Inc.

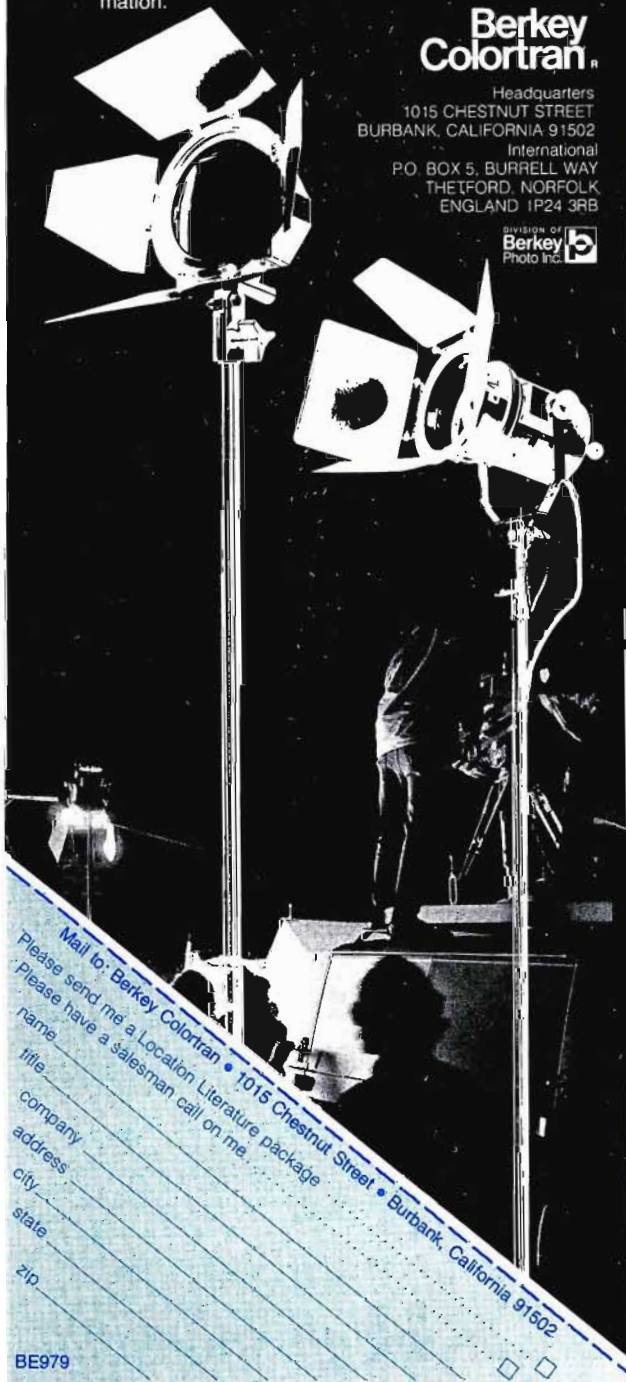

Mail to: Berkey Colortran • 1015 Chestnut Street • Burbank, California 91502

Please send me a Location Literature package

Please have a salesman call on me.

name _____

title _____

company _____

address _____

city _____

state _____

zip _____

BE979

Feedback

April, 1909. So, he used Victrola and Edison phonographs to play recorded music, plus a piano (he was a fine musician) on the first broadcast ever on earth of modern radio. On this day, the staff (as shown on page 98 of your May issue) began playing music and Dr. Herrold, standing in the studio door, announced the records DJ-style while the operator ran the records.

After about two hours of this, the first broadcast recorded in history, the telephone rang. It was the Mare Island Navy Yard. Mare Island's wireless operator asked, "Are you playing music on our wireless channel?" The answer was yes and the boys went wild.

I am 82 and still active managing my station KICO in the Imperial Valley.

W. L. Gleeson
President, KICO
Calexico, CA

From Illinois

Please allow me to hand you some flowers. Yours is one of the finest publications for our industry. When time allows, I read virtually every word, and very often save complete issues for future reference. Many thanks from a working engineer for a fine, up-to-date, and informative magazine.

E. Neil Pike,
WSIE,
Edwardsville, IL

From New York

Request you clarify circuit changes in steps 6 and 7 of Station to Station, "Transistors solve tube problems for 529" (**Broadcast Engineering**, December 1978). Both paragraphs indicate installation of a 10 μ F silver mica capacitor from pin 3 to V-264 socket to ground. I believe you meant to say V-164 in paragraph 6 and V-264 in paragraph 7.

S. Charles Campione
APO New York

Editor's note: The article was in error and thanks to Mr. Campione the error has been corrected.

From Illinois

This is a letter that I have been meaning to write to you for some time because it appears to be too good to be true.

As president of a communications consulting firm and a video production company, the Kapco Communications division, I need to know what developments are taking shape in the field of closed-circuit video. Because I'm intrinsically involved in the communications process, I also want to keep up with the broadcast and technical aspects of my business. Consequently, I read both *Video Systems* and **Broadcast Engineering** magazines and find them to be way above the quality of other like publications.

My only criticism is with the lack of a letters column. I think it would be great to have some method for feedback. Anyhow, keep up the good work!

Kenneth Rubel
K. L. Rubel and Associates,
Chicago, IL

We've got you covered...

24 hours a day. Every day!

Cinema Products wrote the book on after-sales backup and reliable service when we introduced our CP-16 line of news/documentary cameras to the television industry. And we're doing the same for our MNC-71CP broadcast-quality ENG/EFP video cameras!

When you buy an MNC-71CP, you are automatically covered by Cinema Products' outstanding around-the-clock video service program. Twenty-four hours a day. Seven days a week. Nothing offered by anyone else in the television industry even comes close!

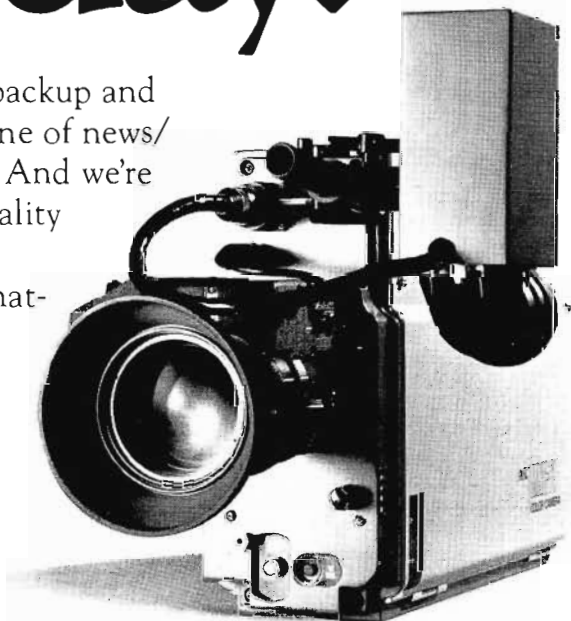

MNC-71CP
Manufactured by **NEC**
exclusively for Cinema Products.

Note and compare:

- ☑ The MNC-71CP is covered by a full one-year warranty — unprecedented in the broadcast industry! (And there's no service charge ever for warranty work.)
- ☑ Replacement parts available anywhere in the United States within 24 hours!
- ☑ Factory-sponsored MNC-71CP maintenance training seminars for your service technicians at no charge.
- ☑ An extensive network of MNC-71CP dealers in 15 locations around the country with "stand by" loaner/rental cameras... *just in case.*
- ☑ An easy-term "state-of-the-art" lease/upgrade program provides built-in insurance against obsolescence.

For full details, call toll-free: 800-421-7486.

cinema E products
CORPORATION

Technology In The Service Of Creativity

2037 Granville Avenue, Los Angeles, California 90025
Telephone: (213) 478-0711 • (213) 477-1971 • Telex: 69-1339

FCC rearranges and adds to broadcasting rules in "reregulation" effort

With the death of the Communications Act rewrite, H.R. 3333, and little hope held out for Senate bills S-611 and S-622, broadcasters must rely on the mercy of the FCC for any deregulation. The commission expects to have its own proposals ready later this year. Until then, the commission has been pursuing a path it calls "reregulation," or restructuring the broadcast rules.

So far, the FCC has reshuffled its "Broadcast Applications and Proceeding" from Subpart D of Part 1 to Subpart H of Part 73 (substantially the same rules—different location); it has referenced some of its policies to its rules; and it has amended 32 separate rule sections of Parts 73 and 74.

The new amendments include the following.

- Delete the requirement for annual skeleton proof of AM station directional antennas used with remote control operation for all stations.

having approved antenna sampling systems;

- Permit AM stations to use the indirect method of power determination whenever there is a temporary malfunction of a remote reading, remote control or extension meter indication of antenna or common point current;

- Provide guidance in obtaining data necessary to correctly design approved sampling systems for AM directional antennas, with sampling transmission lines of unequal length;

- Clarify the technical requirements for TV remote control and failsafe circuits to avoid use of unnecessarily complex devices that could result in loss of program service to the public and unnecessary expense to station licensees;

- Resolve ambiguity in tolerance specifications for TV video waveform equalizing pulses, by redefining the tolerance in terms of duration rather than area of the pulse;

- Restructure and rewrite the rule on rebroadcasting of signals from other broadcast and non-broadcast stations with editorial corrections requested by the National Bureau of Standards and the Naval Observatory on the use of standard time signals;

- Permit the use of automatic Morse Code for station identification of remote pickup stations for licensees wishing to do so for operating convenience. The code identification procedures are identical to those adopted previously for stations in the Private Radio Services;

- Relax the station identification requirements for auxiliary broadcast stations to agree with previous relaxations in the AM, FM and TV rules;

- Clarify the operator and station identification requirements for fixed microwave links used by broadcast licensees. These stations may now operate fully unattended, similar to

SMPTÉ Edit Code Generator and Reader

Generator/Reader, Slave Gen, Edit Code/Computer Interface, Character Generator, Syndicated Tape Programmer

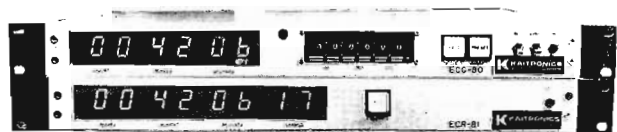

Single Line Broadcast Equipment Control System

Allows easy expansion and relocation of control of any number of film chains and VTRs in a TV studio.

Programmable Memory Control

A versatile instrument for any machine control application.



It provides 128 coincidence comparators, 8 control outputs for pre-programming any combination of operational sequences.

SMPTÉ edit code or clock time version.

Digital printout and keyboard entry (optional).

For further information, call
Paul Tarrodaychik
(408) 739-4262

KAITRONICS 1540 Gilbreth Rd., Burlingame, CA 94010 / TEL. (415) 697-9102

Circle (12) on Reply Card

MICROTIME

For Video Processing

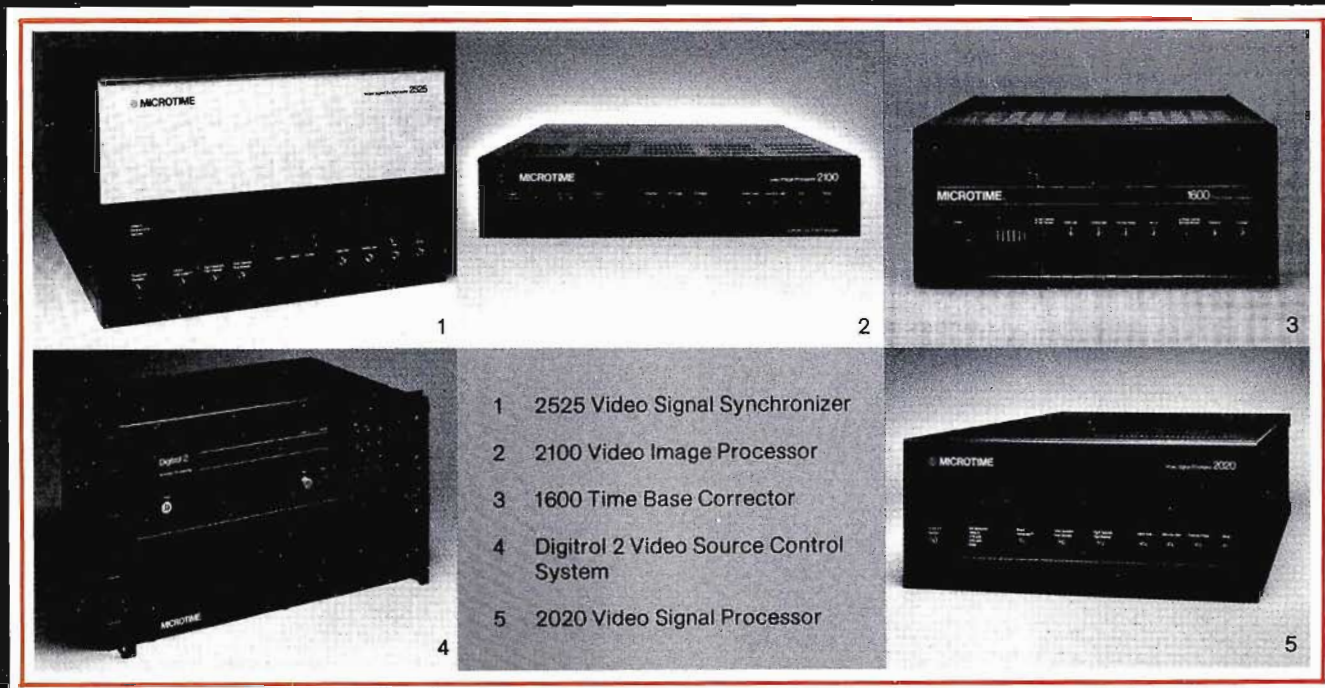

- 1 2525 Video Signal Synchronizer
- 2 2100 Video Image Processor
- 3 1600 Time Base Corrector
- 4 Digitrol 2 Video Source Control System
- 5 2020 Video Signal Processor

Microtime offers an entire range of video products for advanced Time Base Correction, Image Processing, Remote or Local Synchronizing, and Automated Programming for the Best pictures possible.

2525 Video Signal Synchronizer

Synchronizes any video source, 3/4" heterodyne, 2" quad, satellite feeds, to station sync. Provides field 1, field 2 or frame freeze for digital video effects. Auto freeze on last field of active video. Infinite H phase resolution and RS-170A Sync Generator for interfacing with any switcher.

2100 Video Image Processor

Provides 6dB video noise reduction in luminance and chrominance, horizontal and vertical detail improvement, chroma crispening and chroma hue error reduction. Automatic Chroma/Luminance delay compensation corrects chroma smear inherent in most heterodyne VTRs. Improves the overall picture quality of any video picture.

1600 CCD Time Base Corrector

The Standalone TBC uses charge-coupled device technology to provide high performance at low cost. 55 dB Signal-to-Noise Ratio, 4 H line correction range, Auto Trac 2 and automatic sync advance are standard.

Digitrol 2 Video Source Control System

Highly versatile automated programmer for use in studio applications, CATV automation, video tape duplication, automatic commercial insertion, editing control, and off-air recording and delay applications.

2020 Video Signal Processor

Time base corrects any video source using digital technology. 58 dB Signal-to-Noise Ratio, 4 H line correction range, Auto Trac 2 and automatic sync advance are standard. Line Error Detection, Velocity Correction, 24 H line Wide Window correction range, Dropout Compensation, Image Processing and Noise Reduction Options are available to fit your particular needs.

All Microtime products are available and supported through our worldwide distribution network.

Call today for the name of the distributor nearest you.



Microtime, Inc.
1280 Blue Hills Avenue, Bloomfield, CT 06002 Telephone (203) 242-0761 TWX 710-425-1165
Microtime International
Rokin 9-15 Amsterdam, Holland 1012K Telex (844) 16354

Circle (10) on Reply Card

CUERAC SERIES 1A

FUTURE JOCK

CUERAC is the world's first complete random access cartridge automation system.

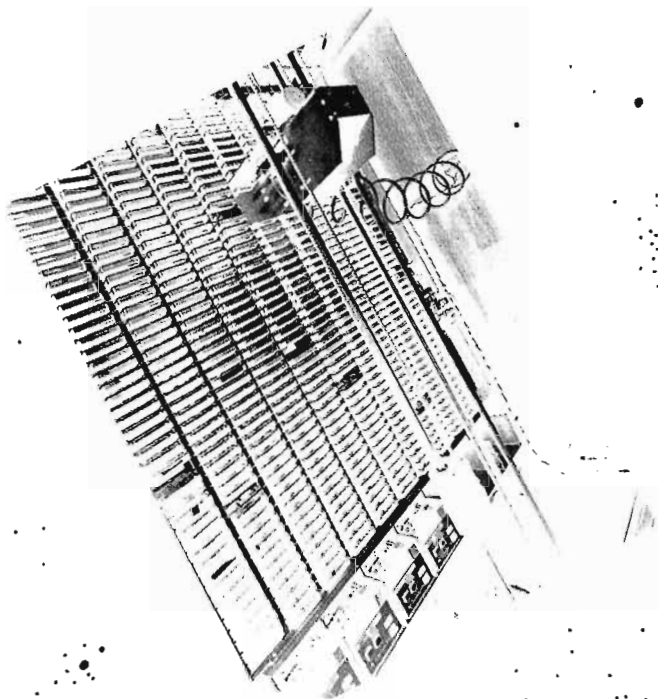

- Fully automatic computer controlled random access library of 500 cartridges.
- Computer expandable to control up to five (5) CUERAC libraries giving random access to a total of 2500 cartridges or 1-4 CUERACS and up to 40 single source replay units.
- Continuous visual display of program: current status, next 10 selected events, lapsed time, actual time, system alarm, syntax error.
- Simple programming for last minute scheduling.
- Provides FCC and diagnostic hard copy logging.



CONSOLIDATED ELECTRONIC INDUSTRIES INCORPORATED
Waterview Building, Suite 906
1925 North Lynn Street
Arlington, VA 22209
703-524-9811

Circle (230) on Reply Card

"See us at NRBA"

Industry news

the unattended operation of similar stations in the Common Carrier and Private Microwave Services;

- Relax the requirement that licensees of remote pickup station transmitters attach or display full license information on the portable or mobile transmitter units. Similar identification and license posting requirements were previously deleted for the Private Radio Services as no longer having any regulatory purpose; and

- Revise or add technical definitions for frequency modulation, frequency tolerance and radio frequency radiation to conform with American National Standards definitions and with other FCC rules.

FCC wants to know why commercials seem loud

The FCC has begun another inquiry to obtain information and comments on measuring the loudness of commercials broadcast by radio and television stations. (The last inquiry lasted three years and ended 14 years ago.) The commission said it would prefer that the industry resolve the problem of objectionably loud commercials itself, but threatened regulatory action if industry measures are likely to be ineffectual.

Some of the questions on which the FCC is seeking comments from the industry (due December 15) include the following:

- What methods (devices) are suitable for measuring the instantaneous loudness of complex sounds such as voice or music?
- How can a sound segment be characterized in terms of loudness?
- How can two sound segments be compared in terms of loudness?
- To what extent (how loud and how many) are commercials objectionably loud?
- To what extent is there objectionable loudness in other types of material such as public service announcements or station promotionals?
- What causes objectionable loudness in commercials?
- Do listeners confuse loudness with noisiness or annoying sound?
- Is there some factor that is primarily the cause of excessive loudness?
- Is modulation the key, only one of several factors, or an unreliable indicator of loudness?
- What forms should loudness standards take and what limits are reasonable?

Second Generation

Tini "Q-G" — The New Switchcraft Connector That Has Less Bulk! Less Weight! And Low Cost! It's designed for today's miniaturized lavalier microphones and instrumentation. Disconnect is quick and easy!

Take it apart. See Tini "Q-G" quality. Silver-plated pins and contacts for starters. "Non-scooping" plugs and receptacles have recessed pins to protect against accidental damage. They're keyed for proper mating. Tini "Q-G" reflects the proven quality of Switchcraft "Q-G" and "QGP" professional audio connectors.

Choose either three, four, or five pin/contact styles in both cord plugs and receptacles. The cord plug diameter measures a mere .413"... accepts cables up to .115" dia. with flex relief bushing 170" dia. without bushing.

Tini "Q-G" receptacles are available with PC terminations and a choice of seven trim, colored panel escutcheons for quick, easy identification. The rich metal cord plug housing has a nickel finish that minimizes glare and lighting "hot spots"

Compare! You'll easily see why Tini "Q-G" gives you more. But then it's from Switchcraft... a leader for decades in audio connection design



Call Ron Larson
at (312) 792-2700 for full details and
Catalog No. NPB-341.

SWITCHCRAFT[®]
INC.

5555 N. Elston Avenue, Chicago, Illinois 60630
(312) 792-2700

A Raytheon Company

Circle (11) on Reply Card

INNOVATIVE

TITLING GENERATORS



T-1024 SERIES



T-2001/T-5002



T-1000A

TOMORROW'S PRODUCTS ... TODAY

Our T-1024 SERIES provides features and performance hereto not available in an inexpensive system.

While compact, it boasts an 8 page memory expandable to 16 pages, auto line centering, character insert/delete, and a highly legible display of 24 characters per line using a 10 x 14 character matrix. **PRICED FROM \$1095.**

Our T-1000A is designed for simplicity of operation with outstanding features.

Fingertip controls provide access to a 16 page memory with simultaneous program and preview display channels, variable length roll, crawl, adjustable title window, and eight choices for character font enhancement. **PRICED \$3995.**

NEW! Our T-2001 offers programming flexibility at an affordable price.

Select on a character line basis, three character heights, two character widths, black or white characters, and three choices of edging. The font library provides 128 characters including upper/lower case, and 32 graphic symbols. Special editing and control features provide operator programming flexibility and ease of operation. **PRICED FROM \$5995.**

NEW! Our T-5002 encompasses all of the features of our other titling systems and more.

Imagine the features of the T-2001 along with a super high resolution dual font library, colored characters or background, and an independent edit channel which can double as a second program channel:

Optional expanded memory, two channel mix, and custom characters or logos makes the T-5002 an unusual titler. **PRICED FROM \$8995.**



Video Data Systems

... IN TOUCH WITH THE FUTURE

VIDEO DATA SYSTEMS, corporate office, New York, N.Y. (516-231-4400);
VIDEO DATA SYSTEMS, National Sales, Salt Lake City, UT. (801-272-9296);
International Sales, ADCOM ELECTRONICS, LTD., Ontario, Canada
(416-251-3355); CATEC AG LUZERN, Luzern, Switzerland (041-22-66-19).

Circle (28) on Reply Card

Industry news

- Is there some one factor which, if controlled, would minimize the problem?
- In what way are the marketplace forces delinquent in this area?
- In what way could government regulation and marketplace forces act together to minimize the problem?
- Should the FCC control loudness solely by regulation, what specific form should such regulations take, and do current regulations aggravate the problem? and
- Could an automatic loudness control be incorporated into TV sets that would be adjustable for the receiver location and listener preference?

1978 is record year for TV ad revenues

Advertisers spent \$8.06 billion, or 17.8% more on television in 1978 than in the previous year, according to figures released by the FCC. Total industry revenues, less agency commissions, were \$6.9 billion. Industry expenses increased 17.3% to \$5.3 billion and pre-tax profits rose 17.6% to \$1.65 billion.

Of the \$8.06 billion of television advertising expenditures, \$3.72 billion were for network advertising, up 14.9% from 1977; \$2.30 billion were for national and regional advertising, up 16.8%; and \$2.03 billion were for local advertising, up 24.5%.

The three national networks reported revenues of \$2.96 billion, up 14.8% from 1977. But, profits from network operations were \$373.5 million, down 8% from 1977. The three networks reported spending \$265 million on their news and public affairs operations. This compares with \$207 million in 1976.

FCC releases station and complaint totals

The FCC has released the following totals for broadcast stations on the air as of June 30, 1979: 4548 AM radio (no change from May), 3111 FM radio (no change), 993 FM educational (down one), 220 UHF commercial (no change), 517 VHF commercial (no change), 158 UHF educational (no change), and 105 VHF educational (no change).

The commission also reports that broadcast complaints totaled 14,400 in May 1979, a decrease of 814 from April. Other comments and inquiries for May totaled 2694, a decrease of 11,810 from the previous month. The FCC sent 2079 letters in response to

Circle (239) on Reply Card

Electron Tube



Semiconductor



1979 BROADCAST PARTS CATALOG
Supersedes all other catalogs and price lists.

RF GAIN, LTD.: YOUR ONE STOP SOURCE FOR RF POWER DEVICES
BE SURE WITH QUALITY, DELIVERY, AND SERVICE

TRANSMITTING TUBES USED IN BROADCAST

TYPE	PRICE	TYPE	PRICE
3CX1000A7	\$333.00	5CX1500A	\$410.00
3CX1500A7	289.00	5-500A	173.00
3CX2500A3	275.00	575A	32.75
3CX2500F3	275.00	802	32.00
3CX3000A1	303.00	805	50.75
3CX3000A7	418.00	807	6.75
3CX3000F1	344.00	810	53.00
3CX3000F7	417.50	811A	13.75
3CX5000H3	693.50	813	38.00
3CX10000A3	848.00	828	75.00
3CX10000A7	990.00	833A American	139.50
3CX15000A7	990.00	833 European	85.00
3CX20000A7	1099.00	845	52.50
3CV30000H3	1240.00	866A	8.25
3-400Z	85.00	872A	16.75
3-500Z	85.00	892R	1475.00
3-1000Z	222.00	F1099	877.00
4CX250B	36.00	5671	5210.00
4CX250BC	63.00	5762 American	550.00
4CX300A	132.50	5762 European	425.00
4CX300Y	181.00	5879	3.65
4CX1000A	295.00	5924A	675.00
4CX1000K	411.00	5933	14.25
4CX1500A	403.00	6076	535.00
4CX1500B	362.00	6076A	509.00
4CX3000A	606.00	6146A	6.20
4CX5000A	689.00	6161	295.00
4CX10000D	799.00	6166A/7007	1825.00
4CX15000A	1095.00	6181	2055.00
4CX35000C	3795.00	6696A	1860.00
4X150A	43.50	6697A	2230.00
4X500A	201.00	7237A	517.00
4-65A	54.00	7289	38.00
4-125A	60.00	7459	575.00
4-250A	71.00	7527	75.00
4-400A	71.00	7527A	144.50
4-400C	78.50	8008	19.10
4-500A	123.00	8122	64.75
4-1000A	294.00	8791V1	254.50
		8792V1	459.00
		8806	1510.00
		8807	1670.00
		8873	133.00
		8874	133.00
		8875	133.00
		8890	1510.00
		8891	2055.00
		8916	2055.00

RF Gain Ltd.

Call: TOLL FREE 800 645-2322
or 516 536-8868

100 Merrick Road
Rockville Centre, N.Y. 11570

Contact us on Types not listed and for competitive up-to-date price and delivery.

Solid State Replacements For Vacuum Tube Rectifiers
 All solid-state replacements are the **FINEST QUALITY** made. Our tremendous buying power allows us to offer these at the **LOWEST POSSIBLE PRICES!**

TYPE	REPLACES TUBE TYPES	FULL WAVE OR HALF WAVE	P.I.V.	AVERAGE DC CURRENT	PRICE EACH
SSR-1	83, 5Z3, 80, 82, 83V	F.W.C.T.	1600	750 Ma.	\$ 4.95
SSR-2	OZ4, 5X4, 5Y4, 6AX5, 5852, 5839	F.W.C.T.	1600	750 Ma.	3.60
SSR-3	5AV4, 5AW4, 5AZ4, 5T4, 5U4, 5W4, 5Y4, 5Z4, 5AX4, 5AV4, 5931, 6004, 6087, 6106	F.W.C.T.	1600	750 Ma.	3.60
SSR-4	5AU4, 5AW4, 5U4, 5W4, 5Y3	F.W.C.T.	1600	600 Ma.	3.75
SSR-5	3B24, 3B24W		20,000	.075 A.	25.50
SSR-6	5R4GY, 5R4W	F.W.C.T.	2800	500 Ma.	5.75
SSR-7	6AV4, 6AX4	F.W.C.T.	4500	.25 A.	5.50
SSR-8	6X4, 12X4, 6032	F.W.C.T.	1600	500 Ma.	4.50
SSR-9	6Z4, 84	F.W.C.T.	1500	.085 A.	4.40
SSR-10	575A	H.W.	15,000	1.5 A.	36.00
SSR-11	673	H.W.	15,000	1.75 A.	42.50
SSR-12	816, 836	H.W.	7000	300 Ma.	9.00
SSR-13	866A, 866AX, 3B28	H.W.	10,000	500 Ma.	7.25
SSR-14	872A, 872AX, 4B32	H.W.	10,000	1.25 A.	25.95
SSR-15	8008, 8008XE	H.W.	10,000	1.25 A.	25.95



SOCKETS AND CHIMNEYS

TYPE	PRICE	TYPE	PRICE
SK-300	\$375.00	SK-740	\$ 32.00
SK-300A	255.00	SK-760	31.50
SK-310	242.00	SK-761	33.00
SK-400	166.00	SK-770	33.00
SK-410	25.00	SK-800B	135.00
SK-500	166.00	SK-810B	135.00
SK-510	26.00	SK-820	224.00
SK-600	32.00	SK-830A	224.00
SK-600A	40.00	SK-831	224.00
SK-602	44.00	SK-840	224.00
SK-602A	45.00	SK-860	139.00
SK-607	43.00	SK-890B	156.00
SK-610	43.00	SK-900	196.00
SK-610A	50.00	SK-1300	195.00
SK-611	43.00	SK-1310	189.00
SK-612	61.50	SK-1320	210.00
SK-620A	45.00	SK-1400A	275.00
SK-630A	50.00	SK-1420	275.00
SK-640	28.00	SK-1470A	234.00
SK-650	28.00	SK-1490	234.00
SK-655	34.00	SK-1500	633.00
SK-660	40.00	SK-1510	735.00
SK-660A	40.00	SK-1900	168.00
SK-700	139.00	SK-1920	9.90
SK-710	139.00	SK-2200	46.00
SK-711A	139.00	SK-2210	46.00
SK-712A	139.00	SK-2220	242.00

CHIMNEYS

TYPE	PRICE
SK-306	\$17.00
SK-316	17.00
SK-406	26.00
SK-416	26.00
SK-426	26.00
SK-506	33.00
SK-516	33.00
SK-606	7.50
SK-626	6.75
SK-636B	26.00
SK-646	31.00
SK-656	31.00
SK-806	30.00
SK-816	20.00
SK-906	33.00
SK-1306	20.00
SK-1406	24.00
SK-1426	20.00
SK-1511	75.00
SK-2216	37.00

HEAT SINKS AND CONNECTORS

TYPE	PRICE	TYPE	PRICE
HR1	\$3.80	HR6	\$5.50
HR2	5.50	HR7	5.50
HR3	5.50	HR8	5.50
HR4	3.80	HR9	5.50
HR5	3.80	HR10	5.50

FINGER STOCK

TYPE	PRICE	TYPE	PRICE
CF100	\$11.90	CF600	\$26.00
CF200	17.00	CF700	15.00
CF300	14.25	CF800	17.00
CF400	19.00	CF900	23.75
CF500	19.00		

BROADCAST QUALITY CAMERA TUBES

R C A

BC4592 Series	\$1998.00	BC4909	\$1662.00
BC4593	2198.00	BC4992 Series	1998.00
BC4594 Series	2198.00	BC4993	2198.00
BC4809	520.00	BC4994 Series	2198.00
BC4892 Series	1998.00	BC7735	168.00
BC4893	2198.00	BC8134	488.00
BC4894 Series	2198.00	BC8480	1212.00
BC4907	1385.00	BC8507	172.00
BC4908	1662.00	BC8541	172.00

EEV Types, Industrial types not listed; CCTV, Industrial and X-Ray Grade available upon request.

**RECEIVING TUBES FOR BROADCAST SYSTEMS
 MAJOR BRANDS, FACTORY BOXED**

1B3GT	\$1.92	6BR8A	\$2.44	6LB6	\$3.94
1V2	1.21	6BS8	2.40	6LF6	3.89
1X2B/C	1.96	6BU8	2.40	6MJ6/6LQ6/ 6JE6	4.30
5AR4	2.54	6BZ6	1.54	6SJ7	4.58
5U4GB	1.54	6C4	1.91	6SL7GT	2.63
5Y3GT	1.61	6CA4	1.77	6SN7GTB	1.88
5Z3	4.31	6CB5A	3.66	6T8	2.20
6AB4	1.69	6CB6A	1.61	6U8	1.90
6AF4A	2.54	6CG8A	2.09	6V6GT	2.25
6AG5	2.01	6CJ3	1.81	6X4	1.76
6AH6	3.22	6CL6	2.38	6X5GT	1.77
6AK5	2.30	6CL8A	2.35	12AB5	1.77
6AK6	1.79	6CM6	2.06	12AT7	1.67
6AL5	1.58	6CM8	1.91	12AU6	1.65
6AM4	4.32	6CS7	1.92	12AU7A	1.49
6AM8	2.52	6CX8	2.71	12AV6	1.43
6AN4	2.41	6DC6	1.64	12AV7	2.30
6AN8A	2.24	6DE7	2.15	12AX7	1.54
6AQ5A	1.64	6DK6	1.68	12AY7	3.94
6AQ6	1.76	6DL4	2.65	12B4A	2.04
6AT6	1.20	6DQ6B	2.61	12BA6	1.42
6AU4GTA	2.25	6DT6	1.61	12BE6	1.75
6AU5GT	2.77	6DV4	5.00	12BH7A	1.92
6AU6	1.57	6EA8	1.91	12BR7	2.13
6AU8A	2.45	6EH7/EF83	1.96	12BW4	1.82
6AW8A	2.17	6EJ7/EF184	1.78	12BY7	1.73
6AX5GT	2.18	6EV5	2.18	12JB6	3.15
6BA6	1.64	6EW6	1.74	12SN7GT	2.15
6BC4	3.82	6FQ7	1.47	20LF6	3.99
6BC5/6CE5	1.54	6GH8A	1.53	35W4	1.23
6BC8	2.53	6GK6	1.71	50C5	1.49
6BE6	1.79	6GW8	1.94	5879	3.03
6BH6	1.84	6HQ5	2.45	6267	1.76
6BJ6	1.91	6J4	3.63	6973	2.40
6BL8/ECF80	1.36	6J6	2.62	7027	3.61
6BM8/ECL82	2.01	6JB6	2.93	7189	2.06
6BN6	2.25	6JS6	3.59	7199	2.52
6BN8	2.04	6KD6	4.10	7868	2.65
6BQ5	1.91	6KZ8	2.01	8417	3.75
6BQ7A	2.40	6L6GC	2.95		

RF Gain Ltd.

CALL TOLL FREE 800-645-2322

100 MERRICK ROAD, ROCKVILLE CENTRE, NEW YORK 11570
N.Y. State call collect 516-536-8868

Dear Friends:

If you've been wondering where Dave Gilden went, please read a little further. I'm going out on my own. The name of my new corporation is "R.F. GAIN, LTD.". We are located in Rockville Centre, N.Y. just 15 minutes from JFK Airport.

I hope to provide you with the service, speed, and accuracy you're accustomed to. I have taken all the feedback you've given me and will provide some new ideas to cater to your needs.

Our product line will be expanded in the beginning to provide you with integrated circuits at reasonable prices. My Transistor cross-reference list is expanded with an emphasis on cross-referencing RF Power Transistors. Finally, we will provide you with Tubes of all major manufacturers with more choices available. Our inventory will be the largest in the country.

As before, we request everybody to call us on our toll-free number - 800-645-2322. We will have sales engineers familiar with the products we sell so, remember "Dave is Back" to provide you with more savings per order, fast delivery, prompt warranty service, and a friendly voice.

If you've been pleased with my service in the past, let me continue to supply your firm in the future.

Sincerely,



Dave Gilden

POLICY STATEMENT

Terms: - Rated Firms — Net 30 Days

Other — Furnish Trade References — 2% Discount if payment accompanies order

All shipments F.O.B. RFG, usually within 24 hours of order. Emergency Shipments Our Specialty.

All products carry Standard Factory Guarantee.

All prices subject to change without notice.

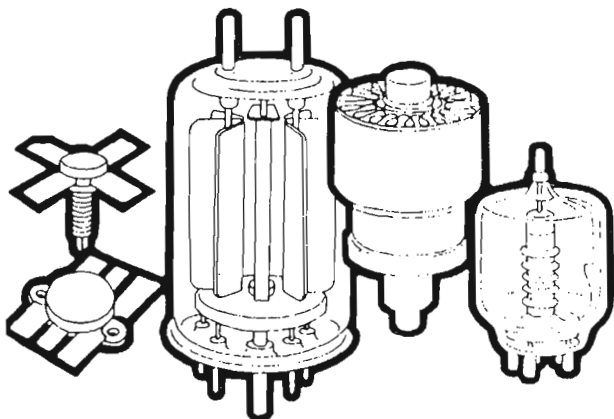

RF Gain Ltd.

For Off-The-Shelf Delivery

on Factory Boxed

Current Code

Transmitting Tubes.

Industry news

these comments, inquiries and complaints.

MDS report guidelines

The FCC has released guidelines on what information MDS interference studies should contain in the event that the location of the transmitting antenna of a proposed MDS station is less than 50 miles from an authorized or previously applied for station. This includes the following:

- A map showing the contour of a 45dB carrier to interference level around both the proposed station and any authorized or previously applied for transmitting antenna sites.
- If the applicant believes that other factors will significantly alter the above contour, these factors shall be listed along with a second 45dB contour illustrating their effect.

In cases where the existing previously authorized or proposed station is or would be affected by other authorized or proposed stations within 50 miles of it, the following should be provided as part of the engineering statement:

- A map showing the contours of the 45dB carrier to interference levels around all such authorized or previously applied for stations without the effect caused by the new applicant, assuming the stated transmitting site characteristics.
- A map showing the contours of the 45dB carrier to interference level taking into account both the authorized or previously filed for stations and the station proposed in the new application.

For more information, contact Herb Wilson, FCC, 1919 M. St. NW, Washington, DC 20554, (202) 632-6440.

Channel use study out

Television Channel Utilization as of December 31, 1978, is a FCC report showing by market, how commercial and noncommercial channels are being used. It details the number of VHF and UHF channels licensed, the number for which construction permits have been granted, the number for which an application has not been filed, the number of UHF channels allocated for television but not available until further FCC action, and the total number of channels allocated.

The report shows that, as of December 31, 1978, applications were pending for 42 UHF commer-

SMPTE EDIT-CODE READER AND CHARACTER-GENERATOR

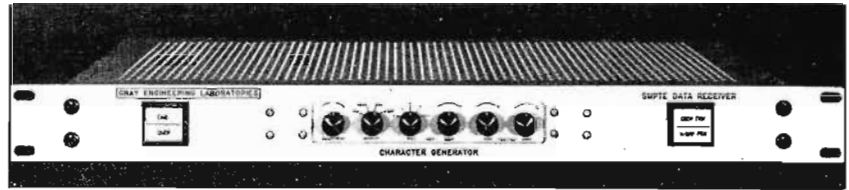

THE NEW STANDARD OF THE INDUSTRY

FEATURES: "THE McFADIN WINDOW"® wide-range digital decoder; 1¾" rack mounting; Drop-Frame indicator; vertical interval inserting; choice of Time-Code or User-Bits; all front panel controls; regenerated Time-Code output (DUB). **MODEL DR-107**



504 W. Chapman Ave.
Orange, Ca. 92668
714-997-4151

See us at the SMPTE conference, booth 565, in Los Angeles, Oct. 21 to 25, 1979.

Circle (245) on Reply Card

Camera Titling Made Easy

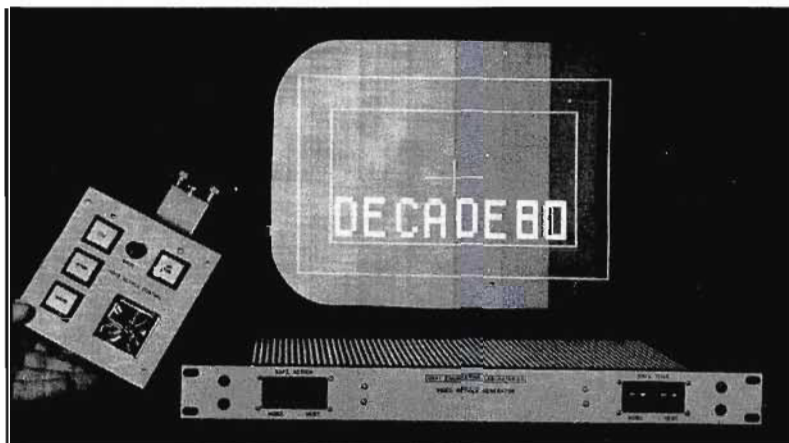

WITH THE NEW VIDEO RETICLE GENERATOR VR-116

- Independent control of Safe Title and Safe Action reticles
- Unrestricted selection of limits both horizontally and vertically
- Remote control switching of Safe Title, Safe Action and cross-hairs
- Continuous brightness control from 0 to 100% luminance value
- Joy-stick control of Safe Action reticle from dead-center to edge of blanking area



504 W. Chapman Ave.—Orange, Ca. 92668—714-997-4151

See demo of this equipment at the SMPTE show booth 565, Los Angeles, Oct. 21-25

Circle (13) on Reply Card

September 1979 *Broadcast Engineering* 21

Family Technology

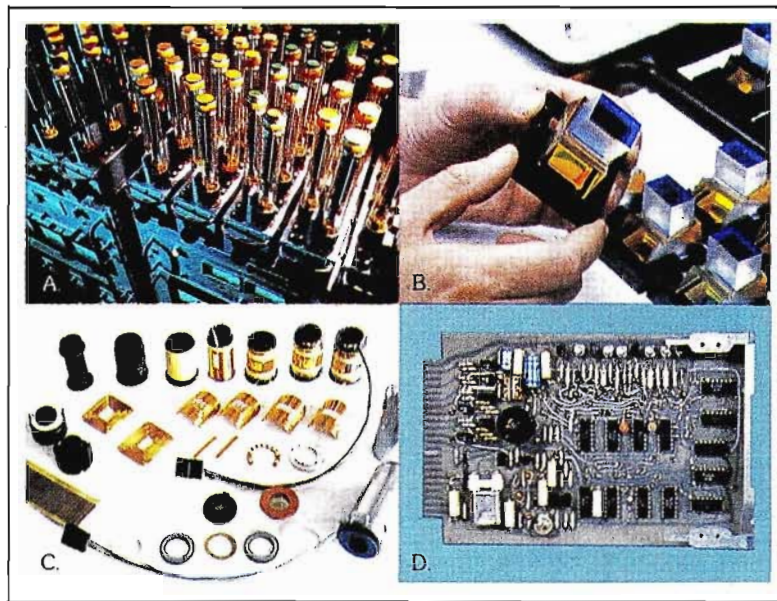

A. Plumbicon™ Tube Technology
C. Yoke Technology

B. Prism Technology
D. Electronic Circuitry Technology

Philips called it, “Focus on Technology” at NAB '79 in Dallas. Simply put, it was a demonstration of the single, most important reason for the basic superior technology and design advantages that make Philips the acknowledged leader in color television:

“Philips is the *only* camera manufacturer who designs, develops and produces *all* four, critical, picture-determining components — Pick-up Tubes, Prisms, Deflection Yokes, and Electronic Circuitry — each designed for optimum, total camera system performance.”

This basic technological advantage enables Philips to continue offering the world's finest line of broadcast cameras. The most diversified camera family in both price and application. *The Technology Family.*



Technology Family



LDK-14—Newest technological breakthrough.

$\frac{3}{8}$ -inch ENG/EFP/Studio broadcast camera with picture quality and features of Philips larger studio cameras. Lightweight, rugged, one piece with the look and feel of a film camera. Low power consumption; high sensitivity; dynamic beam control (DBC); fully automatic operation including auto-centering, and switchable black stretch. Available with simplified remote control or full facility control unit with full bandwidth chroma key.



LDK-25 Family with ACT or new 1-inch 73XQ Diode-Gun Plumbicons and camera circuitry for higher resolution and lower lag than 30mm cameras. With better than 65% depth of modulation at 400 lines! Makes the finest, state-of-the-art multicore studio and field camera ever produced better than ever. And Philips exclusive rear-loading design delivers the maximum out of this new Diode-Gun technology.

Rounding out the LDK-25 family are: the LDK-5, a digitally controlled triax version for remotes and modernized studio operation; and the LDK-15L, an LDK-5 in a self-contained mode or can be used with the LDK-5 or 25 CCU in system configurations.



VIDEO 80... innovative convertible camera system for multi-use applications. Unique, three $\frac{3}{8}$ -inch Plumbicon camera head converts in seconds from studio mode (available with optional, multi-position, tiltable viewfinder) to new, lightweight EFP field production mode with $1\frac{1}{2}$ " viewfinder to totally self-contained ENG portable. Even to special application modes for telecine, microscopy, endoscopy, etc. Easy set up and operation by non-technical personnel and automatic features for total mobility. VIDEO 80 also offers a complete expandable production system for start up or expansion of existing systems.

I.F. Transmitters... Philips is also the recognized world leader in transmitter technology, now with the fastest growing UHF/VHF transmitter line in North America. Output ranges up to 110kW. Equally suited for single or parallel operation with

automatic or remote control for unattended operation.

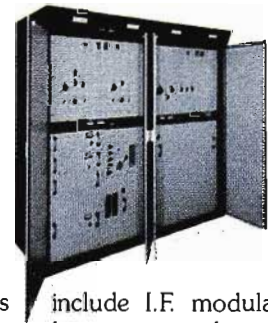

Features include I.F. modulation, solid state design except for power stages, high stability and ease of installation and maintenance. SAW filter, reducing number of controls to achieve proper group-delay. Small size and minimum floor space made possible by the advanced design and a unique common exciter that can be retrofitted into earlier competitive systems.

Also included in Philips "Focus on Technology" and part of our growing family of system products:

- One-inch **Video Recorders** to meet your specific requirements.
- New digital **Video Noise Reducer** — Fully automatic.
- A state-of-the-art **Tape Synchronizer** for totally integrated systems operation.

It all adds up to the widest range of cameras and television equipment in the industry. More information is yours simply by writing today on your company letterhead (indicating product interest) to: Philips Broadcast Equipment Corp., 91 McKee Drive, Mahwah, N.J. 07430 (201) 529-3800. (Canada: Philips Broadcast Equipment, 601 Milner Ave., Scarborough, Ontario M1B 1M8).

Innovative Leader in World Television

PHILIPS

TM-N.V. Philips

Industry news

cial channels located in the top 50 markets, and for nine channels in the second 50 markets. In the top 100 markets, 111 UHF commercial channels had not been applied for. In markets 101-200, applications were pending for 23 UHF commercial channels; 90 channels were vacant and not applied for. Of the 61 vacant and not applied for VHF commercial channels, 5 were located in markets 101 through 200 and the remaining 56 were outside 200

markets; applications are pending for 11 VHF commercial channels. Copies of the report may be obtained from the Office of Public Affairs, Room 207, 1919 M St. NW, Washington, DC 20554, (212) 632-7260.

French television pioneer wins ITU Centenary Prize

The International Telecommunications Union (ITU) has awarded its

first ITU Centenary Prize to Georges Valensi, a French engineer and scientist, for his contribution to the development of international telecommunications.

Besides playing a cardinal role in developing international telephony and the world telecommunications network, Valensi contributed to the emergence of color television. His detailed research in physiological optics and colorimetry led to a French patent in 1938 which was the basis for British and American patents validating his reverse compatibility concept for color signal transmission. NTSC, PAL and SECAM make use of this underlying principle, even though the coding methods differ.

The prize will be presented September 23, 1979, in conjunction with the 3rd World Telecommunications Exhibition, Telecom 79, in Geneva.

The ITU is the United Nations' specialized agency for telecommunications. It was founded in 1865 and has 154 member countries.

US and Canada negotiate for UHF-TV allocations

Negotiations are being conducted between Canadian and United States representatives to relocate Canadian UHF-TV allocations to channels below Channel 70. This is a result of steps to implement Land Mobile operation in the 806-890MHz band (TV channels 70 through 83).

Some conflicts remain between US allocations and some of the Canadian proposals listed in the new plan. Negotiations to resolve these conflicts are continuing and corresponding adjustments to the plan will be developed as necessary.

Inter-satellite links ahead

INTELSAT has awarded a US \$170,000 contract to the Electron Dynamics Division of the Hughes Aircraft Company for the design, fabrication and testing of a feasibility model of a Travelling Wave Tube (TWT). The TWT would be a vital component of the on-board satellite equipment required to operate an inter-satellite link.

This is the 102 member-country organization's first step towards establishing inter-satellite communications links within its systems. The objective is to advance technology in this area sufficiently to enable it to install facilities for inter-satellite links on its satellites launched after 1984.

Now—you can add Rotary Matrix & Star wipes to any size switcher!

with CDL's new Extended Effects Generator EEG-1980

It's easy. EEG plugs into your switcher's external key input, and . . .

EEG effects can be used simultaneously with your own effects, such as a Clock Wipe within your circle pattern . . . or use them independently.

Plus you can use your key softness control for some spectacular Rotary, Matrix & Star effects.

See how affordable and easy it is to update your switcher. Write or call for a demo.

CENTRAL DYNAMICS

New York: 10 W. Main St., Elmsford, NY 10523, 914-592-5440
 Chicago: 312-991-4720 Los Angeles: 213-789-0574
 Atlanta: 404-491-9037 Dallas: 214-741-3332
 Denver: 303-623-7603 CANADA-Montreal: 514-697-0810

Circle (14) on Reply Card

ALL NATURAL.

(for a healthy image.)

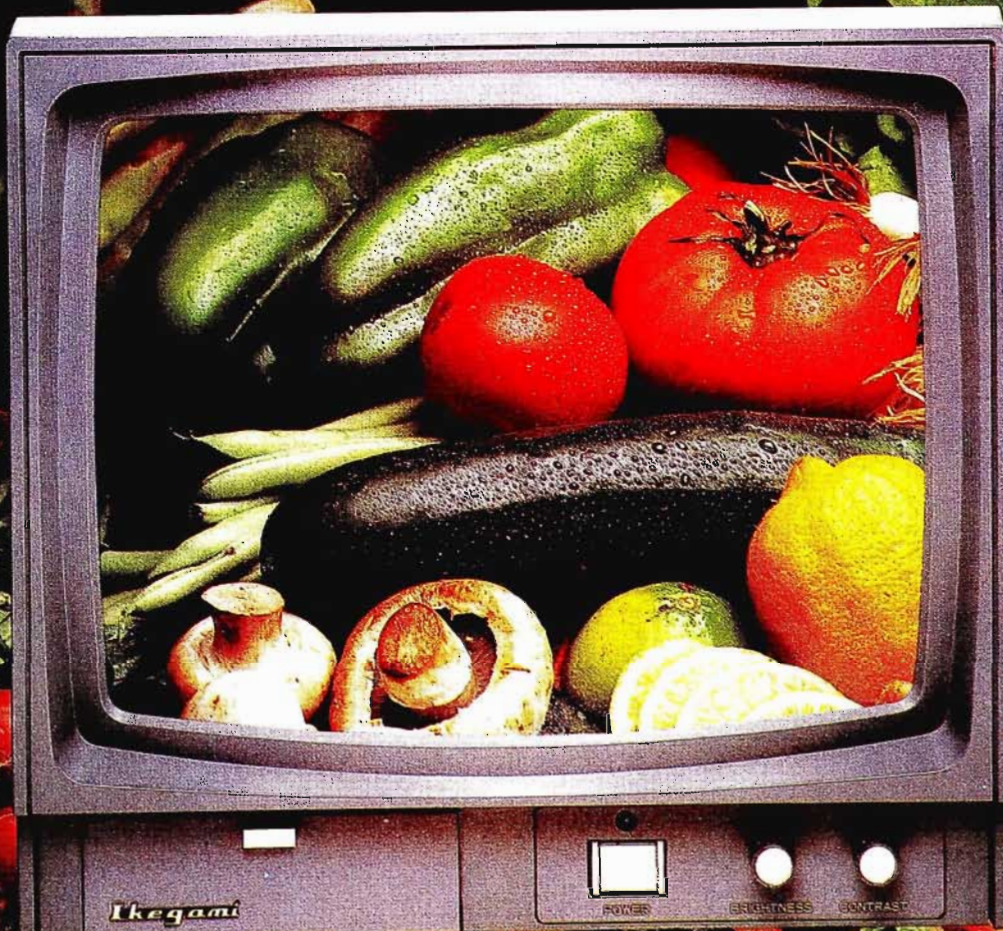

Take the purity, quality and precision of nature and incorporate it into a broadcast monitor capable of providing the most exacting picture imaginable, and you'll have created the All Natural Ikegami Broadcast Color Monitor.

All Natural because what you'll see is a picture in its purest form: down to the finest detail or defect.

Ikegami Broadcast Color Monitors maintain a healthy image.

It's why more and more engineers are specifying *Ikegami Broadcast Color Monitors*.

With features like our comb filter which results in resolution at 600 plus lines, shadow mask CRT's power-protective circuits to avoid damage to the picture tube, an active convergence circuit, a phase lock system which eliminates horizontal hold control, sturdy construction, modular PC boards for simple servicing and maintenance, a

built-in degaussing circuit and magnetic shield to permit movement without affecting picture quality, and a wide range of models including 25, 20, 16, and 14 inch units (14 and 20 inch units offering standard and high resolution models), isn't it time you got into shape with Ikegami Broadcast Color Monitors?

For high-end, precision broadcast color monitors, it's Ikegami—naturally!

For details and additional information contact:
Ikegami Electronics (USA) Inc., 57 Brook Ave.,
Maywood, N.J. 07607, (201) 368-9171; West Coast:
19164 Van Ness Ave., Torrance, Calif. 90501,
(213) 326-2814; South West: 330 No. Bell East,
Suite 228, Houston, Texas 77060, (713) 445-0100.

Ikegami

Video Products Built To Ideal Standards

Available For Prompt Delivery

Circle (15) on Reply Card

Industry news

The organization claims that such links would have significant advantages. At present, direct satellite transmissions can only be provided between points within a single satellite coverage area—about one-third of the earth's surface.

Communications bound for destinations outside the coverage area must complete their journey via land-based links or through a second satellite hop.

With inter-satellite links, these

signals could be switched directly from the first satellite to the second—thus saving one down and one up link transmission, freeing this capacity for other communications.

INTELSAT says it also would enable one earth station to communicate through more than one satellite in each area, improving system flexibility by increasing the number of receive stations which can be accessed directly.

FCC fears limited powers if RF radiation regulated

Controversy over the effects of low-level and long-term exposure to RF radiation is on the increase. So, the FCC has opened an inquiry on how to discharge its regulatory duties if a health and safety agency should limit allowable RF radiation exposure levels.

The commission said a parallel purpose of the inquiry is to provide documentation so that it can participate in rulemaking proceedings of the health and safety agencies and ensure that any new standards adopted take into account the impact on the licensees and equipment regulated by the FCC and on the public.

Comments are due by December 15 and replies by March 15, 1980.

Radiation is classified in two types for health and safety purposes. High frequency-high energy radiation such as x-rays and gamma rays, which are beyond the range of frequencies the FCC regulates, are capable of causing harm through ionization of atoms in living tissues. FCC-regulated frequencies do not have sufficient energy to cause ionization, but in sufficient amounts are capable of causing damage through generation of heat.

A spokesman at one electronic shielding manufacturing company says the level of worldwide radio frequency radiation has risen from virtually zero a few decades ago to today's "pollution-level index." Arnold Zais of Keene Corporation, calls it "radio frequency pollution" and says it is increasing at the rate of 50% a year.

Sources of radio frequency radiation include commercial radio and television; radar and microwave communications; military, amateur, citizen's band and police radios; communications and other satellites; high voltage electrical transmission lines; industrial and military equipment; lighting systems; and natural radiation phenomenon from outer space.

FCC enters environment assessment business

After consulting with the Council on Environmental Quality, the FCC has proposed amendments to its rules covering the environmental impact aspects of communications facilities it authorizes.

The proposed commission rules provide that, before action is taken

3D

SERIES



Proven.
Over 5,000 ITC 3D's in use—15,000 decks—Stereo and Mono.

Economical.
Three premium line reproducers cost little more than two SP Series single decks.

Compact.
Three deck convenience in the space of two SP single decks.

Recorder.
Add a WRA Recording Amplifier and the bottom deck becomes a Master Recorder/Reproducer.

Broadcasters' No. 1 Choice



To place a no-risk order (30 day guarantee of satisfaction)

Call Toll-Free: 800-447-0414.

In Alaska, Hawaii or Illinois Call Collect: 309-828-1381

INTERNATIONAL TAPETRONICS CORPORATION

2425 South Main Street, Bloomington, Illinois 61701

Marketed exclusively in Canada by McCurdy Radio Industries, Ltd. Toronto

Circle (16) on Reply Card

© 1979 ITC

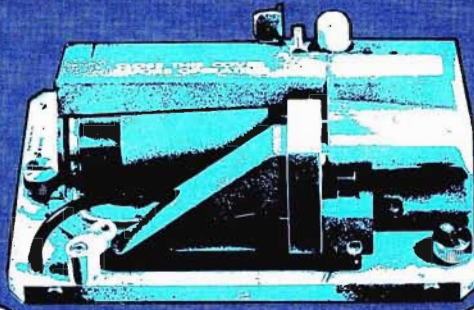

RCA HB and SHB/PT

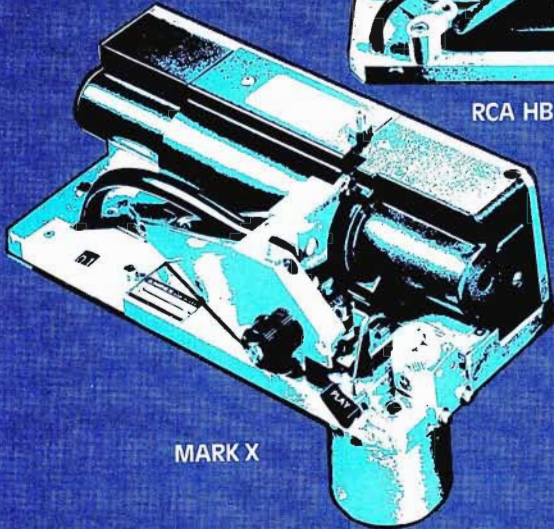

MARK X

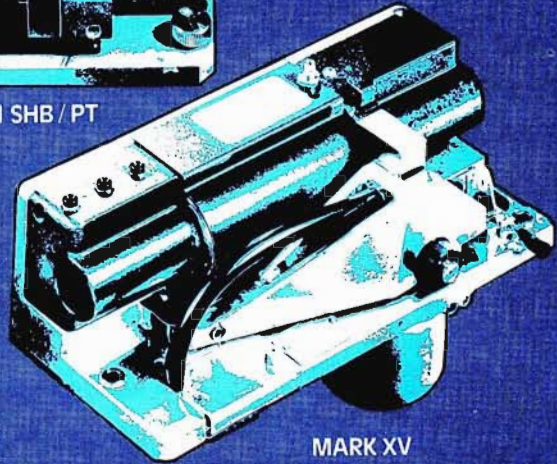

MARK XV

Superior pictures at lower cost! Join the ferrite generation.

Spin Physics will save you 25% to 40% of your costs and give you 2 to 5 times longer life than you receive from ordinary video heads. Get the facts from our full-time field engineer who serves your region.

Superior pictures and significant savings are yours when you specify state-of-the-art high technology hot-pressed ferrite quad video heads from Spin Physics. Bring your quad machines into the new generation — the ferrite generation. The money you save on refurbishing may help toward new generation equipment in some other aspects of your operation. Our steadily growing customer list includes smart operators in all sizes of stations and production centers, and in NTSC, PAL and SECAM standards. You owe it to yourself to compare Spin Physics' advantages.

CALL THE REGIONAL OFFICE FOR YOUR AREA TO SEE THE SPIN PHYSICS STORY IN PERSON

EASTERN: R. Kent White, 301-839-3218
CENTRAL: LeRoy Koonsman, 214-245-1816
SOUTHWEST: Ed Gehle, 805-964-3316
NORTHWEST: Ken Thompson, 415-961-7794

For factory direct information, contact David Franssens, Video Products Manager, or Gene Long, National Sales Manager at 714-453-5410



A KODAK COMPANY

3099 Science Park Road, San Diego, California 92121

Telephone 714-453-5410 Cable SPINEX SANDIEGO TWX 910-322-1737

Circle (17) on Reply Card

FREE* FOR

AUDIO CONSOLES (The Silent Series)

DC-38: 5, 8 or 10 mixers, up to 40 inputs; \$2,447 to \$4,980.



SC-5, DC-5, DC-8:
5 & 8 mixer, 12 to
18 inputs: \$995 to
\$2,375.

P5M: Portable: 5
mixers, 8 inputs; built-in
compressor: \$545.

DC-12: Remote
control; up to 12 mixers
(expandable to 20) with 2 inputs
each: \$4,200 to \$5,200.

THE PHASE-ERROR-FREE CART PRODUCTION CENTER

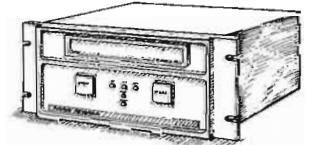

(Demos now,
deliveries Jan./80)
PhaseMaster:
Phase-error-free
record/reproduce/duplicate;
full complement of
broadcast features and
construction.

MA Series: Studio
monitors; 12 W mono, 20
W stereo; 10 Hz-50 kHz±1
dB; distortion 0.05% max:
\$121 and \$171.

MIC/LINE/STUDIO AMPLIFIERS:

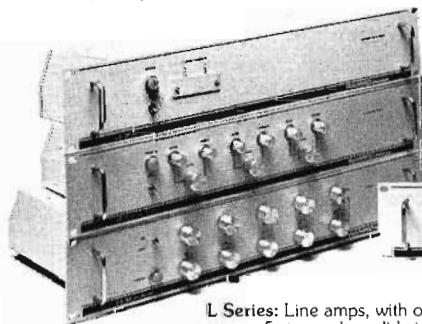

L Series: Line amps, with or without equalization; up to 10
mono, 5 stereo ch.; solid-state balanced and unbalanced
inputs; +21 dBm max. in and out; response 10 Hz-50 kHz
+0, -1 dB; distortion 0.008%: \$135 to \$453.

SMA Series: Studio monitor; 25 W rms/ch.
stereo; 15 Hz-50 kHz±1 dB; distortion
0.6% max: \$325.

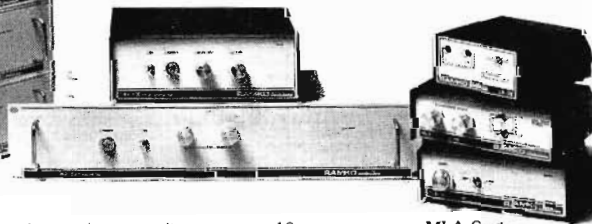

MLA Series:
Mic/line inputs;
studio or remote:
\$128 to \$185.

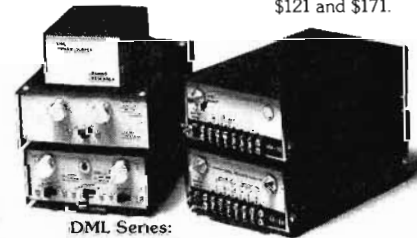

DML Series:
Dual mic in to
amplify, mix, limit and control
gain; built in compressor; AC
and DC: \$239 to \$281.

AUDIO ROUTER/AMPLIFIER

ARA-1612: Up to 16 in, 12 out; LED status display;
\$1099 to \$2296.

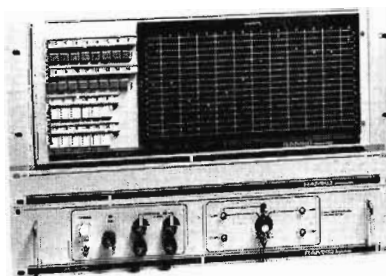

TURNTABLE PREAMPLIFIERS

MP-8 & SP-8: Mono & stereo; S/N
-77 dB; ±1 dB RIAA: \$98 & \$144.
ESP-38: 0.03% distortion; S/N
-85 dB; ± 25 dB RIAA: \$325.

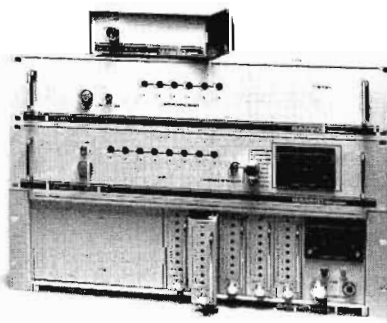

AUDIO DISTRIBUTION AMPLIFIERS

DA Series: 12 versions from 1 x 30 mass feed to 20
x 80 rack mount; 20 Hz to 20 kHz±0.5 dB; -75 dB
separation: \$145 to \$2276.

Prices subject to change without prior notice.

2 WEEKS.

***You can use any of the gear you see free for 2 weeks (with credit approval prior to shipment).**

Play with the cart/cassette record/playback/duplication center that eliminates stereo phase shift error once and for all. The most advanced turntable preamp in captivity. Consoles so advanced, so silent you're not going to believe them until you try them. Or an audio router that makes whatever you've got now look—and sound—like so much spaghetti.

Then, if it's not for you, just ship it back.

But in all fairness, we have to warn you—once you've tried Ramko, chances are you're hooked for life.

Phase shift doesn't matter in mono.

So instead of adding failure-prone electro-mechanical components or re-inventing the cartridge, in the Ramko PhaseMaster Cart/Cassette Duplicating Center, we simply encode the stereo before it ever sees the heads or tape, then decode the signal after it leaves these two major sources of stereo phase shift error.

The result is phase-error-free recording/reproduction/duplication, and performance specifications that meet or exceed whatever cart drives you're using now.

Features include: an A and B cart deck; an A cart deck; and a cassette deck. Simple cassette-to-cart(s) and cart-to-cassette duplication. Automatic switching of record/playback, encoding/decoding and mono/stereo. Left, right and phase analysis meters. Front panel input selection. Three cue tones. And so much more that you'll just

have to contact us for details and a demonstration.

Ask for the Ramko PhaseMaster.

Just another turntable preamp?

Look at what one user wrote:
"Three days ago I replaced the (brand name) preamps in our studio with your ESP-38 preamps."

"The result was astounding. The next day we had six unsolicited calls from local stereo stores. All commented on our improved disk reproduction and wanted to know what we had done."

"The comments from listeners have been excellent."

Try it. You're going to like it a lot.

For AM stereo, or an FM station upgrade.

Ramko consoles come with features you won't even find in more expensive competitive units.

Total dc control of all mixing and switching function means no more noisy pots and switches, no stereo tracking error, and much more resistance to RFI.

We've developed solid-state balanced inputs for better sound. Added gain select on each input. Included switch-programmable cue and monitor mute selection. Provided mono, stereo and phase meters as standard features.

And then we backed everything with a 2-year warranty (4 years on the DC-38 and DC-12).

Kiss your patch panels good-bye.

Because with the Ramko ARA-1612 Audio Router/Amplifier you use front panel pushbuttons to route 16 inputs to any of 12 outputs, simultaneously or individually, with an instant LED display of what is

going where. You've never seen anything like it.

IC switching and isolation buffers mean no loading and no degradation of S/N or frequency response with multiple feeds (stack them for up to 45 in and thousands out). On-board switches change stereo to mono instantly. Individual gain control on all inputs allows precise level matching. Frequency response is 20 Hz–20 kHz±0.5 dB; S/N is –75 dB; distortion <0.3%; and input/output levels are +21 dBm max.

And all this is yours at the lowest cost per crosspoint in the industry.

The music goes 'round and 'round...

For moving sound around, we offer more different kinds of amplifiers than anybody.

Ten models of Audio Distribution Amplifiers, each with 10 Hz–20 kHz±0.5 dB frequency response, less than 0.1% distortion, and more inputs and outputs for the size and price than any other comparable ADA.

Four different Line Amplifiers with 20 Hz–50 kHz±0, –1 dB frequency response, 0.008% distortion, balanced in and out, and +21 dBm max out.

Portable and studio dual function MIC/LINE amplifiers with balanced in and out, built-in RFI suppression, 20 Hz–20 kHz±0.5 dB frequency response, gain from 64 dB on MIC to 26 dB on the high level channels, and distortion at an inaudible 0.1%.

And isn't that music to your ears?

To hear more, contact: Ramko Research, 11355 Folsom Blvd., Rancho Cordova, CA 95670.

Or just call (916) 635-3600 collect today.

RAMKO
Brains, not brawn.

Circle (18) on Reply Card

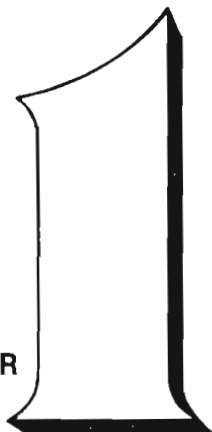

STILL NUMBER

in design, performance
and features

Spotmaster®

5300B

MULTI - DECK

The cart machine with features competitors can't match...

FEATURES

- Nortronics® Duracore™ Heads
- Single Connector Plug-In Decks
- Companion Record Amplifier
- Low-Voltage Solenoid
- Independent Azimuth Adjustment
- Shielding Above & Below the Head
- LED Service Aids
- Tapered Cartridge Guides
- Companion Audio Switcher

Do the decks lock in place to a bulkhead permitting operation with the front panel down?

5300B	ITC 3D	HARRIS 90-3
YES	YES	No
YES	No	No
YES	YES	No
YES	No	No
YES	No	No
YES	No	No
YES	No	No
YES	YES	No
YES	No	YES



Plug-in removable decks and superb electronics make this the most up-to-date monaural or stereo three deck cart machine available. Rugged machined deck, quiet air-damped solenoid, unique cartridge guidance system, drop down front panel and run lights next to each deck. The improved 5300B now includes individual level controls for each cue tone.

For complete information call or write your local *Spotmaster®* distributor or contact:



a FILMWAY company

BROADCAST ELECTRONICS INC.

4100 NORTH 24th STREET • P.O. BOX 3606
QUINCY, IL 62301 • PHONE: (217) 224-9600

Circle (19) on Reply Card

Industry news

on authorizations for facilities classified as "major" because of their location, an environmental assessment will be prepared and published.

FCC commissioner Abbott Washburn was alone in dissenting the action and issued a statement saying that the FCC doesn't know anything about environmental protection and that FCC person-hours should not be tied up in reading environmental assessments which the FCC is not compelled by law to require.

For more information on the proposed rule, contact Upton Guthery, FCC, (202) 254-6530.

TV experiments for deaf

Captioning for the hearing impaired is a subject that has been on the FCC's agenda lately, but the commission says it is awaiting the outcome of voluntary closed captioning before making any moves. In upholding a recent denial of a complaint by the Los Angeles Council on Deafness against eight TV stations, the FCC claimed that if closed captioning should not be successful, it might be necessary to regulate.

One such voluntary closed captioning project the commission is watching is being undertaken by the Public Broadcasting System, the National Broadcasting Company and the American Broadcasting Company. If successful, a total of up to 20 hours of captioned programming for the hearing impaired will be broadcast weekly by 1980. Special decoding devices needed will be provided by Sears, Roebuck & Company, with no mark-up for profit. The Department of Health, Education and Welfare will help establish and fund a nonprofit National Captioning Institute that will caption programming for the networks.

In the meantime, the FCC has made available a videotape of a meeting it held on the subject last April. The meeting included a briefing on plans for closed captioning of TV programs and a panel discussion among representatives of the broadcast industry, the Public Broadcasting Service and the federal government.

Copies of the 4-hour tape may be taken out on loan from or viewed at the FCC's various field offices. For more information, call Jon Crowe, Public Service Branch chief, at (202) 634-1940.

OPTIMOD

CLEANER, BRIGHTER, LOUDER.

OPTIMOD-FM combines compressor, limiter, and stereo generator into an integrated system that's become the #1 audio processor for North American FM's. Users report improved quality, coverage, and loudness—and love the easy installation.

And the new OPTIMOD-AM permits progressive-minded AM broadcasters with quality plants to broadcast a standout signal that's perceived as "almost high fidelity" on common car, table, and portable radios—without loudness loss or objectionable distortion. Hundreds are already in use.

AM or FM—OPTIMOD creates sound that dominates the dial. To find out more, call us toll-free (800) 227-4498. In California or outside the U.S. (415) 957-1067.

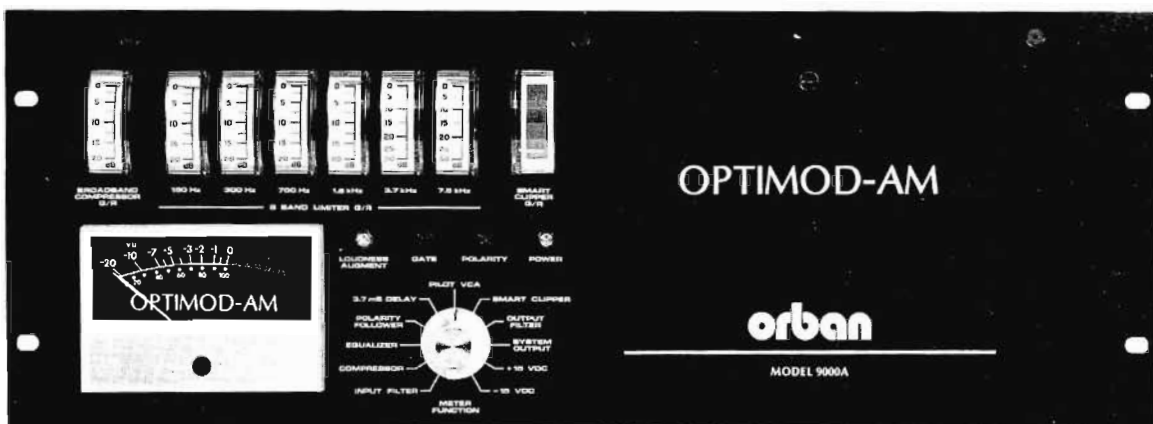
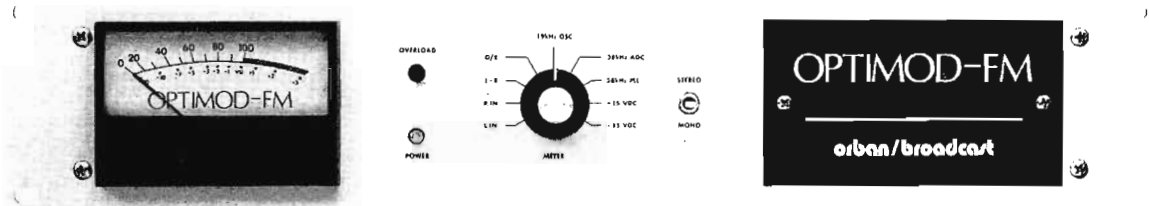

orban

Orban Associates Inc., 645 Bryant Street, San Francisco, CA 94107

For more information on Optimod-AM circle (20) on reply card
 For more information on Optimod-FM circle (21) on reply card

September 1979 *Broadcast Engineering* 31

business news

Bell & Howell purchases Mach One video editing

Bell & Howell's TeleMation division has acquired the assets and business of Mach One Digital Systems. The company's Mach One videotape editing systems will complement TeleMation's existing line of broadcast and teleproduction equipment, according to Bell & Howell Video Group president Robert B. Pfannkuch. The editor will be sold and serviced through TeleMation, which also will start to manufacture the Mach One system at its Salt Lake City plant by the beginning of the fourth quarter of 1979.

Bell & Howell also has announced its entry into the field of designing and manufacturing display monitors for the computer terminal, word processing and medical markets. The products will be marketed to the computer industry and other OEM markets under the Bell & Howell name and will be marketed to the professional video markets under the TeleMation brand name.



3M Mincom wins Maker of the Microphone award

The Maker of the Microphone Award has been presented to 3M's Mincom division for "outstanding contribution to the world of sound." Specifically, the division was commended for its development of a practical digital audio recording system with electronic editing and disc-mastering interface.

The award is a trophy presented

annually in memory of Emile Berliner, who invented the microphone, the disc record, the disc record player (gramophone) and the method of mass producing discs from a single master record.

The award was presented by his grandson, Oliver Berliner (left), to Marshall Hatfield, vice president of the division.

CFRN CRY CKCY KBOX KGRO KLOE-TV KINT KLIN
 KNXV KPAC KRVN KYAK KYXY W WATD
 /BOK WCBQ WFLN WDAR WDLB W FOS
 WFTN WHAT WHP WIBF WIBX WIKZ WIRG WJ WW
 WKXL WKAP WLBR WLDS WLEW WLNH WLOB WLSW
 VRSC WLW WRVA WNNR W W O
 SSV WTCM WSB WTRI WTYR W SA

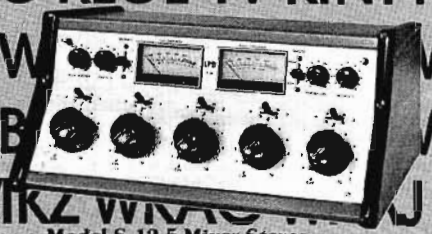

Model S-12 5 Mixer Stereo

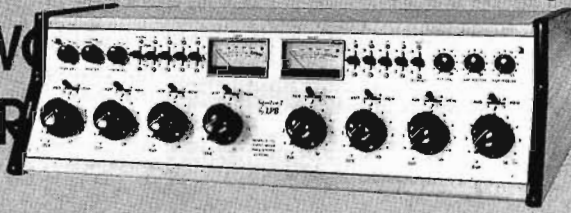

Model S-13C 8 Mixer Stereo/Mono

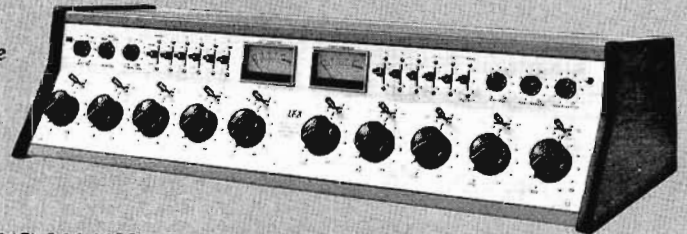

Model S-20 10 Mixer Dual Stereo

VERSATILITY

There's an LPB Signature II Series audio console in 5, 8 or 10 mixer configuration to fit your precise requirements. Air or production. Mono, dual mono or stereo. Why look elsewhere?

LPB® LPB Inc.
 28 Bacton Hill Road, Frazer, PA 19355 (215) 644-1123
 Manufacturers and Distributors of Broadcast Equipment Since 1960

See us at NRBA, Booth 412



**If you want
Plumbicon* picture quality
from your ENG camera—
specify Plumbicon TV camera tubes.**

As predicted, the Plumbicon $\frac{2}{3}$ -inch camera tube
changed the entire course of broadcast journalism
and helped make ENG the world's most
important medium of information.

Amperex[®]

TOMORROW'S THINKING IN TODAY'S PRODUCTS

A NORTH AMERICAN PHILIPS COMPANY

Circle (22) on Reply Card

AMPEREX ELECTRONIC CORPORATION, SLATERSVILLE DIVISION, SLATERSVILLE, RHODE ISLAND 02876 • TELEPHONE: 401-762-3800

* Registered trademark N.V. Philips of the Netherlands.

THE NETWORKS' CHOICE. (AND EVERYONE ELSE'S.)

At Camera Mart, we've been a leading equipment supplier to broadcasters and producers for years. We're no strangers to the 'instant' needs, unexpected calls, tough standards and difficult operating conditions that are often S.O.P. in this rough-and-tumble business. But you probably know that...at least, when it comes to film.

What you may *not* know is, for the past few years, we've been quietly doing the same in *video*! Testing and selecting the leading equipment for performance and reliability. And offering a wide selection of production and post-production components and packages—on rental, lease and purchase plans with our customary flexibility.

But don't take our word for it: talk to our customers. You'll see why so many people the industry depends on, depend on us.



40 years of excellence
Camera Mart

THE CAMERA MART, INC.
456 West 55th Street, New York 10019
(212) 757-6977/Telex: 1-2078
Sales • Service • Rental



Circle (23) on Reply Card

Business news

TeleMation recently signed a marketing agreement with Dytek Industries of Denver, CO. TeleMation will distribute Dytek's production switcher line, known as the SL Series Video Controllers and its DVC Series switchers.

Harris plans to buy CVS

Harris Corporation has purchased Consolidated Video Systems (CVS) of Sunnyvale, CA, for approximately \$13 million. Harris said the move will enable it to enter the digital video equipment market. CVS, with current sales of about \$9 million annually, produces video equipment for television stations, cable TV companies and industrial, educational and government TV users.

In 1974, CVS won an Emmy for the technical contribution to television provided by the company's digital time base corrector. The Harris acquisition plan calls for CVS to remain in California and to be operated as part of the Harris Broadcast Products division.

In other news at Harris, the company has formed a new division to market information systems overseas. The new unit, the Harris Information Systems International Division, will handle sales and customer service for computers, distributed data processing systems and interactive and remote batch terminals in all countries outside the US and Canada.

M. Andrew Haladej has been named president-general manager of the new division.

Microwave Associates

Microwave Associates has entered the semiconductor service business to be headed by Walter Sobie. The new operating group will market services which include custom metallization, photo-resist scribing techniques using lasers, diamonds and saws, scanning electron microscopy, energy dispersive x-ray analysis and atomic emission spectrometer services.

Black Africa to invest heavily in communication

According to a 530-page study by Frost & Sullivan, Black Africa will invest between \$12.5 billion and \$15 billion in telecommunications systems and equipment through 1990 (1978 prices). Black Africa comprises 41 separate states covering 12 million square miles.

Only some \$2.1 billion in contracts

THE BETTER WAY

we do
it all...in

Routing Switchers!

small

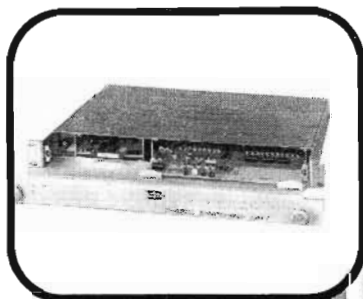

**D-4300 Series
Video & Audio Switchers**
Available as 6x1 video, 6x1 audio, 16x1 audio-video, 20x1 video and 20x1 audio. Video only, audio only, or video-audio. May be stacked for multiple output bus applications. Uses digital control system with coax remote control cable. Each output bus has an independent control system.

medium

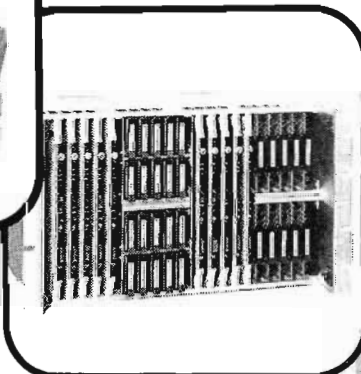

**D-400 Series
Video & Audio Switchers**
Available in 20x10, 20x15, 20x20, 30x10 and 30x15 video and audio basic matrix sizes which may be used as building blocks for larger systems for up to 100 inputs. Control system is BCD. Each output bus has an independent control system.

Large

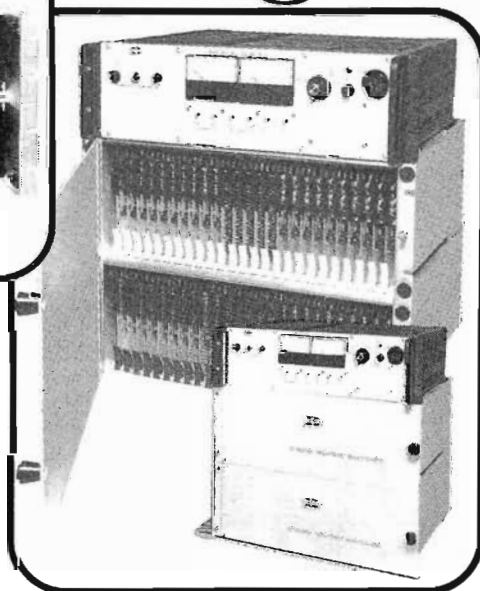

**D-2000 Series
Video & Audio Switchers**
Available in 25x20, 25x25 and 50x25 video and audio basic matrix sizes. Digital control system is designed for 250 inputs and coax is used for remote control cable. Each output bus has an independent control system.

For More Information,
Write or Call

D
DATATEK
CORP

1166 W. CHESTNUT ST. , UNION, N.J. 07083 • (201) 964-3856

Circle (24) on Reply Card

September 1979 *Broadcast Engineering* 35

Watch what we can do for you now...

with our new models and our faster delivery.



As manufacturers of solid state video equipment, Electrohome has gained worldwide acceptance with reliable, high-performance 9", 11", 14", 17", 23" monochrome, 19" and 25" color monitors. Built to NTSC and PAL standards, these monitors are specifically designed for broadcast, educational, industrial, commercial, medical, security and data applications.

Now, we have added the new 2000 Series to our product range. Developed to meet high standards of the broadcast industry, the 2000 Series color monitor is modular for easy adaptability to RGB/NTSC/PAL encoded signals. Available in 19" case and rack and 25" case, the 2000 Series maintains Electrohome's high standard of engineering.

In addition to an expanded line, Electrohome has a new west coast distributor network to provide fast delivery. For complete information on all our video equipment, contact Electrohome Limited at one of these offices:

Electro-Visual Corporation of America

3617 West Macarthur Blvd., Suite 508, Santa Ana, Calif. 92704
(714) 545-6991

Electrohome (U.S.A.) Limited

182 Wales Ave., Tonawanda, N.Y. 14150
(716) 694-3332

Electrohome Limited

809 Wellington St. N., Kitchener, Ontario, Canada N2G 4J6
(519) 744-7111
Telex: 069-5449

ELECTROHOME

... an extra degree of excellence in video equipment for every application.

Circle (25) on Reply Card

Business news

.....
have been placed so far, the study finds, with British companies having secured the biggest market chunk.

The study warns, however, that "there is a high probability that investment will be delayed either as a result of inflation or through difficulties in raising funds." The market outlook also shows a wide disparity among countries, from the least-developed country, the Republic of Benin, to oil-rich Nigeria.

For more information, contact Customer Service, Frost & Sullivan, Dept. BE, 106 Fulton Street, New York, NY 10038, (212) 233-1080. Report number E300.

Tube company formed

Dave Gilden has formed RF Gain, Ltd., which will supply transmitter and other tubes to the broadcast industry. The company is located at 100 Merrick Road, Rockville Center, NY 11570, (516) 536-8868.

INTELSAT reports 25% increase in satellite use

Demand for worldwide international telecommunications via the INTELSAT satellite system increased by more than 25% during 1978. This does not include occasional use services such as international satellite television, which jumped by 53.3% to over 11,600 channel hours. INTELSAT is the 102-member country organization which owns and operates the telecommunications satellites used by countries around the world.

The organization also predicts global international telecommunications via satellite to increase by about 100% by 1983. This prediction came out of the 1979 Global Traffic Meeting in Washington, DC. More than 200 delegates representing over 100 countries attended the week-long meeting with the purpose of determining short, medium and long term demand forecasts for the telecommunications service provided by the INTELSAT global satellite system.

Ampex: Belgium VTRs; scraps duplication plans

Ampex has announced that it will begin producing VPR-2 helical scan VTRs and TBC-2 digital time base correctors at its Nivelles, Belgium, facility. The facility will produce VPR-2s in the PAL and SECAM broadcast formats.

The company also has reached an

1964 WIRELESS MICROPHONE
 1968 HANDHELD WIRELESS MIC
 1969 TRANSISTORIZED SYSTEM
 1971 CRYSTAL CONTROLLED RECEIVER
 1972 PORTABLE RECEIVER
 1974 HELICAL FRONT END RECEIVER
 1976 DIVERSITY SYSTEM
 1978 PORTABLE DIVERSITY RECEIVER

1979

DYNEX

In 1964 Vega developed the first wireless microphone system that offered full-fidelity sound, the first real innovation in microphones in over 50 years. Now we are proud to introduce our latest innovation . . . Dynex!

Dynex adds dynamic input range expansion to wireless microphone operation thereby eliminating the need for continuous mic gain adjustments. Set it and forget it . . . it's that simple. Two years of extensive field use with the Dynex option enables us to guarantee the same proven reliability, quality and performance that you have come to



Model 77 Transmitter

expect from Vega.

We have continually improved our systems during the past 15 years, so you can be assured that

today's Vega systems are designed with the latest in high-technology electronics and sophisticated audio engineering. Besides offering you the finest systems available, Vega is constantly working with the industry to further the art of audio processing. One example is Vega's F.C.C. petition which resulted in obtaining clear wireless channels for broadcasters and filmmakers last year.

Vega offers a variety of systems that give you a new order of freedom and that foster new confidence in your performance. When new techniques are developed . . . they're from Vega.

 **Cetec Vega**

Division of Cetec Corporation

P.O. Box 5348 • El Monte, CA 91731 • (213) 442-0782 • TWX: 910-587-3539

Circle (26) on Reply Card

**“FINALLY THERE’S A ONE-INCH
AS WELL UPSIDE DOWN**



VIDEO RECORDER THAT WORKS AS IT DOES RIGHT SIDE UP.

DAVID HALL / OPRYLAND PRODUCTIONS

Opryland Productions is one of the largest video production houses east of the Mississippi. The company's facilities have been used for shows as varied as "Nashville on the Road," "Big Ten Basketball," and "Dance in America."

David Hall, General Manager of Opryland Productions, has been using the Sony BVH-1000 video recorder for close to two years and two BVH-500 portable recorders for about six months.

"Sony one-inch equipment has expanded our capabilities considerably," says Hall. "With a BVH-500, we were able for the first time to get broadcast quality tape on a roller coaster for an upcoming special."

"We also took the BVH-500 on a ferris wheel and in a helicopter to tape 'Superstars at the Ohio State Fair.' It performed as well as they did."

"Now we're using Sony on almost all shows we tape in the field. The big advantages are portability and cost. Durability, too. Sony even bailed us out when we were taping a quad production and our equipment broke down. We used Sony to finish the job, then transferred the results to quad. The client was more than satisfied."

"And when the Dominican Republic asked us to tape the visit of Pope John Paul II, we couldn't have done it without our Sony video recorders," Hall adds.

"Because they travel so well, we could get down there fast and do a professional job."

Of course, Sony makes a full line of one-inch broadcast equipment, all of it backed by state-of-the-art technology. We have video recorders, cameras, editors, and the BVT-2000 digital time base corrector.

For information, write Sony Broadcast, 9 West 57th Street, New York, N.Y. 10019. Or call us in New York at (212) 371-5800; in Chicago at (312) 792-3600; or in Los Angeles at (213) 537-4300.

Like David Hall at Opryland, you'll be impressed. Even if your productions don't have you going around in circles.

SONY BROADCAST

Sony is a registered trademark of Sony Corp.

Circle (27) on Reply Card

Go anywhere SMPTE Edit Code Generator and Companion Reader that will give you an instant shot list.



The only portable SMPTE Code Generator. Shintron Model 640 SMPTE Edit Code Generator.

- Goes anywhere with your ENG crew.
- Light and rugged. It attaches to your VTR and produces accurate edit code as you shoot important scenes.
- You cannot enjoy full advantages of ENG unless you have the 640 SMPTE Edit Code Generator.
- EBU European Standard version available.



Model 644 Edit Code Reader

When Shintron builds a new product, we think of our customers' convenience first. Good Edit Code Readers are a dime a dozen today, but which one can generate an instant shot list? The only one is Model 644 Edit Code Reader / Raster Display and Shot List printer.

SHINTRON

Worldwide

Cambridge, MA 02142 USA
(617) 491-8700 / telex: 921497

Circle (127) on Reply Card

Need it in a hurry?

We ship most catalog items from stock the same day an order is received.

Fast service and dependability is our standard. Request our free catalog of equipment and components.

We have 16 years of experience in serving the broadcaster's equipment requirements.

Broadcast Equipment & Supply Co., Inc.

P.O. BOX 3141
BRISTOL, TENNESSEE 37620
(615) 878-2531

Circle (128) on Reply Card

40 *Broadcast Engineering* September 1979

Business news

agreement to sell the machinery and related inventory of its custom duplicating facilities in Elk Grove Village, IL, to CBS Records.

Poniatoff awards

Ampex presented four 1979 Alexander M. Poniatoff (AMP) awards to its employees for technical achievements. Winners were Peter Jensen, engineering section manager, audio-video systems division; Billy Baker, senior staff engineer, data systems division; Chi Chao and Bhupendra Shah, project engineers, magnetic tape division.

Jensen was honored for contributions to the development of video time base correctors. Baker received his award for the invention of the super high bit recorder automatic tracking system for instrumentation recorders. Chao and Shah shared an award for their development of the sandmill process used to manufacture some of the company's videotape.

Scully bought by Ampro

Ampro Broadcasting has purchased Scully Recording Instruments, formerly a division of Dictaphone, and has changed its name to Ampro/Scully to reflect the new association. Ampro/Scully has added facilities in Newtown, PA, for manufacturing and warehousing Scully recorders. Executive offices also have been relocated to 826 Newtown/Yardley Road, Newtown, PA 18940, (215) 968-9000.

SALES CONTRACTS

Bosch Fernseh

Sales of Bosch Fernseh's BCN range of 1-inch VTRs continue to rise rapidly, according to the company. Over 100 orders were received for BCN units in April.

Robert Bosch GmbH, Darmstadt, is scheduled to deliver two high-speed reporter vehicles for the 1980 Moscow Olympics. The ENG/EPF vehicles will travel about 100 mph at fully loaded top speeds. They will be equipped with two KCA cameras with base stations. Monitoring, VTR, audio mixing and radio link equipment is built into the car.

Coastcom

Coastcom has received an official notice to proceed from the Collins Transmissions Systems Division of



STATE OF THE ART

AMPEX 196 SERIES BROADCAST 1" HELICAL TAPE

This is the tape Ampex *had* to design to demonstrate the fantastic capabilities of our VPR-2, the machine that is revolutionizing professional video recording.

With Series 196, color brilliance is preserved and signal-to-noise ratio is unaffected even after multiple playback passes, lengthy still framing and heavy post-production editing. This tape is the ultimate match for the VPR-2—a brilliant combination

that is unsurpassed in today's video recording industry. Available in SMPTE Type "C" or "B" formats. 34 min/66 min/94 min.

Contact Ampex Corporation, Magnetic Tape Division, 401 Broadway, Redwood City, CA 94063, 415/367-2011.

AMPEX



OFFICIAL SUPPLIERS VIDEO RECORDERS AND MAGNETIC TAPE XXII OLYMPIAD

Circle (29) on Reply Card

Business news

Rockwell International to produce and ship nearly \$1 million of Coastcom's Model 412 single channel per carrier (SCPC) modulators and demodulators during the remainder of 1979.

E-Systems

E-Systems TelSatCom Division, Garland, TX, has signed a contract with Empresa Nacional de Telecomunicaciones TELECOM Bogota, Colombia, to engineer, furnish and install a 13-meter non-standard Intelsat earth terminal on a turnkey basis. The terminal, to be located in Leticia, Amazonas State, will be linked to the Colombian domestic satellite network, utilizing leased satellite capacity of the Intelsat system.

Marconi Communication

Marconi Communication Systems is under contract to supply and install a 750kW broadcast transmitter to the Kuwait Broadcasting and Television Service. The contract, valued at nearly \$4.4 million, also provides for any necessary updating

of the three Marconi 750kW transmitters currently in use.

Marconi also has received contract for VHF and UHF television transmitters to be used by RAI—Radiotelevisione Italiana. The nearly \$2.2 million order calls for the VHF transmitters to replace existing equipment operating on the first TV channel while the UHF transmitters are a part of a major project which includes replacement of some transmitters of the second TV channel and the establishment of an additional color TV channel.

Another large order has been received by Marconi for five television cameras, two telecines, installation materials, spares and training of the personnel at the Radio and TV Organization of the Yeman Arab Republic. The order will re-equip two studios at the television center in the nation's capital.

Microdyne

Microdyne booked over \$1.2 million in new orders for satellite TV receiving equipment at the National Cable Television Association con-

vention in Las Vegas. A company spokesman indicated that this was the highest volume of business ever booked by the company at a single trade show.

Neve Electronics

Neve Electronics International has received orders for two consoles from Anglia TV's facilities in Norwich. The largest of the two was a custom-built 36-input channel mixing desk based on the 5315/24-input channel model. The second was an 8301 10-channel "Kelso" transportable console.

Neve also reports sales of a 44-input 32-track 8088 console to Queen Village Recording, and a 8068 recording console with a custom 48-channel Necam automation system to Sound Labs.

Quantel

Quantel Limited has received an order for 15 DPE 5000 NTSC Digital Production Effects systems and other digital video devices valued in excess of \$2 million from the

BUILT TO MAKE IT!

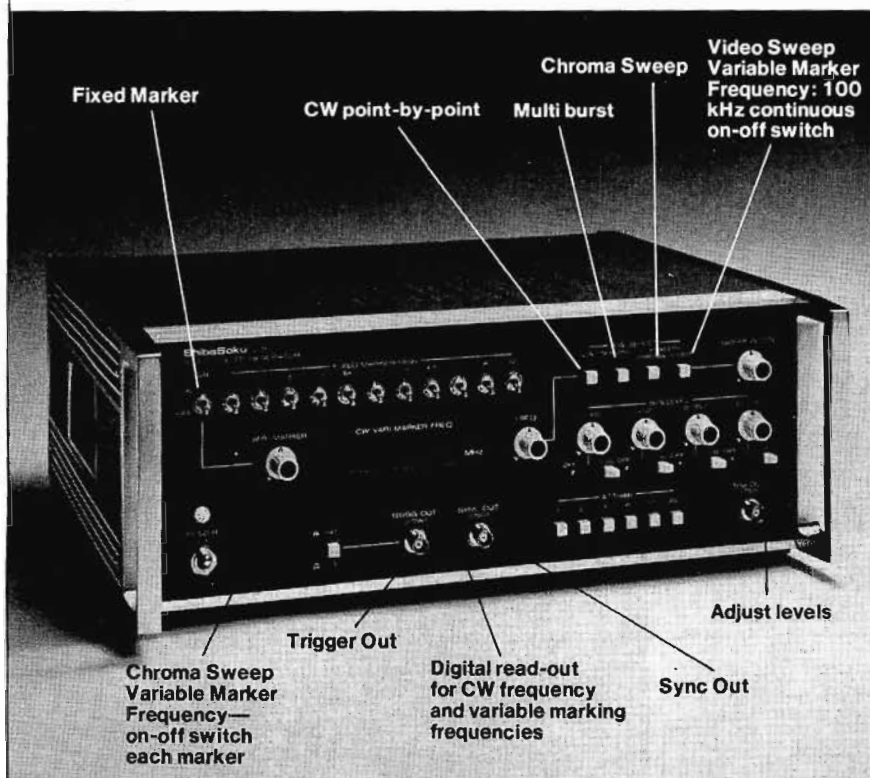

AND MAINTAIN IT!! Measures frequency response on TVs, VTRs and other video equipment.

The Asaca Video Sweep Generator 205 contains a built-in standard color sync signal generator. The color burst can be switched on and off so the 205 is ideal for oscillator comparisons to measure frequency response of color equipment.

There is a selection of output signals: video sweep (0.1 - 10 MHz), chroma sweep (sub carrier ± 2 MHz), CW and multi-burst.

Also, the 205 features facilities for composite sync signal outputs and trigger pulse outputs (H. D/V. D. Selectable) and so it can be used for oscilloscope triggering. Digital read out for CW frequency and variable marking.

Contact your Asaca distributor for details or demonstration. Or write to:

ASACA®

ASACA CORPORATION OF AMERICA
1289 Rand Road, Des Plaines, Ill. 60016
(312) 298-4380

In the far east, contact ShibaSoku, Ltd.
19-13 Chome, Fukuzawa, Setagaya-ku
Tokyo, Japan Phone: 703-5151

Circle (30) on Reply Card

12X. 18X. 25X. ZOOM!

And over a dozen other ways to make
any camera look its best.

Whatever your camera, production goals and budget, it pays to talk to Canon first. Because we offer you more to choose from. And more *value*, whatever your choice — in full servo or manual models for ENG/EFP studio or field.

To give you greater versatility, there's the widest choice of focal lengths and longest zoom ratios. For greater sensitivity,

larger relative apertures. For flexibility, shorter MODs, lighter weight and more compact size. (Often, at a surprisingly compact price.) All, backed by fast, *dependable* factory service.

Whether you're buying a new camera or upgrading your present one, give us a call.

And discover why more people depend on Canon.

Canon®

Canon U.S.A. Head Office: 10 Nevada Drive, Lake Success, N.Y. 11040 (516) 488-6700 • 140 Industrial Drive, Elmhurst, IL 60126 (312) 833-3070
123 Paularino Avenue East, Costa Mesa, CA 92626 (714) 979-6000
Canon Optics & Business Machines, Canada, Ltd., 3245 American Drive, Mississauga, Ontario L4V 1B8, Canada
Canon Amsterdam N.V., Industrial Products Division De Boelelaan 8, Amsterdam, Netherlands

Circle (31) on Reply Card



Business news

National Broadcasting Company. Besides the digital effects systems, the order includes four NTSC DFS 3100 digital framestore synchronizers, five DPE 5001S digital production effects systems, four DFS 3001S digital framestore synchronizers and a DSC 4002 digital standard converter for converting the Soviet Secam signals to NTSC.

RCA

RCA reports the following major sales and contracts since the first of

June:

- 90 color TV cameras and associated equipment, valued at about \$5.5 million, to Radiotelevisione Italiana (RAI);
- Cablevision Systems equipment and installation services, valued at about \$4.5 million, to Fresno Cable TV;
- television program production equipment, valued at more than \$1.5 million, to KCET, Los Angeles;
- transmitting and studio equipment, valued at more than \$1.5 million, to Ziff Davis Broadcasting;

- television program production equipment, valued at more than \$1.5 million, to The Production Company, Houston;
- television program production equipment, valued at about \$1.1 million, to Televisao Guaiba Ltda., Porto Alegre, Brazil;
- transmitting and studio equipment, valued at more than \$600,000 to Radio Difusora do Maranhao, Brazil;
- studio and editing equipment, valued at more than \$500,000, to Synatrak, Hollywood, FL;
- a 2-way radio system, valued at more than \$125,000, to ABC-TV for coverage of the Winter Olympics; and
- 15 portable color television cameras to Bulgarian Television, Bulgaria.

Fight Inflation With Harris Criterion 90 Series

Unbeatable Price and Performance

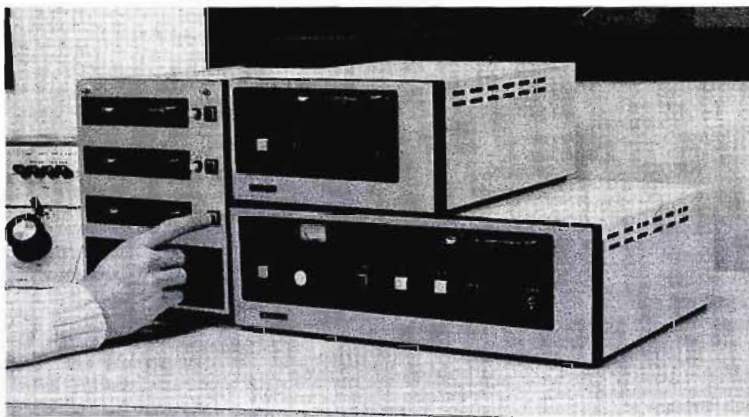

For the discriminating broadcaster whose demand for quality is increasing, but whose budget isn't, Harris offers the inflation fighting Criterion 90 cartridge machine.

100% solid state construction and simplicity of design coupled with computerized testing and strict quality

control guarantees the Criterion 90 a long life of superior audio performance—and the price is well within your budget.

Call Harris Corporation, Broadcast Products Division, Quincy, Ill. 62301, for more information on inflation fighter prices and a 30 day field trial.

See you at NRBA
Oct. 7-10
Booths 3-7



HARRIS
COMMUNICATION AND
INFORMATION PROCESSING

Sony Broadcast

Sony Broadcast has sold electronic news gathering equipment valued at more than \$1 million to the five owned and operated television stations of Group W (Westinghouse Broadcasting Company). The order included 30 BVP-300 broadcast video cameras and 50 BVU-50 ¾-inch videotape recorders.

Thomson-CSF

Radiotelevisione Italiana (RAI) has ordered television and video equipment from Thomson-CSF. The first delivery will include UHF 2+2kW and 10+10kW transmitters. The company will supply nine still image analyzers for color slide projection.

FINANCIAL

Ampex

Ampex has declared its first dividend in its 35-year history. The dividend of 5 cents per quarter, payable August 28 to stock of record July 26, was declared less than two weeks after the company reported record net earnings and revenues.

Anixter Brothers

Third quarter net income rose 159% on a 46% sales gain at Anixter Brothers. Sales for the third quarter totaled \$69.8 million over \$47.8 million in the period the previous year. Net income rose to \$2.3 million or 71 cents per share, from \$888,000 or 28 cents per share last year.

Circle (32) on Reply Card

**Marconi Television Interval Timer
Model 2920 measures the
following parameters**

**MARCONI has the
proven answer to
'H' & 'V' Blanking
Measurements**

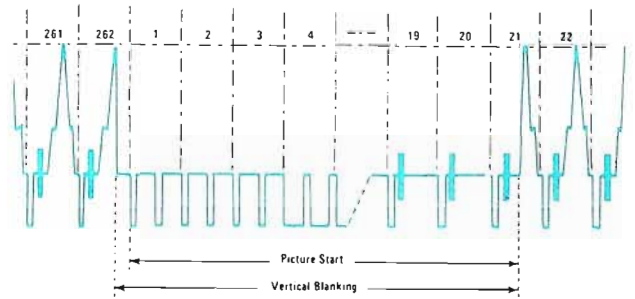

VERTICAL BLANKING MEASUREMENTS

- Total Vertical Blanking Interval
- Picture Start
- Equalizing Pulse Width
- Serration Width

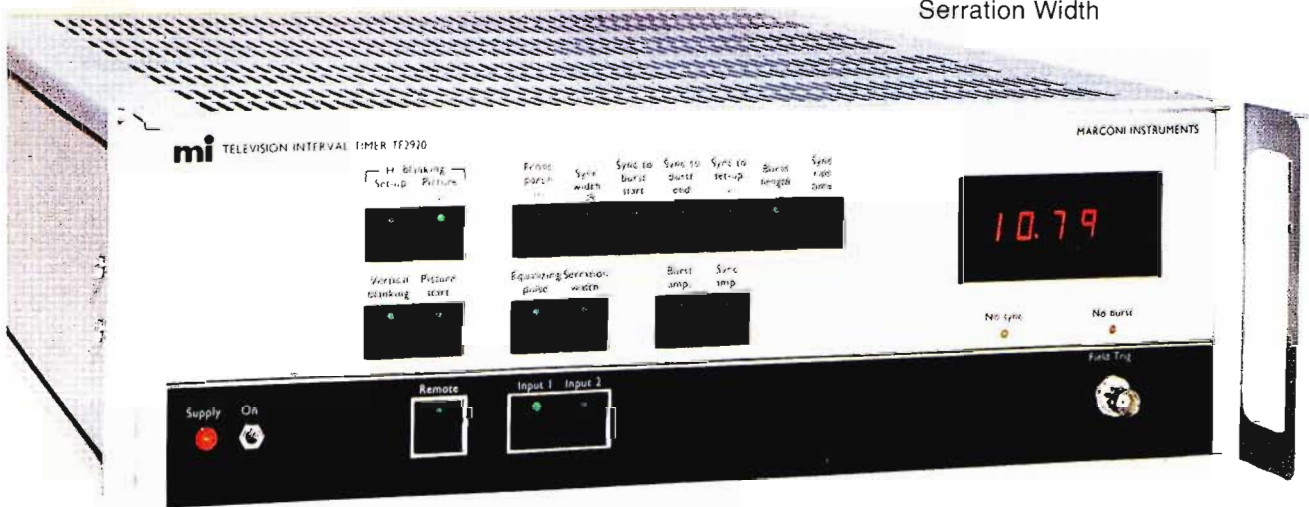

**See How Easily Timing Measurements
Can Now Be Made**

- Fast accurate measurements at the touch of a button
- Results from samples taken throughout active field
- Blanking at set-up (+4 IRE) and picture (+20 IRE) measured independently to 10 nsec. resolution
- Vertical Blanking resolved to 1/10 line
- Printout from BCD output on command
- All functions may be remotely controlled for simple system integration
- Manufactured in U.S.A., domestic price \$4950

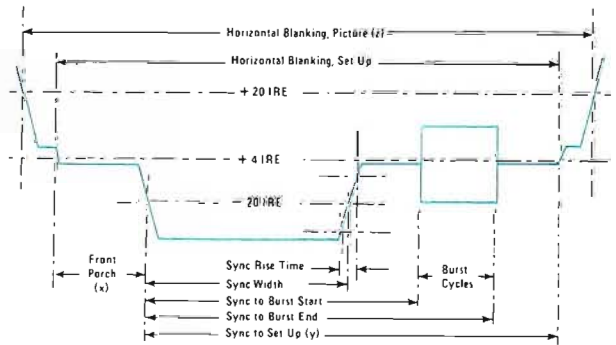

HORIZONTAL BLANKING MEASUREMENTS

- Set Up Blanking (+4 IRE)
- Picture Blanking (+20 IRE), (z)
- Front Porch, (x)
- Sync Width
- Sync to Burst Start
- Sync to Burst End
- Sync to Set-Up, (y)
- Burst Length in cycles
- Sync Rise Time

REFERENCE MEASUREMENTS

- Burst Amplitude in IRE
- Sync Amplitude in IRE

**marconi
instruments**

100 STONEHURST COURT, NORTHVALE, NEW JERSEY 07647
TELEPHONE: (201) 767-7520 • TWX: 710-991-9752

Circle (33) on Reply Card

Business news

Atlantic Research

Earnings at Atlantic Research for the first six months of 1979 increased by 17% over the same period last year. Net income was \$734,000 on sales of \$24.8 million, compared to \$625,000 and \$21.5 million for a like period in 1978. Earnings per share were 63 cents this year compared to 62 cents in 1978.

Cohu

Cohu reported net income of

\$475,035 or 28 cents per share for the first six months of 1979. Revenues were \$10.6 million compared to income of \$216,759 or 13 cents per share on revenues of \$9.1 million in the like period of 1978. An eighth consecutive quarterly cash dividend of 4 cents per share has been declared by the directors.

Comcast

Comcast has declared a quarterly cash dividend of 3 cents per share on Class A and Class B common

stock. The payment will be made September 27 to shareholders of record as of September 6.

COMSAT

Consolidated second quarter net income of \$10.6 million or \$1.32 per share, has been reported at COMSAT. This is an increase of 37% from \$7.7 million or 96 cents per share for the second period of 1978. Compared with the first quarter of 1979, second quarter net income decreased by \$1.3 million or 17 cents per share.

Datatron

Datatron reported a profit of \$34,254 on sales of \$1,249,477 for the third quarter ended March 31.

Farinon

Farinon has announced increased sales and earnings for its fiscal year ended March 31, 1979. Sales for the year were \$92.8 million or 23% above last year's sales of \$75.4 million. Net income at \$5.7 million was also 23% above the previous year's income of \$4.6 million. Net income per share for the year was \$1.18 compared with last year's \$1.00.

RCA

Second quarter earnings at RCA rose 9% over the record profit in the same quarter of 1978 on a sales gain of 17%. Net profit for the three months ended June 30, 1979, was \$85.6 million, compared with \$78.3 million in the same period last year. Quarterly earnings per common share rose from \$1.02 a year ago to \$1.13. Sales for the quarter reached \$1.89 billion, against \$1.61 billion a year ago.

Scientific Atlanta

Scientific Atlanta reported sales of \$86 million for the nine months ended March 31, 1979. That is 29% over the same period last year. Net earnings of \$5 million were 37% higher than in the first nine months of last year. Net earnings were equal to \$1.85 per share, compared with \$1.50 per share in the first nine months of previous year.

Sennheiser Electronic

Sennheiser Electronic of West Germany has reported sales of \$28.9 million in 1978, an increase of 10% over the previous year. Headphones now account for almost half of the manufacturer's sales, compared with only 1% 10 years ago. □

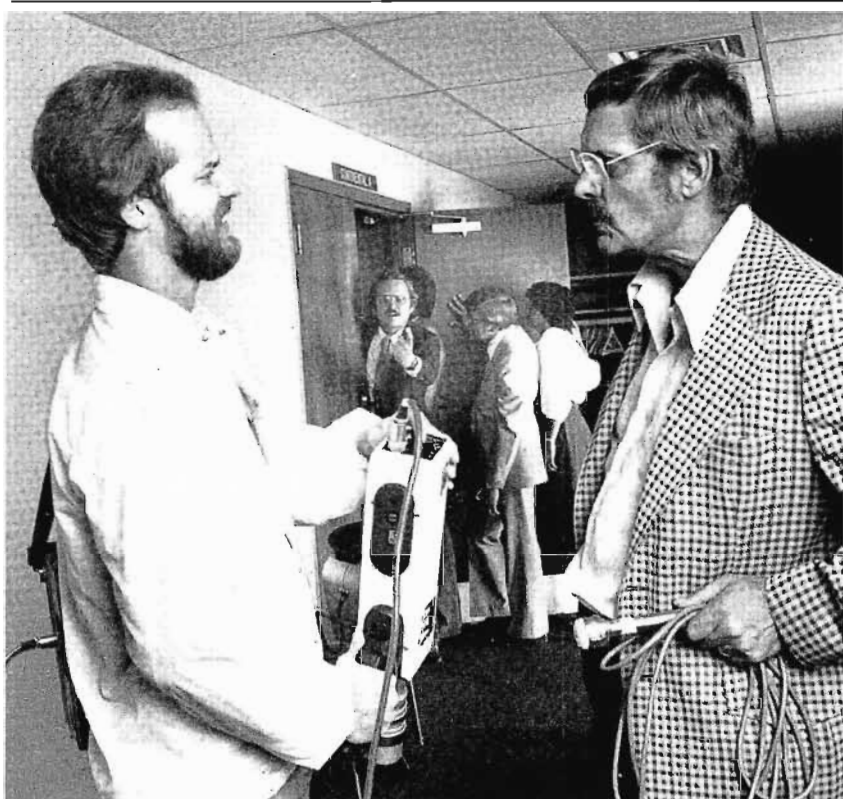

The Senator just announced he's running again. Too bad your camera isn't.

If you've lost a story because of weak, unreliable batteries, take a look at Alexander Ni-Cad replacement batteries. Alexander was a pioneer in the development of nickel-cadmium batteries for ENG and EFP. And we're working closely with station engineers and videographers to develop new power products for even greater reliability.

Alexander. Batteries are our only business.

 **ALEXANDER**
Alexander Manufacturing Co.
Box 1645 — 1511 South Garfield Place
Mason City, Iowa 50401
Phone (515) 423-8955

Circle (34) on Reply Card

System-Cameras for all Applications

50 BOSCH
FESTIVALEN
1976-1978

The universal camera range for studio productions, outside broadcasts, electronic news and field operation. Fully automatic production camera KCK with additional hand held version KCK-R. New economic 2/3 inch option: KCP. Self contained multipurpose camera system KCA with comprehensive base station features. Ease of operation with a high degree of automation. The latest technology with the economy and flexibility of system design. A rational and progressive camera concept in all color standards. From Bosch.

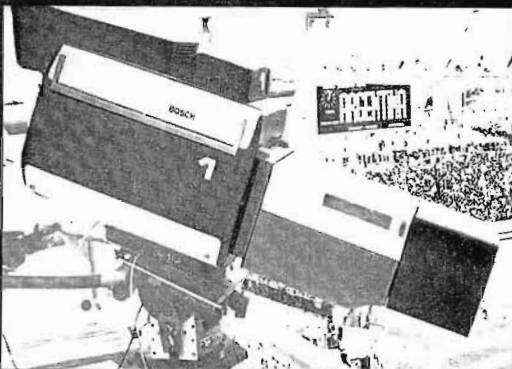

Your Video System Partner
BOSCH
Television Systems Division

Further information obtainable from our regional representatives, subsidiaries or head-office in Darmstadt · Robert Bosch GmbH, POB 429, D-6100 Darmstadt, Fed. Rep. of Germany · Robert Bosch Ltd., POB 166, Watford, Great Britain · Robert Bosch Corp., 279 Midland Ave., Saddle Brook N.J. 07662, USA · Robert Bosch Pty. Ltd., 69 Edward Street, Pyrmont NSW 2009, Australia · Robert Bosch Pte. Ltd., POB 4, Thomson Road, Singapore 20.

Circle (35) on Reply Card

September 1979 *Broadcast Engineering* 47



improves antenna stability for AM directionals.

"In addition to dielectric integrity, PHILLYSTRAN tower guys offer several major advantages. These non-conducting guys combine high strength, light weight and inherent flexibility for installation ease. They also are essentially maintenance-free, even around salt-laden corrosive atmospheres.

"Since these non-metallic synthetic guys eliminate white-noise arcing, they should be considered where high water tables and common grounding, severe lightning storms, or frequently inclement weather tend to create transmission and reception problems.

"Several broadcasters improved antenna stability for AM directionals by replacing steel guys with PHILLYSTRAN:"

See US
at NRBA
Booth 502
Oct. 7-10

Joseph Sherman
Partner
Sherman and Beverage
Consulting Engineers
Medford, NJ

PHILLYSTRAN® Tower Guys are
• non-conducting • maintenance-free • easy-to-install

Please send

- "10 reasons why your best buy for tower guys is PHILLYSTRAN®"
- "PHILLYSTRAN® offers the advantages of synthetic fibers...plus the strength of steel!"

NAME _____

TITLE _____

COMPANY _____

ADDRESS _____

CITY _____

STATE _____ ZIP _____



PHILADELPHIA RESINS CORP.
20 Commerce Drive
Montgomeryville, PA 18936
(215) 855-8450
Telex 84-6342

BE

Circle (36) on Reply Card

association news

National Association of Broadcasters

1771 N Street, NW
Washington, DC 20036



Lerner elected chairman of NAB radio board

Arnold S. Lerner and Edward O. Fritts have been elected to 1-year terms as chairman and vice chairman, respectively, of the National Association of Broadcasters' radio board of directors. Lerner is chairman of WLLH, Lowell, MA, and

Fritts is president of Fritts Broadcasting, Indianola, MS. In the new positions, both will serve on the executive committee which advises Vincent T. Wasilewski, president, on the implementation of NAB policies.

FCC asked to rethink microwave frequency decision

The NAB has asked the FCC to reconsider its decision on microwave frequency use and not allow the expansion of Cable Television Relay Service (CARS) into the band set aside for broadcast auxiliary service which includes ENG operations. The petition stated that, "with an astounding lack of foresight and with little, if any, regard for the full record, the FCC has struck a

critical blow to the future of ENG, creative public service programming and overall video responsiveness by the broadcast television medium." If the commission insists on some entry of the CARS service into this band, "it must do so on either a waiver basis or by according CARS nothing more than a secondary status, at least in the top 100 television markets."

Voluntary receiver performance program proposed

In two separate actions made recently, the NAB proposed a voluntary program of AM and FM radio performance standards and an inclusion in the capability of television receivers to reject noncommercial FM interference to channel 6.

In the area of radio performance standards, the NAB is proposing that receiver manufacturers voluntarily submit tests to NAB or an independent laboratory. Under the plan, the NAB would authorize the manufacturer to attach a seal signifying compliance if the radio meets the standard. Three classes of performance are proposed: A, B

and C. The purpose is to encourage design improvements in receivers and to help buyers utilize electrical performance as part of their purchasing decision.

Regarding TV receiver performance, the NAB said that the action would be a long-term solution and urged the FCC to adopt their earlier plan which asked for FM station assignment policy modifications, FM power limitations, FM vertical polarization requirements and the creation of an FCC task force to consider the channel 6 interference problem and prepare a plan of action.

NAB asks FCC to regulate home satellite reception

The NAB has requested that the FCC make an inquiry and adopt policies governing home satellite reception before proliferation of receive-only earth stations occurs. According to the association, "unregulated growth of such reception antennas could lead first to the serious impairment of the program

supply market, through unlawful and uncompensated use of program product, and second, could threaten the conventional terrestrial television system and the principle of local video service responsive to local needs and interests." The NAB urged the commission to maintain a system of earth station licensing and

Direct drive made Panasonic Series 9000 a great 3/4" editing system. Here's what makes the new 9000A an even better one.

The new Panasonic Series 9000A offers even more impressive performance, even more quality, and more professional features than the Series 9000 did last year. And we still have the lowest price tag in the business.

The new system consists of the NV-9500A editing recorder, the inexpensive NV-9200A player/recorder, and the NV-A950, the versatile editing controller that goes between them.

Together, they deliver the cleanest Panasonic frame-to-frame edits ever.

S/N ratios are our highest ever, 46 dB color and 50 dB black and white, thanks to new crystal-oriented HPF™ video heads. And in addition to those crisp, clean edits, you get reduced audio delay at the edit point. And substantially increased frequency response at the first generation.

That's not all: The newly increased frequency response works with a patented dubbing mode for

even better dubbing quality. And still another of the many important improvements is a new tape guide path on the video head cylinder. It reduces tape edge movement for an even better RF envelope, and an even better signal—the best yet from Panasonic.

You get all these improvements, plus professional features you can count on in a Panasonic editing system: Like controls that are completely solenoid-operated. A separate RF output for use with an external DOC. Even subcarrier and external sync inputs for use with a time base corrector.

The Panasonic Series 9000A 3/4" editing system. The only thing that looks better than its performance is its price.

For more information, write: Panasonic Company, Video Systems Division, One Panasonic Way, Secaucus, N.J. 07094. In Canada, Panasonic Video Systems Department, Mississauga, Ontario.

Exterior cabinetry is simulated woodgrain.



Panasonic
just slightly ahead of our time.

Circle (37) on Reply Card

NAB

noted that any proliferation of earth stations or modification of current satellite uses would be in direct violation of domestic and international restrictions.

Advisory team requested

In a letter to the secretary of the FCC, Erwin Krasnow, senior vice president of the NAB, repeated a request that the commission establish a joint government-industry advisory committee on full-time radio services. Krasnow stated that the

committee should be "established to make a comprehensive review of all proposals pertaining to aural allocations, including the proposed restructuring of some of the Class I-A clear channels." The NAB believes that an overall national radio allocations policy is necessary rather than a piecemeal approach.

Antitrust suit brought

The US Justice Department recently requested that the US district court of Washington, DC, rule that

the NAB television code standards are in violation of the Sherman Antitrust Act and should prohibit their use. The code, in effect since 1952, places the following restraints on nonprogram time, including commercials:

- for network affiliates: in prime time, 9½ minutes per hour, and 30 seconds per hour for promotional announcements when deemed necessary;
- in children's programming on Saturdays and Sundays, 9½ minutes per hour;
- in children's programming on other days, 12 minutes per hour;
- all other time, 16 minutes per hour;
- time, seven minutes per half hour; and
- in all other times, eight minutes per half hour.

According to the government's suit, the codes place unreasonable restraints on trade and commerce, however, the NAB contends that the codes are in the public interest.

Minority fund grows

The Minority Investment Fund established last February by the NAB to assist minorities in purchasing broadcast facilities has received corporate guarantees and cash contributions of almost \$9 million to date. The goal is to obtain \$15 million in contributions from individuals and corporations which will be supplemented by matching funds from the Small Business Administration.

Dismissal of complaint against form requested

The dismissal of a Citizens Communications Center complaint against their request that the FCC modify and clarify its revised annual employment report has been requested by the National Association of Broadcasters (NAB). NAB says the complaint contains "seriously distorted characterizations of NAB's petition and of the employment and employment reporting practices of the broadcast industry."

In its original filing the association had suggested that the commission add job titles erroneously omitted from the revised form, include particular titles in more than one job category and reinstitute the provision allowing licensees to place employees in job categories where equivalent to similar positions are found. □



Wang Time Tunnel™ because: What they don't hear can't hurt you!

All it takes is one inadvertent obscenity or ethnic slur and away goes a chunk of the market you are trying so hard to nail down.

Time Tunnel™ solves the problem for 26 cents an hour with a six second digital delay that lets you drop, chop or bleep anything you don't like, long before it hits the air.

Call the gang at Wang at 800-258-1034
for information on our free trial offer.

It could be the last time you ever have to worry
about your station airing the wrong words at the wrong time.

WANG

Wang Voice Communications, Inc., Hudson, NH 03051

Circle (38) on Reply Card

Super LEADER Package

PROOF-OF-PERFORMANCE at Unheard of Prices!

LEADER LAG-125 LOW DISTORTION AUDIO GENERATOR



- Clean square waves test transient response.
- Low distortion sine wave output — less than .03%.
- Burst signals for transmitter tests.
- Pushbutton frequency range switching, 5 steps.
- 0 to 50 dB calibrated attenuator.
- Frequency sync. from external source.
- 600 Ohm output termination.

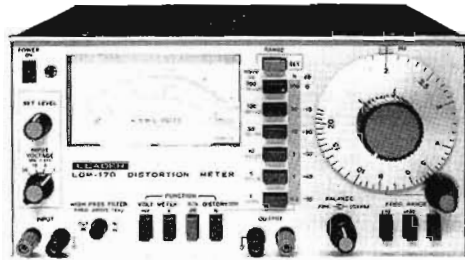

LEADER LDM-170RF DISTORTION METER

- Completely RF shielded
- Voltage range 1 mV to 300 V in 12 ranges
- Accuracy $\pm 5\%$ of full scale
- Distortion ranges: 100%, 30%, 10%, 3%, 1%, .3%
- Less than .03% residual distortion
- Monitor output

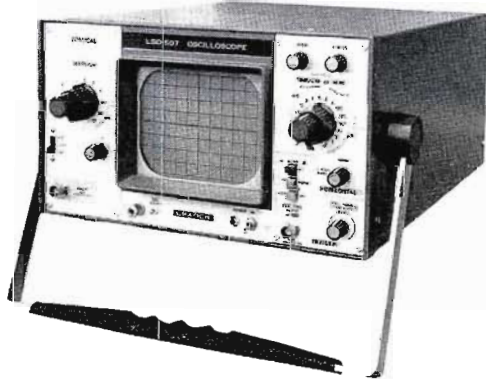

LEADER LBO-507A 20 MHZ TRIGGERED OCILLOSCOPE

- Stable, bright display
- Outstanding trigger sensitivity over entire operational range.
- 10 mV sensitivity and 17.4 nSec rise time.
- X5 magnification
- Includes probe

**IMMEDIATE DELIVERY &
TWO-YEAR WARRANTY
MONEY-BACK GUARANTEE IF YOU
ARE NOT COMPLETELY SATISFIED.**

Check These Prices!

Leader LAG-125 Low Distortion Audio Generator	\$525
Leader LDM-170RF Distortion Meter	\$640
Leader LBO-507A 20 MHZ Triggered Ocilloscope	\$580
PACKAGE PRICES:	
LAG-125, LDM-170RF, LBO-507A	\$1,600
LAG-125, LDM-170RF	\$1,100

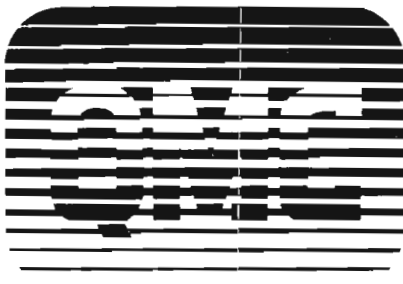

CALL TOLL FREE 1-800-241-7878
IN GEORGIA CALL COLLECT 404/324-1271

Quality Media Corporation

P.O. BOX 7008 • COLUMBUS, GA. 31908

Circle (39) on Reply Card

September 1979 *Broadcast Engineering* 51

NRBA

National Radio Broadcasters' Association

1705 De Sales Street, NW
Washington, DC 20036

NRBA proposes new radio deregulation measures

The NRBA has begun to press for a radio deregulation bill now that HR-3333 is dead. The association has submitted a summary of radio deregulation proposals to Representatives Lionel Van Deerlin and James Broyhill. These congressmen will share the proposals with other members of the House Communications Subcommittee in the near future.

Highlights of the proposals include the following:

- Radio licenses extended to 7 years;
- Licensees will meet the public interest, convenience and necessity standard by broadcasting a certain

percentage of non-entertainment programming—this percentage, to be determined by the FCC, shall not exceed 8% for AM stations or 6% for FM stations;

- License revocation only in cases of willful and intentional reporting of false information to the FCC, willful and repeated failure to operate as set forth in the license, violations of lottery, fraud and/or obscenity laws as outlined in the United States Criminal Code;
- The FCC shall be prohibited from evaluating program content, format, presentation or topics covered in non-entertainment programming in renewal proceedings;

- Section 317 of the Communications Act of 1934, sponsorship identification rules, will be repealed;
- In the event a renewal application is designated for hearing, competing applications will not be entertained;
- Ownership will be limited to 10 AM and 10 FM stations—no restrictions on cross-ownership of AM and FM stations;
- FCC required to set standards for petitions to deny or revoke, and to establish sanctions for abuse of these processes—parameters for standards and sanctions to be set by statute; and
- Establish fund to make moneys available to minority applicants qualified to own and operate a radio station. Fund to be administered by the FCC.

Benefit questions asked

The NRBA has distributed forms to its member stations in order to determine their interest in developing several employee benefit plans. This includes Group Life, Basic Hospitalization, Major Medical,



DOES YOUR SYSTEM PERFORM TO ITS FULL POTENTIAL?

Restore your signal to the quality you should expect with the Sigma Electronics video processing system.

Sigma's video processing system consists of the field-proven genlock sync generator, CSG-300, and the new video processing amplifier, VPA-100.

Optimize your video signals by independently controlling video, chroma, burst, sync and blanking.

YOU CAN AVOID PRODUCT REDUNDANCY

Sigma's VPA-100 will perfectly mate to your existing sync generator.



SIGMA ELECTRONICS INC.

1830 STATE STREET, EAST PETERSBURG, PA 17520

(717) 569 2681

Circle (40) on Reply Card

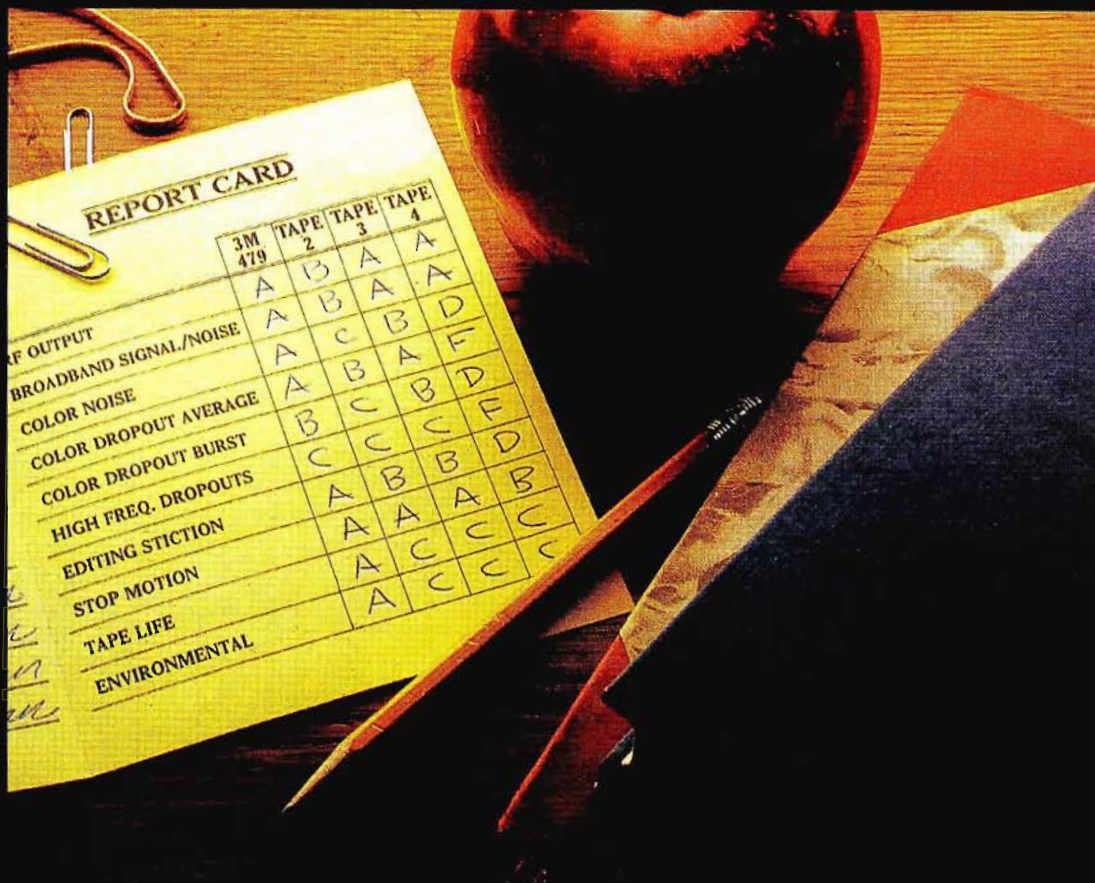

"Scotch" is a registered trademark of 3M Company.

IN A TEST OF ONE-INCH VIDEO TAPES, WE ACED OUT THE COMPETITION.

When we tested the top four brands under strict lab conditions, the overwhelming performance leader was Scotch 479 Master Broadcast Video Tape. In fact, we came out on top in all ten performance categories.

If that isn't reason enough to make us your choice, maybe this is. We're the only one-inch supplier that winds your tape onto a special cushioned flange reel to protect against shipping and handling damage. And we pack and ship our tape in a flame-retardant case to give you even more protection.

We're the people who pioneered the development of video tape 25 years ago. And according to the pros who know video tape best, we're still the best video tape. Give or take an inch.



3M

JVC's \$17,000 editing system.



If you think a third audio channel and 10 extra lines of resolution are worth an extra \$6000 in a 3/4" video editing system, read no further.

But if you'd like to save \$6000 compared to the nearest performing competition...yet perform advanced editing functions at tape speeds up to 10 times normal (a JVC exclusive)...and produce broadcast quality tapes even if you're not an expert...then the CR-8500LU system including RM-85U Editing Control Unit is for you. It has many features you won't find elsewhere

except on that higher priced system. Plus some you won't find even there.

Fast, no-glitch editing

With pushbutton ease, you get distortion-free frame-to-frame editing, thanks to JVC's built-in rotary erase head, blanking switcher and advanced servo mechanism. First, you have a choice of 11 forward and rewind search speeds, from still-frame to an unequalled 10 times normal. After picking edit points, you also have a wide choice of automatic preroll times. (The more expensive

system limits you to 2 or 5 seconds.) Then you can preview your edits and adjust edit points. Preroll again, and edits are made automatically, electronically, at exactly the selected points ± 2 frames—an accuracy equal to the higher priced system. There's also a horizontal sync phase compensator to minimize timing error. A patented dubbing switch for maintaining stable color. And much more.

The RM-85U Editing Control Unit has independent LED displays for player and recorder. Each gives elapsed tape time in

For those who need funds, not frills.



minutes, seconds and frames. Or, the exact length of one edit—a JVC exclusive. But wait! Maybe you don't even need a full system.

Stand-alone versatility

Let's say you just want to assemble or insert edit live material onto a tape. All you need is one CR-8500LU Recorder/Editor...which still gives you the benefit of automatic preroll. By contrast, the higher priced brand makes you buy a control unit as well.

Let a JVC dealer show you how our editing system gives

you much more for your money. For the name of your nearest dealer, call one of these numbers collect: East, 212-476-8300; Midwest, 312-364-9300; South, 713-741-3741; West, 213-537-6020. US JVC Corp., 58-75 Queens Midtown Expressway, Maspeth, NY 11378.

JVC[®]
PROFESSIONAL VIDEO DIVISION
US JVC CORP.

BE-9/79

Mail to US JVC Corp.,
58-75 Queens Midtown Expressway,
Maspeth, NY 11378.

I'd like to know more about the
CR-8500LU editing system including
RM-85U Editing Control Unit.

Name _____

Title _____

Company _____

Address _____

City, State, ZIP _____

Phone _____

Type of operation _____

Circle (41) on Reply Card

September 1979 *Broadcast Engineering* 55

NRBA

Dental Insurance, Long Term Disability and High Limit Accident. The form asks, for each plan, whether the station now has, would be interested in or might join if the NRBA comes up with a better plan than the station now has.

The form was due August 1.

Community service study

According to a recently completed NRBA survey, radio stations in one and two station markets will contin-

ue to serve their communities of license in the absence of government regulation.

The study was prompted by concerns expressed by the National Telecommunications & Information Agency and the White House Domestic Policy staff that one and two station radio markets might not be subject to the same types of competitive marketplace conditions that would force larger radio markets to meet the needs of the listening public.

The survey found that 93% of

single-station markets receive an average of 12 strong radio signals from other markets. More than 85% of these indicated that the outside radio stations also sell advertising in their markets.

The study also cited results from 1978 studies by Frank Magid Associates which showed that good local news coverage is a primary reason people choose one station over another.

Severeid receives award

Eric Severeid, semi-retired CBS news correspondent, will be awarded the NRBA Golden Radio Award October 8, during the Sixth Annual Conference and Exposition at the Washington Hilton in Washington, DC.

The Golden Radio Award is presented when merited for outstanding contributions to the radio industries. Previous recipients include Representative Lionel Van Deerlin, ex-FCC chairman Richard Wiley and Lowell Thomas.

5 new regional directors elected to NRBA board

The ballots have been tallied and five new NRBA regional directors have been elected. The following will serve 2-year terms: Bob Herpe, WPLR/WOMN, New Haven, CT, Region 1; Bernie Mann, WGLD/WOKX-High Point, WKIX/WYYD-Raleigh, Region 3; Ron Kempff, WHIO AM/FM, Dayton, OH, Region 5; Paul Lange, KDLR, Devils Lake, ND, Region 7; and Eric Hauenstein, KDKB AM/FM, Phoenix, AZ, Region 9.

Suspect petition misuse

The NRBA has filed with the FCC a request for an inquiry into the uses which have been made of petitions to deny over the last 10 years.

The association says that the basis for the request is that an "aura of misuse and abuse has grown up around petitions to deny." It added that it appears that petitioners frequently file frivolous and unsupported applications and burden the commission's staff. Further, questions have occasionally been raised about the propriety of the reimbursement aspects of some agreements under which petitioners withdraw their petitions (or agree not to file them in the first place) in return for reimbursement of expenses, among other things. □

When you cover the action from the source...

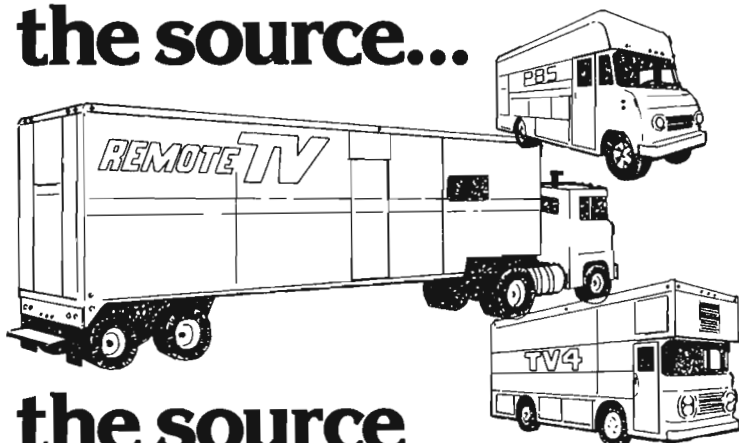

the source for mobile studios should be Gerstenslager.

In a van or trailer, your most modern, best equipped studio could be your Gerstenslager. It all starts when you tell us what you need. The job to be done. Then we'll work with your engineers and principal equipment suppliers. Develop the plans. Detail placement of every piece of equipment, generators, wiring, climate control, consoles. Exactly as you want it. Then, build the unit from the frame up. A studio on wheels that is actually a dependable broadcasting station comparable to conventional studio systems.



How we do it with examples of work we have done for others is included in this brochure. It's yours for the asking. Write or call: (216) 262-2015.



GERSTENSLAGER

The Gerstenslager Company, Wooster, Ohio 44691

Circle (42) on Reply Card

ADM

Control the complete audio spectrum. At the controls of the new ADM® broadcast consoles you command every aspect of audio broadcast production. At your fingertips is a unit far beyond the scope of ordinary expectation. It's designed to the most exacting standards; manufactured to the most rigid tolerances. Its functions appear limitless; its quality obvious. So confident is ADM of their consoles, that they're backed with an exclusive five year warranty. For a complete catalog and list of users contact Audio Designs and Manufacturing, Inc., 16005 Sturgeon, Roseville, MI 48066. Phone: (313) 778-8400. TLX-23-1114.
The Audio Company.



Some things are easily broken...

...not the CO90!



The CO90 miniature condenser microphone was designed by engineers who understand the "real world" requirements of a studio microphone. They've included things like cable assemblies that can be easily and inexpensively replaced in the field. But the CO90 has one feature that no other manufacturer can offer - the Electro-Voice warranty.

Electro-Voice backs up the CO90 with the only two-year unconditional warranty in the business. That means Electro-Voice will repair or replace your CO90 when returned to Electro-Voice - *no matter what caused the damage.*

Electro-Voice can offer that type of warranty because the CO90 was designed to withstand the rigors of professional use. If your application demands a miniature condenser microphone that can take less-than-gentle treatment, the CO90 is the one you should buy.

EV **Electro-Voice**[®]
a **gulton** company

600 Cecil Street, Buchanan, Michigan 49107

Circle (43) on Reply Card

58 **Broadcast Engineering** September 1979

association news

AMERICAN SOCIETY OF
TELEVISION CAMERAMEN, INC.

P.O. Box 296, Sparkill, NY 10976



Take 1: More feedback on jobs and training in TV

The current series of columns relating to jobs, training and pitfalls, as relating to the TV operations area, has set off an avalanche of incoming mail. Letters have been received from interested parties such as guidance counselors at the radio/TV universities, vocational institute representatives, employers and lastly, would-be employees.

This response is welcome as evidence that we are relating what seemingly is important and relevant to **BE's** readers. Also, that we may be able to be of some real assistance to these various parties that represent quite a comprehensive cross-section of the TV Family.

Without identifying individuals, here are some brief extracts of what is being received. An instructor at a midwestern technical institute writes: "...You addressed some common problems...many of which concern us as a broadcast training station. ...As we continue to send graduates into the broadcast field, we are encountering the importance and necessity for 1) a national broadcast organization that would promote professional standards within the industry; 2) a national job information clearinghouse;...and 3) a resource information center that would provide the broadcast worker and trainee with seminars, newsletters, new equipment and happenings in the industry." Another letter from a graduate coordinator at a large northern university's school of radio/TV says, "Please send information on how ASTVC can help our students prepare for careers in television. We have nearly 700 undergraduate majors in radio and television...arrange for a

rep of ASTVC to visit our campus."

A systems division manager of a southwestern production house wrote "Our company is involved in field production, post-production editing and duplication based here in Arizona...Your article in **BE** attracted my attention because we are having the same problems related in the article. ...I would be interested in receiving...information you can send me regarding *qualified* personnel as we will require very shortly one producer, one director, four camera-people, script writers, etc...I would...entertain the prospect of receiving resumes from those interested."

This next letter is representative of many expressing similar points of view, and quite possibly is the one most common criticism we hear. "...As a recent college graduate, the article was just what I was looking for in terms of job-seeking guidance. I do not consider myself (as yet) a cameraperson...although I did take the (required) TV/film courses...for my MassComm BA degree. Most of my years in college centered around the student-run... station. My college courses failed to prepare me for a career in broadcasting because of a lack of state-of-the-art equipment, and although new facilities are being built, the department's staff has dwindled to one full-time professor. Such is the case with many...schools."

We believe that the letters printed (in extract form) for your general information and guidance represent the thoughts and experiences of so many people in our industry. Still, this is just a superficial view of the many complicated and frustrating

WHY FUJI?

Just a few short years ago, few people in the industry even knew our name. Let alone, what we stood for.

Then we introduced H701E—the low noise, high-band broadcast videotape that gave the industry a whole new set of performance standards. And Beridox.

A videocassette tape formulation combining the best features of chromium and ferric oxide. Now available in one-inch, as well.



Now, it seems a lot of people are standing in line for our products. Because they know—and like—what we stand for.

Fuji. Count on us to improve your image. For more information, write or call.

FUJI

Magnetic Tape Division of Fuji Photo Film U.S.A., Inc.
350 Fifth Avenue, New York 10001 (212) 736-3335
West-Coast: 1211 East Artesia Blvd., Carson, CA 90746
Midwest: 610 Bonnie Lane, Elk Grove Village, IL 60007
Southwest: 3500 Gardenbrook Drive, Dallas, TX 75234

Circle (44) on Reply Card

... in lighting
control
systems

EDI's New Trouper Line . . . The Clear Choice

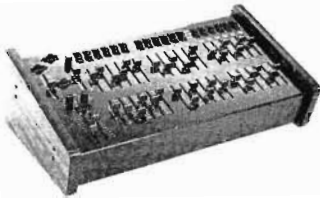

It is The Clear Choice because this portable controller line Truly Cuts Costs... many standard Trouper features may be optional elsewhere, even if they can be found in a trouper configuration.

The basic Trouper comes in a desk or trouper model and comprises two scenes of up to 36 channels each, with switches above the channels indicating operational modes: Master, Independent, and Full Independent. Two time faders (0-100 seconds) associated with split cross faders-plus a switch to defeat the split mode-mean precise, dipless cross fades. Unique to the Trouper is a **third** time fader, providing a timed Independent Master.

With EDI's Trouper you also save time and money on calibration. Calibration for the entire unit requires just a single adjustment to one control card.

Prices start at \$695.00 for a 2 scene 12 channel Trouper and range to \$1495.00 for a 2 scene 36 channel. More on the Trouper? It's expandable... add other units and slave them to the original. For even more, write us or call (Phone (503) 645-5533)



Electronics Diversified Inc.
LIGHTING CONTROL SPECIALISTS
1675 N.W. 216TH
HILLSBORO OREGON 97123
TELEPHONE (503) 645-5533

Electronics Diversified, Inc.
Lighting Control Specialists
1675 N.W. 216th
Hillsboro, Oregon 97123

Circle (45) on Reply Card

ASTVC

problems that present themselves to all those interested in the human resources factor of this industry. In future issues of this column, we will examine related areas of concern and, by telling it like it is, endeavor to answer those questions put to us by member and non-member alike. We are most grateful to the editors of **Broadcast Engineering** for providing us with the means to present this forum which we know to be of interest and value to so many of our readers.

Take 2: The Arabs are coming!

Our column in the June issue of **BE** related how the ASTVC was chosen by the US Department of Labor to coordinate the training program for several visitors representing Yemen Broadcast Authority. As stated then, we believe that what we learn through our efforts to provide a comprehensive training program for these people will prove most useful to the ASTVC in aiding us in many of our own programs for members.

We would like to say how pleased we are for those offers to cooperation and assistance extended us by organizations such as NBC, WNET (PBS), USMA-TV and the pending commitments of several others. These guests of the Labor Department's Bureau of International Visitors will first undergo an extensive English language refresher course slated to begin at Georgetown University on or about August 6. At the conclusion of this course, present plans call for a period of intern or over-the-shoulder type training at one or more Washington-based outlets. From there, they will travel to NYC to undergo related training at still more broadcast and/or production houses. For one or two of them, there will be a period of indoctrination at one or more transmitter sites.

Additionally, there may be a period of residence instruction provided by one of the vocational/technical schools to be chosen if necessary. Once again, the ASTVC hopes to learn much that can be of future value to our membership and the readers of this column. We will analyze most carefully the training programs (and results) provided by this project and the various participating agencies. □

... in lighting
control
systems

T.A.M.... The Adaptable Memory

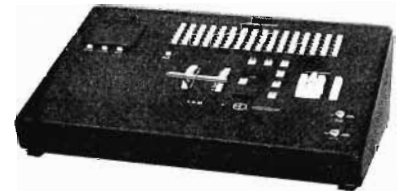

...with Multi- Scene Preset

The T.A.M....from E.D.I....adds memory to virtually any multi-scene manual controller. Installation is simple and quick. Operation is manual or memory... or a combination of either.

- Channels — up to 120.
- Cues — up to 250.
- Split Dipless Crossfader.
- Electronic Time Faders.
- LED Channel Intensity Indicators.
- Sub-Masters.
- Disk Program Storage.
- Many Other Features.

If you're thinking memory in lighting controls, compare adaptability — compare the T.A.M. from E.D.I. There's other reasons why you should keep the T.A.M. in mind. Phone or write us about them or send for the T.A.M. descriptive brochure. (Phone (503) 645-5533)



Electronics Diversified Inc.
LIGHTING CONTROL SPECIALISTS
1675 N.W. 216TH
HILLSBORO OREGON 97123
TELEPHONE (503) 645-5533

Electronics Diversified, Inc.
Lighting Control Specialists
1675 N.W. 216th
Hillsboro, Oregon 97123

Representatives Wanted

Circle (247) on Reply Card



Beaveronics, Inc.

STUDIO PRODUCTION VIDEO SWITCHING SYSTEMS

(Also available in PAL and PAL-M versions)

8 Haven Avenue
Port Washington, New York 11050
Tel: (516) 883-4414

FOR REMOTE & SMALL PRODUCTION FACILITIES

MODEL J & D 712

\$7,400.00

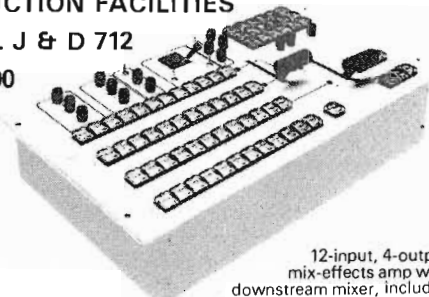

12-input, 4-output mix-effects amp with downstream mixer, includes downstream preset & program busses with cut bar, RGB chroma key

Standard Features

- 12 inputs including Black-burst and Color Background
- Built-in Black Burst Generator
- Built-in Colorizer
- Built-in RGB Chroma keyer
- Four Switching busses
- Downstream Preset and Program Busses with cut bar
- Rack-mounted electronics
- Adjustable Soft Wipe
- Adjustable Border edges
- Color Matte
- Vertical Interval switching thru-out
- Illuminated Momentary Contact push buttons
- Internal, external, Chroma-key, and matte inputs to keyer

- Built-in pattern modulator with frequency and amplitude controls
- Full Tally
- Pattern symmetry control
- Illuminated Momentary contact push buttons for effects selection
- Normal/Reverse/Normal-reverse wipe transitions
- Pattern limit controls for presetting size of patterns or varying vertical and horizontal aspect ratio
- Loop-through inputs
- Input amplifiers with clamping
- Synchronous/Non-synchronous inhibit
- Modular construction with front access plug-in modules

Options:

Downstream Keyer

FOR MODERATE SIZE FACILITIES

MODEL B1-154

\$10,990.00



15-input, 4-bus mix/eff/key amp with downstream mix/key amp. Many optional features including DSK & quad-split, etc.

FOR SOPHISTICATED FACILITIES

MODEL B1-156

\$21,795.00

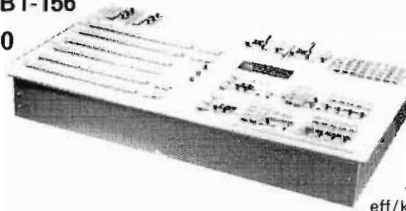

15-input, 6-bus with two full mix/eff/key systems & dir. pgm & pre busses: many options available, DSK, quad, etc.

MODELS 154 & 156

STANDARD FEATURES

1. **Switcher Models 154 and 156** are of the same basic design and utilize the same electronic sub assemblies. These switchers have the same standard basic features, differing only in the number of busses and in the number of mix/effects units. The basic standard features include 32-pattern mix/effects, color black and color matte background generator, and a mix/key unit in the case of the Model 154.
 2. **Input Amplifiers**
 - loop through high impedance input • gain equalization for 1000' cable • 22° sub carrier phase control • clamped inputs (10% to 90% APL) • sync addition on non composite signals if desired.
 3. **Tallies**
 - isolated dry contact relay closure on all inputs (2 amps at 50 v.)
 4. **Mix-Effects Units (Includes Keying Function)**
 - One (1) used in Model B1-154
 - Two (2) used in Model B1-156.
- Fades (or Supers), Wipes, Keys may be produced. Positioner Joystick for each M/E positions patterns.
- **Pattern Modulation** may be accomplished by an internal waveform generator. Modulating sources may be either (1) sine wave, (2) square wave, (3) saw tooth, or (4) an external customer generated source.
 - **Mix Key and Wipe Key** available.
 - **Soft Wipe and Soft Key** available with adjustable variations.
 - **Push to Preview** obtained by depressing knob on clip potentiometers (provides for M/E monitor output).
 - **Wipe Mode**—3 interlocked buttons select "NOR", "REV" or "N/R".
 - **Hard Wipe, Soft Wipe or Border** can be selected with degree of softness made by "Edge" control adjustment.
 - **Border** may be **Colorized** by adjustment of "Hue" and "Luminance" control.
 - **Symmetry of Pattern** may be adjusted by "SYM" knob.
 - **Preset Wipe Limits** are set by potentiometers. "H" and "V" vertical preset limits activated by Pattern Limit button.
 - **Spotlight** alternate action push button produces a 6 db. level difference between "A"

and "B" input channels in the "Wipe" mode. (Operates on all patterns.)

- **Pattern Assignment** is made by depressing "ASSIGN" button. Pattern select feature may be "locked" to pattern matrix by depressing the "ASSIGN" button a second time on the same pattern. Patterns assigned appear on LED display on M/E control panel.
- **Non-Synchronous Inputs.** An "NS" indicator is provided. Tearing is prevented by not allowing a non-synchronous signal to be switched except at extreme position of fader handle where a "cut" transition occurs.
- **Key Input Sources** may be either (1) "A" bus video for self keying, (2) preview Key bus, (3) chroma key, or (4) an external key source.
- **Key Invert** selector provided to accommodate either positive or negative video as a keying source.
- **Key Fill** may be either "A" video for self keying or a colorized matte.
- **Mix/Key** provided a lieu of second Mix/Effects function for Model B1-154 switching system. Provides for all mix and keying functions of mix/effects system (as previously described) except for the pattern effects.

OPTIONAL FEATURES

May be added at any time (required control panel wiring already installed)

- Chroma Keyer (C.K.)** \$950.00
 - Hue—selects hue of keying color • Gain—adjusts the amplitude • Clip—adjusts the clip level for keying • Camera (4 x 1) input switcher—selects RGB output of any one of 4 cameras to feed C.K.
- Down Stream Keyer (DSK)** \$1,275.00
 - Keys in titles, inserts, or fades to black with or without insert • Color matte background
 - Key sources: (1) Mix/Effect, (2) Chroma Key, (3) External • Push to Preview (Monitor)
- DSK Border** \$1,200.00
 - Border—black edge around insert • Shadow—black edge on right side and bottom of insert
- Quad Split** \$1,190.00
 - Provides four (4) variable size quadrants from ten possible sources with variable width border.
- Aux Busses—(Model 156 only)** \$2,100.00
 - Two remote outputs are available—remote control panel and amps required.

All Beaveronics Switching Equipment Carries a Two Year Warranty

OTHER ITEMS AVAILABLE FROM BEAVERONICS

FAYAG MASTER CLOCK SYSTEMS

- Master control switchers AFV with audio breakaway
- Routing switchers with AFV

CHECK BEAVERONICS FOR:
• Specialized custom switchers
• Selected terminal equipment

Available with accuracy better than 1 second/yr.



Table Top



Surface Mtg.

Semi-flush

Write or phone for details.

Beaveronics, Inc.

8 Haven Avenue • Port Washington, New York, 11050 • Tel: (516) 883-4414

Prices and Specifications Subject to Change Without Notice.

Circle (46) on Reply Card

September 1979 *Broadcast Engineering* 61

State broadcasting organizations and other associations

State associations

Arkansas Broadcasters Association

The ABA has joined several organizations in a combined effort to inform the public about the Freedom of Information Act in Arkansas. June 1st was proclaimed as a special day to observe the operation and the openness of municipal courts in Arkansas.

Colorado Broadcasters Association

Due to changing the date of the 1980 Winter Convention, now January 24-26, there will be a change in dates for the submission of entries in the Colorado Broadcasters Association Annual Awards of Excellence.

It is anticipated that for 1979 only, entries must be broadcast on or before November 30, 1979, and submitted by December 5, 1979.

Georgia Association of Broadcasters

Fred Pierce of WICL Radio/TV, Savannah, has been elected 1979-80 president of the GAB. In accepting the job, Pierce called on broadcasters throughout Georgia to get involved in the fight to influence legislation positive to the broadcast industry.

Kansas Association of Broadcasters

The Annual KAB Engineer's Sem-

inar, held June 6 at The Hilton Inn, Wichita, attracted more than 30 participants. Engineers discussed such topics as AM Stereo, FCC field inspections and Broadcast Loops—What's New, and How to Keep Telco Costs down for Your Station.

Kentucky Broadcasters Association

The Kentucky Broadcasters Association has announced that four new members of the board of radio district directors have been elected. All candidates were unopposed and will serve 2-year terms beginning November 1, 1979. They are Shelby McCallum, Radio WCBL-AM/FM; Charles M. Anderson, Radio WKVE; William J. Laney, Radio WNVL; and Roy A. Redmond, Radio WFTM-AM/FM.

Senator Barry Goldwater will speak at the October 24-26 convention at the Lexington Hyatt Regency.

Missouri Broadcasters Association

The MBA fall meeting will be held October 18-21. A big program area will be the elections of 1980: how to handle candidates, both news and

at AUDI-CORD we build CARTRIDGE MACHINES and — we're not done yet — more new products coming

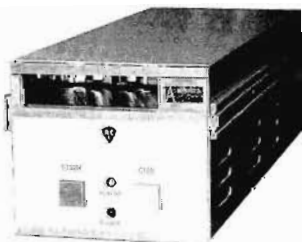

"A" SERIES

An intermediate priced cartridge tape machine series with most of the quality and features found in units costing much more.

1 Tone Models:
Mono—\$649
Stereo—\$699.
(For 3 Tones
Add \$20.)

GIVE US A CALL AND TALK CARTRIDGE NEEDS

3 TRANSPORT REPRODUCER:



1 Tone Models:
Mono—\$1919.
Stereo—\$2069.
(For 3 Tones
Add \$60.)

THE "A" SERIES PLAYBACK:

- Modular constructed for easy service.
- Interchangeable transports and other assemblies.
- 1 or 3 tone — mono or stereo.
- Replay reminder system.
- Full remote control — automation compatible.
- Meets the needs of the 1976 NAB standards.
- Latching connectors — slip/lift cover.

Modu-Cart 100 Series

MODEL 115 RECORD-REPRODUCER



1 Tone Models:
Mono—\$1389.
Stereo—\$1509.
(For 3 Tones
Add \$40.)
Timer Add \$130.

look at the features:

100% Modern Solid State Electronics; Replay Lock-Out Circuit—Prevents Double Airing; Front Access Controls—Removable Desk Covers; Heavy Duty Inverted Head Mountings; Rugged Mechanical Design—Cool and Quiet; Optional Digital Recording Timer; Internal Record Response Test System; Six Position Auto-Switched Meter; +18 dBm Audio Output—Wide Headroom; Desk or Rack Mount Optional; 24 Model Variations For Your Needs.

MODEL 100 REPRODUCER

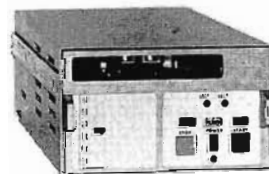

1 Tone Models:
Mono—\$809
Stereo—\$889.
(For 3 Tones
Add \$40.)

AT AUDI-CORD

VALUE IS NOT EXPENSIVE

RACK CABINETS OPTIONAL FOR ALL MACHINES.

Tomorrow's Design Today — At Yesterday's Prices

AC AUDI-CORD CORPORATION
1845 W. Howe Ave., P.O. Box 611 Normal, IL 61761
(309) 452-9461

Circle (47) on Reply Card

The Audio-Technica philosophy:

EQ should be used to improve the sound... not to fix the mike!

Introducing affordable smooth sound. The remarkable AT801 and AT811 Electret Condensers. With curves so smooth you would have to pay a bundle to match them anywhere else.

Response like this has a number of benefits. First, your EQ is used only to touch up the sound, not to correct built-in errors of the microphone. Which leaves more leeway to control the overall sound.

And without unwanted peaks you have more usable headroom. That's vital when you're working near the dynamic limit of a preamp or line amp. Sound stays clean and sharp. Compressors or limiters sound less forced, because they are controlling peaks in the *sound*, not peaks in the *mike*!

But perhaps the biggest advantage is the versatility of these A-T condensers. Because they have just the right amount of presence for today's recordings, they're not limited to just one kind of instrument... just one type of voice. Put them *anywhere* in the mix: brass, reeds, percussion, chorus, or strings. Then listen. What you hear in the studio you'll hear at the console. Which is a great place to start in miking any session.

At their highly affordable prices, these are two of the best bargains you'll find these days. Reliable, clean-sounding, and the most predictable microphones you can use. Make them a mainstay in your studio today. Write for spec sheets and dealer list.

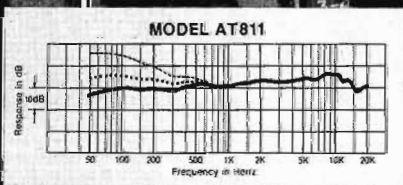
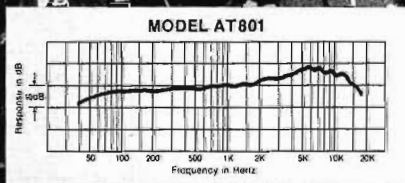

Great sound, right from the start!



audio-technica®
INNOVATION □ PRECISION □ INTEGRITY

AUDIO-TECHNICA U.S., INC., Dept 99BE
33 Shiawassee Avenue, Fairlawn, Ohio 44313

Circle (48) on Reply Card

Other associations

sales; election return computation at national and state levels; and returns broadcasts in smaller markets.

Ohio Educational Television Network

WGTE-TV Toledo, and WGUG-FM, Cincinnati, were winners in the 1979 Ohio Educational Broadcasting Awards competition presented June 11 in Bowling Green. The Toledo station accepted Oebies in both the Public Information and Development

categories with its "Vibrations in Black" awareness campaign and Studio Club Membership drive respectively while WGUC-FM claimed honors in the same categories with its "Show Off '78" awareness campaign and fund raising marathon.

Rhode Island Broadcasters Association

The association has elected the following officers: Dave Russell, president; Sandy Davey, executive

vice president; Bob Carson, treasurer; and Don Kane, secretary.

South Carolina Broadcasters Association

At the last meeting of the South Carolina Broadcasters Association, the board of directors announced that judging of the entries for the association's awards activities had begun. Also, a form has been sent to all member stations requesting information about their EBS status.

Broadcast media teams must be ready at a moment's notice. With Christie's integrated system; the REFLEX® 20 Charger and sempiternal ni-cad battery packs, there is virtually no wait. Recharge? The fastest in the industry. 12 to 20 minutes and you're completely charged.

Because of the revolutionary "burping" system the batteries remain cool, their cycle life is extended up to 10 times that of conventional ni-cads and 50 times that of other rechargeable batteries.

The Christie System . . . reliable, effective and 90-97% efficient.



50 years experience plus REFLEX® 20 makes you: CHRISTIE-READY.



1929-
1979

50
YEARS
THE SOURCE

SINCE 1929
CHRISTIE
ELECTRIC CORP.

3410 WEST 6TH STREET, DEPT. W
LOS ANGELES, CALIFORNIA 90043
(213) 750-1151 TWX 910-321-3867

Write for valuable new information
or call toll free (800) 421-2058

Circle (49) on Reply Card

National/International groups

ABES

An association of broadcasters dedicated to the establishment and maintenance of optimum technical standards in the regulation of radio broadcasting, the Association of Broadcast Engineering Standards, is now actively expanding its membership and addressing industry issues. According to William Potts, Jr., ABES secretary, a special committee of the board of directors has been formed to screen and select an executive director. The special committee is currently meeting with candidates and hopes to have an executive director, who will be based in Washington, selected early in September.

At a major meeting on March 25th the ABES elected the following officers for a 1-year period: Richard R. Miller, KBOW, Butte, MT—president; Jeffrey Hatch, Communications Investment, Salt Lake City, UT—vice president; Thomas K. McKnight, Combined Communications, Phoenix, AZ—vice president; Col. John Bowman, Washington, DC—treasurer; and William J. Potts, Jr., Haley, Bader & Potts, Washington, DC—secretary.

The ABES Technical Committee includes the following members: James Wulliman, WTMJ, Milwaukee, WI; Russel Arnold, Wabash Valley Broadcasting, Terre Haute, IN; Col. John Bowman, Washington, DC; Ralph Green, CBS Radio, New York; Everett Lawson, WLAC, Nashville, TN; and George J. Capalbo, RKO Radio, Boston, MA. All have been elected to the committee for a one-year term.

Persons interested in joining the ABES, or in making their views clear on critical issues, may write William J. Potts, Jr., ABES Secretary, Suite 700, 1730 M Street Northwest, Washington, DC 20036.

Total system capability
and a full range
of equipment

Marconi



From the earliest days of broadcasting, MARCONI has been a world leader in the design and production of high performance systems. MARCONI pioneered the automatic camera and only MARCONI offers you second generation automatic cameras ... with a unique design based on the benefits of field experience. There are over 100 MARCONI remote vehicles in service so you can have total confidence in our equipment design and guidance in solving your specific problems.

Whether your interest is in 1 inch VTR's, cameras, transmitters, digital standard converters or complete systems, call MARCONI - our experience, in more than 120 countries, is available to you.

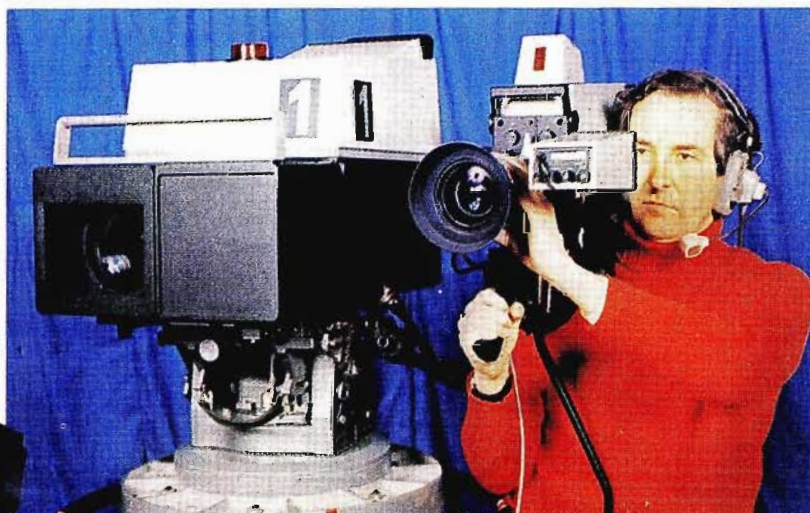

Marconi Electronics, Inc.

100 Stonehurst Court • Northvale, NJ 07647 • 201-767-7250

In Canada, Call Canadian Marconi Company (514) 341-7630

Circle (50) on Reply Card

September 1979 *Broadcast Engineering* 65

Low Cost High Performance Professional Degaussers

- Save Time
- Save Tape and Film
- Save Money

WRE's wide range of degaussers are designed for years of dependable service for clean and simple erasure of magnetic film and tapes in just about any configuration.

Backed by years of proven reliability, these units are the answer to cutting man-hours and reducing material costs by allowing reuse of prerecorded media.



TYPE 9205A Degausser is ideally suited for complete erasure of program and residual noise from video, audio, and data recording tape and magnetic film—in reels, cartridges and cassettes. This unit will bulk erase reels up to 2 inches thick and 17 inches in diameter. Available for 115 or 230 volt operation.



TYPE 642-21 Degausser is similar to the 9205A except it is limited to erasure of 10 1/2 inch reels. This unit is recommended where size and cost are limiting factors.



TYPE 8905 Magnetic Erasing Pencil is an excellent tool for erasing limited, small areas of tape or film and for demagnetizing record/play heads. In program material, words, complete sentences, and even syllables may be erased. This unit is equipped with a press-to-operate switch on the handle.

MODEL 22-323-1 Foot Switch is a companion accessory to the bulk degaussers that allows convenient, "hands free" operation and provides a positive means of turning the degausser off immediately after use. This is a momentary acting switch and can help extend the life of the degausser.

If you're looking for a degausser with proven reliability that will save you time and money, call or write WRE today.



2119 Schuetz Road • St. Louis, Mo. 63141 U.S.A.
314 567-5366 • Telex: 442560
Circle (51) on Reply Card

66 *Broadcast Engineering* September 1979

Other associations

SMPTE

The record for the greatest number of booths taken at a SMPTE exhibit has been broken by the upcoming SMPTE exhibit that is scheduled for the Century Plaza Hotel in Los Angeles October 21-26. Three hundred booths have been taken so far; the previous record was 220 booths at the Los Angeles Exhibit in 1977. There will be 140 companies from both the motion-picture and television industries participating in this exhibit. In addition to the exhibit the conference will feature a 5-day program of sessions on the subjects of television and motion-picture technology. More than 7000 people from the motion-picture and television industries are expected to attend. For more information, contact SMPTE, 862 Scarsdale Ave., Dept. BE, Scarsdale, NY 10583.

PMPEA

"The Visual Effect of Special Effects" symposium hosted by William A. Fraker, ASC will be presented by the PMPEA in conjunction with the 121st SMPTE October conference in Los Angeles. The association is now sponsoring its fifth annual seminar that has each year produced an informal hands-on atmosphere of hardware usage. Tickets will be on sale prior to the show at the Century Plaza Hotel during the SMPTE Sunday registration and Monday exhibit hours. Tickets are \$6 per person. Mail requests and inquiries to PMPEA National Headquarters, Dept. BE, University Tower, Suite 806, 6440 N. Central Expressway, Dallas, TX 75206, (214) 696-1448.

AMTA

The Antenna Measurement Techniques Association was formed March 12-13 in Atlanta as a non-profit organization composed of individuals interested in advancing the art of antenna measurement. The meeting was attended by key personnel from government and commercial organizations representing the interest of the antenna test and measurement field and manufacturers of antenna test instrumentation. Plans for the organization include a software pool which would be available to all members to assist in the development of programming for automatic systems.

For additional information, contact Joe Pape, Scientific-Atlanta, 3845 Pleasantdale Road, Atlanta, GA 30340, (404) 449-2354. □

Sound Advice

The Problem: Selecting a first playback stage, low noise tube for an Ampex Professional Audio tape recorder.

The Solution: Replace the tube with a VIF 1006 JFET device that has lower noise, higher amplification, and will last about 600 times longer than an equivalent tube without drift or aging.

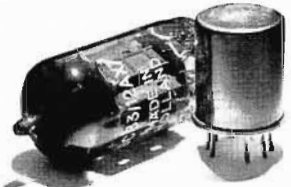

The Price: \$33.00 each. Some Ampex models require an Adaptor, available at \$16.00 each.

VIF INTERNATIONAL®
P.O. Box 1555
Mountain View, CA 94042
(408) 739-9740

Circle (193) on Reply Card

NEW FREE CATALOG

TROMPETER ELECTRONICS

has just published a new 40 page catalog T13, illustrating a complete line of coax, twinax, triax and quadax connectors, patch panels, plugs, jacks, patch cords, cable assemblies, networks and accessories. The catalog includes an eight page technical discussion of noise in cable systems and a new section covering Electro-Optics.

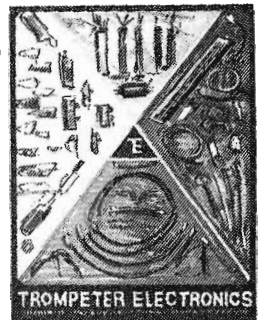

SEND FOR YOUR FREE COPY TODAY.

TROMPETER ELECTRONICS, INC.

8936 Comanche Avenue, Chatsworth, CA. 91311

(213) 882-1020/TWX: 910-494-1210

Circle (238) on Reply Card

CREATIVE FREEDOM

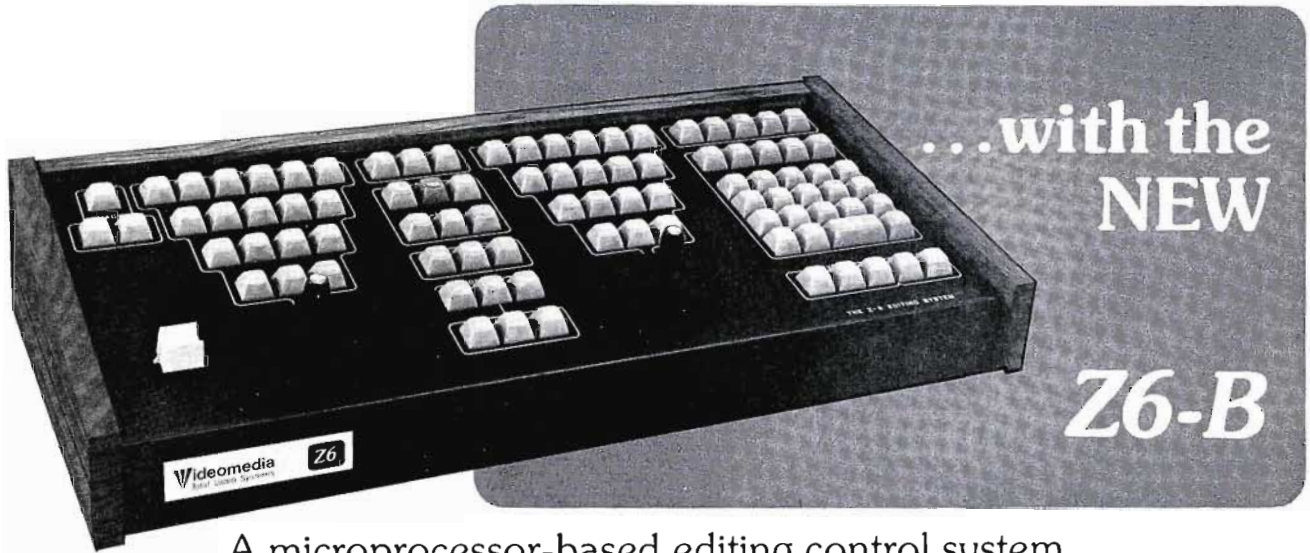

A microprocessor-based editing control system

Who more than you, deserves all this?

The Z6/B has all of the outstanding features of its predecessor, the Z6/A plus . . .

- **Auto Edit** — any or all 99 events can be performed at the push of a single button.
- **Sync** — a Z6 exclusive, keeps both tapes synchronous with respect to each other. Move either tape in either direction and the other transport will move the exact number of frames.
- **ADR** — Automatic Data Replacement, when activated, sends the editor in a "looping" condition. The operator can replace data numerous times until it is a "take."
- **Auto Cal** — automatically assigns the proper number to the proper frame of video on any new tape. No longer do known locations or SMPTE addresses need to be referenced.

Z6/B standard features include . . .

- Bi directional joystick shuttle
- Auto search
- 99 event memory
- Full status display
- Cruise control
- Rehearse, perform, review edit
- Error and prompting message
- Programmable Pre and Post rolls
- Single glide ballistics
- NO mechanical mods to VTR's
- SMPTE or Micro-code display
- Return to "in" or "out" points
- Micro-loc* — frame accuracy
- Consecutive non stop mode change
- Full VTR remote control
- A/B monitor select
- Tag functions

Z6/B options include . . .

- Drop frame/Non drop frame readout
- Dump — an exclusive Z6 feature which records all memory on the video tape itself
- Line Printer — allows a hard copy read-out of all edit decisions and parameters

Z6 is truly the most powerful video tape editing system available. Call Videomedia or your local dealer for more information.

*pat. pend.



The Z6 data display is a continuous readout of all edit parameters, including operator prompting messages.

Videomedia
Professional Television Systems

250 North Wolfe Road, Sunnyvale, CA 94086 408/733-6500

Circle (52) on Reply Card

September 1979 *Broadcast Engineering* 67

WILKINSON ELECTRONICS

AM-250SS SOLID STATE 250 WATT AM TRANSMITTER

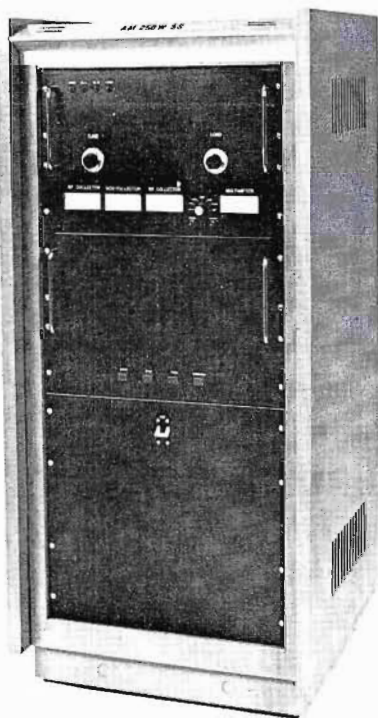

FEATURES

- Not Susceptible To Reacting Loads
- Low Operating Cost - Extreme Efficiency
- Drawer Construction - Extreme Accessibility
- Expandable - Combine two for 500 Watts
- Available at 125 Watts or Less
- Power Flexible - 115 or 220 volts AC
- 125% Modulation Capability
- Exceeds U.S. FCC Specifications

The Wilkinson Electronics AM-250SS is an all solid state 250 watt Am transmitter housed in an attractive 24 inch cabinet, 52 inches in height. All components are mounted in two drawers for maximum accessibility and ease of maintenance. Space is available in the cabinet for a second transmitter making it possible to combine two 250 watt units to obtain 500 watts. It is also available at any power below 250 watts at a reduced price.

WILKINSON
ELECTRONICS, INC.

701 CHESTNUT ST. • BOX 738
TRAINER, PA. 19013 • TELEPHONE (215)497-5100
TWX 510-669-3188 CABLES: WILEC WILEC CHR

Circle (53) on Reply Card

people
in the news

Radio/Television

Robert N. Ordoñez, vice president, Donrey Media Group's broadcast division, has resigned. **Gene Spry**, also general manager of Donrey's KORK-TV, Las Vegas, will assume the additional duties of vice president of the broadcast division.

Solaris Television Studios' new vice president/general manager is **Jerry O'Brien**. Formerly vice president/finance of the television production and post-production company, he will be responsible for all corporate financial management and studio supervision.

John A. Tagliaferro has been appointed vice president-operations at the Hughes Television Network. Tagliaferro has been vice president-communications services since 1977. In his new position he will be responsible for the division and technical and production capabilities at the Madison Square Garden facilities.

The New Jersey Public Broadcasting Authority board of commissioners has named **Gordon A. MacInnes, Jr.** as its executive director. MacInnes was selected from a field of 130 applicants. From 1970 to 1978 MacInnes served as the executive director of The Fund for New Jersey and assisted in the development of the New Jersey Coalition for Fair Broadcasting, the Center for Analysis of Public Issues, the Office of Newark Studies and Schoolwatch.

Outlet Company recently announced the appointment of **Charles F. Kennedy** as senior vice president of the television station group as a reorganization of the broadcast division. Kennedy was most recently the division's vice president of planning.

Recent elections at Cox Broadcasting have resulted in the following: **Alan D. Chunka** to vice president; **John Boyette**, **John J. Rouse, Jr.**, and **Robert E. Gartin** to assistant treasurers; and **Linda Stewart** to assistant secretary. **Elaine K. Boryk** has been appointed controller.

Edward L. Corn has been appointed chief engineer, KORK-AM/FM, Las Vegas. He has spent the last three years in engineering positions with KIOA and KCBC, Des Moines, IA.

Reid Carpenter has been promoted from director of engineering to vice president and director of engineering at KUTV. Carpenter has been with the Salt Lake City station since it went on the air in 1952 as design construction engineer and studio supervisor.

Jonathan E. Fricke has been named operations manager of WSAI, Cincinnati with responsibility for the supervision and direction of all station departments except for sales. Fricke most recently served as program director.

The Christian Broadcasting Network has named **Tom Smith** to the position of general manager at WXRI-FM. Smith also will serve as general manager and general sales manager of the CBN operated WYAH-TV station. He will be responsible for sales management,

CORRECT SCH IS IMPORTANT FOR PROGRAM INTEGRATION.

The SCH-730N Sync/Subcarrier Phase Monitor permits fast, accurate measurement, adjustment and continuous monitoring of this elusive parameter . . . simply and inexpensively!

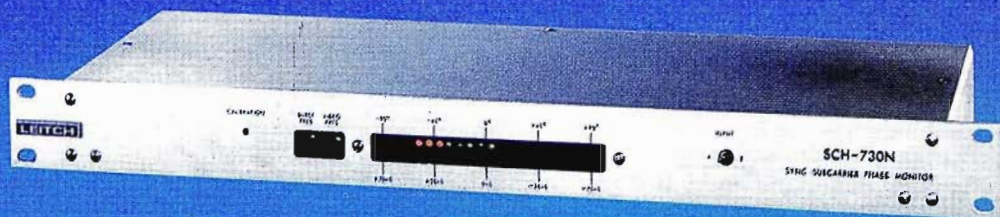

Wrong SCH

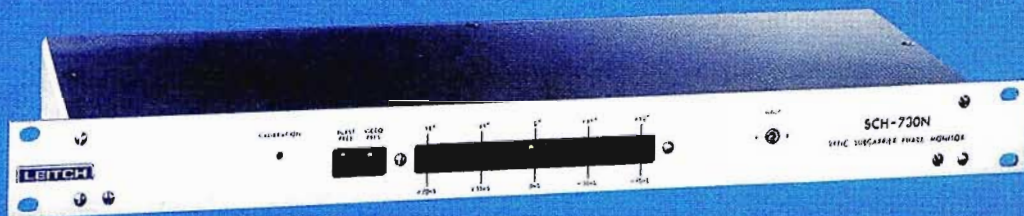

Correct SCH

Two bridging inputs for
1 volt p-p ± 3 dB composite video
(A/B selection)
Monitor range: $\pm 90^\circ$ (± 70 ns)
Resolution: better than 9° (7 ns)
NO EXTERNAL REFERENCE REQUIRED!

LEITCH

Progressive Concepts in Television Technology

Leitch Video Limited, 705 Progress Avenue, Scarborough, Ontario, Canada M1H 2X1
Tel: (416) 438-5060 Telex: 065-25420

Leitch Video Inc., 210 South 8th Street, Lewiston, N.Y. 14092 — Tel: (716) 754-4349

Circle (54) on Reply Card

People in the news

administration and operation of the FM station.

At KCET-TV/Los Angeles, **Steve deSatnick** has been promoted to vice president of operations and engineering. Previously, deSatnick was the station's director of operations and engineering.

Steve Flyte has joined KABC-TV/Los Angeles as a mini-cam engineer for their news department. Flyte was formerly with KATU-TV/Portland, OR, in the same capacity.

Emmett H. Massie is now director of engineering for public television station WUFT, Gainesville, FL. Massie formerly was chief of technical operations for the United States Army Intelligence School at Fort Devens, MA.

Recent staff appointments at KFVS-TV, Cape Girardeau, MO, include **Warren Bottorff** to chief engineer, and **Jerrold Hollis** to production manager. Bottorff was most recently at WRVY-TV, Dothan, AL; Hollis has been with KFVS-TV.

Don Kerouac has been promoted to chief engineer of WKAN, Kankakee, IL. Kerouac joined the station a year ago.

WGN Continental Broadcasting Company has announced the retirement of **Ralph F. Batt**, vice president and manager of engineering. Batt had been with WGN since 1940.

George Semyan, WJLA-TV technician in Washington, DC, died May 17, 1979, of a heart attack. The 59-year-old television pioneer had been with the station for 31 years. He pioneered televising early presidential inaugurations, press conferences, medical TV experimentation, Redskins' football, parades and congressional hearings (Army-McCarthy hearings).

Agencies/Associations

Thomas E. Bolger was elected to a 1-year term as chairman of the 48-member National Association of Broadcasters' board of directors. Bolger is president, WMTV-TV, Madison, WI.

The National Association of Broadcasters' Television Board of Directors has elected **Robert K. King** as its chairman. King is senior vice president, Capital Cities Communications, Philadelphia.

Ragan Henry, owner of Broadcast Enterprises Network, has been elected president of the National Association of Black-Owned Broadcasters. **Elliott E. Franks** has become chairman. Other officers elected were **Pierre Sutton** of Inner City Broadcasting, and **Eugene Jackson** of the National Black Network.

The SMPTE's executive director, **Denis A. Courtney**,

Useful Bits of Data

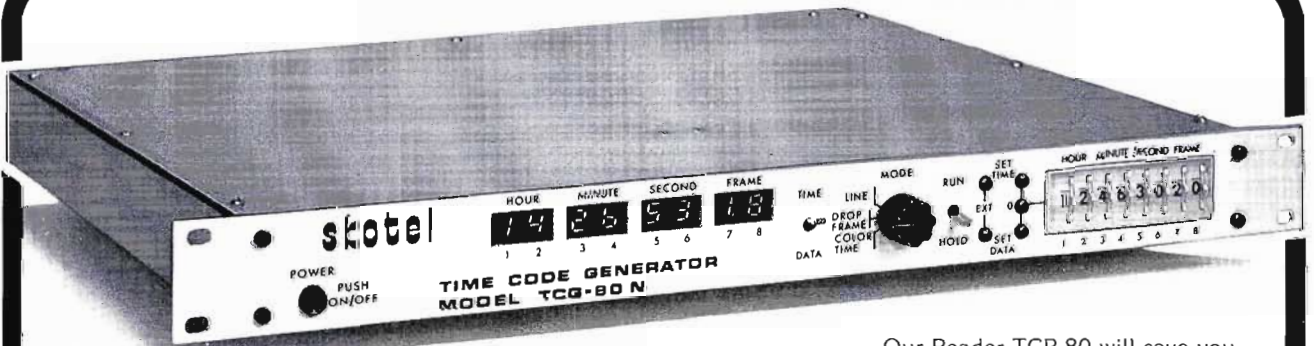

Skotel Time Code Generators and Readers will conveniently and accurately identify audio and video tapes with SMPTE User Data.

The TCG-80N Generator has unique features that meet the growing demand for identifying tapes with start of program sequences, scene/take numbers, official time of sporting events, time countdowns and documentary data.

The User Data memory can be loaded from the thumbwheels or from an external source, and the Data and Time code is displayed on the front panel.

Another feature that can be added to the Generator and Reader is our video character generator. It has an integral insert keyer that can simultaneously insert User Data and Time code into selected positions in the video of a work print or on a monitor.

Our Reader TCR-80 will save you time because it reads User Data and Time code from hand turn reel speed to 40 times play speed.

If we have all this, you can count on Skotel to include all the other features you require in Time code Generators and Readers.

For complete details and application information call . . .

North: Mike Dyer
(313) 478-2157

East: Jim Landy
(609) 424-4660

South: Gene Sudduth
(214) 785-5764

skotel

SKOTEL CORPORATION
1445 Provencher
Brossard, Que.,
Canada J4W 1Z3
(514) 676-1813

Circle (55) on Reply Card

Looking for a professional audio product?

Westlake Audio is a lot more than a studio builder. We represent, stock, sell and service the finest professional audio products available today! Microphones, tape machines, amplifiers, speakers, consoles and more. Whatever your product need, call Westlake Audio.

Consoles

Audiotronics • Automated Processes • Harrison • Celec
Allen & Heath • Yamaha

Tape Machines

3M • Electro Sound • Otari and Nakamichi

Synchronizers

Automated Processes • 3M • EECO

Monitor Speakers

Westlake Audio • JBL • Gauss/Celec

Amplifiers

Crown • JBL • Crewin-Vega • SAE • Yamaha

Microphones

AKG • Electro-Voice • Neumann • Sennheiser • Shure • Sony

• Beyer • PML

Support Equipment

Allison Research • Amber • Atlas • Auratone • Countryman • DBX

• Dolby • Editall • Eventide Clockworks • Inovonics • Koss

• Lang Electronics • MRL • MXR • Multi-Sync • Orban-Parasound

• Pandora • Pultec • Sennheiser • Sony • Stephens • Superex

• U.R.E.I. • White • EMT • Micmix

Custom Acoustic Design and Construction

Complete Studio, Control Room and Echo Chamber Design,
Construction, Wiring and System Interface.



K140
"cardan"

K140
"cardan"

K140
"carda"



series 65k allison research, usa.

YAMAHA

from acoustic design
to down beat...

**Westlake
Audio**

6311 Wilshire Boulevard
Los Angeles, California 90048
(213) 655-0303
Telex 698645

Circle (56) on Reply Card

Specialist in Telecines and Monitors

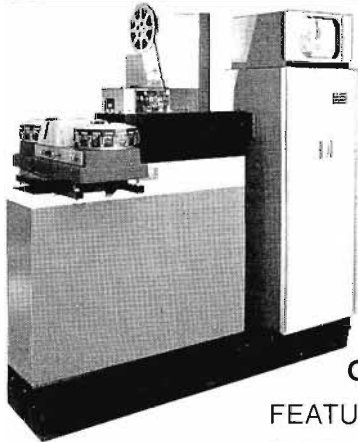

1550 B Telecine

*"The
Performer"*

With all new
Encoder/
Enhancer/
Automatic
Differential
Gamma Balance/

FEATURING

Outstanding Colorimetry

- 700-Line Center Resolution
- Two-Level Image Enhancement
- Bias Lighting ● Low-Lag Operation
- Automatic Black & White Balance
- Instant Paint ● Remote Operation
- Color Comp Variable Masking (optional).

Monochrome Monitors Available Now

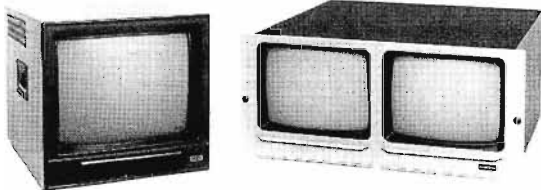

FEATURING AVL* Cohu's exclusive Auto-
matic Video Level*, the feature that makes it
possible to maintain a set contrast level
independent of signal strength ● 800-Line
Center Resolution ● Back Porch Gated DC
Restoration ● Differential Input by Jumper
Selection ● Loop-Through Input ● 525/
60 U.S. and 625/50 CCIR Scan Rates
● Regulated Power Supplies ● All Solid-
State Circuitry ● Continuous Duty Operation
● PLUS Plug-in Modularized Circuit Boards
that are interchangeable among all models.

**You expect more from Cohu
...and you get it.**



Post Office Box 623
San Diego CA 92112
Phone (714) 277-6700
TWX 910-335-1244

People in the news

.....
has retired after 26 years with the organization.
Donald F. Breidt has succeeded him. Breidt comes to
SMPTE from Harcourt Brace Jovanovich.

Robert B. Mitchell will succeed Wayne C. Cornilis as
vice president for membership for the National
Association of Broadcasters it was recently an-
nounced. Mitchell, who joined the staff in January,
has been in broadcasting since 1955, in various
capacities. In another appointment, **Peter A. Lund**,
vice president of the CBS owned AM stations in New
York City, was named to the board of directors.

Richard J. Shiben has been named chief of the FCC
Broadcast Bureau. Shiben has been with the
commission since 1962, most recently as chief of the
bureau's renewal and transfer division.

The FCC has appointed **Frank G. Washington** deputy
chief of the Broadcast Bureau. Washington, who has
been serving as chief of the policy and rules division
of the Broadcast Bureau since May 6, joined the FCC
in November 1977.

The FCC has announced that **Roy J. Stewart**, chief of
the Broadcast Bureau's transfer branch, has been
appointed chief of the bureau's renewal and transfer
division.

Henry L. [Jeff] Baumann has been named chief of the
FCC policy and rules division. Formerly chief of the
Broadcast Bureau's renewal branch, he has been with
the FCC since October 1969.

Officers for The Society of Cable Television Engineers
for 1979-80 are: **Harold R. Null**, vice president of
engineering for Storer Cable TV, president; **William
H. Ellis**, engineering director for Evansville Cable TV,
eastern vice president; **Frank J. Bias**, vice president of
engineering for Viacom Communications, western vice
president; **Kenneth S. Gunter**, executive vice president
and director of UA-Columbia Cablevision, secretary;
and **Thomas A. Olson**, president of Tomco Communi-
cations, treasurer.

Roger Allan, WRKO, Boston, has been elected to the
board of director's post for the Radio and Television
News Directors Association. He has served on the
board of directors for two terms in the past.

Animator **Harry Klynn** and programmer **Stu Rosen**
have been added to the Academy of Television Arts &
Sciences board of governors.

David Schnuelle, chief engineer at TPC Communi-
cations, has been named to a committee of the Audio
Engineering Society, which will study the problem of
transmission of audio signals in TV broadcast.
Schnuelle worked with National Teleproductions and
the University of Kentucky Television Center before
joining TPC in 1974.

Manufacturers/Distributors

UMC Electronics has announced two appointments.
James C. Leu is now president of the company. He
was president of the US Electrical Motors division of
the Emerson Electric Company. **Philip Lohman** is now
vice president-marketing, UMC. He was previously
assistant vice president-international for the US Elec-

Circle (57) on Reply Card

If you think their character generator is easy to operate, just go ahead and exawkm.



Before you invest in a top of the line character generator, you should know more than just what it can do. That's why the versatile new 3M D-8800 character generator could be just the one for you. You see, all instructions are in English, not in code. And we've put them on a convenient L.E.D. panel above the keyboard for less wasted eye motion. So even a beginner can soon be composing in all kinds of fonts and colors. See your 3M representative right away for the character generator any of your people can run, or call 612-736-1032 for more information. Unless of course, you'd rather exawkm.

3M

Circle (58) on Reply Card

AM, FM, TV... ?

CCA is all you need in broadcast equipment

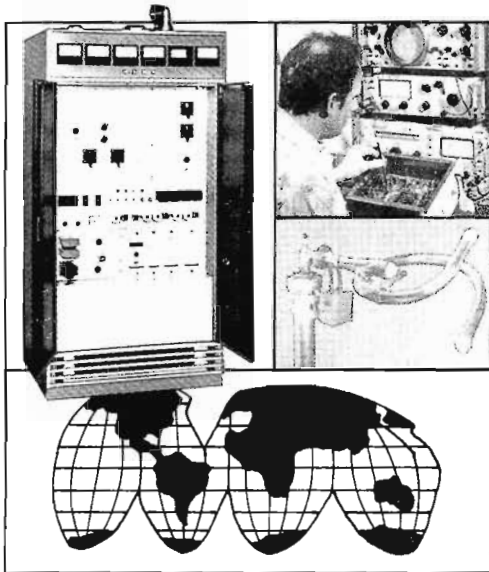

In broadcasting, you need equipment . . .
and suppliers . . . you can depend on.

At CCA, broadcast equipment is our specialty, our only business. For nearly two decades we've offered a complete line of transmitters, antennas, consoles and associated equipment . . . both as individual units and complete turnkey packages . . . for FM, AM and TV broadcasting.

Thousands of CCA equipped stations are now in operation around the world.

Our nationwide network of representatives is backed by a toll free telephone hot-line to give you emergency service and technical information 24 hours a day, seven days a week.

That's why we say CCA is all you'll ever need. Equipment, and a supplier, you can count on.

CCA

Electronics Corporation

Broadcast Plaza Box 5500

Cherry Hill, N.J. 08034

609-424-1500—Telex 845 200

24 Hour Toll free Hot-line 800-257-8171

People in the news

trical Motors division of Emerson Electric Company.

Ampro/Scully has announced several management changes: **Tom Creighton**, formerly national sales manager, is now vice president of sales and marketing; **Bill Hamilton**, formerly eastern regional manager at Scully, has been appointed national sales manager; and **Ed Zdobinski** has been appointed customer service manager for Scully products.

Richard N. Lawrence has been promoted to general manager of Lenco Electronics Division. Previously, Lawrence was sales manager for the company.

Philips Test & Measuring Instruments has named **Robert Hynes** national sales manager. He was eastern regional sales manager for the company.

William C. Ebell has joined A. F. Associates as national sales manager. Ebell was senior sales engineer with Ampex, AVSP division.

Ken Kohda, TDK Electronics, adds the title of general manager to that of vice president of the quality audio and videotape marketer/manufacturer for the firm. **Ann Boucher** has been appointed advertising and publicity manager.

Sharp Electronics has promoted four executives: **Mike Akamatsu** has been promoted to a new executive level position with the company's international division in Japan. **Charles Daigneault** has been promoted to executive vice president. **Ted Inoue** has been named assistant executive vice president and **Ted Nakano** has been promoted to general manager, business administration, consumer electronics division. Also at Sharp, **Ron Colgan** will assist the company's West Coast dealer network for the professional products department. Two new regional salesmen also have been named: **Jim Freeman** to southeastern regional sales manager, and **Robert McNeill** to eastern regional sales manager.

RCA has announced several staff appointments: **Stanley E. Basara**, promoted to division vice president and general manager of RCA Broadcast Systems; **Donald M. Cook**, appointed division vice president and general manager of RCA Distributor and Special Products division; **Dr. James Vollmer**, elected RCA group vice president with responsibility for the Commercial Communications Systems division and the Government Systems division; and **Paul R. Tatge**, appointed manager of Satellite Communications Services for the RCA Service Company.

Hitachi has announced the appointment of **Clyde W. Smith** as vice president of research and development. Smith was director of audio/video engineering at Thompson-CSF and was responsible for the Microcam Program.

Microtime has announced the appointment of **Robert J. Anderman** as director of marketing. Anderman came to Microtime from McM Martin Industries where he served as broadcast sales manager.

John F. Delissio returns to the broadcast products division of Harris as vice president of international sales. Delissio previously served as director of international sales and then as director of domestic sales until his appointment of vice president of

Circle (59) on Reply Card



when cost is more important than price

Value conscious broadcasters specify the Studer B67 because it outperforms its competitors on the really significant broadcaster criteria:

- Studer state-of-the-art quality
- Long service life with low failure rate
- Speed and ease of user maintenance

If you're more concerned with *total* cost than just initial price, write to us for complete information on the superiority of the Studer B67 Broadcast Recorder/Reproducer. We'll show you why it's your best tape recorder investment.

Circle (60) on Reply Card

STUDER



Studer Revox America, Inc., 1819 Broadway, Nashville, Tenn. 37203 / (615) 329-9576 • In Canada: Studer Revox Canada, Ltd.

**OUR NEW
TURNTABLE IS
SENSATIONAL!
JUST LIKE THE REST OF
THE RUSSCO LINEUP.**

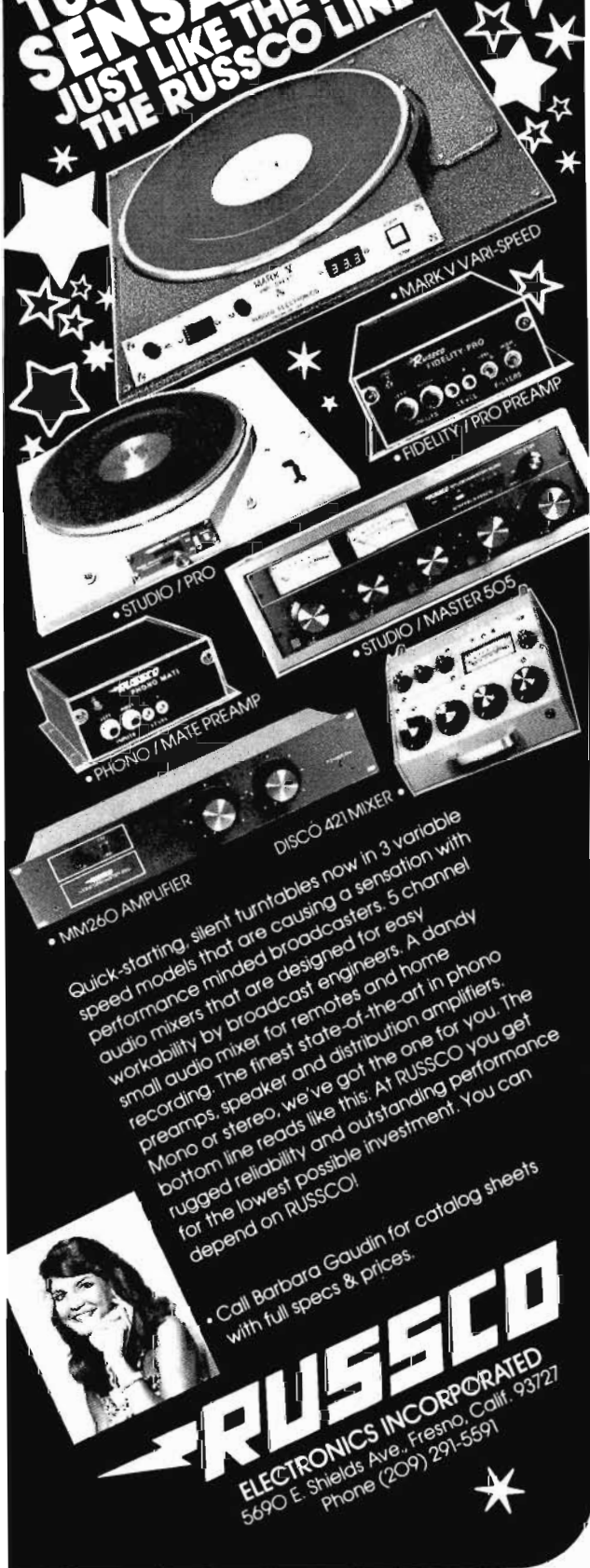

• MM260 AMPLIFIER
• STUDIO / PRO
• PHONO / MATE PREAMP
• MARK V VARI-SPEED
• FIDELITY / PRO PREAMP
• STUDIO / MASTER 505
• DISCO 421 MIXER

Quick-starting, silent turntables now in 3 variable speed models that are causing a sensation with performance minded broadcasters. 5 channel audio mixers that are designed for easy workability by broadcast engineers. A dandy small audio mixer for remotes and home recording. The finest state-of-the-art in phono preamps, speaker and distribution amplifiers. Mono or stereo, we've got the one for you. The bottom line reads like this: At RUSSCO you get rugged reliability and outstanding performance for the lowest possible investment. You can depend on RUSSCO!



• Call Barbara Gaudin for catalog sheets with full specs & prices.

RUSSCO
ELECTRONICS INCORPORATED
5690 E. Shields Ave., Fresno, Calif. 93727
Phone (209) 291-5591

Circle (61) on Reply Card

People in the news

marketing at the satellite communications division in 1977.

Scientific-Atlanta has named **Donald Begitschke** manager of engineering for its Optima Division. Begitschke will have responsibility for the engineering and design functions for the enclosure manufacturer.

UMC Electronics has named **David M. Kelly** sales and marketing manager for their broadcast products division. Kelly most recently served as an associate with the Chapman Company, a nationwide radio and TV station broker.

Ampex has added three sales engineers to the marketing staff of the audio-video systems division: **Bob Natwick**, video sales engineer for the northeast; **Tony Dean**, audio sales engineer for the northeast; and **Earl Higgins**, video sales engineer for the southeast.

EEV has announced **Robert E. Knowles** as product sales manager for Arkansas, Kansas, Louisiana, Minnesota, Nebraska, North Dakota, Oklahoma, South Dakota and Texas. **Harry Kozicki** has been appointed product sales manager for Alabama, Florida, Georgia, Mississippi, North Carolina, South Carolina, Tennessee, Virginia, West Virginia and Puerto Rico.

Sony Consumer Products has named **Don LaDieu** national accounts manager. Previously, LaDieu served as regional sales manager in Sony's New England Office.

Electro-Voice's new high fidelity products marketing manager is **Tony Satariano**. He comes to the company from the Koss Corporation where he was midwest regional sales manager.

Harvey Ray is Commercial Electronics Incorporated's new eastern regional sales manager. He was formerly vice president at ITI Glendale. **Dave Lindsey** is CEI's midwestern regional sales manager. He was formerly national product manager at GBC.

Herman Schloss has been named vice president of US JVC's Pro Vid division. Prior to his appointment, Schloss directed the division's operations as national sales manager.

Telex Communications announced the appointment of two representative organizations for its broadcast and professional audio products group. On the East Coast **LCA Sales** was appointed for greater NYC, New Jersey, Delaware and Eastern Pennsylvania; **Robert Milk Company** was named for Indiana and Kentucky.

McMartin Industries has appointed **Don Denver** to national sales administrator. Prior to joining the company, he held an administrative and engineering post at KECK in Lincoln, NE. Also at McMartin, **Charles E. Goodrich** has been named director of marketing. Formerly, he was director of engineering.

Richard F. Corrigan and **Stanley Risetter** have joined Fuji Photo Film USA as sales representatives in the Midwest and Southwest. Both will specialize in sales and support of broadcast products. □

America's Largest Manufacturer of Broadcast Cameras. West of the Delaware River.

A JILLION CAMERAS

SINCE 1968. We've been at it longer and better than most. Consequently, we know TV cameras. In 1977 we committed CEI to a new direction in broadcast color television cameras. At last components were small. Needs were different. Flexibility was key. And portability was a must. So, we developed the 310 system and not just one more bulky contraption with unnecessary flaps, doors, handles, corners, louvers, wires, cables ... and weight.

TOTE IT. MOUNT IT. POINT IT. USE IT. The CEI 310 is a camera designed to be used. It is a true two-in-one camera which performs beautifully in either studio or field applications. When you want to change from one to the other, you can do so simply in a matter of minutes. Plus CEI cables hook together without special-ordered adaptors — for a range of up to 2400 feet. The CEI 310 is built for real live people. When field equipped, it's naturally suited for the shoulder. The eight pound head rests easily for hours at a time. The cord's exit path follows a normal line down the back of the cameraman.

A SIMPLE LITTLE THING, OUR EU. A six-sided box, blank on four sides: The front panel has all the controls. The rear has all the connections. That's it. Simplicity itself. Inside, the first five of our printed circuit boards handle the normal functions you'd expect. But what we call "board 6" is for today's engineer. Because it's for tomorrow. And it's empty. That's where we put such things as automatic pedestal, iris window shade and a SMPTE time code generator. That's today. For tomorrow there'll be more. The point is, once you've got our basic unit we can offer you bells and whistles for years to come. They'll always fit your 310.

RUGGED RELIABILITY. Kick it around. A lot. The 310 has been places you've never seen: Coal mines, helicopters, surgery, sports fields, studios, wheel wells, fishing piers and cable cars. CEI stands behind our guarantee of service and parts in less than 48 hours. But you don't have a broken 310? We're not surprised. Few people do. That's why we offer you an unedited list of uncoached users. We're betting you'll find a preponderance of good comments about CEI and its cameras.

WE SHOW UP AT THE SHOOT-OUTS. Everybody claims to meet their specifications. And finely-tuned, in a clean room, some do. Ours goes the next step better, in actual use, every day: The 310 actually beats our published specs. We would be happy to lend you a camera for an evaluation in your facility. Our Chief Engineer speaks your language and he is here every day to answer your technical questions. Give us a call.

CEI

880 Maude Avenue
Mountain View, CA 94043
(Telex) 348-436
(415) 969-1910

Circle (62) on Reply Card

Maybe someday all cameras will look like ours.

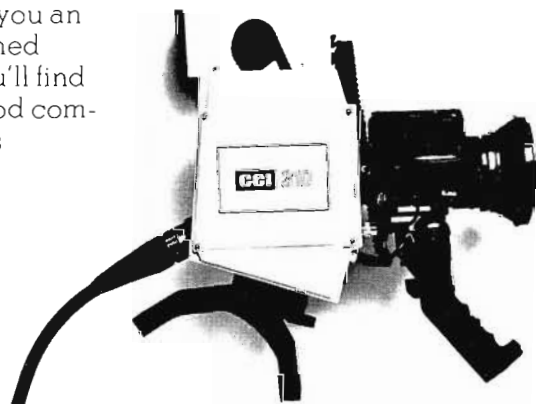

THE WILKINSON AM2500B 2.5 KW AM BROADCAST TRANSMITTER

FEATURES

- Solid State Modulator Driver
- Solid State Exciter
- Only One Tube Type - (4) 4-1000A
- Variable Vacuum Capacitor Tuning
- Motorized Variable Capacitor Loading
- Low Distortion, High Level Modulation
- Accessible Drawer Construction
- Solid State Timing Circuits
- Self-Testing Silicon Power Supplies
- Automatic Recycle
- Simplified PA Tuning - Only two controls
- Double Duty Plate & Modulation Transformers
- Pretuned at Customer's Frequency
- Power Cutback (optional)
- Designed for Remote Control
- Ample, Roomy Cabinet for Ease of Service
- Completely Metered
- Uses Standard Parts with Original Maker Numbers

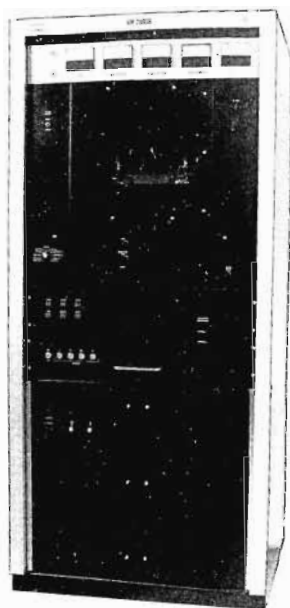

WILKINSON
ELECTRONICS, INC.

P.O. BOX 738, TRAINER, PA. 19013
TELEPHONE (215) 497-5100

Circle (63) on Reply Card

meetings, events & seminars

September 19-26—The World Telecommunication Forum will be held in the Palais des Expositions of Geneva, Switzerland. The forum is organized by the International Telecommunication Union (ITU) and professional engineering societies from around the world.

Part 1 of the forum, "Telecommunication perspectives and economic implications," takes place from September 19 to 21; Part 2, the "Integration of the world telecommunications network," will take place from September 24 to 26.

For more information, contact Rita Glita, American Express Travel Service, 7, rue du Mont-Blanc, Boite postale 859, 1211 GENEVE 1 (Switzerland), (022) 31 76 00.

September 20-26—The Third World Telecommunications Exhibition, TELECOM 79, will be held in the Palais des Expositions of Geneva, Switzerland. Specialists, delegates of the telecommunications administrations in some 140 countries, engineers and industry representatives will be on hand to assess the displays of nearly 600 exhibitors from about 40 countries.

The exposition will coincide with the opening in Geneva of the World Radio Conference.

For more information, contact Rita Glita, American Express Travel Service, 7, rue du Mont-Blanc, Boite postale 859, 1211 GENEVE 1 (Switzerland), (022) 31 76 00.

September 24-November 30—The World Administrative Radio Conference (WARC) will open on September 24, 1979. Organized by the International Telecommunication Union, it will last 10 weeks and will be held at the Geneva International Conference Center and in the ITU headquarters building. The purpose of WARC-79 is to revise, harmonize and bring up to date the international regulations applicable to all radio communication services. As a governmental conference, the decisions made will have the force of a treaty. For more information contact Union Internationale Des Telecommunications, Place des Nations, 1211 Geneve 20, (022) 99 51 11.

October 7-10—The National Radio Broadcasters Association (NRBA) will hold their Sixth Annual Conference and Exposition at the Washington Hilton hotel in Washington, DC. For more information contact the National Radio Broadcasters Association, Suite 500, 1705 DeSales St., NW, Washington, DC 20036.

October 9-13—The Inter-American Association of Broadcasters will meet at the Mayflower Hotel in Washington, DC.

For more information, contact Hector Armengual, Inter-American Association of Broadcasters, Calle Yi, 1264-Montevideo, Uruguay, 90-4456.

October 11-14—The American Film Institute national conference on film and television is scheduled for the Sheraton Universal hotel, Universal City, CA.

For more information, contact the American Film Institute, Kennedy Center, Washington, DC 20566.

October 16-18—The 10th annual Video Expo/New

We interrupt this magazine

One call is all it takes to get anything and everything you need in broadcast equipment — from turntables to AM and FM transmitters.

Choose from Rockwell-Collins equipment plus that of close to a hundred different manufacturers. It's one-stop shopping with fourfold advantages:

1. Quality products. Our transmitters and consoles are the result of our technical excellence and single-minded dedication exclusively to the radio broadcaster for over 40 years. We've never once deviated from our goal: to make our name synonymous with quality, reliability and long life... for your benefit.

2. Broad choice of products. In addition to our own Generation 4[®] FM transmitters and our all-new Power Rock 5-kW AM transmitters (the cleanest,

to bring you all you need in broadcast equipment.

brightest, loudest AM in town), we carry products from the largest team of respected specialty vendors available anywhere from a single source — from ADC to UREI, with nearly a hundred other such leaders in between. If we don't have what you want, chances are we can get it for you. Fast.

3. Flexible financing arrangements. If it's under \$1000, you can use your own or your company's Master Charge. For larger orders, take your choice of time-purchase (up to 5 years) or lease plans.

4. Unbeatable customer support. Your emergency is our emergency. We're ready to respond — without delay — 24 hours a day, 365 days a year.

See the cities listed below for the representative nearest you — and call him for one-stop shopping, Rockwell-Collins style. Ask him for a copy of our new brochure, or contact: Collins Broadcast Marketing, Commercial Telecommunications Group, Rockwell International, Dallas, Texas 75207. Phone: 214/996-5424.



Rockwell International

...where science gets down to business

Easthampton, Mass. (413) 527-4430 • Newton, N.J. (201) 383-8797 • Knoxville, Tenn. (615) 573-9717 • Birmingham, Ala. (205) 822-1078
Ft. Wayne, Ind. (219) 485-8354 • Minneapolis, Minn. (612) 479-2633 • Kansas City, Mo. (816) 443-2080 • Yuma, Ariz. (602) 783-6380
Portland, Ore. (503) 254-2818

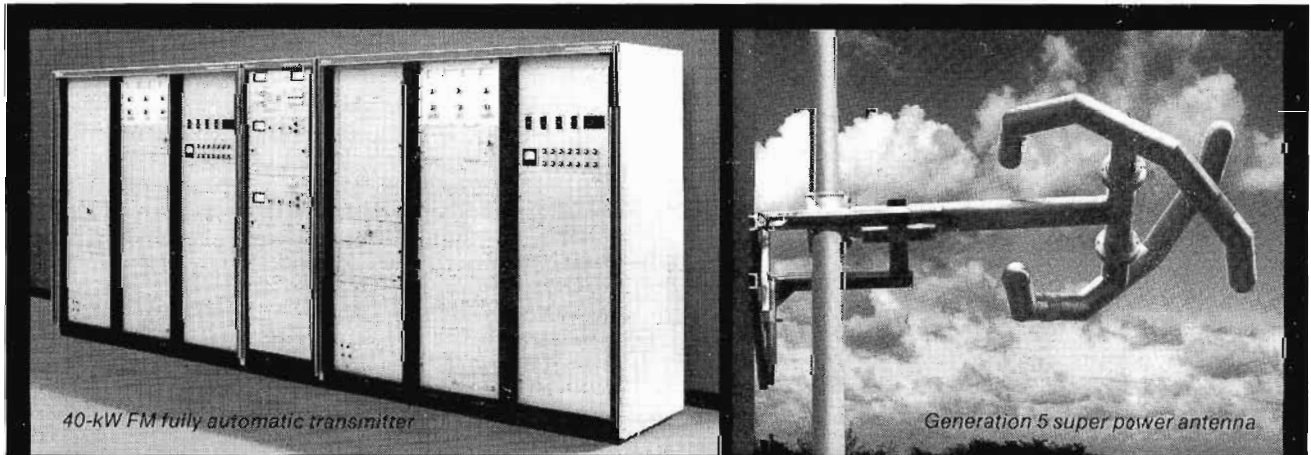

40-kW FM fully automatic transmitter

Generation 5 super power antenna

The latest words in communications: Rockwell-Collins.

Brussels 242-4048 • Cairo 801525 • Frankfurt (Rodgau 6 Weiskirchen) (0) 5106-4093 • Hong Kong 5-274-321 • Kuala Lumpur 27283 • London 01-759 9911 • Manila 829-2742 • Mexico City (905) 533-1846
Melbourne (Lilydale) (03) 726-0766 • Paris (Rungis Principal) 687-31-02 • Rio de Janeiro (021) 246-3276 • Riyadh 89060 or 68324 • Rome (0) 6-862-415 • Seoul 74-9276 or 793-5206 • Tehran 685-180
Tokyo 478-1278 or 478-1279 • Toronto (416) 252-3761

Circle (64) on Reply Card

September 1979 *Broadcast Engineering* 79

What do these manufacturers have in common??

**GE, Magnavox, Hitachi,
Toshiba, Sony, Mitsubishi,
Panasonic, JVC, Sanyo,
NHK and NEC . . .**

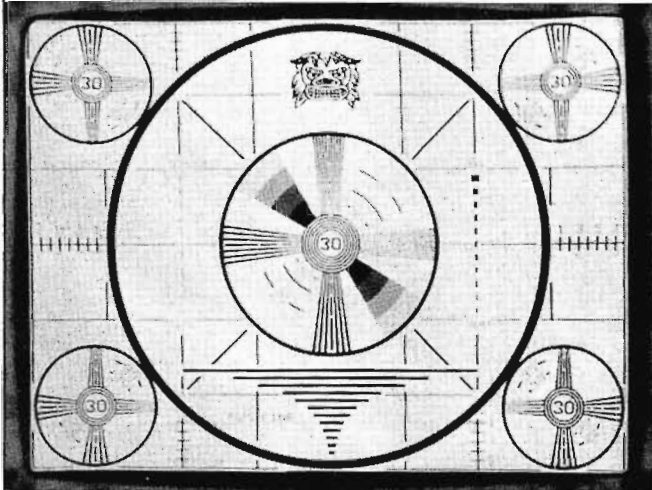

They all have the 588 Digital Test Pattern Generator on the Production Line!

The test pattern is produced by circuitry that is completely digital in nature and which substitutes for a monoscope tube. The digital circuit is very dependable and stable. There is no distortion. No pattern deterioration. There is an excellent signal to noise ratio.

Pattern data is stored in a read-only memory element (ROM). This standard-test-pattern generator can be employed both for adjusting television video equipment and for judging its merits and demerits . . . both on production lines and for the maintenance of broadcasting equipment.

The 588 generator can be applied to these picture quality checkpoints: resolution, focus, screen's center size, deflection linearity, vertical/horizontal aspect ratio, shading, streaking, gradation and luminance settings, interlace.

As an option, color burst signals can be added to the patterns through the insertion of external color signals.

Both high resolution and PAL version available.

Write for free information and demonstration.

We Create Change

ASACA®

ASACA CORPORATION OF AMERICA
1289 Rand Road, Des Plaines, Ill. 60016
Phone (312) 298-4380

In the far east, contact
ShibaSoku Co., Ltd.
19-13 Chome
Fukuzawa Setagaya-ku, Tokyo, Japan
Phone: 703-5151

Meetings, events & seminars

York will be held in the Rotunda of Madison Square Garden. The world's largest non-broadcast television trade exposition, Video Expo will feature exhibits, general sessions and seminars.

For more information, contact Knowledge Industry Publications, 2 Corporate Park Drive, White Plains, NY 10604, (800) 431-1880 outside New York state or (914) 694-8686 in New York state.

October 21-26—The 121st Technical Conference and Equipment Exhibit of the Society of Motion Picture and Television Engineers (SMPTE) will be at the Century Plaza Hotel in Los Angeles, CA. The conference will feature five days of technical sessions on motion pictures and television. The SMPTE equipment exhibit, beginning Monday, is expected to have more than 250 booths of equipment with many of the major film and video equipment manufacturers participating. For additional information write SMPTE Conference, Dept. BE, 862 Scarsdale Ave., Scarsdale, NY 10583.

October 27-November 3—Telemark '79, the 2nd Exhibition of Installations and Equipment for radio/television stations and the 2nd Borsa Programmi for producers and distributors of programs for radio/television will take place at the Exhibition Park of Novegro, Airport Milan/Linate. For more information, contact COMIS Lombardia, Via Boccaccio, 7 - 20123 Milano, Italy, Telephone (02)80 92 81.

October 29-31—Scientific Atlanta's 5th annual Satellite Earth Station Symposium will be held at the Marriott Hotel in downtown Atlanta. The meeting is offered to executives and technical managers of cable systems, broadcasters and other communications firms. The symposium will feature the experiences of communications firms now receiving satellite-relayed programs and signals by the use of satellite earth terminals. For additional information contact Kenneth F. Leddick, broadcast marketing manager, Scientific-Atlanta, Dept. BE, 3845 Pleasantdale Road, Atlanta, GA 30340.

November 2-5—The 64th Technical Meeting and Exhibits fall conference of AES will be held at New York City's Waldorf-Astoria Hotel. Convention chairman is Eric Porterfield, Columbia Records, 51 West 52nd Street, New York, NY 10019, (212) 975-4461.

November 7-8—A fall engineering conference on emerging technologies will be hosted by the Society of Cable Television Engineers. The meeting will explore fiber optics and its impact on cable television/broadband communications.

For more information, contact SCTE, 1100 17th Street NW, Washington, DC 20036, (202) 659-2131.

November 11-15—The National Association of Educational Broadcasters will hold their 55th Annual Convention at the Conrad Hilton in Chicago. Highlights include the 2nd Annual Video Fair, a preview of programs being distributed to public broadcasting.

For more information, contact: National Association of Educational Broadcasters, Dept. BE, 1346 Connecticut Avenue NW, Washington, DC 20036.

November 15-18—The First International Video Music Conference, sponsored by *Billboard* magazine, will be held at the Sheraton-Universal in Los Angeles.

Circle (65) on Reply Card



RCA



It's the RCA tradition of growth and innovation; a tradition of being an engineer's company dedicated to pioneering new technologies. We brought

Nipper™ back to emphasize the fact that although we are one of the nation's largest industrial firms, we are still an imaginative, pioneering bunch of innovators not unlike the group who started it all. If you have some ideas you'd like to get on the move, talk with us.

We have openings at all experience levels for BS/MSEE's with backgrounds in RF systems and antenna design, closed loop servo systems, high speed digital signal processing, VTR's, and related areas of

electromagnetic imaging, recording, and transmission. For further career information with RCA in the above areas, send your resume and background information to John Hendrickson, RCA Broadcast Systems, Bldg. 3-2, Camden, NJ 08102. We'll return a full-color print of our familiar trademark Nipper, to you, suitable for framing, at no obligation.

We are an equal opportunity employer Male/Female.

A Tradition On The Move!

Circle (66) on Reply Card

September 1979 *Broadcast Engineering* 81

**maxi-
tel** THE LATEST
IN REMOTE BROADCAST
EQUIPMENT

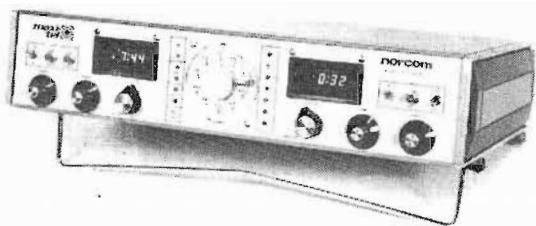

Utilizing the latest "state of the art" electronic design, the MAXI-TEL is your answer to all of your remote broadcast problems when using telephone lines. When you are at sports games, grand openings, conventions, or whatever. The "MAXI-TEL" will serve you flawlessly with exceptional broadcast quality. 120 volt operation plus up to 40 hours of battery back-up with alkaline "D" cell batteries makes the MAXI-TEL one of your most reliable pieces of broadcast equipment that you own.

**Allied
Broadcast
Equipment**

Chicago Sales Phone 312-784-2257
635 SOUTH E STREET • P.O. BOX 786
RICHMOND, INDIANA 47374
PHONE (317) 962-8596

Circle (67) on Reply Card

Meetings, events & seminars

An advisory board has been chosen which will present panel discussions, presentations and demonstrations. Hands-on workshops and video showcases of top creative material will be featured.

For more information, contact Billboard International Video Music Conference, 9000 Sunset Blvd., Los Angeles, CA 90069, (213) 273-7040.

November 26-27—Video Rights '79 is being held at the Cafe Royal, London, under the chairmanship of John Johnson, program consultant, and professional broadcaster in sound and vision. It was designed to examine the solutions to the rights tangle. For more details, contact Agneta Moe, Nord Media Ltd., Dept. BE, 37 New Bond Street, London W1Y 9HB, England, 01-629 9381.. telex 25567.

November 27-29—The National Telecommunications Conference will be held at the Shoreham-Americana Hotel in Washington DC. NTC '79 is co-sponsored by the Communications Society, Aerospace and Electronic Systems Society, and Geoscience Group. For more information contact Dr. Thomas P. Quinn, chairman, Technical Program NTC '79, Dept. BE, P.O. Box 31031, Temple Hills, MD 20031.

January 9-11, 1980—The Armed Forces Communications and Electronics Association will host the first Western Conference & Exposition (Western Expo '80) at the Disneyland Hotel in Anaheim, CA. The conference will feature the participation of key leaders in the military, industry and government community whose areas of interest are electronics,

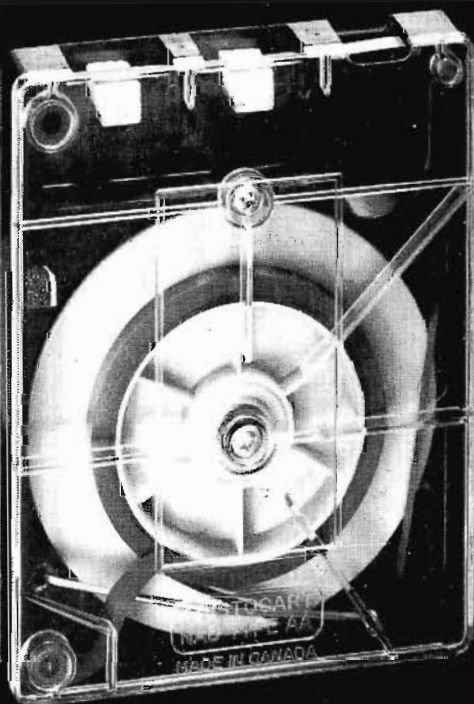

NAB TYPE AA Cartridge
manufactured by
ARISTOCART DIV. WESTERN BROADCASTING LTD.
505 BURRELL ST. VANCOUVER, CANADA V7X 1M6
TEL: (604) 687-2844 TELEX: 04-54639

**We've set
the industry's highest standard
of cartridge sound reproduction
— and we maintain it
in every cartridge**

With ARISTOCART, quality variation problems and time-consuming selection routines are eliminated. What you tape is what you hear — consistently. Each ARISTOCART is individually tested for phase, frequency response and overall performance. On a properly aligned machine, it will deliver stereo fidelity at least equal to the most sophisticated reel-to-reel equipment. Or we replace it at our expense. Another plus: ARISTOCART's exclusive pressure pad configuration prolongs the life of your expensive head by as much as 100%. So you save significantly on maintenance.

Note to AM operators: ARISTOCART delivers superb mono quality now and incomparable stereo when you convert, without further alteration.

ARISTOCART

The cartridge for people who care how they sound

Circle (68) on Reply Card

SONY INTRODUCES WIRELESS MICROPHONE SYSTEMS WITH AN INNOVATION NOBODY ELSE HAS: SIGNIFICANTLY BETTER SOUND.



Until now, using a wireless microphone system meant sacrificing the quality of the sound in a trade-off for portability.

No more.

Sony has engineered wireless microphone systems as portable and versatile as any on the market.

But with a very big difference. Excellent sound.

To begin with, Sony offers a wider dynamic range than any other wireless system, a range of 96 dB. This accommodates sound pressure levels up to 130 dB. (While most other wireless systems have limiters which hold their dynamic range to, at most, 75 dB, Sony engineering has produced a system that requires no limiters.)

So what goes into the microphone comes out again at the same sound level. And nothing takes away from the thrill of performance.

What's more, audio distortion is less than 0.1% and signal-to-noise ratio is better than 57 dB (both ± 2.4 kHz deviation, at 1 kHz).

And the new Sony systems are virtually drift-free. Frequency stability is an amazing $\pm 0.005\%$.

Furthermore, Sony wireless systems are available with up to 14 channels in UHF, which means that interference from other sound sources is much less likely than at lower frequencies.

And while many wireless systems are put together with a mixture of components from several manufacturers, Sony uses only one: Sony.

So we've been able to create fully integrated systems that offer you a wide variety of options.

For EFP and ENG, Sony's system includes a tiny lavalier mike, a transmitter about the size of a cigarette

pack and a tuner smaller than a paperback book.

The system also comes with a shoulder-strap antenna and a leather carrying case. Altogether, it's compact and efficient and offers outstanding sound.

For studio and stage use, Sony has a modular rack-mounted system that can be engineered in any combination you want, from single-channel to multi-channel diversity reception.

It can be portable or fixed, and runs from 110 volts AC or 24 volts DC.

For more information, call Sony Professional Audio Products at (212) 371-5800, extension 143 or 145.

You'll find out that no other wireless systems sound as good as Sony's.

SONY

We've never put our name on anything that wasn't the best.

TRADE-IN THOSE OLD SONY VO-2850'S FOR NEW SONY VO-2860'S. TOP ALLOWANCE OFFERED.

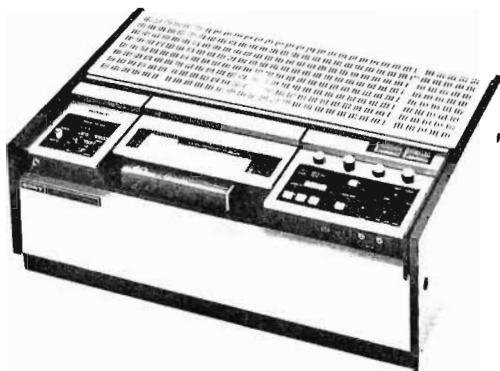

**This month's special—New Sony color portable camera DXC-1610—\$2450.00
Freight Paid**

PRE-OWNED EDITING SYSTEMS

We have a large selection of reconditioned Sony color video tape recorders, VO-2850's (with warranty). Sold individually or complete system.

- 1—VO-2850A \$2995.00
- 2—VO-2850A's w/RM-400 editor \$6295.00

Call Us First—Bud Lines or Cheryl McKinney

**LINES VIDEO
SYSTEMS**

Jefferson at McDaniel
Springfield, Missouri 65806
(417) 862-5533

Authorized Dealer for Sony or JVC

Circle (242) on Reply Card

Meetings, events & seminars

computer audio-visual, command and control, and communications.

For more information, contact Judith H. Shreve, AFCEA National Headquarters, One Skyline Place, 5205 Leesburg Pike, Suite 300, Falls Church, VA 22041, (703) 820-5028.

January 20-23, 1980—The National Religious Broadcasters convention will take place at the Washington Hilton, Washington, DC.

For more information, contact Box 2254, Morristown, NJ 07960, (201) 540-8500.

April 13-16, 1980—Las Vegas will be the site of the 1980 convention of the National Association of Broadcasters. For additional information contact NAB, Dept. BE, 1771 N St., NW, Washington, DC 20036.

April 28-30, 1980—ISCAS/80 will be held at the Shamrock Hilton Hotel, Houston, TX. Workshops will be conducted by various technical committees of the Circuits and Systems Society immediately preceding the symposium on April 27. The symposium, sponsored by the IEEE Circuits and Systems Society, will be the 13th annual international conference devoted to all aspects of the theory, design and application of circuits and systems. Authors may contribute either a full paper, summary or abstract for presentation at the symposium after July 1, 1979, to the technical program chairman, Professor T. A. Bickart. For additional information contact T. A. Bickart, Dept. of Electronic and Comp. Engineering, Dept. BE, Syracuse University, Syracuse, NY 13210. □

CHYRON

The electronic graphics people

CHYRON TELESYSTEMS DIVISION OF CHYRON CORPORATION

265 Bethpage-Spagnoli Road, Melville, New York 11746

Telephone: (516) 249-3296 ■ Telex: 144522 CHYRON MELV

VISIT US AT SMPTE BOOTH 522

Circle (71) on Reply Card

SWITCHERS DON'T MAKE MISTAKES...PEOPLE DO

That's why we've designed a whole new series of human-engineered control panels that are setting new standards for goof-proof switching.

Once you've designed audio and video routing switcher matrices as transparent and reliable as ours, there's not much room for further improvement at that end. However, there has been a need for improvement in the control end--particularly where operators must make accurate, quick-decision source selections. The panels described below are designed to eliminate the confusion too often associated with routing switcher control, while providing the control flexibility so important to present-day signal routing requirements.

For installation simplicity, each of these new panels connects directly to the system party line via loop-through coax connections. They provide continuous status readout and can be encoded to permit each input (or output) to be addressed by its name (VTR-2, CAM-4, etc.) rather than by an arbitrary matrix number.

We are also prepared to supply custom variations of these panels to suit your exact requirements.

CSP-200

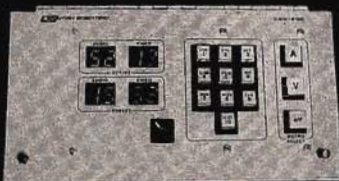

Permits audio and/or video selection--including simultaneous A/V switching from different sources--on a single output bus. Available in recessed mount, one unit per rack panel and two units per rack panel versions

CSP-300/R



Full Matrix Control Panel. Permits audio and/or video switching on any selected bus. Encoded version can be restricted to switch only on specific pre-assigned busses. Rackmount or recessed.

CSP-10



Controls and statuses ten busses (20 with Program Select switch installed). Provides separate audio and video switching and statusing.

CSP-20/CX-20

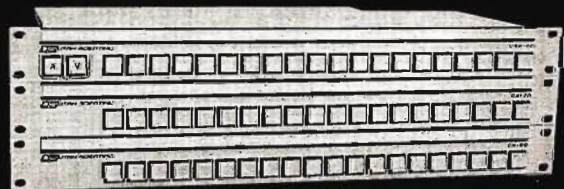

Permits button-per-source input selection on assigned bus. Basic panel accommodates 20 inputs. Expansion in 20-button increments is provided by adding CX-20 slave panels. Permits fast single-stroke selection of any input. Button lamps provide both audio and video status from refresh memory while *Only* buttons permit selective audio or video switching.

US UTAH SCIENTIFIC

2276 South 2700 West ■ Salt Lake City, Utah 84119 ■ Phone: 801-973-6840

For literature only circle (72) on reply card
For salesman call circle (73) on reply card

World Administrative Radio Conference: Ten decisive weeks for the future of broadcasting/telecommunications

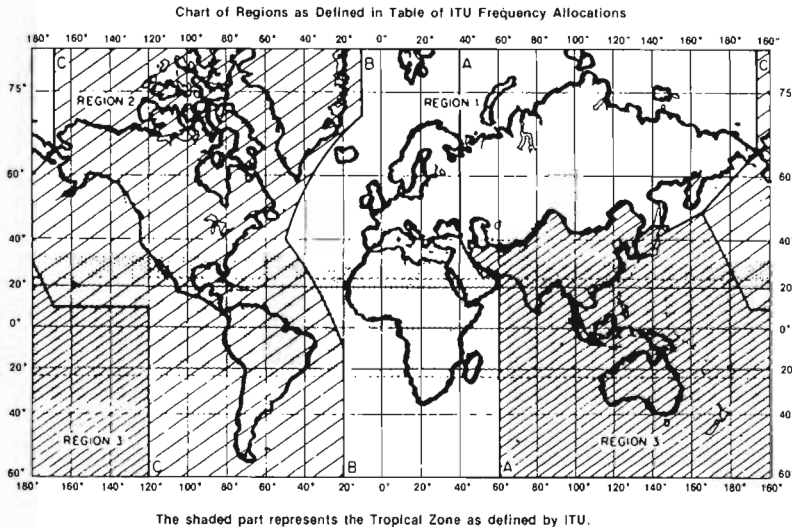

The shaded part represents the Tropical Zone as defined by ITU.

The World Administrative Radio Conference (WARC), the most important radiocommunications conference to be held for 20 years, will be opening September 24, 1979. Organized by the International Telecommunication Union (ITU), it will last 10 weeks and will be held at the Geneva International Conference Centre (CICG) and in the ITU headquarters building.

The purpose of WARC-79 is to revise, harmonize and bring up-to-date the international regulations applicable to all radiocommunications services. It is a governmental conference whose decisions have the force of a treaty. The international legislation governing telecommunications, established and approved by the 154 member countries of the ITU, comprises the International Telecommunication Convention, a treaty which defines the basic principles in telecommuni-

International Telecommunications Union

The International Telecommunication Union (ITU) is the specialized agency of the United Nations for telecommunications. It regulates, plans, coordinates and standardizes telecommunications of every type. It was founded in 1865 and has 154 member countries. Its headquarters in Geneva comprises four permanent organs: the General Secretariat, the International Frequency Registration Board (IFRB), the International Radio Consultative Committee (CCIR) and the International Telephone and Telegraph Consultative Committee (CCITT).

The Plenipotentiary Conference is the supreme organ of the Union and is responsible for revising the International Telecommunication Convention and defining the general policies of the ITU. The first such conference was held in Paris in 1865.

World Telecommunication Day is celebrated on May 17 each year by 154 ITU member countries. This date marks the anniversary of the signing of the first International Telegraphic Convention in Paris in 1865.

Canadians face WARC issues

According to Canada's communications minister, Jeanne Sauvé, the federal government has approved recommendations for Canada's participation in and proposals to the WARC.

"All users of the air waves, from ham radio operators to broadcasters, have a stake in the outcome of the conference," Mme. Suavé said. "Since the spectrum is a valuable, but limited, natural resource, and since the demand for telecommunication services using the spectrum is growing, Canada and other nations must ensure that this resource is used in a manner that will ensure that frequencies are available for the development of services in the years ahead."

As Canadian radiocommunication requirements have grown, Canada's participation in WARC has increased in order to ensure adequate

TELECOM 79

Opening concurrently with WARC-79, the 3rd World Telecommunication Exhibition, TELECOM 79, will be held at the Palais des Expositions, Geneva, from September 20 to 26.

This exhibition, organized by the ITU in accordance with the wish expressed by its 154 member countries, is placed under the patronage of the Swiss government. With more than 500 exhibitors from some 40 countries occupying nearly 70,000 square meters, it will be the largest telecommunication exhibition ever held. In addition to the exhibition itself, the following events will be

held in connection with TELECOM 79:

- the 3rd World Telecommunication Forum, attended by some 2000 participants: senior telecommunications officials, economists and engineers;
- the 3rd International Festival of Telecommunication and Electronics Films, *The Golden Antenna*;
- the 1st World Book Fair on telecommunications and electronics.

Among the tens of thousands of visitors expected will be many ministers and directors-general of telecommunications.

DYNAMIC NEW DIMENSIONS IN VISUAL PRESENTATION —with General Electric Professional Large Screen TV Projection



IN BUSINESS—General Electric projectors display real-time computer-generated data for Merrill Lynch Government Securities, New York.



IN ENTERTAINMENT—General Electric color projector brings large screen race action to Ontario Jockey Club, near Toronto, Ontario, Canada.

General Electric professional large screen television projectors—displaying color or monochrome pictures up to 25 feet wide—bring new dimensions of presentation impact to a broad spectrum of applications.

A wide choice of new and improved color and monochrome models is available to meet specific requirements for television display applications, in standard or high brightness, for various scan standards.

The color projectors utilize General Electric's exclusive single optical path light valve. All color information is projected simultaneously in one light beam. This system eliminates time-consuming registration of three separate color images, which is required for all other television projectors.

These projectors can display any size television picture from two feet to 25 feet wide, with high resolution and contrast over their full range of light output.

Among the primary applications of the projectors are:
Medical and Dental Education. Technique and procedural training.

Business. Sales meetings, industrial training, product presentations, real-time display of computer-generated data, teleconferences.

Aerospace and Defense. Situation displays, simulator training.

Entertainment. Theatre television and closed-circuit TV events, overflow crowds, discotheque special effects.

Television Production. Backgrounds for news programs, special effects, data display, program previewing.

Call or write: General Electric Company, Video Display Equipment Operation, Electronics Park 6-206, Syracuse, NY 13221. Phone: (315) 456-2562/2533/2179.

GE Professional Large Screen Television Projector Specifications

COLOR PROJECTORS									
Model	Light Output in Lumens			Resolution* in Lines per Picture Height		Input Power Req.		Scan Standards***	Video Input**
	Open Gate, Min.	Modulated TV, Min.	Modulated TV, Typ.	Min. Horiz.	Min. Vert.	Watts	Volt-Amps.		
PJ 5000	550	220	280	750	300	1200	1600	525 li./60 fps; 625 li./50 fps	(1)
PJ 5050	1250	500	650	750	300	1600	2150	525 li./60 fps; 625 li./50 fps	(1)
PJ 5800	550	200	280	750	600	1200	1600	875 lines, 60 fps	(2)
PJ 5850	1250	500	650	750	600	1600	2150	875 lines, 60 fps	(2)
PJ 5100	550	200	280	750	650	1200	1600	1023 lines, 60 fps	(2)
PJ 5150	1250	500	650	750	650	1600	2150	1023 lines, 60 fps	(2)
MONOCHROME PROJECTORS									
PJ 7000	1000	600	750	800	400	1000	1350	525 li./60 fps; 625 li./50 fps	(3)
PJ 7050	1700	1000	1250	800	400	1000	1350	525 li./60 fps; 625 li./50 fps	(3)
PJ 7055	3300	2000	2400	800	475	1500	2000	525 li./60 fps; 625 li./50 fps	(3)
PJ 7800	1000	600	750	800	650	1000	1350	875 lines, 60 fps	(3)
PJ 7850	1700	1000	1250	800	650	1000	1350	875 lines, 60 fps	(3)
PJ 7855	3300	2000	2400	800	650	1500	2000	875 lines, 60 fps	(3)
PJ 7100	1000	600	750	800	750	1000	1350	1023 lines, 60 fps	(3)
PJ 7150	1700	1000	1250	800	750	1000	1350	1023 lines, 60 fps	(3)
PJ 7155	3300	2000	2400	800	750	1500	2000	1023 lines, 60 fps	(3)

Line Power, All Projectors: 117 or 240 v., ± 10%, 50/60 Hz

*Resolution measurements made with wide-band video input.

**Video Input Key: (1) NTSC or RGB. (2) RGB. (3) NTSC or Wide-Band.

***For use at other scanning rates, contact General Electric (VDEO) for special application/model information.

GENERAL ELECTRIC

Circle (74) on Reply Card

September 1979 *Broadcast Engineering* 87

Canada position

provisions for the operation and growth of Canadian radiocommunication systems. Canada is one of about 20 countries that submit proposals which are used as the basis for revisions; the other member countries of the ITU usually participate in the conferences but do not submit proposals.

For WARC-79, the Canadian preparations began in late 1974 with the formation of the Canadian Interdepartmental Committee (CIC) made up of frequency management experts representing all federal government departments and agencies with interests in radiocommunications (Communications, Transport, Defense, External Affairs, Energy, Mines and Resources, NRC, CRTC, CBC, RCMP, Teleglobe and Telesat). After extensive technical studies and public consultations with the private sector and provincial governments, including the public distribution of two drafts, the CIC has prepared two groups of technical proposals for revising the International Radio Regulations.

The Canadian proposals for this WARC are contained in a 200-page document. Among the main Canadian proposals are the following:

- that additional spectrum be allocated for mobile communications in the UHF band;
- that the standard AM broadcasting band be extended to provide for additional channels to permit coverage of areas in Canada not at present adequately served;
- that the amount of shortwave spectrum employed for international broadcasting be substantially increased;
- that additional radio spectrum be provided for Canadian and international requirements for radiocommunications by satellites;
- that additional spectrum be provided for the amateur radio service.

As **BE** goes to press, 41 delegates have been selected to represent the Canadian interests at WARC.

As a result of the public consultations and the interdepartmental participation in the preparations, it is considered that the proposals fully reflect current and future Canadian radiocommunication requirements. Since the WARC will establish new technical standards for radiocommunication equipment, particular care has been taken to ensure that the Canadian proposals are compatible with the current and planned models of radiocommunication equipment manufactured in Canada.

WARC-79

cations and which sets out the structure and *modus operandi* of the ITU.

This convention is supplemented by administrative regulations which govern the use of telecommunications and are binding on all members of the ITU:

- telegraph regulations;
- telephone regulations;
- Radio Regulations (RR) which deal with the use of the frequency spectrum, the use of the geostationary orbit, conditions for the operation of radio stations and the relevant administrative provisions; and
- additional Radio Regulations, which deal with questions relating to traffic and charges in the aeronautical mobile service and the maritime mobile service.

It is the last two bodies of regulations, the Radio Regulations being the most voluminous (1473 pages including appendices, resolutions and recommendations against 51 pages for the additional regulations) which will be reviewed to a large extent by the conference.

The last conference with a comparable mandate was held in Geneva in 1959. Since that time, specialized world conferences have

Stand back 50 feet. Imagine seeing the numerals this easily while timing a newscast.

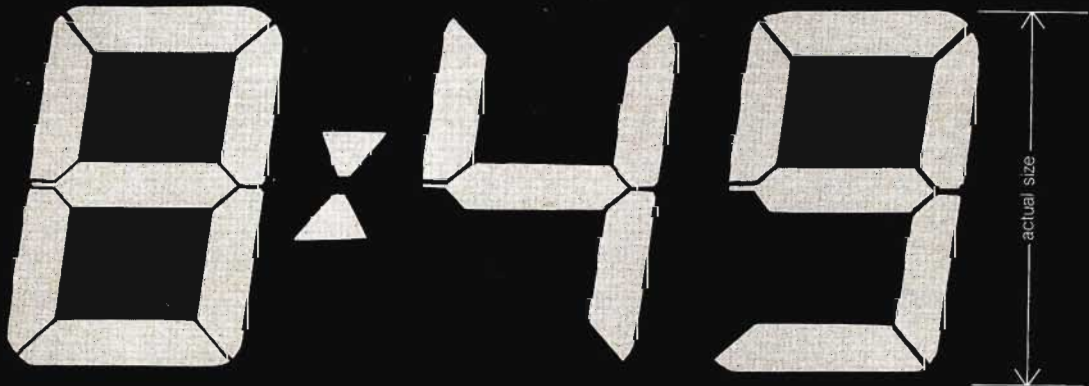

When compared to the features on your present clock, Celestra has an optional timer that permits countup/countdown use, plus instant switchback to the exact time. Offers outstanding reliability for precise timings of everything from documentaries to detergent commercials. What's more, the 2" liquid crystal numerals can be read in both high and low ambient light. For more information on

Celestra, call Mark Kenyon, Simplex Time Recorder Co., Gardner, MA 01441. (617) 632-2500.

 **Simplex**

Circle (75) on Reply Card

Introducing the new TDK testing machines.

At TDK, we know that your test cassette is a vital element of your laboratory or service procedure. So when we created a series of test tapes, we approached them as integral components, with both tape and housing engineered as precisely as your test instruments.

You'd expect that from the makers of TDK SA, the high bias reference standard for many manufacturers' cassette decks.

TDK test cassettes don't jam and they're dropout-free. They're built to last under unceasing use. If you're a store service manager, assembly line quality control inspector, or highly discerning audiophile, you need that kind of precision and reliability. To make absolutely sure you get it,

we custom quality-control each and every one.

No matter what data you need, TDK has a test cassette to help you find it out: bias/EQ alignment; playback level calibration; Dolby calibration; head azimuth alignment; wow and flutter and tape speed and 11, five and three-point frequency characteristics checks.

Check out the complete line of TDK test cassettes by writing, or calling (516) 746-0880. When you do, find out about our bulk duplication cassettes, bulk duplication pancake tape, audio visual, leaderless, data and endless cassettes, too.

You'll find that the same TDK quality and reliability that goes into our test tapes applies all the way down the line.



TDK

World leader in recording tape technology.

TDK Electronics Corp., 755 Eastgate Blvd., Garden City, NY 11530
 2906 W. Peterson Ave., Chicago, IL 60645; 2041 Rosecrans Ave., Suite 365, El Segundo, CA 90245.
 Circle (76) on Reply Card

WARC-79

met to take account of new technical developments and new frequency requirements for each particular radio service: the service using space techniques, the maritime mobile, aeronautical mobile, sound and television broadcasting and direct satellite broadcasting services.

The international regulations revised by WARC-79 will, in all

likelihood, remain in force until the year 2000 or longer. They will have a considerable influence on the development of all types of telecommunications in the 21st century.

Origin of WARC-79

The tenth Plenipotentiary Conference of the ITU (Malaga-Torremolinos, 1973) adopted a resolution to convene WARC-79, considering:

- that, since 1959, various world administrative radio conferences

US plans strong delegation to WARC

Under the leadership of Glen Robinson, formerly an FCC commissioner and now a law professor at the University of Virginia, the US delegation of around 64 specialists will descend on Geneva to represent US interests at WARC-79.

Robinson is now on leave and working for the state department to coordinate the US effort. Members of the delegation representing the broadcast interests will be Neal McNaughten and Charles Breig of the FCC Broadcast Bureau and George Bartlett of the National Association of Broadcasters.

The US proposals for WARC-79 are contained in a formal document already before the WARC. Work behind this document represents extensive efforts by people and organizations from every facet of broadcasting and telecommunications.

Technical inputs for the broadcasting proposals contained in the US document to the ITU were obtained chiefly through eight notices issued by the FCC. These resulted in working groups to allow industry and private sectors to participate in establishing the US position on

Historical notes

The advent of radiotelegraphy at the end of the nineteenth century was due to the work of scientists such as Maxwell, Lodge, Hertz, Branly, Popov, Marconi and many others. Ships were the first to benefit from the new technique: unlike cables or wires, electromagnetic waves are not subject to artificial boundaries and the distances they cover generally depend on the transmission power.

From the very beginnings of radiotelegraphy it was acknowledged that radiocommunications are by their very nature international. In 1903, less than two years after news of the first transmission of a radiotelegraph signal across the Atlantic (December 12, 1901) had

been received, the first intergovernmental radio telegraph conference was held to establish international regulations governing the use of radio waves.

Many intergovernmental radio conferences have been held to establish or revise radio regulations on a world or regional level. All of these conferences stem from the Radio Regulations drawn up in 1906 and have been organized either in response to an invitation by a member of the ITU or by the ITU itself. The objective of the ITU, when it was founded in 1865, was the establishment of international regulations for telegraphy; later it concerned itself with telephony and then finally with radio, in 1903.

btx 15-track TV audio

The superb BTX 4500 SMPTE interlocking system expands video production capability to include outboard multi-track audio recorders.

Any audio recorder may be precisely locked to any VTR to enhance your TV audio production capacity.

The BTX Corporation

438 Boston Post Road, Weston, Massachusetts 02193 • (617) 891-1239
6255 Sunset Boulevard, Hollywood, California 90028 • (213) 462-1506



Circle (77) on Reply Card

“These Auditronics 501 modules are all that survived the fire...”

that totally destroyed our East 46th Street Superdupe and SDC Recording Studio complex last year,” says Herb Gordon, studio owner. “Almost before the wreckage cooled and the insurance adjuster completed his work, I was already planning the equipment purchases we would need to get back into business.”

“In all the years we had the Auditronics 501 consoles prior to the disaster, I don’t remember anything going bad. Our purposes were well served by our old 501s, so I went back to Auditronics the week after the fire to order three more of the latest model 501s.”

Herb Gordon and over 300 other satisfied users of Auditronics mixing consoles have learned much about Auditronics performance, quality and reliability since we delivered our first 501 back in 1971. If you would like to know what they know, call or write for complete product information and the name of your nearest Auditronics dealer.

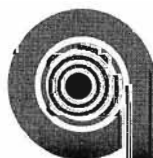

auditronics, inc.

3750 Old Getwell Road, Memphis, Tennessee 38118 (901) 362-1350

Circle (78) on Reply Card

September 1979 *Broadcast Engineering* 91

US position

significant issues, including television, AM and FM radio, international broadcasting, and satellites. These groups provided a wealth of inputs to the FCC, including requirements for the spectrum allocation tables.

In addition, the FCC considered inputs from private individuals, interested companies, station personnel, and the three major networks.

The formal positions of the US contained in the document submitted to WARC is now public information. But, there are fall-back positions on issues that remain confidential. The impact of some of the negotiated decisions to be made at WARC may not be felt for months or years to come.

In brief, some of the proposals contained in the US document include the following.

- Expansion of the AM band from 1605kHz to 2000kHz to be shared with the radio location service. Very little change is being reported for FM.
- For television, a sharing of the

band is being proposed for fixed and mobile services.

- For satellite service, a new band of 500MHz is being proposed to extend the band from 12.2 to 12.7GHz. The fixed satellite services would retain the 11.7 to 12.2GHz band and the broadcast satellites would utilize the proposed extension.

The associated problem is to find an uplink to feed the broadcast satellite. The US is proposing a shared 17.1 to 17.6GHz band, but agreement on the sharing circumstances may be difficult to attain.

There will be extensive work required following WARC to put decisions made there into perspective. Plans are under way for a March 1980 meeting in South America on the MF broadcasting band throughout Region 2, in which the United States is located. This meeting presumably would resolve the 9kHz/10kHz spacing problem in Region 2. The FCC is still accepting filings on this topic to pave the way for a US position at this meeting.

WARC-79

have amended the Radio Regulations and additional radio regulations on specific points without having been able to harmonize the decisions taken because of the limited nature of their agenda;

- that, as a result of technical advances, some of the provisions in these regulations should be reconsidered, particularly with regard to certain services which are developing rapidly;
- that, for these reasons, a general revision of the Radio Regulations and of the additional radio regulations should be undertaken in a world conference in 1979.

As directed by the Plenipotentiary Conference, the ITU Administrative Council at its annual sessions took adequate measures to ensure the administrative and technical preparation of the conference. On the technical level, the Administrative Council's action was 2-fold: to structure the Radio Regulations so as to provide the conference with a framework for the revision of the regulations, and to provide technical standards to equip the conference with international standards on which to base its decisions.

Structure of the regulations. At its

For Precision Indexing

EECO MTG 550 Series

Master Time Code Generators



2-79 1119

The MTG 550 is used for NTSC, PAL, or SECAM

AMPEX Ampex is world-wide distributor for EECO broadcast products.

EECO's MTG 550 Series SMPTE/EBU Generators incorporates the latest state-of-the-art CMOS/LS TTL logic resulting in reduced size, weight and power requirements.

Slave and user bit input options are now standard together with new alarm features at reduced costs.

Instant reliability is assured by exclusive use of aged burned-in integrated circuits.

Four low price Models are now available.

- MTG 551-NTSC
- MTG 552-PAL B
- MTG 553-SECAM
- MTG 554-PAL M

Available from your nearest AMPEX Sales office world wide distributor for EECO Broadcast Products.

EECO
Incorporated

1601 East Chestnut Avenue • Santa Ana, California 92701
Phone: (714) 835-6000 • TWX 910-595-1550
Telex 67-8420

Circle (79) on Reply Card

WHY JBL FLATTENS THE COMPETITION.

INTRODUCING THE 4313.

Flat frequency response. It means accuracy. Naturalness. Reality.

JBL gives it to you without the bigger box that you'd expect along with it, since the 4313 only measures about 23" by 14" x 10"!

This new, compact professional monitor produces deep, distortion-free bass. And does it with a newly developed 10" driver.

Its massive magnet structure and voice coil are equivalent to most 12" or 15" speakers. Yet it delivers heavy-duty power handling and

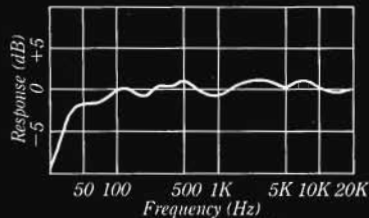

*On-axis frequency response,
4313 monitor.*

a smoother transition to the mid-range than most larger-cone speakers.

The 4313's edge-wound voice coil midrange accurately reproduces strong, natural vocals and powerful transients.

Up top, a dome radiator provides high acoustic output with extreme clarity and wide disper-

sion. A large 1" voice coil gives it the ruggedness needed in professional use.

Working together, these precision-matched speakers offer superb stereo imaging, powerful sound levels and wide dynamic range.

Audition the 4313 soon.

We think you'll agree that its combination of flat response, power and moderate size flattens the competition.

James B. Lansing Sound, Inc.,
8500 Balboa Boulevard,
Northridge, California
91329.

FIRST
WITH THE
PROS.

JBL

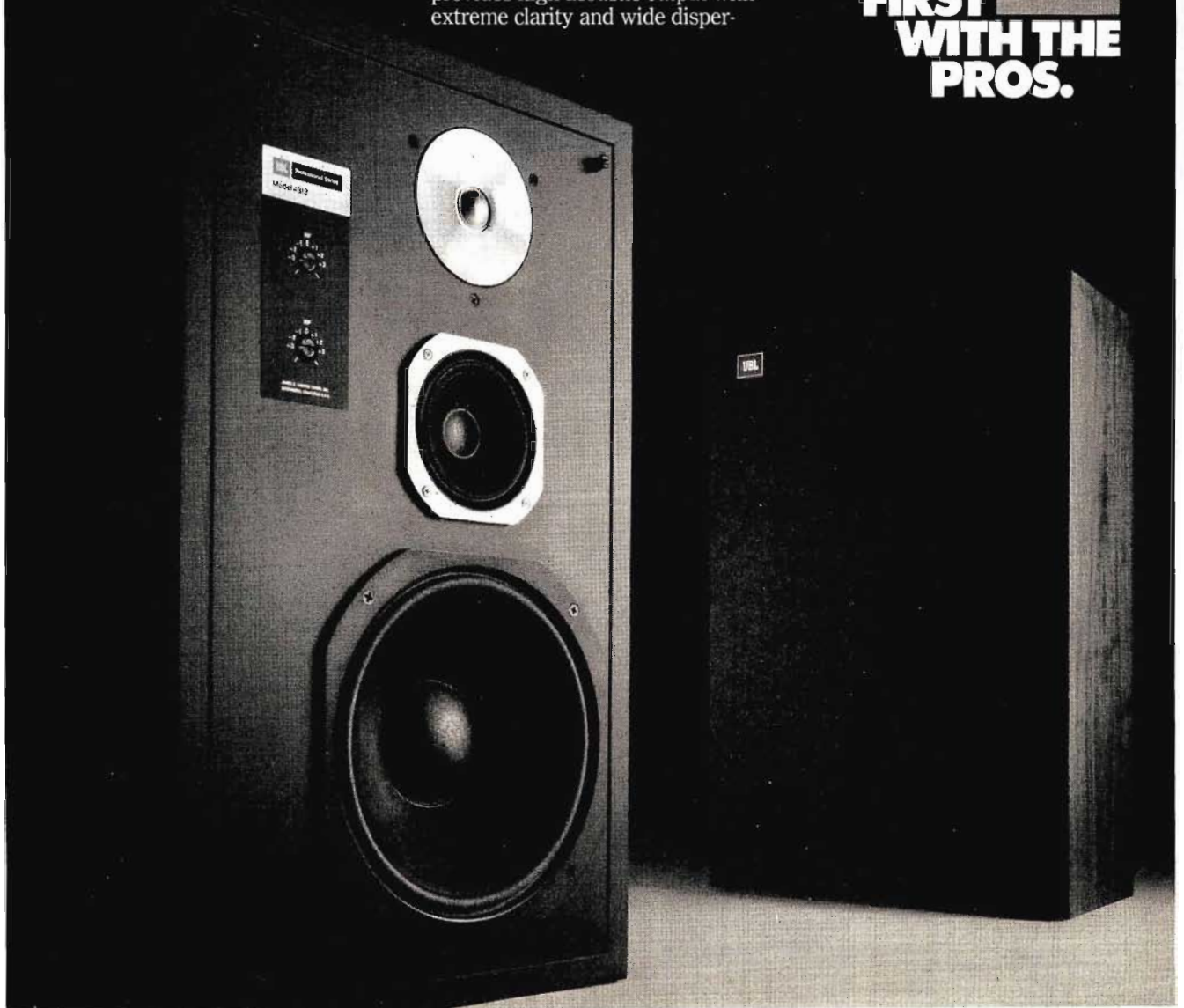

Circle (80) on Reply Card

September 1979 *Broadcast Engineering* 93

WARC-79

30th session in 1975, the Administrative Council convened a group of experts to prepare the draft of a possible rearrangement of the Radio Regulations.

This group, which comprised experts from telecommunication administrations of members of the ITU assisted by representatives of the permanent organs of the union, met in Geneva on January 19, 1976 and worked for four weeks. Its task consisted of separating in the existing regulations the administrative provisions from those relating to operation, and to classify the latter according to the various services concerned. The group's report was considered and approved by the World Administrative Broadcasting-Satellite Radio Conference (Geneva, 1977) and was subsequently distributed by the ITU to all member administrations so that it could be used as a framework for the preparation of their proposals to WARC.

Technical standards. At its 31st session the Administrative Council instructed the International Radio Consultative Committee (CCIR), one of the permanent organs of the ITU:

- to carry out the studies necessary to achieve timely provision of the technical information likely to be needed as a basis for the work of the conference; and
- to arrange for a special joint meeting of CCIR study groups at the end of 1978 to assemble this technical information.

Participation in the conference

The national delegations to ITU conferences are designated by the members of the union. A delegation is defined in the International Telecommunication Convention as "the totality of the delegates and, should the case arise, any representatives, advisers, attachés, or interpreters sent by the same country. Each member (country) shall be free to make up its delegation as it wishes. Accreditation of delegations to administrative conferences shall be by means of instruments signed by the head of state, by the head of the government, by the minister for foreign affairs, or by the minister responsible for questions dealt with during the conference."

The following are also entitled to attend conferences: United Nations observers; observers from regional telecommunications organizations; observers from specialized agencies of the United Nations and from the

International Atomic Energy Agency; observers from accredited international organizations which have submitted a request for admission; and representatives of recognized private operating agencies duly authorized by the member country to which they belong.

About 1500 delegates from some 140 member countries of the ITU are expected.

ITU member activities

Many member countries of the ITU have set up national governmental coordination committees grouping the various users of radio-communications to prepare proposals for submission to the conference. Numerous bilateral and multilateral discussions also have been held by member countries to coordinate their proposals as far as possible. Many of these proposals already have been received at ITU headquarters; they may only be submitted by members of the union. They are currently expected to amount to more than 3500 typed pages by the eve of the conference.

In addition, a number of national or international organizations concerned with radiocommunications have already held or will hold meetings to discuss preparations for WARC. □



Break Out of the Studio with McMartin RPU

Hand-held, mobile and fixed-base transmitters. Portable and studio receivers. McMartin Industries has everything you need to cover any news story, sports event or entertainment happening. No need for phone lines.

150 MHz and 450 MHz bands available. All specifications exceed FCC requirements.

**Write for more information or
contact your McMartin salesman.**

MCMARTIN • McMartin Industries, Inc. • 4500 S. 76th St. • Omaha, NE 68127 • Phone (402) 331-2000 • Telex 484485

Circle (81) on Reply Card

The Professional's Choice— the you-name-it, you-got-it video test set.

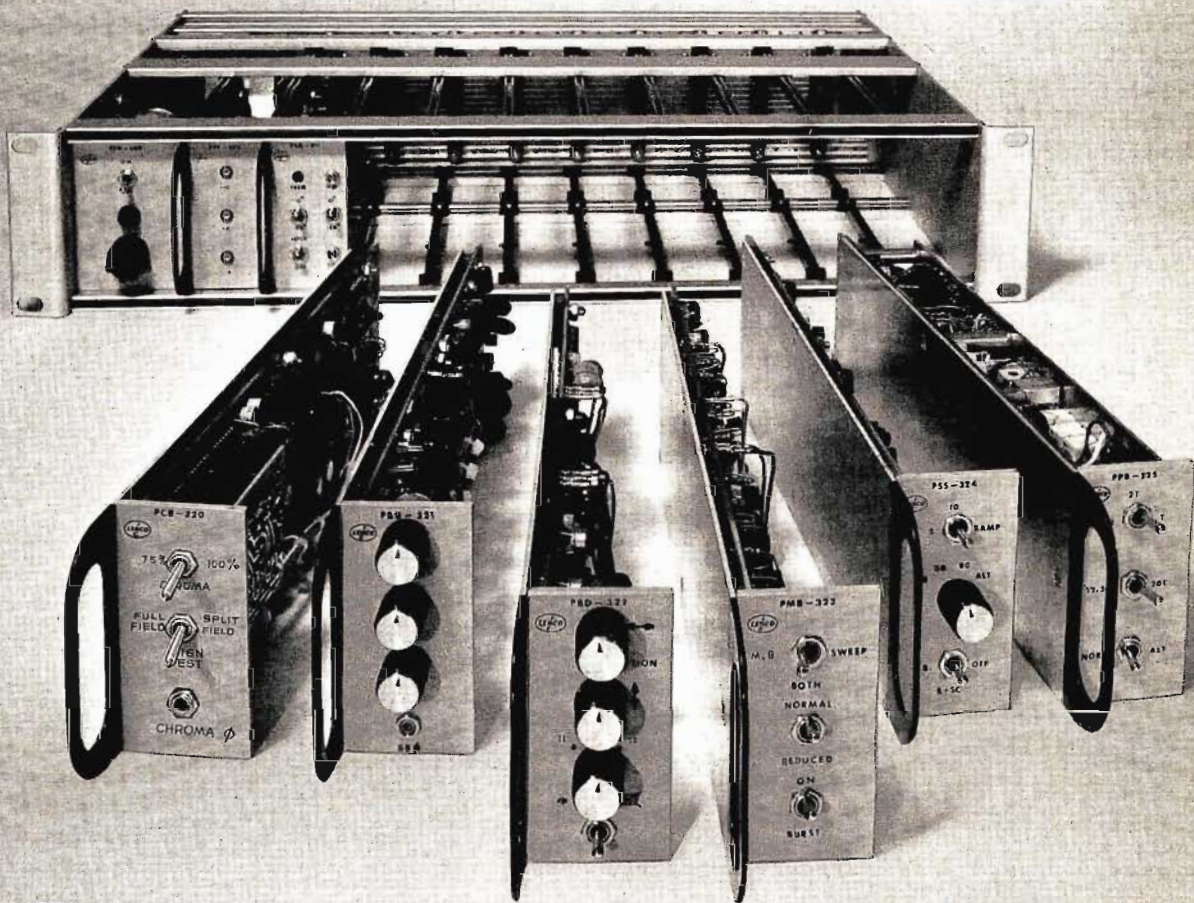

This totally integrated modular video test set is designed for the discriminating professional. The Lenco 300 System lets you specify video test signals to meet your system requirements, not the manufacturer's.

Use the Lenco PSG-310 Digital Color Sync Generator, or one of your own generators, with any one, a combination, or all of the test modules. Mix 'em or match 'em any way you want. There are 29 test signals available to answer all of your system test specifications.

With the Lenco 300 System, you get a lot more for a lot less. For instance, all of our advanced

test signal modules have composite video delay, making Lenco the *only* manufacturer that can *individually time* the test signals to your system.

And we're the only American manufacturer that supplies a color bar generator with the new SMPTE alignment test signal (reverse bars).

We're so sure of your acceptance of Lenco equipment that we offer a *two-year* warranty on all parts and labor—and that includes freight to and from our factory!

Call or write for a demonstration today. You'll find Lenco to be your first—and only—video test set alternative.



LENCO, INC., ELECTRONICS DIVISION

300 N. Maryland St., Jackson, MO 63755, (314) 243-3147

13620 Littlecrest Dr., Dallas, TX 75234, (214) 241-0976 • Post Office Box 301, Atchison, KS 66002, (913) 367-1146

2390 Tiffany Circle, Decatur, GA 30035, (404) 288-2080

Box 4042, Albany, GA 31706, (912) 436-4927 • 7303 Poplar Lane, Middletown, MD 21769, (301) 371-5588

Circle (82) on Reply Card

September 1979 *Broadcast Engineering* 95

Technical achievements in producing *Live from Lincoln Center*

By Donald W. Redell, Broadcast Engineering correspondent

Since the advent of videotape about 20 years ago, there has been very little live television aired on the three major networks except for sports, news and **Saturday Night Live**. The fourth network, PBS, offers an alternative in live programming—**Live from Lincoln Center**.

On January 30, 1976, *Live From Lincoln Center* began providing live television events to the Public Broadcasting network and has broadcast 27 of them since. The latest was The American Ballet Theater's production of *Sleeping Beauty* in May. Nearly every form of the serious musical and performing arts events has been produced at Lincoln Center in this series: ballet, opera, symphony orchestras and virtuoso recitals—all live.

Live From Lincoln Center, however, is a new kind of networking. Before videotape, getting the program on Telco facilities, across the country on phone lines and to the viewer was all that was necessary. Video was the

major problem; after all, networks had been doing radio since the 1920s, and audio was easy. In addition, the needs of the cameras and of the television production staff came first; the on-stage production and the audience had to adjust.

Live From Lincoln Center has changed all that. Audio now is at least as important as video; the Lincoln Center audience is never aware that there is a television pickup present, and the performers are never asked to vary their performances for the cameras. In fact, there is never a special camera rehearsal. All television planning is done around the live production and never interferes with it.

To accomplish this feat, experimentation began in 1971 with the first Lincoln Center for the Performing Arts program to be telecast. *Le Coq D'Or*, which originated at The New York State Theater, was seen by cable subscribers on TelePrompTer's Manhattan CATV system. Between November 1971 and May 16, 1975 there were nine experimental *Live From Lincoln Center* broadcasts of various kinds, each of which had at least one engineering or production first, and in the 27 succeeding broadcasts there were 18 more firsts. Out of all of these

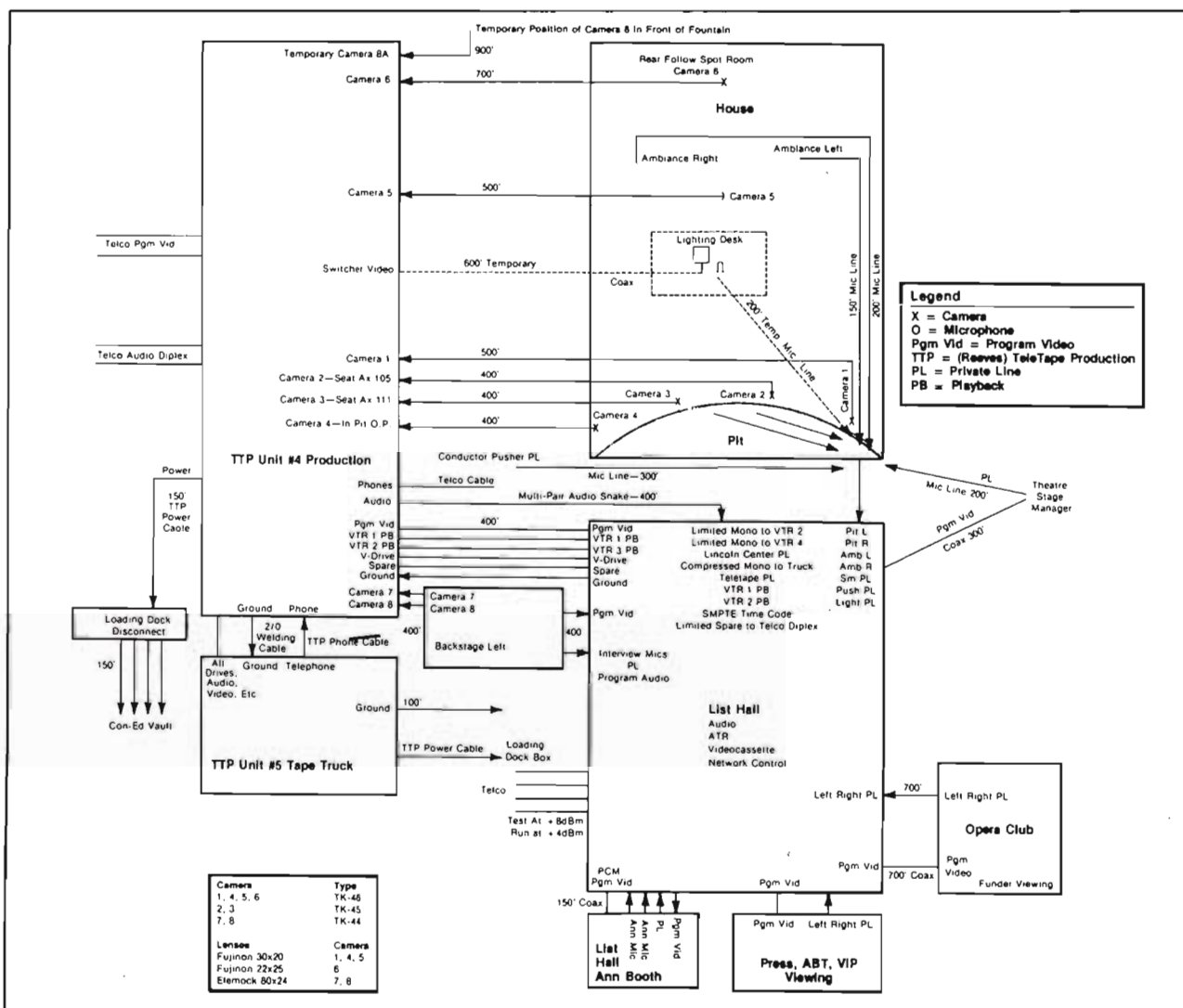

This cable layout for the American Ballet Theater production is typical for a *Live from Lincoln Center* event.

experiments and broadcasts evolved the following set of parameters.

Lighting—Light levels often fall below 1 fc and rarely exceed 25 fc; lighting ratios often exceed 1000:1; dimmed incandescent lights often are used in the same scene as xenon and carbon arcs; all lighting instruments may be gelled different colors; bare flames, bare bulbs, flashbulbs and flash powder must often appear in a scene.

Contrast—Within these lighting conditions characters may appear together wearing everything from black velvet to white satin with sequins.

Camera positioning—Cameras which may have to pick up a tight face shot may be located more than 100 ft from their subject; cameras used in ballet must be located at front row center for proper perspective and must have their lenses above stage level, yet must remain invisible to the audience; cameras used in outdoor shots may endure subzero blizzard conditions and then must be repositioned indoors, set up again, and ready to go within the space of a single scene; cameras often are located in virtually inaccessible positions, cramping operators and making maintenance difficult.

Sound pickup—Microphones must be invisible to the

Lincoln Center media development "firsts"

November 9, 1971—First performing arts program telecast on a CATV system: Rimsky-Korsakov's *Lo Coq D'Or*, by the New York City Opera, televised live by Teleprompter Manhattan Cable Television from the New York State Theater.

December 3, 1973—First use of an image intensified color TV camera in any television production, during the experimental taping of the Metropolitan Opera's *Tales of Hoffman*.

November 20, 1974—First live anamorphic video projection experiment, in conjunction with Camera Mart, General Electric and Video Camera Services.

January 28, 1975—First transmission of ballet via satellite: The Colorado Concert Ballet via NASA's ATS-6 satellite from Denver to New York. This was also the first time a television signal from a satellite had ever been received directly within the City of New York and the first interactive dance instruction by satellite.

May 16, 1975—First use of ultra long focal length lenses in televising a concert, during an experimental taping of the New York Philharmonic.

tube talk

30 mm

**P8400
Leddicon®
The new tube
for a
new image.**

Here's why . . .

Lag is significantly improved for all channels with the P8400's exclusive variable integral light bias . . . and it's easy to set with the pot and calibrated scale on the base.

Sharper, crisper pictures at all light levels are assured with our new P8400HG tubes (high resolution green) that have 15-20% more depth of modulation.

The best "red" reproduction. The P8400 precision infrared filter cuts off false reds.

Anti microphony double damped mesh . . . only in EEV Leddicons.

Find out how the P8400 Leddicon can improve your image . . . call or write for our Tube Talk brochures.

* Registered Trademark of
EEV Lead Oxide Camera Tubes



**At EEV . . . your image
is our business.**

EEV, INC.
E

7 Westchester Plaza, Elmsford, NY 10523, 914-592-6050
EEV CANADA, LTD., Rexdale, Ontario, 416-745-9494
English Electric Valve Co. Ltd., Chelmsford, England
Telex 851-99103

Members of the GEC Group of Companies

Circle (83) on Reply Card

September 1979 **Broadcast Engineering** 97

Live from Lincoln Center

audience; in operas, singers must be picked up as far as 150 ft from the edge of the stage or as much as three stories above the stage floor; intermission guests often refuse to wear a microphone, yet must be picked up in a noisy environment amidst stagehands changing scenery or musicians tuning up; in addition to the microphones picking up a performance, separate microphones must be used for each position of the host, each intermission guest (occasionally in different locations), and announcers, who may be located more than 500 ft from the audio mixing board.

Sound transmission—All shows, domestic or international, must be transmitted live with stereo sound, even though that may involve satellites, microwave, land lines, delay lines and as many as 14 different common carriers; international feeds may require different announcers or videotape audio than domestic feeds and may desire video without titles and subtitles as well; sound networks must be established and tested immediately before air time.

Overall—All shows are transmissions of live performances with paying audiences: neither the audience nor the performance (staging, lighting, etc.) may be interfered with. Given those constraints, the show must look as good as any network studio show (lest it be turned off) and must sound like a high-fidelity stereo recording. Foreign language operas must be subtitled live. Program synopses must be transmitted somehow both visually and orally.

Countdown to broadcast

To accomplish this and to broadcast on schedule,

Media "firsts"

January 30, 1976—First concert ever broadcast under existing performance conditions; first nationwide live television-stereo simulcast network; first stereo simulcast via satellite—all during *Live From Lincoln Center—The New York Philharmonic* on PBS and in stereo in 15 cities. Nominated for Emmy Awards for best classical music program, best sound, and outstanding achievement for the stereo simulcast network.

February 3, 1976—First patent ever issued for an accessory to allow high fidelity stereo audio reception of television programs, Number 3,936,594.

April 21, 1976—First opera ever broadcast under existing performance conditions; first live stereo network ever to reach more than half of all US television households—both during *Live From Lincoln Center—The Ballad of Baby Doe* on PBS and in stereo in 48 cities.

June 30, 1976—First broadcast of a full-length ballet, *Swan Lake*, on PBS and in stereo in 50 cities.

On FEATURES, PERFORMANCE and QUALITY, the 6112 OUTPERFORMS all switchers in the \$6,000 — \$13,000 category

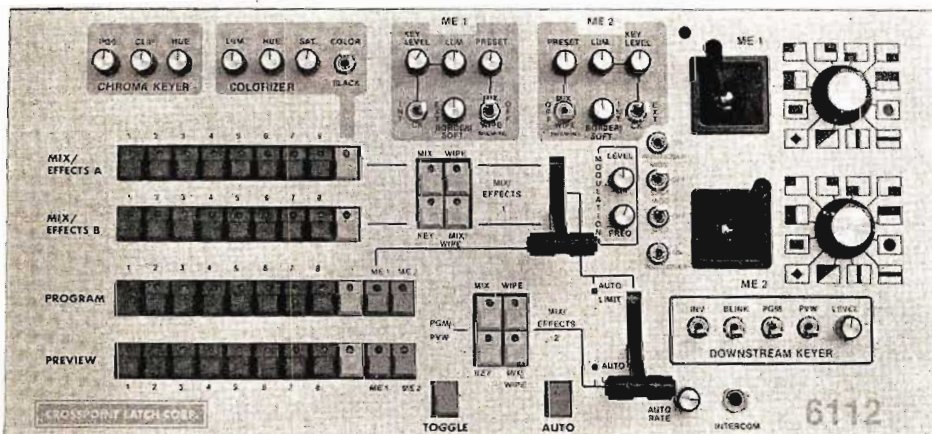

Two fully independent special effects generators each with double re-entry; downstream keyer.

Plug-in option:
Encoded Chroma
Keyer \$950.00

Price \$5995.00

Here you have one switcher that covers the entire range. Except for the number of inputs (nine including colorizable black) nothing comes even close to matching the performance of the 6112—excellent balance in video levels because of the technique of double clamping on the back porch, very stable and linear patterns, inherent timing, stability with no internal adjustments since there is nothing to drift, silky smooth fader arms with zero backlash, a downstream keyer with preview, automatic and manual faders, borders, standardized plug-in boards which are interchangeable with all our other switchers, just to mention a few points.

Ask your dealer to show you his demo tape. Call or write for information on the 6112 or our other switchers and products.

CROSSPOINT LATCH CORPORATION

316 Broad St., Summit, N.J. 07901 Tel. (201) 273-1090

Circle (84) on Reply Card

Now You Can Afford To Do A-B Rolls With Your HET VTR'S.

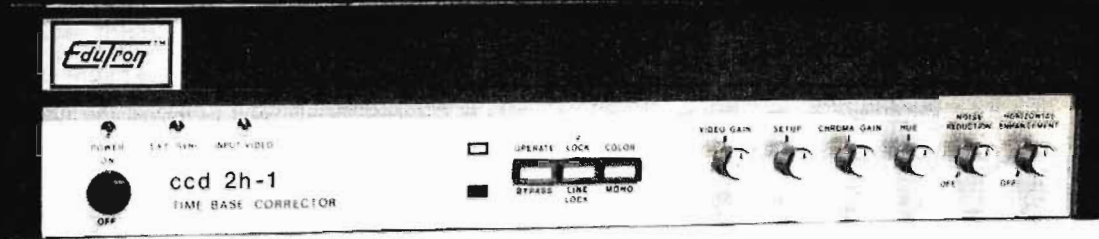

Introducing the Edutron ccd2h-1. Full Time Base Correction For Only \$5,800.

The ccd2h-1, when used at your editing station or for post production, can solve many problems while it is correcting and enhancing your heterodyne VTR signal. You will be able to synchronize your VTR, allowing you to use it as a source to do mixing at your switcher. With two ccd2h-1's, you can now do A-B rolls between two VTR's.

By using the latest advancements in charge-coupled-device memory technology, we can give you superior performance at a realistic price. The ccd2h-1 has a signal-to-noise ratio of 58 db, $\frac{1}{2}^\circ$ of differential phase, and 1% differential gain. This will give you the best possible reproduction of the video from your VTR.

If you have bad tapes you would like to clean up or good tapes you would like to make look even better, the ccd2h-1 is ready. By using a unique noise coring that gives up to 4 db of noise reduction, all generations of tapes will look better. A horizontal

enhancement of up to 200% boost will sharpen your video. All of this is standard in the ccd2h-1 and available at no extra cost.

The two horizontal lines of window correction will handle typical distortions. The automatic steerable advanced sync will make the window appear much wider as it keeps your VTR centered in the window. This will give you maximum correction range and a zero time system delay.

For complete specifications and the name of your nearest Edutron dealer, please write or call us at: EDUTRON INC., 25 Oak Street, Suite 1, Roswell, Georgia 30075. Phone (404) 992-1626.

The Video Electronics Company

Circle (85) on Reply Card

Schneider

TV Lenses all
over the
world

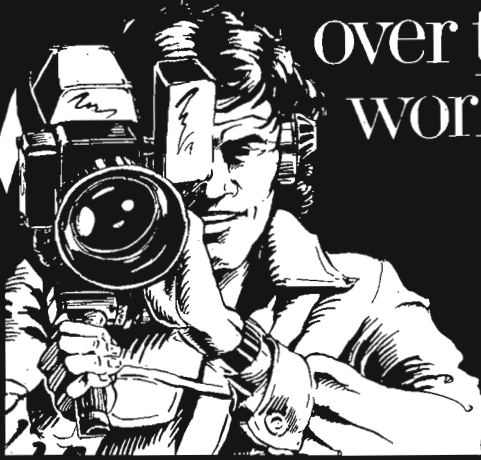

TV Lenses for 1 1/4" Cameras

TV 11 × Studio/OB	2.1/18-200
TV 13 × Studio	2.1/18-235
TV 15 × Wide Angle	2.1/16-240
TV 30 × Standard	2.1/20-600
TV 30 × Wide Angle	2.1/16-480
TV 30 × Tele/OB	2.1/33-1000

TV Lenses for 1" Cameras

TV 10 × Studio	2 /17-170
TV 11 × Studio/OB	1.7/14-150
TV 13 × Studio	1.7/14.5-190
TV 15 × Wide Angle	1.7/12.5-190
TV 20 × Special	2 /17-340
TV 30 × Standard	1.7/16-480
TV 30 × Wide Angle	1.7/12.5-375
TV 30 × Tele/OB	1.7/26-800

TV Lenses for ENG/EFP Cameras

TV 10 × Standard ENG/EFP	1.8/10-100
TV 15 × Wide Angle ENG/EFP	1.7/8.5-125
TV 20 × Standard EFP	1.4/12-240
TV 30 × Standard EFP	1.4/11-330
TV 30 × Wide Angle EFP	1.4/8.7-260
TV 30 × Tele EFP	1.4/18.5-550

Jos. Schneider GmbH & Co.
Optische Werke
D-6550 Bad Kreuznach
Fed. Rep. Germany
Telefon (06 71) 60 11, P.O. Box 947
Telex 0422 800



USA and Canada: Tele-Cine Inc. 5434 Merrick Road,
Massapequa, N.Y. 11758 • Telefon (516) 798-2828

Circle (86) on Reply Card

100 *Broadcast Engineering* September 1979

Live from Lincoln Center

design engineer Mark Shubin starts about a year in advance by booking the AT&T circuits with Telco representative Paul Dujardin, to whom Shubin attributes much of the success of the network. The fall show's master list carries 69 separate lines, including all the lines booked (locally and nationally) from the three Lincoln Center auditoriums to and among various points, such as NBC, WNET (New York), Western Union and NR (Telco's Network Radio). Telco's Dujardin works closely with Shubin on each show, from booking the lines through to sign-off, putting out all the fires as they occur and rerouting when necessary.

The next booking is with the facilities company which supplies the mobile unit and maintenance crew. Usually that's Reeves/Teletape, and with the unit comes John Leay, engineering consultant. About six months in advance a hold is put on the facilities and confirmed a month before the broadcast. Next, all the equipment is checked out at the facility's studios.

The audio equipment, dollies, monitors and cables arrive at Lincoln Center three days before the broadcast. The stage hands lay cable and the audio staff begins setting up the extensive audio equipment in List Hall, a small recital hall near Metropolitan Opera's backstage. Two days before air the camera unit arrives, cameras are set up, chipped and aligned. (Chipping is done live with a young man wearing a black T-shirt with a color chart on the front. Chip chart and skin tones in one!)

The Chyron is loaded with crawl copy and other graphic

Media "firsts"

August 18, 1976—First live 3-D video projection experiment, in conjunction with General Electric, Camera Mart and Stephens & Associates.

August 30, 1976—First stereo simulcast tariff ever filed with the FCC goes into effect; filed by Western Union specifically for Lincoln Center.

September 30, 1976—First satellite/terrestrial network test to prove insignificant delay regarding lip-synchronization, utilizing NBC Television Network.

November 3, 1976—First television show ever transmitted under a stereo simulcast tariff.

November 28, 1976—First live full-length recital televised, André Watts.

March 15, 1977—First live telecast of an opera from the Metropolitan Opera at Lincoln Center, *La Boheme*.

June 2, 1977—First telecast of a ballet from the Metropolitan Opera, American Ballet Theatre's *Giselle*.

September 24, 1977—First use of unobtrusive cameras within the orchestra in a

Storeel is dedicated to conserving energy. Yours.

Energy conservation is much in the news these days. Like the weather, many talk about it but few do anything about it. We haven't figured how to change the weather, but we do have several systems specifically engineered for broadcasters that both conserve energy and add efficiency. The very latest (shown installed) is called **STOR-MAX™**.

Save energy (yours) by converting your overcrowded film and VTR libraries to the new "Instant Access" high-density systems engineered and distributed only by Storeel. **Modular Rapid Transit Storage™** maximizes units stored per square foot of floor space, minimizes retrieval time, optimizes energy efficiency.

Our many years of design and engineering pay off in solutions to your storage problems.

Call or write "The Railriders" at Storeel today for free estimate. No obligation, of course.



Illustrated catalog of Storeel's "confusion eliminators" available upon request. Write on your letterhead or telephone for your free copy.

STORREEL CORP.

**The
Space-Saving
Engineers**

2050-C Carroll Avenue, Suite 2 • Atlanta, Georgia 30341 • Telephone (404) 458-3280

Circle (87) on Reply Card

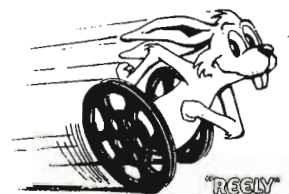

September 1979 **Broadcast Engineering** 101

**Creative Flexibility . . .
Great.
Under \$6,000.
Amazing!**

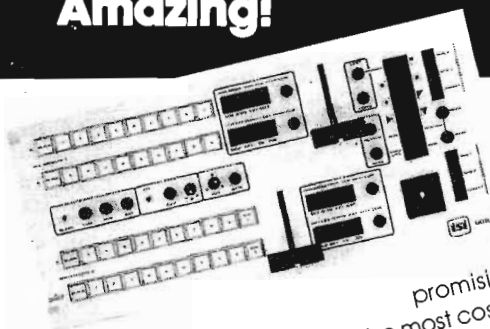

Finally.
An uncom-
promising switcher

that even the most cost conscious
facility can afford.

Because while we're saving you money we're also giving you today's most desired production features. Like two Mix Effects Systems that utilize our exclusive shared pattern generator. Which enables mix, wipe, and mix or wipe key (with 'matte' key and key invert) on each M/E.

And our 'rotate' pot that lets you create hundreds of standard and special wipes from the seven basic patterns.

Need adjustable and variable hard, soft, and bordered edges? It's standard on the 902 along with pattern modulation, electronic spotlight, positioner, and preset pattern select.

We don't stop with features, either. With ten tailed inputs (including blackburst/colorizer), true Mix Effects re-entry, and separate program and preview output switching busses the 902 gives you 'big board' flexibility.

Last (but certainly not least!) The 902 carries ISI's full two (2) year warranty. And, with almost two hundred units delivered and in the field, one of the industries best service records.

When you add it all up, it all adds up to 902!

For the name of your nearest authorized ISI Video Products Distributor call: 800-874-7590 (Toll Free), 904-373-6783 (Florida Only)

(Available in PAL/PAL-M Format October 1, 1979)

**Innovative Switching Ideas
from the people at:**



INDUSTRIAL SCIENCES INC
P.O. BOX 1495
GAINESVILLE, FLORIDA 32602

Live from Lincoln Center

material. On the afternoon before air, director Kirk Browning and the camera crew view the single camera, wide-angle videotape that was shot at a dance rehearsal and camera shots are set. At 8 PM there is a performance which the television crew uses as a dress rehearsal and which is taped on 3/4-inch tape for viewing the next day.

On air day, after the cameras are fired, there is a rehearsal of the intermission interviews, and at 2 PM the cameramen and Browning view the previous day's tapes to refine the shooting script. At 5 PM the opening is rehearsed—the roll-in reel cues, the Chyron, etc. From 6:05 to 7:05 PM Shubin tests the network—and until 8 PM if there are problems. 8 PM to 11 PM is AIR—LIVE.

To broadcast *Live From Lincoln Center-ABT's Sleeping Beauty* on May 2, it took, besides the production staff:

- 8 Cameramen
- 2 Video operators
- 2 Videotape men
- 3 Audio engineers
- 1 Audio designer
- 1 Technical consultant

- 1 Electronic graphics man
- 1 TD/switcher
- 1 Senior technician
- 3 Maintenance men
- 1 Technical designer

This technical crew operated eight cameras, the entire audio and network control room in List Hall, four mics for

Media "firsts"

live concert, The New York Philharmonic, Zubin Mehta conducting.

October 18, 1977—First live opera transmitted with subtitles, New York City Opera's *Manon*.

January 31, 1978—First live telecast of the New York City Ballet, *Coppelia*.

February 12, 1978—First live solo recital telecast from the Metropolitan Opera, Luciano Pavarotti.

September 20, 1978—First live transatlantic stereo simulcast, *Horowitz: Live!*, fed simultaneously to the NBC, BBC, Antenne 2 (France), ZDF (Germany), and ORF (Austria) networks, tape delayed for Japan with the first international distribution of a television program on stereo SMPTE Type C 1-inch videotape.

December 10, 1978—First live telecast of chamber music from Alice Tully Hall.

March 12, 1979—First test of the PBS Digital Audio Transmission Equipment system from a broadcast site, utilizing common carrier facilities.

Circle (88) on Reply Card

"We evaluated all carts and have standardized on the Audiopak® AA-3"

—Bob Kanner
Chief Engineer
KRTH, FM 101
KHJ, AM 93
Los Angeles

"Our test results show that the Audiopak® AA-3 holds stereo phasing better than any other cart on the market."

"The excellent phase stability of the AA-3 will be of major importance as AM stations convert to stereo."

"The High Output, Low Noise (HOLN) tape in the AA-3 gives us excellent frequency response combined with 6db more head-room."

"The AA-3 maintains excellent tape motion with low wow and flutter."

"We had had previous cart pressure pad problems with our multiple playback machines — these have been resolved by the durability of the AA-3 pressure pads."

"The AA-3 is the 'state of the art' in cartridges — it meets or exceeds the specifications of the current NAB standards."

Capitol

Capitol Magnetic Products
A Division Of Capitol Records, Inc.
1750 North Vine Street
Los Angeles, California 90028



New Audiopak® AA-3 Broadcast Cartridge

MORE... FOR LESS!

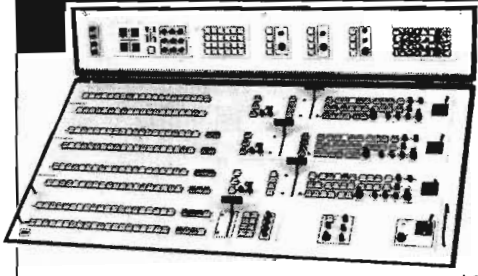

We're ISI
and quite
frankly we're
concerned

that you might be thinking about a 'big board' production switcher, without thinking of us. And that would be a shame. Because we've developed a common sense approach to production switching that gives you high powered performance at a surprising price.

Our 1200 series for example, has all the effects, patterns, and features you'd expect to find on a top of the line switcher. Plus some things no one else offers, or offers only as extra cost options. Like fade through black. Or tandem keying that allows you to do primary key (luminance or chroma) then add a second downstream key with outline, shadow, or border. All on a single, standard 1200 series Mix Effects System.

Look at our board. It gives you the creative flexibility to use more of the 1200's features—more of the time. Because it's simple and straightforward. No tricks or special combinations to remember.

Service? With our full two-year warranty, on sight test and check out, and toll free technical support number. We won't hang you up by letting you down.

So, if you're thinking about production switchers, remember this: by keeping it simple, we'll give you more! And cost you less! Now that's worth thinking about.

For complete specifications, and the name of your nearest authorized ISI Professional Video Products Distributor call:
800-874-7590 (Toll Free) 904-373-6783 (Florida Only)



Innovative Switching Ideas
from the people at:
INDUSTRIAL SCIENCES INC
P.O. BOX 1495
GAINESVILLE, FLORIDA 32602

Circle (90) on Reply Card

Live from Lincoln Center

the performance, and two mics for the intermission interviews.

Support equipment

Much of the technical equipment is either special or specially operated.

- **First, the cameras.** Because the Metropolitan Opera House and Avery Fisher Hall are very large, and the parameters listed above must be observed, the cameras (TK 46s and TKP 45s) are not out of the ordinary, but the lenses and set-ups are. The TK 46s are fitted with Fujinon lenses, which were chosen because of their exceptional optical quality and coating. The TKP 45s have a developmental lens designed by Rank Taylor Hobson in England and custom fitted to the cameras. The lens and a bracket are mounted on the camera tripod, and the camera is attached to the lens (so that the lens supports the cameras rather than the reverse).

The cameras are set up to run with extended gain at the expense of some noise like a sports pick up. The tubes are hand picked for minimum problems in black, to lessen noise, and for minimum lag and microphonics since the two TKP 45s are in the front row next to the orchestra. In addition, the stage scenes are evaluated for lighting; hot spots and follow spots are brought down so that contrast is more nearly controlled. Generally the

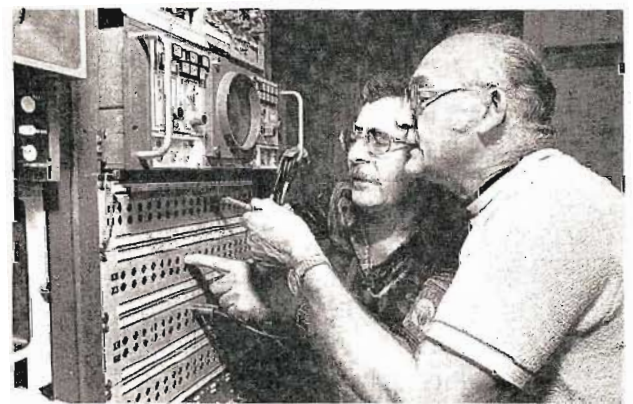

Harold Dunn (left) and Bill Kidda, of Reeves Teletape, set up to broadcast *Live from Lincoln Center*. (Photograph by Susan S. Perry)



The audio technical crew prepares for broadcasting the New York City Opera. From front left are Mark Schubin, technical director; Gino Lombardo; Raymond Matthews; and Michael Shoskes, audio technicians. (Photograph by Susanne Faulkner Stevens)

cmf
New York 14609

Kpfa
FM 94

2207 Shattuck Ave.
Berkeley, Calif. 94704

WILL-FM/91
KWPC
BOX 116 / MUSCATINE, IA 52761
PHONE (319) 263-2442

The NEW ZOO
KZJU
Box 5788 Stanford, Ca. 94305
(415) 328-2000
90.1 FM

WUOL
University of Louisville

KSFA 860
PREFERRED RADIO
KTBC
92.1 STEREO

887
WERN

WBDS-FM 98

W-100
FM 100
CHICAGO

CEMO 93.9

KYOA
FM-108
AM-14
INCORPORATED
P.O. BOX 1877
1017 FRONT ST
SACRAMENTO, CA 95808

KSAR
WGUC
Saddleback College Radio 95.3 FM

KfAC
Los Angeles

KKHI
The Classic Stations
1550
STEREO
195.7

WRT
Chicago's Finest
93.5 FM

WGET
Rock Station

KPED

WPXY
FM 98

104.1 FM GRAND RAPIDS
WVGR
WUOM
ANN ARBOR 91.7 FM

Choi
fm

KLEF

94.3
THE FOX-WTKL

KKLV
104.1 FM
3900
OLD MARYLAND BLVD
P.O. CHICAGO, ILLINOIS
(807) 272-9390

WSNI
FM 104

ROCKY
WRKY 103

WQIR FM
WGIR FM
WQIR FM
WQIR FM
NATURAL 101

KCOT
P.O. Box 30
Lamesa, Texas 79331 (808) 872-2404

KMKF 101.5

WVIR
104.3 FM STEREO
1500 AM

WPIT
FM 101

MPR
MINNESOTA PUBLIC RADIO, INC.
KSJR-FM 90.1
KRSE-FM 91.7
KLSE-FM 92.9
KSJN-FM 91.1
KCCM-FM 91.1

KSOR
STEREO DOLBY

FMROC
WKEM
104.7
RADIO PARK, FULTON, N.Y. 13069
TELEPHONE: SYRACUSE (315) 695-2111

KFMH

DOLBY FM: QUALITY CALL LETTERS

These stations, and many others, broadcast Dolby FM. Their engineers know the difference Dolby FM makes in sound quality, and their managers know how widely recognized the name Dolby is among today's sound-conscious listeners.

But not everyone has heard the difference Dolby FM can make. That's why at the NRBA convention Dolby Labora-

tories will be conducting brief demonstrations of the Dolby FM system.

Hear the difference for yourself. Discuss with us the possibility of your broadcasting Dolby FM experimentally, without obligation. In time you too may want to add your call letters to the growing list of Dolby FM broadcasters.

Hear the difference: Dolby at NRBA Washington D.C. October 7-10
The Dupont Suite, located on the Terrace Level, one floor above the Exhibit Hall.



'Dolby' and the double-D symbol are trademarks of Dolby Laboratories
731 Sansome Street, San Francisco, CA 94111
Telephone (415) 392-0300, Telex 34409

Live from Lincoln Center

picture leaves Lincoln Center looking pretty good. On occasion a little noise is evident, but given the requirements of the broadcast, the video is excellent.

• **Next the audio** is fed to List Hall in stereo (incidentally, 3/4-inch videocassettes are recorded there) where it goes through two identical boards. One feeds the whole audio portion of the program and one provides a clean feed, without announce and similar material, for foreign broadcasts.

Audio emphasized

Lincoln Center and producer John Goberman felt from



The control booth is the scene of tense action in broadcasting the New York Philharmonic, *Live from Lincoln Center*, Zubin Mehta conducting. Director Kirk Browning sits in the center. (Photograph by Susanne Faulkner Stevens)

the beginning that in order to succeed with *Live From Lincoln Center* a major development in the recording and transmitting of sound was needed. Since the inception of television broadcasting and up to the present, audio has been secondary to video. Microphones generally are visible or on booms outside the shot. In addition, the quality of audio has not been emphasized since television sets have 3-inch monaural speakers, and the attitude has been to "get the sound there, that's enough."

Live From Lincoln Center producers planned to broadcast serious music, and satisfying the serious

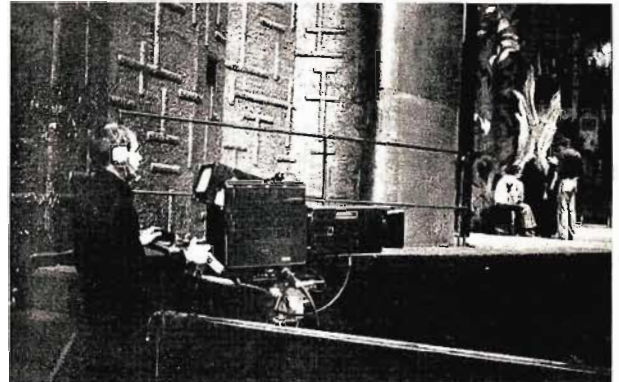

The cameraman focuses on a scene from "An Evening of Ballet with the American Ballet Theater," *Live from Lincoln Center*.

THE STATE OF OUR ART

- New "series II" improved headsets
- 50 station capability with up to 8 channels using S88 switchboard monitor
- External program feed with volume control
- Wide frequency response (200Hz to 12kHz) for exceptional intelligibility
- Designed for high noise environments
- Visual signalling uses bright amber lights
- Adjustable sidetone reduces feedback and background noise

- Mic on-off feature standard with headset and remote stations
 - Single and two channel systems virtually immune to RF and SCR dimmer noise
 - Remote stations available in portable, wall mount and rack mount versions including speakers for paging and monitoring
- Catalogue with complete specifications available upon request

 **Clear-Com**
intercom systems

759 Harrison Street
San Francisco, CA 94107
(415) 989-1130



EASTERN CANADIAN DISTRIBUTOR, La Salle Audio, Montreal (514) 342-4503
WESTERN CANADIAN DISTRIBUTOR, Cedar Grove Sound Co., Ltd., Vancouver, B.C. (604) 273-1851

Circle (94) on Reply Card

DELTA BROADCAST PRODUCTS

AMC-1

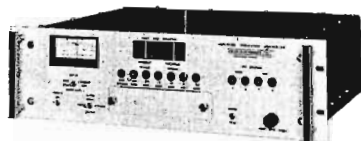

The **Amplitude Modulation Controller** is the only modulation controlling system that provides a completely closed loop around the transmitter. The sampling of actual modulation levels after the PA output network assures precise adjustment for optimum modulation levels. The AMC-1 also keeps a digital count of positive and negative overmodulation bursts for both present and previous one minute periods.

DAM-1



The **Digital Antenna Monitor** couples pushbutton ease of operation with digital accuracy. The DAM-1 will accept RF samples from up to 12 towers (with an auxiliary panel) and features $\pm 1^\circ$ phase and $\pm 2\%$ current ratio accuracies. Remote panels and other accessories are available.

AAM-1

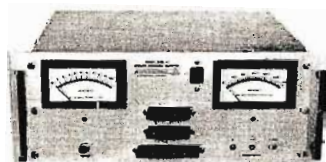

The **Analog Antenna Monitor** gives stable phase and ratio readings even in high RF fields. Separate phase and ratio mirrored-scale meters assure accurate meter indications.

TMCS



The **TMCS Antenna/Transmitter Remote Control System** offers complete transmitter and antenna parameter control for stations utilizing the DAM-1 Antenna Monitor. Alarm indications and failsafe circuitry is also provided, giving complete transmitter system control.

APC-1



The **Automatic Power Controller** is your insurance against citations for over- and under-power operation. The APC-1 continuously monitors the transmitter output power, and makes automatic power adjustments with the transmitter loading control. This assures proper power adjustment at all times.

6730-E
6740-B

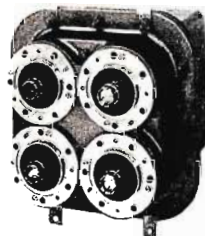

Designed to switch two transmitters from antenna to dummy load, the 6730E interfaces with 1 5/8 inch coaxial cable. For 3 1/8" lines, the 6740-B transfer switch is used. Either manually or remote controlled, the **Transfer Switch** is fully interlocked and can be wired to existing equipment to prevent "hot" switching.

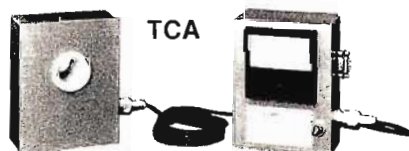

State of the art antenna current metering has arrived in the **TCA Ammeter Systems**. Accurate, Modulation-free, temperature stable current indications are found in the TCA. Models include single and dual scale meters.

TCT



Delta's **Toroidal Current Transformers** provide accurate sampling current and phase values without the problems associated with sampling loops. Three output voltage ranges are available, as well as high voltage models for high-power facilities.

OIB-3

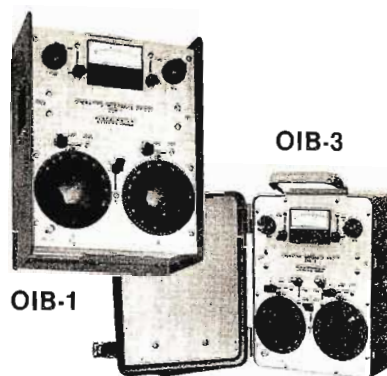

OIB-1

The **Operating Impedance Bridge** measures the impedance of networks, radiators, and the like while they operate under full power. VSWR as well as complex impedances of up to $400 \pm j300$ ohms can be measured.

The **OIB-3 Operating Impedance Bridge** provides extended resistance and reactance ranges, measuring up to $1000 \pm j900$ ohms. The bridge has a built-in carrying case and RF amplifier for improved nulling.

RG-3



The **Receiver/Generator** combines a two-watt RF output and a correlation detector circuit that virtually eliminates interference problems. The RG-3 can be used in conjunction with any conventional impedance bridge including the OIB series.

CPB-1

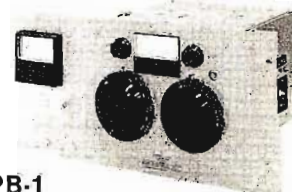

The **Common Point Impedance Bridge** is designed for permanent installation; and allows continuous monitoring of the common point, thus facilitating network adjustment. This model can be provided with one of Delta's TCA ammeters mounted in the front panel.

DPM-1



Delta's **Digital Panel Meter** displays up to sixteen channels of information in a 3 1/2 digit LED display. Any combination of operating parameters can be selected, such as plate current and voltage, common point current, base currents, etc.

DELTA ELECTRONICS



5730 GENERAL WASHINGTON DRIVE
P.O. Box 11268 • ALEXANDRIA, VIRGINIA 22312
TELEPHONE: 703-354-3350 TWX: 710-832-0273

Circle (93) on Reply Card

September 1979 *Broadcast Engineering* 107

Live from Lincoln Center

music audience requires the sound to do more than just get there.

The nearly three years of experimentation developed high quality mics, many designed by the Lincoln Center technical staff. Then the problem became delivery of that high fidelity sound. It was decided to simulcast in stereo via FM radio stations and to diplex and multiplex the signal.

A Van Cliburn recital with the New York Philharmonic on January 30, 1976 was the first network *Live From Lincoln Center*. Nine days before the show a test of diplexing equipment was initiated with Western Union, and the next day it worked. Five days before the show, Lincoln Center's desire to use the equipment was presented to Western Union's Board of Directors and four days before air the Board approved it but required that specific West Coast equipment be used. On the day before air it arrived, was unpacked and set up. It worked. For the second show, *The Ballad of Baby Doe*, two and a half months later, new diplexing equipment had been specially designed and approved.

For the Van Cliburn concert the network consisted of 13 cities plus New York and Los Angeles, making the network national. The second show had 40 cities, using about 12 different network carriers, and the program was available to 50% of the US audience. Now the network reaches, via satellite and the audio network, 250 Public Television stations, and 60 to 70 FM stations.

Audio/video routing

The audio and video take two different network routes. The audio leaves the board, and goes to a *Rack* (called Rack, designed by Mark Shubin), which adds limiting

necessary for reception by the satellite, and splits and isolates the various stereo feeds to the network. If there is a failure of one or two feeds, the others won't go down either. Rack has two normal audimeters plus 28 *idiot meters* which indicate that the audio is going through, with no indication of quality or gain. Son of Rack is in design now for next year's series.

From Rack, the audio goes to WNET via New York Telco where it's put into a 250ms delay unit to compensate for the time lost when the video goes up to the satellite and back. From there it goes by land line to NR at AT&T. It is then microwaved to the stations by diplexing on the AT&T video network and by multiplexing into the multiplex message network (like the telephone system) occupying the space of 12 phone calls. At the local TOC (Television Operating Center) the diplex signal is decoded and the multiplex is pulled off onto a local loop and sent to the station.

The video signal leaves the mobile unit via coax to the microwave transmitter on the roof of Lincoln Center to the Telco building on 11th Avenue in New York. From there it's sent to WNET which acts as master control. WNET sends the signal either to Washington, DC or to Hartford, CT, via Telco microwave. At the Hartford Eastern Educational Network uplink, or the one at MacLean, VA, video goes to the Westar satellite PBS transponder and to the ground station at each receiving PBS station. *Sleeping Beauty* was the first *Live From Lincoln Center* to be received by every station via satellite.

After nine major experimental productions and 27 *Live From Lincoln Center* broadcasts, producer John Goberman says, "Each show becomes a little easier, but it's basically about the same as in the beginning. The difference is that we have a few better lenses, better cameras, and more people can do it now." □

The Complete FM Stereo Processing System

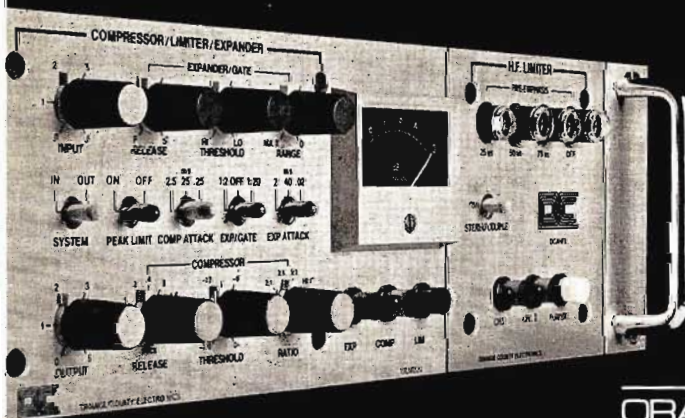

The Orange County CLX-5 FM belongs in your FM chain to assure you of transparent, non-fatiguing sound. And the versatile controls allow you to optimize performance to your specific format whether it be beautiful music or Top 40.

- Ultra-fast peak limiter with 250:1 slope for absolute overmodulation protection
- Optimum modulation through the use of "no-overshoot" low pass filter
- Compressor with adjustable ratio, threshold, attack and release times, for loudness enhancement
- Highly effective expander/noise-gate for noise reduction
- High frequency limiter with selectable pre-emphasis characteristics which include standard 75us, or 25us Dolby® FM
- Overall performance specs and construction to the highest industry standard

Also investigate the VS-3 Stereo Processor which offers internally pre-set functions for the budget-conscious station looking for great sound.



ORANGE COUNTY ELECTRONICS INTERNATIONAL INC.

Exclusive Sales & Marketing:

Parasound

680 Beach Street, San Francisco, Ca. 94109 (415) 673-4544

Dealer Inquiries Invited

Circle (70) on Reply Card

ELECTRONIC INDUSTRIES INC.

SERVICE FOR BROADCASTERS

ANTENNAS

AM Antennas
Pi-Rod
LBA (Folded Uni-Pole)
Porta-Towers
FM Antennas
Phelps-Dodge
Antenna Tuners
Wilkinson

TRANSMISSION LINE & CABLE

Belden
Cablewave

AM TRANSMITTERS

CCA
Wilkinson

FM TRANSMITTERS

CCA
LPB
QEI
Wilkinson

FM EXCITERS - STEREO GENERATORS

CCA
Optimod
QEI
Wilkinson

MONITORS

Belar
McMartin
Potomac Instruments
QEI

AUDIO PROCESSORS

Broadcast Electronics
Dorrrough
Inovonics
Marti
Orange County
Orban

AUDIO CONSOLES

Broadcast Electronics
LPB
Maxi-Tel
McMartin
Micro-Trak
Pro-Tech
Russco
Shure

TURNTABLES

QRK
Russco
Technics

STONE ARMS

Micro-Trak
QRK
Shure

TURNTABLE PREAMPS

Broadcast Electronics
Micro-Trak
Russco
Shure

FIDELIPAC® GIVES YOU A CHOICE

SERIES 300

40 Sec. - \$2.55
70 Sec. - 2.63
100 Sec. - 2.74
2½ Min. - 2.88
3½ Min. - 3.04
5½ Min. - 3.39



MODEL 300
The most popular NAB cartridge... performance and price make it the mono broadcaster's first choice.

SERIES 350

40 Sec. - \$3.06
70 Sec. - 3.13
100 Sec. - 3.20
2½ Min. - 3.31
3½ Min. - 3.43
5½ Min. - 3.68



MODEL 350
For use in stereo machines with inadequate tape guidance. The precision is provided by adjusting the cartridge.

MASTER CART

40 Sec. - \$2.65
70 Sec. - 2.73
100 Sec. - 2.85
2½ Min. - 3.00
3½ Min. - 3.17
5½ Min. - 3.50



MASTER CART
For the modern stereo broadcaster satisfied with nothing less than the ultimate in performance.

FIDELIPAC MADE - FIDELIPAC WARRANTED - NO HOME LOADS

PIONEER BUILDS THEM - - ELECTRONIC IND. SELLS THEM - - NATION-WIDE

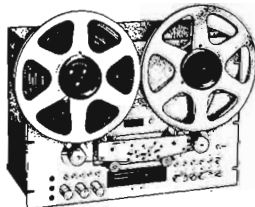

RT 901 WITH 10½" REELS

\$695.00

for standard units

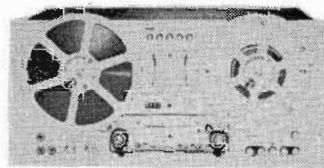

RT 701

WITH 7" REELS

\$525.00

for standard units

Easy conversion from 1/4 track to 1/2 track with Nortronic Heads



Ye Olde Editor
of
Common Point

-- the monthly mailer with a little news, views and bargain buys. Now in 22 states and growing.

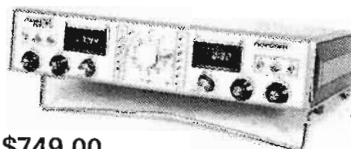

\$749.00

THE LATEST IN
REMOTE EQUIPMENT

PORTA-TOWER



STUDIO TRANSMITTER LINK

Marti
Moseley
Micro-Control
Vega

REMOTE CONTROL

Marti
Moseley
Micro-Control

MICROPHONES

AKG
Electro-Voice
Shure

MICROPHONE STANDS & ARMS

AKG
Astatic
Electro-Voice
Luxo
Shure

TAPE CARTRIDGE MACHINES

Broadcast Electronics
Telex

TAPE RECORDERS

Ampex
JVC
Pioneer
Revox
Technics

RECORDING TAPE

Audiopak
BASF
Fidelipac
Maxell
TDK

EQUIPMENT RACKS

BUD

JACK PANELS & PATCHCORDS

ADC
Switchcraft

TAPE HEADS

Nortronic

TUBES & TRANSISTORS

Amperex
Eimac
General Electric
National
RCA

TEST EQUIPMENT

B & K
NLS
Sencore

RELAYS

Potter & Brumfield

CALL SPOKESHAVEN - PERSON TO PERSON - COLLECT AT

ELECTRONIC INDUSTRIES INC.

414-235-8930

19 E. Irving, Oshkosh, Wis. 54901

414-235-8930

*Prices shown are subject to change - call for confirmation.

Circle (95) on Reply Card

September 1979 *Broadcast Engineering* 109

Introductory digital circuits

Part 2:

Logic circuits and simplification

By Dr. Ron Jetton, Bradley University, Peoria, IL

This article covering the basics of digital circuitry is Part 2 of a series on digital technology for broadcasters. The continuing series will include applications to audio and video portions of broadcasting and will consider implementing digital into station operation.

Part 1 of this series examined the mathematical language of digital circuits. A summary of the important theorems and laws of Boolean Algebra is given in Table 1. It is extremely helpful in gaining an understanding of logic circuits and their design and simplification if the basic concepts of Boolean Algebra are well understood.

Part 1 showed the relationship between logical, true/false statements and Boolean variables. The next step is to discuss the relationship existing between Boolean algebra and switching circuits.

A switching circuit can be considered in its elemental form to be simply a black box with input and output terminals as shown in Figure 1.

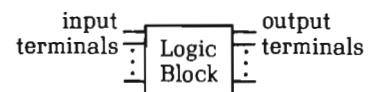

Figure 1

The input and output terminals of the logic block will be thought of in a more restricted sense than in ordinary analog circuits. Each input or output terminal must be in one of two possible states. Depending on the nature of the block, the states may be on or off, up or down, positive or negative, or high or low.

First consider circuits in which an output is determined only by the present states existing at the inputs. Such circuits are referred to as *combinational* while circuits in which outputs are a function of past states as well are termed *sequential*. An understanding of combinational

TABLE 1

Basic laws:	$0 \bullet A = 0$	1
	$1 + A = 1$	2
	$1 \bullet A = A$	3
	$0 + A = A$	4
Manipulative laws:	$A + B = B + A$	5a
	$AB = BA$	5b
	$A + (B + C) = C + (A + B)$	6a
	$A(BC) = C(AB)$	6b
	$A(B + C) = AB + AC$	7a
	$A + (BC) = (A + B)(A + C)$	7b
deMorgan's theorem:		
	$\overline{AB} = \overline{A} + \overline{B}$	8a
	$\overline{A + B} = \overline{A} \overline{B}$	8b
Simplification theorems:		
	$AB + AC = A(B + C)$	9a
	$(A + B)(A + C) = A + BC$	9b
	$AB + \overline{A}B = B$	10a
	$(A + B)(A + \overline{B}) = A$	10b
	$A + \overline{A}B = A + B$	11a
	$A(A + B) = A$	11b
	$A + \overline{A}B = A + B$	12a
	$A(\overline{A} + B) = \overline{A}B$	12b
	$AB + \overline{A}C + BC = AB + \overline{A}C$	13a
	$(A + B)(\overline{A} + C)(B + C) = (A + B)(\overline{A} + C)$	13b

SIGNAL PROCESSING FOR BROADCASTING'S NEW PHASE

Original designs from **audio & design recording**

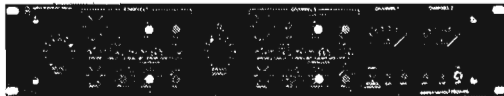

F760X-RS Complex-Limiter

- Separate peak level limiting with
- Multi-ratio variable threshold compressor and noise-reducing low level gain reduction from
- Expander with gating option

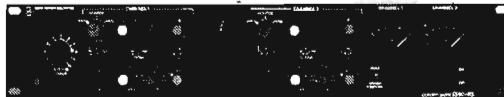

E560 Selective Limiter

- ADR unique product
- Band splits with integral, full-function limiter
- Can provide 75 μ S variable pre-emphasis
- Rack mounting and self-powered



F600 Broadcast Limiter

- Stereo/dual mono operation
- Integral power supply
- System bypass on each channel
- 10 μ S - 25mS attack
- 25mS - 3.2 secs and 'auto' release

Contact Nigel Branwell, ADR, P.O. Box 786, Bremerton, WA 98310 (206) 275-5009



**audio &
design
recording**

Circle (96) on Reply Card

Providing the international audio industry with clean, quiet, dependable Signal Processing for more than 15 years.

Excellent specs. Exemplary sound. Definitive practicality.

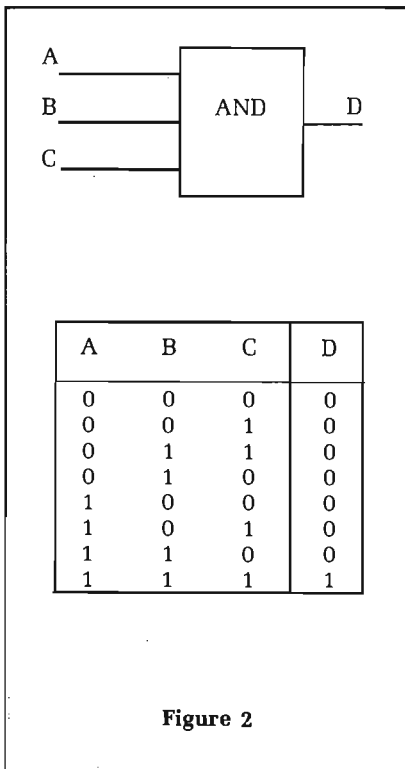

Figure 2

circuits is necessary to proceed in a rational way to sequential circuits.

Since the output of a logic circuit is a function of its inputs and a Boolean expression is a function of its variables, manipulations and simplification of a Boolean expression are related to network simplification.

Logic blocks

The five basic logic blocks needed to make up functional circuits are AND, OR, NOT, NOR, and NAND.

The AND block output equals 1 only when all of the inputs are 1 and is 0 when one or more inputs are 0. Figure 2 illustrates a 3-input AND block with its corresponding truth table.

The OR function output equals 1 only when one or more of the inputs equal 1 and equals 0 only if all of the inputs are 0. Figure 3 illustrates a 2-input inclusive OR block and its corresponding truth table.

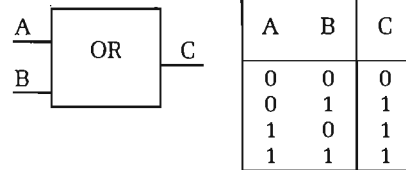

Figure 3

The NOT function equals 1 only when its input equals 0. Also, the function equals 0 when its input equals 1. This block, of course, has only one input. Figure 4 illustrates the NOT circuit and its truth table.

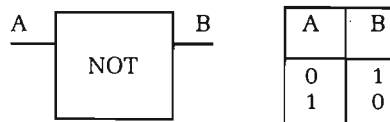

Figure 4

The NOR function is, of course, a

BEGIN STRIP 0:00

STRIP COMPLETE 0:20

CRIMP CENTER CONTACT 0:30

CRIMP FERRULE 0:50

CONNECTION COMPLETE 1:00

THE ONE MINUTE CONNECTION KIT

Strip and Complete Your Coaxial BNC Connections In 60 Seconds Or Less!

Designed for AMP, Amphenol or Kings BNC Connectors, the Paladin Coax Termination kit is a significant productivity advance for stripping and crimping BNC Coax Connectors. The lightweight kit is perfect for field use.

The ratcheted crimp tool with replaceable dies gives constant quality connections everytime! Paladin's amazing Coax Wire Stripper prepares the cable in less than twenty seconds! **LOW COST, HIGH QUALITY** from Paladin. See your local Paladin distributor.

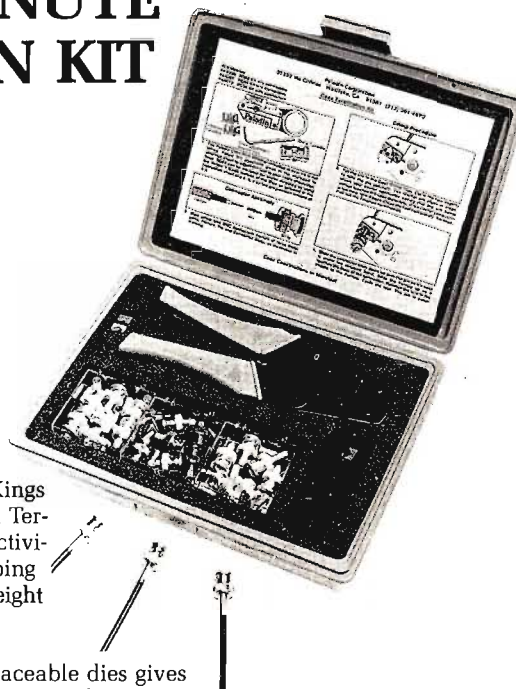

Paladin Corporation
 31332 Via Colinas
 Westlake, CA 91361
 (213) 991-4970

Circle (97) on Reply Card

Professional Sound Systems Start With The Stanton 881S

Stanton Magnetics presents the new 881S Professional Calibration Standard Cartridge. It's the cartridge preferred by recording engineers worldwide and it assures a new standard for home audiophiles desiring the very best in recorded sound. Its patented, low mass Stereohedron™ stylus

tip makes possible the flawless reproduction of high velocity modulations present on today's finest recordings.

The Stanton 881S... where great sound begins. Stanton Magnetics, Terminal Drive, Plainview, NY 11803



STANTON

THE CHOICE OF THE PROFESSIONALS™



© 1979 STANTON MAGNETICS

Circle (98) on Reply Card

More Than 360° of Phase >>>> QUICKLY WITH THE Matthey UN360 VIDEO TIMING TOOL

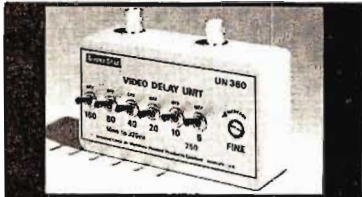

- Video Performance ● 75Ω
- 10-325ns ● Passive
- ±4ns Trim

Television Equipment Associates, Inc.

BILL PEGLER, Director
BOX 260 · SOUTH SALEM, N.Y. 10590
914-763-8893



Circle (92) on Reply Card

Digital Basics

complemented OR (NOT OR) function. The output of this functional block is 0 only when one or more of the input variables equals 1. The output will be 1 only when all of the input variables are equal to 0. The NOR circuit and its truth table are illustrated in Figure 5.

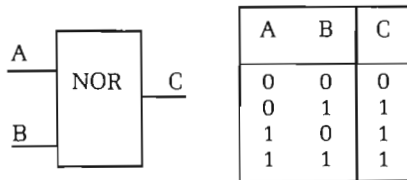

Figure 5

The last of the basic building blocks is the NAND function (NOT AND). This function has an output equal to 0 when all of its inputs equal 1 and an output of 1 when

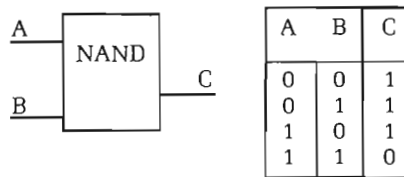

Figure 6

one or more inputs are 0. Figure 6 illustrates a 2-input NAND circuit and its truth table.

These five logic functions use the Boolean values 0 and 1 to represent the values taken on by the various variables. Realizing that 1 or 0 may be replaced by any discreet pair of values such as "+" and "-", or "on" and "off," the truth tables containing the algebraic values 0 and 1 can be used to describe the conditions on actual logic blocks. Just pair off the Boolean values 1 and 0 with state values such as voltages, polarities or other physical quantities. For instance, a value 1 may be assigned to the higher of two voltage levels and 0 to the lower. All that is necessary is that there be two distinct values of voltages to consider.

Positive and negative logic

The discussion above assumes that the Boolean value 1 will correspond to a "higher" or "up" or "on" physical value. This is not always done, and it is sometimes convenient to employ the opposite assignment of values.

$$- = 1$$

$$+ = 0$$

This results in what is referred to

DENSON ELECTRONICS DOES IT AGAIN

Due to the large volume purchasing power of Denson Electronics Corporation, we are able to offer excellent values on specially selected Shintron items.



SHINTRON 370 MARK III SAVE UP TO 1/3
☆ 10 Basic Wipe Patterns **\$2495.**
☆ Universal Input System
☆ Vertical Interval Switching on Preview and Program Busses
☆ Built-in Keyer and Colorizer

#9207—Model 370 Mark III Color Special Effects Generator has 6 inputs with vertical interval switching. Background & Color Black Generators, built-in tally contacts. Rack mount 7"H. Requires separate color sync generator. Brand new factory pack and warranty. Special \$2495.00.



Model 350 NTSC Encoded Chroma Keyer

#9208—Model 350 NTSC Encoded Chroma Keyer. A fabulous unit for a wide range of special effects. Brand new, factory pack. Regular price \$3000. A DEC Special **\$1995.**

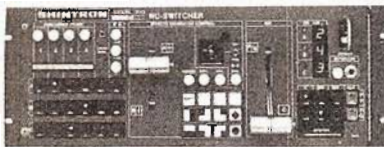

373 DX

Built In:

- Sony Camera Compatibility

- Color Bar, Automatic Color Black and Color Background Generators

- SYNC Generator
- 10 Wipe Patterns, Soft Wipe, Border Wipe, and Ext. Key

- Digital Tally Indicator, and Intercom
- Front Panel Subcarrier Phase Shifter

#9204—Model 373DX, the Cadillac of Chromatic Production Switchers. Brand new, factory pack. **\$7420.**

#9202—Same 373DX Switcher as above except like new factory refurbished demonstrator full warranty. **\$4995.**

#9199—Model 373NU. Same as 373 DX except with BNC connectors. Brand new. \$7420. Write for free factory spec sheet on above individual items and flyers of new and used video equipment.

THE DENSON ELECTRONICS CORP.

OFFICE Longview St.

TEL. Area Code 203/875-5198

10 a.m.-3 p.m. Monday, Tuesday, Thursday & Friday—otherwise by appointment

MAIL POST OFFICE BOX 85. ROCKVILLE CONN 06066 USA

PHILIPS®

Video 80 Color Camera System with Prism Optics for just \$49,990



Professional Performance • High Sensitivity and Resolution
• Superior Color Rendition • Proven Reliability

Price includes:

2 - 9801/0911 color cameras each with
3 - XQ1428 Plumbicons®, 10/100mm f1.8
fully motorized macro zoom lens, two head
sets and 15 meter camera cables
2 - ITE tripod sets H9P, T6-D6
1 - PVM 1211 Sony Monitor

1 - WV763 Triple 5" Panasonic Monitor
1 - M67 Shure Mixer
1 - 2103 ADC Switcher
1 - 1474 Tektronix Sync Generator
2 - Equipment Cases
Delivery, assembly and setup

Camera features makes waveform monitoring unnecessary.

Substitutions permitted

Call (215) 223-8200

West Coast call Keith Hughes (213) 766-8184

LERRO

ELECTRICAL CORPORATION
COMMUNICATIONS SYSTEMS DIVISION

3125 North Broad Street, Philadelphia, PA 19132

PLUMBICON® is a registered trademark of N.V. Philips' of The Netherlands

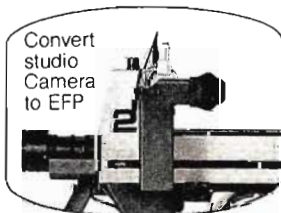

Add \$1990

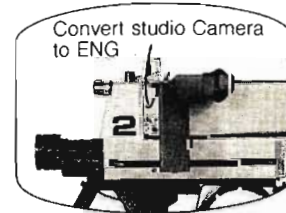

Add \$9950

Digital basics

as negative logic, and in terms of the logic blocks previously considered the following statements can be made:

- an OR circuit performs the AND function
- an AND circuit performs the OR function
- a NOR circuit performs the NAND function
- a NAND circuit performs the NOR function
- a NOT circuit is still a NOT function.

To avoid confusion it is helpful to label the block with the function it performs and use a notation that will indicate when negative logic is being used on an input or output. An example of this concept is the use of the so-called bubble notation. A small circle or bubble is drawn at the junction of an input or output line and the function block to indicate the assignment of negative logic to that line.

As an example, consider the block shown in Figure 7.

A voltage or physical state truth table for both circuits of Figure 7 would be as shown in Figure 8.

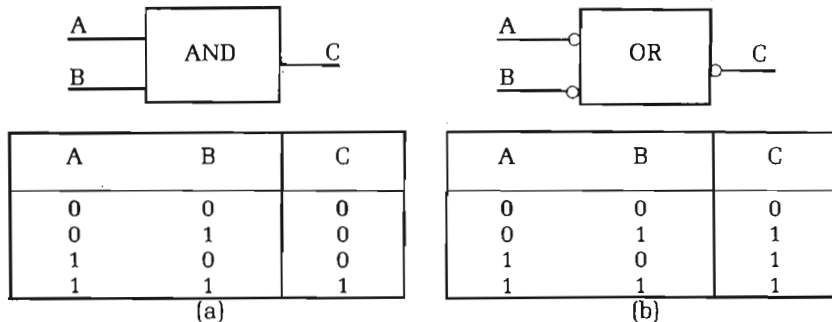

Figure 7

A	B	C
-	-	-
-	+	-
+	-	-
+	+	+

Figure 8

The negative logic versions of the OR, NAND and NOR circuits are shown in Figures 9, 10 and 11.

Note that by making use of complementation (inverters) OR gates may be used to perform an AND function and AND gates may be used to perform an OR function. This reasoning leads to the following statements regarding realization of Boolean expressions:

- Any Boolean function can be realized with AND and NOT functions only.
- Any Boolean function can be realized with OR and NOT functions only.
- Any Boolean expression can be realized with NAND functions only.
- Any Boolean expression can be realized with NOR functions only.

In the latter two cases the NOT function can be obtained by using only one input of the NOR or NAND blocks.

Minterm and maxterm forms

Maxterm and minterm are two

slow scan TV, compressed video, narrow band video . . .

TV FACSIMILE

. . . whatever you call it, it will expand your communications capabilities.

CVI systems convert normal TV signals to audio bandwidths, then transmit single frames of video information via the dial-up telephone network or dedicated circuits.

- Use standard CCTV cameras & monitors
- Transmission time from 4 to 156 seconds
- Resolution to 512 x 512 pixels
- To 256 levels of gray
- Available in 525 or 625 line standards

Specifications and applications material cheerfully sent on request.

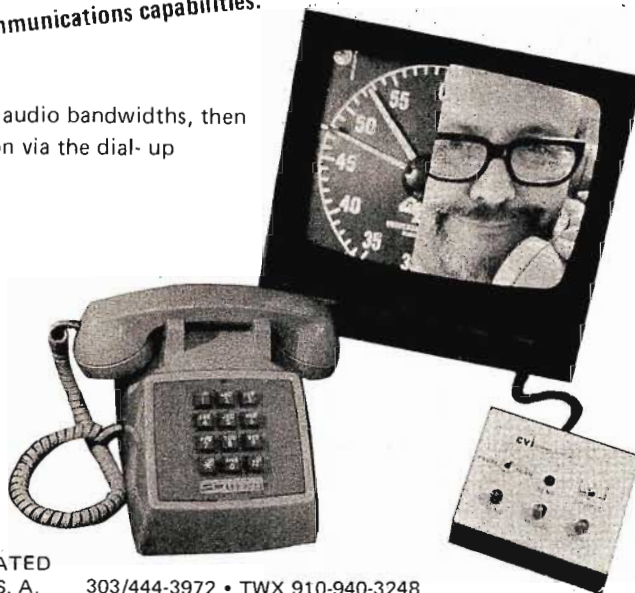

cvi

COLORADO VIDEO, INCORPORATED
 Box 928 • Boulder CO 80306 U. S. A. 303/444-3972 • TWX 910-940-3248
 Video instruments for data acquisition, processing, transmission, display

Circle (101) on Reply Card



VERSATILE.

O'Connor Model-50. A fluid head with 378 combinations.

NEW, ADJUSTABLE BALANCE, QUICK RELEASE PLATFORM.

The Model 50-D Fluid Head can be ordered with one of six different platforms. Each has its special features and purposes, but our newest is the ultimate.

First, it has a unique camera mounting plate which can be attached to your camera in one of eight different positions. This is used to balance your camera on the head, greatly improving the head's performance.

Besides an adjustable camera mounting plate, the entire platform (with camera atop) can be shifted



back and forth on the head so that you can find the precise center of gravity for whatever particular gear you're using at any given moment, such as heavy lenses, large magazines, etc.

It takes only a second to release your entire camera with O'Connor's new quick release option. To prevent accidental releases, it has a built-in safety feature.

WITH BASES, WE'RE LOADED.

The Model 50 can be ordered with one of six bases. Besides two Pro Jr. types, Mitchell, Arri 16 and

Arri 35, we also offer the O'Connor Claw Ball Base with the "ultra positive grip." The distinctive aluminum ridges



dramatically increase the holding power with far less effort needed to secure it in position. This Claw Ball design can also be adjusted $\pm 15^\circ$ to the horizontal plane within the top casting of the tripod to correct or alter your panning plane.

O'CONNOR COUNTERBALANCE DEFIES GRAVITY.

Three counterbalance spring options are available for the Model 50. It is important that you use the proper method to determine which spring is correct for your needs. If you're not sure, consult an O'Connor dealer or talk to us direct.

When you have the correct counterbalance spring, you should be able to stop the camera at any point in the normal tilting range and release the handle without the camera moving.

And it should take no more effort to tilt it upward than it does to tilt it downward. We specifically design counterbalance into all our heads to correct this natural act of gravity so that your "tilts" are as steady as your "pans."

MORE CONTROLS FOR MORE CONTROL.

Like all O'Connor heads, the Model 50 is designed to provide maximum versatility. Separate controls for the pan drag, pan lock, tilt drag and tilt lock—all improve the flexibility and repeatability of camera movement.

O'CONNOR HAS MORE OPTIONS.

More options mean a more versatile system for you. In addition to some of the items already mentioned for the Model 50, we also have adjustable double video handles, hi-hats, cases, adapters, teak tripods and the ever amazing Hydro-ped.

ORDER IT YOUR WAY.

The basic O'Connor Model 50 fluid camera head can be ordered 378 different ways. If you're not sure how you want yours, maybe you should send for our brochure and price list to help you pick the equipment that's perfect for your needs.

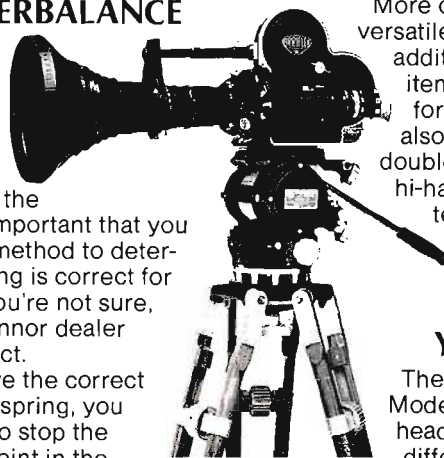

O'Connor

FLUID CAMERA HEADS

O'Connor Engineering Labs., Inc., 100 Kalmus Drive, Costa Mesa, CA 92626 • Phone (714) 979-3993 • TELEX 685 641
O'Connor Engineering Ltd., 11 Rue des Moraines, 1227 Carouge, Geneva, Switzerland • Phone (022) 42 79 38 • TELEX 23 329

Circle (102) on Reply Card

September 1979 *Broadcast Engineering* 117

Digital basics

State		
A	B	C
-	-	-
-	+	+
+	-	+
+	+	+

Positive logic		
A	B	C
0	0	0
0	1	1
1	0	1
1	1	1

Negative logic		
A	B	C
1	1	1
1	0	0
0	1	0
0	0	0

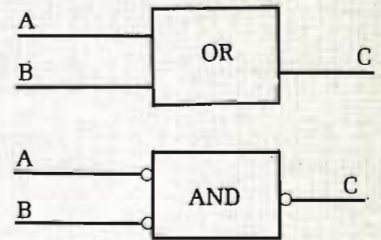

Figure 9 (OR circuit)

State		
A	B	C
-	-	+
-	+	+
+	-	+
+	+	-

Positive logic		
A	B	C
0	0	1
0	1	1
1	0	1
1	1	0

Negative logic		
A	B	C
1	1	0
1	0	0
0	1	0
0	0	1

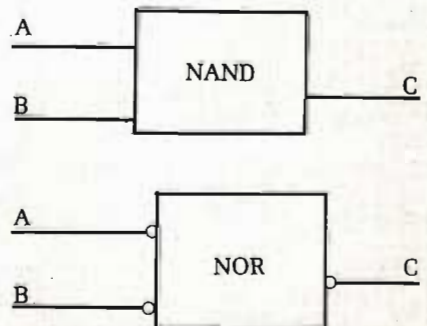

Figure 10 [NAND circuit]

"Stainless Towers... the best choice we ever made!"



No matter how many times we've heard this from customers, we'd love to hear it this time from you!

When you choose Stainless to fill your tower needs you get quick access to a wealth of experience. We don't just *sell* towers, we give you performance-proven advice on all aspects of the job, even ones you may have overlooked in your specs.

We'll show you how we cut costs with no sacrifice of quality, using automated processes for faster, cheaper and better results.

Stainless will build to *your* specs on *your* site or, we'll pick the best site, run soil analyses, then design, build and erect the optimum performance tower you need. We've been satisfying government, military and industrial customers, worldwide, for over 30 years. Every Stainless Tower, whether 200' or 2000', has priceless experience and reliability built in — to last!

Call Stainless, "the Tower People" and make a good investment for the future.



The tower people
Stainless, inc.

North Wales, PA 19454 U.S.A.
Phone: (215) 699-4871 • TWX: 510-661-8097

CO179

Circle (103) on Reply Card

INSTANTANEOUS Digital Command

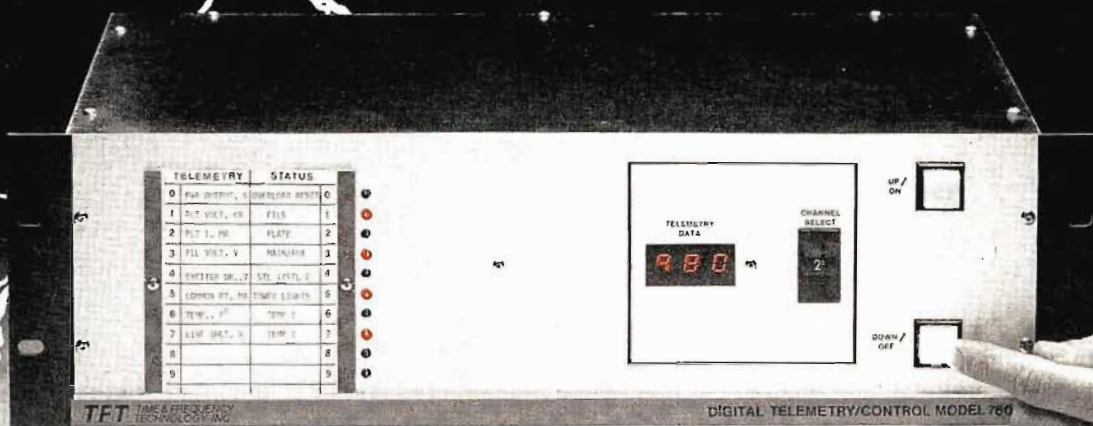

30 Functions for only \$2195

TFT Model 7601 represents a major breakthrough in remote control systems. Now, you can get 10 channels of digital command functions plus 10 channels of digital telemetry functions for less than \$2200! And it's the same high quality, reliable design that has made TFT equipment a standard in the broadcast industry. Just check this line-up of features:

DATA SECURITY ASSURED

Full command-code redundancy, *plus* odd/even parity check, makes digital data errors virtually impossible. A TFT proprietary feature. Even lightning induced noise has no effect on integrity of command functions.

INSTANTANEOUS COMMAND

Less than 0.2 second marks the time for a complete command/execute function with the new TFT high speed data modem.

ONE MAN CALIBRATION

The front panel of the Model 7601R (Remote Terminal) has a DVM and scaling potentiometers so that just one man, on-site, can perform the FCC required weekly calibration. A studio lock-out switch provides complete operator safety for on-site work.

CHOICE OF TRANSMISSION METHODS

Model 7601 interconnection can be either telephone lines or radio links which include STL, TLS or SCA.

MINIMAL SERVICE DOWNTIME

Quick-disconnect rear barrier strips allow fast removal of the 7601 from the rack without disconnecting any of the interface wiring between the remote terminal and the transmitter or alarm sampling points.

TEN OPTIONAL STATUS CHANNELS

In addition, 10 status indicator functions may be factory or field installed to provide instant status display and alarm.

The Model 7601 is just one of a full line of field-proven, reliable, fail-safe remote control systems offered by TFT. Other remote control systems designed for AM, FM and TV include the Model 7610, a 110-channel digital telemetry/status/control system; the Model 7815, a fully independent 15 to 45 channel DIRECT control/status/alarm system; the Model 7840 data acquisition, automatic logging and alarm system and a complete line of remote control accessories. They're all available from TFT. For all the facts on these and other TFT products call or write:

TFT TIME AND FREQUENCY TECHNOLOGY, INC.
3090 OAKMEAD VILLAGE DR., SANTA CLARA, CA. 95051 (408)246-6365 TWX 910-338-0584

Circle (104) on Reply Card

Broadcast
Component Distributors

BROADCOM T.M.

Cartridge Machines

- Audio Tape Cartridges
- AGC Amplifiers
- Compressing Amplifiers
- Mic-Line Amplifiers
- AM/FM Limiting Amplifiers
- Reverb Systems
- Monitor Amplifiers
- Audio Distribution Amplifiers
- Mixing Amplifiers
- High Power Amplifiers
- Antennas—AM/FM Transmitting
- Tone Arms
- Automation Systems
- Cartridge Splice Finders
- Alignment Tape & Accessories
- Audio Consoles, Mono/Stereo/Multi Channel
- Audio Delay Equipment
- Bulk Erasers—Audio & Video
- Audio Splicing & Editing
- Accessories
- Equalizers

Sales-Service

▶ Scully

Recording Instruments

- Program Loggers
- Reel-to-Reel Tape Decks
- Phono Pre-Amps
- Microphones & Stands
- Headphones
- Phono Cartridges
- Replacement Magnetic Heads
- Monitor Speakers
- AM/FM/FM Stereo Exciters
- 5 KW AM Transmitter
- 10 KW AM Transmitter
- 50 KW AM Transmitter
- 2.5 KW FM Transmitter
- 10 KW FM Transmitter
- 15 KW FM Transmitter
- 25 KW FM Transmitter
- 40 KW FM Transmitter
- 50 KW FM Transmitter

Equipment Leasing

Repair Service

- Complete Studio Systems
- Studio Furniture
- AM/FM/FM Stereo
- Monitoring Devices
- Cartridge Tape Winders
- Turntables
- Sound Re-enforcement Mixers
- Noise Reduction Systems
- Remote Broadcast Systems
- Tone Sensors & Generators
- Recording Tape
- Time Announce Tapes
- Telephone Answering Equipment
- Tape Timers
- AM/FM/FM Stereo Receivers
- "On-Air" Lights
- Portable Tape Recorders
- Educational Transmitters (10 W)
- Carrier Current Systems
- Digital Clocks & Chronographs
- Recorder Replacement Electronics

24 Hour Parts Service

(215) 437-0607

Communication Medias

Tilghman at Jefferson, Allentown, PA 18102

Circle (105) on Reply Card

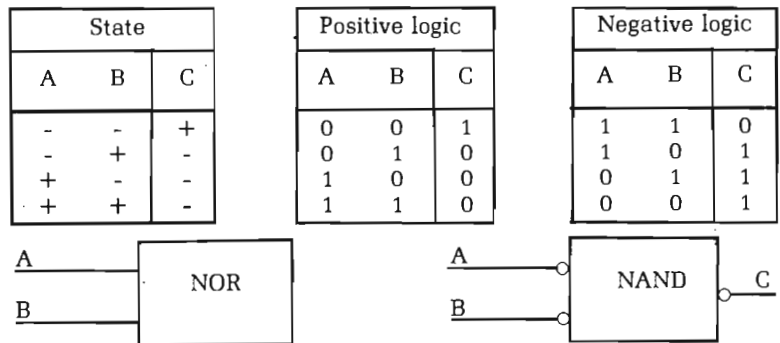

Figure 11 [NOR circuit]

Digital basics

very common forms for logic expression or Boolean equations. Either form may be used as the basis for a logic circuit. A special form of truth table (which is now obsolete) was the origin of the terms.

- The minterm form may also be thought of as a sum of products formulation. For example:

$$X = (ABC) + (\bar{A}BC) + (A\bar{B}C)$$

- The maxterm form can be considered to be a product of sums formulation such as:

$$X = (\bar{A} + \bar{B} + C)(A + \bar{B} + \bar{C})$$

In terms of logic circuits, a particular expression may be implemented by either form as a result of deMorgan's Theorem. For example, to implement the expression

$$X = (\bar{A}B) + (AB),$$

a minterm formulation would be as shown in Figure 12.

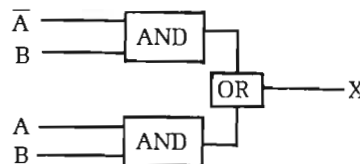

Figure 12

A logic function may be imple-

mented in maxterm form as shown in Figure 13.

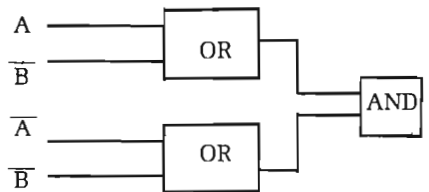

Figure 13

This circuit is obviously implemented from the expression

$$X = (A + \bar{B})(\bar{A} + B).$$

The sum of products, or minterm form of an expression, may be written directly from a truth table. That is, the truth table can be considered to be a minterm formulation. For example, the truth table in Figure 14 can be translated into the circuit as shown.

A	B	C	X
0	0	0	0
0	0	1	1
0	1	0	0
0	1	1	0
1	0	0	0
1	0	1	1
1	1	0	0
1	1	1	0

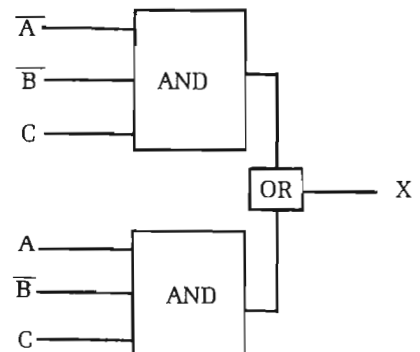

Figure 14

Consider a 0 in the A column to be \bar{A} and a 1 in the A column to be A with a similar interpretation for the B and C columns. Thus,

$$X = \bar{A}\bar{B}C + A\bar{B}C$$

can be written for the X variable by forming terms for each combination that results in X having an entry of 1. The circuit shown can be drawn directly from the Boolean equation.

The minterm form is the most commonly used; however, the maxterm form may be used. It is formed by complementing a minterm truth table. For example, given the minterm table in Figure 15(a), complementation results in the maxterm table of Figure 15(b).

A	B	X
1	1	0
1	0	1
0	1	0
0	0	1

(a)

A	B	X
0	0	1
0	1	0
1	0	1
1	1	0

(b)

Figure 15

The minterm and maxterm forms perform identical logic functions and are interchangeable from the standpoint of logical function. One of the formulations may appear to be more complex than the other due to redundant terms. Inclusion of these redundant terms represents an unnecessary expense and needless complexity when designing a circuit. Therefore, it is desirable to denote some design effort to simplification of the algebraic expressions or networks.

The next part of this series will consider some of the methods of simplification. These methods are all based on the basic premise that input combination can be divided into three groups:

- combinations for which an output is desired, i.e. output equals 1;
- combinations for which no output is desired, i.e. output equals 0; and
- combinations which can't occur (physically impossible) or where it doesn't matter if the output is 1 or 0.

The inclusion of terms of the third type may either complicate an expression (increasing the complexity and cost of a circuit) or may actually simplify an expression (reducing the cost and complexity of a resulting circuit). Thus, the simplification methods discussed are crucial in optimizing a design. □

Fidelipac gold is on the standard!

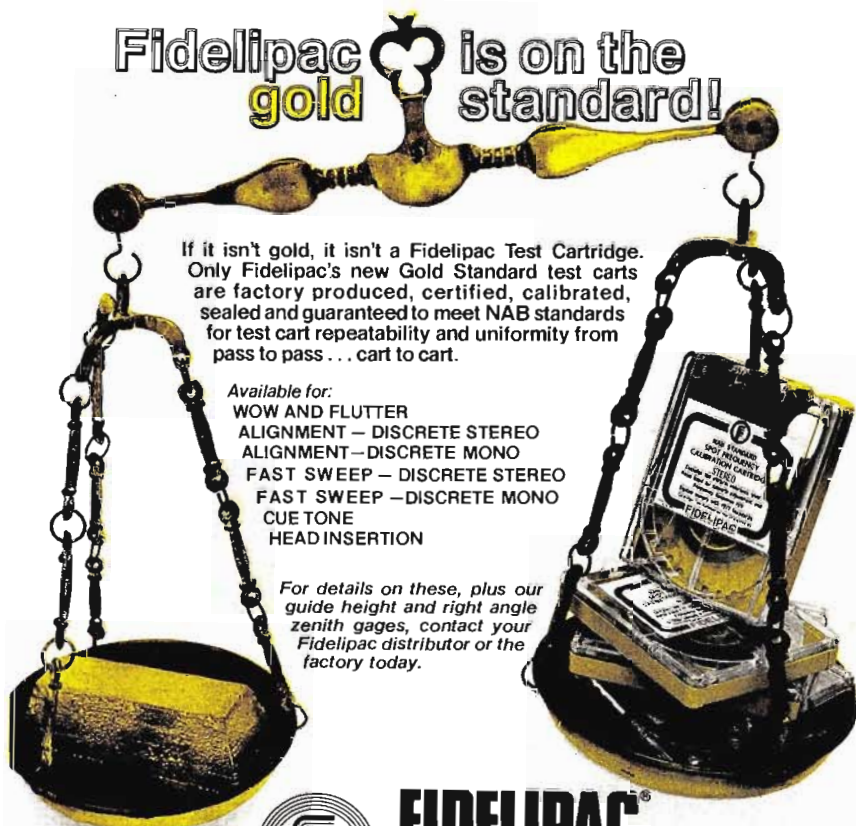

If it isn't gold, it isn't a Fidelipac Test Cartridge. Only Fidelipac's new Gold Standard test carts are factory produced, certified, calibrated, sealed and guaranteed to meet NAB standards for test cart repeatability and uniformity from pass to pass . . . cart to cart.

- Available for:
- WOW AND FLUTTER
 - ALIGNMENT - DISCRETE STEREO
 - ALIGNMENT - DISCRETE MONO
 - FAST SWEEP - DISCRETE STEREO
 - FAST SWEEP - DISCRETE MONO
 - CUE TONE
 - HEADINSERTION

For details on these, plus our guide height and right angle zenith gages, contact your Fidelipac distributor or the factory today.



FIDELIPAC®

109 Gaither Drive • Mt. Laurel, NJ 08054
(609) 235-3511 U.S.A.

© Trademark

See us at NRBA Booth #11

Circle (107) on Reply Card

MUSIC / SOUND DISTRIBUTORS

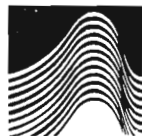

MUSIC/SOUND . . .
THE PRO LINES

MUSIC/
SOUND . . .
THE PRO
SALES
AND
SERVICE
TEAM

- BASF • TASCAM •
- AMPEX • TEAC •
- MEMOREX • KLH-
- BURWEN • SANYO •
- TECHNICS PRO •
- PANASONIC PRO •
- STANTON • VICON •
- BOGEN • TELEX •
- SHURE • MANY MORE!

Professional salesmen, trained to meet the demands of professionals for fast, knowledgeable, efficient service.

MUSIC / SOUND DISTRIBUTORS

6730 Santa Barbara Ct. • Elkridge, Md. 21227

FOR PRO-LEVEL
EQUIPMENT
YOU NEED
PRO-LEVEL
SALES AND
SERVICE

WRITE FOR
OUR

FREE

56-PAGE
CATALOG TODAY

Music/Sound Distributors
DEPT. BE-9
6730 Santa Barbara Ct.
Balto., Md. 21227

THE PROS...

Circle (106) on Reply Card

September 1979 *Broadcast Engineering* 121

National Radio Broadcasters Association 6th Annual Conference & Exposition

October 7-10, 1979
Washington Hilton Hotel
Washington, DC

NRBA '79 attendees will see the largest show in NRBA history. Previous exhibitor sign-up records already have been exceeded, and new attendance records are expected.

The exhibitor list for the convention is still growing, but registrants

will receive a program listing all exhibitors and their booth assignments.

Those not attending NRBA '79 may use the following list to receive NRBA '79 exhibitor data. This listing is up-to-date as of press time, but a complete replay of NRBA '79 containing information gathered at the show will appear in the November issue of **BE**. For exhibitor information, circle the number following the equipment or service on **BE's** reader service card. The exhibitor(s) will mail the requested information.

(Where available, specific exhibitor products for NRBA have been listed; where this information is not yet available, "product line" indicates that NRBA-related information will be mailed.)

The italicized listings denote new products being introduced at NRBA '79.

Further information on the convention may be obtained by contacting the National Radio Broadcasters Association, 1705 De Sales Street N.W., Suite 500, Washington, DC 20036, (202) 293-3570.

NRBA Exhibitor/Products

American Quotation System

Data screen & printer (250)
PROdata system (251)

Ampro/Scully

Broadcast consoles (252)
Cartridge machines (253)
Audio recorders (254)

Andrew

Product line (255)

Audio & Design Recordings

Ex-Press Limiter (256)
Dual noise gate (257)
Transformer mic preamp (258)
Delay lines (259)
Distribution amplifiers (260)
Limiters/compressors/equalizers (261)

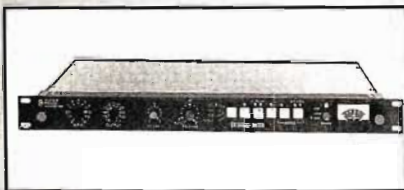

The Ex-press Limiter by Audio & Design Recording is a compressor/limiter/expander with the function mode controlled by digital logic momentary switches.

Auditronics

Product line (262)

Automated Broadcast Controls

Sequential controller (263)
25Hz tone detector (264)
Microprocessor interface (265)
Automation controls system (266)
Clocks/loggers (267)
Cartridge machines (268)

Automated Music

Music formats (269)

Automated Processes

AM/FM mono/stereo audio consoles (270)
On-air & production audio consoles (271)
Audio processing module (272)
Intercom system (273)

Automation Electronics

Autotron traffic system (274)
Radio sales system (275)
Traffic logging system (276)
Word-processor (277)
Music analysis (278)

Belar Electronics Laboratory

Product line (279)

Bloomington Broadcasting

Music research package (280)
Business computer systems (281)

Bonneville Broadcast Consultants

Product line (282)

Bonneville Data Systems

Product line (283)

Broadcast Consultants

Product line (284)

Broadcast Electronics

Product line (285)

Broadcast Programming Int'l.

Special holiday programs (286)
Music formats (287)

Bureau of Census

Literature (288)

CCA Electronics

To announce several new products (289)

Cablewave Systems

Transmission lines (290)
Cables/connectors (291)
Microwave antennas (292)
Pressurization equipment (293)

Capitol Records

Product line (294)

CaVox Stereo Productions/Tape-Athon

Tape-Athon programmer (295)
Background music automation (296)
Music formats (297)
Audio systems (298)

Century 21 Programming

Music programs (299)

Cetec

Product line (300)

Computer Concepts

Broadcast traffic systems (301)

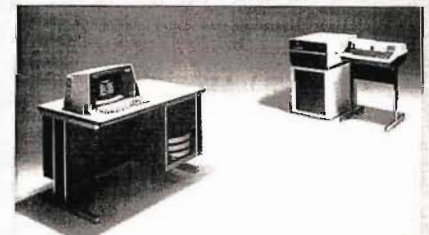

Computer Concepts will feature their building-block broadcast traffic computer systems which allow customers to buy only as much system as is needed.

Computers & Peripherals
Product line (302)

Comrex
Low frequency extenders (303)

Concept Productions
Radio formats (304)
Voice/music synchronizer (305)

Consolidated Electronic Industries
Servo motor cart machine (306)
Reel-to-reel stereo tape reproducer
(307)
Computer logger system (308)
Cart handling system (309)
Cartridge machines (310)

Custom Business Systems
Accounting package (311)
Business computer system (312)

Delta Electronics
Modulation controller (313)
Power controller (314)
Antenna monitors (315)
Remote control systems (316)
Coaxial transfer switches (317)
Current transformers (318)
Compensated rectifier (319)
Impedance bridges (320)
Receiver/generator/ammeters (321)
DPMs (322)

Dolby Laboratories
FM processors (323)

Drake-Chenault
Product line (324)

Fidelipac
NAB tape cartridges (325)
Cartridge storage racks (326)
Wow & flutter meter (327)
Alignment tapes/gauges (328)
Tape handling accessories (329)

From Studio B
Comprehensive sales/promo package
(330)
Radio programs (331)

Groton Computer
Computer terminal (332)
Lending library/A-V cassettes (333)

Harris
Program automation system (334)
Tri-bond AGC amplifier (335)
Facilities controller (336)
25kW FM transmitter (337)
AM stereo system (338)

IGM/NTI
Live assist system (339)
Automation system (340)
Instacart system (341)
Go-Cart system (342)
Automatic logging system (343)

International Business Services
Product line (344)

PERFECT TIMING

Low Cost ESE Right On Timers

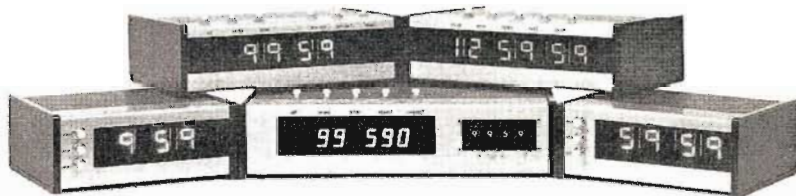

- ES-301:** Four digit gas discharge display, one hundred minute timer (99:59) with six controls: Count Up, Count Down, Min-Set, Sec-Set, Stop, Reset. **\$216.00**
- ES-302:** Equivalent to ES-301 plus fast-set lever wheel programming. **\$277.00**
- ES-400:** Three digit ten minute timer (9:59) with Start, Stop, Reset. **\$114.00**
- ES-510:** Four digit sixty minute timer (59:59) with Start, Stop, Reset. **\$146.00**

STANDARD OPTIONS AVAILABLE: Kit; Slave; BCD Output; Remote Connector: 6' Remote Cable and Pushbutton Set; 220V A.C., 50Hz; 9" or 19" Front Panel 3 1/2" high; 3 Wire Cord and Molded Plug. Tenths of seconds are available on all timers. Relay Contact Closure at Zero and or Stop at Zero available on ES-301 and ES-302. Custom options and special orders available.

WRITE, WIRE OR CALL TODAY

142 Sierra Street

EL Segundo, California 90245

(213) 322-2136



Circle (108) on Reply Card

Dielectric: Supplier of quality components to the communications industry

For 40 years Dielectric has supplied various segments of the communications industry with high quality, durable components and systems.

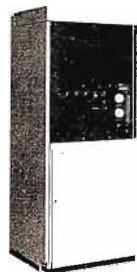

For the *Broadcast* industry, motor driven coaxial switches, transmission lines, high power loads, and waveguides. For the *Telephone* industry, compact dehydrators for cable drying. For the *2-Way Radio* industry, RF wattmeters and dummy loads.

Today, Dielectric recognizes its responsibility and continues producing high quality components for this important communications industry. For more information on Dielectric's products and services, circle the appropriate reader service number:

- Broadcast Industry - circle 233
Telephone Industry - circle 234
2-Way Radio Industry - circle 235

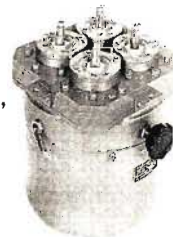

GS DIELECTRIC COMMUNICATIONS
A UNIT OF GENERAL SIGNAL
RAYMOND, MAINE 04071 • TEL. 207-655-4555 • 800-341-9678

DO YOU NEED A CHARACTER GENERATOR

THAT CAN DO ALL THIS FOR YOU?

- Match your budget and requirements with a system that can grow in the future with your needs.
- Give you your choice of one or two channels, desktop or rack mounting, basic or extended font capacity.
- Provide high character resolution, multistyle or multisize font capacity.
- Provide a high capacity, easy to use diskette storage system for fonts and displays.
- Give you advanced capabilities, such as animation, in even the most inexpensive model.
- Give you a choice of optional keyboard font compose or camera based font/logo composition.
- Give you high reliability, simple rapid diagnostics, high equipment reliability.

YES?

YOU NEED A VISTA 80 GRAPHICS SYSTEM!

MPB Technologies, Inc.
P.O. Box 160, Ste. Anne de Bellevue, Quebec, Canada
H9X 3L5. Tel. 514-457-2035

Circle (113) on Reply Card

Change Sound to Silence with a **TABERASER**



This rugged, heavy duty bulk tape eraser wipes sound from all magnetic tapes, cartridges, cassettes and magnetic film stock; handling up to 2".

It erases with minimum residual noise because the field automatically diminishes at the end of each 30-second cycle. A thermal control and blower keeps the unit below 71° C.

Available for 60Hz or 50Hz operation.

For the distributor in your area—Call or write:

TABER Manufacturing & Engineering Company
2081 Edison Ave. • San Leandro, Ca. 94577 • (415) 635-3831

Circle (112) on Reply Card

124 *Broadcast Engineering* September 1979

NRBA convention

ITC

Audiotape cartridge machine (345)
1K library storage system (346)
Cartridge recorders/reproducer (347)
Reel-to-reel recorders/reproducers
(348)
Erase/splice locator (349)
Delay systems (350)

Irv Joel & Associates

Radio console (351)
Broadcast instrumentation (352)

Jennings/McGlothlin

Product line (353)

Joseph Lutz

Product line (354)

Kahn Communications

Product line (355)

Kaman Sciences

Business automation systems (356)

LPB

150W & 300W FM transmitters (357)
Audio consoles (358)
Amplifiers & preamps (359)
Compressor/limiter (360)
Turntable (361)
Studio furniture (362)

McCurdy Radio Industries

Audio console (363)
Spectrum translator (364)
Turntable (365)
Intercom (366)
Distribution amplifier (367)
Switcher (368)
VU meter (369)
Monitors (370)

McMartin Industries

AM/FM transmitter (371)
Monitors & exciters (372)
Consoles (373)
Remote receivers/transmitters (374)
FM/SCA receivers (375)
Turntables (376)
EBS equipment (377)

Microphone (MET) Electronics

Product line (378)

Micro-Trak

Turntable (379)
Audio consoles (380)
Amplifiers/preamps (381)
Remote systems (382)
Headphone extender (383)
Disco systems (384)

Money Machine

Product line (385)

Moseley Associates

Audio gain rider (386)
Audio limiter (387)
Subcarrier main frame (388)
Microprocessor remote control (389)

Telecontrol systems (390)
 STL equipment (391)
 Pickup/return links (392)
 SCA/stereo generators (393)

Motorola
 Product line (394)

Musicworks
 Music formats (395)

Mutual Broadcast System
 Product line (396)

Fred A. Nudd
 Towers (397)
 Monopoles (398)

Orban Associates
 Live processor (399)
 Live equalizer (400)
 Live de-esser (401)
 Spring reverb (402)
 Stereo limiter (403)



Orban equalizer model 672A is a quasi-parametric equalizer designed to enhance the announce microphone and to create special effects to make a station stand out.

Otari
 Product line (404)

Phelps Dodge
 Product line (405)

Philadelphia Resins
 Antenna guy rope (406)

Progressive Radio Network
 Product line (407)

QEI
 Product line (408)

QRK Electronics Products
 Audio consoles (409)
 Preamps (410)
 Turntables/tone arms (411)

Ramko Research
 Product line (412)

RCA
 Product line (413)

RCA American
 Product line (414)

Rockwell-Collins
 AM/FM transmitters (415)
 Stereo consoles (416)

Hold the pickles! Hold the lettuce!



Our Custom Audio Series consoles let you have unsurpassed quality & performance your way! Up to 24 inputs plus optional EQ, reverb, monitor amps, digital clocks & timers, all at surprisingly low prices!

CALL COLLECT 713-782-4592

for our unbeatable console specs, plus details on our preamps, monitors, timers & much more.

Logitek Electronic Systems, Inc. 3320 BERING DRIVE, HOUSTON, TEXAS 77057

Circle (114) on Reply Card

Frezzi ENERGY High-Capacity Battery Packs

Made in U.S.A.



This is "Frezzi-Belt" Model F-12-77. It powers Ikegami Model 37/77/79 Video Cameras.



Less than 1 hour re-charge time with "Frezzi-Fast" Chargers.

Portable Power for all video cameras, video recorders, & hand-held "Frezzi-Lights"™

For information call (N.J. 201) 427-1160 (N.Y.C. 212) 594-2294

Frezzolini E.N.G. support equipment.  **Frezzolini Electronics Inc.**
 7 Valley St. Hawthorne, N.J. 07506 USA

Export Agents:  11 Caesar Place, Moonachie, N.J. 07074 U.S.A. • (201) 939-0875
 Telex: Cinecraft Moon TLX 13-8875 • Cables: Cinecraft Moonachie

SEE FREZZOLINI® at SMPTE, Los Angeles, BOOTHS 428-429, OCTOBER 21-26, 1979.

Circle (115) on Reply Card

AGAIN & AGAIN POTOMAC INSTRUMENTS IS

PRODUCT INNOVATION
1ST

- First First** FCC Approved Antenna Monitor
- First First** Harmonic Reading Field Strength Meter for Standard Broadcast Stations
- First First** Digital Antenna Monitor
- First First** Frequency Synthesized RF Generator with Coherent Detector for RF Bridge Applications
- First First** Solid State Combination VHF Field Strength Meter and RF Generator
- First First** Audio Generator with these Features: L&R Outputs, Stereo Matrix Switch, IM Signal Source, Signal Leveling, Precision Attenuators, Mike and Line Source Impedance, Balanced and Unbalanced Outputs
- First First** Audio Analyzer with these Features: L&R Inputs, Auto Leveling and Auto Nulling THD Analyzer, IMD Analyzer, Wow and Flutter Meter, Stereo Phase Meter, Differential Gain Meter

CONTACT US NOW FOR DESCRIPTIVE LITERATURE ON OUR COMPLETE LINE OF BROADCAST INSTRUMENTATION.

POTOMAC INSTRUMENTS 932 PHILADELPHIA AVE.
SILVER SPRING, MD 20910
(301) 589-2662

Circle (116) on Reply Card

Dependable

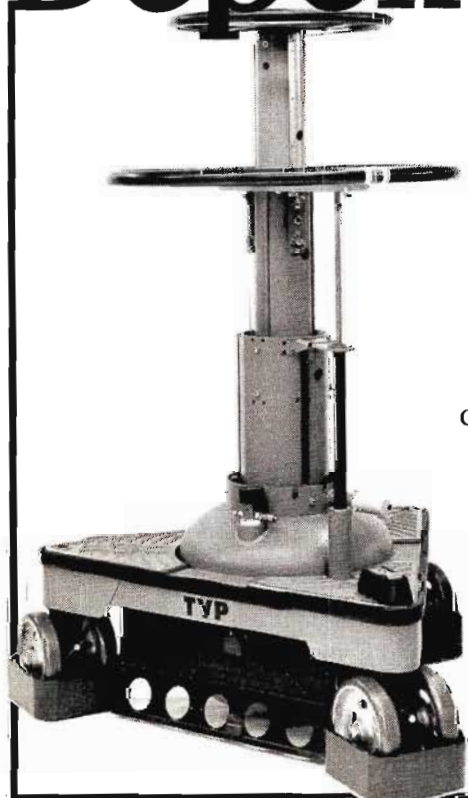

The P-50, we improved it to make it more dependable than ever. No other TV camera pedestal can come close to the P-50 in reliability and versatility (height: 21" min./57" max.; load capacity: 350 lbs.).

With 20 years of experience in building quality camera pedestals, we bring you the P-50 at a more affordable price than its competitors. The P-50, you can depend on it.

**TeleVision
Products Co.**

9016 AVIATION BLVD.
INGLEWOOD, CA 90301
(213) 776-3276

Circle (117) on Reply Card

126 *Broadcast Engineering* September 1979

NRBA convention

Sharepoint Systems

SCA generator/processor (417)
Cartridge controller (418)
Peak program meter (419)
Transmitter control system (420)
Intercom system (421)
Video DA (422)
Audio DA (423)

Sintronic

AM/FM transmitters (424)

Sono-Mag

Product line (425)

Stainless

Custom installation photos (426)

Station Business Systems

Product line (427)
CentraCart machines (428)

Tangent Communications

Product line (429)

Telex Communications

Intercom system (430)
Tape transports (431)
Cartridge recorders (432)
Tape recorders (433)
Tape loggers (434)
Headsets (435)
Amplifiers (436)

Time & Frequency Technology

Microprocessor remote control system (437)
Data acquisition system (438)
Remote controller (439)
AM/FM/TV monitors (440)
STL equipment (441)
EBS equipment (442)

Torbet Radio

Product line (443)

Trac-Lab Computer Systems

Computerized logging and billing systems (444)



Trac-Lab introduces its stand-alone computerized business systems to provide logs and billing information for radio, TV, and cable systems.

UMC Electronics

Announce assist system (445)
Stereo production console (446)
Cartridge player (447)
Cartridge recorders/reproducers (448)
Splice finders/erasers (449)
Audio control console (450)
Replacement heads/motors (451)

UPI

Audio network data (452)
Broadcast wire/datanews (453)

US Tape & Label

Promo strips, labels, iron-ons, caps (454)

Thomas J. Valentino

Production music library (455)
Production sound effects library (456)
IDs and logos (457)

Versa-Count Engineering

10W/50W FM exciters (458)
FM modulation monitor (459)
Stereo monitor (460)
RF power amplifier (461)
FM translators (462)
FM transmitters (463)
Stereo generators (464)
SCA generators (465)
Audio distribution amplifiers (466)

Wang Laboratories

Product line (467)

Wang Voice Communications

Product line (468)

Wearhouse

Custom imprinted clothing (469)

Weather Services

CRT weather display (470)

Welsh Company

Product line (471)



This CRT system from Weather Services will display current weather parameters for any location in North America.

MAP IMPAC™ Series... Modular PC Card System

A COMPLETE LINE OF PLUG-IN PC CARD AUDIO MODULES & ACCESSORIES FOR PROFESSIONAL APPLICATIONS IN -

- AM - FM - TV BROADCASTING
- RECORDING STUDIOS
- ENGINEERED SOUND SYSTEMS

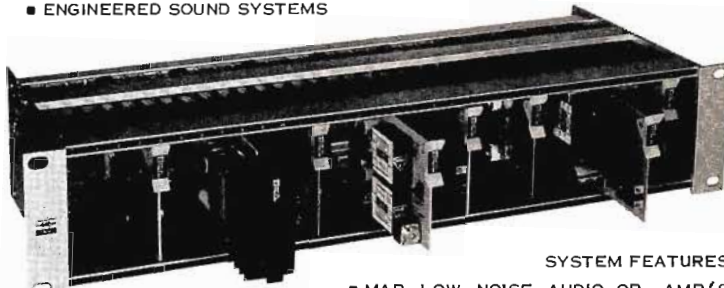

SYSTEM FEATURES

- MAP LOW NOISE AUDIO OP-AMP'S
- SELF-CONTAINED OR REMOTE CONTROLLED OPERATION
- SOLID-STATE (FET) SWITCHING & VCA LEVEL CONTROLS
- AMPLIFIERS WITH BUILT-IN INPUT & OUTPUT TRANSFORMERS
- INTEGRAL CARD EJECTION HANDLES & KEYED CONNECTORS



**MODULAR
AUDIO PRODUCTS**
■ A UNIT OF MODULAR DEVICES, INC.

50 Orville Drive ■ Airport International Plaza ■ Bohemia, New York 11716 ■ 516-567-9620

Circle (118) on Reply Card

SPORTSCASTER HEADSET

ISN'T IT TIME YOU GAVE YOURSELF A HELPING HAND ???

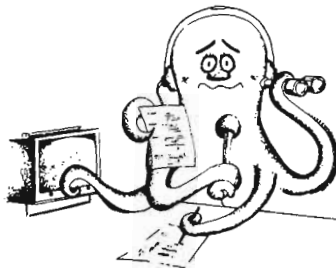

Hands-free communication is within your reach. Television Equipment's well-proven Sportscaster headset, with integral dynamic boom mike, gives you complete freedom of movement - just right for those tense moments when you need to consult your references.

The headset has a...



Dynamic Boom Microphone; 400 OHMs, frequency range 50-15,000 Hz, sensitivity 2mV (loaded) for close speech.

Double Headphones: independently wired, 200 OHMs each, frequency range 50-15,000 Hz.

Ventilated foam cushions eliminate perspiration and let you hear ambient sound (optional ear-enveloping cushions).

Weight: 6½ oz. Practically unbreakable components. Optional cough switch.

at: \$119 - Single Phone
\$149 - Double Phone

Delivery from stock Satisfaction guaranteed

For your helping hand phone today...



Television Equipment Associates, Inc.

BOX 260 • SOUTH SALEM, NEW YORK 10590
914 • 763-8893 TWX 710-575-2600

BILL PEGLER, *President*

Circle (119) on Reply Card

September 1979 *Broadcast Engineering* 127

WGBH engineers talk about the Ikegami HK-312



WGBH covers Boston Pops Orchestra concerts with Ikegami HK-312 cameras from Symphony Hall, Boston.

Eight Ikegami HK-312 studio color cameras are in service at WGBH, Boston, some dating back to October 1977 — long enough for intelligence on their performance. From recent interviews with key WGBH people, read these excerpts.

Pops without noise

Tom Keller, Director of Engineering:

“The HK-312s have such high sensitivity that we were able to reduce significantly our light levels at the Boston Pops and Symphony telecasts. Yet, despite the major light reduction, we experienced no visible noise with the HK-312s... With their remarkable reliability record, we can depend on 6 cameras for 6-camera coverage, and not 7 for 6 as in the past. After all, you can't stop a live orchestra performance for a retake if you've lost a camera.”

2 IRE, but a complaint

Ken Hori, Senior Engineer for Advanced Development:

“We tested several camera makes for RFI within a quarter-mile of a 50 KW radio transmitter. The HK-312 measured 2 IRE, whereas most others were in the 5 to 7 IRE area, and some as high as 20 IRE... For symphony remotes we'd need 2 to 5 hours for warm-up, but nowadays we're set up in less than an hour... We like its straightforward design — example, its truly high signal-to-noise ratio as compared to other cameras that resort to reduced bandwidth to attain a comparable ratio but wind up delivering noise too...”

We did get one complaint from the maintenance crew. They said that because they rarely found the problem of a down HK-312, they would never get to know the HK-312 well enough to fix it.

Washouts and dropouts

*Bill Fairweather,
Video Control Engineer:*

“During a lighting seminar staged here by Imero Fiorentino Associates, an actor in a normally lighted scene held up a sheet of white paper with printing on

it to show loss of detail in the case of more than 60 percent tv white reflectance. The HK-312, however, was able to retain enough detail for the printing to be readable on the monitor.

Next came a demonstration of the dangers of too much or too little light on a chroma-key background. The HK-312 held the key to such a low light level on the blank background that the lecturer grinned and said, “I guess WGBH has pretty good cameras!” and went on to the next subject.”

The HK-312 is the camera that met WGBH criteria for performance, stability, and reliability. They also have HL-53s, high-performance portable cameras that interface with HK-312 CCUs and can operate portably with their own CCUs.

Adapters for triax cable, using digital techniques, make their cameras remote-usable at nearly a mile from base stations, yet easily revertible to multi-core cable whenever needed.

In daily use, their HK-312s and HL-53s are interfaced with microprocessor-computer control units that automatically cycle them through all set-up adjustments, including black-and-white balance, flare and gamma correction, video gain, and eight registration functions, then recheck all those adjustments — all within 45 seconds. The cameras can also operate independently of the set-up computers, a feature that is an Ikegami exclusive.

If all of this suggests that the HK-312 is probably the best studio/field color camera in the industry, consider this: camera, set-up computer, and triax adaptor are not only operational, they are deliverable. For details or a demonstration, contact **Ikegami Electronics (USA) Inc.**, 37 Brook Ave., Maywood, NJ 07607, (201) 368-9171 / West Coast: 19164 Van Ness Ave., Torrance, CA 90501, (213) 328-2814 / Southwest: 330 North Belt East, Houston TX 77060, (713) 445-0100.

Ikegami HK-312

Circle (120) on Reply Card

Circular polarization (CP) field tests

By Bill Loveless, chief engineer, Bonneville International

Circular Polarization (CP) does not provide better television reception than the traditional Horizontal Polarization (HP), based on a series of field tests Bonneville International Corporation conducted in the Salt Lake Valley. Both the field tests and electromagnetic field theory demonstrate that horizontal signal polarization is generally superior to CP in poor reception areas.

The tests were implemented to evaluate the installation of a CP transmitter in Bonneville International Corporation's Seattle, WA, television outlet, KIRO. The tests were conducted in the Salt Lake Valley because the company has two similar high-band VHF stations with transmitters located at the same site. Both are public television stations, and so both broadcast materials from the same sources. However, one station uses a CP transmitter, and the other employs the traditional HP transmission mode. Thus, the tests were conducted under actual broadcast conditions and in a wide variety of receiver locations, including open areas, urban high-rise building areas, mountainside areas, and others.

Bonneville International Corporation recently purchased a double power TV transmitter for a new CP installation at the company's Seattle outlet, KIRO TV Channel 7, on the premise that CP is a good solution to correct TV reception defects such as multipath ghosts, as reported in various trade journal articles. However, two well-known TV consulting engineers independently expressed

to us their concern about the degrading effects of CP under certain reception conditions. In order to help solve our dilemma and to get some factual information first hand, Bonneville Engineering decided to run some comparative field tests and document the results.

Being based in Salt Lake City, it was convenient to make comparative CP/HP tests, since the two VHF TV stations co-located at the same transmitter on Mt. Vision, 20 miles southwest of Salt Lake City. KBYU, Channel 11, is CP with the new Harris transmitter and antenna, while KUED, Channel 7, is conventional HP. The field tests were designed to address the following questions:

- Does CP cancel multipath ghosts and reflections in the TV picture? If so, under what conditions and how much?
- Does CP provide a stronger, more snow-free TV picture than HP? If so, under what conditions?
- How much does CP cause multipath ghosts and reflections that degrade rather than improve TV reception? Under what conditions?

Test antennas—A specially built CP receiving antenna cut to Channel 11 was ordered from Simplicity Tool Company of Portland, OR. The antenna consists of a 5-element horizontal yagi mechanically phased 90° in front of a 5-element vertical yagi on the same boom. The boom is end mounted to the mast behind the vertical reflector for minimum mast interaction. A remotely switchable phasing system is used to switch the CP antenna feeds between vertical, horizontal, right-hand circular, left-hand circular and a separate rabbit-ear antenna mounted atop the vertical mast. The rabbit-ear antenna length was adjusted halfway between maximum Channel 7 and 11 video carrier signal strength on the field meter with elements set 45° from vertical.

Additionally, two separate 5-ele-

ment horizontal yagis (one cut to Channel 7 and the other cut to Channel 11) on separate masts were used to compare the HP component of the Channel 11 CP signal with the Channel 7 HP signal. A Rohde & Schwarz field meter, a 17-inch Sony color TV set, and a 35 mm SLR color film camera were used to document the picture.

Test procedure—Using a control site with near perfect TV reception conditions approaching free space, the video carrier signal strength readings along with color photographs of the TV set picture were taken using the various antenna and polarization combinations on the CP station, Channel 11, and the HP station, Channel 7. After obtaining predictable free space results at the control site, 11 other sites, each with various reception conditions, were selected and visited. The same group of measurements and photographs were taken at each site. In every case, the antennas were positioned for a uniform signal field at a fixed height of 15 ft and oriented for maximum signal.

Results of CP tests—In the good reception areas, the CP signal delivered the expected "double power" signal strength on the CP receiving antenna with excellent picture quality and no ghosts. However, to our great disappointment, at the poor reception sites where ghosts and multipath are visible, the Channel 11 CP signal on the CP receiving antenna did not reduce ghosts and multipath reflections. In fact, the conventional HP Channel 7 had the strongest signal with the least ghosting on all the antenna combinations, including rabbit ears. The performance of CP was disappointing, to say the least.

In trying to explain the poor CP results, the theory was studied again. Theory indicates that in order for a CP receiving antenna to cancel CP ghosts, condition 1, the

Editor's note: In the wave of advances in CP antenna design and installation successes, this paper suggests some caution may be exercised in system selection. The data and its interpretation, along with the conclusions and recommendations, are those of the author. They are printed here as a service to the industry, but, such publication does not imply **Broadcast Engineering** endorsement as to test results, interpretation or recommendations.

There's a good chance that we know more about studio lighting than you do.

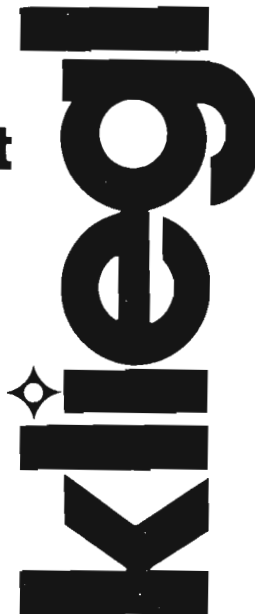

vertical component of the CP ghost signal, must be phased 90 degrees leading and of equal amplitude to the horizontal component of the CP ghost.

Furthermore, to obtain double power from the CP receiving antenna, condition 2, the vertical component of the direct CP signal, must be phased 90 degrees lagging and of equal amplitude to the horizontal component of the CP signal. Both of these free space conditions seemed to be closely approximated in the good reception areas but not in the multipath ghost area.

CP theory also indicates that if the CP reflected ghost signal does not have the desired phase and equal amplitude relationship between its horizontal and vertical components, then the ghost is amplified and the direct signal is reduced. This is condition 3.

Realizing that there are two different types of ghosts, a study was made to determine what two reflection conditions will produce a condition 1 ghost, cancellable with a CP receiving antenna, and a condition 3 non-cancellable ghost. An important clue was found by comparing the TV set picture photos from the separate horizontal and vertical antenna signal components of the CP signal. In the multipath areas, the vertical component was consistently lower in amplitude and contained significantly more multipath ghosts, while the horizontal component was stronger and relatively free from ghosts. It became obvious that the defective vertical component of the CP signal was causing the condition 3 ghosts. With this clue, further study of Electromagnetic Field Theory confirmed and explained the CP test results so that predictions could be made.

General predictions regarding CP—Condition 1 ghosts can be produced by a CP signal reflecting from a highly conductive flat surface, such as the side of a metal skinned

Kliegl was in the lighting business for more than 40 years before and we've been furnishing TV lighting and control equipment for more than 40 years after the advent of television. The fact is we've been able to help more than a thousand studios and facilities, including the five major networks in North America.

Our seasoned staff will be happy to assist you in coming up with a carefully-engineered custom design to fit your specific and special needs.

Or, if you want a really economical buy, one of our typical packages will meet the usual needs for standard sized studios.

If you like the look of your studio before you've talked to us, you'll love it after it's lighted with Kliegl equipment.

For further information, see your local agent or dealer or write Kliegl.

Kliegl Bros.
32-32 48th Ave.
Long Island City
New York 11101
212/786-7474

Circle (122) on Reply Card



Equipto Enclosures

... the highest quality electronic cabinets you can buy!

Here's why:

1. Designs are handsome and functional
2. Cabinetry is durable, rugged
3. Service — prompt and dependable

Whatever you're looking for in cabinetry or desk systems, we have several lines of modular enclosures available to effectively display and protect your instrumentation. Or, we'll custom design enclosures to suit your individual needs. Choice of color at no extra charge.

Ask about our Engineering Evaluation program.

WRITE FOR FREE CATALOG



Equipto For Quality
EQUIPTO ELECTRONICS CORPORATION
403 Woodlawn Ave. • Aurora, Illinois 60507
Phone: 312/897-4691

Circle (123) on Reply Card

CP tests

building. These ghosts should be reduced by using a proper CP receiving antenna.

Condition 2 is a CP signal under free space conditions without ground reflections. Double power can be captured with a proper CP receiving antenna.

Condition 3 ghosts can be produced by a CP signal reflecting from a poor conducting dielectric surface such as concrete, asphalt, brick, dirt, rock, mountains, trees, water, grass, ice, apartment and office buildings and ground reflections. These ghosts cannot be cancelled by a CP receiving antenna. Path obstacles, irregular metallic shapes and power lines also can produce condition 3 ghosts. The critical angle associated with reflections from poor conducting surfaces is the Brewster angle. For typical ground reflections, the Brewster angle is 6 degrees. The CP signal component normal to the surface is reflected with rapidly changing amplitude and phase near the Brewster angle.

At angles of incidence equal to the Brewster angle, the normal component is absorbed and not reflected. At small angles near zero

degrees, both the normal and parallel components are reflected with equal amplitude and uniform 180 degree phase shift. At higher angles the normal component is poorly reflected with increasing amplitude and phase shift approaching zero degrees. The CP signal component parallel to the surface is reflected at full amplitude and 180 degree phase shift for all angles of incidence. These CP signal reflections produce condition 3 ghosts that cannot be cancelled with a CP receiving antenna.

The Electromagnetic Laws of Physics and CP Theory may be used to explain and predict the poor results obtained in the CP tests in the multipath areas. The same laws and tests also confirm the conclusions reached by panel 9 of the National Television Standards Committee, NTSC, when in 1941 it observed that horizontal polarization was superior to vertical polarization in regard to multipath and ghosts.

Conclusions—After gaining an understanding of the practical capabilities of CP, with its limitations, the useful benefits of CP seem to be somewhat diminished. CP works properly under free space condi-

tions where it is really not needed. Under these ideal conditions, CP's advantages are:

- Condition 1 ghosts can be reduced with a proper CP receiving antenna.
- Double power can be extracted with a proper CP receiving antenna.
- Rabbit-ear and fish-pole antennas are less critical to adjust because the vertical component is present in CP. However, as expected, these antennas produce no more power from a CP signal than from an HP signal.

In the fringe and multipath reception areas where help is really needed, CP has a disadvantage. The defective vertical component of the CP signal is usually low in amplitude and has multipath ghosts. This non-correctable condition causes condition 3 ghosts and reduces the signal strength on all antennas, including CP and rabbit ears.

Recommendation—Both CP field tests and Electromagnetic Field Theory demonstrate that horizontal signal polarization is generally superior to CP in the poor reception areas on all types of antennas. Standard HP is therefore recommended over CP as the preferred mode of TV transmission. □

The TV Blanking Analyzer You've been hearing about!



With AFA's HV-100 TV Blanking Analyzer even an inexperienced operator can take horizontal and vertical blanking measurements **in seconds**, using only a wave form monitor or pulse-cross picture monitor.

Position the reference markers at the desired points on the monitor and interval is automatically indicated on large digital display... **that's all there is to it!**

Measurements Provided

- Picture Blanking
- Set Up Blanking
- Front Porch
- Sync Width
- Burst Length
- Sync to: Burst End
Burst Start
Set Up
- Vertical Blanking

Specification Highlights

- Horizontal Resolution** .02 u sec
- Vertical Resolution** 1/2 horizontal line
- Horiz. Time Reference** 10 MHz Crystal Clock
- Horizontal Range** .5 to 14.5 u sec
- Vertical Range** 12.0 to 30.0 lines

Rackmount or Tabletop

Price: \$1690.00

For info, or to order, Call:

**201-767-1000
415-856-1060**

AFA

A.F. ASSOCIATES, INC.
100 Stonehurst Court, Northvale, NJ 07647
2465 E. Bayshore, Suite 301, Palo Alto, CA 94303

Circle (124) on Reply Card

**NOW... The leading magazine
of broadcast technology,**

**BROADCAST.
engineering**

**brings you an important
new technical tool...**

DIRECTIONAL ANTENNA HANDBOOK

by Robert A. Jones, PE

ONLY \$12.95

Based on the recent **Broadcast Engineering** series, this 104 page volume focuses on the essentials of directional antennas then expands to encompass the entire arena of design, from a two tower array through twelve tower systems. Chapters cover such important areas as:

- Design of nighttime directional antennas.
 - Calculating RMS efficiency.
 - The FCC's Standard Method of calculating directional antennas for submission with FCC applications.
- Additional sections review the basic math used in calculations and provide tips on using computers and hand calculators for computation.

Whether you use a consultant or design your own systems, this book is an absolute must. Order yours today!

The Latest From The Leader In Broadcast Technology...
Broadcast Engineering's Directional Antenna Handbook
ONLY \$12.95

Directional Antenna Handbook

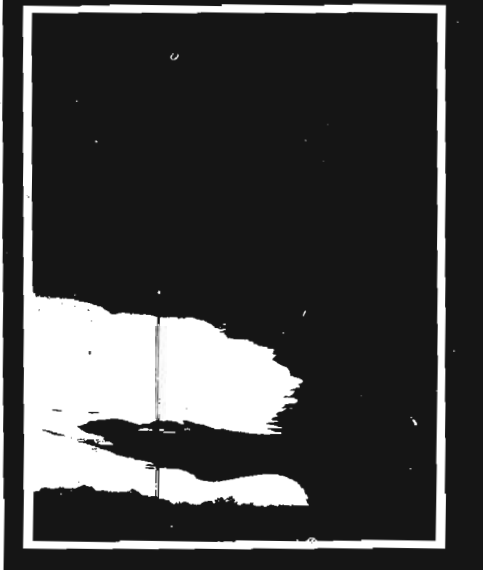

ORDER FORM

**BROADCAST.
engineering**

P.O. Box 12901, Overland Park, KS 66212

Please send me _____ copies of the Directional Antenna Handbook at \$12.95 each. (Postage Included.)

My check or money order is enclosed.

Name _____

Address _____

City _____

State _____ Zip _____

PORTABLE AC/DC COLOR MONITORS

CP 8000 8" AC-DC



FEATURES

- HV REGULATION
- PULSE CROSS
- UNDERSCAN
- A-B INPUTS
- MODULAR CIRCUITRY
and MUCH MORE
- RACK MOUNTING AVAILABLE



P.O. BOX 117 • BOYERTOWN, PA 19512
PHONE 215-367-6055

Circle (125) on Reply Card

Blanking Problems?



A new instrument from World Video, Inc. will enable you to check your blanking and measure it quickly and accurately.

The PWI provides a quick and accurate measurement of any pulse or combination of pulses on the H line. In addition, vertical blanking may be measured to an accuracy of 1/2 line with independent measurement of vertical field A & B. All measurements are easily read in microseconds or lines on the front panel LED display.

PWI is installed in-line with a waveform or pulsecross monitor and does not require modifications to other equipment.



P.O. BOX 117 • BOYERTOWN, PA 19512
PHONE 215-367-6055

Circle (126) on Reply Card

Station- to-Station

Tape recorder air-checks programming

By John Shepler, chief engineer, WROK/WZOK, Rockford, IL

Many program directors and announcers air-check their shows by having a recorder running only when the studio microphone is on. The usual method involves wiring the motor circuit of a cassette machine through the microphone muting relay. Although this works, it is desirable to have a studio quality reel machine start and stop in conjunction with the microphone switch.

At WZOK there are two ITC 850 reel-to-reel recorders in the FM control room. An enclosed circuit starts the recorder when the microphone is on and stops it when the mic goes off. A switch (S1) determines whether the machine will run normally or in the air-check mode. When S1 is closed, the record and start circuits are energized through diodes D1 and D2. The stop circuit is controlled through diode D3

which is routed through a set of normally closed contacts on the microphone mute relay in the board (S2).

If the microphone is off, the mute contacts are closed and the stop circuit is energized. The stop circuit will take precedence over the other circuits and the machine will remain stopped. When the relay contacts open (microphone on) the stop circuit will be open and the machine will start in the recording mode.

The circuit is simple to construct using three rectifier diodes (type 1N4004 or equivalent). The recorder connections are made on the remote control plug (P1) which may also be used for its normal function. When the switch S1 is open, the recorder behaves just as though the air-check features was not connected. All normal remote control connections also remain the same.

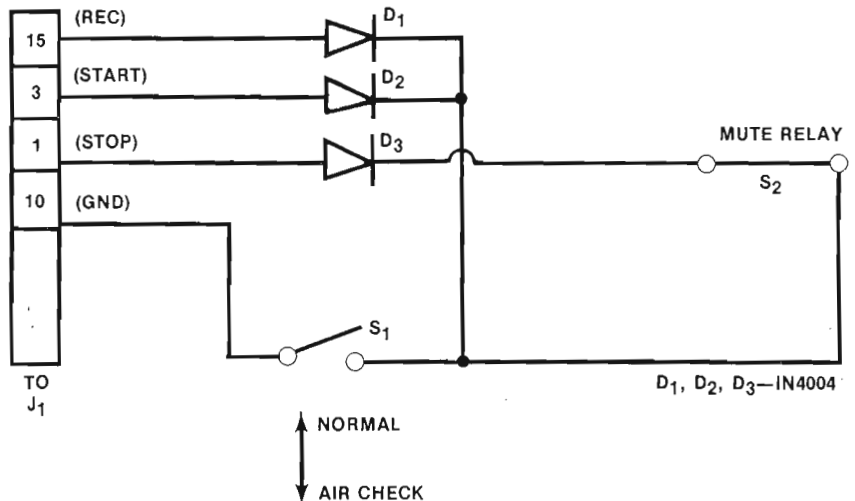

Back in action with improvised horn feed

By Steve Flyte, ENG engineer, KATU, Portland, OR

KATU, the ABC affiliate in Portland, OR, has used live/tape ENG capabilities extensively and aggressively since January 1976. So, I

figured December 27, 1978 was going to be more or less a routine day for me. I was driving our Mobile Two news van to Salem, 50

ELECTRONICS UPGRADING Seminars

at ST. LOUIS, MO.

CONSUMER/DEALER TECHNICIANS
NOVEMBER 7 - 9, 1979

INDUSTRIAL MAINTENANCE TECHNICIANS
NOVEMBER 14 - 16, 1979

SPECIAL OPTION - VTR Servomechanism Servicing
NOVEMBER 10 or 17, 1979

Consumer or industrial electronics upgrading made easy.
Unique, concise tell-and-show methods, plus hands-on experience,
place new electronics technology at your fingertips.

So VITAL that no electronics servicer should miss it!

SUMMARY OF THREE-DAY SEMINAR

DAY 1 - TRIGGERED SCOPES Hands-On Workshop

Learn to manipulate modern scopes wisely and knowledgeably. Speed up troubleshooting of even the most complex equipment. This familiarization program explains controls for CRT, vertical input, time base, and triggering...plus advanced scope techniques. Scope displays become easy to analyze after this day-long session, with Forest Belt instructing.

DAY 2 - SOLID-STATE UPGRADING and Updating

Gain unexpected insight into new and established solid-state devices and technology. Practical, entertaining tips on solid-state circuitry teach you how to troubleshoot quickly. Industrial maintenance session covers higher-power solid-state devices and applications. Wayne Lemons instructs.

DAY 3 - DIGITAL ELECTRONICS for Home or Industry

Clear up mysteries of digital electronics: gates, flip-flops, R-S stages, truth tables, and more. Practical help in troubleshooting digital circuits. Instruments that make servicing clear and direct. An information-packed day that puts you on top of digital technology, whether for consumer or industrial electronics. James R. Manery and Forest Belt instruct.

VTR Servomechanisms - OPTIONAL (Separate Fee of \$150)

Take the uncertainty and frustration out of VTR servicing. Forest Belt guides you step-by-step through the electronic heart of motor control in Beta and VHS video recorders. Truly understand the unusual three-phase, electronically commutated, direct-drive DC motor that spins the helical-recording heads drum. On the day industrial technicians attend, U-Matic will be treated too.

FEES:

Consumer/Dealer Tech Session November 7, 8, 9, 1979	\$ 750 *
Industrial Tech Session November 14, 15, 16, 1979	\$ 850 *
VTR Servomechanisms Session November 10 or 17, 1979	\$ 150 †

FEES INCLUDE:

- † * Timely training
- † * Best teachers
- † * Carry-home manual
- * Hands-on experience
- † * Certificate of training
- * All workshop materials and functions
- * Hotel room (double-occupancy)
- * Meals † Lunch only

Here's my enrollment.

NAME _____ AGE _____
 COMPANY _____ TITLE _____
 ADDRESS _____
 CITY _____ STATE _____ ZIP _____
 PHONE () _____

Mail to: **Liaison**
P. O. Box 40821
Indianapolis IN 46240

I want to attend:

- Consumer/Dealer Technician Session
November 7, 8, and 9, 1979 \$ 750
- Industrial Maintenance Technician Session
November 14, 15, and 16, 1979 \$ 850
- VTR Servomechanisms Session - Consumer
November 10, 1979 \$ 150
- VTR Servomechanisms Session - Commercial
November 17, 1979 \$ 150

TOTAL Enclosed \$ _____
 Check number _____ Money Order _____

Sorry, but the Tangent Series 80 Production Console offers only two standard features.

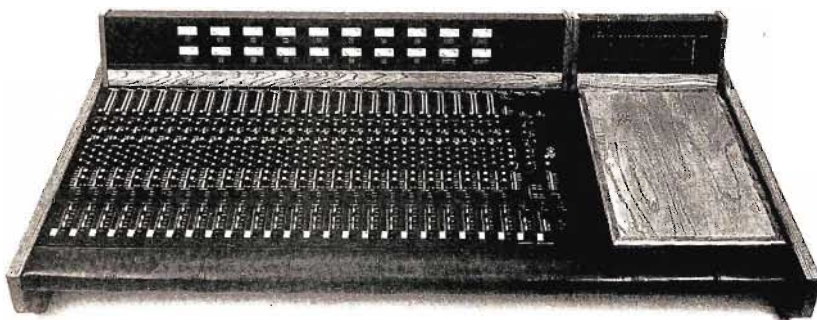

The two most important features are the basics of the Tangent Series 80 . . . flexibility and reliability. From those **you design** the system that fits your complicated needs.

Reliability? We build the series 80 custom production consoles specifically for the broadcast, film, and video production industry, using only durable, quality components such as Penny & Giles conductive plastic faders and extrusion-anchored mainframes. Built solid, built for years of round-the-clock use.

Flexibility? Semi-parametric equalization, multiple echo and cue sends, and up to 16 output assign busses are some of the options that give you full capability for any production situation.

You design it? What you need and want on your console is strictly up to you . . . except we insist you always take our two standard features. Call us at (602) 267-0653 today and let's make plans.

tangent 

2810 South 24th Street / (602) 267-0653
Phoenix, Arizona 85034

Circle (233) on Reply Card

Station-to-station

miles south of Portland, to meet the Channel 2 and ABC Network news teams to transmit their videotapes back to Portland for their respective news broadcasts.

After meeting with the crews and discussing our operation plans for the day, I proceeded up the hill not far from the Marion County Courthouse to establish our microwave circuit. It was when I arrived up on the hill that I discovered our Nurad circularly polarized feed section for our 4-ft dish on the roof was missing. Like most of the news vans around the country, Mobile Two stores its feed section inside the van when traveling, and when the dish is erected for transmitting, the center feed horn with its four arms is held to the dish with four small tabs.

Without that one component, our \$275,000 news van was not worth a thing to anybody. The first idea that came to mind was to try to fabricate some sort of makeshift assembly to fit to the dish. A telephone call to the local TV station proved negative—no extra 2GHz dish components laying around the shop. Next, I tried the Microflect Company. They install large microwave repeater sights all over the nation. After going through their junk box, all we could come up with was a feed horn for a 10-ft dish, instead of something for the 4-footer mounted on the van. Figuring that the focal length would be wrong, I decided to try it anyway.

The borrowed feed assembly was quite heavy and approximately 4-ft long. It required lots of rope and gaffer tape to hold it into place.

After installation, I contacted the studio—nothing. I really didn't expect anything with the focal length being so far off.

Almost ready to bag it with the agony of defeat, I decided to try one more thing. There happened to be a short piece of RG-11/U coax in the van with an N connector on it. I called back to the station and asked the assistant chief engineer to look up in the Nurad manual what the proper focal length was supposed to be. He called back and said approximately 22 inches.

At this point, I took some of my 15 years of experience with amateur radio antennas to mind (dipoles and yagis) and fanned the shield and center conductor on the end of the coax into a small dipole, each side being ¾-inches long. I ran the coax through a small hole in the center of the dish, pulled it out to 22 inches



from the center, and just held the little dipole out in midair with lots of gaffer tape supporting it. I oriented the dipole in the horizontal configuration, and called the station again to look for my signal.

I went up on the roof of the van and started tuning the dish. To everybody's surprise a trace of bars were starting to appear on the monitors and scopes at the station. We all felt like Marconi sending his first radio signals across the Atlantic. More tuning proceeded, and finally the studio told me we had a fine quality, fully broadcastable signal with this Rube Goldberg concoction. We were all amazed. (Have you ever opened up one of the Nurad horns and seen the complexity of plumbing, coaxes, etc.?)

Soon, Channel 2 News and ABC arrived, and they sent their tracks and everybody was happy. Later that night, I drove back to Portland, and we did a live basketball remote from Memorial Coliseum for Channel 2 News. What a day!

FREEZE-FRAME & SLO-MO

"the easy way"

ATHENA 4000

*

ATHENA 5000

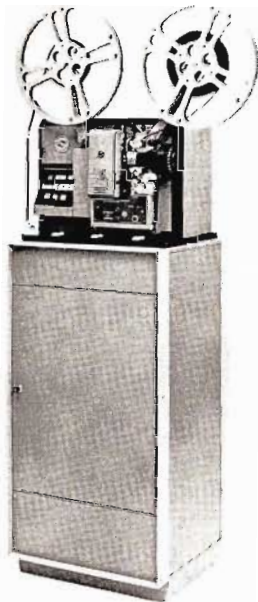

The Athenas give you six more features than the RCA TP-66 or the EK CT-500: **AT LOWER COST!**

1. Freeze-frame, instant start/stop, animation, slo-mo—all direct from film to tape by TV film chain.
2. Digital control CMOS circuitry for complete low-voltage remote control and/or computer control.
3. 115V 60 HZ or 220V 50 HZ
4. Modular digital design for easy service.
5. Extended 2-3 year warranty.
6. Insured against obsolescence—retrofitable to new design improvements and options.

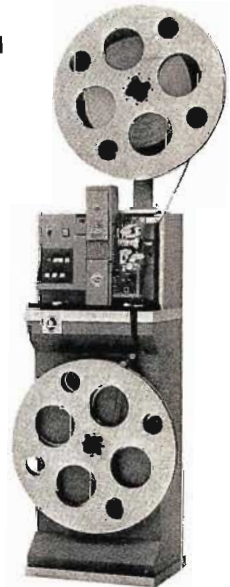

Call or write Pat Smith, Dave Stern or Bob Lawrence for additional information and/or name of nearest dealer.



L-W INTERNATIONAL
6416 Variel Avenue
Woodland Hills, CA 91367 U.S.A.
Telephone: 213/348-8614

Circle (131) on Reply Card

The AUTOMATIC Audio Test System

That Measures. . .

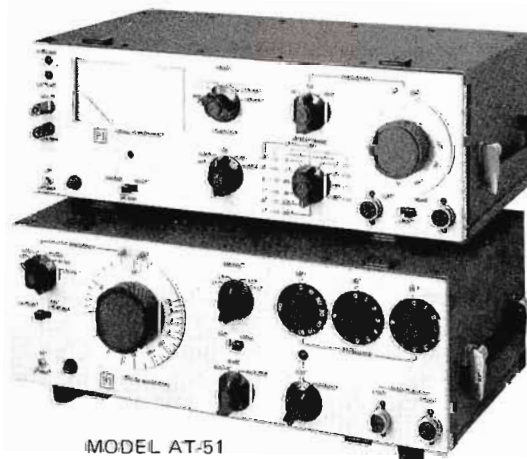

MODEL AT-51
AUDIO TEST SYSTEM

- Harmonic Distortion
- Intermodulation Distortion
- Volts
- dB
- Signal + Noise / Noise Ratio
- Wow and Flutter
- Stereo Phasing
- Differential Gain in Stereo Channels

Contact Us Now For Complete Details And Descriptive Literature.

POTOMAC INSTRUMENTS

932 PHILADELPHIA AVE.
SILVER SPRING, MD. 20910
(301) 589-2662

Circle (132) on Reply Card

September 1979 *Broadcast Engineering* 137

FACT!

No one can match The Complete Lightning Protection Systems from LEA.

- ANTENNA DISSIPATION ARRAYS TO PREVENT LIGHTNING STRIKES
- GUY CHARGE DISSIPATION CHOKES
- SURGE ELIMINATORS* FOR MAIN POWER LINES OF SERIES HYBRID DESIGN TO HANDLE REPEATEDLY ENERGY LEVELS OF > 5500 JOULES PER PHASE
- * THOUSANDS IN USE REFERENCES AVAILABLE

- KLEANLINE ELECTRONIC FILTERING SYSTEMS TO PROTECT AGAINST LIGHTNING STRIKES AT > 5500 JOULES PER PHASE PLUS AN RF/EMI FILTER TO HANDLE RF INTERFERENCE FOR SENSITIVE SOLID STATE EQUIPMENT.

- TRANSIENT ELIMINATORS FOR DATA LINES, PHONE LINES, COMMUNICATIONS EQUIPMENT WITH A FREQUENCY RESPONSE FROM D.C. TO 1 GIGAHERTZ.

- LIGHTNING WARNING SYSTEMS PROVIDING 1/2 HOUR ADVANCE WARNING OF AN APPROACHING STORM.

- SURGE AND TRANSIENT GENERATORS
- GROUND SYSTEMS
- CONSULTING SERVICES

Lightning Elimination Associates



12516 Lakeland Road
Santa Fe Springs, CA 90670
(213) 944-0916

Circle (133) on Reply Card

Station-to-station

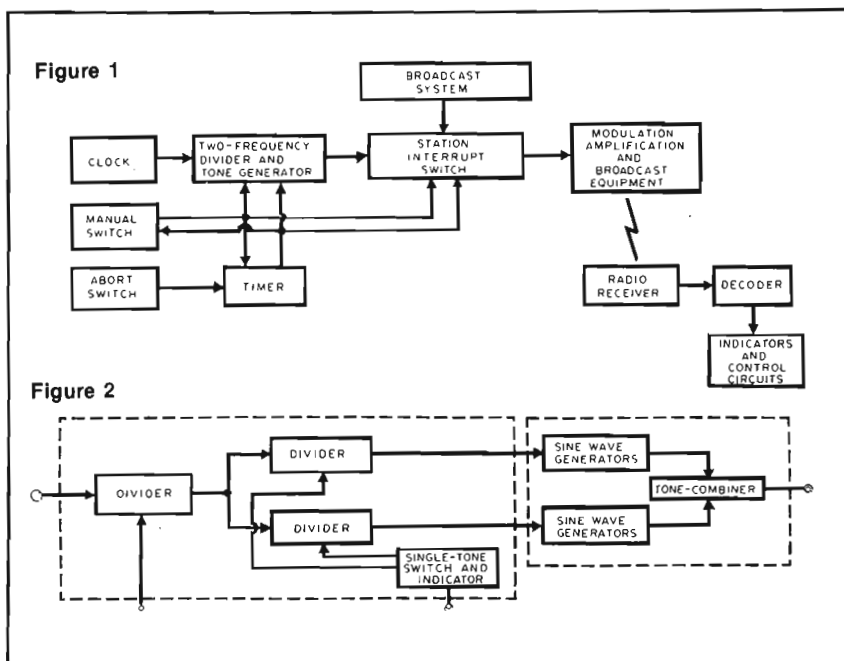

2-tone attention signal broadcasting system

By Patrick Bryant, studio/theater engineer, ABC, Hollywood, CA

In the past, the FCC has required participating broadcast stations to have equipment for broadcasting a warning signal in the form of a carrier-break followed by a 1000Hz tone. The FCC now requires two tones to be broadcast simultaneously at 853Hz and at 960Hz with a variation of less than ± 0.5 Hz for a period of time between 20s and 25s.

One class of such 2-tone broadcasting equipment includes a manual switch, that, when depressed, causes a switch to interrupt the audio signal from the broadcast studio and a generator to generate the 2-tone signals and a circuit that combines the two signals for amplification and modulation.

Conventional implementation of such a system suggests that (1) the time that the warning signals are broadcast is controlled by an analog circuit (such as an RC circuit); and (2) two sine-wave signals are generated in tank circuits for combination and application through the interrupt switch to the amplification and modulation equipment. Such circuitry is known in other types of tone transmitting systems. This type of system has the disadvantage of being relatively expensive and not as precise as desired. The expense occurs because timing equipment

with the required accuracy and the equipment necessary to generate the sine waves is expensive.

Signaling systems are known which generate the two frequencies digitally, convert them to sine waves, and combine these sine waves for broadcasting. Such a system is disclosed in US Patent 3,676,780 to Niemann. However, this type of equipment has relatively high distortion and low accuracy in the timing of the signals. One cause of the distortion is that the digital signals are applied directly without differentiation to resonant tank circuits for conversion to sine waves. This distortion, coupled with any distortion from the application of the signals through telephone wires from the interrupt switch, is a disadvantage which would impede the direct use of such equipment in a 2-tone attention signal generator.

A new circuit (US Patent 4,103,235) provides a novel 2-tone attention signal broadcasting system. The circuit was designed to provide (1) a 2-tone attention signal broadcasting system which is relatively inexpensive; (2) a system with a relatively simple and inexpensive timing system that provides precise timing of the duration of the signals; (3) a low distortion 2-tone system;

(4) a sine-wave generator which provides a low distortion sine-wave output signal from a square-wave input signal; (5) a system for generating two frequencies from a single clock frequency and combining them into a 2-tone sine-wave audio signal; and (6) an interrupt system for terminating the audio signal from a broadcasting station and transmitting instead a 2-tone attention signal to the amplification, modulation and transmitting equipment.

Accordingly, the 2-tone attention signal broadcasting system described here includes an encoder and an interrupt switch. The switch interrupts the audio signal which is being transmitted from the studio to the modulation, amplification and broadcasting equipment upon the depressing of a manual switch and transmits instead a 2-tone signal developed by the encoder for a fixed period of time between 20s and 25s. The 2-tone signal is received by receivers forming part of the 2-tone attention signal broadcasting system and decoded to provide an alarm and to demute certain radio receivers for a reception of further information.

Complete details of the entire system may be obtained by purchasing referenced patent from the US Patent and Trademark Office, Washington, DC 20231.

Building a digital lock

By John Linebarger, WREG-TV, Memphis, TN

We have constructed a digital lock to eliminate a large number of keys that would be necessary if a majority of station employees were to have access to the building entrance or any door for that matter. Additionally, eliminating the need for even having a key would eliminate lost or stolen keys.

The lock can be constructed using TTL logic devices available from the shelf of any electronics retailer. A power supply of 150 mA should be plenty for power with the exception of the external door controls or alarm.

The circuit is very straight forward. In order to gain access, one presses four buttons or flips four switches to enable the device to function. After this is done, a TTL logic level is sent to a transistor driver for door release. If the wrong

Convert Your Analog Remote Control to DIGITAL metering

TEL 171 Digital Telemetry conversion kits for Moseley TRC-15A remote control.

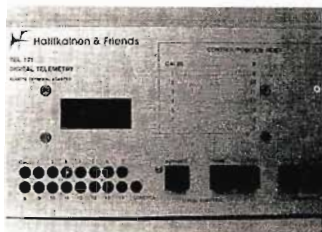

- Adds LOCAL DISPLAY to remote site.
- Permits One-Man meter calibration.

- Easy to read display.
- Automatically locates decimal points.
- Eliminates calibrate and zero-set controls.

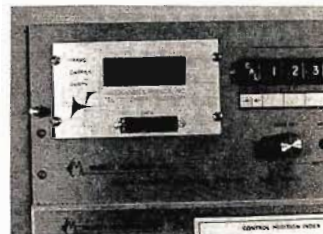

Hallikainen & Friends

101 D4 Suburban Road, San Luis Obispo, CA 93401

Circle (134) on Reply Card



A professional makes even the toughest jobs seem easy

That's the way it is with Waters professional audio attenuators. They feature glass-hard MystR® conductive plastic elements and slip rings as well as precious metal contacts. What's more, Waters computer-controlled curve-shaping technique assures superior tracking.

Result: smooth, quiet, long-life performance under the most grueling service conditions.

You'll find Waters complete line of professional audio controls meets every need — linear or rotary motion — mono, stereo, or quad. Two standard impedance values are now available, 600 or 10,000 ohms.

If you're into mixing, you ought to get the complete story on Waters audio controls. Write today, or call us at 617-358-2777.

It's the professional way.

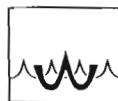

**WATERS
MANUFACTURING, INC.**

Longfellow Center, Wayland, MA 01778 617-358-2777

Circle (135) on Reply Card



September 1979 *Broadcast Engineering* 139

You can take this memory and STUFF IT.

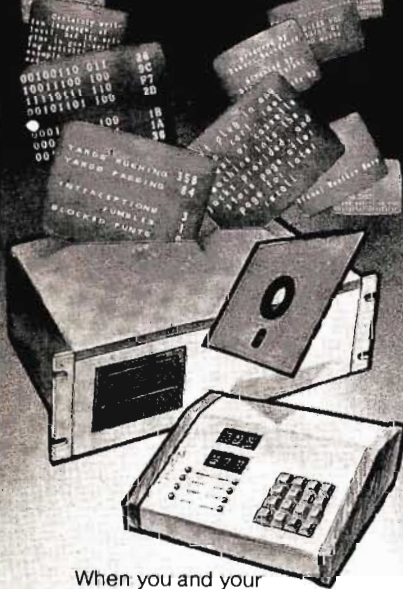

When you and your character generator have a lot to say ... long credit rolls ... sports stats ... lectures ... titling for the hearing-impaired ... the Knox KD128 disc memory system can hold 350 pages of it.

And it's programmable. With a single keyboard, you can create your copy and write a program — onto the same disc — that will completely cue the playback. Roll or crawl non-sequential pages.



Have random pages recalled and displayed for a preset amount of time. All day, if you want.

Build a few pauses into the program if you need to get into it in real time.

You should see what you can do with it.

Call your Knox rep and you can.



A DIVISION OF COMPUTER OPERATIONS, INC.
9700-B George Palmer Highway, Lanham, MD 20801
301-459-2106

Circle (136) on Reply Card

Station-to-station

code is pressed and then **enable** is pressed, an alarm TTL level is sent. Again this signal can drive a transistor stage to sound an attempt to open the door.

The device was installed on an interior door that only certain employees have access to. It has

worked very well but a series of set-reset flip flops for the code buttons would have simplified things. It is a little awkward pressing five buttons at once. Of course, the more devices in the lock the less likely someone is going to want to build it.

GENERAL PURPOSE DIGITAL LOCK
IN THIS CONFIGURATION 1010 OPENS
DOOR; ETC. ALL OTHERS WITH THE
EXCEPTION OF 0000 WILL SOUND ALARM.

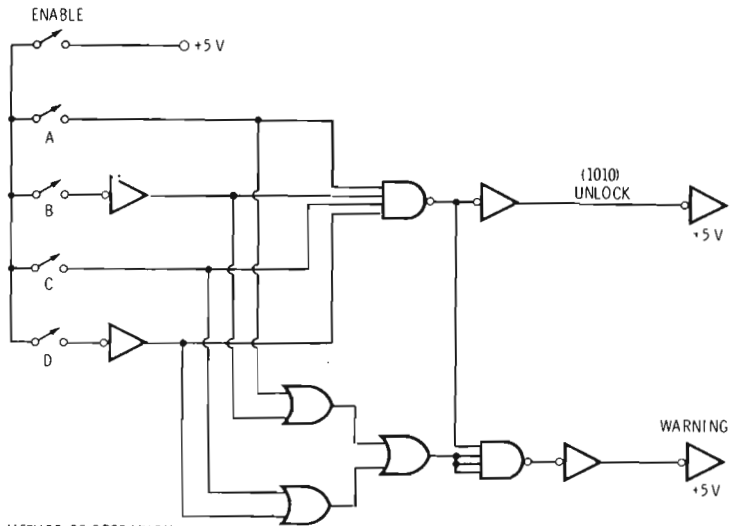

METHOD OF OPERATION:

1. CLOSE SWITCH ACCORDING TO COMBINATION. (1010)
2. PUSH ENABLE FOR UNLOCK.
3. RESET SWITCHES

COMBINATION CAN BE ALTERED ACCORDING TO INVERTOR PLACEMENT.

Figure 1

THE UNLOCK OR THE ALARM CIRCUIT CAN
FEED A TIMING DEVICE FOR A HOLD FEATURE.

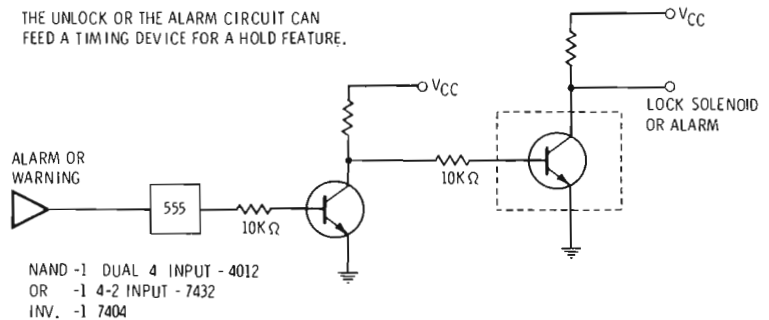

NAND -1 DUAL 4 INPUT - 4012
OR -1 4-2 INPUT - 7432
INV. -1 7404

5V - POWER SUPPLY

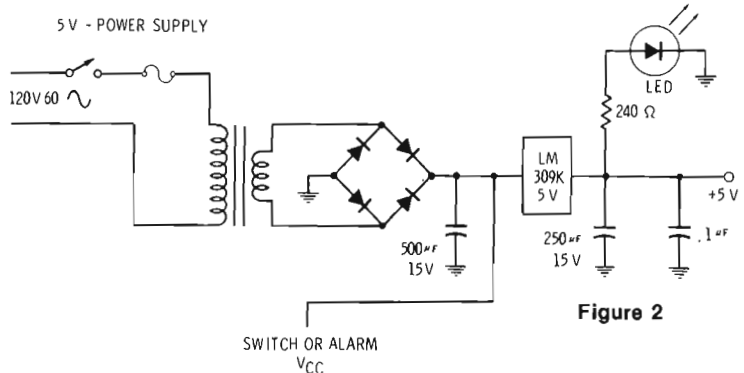

Figure 2

An improved digital logic probe

By Edward P. Alciatore, III, weekend supervisor, WCKT-TV, Miami

There was an article in November, 1977, **BE** on how to build an inexpensive digital logic probe. Since everything is becoming more digital, I immediately started looking for the parts for this useful device. Several days later, after spending even less than the \$3.50 claimed by the original author, I had my probe ready for testing. The high and low lamps worked perfectly, but the pulse lamp would not function.

I determined that the circuit would work if the $1/\mu\text{F}$ capacitor had a large amount of leakage. This struck me as a rather undesirable situation, so I revised the pulse detector section as shown in Figure 1. I also raised the input impedance by using voltage divider R1 (680 K), R2 (300 K) to bias the probe at 1.5 V when no input is present and I selected resistors R3 (2600), R4 (1900) and R5 (500) to provide a low threshold of 0.5 V and high threshold of 2.4 V. This combination of probe bias and threshold voltages provides a better match to TTL characteristic and turns all the

lamps off when the probe is not being used or if the circuit being probed is in a high impedance state. This precludes getting false low readings.

I used this version for some time but found that, useful as it was, it did not show the fast, low duty cycle pulses often found in digital circuits. These pulses are one of the prime reasons for using a logic probe. You always miss them on the scope due to limited bandwidth, improper triggering or a brightness control that stops $1\frac{1}{2}$ turns before the necessary intensity level is reached.

Looking at the circuit again, I quickly determined that the limited bandwidth of the LM339 was the problem. However, since we are trying to detect logic pulses, logic ICs should provide a good means of catching them. In Figure 2, the 74123 is a dual, edge triggered, mono stable multivibrator. By using the normal input on one section and the inverting input on the other section, one of the outputs will be present for either positive going or

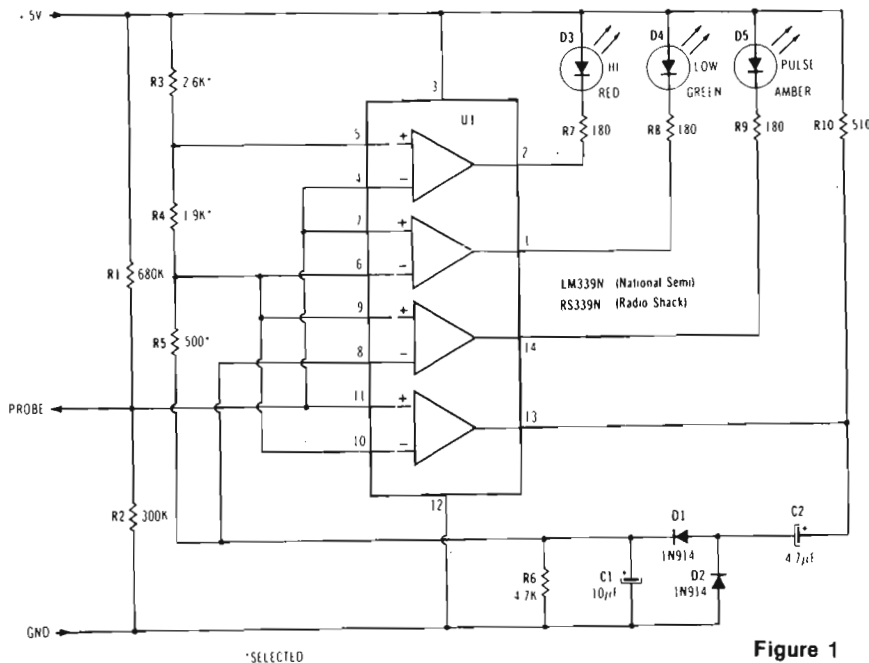

Figure 1

OTARI MX-5050-B BROADCAST RECORDER



Otari's new MX-5050-B continues the proud heritage of the MX-5050 Series, a recorder now extensively used by television and radio broadcasters worldwide. The new version has all the proven features of the earlier pace setter, including front adjustable bias and record EQ, built-in test oscillator, edit and cue, splicing block, motion sensing, selective reproduce, and adds many new features all its own: ultra reliable TTL switching, noise free inserts, three speeds in field-selectable pairs of $15/7\frac{1}{2}$ or $7\frac{1}{2}/3\frac{3}{4}$ ips, 24 dBm headroom with 28 dBm output into 600 ohms, dc capstan servo with $\pm 7\%$ speed control (to match program length to a time slot), peak reading LED plus standard full sized VU meters, return to zero memory, and LED function indicators, among others.

Add these features to a 66 dB S/N ratio and a frequency response from 30 to 22,000 Hz ± 2 dB at 15 ips and you have a machine that competes with those costing thousands of dollars more.

Compare features and benefits, compare performance, compare our track record for reliability. Call Ruth Pruett at 415/593-1648.

PREFERRED
BY PROFESSIONALS

OTARI
WORLDWIDE

Otari Corporation
981 Industrial Road
San Carlos, California 94070
415/593-1648 TWX 910-376-4890
Circle (137) on Reply Card

We Make Fiber Optics Work

Optical Communications is not new, but broadcast quality optical communication for TV is a whole new story. And Telemet has installed more Optical Communication links for TV Broadcasters than anyone else. So get the whole story from the people who wrote the book — use the coupon below.

OK Telemet, send me the complete story on Fiber Optic Communication Links for TV Broadcasters.

NAME _____
 TITLE _____
 COMPANY _____
 ADDRESS _____
 CITY _____
 STATE _____
 ZIP _____
 PHONE _____

Telemet

185 Dixon Avenue
 Amityville, N.Y. 11701
 (516) 842-2300



A Geotel Company

Circle (138) on Reply Card

Station-to-station

negative going transitions. R11-C1 and R12-C2 determine the length of the output pulses and therefore how long the pulse lamp is lit. The values shown should provide about 0.1 s.

The inverted outputs from U2 are combined in U3 which acts as a NOR gate. This output will be high for 0.1 s after each positive or negative transition in the probe. The third section of U1 compares this with a 1.5 V reference and drives the pulse lamp, D3. The other section of U3 is used as a buffer between the probe and U2; it accounts for most of the input loading of 1.2 unit TTL loads.

The high and low detectors are simple voltage comparators as in the original circuit. F1 and D4 form a protection circuit which I haven't tested so you may use them or not as you wish.

I packaged the circuit with a double sided PC board in a 1"x2"x3" (nominal) plastic box with a metal cover. The circuit board is mounted on four 4-40X 3/4-in screws

used as standoffs and the LEDs are mounted with long leads to allow them to fit through holes in the cover. I kept the probe and power leads to a reasonable length to avoid stray capacitance and pickup. A single sided board with jumpers, perfboard or even the IC bricklaying techniques could also be used.

The main disadvantage of this approach is that the probe is now limited to the various forms of TTL and a 5 V supply voltage. On the positive side, the 74123 is guaranteed to detect 40 ns pulses and in tests, my probe detected the shortest pulses I could breadboard, about 8 ns. This, plus the other improvements, should make it a very good TTL probe.

My cost was well under \$10 although you could exceed this amount if you pay top price for too many of the parts. I have found this probe to be an excellent TTL troubleshooting aid and it fits well in my policy of acquiring minimum cost test equipment with the maximum possible utility.

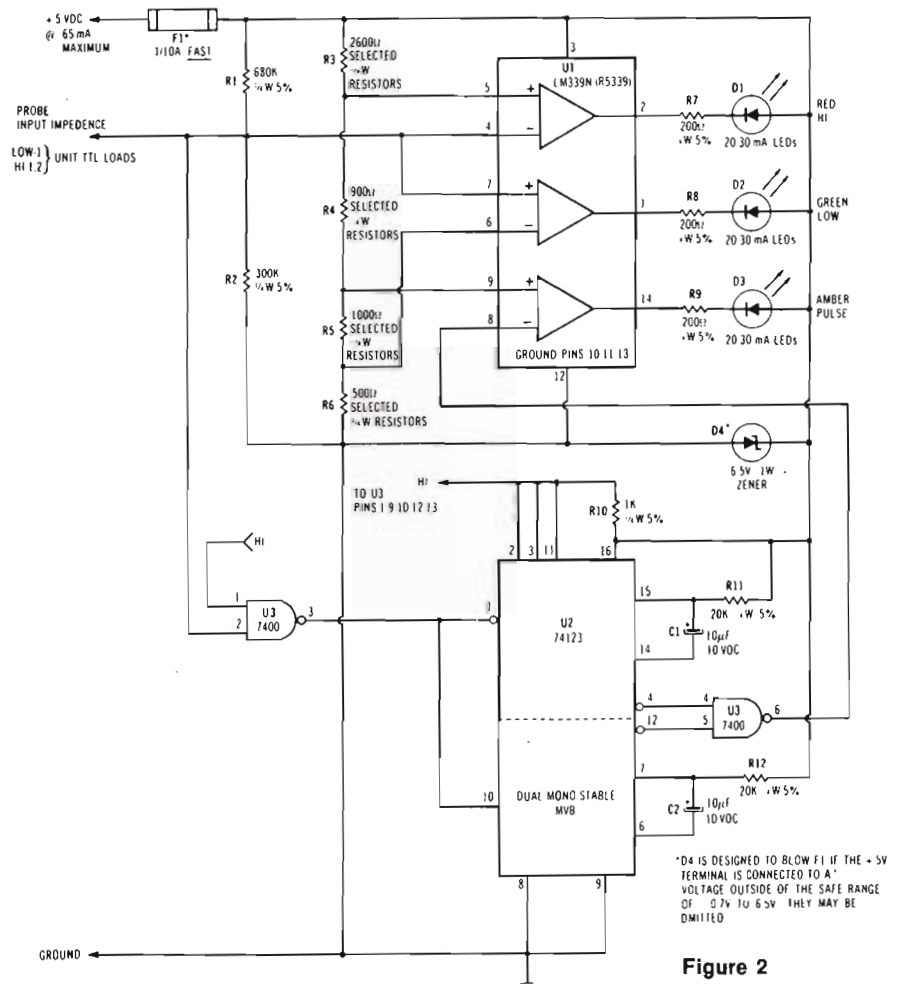
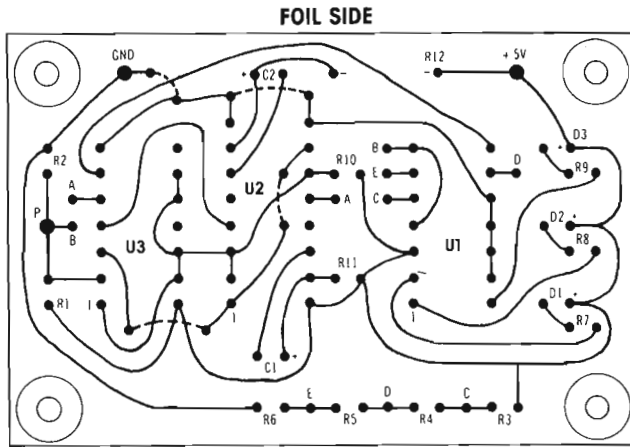
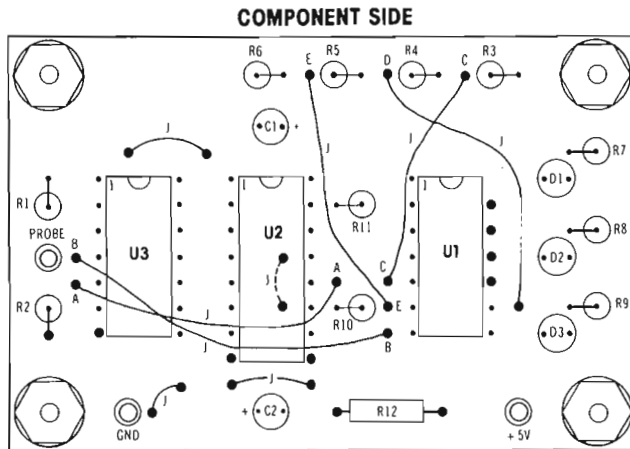

Figure 2

OTARI MARK II BROADCAST RECORDER



DASH LINE INDICATED JUMPERS ON COMPONENT SIDE



J = JUMPER (9 JUMPERS TOTAL)

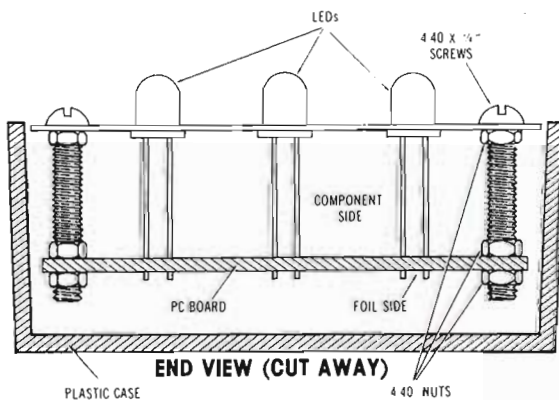

A second generation recorder incorporating all the field-proven Otari features plus several new items of special interest to broadcasters. These include: modular transport and electronics for convenient console, rack or portable mounting, plug-in cards for ease of maintenance, splicing block, complete accessibility to all electronics adjustments for fast bias and record/reproduce alignment, variable speed ($\pm 7\%$) dc capstan servo to precisely match program length to a specific time slot, and interface jack for dbx or Dolby noise reduction switching. Standard Otari features include true professional quality and reliability, motion sensing, selective reproduce on all channels, 19 dBm headroom, XLR connectors, edit and cue, and built-in test oscillator. Available in two-channel 1/4-inch or four-channel 1/2-inch models.

Compare features and benefits, compare performance, compare our track record for reliability. Call Ruth Pruett at 415/593-1648.

**PREFERRED
BY PROFESSIONALS**

OTARI®

WORLDWIDE

Otari Corporation
981 Industrial Road
San Carlos, California 94070
415/593-1648 TWX 910-376-4890
Circle (139) on Reply Card

Station-to-station

The 150 Hz/8kHz tone detector for cartridge machines

By Tom M. Cupp, broadcast operations engineer, WCTE-TV, Cookeville, TN

I have designed and built a 150 Hz/8 kHz tone detector for cartridge machines. A description of the circuit and components follows.

The power supply for the tone detector is a dual voltage supply that supplies the +30 Vdc (relay pull-in voltage) and the regulated +5 Vdc (detector circuit voltage). C1, C2 and C3 are filter capacitors. R1 is a 2 W dropping resistor. Five detector circuits can easily be powered by this circuit.

The preamp may or may not be needed, depending upon the cart machine used. I found it necessary with the ITC-3D and the Harris Criterion machines. This circuit amplifies the tone to a level that provides a good sample at the detector IC input. The amplifier is common to both the 150 Hz and the 8 kHz tones.

The 150 Hz detector IC is a LM 567 tone decoder phase locked loop with a 0 to 14% controllable bandwidth determined by R8 and R9 and adjusted by R9. These resistors provide an approximate bandwidth of 140 Hz to 160 Hz.

When the determined tone is detected IC 1 provides a saturated transistor switch to ground which, after passing through a 7404 inverter (one section of the 7404), is fed to the relay pull in circuit.

To best adjust the detector circuit:

- Hook a frequency counter to pin 5 of the IC. Adjust R9 until 150 Hz is obtained. You are adjusting the current controlled internal oscillator.
- From a reliable audio oscillator, feed 150 Hz into the IC on pin 3. (1 V or less)
- Place a dc voltmeter on pin 8 of the IC. If the circuit is working properly, you will read zero V when the tone is present.
- Remove the tone from pin 3. You should now read +5 V on pin 8.
- A slight adjustment of R9 may be necessary to compensate for characteristics of tape and cartridge machine.

Basic operation of the 8 kHz detector is the same as the 150 Hz

SMPTE Editing!



- Datametrics Compact SP733 Reads Time/User Information Over All Input Ranges.
- Manual Use Based on Display and/or Video Inserter.
- Automatic Use Based on Logic Compatible Outputs.



datametrics

Datametrics, Inc.
340 Fordham Road, Wilmington, Mass. 01887
Tel: (617) 658-5410 TWX 710-347-7672

Circle (140) on Reply Card

NORTH



C.S.P.

Inc.

203 Airport Road • Doylestown, PA 18901
Phone: 800-523-6010 • In Pennsylvania: 215-345-7386

Circle (141) on Reply Card

detector but the frequency determining components are different. Also C11 is a paper .047 μF used for stability. Frequency adjustments are made with R13. Frequency range or bandwidth is from 7500 Hz to 8500 Hz.

After passing through the 7404 inverter, the signal passes through a special delay circuit. This circuit may or may not be desirable for your operation. Some cart machines run through 150 Hz oscillator being started up. This action causes the 150 Hz detector (if used as an end of message detector) light to momentarily flash. The delay circuit is of 1

to 2 s delay and will prevent this. When saturated with several bursts of 150 Hz, the delay will in effect become invisible to the signal. Again, this action may not be undesirable to your operation. The delay circuit consists of C9 and R11.

The basic operation with the 8 kHz relay pull in circuit is the same as the 150 Hz circuit, but the delay circuit should not be used.

Practically all parts used in the circuit were bought at a local Radio Shack. Each deck or cart machine requires a 150 Hz and 8 kHz detector costing about \$30 each. The power supply costs about \$15.

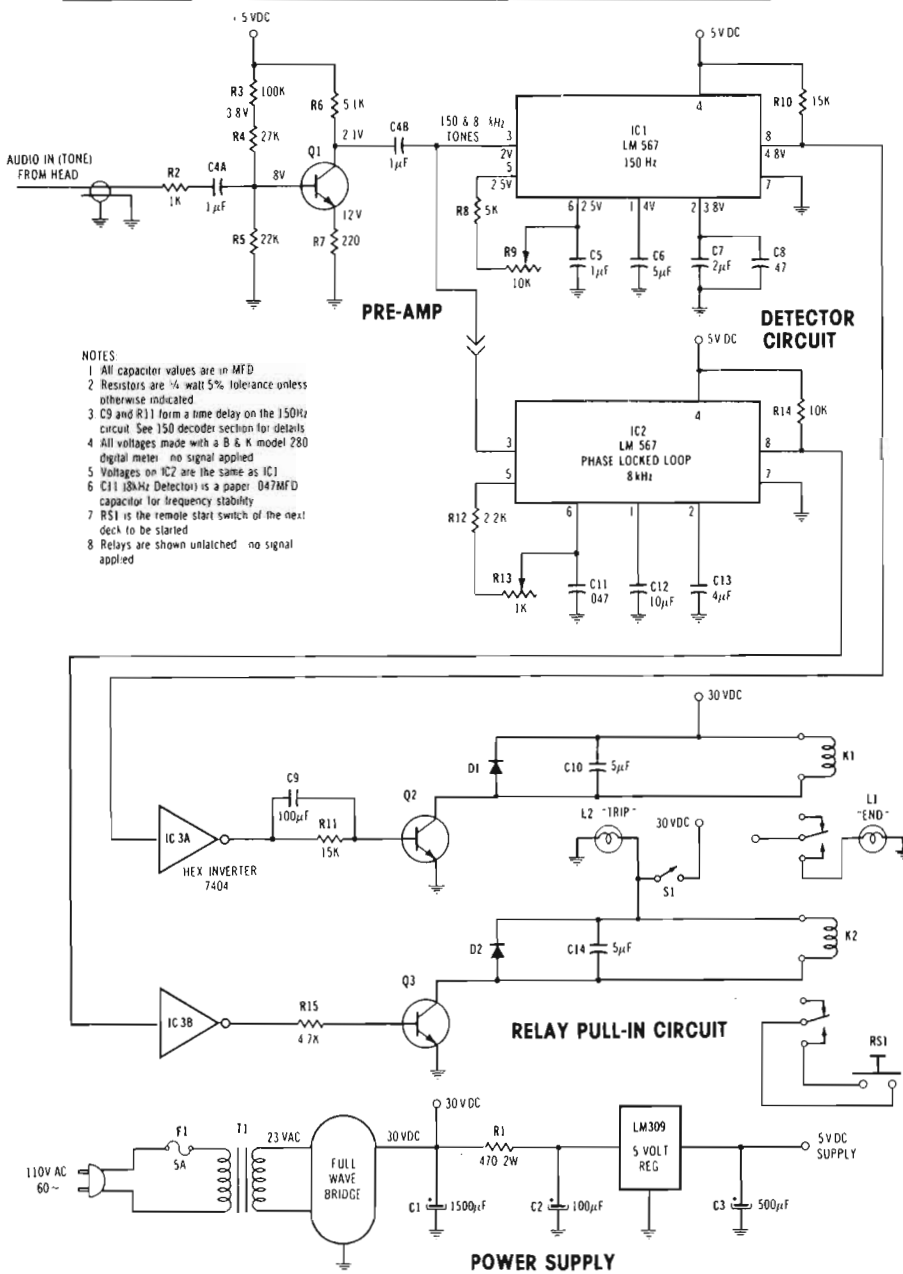

- NOTES
- 1 All capacitor values are in MFD
 - 2 Resistors are $\frac{1}{4}$ watt 5% tolerance unless otherwise indicated
 - 3 C9 and R11 form a time delay on the 150Hz circuit. See 150 decoder section for details
 - 4 All voltages made with a B & K model 280 digital meter, no signal applied
 - 5 Voltages on IC2 are the same as IC1
 - 6 C11 (8kHz Detector) is a paper .047MFD capacitor for frequency stability
 - 7 RS1 is the remote start switch of the next deck to be started
 - 8 Relays are shown unlatched, no signal applied

ARS-1000 AUTOMATED RADIO STATION REPRODUCER

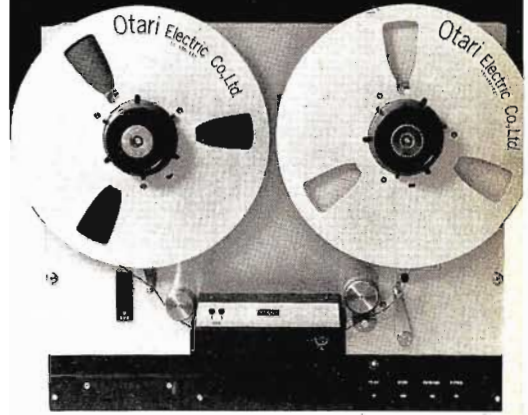

Widely used in leading automation systems. Specifically designed to meet their stringent requirements for highest audio performance, long term reliability and around-the-clock operation. Basically, the ARS-1000 is a work horse two-channel stereo reproducer with two tape speeds (7½ and 3¾ ips) and the following features: heavy duty 19-inch top plate, head mounted pre-amp to minimize hum, RFI and yield superior S/N, special long-life polyurethane pinch roller tire, friction reducing ball bearings, heavy duty motor and brake assemblies, and gold plated PCB connectors. It's easy to maintain with its plug-in PCB's and mother board configuration, easy-access flip-up head cover, and front adjustable output level and head azimuth (to minimize stereo phasing errors). Its operating features include removable Play and Stop, a ready light to indicate proper tape threading, head lifters for fast modes, a cue control for audible monitoring, and optional 25 Hz cue tone sensor. All connections are brought out to a single 25 pin Cinch connector.

Compare features and benefits, compare performance, compare our track record for reliability. Call Ruth Pruett at 415/593-1648.

PREFERRED
BY PROFESSIONALS

OTARI®

WORLDWIDE

Otari Corporation
981 Industrial Road
San Carlos, California 94070
415/593-1648 TWX 910-376-4890

Circle (142) on Reply Card

MODEL 850-TR



The SERIES 850 AUDIO CONSOLES are specifically designed for the broadcast and production situation. Model 850TR is ideal for television production...it offers convenience and flexibility at reasonable cost.

- 12 Channels
- 4 Buss plus master mixing
- 6 EQ Channels
- Illuminated push-button controls
- All channels switchable high level/mic
- Built-in digital timer
- 8 x 4 input selector optional

DYMA ENGINEERING

(505) 758-8686
P.O. Box 1697
213 Pueblo del Sur
Taos, New Mexico 87571

Circle (143) on Reply Card

Station-to-station

Transmission line pulser

By Victor Castens, KOAM-TV, Pittsburg, KS

We developed a simple circuit (Figure 1) to enable us to locate noisy bullets or bad joints present in a transmission line. The test circuit is a 555 square-wave oscillator driving a one transistor output line driver.

Figures 2 and 3 show the results that were obtained when we checked each of the two feed lines to a RCA TF-12BH antenna. In Figure 2, T1 is located at the matching section near the base of the antenna, 573 ft from the test location. Figure 3 shows the results

of a test made of the second feed line to the same antenna. This oscilloscope photo shows the effects of a noisy bullet at 9.5 μ s, point T, 465 ft. Notice the thickened line to the right of T. This bounce is due to the varying resistance of the bullet near that level.

Figure 4 is a graphic diagram of the results of the pulse generator output with no line attached, an open cable and a shorted cable. A listing of velocity factors also is included for use in computing the distances involved to a line problem.

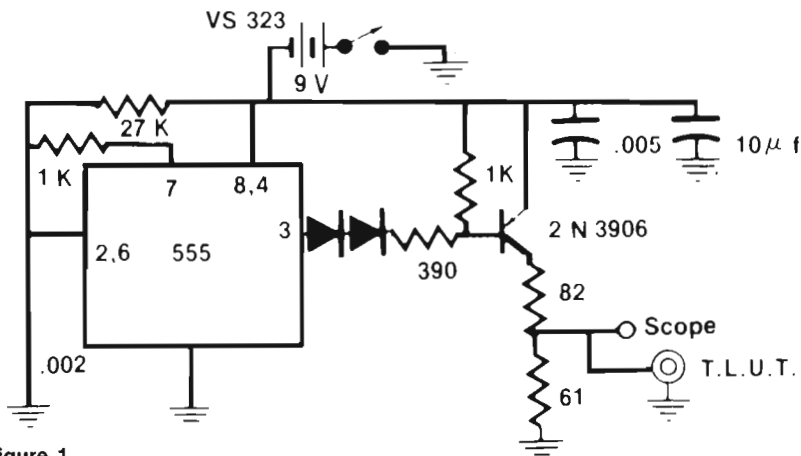

Figure 1

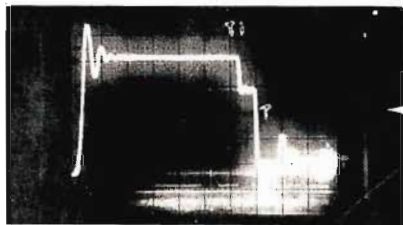

Figure 2

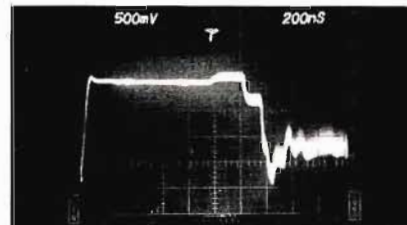
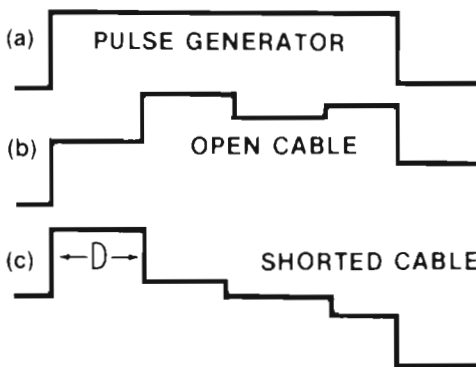

Figure 3



D = ROUND TRIP, MICROSECONDS
V = VELOCITY FACTOR: 3" = 100%
RG9 etc. = 66%, Foam = 80%.
 $490 \times V \times D$ = Length, feet.

Figure 4

Electret condenser mics

By Ian M. Evans, news director, KRCR-TV, Redding, CA

KRCR-TV uses five miniature electret condenser microphones on the news set each night. Several more are used with the mini-cams by our commercial production department. We're satisfied with them, and while the \$50 to \$75 price each isn't hurting the station's finances, \$2.49 is more attractive.

You can readily see why the electret condenser microphone elements advertised for \$2.49 in a Radio Shack flyer (Catalog 270-092) caught my attention. Fidelity seemed fine, comparing favorably with the Sony ECM-50s we've been using. My response check was a little on the informal side, amounting to plugging one Radio Shack and one Sony into separate channels of a mixer and then listening to the mixer output on a good pair of headphones. If anything, the Radio Shack unit had a better bass response. A small response chart printed on the back of the blister pack that the microphone element came in showed a slight peak in output at 6 kHz, but, if it was there, I couldn't hear it.

Your \$2.49 investment brings only the actual microphone element, you'll have to think up a package and cabling for it. I developed the idea of sticking the element and a necessary capacitor inside the plastic barrel of a ¼-inch phone plug. The element makes a snug fit and no glue is necessary to hold it in place. Like most broadcast stations, the 3-wire Cannon-type plug is our standard and one was readily available from the engineering department's junkbox.

That little capacitor in with the mic element allows you to superimpose the audio output signal on the wire carrying the power. That's necessary if you're unable to come up with miniature 2-conductor shielded cable. The capacitors I used were 5 µF at 15 V, electrolytic. You can substitute on capacitance value here, anything reasonably close should work. Supply voltages from about 3 V through 10 V should work, I chose 9 V because of the easy accessibility of the NEDA 1604-type battery.

So far, the units I've put together have been running more than six months with no battery failure. If so, then 12 of these batteries amount to a 6-year supply. Naturally, a more expensive alkaline type battery should last substantially

longer, probably well over a year.

Fastening the microphone to the talent's tie or lapel can be done with an alligator clip or an old tie clasp. I fastened the mic to the clasp with a couple of drops of

cyanocrylate glue. This dries in a few minutes, with a strong bond.

The experiment also gave me a chance to improve on what I've considered a weak spot in the physical design of miniature micro-

Scully Recorders



**NOW
being shipped.
Call us!**

With the acquisition of Scully recording instruments, we are now better able to fulfill a wider range of equipment for your studio.

We are shipping Scully recorders series 250 and 280-B from our new plant in Pennsylvania.

AMPRO  Scully

Professional Equipment for Broadcasting Professionals
826 NEWTOWN-YARDLEY RD., NEWTOWN, PA 18940
(215) 968-9000 • TWX: 5106672299 • CABLE: AMPROSCUL NTOW

Circle (144) on Reply Card

September 1979 *Broadcast Engineering* 147

Station-to-station

phones. My station always has at least one of these units in the shop for repairs, usually broken leads either at the microphone or at the output connector. I mounted the battery, battery connector and coupling capacitor in a small plastic utility box that fastens at the waist. An unexpected tug pulls off an

easy-to-repair solder joint rather than those microscopically tiny connections. The banker's clip used to hold the utility box to the wearer's belt is available at office supply stores.

You may have noticed the output of this microphone is unbalanced. Our microphones are 60 ft of cable

away from the control room, but we notice no problem. It will be necessary to ground the unused contact in the microphone output plug. This allows the microphone's output voltage to appear across the mixer's input transformer or transistor, while still keeping the cable shield at ground potential. □

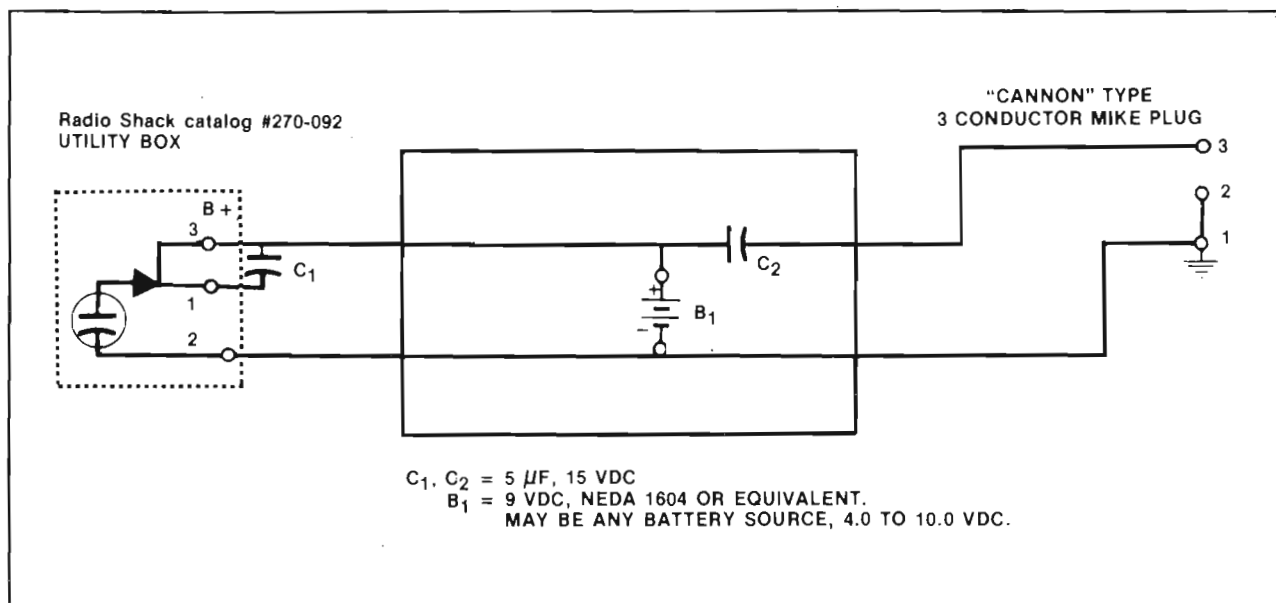

Announcing the New PW-200 Pulse Width Measuring Set



The PW-200 generates precision markers which are locked to either station sync or to incoming video. These markers are inserted into incoming video for viewing on a standard B&W picture monitor or television waveform monitor.

VERTICAL or HORIZONTAL mode is selected via front panel switching and front panel controls are used to adjust the position of the markers to the start and finish of the pulse to be measured. The time between markers is computed by the internal 10 MHz clock and is numerically displayed on the LED readout.

STANDARD PW-200 FEATURES INCLUDE:

- Internally generated pulse-cross-allow measurements to be made on any standard B&W monitor.
- Separate, non-interacting controls for vertical and horizontal rate measurements.
- Two isolated outputs—one for pulse-cross monitor display and one to feed a waveform monitor with markers inserted into the video signal.

broadcast video systems Ltd.

1050 McNICOLL AVE.
TEL. (416) 497-1020

AGINCOURT, ONT. M1W 2L8
TELEX 065-25329

Unit P, 1050 E. Dominguez St., Carson, Cal. 90746
Tel. (213) 637-2517

Telex 0686-201

Circle (145) on Reply Card

hardware report

Tech note: The solution to 3/4-inch tape edge damage

Most tape edge damage in 3/4-inch cassettes occurs when the pack rides at the wrong height inside the cassette, having been positioned at that height by a misaligned spindle. In some cases, the tape will continue to play in the defective drive without any sign of damage, since the tape in the cassette has adjusted to the particular height of the misalignment. But as soon as the cassette is moved to a correctly-adjusted drive, or a drive that is adjusted to a height different from the first, the tape edge rubs against the guides as it travels around the scanner to the take-up reel, or against the edge or reel of the cassette as it enters the cassette housing. In some cases, tape edge

Editor's note: *Hardware Report* contains notes and short articles about manufacturer's broadcast products and technology advances. **Broadcast Engineering** has not tested the products to confirm the manufacturer's specifications. The sources cited should be contacted for complete data.

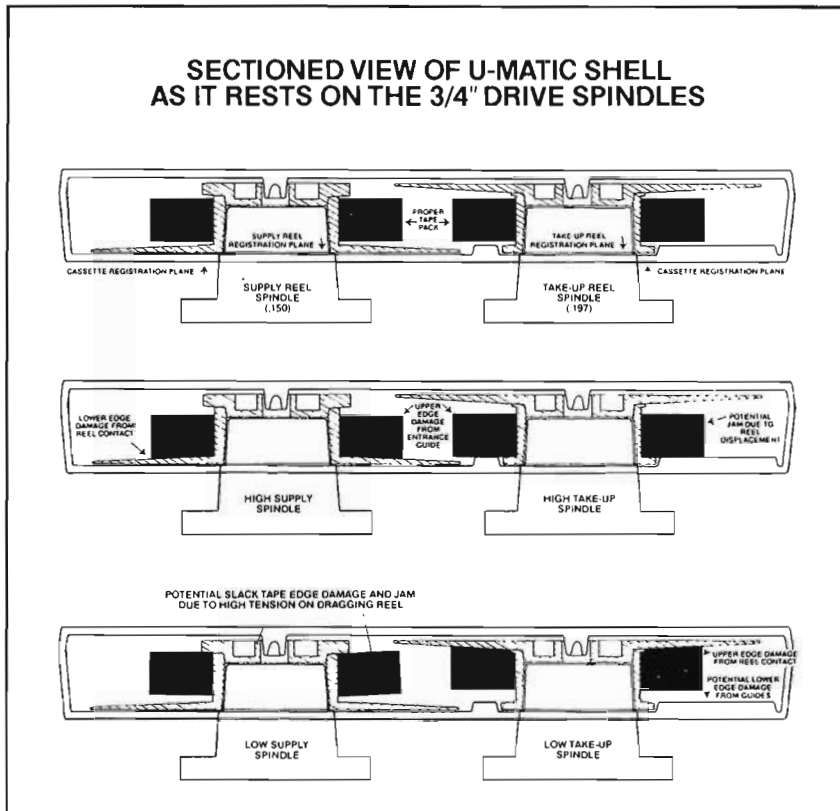

OUR BEAM DELIVERS

COLOR or B & W
Television Signals
with Audio

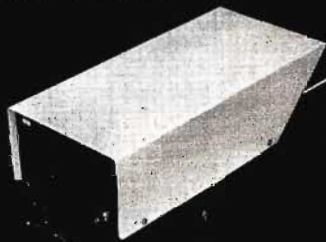

INFRARED OPTICAL
TRANSMITTER sends Audio & Video
up to 1/2 mile. No cables to be laid.
No license is required. Any 1V Ip-pI Signal
& Broadcast Rated Systems available.

from **\$4,415**

Dealer Inquiries Invited 805-967-0423



AMERICAN LASER SYSTEMS, INC.

SANTA BARBARA, CALIFORNIA

106 JAMES FOWLER ROAD, GOLETA, CA 93017

Circle (146) on Reply Card

September 1979 *Broadcast Engineering* 149

When accuracy Counts...Count on Belar for AM/FM/TV MONITORS



BELAR
AM MODULATION MONITOR

BELAR CALL ARNO MEYER (215) 687-5550
ELECTRONICS LABORATORY, INC.
LANCASTER AVENUE AT DORSET, DEVON, PA. 19333 • BOX 826 • (215) 687-5550

Circle (147) on Reply Card

Mark IV-T Metric Weatherminder

The original weather console designed especially for the announcer's table. Now equipped with dials reading Metric or combination U.S./Metric. The basic instrument cluster for local programming. Professional equipment at modest cost.

Department B

Texas Electronics, Inc.

P. O. Box 7225

Dallas, TX 75209 (214) 631-2490

Metric or U.S./Metric Readings for
Wind Direction & Speed
Barometric Pressure
Remote Temperature



Also, a complete line of
weather instruments, re-
corders, sensors, controllers,
etc.

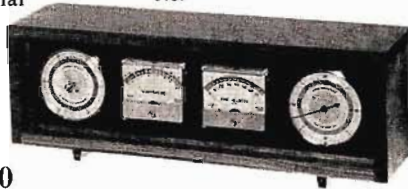

Circle (148) on Reply Card

TAPE EQUIPMENT DEMAGNETIZER

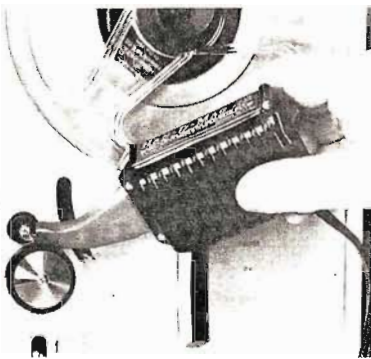

The powerful Han-D-Mag is several times more effective in demagnetizing audio and video magnetic tape path components, -- (capstans, guides, heads etc.) to the lowest residuals. Price 115 volt model \$26.50. Also furnished with gauss-meter, test strips etc., as a professional maintenance kit.

Ask for Literature

R. B. ANNIS CO.

1101 N. DELAWARE ST.

Indianapolis, Indiana 46202

Circle (149) on Reply Card

TOTAL VTR LEADER FORMAT

The New Dynatel Countdown LPG-2 Automatic Cue Generator

- Quality engineered for dubbing & editing rooms
- Built in character generator & tone burst oscillator
- Keyed character countdown over slate input
- Sequences through color bar input to character countdown & program start
- Full front panel cycle time controls
- Adjustable pre-roll function
- Rear panel remote connector

Get all the facts, call or write today



ADCOM COMMUNICATIONS 555 W. 57th St. N.Y., N.Y. 10019 212 265-1760 416 251-3355

Circle (150) on Reply Card

150 **Broadcast Engineering** September 1979

Hardware report

.....

damage may occur immediately; at other times, the tape may be packed so high on the supply reel that it slips off the transport in the threading operation and wraps around the scanner, necessitating disassembly of the machine. This spindle height misalignment frequently causes the take-up pack to jam against the housing as it rotates inside the cassette. The resulting friction may become so serious that take-up is slowed; the capstan continues to pull tape off the supply reel without take-up tension and the tape rides loosely around the transport. When the hindered take-up reel intermittently moves, it yanks the loose tape into the cassette, resulting in stretched tape in addition to edge damage.

Tape edge damage is often unnoticeable by the naked eye when inspecting the tape, but the slightest damage along the edge of helical scan tape can have serious adverse effects on tape performance.

Symptoms of edge damage

The results of tape damage are visible long before the most obvious stage of malfunction—loss of vertical lock. When tape is pulled away from the traveling heads, even for



only a moment, loss of sync causes tearing and skewing of the picture in the RF portion of the screen and can travel up into the viewing area of the picture if damage is severe. Control track pulses recorded along the tape edge are crucial in maintaining proper head drum and capstan synchronization. When there is edge damage, the tape loses contact with the heads, which results in a rolling picture that continues to roll until the moving head can lock up with the next available sync pulse. Tape damage of this sort is usually permanent,

rendering that portion of the tape useless.

All of these problems can be solved by the proper alignment of reel tables. If the tape travels at a centered height, it will wind into the cassette without rubbing against the plastic reel, cassette housing or machine guides. The reels inside the cassette are able to rotate freely and smoothly with the motor speed. In addition, if reel tables are adjusted to the correct height above the drive registration planes, cassettes can be played on any correctly-adjusted drive without the resulting edge damage. Cassette life will be dramatically increased once the machine spindles are properly aligned.

Because previous manual means of measuring alignment were inadequate to measure and solve the problem, Memorex, 1200 Memorex Dr., Santa Clara, CA 94303, developed a cassette-like gauge called SHAG (Spindle Height Alignment Gauge). SHAG has dial indicators which, when placed into the drive, quickly register the difference between the machine registration post and the machine registration surfaces of the drive spindles. A mini-cassette version was also developed and tested, again with good results. The final version of the gauge can be used on all brands of standard or portapack VCRs.

With SHAG it is possible to check the registration planes to reel table height in less than a minute. The SHAG is placed on a set-up block which is designed for the standard heights of 3/4-inch cassette reel tables. Two dial indicators, one for the supply spindle and one for the take-up spindle, are zeroed using thumb screws on the side of the gauge. SHAG is then lifted off the block and placed into the videocassette drive, and the reading of the indicators give the height deviation from the standard spindle height (i.e. supply reel: 0.150-in; take-up reel: 0.197-in). Proper spindle height specifications within 0.0005-in are indicated on SHAG, with no disassembly of the machine necessary for the reading. This reading indicates the exact amount of shimming necessary to achieve proper spindle height alignment, and upon completion of adjustment and reassembly, SHAG will confirm that proper alignment has been achieved. Richard Engebretson, Engineering Services Manager, Memorex.

THE SUPER SYSTEM

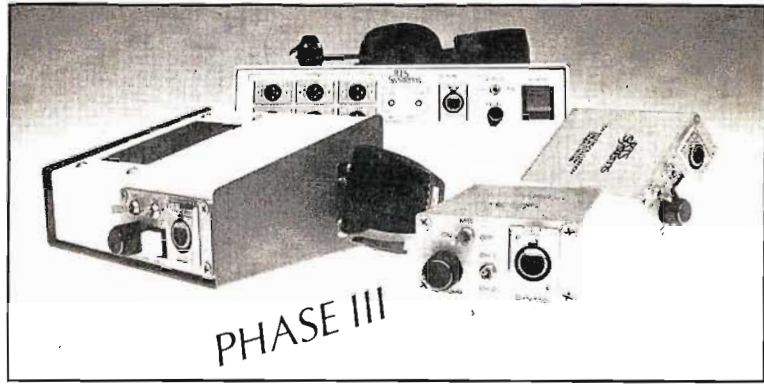

RTS Systems introduces an innovative new intercom system for teleproduction communications in studio and field. With *Super System Phase III*, we've incorporated a number of advances which mark a significant increase in product versatility.

Our new design features the portability of 12 volt battery power and the convenience of dry-line operation. The system can be arranged with up to 50 various user stations on line, and may be coupled to existing communications lines using our new RTS interface devices.

Phase III offers impressive capabilities like powerful headphone amplification, two (or more) channel operation, microphone level limiting, and stable sidetone level. The new units are handsomely packaged and completely field serviceable.

With increased flexibility, improved circuitry, and greater reliability, our *Super System* represents a new development in meeting the demands of modern teleproduction. For additional information, contact RTS Systems, Inc.

RTS
Systems INC.

1100 West Chestnut, Burbank, CA 91506

Circle (151) on Reply Card

Our phono preamp's GUARANTEED to SOLVE your HUM & RF PROBLEMS

- The ONLY phono preamp anywhere with **BALANCED INPUTS**
- More than 100dB common-mode rejection at 60hz
- $\pm 0.5\text{dB}$ 50hz-15khz, $\pm 1.0\text{dB}$ 20hz-20khz RIAA response
- -74db S/N (ref. -45dBm at 1khz)
- Wire-capturing terminal block for quick, easy installation
- May be operated unbalanced with no loss of frequency or noise performance



Only \$240 (Stereo)
\$175 (Mono)

Call COLLECT 713-782-4592 for FREE
15 DAY APPROVAL!

Logitek

Electronic Systems, Inc. 3320 BERING DRIVE, HOUSTON, TEXAS 77057

Circle (152) on Reply Card

BML THE ^aSTEP GENERATOR and DECIBEL METER FOR FAST AND ACCURATE AUDIO PROOFS



BALD MOUNTAIN LAB.
230 BELLEVUE RD.
TROY N.Y. 12180

CALL 1-518-279-9753
AUTO-RANGING DECIBEL METER \$1395
AUDIO STEP GENERATOR \$1295

Circle (153) on Reply Card

September 1979 *Broadcast Engineering* 151

TOWER WARNING LIGHTS



Complete Kits

New/Improved solid state microwave control for easier maintenance. Many special features. 300mm Beacons • Flashers • Obstruction Lights • Photo Controls • Isolation Transformers • Lamp Failure • Alarm Systems • Meets all FCC/FAA Regulations • Technical Support Provided.

HUGHEY & PHILLIPS

3050 N. California St., Burbank, CA 91504

Circle (154) on Reply Card

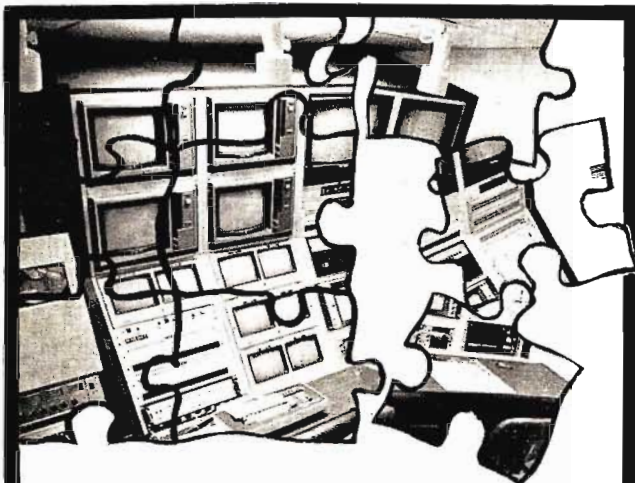

We put it all together.

Video Systems Network, Inc. is the West's largest systems design house and supplier of television equipment. Because we handle all major brands, we're able to provide an impartial consulting service for systems design and procurement specs. We've been in business for 11 years, so we've got the essential expertise and dependability. And we service everything we sell.

American Data • Arvin Echo • Antron • Barco • CEI
CVS • DVS • Grass Valley • Hitachi • IVC • 3-M • NEC
Panasonic • Phillips • RCA • Sony • Teac • Tektronix
Toshiba • Telemation • Videotek

VSN 12530 Bearrice St. • Los Angeles, CA 90066
(213) 871-0677/390-7575 • (800) 421-6521

Circle (155) on Reply Card

new literature

Electro-optics design

AMP—Designer Digest 11 covers new electro-optics packaging, plating in the electronics industry, crimping conductive inks and easier connection termination. The 14-page brochure also covers basic fiber optic terminology and includes a table on contact plating materials.

Circle (475) on Reply Card

Replacement batteries

Alexander Manufacturing—Batteries for pagers, hand-held 2-way radios, portable videotape recorders, cameras and emergency medical equipment are included in a 12-page catalog. Nickel-cadmium, alkaline, mercury and single-cell batteries, as well as automatic battery chargers, are all described.

Circle (476) on Reply Card

Tools & safety equipment

Anixter Pruzan—More than 6000 tool and safety equipment items are illustrated and described in a 150-page pocket size catalog. The items are designed for those who build and maintain CATV, telephone and power lines.

Circle (477) on Reply Card

Microphone selectors

Audio-Technica—Three slide-rule microphone selectors to help recordists, sound installers and professional musicians choose and position the right mics for sound reinforcement and recording situations are available. Information covered includes the sound frequency range of 26 instruments, male and female voices, plus complete band and orchestra.

Circle (478) on Reply Card

TV signal distribution

Blonder-Tongue—The company's complete line of television signal distribution products for MATV, CATV, audio-video and home use are described and illustrated in a catalog. Individual product specifications, application drawings and product features are highlighted.

Circle (479) on Reply Card

TV furniture

Bretford Manufacturing—Two TV brochures are available. A 4-page booklet displays the company's TV/VTR cabinets, centers and stands. The second is a 2-page brochure featuring mobile tables with TV and AV applications.

Circle (480) on Reply Card

Slide presentations

Buhl Video—A free booklet describes how to produce slide presentations and how to transmit their programming to video using the Mobile Multiplexer filmchain. "Care and Feeding of the Mobile Multiplexer" offers information on techniques for making slides, a sample story board, and choices and recommendations for dissolve controls.

Circle (481) on Reply Card

Perfect Timing

MASTER CLOCK SYSTEMS

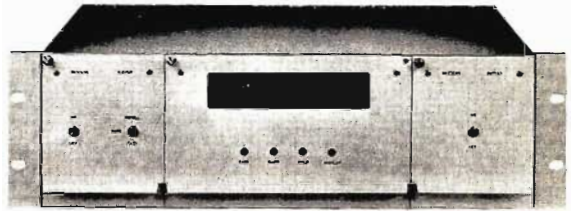

If seeing the same time on all your clocks is important, select **ES 192** - Line Frequency timebase, for only \$300.

If a guaranteed accuracy of three seconds per month is what you want, choose **ES 160** - \$966.

How about one second per month? **ES 160/1** - \$1134.

Or National Bureau of Standards accuracy! **ES 190** is synchronized to Radio Station WWV to provide a Master with unquestioned accuracy. \$1134 with receiver and antenna.

For a Time/Temperature Master, ask for **ES 196** - \$709.

ESE Master Clock Systems are simple to install. All Masters have a Serial Time Code output, able to drive twenty slave displays without buffering. Slaves range in size from .3" LED to 3" gas discharge displays, priced from \$146 to \$415.

IF YOU ALREADY HAVE A SYSTEM AND WANT TO EXPAND IT, get the **ES 167** Serial Time Code Generator (\$136), then add any number of our low cost slaves.

Many, many options and accessories are available. Ask us about them. Our brochure tells the whole story, but not for long. We keep adding new products.



Write, Wire or Call: (213) 322-2136
142 SIERRA STREET • EL SEGUNDO, CALIFORNIA 90245

Circle (156) on Reply Card

Digital & linear ICs

Cherry Semiconductor—A 12-page guide to designing custom digital and linear bipolar ICs is available. Included is a discussion of the three phases: design and breadboard, layout and prototype, and circuit review and production release.

Circle (482) on Reply Card

Monochrome TV monitors

Cohu—The DM Series monochrome monitors is the subject of a product data sheet. The illustrated brochure includes features and specifications of the modularly constructed series.

Circle (483) on Reply Card

TV equipment

Cohu—A new edition of Short Form Catalog Number 6-545 describing the company's current line of broadcast television products is available. Included are descriptions and photographs of all equipment.

Circle (484) on Reply Card

Remote camera system

Cohu—A product data sheet describes the DTMF series remote camera control system which can remotely control up to 100 camera locations. Product description, features, specifications and photographs are included.

Circle (485) on Reply Card

Power supply

Computer Products—The Power Products division is offering an updated 20-page catalog with functional descriptions, photographs, electrical/mechanical specifications, prices and ordering information for four series of power supplies. The series consist of high-efficiency switchers, encapsulated high-efficiency switchers, dc-dc converters, and linear encapsulated power supplies with single, dual, triple and logic outputs.

Circle (486) on Reply Card

Test & measuring

Continental Specialties—A 32-page catalog features frequency counters, logic troubleshooting tools, an ultravariab pulse generator, a sweepable function generator and solderless breadboarding. Each section includes photographs, specifications and descriptions.

Circle (487) on Reply Card

Editing systems

Convergence—A 15-page catalog describes the company's line of ECS-100 Superstick Editing Systems. Besides illustrating the basic series, the catalog includes interface packages, VCR upgrade packages, interface modules and general specifications.

Circle (488) on Reply Card

Mast & tower data

Decca Austin Instruments—Product data sheets de-

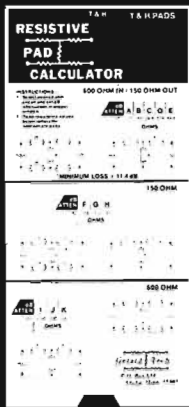

AUDIO PADS MADE SIMPLE

with the
**RESISTIVE
PAD
CALCULATOR**

Do you design, install, or maintain audio gear? This unique calculator will make your life easier.

When you need an H or an O pad, why search for the resistor values in the back of an old equipment catalog? Why fumble with formulas from your old engineering textbook? The Resistive Pads CALCULATOR puts the resistance values at your fingertips. PRECISE resistance values for T, H, Pi, and O pads in 1 dB steps up through 60 dB. Separate scales for 600 Ohm, 150 Ohm, and 600-to-150 Ohm pads. All in a convenient, simple-to-use slide chart.

The popular Resistive Pads MANUAL makes an ideal companion to the CALCULATOR. The MANUAL contains the pad data found in the CALCULATOR... PLUS a detailed description of VU meter pads, complete with pad chart... PLUS information on stereo splitting pads, bridging pads, pad selection, variable pads, attenuation measurement, and more!

TO ORDER, SEND:
\$6.95 for the CALCULATOR,
or \$5.95 for the MANUAL.
SAVE \$2.00 and order BOTH
for \$10.90 (postpaid)
Satisfaction Guaranteed

Gerard Tech
formerly Electric Sound of Minnesota
P.O. Box 634
Anoka, Minnesota 55303

Circle (157) on Reply Card

NEED A HAND?

After planning and installing some of the most creative and up-to-date sound systems in top Japanese broadcasting studios, our engineers now know that they can solve any problems. even yours. Cost performance assured.

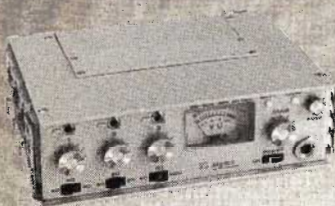

" Σ SIGMA"
lives up to its reputation as the best portable mixer in the world.

Σ sigma
SYSTEM ENGINEERING

TOKYO Office: Fukuda-2 Bldg., 2-57-9, Higashi-Ikebukuro,
Toshima-ku, Tokyo, Japan
Tel: (03)983-1906

OSAKA Office: Sano Bldg., 2-1-59, Tenjinbashi, Kita-ku,
Osaka, Japan Tel: (06)353-8289

Circle (158) on Reply Card

154 Broadcast Engineering September 1979

New literature

scribe the firm's line of mast and tower equipment: guy strain insulators, base insulators, lighting transformers, and static drain resistors.

Circle (489) on Reply Card

Multi-image production

Eastman Kodak—A book of programmed multi-image production, "Images, Images, Images," examines the justification for as well as the planning, production, and presentation of multi-image programs. The 244-page book covers various topics, including setting objectives, selecting the media and visual format, writing the project proposal, choosing the right equipment, producing the visuals, creating the script, editing the visuals and programming the equipment.

Circle (490) on Reply Card

Resistive pads

Electric Sound of Minnesota—A 28-page "Resistive Pads Manual" is offered in the Audio Reference Series. Contents include adjustable pads, center-tapped pads, choosing pads, measuring attenuation, VU meter pads, bridging pads, lattice splitting pad and specifications. A resistive pad calculator also is offered.

Circle (491) on Reply Card

FCC proceedings update

FCC—The Annual Report on Major Matters, which reflects the status of major proceedings as of December 31, 1978, is available. Written in a "plain English" style, the document is designed to keep Congress, the public and the commission's staff apprised of pending proceedings.

Circle (492) on Reply Card

CATV equipment

GTE Sylvania—A catalog describes the company's line of CATV equipment and accessories. The 71-page booklet includes technical specifications, charts and block diagrams covering the family of mainline and distribution amplification stations and accessories.

Circle (493) on Reply Card

Oscilloscope bulletin

Gould—The OS3500 oscilloscope and optional DM3010 digital measuring unit are described in a 2-page illustrated bulletin. The portable scope features a bandwidth from dc to 60MHz (-3dB); and 8cm x 10cm CRT operating at 12kV; and maximum vertical sensitivity of 2 mV/cm.

Circle (494) on Reply Card

Oscillographic recorders

Gulton—Full details on 2, 4, 6 and 8 channel oscillographic chart recorders using plug-in signal conditioners and 1 and 2 channel multiple sensitivity oscillographic recorders are featured in a catalog. It includes photos of all recorders, electrical and mechanical specifications, plug in signal conditioner specifications, and options.

Circle (495) on Reply Card

Microwave handbook

Hewlett-Packard—More than 350 microwave compo-

nents used in coaxial and waveguide measurements are featured in the 1979-80 edition of the *Coaxial and Waveguide Catalog*. Sections include a microwave measurement handbook, attenuators, detectors, couplers, filters, power sensors, slotted lines and 75 Ω items.

Circle (496) on Reply Card

Fiber optics

Information Gatekeepers—Volumes I and II of the company's Fiber Optic Manual and Handbook series has been published. The manuals are written for communications engineers and specialists with little or no experience in fiber optics technology and include such areas as typical equipment parameter design methods and specifying waveguide digital connector systems.

Circle (497) on Reply Card

Mosfet transistors

International Rectifier—SPA 913 is an 8-page application note which describes power Mosfet transistors and compares them with conventional bipolar devices. The brochure describes basic applications including switching power supplies, audio amplifiers, motor speed controllers and RF amplifiers.

Circle (498) on Reply Card

ITA source directory

International Tape Association—A 56-page directory which lists products, service and activities of ITA member companies is available free. It encompasses all areas of the audio/video tape and disc industry.

Circle (499) on Reply Card

Video glossary

JVC—Harry Elias, Vidstar division vice president, has assembled a glossary of the most commonly used video terms. It was compiled to aid the informed selection of a VCR system.

Circle (500) on Reply Card

Equipment rental

Leasametric—Rental catalog contains model numbers, descriptions and rental rates for more than 4000 separate pieces of equipment. Listed in the free catalog are 1, 3, 6 and 12-month rental rates for I/O terminals, general-purpose test instruments and microprocessor development systems.

Circle (501) on Reply Card

Film guidebook

The Means Ltd.—A Colorado film guidebook is designed as a personnel and services directory for on-location shooting of television programs, motion pictures, documentaries and commercials within the state. The listings include location scouts, light personnel, grips, set designers, wardrobe and costume houses, stylists, hotels, motels, restaurants and catering services.

Circle (502) on Reply Card

Film catalog

Modern Talking Picture Service—A 41-page catalog of more than 400 films available on free loan to television stations is available. The films are sponsored by business firms, trade associations, government agen-

Perfect Levels

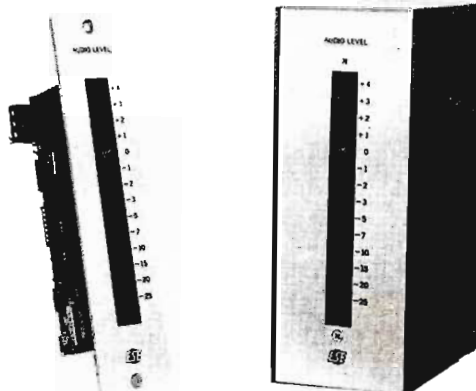

ES 214 Dynamic Audio Level Indicator

made especially for the broadcaster and recording engineer

Features:

- Peak Audio Levels or Apparent Loudness (Fast Averaging)
- Uses Standard V.U. Scale
- High Brightness, 3-Color Display
- Transformer Isolated Input
- Unregulated "Single-Supply"
- High Input Impedance and Sensitivity
- Low Cost

There are a number of Audio Level Indicators using L.E.D. bar graphs on the market today. Their acceptance is becoming widespread due to obvious advantages. However, the ES 214 gives you more: Transformer Isolated Input others consider too costly; A Power Supply Regulator on the circuit board, so you can use any unregulated D.C. voltage from +15 to +35 while others require dual supplies; The Standard Scale so you don't have to adapt to new numbers; and, the ability to select Peak Responding Mode or a special Fast Averaging Mode to approximate Apparent Loudness.

Get a handle on your levels with the ES 214

\$105.00



(213) 322-2136

142 SIERRA STREET • EL SEGUNDO, CA 90245

Circle (159) on Reply Card

September 1979 *Broadcast Engineering* 155

Winsted

ROLLING CABINETS

Double your
tape storage
space!

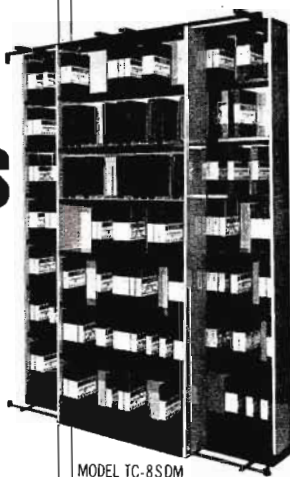

MODEL TC-8SDM

Store up to 161 of the 3/4" videocassette tapes in each of these space-saving cabinets, units move effortlessly on low-profile steel tracks to give you easy access to cabinets positioned behind them. Similar storage systems available for 1"-2" video tapes, cartridges & film. **For full-line catalog of video consoles, tape and film trucks, film and videotape storage systems call toll-free or write**

THE WINSTED CORPORATION 8127 Pleasant Ave. So. Minneapolis, MN 55420
(612) 888-1957 Toll Free Number: (800) 328-2962

Winsted

Circle (160) on Reply Card

NOW! COMPLETE REPRODUCE HEAD CALIBRATION

The new Magnetic Tape Reproduce Calibrator (Flux Loop Test System) accurately establishes and isolates the magnetic characteristics of the reproduce head. It allows one to use a Reproduce Alignment Tape to isolate and establish losses produced by gap characteristics and spacing effects. Gap losses and reproduce equalization are tabulated in the recently introduced Standard Tape Manual.

In addition to the new Reproduce Calibrator and the Standard Tape Manual, STL offers the most complete selection of magnetic test tapes available - Frequency Alignment - Pink Noise - Sweep - Speed & Flutter. All are available in reel-to-reel, cassette and cartridge.

Write or phone for fast delivery. Write for free catalog and detailed information on the new calibrator.

STL STANDARD TAPE LABORATORY, Inc.
26120 Eden Landing Road / #5 / Hayward, CA 94545
(415) 786-3546

Circle (161) on Reply Card

New literature

.....
cies, professional societies and other organizations. It includes public service messages, documentaries, how-to-do-it features, sports and travel pieces.

Circle (503) on Reply Card

Oscilloscope how-to book

Parker Publishing Company—The *Practical Oscilloscope Handbook* by John Douglas-Young covers servicing, operation, maintenance and repair of the oscilloscope, as well as giving detailed analyses of all principal waveshapes. More than 100 drawings, photographs and fault-finding tables are included.

Circle (504) on Reply Card

Tower guys

Philadelphia Resins—Ten advantages of nonmetallic, non-conducting tower guys for radio and TV and for CATV applications are explained in a brochure. The Phillystran tower guys are said to be essentially maintenance-free, even around salt-laden, corrosive atmospheres.

Circle (505) on Reply Card

Testing & measuring

Philips Test & Measuring Instruments—A catalog contains informational, technical specifications and illustrations of all the company's current products. The free catalog groups products by category, including oscilloscopes, counters and counter/timers, recorders, signal generators, and radio and TV service equipment.

Circle (506) on Reply Card

Telecommunications' future

Prentice-Hall—*Future Developments in Telecommunications* is a guide to digital transmission, storage and manipulations which forecasts future trends. Written by James Martin, the book encompasses topics from video telephones to satellite antennas on rooftops. A table of events for probable growing trends up to the year 2000 is included.

Circle (507) on Reply Card

Flat cable system

Robinson-Nugent—A short form catalog features information on the IDC flat cable system as well as material specs, dimensional drawings and ordering information on the R-N line of IDC socket connectors, headers, cable plugs and transition connectors.

Circle (508) on Reply Card

Frequency and time equipment

Rohde & Schwarz—A 24-page brochure entitled *Frequency and Time* describes applications of standard frequency and time equipment and a history of standard time and standard frequency. A table lists frequency and time emissions.

Circle (509) on Reply Card

TV monitors

Rohde & Schwarz Sales—A 24-page brochure features the full line of Barco professional color TV monitors. Included in the brochure are technical specifications, display performance, detailed descriptions of all controls, illustrations and ordering information.

Circle (510) on Reply Card

Signal source

Scientific-Atlanta—A brochure contains applications information, specifications and ordering instructions for the Series 2150B signal source, designed for antenna range applications. The signal source and RF plug-in oscillators may be located at the transmit site and may be remotely tuned up to 2500ft away. Locating the signal source at the transmit site provides maximum RF power to the transmit antenna.

Circle (511) on Reply Card

Enclosures

Scientific-Atlanta—A brochure describes the Optima line of enclosures, including small cases, vertical cabinets, desks and consoles. New products and accessories illustrated include modular desks and plexiglas doors for cabinets.

Circle (512) on Reply Card

Saticon cameras

Sharp Electronics—A brochure is available which describes the company's line of 3-tube, 2/3-inch Saticon bias-lighted color cameras. The publication features the XC-530 self-contained professional portable ENG/EFP color camera and a XC-500 multi-function professional studio color camera. Features, specification charts and a list of available accessories for each camera are included.

Circle (513) on Reply Card

Corporate brochure

TPC Communications—A full color brochure provides information about the firm including major areas of performance and a review of the capabilities of the subsidiary companies. A description of the company's StarTruck mobile video unit also is featured.

Circle (514) on Reply Card

Product selector

UMC Electronics—A 6-page Quick Reference Product Selector provides capsule information on all products in the firm's line. A photograph, short description, and price are given for each product, including cart machine rack adaptor kits, accessories and options.

Circle (515) on Reply Card

UL video standards

Underwriters Laboratories—The first edition of the Standard for Safety, Low Voltage Video Products Without Cathode-Ray-Tube Displays, UL-1409, has been published and becomes effective April 1, 1980. Products covered include videotape recorders; video-receiving, -processing, -producing, and -amplification equipment; television cameras without CRT viewfinders; television-antenna amplifiers, cable television converters; picture tube degaussers; and similar video equipment.

Circle (516) on Reply Card

Character generators

Unitel—Literature is available describing the Scriptel range of microprocessor-controlled character generators. Two units are detailed: The Scriptel P features color, proportional spacing, many composition and animation facilities, and several options; the Scriptel V is designed for OB vans or small TV studios and

STOP GROUND-LOOP HUM!

VIDEO HUM STOP COIL...HSC 1

Will ELIMINATE HUM and other INTERFERENCE in Video Lines caused by differences in Ground Potential.

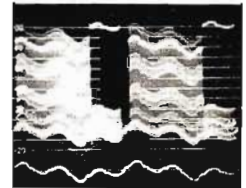

NEW!



**\$140
F.O.B.
N.Y.**

- For Color and Black and White.
- FLAT-DC to 6.5 MHz.
- No Low-Freq. or Hi-Freq. Roll-off.
- No Differential Phase Distortion.
- No Differential Gain Distortion.
- No Envelope Delay.
- Passive Device - Failure Free-Low Price.
- Small Compact Package 4" x 4" x 2-1/4".

ELIMINATES HUM AND INTERFERENCE:

IN STUDIO

- Between Buildings
- On long runs in Buildings
- Between Studio and Transmitter
- For Incoming Telco circuits
- On Outgoing Telco circuits

IN FIELD

- Betw. Remote Truck and Telco
- Betw. Remote Truck and Microwave
- For Intertruck Hookup
- For VTR Units
- For Monitoring Lines

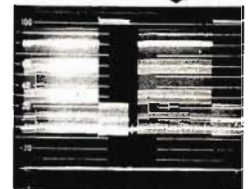

Available on
10 day free trial

AUDIO-VIDEO ENGINEERING COMPANY
65 Nancy Blvd., Merrick, N.Y. 11566
Tel. (516) 546-4239

Circle (241) on Reply Card

The 40 Second fastfit™ 8281 Connector*

Just Trim & Twist!

fastfit™ ... for a fast connection.

Call or Write for your Free Sample

* Also available in other wire sizes for BNC and UHF Connectors.

 **Cambridge Products Corporation**
A Subsidiary of HI-G Corporation

MANUFACTURERS OF COMMUNICATIONS CONNECTORS
244 WOODLAND AVENUE • BLOOMFIELD, CONNECTICUT 06002
(203) 243-1761 • (800) 243-8814

Circle (232) on Reply Card

Erases video cassettes in 5 seconds!



NEW GARNER VIDEO'RASER

Now you can completely automate your video tape erasing jobs with Garner's new Video Raser unit. It's a simple one-step, in-and-out operation. Tapes pass on a continuous belt over high flux coils, giving you tape erasure depth exceeding professional standards. Built rugged and compact, it easily handles video cassettes. You'll also like the Video Raser's competitive price.

Look to Garner for quality electronic audio and video products. For more information, write or call:

garner

GARNER INDUSTRIES

BE-9

4200 N. 48th St., Lincoln, NE 68504, Tel. 402-464-5911

Circle (231) on Reply Card

OPTICAL EFFECTS

THROUGH MICROPROCESSOR-
CONTROLLED SLIDE DISSOLVE

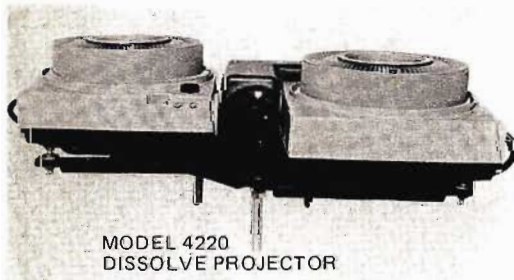

MODEL 4220
DISSOLVE PROJECTOR

- * STATIONARY OPTICS
- * ADJUSTABLE DISSOLVE RATE
- * SUPERIMPOSITION
- * EXTRA LARGE CAPACITY
- * AUDIO PROGRAMMABLE

FROM THE WORLD'S LARGEST SUPPLIER
OF TELECINE EQUIPMENT



LAIRD TELEMEDIA INC.

2125 SOUTH WEST TEMPLE • 801 487-6251
SALT LAKE CITY, UTAH 84115

Circle (164) on Reply Card

New literature

.....
features internal time counter and 16 page memory.

Circle (518) on Reply Card

Film & video rental

Victor Duncan—A catalog lists and describes the full line of video and film cameras plus accessories available from the company. Rental terms and conditions are included in the back of the catalog.

Circle (519) on Reply Card

Breadboarding

Wainwright Instruments—A catalog describes the company's Breadboarding System. Included are photographs and descriptions. A price list also is available with detailed information on kit contents. □

Circle (520) on Reply Card

ALTHOUGH
THE UNITED WAY
IS IN THE BUSINESS
OF GIVING AWAY
MONEY, WE
DON'T
JUST GIVE
IT AWAY.  **United Way**

Numbers can make all the difference.

It is always a serious error to ignore numbers or talk about them in vague terms. BPA (Business Publication Audit of Circulation, Inc.) guarantees the circulation figures of our member magazines — issue after issue. When you advertise in BPA-audited magazines, you get precise, nonpromotional numbers.

BPA We count, so
your ads will.

new products

TV blanking analyzer

A.F. Associates' HV-100 Television Blanking Analyzer allows horizontal or vertical blanking measurements to be taken using only a waveform monitor or pulse-cross picture monitor.



Measurements include picture blanking; set up blanking; front porch; sync width; burst length; sync to burst-end, burst-start or set-up; and vertical blanking. The unit, in its rackmount or table-top version, is designed to be inserted into a video monitor feed. It provides a video input and output, operating on 115V, 60Hz.

Circle (521) on Reply Card

Reverberation unit

AKG Acoustics has begun shipping the EZ version of the BX-10 portable reverberation unit. The torsional transmission line system

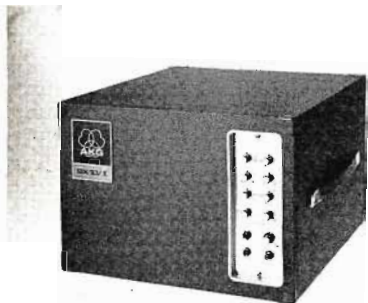

has been redesigned and equalization has been added to the TTL system electronics. For speech applications there is a special short-decay time version available, the BX-10E2-Short.

Circle (522) on Reply Card

Make up controller

An automation make up controller



has been added to Aitken Communications' existing automation system. Features include an active notch filter to remove 25 Hz program material and a low distortion oscillator. A front panel or remote push-button which overrides the timer controls the unit.

Circle (523) on Reply Card

Boom box

The Boom Box from Allied Broadcast Equipment, was created for the disco market but lends itself to constructive use with pop and AOR formats. The unit creates sub-harmonics of existing program material. Because the unit operates on the principle of synthesis there is some audible fuzzing of the human voice as the unit attempts to provide bass for the person speaking. Various methods are being employed to minimize or eliminate this effect.

Circle (524) on Reply Card

Plumbicon camera tube

A 1/2-inch Plumbicon camera tube, type 74XQ, has been introduced by Amperex Electronics. The unit is a diode gun tube with very high resolution, typically 55% response at 400 TVL. A high beam reserve can provide 4 f stops for highlight



protection when used with the dynamic beam control. The tube is suited for studio use as well as ENG and EFP applications.

Circle (525) on Reply Card

1-inch videotape

A 1-inch broadcast quality videotape developed to achieve maximum performance from the helical scan video recorders has been introduced by Ampex. Ampex 196 Series broadcast helical videotape is compatible with all 1-inch high-band helical recorders and all video standards.

Remote Control Switcher



SERIES 10

- Signal switching with solid-state reliability
- 10-in by 10-out matrix
- Video, audio, time-code switching
- Remote control via a single coax
- Battery-protected memory and tally contacts standard
- Vertical-interval video switching

DYNAIR

5275 Market St., San Diego, Ca. 92114
Telephone: 714/263-7711
TWX: 910/335-2040

Circle (165) on Reply Card



VIDEO L-C DELAY LINES

A complete line of passive switchable and strappable Variable Delay Lines manufactured specifically for the video industry. Finest specifications available anywhere. Lowest pricing. Delivery from stock.

VIDEO L-C FILTERS



We manufacture a wide range of Linear Phase Lowpass & Bandpass, as well as the sharpest Lowpass, High-pass & Bandpass Filters available in the entire industry. NTSC Lowpass, Band Reject & Bandpass Filters are our specialties. Fastest delivery of prototypes.

Call/Write for Video Delay Lines & Video Filters Catalogs.

ALLEN AVIONICS, INC.
224 E. 2nd St., Mineola, NY 11501
Phone: (516) 248-8080

Circle (166) on Reply Card

Video Jacks Plugs Patch- Cords

GENUINE
WESTERN ELECTRIC

BRAND NEW GUARANTEED
(WHILE PRESENT STOCKS LAST)

CURRENTLY USED BY THE NETWORKS
AND THROUGHOUT THE BROADCAST
INDUSTRY

AT SURPLUS PRICES

477B JACKS, 75 OHM	\$5.00
372A HAIR PIN	\$6.00
358A PLUGS	\$3.50

LARGE STOCK AUDIO JACKS, PLUGS,
PATCH-CORDS, PATCH BAYS

SCREEN ROOM POWER FILTERS

P-LINE—TELEPHONE LARGE
EQUIPMENT STOCK
* IMMEDIATE DELIVERY

TELECTRIC
CO.

1218 VENICE BLVD.
LOS ANGELES, CAL 90006
213-748-2281

Circle (167) on Reply Card

New products

Two packaging styles are also provided. The standard Tyvek-coated shelf box features built-in

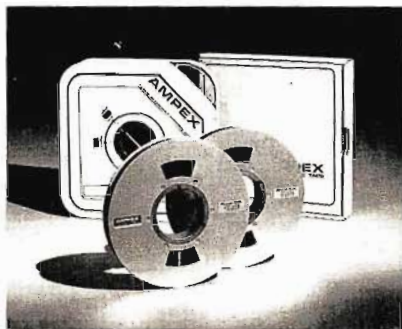

hub support and a moisture and soil repellent exterior. The tape is also available in a flame retardant stackable shipper.

Circle (526) on Reply Card

Telephone interface

Ampro/Scully's PhoneCon is an interface device allowing Ampro cartridge tape equipment to be used

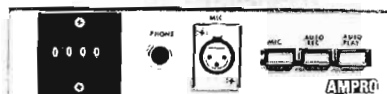

for telephone answering and message recording. The unit incorporates a built-in FCC-approved telephone line coupler to avoid continuous monthly charges for a phone company supplied coupler. Also, a separate Ampro cartridge tape recorder can be controlled by the PhoneCon to record the caller's reply.

Circle (527) on Reply Card

Weather radar accessor

Arvin CATV is offering a system, Tel-Weather TW-2, which accesses and displays NOAA weather radar data. The system can be connected to virtually any of the US National Weather Services' 111 weather radars. The system is independent of the Weather Bureau's Remote Radar transmitters which provide the weather data as an analog signal by phone line.

The TW-2 provides direct access of radar direction, range and intensity information, and converts these data into digital form for transmission over a 1200 baud dedicated communications line to a receiver where it is reassembled into a line-by-line television signal.

Circle (528) on Reply Card

jensen transformers

BY REICHENBACH ENGINEERING

Wide Bandwidth
Minimum Transient Distortion
Low Noise

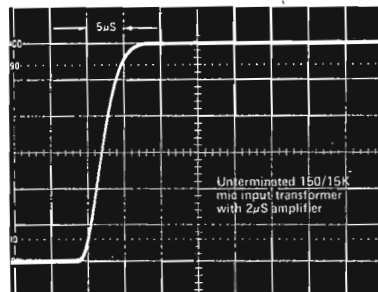

Years of transformer manufacturing and design experience, combined with computer assisted technology, have enabled us to make a *significantly audible improvement* in the performance of audio transformers.

Write or call for information
1617 NORTH FULLER AVENUE
HOLLYWOOD, CA 90046
(213) 876-0059

(Visitors by appointment only.)

Circle (168) on Reply Card

STOP PLAYING DIRTY TAPES

Use the N.O.V.A. Block.
A Sapphire Tape
Cleaner.

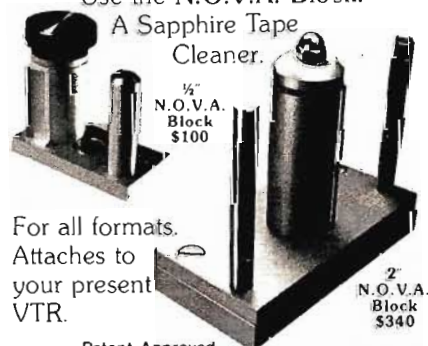

For all formats.
Attaches to
your present
VTR.

Patent Approved

N*O*V*A Corporation
5801 Uplander Way • Culver City, CA 90230

Circle (169) on Reply Card

Recording mics

Audio-Technica's AT-816 unidirectional dynamic microphone also



is supplied in stereo matched pairs as the AT-816/2. The microphones are said to be ideal for tape recording.

Circle (529) on Reply Card

Audio step generator

Bald Mountain Lab's model 1760 FM audio step generator offers nine precise crystal controlled frequencies which are available instantly.



Frequencies are pushbutton selectable and can be sequentially stepped one time or repeatedly. Output impedance is 600 or 150 Ω . A precision output attenuator and front panel output jack are featured.

Circle (530) on Reply Card

Spotlight

Berkey Colortran offers a 4.5-inch 500 W ellipsoidal reflector spotlight designed for use in theatrical, photographic and television studio

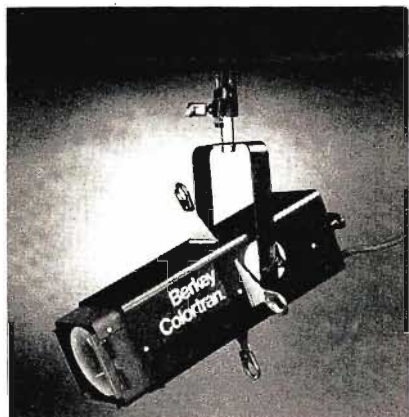

applications. The lens barrel design permits a 50, 40 or 30 degree field of angle to be achieved by the movement of one lens within the

lens barrel. The unit accepts 250, 400 and 500 W 120 V mini-can screw base lamps.

Circle (531) on Reply Card

Production camera

The KCP 60 from Bosch Fernseh is a studio and outside broadcast camera utilizing three $\frac{2}{3}$ -inch pick-

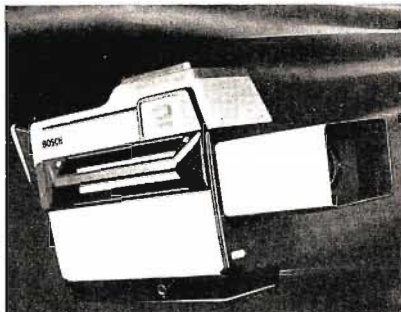

up tubes and dynamic beam control circuitry, which can handle up to 16 times overload when used with diode gun tubes.

The camera includes a weather-proof head with shock resistant optics and an adjustable viewfinder.

Circle (532) on Reply Card

Mobile multiplexer

Buhl Optical is offering a videocassette tape entitled *Ready One! Take One!*, which demonstrates their mobile multiplexer filmchain. The system is a filmchain without a dedicated camera which allows switching a video camera with a standard TV zoom lens from filmchain to studio use. The tape also shows how the unit interfaces audiovisual and video operations.

Circle (533) on Reply Card

Broadcast cartridge

The Audiopak AA-3 stereo phase broadcast cartridge from Capitol Magnetic Products features a ramp and cone tape guidance which is said to provide optimum geometry for movement of the tape from the center of the spool to the proper operating plane. Capitol's high output, low noise (HOLN) lubricated tape designed for studio mastering is used in the cartridge. The low friction binder on the backcoating and oxide sides reduces wear and extends the life of the tape.

Circle (534) on Reply Card

Camera stabilizer

A second version of the steadicam film/video camera stabilizing system (universal model II) is available from Cinema Products. Several modifications in the unit permit

Computer Controlled Switcher

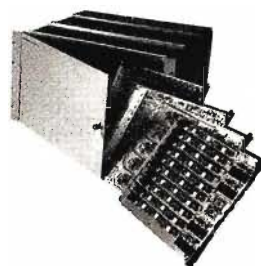

SYSTEM 21 SWITCHING

- Route video, audio, data
- 10 x 10 to 1000 x 1000
- Matrix or trunking
- Battery-protected memory
- 100% preset - salvo
- RS-232 computer interface

DYNAIR

5275 Market St., San Diego, Ca. 92114
Telephone: 714/263-7711
TWX: 910/335-2040

Circle (170) on Reply Card

ELECTRO IMPULSE

Thanks You for Making Our Model DPTC-20KFM Dummy Load One of our Most Successful Products!



MODEL
DPTC-20KFM
Rated 25KW
DC-110MHz
VSWR 1.15:1

Load is Dry,
Forced Air Cooled,
Fully Interlocked and
**WARRANTED
FOR 25 MONTHS**

Our New General Catalog 890 is now available upon request covering:

- Dummy Loads • Baluns • Calorimeters
- Power Meters/Attenuators

**Electro
IMPULSE, INC.**

OUR 29th
YEAR OF
GROWTH

116 Chestnut St., Red Bank, N.J. 07701
Telephone: 201-741-0404

Circle (171) on Reply Card



SPECIFY

SILVERCEL BATTERIES

by **Yardney**

- Ideal For Electronic News Gathering ...Cameras And VTR Equipment
- 3 Times The Power...Much Less Weight

The accepted standard of excellence, Yardney Silvercels are LIGHTER but MORE POWERFUL. Many more running hours are built into Silvercels than any other system of comparable size and weight.

QUICK CHARGE when needed without battery damage. No discharge memory problems. Your camera will never be out-of-service because of charging problems.

Selected by original camera manufacturers and in demand as replacement batteries everywhere. Write for catalog.

Yardney
ELECTRIC CORPORATION
82 Mechanic Street
Pawcatuck, Connecticut 02891
(203) 599-1100

Follow the Network Leaders



Circle (172) on Reply Card

New products

.....

greater maneuverability and safety in operation. A breakaway-style operator's vest features an emergency release cord which allows the operator to get out of the system quickly in an emergency. The raised video monitor is positioned between the camera-mounting platform and the sled-like lower portion, which allows tilting and rotating.



For further information, write to Cinema Products, 2037 Granville Avenue, Los Angeles, CA 90025.

TENDEL'S NEW T.U.S.H.* GAGE IS FOR YOUR U-MATIC...

The people who brought you the TENDELOMETER® NOW proudly present the

*TENDEL U-MATIC SPINDLE HEIGHT GAGE



The T2-H15-UM TENDELOMETER® Tape Tension Gage shown checking the critical hold-back tension on a Sony 2850. Price \$225 complete.

The **T.U.S.H.** Gage is simply inserted into your U-Matic - the indicators are visible through the cassette window. No need to remove the cassette top chamber to read the indicators.



The **T.U.S.H.** Gage measures the critical tape reel spindle heights. It is a must to prevent tape damage due to binding. Technical as well as non-technical persons can determine if the machine needs adjustment.



The **T.U.S.H.** Gage comes complete with master gage, instructions, and carrying case. Price \$495 complete.

Write or call for more information; or order direct.

TENDEL
50 Curtner Ave.
Campbell, CA 95008
(408) 377-6588

Remote station

The RS-250 remote station by Clear-Com enables cameramen, floormen and crane operators to separately and simultaneously monitor two channels of intercom and one program feed on binaural headphones with individual volume controls. Standard features include binaural output, microphone on/off switch, talk channel select and balanced transformer isolated program input.

Circle (535) on Reply Card

Remote camera system

The DTMF remote camera control system by Cohu features dual tone multi-frequency encoding and digital techniques to remotely control up to 100 television cameras.



The basic system consists of a transmitter at the control station and a receiver at each camera location. Available options include a

See us at Video Expo in N.Y. and at the S.M.P.T.E. Show in L.A.
Circle (173) on Reply Card

A FILM CHAIN WITHOUT A DEDICATED CAMERA

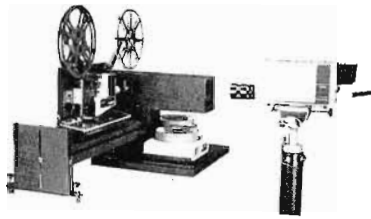

MOBILE MULTIPLEXER!

Save the high cost of an extra color camera. Studio camera adapts to film chain use in seconds.

Use standard TV zoom lens.

Input: Two 35mm slide projectors in dissolve mode plus 16mm or Super-8.

Screen used for previewing is easily removed for conventional field lens operation.

Mobile Multiplexer saves studio space.

At \$1100

out performs units at twice the price!

Send in your 10 minute, 3/4" video-cassette. We'll transfer our demonstration tape describing the MM onto it and return it, postpaid.

BUHL OPTICAL
1009 Beech Avenue
Pittsburgh, Pa. 15233
Phone: 412-321-0076



Circle (243) on Reply Card

REBUILT POWER AMPLIFIER TUBES

- New Tube Warranty
- Guaranteed Satisfaction
- Off Shelf Delivery
- Fraction Of New Price

PARTIAL LIST OF TYPES:

125A	5771	6803
207	5891	6804
356	5918	6920
891	5919	7007
891R	6420	7480
892	6421	7560
892R	6422	7804
893AR	6423	7805
1089	6424	8461
5667	6425	8550
5671	6426	8795
5681	6427	23185
5682	6696	23431
5770	6697	23454

- Duds Purchased Or Rebuilt
- Send For Quote

VACUUM TUBE INDUSTRIES
35 Pequit St., Canton, Mass. 02021
617-828-1650

Circle (234) on Reply Card

computer interface with remote control interlock, remote status feedback and switcher control.

Circle (536) on Reply Card

Transceiver

Model 280 transceiver from Colorado Video allows video teleconferencing over normal, dial-up telephone lines. Three functions are combined in the unit: freezing of a

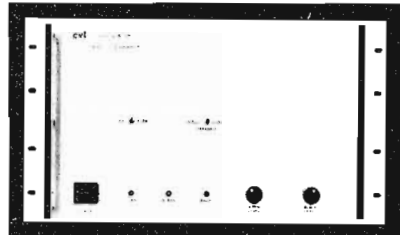

single frame of video, conversion of the frozen picture to a slow scan television signal for transmission over audio channels, and reception and reconversion of slow scan TV signals to conventional TV standards. Standard features include solid state design, operation in moving environments, remote control, real time monitoring of A/D operation and gen-lock to other video sources for systems operation.

Circle (537) on Reply Card

Edit code reader

Datametrics SMPTE edit code reader SP-733 features time or user bit operation, eight digit hexadecimal display/output, range of 1/5 to 40 times recorded speed, and automatic forward/reverse sensing. Displays include code present indicator, forward direction indicator, drop frame format indicator, time operation indicator, user bit operation indicator, and display hold indicator.

Circle (538) on Reply Card

Lightning/surge arrestor

Delta Lightning Arrestors offers a protector which prevents damage to electrical equipment caused by lightning or surge. The unit presents a low resistance path to ground, while blocking the power current. When in the conduction mode, the arrestor's internal resistance is comparable to a 1ft bus of number four aluminum. When shut off, the resistance goes to a billion ohms.

Circle (539) on Reply Card

Videodisc recorder/electronic slide Eigen Video has combined random

Color Terminal Equipment

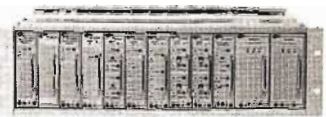

SERIES 5900

- Broadcast specifications
- Six-output video, pulse, audio DA's
- Six-output subcarrier and pulse delay DA's
- Color sync generator with optional genlock
- Black burst generator
- Remote control video and audio switching

DYNAIR

5275 Market St., San Diego, Ca. 92114
Telephone: 714/263-7711
TWX: 910/335-2040

Circle (175) on Reply Card

Audio Transformers

The SESCOM "MI-Series" Audio Transformers are specifically designed for broadcast and recording applications.

Shielded Terminals

Open Frame

Plug-In

Wire Leads

FEATURES

1. Low distortion < .2% @ 30 Hz
2. Broad frequency response ± 1 db 20-20KHz
3. Electro-static shielding
4. Six power levels: -40, -30, -10, +4, +18 and +30 dBm
5. Various primary and secondary impedances
6. Double and single mu-metal shields
7. Both shielded and open versions.

SEND FOR YOUR FREE COPY OF OUR NEW CATALOG

We also manufacture direct boxes, Mic-splitters, snakes and audio modules

"Quality Engineered Sound Products"

SESCOM, INC. P.O. Box 590,
12931 Budlong Ave.,
Gardena, CA 90247 U.S.A.
(213) 770-3510, (800) 421-1828
TWX (910) 346-7023

Circle (176) on Reply Card

YOUR best buy in
TURNABLES is:

Technics

by Panasonic

Your best deal for
BROADCASTING
EQUIPMENT is:

Val-Tronics

A complete line of: AM-FM Transmitters, all powers; All types of Microphones and Headphones; AM, FM, Stereo, SCA, Modulation, Antenna Monitors; All Types of Audio Consoles, Tape Cartridge Machines; AGC Amplifiers; ATS Systems; Limiters; STLs; FM Antennas; Tone Arms; Coaxial Cable; Audio Tape; Tape Cartridges; Turntables; Tubes, Recording Heads; Mixers; Preamplifiers; Tape Recorders; Remote Control Systems; RPU's; Reverb Systems; Speakers, Towers.

Val-Tronics Inc.
Penn Park Bld.
Pittston, PA 18640
(717) 655-5937
CALL COLLECT

Circle (178) on Reply Card

**IF YOU NEED
ATTENUATORS
YOU NEED THIS
CATALOG!**



**AUDIO AND RF ATTENUATORS
TO MEET ANY REQUIREMENT**

Here in one compact and informative 24 page booklet is all the data you need to select a Precision Audio and RF Attenuator for your application.

Reference Charts, Circuit Diagrams, Types and Uses, Current and Voltage Ratio Tables, Ratings, Etc., make this a handy and invaluable reference.

SEND FOR YOUR FREE COPY TODAY.

TECH LABS, INC.

Bergen & Edsall Blvds.
Palisades Park, N.J. 07650
Tel.: (201) 944-2221

Circle (179) on Reply Card

New products

.....
access control of 600 electronic slides with full instant replay slow motion. A keyboard control addresses any location within the 600-capacity disc chassis. Once located, a sequence can be played as single steps, animation crawl or at speeds up to full motion, in either direction.



The single images can be displayed as either fields or frames. Sources for slides are live camera, film chain or ENG tapes. The model 16 includes high-band signal system, J-control and digital time base corrector/dropout compensator.

Circle (540) on Reply Card

Omnidirectional mic

Electro-Voice has introduced a shock-mounted omnidirectional microphone, the D056. Primarily intended for hand-held broadcast and



sound reinforcement, the main acoustic cavity and the diaphragm/voice coil assembly are isolated as an integral unit from the case. Frequency response extends to 18,000Hz. There is a slight emphasis in the 2000-12,000Hz range, with a slow rolloff below 200Hz to reduce low frequency noise interference.

Circle (541) on Reply Card

Bulk eraser

Fidelipac has introduced a hand-held bulk eraser called Blank-IT. The unit includes a high mu core capable of erasing magnetic tape of all formats, including audiotape of up to 1-inch, computer tape and both VHS and Beta videocassettes.

Bring automated sound to life.

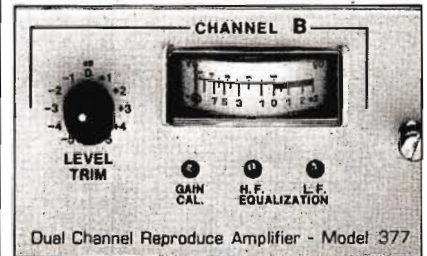

The Inovonics 377 Dual-Channel Tape Playback Pre-amp adds new life to radio automation system sound. You can expect high stability, low noise, and wide-range response — with new or existing installations.

Model 377 works with a variety of tape heads and transports, and is pin-compatible with older Ampex and Schafer equipment.

Bring automated sound to life. Call or write today for details.
Model 377 — \$395.

Inovonics Inc.
503-B Vandell Way
Campbell, CA 95008
(408) 374-8300



Circle (188) on Reply Card

EXPAND VIDEO PRODUCTION CAPABILITY

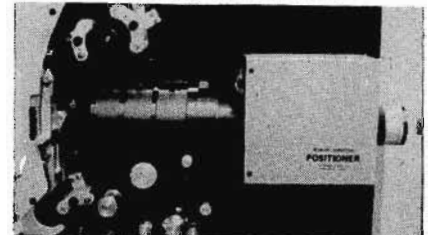

Zoom Blow-Up/Reduction Positioner
Shown on RCA FR - 35 Projector

ADD A NEW DIMENSION DURING TAPE TO FILM TRANSFERS

Zoom from 1/4 film frame to 1/4 video raster — Pan & tilt to change composition. Locate film image anywhere in video picture. Create new scenes, multiple images or add titles.

Manual or Servo Models
For 16/35mm Film & 35mm Slide

ALSO

- CINE LENS ADAPTORS FOR 3 TUBE PRISM TV CAMERAS
- CONTINUOUS SHUTTER KIT for TP-66,
- ASSURES "CONSTANT COLOR" MICROSCOPE and ENDSCOPE ADAPTORS
- CUSTOM OPTICAL SYSTEMS

the WARREN R. SMITH CO.
P.O. Box 324
Ocean Gate, N.J. 08740
(201) 269-6795

Circle (189) on Reply Card

Duty cycle for the unit is five minutes on, 15 minutes off (the unit



shuts off when its duty cycle has been exceeded).

Circle (542) on Reply Card

User-bit encoder

Gray Engineering Labs' User-Bit Encoder, UBE-118, features the use of multiplexing 320 separate user bits in the SMPTE edit code, every 10 frames. This allows the operator to transmit many more kinds of information, such as calendar date, video machine number, titles, reel number, operator identification, company code, customer code, etc. These data can be encoded in memory and can be transmitted, changed or recalled at will.

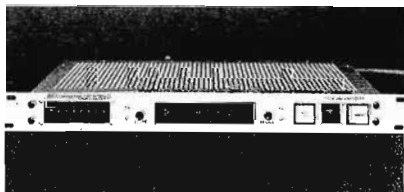

The unit is designed to be used with the company's Edit Code Generators DT-104, DT-113, or the User Bit Modifier-Display MD-111.

Circle (543) on Reply Card

Color monitor

Hitachi's CM-182 18-inch color monitor features resolution in excess of 370 lines. Signal-to-noise ratio is more than 46dB, and deflection linearity is less than 2% (within the central zone of diameter equal to picture height).

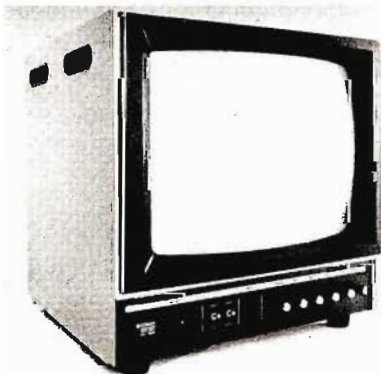

The NTSC monitor is recommended for broadcast and medical TV applications which demand accurate colorimetry.

Circle (544) on Reply Card

Production switcher

The PAL and PAL-M versions of ISI's model 902 video production switcher is now available. The unit features two mix effects systems utilizing a shared pattern generator with rotate and modulate enabling hundreds of possible wipes. Standard features include electronic spotlight, border generator, preset pattern limit, key invert, matte key and joystick positioner.

Circle (545) on Reply Card

Automation preamp

Inovonics has introduced a dual-channel tape playback preamp. The model 377 interfaces with a wide variety of tape heads and transports



and is pin-compatible with Ampex and Schafer equipment. The preamp is RFI-proofed and offers balanced outputs capable of 24 dBm. Panel features include multiturn gain and equalization adjustments.

Circle (546) on Reply Card

RGB-to-NTSC encoder

Lenco has introduced an RGB-to-NTSC color encoding system that enables computer graphics or alphanumeric information to be displayed on standard commercial color television monitors.



The CCE-850 is designed to encode high-resolution RGB colorgraphic computer displays, regardless of scan rates.

The encoder may be used with any computer graphics system when NTSC video is required for videotaping and distribution. An additional feature includes a color reference test pattern to allow for proper NTSC color monitor alignment.

Circle (547) on Reply Card

Off-air TV Demodulator



RX-4B

- High-quality performance
- Optional plug-in front ends VHF, UHF, crystal control
- Optional chopper for video modulation monitoring or closed-loop VIR operation
- For Broadcast, CATV, CCTV use

DYNAIR

5275 Market St., San Diego, Ca. 92114
Telephone: 714/263-7711
TWX: 910/335-2040

Circle (180) on Reply Card

CDE CORNELL-DUBILIER

Transmitting Mica Capacitors



STOCK DELIVERY
ON MOST RATINGS

ITT JENNINGS
VACUUM CAPACITORS

SURCOM ASSOCIATES

305 Wisconsin Avenue
Oceanside, California 92054
(714) 722-6162

Circle (181) on Reply Card

Comrex Corporation Manufactures

Wireless Microphones:

Our 450 MHz system is THE ENG broadcast standard.

Cue Systems:

The ideal way to direct ENG field personnel. This 1 watt IFB system allows ENG crew to hear both program and instructions in one pocket receiver.

TV Aural Monitors:

Rugged pocket receivers fixed to your TV channel for live off-air cueing. From 50-500 MHz.

Low Frequency Extenders:

A new category of broadcast equipment. Broadcast quality on a standard dial telephone line. If you broadcast news, sports, weather, farm, stock market, religious, or special interest programs, THIS IS A MUST-KNOW!

For further information, call or write:

COMREX

18 Years In Broadcasting

PO Box 269
60 Union Avenue
Sudbury, Massachusetts 01776
TEL: (617) 443-8811
TWX 710 347-1049

Circle (182) on Reply Card

New products

TV interval timer

Marconi has introduced the television interval timer model 2920. The timer provides digital readout

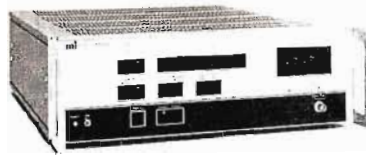

of 15 different parameters. Changes in measurements can be monitored directly by front panel selection of the particular parameter of interest. All functions may be controlled remotely.

Circle (548) on Reply Card

Audio control center

The "S" system by Micro-Trak is a packaged 6-channel broadcast system which provides turntables,



turntable preamplifiers, interconnecting wiring and the model 6618 6-channel audio control console. The 30"x80" operating desk provides space for desk top equipment such as cart machines as well as accessory space in the pedestal.

Circle (549) on Reply Card

Amplifiers

Modular Audio Products (MAP) has introduced models 7821 and 7822 rack mounting audio distribution amplifiers. Both feature low distortion and noise through the use of MAP audio op-amps in a transformerless bridging input, differential amplifier configuration. Both units also feature self-contained power supplies.



Model 7821 provides eight balanced outputs from one input, while model 7822 provides 16 balanced outputs from two separate inputs. All outputs are 600 Ω at up to +20dBm level per output, with a minimum of 80dB of isolation between outputs, and from output to input. Alternatively, model 7821 can provide 16 unbalanced outputs and model 7822 can provide 32 unbalanced outputs. Inputs can be strapped for a single source feed. The amplifiers are internally protected against short circuit and input overload.

Circle (550) on Reply Card

TV transmitters

NEC offers the PCN-1200 series VHF and the PCU-700 series UHF TV transmitters. The PCN-1200 series transmitters employ IF modulation and feature a minimum of vacuum tubes. Other features include a broad-band matching system allowing full spectrum coverage of Band III (170-230 MHz) without adjustment, integrated circuit technique to minimize the number of electrical and mechanical parts and integrated CIN Diplexer for size reduction and ease of installation and maintenance. The series is available in 1, 2, 5, 10 and 25 kW models.

The PCU-700 series uses all solid-state IF modulator and exciter high-efficiency Klystrons for both visual and aural power amplifiers. Features include 30% reduction in parts by use of IC and other current circuit techniques high-performance non-linear distortion compensation circuit for both DG and DP adopted at IF frequency and new vestigial side-band SAW type filter for steeper sideband response. The series is available in 10, 30, 40, 55, 60 and 110 kW models.

Circle (551) on Reply Card

Equalizer accessory

Orban Associates has announced the availability of a transmitter equalizer accessory for their Optimod-AM compressor/limiter/equalizer system. The equalizer is designed to compensate for low frequency tilt inherent in many transmitters and also to compensate for transmitter-antenna system overshoot and ringing.

Two separate equalizer sections (remotely switchable) permit independent adjustment of day/night transmitters or day/night power levels. Each section has three controls: one for low-frequency tilt and

two for high-frequency compensation. When desired, the entire transmitter equalizer can be switched out. A front panel jack permits convenient insertion of square wave test signals for initial setup. LEDs indicate the day/night status of the circuit.

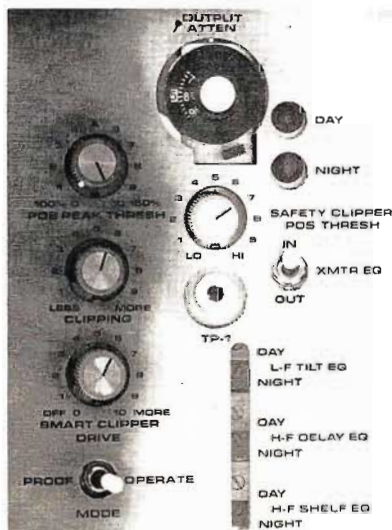

It is available as an accessory kit for retrofit into existing units and is being included on all current production units.

Circle (552) on Reply Card

24-track recorder

The MTR-90 Masterecorder from Otari is available in 16 or 24 track versions or in a 16 track prewired for 24 tracks. The unit features symmetrical pinch-roller-free direct



drive, 30 and 15 ips tape speeds, fulltime servo system for capstan and reel motors, digital tape timer, automatic monitor switching and variable-speed cue control. Auto locator with full shuttle search-to-cue capabilities and 10 memory capacity and a 16/24 track conversion kit are optional.

Circle (553) on Reply Card

Camera tubes

Philips has announced the 74XQ series of 2/3-inch Plumbicon television camera tubes for ENG appli-

cations. Resolution for these tubes is typically 55% at 400 TV lines (uncorrected for the lens). The 74XQ has a high beam reserve and when used with dynamic beam control it can provide four F-stops of highlight protection to minimize comet-tailing.

The 2/3-inch camera tube also is suitable for studio use, such as continuity, interviews and news reading, as well as for electronic field production (EFP).

Special features of the 74XQ series are the use of a photoconductive layer for increased resolution, and the use of a diode electron gun for dynamic beam control to minimize comet-tailing and blooming.

Circle (554) on Reply Card

16mm telecine

RCA has introduced a 16mm film handling system with advanced capabilities for specialized broadcast and teleproduction telecine applications. The FR-16 projector system features an incremental 16mm film handling system designed for presenting an illuminated film frame to a telecine camera. A servo controlled film drive mechanism functions as a film drive station using a low-inertia dc servo motor with a large diameter sprocket.

Start, from zero to cine speed (24 or 25 frames per second), occurs in less than five film frames. Stop occurs in less than one film frame. A smooth stop-reverse-start sequence, as a special effect, occurs in less than one-half second.

In the freeze frame (still) mode, the application of light remains the same as when the projector is operating, with no degradation of the picture.

Circle (555) on Reply Card

Microphone mixer

The model HPMO41 microphone mixer by RTS Systems is designed for professional applications ranging from location film and tape to major recording console input augmentation.

Input features include four Lo-Z mic inputs, a 3-position attenuator switch, a 3-position high pass switch, limiter circuit on each input, a phase reverse switch for each input, and an auxiliary input. Other features include a tone oscillator with on/off switch on front panel and trim pot on the circuit card, a peak indicator LED on the front panel, an illuminated VU meter with buffer amplifier and range select switch for +8dB or +4dB for zero reading on the meter, and a 1W

QUALITY TALKS FOR KRGV

Weslaco, Texas

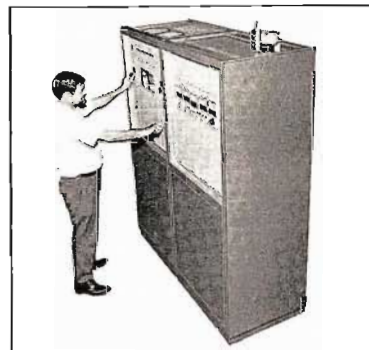

Continental's new 5/10 kW AM transmitter is setting records for acceptance. It has performance and efficiency, with the cleanest sound around. Listen to Continental: quality talks.

Write for brochure: Continental Electronics Mfg. Co. Box 270879 Dallas, Texas 75227 (214) 381-7161

Continental Electronics

Circle (158) on Reply Card



FOR ALL YOUR TUBE NEEDS



is the FRANCHISED DISTRIBUTOR for the following Electron Tube Manufacturers.

Amperex

RCA



VARIAN ASSOCIATES

We can also supply many other brands. For over 25 years JSH has been supplying and stocking tubes. Over 5,000 line items of electron tubes and semiconductors are stocked in depth in our huge warehouse ready for immediate shipment. We know your need for fast service. Your order will ship in 8 hours... sooner if you need it!

For our brand new catalog call Toll Free:

800-421-0942 (outside Calif.)

800-252-0030 (within Calif.)

Or call our direct sales number (213) 559-5780



JSH ELECTRONICS, INC.
A MEMBER COMPANY OF VSI ELECTRONICS
8549 HIGUERA STREET P.O. BOX 2898
CULVER CITY, CALIFORNIA 90230
(213) 559-6900

Circle (186) on Reply Card

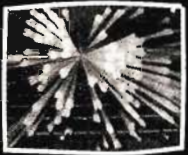
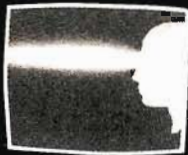

Dolphin helps maximize your creativity.

World leaders in producing quality film and television communications with speed and economy.

Dolphin
Productions, Inc.
computer animation

140e.80th NYC. 628-5930
(212) 10021

I'd like to see Dolphin's latest show reel.

Name _____
Company _____
Address _____

BF

Circle (187) on Reply Card

1127 PRODUCTION SWITCHER

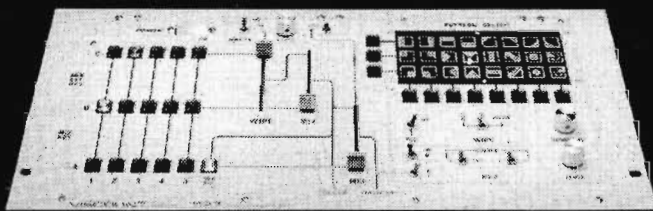

• \$3765

- COLOUR • DOWNSTREAM KEY
- ROTATIONAL PATTERNS
- MICROPROCESSOR BASED

ISCOUNT INDUSTRIES Ltd

105 EAST 69th AVE., VANCOUVER, B.C.,
CANADA V5X 2W9 - PHONE (604) 327-9446 TELEX 04-508605

CALL OR WRITE FOR FULL DETAILS

Circle (177) on Reply Card

New products

headphone amplifier with front panel volume control and headphone jack.

Circle (556) on Reply Card

Monitor

The model MAS-1 monitor amplifier/speaker from Ramko Research is an all purpose utility amplifier with



speaker and headphone jack. Standard features include a 20k balanced bridging input, 1 W RMS audio amplifier, 12 position input select switch and level control.

Circle (557) on Reply Card

Wireless microphones

The Schaffer B&T wireless instrument and microphone by the Ken Schaffer Group is said to have the same performance capabilities as its more expensive counterpart, the



Schaffer-Vega Diversity System, with one exception: Musicians must allow a few minutes for a sound check to ensure the absence of dead spots by selecting optimum antenna placement. Signal-to-noise ratio of better than 90dB, crystal controlled stability, interference proof performance and no tuning are common to both systems.

Circle (558) on Reply Card

Distribution amplifiers

The Masterline series of UHF/VHF distribution amplifiers designed for small TV signal distribution systems is available from Singer Products. The system is a medium

gain, low noise, broadband amplifier with both VHF and UHF amplifiers.



Front panel switches permit the selection of combined or separate VHF/UHF inputs and the switching in of a built-in FM stop filter.

Circle (559) on Reply Card

FM transmitter

Sintronic has introduced the model S1-F-25 FM broadcast transmitter, 27.5kW, designed for long-term performance in the 87.5-108MHz FM broadcast band.

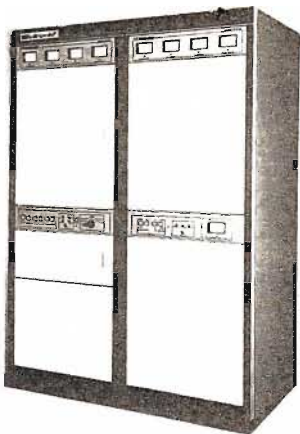

The transmitter is housed in a dual section, single cabinet. The left section consists of the driver and the right section houses a complete RF power amplifier with separate power supply. A combination of meters, illuminated pushbuttons and LEDs provide full visual monitoring of transmitter status and primary operational parameters at a glance. Major control panel and facilities are included in the transmitter for remote control and metering.

The company's S1-10E exciter is the heart of the transmitter. It uses six ICs and four transistors in its front-panel visual monitoring system. Operating status is monitored continuously by five LED indicators which normally are illuminated through electronic sensing circuitry.

Circle (560) on Reply Card

Lavalier microphone

The ECM-50PS lavalier microphone by Sony is suited to binaural recording because of its compact size, S/N ratio of 66 dB and sensitivity of 56 dB. The mic uses



the standard cannon output connector and is equipped with a 2-way power system (battery or studio power supply).

Circle (561) on Reply Card

Audiocassette tape

TDK Electronics has developed a metal tape, designated MA-R, which is loaded into a Reference Standard cassette mechanism made of die-cast metal.

The 60-minute metal cassette tape utilizes particles which have greater magnetic energy than oxide particles. Coercivity of the new tape is



1050 oersteds, while remanence has been fixed at 3000 gauss. In a suitably biased cassette deck, an increase of high-frequency maximum output level (MOL) of as much as 7dB can be expected.

The die-cast metal shell is said to be less sensitive to warp than conventional plastic molded shells, and is not subject to deformation caused by changes in ambient temperature or humidity.

Circle (562) on Reply Card

Sportscaster headset

A professional boom-mic headset for live sports broadcasting has been introduced by Telex. Designed for use in moderately noisy conditions, the Sportscaster II is effective for broadcasts from a press box, interview on the side lines, or reporting from the playing field or track.

The headset, model CS-91, features an omnidirectional dynamic microphone and an in-line push-to-cough switch which lets the announcer mute the microphone when

QUALITY TALKS FOR WAGL

Lancaster, South Carolina

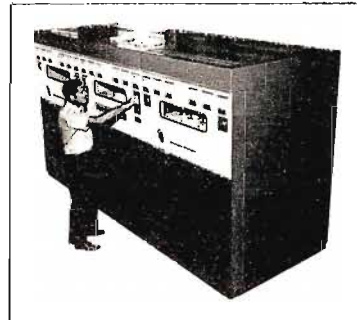

Continental's 317C is the best measure for any 50 kW AM transmitter purchase. Performance, 125% positive modulation and reserve power capabilities are unbeatable. Today's best sound in 50 kW AM is Continental.

Write for brochure. Continental Electronics Mfg. Co. Box 270879 Dallas, Texas 75227 (214) 381-7161

Continental Electronics

Circle (190) on Reply Card

Audio Tape for professionals

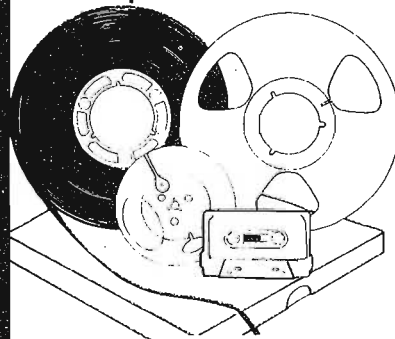

REEL TO REEL TAPE

Ampex, 3M. All grades. On reels or hubs.

CASSETTES, C-10-C-90.

With Agfa, Ampex, 3M tape.

LEADER & SPLICING TAPE

EMPTY REELS & BOXES

All widths, sizes.

— COMPETITIVE • FROM STOCK —

For your catalog, call or write: Tom Franke

312/297-0955



Recording Supply Co.

Div. of Polyline Corp.

1233 Rand Road
Des Plaines, IL 60016

Circle (191) on Reply Card



Our components are operating in over 500 stations, including over 100 complete Tuning & Phasing Systems throughout the world.

- Duty paid on orders \$200.00 or over;
- Large stock available;
- Delivery to your door by UPS or air;
- Phone collect or write for quotation:

GELECO Electronics Ltd.

2 Thorncliffe Park Dr,
Toronto, Ont.
Phone (416) 421-5631

Circle (129) on Reply Card

Tune In Performance
For Your Scully Studio Recorders.

Think Ferrite

10 Times Life • All Track Formats • 100's in Service
Unconditional Warranty.

Ferrite Heads Available for all Professional Recorders.



SAKI MAGNETICS INCORPORATED
(A California Corporation)

5770 Uplander Way • Culver City, CA 90230 • (213) 649-5983

Circle (130) on Reply Card

New products

.....
needed. The circumaural cushions of the binaural headphone receivers attenuate noise to let the announcer



monitor the program in one ear while receiving cues in the other. Extra comfort socks for the ear cushions are included, and a snap-on foam filled headband cushion provides ventilation during prolonged periods of use.

Circle (563) on Reply Card

Spindle height gauge

The Tentel U-matic Spindle Height gauge (TUSH) is designed for ¾-inch video recorders. It has two indicators which read in thousandths of an inch, mounted on a ½-inch thick aluminum die plate.

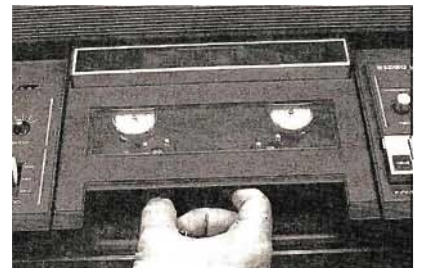

The TUSH not only measures the heights of both the supply and take-up spindles, but can measure out of flatness of the four cassette locating pins. The gauge includes a master checking block, instructions and carrying case.

Circle (564) on Reply Card

Videocassette storage

A videocassette storage system designed for ¾-inch and mini-¾-inch cassettes has been designed by the magnetic audio/video products division of 3M.

A shipper/storage case, a metal bar that can be cut to any length and mounted on a studio or storage room wall and a portable 6-pack

hanger rack make up the Scotch hanger system: A 4-wheel mobile



cart is capable of holding and transporting more than 100 boxed or unboxed videocassettes.

Circle (565) on Reply Card

Digital monitoring

A digital remote control and status monitoring system (model 7815) is available from Time & Frequency Technology. The system features fully duplexed digital data with parity check, control and status functions for 15 channels (expandable to 45), double scan compare logic for full data integrity, built-in crystal controlled FSK data modems and interconnection adaptability for phone line or radio.



The configuration of the system consists of 15 independent front panel toggle switches for easy control of 15 on/off functions. Each function is verified by an adjacent and independent LED status indicator which is activated by a telemetry signal from the remote site.

The system may be expanded by the addition of up to two model 7830 channel expanders to give an ultimate capability of 45 separate control and status functions. A time sharing communications link with other remote control and telemetry systems also is available as an option. A site selector may be added to the system to provide control and monitoring of up to 16 separate locations with a single system.

Circle (566) on Reply Card

Editing system

A single event, frame accurate editing system is available from

Videomedia. Mini Z features bi-directional shuttle arms, auto search, cruise control, auto tag and edit—rehearse, perform and review.

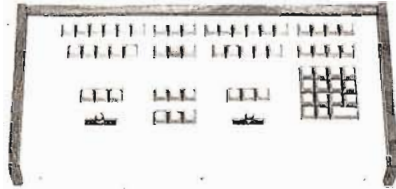

With the Micro-Loc option, the system is dead-lock accurate and offers a numeric display in either SMPTE format or pulse count readout. The editing system incorporates a complete data readout with all editing parameters displayed and continuously updated as the editing session progresses. Error messages prompt the operator through each sequence, calling attention to illegal or illogical commands.

Circle (567) on Reply Card

Dummy load

Wilkinson has introduced the DLU 80-80kW self-contained calorimeter dummy load. Using a closed loop system and film type resistor, the unit permits accurate power measurement up to 80kW. It features nonmeasurable VSWR, frequency

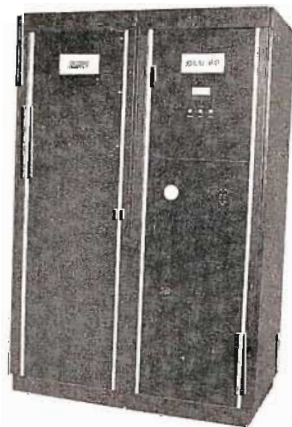

range of dc to 1.8GHz, easy power readout, and mobility for multiple uses. The unit exceeds FCC specifications.

Circle (568) on Reply Card

Dubbing console

Winsted Corporation's 990 dubbing console features rugged steel construction and caster-mounted

QUALITY TALKS FOR KXL

Portland, Oregon



Continental's 317C is the best measure for any 50 kW AM transmitter purchase. Performance, 125% positive modulation and reserve power capabilities are unbeatable. Today's best sound in 50 kW AM is Continental.

Write for brochure: Continental Electronics Mfg. Co. Box 270879 Dallas, Texas 75227 (214) 381-7161

Continental *Co.*
Electronics 

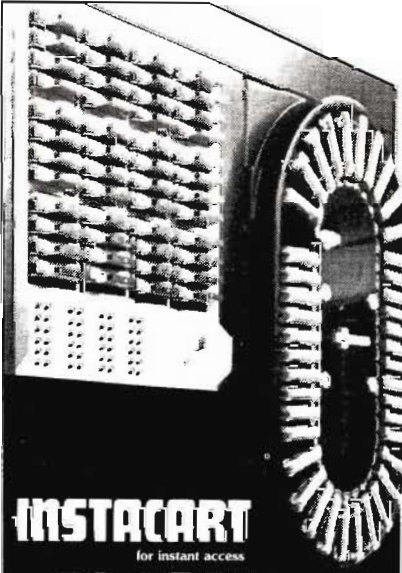

INSTACART
for instant access

GO-CART
for high capacity at lowest cost

from
IGM/NTI

A DIVISION OF
IGM

(206) 733-4567
4041 HOME ROAD, BELLINGHAM, WA 98225

Circle (197) on Reply Card

WILKINSON ELECTRONICS MANUFACTURES

10 WATT FM TRANSMITTERS*
 100 WATT FM TRANSMITTERS*
 250 WATT FM TRANSMITTERS*
 500 WATT FM TRANSMITTERS*
 1 KW FM TRANSMITTERS*
 1.5 KW FM TRANSMITTERS*
 2.0 KW FM TRANSMITTERS*
 4 KW FM TRANSMITTERS*
 5 KW FM TRANSMITTERS
 7.5 KW FM TRANSMITTERS
 10 KW FM TRANSMITTERS
 20 KW FM TRANSMITTERS
 25 KW FM TRANSMITTERS
 50 KW FM TRANSMITTERS
 FM LINK TRANSMITTERS*
 FM RELAY RECEIVERS*
 STEREO & SCA GENERATORS
 250 WATT AM TRANSMITTER*
 1 KW AM TRANSMITTERS
 5 KW AM TRANSMITTERS
 10 KW AM TRANSMITTERS
 20 KW AM TRANSMITTERS
 25 KW AM TRANSMITTERS
 50 KW AM TRANSMITTERS
 MONAURAL AUDIO CONSOLES
 STEREO CONSOLES*
 AM MODULATION MONITORS*
 AM RF AMPLIFIERS*
 LIMITING AMPLIFIERS*
 AGC AMPLIFIERS*
 TURNTABLE PREAMPLIFIERS*
 MONITORING AMPLIFIERS*
 REMOTE AMPLIFIERS*
 DISTRIBUTION AMPLIFIERS*
 LINE AMPLIFIERS*
 LIGHTNING PROTECTORS*
 SILICON RECTIFIER STACKS*
 AIR COOLED DUMMY LOADS -
15-25-50-80-KW-AM to UHF
 * All Solid State

WILKINSON ELECTRONICS, INC.

701 CHESTNUT ST.
 P.O. BOX 738
 TRAINER, PA 19013
 (215) 497-5100
 TWX 510 669 3188

Circle (198) on Reply Card

New products

mobility and will hold all sizes of VTR equipment. Four all-steel VTR drawers and monitor shelves which adjust on 1-inch increments are featured.

Circle (569) on Reply Card

Color generator

The B&K-Precision model 1250 NTSC generator is a cost-effective unit intended for broadcast, CATV and industrial television applications. It generates the standard



NTSC bar pattern with a -IWQ signal occupying the lower quarter of the pattern as well as the full-screen color bar pattern. Another feature is the 5-step staircase pattern with selectable chroma levels. Other patterns include dot, crosshatch, center cross and color raster for convergence checks and adjustments.

Circle (570) on Reply Card

Analog TBC

Consolidated Video Systems has introduced an analog TBC for non-broadcast, heterodyne VTR users. The CVS 506 reduces or eliminates skew, jitter, flagging and other picture distortions. It uses charge coupled device (CCD) circuitry and works with any heterodyne VTR format, including 3/4-inch, Beta and VHS.



Standard features of the CVS 506 include a built-in proc amp and automatic color/mono selection.

Circle (571) on Reply Card

For Sale ---

AUTOMATION EQUIPMENT AND PARTS

- New reel-to-reel Spot Locator
- 25 HZ make-up unit (I'd rather do it myself)
- 25 HZ tape control start, stop, cue the tape, and feed the audio
- Stereo monitor AMP takes 3-1/2" rack space
- 25 HZ notch filter *in -°out 25 HZ 35 db down
- Random select your carousel (TM) or cartel
- Sequential Automation Systems



COMMUNICATIONS, INC.

Call 805-765-5403

214 Harrison Street

Taft, California 93268

Circle (199) on Reply Card

La Compaginación Profesional
 Comienza
 El Día que Ud. Descarta Sus
 Máquinas de Videocassette
 Viejas por las Nuevas

JVC

Sistema de Editar
CR8500 LU/RM85U

Inserte o construya la compaginación del video con la exactitud hasta de un cuadro. Compaginación o doblaje del audio con exactitud hasta de una palabra en una pista o en ambas. Velocidades variables de búsqueda Memoria de editar de 90 minutos. Solicite Ud. hoy mismo los folletos y precios más recientes de éste y otros Productos de Video Profesionales JVC

a:
COMEX CORPORATION
 P.O. Box 17011

Dulles International Airport
 Washington, D.C. 20041, E.U.A.
 Teléf. : (703) 471-4215

Circle (200) on Reply Card

Lamps

Custom Audio Electronics has announced the availability of goose-neck lamps for illumination of control panels and work spaces in dimly lit areas.



The lamps come equipped with a bayonet type bulb and 360-degree swivel base. A kit including lamp, base, dimmer, power supply, cable and mounting hardware is offered.

Circle (572) on Reply Card

Microphone system

Eddor has introduced the E-COM 150-210 MHz band wireless microphone system, complimentary to the 30-50 MHz wireless mic systems.



Transmitter includes the E-COM 1 pocket transmitter and the E-COM 2 handheld microphone transmitter. Receiver includes the single channel crystal controlled E-COM 3, the E-COM 5 true diversity receiver for using two antennas and the E-COM 7 mini-receiver.

Circle (573) on Reply Card

Mono/stereo matrix

Eventide's Monsternat model RD770 mono/stereo matrix converts the stereo signal into left-plus-right

and left-minus-right, putting the L+R mono signal on one cart track. The second track carries the differ-



ence, L - R, signal. Full stereo is restored on playback and dematrixing. Using the dbx noise reduction system, the unit is available in two formats: record/play, which provides encoding and decoding for one cart machine; or play/play, which can handle two cart machines in the play mode.

Circle (574) on Reply Card

Marking beacon

Flash Technology Corporation of America has introduced a flashing white aviation obstruction marking beacon. The FTB-319 ElectroFlash Beacon meets the new FAA night/twilight marking requirements.



Flashing 40 times per minute, it features self-contained solid state timing and photoelectric controls and has an expected flashtube life exceeding two years. The beacon is a 75 W, AC-powered, flashing light that needs less than 10% of the power consumed by conventional 300mm incandescent beacons.

Circle (575) on Reply Card

dBS system

The Swintek dBS system, available on Alan Gordon Enterprises'



QUALITY TALKS FOR KGNC

Amarillo, Texas

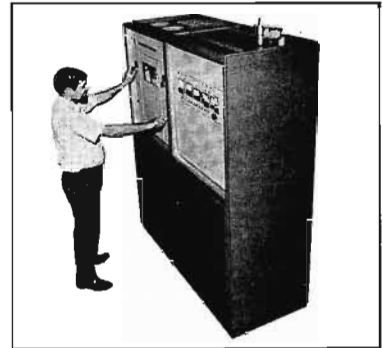

Continental's new 5/10 kW AM transmitter is setting records for acceptance. It has performance and efficiency, with the cleanest sound around. Listen to Continental: quality talks.

Write for brochure: Continental Electronics Mfg. Co. Box 270879 Dallas, Texas 75227 (214) 381-7161

Continental Electronics

Circle (201) on Reply Card

PERFECT PAIR



UAP
Div., Audio Intl., Inc.

HERE'S A MATCHED SET OF BATTERY/OR/A.C.-POWERED AUDIO AMPLIFIERS FOR LOW-BUDGET/HIGH-GRADE REMOTE BROADCASTS: **ARA-11** BOOSTS A DYNAMIC MIC. UP TO +8 LEVEL WITH 10db HEADROOM. INCLUDES COMPRESSOR FOR HANDS-FREE 1-MAN USE; INTERNAL OR EXTERNAL POWER. ADD **ARM-31** 3-MIC. MIXER WITH VU METER THAT READS COMPRESSION OR LEVELS. SWITCH-OFF COMPRESSOR IF DESIRED. RUGGED, VIRTUALLY DAMAGE-PROOF AND FOOL-PROOF.

Ultra Audio Products
P.O. BOX 921 • BEVERLY HILLS
CA 90213 • 213/276-2726

Circle (202) on Reply Card

WORK SMART NOT HARD

COMPUTER EDITING WITH COMMANDER I

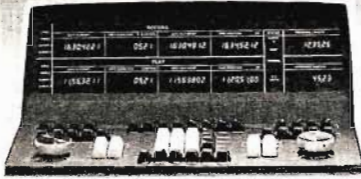

SMPTE / EBU TIME CODE WITH USER BIT

- Portable, self contained desk top editor
 - Split edits, IN or OUT, or both (depends on VTR's)
 - Servoing for exact frame editing
 - Industry compatible punched tape input/output.
 - Back timing of Edits
 - Memory storage — up to 25 events
 - Automatic assembly capability
 - Complete display for edit point, duration, show length and keyboard
 - Edits through midnight without loss of continuity
 - Compatible with most 2", 1" or 3/4" VTR's and combination of same
 - Built in Time Code readers with User Bit capability
 - Formats punched paper tape with cuts dissolves, wipes and keys
 - Separate VTR motion controls
 - Automatic and Manual Color Framing.
 - Variable motion control for selective Ampex, JVC, RCA, and Sony VTR's without modifications
 - Standard 1 year warranty for parts, labor and software
 - Two interfaces for 2", 1" or 3/4" included
 - Keyboard entry
 - On-the-Fly Mark IN
Mark OUT
- for Video
Audio 1
Audio 2
- COMPARE**
P.S. DEALER INQUIRIES
WELCOMED
- Simplicity of operation
 - Duration Displays for Play and Record
 - Show length Display either ascending or descending
 - Auto Search, Cue, Review and Edit preview
 - T/C Readers for 24, 25 or 30 DF/NDF Rates.

Complete System \$12,950
Call or Write for UMI Product Catalog



United Media, Inc.

1571-D Parkway Loop
Tustin, CA 92680 • (714) 731-3011

Circle (203) on Reply Card

New products

Mark 2L-dBS transmitter and Mark 50A-dBS receiver, offers virtual elimination of buzz noises and high-fidelity audio recordings. The signal-to-noise ratio is increased by at least 15 dB. Another advantage is the increased dynamic range utilizing the compander method rather than the compression method.

Circle (576) on Reply Card

Computer terminal

Hazeltine has introduced the 1420 low-cost computer terminal designed for support of small business systems using data and word pro-



cessing software. The unit features a typewriter-style keyboard and high intensity, blink or non-display modes. A program function key mode as well as column and field tabs are standard.

Circle (577) on Reply Card

Micro mixer

Holland Electronics offers the 401 micro mixer for ENG applications. The mixer is fully-portable and operates from internal rechargeable batteries. Standard features include transformer coupled mic inputs, transformer coupled outputs, built in switchable AGC and built in 1 kHz tone oscillator.

Circle (578) on Reply Card

Automated console

The JH-600, MCI's console, is an in-line audio console with each I/O module containing one complete mic



channel and one complete remix channel. On the JH-600 the VCA fader assemblies have been mechanically separated from the rest of the module. It comes in two

TOP CASH FOR CLEAN, WORKING AM & FM TRANSMITTERS AND STUDIO GEAR

We Carry All Lines Of
New & Used
Broadcast Equipment

LET US BE
YOUR LOW BIDDER.



B.A.A. INTERNATIONAL, INC.
1229 N.E. 12th Street
Ft. Lauderdale, Fl. 33334
Phone: (305) 564-4422
Cable: BROADCAST

Circle (204) on Reply Card

ATTACH
ADDRESS
LABEL
FROM
CURRENT
ISSUE
HERE

MOVING?
Let us know
before you
go!

Please be sure to notify us so that service will not be interrupted. Write your new address, change of title, or change of company name on lines below.

When you write, why not give us the names and titles of business associates who you think might enjoy receiving copies of this magazine? Thank you for your help.

and please always include such a label whenever you write us. We'll be able to serve you better, and faster.

Name _____
Title _____
Company _____
City _____
State _____ Zip _____

Mail To: **Broadcast Engineering**

Subscription Dept.

P.O. Box 12901

Overland Park, KS 66212

**PICLEAR
FILM ENHANCEMENT
SYSTEMS**

**PRESENTS
INFORMATION FROM
MOTION PICTURE FILM
AS
RECORDED
ORIGINALLY**

**SURFACE DIRT
REMOVED**

**SCRATCHES
RENDERED INVISIBLE
DURING PROJECTION**

PICLEAR, INC.

180 East Prospect Ave.
Mamaroneck, N.Y. 10543

Circle (194) on Reply Card

**THE MEAN
LITTLE KIT**

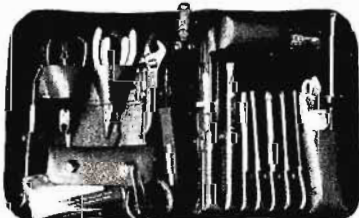

New compact 24-piece kit of electronic tools for engineers, scientists, technicians, students, executives. Includes 7 sizes screwdrivers, adjustable wrench, 2 pair pliers, wire stripper, knife, alignment tool, stainless rule, hex-key set, scissors, 2 flexible files, burnisher, miniature soldering iron, solder aid, coil of solder and desoldering braid. Highest quality padded zipper case, 6 x 9 x 1 3/4 inside. Satisfaction guaranteed. Send check, company purchase order or charge Visa/BankAmericard or Mastercharge. We pay the shipping charges.

JTK-6 Tool Kit \$75.00



FREE CATALOG

128-pages of hard-to-find precision tools. Also contains 5 pages of useful "Tool Tips" to aid in tool selection. Send for your free copy today!



JENSEN TOOLS INC.
1230 S. PRIEST DR. TEMPE, AZ 85281

Circle (195) on Reply Card

frame sizes, the JH-618 (18 inputs) or JH-636 (36 inputs).

Features for the automated console include differential line inputs and optional differential mic pre-amps.

Circle (579) on Reply Card

Microwave leak detector

Metrifast's hand-held microwave leak detector monitors unsafe radiation levels in microwave equipment which might occur through equipment damage, misuse or wear. A light-emitting diode in the center of the arrow-shaped device glows red when in contact with radiation levels above the prescribed US minimum of 5mW/cm² at a distance of 2 inches.



The unit, model 748, is comprised of a microwave dipole receiving antenna connected to a passive non-linear alarm which is energized solely by radiation received by the antenna. There are no batteries or moving parts.

Circle (580) on Reply Card

Digital effects system

The three enhancement options available for the Quantel DPE 5000 digital effects system by Micro Consultants include Picture Reversal, Autolink and Multilink.

Picture Reversal gives the illusion of a picture reversing or producing a mirror image. Reversing the picture in succession creates a spinning effect while changing the picture size and position during spinning creates a tumbling effect.

The Autolink option permits several DPE 5000 control panels to be used with one DPE 5000 effects system.

Multilink allows interlinking of up to four DPR 5000s with up to four control panels when multiple picture manipulation is required.

Circle (581) on Reply Card

Contact sleeve

Neutrik's Helicon contact sleeve is said to provide high-reliability contacts with low contact resistance on a long-term basis. High-quality phos-

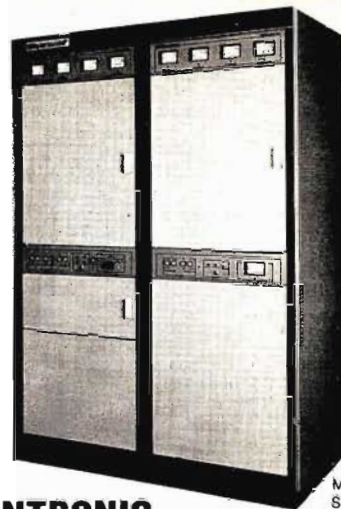

Model SI-F-25

**SINTRONIC
AM & FM TRANSMITTERS**

A 27.5 kW Fm transmitter with a solid design, terrific performance, and at a price that makes our cost-performance ratio hard to match. Call or write for all the details.

Sintronic

212 Welsh Pool Road, CORPORATION
Lionville, PA. 19353 (215) 363-0444.

Circle (205) on Reply Card

**REPLACEMENT TRANSFORMERS
FOR GATES, COLLINS, RCA, ETC.**



GATES PLATE TRANSFORMERS	
FM-250	\$175
FM-18	\$400
BC1E/F	\$350
BC1G/H	\$350
BC11	\$350
BC5P	\$1050

GATES MODULATION TRANSFORMERS	
BC1 SERIES	\$400
BC5 SERIES	\$1000

GATES MODULATION REACTORS	
BC1 SERIES	
(40 HY @ 0.6 ADC)	\$400
BC5 SERIES	
(35 HY @ 1.4 ADC)	\$600

DC FILTER CHOKES	
5.0 HY @ 1.0 ADC	
(REPLACES BE-0572)	\$175
5.0 HY @ 2.0 ADC	\$225
8.0 HY @ 1.5 ADC	\$200
10.0 HY @ 1.0 ADC	\$200

MISCELLANEOUS	
RCA BTA 1R/S TRANSFORMER	\$400
VANGUARD 1 PLATE TRANSFORMER	\$450
COLLINS 20V2 PLATE TRANSFORMER	\$350

MANY OTHER TRANSFORMERS ALSO AVAILABLE. CALL US FOR FREE QUOTATIONS. LARGE STOCK AND FAST DELIVERY.

24 MONTH GUARANTEE ON ALL ITEMS
Peter W. Dahl Co.

4007 Fort Blvd. • El Paso, Texas 79930
Telephone (915) 566-5365

Circle (206) on Reply Card

Even With A Cast Of Hundreds,

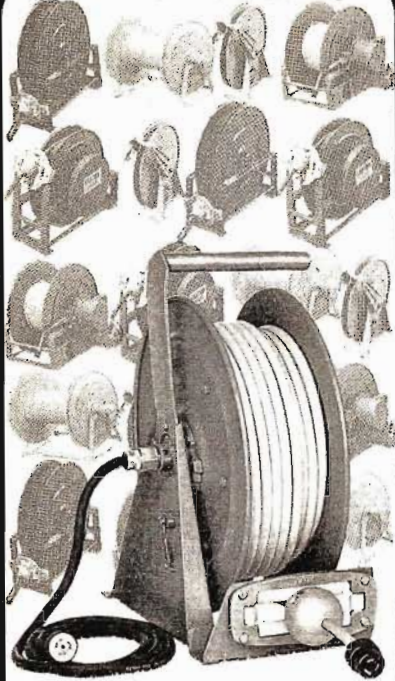

We're Always Glad To Do A Special

- Mix 'n match stock parts to custom design the ideal reels for your mobile unit or studio.
- Sizes, shapes, capacities unlimited. A wide choice of rewind options.
- Microphone cable, coaxial cable, power cable: hookup & pickup go smoother & faster with Hannay Reels.
- No other reel is remotely as efficient! Free fact-packed Reel Guide! Ask for your copy today.

Buy Hannay Reels and Wind Up With The Best



HANNAY REELS

CLIFFORD B. HANNAY & SON, INC., WESTERLO, N.Y. 12193

Circle (207) on Reply Card

New products

phor bronze is formed into a tube with a front guiding sleeve followed by two helical spring-like fingers with contact dimples.

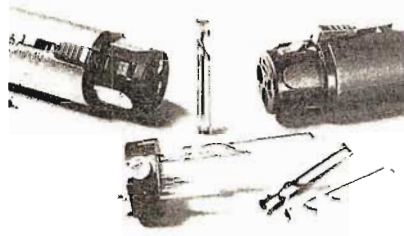

The helical form of these fingers provides longer spring elements than commonly used. The staggered position of the contacts produces an insertion force which is lower at the beginning of contact engagement and increases as the two connectors seat. Two-point wiping action also is provided. The shape of the wiping contacts has been designed to improve the desired self-cleaning action without undue contact pressure which might wear through the plating of the mating connector pin.

Circle (582) on Reply Card

Recording/mixdown console

Neve Electronics International has introduced the 8098 48 track recording and mixdown console which features reverb return inputs and multi-frequency line-up oscillator.

Standard features include 56 input channels, master mic/line changeover facilities, four reverb outputs and muting positional solo facilities on all channels.

Circle (583) on Reply Card

Oscilloscope

A portable 15 MHz oscilloscope offered by Philips Test and Measuring Instruments features an 8x10 cm



screen, a choice of display modes and automatic triggering. The PM

**ENERGY.
We can't afford
to waste it.**

TRANSLATORS

VHF - TV

FM

UHF TV

SOLAR POWERED

MICROWAVE FED

SATELLITE FED

ALSO REPAIR PARTS AND UP DATING KITS FOR ALL ADLER, LITTON AND KEITH ANDERSON TRANSLATORS

Television Technology Corporation

5970 West 60th Avenue • Arvada, Colorado 80003

303-423-1652 / TWX 910-938-0396

Circle (208) on Reply Card

EVERY YEAR
MILLIONS OF
UNITEDWAY
VOLUNTEERS WORK
TIME AND A HALF
SO YOU'RE NOT
BOTHERED
TIME AND
AGAIN.  United Way

3207 provides a separate manual trigger control. Both internal and external triggering are possible with internal trigger sensitivity 0.75 div at 100 kHz.

Circle (584) on Reply Card

Shipping cases

Plastic Reel Corporation is offering the Video Vault series of

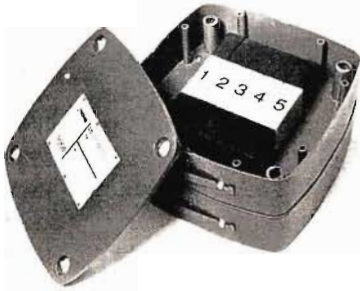

Plio-Magic shipping cases designed to hold up to 10 3/4-inch cassettes. The cases feature independent locking security on all four corners; lightweight, high-impact design;

overlapping construction to keep out dirt and moisture; integral carrying handle and labelling.

Circle (585) on Reply Card

DC turntable

The Galaxy by QRK Electronic Products is a dc turntable which features an electronic speed control for plus or minus 10% speed variation on both 33 1/3 and 45 RPM.



The turntable features instant starting without speed loss and back cueing with no motor drag.

Circle (586) on Reply Card

Coax transmission line

SWR claims that technological improvements in their coaxial trans-

VIDEO TAPE EXCHANGE
VIDEO TAPE EXCHANGE
VIDEO TAPE EXCHANGE

VIDEO TAPE EXCHANGE
USED BRAND
NAME VIDEO TAPE
EVALUATED - GUARANTEED
SONY — SCOTCH — FUJI

KCA 60	\$14.75	KCA 10	\$ 7.50
KCA 30	\$11.50	KCS 20	\$10.50

SPECIAL-NEW FUJI KCA 60 \$24.00

VIDEO TAPE EXCHANGE
 855 AVE. of the AMERICAS N.Y., N.Y. 10001
 (212) 695-6644
 A DIVISION OF CINE FILM EXCHANGE, INC.

Circle (209) on Reply Card

50% OFF
 G.E. & Sylvania

STAGE & STUDIO LAMPS
 SAVE By Letting Us Bid
 On Your Annual Needs!

We prepay trans. on \$150.00 net orders. We allow surface trans. overseas. Your satisfaction guaranteed. Order today, or write for Sittler's complete price sheet.

Sittler's SUPPLIES, INC.

702 E. Washington St., P.O. Box 10-A
 Washington, Iowa 52353 Ph. 319-653-2123

Circle (210) on Reply Card

NEW... THE SYSTEM S STUDIO
A PREWIRED SIX CHANNEL BROADCAST SYSTEM

6618 audio console
 6 channel 18 input
 handsome styling
 prewired for turntables
 for new studio or stereo conv

contact your Micro-Trak dealer or call 413 536-3551

MICRO-TRAK CORPORATION
 620 RACE STREET HOLYOKE, MASSACHUSETTS 01040

Circle (213) on Reply Card

FREE CATALOG & AUDIO APPLICATIONS

CONSOLES
 KITS & WIRED
 AMPLIFIERS
 MIC., EQ, ACN, LINE,
 TAPE, DISC, POWER
 OSCILLATORS
 AUDIO, TAPE BIAS
 POWER SUPPLIES

OPAMP LABS INC.
 1033 N. SYCAMORE AVE.
 LOS ANGELES, CA. 90038
 (213) 934-3566

Circle (211) on Reply Card

BUILDS STUDIOS
 *AUDIO CONSOLES
 *STUDIO CABINETS

DYMA
 BOX 1697
 TAOS, N.M. 87571
 (505) 758-8686

Circle (212) on Reply Card

1979 RATE CARD

Colorado Magnetics



P. O. Box 713
 Colorado Springs
 Colorado 80901
 303 / 596-0684

LENGTH	Fidelipac		Audiopak	
	300 NAB	380 NAB	A-2	AA-3
Empty	1.69	1.85	1.92	-
20 sec	2.01	2.10	2.53	3.12
40 sec	2.16	2.21	2.58	3.20
70 sec	2.19	2.25	2.64	3.27
100 sec	2.25	2.32	2.73	3.38
2.5 min	2.48	2.56	2.83	3.51
3.5 min	2.59	2.67	2.96	3.66
4.5 min	2.72	2.75	3.08	3.81
5.5 min	2.89	2.96	3.21	3.97
7.5 min	3.06	3.14	3.41	4.21
10.5 min	3.48	3.56	3.73	4.61



- Prices are cash with order or C.O.D.
- Prices based on 100+ order
- Prices subject to change without notice
- Quantity discounts available

FIDELIPAC ACCESSORIES	Price
Studio On-Air Light	36.00
Cartridge Wall Rack - Holds 25	19.00
Mobile Cartridge Rack - Holds 200	195.00
Table Top Cartridge Rack - Holds 48	54.00
Table Top Cartridge Rack - Holds 96	93.50
Blank It Bulk Eraser, Hand Held	59.95
Audiolab Electronics Bulk Eraser	82.00
Alignment Cartridge - Monophonic	42.00
Alignment Cartridge - Stereophonic	42.00

- Complete Reloading/Rebuilding available
- Cartridges and accessories in stock - ready for shipment
- All products sold by Colorado Magnetics carry a 90-day guarantee
- Annual purchase plans for large orders

Circle (214) on Reply Card

New products

mission lines result in a 2-fold improvement in heat dissipation for some line sizes. The firm's Cool "K"

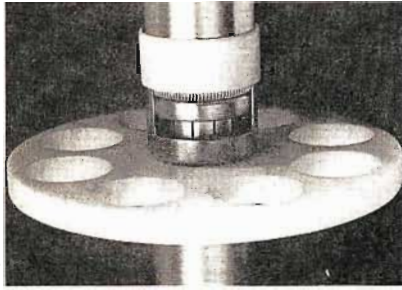

transmission lines use TE copper connectors with a thermal coupling design.

Circle (587) on Reply Card

Signal analyzer

Model WR-515B color bar Signal-

yst from VIZ Test Instruments incorporates solid-state electronics, rugged construction and compact size for bench and field servicing applications.



The device provides the signals necessary for servicing color TVs, videotape recorders, MATV, CATV and CCTV systems. Over a dozen tests are possible through three separate color bar patterns with the

sixth bar marked for quick identification.

Circle (589) on Reply Card

Slide projector

Model LD-4200 lap-dissolve 35mm slide projector from Zei-Mark features two Ektagraphics E-2 slide

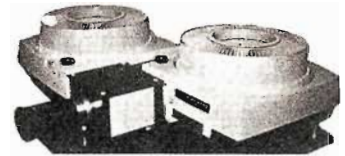

projectors (with horizontal registration) and an optical beam-splitter. An 8-inch f/5 projection lens in the optical assembly permits an image size range of 1.6-inch to 2.1-inch high.

Circle (590) on Reply Card



VHF HI-BAND WIRELESS MICROPHONE SYSTEM

The HME System 22EF combines the convenience of a flat pack portable receiver with a broadcast quality wireless microphone. Special Dynamic Expansion processing increases the dynamic range up to 95 dB.

The transmitter, compatible with any electret or dynamic microphone, is powered by a 9V alkaline battery. The lightweight receiver is powered by either alkaline or NiCad batteries, ac or dc power, (polarity is reversible), and is a perfect mate for your recorder or minicam. PRICE: \$1,890.00.

hme 6151 FAIRMOUNT AVENUE
SAN DIEGO, CALIFORNIA 92120
HME ELECTRONICS, INC. TELEPHONE (714) 280-6050

Circle (215) on Reply Card

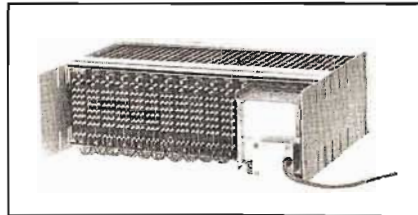

AUDIO DISTRIBUTION AMPLIFIER PACKAGE

The SA-200 DA, is available in two basic packages. Shown is the wiring side of the 12 card frame which contains a Dual Regulated Power Supply and rear mounted Terminal Boards for ease of installation. Provides 12 Inputs and 72 Outputs at a cost of \$2,495.00. Other products include: Custom Audio Consoles, Studio Intercom Systems, Studio Monitor Systems, **SCIENTIFIC SYSTEMS, INC.** 92 Westwood Dr., Toms River, New Jersey, 08753, (201) 255-2230. Sales Office: 191 West Field Ave., Clark, New Jersey, 07066, (201) 381-1088.

Circle (217) on Reply Card

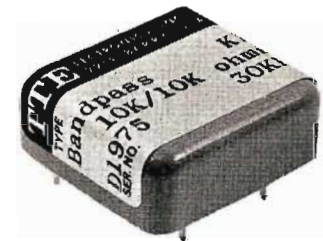

FILTERS

1,000,000 Standard Types
BANDPASS • BANDSTOP

Select any Frequency from 3Hz to 500MHz such as • CUE TONE 25HERTZ NOTCH • LOW NOISE 50HERTZ HIGHPASS • STEREO GENERATOR 19KHz LOWPASS
15.75KHz CATV Bandpass, 300 Hz Telephone Simulation Lowpass, 21Hz Bandpass, 18KHz Lowpass, 1KHz notch, 4MHz Lowpass, 7.6KHz Lowpass.

TTElectronics, Inc. 2214 Barry Ave
Los Angeles, 90064, (213)478-8224

Circle (235) on Reply Card

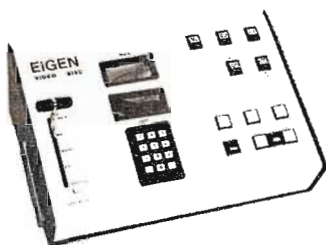

ELECTRONIC SLIDES / SLOW-MOTION COMBINATION

Random access 600 stills, and have slo-mo capability for sports and editing. Combination controller, high-Band color, Digital TBC/DOC @ \$27,000.

EIGEN VIDEO P.O. Box 1027
Grass Valley, CA 95945 916/273-1341

Circle (216) on Reply Card

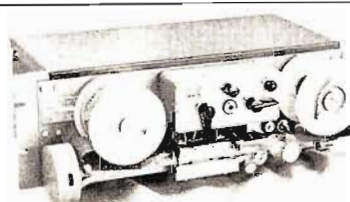

TAMPER-PROOF 24 HOUR MONITORING SYSTEM

SoundScriber Model S-124-T keeps a mistake-proof, permanent record of all programming—around the clock, every day of the year. Every broadcast minute of every program is recorded with indisputable accuracy on a time-calibrated tape—invaluable for verification or legal documentation. New Easi-Semble design allows direct rack mounting. The unit uses tape 2" in width, perfect for discarded videotape. Contact factory for direct pricing. SoundScriber, 85 Willow Street, New Haven, Conn. 06511.

Circle (218) on Reply Card

WE'RE FIGHTING FOR YOUR LIFE

Have Your Blood Pressure Checked

The American Heart Association

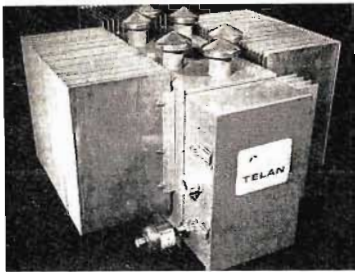

REMOTE ELECTRICAL POWER SYSTEMS (REPS)
Teledyne manufactures a family of remote electrical power systems which provide power for communication systems, navigation systems, data collection stations, railroad signals and cathodic protection. In addition to the standard thermoelectric generators a new series is now available with Factory Mutual approval for applications in hazardous locations. Thermoelectric/solar systems are also available for long term unattended operation.

TELEDYNE ENERGY SYSTEMS
110 West Timonium Road
Timonium, Maryland 21093
301-252-8220

Circle (219) on Reply Card

SOLID STATE TOWER FLASHERS

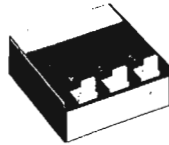

A new series has been added to SSAC's line of "B-Kon-Flash". The new devices with a load current rating of 300 Amperes inrush will operate up to four beacons at 230 VAC, two beacons at 120 VAC. Also available are auxiliary units for synchronous operation of additional beacons on separate lines or for alternating flashing of beacons.

Lamp Life is increased by approximately 10 X due to Zero Voltage Switching. Device measures 2 x 2 inches and is completely encapsulated. Price in 1-9 quantity, \$41.52 each, FOB Factory. For more information call John Arnold at (315) 622-1000.

SSAC Inc.
PO Box 395, Liverpool, NY 13088

Circle (220) on Reply Card



UHF WIRELESS MICROPHONE SYSTEM

The HME System 24E—newest member of the HME family—operates on 400-470 MHz. It utilizes the FM (frequency modulation) transmission method, plus special Dynamic Expansion processing that increases the dynamic range up to 95 dB.

The same superior design features of HME's professional VHF Systems are also incorporated in the System 24E. PRICE: \$2,300.00.



HME ELECTRONICS, INC.

6151 FAIRMOUNT AVENUE
SAN DIEGO, CALIFORNIA 92120
TELEPHONE (714) 280-6050

Circle (221) on Reply Card

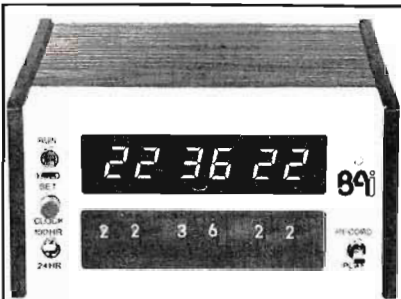

START YOUR RECORDERS!

Missed any network or off-the-air recordings lately? Then the Model 400 Clock/Timer can help! Just set the record time and recording is automatic. On time playback, too. Start time is constantly displayed along with real time. Easy setting lever-switches also make it handy in the control room.

Broadcast Aids Inc.
20 Red Rose Drive
Levittown, PA. 19056
215-547-7133

Circle (222) on Reply Card

WIRELESS & eventide

The industry's first choice in wireless mics, communications equipment and audio special effects.

SCHAFFER B&T WIRELESS SYSTEM
SCHAFFER-VEGA DIVERSITY SYSTEM

EVENTIDE
1745M DELAY LINE • H910 HARMONIZER
BD955 BROADCAST (OBSCENITY) DELAY
SPECPET™
Intelligent, Video Display, Audio Spectrum Analyzer

MARK 200 COMMUNICATORS
Duplex, Wireless
REDICOM WALKIE-TALKIES



THE KEN SCHAFFER GROUP, INC.
10 E. 49 St., N.Y., N.Y. 10017
(212) 371-2335

Circle (223) on Reply Card

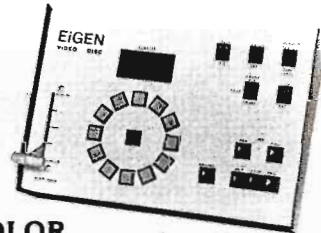

COLOR SLOW-MOTION DISC RECORDER

Sports • Animation • Slides

from \$25,000, including TBC/DOC
CCTV versions from \$15,000.
for full specifications:

EIGEN VIDEO

P.O. Box 1027
Grass Valley, CA 95945
916/273-1341

Circle (224) on Reply Card

PULTEC®



EQUALIZERS & FILTERS

Twenty five years of **capable, dependable** service in radio & TV stations and recording studios. U.S. and overseas. Picture is solid state Model EQP-1A3 Audio Program Equalizer.

PULSE TECHNIQUES, INC. 1411 Palisade,
Teaneck, N.J. 07666. Tel. (201) 837-2575
Cable: **PULTEC, TEANECK, NEW JERSEY**

Circle (225) on Reply Card

GREAT AUDIO STARTS HERE!



Production Consoles

- BROADCAST
- QUALITY
- T.V. AUDIO
- RECORDING



QUANTUM AUDIO LABS, INC.

1909 Riverside Dr. • Glendale, Ca. 91201
(213) 841-0970

Circle (226) on Reply Card

PAY WHOLESALE PRICES
for your
TUBES & SEMICONDUCTORS.

CeCo is an established franchised super distributor of major lines & offers:

- Largest stocking inventory
- 24-hour usual shipping service
- 24-hour emergency phone service.
- Call collect on your requirements.



212-646-6300
OR TOLL FREE
800-221-0860

COMMUNICATIONS, Inc.

2115 AVENUE X
BROOKLYN, NEW YORK 11235

Circle (227) on Reply Card

WHEN YOU THINK OF THE LEGENDARY AMPEX VR-1200's AND VR-2000's THINK OF AFA...

We're keeping the legend alive!

AMPEX VR-2000's and VR-1200's are the stuff legends are made of... they're the best. So if you can't afford a New VTR... consider owning a "pre-owned" legendary AMPEX VTR instead.

Our customers, including TV Stations, Manufacturers, Institutions, TV and Film Production Facilities have purchased \$8 million in AMPEX VR-2000's, VR-1200's, AVR-1's, HS-200's and paid only half that price. They know they're still getting the best in VTR's.

AFA VTR's are fully rebuilt and good as new... even better! These "legends" are in a class of their own... and at prices that are becoming legendary in their own rights.

And when the New AMPEX VTR's become legend... AFA will be there to keep them "alive" too.

Who knows... some day someone will have to keep our legend alive.



AFA...the largest rebuilder of the best VTR's in the world.

AFA

A.F. ASSOCIATES, INC.

100 Stonehurst Court, Northvale, NJ 07647

2465 E. Bayshore, Suite 301, Palo Alto, CA 94303

201-767-1000
415-856-1060

Circle (228) on Reply Card

1979 BROADCAST BUYERS' GUIDE

-
- *Product directory section begins on page 182.*
 - *Manufacturers' addresses section begins on page 228.*
 - *Dealer/distributor section begins on page 242.*
 - *Edges of each section are color coded so that they can be found easily.*
-

Since our first edition of the Buyers' Guide 11 years ago, the broadcasting industry has grown tremendously in complexity of equipment and completeness of broadcast services. Just as the industry has responded to the use of new technologies—most notably the microprocessor in all phases of automation—the Buyers' Guide has responded by providing the most complete directory possible for engineers, managers; and purchasing agents requiring broadcasting equipment or services. Reflecting the current healthy state of our industry, this year's Buyers' Guide has nearly 800 product categories, lists more than 700 manufacturers, and contains more than 200 advertisers. It's the result of a dedicated staff effort to make it our finest tool for purchasing the industry's hardware, software and services.

Each year, **Broadcast Engineering** mails extensive questionnaire forms to suppliers around the world. They are asked to identify, by special code number, every product they currently market. In the process, scores of new products and companies are added, while lines that have been phased out—and firms that have left the field—are deleted. Once amassed and

assembled, these new data are processed through a unique computer operation, programmed to "read" the code numbers and assign company names and Red Listings to appropriate product headings.

Advertisers in this issue are listed in **red** under each appropriate product heading. These Red Listings include the ad page location to serve as a direct reference to the product information you are seeking.

Broadcast Product Dealer/Distributors are listed separately in the section beginning on page 242, followed by the states they serve and the products/services they provide. If they are advertisers, their ad appears either on the page of their listing or on the facing page. A full explanation of this section appears on page 242.

Broadcast Product Manufacturers' Addresses begins on page 228. There, you will find a complete, alphabetized index of mailing addresses for all of the companies listed in the Product Directory. Additional information appears under the index listing for advertisers in this issue: the name and telephone number of the home office sales manager, followed by, in many cases, a roster of regional sales contacts for that firm.

Reader Service Cards are bound into this edition for your convenience. Each card is valid for a full year. By circling the appropriate numbers on the card, you can secure additional information directly from the advertiser through August 1980.

product directory

ATS --See Automated Transmission Systems

Alarms, Carrier

Bayly Engineering Ltd. Member of
AEG-Telefunken Group
CCA Electronics Corp.
Hallikainen & Friends, Inc.
Harris Corp. Broadcast Products Div.

Alarms, Fault

B & I Electronics, Inc.
Bayly Engineering Ltd. Member of
AEG-Telefunken Group
Belar Electronics Lab., Inc.
Bird Electronic Corp.
Dranetz Engineering Labs., Inc.
Harris Corp. Broadcast Products Div.
Hughey & Phillips Inc.
Moseley Associates, Inc.
National Electrolab Ltd.
Pinzone Communications Products Inc.

Alarms, Teletype Receiver

B & I Electronics, Inc.
Moseley Associates, Inc.
Sono-Mag Corp.

Alarms, Tower Light Failure --
See Tower Light Failure Alarms

Alarm Systems, Burglar

Atlas Sound
G C Electronics Div. Wallace Murray
Harris Corp. Broadcast Products Div.
Heath Co.
ITI Electronics, Inc.
Mallory Distributor Prod. Co. Div. P. R.
Mallory & Co. Inc.
Wang Voice Comm. Inc.

Alarm Systems, Fire

See Adv. Page

IGM171

Atlas Sound
G C Electronics Div. Wallace Murray
Harris Corp. Broadcast Products Div.
Heath Co.
IGM Div. of Northwestern Tech.
ITI Electronics, Inc.

Amplifier Kits

DYMA Engineering, Inc.
Heath Co.
Opamp Labs, Inc.
TM Systems, Inc.

Amplifiers, AF-AGC

See Adv. Page

Delta Electronics Inc.
(Va.)107
Orange County
Electronics Int'l., Inc......108
Wilkinson Electronics,
Inc......172

Altec Lansing Sound Products
Audio & Design Recording Inc.
BGW Systems Inc.
Broadcast Electronics, Inc.
Delta Electronics Inc. (Va.)
DYMA Engineering, Inc.
Elcom Engineering Co.
Eventide Clock Works Inc.
Gregg Laboratories

Harris Corp. Broadcast Products Div.
Inovonics
Marti Electronics
McCurdy Radio Ind. Inc.
Modular Audio Products Unit of
Modular Devices, Inc.
Monroe Electronics, Inc.
Moseley Associates, Inc.
Motorola Semiconductor Products Inc.
Rupert Neve, Inc.
Opamp Labs, Inc.
Orange County Electronics Int'l., Inc.
Pacific Recorders and Engrg. Corp.
Protech Audio Corp.
RCA Broadcast Systems
ROH Corporation
Richmond Sound Design, Ltd.
Russco Electronics Mfg. Inc.
Scientific Systems, Inc.
Singer Products Co., Inc.
Sono-Mag Corp.
Sphere Electronics
TM Systems, Inc.
Thomson-CSF Laboratories, Inc.
Track Audio, Inc. (TA)
Transist-O-Sound Inc.
Wilkinson Electronics, Inc.
Yamaha International Corp.

Amplifiers, AF Compressing

See Adv. Page

Audio & Design
Recording Inc.111
Orange County
Electronics Int'l., Inc......108
Ramko Research Inc. 28-29

Altec Lansing Sound Products
Audio & Design Recording Inc.
Automated Processes, Inc.
Bayly Engineering Ltd. Member of
AEG-Telefunken Group
Bogen Div. Lear Siegler, Inc.
Broadcast Electronics, Inc.
Cetec Broadcast Group
Coastcom
Communications, Ltd.
DYMA Engineering, Inc.
E.M.S Inc.
EMT Franz VGmbH
Elcom Engineering Co.
Eventide Clock Works Inc.
Gotham Audio Corp.
Gregg Laboratories
Harris Corp. Broadcast Products Div.
Inovonics
LPB Inc.
Marti Electronics
McCurdy Radio Ind. Inc.
Modular Audio Products Unit of
Modular Devices, Inc.
Monroe Electronics, Inc.
Moseley Associates, Inc.
Rupert Neve, Inc.
Opamp Labs, Inc.
Orange County Electronics Int'l., Inc.
Pacific Recorders and Engrg. Corp.
Protech Audio Corp.
Quad-Eight Electronics
RCA Broadcast Systems
ROH Corporation
Ramko Research Inc.
Richmond Sound Design, Ltd.
Sescom, Inc.
Singer Products Co., Inc.
Sono-Mag Corp.
Sontec Electronics
Spectra Sonics
Sphere Electronics
TM Systems, Inc.
Thomson-CSF Laboratories, Inc.
Track Audio, Inc. (TA)
United Recording Electronics
Industries
Wang Voice Comm. Inc.

Wilkinson Electronics, Inc.

Amplifiers, AF General Purpose

See Adv. Page

Modular Audio
Products127
RCA Broadcast
Systems..... 81
Ramko Research Inc. 28-29
Wilkinson Electronics,
Inc......172

Altec Lansing Sound Products
Audio Designs & Mfg.
Audio Interface, Inc.
Autogram Corp.
Automated Processes, Inc.
BGW Systems Inc.
Bayly Engineering Ltd. Member of
AEG-Telefunken Group
Bell Audio Systems, Inc.
Bogen Div. Lear Siegler, Inc.
Broadcast Electronics, Inc.
Cetec Broadcast Group
Communications, Ltd.
Crown International, Inc.
Datatek Corp.
DYMA Engineering, Inc.
E.M.S Inc.
Fisher Berkeley Corp.
Grandy, Inc.
Harris Corp. Broadcast Products Div.
Heath Co.
Holland Electronics
ITI Electronics, Inc.
International Nuclear Corp.
Ivie Electronics
Johnson Electronics Inc.
Link Electronics Ltd.
Logitek Electronic Systems, Inc.
Marti Electronics
McMartin Industries, Inc.
Micro-Trak Corp.
Modular Audio Products Unit of
Modular Devices, Inc.
Monroe Electronics, Inc.
Motorola Semiconductor Products Inc.
Rupert Neve, Inc.
Norton Associates Inc.
Opamp Labs, Inc.
Orange County Electronics Int'l., Inc.
Paso Sound Products Inc.
Protech Audio Corp.
QSC Audio Products
Quad-Eight Electronics
RCA Broadcast Systems
ROH Corporation
Ramko Research Inc.
Richmond Sound Design, Ltd.
Russco Electronics Mfg. Inc.
Sansui Electronics Corp.
Sescom, Inc.
Singer Products Co., Inc.
Sono-Mag Corp.
Sontec Electronics
Spectra Sonics
Sphere Electronics
TM Systems, Inc.
Telex Communications, Inc.
Track Audio, Inc. (TA)
UMC Electronics Co. Broadcast
Products Div.
Ultra Audio Pixtec
United Recording Electronics
Industries
Vamco Engineering
Ward-Beck Systems, Ltd.
Wilkinson Electronics, Inc.
Yamaha International Corp.

Amplifiers, AF Peak Limiting AM

See Adv. Page

Audio & Design
Recording Inc.111
Delta Electronics Inc.
(Va.)107
Orange County
Electronics Int'l., Inc......108
Orban Assoc. Inc. 31
Wilkinson Electronics,
Inc......172

Altec Lansing Sound Products
Audio & Design Recording Inc.
Audio Designs & Mfg.
Automated Processes, Inc.
Broadcast Electronics, Inc.
CCA Electronics Corp.
Cetec Broadcast Group
Communications, Ltd.
Delta Electronics Inc. (Va.)
DYMA Engineering, Inc.
EMT Franz VGmbH
Elcom Engineering Co.
Eventide Clock Works Inc.
Gotham Audio Corp.
Gregg Laboratories
Harris Corp. Broadcast Products Div.
Inovonics
LPB Inc.
Marti Electronics
Moseley Associates, Inc.
Rupert Neve, Inc.
Orange County Electronics Int'l., Inc.
Orban Assoc. Inc.
Pacific Recorders and Engrg. Corp.
QEI Corp.
RCA Broadcast Systems
Singer Products Co., Inc.
Sono-Mag Corp.
Sontec Electronics
Spectra Sonics
TM Systems, Inc.
Thomson-CSF Laboratories, Inc.
Track Audio, Inc. (TA)
United Recording Electronics
Industries
Wang Voice Comm. Inc.
Wilkinson Electronics, Inc.

Amplifiers, AF Peak Limiting FM

See Adv. Page

Audio & Design
Recording Inc.111
Orange County
Electronics Int'l., Inc......108
Orban Assoc. Inc. 31
Wilkinson Electronics,
Inc......172

Audio & Design Recording Inc.
Automated Processes, Inc.
Broadcast Electronics, Inc.
Cetec Broadcast Group
Communications, Ltd.
DYMA Engineering, Inc.
EMT Franz VGmbH
Elcom Engineering Co.
Gotham Audio Corp.
Gregg Laboratories
Harris Corp. Broadcast Products Div.
Inovonics
LPB Inc.
Marti Electronics
Moseley Associates, Inc.
Orange County Electronics Int'l., Inc.
Orban Assoc. Inc.
Pacific Recorders and Engrg. Corp.
QEI Corp.
RCA Broadcast Systems
Singer Products Co., Inc.

Sono-Mag Corp.
Sontec Electronics
Spectra Sonics
Thomson-CSF Laboratories, Inc.
Tweed Audio USA Inc.
United Recording Electronics Industries
Wilkinson Electronics, Inc.

Amplifiers, AF Remote

See Adv. Page

Ultra Audio Pixtec.....173

Altec Lansing Sound Products
Audio Designs & Mfg.
Automated Processes, Inc.
Bogen Div. Lear Siegler, Inc.
Broadcast Electronics, Inc.
Cetec Broadcast Group
DYMA Engineering, Inc.
Harris Corp. Broadcast Products Div.
Ivie Electronics
McMartin Industries, Inc.
Micro-Trak Corp.
Moseley Associates, Inc.
Rupert Neve, Inc.
Opamp Labs, Inc.
QRK Electronic Products
RCA Broadcast Systems
Richmond Sound Design, Ltd.
Scientific Systems, Inc.
Spectra Sonics
Transist-O-Sound Inc.
Ultra Audio Pixtec
Wilkinson Electronics, Inc.

Amplifiers, AF Reverberation

Altec Lansing Sound Products
Automated Processes, Inc.
DYMA Engineering, Inc.
Gotham Audio Corp.
MICMIX Audio Products, Inc.
Rupert Neve, Inc.
Opamp Labs, Inc.
Protech Audio Corp.
Quad-Eight Electronics
Singer Products Co., Inc.
Spectra Sonics

Amplifiers, AF Stereo

See Adv. Page

Ramko Research Inc. 28-29

Altec Lansing Sound Products
Audio Interface, Inc.
Audionics, Inc.
Autogram Corp.
Automated Processes, Inc.
BGW Systems Inc.
Bogen Div. Lear Siegler, Inc.
Broadcast Electronics, Inc.
CCA Electronics Corp.
Cetec Broadcast Group
Crown International, Inc.
DYMA Engineering, Inc.
Harris Corp. Broadcast Products Div.
Heath Co.
James B. Lansing Sound, Inc.
Logitek Electronic Systems, Inc.
Micro-Trak Corp.
Modular Audio Products Unit of Modular Devices, Inc.
Moseley Associates, Inc.
Motorola Semiconductor Products Inc.
Opamp Labs, Inc.
Orange County Electronics Int'l., Inc.
Protech Audio Corp.
QRK Electronic Products
QSC Audio Products
RCA Broadcast Systems
ROH Corporation
Ramko Research Inc.
Sansui Electronics Corp.
Sigma Electronics, Inc.
Singer Products Co., Inc.
Spectra Sonics
Studer Revox America
Telectro Systems Corp.
Telex Communications, Inc.
UMC Electronics Co. Broadcast Products Div.
Wilkinson Electronics, Inc.
Yamaha International Corp.

Amplifiers, Audio Loop

DYMA Engineering, Inc.
Micro-Trak Corp.
Ramko Research Inc.
Spectra Sonics
Telectro Systems Corp.

Amplifiers, Bridging

See Adv. Page

Modular Audio Products127
Ramko Research Inc. 28-29

Audio Designs & Mfg.
Auditronics, Inc.
Autogram Corp.
Automated Processes, Inc.
BGW Systems Inc.
Bayly Engineering Ltd. Member of AEG-Telefunken Group
Blonder-Tongue Labs.
Bogen Div. Lear Siegler, Inc.
Delta Electronics Inc. (N.C.)
DYMA Engineering, Inc.
Dynair Electronics, Inc.
Gould Inc. Instruments Div.
Grass Valley Group, Inc.
Harris Corp. Broadcast Products Div.
ITI Electronics, Inc.
International Nuclear Corp.
Kaitronics Corp.
James B. Lansing Sound, Inc.
Merill Cable Equipment Corp.
Micro-Trak Corp.
Modular Audio Products Unit of Modular Devices, Inc.
Norton Associates Inc.
Opamp Labs, Inc.
Orange County Electronics Int'l., Inc.
Protech Audio Corp.
Quad-Eight Electronics
RCA Broadcast Systems
ROH Corporation
Ramko Research Inc.
Richmond Sound Design, Ltd.
Scientific-Atlanta, Inc.
Secom, Inc.
Sigma Electronics, Inc.
Sono-Mag Corp.
Sontec Electronics
Spectra Sonics
3M Co. Mincom Div.
Vamco Engineering

Amplifiers, Clamping

See Adv. Page

Lenco Inc. 95

American Data Corp. A North American Philips Co.
Automated Processes, Inc.
Broadcast Video Systems, Ltd.
Central Dynamics Corp.
Di-Tech Inc.
DYMA Engineering, Inc.
Dynair Electronics, Inc.
Farinon Video
Grass Valley Group, Inc.
Industrial Sciences, Inc. (ISI)
International Communications & Control Corp.
International Nuclear Corp.
Kaitronics Corp.
Leitch Video Ltd.
Lenco Inc. Electronics Div.
Marconi Electronics Inc. Broadcast & Communication Div.
RCA Broadcast Systems
Telemet A Geotel Co.

Amplifiers, Compressing

See Adv. Page

Audio & Design Recording Inc.111
Orange County Electronics Int'l., Inc.....108
Orban Assoc. Inc. 31
Ramko Research Inc. 28-29

Altec Lansing Sound Products
Audio & Design Recording Inc.

Automated Processes, Inc.
Bogen Div. Lear Siegler, Inc.
Broadcast Electronics, Inc.
Cetec Broadcast Group
Coastcom
Communications, Ltd.
DYMA Engineering, Inc.
Elcom Engineering Co.
Gotham Audio Corp.
Harris Corp. Broadcast Products Div.
Inovonics
Marti Electronics
Roger Mayer Electronics, Inc.
Modular Audio Products Unit of Modular Devices, Inc.
Moseley Associates, Inc.
Rupert Neve, Inc.
Opamp Labs, Inc.
Orange County Electronics Int'l., Inc.
Orban Assoc. Inc.
Pacific Recorders and Engrg. Corp.
Protech Audio Corp.
QEI Corp.
Quad-Eight Electronics
RCA Broadcast Systems
ROH Corporation
Ramko Research Inc.
The Ken Schaffer Group, Inc.
Spectra Sonics
TM Systems, Inc.
Thomson-CSF Laboratories, Inc.
Track Audio, Inc. (TA)
United Recording Electronics Industries
Wang Voice Comm. Inc.

Amplifiers, DC

See Adv. Page

Modular Audio Products127

Automated Processes, Inc.
Bayly Engineering Ltd. Member of AEG-Telefunken Group
Boston Sound & Power Systems
Central Dynamics Corp.
Crown International, Inc.
DYMA Engineering, Inc.
Gould Inc. Instruments Div.
Harris Corp. Broadcast Products Div.
Modular Audio Products Unit of Modular Devices, Inc.
Moseley Associates, Inc.
Motorola Semiconductor Products Inc.
Opamp Labs, Inc.
Panasonic Company
Paso Sound Products Inc.
Spectra Sonics
TM Systems, Inc.
Tektronix Inc.

Amplifiers, Distribution Audio

See Adv. Page

Dynair Electronics, Inc.163
Modular Audio Products127
Ramko Research Inc. 28-29
Scientific Systems, Inc.178
Wilkinson Electronics, Inc.172

Altec Lansing Sound Products
American Data Corp. A North American Philips Co.
Audio & Design Recording Inc.
Audio Designs & Mfg.
Auditronics, Inc.
Automated Processes, Inc.
BGW Systems Inc.
BSM Systems
Bayly Engineering Ltd. Member of AEG-Telefunken Group
Bell Audio Systems, Inc.
Bogen Div. Lear Siegler, Inc.
Bonnevillle Productions Div. of Bonneville Int'l. Corp.
Boston Sound & Power Systems
Broadcast Electronics, Inc.
CCA Electronics Corp.
Channelmatic, Inc.
Datatek Corp.
Di-Tech Inc.
DYMA Engineering, Inc.

Dynair Electronics, Inc.
Dynasciences Div. Whittaker Corp.
Edcor
Farinon Video
Harris Corp. Broadcast Products Div.
Holland Electronics
ITI Electronics, Inc.
Ikegami Electronics (USA) Inc.
Industrial Sciences, Inc. (ISI)
International Communications & Control Corp.
International Nuclear Corp.
Johnson Electronics Inc.
LPB Inc.
Marconi Electronics Inc. Broadcast & Communication Div.
Micro-Trak Corp.
Modular Audio Products Unit of Modular Devices, Inc.
Rupert Neve, Inc.
Opamp Labs, Inc.
Pacific Recorders and Engrg. Corp.
Panasonic Company
Protech Audio Corp.
QRK Electronic Products
RCA Broadcast Systems
ROH Corporation
Radiation Devices Co., Inc.
Ramko Research Inc.
Richmond Sound Design, Ltd.
Scientific Systems, Inc.
Shintron Co. Inc.
Sigma Electronics, Inc.
Singer Products Co., Inc.
Sontec Electronics
Spectra Sonics
Telectro Systems Corp.
Telemation, A Div. of Bell & Howell
Telemet A Geotel Co.
Thomson-CSF Laboratories, Inc.
Tweed Audio USA Inc.
Ultra Audio Pixtec
Vamco Engineering
Versa Count Engineering
Vital Industries Inc.
Ward-Beck Systems, Ltd.
Wilkinson Electronics, Inc.

Amplifiers, Distribution Video

See Adv. Page

Dynair Electronics, Inc.163
Lenco Inc. 95

American Data Corp. A North American Philips Co.
Applied Video Electronics, Inc.
Broadcast Video Systems, Ltd.
Central Dynamics Corp.
Channelmatic, Inc.
Cohu, Inc. Electronics Div.
Comprehensive Video Supply Corp.
Dage-MTI, Inc.
Datatek Corp.
Di-Tech Inc.
DYMA Engineering, Inc.
Dynair Electronics, Inc.
Dynasciences Div. Whittaker Corp.
GBC Closed Circuit TV Corp.
Grass Valley Group, Inc.
Harris Corp. Broadcast Products Div.
Ikegami Electronics (USA) Inc.
Industrial Sciences, Inc. (ISI)
International Communications & Control Corp.
International Nuclear Corp.
Javelin Electronics
Leitch Video Ltd.
Lenco Inc. Electronics Div.
Marconi Electronics Inc. Broadcast & Communication Div.
Merlin Engineering Works, Inc.
Microwave Power Devices, Inc.
Panasonic Company
Panasonic Co. Video Systems Div.
QSI Systems, Inc.
RCA Broadcast Systems
Radiation Devices Co., Inc.
Rohde & Schwarz Sales Co.
Scientific-Atlanta, Inc.
Shintron Co. Inc.
Sigma Electronics, Inc.
Telemation, A Div. of Bell & Howell
Telemet A Geotel Co.
3M Co. Mincom Div.
Vamco Engineering
Viscount Industries Ltd.

Vital Industries Inc.

Amplifiers, FM

Keith Anderson Co.
Bayly Engineering Ltd. Member of
AEG-Telefunken Group
Belar Electronics Lab., Inc.
CCA Electronics Corp.
Cetec Broadcast Group
Comark Communications Industries,
Inc.
The Finney Co.
Harris Corp. Broadcast Products Div.
LPB Inc.
McMartin Industries, Inc.
Microwave Power Devices, Inc.
Moseley Associates, Inc.
RHG Electronics Laboratory, Inc.
Singer Products Co., Inc.
Versa Count Engineering
Wilkinson Electronics, Inc.

Amplifiers, Headphone

Eddor

Amplifiers, Keying

American Data Corp. A North
American Philips Co.
Audio & Design Recording Inc.
Broadcast Video Systems, Ltd.
Central Dynamics Corp.
Industrial Sciences, Inc. (ISI)
Roger Mayer Electronics, Inc.
Thomson-CSF Laboratories, Inc.
Video Devices Co.

Amplifiers, Line

See Adv. Page

**Modular Audio
Products127
Ramko Research Inc. 28-29
Wilkinson Electronics,
Inc.172**

Altec Lansing Sound Products
American Data Corp. A North
American Philips Co.
Audio Designs & Mfg.
Audionics, Inc.
Automated Processes, Inc.
Bayly Engineering Ltd. Member of
AEG-Telefunken Group
Blonder-Tongue Labs.
Bogen Div. Lear Siegler, Inc.
Bonneville Productions Div. of
Bonneville Int'l. Corp.
CCA Electronics Corp.
Central Dynamics Corp.
Cetec Broadcast Group
DYMA Engineering, Inc.
The Finney Co.
Harris Corp. Broadcast Products Div.
ITI Electronics, Inc.
International Communications &
Control Corp.
International Nuclear Corp.
Johnson Electronics Inc.
James B. Lansing Sound, Inc.
Marti Electronics
Roger Mayer Electronics, Inc.
McMartin Industries, Inc.
Merill Cable Equipment Corp.
Micro-Trak Corp.
Modular Audio Products Unit of
Modular Devices, Inc.
Monroe Electronics, Inc.
Opamp Labs, Inc.
Pacific Recorders and Engrg. Corp.
Protech Audio Corp.
QRK Electronic Products
Quad-Eight Electronics
ROH Corporation
Ramko Research Inc.
Richmond Sound Design, Ltd.
Scientific Systems, Inc.
Sono-Mag Corp.
Spectra Sonics
TM Systems, Inc.
United Recording Electronics
Industries
Wilkinson Electronics, Inc.

Amplifiers, Masking

QSC Audio Products
Richmond Sound Design, Ltd.

Amplifiers, Microphone

See Adv. Page

**Logitek Electronic
Systems, Inc. 125, 151
Modular Audio
Products127
Ramko Research Inc. 28-29
Ultra Audio Pixtec.....173**

AKG Acoustics Div. Philips Audio
Video Systems
Altec Lansing Sound Products
Audio Designs & Mfg.
Autogram Corp.
Automated Processes, Inc.
Broadcast Electronics, Inc.
CCA Electronics Corp.
Cetec Broadcast Group
DYMA Engineering, Inc.
Dynair Electronics, Inc.
Eddor
Hamilton Electronics Corp.
Harris Corp. Broadcast Products Div.
Holland Electronics
International Communications &
Control Corp.
International Nuclear Corp.
Ivie Electronics
Johnson Electronics Inc.
Link Electronics Ltd.
Logitek Electronic Systems, Inc.
Roger Mayer Electronics, Inc.
McMartin Industries, Inc.
Micro-Trak Corp.
Modular Audio Products Unit of
Modular Devices, Inc.
Nagra Magnetic Recorders, Inc.
Rupert Neve, Inc.
Norton Associates Inc.
Opamp Labs, Inc.
Protech Audio Corp.
QRK Electronic Products
Quad-Eight Electronics
RTS Systems, Inc.
Ramko Research Inc.
Richmond Sound Design, Ltd.
Scientific Systems, Inc.
Sescom, Inc.
Sontec Electronics
Special Instruments Lab, Inc.
Portasound Div.
Spectra Sonics
Sphere Electronics
Transist-O-Sound Inc.
UMC Electronics Co. Broadcast
Products Div.
Ultra Audio Pixtec
United Recording Electronics
Industries

Amplifiers, Mixing

See Adv. Page

**Modular Audio
Products127
Ramko Research Inc. 28-29
Russco Electronics
Mfg. Inc. 76
Ultra Audio Pixtec.....173**

Altec Lansing Sound Products
American Data Corp. A North
American Philips Co.
Audio Designs & Mfg.
Autogram Corp.
Automated Processes, Inc.
Bell Audio Systems, Inc.
Bogen Div. Lear Siegler, Inc.
Broadcast Electronics, Inc.
Broadcast Video Systems, Ltd.
CCA Electronics Corp.
Central Dynamics Corp.
Cetec Broadcast Group
Cezar International
Crosspoint Latch Corp.
Dage-MTI, Inc.
DYMA Engineering, Inc.
Eddor
Harris Corp. Broadcast Products Div.

Holland Electronics
Industrial Sciences, Inc. (ISI)
Integrated Solid Systems Inc. GLI
Brand
International Nuclear Corp.
Johnson Electronics Inc.
James B. Lansing Sound, Inc.
Roger Mayer Electronics, Inc.
McMartin Industries, Inc.
Micro-Trak Corp.
Modular Audio Products Unit of
Modular Devices, Inc.
Nagra Magnetic Recorders, Inc.
Opamp Labs, Inc.
Protech Audio Corp.
QRK Electronic Products
Quad-Eight Electronics
RCA Broadcast Systems
ROH Corporation
RTS Systems, Inc.
Ramko Research Inc.
Richmond Sound Design, Ltd.
Russo Electronics Mfg. Inc.
Spectra Sonics
TEAC Corp of America
Transist-O-Sound Inc.
UMC Electronics Co. Broadcast
Products Div.
Ultra Audio Pixtec

Amplifiers, Monitor

See Adv. Page

**Aitken
Communications Inc.172
Logitek Electronic
Systems, Inc.125
Modular Audio
Products127
Ramko Research Inc. 28-29
Wilkinson Electronics,
Inc.172**

Aitken Communications Inc.
Altec Lansing Sound Products
American Data Corp. A North
American Philips Co.
Audionics, Inc.
Automated Processes, Inc.
BGW Systems Inc.
Bayly Engineering Ltd. Member of
AEG-Telefunken Group
Belar Electronics Lab., Inc.
Bell Audio Systems, Inc.
Bogen Div. Lear Siegler, Inc.
Brown Electronic Labs
CCA Electronics Corp.
California Instruments
Comark Communications Industries,
Inc.
Continental Electronics Mfg. Co.
Crown International, Inc.
DYMA Engineering, Inc.
Eddor
Electro Sound, Inc.
Eumig USA, Inc.
Farinon Video
Harris Corp. Broadcast Products Div.
Harris Corp. PRD Electronics Div.
International Nuclear Corp.
James B. Lansing Sound, Inc.
Logitek Electronic Systems, Inc.
Marti Electronics
McMartin Industries, Inc.
Micro-Trak Corp.
Modular Audio Products Unit of
Modular Devices, Inc.
Nagra Magnetic Recorders, Inc.
The Narda Microwave Corporation
National Electrolab Ltd.
Rupert Neve, Inc.
Opamp Labs, Inc.
Orange County Electronics Int'l., Inc.
Protech Audio Corp.
QRK Electronic Products
QSC Audio Products
Quad-Eight Electronics
RCA Broadcast Systems
ROH Corporation
Ramko Research Inc.
Russo Electronics Mfg. Inc.
Scientific Systems, Inc.
Sescom, Inc.
Sigma Electronics, Inc.
Spectra Sonics
TEAC Corp of America
TM Systems, Inc.
Telemation, A Div. of Bell & Howell
Tweed Audio USA Inc.
Ultra Audio Pixtec

Ward-Beck Systems, Ltd.
Wilkinson Electronics, Inc.

Amplifiers, Operational

See Adv. Page

**Modular Audio
Products127**

Amperex Electronic Corp. Slatersville
Div.
Automated Processes, Inc.
Computer Labs Div. of Analog
Devices, Inc.
DYMA Engineering, Inc.
Gotham Audio Corp.
Holland Electronics
Jensen Transformers
Modular Audio Products Unit of
Modular Devices, Inc.
Motorola Semiconductor Products Inc.
Opamp Labs, Inc.
Pacific Recorders and Engrg. Corp.
Protech Audio Corp.
Quad-Eight Electronics
Richmond Sound Design, Ltd.
Singer Products Co., Inc.
Spectra Sonics
Sphere Electronics
Tektronix Inc.
United Research Lab Corp.

Amplifiers, Power

See Adv. Page

**Logitek Electronic
Systems, Inc.125
Ramko Research Inc. 28-29**

AVAB America Inc.
Acrodyne Industries Inc.
Altec Lansing Sound Products
American Data Corp. A North
American Philips Co.
Audionics, Inc.
Automated Processes, Inc.
BGW Systems Inc.
Bayly Engineering Ltd. Member of
AEG-Telefunken Group
Belar Electronics Lab., Inc.
Bell Audio Systems, Inc.
Bogen Div. Lear Siegler, Inc.
Brown Electronic Labs
CCA Electronics Corp.
California Instruments
Comark Communications Industries,
Inc.
Continental Electronics Mfg. Co.
Crown International, Inc.
DYMA Engineering, Inc.
Eddor
Electro Sound, Inc.
Eumig USA, Inc.
Farinon Video
Harris Corp. Broadcast Products Div.
Harris Corp. PRD Electronics Div.
International Nuclear Corp.
James B. Lansing Sound, Inc.
Logitek Electronic Systems, Inc.
McMartin Industries, Inc.
Micro-Trak Corp.
Modular Audio Products Unit of
Modular Devices, Inc.
Moseley Associates, Inc.
Motorola Semiconductor Products Inc.
Nagra Magnetic Recorders, Inc.
Opamp Labs, Inc.
Orange County Electronics Int'l., Inc.
Panasonic Company
Paso Sound Products Inc.
Protech Audio Corp.
QSC Audio Products
Quad-Eight Electronics
RCA Broadcast Systems
ROH Corporation
Ramko Research Inc.
Sansui Electronics Corp.
Scientific Systems, Inc.
Sescom, Inc.
Spectra Sonics
Studer Revox America
Superex Electronics Corp.
Technical Audio Products Corp.
Telectro Systems Corp.
Telex Communications, Inc.
Tweed Audio USA Inc.

UMC Electronics Co. Broadcast Products Div.
 Ultra Audio Pixtec
 Varian Associates, Inc. Electron Device Group
 Ward-Beck Systems, Ltd.
 Wilkinson Electronics, Inc.
 Yamaha International Corp.

Amplifiers, Processing Audio

See Adv. Page

Audio & Design Recording Inc.111
Delta Electronics Inc. (Va.)107
Orange County Electronics Int'l., Inc......108

Altec Lansing Sound Products Audio & Design Recording Inc.
 Automated Processes, Inc.
 CCA Electronics Corp. Communications Int'l.
 Delta Electronics Inc. (Va.)
 DYMA Engineering, Inc. E.M.S Inc.
 Elcom Engineering Co.
 Gregg Laboratories
 Inovonics
 Kahn Communications, Inc.
 MICMIX Audio Products, Inc.
 Roger Mayer Electronics, Inc.
 Modular Audio Products Unit of Modular Devices, Inc.
 Moseley Associates, Inc.
 Orange County Electronics Int'l., Inc.
 Pacific Recorders and Engrg. Corp.
 Protech Audio Corp.
 ROH Corporation
 Sontec Electronics
 Spectra Sonics
 Telectro Systems Corp.
 Wang Voice Comm. Inc.

Amplifiers, Processing Video

See Adv. Page

Lenco Inc. 95
Microtime, Inc. 13
RCA Broadcast Systems..... 81
Sigma Electronics, Inc. 52

Broadcast Video Systems, Ltd.
 Central Dynamics Corp.
 Cohu, Inc. Electronics Div.
 Dynasciences Div. Whittaker Corp.
 Grass Valley Group, Inc.
 Harris Corp. Broadcast Products Div.
 Industrial Sciences, Inc. (ISI)
 International Nuclear Corp.
 Leitch Video Ltd.
 Lenco Inc. Electronics Div.
 Marconi Electronics Inc. Broadcast & Communication Div.
 Microtime, Inc.
 RCA Broadcast Systems
 Siegel Electronics
 Sigma Electronics, Inc.
 Tektronix Inc.
 Telemation, A Div. of Bell & Howell
 3M Co. Mincom Div.
 Versa Count Engineering
 Vital Industries Inc.

Amplifiers, Pulse

See Adv. Page

Dynair Electronics, Inc.163
Lenco Inc. 95

American Data Corp. A North American Philips Co.
 Applied Video Electronics, Inc.
 Broadcast Video Systems, Ltd.
 Central Dynamics Corp.
 Cohu, Inc. Electronics Div.
 Datatek Corp.
 Di-Tech Inc.
 Dynair Electronics, Inc.
 Dynasciences Div. Whittaker Corp.
 EIMAC Div. of Varian
 Grass Valley Group, Inc.

Harris Corp. Broadcast Products Div.
 Industrial Sciences, Inc. (ISI)
 International Nuclear Corp.
 Kaitronics Corp.
 Leitch Video Ltd.
 Lenco Inc. Electronics Div.
 Link Electronics Ltd.
 Marconi Electronics Inc. Broadcast & Communication Div.
 Microwave Power Devices, Inc.
 Panasonic Company
 Panasonic Co. Video Systems Div.
 RCA Broadcast Systems
 RHG Electronics Laboratory, Inc.
 ROH Corporation
 Radiation Devices Co., Inc.
 Shintron Co. Inc.
 Sigma Electronics, Inc.
 Tektronix Inc.
 Telemation, A Div. of Bell & Howell
 Telemet A Geotel Co.
 3M Co. Mincom Div.
 Varian Associates, Inc. Electron Device Group
 Vital Industries Inc.

Amplifiers, Pulse Delay

See Adv. Page

Dynair Electronics, Inc.163
Lenco Inc. 95

American Data Corp. A North American Philips Co.
 Broadcast Video Systems, Ltd.
 Central Dynamics Corp.
 Cohu, Inc. Electronics Div.
 Di-Tech Inc.
 Dynair Electronics, Inc.
 Grass Valley Group, Inc.
 Industrial Sciences, Inc. (ISI)
 Leitch Video Ltd.
 Lenco Inc. Electronics Div.
 Sigma Electronics, Inc.
 Telemation, A Div. of Bell & Howell

Amplifiers, Quad

See Adv. Page

Beaveronics, Inc. 61

Beaveronics, Inc.
 DYMA Engineering, Inc.
 Optical Radiation Corp.
 Protech Audio Corp.
 Spectra Sonics

Amplifiers, Remote

See Adv. Page

Ultra Audio Pixtec.....173
Wilkinson Electronics, Inc......172

Belar Electronics Lab., Inc.
 Broadcast Electronics, Inc.
 Cetec Broadcast Group
 DYMA Engineering, Inc.
 Harris Corp. Broadcast Products Div.
 McMartin Industries, Inc.
 Micro-Trak Corp.
 Protech Audio Corp.
 RCA Broadcast Systems
 Richmond Sound Design, Ltd.
 Spectra Sonics
 Ultra Audio Pixtec
 Wide Band Engineering Co., Inc.
 Wilkinson Electronics, Inc.

Amplifiers, RF General Purpose

AILTECH Div. Cutler-Hammer Los Angeles Operation
 Keith Anderson Co.
 Anderson Scientific
 Blender-Tongue Labs.
 CSI Electronics, Inc.
 Comark Communications Industries, Inc.
 Computer Magnetics Corp.
 Continental Electronics Mfg. Co.
 Harris Corp. Broadcast Products Div.
 International Microwave Corp.
 McMartin Industries, Inc.
 Merrill Cable Equipment Corp.

Microwave Power Devices, Inc.
 Motorola Semiconductor Products Inc.
 Mu-Del Electronics, Inc.
 The Narda Microwave Corporation
 National Electrolab Ltd.
 RHG Electronics Laboratory, Inc.
 Radiation Devices Co., Inc.
 Rodelco Corp.
 Singer Products Co., Inc.
 Television Technology Corp.
 Wide Band Engineering Co., Inc.
 Wilkinson Electronics, Inc.

Amplifiers, RF Peak Limiting

Harris Corp. Broadcast Products Div.
 Moseley Associates, Inc.
 The Narda Microwave Corporation
 RCA Broadcast Systems
 RHG Electronics Laboratory, Inc.
 Thomson-CSF Laboratories, Inc.

Amplifiers, RF Power

Acrodyne Industries Inc.
 Keith Anderson Co.
 Anderson Scientific
 Belar Electronics Lab., Inc.
 Blender-Tongue Labs.
 CCA Electronics Corp.
 CSI Electronics, Inc.
 Cetec Broadcast Group
 Comark Communications Industries, Inc.
 Computer Magnetics Corp.
 Continental Electronics Mfg. Co.
 EEV, Inc.
 EIMAC Div. of Varian
 EMCEE Broadcast Products
 English Electric Valve Co. Ltd.
 Harris Corp. Broadcast Products Div.
 Harris Corp. PRD Electronics Div.
 Howe-Yin Research Co. Inc.
 International Microwave Corp.
 Jerrold Electronics Corp.
 LPB Inc.
 Marconi Communication Systems Ltd.
 McMartin Industries, Inc.
 Microwave Power Devices, Inc.
 Moseley Associates, Inc.
 Motorola Semiconductor Products Inc.
 Mu-Del Electronics, Inc.
 National Electrolab Ltd.
 Nurad, Inc.
 QEI Corp.
 RMC-Radio Mfg. Co.
 Rohde & Schwarz Sales Co.
 Scientific Radio Systems, Inc.
 Singer Products Co., Inc.
 Sintronic Corp.
 Television Technology Corp.
 Townsend Associates, Inc.
 Triple Crown Electronics, Inc.
 Varian Associates, Inc. Electron Device Group
 Wilkinson Electronics, Inc.

Amplifiers, Sensing

Moseley Associates, Inc.
 Motorola Semiconductor Products Inc.

Amplifiers, Stabilizing

Grass Valley Group, Inc.
 International Nuclear Corp.
 Lenco Inc. Electronics Div.
 Marconi Electronics Inc. Broadcast & Communication Div.
 Telemet A Geotel Co.

Amplifiers, Stereo Booster

CCA Electronics Corp.
 Modular Audio Products Unit of Modular Devices, Inc.
 Orange County Electronics Int'l., Inc.
 Protech Audio Corp.
 Spectra Sonics

Amplifiers, Stereo Limiter

See Adv. Page

Audio & Design Recording Inc.111

Urban Assoc. Inc. 31

Audio & Design Recording Inc.
 Automated Processes, Inc.
 BGW Systems Inc.
 Broadcast Electronics, Inc.
 CCA Electronics Corp.
 Cetec Broadcast Group Communications, Ltd.
 DYMA Engineering, Inc.
 EMT Franz Vgmbh
 Elcom Engineering Co.
 Gotham Audio Corp.
 Harris Corp. Broadcast Products Div.
 Inovonics
 Roger Mayer Electronics, Inc.
 Moseley Associates, Inc.
 Rupert Neve, Inc.
 Orange County Electronics Int'l., Inc.
 Urban Assoc. Inc.
 Protech Audio Corp.
 QEI Corp.
 RCA Broadcast Systems
 ROH Corporation
 Singer Products Co., Inc.
 Sontec Electronics
 Spectra Sonics
 Thomson-CSF Laboratories, Inc.
 Track Audio, Inc. (TA)
 United Recording Electronics Industries
 Wilkinson Electronics, Inc.

Amplifiers, TV Video

See Adv. Page

Lenco Inc. 95

Blender-Tongue Labs.
 Broadcast Video Systems, Ltd.
 CCA Electronics Corp.
 Canadian General Electric Co., Ltd.
 Dage-MTI, Inc.
 Datatek Corp.
 Delta Electronics Inc. (N.C.)
 Dynair Electronics, Inc.
 Dynasciences Div. Whittaker Corp.
 GBC Closed Circuit TV Corp.
 Grass Valley Group, Inc.
 Harris Corp. Broadcast Products Div.
 Howe-Yin Research Co. Inc.
 International Nuclear Corp.
 Javelin Electronics
 Leitch Video Ltd.
 Lenco Inc. Electronics Div.
 Link Electronics Ltd.
 Marconi Electronics Inc. Broadcast & Communication Div.
 Motorola Semiconductor Products Inc.
 RCA Broadcast Systems
 Radiation Devices Co., Inc.
 Siegel Electronics
 Tektronix Inc.
 Telemet A Geotel Co.
 Texscan Corp.
 3M Co. Mincom Div.
 Vamco Engineering
 Varian Associates, Inc. Electron Device Group

Amplifiers, Video Sweep

Lenco Inc. Electronics Div.
 Tektronix Inc.

Amplifiers, Zero Studio Delay

Grass Valley Group, Inc.
 Lenco Inc. Electronics Div.

Analyzers, Audio System

See Adv. Page

Bald Mountain Lab151
Potomac Instruments, Inc. 126, 137

Bald Mountain Lab
 Crown International, Inc.
 DYMA Engineering, Inc.
 Inovonics
 Leader Instruments Corp.
 Potomac Instruments, Inc.
 Rockland Systems Corp.
 The Ken Schaffer Group, Inc.

Analyzers, Distortion

See Adv. Page

Potomac Instruments, Inc.137
Sound Technology 9

Amber Electro Design, Ltd.
 B & K Instruments Inc.
 Barker and Williamson, Inc.
 Broadcast Electronics, Inc.
 Crown International, Inc.
 DYMA Engineering, Inc.
 Frequency Devices Inc.
 Harris Corp. Broadcast Products Div.
 Heath Co.
 Ivie Electronics
 Leader Instruments Corp.
 Marconi Instruments Div. of Marconi Electronics Inc.
 Potomac Instruments, Inc.
 Radiometer Elec. U.S. Inc.
 Rockland Systems Corp.
 Rohde & Schwarz Sales Co.
 Sound Technology
 TM Systems, Inc.
 Tektronix Inc.

Analyzers, Harmonic

See Adv. Page

Potomac Instruments, Inc. 126, 137
Sound Technology 9

AILTECH Div. Cutler-Hammer Los Angeles Operation
 Amber Electro Design, Ltd.
 B & K Instruments Inc.
 Barker and Williamson, Inc.
 Harris Corp. Broadcast Products Div.
 Ivie Electronics
 Kay Elemetrics Corp.
 Leader Instruments Corp.
 Marconi Instruments Div. of Marconi Electronics Inc.
 Potomac Instruments, Inc.
 Rockland Systems Corp.
 Rohde & Schwarz Sales Co.
 Sound Technology
 Tektronix Inc.

Analyzers, Insertion Signal

Cezar International
 Marconi Instruments Div. of Marconi Electronics Inc.
 Phillips Test & Measuring Instruments, Inc.
 Rockland Systems Corp.

Analyzers, Intermodulation

See Adv. Page

Potomac Instruments, Inc. 126, 137
Sound Technology 9

Amber Electro Design, Ltd.
 B & K Instruments Inc.
 Barker and Williamson, Inc.
 Crown International, Inc.
 Heath Co.
 Marconi Instruments Div. of Marconi Electronics Inc.
 Potomac Instruments, Inc.
 Rockland Systems Corp.
 Rohde & Schwarz Sales Co.
 Sound Technology
 Tektronix Inc.
 Triple Crown Electronics, Inc.

Analyzers, Power Line Disturbance

Dranetz Engineering Labs., Inc.

Analyzers, RF Network

AILTECH Div. Cutler-Hammer Los Angeles Operation
 Alford Mfg. Co.
 Harris Corp. PRD Electronics Div.
 Rohde & Schwarz Sales Co.

Scientific-Atlanta, Inc.
 Tektronix Inc.
 Wide Band Engineering Co., Inc.

Analyzers, Sideband

Kahn Communications, Inc.
 Marconi Instruments Div. of Marconi Electronics Inc.
 Rockland Systems Corp.
 Rohde & Schwarz Sales Co.
 Tektronix Inc.
 Teletel A Geotel Co.

Analyzers, Spectrum

AILTECH Div. Cutler-Hammer Los Angeles Operation
 AVAB America Inc.
 Amber Electro Design, Ltd.
 Anderson Scientific
 B & K Instruments Inc.
 Eventide Clock Works Inc.
 Harris Corp. Broadcast Products Div.
 Ivie Electronics
 Kahn Communications, Inc.
 Kay Elemetrics Corp.
 Marconi Instruments Div. of Marconi Electronics Inc.
 QEI Corp.
 Rockland Systems Corp.
 Rohde & Schwarz Sales Co.
 The Ken Schaffer Group, Inc.
 Spectrum Instruments, Inc.
 Tektronix Inc.
 Teletel A Geotel Co.
 Texscan Corp.
 Track Audio, Inc. (TA)

Analyzers, Video

B & K Precision Dynascan Corp.
 Colorado Video Inc.
 Imero Fiorentino Associates, Inc.
 Harris Corp. Broadcast Products Div.
 Lenco Inc. Electronics Div.
 Marconi Instruments Div. of Marconi Electronics Inc.
 Rohde & Schwarz Sales Co.
 Sencore Inc.
 Tektronix Inc.
 Teletel A Geotel Co.

Animation Equipment, Video

See Adv. Page

Dolphin Productions, Inc.168
MPB Technologies Inc.124

Dolphin Productions, Inc.
 Echo Science Corp.
 Interand Corp. Telestrator Div.
 MPB Technologies Inc.
 Television Equipment Associates

Antenna Alignment Systems, Microwave

Advance Industries
 Gabriel Electronics, Inc.
 Innovative Television Equipment, Inc.
 Micro Communications, Inc.
 Nurad, Inc.
 Power-Optics Inc.
 Scientific-Atlanta, Inc.
 Texscan Corp.
 Tri-Ex Tower Corp.
 Varian/Beverly Micro-Link Products

Antenna and Tower Guys

See Adv. Page

Philadelphia Resins Corp. 48
Stainless, Inc.118

Advance Industries
 Aluma Tower Co.
 CCA Electronics Corp.
 Cetec Broadcast Group
 DHV, Inc.
 G C Electronics Div. Wallace Murray
 Harris Corp. Broadcast Products Div.

Hy-Gain Electronics Div. of Telex Communications Inc.
 Fred A. Nudd Corp.
 Philadelphia Resins Corp.
 Singer Products Co., Inc.
 Stainless, Inc.
 Suda Seisakusho Co., Ltd.
 Swager Tower Corp.
 Technology For Communications Int'l.
 Tri-Ex Tower Corp.
 Unarco-Rohn Div. of Unarco Ind., Inc.
 Tektronix Inc.
 Utility Tower Co.

Antenna and Tower Installation and Services

See Adv. Page

Stainless, Inc.118

Advance Industries
 CCA Electronics Corp.
 Cetec Broadcast Group
 Fort Worth Tower Co., Inc.
 Gabriel Electronics, Inc.
 Harris Corp. Broadcast Products Div.
 Hy-Gain Electronics Div. of Telex Communications Inc.
 Marconi Communication Systems Ltd.
 Micro Communications, Inc.
 Microflect Co., Inc.
 Fred A. Nudd Corp.
 Nurad, Inc.
 Prodelin Inc.
 RCA Broadcast Systems
 Soll, Inc.
 Stainless, Inc.
 Suda Seisakusho Co., Ltd.
 Swager Tower Corp.
 Technology For Communications Int'l.
 Tri-Ex Tower Corp.
 Unarco-Rohn Div. of Unarco Ind., Inc.
 Utility Tower Co.
 V&B Tower Const. Co., Inc. Atlas Tower Mfg.

Antenna Baluns, RF Dry

See Adv. Page

Electro Impulse, Inc.161

Barker and Williamson, Inc.
 DHV, Inc.
 Dielectric Communications A Unit of General Signal
 Electro Impulse, Inc.
 Hy-Gain Electronics Div. of Telex Communications Inc.
 North Hills Electronics, Inc.
 Phelps Dodge Communications Co.
 Potomac Instruments, Inc.
 Scala Electronic Corp.
 Technology For Communications Int'l.
 Wilkinson Electronics, Inc.

Antenna Dummy Loads

See Adv. Page

C. S. P. Inc.144
Electro Impulse, Inc.161
Wilkinson Electronics, Inc.172

Barker and Williamson, Inc.
 Bayly Engineering Ltd. Member of AEG-Telefunken Group
 Bird Electronic Corp.
 CCA Electronics Corp.
 C. S. P. Inc.
 Continental Electronics Mfg. Co.
 Dielectric Communications A Unit of General Signal
 Electro Impulse, Inc.
 Harris Corp. Broadcast Products Div.
 Kappa Networks, Inc.
 Marconi Communication Systems Ltd.
 Marconi Electronics Inc. Broadcast & Communication Div.
 Maury Microwave Corp.
 Micro Communications, Inc.
 RCA Broadcast Systems
 Rex Rheostat & Co., Inc.
 Shively Laboratories, Inc.
 Wilkinson Electronics, Inc.

Antenna Heater Controls

CCA Electronics Corp.
 Cetec Broadcast Group
 Micro-Trak Corp.

Antenna Ice Warning Systems

CCA Electronics Corp.
 Cetec Broadcast Group
 Harris Corp. Broadcast Products Div.
 Micro-Trak Corp.
 RCA Broadcast Systems

Antenna Remote Indicators

See Adv. Page

C. S. P. Inc.144

CCA Electronics Corp.
 C. S. P. Inc.
 Dielectric Communications A Unit of General Signal
 Harris Corp. Broadcast Products Div.
 Hy-Gain Electronics Div. of Telex Communications Inc.
 Nurad, Inc.
 Scientific-Atlanta, Inc.

Antenna RF Current Controllers

See Adv. Page

C. S. P. Inc.144
Delta Electronics Inc. (Va.)107

CCA Electronics Corp.
 C. S. P. Inc.
 Delta Electronics Inc. (Va.)
 Harris Corp. Broadcast Products Div.

Antenna Sampling Systems

See Adv. Page

C. S. P. Inc.144
Delta Electronics Inc. (Va.)107

CCA Electronics Corp.
 C. S. P. Inc.
 Cablewave Systems Inc.
 Cetec Broadcast Group
 Delta Electronics Inc. (Va.)
 Elcom Engineering Co.
 Geleco Electronics Ltd.
 Harris Corp. Broadcast Products Div.
 Moseley Associates, Inc.
 Multronics, Inc.

Antenna Systems

See Adv. Page

C. S. P. Inc.144
Delta Electronics Inc. (Va.)107
Geleco Electronics Ltd.170

Alford Mfg. Co.
 Andrew Corp.
 Anixter-Mark
 Bogner Broadcast Equipment Corp.
 CCA Electronics Corp.
 C. S. P. Inc.
 Cablewave Systems Inc.
 Cetec Broadcast Group
 Continental Electronics Mfg. Co.
 Delta Electronics Inc. (Va.)
 Dielectric Communications A Unit of General Signal
 The Finney Co.
 G C Electronics Div. Wallace Murray
 Gabriel Electronics, Inc.
 Geleco Electronics Ltd.
 Granger Associates
 Harris Corp. Broadcast Products Div.
 Hy-Gain Electronics Div. of Telex Communications Inc.
 Jerrold Electronics Corp.
 Marconi Communication Systems Ltd.
 Micro Communications, Inc.
 Multronics, Inc.
 Nurad, Inc.
 Phelps Dodge Communications Co.

Prodelin Inc.
 RCA Broadcast Systems
 Rohde & Schwarz Sales Co.
 Scala Electronic Corp.
 Shively Laboratories, Inc.
 Singer Products Co., Inc.
 Sitco Antenna Co.
 Technology For Communications Int'l.

Antenna Tuning Units

See Adv. Page

CCA Electronics Corp. 74
C. S. P. Inc. 144
Geleco Electronics Ltd. 170

CCA Electronics Corp.
 CSI Electronics, Inc.
 C. S. P. Inc.
 Cetec Broadcast Group
 Collins Div. Rockwell International
 DHV, Inc.
 Dielectric Communications A Unit of
 General Signal
 G C Electronics Div. Wallace Murray
 Geleco Electronics Ltd.
 Harris Corp. Broadcast Products Div.
 Maury Microwave Corp.
 Micro Communications, Inc.
 Multronics, Inc.
 RCA Broadcast Systems
 Texscan Corp.
 Wilkinson Electronics, Inc.

Antenna VSWR Indicators

See Adv. Page

CCA Electronics Corp. 74

Bird Electronic Corp.
 CCA Electronics Corp.
 CSI Electronics, Inc.
 Cetec Broadcast Group
 Dielectric Communications A Unit of
 General Signal
 DYMA Engineering, Inc.
 Harris Corp. Broadcast Products Div.
 Micro Communications, Inc.
 Moseley Associates, Inc.
 Sencore Inc.
 Singer Products Co., Inc.
 Texscan Corp.

Antennas, Directional System

See Adv. Page

CCA Electronics Corp. 74
C. S. P. Inc. 144

Alford Mfg. Co.
 Bogner Broadcast Equipment Corp.
 CCA Electronics Corp.
 CSI Electronics, Inc.
 C. S. P. Inc.
 Cetec Broadcast Group
 Collins Div. Rockwell International
 Continental Electronics Mfg. Co.
 DHV, Inc.
 Dielectric Communications A Unit of
 General Signal
 The Finney Co.
 Gabriel Electronics, Inc.
 Geleco Electronics Ltd.
 Harris Corp. Broadcast Products Div.
 Hy-Gain Electronics Div. of Telex
 Communications Inc.
 Innovative Television Equipment, Inc.
 Micro Communications, Inc.
 Multronics, Inc.
 Nurad, Inc.
 RCA Broadcast Systems
 Rohde & Schwarz Sales Co.
 Scala Electronic Corp.
 Shively Laboratories, Inc.
 Singer Products Co., Inc.
 Technology For Communications Int'l.

Antennas, Receiving FM

Keith Anderson Co.
 Anderson Scientific
 Anixter-Mark
 Belar Electronics Lab., Inc.
 Catel Div. United Scientific Corp.
 Communications, Ltd.

The Finney Co.
 G C Electronics Div. Wallace Murray
 Harris Corp. Broadcast Products Div.
 Hy-Gain Electronics Div. of Telex
 Communications Inc.
 Johnson Electronics Inc.
 McMartin Industries, Inc.
 Micro Communications, Inc.
 Rohde & Schwarz Sales Co.
 Scala Electronic Corp.
 Scientific-Atlanta, Inc.
 Sitco Antenna Co.

Antennas, Receiving LF

Anixter-Mark
 Elcom Engineering Co.
 McKay Dymek Co.
 Rohde & Schwarz Sales Co.
 Technology For Communications Int'l.

Antennas, Receiving MF

Anixter-Mark
 Belar Electronics Lab., Inc.
 Elcom Engineering Co.
 G C Electronics Div. of Telex
 Communications Inc.
 McKay Dymek Co.
 Rohde & Schwarz Sales Co.
 Technology For Communications Int'l.

Antennas, Receiving UHF

Keith Anderson Co.
 Anderson Scientific
 Anixter-Mark
 Blonder-Tongue Labs.
 EMCEE Broadcast Products
 The Finney Co.
 G C Electronics Div. Wallace Murray
 Heath Co.
 Hy-Gain Electronics Div. of Telex
 Communications Inc.
 Jerrold Electronics Corp.
 Micro Communications, Inc.
 Nurad, Inc.
 Phelps Dodge Communications Co.
 Prodelin Inc.
 RCA Distributor & Special Products
 Div.
 Rohde & Schwarz Sales Co.
 Scala Electronic Corp.
 Scientific-Atlanta, Inc.
 Singer Products Co., Inc.
 Sitco Antenna Co.

Antennas, Receiving VHF

Keith Anderson Co.
 Anderson Scientific
 Anixter-Mark
 Blonder-Tongue Labs.
 Communications, Ltd.
 EMCEE Broadcast Products
 The Finney Co.
 G C Electronics Div. Wallace Murray
 Heath Co.
 Hy-Gain Electronics Div. of Telex
 Communications Inc.
 Jerrold Electronics Corp.
 Micro Communications, Inc.
 Nurad, Inc.
 Phelps Dodge Communications Co.
 Prodelin Inc.
 RCA Distributor & Special Products
 Div.
 Rohde & Schwarz Sales Co.
 Scala Electronic Corp.
 Scientific-Atlanta, Inc.
 Sitco Antenna Co.

Antennas, Receiving Microwave

Andrew Corp.
 Anixter-Mark
 Bogner Broadcast Equipment Corp.
 Cablewave Systems Inc.
 Engineering Associates
 Farinon Video
 Maury Microwave Corp.
 Micro Communications, Inc.
 NEC America, Inc. Broadcast Equip.
 Div.
 Nurad, Inc.
 Prodelin Inc.
 Scientific-Atlanta, Inc.

Singer Products Co., Inc.
 TerraCom Loral Corp.

Antennas, Remote Pickup

See Adv. Page

CCA Electronics Corp. 74

Andrew Corp.
 Anixter-Mark
 Belar Electronics Lab., Inc.
 CCA Electronics Corp.
 Cetec Broadcast Group
 Farinon Video
 Harris Corp. Broadcast Products Div.
 McMartin Industries, Inc.
 Micro Communications, Inc.
 Moseley Associates, Inc.
 Motorola Communications and
 Electronics Inc.
 Nurad, Inc.
 Scala Electronic Corp.
 Scientific-Atlanta, Inc.

Antennas, Remote Transmitting, Radio

See Adv. Page

CCA Electronics Corp. 74

Anixter-Mark
 CCA Electronics Corp.
 Cetec Broadcast Group
 Dielectric Communications A Unit of
 General Signal
 Farinon Video
 Harris Corp. Broadcast Products Div.
 Moseley Associates, Inc.
 Scala Electronic Corp.
 Technology For Communications Int'l.

Antennas, STL

See Adv. Page

CCA Electronics Corp. 74

Andrew Corp.
 Anixter-Mark
 CCA Electronics Corp.
 Cablewave Systems Inc.
 Cetec Broadcast Group
 Contel Mfg.
 Dielectric Communications A Unit of
 General Signal
 Gabriel Electronics, Inc.
 Harris Corp. Broadcast Products Div.
 Micro Communications, Inc.
 Micro Control Associates, Inc.
 Moseley Associates, Inc.
 Nurad, Inc.
 Prodelin Inc.
 Scala Electronic Corp.
 Singer Products Co., Inc.
 Swager Tower Corp.
 TerraCom Loral Corp.
 Utility Tower Co.

Antennas, Transmitting FM

See Adv. Page

CCA Electronics Corp. 74

Alford Mfg. Co.
 Keith Anderson Co.
 Anderson Scientific
 CCA Electronics Corp.
 Cetec Broadcast Group
 Collins Div. Rockwell International
 Comark Communications Industries,
 Inc.
 Dielectric Communications A Unit of
 General Signal
 Harris Corp. Broadcast Products Div.
 Hy-Gain Electronics Div. of Telex
 Communications Inc.
 Marconi Communication Systems Ltd.
 McMartin Industries, Inc.
 Micro Communications, Inc.
 Phelps Dodge Communications Co.
 RCA Broadcast Systems
 Scala Electronic Corp.
 Shively Laboratories, Inc.
 Singer Products Co., Inc.

Antennas, Transmitting HF

See Adv. Page

CCA Electronics Corp. 74

CCA Electronics Corp.
 Comark Communications Industries,
 Inc.
 DHV, Inc.

Antennas, Transmitting LF

See Adv. Page

CCA Electronics Corp. 74
Stainless, Inc. 118

CCA Electronics Corp.
 Cetec Broadcast Group
 Comark Communications Industries,
 Inc.
 Continental Electronics Mfg. Co.
 Dielectric Communications A Unit of
 General Signal
 Harris Corp. Broadcast Products Div.
 Marconi Communication Systems Ltd.
 Micro Communications, Inc.
 Stainless, Inc.

Antennas, Transmitting MF

See Adv. Page

CCA Electronics Corp. 74

CCA Electronics Corp.
 Cetec Broadcast Group
 Continental Electronics Mfg. Co.
 Dielectric Communications A Unit of
 General Signal
 Harris Corp. Broadcast Products Div.
 Hy-Gain Electronics Div. of Telex
 Communications Inc.
 Marconi Communication Systems Ltd.
 Marconi Electronics Inc. Broadcast &
 Communication Div.
 McMartin Industries, Inc.
 Shively Laboratories, Inc.

Antennas, Transmitting UHF

See Adv. Page

CCA Electronics Corp. 74

Acrodyne Industries Inc.
 Alford Mfg. Co.
 Keith Anderson Co.
 Anderson Scientific
 Andrew Corp.
 Anixter-Mark
 Bogner Broadcast Equipment Corp.
 CCA Electronics Corp.
 Canadian General Electric Co., Ltd.
 Cetec Broadcast Group
 Comark Communications Industries,
 Inc.
 Dielectric Communications A Unit of
 General Signal
 EMCEE Broadcast Products
 Harris Corp. Broadcast Products Div.
 Hy-Gain Electronics Div. of Telex
 Communications Inc.
 Marconi Communication Systems Ltd.
 Marconi Electronics Inc. Broadcast &
 Communication Div.
 Micro Communications, Inc.
 Nurad, Inc.
 Phelps Dodge Communications Co.
 Prodelin Inc.
 RCA Broadcast Systems
 SWR Inc.
 Scala Electronic Corp.
 Shively Laboratories, Inc.
 Sitco Antenna Co.

Antennas, Transmitting UHF/VHF, Circularly Polarized

See Adv. Page

CCA Electronics Corp. 74

Alford Mfg. Co.
 Anderson Scientific
 Anixter-Mark
 Bogner Broadcast Equipment Corp.
 CCA Electronics Corp.

Cetec Broadcast Group
Comark Communications Industries, Inc.
Dielectric Communications A Unit of General Signal
Harris Corp. Broadcast Products Div.
Hy-Gain Electronics Div. of Telex Communications Inc.
Nurad, Inc.
RCA Broadcast Systems
SWR Inc.

Antennas, Transmitting VHF

See Adv. Page

CCA Electronics Corp. 74

Acrodyne Industries Inc.
Alford Mfg. Co.
Keith Anderson Co.
Anderson Scientific
Anixter-Mark
Bogner Broadcast Equipment Corp.
CCA Electronics Corp.
Canadian General Electric Co., Ltd.
Cetec Broadcast Group
Comark Communications Industries, Inc.
Dielectric Communications A Unit of General Signal
EMCEE Broadcast Products
The Finney Co.
Harris Corp. Broadcast Products Div.
Hy-Gain Electronics Div. of Telex Communications Inc.
Marconi Communication Systems Ltd.
Marconi Electronics Inc. Broadcast & Communication Div.
Micro Communications, Inc.
Nurad, Inc.
Phelps Dodge Communications Co.
Prodelin Inc.
RCA Broadcast Systems
Scala Electronic Corp.
Shively Laboratories, Inc.
Singer Products Co., Inc.
Sito Antenna Co.

Antennas, Transmitting Microwave

Andrew Corp.
Anixter-Mark
Bogner Broadcast Equipment Corp.
Cablewave Systems Inc.
Farinon Video
Harris Corp. Broadcast Products Div.
Marconi Communication Systems Ltd.
Micro Communications, Inc.
Micro Control Associates, Inc.
Nurad, Inc.
Prodelin Inc.
Rohde & Schwarz Sales Co.
Scientific-Atlanta, Inc.
Singer Products Co., Inc.
TerraCom Loral Corp.
Tri-Ex Tower Corp.

Antennas, TV Earth Station

Anderson Scientific
Anixter-Mark
Collins Div. Rockwell International
Farinon Video
Fort Worth Tower Co., Inc.
Gardiner Communications Corp.
Harris Corp. Broadcast Products Div.
Hughes Aircraft Co. Microwave Communications Products
Marconi Communication Systems Ltd.
Microdyne Corp.
Nurad, Inc.
Prodelin Inc.
Scientific-Atlanta, Inc.
Tri-Ex Tower Corp.

Arms, Tone

Audio-Technica U.S., Inc.
Broadcast Electronics, Inc.
Cetec Broadcast Group
EMT Franz VGmbH
Harris Corp. Broadcast Products Div.
LPB Inc.
McCurdy Radio Ind. Inc.
Micro-Trak Corp.

Osawa & Co. (USA), Inc.
QRK Electronic Products
Russo Electronics Mfg. Inc.
Shure Brothers Inc.
Singer Products Co., Inc.
Stanton Magnetics Inc.

Attenuators, Audio

See Adv. Page

Gerard Tech 154
Tech Laboratories Inc. 164
Waters Mfg. Inc. 139

AKG Acoustics Div. Philips Audio Video Systems
Allen Avionics
Altec Lansing Sound Products
Audio Designs & Mfg.
Auditronics, Inc.
Automated Processes, Inc.
Barker and Williamson, Inc.
Bayly Engineering Ltd. Member of AEG-Telefunken Group
Cetec Broadcast Group
Duncan Electronics, Inc.
DYMA Engineering, Inc.
Gerard Tech
Gotham Audio Corp.
Harris Corp. Broadcast Products Div.
ITI Electronics, Inc.
Kay Elemetrics Corp.
Kings Electronics Co., Inc.
Leader Instruments Corp.
Marconi Instruments Div. of Marconi Electronics Inc.
Orange County Electronics Int'l., Inc.
Potomac Instruments, Inc.
Protech Audio Corp.
ROH Corporation
Richmond Sound Design, Ltd.
Rohde & Schwarz Sales Co.
Sescom, Inc.
Shalloco, Inc.
Spectra Sonics
Tech Laboratories Inc.
Texscan Corp.
Vidaire Electronics Mfg.
Waters Mfg. Inc.
Weinschel Engineering Co.

Attenuators, Fixed

See Adv. Page

CCA Electronics Corp. 74
Electro Impulse, Inc. 161
Gerard Tech 154
Tech Laboratories Inc. 164
Waters Mfg. Inc. 139

Allen Avionics
Bayly Engineering Ltd. Member of AEG-Telefunken Group
Bird Electronic Corp.
CCA Electronics Corp.
Cetec Broadcast Group
Dielectric Communications A Unit of General Signal
Electro Impulse, Inc.
The Finney Co.
Gerard Tech
Harris Corp. Broadcast Products Div.
Harris Corp. PRD Electronics Div.
Holland Electronics
ITI Electronics, Inc.
Kay Elemetrics Corp.
Kings Electronics Co., Inc.
Maury Microwave Corp.
Merill Cable Equipment Corp.
Mu-Del Electronics, Inc.
The Narda Microwave Corporation
Rohde & Schwarz Sales Co.
Shalloco, Inc.
Tech Laboratories Inc.
Tektronix Inc.
Texscan Corp.
Trompeter Electronics
Waters Mfg. Inc.
Weinschel Engineering Co.

Attenuators, Impedance Matching

See Adv. Page

CCA Electronics Corp. 74
Electro Impulse, Inc. 161
Gerard Tech 154
Tech Laboratories Inc. 164
Waters Mfg. Inc. 139

AKG Acoustics Div. Philips Audio Video Systems
Alford Mfg. Co.
Allen Avionics
Blonder-Tongue Labs.
CCA Electronics Corp.
Cetec Broadcast Group
Dielectric Communications A Unit of General Signal
Electro Impulse, Inc.
Gerard Tech
Harris Corp. Broadcast Products Div.
Kay Elemetrics Corp.
Maury Microwave Corp.
Merill Cable Equipment Corp.
Mu-Del Electronics, Inc.
The Narda Microwave Corporation
Rohde & Schwarz Sales Co.
Shalloco, Inc.
Tech Laboratories Inc.
Tektronix Inc.
Texscan Corp.
Waters Mfg. Inc.
Weinschel Engineering Co.

Attenuators, Microwave

See Adv. Page

Electro Impulse, Inc. 161
Tech Laboratories Inc. 164

AILTECH Div. Cutler-Hammer Los Angeles Operation
COMPAC
Dielectric Communications A Unit of General Signal
Electro Impulse, Inc.
Harris Corp. PRD Electronics Div.
Kay Elemetrics Corp.
Kings Electronics Co., Inc.
Maury Microwave Corp.
Mu-Del Electronics, Inc.
The Narda Microwave Corporation
Rohde & Schwarz Sales Co.
Systrom-Donner
Tech Laboratories Inc.
Tektronix Inc.
Texscan Corp.
Varian Associates, Inc. Electron Device Group
Weinschel Engineering Co.

Attenuators, RF

See Adv. Page

Electro Impulse, Inc. 161
Tech Laboratories Inc. 164

AILTECH Div. Cutler-Hammer Los Angeles Operation
AVA Electronics
Anderson Scientific
Bird Electronic Corp.
COMPAC
Dielectric Communications A Unit of General Signal
Electro Impulse, Inc.
Harris Corp. Broadcast Products Div.
Harris Corp. PRD Electronics Div.
Holland Electronics
Jerrold Electronics Corp.
Kahn Communications, Inc.
Kay Elemetrics Corp.
Kings Electronics Co., Inc.
Marconi Instruments Div. of Marconi Electronics Inc.
Merill Cable Equipment Corp.
Micro Communications, Inc.
Mu-Del Electronics, Inc.
Oak Industries, Inc.
RHG Electronics Laboratory, Inc.
Rohde & Schwarz Sales Co.
Shalloco, Inc.
Systrom-Donner
Tech Laboratories Inc.

Tektronix Inc.
Texscan Corp.
Triple Crown Electronics, Inc.
Vidaire Electronics Mfg.
Weinschel Engineering Co.

Audio Level Indicators, LED

See Adv. Page

ESE 155

ESE

Audio Processors, FM

See Adv. Page

Dolby Laboratories, Inc. 105
Orban Assoc. Inc. 31

Dolby Laboratories, Inc.
Orban Assoc. Inc.

Audio Stacks, Rebuilt or Rebuilding Services for VTR

See Adv. Page

Videomax Div. 1

Computer Magnetics Corp.
International Electro-Magnetics
Merlin Engineering Works, Inc.
Minneapolis Magnetics
Taber Mfg. & Engr. Co.
Videomax Div. Orrox Corp.

Automated Transmission Systems (ATS)

See Adv. Page

Delta Electronics Inc. (Va.) 107
Time & Frequency Tech., Inc. 119

CCA Electronics Corp.
C. S. P. Inc.
Cetec Broadcast Group
Delta Electronics Inc. (Va.)
DYMA Engineering, Inc.
Harris Corp. Broadcast Products Div.
Moseley Associates, Inc.
PWH Electronics
Potomac Instruments, Inc.
QEI Corp.
Sharepoint Systems Inc.
Time & Frequency Tech., Inc.

Automation, Data Processing

Automation Electronics, Inc. Autotron Systems, Div.
Bic Computers
Boston Sound & Power Systems
Central Dynamics Corp.
Columbine Systems, Inc.
Computer Business Systems, Inc.
Computer Management Systems, Inc.
Cox Data Services Suite 100/Prado North
Groton Computer Inc.
Harris Corp. Broadcast Products Div.
Kaman Sciences Corp.
Marconi Communication Systems Ltd.
Marconi Associates, Inc.
PWH Electronics
Quad-Eight Electronics
Sono-Mag Corp.
Vital Industries Inc.

Automation, Equipment Control, Radio

See Adv. Page

Consolidated Electronic Industries 14

Autogram Corp.
Automated Broadcast Controls
The BTX Corp.
Boston Sound & Power Systems
Broadcast Electronics, Inc.

Cetec Broadcast Group
Computer Business Systems, Inc.
Consolidated Electronic Industries
Elcom Engineering Co.
Harris Corp. Broadcast Products Div.
IGM Div. of Northwestern Tech.
International Communications &
Control Corp.
Moseley Associates, Inc.
PWH Electronics
Sharepoint Systems Inc.
Sono-Mag Corp.
Tape-Athon Corp.

Automation, Equipment Control, TV

See Adv. Page

Kaitronics Corp...... 12
Microtime, Inc...... 13
Time & Frequency Tech., Inc...... 119
Vital Industries Inc...... BC

American Data Corp. A North
American Philips Co.
CMX Systems & Videomax Div's. of
Orrox Corp.
Central Dynamics Corp.
Dytek Industries, Inc.
Grass Valley Group, Inc.
Harris Corp. Broadcast Products Div.
Holland Electronics
IGM Div. of Northwestern Tech.
International Communications &
Control Corp.
Kaitronics Corp.
Magna-Tech Electronic Co., Inc.
Marconi Communication Systems Ltd.
Microtime, Inc.
Moseley Associates, Inc.
PWH Electronics
RCA Broadcast Systems
Sono-Mag Corp.
Studer Revox America
Time & Frequency Tech., Inc.
Video Specialties
Videomedia
Vital Industries Inc.

Automation, Lighting Control

Berkey-Colortran Inc.
Electro Controls
Kliegl Bros. Lighting
Skirpan Lighting Control Corp.
Strand Century, Inc.
Technamics Co.
Theatre Techniques Inc.

Automation, Program Control

See Adv. Page

Aitken Communications Inc...... 172
Consolidated Electronic Industries 14
Microtime, Inc...... 13
Vital Industries Inc...... BC

Aitken Communications Inc.
American Data Corp. A North
American Philips Co.
Automated Broadcast Controls
Broadcast Electronics, Inc.
Central Dynamics Corp.
Cetec Broadcast Group
Consolidated Electronic Industries
Datatron, Inc.
Dytek Industries, Inc.
Grass Valley Group, Inc.
Harris Corp. Broadcast Products Div.
IGM Div. of Northwestern Tech.
Kaitronics Corp.
Kaman Sciences Corp.
Marconi Communication Systems Ltd.
Microprobe Electronics
Microtime, Inc.
Rupert Neve, Inc.
PWH Electronics
Quad-Eight Electronics
Sono-Mag Corp.
Tape-Athon Corp.
Technamics Co.
Tektronix Inc.

Telex Communications, Inc.
Video Specialties
Vital Industries Inc.
Ward-Beck Systems, Ltd.

Automation, Program Logging

See Adv. Page

Consolidated Electronic Industries 14
Microtime, Inc...... 13
Time & Frequency Tech., Inc...... 119

Automated Broadcast Controls
Automation Electronics, Inc. Autotron
Systems, Div.
Broadcast Electronics, Inc.
Central Dynamics Corp.
Cetec Broadcast Group
Consolidated Electronic Industries
Datatron, Inc.
Grass Valley Group, Inc.
Groton Computer Inc.
Hallikainen & Friends, Inc.
Harris Corp. Broadcast Products Div.
IGM Div. of Northwestern Tech.
Microtime, Inc.
PWH Electronics
Panasonic Company
QSI Systems, Inc.
Sono-Mag Corp.
Studer Revox America
Telex Communications, Inc.
Time & Frequency Tech., Inc.
Vital Industries Inc.

Automation, Projector

See Adv. Page

Laird Telemedia Inc...... 158

Kaitronics Corp.
Laird Telemedia Inc.
Marconi Electronics Inc. Broadcast &
Communication Div.
Spindler & Sauppe, Inc.
Technamics Co.

Automation, Switching

See Adv. Page

Consolidated Electronic Industries 14
Microtime, Inc...... 13
Vital Industries Inc...... BC

Adcom Communications Inc.
American Data Corp. A North
American Philips Co.
Automated Broadcast Controls
Bias/Data Communications Corp.
CMX Systems & Videomax Div's. of
Orrox Corp.
Central Dynamics Corp.
Cetec Broadcast Group
ComTec Video Systems Mincom Div.
3M
Consolidated Electronic Industries
Data Communications Corp.
Dytek Industries, Inc.
Grass Valley Group, Inc.
IGM Div. of Northwestern Tech.
Image Video Ltd.
Marconi Electronics Inc. Broadcast &
Communication Div.
Microprobe Electronics
Microtime, Inc.
Panasonic Company
Richmond Sound Design, Ltd.
Sono-Mag Corp.
Technamics Co.
Vital Industries Inc.

Automation Systems, Business

Automation Electronics, Inc. Autotron
Systems, Div.
Bias/Data Communications Corp.
Bic Computers
Bloomington Broadcasting
Boston Sound & Power Systems
Columbine Systems, Inc.
Computer Business Systems, Inc.

Computer Management Systems, Inc.
Groton Computer Inc.
PWH Electronics
Station Business Systems Div. Control
Data Corp.

Automation, Tape Control, Cartridge

See Adv. Page

Aitken Communications Inc...... 172
Consolidated Electronic Industries 14
IGM 171

Aitken Communications Inc.
Autogram Corp.
Automated Broadcast Controls
Broadcast Electronics, Inc.
CMX Systems & Videomax Div's. of
Orrox Corp.
Central Dynamics Corp.
Cetec Broadcast Group
Consolidated Electronic Industries
Delta Electronics Inc. (N.C.)
Harris Corp. Broadcast Products Div.
IGM Div. of Northwestern Tech.
Microprobe Electronics
RCA Broadcast Systems
Sharepoint Systems Inc.
Singer Products Co., Inc.
Sono-Mag Corp.
Tape-Athon Corp.
Telex Communications, Inc.
UMC Electronics Co. Broadcast
Products Div.

Automation, Tape Control, Reel

See Adv. Page

Aitken Communications Inc...... 172

AEG-Telefunken Magnetic Tape
Recorder Dept.
Aitken Communications Inc.
Autogram Corp.
Automated Broadcast Controls
The BTX Corp.
Broadcast Electronics, Inc.
CMX Systems & Videomax Div's. of
Orrox Corp.
Central Dynamics Corp.
Cetec Broadcast Group
Harris Corp. Broadcast Products Div.
IGM Div. of Northwestern Tech.
Microprobe Electronics
Otari Corp.
RCA Broadcast Systems
Sharepoint Systems Inc.
Singer Products Co., Inc.
Sono-Mag Corp.
Studer Revox America
Tape-Athon Corp.
Telex Communications, Inc.

Automation, Transmitter Logging

See Adv. Page

Time & Frequency Tech., Inc...... 119

CCA Electronics Corp.
Dielectric Communications A Unit of
General Signal
Harris Corp. Broadcast Products Div.
Marconi Instruments Div. of Marconi
Electronics Inc.
Moseley Associates, Inc.
PWH Electronics
Sharepoint Systems Inc.
Soll, Inc.
Sono-Mag Corp.
Time & Frequency Tech., Inc.

Automation, Video Display Terminals

Automation Electronics, Inc. Autotron
Systems, Div.
Data Communications Corp.
Sharepoint Systems Inc.
Soll, Inc.

Teknekron/ARG
Time & Frequency Tech., Inc.

Automation, Videotape Machine

See Adv. Page

Kaitronics Corp...... 12
Microtime, Inc...... 13
Videomedia..... 67

Ampex Corp.
Automation Techniques, Inc.
The BTX Corp.
Bosch-Fernseh Corp.
CMX Systems & Videomax Div's. of
Orrox Corp.
Central Dynamics Corp.
Channelmatic, Inc.
Kaitronics Corp.
Media Concepts, Inc.
Merlin Engineering Works, Inc.
Microtime, Inc.
Phasecom Corp.
RCA Broadcast Systems
Videomedia

Battery Packs and Chargers

See Adv. Page

Alexander Mfg. Co...... 46
Christie Electric Corp...... 64
Frezzaolini Electronics, Inc...... 125
Yardney Electric Corp...... 162

Alexander Mfg. Co.
Anton/Bauer Inc.
Christie Electric Corp.
Cine 60, Inc.
Cinema Products Corp.
Frezzaolini Electronics, Inc.
Alan Gordon Enterprises Inc.
Harris Corp. Broadcast Products Div.
Ikegami Electronics (USA) Inc.
KAPCO Communications
Leadal, Inc.
Mole-Richardson Co.
Multiplier Industries Corp.
Nagra Magnetic Recorders, Inc.
North Wind Power Co.
Panasonic Company
Panasonic Co. Video Systems Div.
Sencore Inc.
Sony Corp. of America
Television Products Co. Inc.
Yardney Electric Corp.

Blowers and Fans

Amco Engineering Co.
Bud Industries, Inc.
Javelin Electronics
Stantron Div. Wyco Metal Products

Bridges, Common Point

See Adv. Page

C. S. P. Inc...... 144
Delta Electronics Inc. (Va.)..... 107
Potomac Instruments, Inc...... 126

CCA Electronics Corp.
C. S. P. Inc.
Delta Electronics Inc. (Va.)
Harris Corp. Broadcast Products Div.
Potomac Instruments, Inc.

Buzz Tone Eliminators, Videotape Edit

Merlin Engineering Works, Inc.

Cabinets, Cartridges and Records

See Adv. Page

Winsted Corp...... 156

Advance Products Co.
Bretford Mfg. Co.

DYMA Engineering, Inc.
Harris Corp. Broadcast Products Div.
Lyon Metal Products, Inc.
Micro-Trak Corp.
Wallach & Associates Inc.
Winsted Corp.

**Cabinets, Consoles and Racks
(Enclosures Only)**

See Adv. Page

Equipto Storage Systems..... 131
Storeel Corp. 101
Winsted Corp. 156

Advance Products Co.
Amco Engineering Co.
Anvil Cases, Inc.
Automated Broadcast Controls
Bayly Engineering Ltd. Member of
AEG-Telefunken Group
Broadcast Electronics, Inc.
Bud Industries, Inc.
Cases Inc.
Cetec Broadcast Group
DYMA Engineering, Inc.
Emcor Products GF Business
Equipment, Inc.
Enclosure Corp.
Equipto Storage Systems
Harris Corp. Broadcast Products Div.
Javelin Electronics
Laird Telemedia Inc.
MacKenzie Laboratories, Inc.
McCurdy Radio Ind. Inc.
Micro-Trak Corp.
Nurad, Inc.
Paso Sound Products Inc.
Plastic Reel Corp. of America
Quad-Eight Electronics
Research Technology, Inc.
Ruslang Corp.
Scientific-Atlanta, Inc.
Shintron Co. Inc.
Stantron Div. Wyco Metal Products
Storeel Corp.
Tektronix Inc.
Vector Electronic Co., Inc.
Winsted Corp.

Cabinets, Equipment, Custom

Advance Products Co.
Anvil Cases, Inc.
Audicon, Inc.
Bretford Mfg. Co.
C. S. P. Inc.
Centro Corp.
DYMA Engineering, Inc.
Emcor Products GF Business
Equipment, Inc.
Kreomite, Inc.
Leedal, Inc.
Micro-Trak Corp.
Parsons Mfg. Corp.
Ruslang Corp.
Sound Dynamics, Inc.

Cable, Camera

Belden Corp.
Bosch-Fernseh Corp.
Boston Insulated Wire & Cable Co.
Brand-Rex Co.
Comprehensive Video Supply Corp.
GBC Closed Circuit TV Corp.
Harris Corp. Broadcast Products Div.
Ikegami Electronics (USA) Inc.
Javelin Electronics
Marshall Electronics
Panasonic Co. Video Systems Div.
Times Fiber Communications, Inc.
Times Wire and Cable
WIDL Video

Cable, Coaxial and Audio

See Adv. Page

Trompeter Electronics 66

AKG Acoustics Div. Philips Audio
Video Systems
AVA Electronics
Alford Mfg. Co.

Andrew Corp.
Audicon, Inc.
Audio-Technica U.S., Inc.
Belden Corp.
Blonder-Tongue Labs.
Boston Insulated Wire & Cable Co.
Brand-Rex Co.
CCA Electronics Corp.
CCS Hatfield Communications
Products
COMPAC
C. S. P. Inc.
Cablewave Systems Inc.
Cetec Broadcast Group
Comm/Scope Co.
Comprehensive Video Supply Corp.
EMT Franz VGmbH
The Finney Co.
GBC Closed Circuit TV Corp.
G C Electronics Div. Wallace Murray
Gabriel Electronics, Inc.
General Cable Corp.
Javelin Electronics
Marshall Electronics
Maury Microwave Corp.
Media Concepts, Inc.
Micro Communications, Inc.
Micro Control Associates, Inc.
Nagra Magnetic Recorders, Inc.
Neutrik
Nurad, Inc.
PHELPS Dodge Communications Co.
Prodelin Inc.
SWR Inc.
Singer Products Co., Inc.
Times Fiber Communications, Inc.
Times Wire and Cable
Trompeter Electronics
WIDL Video
Whirlwind Audio
Whirlwind Music

Cable, Optical Fiber

See Adv. Page

Telemet 142

Comm/Scope Co.
General Cable Corp.
Harris Corp. Broadcast Products Div.
Radiation Devices Co., Inc.
Rank Precision Industries, Inc. (N.Y.)
Telemet A Geotel Co.
Times Fiber Communications, Inc.
Times Wire and Cable

Cable Laying Equipment

J I Case Davis Div.
Ditch Witch Div. of Charles Machine
Works Inc.
Roll-A-Reel
Suda Seisakusho Co., Ltd.

Cable Locators, Underground

Aqua-Tronics, Inc.
Rycom Instruments

Cable Stripping Tools

See Adv. Page

Paladin Corp. 112

Cambridge Products
Marshall Electronics
Paladin Corp.
Western Electronic Products Co.

Calibration Service, Instrument

Alford Mfg. Co.
B & K Instruments Inc.
Bird Electronic Corp.
Commercial Radio Monitoring Co., Inc.
National Electrolab Ltd.
Photo Research Div. of Kollmorgen
Corp.
Potomac Instruments, Inc.
Sadelco, Inc.
Sencore Inc.
Tektronix Inc.

Calorimeters, RF

See Adv. Page

Electro Impulse, Inc. 161

Bird Electronic Corp.
Electro Impulse, Inc.
Harris Corp. PRD Electronics Div.

**Camera Carrying Stabilizers,
Operator Vest Mount**

Cinema Products Corp.

**Camera Carrying Systems,
Television Portapak**

Cine 60, Inc.
GBC Closed Circuit TV Corp.
Gruber Products Co.
Harris Corp. Broadcast Products Div.
Javelin Electronics
K & H Products, Ltd.
Lee-Ray Industries, Inc.
Sony Corp. of America
US JVC Corp. Professional Video Div.

**Camera Dollies, Stands and
Tripods**

See Adv. Page

**O'Connor Eng. Labs.
Inc. 117**

**Television Products
Co. Inc. 126**

Berkey-Colortran Inc.
Cinema Products Corp.
Cohu, Inc. Electronics Div.
Comprehensive Video Supply Corp.
Davis & Sanford Co. Inc.
GBC Closed Circuit TV Corp.
Alan Gordon Enterprises Inc.
Gruber Products Co.
Harris Corp. Broadcast Products Div.
Innovative Television Equipment, Inc.
Javelin Electronics
K & H Products, Ltd.
Lee-Ray Industries, Inc.
Miller Professional Equipment, Inc.
O'Connor Eng. Labs. Inc.
Panasonic Company
Panasonic Co. Video Systems Div.
Quick-Set Inc.
SGL Waber Electric
Television Products Co. Inc.

Camera Pan and Tilt Heads

See Adv. Page

**O'Connor Eng. Labs.
Inc. 117**

Arriflex Corp.
Asaca Corp. of America
Cohu, Inc. Electronics Div.
Davis & Sanford Co. Inc.
Electro & Optical Systems Ltd.
GBC Closed Circuit TV Corp.
Alan Gordon Enterprises Inc.
Harris Corp. Broadcast Products Div.
Ikegami Electronics (USA) Inc.
Innovative Television Equipment, Inc.
Javelin Electronics
Miller Professional Equipment, Inc.
O'Connor Eng. Labs. Inc.
Panasonic Company
Power-Optics Inc.
Quick-Set Inc.
Tele-Cine Inc.
Television Products Co. Inc.

**Camera Remote Control
Equipment**

See Adv. Page

**Hitachi Denshi
America, Ltd. 3**

**Philips Broadcast
Equip Corp. 22-23**

Bosch-Fernseh Corp.
Catel Div. United Scientific Corp.

Cohu, Inc. Electronics Div.
Dage-MTI, Inc.
Electro & Optical Systems Ltd.
GBC Closed Circuit TV Corp.
Harris Corp. Broadcast Products Div.
Hitachi Denshi America, Ltd.
Ikegami Electronics (USA) Inc.
Innovative Television Equipment, Inc.
Javelin Electronics
Marconi Communication Systems Ltd.
Panasonic Company
Philips Broadcast Equip Corp.
Power-Optics Inc.
Quick-Set Inc.
Swickegami Div. Of Spectrum Video
Tele-Cine Inc.
Telemation, A Div. of Bell & Howell
Times Fiber Communications, Inc.

Cameras, Film Chain

Bosch-Fernseh Corp.
CMX Systems & Videomax Div's. of
Orrox Corp.
Cohu, Inc. Electronics Div.
Commercial Electronics, Inc.
GBC Closed Circuit TV Corp.
Harris Corp. Broadcast Products Div.
Hitachi Denshi America, Ltd.
Ikegami Electronics (USA) Inc.
Marconi Communication Systems Ltd.
Philips Broadcast Equip Corp.
RCA Broadcast Systems
Sharp Electronics Corp.
Telemation, A Div. of Bell & Howell

Cameras, Film Cine

Arriflex Corp.
Canon USA, Inc. Optics Div.
Cinema Products Corp.
Eastman Kodak Co.
Frezzolini Electronics, Inc.
Alan Gordon Enterprises Inc.
Harris Corp. Broadcast Products Div.
Super 8 Sound, Inc.

Cameras, Film Still

Canon USA, Inc. Optics Div.
Durst US-Sickles Inc.
Eastman Kodak Co.

**Cameras, TV Color Studio
Broadcast**

See Adv. Page

Bosch-Fernseh Corp. 47
Commercial

Electronics, Inc. 77

Hitachi Denshi

America, Ltd. 3

Ikegami Electronics

(USA) Inc. 128-129

Marconi Electronics

Inc. 65

Philips Broadcast

Equip Corp. 22-23

RCA Broadcast

Systems 81

Ampex Corp.
Bosch-Fernseh Corp.
Cohu, Inc. Electronics Div.
Commercial Electronics, Inc.
GBC Closed Circuit TV Corp.
Harris Corp. Broadcast Products Div.
Hitachi Denshi America, Ltd.
Ikegami Electronics (USA) Inc.
International Video Corp.
Link Electronics Ltd.
Marconi Communication Systems Ltd.
Marconi Electronics Inc. Broadcast &
Communication Div.
NEC America, Inc. Broadcast Equip.
Div.
Panasonic Company
Panasonic Co. Video Systems Div.
Philips Broadcast Equip Corp.
RCA Broadcast Systems
Sony Corp. of America
Thomson-CSF Laboratories, Inc.
Toshiba Int'l. Corp. Broadcast
Electronic Systems

Cameras, Video Color ENG/EFP

See Adv. Page
Bosch-Ferhseh Corp. 47
Cinema Products Corp...... 11
Commercial Electronics, Inc. 77
Hitachi Denshi America, Ltd. 3
Ikegami Electronics (USA) Inc. 128-129
Marconi Electronics Inc. 65
Philips Broadcast Equip Corp...... 22-23
RCA Broadcast Systems..... 81
Sony Corp. of America.... 38-39
US JVC Corp...... 54-55

Ampex Corp.
 Asaca Corp. of America
 Bosch-Ferhseh Corp.
 Cinema Products Corp.
 Cohu, Inc. Electronics Div.
 Commercial Electronics, Inc.
 GBC Closed Circuit TV Corp.
 Alan Gordon Enterprises Inc.
 Harris Corp. Broadcast Products Div.
 Hitachi Denshi America, Ltd.
 Ikegami Electronics (USA) Inc.
 International Video Corp.
 Link Electronics Ltd.
 Marconi Communication Systems Ltd.
 Marconi Electronics Inc. Broadcast & Communication Div.
 Media Concepts, Inc.
 NEC America, Inc. Broadcast Equip. Div.
 Panasonic Company
 Panasonic Co. Video Systems Div.
 Philips Broadcast Equip Corp.
 RCA Broadcast Systems
 Sharp Electronics Corp.
 Sony Corp. of America
 Thomson-CSF Laboratories, Inc.
 Toshiba Int'l. Corp. Broadcast Electronic Systems
 US JVC Corp. Professional Video Div.

Capacitors, Transmitting, Mica and Vacuum

See Adv. Page
C. S. P. Inc. 144

Bayly Engineering Ltd. Member of AEG-Telefunken Group
 CCA Electronics Corp.
 C. S. P. Inc.
 Cetec Broadcast Group
 Comet Sales
 EEV, Inc.
 EEV Canada Ltd.
 English Electric Valve Co. Ltd.
 Harris Corp. Broadcast Products Div.
 ITT Jennings
 KD Components, Inc.
 T T E, Inc.

Cartridge Machine Alignment Tape

See Adv. Page
Fidelipac 121

Ampro Broadcasting
 Broadcast Electronics, Inc.
 Cetec Broadcast Group
 Fidelipac
 Harris Corp. Broadcast Products Div.
 Nortronics Co., Inc. Recorder Care Div.
 Taber Mfg. & Engr. Co.

Cartridge Machine Rebuilding Services

Broadcast Electronics, Inc.
 Cetec Broadcast Group

Cartridge Machines, Dual Deck

See Adv. Page
Consolidated Electronic Industries 14
Harris Corp. 44

Broadcast Electronics, Inc.
 Cetec Broadcast Group
 Consolidated Electronic Industries
 Harris Corp. Broadcast Products Div.
 International Electro-Magnetics
 MacKenzie Laboratories, Inc.
 McCurdy Radio Ind. Inc.
 RCA Broadcast Systems
 Singer Products Co., Inc.
 Sono-Mag Corp.
 UMC Electronics Co. Broadcast Products Div.

Cartridge Machines, Multiple Deck

See Adv. Page
Audi-Cord Corp. 62
Broadcast Electronics, Inc. 30
Consolidated Electronic Industries 14
Harris Corp. 44
IGM 171
International Tapetronics Corp. 26
RCA Broadcast Systems..... 81
Ramko Research Inc. 28-29

Ampro Broadcasting
 Audi-Cord Corp.
 Automated Broadcast Controls
 Broadcast Electronics, Inc.
 Cetec Broadcast Group
 Consolidated Electronic Industries
 Harris Corp. Broadcast Products Div.
 IGM Div. of Northwestern Tech.
 International Electro-Magnetics
 International Tapetronics Corp.
 MacKenzie Laboratories, Inc.
 McCurdy Radio Ind. Inc.
 RCA Broadcast Systems
 Ramko Research Inc.
 Singer Products Co., Inc.
 Sono-Mag Corp.
 UMC Electronics Co. Broadcast Products Div.

Cartridge Machines, Random Access

See Adv. Page
Aitken Communications Inc. 172
Broadcast Electronics, Inc. 30
Consolidated Electronic Industries 14
IGM 171
RCA Broadcast Systems..... 81
Ramko Research Inc. 28-29

Aitken Communications Inc.
 Automated Broadcast Controls
 Broadcast Electronics, Inc.
 Cetec Broadcast Group
 Consolidated Electronic Industries
 Harris Corp. Broadcast Products Div.
 IGM Div. of Northwestern Tech.
 MacKenzie Laboratories, Inc.
 McCurdy Radio Ind. Inc.
 RCA Broadcast Systems
 Ramko Research Inc.
 Singer Products Co., Inc.
 Sono-Mag Corp.
 Telex Communications, Inc.
 UMC Electronics Co. Broadcast Products Div.

Cartridge Machines, Single Deck

See Adv. Page
Audi-Cord Corp. 62
Broadcast Electronics, Inc. 30
Consolidated Electronic Industries 14
Harris Corp. 44
International Tapetronics Corp. 26
RCA Broadcast Systems..... 81
Ramko Research Inc. 28-29

Amilon Corp.
 Ampro Broadcasting
 Audi-Cord Corp.
 Bell Audio Systems, Inc.
 Broadcast Electronics, Inc.
 Cetec Broadcast Group
 Consolidated Electronic Industries
 Contel Mfg.
 Harris Corp. Broadcast Products Div.
 IGM Div. of Northwestern Tech.
 International Electro-Magnetics
 International Tapetronics Corp.
 MacKenzie Laboratories, Inc.
 McCurdy Radio Ind. Inc.
 Micro-Trak Corp.
 Novadyne Inc.
 Pacific Recorders and Engrg. Corp.
 Panasonic Company
 RCA Broadcast Systems
 Ramko Research Inc.
 Singer Products Co., Inc.
 Sono-Mag Corp.
 Telex Communications, Inc.
 Track Audio, Inc. (TA)
 UMC Electronics Co. Broadcast Products Div.

Cartridge Machines, Stereo

See Adv. Page
Audi-Cord Corp. 62
Broadcast Electronics, Inc. 30
Harris Corp. 44
International Tapetronics Corp. 26
Ramko Research Inc. 28-29

AEG-Telefunken Magnetic Tape Recorder Dept.
 Amilon Corp.
 Ampro Broadcasting
 Audi-Cord Corp.
 Broadcast Electronics, Inc.
 Cetec Broadcast Group
 Harris Corp. Broadcast Products Div.
 IGM Div. of Northwestern Tech.
 International Tapetronics Corp.
 Micro-Trak Corp.
 Pacific Recorders and Engrg. Corp.
 RCA Broadcast Systems
 Ramko Research Inc.
 Singer Products Co., Inc.
 Telex Communications, Inc.
 Track Audio, Inc. (TA)
 UMC Electronics Co. Broadcast Products Div.

Cartridge Reconditioning Services

Broadcast Electronics, Inc.
 Harris Corp. Broadcast Products Div.

Cartridge Recording Services

CaVox Stereo Productions
 Media Concepts, Inc.
 Tape-Athon Corp.

Cartridge Reloading Services, Audio

Aristocart Div. Western Broadcasting, Ltd.
 Audico, Ltd.
 Broadcast Electronics, Inc.
 CaVox Stereo Productions

Cartridge Reloading Services, Video

Audico, Ltd.

Cartridge Splice Finder

Ampro Broadcasting
 Broadcast Electronics, Inc.
 Cetec Broadcast Group
 Harris Corp. Broadcast Products Div.
 IGM Div. of Northwestern Tech.
 International Tapetronics Corp.
 RCA Broadcast Systems
 UMC Electronics Co. Broadcast Products Div.

Cartridges, Magnetic Tape

See Adv. Page
Aristocart Div. 82
Capitol Magnetic Products 103
Fidelipac 121
IGM 171

Ampex Corp.
 Aristocart Div. Western Broadcasting, Ltd.
 Audico, Ltd.
 Audio Magnetics Corp.
 BSC Inc.
 Broadcast Electronics, Inc.
 Capitol Magnetic Products
 Cetec Broadcast Group
 Consolidated Electronic Industries
 Contel Mfg.
 Fidelipac
 Fuji Photo Film USA, Inc. Magnetic Tape Div.
 Harris Corp. Broadcast Products Div.
 IGM Div. of Northwestern Tech.
 MacKenzie Laboratories, Inc.
 Maxell Corp. of America
 Memorex Corp. Professional Products Group
 Novadyne Inc.
 Singer Products Co., Inc.
 Sono-Mag Corp.
 Telex Communications, Inc.
 3M Co. Magnetic Audio/Video Prod. Div.
 UMC Electronics Co. Broadcast Products Div.

Cartridges, Phono

See Adv. Page
Stanton Magnetics Inc. 113

AKG Acoustics Div. Philips Audio Video Systems
 Audio-Technica U.S., Inc.
 Broadcast Electronics, Inc.
 Cetec Broadcast Group
 EMT Franz VGmbH
 Gotham Audio Corp.
 Harris Corp. Broadcast Products Div.
 McCurdy Radio Ind. Inc.
 Micro-Trak Corp.
 Neutrik
 Osawa & Co. (USA), Inc.
 QRK Electronic Products
 Shure Brothers Inc.
 Singer Products Co., Inc.
 Stanton Magnetics Inc.

Cartridges, Stereo

See Adv. Page
Aristocart Div. 82
Fidelipac 121
IGM 171
Stanton Magnetics Inc. 113

Aristocart Div. Western Broadcasting, Ltd.
 Audio-Technica U.S., Inc.
 Broadcast Electronics, Inc.

Cetec Broadcast Group
 Fidelipac
 Harris Corp. Broadcast Products Div.
 IGM Div. of Northwestern Tech.
 Micro-Trak Corp.
 QRK Electronic Products
 Shure Brothers Inc.
 Sono-Mag Corp.
 Stanton Magnetics Inc.
 Telex Communications, Inc.
 UMC Electronics Co. Broadcast Products Div.

Cartridges, Videotape

Ampex Corp.
 Audico, Ltd.
 Cinema Products Corp.
 Fuji Photo Film USA, Inc. Magnetic Tape Div.
 Maxell Corp. of America
 Memorex Corp. Professional Products Group
 Panasonic Co. Video Systems Div.
 RCA Broadcast Systems
 Recortec Inc.
 Sony Corp. of America
 3M Co. Magnetic Audio/Video Prod. Div.

Cases, Film and Tape, Carrying and Shipping

Amaray Int'l. Corp.
 Anvil Cases, Inc.
 Cases Inc.
 Lowenthal Mfg.
 Maxell Corp. of America
 Neumade Products Corp.
 Parsons Mfg. Corp.
 Plastic Reel Corp. of America
 Reliance Plastics & Packaging Div.
 Research Technology, Inc.
 Schuessler Case Co., Inc.
 Star Case Mfg. Co. Inc.
 Thermodyne International Ltd.
 3M Co. Magnetic Audio/Video Prod. Div.
 Univex International
 Vulcan Binder & Cover
 WIDL Video

Cases, Video Equipment Transit

Anvil Cases, Inc.
 Cases Inc.
 Comprehensive Video Supply Corp.
 Ikelheimer-Ernst, Inc. Fiberbilt Photo Products
 Multiplier Industries Corp.
 Panasonic Co. Video Systems Div.
 Parsons Mfg. Corp.
 Reliance Plastics & Packaging Div.
 Star Case Mfg. Co. Inc.
 Thermodyne International Ltd.

Cassette Duplication Machines

Audico, Ltd.
 International Audio, Inc.
 Ray Jacobs Audio, Inc.
 Magnifax, Inc.
 Panasonic Company
 Pentagon Industries, Inc.
 Singer Products Co., Inc.
 Sony Corp. of America
 Telectro Systems Corp.
 Telex Communications, Inc.

Cassette Machines, Dual Deck

Automation Techniques, Inc.
 Cetec Audio
 Edco Products, Inc.
 Telectro Systems Corp.

Cassette Machines, Multiple Deck

Automation Techniques, Inc.
 Edco Products, Inc.

Telectro Systems Corp.

Cassette Machines, Random Access

Amilon Corp.
 Ampex Corp.
 Automation Techniques, Inc.
 Eumig USA, Inc.
 Panasonic Company
 Telectro Systems Corp.

Cassette Machines, Single Deck

See Adv. Page
Ramko Research Inc. 28-29

Amilon Corp.
 Edco Products, Inc.
 Eumig USA, Inc.
 Hamilton Electronics Corp.
 Heath Co.
 Panasonic Company
 Ramko Research Inc.
 Sansui Electronics Corp.
 TEAC Corp of America
 Telectro Systems Corp.
 Telex Communications, Inc.

Catalogs, Dealer, Custom

See Adv. Page
Trompeter Electronics 66

Trompeter Electronics

Character Generators

See Adv. Page
Chyron Telesystems 84
Gray Engineering Labs 21
Kaitronics Corp. 12
Knox Video Products 140
MPB Technologies Inc. 124
3M Co. 73
Video Data Systems 16

BEI Beston Electronics, Inc.
 The BTX Corp.
 Chyron Telesystems
 Datatron, Inc.
 Dynasciences Div. Whittaker Corp.
 EECO Inc.
 EEG Enterprises, Inc.
 Gray Engineering Labs
 Harris Corp. Broadcast Products Div.
 Interand Corp. Telestrator Div.
 International Communications & Control Corp.
 Kaitronics Corp.
 Knox Video Products
 Laird Telemedia Inc.
 MPB Technologies Inc.
 MSI Television
 Motorola Semiconductor Products Inc.
 Panasonic Company
 Portac Inc.
 QSI Systems, Inc.
 SPI-ITT Metrix Instruments Div.
 Shintron Co. Inc.
 System Concepts Inc.
 Tektronix Inc.
 Telemation, A Div. of Bell & Howell
 Thomson-CSF Laboratories, Inc.
 3M Co. Mincom Div.
 Time Tech Corp.
 Unitel
 Video Data Systems
 Video Devices Co.
 Weathermation, Inc.

Character Generators, Wire Service Memory System

See Adv. Page
Video Data Systems 16

BEI Beston Electronics, Inc.
 MSI Television
 Unitel
 Video Data Systems

Choppers

Tektronix Inc.
 Townsend Associates, Inc.

Chroma Key Background Movement Devices

Marconi Communication Systems Ltd.
 NEC America, Inc. Broadcast Equip. Div.
 Power-Optics Inc.

Chroma Keyer-Decoders

Broadcast Video Systems, Ltd.
 Central Dynamics Corp.
 Dynasciences Div. Whittaker Corp.
 Grass Valley Group, Inc.
 Industrial Sciences, Inc. (ISI)
 International Nuclear Corp.
 Lenco Inc. Electronics Div.
 Marconi Communication Systems Ltd.
 Siegel Electronics
 Telemet A Geotel Co.

Chroma Keyers

See Adv. Page
Crosspoint Latch Corp. 98
Vital Industries Inc. BC

American Data Corp. A North American Philips Co.
 Broadcast Video Systems, Ltd.
 Central Dynamics Corp.
 Computer Image Video Controllers
 Dytex Industries, Inc.
 Corning Glass Works
 Crosspoint Latch Corp.
 Dynasciences Div. Whittaker Corp.
 Glentronix Ltd.
 Grass Valley Group, Inc.
 Ikegami Electronics (USA) Inc.
 Industrial Sciences, Inc. (ISI)
 International Nuclear Corp.
 Marconi Communication Systems Ltd.
 Panasonic Company
 Panasonic Co. Video Systems Div.
 RCA Broadcast Systems
 Shintron Co. Inc.
 Telemet A Geotel Co.
 Thomson-CSF Laboratories, Inc.
 3M Co. Mincom Div.
 Vital Industries Inc.

Clamps, Equipment Mounting

Packaged Lighting Systems
 Suda Seisakusho Co., Ltd.

Cleaner, Circuit Board

G C Electronics Div. Wallace Murray
 Miller-Stephenson Chemical Co., Inc.

Cleaner, Magnetic Tape Head

See Adv. Page
N.O.V.A. Corp. 160

Ampex Corp.
 Audio Magnetics Corp.
 Broadcast Electronics, Inc.
 Comprehensive Video Supply Corp.
 Fidelipac
 G C Electronics Div. Wallace Murray
 Memorex Corp. Professional Products Group
 Miller-Stephenson Chemical Co., Inc.
 N.O.V.A. Corp.
 Nortronics Co., Inc. Recorder Care Div.
 Pentagon Industries, Inc.
 RMC-Radio Mfg. Co.
 Sono-Mag Corp.
 Studer Revox America
 TEAC Corp of America
 Telectro Systems Corp.
 3M Co. Magnetic Audio/Video Prod. Div.
 United Recording Electronics Industries

Clocks and Chronographs

See Adv. Page
Beaveronics, Inc. 61
ESE 123

Beaveronics, Inc.
 Broadcast Electronics, Inc.
 ESE
 Glentronix Ltd.
 Harris Corp. Broadcast Products Div.
 Harwood Mfg. Co. Subs. Elgin Nat'l. Industries, Inc.
 Heath Co.
 Leitch Video Ltd.
 Singer Products Co., Inc.
 Sono-Mag Corp.
 Soundscriber Magnetic Recording Co., Inc.
 Telectro Systems Corp.
 Torpey Controls & Engineering Ltd.
 Vamco Engineering

Clocks, Digital and Digital Driver

See Adv. Page
ESE 123

Applied Video Electronics, Inc.
 Automated Broadcast Controls
 Beaveronics, Inc.
 Boston Sound & Power Systems
 Broadcast Aids, Inc.
 Broadcast Electronics, Inc.
 Cetec Broadcast Group
 Channelmatic, Inc.
 Datametrics Inc.
 Datatron, Inc.
 EECO Inc.
 ESE
 Glentronix Ltd.
 Harris Corp. Broadcast Products Div.
 Heath Co.
 Kaitronics Corp.
 Leitch Video Ltd.
 Logitek Electronic Systems, Inc.
 Motorola Semiconductor Products Inc.
 Nationwide Electronic Systems, Inc.
 OPCA
 PWH Electronics
 Pacific Recorders and Engrg. Corp.
 QRK Electronic Products
 QSI Systems, Inc.
 RMC-Radio Mfg. Co.
 Ramko Research Inc.
 Singer Products Co., Inc.
 Systron-Donner
 Telectro Systems Corp.
 Torpey Controls & Engineering Ltd.
 Vamco Engineering
 Video Devices Co.

Clocks, Station Master Control

See Adv. Page
Beaveronics, Inc. 61
ESE 153

Beaveronics, Inc.
 Channelmatic, Inc.
 Datametrics Inc.
 ESE
 Glentronix Ltd.
 Harris Corp. Broadcast Products Div.
 Kaitronics Corp.
 Leitch Video Ltd.
 Nationwide Electronic Systems, Inc.
 PWH Electronics
 QSI Systems, Inc.
 RMC-Radio Mfg. Co.
 Singer Products Co., Inc.
 Sono-Mag Corp.
 Torpey Controls & Engineering Ltd.
 Video Devices Co.

Collimeters

Ramko Research Inc.

Color Correction Equipment

See Adv. Page
Microtime, Inc. 13

Ampex Corp.
Belden Communications, Inc.
Bosch-Fernseh Corp.
Datatek Corp.
Glentronix Ltd.
Harris Corp. Broadcast Products Div.
Ikegami Electronics (USA) Inc.
Marconi Communication Systems Ltd.
Marconi Electronics Inc. Broadcast & Communication Div.
Microtime, Inc.
Photo Research Div. of Kollmorgen Corp.
Power-Optics Inc.
Siegel Electronics
Tektronix Inc.
Telemation, A Div. of Bell & Howell
Television Equipment Associates
Thomson-CSF Laboratories, Inc.

Colorizers --See Generators, Special Effect

Combiners, Power

See Adv. Page

C. S. P. Inc.144
Geleco Electronics Ltd......170

C. S. P. Inc.
Cetec Broadcast Group
Collins Div. Rockwell International
Comark Industries Inc.
Continental Electronics Mfg. Co.
Dielectric Communications A Unit of General Signal
Electro Impulse, Inc.
Geleco Electronics Ltd.
Harris Corp. Broadcast Products Div.
Micro Communications, Inc.
Mu-Del Electronics, Inc.
The Narda Microwave Corporation
North Hills Electronics, Inc.
Shively Laboratories, Inc.

Common Point Bridges --See Bridges, Common Point

Communication Systems, Land Mobile

See Adv. Page

The Gerstenslager Co. 56

AILTECH Div. Cutler-Hammer Los Angeles Operation
Atlantic Research Corp.
Bayly Engineering Ltd. Member of AEG-Telefunken Group
CCA Electronics Corp.
Centro Corp.
DYMA Engineering, Inc.
The Gerstenslager Co.
Harris Corp. Broadcast Products Div.
International Microwave Corp.
Marconi Communication Systems Ltd.
Marconi Electronics Inc. Broadcast & Communication Div.
Motorola Communications and Electronics Inc.
Motorola Communications and Electronics Inc.
Multiplier Industries Corp.
Panasonic Company
Paso Sound Products Inc.
Phelps Dodge Communications Co.
RCA Broadcast Systems
Singer Products Co., Inc.
Superex Electronics Corp.
Tri-Ex Tower Corp.

Communication Systems, Microwave

Anderson Scientific
Atlantic Research Corp.
Avantek, Inc.
CCA Electronics Corp.
Cablewave Systems Inc.
California Microwave
Coastcom
Collins Div. Rockwell International
Comark Industries Inc.
Comsearch, Inc.

DYMA Engineering, Inc.
GTE Lenkurt, Inc.
Gabriel Electronics, Inc.
Granger Associates
Harris Corp. Broadcast Products Div.
Hughes Aircraft Co. Microwave Communications Products
Ikegami Electronics (USA) Inc.
International Microwave Corp.
Marconi Communication Systems Ltd.
Micro Control Associates, Inc.
Microflect Co., Inc.
Moseley Associates, Inc.
Motorola Communications and Electronics Inc.
Motorola Communications and Electronics Inc.
NEC America, Inc. Broadcast Equip. Div.
Nurad, Inc.
RHG Electronics Laboratory, Inc.
Singer Products Co., Inc.
Tepeco Corp.
TerraCom Loral Corp.
Tri-Ex Tower Corp.
Varian Associates, Inc. Electron Device Group
Varian/Beverly Micro-Link Products

Communication Systems, Multiplex

See Adv. Page

IGM171

Atlantic Research Corp.
Bayly Engineering Ltd. Member of AEG-Telefunken Group
Catal Div. United Scientific Corp.
Coastcom
Collins Div. Rockwell International
Farinon Video
GTE Lenkurt, Inc.
Granger Associates
IGM Div. of Northwestern Tech.
International Microwave Corp.
Kaitronics Corp.
Marconi Communication Systems Ltd.
Marconi Electronics Inc. Broadcast & Communication Div.
Moseley Associates, Inc.
Motorola Communications and Electronics Inc.
The Ken Schaffer Group, Inc.
Singer Products Co., Inc.
Telegen/Sofratev
TerraCom Loral Corp.
Times Fiber Communications, Inc.

Communication Systems, STL

Bayly Engineering Ltd. Member of AEG-Telefunken Group
CCA Electronics Corp.
Cablewave Systems Inc.
Cetec Broadcast Group
Coastcom
Comark Industries Inc.
Comsearch, Inc.
Custom Audio Electronics
DYMA Engineering, Inc.
Farinon Video
GTE Lenkurt, Inc.
Harris Corp. Broadcast Products Div.
Hughes Aircraft Co. Microwave Communications Products
International Microwave Corp.
Marti Electronics
Micro Control Associates, Inc.
Moseley Associates, Inc.
NEC America, Inc. Broadcast Equip. Div.
Nurad, Inc.
RHG Electronics Laboratory, Inc.
Radiation Devices Co., Inc.
Singer Products Co., Inc.
Tepeco Corp.
TerraCom Loral Corp.
Varian/Beverly Micro-Link Products

Communication Systems, Teleprinter

GTE Lenkurt, Inc.
Moseley Associates, Inc.

Comparators, Video

Leitch Video Ltd.
Television Equipment Associates

Compensators, Dropout

See Adv. Page

Microtime, Inc. 13

Digital Video Systems
Merlin Engineering Works, Inc.
Microtime, Inc.
RCA Broadcast Systems
3M Co. Mincom Div.

Connectors, Cable

See Adv. Page

Cambridge Products157
Switchcraft Inc. 15
Telectric Co.160
Trompeter Electronics 66

AMP Special Industries
AVA Electronics
Bayly Engineering Ltd. Member of AEG-Telefunken Group
Blonder-Tongue Labs.
Boston Insulated Wire & Cable Co.
CCA Electronics Corp.
Cambridge Products
Ercona Corp.
The Finney Co.
G C Electronics Div. Wallace Murray
Harris Corp. Broadcast Products Div.
ITT Cannon Electric
Javelin Electronics
Jerrold Electronics Corp.
Magnavox CATV Systems, Inc.
Marshall Electronics
Maury Microwave Corp.
Micro Communications, Inc.
Neutrik
Paladin Corp.
Phelps Dodge Communications Co.
Rex Rheostat & Co., Inc.
Sono-Mag Corp.
Switchcraft Inc.
Tektronix Inc.
Telectric Co.
Times Wire and Cable
Trompeter Electronics
Union Connector Co., Inc.
Whirlwind Audio
Whirlwind Music

Consoles, Audio AM

See Adv. Page

Audio Designs & Mfg. 57
DYMA Engineering, Inc.146
LPB Inc. 32
Logitek Electronic Systems, Inc.125
Micro-Trak Corp.177
Quantum Audio Labs, Inc.179
Ramko Research Inc. 28-29
Tangent Systems, Inc.136
Wilkinson Electronics, Inc.172

Amco Engineering Co.
Ampro Broadcasting
Audio Designs & Mfg.
Audio Interface, Inc.
Auditronics, Inc.
Autogram Corp.
Automated Processes, Inc.
Broadcast Audio Associates
Broadcast Electronics, Inc.
Bud Industries, Inc.
Cetec Audio
Cetec Broadcast Group
Collins Div. Rockwell International
Communications Int'l.
Contel Mfg.
Custom Audio Electronics
DYMA Engineering, Inc.
Harris Corp. Broadcast Products Div.
Howe Audio Productions, Inc.

Integrated Solid Systems Inc. GLI Brand
International Communications & Control Corp.
LPB Inc.
Logitek Electronic Systems, Inc.
McCurdy Radio Ind. Inc.
McMartin Industries, Inc.
Micro-Trak Corp.
Modular Audio Products Unit of Modular Devices, Inc.
Rupert Neve, Inc.
Opamp Labs, Inc.
Pacific Recorders and Engrg. Corp.
Protech Audio Corp.
QRK Electronic Products
Quad-Eight Electronics
Quantum Audio Labs, Inc.
RCA Broadcast Systems
Ramko Research Inc.
Richmond Sound Design, Ltd.
Russco Electronics Mfg. Inc.
Singer Products Co., Inc.
Sontec Electronics
Spectra Sonics
Sphere Electronics
Studer Revox America
Tangent Systems, Inc.
Track Audio, Inc. (TA)
Tweed Audio USA Inc.
UMC Electronics Co. Broadcast Products Div.
United Recording Electronics Industries
Ward-Beck Systems, Ltd.
Wilkinson Electronics, Inc.
Yamaha International Corp.

Consoles, Audio FM

See Adv. Page

Audio Designs & Mfg. 57
Auditronics, Inc. 91
DYMA Engineering, Inc.146
LPB Inc. 32
Logitek Electronic Systems, Inc.125
Micro-Trak Corp.177
Ramko Research Inc. 28-29
Tangent Systems, Inc.136

Amco Engineering Co.
Ampro Broadcasting
Audio Designs & Mfg.
Audio Interface, Inc.
Auditronics, Inc.
Autogram Corp.
Automated Processes, Inc.
Broadcast Audio Associates
Broadcast Electronics, Inc.
Bud Industries, Inc.
Cetec Audio
Cetec Broadcast Group
Collins Div. Rockwell International
Communications Int'l.
Contel Mfg.
Custom Audio Electronics
DYMA Engineering, Inc.
Harris Corp. Broadcast Products Div.
Holland Electronics
Howe Audio Productions, Inc.
Integrated Solid Systems Inc. GLI Brand
International Communications & Control Corp.
LPB Inc.
Logitek Electronic Systems, Inc.
McCurdy Radio Ind. Inc.
McMartin Industries, Inc.
Micro-Trak Corp.
Modular Audio Products Unit of Modular Devices, Inc.
Rupert Neve, Inc.
Opamp Labs, Inc.
Pacific Recorders and Engrg. Corp.
Protech Audio Corp.
QRK Electronic Products
Quad-Eight Electronics
Quantum Audio Labs, Inc.
RCA Broadcast Systems
Ramko Research Inc.
Richmond Sound Design, Ltd.
Russco Electronics Mfg. Inc.
Singer Products Co., Inc.
Sontec Electronics

Spectra Sonics
 Sphere Electronics
 Studer Revox America
 Tangent Systems, Inc.
 Track Audio, Inc. (TA)
 Tweed Audio USA Inc.
 UMC Electronics Co. Broadcast Products Div.
 United Recording Electronics Industries
 Ward-Beck Systems, Ltd.
 Wilkinson Electronics, Inc.
 Yamaha International Corp.

Consoles, Audio Portable

See Adv. Page

Audio Designs & Mfg. 57
DYMA Engineering, Inc. 146
LPB Inc. 32
Ramko Research Inc. 28-29
Sigma System Engineering.....154

AVAB America Inc.
 Altec Lansing Sound Products
 Amco Engineering Co.
 Audio Designs & Mfg.
 Auditronics, Inc.
 Automated Processes, Inc.
 BSC Inc.
 BSM Systems
 Bayly Engineering Ltd. Member of AEG-Telefunken Group
 Boston Sound & Power Systems
 Broadcast Audio Associates
 Broadcast Electronics, Inc.
 Bud Industries, Inc.
 Central Dynamics Corp.
 Cetec Broadcast Group
 Coherent Communications Communications Int'l.
 Custom Audio Electronics
 DYMA Engineering, Inc.
 Hallikainen & Friends, Inc.
 Harris Corp. Broadcast Products Div.
 Industrial Sciences, Inc. (ISI)
 Integrated Solid Systems Inc. GLI Brand
 International Communications & Control Corp.
 LPB Inc.
 Roger Mayer Electronics, Inc.
 McCurdy Radio Ind. Inc.
 McMartin Industries, Inc.
 Micro-Trak Corp.
 Moseley Associates, Inc.
 Rupert Neve, Inc.
 Opamp Labs, Inc.
 Protech Audio Corp.
 QRK Electronic Products
 Quad-Eight Electronics
 Quantum Audio Labs, Inc.
 RCA Broadcast Systems
 Ramko Research Inc.
 Richmond Sound Design, Ltd.
 Russco Electronics Mfg. Inc.
 Sigma System Engineering
 Singer Products Co., Inc.
 Sontec Electronics
 Special Instruments Lab, Inc. Portasound Div.
 Spectra Sonics
 Sphere Electronics
 Studer Revox America
 TEAC Corp of America
 Theatre Techniques Inc.
 Track Audio, Inc. (TA)
 Tweed Audio USA Inc.
 Ultra Audio Pixtec
 Ward-Beck Systems, Ltd.
 Yamaha International Corp.

Consoles, Audio Recording

See Adv. Page

Audio Designs & Mfg. 57
Auditronics, Inc. 91
DYMA Engineering, Inc. 146
LPB Inc. 32
Logitek Electronic Systems, Inc. 125

Micro-Trak Corp. 177

AVAB America Inc.
 Altec Lansing Sound Products
 Amco Engineering Co.
 Audio Designs & Mfg.
 Audio Interface, Inc.
 Auditronics, Inc.
 Autogram Corp.
 Automated Processes, Inc.
 BSC Inc.
 Broadcast Audio Associates
 Broadcast Electronics, Inc.
 Bud Industries, Inc.
 Cetec Audio
 Cetec Broadcast Group
 Coherent Communications
 Collins Div. Rockwell International
 Communications Int'l.
 Custom Audio Electronics
 DYMA Engineering, Inc.
 Harris Corp. Broadcast Products Div.
 Holland Electronics
 Integrated Solid Systems Inc. GLI Brand
 International Communications & Control Corp.
 LPB Inc.
 Logitek Electronic Systems, Inc.
 MCI, Inc.
 Magna-Tech Electronic Co., Inc.
 Roger Mayer Electronics, Inc.
 McCurdy Radio Ind. Inc.
 McMartin Industries, Inc.
 Micro-Trak Corp.
 Modular Audio Products Unit of Modular Devices, Inc.
 Rupert Neve, Inc.
 Opamp Labs, Inc.
 Pacific Recorders and Engrg. Corp.
 Protech Audio Corp.
 Quad-Eight Electronics
 Quantum Audio Labs, Inc.
 RCA Broadcast Systems
 Richmond Sound Design, Ltd.
 Singer Products Co., Inc.
 Sontec Electronics
 Spectra Sonics
 Sphere Electronics
 Studer Revox America
 TEAC Corp of America
 Tweed Audio USA Inc.
 UMC Electronics Co. Broadcast Products Div.
 Ward-Beck Systems, Ltd.
 Yamaha International Corp.

Consoles, Audio TV

See Adv. Page

Audio Designs & Mfg. 57
Auditronics, Inc. 91
DYMA Engineering, Inc. 146
LPB Inc. 32
Logitek Electronic Systems, Inc. 125
Micro-Trak Corp. 177
Ramko Research Inc. 28-29
Tangent Systems, Inc. 136

Amco Engineering Co.
 Ampro Broadcasting
 Audio Designs & Mfg.
 Auditronics, Inc.
 Autogram Corp.
 Automated Processes, Inc.
 BSC Inc.
 Broadcast Audio Associates
 Broadcast Electronics, Inc.
 Bud Industries, Inc.
 Central Dynamics Corp.
 Cetec Audio
 Cetec Broadcast Group
 Communications Int'l.
 DYMA Engineering, Inc.
 Dytek Industries, Inc.
 Glentronix Ltd.
 Hallikainen & Friends, Inc.
 Harris Corp. Broadcast Products Div.
 Holland Electronics
 Howe Audio Productions, Inc.
 Industrial Sciences, Inc. (ISI)
 International Communications & Control Corp.
 International Nuclear Corp.

J&D International, Elec. Div. Unit E-East
 LPB Inc.
 Logitek Electronic Systems, Inc.
 MCI, Inc.
 Marconi Electronics Inc. Broadcast & Communication Div.
 McCurdy Radio Ind. Inc.
 McMartin Industries, Inc.
 Micro-Trak Corp.
 Modular Audio Products Unit of Modular Devices, Inc.
 Rupert Neve, Inc.
 Opamp Labs, Inc.
 Pacific Recorders and Engrg. Corp.
 Protech Audio Corp.
 QRK Electronic Products
 Quad-Eight Electronics
 Quantum Audio Labs, Inc.
 RCA Broadcast Systems
 Ramko Research Inc.
 Richmond Sound Design, Ltd.
 Singer Products Co., Inc.
 Sontec Electronics
 Spectra Sonics
 Sphere Electronics
 Tangent Systems, Inc.
 Tweed Audio USA Inc.
 UMC Electronics Co. Broadcast Products Div.
 Ultra Audio Pixtec
 United Recording Electronics Industries
 Ward-Beck Systems, Ltd.
 Yamaha International Corp.

Consoles, Routing --See Switchers, Routing

Consoles, Stereo

See Adv. Page

Audio Designs & Mfg. 57
Auditronics, Inc. 91
DYMA Engineering, Inc. 146
LPB Inc. 32
Logitek Electronic Systems, Inc. 125
Micro-Trak Corp. 177
Ramko Research Inc. 28-29
Wilkinson Electronics, Inc. 172

Altec Lansing Sound Products
 Ampro Broadcasting
 Audio Designs & Mfg.
 Audio Interface, Inc.
 Auditronics, Inc.
 Autogram Corp.
 Automated Processes, Inc.
 BSC Inc.
 Broadcast Audio Associates
 Broadcast Electronics, Inc.
 Bud Industries, Inc.
 Cetec Audio
 Cetec Broadcast Group
 Coherent Communications
 Collins Div. Rockwell International
 Custom Audio Electronics
 DYMA Engineering, Inc.
 Electrohome Ltd.
 Harris Corp. Broadcast Products Div.
 Howe Audio Productions, Inc.
 Integrated Solid Systems Inc. GLI Brand
 International Communications & Control Corp.
 LPB Inc.
 Logitek Electronic Systems, Inc.
 MCI, Inc.
 McCurdy Radio Ind. Inc.
 McMartin Industries, Inc.
 Micro-Trak Corp.
 Modular Audio Products Unit of Modular Devices, Inc.
 Rupert Neve, Inc.
 Opamp Labs, Inc.
 Pacific Recorders and Engrg. Corp.
 Protech Audio Corp.
 QRK Electronic Products
 Quad-Eight Electronics
 Quantum Audio Labs, Inc.
 RCA Broadcast Systems
 Ramko Research Inc.

Richmond Sound Design, Ltd.
 Russco Electronics Mfg. Inc.
 Singer Products Co., Inc.
 Spectra Sonics
 Sphere Electronics
 Studer Revox America
 Track Audio, Inc. (TA)
 Tweed Audio USA Inc.
 UMC Electronics Co. Broadcast Products Div.
 United Recording Electronics Industries
 Ward-Beck Systems, Ltd.
 Wilkinson Electronics, Inc.

Consoles, Video Portable

See Adv. Page

Beaveronics, Inc. 61
Crosspoint Latch Corp. 98
DYMA Engineering, Inc. 146

Adcom Communications Inc.
 Amco Engineering Co.
 American Data Corp. A North American Philips Co.
 Beaveronics, Inc.
 Broadcast Audio Associates
 Broadcast Video Systems, Ltd.
 Bud Industries, Inc.
 Central Dynamics Corp.
 Centro Corp.
 Computer Image Video Controllers
 Dytek Industries, Inc.
 Crosspoint Latch Corp.
 DYMA Engineering, Inc.
 Dytek Industries, Inc.
 GBC Closed Circuit TV Corp.
 Ikegami Electronics (USA) Inc.
 Image Video Ltd.
 Industrial Sciences, Inc. (ISI)
 International Nuclear Corp.
 J&D International, Elec. Div. Unit E-East
 Merlin Engineering Works, Inc.
 RCA Broadcast Systems
 Ross Video Ltd.
 Sony Corp. of America
 Telemet A Geotel Co.
 Vital Industries Inc.
 Winsted Corp.

Consoles, Video Studio

See Adv. Page

Beaveronics, Inc. 61
Crosspoint Latch Corp. 98
DYMA Engineering, Inc. 146
Industrial Sciences, Inc. (ISI) 102, 104
Tangent Systems, Inc. 136
Vital Industries Inc. BC

Adcom Communications Inc.
 Amco Engineering Co.
 American Data Corp. A North American Philips Co.
 Beaveronics, Inc.
 Broadcast Audio Associates
 Broadcast Video Systems, Ltd.
 Bud Industries, Inc.
 Central Dynamics Corp.
 Centro Corp.
 Computer Image Video Controllers
 Dytek Industries, Inc.
 Crosspoint Latch Corp.
 Dage-MTI, Inc.
 DYMA Engineering, Inc.
 Dytek Industries, Inc.
 GBC Closed Circuit TV Corp.
 Glentronix Ltd.
 Grass Valley Group, Inc.
 Ikegami Electronics (USA) Inc.
 Image Video Ltd.
 Industrial Sciences, Inc. (ISI)
 International Nuclear Corp.
 J&D International, Elec. Div. Unit E-East
 Laird Telemedia Inc.
 Marconi Electronics Inc. Broadcast & Communication Div.
 Merlin Engineering Works, Inc.
 Panasonic Company
 RCA Broadcast Systems

Ross Video Ltd.
Sony Corp. of America
Tangent Systems, Inc.
Vital Industries Inc.
Winsted Corp.

**Controllers, Equipment, Network
Tone Activated**

See Adv. Page

Kaitronics Corp. 12

Cetec Broadcast Group
Channelmatic, Inc.
IGM Div. of Northwestern Tech.
Kaitronics Corp.

Converters, A/D and D/A

Computer Labs Div. of Analog
Devices, Inc.
Digital Video Systems
Micro Consultants
Motorola Semiconductor Products Inc.
Tektronix Inc.

Converters, Frequency

ALTECH Div. Cutler-Hammer Los
Angeles Operation
California Instruments
California Microwave
Catel Div. United Scientific Corp.
The Finney Co.
Marconi Electronics Inc. Broadcast &
Communication Div.
Motorola Semiconductor Products Inc.
Mu-Del Electronics, Inc.
North Hills Electronics, Inc.
Oak Industries, Inc.
Phillips Test & Measuring Instruments,
Inc.
RHG Electronics Laboratory, Inc.
Telemet A Geotel Co.
Triple Crown Electronics, Inc.
Varian Associates, Inc. Electron Device
Group

**Converters, Phase --See Phase
Converters, Single to Three-
Phase**

Counter-Timers

See Adv. Page

Broadcast Aids, Inc. 179

ESE 123

**Logitek Electronic
Systems, Inc. 125**

Audico, Ltd.
Broadcast Aids, Inc.
Broadcast Electronics, Inc.
Data Precision Corp.
EIP Microwave
ESE
John Fluke Mfg. Co., Inc.
Glentronix Ltd.
Gotham Audio Corp.
Harris Corp. Broadcast Products Div.
Hickok Elec. Inst. Co.
Kaitronics Corp.
Laird Telemedia Inc.
Lectrotech Inc.
Logitek Electronic Systems, Inc.
Motorola Semiconductor Products Inc.
Nationwide Electronic Systems, Inc.
PWH Electronics
Pacific Recorders and Engrg. Corp.
Phillips Test & Measuring Instruments,
Inc.
QRK Electronic Products
QSI Systems, Inc.
Ramko Research Inc.
Sharepoint Systems Inc.
Systron-Donner
Tektronix Inc.
Track Audio, Inc. (TA)
United Systems Corp.
Vamco Engineering

Counters, Frequency

B & K Precision Dynascan Corp.

Continental Specialties Corp.
Data Precision Corp.
EIP Microwave
Elcom Engineering Co.
John Fluke Mfg. Co., Inc.
Harris Corp. Broadcast Products Div.
Heath Co.
Hickok Elec. Inst. Co.
Motorola Communications and
Electronics Inc.
Nationwide Electronic Systems, Inc.
Phillips Test & Measuring Instruments,
Inc.
Scientific-Atlanta, Inc.
Sencore Inc.
Soar Electronics
Tektronix Inc.
Telecommunications Technology
United Systems Corp.

Couplers, Hybrid

Comark Industries Inc.
Electro Impulse, Inc.
Harris Corp. Broadcast Products Div.
Maury Microwave Corp.
Micro Communications, Inc.
Monroe Electronics, Inc.
The Narda Microwave Corporation
North Hills Electronics, Inc.
Shively Laboratories, Inc.
Varian Associates, Inc. Electron Device
Group
Wide Band Engineering Co., Inc.

Crystals, Quartz

Eidson Electronic Co.
Harris Corp. Broadcast Products Div.
Marconi Communication Systems Ltd.
Motorola Communications and
Electronics Inc.
Motorola Semiconductor Products Inc.

Custom Control Systems

A. F. Associates, Inc.
American Data Corp. A North
American Philips Co.
Bayly Engineering Ltd. Member of
AEG-Telefunken Group
Don Britton Enterprises
C. S. P. Inc.
Central Dynamics Corp.
Cetec Broadcast Group
Custom Audio Electronics
Dytek Industries, Inc.
Grass Valley Group, Inc.
Holland Electronics
IGM Div. of Northwestern Tech.
Image Video Ltd.
Industrial Sciences, Inc. (ISI)
Micro-Trak Corp.
Rupert Neve, Inc.
Orange County Electronics Int'l., Inc.
PWH Electronics
Protech Audio Corp.
Quad-Eight Electronics
ROH Corporation
Richmond Sound Design, Ltd.
The Ken Schaffer Group, Inc.
Sharepoint Systems Inc.
Soll, Inc.
Vamco Engineering
Video Specialties

Cyclorama, Studio Drapery

Automatic Devices Co.
Walter S. Brewer Co., Inc.
Janson Industries

**Data Receivers --See Receivers,
Data**

Data Transmitters

Boston Sound & Power Systems
Coastcom
Marconi Communication Systems Ltd.
Nationwide Electronic Systems, Inc.
Radiation Devices Co., Inc.
Telectro Systems Corp.
Times Fiber Communications, Inc.
Varian Associates, Inc. Electron Device
Group

Decoders, Digital Sync

Central Dynamics Corp.
Digital Video Systems
Lenco Inc. Electronics Div.
QSI Systems, Inc.
Telegen/Sofratev

Decoders, Four Channel Stereo

Motorola Semiconductor Products Inc.
Sansui Electronics Corp.

Decoders, Tone

Ampro Broadcasting
Bayly Engineering Ltd. Member of
AEG-Telefunken Group
Cetec Vega
Channelmatic, Inc.
Di-Tech Inc.
Frequency Devices Inc.
Gorman Redlich Mfg. Co.
IGM Div. of Northwestern Tech.
Monroe Electronics, Inc.
UMC Electronics Co. Broadcast
Products Div.

Decoders, Tone, EBS

Broadcast Electronics, Inc.
ESE
Elcom Engineering Co.
Gorman Redlich Mfg. Co.
International Nuclear Corp.
Logitek Electronic Systems, Inc.
Monroe Electronics, Inc.
Time & Frequency Tech., Inc.

Delay Cartridges, Audio

See Adv. Page

Fidelipac 121

Ampro Broadcasting
Broadcast Electronics, Inc.
Cetec Broadcast Group
Fidelipac
International Tapetronics Corp.
Wang Voice Comm. Inc.

Delay Lines

See Adv. Page

Allen Avionics 159

Microtime, Inc. 13

**Television Equipment
Associates..... 114**

Allen Avionics
Amperex Electronic Corp. Statersville
Div.
Anders, Inc.
Audio & Design Recording Inc.
Broadcast Video Systems, Ltd.
Cablewave Systems Inc.
Central Dynamics Corp.
Corning Glass Works
Dielectric Communications A Unit of
General Signal
EMT Franz VGmbH
ESC Electronics Corp.
Eventide Clock Works Inc.
Gotham Audio Corp.
Kappa Networks, Inc.
Leitch Video Ltd.
Marconi Communication Systems Ltd.
Maury Microwave Corp.
Microtime, Inc.
Neutrik
Pacific Recorders and Engrg. Corp.
Phelps Dodge Communications Co.
The Ken Schaffer Group, Inc.
Tektronix Inc.
Television Equipment Associates
Times Wire and Cable
United Recording Electronics
Industries
Wang Voice Comm. Inc.

Delay Lines, Audio, Digital

See Adv. Page

**Wang Voice Comm.
Inc. 50**

Altec Lansing Sound Products
Audio & Design Recording Inc.
Eventide Clock Works Inc.
Kappa Networks, Inc.
Pacific Recorders and Engrg. Corp.
Quad-Eight Electronics
The Ken Schaffer Group, Inc.
URSA Major, Inc.
United Recording Electronics
Industries
Wang Voice Comm. Inc.

Delay Measuring Sets, Envelope

See Adv. Page

**Television Equipment
Associates..... 114**

Asaca Corp. of America
Datatek Corp.
Dranetz Engineering Labs., Inc.
Ivie Electronics
Rohde & Schwarz Sales Co.
Tektronix Inc.
Telemet A Geotel Co.
Television Equipment Associates

Delay Units, Video

See Adv. Page

Allen Avionics 159

Lenco Inc. 95

Microtime, Inc. 13

**Television Equipment
Associates..... 114**

Allen Avionics
Anders, Inc.
Broadcast Video Systems, Ltd.
Central Dynamics Corp.
Corning Glass Works
ESC Electronics Corp.
Kappa Networks, Inc.
Leitch Video Ltd.
Lenco Inc. Electronics Div.
Microtime, Inc.
Telemation, A Div. of Bell & Howell
Television Equipment Associates

Demagnetizers, Bulk Tape

See Adv. Page

Garner Industries 158

**Taber Mfg. & Engr.
Co. 124**

**Wide Range
Electronics 66**

Audico, Ltd.
Broadcast Electronics, Inc.
Cetec Broadcast Group
Fidelipac
G C Electronics Div. Wallace Murray
Garner Industries
Glentronix Ltd.
Harris Corp. Broadcast Products Div.
International Tapetronics Corp.
Magnasync/Moviola Corp.
Magnesonic Mfg. & Sales Co.
Microtran Co., Inc.
Nortronics Co., Inc. Recorder Care Div.
Pentagon Industries, Inc.
Sonar Radio Corp.
Soundscriber Magnetic Recording Co.,
Inc.
TEAC Corp of America
Taber Mfg. & Engr. Co.
UMC Electronics Co. Broadcast
Products Div.
Wide Range Electronics

**Demagnetizers, Limited Area
Tape and Film**

See Adv. Page

R. B. Annis, Co. 150

Wide Range Electronics 66

R. B. Annis, Co.
Magnifax, Inc.
Magnesonics Mfg. & Sales Co.
Pentagon Industries, Inc.
Soundscriber Magnetic Recording Co., Inc.
Wide Range Electronics

Demodulators, Optical

Crosspoint Latch Corp.
Radiation Devices Co., Inc.
Telemet A Geotel Co.
Times Fiber Communications, Inc.

Demodulators, Video

See Adv. Page

Dynair Electronics, Inc. 165

Anderson Scientific
Blonder-Tongue Labs.
Catel Div. United Scientific Corp.
Coastcom
Comark Industries Inc.
Dynair Electronics, Inc.
Electro & Optical Systems Ltd.
Glentronix Ltd.
Harris Corp. Broadcast Products Div.
Javelin Electronics
Jerold Electronics Corp.
Kahn Communications, Inc.
Marconi Instruments Div. of Marconi Electronics Inc.
Phasecom Corp.
Philips Test & Measuring Instruments, Inc.
QSI Systems, Inc.
Rohde & Schwarz Sales Co.
Scientific-Atlanta, Inc.
Tektronix Inc.
Telemet A Geotel Co.
Times Fiber Communications, Inc.
Townsend Associates, Inc.
Videotek, Inc.

Detectors, Microwave

AILTECH Div. Cutler-Hammer Los Angeles Operation
Alford Mfg. Co.
Dielectric Communications A Unit of General Signal
EEV Canada Ltd.
Harris Corp. PRD Electronics Div.
Maury Microwave Corp.
The Narda Microwave Corporation
Systron-Donner
Tektronix Inc.
Texscan Corp.
Weinschel Engineering Co.

Detectors, RF

See Adv. Page

Delta Electronics Inc. (Va.) 107
Potomac Instruments, Inc. 126

Alford Mfg. Co.
Bird Electronic Corp.
Blonder-Tongue Labs.
CCA Electronics Corp.
Comark Industries Inc.
Delta Electronics Inc. (Va.)
Dielectric Communications A Unit of General Signal
Harris Corp. Broadcast Products Div.
Harris Corp. PRD Electronics Div.
Heath Co.
Kaitronics Corp.
Maury Microwave Corp.
Micro Communications, Inc.
Moseley Associates, Inc.
The Narda Microwave Corporation
Potomac Instruments, Inc.
Systron-Donner
Tektronix Inc.
Telemet A Geotel Co.
Television Technology Corp.
Texscan Corp.

Townsend Associates, Inc.
Weinschel Engineering Co.
Wide Band Engineering Co., Inc.

Detectors, Standing Wave

See Adv. Page

Potomac Instruments, Inc. 126

Bird Electronic Corp.
Dielectric Communications A Unit of General Signal
Harris Corp. PRD Electronics Div.
Maury Microwave Corp.
Micro Communications, Inc.
Moseley Associates, Inc.
Potomac Instruments, Inc.
Rohde & Schwarz Sales Co.
Texscan Corp.
Weinschel Engineering Co.

Detectors, Transmitter Quadrature Distortion

Telemet A Geotel Co.

Detectors, Video Presence

Colorado Video Inc.
Comark Industries Inc.
Di-Tech Inc.
Javelin Electronics
Lenco Inc. Electronics Div.
Sharepoint Systems Inc.
Telemet A Geotel Co.

Diagnostic Systems, Digital Logic

Continental Specialties Corp.
Pinzone Communications Products Inc.
Sharepoint Systems Inc.

Differential Phase/Gain Measuring Sets

See Adv. Page

Potomac Instruments, Inc. 137

Datatek Corp.
Harris Corp. Broadcast Products Div.
Potomac Instruments, Inc.
Tektronix Inc.
Telemet A Geotel Co.

Digitizers, Color Video

BJA Systems, Inc.
Central Dynamics Corp.
Computer Labs Div. of Analog Devices, Inc.
Link Electronics Ltd.
Tektronix Inc.

Diplexers

See Adv. Page

C. S. P. Inc. 144

CCA Electronics Corp.
C. S. P. Inc.
Cetec Broadcast Group
Coastcom
Comark Industries Inc.
Continental Electronics Mfg. Co.
Dielectric Communications A Unit of General Signal
Harris Corp. Broadcast Products Div.
Laird Telemedia Inc.
Micro Communications, Inc.
Mu-Dei Electronics, Inc.
Multronics, Inc.
North Hills Electronics, Inc.
Nurad, Inc.
Phelps Dodge Communications Co.
SWR Inc.
Shively Laboratories, Inc.
UTE Microwave, Inc.
Varian Associates, Inc. Electron Device Group
Wide Band Engineering Co., Inc.
Wilkinson Electronics, Inc.

Discs, Video

See Adv. Page

Arvin/Echo Science Corp. 6-7

Ampex Corp.
Arvin/Echo Science Corp.
Chyron Telesystems
Computer Magnetics Corp.
Echo Science Corp.
Eigen Video
Glentronix Ltd.
Panasonic Company
Teknekron/ARG

Display Equipment, Titling

See Adv. Page

Chyron Telesystems 84
Gray Engineering Labs 21
Video Data Systems 16

BJA Systems, Inc.
Bretford Mfg. Co.
Chyron Telesystems
Gray Engineering Labs
Interand Corp. Telestrator Div.
Power-Optics Inc.
Reynolds/Leteron Co.
Tektronix Inc.
Telemation, A Div. of Bell & Howell
Thomson-CSF Laboratories, Inc.
3M Co. Mincom Div.
Video Data Systems

Display Units, Digital

See Adv. Page

The BTX Corp. 90
ESE 123
Kaitronics Corp. 12
Simplex Time Recorder Co. 88

Audiotronics Video Display Div.
BJA Systems, Inc.
B & K Precision Dynascan Corp.
The BTX Corp.
Cetec Broadcast Group
Cherry Electrical Products
Convergence Corp.
Delta Electronics Inc. (Va.)
EECO Inc.
EEV Canada Ltd.
ESE
G C Electronics Div. Wallace Murray
Ikegami Electronics (USA) Inc.
Javelin Electronics
Kaitronics Corp.
MPB Technologies Inc.
MSI Television
Moseley Associates, Inc.
Motorola Semiconductor Products Inc.
Nationwide Electronic Systems, Inc.
OPCOA
PWH Electronics
Pinzone Communications Products Inc.
QSI Systems, Inc.
RMC-Radio Mfg. Co.
Scientific-Atlanta, Inc.
Simplex Time Recorder Co.
TSC Development Labs.
Tektronix Inc.
Telegen/Sofratev
3M Co. Mincom Div.
Vamco Engineering
Video Data Systems

Display Units, Time-Temperature-ID

See Adv. Page

ESE 153

Boston Sound & Power Systems
ESE
IGM Div. of Northwestern Tech.
Javelin Electronics
Laird Telemedia Inc.
MSI Television
Nationwide Electronic Systems, Inc.
OPCOA

PWH Electronics
RMC-Radio Mfg. Co.
3M Co. Mincom Div.
Time & Frequency Tech., Inc.
Vamco Engineering
Video Data Systems

Dividers, Frequency

Maury Microwave Corp.
Motorola Semiconductor Products Inc.
RHG Electronics Laboratory, Inc.

Dividers, Power

See Adv. Page

Trompeter Electronics 66

Alford Mfg. Co.
Bird Electronic Corp.
COMPAC
Cetec Broadcast Group
Comark Industries Inc.
Dielectric Communications A Unit of General Signal
Harris Corp. Broadcast Products Div.
Harris Corp. PRD Electronics Div.
Micro Communications, Inc.
Moseley Associates, Inc.
Mu-Dei Electronics, Inc.
Multronics, Inc.
The Narda Microwave Corporation
North Hills Electronics, Inc.
Phelps Dodge Communications Co.
Scala Electronic Corp.
Shively Laboratories, Inc.
Tektronix Inc.
Trompeter Electronics
Weinschel Engineering Co.
Wide Band Engineering Co., Inc.

Dividers, Voltage

AILTECH Div. Cutler-Hammer Los Angeles Operation
John Fluke Mfg. Co., Inc.
ITT Jennings
Tech Laboratories Inc.

Earth Station Antennas --See Antennas, TV Earth Station

Earth Stations, Down Terminal

Anderson Scientific
California Microwave
Coastcom
Collins Div. Rockwell International
Comsearch, Inc.
Gardiner Communications Corp.
Harris Corp. Broadcast Products Div.
Hughes Aircraft Co. Microwave Communications Products
Microdyne Corp.
Moseley Associates, Inc.
NEC America, Inc. Broadcast Equip. Div.
Scientific-Atlanta, Inc.
TerraCom Lorral Corp.
Varian Associates, Inc. Electron Device Group
Varian/Beverly Micro-Link Products

Earth Stations, Up Terminal

California Microwave
Coastcom
Collins Div. Rockwell International
Compact Video Sales
Comsearch, Inc.
Gardiner Communications Corp.
Harris Corp. Broadcast Products Div.
Hughes Aircraft Co. Microwave Communications Products
Moseley Associates, Inc.
NEC America, Inc. Broadcast Equip. Div.
Scientific-Atlanta, Inc.
Varian Associates, Inc. Electron Device Group
Varian/Beverly Micro-Link Products

Edit Code Generators

See Adv. Page

The BTX Corp...... 90
Datametrics Inc......144
Gray Engineering Labs 21
Kaitronics Corp...... 12
Microtime, Inc. 13
Recortec Inc...... 5
Shintron Co. Inc. 40
Skotel Corp. 70

Automated Processes, Inc.
 The BTX Corp.
 CMX Systems & Videomax Div's. of Orrox Corp.
 Central Dynamics Corp.
 Datametrics Inc.
 Datatron, Inc.
 Dynasciences Div. Whittaker Corp.
 EECO Inc.
 Electro & Optical Systems Ltd.
 Glentronix Ltd.
 Gray Engineering Labs
 International Communications & Control Corp.
 Kaitronics Corp.
 Media Concepts, Inc.
 Microtime, Inc.
 Recortec Inc.
 Shintron Co. Inc.
 Skotel Corp.
 Time Tech Corp.

Edit Code Receivers

See Adv. Page

The BTX Corp...... 90
Datametrics Inc......144
Gray Engineering Labs 21
Kaitronics Corp...... 12
Microtime, Inc. 13
Skotel Corp. 70
United Media, Inc......174

The BTX Corp.
 CMX Systems & Videomax Div's. of Orrox Corp.
 Central Dynamics Corp.
 Datametrics Inc.
 Datatron, Inc.
 Dynasciences Div. Whittaker Corp.
 EECO Inc.
 ESE
 Electro & Optical Systems Ltd.
 Glentronix Ltd.
 Gray Engineering Labs
 International Communications & Control Corp.
 Kaitronics Corp.
 Microtime, Inc.
 QSI Systems, Inc.
 Skotel Corp.
 Time Tech Corp.
 United Media, Inc.

Editing Facilities

DYMA Engineering, Inc.
 KVC, Inc.
 Keeline Int'l.
 Lawhed, Ltd.
 Leedal, Inc.
 Sharepoint Systems Inc.

Editors, Audiotape

AEG-Telefunken Magnetic Tape Recorder Dept.
 Audico, Ltd.
 Automated Processes, Inc.
 The BTX Corp.
 Broadcast Electronics, Inc.
 CMX Systems & Videomax Div's. of Orrox Corp.
 Datatron, Inc.
 EECO Inc.
 Fidelipac
 Sharepoint Systems Inc.

Editors, Film

See Adv. Page

Kaitronics Corp...... 12

Alan Gordon Enterprises Inc.
 Kaitronics Corp.
 Kalart Victor Corp.
 Lipsner-Smith Corp.
 Magnasync/Moviola Corp.
 Neumade Products Corp.
 Research Technology, Inc.
 Super 8 Sound, Inc.

Editors, Videotape

See Adv. Page

Kaitronics Corp...... 12
Panasonic Co...... 49
Sony Corp. of America... 38-39
US JVC Corp...... 54-55
United Media, Inc......174
Videomedia..... 67

Ampex Corp.
 Audico, Ltd.
 CMX Systems & Videomax Div's. of Orrox Corp.
 Central Dynamics Corp.
 Computer Image Video Controllers
 Dytek Industries, Inc.
 Consolidated Video Systems
 Convergence Corp.
 Datatron, Inc.
 Dynasciences Div. Whittaker Corp.
 Dytek Industries, Inc.
 EECO Inc.
 E.M.S Inc.
 Electro & Optical Systems Ltd.
 Kaitronics Corp.
 Keeline Int'l.
 Lawhed, Ltd.
 Mach One Digital Systems, Inc.
 Nanotec
 Panasonic Company
 Panasonic Co. Video Systems Div.
 RCA Broadcast Systems
 Recortec Inc.
 Sony Corp. of America
 US JVC Corp. Professional Video Div.
 United Media, Inc.
 Vamco Engineering
 Video Associates Labs
 Video Devices Co.
 Videomedia

Educational Courses, Broadcasting/Electronics

Cleveland Institute of Elec., Inc.
 Heath Co.
 Motorola Semiconductor Products Inc.

Electronic Still Store

ADDA Corp.
 Ampex Corp.
 Consolidated Video Systems

Enclosures, Module Card Tray

Bayly Engineering Ltd. Member of AEG-Telefunken Group
 Monroe Electronics, Inc.
 Orange County Electronics Int'l., Inc.
 Protech Audio Corp.
 ROH Corporation
 Scientific-Atlanta, Inc.
 Vector Electronic Co., Inc.

Encoders, Color Video

See Adv. Page

Broadcast Video Systems, Ltd......148
Chyron Telesystems 84
Cohu, Inc...... 72
Crosspoint Latch Corp...... 98
Lenco Inc...... 95

Amtron Corp.
 Broadcast Video Systems, Ltd.
 Chyron Telesystems

Cohu, Inc. Electronics Div.
 Crosspoint Latch Corp.
 Glentronix Ltd.
 Harris Corp. Broadcast Products Div.
 Ikegami Electronics (USA) Inc.
 Lenco Inc. Electronics Div.
 MPB Technologies Inc.
 Marconi Electronics Inc. Broadcast & Communication Div.
 Philips Test & Measuring Instruments, Inc.
 Sony Corp. of America
 Telegen/Sofratev
 Telemation, A Div. of Bell & Howell
 3M Co. Mincom Div.

Encoders, Four Channel Stereo

See Adv. Page

Lenco Inc...... 95

Lenco Inc. Electronics Div.
 Sansui Electronics Corp.

Encoders, Tone

Bayly Engineering Ltd. Member of AEG-Telefunken Group
 Cetec Broadcast Group
 Cetec Vega
 Channelmatic, Inc.
 Di-Tech Inc.
 Frequency Devices Inc.
 Gorman Redlich Mfg. Co.
 IGM Div. of Northwestern Tech.
 Lampkin Lab. Inc.
 Monroe Electronics, Inc.
 UMC Electronics Co. Broadcast Products Div.

Encoder-Decoders, EBS

Automated Broadcast Controls
 ESE
 Elcom Engineering Co.
 Gorman Redlich Mfg. Co.
 Logitek Electronic Systems, Inc.
 QSI Systems, Inc.
 Time & Frequency Tech., Inc.

Enhancers, Stereo Phase

Cetec Broadcast Group
 Edco Products, Inc.

Enhancers, TV Image

See Adv. Page

Edutron, Inc...... 99
Microtime, Inc. 13
Piclear, Inc......175

Cohu, Inc. Electronics Div.
 Consolidated Video Systems
 Corning Glass Works
 Digital Video Systems
 Dynasciences Div. Whittaker Corp.
 Edutron, Inc.
 Yves Faroudja, Inc.
 Glentronix Ltd.
 Harris Corp. Broadcast Products Div.
 Microtime, Inc.
 Piclear, Inc.
 Siegel Electronics
 Telemet A Geotel Co.
 Thomson-CSF Laboratories, Inc.
 3M Co. Mincom Div.

Equalizers, Audio Emphasis

See Adv. Page

Orban Assoc. Inc. 31

AVAB America Inc.
 Altec Lansing Sound Products
 Audio & Design Recording Inc.
 Audio Designs & Mfg.
 Auditronics, Inc.
 Automated Processes, Inc.
 Bayly Engineering Ltd. Member of AEG-Telefunken Group
 Bell Audio Systems, Inc.
 Bogen Div. Lear Siegler, Inc.
 Cetec Broadcast Group

Crown International, Inc.
 Gotham Audio Corp.
 Heath Co.
 Holland Electronics
 ITI Electronics, Inc.
 Integrated Solid Systems Inc. GLI Brand
 International Electro-Magnetics
 Kahn Communications, Inc.
 Roger Mayer Electronics, Inc.
 McCurdy Radio Ind. Inc.
 Micro-Trak Corp.
 Modular Audio Products Unit of Modular Devices, Inc.
 Rupert Neve, Inc.
 Opamp Labs, Inc.
 Orange County Electronics Int'l., Inc.
 Orban Assoc. Inc.
 Panasonic Company
 Protech Audio Corp.
 Pulse Techniques Inc.
 Quad-Eight Electronics
 ROH Corporation
 Ramko Research Inc.
 Richmond Sound Design, Ltd.
 Sansui Electronics Corp.
 Sontec Electronics
 Spectra Sonics
 Spectrum Instruments, Inc.
 Sphere Electronics
 Superex Electronics Corp.
 TT Electronics, Inc.
 Technical Audio Products Corp.
 Tweed Audio USA Inc.
 United Recording Electronics Industries
 Wang Voice Comm. Inc.
 Ward-Beck Systems, Ltd.

Equalizers, Vertical Aperature

See Adv. Page

Microtime, Inc. 13

Corning Glass Works
 Dynasciences Div. Whittaker Corp.
 Microtime, Inc.
 Thomson-CSF Laboratories, Inc.

Equalizers, Video

See Adv. Page

Microtime, Inc. 13

Allen Avionics
 Broadcast Video Systems, Ltd.
 Central Dynamics Corp.
 Cohu, Inc. Electronics Div.
 Computer Magnetics Corp.
 Datatek Corp.
 Di-Tech Inc.
 Dynair Electronics, Inc.
 ESC Electronics Corp.
 Grass Valley Group, Inc.
 Industrial Sciences, Inc. (ISI)
 International Communications & Control Corp.
 International Nuclear Corp.
 Kappa Networks, Inc.
 Leitch Video Ltd.
 Lenco Inc. Electronics Div.
 Link Electronics Ltd.
 Merlin Engineering Works, Inc.
 Microtime, Inc.
 Telemet A Geotel Co.

Equipment, Reconditioned

See Adv. Page

A. F. Associates, Inc.180
Lines Video Systems..... 84

A. F. Associates, Inc.
 Autodyne
 Lines Video Systems
 Recortec Inc.

Erasers, Magnetic --See (1) Demagnetizers, Bulk Tape, and (2) Heads, Erase Magnetic

Exciters, AM

CCA Electronics Corp.

CSI Electronics, Inc.
Collins Div. Rockwell International
Continental Electronics Mfg. Co.
Harris Corp. Broadcast Products Div.
Kahn Communications, Inc.
Marconi Communication Systems Ltd.
Philips Test & Measuring Instruments, Inc.
RCA Broadcast Systems
Singer Products Co., Inc.
Sintronic Corp.
Wilkinson Electronics, Inc.

Exciters, FM

Bayly Engineering Ltd. Member of
AEG-Telefunken Group
CCA Electronics Corp.
CSI Electronics, Inc.
Cetec Broadcast Group
Collins Div. Rockwell International
Comark Communications Industries, Inc.
Harris Corp. Broadcast Products Div.
LPB Inc.
Marconi Communication Systems Ltd.
McMartin Industries, Inc.
NEC America, Inc. Broadcast Equip. Div.
QEI Corp.
RCA Broadcast Systems
Rohde & Schwarz Sales Co.
Singer Products Co., Inc.
Sintronic Corp.
Solid Electronics Labs
Versa Count Engineering
Wilkinson Electronics, Inc.

Exciters, SCA

CSI Electronics, Inc.
Cetec Broadcast Group
Collins Div. Rockwell International
Comark Communications Industries, Inc.
Harris Corp. Broadcast Products Div.
LPB Inc.
McMartin Industries, Inc.
Moseley Associates, Inc.
NEC America, Inc. Broadcast Equip. Div.
QEI Corp.
RCA Broadcast Systems
Sharepoint Systems Inc.
Solid Electronics Labs
Versa Count Engineering
Wilkinson Electronics, Inc.

Exciters, Stereo

CSI Electronics, Inc.
Cetec Broadcast Group
Collins Div. Rockwell International
Harris Corp. Broadcast Products Div.
Kahn Communications, Inc.
LPB Inc.
Marconi Communication Systems Ltd.
McMartin Industries, Inc.
Moseley Associates, Inc.
NEC America, Inc. Broadcast Equip. Div.
QEI Corp.
RCA Broadcast Systems
Solid Electronics Labs
Versa Count Engineering
Wilkinson Electronics, Inc.

Faders, Studio Lighting Control

See Adv. Page
Waters Mfg. Inc.139
Duncan Electronics, Inc.
Electro Controls
Kliegl Bros. Lighting
Skirpan Lighting Control Corp.
Theatre Techniques Inc.
Waters Mfg. Inc.

Film Cleaner/Conditioner Equipment

See Adv. Page
Piclear, Inc.175

Kinetronics Corp.
Lipsner-Smith Corp.
Neumade Products Corp.
Permafilm Int'l. Corp.
Piclear, Inc.
Plastic Reel Corp. of America
Research Technology, Inc.
Schuessler Case Co., Inc.

Film Inspection and Cleaning Equipment

Houston Photo Products, Inc.
Kinetronics Corp.
Lipsner-Smith Corp.
Neumade Products Corp.
Perf-Fix
Permafilm Int'l. Corp.
Plastic Reel Corp. of America
Research Technology, Inc.
Starex, Inc.

Film, Photographic

Agfa-Gevaert Inc.
Eastman Kodak Co.

Film Chain Light Level Controls

BEI Beston Electronics, Inc.
Cohu, Inc. Electronics Div.
Harris Corp. Broadcast Products Div.
Industrial Sciences, Inc. (ISI)
Laird Telemedia Inc.
The Zei-Mark Corp.

Film Chain Systems

See Adv. Page
Cohu, Inc.72

Bell & Howell Audio Visual Div.
Bosch-Fernseh Corp.
Buhl Optical Co.
CMX Systems & Videomax Div's. of
Orrox Corp.
Cohu, Inc. Electronics Div.
GBC Closed Circuit TV Corp.
Harris Corp. Broadcast Products Div.
Ikegami Electronics (USA) Inc.
Kalart Victor Corp.
Laird Telemedia Inc.
Marconi Communication Systems Ltd.
Marconi Electronics Inc. Broadcast & Communication Div.
Panasonic Company
Panasonic Co. Video Systems Div.
Philips Broadcast Equip Corp.
RCA Broadcast Systems
Sony Corp. of America
Telemation, A Div. of Bell & Howell
The Zei-Mark Corp.

Film Processing Chemicals, Color

Agfa-Gevaert Inc.
Eastman Kodak Co.
Philip A. Hunt Chemical Corp.

Film Processing Services

Bebell Inc.
Eastman Kodak Co.
Houston Photo Products, Inc.

Film Production, Videotape Transfer

See Adv. Page
Warren R. Smith Co.164

Keeline Int'l.
Warren R. Smith Co.

Film Sound Transfer Equipment

See Adv. Page
Dolby Laboratories, Inc.105
Dolby Laboratories, Inc.
Magna-Tech Electronic Co., Inc.
Orange County Electronics Int'l., Inc.
Quad-Eight Electronics

RCA Broadcast Systems
Super 8 Sound, Inc.
Wide Range Electronics

Filters, Active

See Adv. Page
Aitken Communications Inc.172

Aitken Communications Inc.
Amperex Electronic Corp. Slatersville Div.
Andersen Labs, Inc. Advanced Systems Div.
Audico, Ltd.
Audio & Design Recording Inc.
Comark Industries Inc.
Crown International, Inc.
Custom Audio Electronics
DYMA Engineering, Inc.
Frequency Devices Inc.
Gotham Audio Corp.
Kappa Networks, Inc.
Microprobe Electronics
North Hills Electronics, Inc.
Orange County Electronics Int'l., Inc.
Panasonic Company
Protech Audio Corp.
Pulse Techniques Inc.
ROH Corporation
Richmond Sound Design, Ltd.
Rockland Systems Corp.
Spectra Sonics
Spectrum Instruments, Inc.
TT Electronics, Inc.
Track Audio, Inc. (TA)
United Recording Electronics Industries
Varian Associates, Inc. Electron Device Group

Filters, Antenna

See Adv. Page
Allen Avionics159

Allen Avionics
Keith Anderson Co.
Bird Electronic Corp.
Cetec Broadcast Group
Collins Div. Rockwell International
Comark Industries Inc.
Continental Electronics Mfg. Co.
Dielectric Communications A Unit of General Signal
The Finney Co.
G C Electronics Div. Wallace Murray
Harris Corp. Broadcast Products Div.
Jerrold Electronics Corp.
Kappa Networks, Inc.
Merill Cable Equipment Corp.
Micro Communications, Inc.
Nurad, Inc.
Shively Laboratories, Inc.
TT Electronics, Inc.
Texscan Corp.
Varian/Beverly Micro-Link Products
Wide Band Engineering Co., Inc.

Filters, Audio

See Adv. Page
Aitken Communications Inc.172
Allen Avionics159
Pulse Techniques Inc.179

Aitken Communications Inc.
Allen Avionics
Altec Lansing Sound Products
Amber Electro Design, Ltd.
Audico, Ltd.
Audio & Design Recording Inc.
Automated Broadcast Controls
Automated Processes, Inc.
Bayly Engineering Ltd. Member of AEG-Telefunken Group
Cetec Broadcast Group
Coastcom
Comark Industries Inc.
Crown International, Inc.
Custom Audio Electronics
DYMA Engineering, Inc.
ESC Electronics Corp.

Frequency Devices Inc.
Gotham Audio Corp.
Harris Corp. Broadcast Products Div.
IGM Div. of Northwestern Tech.
Ivie Electronics
Jerrold Electronics Corp.
Kappa Networks, Inc.
Roger Mayer Electronics, Inc.
Microprobe Electronics
Monroe Electronics, Inc.
Rupert Neve, Inc.
Orange County Electronics Int'l., Inc.
Panasonic Company
Protech Audio Corp.
Pulse Techniques Inc.
QEI Corp.
Quad-Eight Electronics
RCA Broadcast Systems
ROH Corporation
Richmond Sound Design, Ltd.
Rockland Systems Corp.
Rohde & Schwarz Sales Co.
Sescom, Inc.
Sontec Electronics
Spectra Sonics
Spectrum Instruments, Inc.
TT Electronics, Inc.
Track Audio, Inc. (TA)
Tweed Audio USA Inc.
United Recording Electronics Industries

Filters, Microwave

UTE Microwave, Inc.

Filters, Noise

See Adv. Page
TT Electronics, Inc.178

Audio & Design Recording Inc.
Blonder-Tongue Labs.
Boston Sound & Power Systems
Comark Industries Inc.
EMT Franz VGmbH
The Finney Co.
Frequency Devices Inc.
G C Electronics Div. Wallace Murray
Gotham Audio Corp.
Kahn Communications, Inc.
Kappa Networks, Inc.
Roger Mayer Electronics, Inc.
Orange County Electronics Int'l., Inc.
Panasonic Company
Pulse Techniques Inc.
Quad-Eight Electronics
Spectra Sonics
TT Electronics, Inc.
Tektronix Inc.
Topaz Electronics

Filters, Passive

See Adv. Page
Allen Avionics159
Peter W. Dahl Co.175
Teletric Co.160
Television Equipment Associates.114

Allen Avionics
Andersen Labs, Inc. Advanced Systems Div.
Audio-Video Engineering Co.
Barker and Williamson, Inc.
Bayly Engineering Ltd. Member of AEG-Telefunken Group
Broadcast Video Systems, Ltd.
COMPAC
Coastcom
Comark Industries Inc.
Peter W. Dahl Co.
ESC Electronics Corp.
The Finney Co.
Frequency Devices Inc.
Kappa Networks, Inc.
Maury Microwave Corp.
Roger Mayer Electronics, Inc.
Merill Cable Equipment Corp.
Mu-Del Electronics, Inc.
Multronics, Inc.
North Hills Electronics, Inc.
Orange County Electronics Int'l., Inc.
Panasonic Company

Protech Audio Corp.
Pulse Techniques Inc.
QEI Corp.
Quad-Eight Electronics
Shively Laboratories, Inc.
TT Electronics, Inc.
Tektronix Inc.
Telectric Co.
Television Equipment Associates
Texscan Corp.
Varian Associates, Inc. Electron Device Group
Varian/Beverly Micro-Link Products
Wide Band Engineering Co., Inc.

Filters, Sound Effect

Audio & Design Recording Inc.
Automated Processes, Inc.
Kappa Networks, Inc.
Roger Mayer Electronics, Inc.
Rupert Neve, Inc.
Orange County Electronics Int'l., Inc.
Panasonic Company
Pulse Techniques Inc.
Quad-Eight Electronics
Richmond Sound Design, Ltd.
Spectrum Instruments, Inc.
TT Electronics, Inc.
URSA Major, Inc.

Filters, Variable and Fixed Tuned

Amber Electro Design, Ltd.
Andersen Labs, Inc. Advanced Systems Div.
Audico, Ltd.
Audio & Design Recording Inc.
Automated Processes, Inc.
Comark Industries Inc.
The Finney Co.
Frequency Devices Inc.
Gotham Audio Corp.
Kappa Networks, Inc.
Maury Microwave Corp.
Merill Cable Equipment Corp.
Microprobe Electronics
Multronics, Inc.
North Hills Electronics, Inc.
Orange County Electronics Int'l., Inc.
Panasonic Company
Pulse Techniques Inc.
Quad-Eight Electronics
Rockland Systems Corp.
Spectrum Instruments, Inc.
Systron-Donner
TT Electronics, Inc.
Texscan Corp.
UTE Microwave, Inc.
United Recording Electronics Industries
Varian Associates, Inc. Electron Device Group
Varian/Beverly Micro-Link Products

Filters, Video

See Adv. Page

Allen Avionics159
Television Equipment Associates.....114

Allen Avionics
Andersen Labs, Inc. Advanced Systems Div.
Audio-Video Engineering Co.
Broadcast Video Systems, Ltd.
Coastcom
Comark Industries Inc.
Datatek Corp.
ESC Electronics Corp.
Yves Faroudja, Inc.
Jerrold Electronics Corp.
Kappa Networks, Inc.
North Hills Electronics, Inc.
Panasonic Company
TT Electronics, Inc.
Tektronix Inc.
Television Equipment Associates
The Zei-Mark Corp.

Frame Storers, Digital

See Adv. Page

Digital Video Systems..... IBC

Vital Industries Inc. BC

ADDA Corp.
Bosch-Fernseh Corp.
Consolidated Video Systems
Digital Video Systems
Micro Consultants
NEC America, Inc. Broadcast Equip. Div.
Teknekron/ARG
Vital Industries Inc.

Frame Storers, Floppy Disc

See Adv. Page

Arvin/Echo Science Corp. 6-7

Arvin/Echo Science Corp.
Echo Science Corp.
Eigen Video

Framers, Color

A. F. Associates, Inc.
Central Dynamics Corp.

Frequency Standards

John Fluke Mfg. Co., Inc.
Maury Microwave Corp.
Rohde & Schwarz Sales Co.
Tracor Inc.

Generators, Audio Sine

See Adv. Page

Modular Audio Products127
Potomac Instruments, Inc.126

Amber Electro Design, Ltd.
Automated Processes, Inc.
B & K Precision Dynascan Corp.
Bald Mountain Lab
Barker and Williamson, Inc.
Broadcast Electronics, Inc.
Continental Specialties Corp.
DYMA Engineering, Inc.
Exact Electronics
Frequency Devices Inc.
Harris Corp. Broadcast Products Div.
Hickok Elec. Inst. Co.
Marconi Instruments Div. of Marconi Electronics Inc.
Modular Audio Products Unit of Modular Devices, Inc.
Opamp Labs, Inc.
Philips Test & Measuring Instruments, Inc.
Potomac Instruments, Inc.
Quad-Eight Electronics
Rohde & Schwarz Sales Co.
SPI-ITT Metrix Instruments Div.
Sencore Inc.
Sescom, Inc.
Sound Technology
Spectra Sonics
Tektronix Inc.
Wang Voice Comm. Inc.

Generators, Audio Sweep

See Adv. Page

Bald Mountain Lab151

Amber Electro Design, Ltd.
B & K Instruments Inc.
B & K Precision Dynascan Corp.
Bald Mountain Lab
Continental Specialties Corp.
DYMA Engineering, Inc.
Exact Electronics
Heath Co.
Hickok Elec. Inst. Co.
Leader Instruments Corp.
Marconi Instruments Div. of Marconi Electronics Inc.
Philips Test & Measuring Instruments, Inc.
Rohde & Schwarz Sales Co.
Tektronix Inc.

United Recording Electronics Industries

Generators, Background Color

See Adv. Page

Beaveronics, Inc. 61

American Data Corp. A North American Philips Co.
Beaveronics, Inc.
Broadcast Video Systems, Ltd.
Central Dynamics Corp.
Computer Image Video Controllers
Dytek Industries, Inc.
Crosspoint Latch Corp.
Digital Video Systems
Dytek Industries, Inc.
Grass Valley Group, Inc.
Harris Corp. Broadcast Products Div.
Industrial Sciences, Inc. (ISI)
Lenco Inc. Electronics Div.
Philips Test & Measuring Instruments, Inc.
Shintron Co. Inc.
Tektronix Inc.
Telemation, A Div. of Bell & Howell
Video Data Systems

Generators, Burst

See Adv. Page

Dynair Electronics, Inc.163

Amber Electro Design, Ltd.
B & K Precision Dynascan Corp.
Broadcast Video Systems, Ltd.
Central Dynamics Corp.
Crosspoint Latch Corp.
Datatek Corp.
Digital Video Systems
Dynair Electronics, Inc.
Grass Valley Group, Inc.
Harris Corp. Broadcast Products Div.
Industrial Sciences, Inc. (ISI)
International Nuclear Corp.
Leitch Video Ltd.
Lenco Inc. Electronics Div.
Philips Test & Measuring Instruments, Inc.
Rohde & Schwarz Sales Co.
Sencore Inc.
Tektronix Inc.
Telemation, A Div. of Bell & Howell

Generators, Color Bar

See Adv. Page

Lenco Inc. 95

B & K Precision Dynascan Corp.
Broadcast Video Systems, Ltd.
Cohu, Inc. Electronics Div.
Crosspoint Latch Corp.
Digital Video Systems
Echolab
Harris Corp. Broadcast Products Div.
Heath Co.
Hickok Elec. Inst. Co.
Industrial Sciences, Inc. (ISI)
Leader Instruments Corp.
Lectrotech Inc.
Leitch Video Ltd.
Lenco Inc. Electronics Div.
Link Electronics Ltd.
Marconi Electronics Inc. Broadcast & Communication Div.
N.T.I. America, Inc.
Panasonic Company
Panasonic Co. Video Systems Div.
Philips Test & Measuring Instruments, Inc.
QSI Systems, Inc.
SPI-ITT Metrix Instruments Div.
Sencore Inc.
Shintron Co. Inc.
Sigma Electronics, Inc.
Tektronix Inc.
Telemet A Geotel Co.
3M Co. Mincom Div.
Ultra Audio Pixtec

Generators, Color Sync

See Adv. Page

Asaca Corp. of America..... 42
Broadcast Video Systems, Ltd.148
Dynair Electronics, Inc.163
Lenco Inc. 95

Asaca Corp. of America
Broadcast Video Systems, Ltd.
Crosspoint Latch Corp.
Digital Video Systems
Dynair Electronics, Inc.
Dynamics Inc. Whittaker Corp.
Grass Valley Group, Inc.
Harris Corp. Broadcast Products Div.
Industrial Sciences, Inc. (ISI)
International Communications & Control Corp.
Leitch Video Ltd.
Lenco Inc. Electronics Div.
Link Electronics Ltd.
Marconi Communication Systems Ltd.
Panasonic Company
Panasonic Co. Video Systems Div.
Philips Test & Measuring Instruments, Inc.
QSI Systems, Inc.
RCA Broadcast Systems
Rohde & Schwarz Sales Co.
Sencore Inc.
Sharp Electronics Corp.
Shintron Co. Inc.
Sigma Electronics, Inc.
Tektronix Inc.
Telemation, A Div. of Bell & Howell
Telemet A Geotel Co.
Ultra Audio Pixtec
Viscount Industries Ltd.
Vital Industries Inc.

Generators, Convergence

See Adv. Page

Broadcast Video Systems, Ltd.148

Broadcast Video Systems, Ltd.
Grass Valley Group, Inc.
Harris Corp. Broadcast Products Div.
Leader Instruments Corp.
Lectrotech Inc.
Leitch Video Ltd.
Lenco Inc. Electronics Div.
Link Electronics Ltd.
Philips Test & Measuring Instruments, Inc.
SPI-ITT Metrix Instruments Div.
Sencore Inc.
Sigma Electronics, Inc.
Tektronix Inc.
Ultra Audio Pixtec

Generators, Cross Pulse

See Adv. Page

Lenco Inc. 95

Echolab
Harris Corp. Broadcast Products Div.
Lenco Inc. Electronics Div.
Tektronix Inc.
3M Co. Mincom Div.

Generators, Digital Metronome

Skotel Corp.

Generators, Digital Sync

See Adv. Page

Broadcast Video Systems, Ltd.148
Lenco Inc. 95
RCA Broadcast Systems..... 81
Vital Industries Inc. BC

ADDA Corp.
Broadcast Video Systems, Ltd.
Central Dynamics Corp.

Crosspoint Latch Corp.
 Digital Video Systems
 Dynair Electronics, Inc.
 Grass Valley Group, Inc.
 Harris Corp. Broadcast Products Div.
 Industrial Sciences, Inc. (ISI)
 International Communications &
 Control Corp.
 Leitch Video Ltd.
 Lenco Inc. Electronics Div.
 Marconi Communication Systems Ltd.
 Marconi Electronics Inc. Broadcast &
 Communication Div.
 RCA Broadcast Systems
 Rohde & Schwarz Sales Co.
 Sigma Electronics, Inc.
 Telemation, A Div. of Bell & Howell
 Video Data Systems
 Vital Industries Inc.

Generators, Digital Video Effect

See Adv. Page

Central Dynamics Corp. 24
Industrial Sciences, Inc. (ISI) 102, 104
MPB Technologies Inc. 124

ADDA Corp.
 Central Dynamics Corp.
 ComTec Video Systems Mincom Div.
 3M
 Digital Video Systems
 Electro & Optical Systems Ltd.
 Grass Valley Group, Inc.
 Industrial Sciences, Inc. (ISI)
 MPB Technologies Inc.
 NEC America, Inc. Broadcast Equip.
 Div.
 N.T.I. America, Inc.

Generators, Error Insertion

National Electrolab Ltd.

Generators, FM Subcarrier

See Adv. Page

RCA Broadcast Systems 81

CCA Electronics Corp.
 CSI Electronics, Inc.
 Catel Div. United Scientific Corp.
 Cetec Broadcast Group
 Coastcom
 Collins Div. Rockwell International
 Harris Corp. Broadcast Products Div.
 Marti Electronics
 McMartin Industries, Inc.
 Moseley Associates, Inc.
 QEI Corp.
 RCA Broadcast Systems
 RMC-Radio Mfg. Co.
 Sharepoint Systems Inc.
 Singer Products Co., Inc.
 Solid Electronics Labs
 Tektronix Inc.
 Times Fiber Communications, Inc.
 Wilkinson Electronics, Inc.

Generators, Monoscope

N.T.I. America, Inc.
 Telemet A Geotel Co.

Generators, NTSC Signal Test

See Adv. Page

Asaca Corp. of America 80
Broadcast Video Systems, Ltd. 148
Lenco Inc. 95

Asaca Corp. of America
 B & K Precision Dynascan Corp.
 Broadcast Video Systems, Ltd.
 Digital Video Systems
 Harris Corp. Broadcast Products Div.
 International Communications &
 Control Corp.
 Leader Instruments Corp.

Leitch Video Ltd.
 Lenco Inc. Electronics Div.
 Marconi Electronics Inc. Broadcast &
 Communication Div.
 Marconi Instruments Div. of Marconi
 Electronics Inc.
 N.T.I. America, Inc.
 Philips Test & Measuring Instruments,
 Inc.
 Rohde & Schwarz Sales Co.
 Sigma Electronics, Inc.
 Tektronix Inc.
 Telemet A Geotel Co.
 Ultra Audio Pixtec

Generators, Powered (Electric Motor)

Lampkin Lab. Inc.
 North Wind Power Co.
 Singer Products Co., Inc.

Generators, Powered (Gasoline Engine)

Centro Corp.
 Harris Corp. Broadcast Products Div.
 J&D International, Elec. Div. Unit E-
 East
 Lampkin Lab. Inc.
 Onan
 Singer Products Co., Inc.

Generators Powered (Solar Energy)

North Wind Power Co.
 Teledyne Energy Systems

Generators, SCA

See Adv. Page

Wilkinson Electronics, Inc. 172

CCA Electronics Corp.
 CSI Electronics, Inc.
 Cetec Broadcast Group
 Collins Div. Rockwell International
 Harris Corp. Broadcast Products Div.
 Leader Instruments Corp.
 Marti Electronics
 McMartin Industries, Inc.
 Micro Control Associates, Inc.
 Moseley Associates, Inc.
 QEI Corp.
 Sencore Inc.
 Singer Products Co., Inc.
 Solid Electronics Labs
 Tektronix Inc.
 Versa Count Engineering
 Wilkinson Electronics, Inc.

Generators, Safe Area

See Adv. Page

Broadcast Video Systems, Ltd. 148
Gray Engineering Labs 21

Broadcast Video Systems, Ltd.
 Gray Engineering Labs

Generators, Signal AF

See Adv. Page

Bald Mountain Lab 151
Modular Audio Products 127
Potomac Instruments, Inc. 126

Amber Electro Design, Ltd.
 Automated Processes, Inc.
 B & K Precision Dynascan Corp.
 Bald Mountain Lab
 Communications Int'l.
 Continental Specialties Corp.
 Delta Electronics Inc. (N.C.)
 Exact Electronics
 Frequency Devices Inc.
 Heath Co.
 Hickok Elec. Inst. Co.

Ivie Electronics
 Lampkin Lab. Inc.
 Leader Instruments Corp.
 Modular Audio Products Unit of
 Modular Devices, Inc.
 Opamp Labs, Inc.
 Philips Test & Measuring Instruments,
 Inc.
 Potomac Instruments, Inc.
 Rohde & Schwarz Sales Co.
 SPI-ITT Metrix Instruments Div.
 Sencore Inc.
 Spectra Sonics
 Tektronix Inc.
 Telecommunications Technology

Generators, Signal Dot Bar

See Adv. Page

Asaca Corp. of America 42
Lenco Inc. 95

Asaca Corp. of America
 B & K Precision Dynascan Corp.
 Broadcast Video Systems, Ltd.
 Cohu, Inc. Electronics Div.
 Colorado Video Inc.
 Grass Valley Group, Inc.
 Heath Co.
 Hickok Elec. Inst. Co.
 Leader Instruments Corp.
 Lectrotech Inc.
 Leitch Video Ltd.
 Lenco Inc. Electronics Div.
 Philips Test & Measuring Instruments,
 Inc.
 SPI-ITT Metrix Instruments Div.
 Sencore Inc.
 Tektronix Inc.
 Telemation, A Div. of Bell & Howell
 Telemet A Geotel Co.

Generators, Signal Marker

AILTECH Div. Cutler-Hammer Los
 Angeles Operation
 B & K Precision Dynascan Corp.
 Blonder-Tongue Labs.
 Lectrotech Inc.
 SPI-ITT Metrix Instruments Div.
 Sencore Inc.
 Tektronix Inc.

Generators, Signal Pulse

B & K Precision Dynascan Corp.
 Continental Specialties Corp.
 Leitch Video Ltd.
 Lenco Inc. Electronics Div.
 Marconi Electronics Inc. Broadcast &
 Communication Div.
 Philips Test & Measuring Instruments,
 Inc.
 Rohde & Schwarz Sales Co.
 Systron-Donner
 TM Systems, Inc.
 Tektronix Inc.

Generators, Signal RF

See Adv. Page

Delta Electronics Inc. (Va.) 107
Potomac Instruments, Inc. 126

AILTECH Div. Cutler-Hammer Los
 Angeles Operation
 B & K Precision Dynascan Corp.
 Blonder-Tongue Labs.
 Boonton Electronics
 Delta Electronics Inc. (Va.)
 Engineering Associates
 John Fluke Mfg. Co., Inc.
 Harris Corp. PRD Electronics Div.
 Heath Co.
 Hickok Elec. Inst. Co.
 Lampkin Lab. Inc.
 Leader Instruments Corp.
 Marconi Instruments Div. of Marconi
 Electronics Inc.
 Microdyne Corp.
 Motorola Communications and
 Electronics Inc.

The Narda Microwave Corporation
 Philips Test & Measuring Instruments,
 Inc.
 Potomac Instruments, Inc.
 Radiometer Elec. U.S. Inc.
 Rohde & Schwarz Sales Co.
 SPI-ITT Metrix Instruments Div.
 Sadelco, Inc.
 Scientific-Atlanta, Inc.
 Sencore Inc.
 Systron-Donner
 Tektronix Inc.
 Texscan Corp.
 Weinschel Engineering Co.

Generators, Signal Square Wave

Amber Electro Design, Ltd.
 B & K Precision Dynascan Corp.
 Continental Specialties Corp.
 Exact Electronics
 Heath Co.
 Hickok Elec. Inst. Co.
 Leitch Video Ltd.
 Philips Test & Measuring Instruments,
 Inc.
 Rohde & Schwarz Sales Co.
 SPI-ITT Metrix Instruments Div.
 Sencore Inc.
 Systron-Donner
 Tektronix Inc.
 Weinschel Engineering Co.

Generators, Signal TV Synchronizing

See Adv. Page

Asaca Corp. of America 42
Broadcast Video Systems, Ltd. 148
3M Co. 73

Asaca Corp. of America
 Broadcast Video Systems, Ltd.
 Colorado Video Inc.
 Dage-MTI, Inc.
 Dynair Electronics, Inc.
 Dynasciences Div. Whittaker Corp.
 Echolab
 Grass Valley Group, Inc.
 Leitch Video Ltd.
 Lenco Inc. Electronics Div.
 Link Electronics Ltd.
 Marconi Communication Systems Ltd.
 Marconi Electronics Inc. Broadcast &
 Communication Div.
 Philips Broadcast Equip Corp.
 Philips Test & Measuring Instruments,
 Inc.
 Rohde & Schwarz Sales Co.
 Sencore Inc.
 Tektronix Inc.
 Telemation, A Div. of Bell & Howell
 Telemet A Geotel Co.
 3M Co. Mincom Div.
 Ultra Audio Pixtec

Generators, Signal VITS

See Adv. Page

Lenco Inc. 95
 Harris Corp. Broadcast Products Div.
 Lenco Inc. Electronics Div.
 Marconi Instruments Div. of Marconi
 Electronics Inc.
 Philips Test & Measuring Instruments,
 Inc.
 Rohde & Schwarz Sales Co.
 Tektronix Inc.
 Telemet A Geotel Co.

Generators, Special Effect

See Adv. Page

Beaveronics, Inc. 61
Central Dynamics Corp. 24
Chyron Telesystems 84
Crosspoint Latch Corp. 98
Vitcount Industries Ltd. 168

Vital Industries Inc. BC

American Data Corp. A North
American Philips Co.
BJA Systems, Inc.
Beaveronics, Inc.
Broadcast Video Systems, Ltd.
Central Dynamics Corp.
Chyron Telesystems
Colorado Video Inc.
Computer Image Video Controllers
Dytek Industries, Inc.
Crosspoint Latch Corp.
Dage-MTI, Inc.
Digital Video Systems
Dynair Electronics, Inc.
Dynamics Div. Whittaker Corp.
Dytek Industries, Inc.
Echolab
Ikegami Electronics (USA) Inc.
Industrial Sciences, Inc. (ISI)
Interand Corp. Telestrator Div.
International Nuclear Corp.
Marconi Communication Systems Ltd.
Marconi Electronics Inc. Broadcast &
Communication Div.
Panasonic Company
Panasonic Co. Video Systems Div.
Philips Broadcast Equip. Corp.
Sharp Electronics Corp.
Shintron Co. Inc.
Tektronix Inc.
3M Co. Mincom Div.
Viscount Industries Ltd.
Vital Industries Inc.

Generators, Staircase

See Adv. Page

Lenco Inc. 95

B & K Precision Dynascan Corp.
Broadcast Video Systems, Ltd.
Colorado Video Inc.
International Communications &
Control Corp.
Leader Instruments Corp.
Leitch Video Ltd.
Lenco Inc. Electronics Div.
Link Electronics Ltd.
N.T.I. America, Inc.
Philips Test & Measuring Instruments,
Inc.
Rohde & Schwarz Sales Co.
Tektronix Inc.
Telemet A Geotel Co.

Generators, Stereo

See Adv. Page

Wilkinson Electronics, Inc. 172

Boonton Electronics
CCA Electronics Corp.
CSI Electronics, Inc.
Catel Div. United Scientific Corp.
Cetec Broadcast Group
Collins Div. Rockwell International
Harris Corp. Broadcast Products Div.
Heath Co.
Leader Instruments Corp.
McMartin Industries, Inc.
Moseley Associates, Inc.
Orban Assoc. Inc.
Philips Test & Measuring Instruments,
Inc.
QEI Corp.
Radiometer Elec. U.S. Inc.
Rohde & Schwarz Sales Co.
Sencore Inc.
Solid Electronics Labs
Sound Technology
Wilkinson Electronics, Inc.

Generators, Subcarrier

See Adv. Page

Lenco Inc. 95

ATV Research
Broadcast Video Systems, Ltd.
CSI Electronics, Inc.
Cetec Broadcast Group
Crosspoint Latch Corp.

Grass Valley Group, Inc.
Harris Corp. Broadcast Products Div.
Industrial Sciences, Inc. (ISI)
Leitch Video Ltd.
Lenco Inc. Electronics Div.
Link Electronics Ltd.
Mart Electronics
McMartin Industries, Inc.
Merill Cable Equipment Corp.
Micro Control Associates, Inc.
Moseley Associates, Inc.
Philips Test & Measuring Instruments,
Inc.
RMC-Radio Mfg. Co.
Rohde & Schwarz Sales Co.
Sharepoint Systems Inc.
Shintron Co. Inc.
Sigma Electronics, Inc.
Solid Electronics Labs
Telemation, A Div. of Bell & Howell

Generators, Sync

See Adv. Page

Asaca Corp. of America 42
Broadcast Video Systems, Ltd. 148
Lenco Inc. 95
Sigma Electronics, Inc. 52

Asaca Corp. of America
Broadcast Video Systems, Ltd.
Cohu, Inc. Electronics Div.
Colorado Video Inc.
Crosspoint Latch Corp.
Digital Video Systems
Dynair Electronics, Inc.
Dynamics Div. Whittaker Corp.
Echolab
GBC Closed Circuit TV Corp.
Grass Valley Group, Inc.
Harris Corp. Broadcast Products Div.
Ikegami Electronics (USA) Inc.
Industrial Sciences, Inc. (ISI)
International Communications &
Control Corp.
Javelin Electronics
Leitch Video Ltd.
Lenco Inc. Electronics Div.
Link Electronics Ltd.
Nagra Magnetic Recorders, Inc.
Panasonic Co. Video Systems Div.
Philips Test & Measuring Instruments,
Inc.
Rohde & Schwarz Sales Co.
Sencore Inc.
Sharp Electronics Corp.
Shintron Co. Inc.
Sigma Electronics, Inc.
Tektronix Inc.
Telemation, A Div. of Bell & Howell
Telemet A Geotel Co.
3M Co. Mincom Div.

Generators, Thermoelectric

See Adv. Page

Teledyne Energy Systems 179

Prodelin Inc.
Teledyne Energy Systems

Generators, Time Code (Reader)

See Adv. Page

The BTX Corp. 90
EEOC Inc. 92
Gray Engineering Labs 21
Kaitronics Corp. 12
Recortec Inc. 5
Shintron Co. Inc. 40
Skotel Corp. 70
United Media, Inc. 174

The BTX Corp.
CMX Systems & Videomax Div's. of
Orox Corp.
Central Dynamics Corp.
Datametrics Inc.
Datatron, Inc.
EEOC Inc.
ESE

Electro & Optical Systems Ltd.
Glentronix Ltd.
Gray Engineering Labs
International Communications &
Control Corp.
Kaitronics Corp.
Laird Telemia Inc.
RMC-Radio Mfg. Co.
Recortec Inc.
Shintron Co. Inc.
Skotel Corp.
Systron-Donner
Tektronix Inc.
Time Tech Corp.
United Media, Inc.

Generators, Tone

See Adv. Page

Bald Mountain Lab 151

AILTECH Div. Cutler-Hammer Los
Angeles Operation
Altec Lansing Sound Products
Amber Electro Design, Ltd.
Autogram Corp.
Automated Broadcast Controls
Bald Mountain Lab
Broadcast Electronics, Inc.
Channelmatic, Inc.
Consolidated Electronic Industries
Continental Specialties Corp.
Di-Tech Inc.
Elcom Engineering Co.
Exact Electronics
Frequency Devices Inc.
Gorman Redlich Mfg. Co.
IGM Div. of Northwestern Tech.
Ivie Electronics
Motorola Communications and
Electronics Inc.
Opamp Labs, Inc.
Spectra Sonics
Wang Voice Comm. Inc.

Generators, Tone, EBS

Bald Mountain Lab
Broadcast Electronics, Inc.
ESE
Elcom Engineering Co.
Gorman Redlich Mfg. Co.
International Nuclear Corp.
Logitek Electronic Systems, Inc.
McMartin Industries, Inc.
Time & Frequency Tech., Inc.

Generators, VITS Inserter

See Adv. Page

Lenco Inc. 95

Lenco Inc. Electronics Div.

Generators, VTR Head Signal

See Adv. Page

Adcom Communications Inc. 150

Adcom Communications Inc.

Generators, Video Carrier

See Adv. Page

Merill Cable Equipment Corp.
Philips Test & Measuring Instruments,
Inc.
Rohde & Schwarz Sales Co.
Sencore Inc.
Tektronix Inc.

Generators, Video Sweep

See Adv. Page

Asaca Corp. of America 42

Asaca Corp. of America
B & K Precision Dynascan Corp.
Datatek Corp.
Harris Corp. Broadcast Products Div.
Lectrotech Inc.
Lenco Inc. Electronics Div.
Link Electronics Ltd.

Marconi Instruments Div. of Marconi
Electronics Inc.
N.T.I. America, Inc.
Philips Test & Measuring Instruments,
Inc.
Rohde & Schwarz Sales Co.
SPI-ITT Metrix Instruments Div.
Sencore Inc.
Tektronix Inc.
Telemet A Geotel Co.
Texscan Corp.

Graph Paper

United Recording Electronics
Industries

Ground Straps

Harris Corp. Broadcast Products Div.
Millard Metal Service Center, Inc.

Hand Trucks, ENG Equipment

Coherent Communications
E-N-G Corp.
Lee-Ray Industries, Inc.

Head Alignment Gauges

See Adv. Page

Fidelipac 121

Ampro Broadcasting
Broadcast Electronics, Inc.
Cetec Broadcast Group
Fidelipac
Harris Corp. Broadcast Products Div.
Merlin Engineering Works, Inc.
Nagra Magnetic Recorders, Inc.
Pentagon Industries, Inc.
Videomagnetics, Inc.

Head Cleaning Products, Video

Comprehensive Video Supply Corp.
Memorex Corp. Professional Products
Group
Miller-Stephenson Chemical Co., Inc.
Nortronics Co., Inc. Recorder Care Div.
Sony Corp. of America
3M Co. Magnetic Audio/Video Prod.
Div.

Head Covers, Videotape

Merlin Engineering Works, Inc.

Head Nest Rebuilding Services

International Electro-Magnetics
Lipps Inc.
Minneapolis Magnetics
Taber Mfg. & Engr. Co.
United Research Lab Corp.

Headphones, Announcers Earpiece

See Adv. Page

Television Equipment Associates 127

AKG Acoustics Div. Philips Audio
Video Systems
Audiosears Corp.
Broadcast Electronics, Inc.
Burns Audiotechnics, Inc.
Cetec Broadcast Group
DYMA Engineering, Inc.
Electro-Voice Inc.
Ercona Corp.
Harris Corp. Broadcast Products Div.
Neutrik
R-Columbia Products Co., Inc.
Sennheiser Electronic
Superex Electronics Corp.
Television Equipment Associates
Telex Communications, Inc.

Headphones, Broadcast Monitoring

See Adv. Page

Television Equipment Associates.....127

AKG Acoustics Div. Philips Audio Video Systems
 Audiosears Corp.
 Broadcast Electronics, Inc.
 Ercona Corp.
 Harris Corp. Broadcast Products Div.
 Micro-Trak Corp.
 Miles Associates Div. Miles Products Ltd.
 Neutrik
 Panasonic Company
 R-Columbia Products Co., Inc.
 Sansui Electronics Corp.
 Sennheiser Electronic
 Studer Revox America
 Superex Electronics Corp.
 Television Equipment Associates
 Telex Communications, Inc.

Headphones, Mono

See Adv. Page

Telex Communications, Inc. 4

AKG Acoustics Div. Philips Audio Video Systems
 Audiosears Corp.
 Bell & Howell Audio Visual Div.
 Broadcast Electronics, Inc.
 Burns Audiotechnics, Inc.
 Cetec Broadcast Group
 David Clark Co., Inc.
 Ercona Corp.
 G C Electronics Div. Wallace Murray
 Hamilton Electronics Corp.
 Harris Corp. Broadcast Products Div.
 Heath Co.
 Miles Associates Div. Miles Products Ltd.
 Nagra Magnetic Recorders, Inc.
 R-Columbia Products Co., Inc.
 Sennheiser Electronic
 Singer Products Co., Inc.
 Studer Revox America
 Superex Electronics Corp.
 Television Equipment Associates
 Telex Communications, Inc.

Headphones, Stereo

AKG Acoustics Div. Philips Audio Video Systems
 Audio-Technica U.S., Inc.
 Broadcast Electronics, Inc.
 Burns Audiotechnics, Inc.
 Cetec Broadcast Group
 David Clark Co., Inc.
 Ercona Corp.
 G C Electronics Div. Wallace Murray
 Hamilton Electronics Corp.
 Harris Corp. Broadcast Products Div.
 Heath Co.
 Integrated Solid Systems Inc. GLI Brand
 Micro-Trak Corp.
 Nagra Magnetic Recorders, Inc.
 Neutrik
 Panasonic Company
 R-Columbia Products Co., Inc.
 Sennheiser Electronic
 Singer Products Co., Inc.
 Stanton Magnetics Inc.
 Studer Revox America
 Superex Electronics Corp.
 Television Equipment Associates
 Telex Communications, Inc.
 Vidair Electronics Mfg.

Headphones with Announcers Microphone

See Adv. Page

Television Equipment Associates.....127
Telex Communications, Inc. 4

AKG Acoustics Div. Philips Audio Video Systems
 Audiosears Corp.
 Burns Audiotechnics, Inc.
 Cetec Broadcast Group
 David Clark Co., Inc.
 DYMA Engineering, Inc.
 Electro-Voice Inc.
 Ercona Corp.
 Harris Corp. Broadcast Products Div.
 Micro-Trak Corp.
 Miles Associates Div. Miles Products Ltd.
 Neutrik
 R-Columbia Products Co., Inc.
 Superex Electronics Corp.
 Television Equipment Associates
 Telex Communications, Inc.

Heads, Audio Stack

See Adv. Page

Saki Magnetics, Inc.170

Computer Magnetics Corp.
 Grandy, Inc.
 International Electro-Magnetics
 Lipps Inc.
 Norton Associates Inc.
 Nortronics Co., Inc. Recorder Care Div.
 Saki Magnetics, Inc.
 Taber Mfg. & Engr. Co.
 Vikron, Inc.

Heads, Contactor

Lipps Inc.
 Nortronics Co., Inc. Recorder Care Div.

Heads, Erase Magnetic

See Adv. Page

R. B. Annis, Co.150
Saki Magnetics, Inc.170

R. B. Annis, Co.
 Broadcast Electronics, Inc.
 Computer Magnetics Corp.
 Ercona Corp.
 Grandy, Inc.
 International Electro-Magnetics
 Lipps Inc.
 Magna-Tech Electronic Co., Inc.
 Minneapolis Magnetics
 Norton Associates Inc.
 Nortronics Co., Inc. Recorder Care Div.
 Saki Magnetics, Inc.
 Spin Physics, Inc.
 Taber Mfg. & Engr. Co.
 UMC Electronics Co. Broadcast Products Div.
 Vikron, Inc.

Heads, Film Stripe

See Adv. Page

Saki Magnetics, Inc.170

Cinema Products Corp.
 Grandy, Inc.
 International Electro-Magnetics
 Lipps Inc.
 Magna-Tech Electronic Co., Inc.
 Norton Associates Inc.
 Nortronics Co., Inc. Recorder Care Div.
 Saki Magnetics, Inc.

Heads, Reconditioned or Reconditioning Services for Audio and/or VTR Audio

See Adv. Page

Saki Magnetics, Inc.170
Spin Physics, Inc. 27

CMX Systems & Videomax Div's. of Orrox Corp.
 Computer Magnetics Corp.
 Electro Sound, Inc.
 Grandy, Inc.
 International Electro-Magnetics
 Lipps Inc.
 Minneapolis Magnetics
 Norton Associates Inc.

Saki Magnetics, Inc.
 Spin Physics, Inc.
 Taber Mfg. & Engr. Co.
 United Research Lab Corp.

Heads, Reconditioned or Reconditioning Services for Video

See Adv. Page

Saki Magnetics, Inc.170
Spin Physics, Inc. 27
Videomax Div. 1

Ampex Corp.
 CMX Systems & Videomax Div's. of Orrox Corp.
 Computer Magnetics Corp.
 Gentrionix Ltd.
 Merlin Engineering Works, Inc.
 RCA Broadcast Systems
 Saki Magnetics, Inc.
 Sound Dynamics, Inc.
 Spin Physics, Inc.
 Taber Mfg. & Engr. Co.
 Videomagnetics, Inc.
 Videomax Div. Orrox Corp.

Heads, Recorder Replacement

See Adv. Page

Saki Magnetics, Inc.170
Spin Physics, Inc. 27
Videomax Div. 1

Ampex Corp.
 Ampro Broadcasting
 Broadcast Electronics, Inc.
 Computer Magnetics Corp.
 Electro Sound, Inc.
 Ercona Corp.
 Gentrionix Ltd.
 Grandy, Inc.
 International Electro-Magnetics
 Lipps Inc.
 Minneapolis Magnetics
 Nagra Magnetic Recorders, Inc.
 Norton Associates Inc.
 Nortronics Co., Inc. Recorder Care Div.
 Saki Magnetics, Inc.
 Soundscribe Magnetic Recording Co., Inc.
 Spin Physics, Inc.
 Studer Revox America
 Taber Mfg. & Engr. Co.
 UMC Electronics Co. Broadcast Products Div.
 United Research Lab Corp.
 Videomagnetics, Inc.
 Videomax Div. Orrox Corp.

Heads, Recording Magnetic

See Adv. Page

Saki Magnetics, Inc.170
Spin Physics, Inc. 27
Videomax Div. 1

Broadcast Electronics, Inc.
 Cinema Products Corp.
 Computer Magnetics Corp.
 Electro Sound, Inc.
 Ercona Corp.
 Gentrionix Ltd.
 Gotham Audio Corp.
 Grandy, Inc.
 Harris Corp. Broadcast Products Div.
 International Electro-Magnetics
 Lipps Inc.
 Magna-Tech Electronic Co., Inc.
 Minneapolis Magnetics
 Nagra Magnetic Recorders, Inc.
 Norton Associates Inc.
 Nortronics Co., Inc. Recorder Care Div.
 Saki Magnetics, Inc.
 Soundscribe Magnetic Recording Co., Inc.
 Spin Physics, Inc.
 Taber Mfg. & Engr. Co.
 UMC Electronics Co. Broadcast Products Div.
 Videomagnetics, Inc.
 Videomax Div. Orrox Corp.
 Vikron, Inc.

Heads, Video Recorder

See Adv. Page

Spin Physics, Inc.27
Videomax Div. 1

Ampex Corp.
 Asaca Corp. of America
 Computer Magnetics Corp.
 Gentrionix Ltd.
 Javelin Electronics
 Minneapolis Magnetics
 RCA Broadcast Systems
 Spin Physics, Inc.
 Taber Mfg. & Engr. Co.
 Videomagnetics, Inc.
 Videomax Div. Orrox Corp.

Heat Exchangers

See Adv. Page

Electro Impulse, Inc.161

Comark Communications Industries, Inc.
 Electro Impulse, Inc.
 Harris Corp. Broadcast Products Div.
 Townsend Associates, Inc.

Heaters, Station Van

Valad Electric Heating Corp.

Hum Stop Coils, Video

See Adv. Page

Audio-Video Engineering Co.157

Audio-Video Engineering Co.
 North Hills Electronics, Inc.
 Pleasantville Labs
 Telemation, A Div. of Bell & Howell

Image Repositioners, Video

Consolidated Video Systems
 Digital Video Systems
 Electro & Optical Systems Ltd.
 NEC America, Inc. Broadcast Equip. Div.

Isolators, Electro-Optical

Motorola Semiconductor Products Inc.

Insulators, Antenna Base

Cetec Broadcast Group
 Continental Electronics Mfg. Co.
 Decca Austin Insulators
 Harris Corp. Broadcast Products Div.
 Suda Seisakusho Co., Ltd.
 Utility Tower Co.

Insulators, Guy Strain

Barker and Williamson, Inc.
 Cetec Broadcast Group
 Continental Electronics Mfg. Co.
 Decca Austin Insulators
 Harris Corp. Broadcast Products Div.
 Suda Seisakusho Co., Ltd.
 Utility Tower Co.

Integrated Circuits --See also Semiconductors

Amperex Electronic Corp. Slatersville Div.
 Bayly Engineering Ltd. Member of AEG-Telefunken Group
 Cherry Electrical Products
 Cherry Semiconductor
 EEV Canada Ltd.
 Harris Corp. Broadcast Products Div.
 Mallory Distributor Prod. Co. Div. P. R. Mallory & Co. Inc.
 Motorola Semiconductor Products Inc.
 Panasonic Company
 RCA Solid State Div.

Intercom Systems

See Adv. Page

Clear-Com Intercom Systems.....106
RTS Systems, Inc.151

AVAB America Inc.
 Altec Lansing Sound Products
 Automated Processes, Inc.
 Bogen Div. Lear Siegler, Inc.
 David Clark Co., Inc.
 Clear-Com Intercom Systems
 Crosspoint Latch Corp.
 Custom Audio Electronics
 Edcor
 Electro-Voice Inc.
 Fisher Berkeley Corp.
 G C Electronics Div. Wallace Murray
 Harris Corp. Broadcast Products Div.
 Heath Co.
 Holland Electronics
 McMartin Industries, Inc.
 N.O.V.A. Corp.
 Paso Sound Products Inc.
 R-Columbia Products Co., Inc.
 ROH Corporation
 RTS Systems, Inc.
 The Ken Schaffer Group, Inc.
 Sharepoint Systems Inc.
 Singer Products Co., Inc.
 Television Equipment Associates
 Telex Communications, Inc.
 Theatre Techniques Inc.
 Ward-Beck Systems, Ltd.
 World Video Inc.

Isocouplers

C. S. P. Inc.
 Cetec Broadcast Group
 Harris Corp. Broadcast Products Div.
 Moseley Associates, Inc.
 Motorola Semiconductor Products Inc.
 Shively Laboratories, Inc.

ITFS Systems

Alford Mfg. Co.
 EMCCE Broadcast Products
 Varian Associates, Inc. Electron Device
 Group
 Varian/Beverly Micro-Link Products

Jack Panel Assemblies

See Adv. Page

Telectric Co.160
Trompeter Electronics 66

ADC Products
 Altec Lansing Sound Products
 Audio Accessories Inc.
 Audio Designs & Mfg.
 Automated Processes, Inc.
 Bayly Engineering Ltd. Member of
 AEG-Telefunken Group
 Broadcast Electronics, Inc.
 Bud Industries, Inc.
 C. S. P. Inc.
 DYMA Engineering, Inc.
 Dynatech Data Systems
 Harris Corp. Broadcast Products Div.
 McCurdy Radio Ind. Inc.
 Potomac Instruments, Inc.
 Rex Rheostat & Co., Inc.
 Switchcraft Inc.
 Telectric Co.
 Trompeter Electronics
 Union Connector Co., Inc.
 Ward-Beck Systems, Ltd.

Jacks, Meter Line

C. S. P. Inc.
 Delta Electronics Inc. (Va.)

Keyers, Video Insert

See Adv. Page

Broadcast Video Systems, Ltd.148
Chyron Telesystems 84

American Data Corp. A North
 American Philips Co.
 Broadcast Video Systems, Ltd.
 Central Dynamics Corp.
 Chyron Telesystems
 Computer Image Video Controllers
 Dytex Industries, Inc.
 Dynair Electronics, Inc.
 Grass Valley Group, Inc.
 Image Video Ltd.
 Industrial Sciences, Inc. (ISI)
 Panasonic Company
 Thomson-CSF Laboratories, Inc.
 3M Co. Mincom Div.
 Video Devices Co.

Kits, Amplifier --See Amplifier Kits

Kits, Transmitter --See Transmitter Kits

Knobs, Control

Alco Electronic Products, Inc.
 G C Electronics Div. Wallace Murray
 Mallory Distributor Prod. Co. Div. P. R.
 Mallory & Co. Inc.
 Selco Products Co.
 Singer Products Co., Inc.

Labels, Cartridge Tape

Fidelipac

Lamps, Console, Gooseneck

Custom Audio Electronics

Lamps, Stage and Studio Replacement

See Adv. Page

Kliegl Bros. Lighting131

Bardwell & McAlister
 Berkey-Colortran Inc.
 Electronics Diversified, Inc.
 GTE Sylvania Inc. Lighting Products
 Group
 Kliegl Bros. Lighting
 Packaged Lighting Systems
 Sittler's Supplies, Inc.
 Smith-Victor Corp.
 Strand Century, Inc.

Leased Broadcast Equipment

See Adv. Page

Collins Div.79

Angenieux Corp. of America
 Broadcast Equip. Leasing Co.
 CSI Electronics, Inc.
 Cetec Broadcast Group
 Collins Div. Rockwell International
 D and S Corley Ltd.
 Harris Corp. Broadcast Products Div.
 International Tapetronics Corp.
 Leasametric
 Merlin Engineering Works, Inc.
 Orange County Electronics Int'l., Inc.
 Pentagon Industries, Inc.
 RMC-Radio Mfg. Co.
 Ramko Research Inc.
 Soll, Inc.
 Tele-Cine Inc.
 Varian Associates, Inc. Electron Device
 Group

Lens Repair Services

Angenieux Corp. of America
 Ercona Corp.
 Alan Gordon Enterprises Inc.
 Rank Precision Industries, Inc. (N.Y.)
 Tele-Cine Inc.

Lenses, Adaptor

See Adv. Page

Warren R. Smith Co.164

Angenieux Corp. of America
 D. O. Industries
 Ercona Corp.
 Jos. Schneider GmbH & Co. P.O. Box
 947
 Warren R. Smith Co.
 Tele-Cine Inc.
 3D Television Systems Inc.

Lenses, Optical Fixed

See Adv. Page

Canon USA, Inc.43
Jos. Schneider GmbH & Co.100

Angenieux Corp. of America
 Buhl Optical Co.
 Canon USA, Inc. Optics Div.
 Cinema Products Corp.
 D. O. Industries
 Ercona Corp.
 Frezzolini Electronics, Inc.
 Fujinon Optical, Inc.
 Alan Gordon Enterprises Inc.
 Harris Corp. Broadcast Products Div.
 Hitachi Denshi America, Ltd.
 Javelin Electronics
 Lenzar Optics Corp.
 Panasonic Company
 Power-Optics Inc.
 Rank Precision Industries, Inc. (N.Y.)
 Schneider Corp. of America
 Jos. Schneider GmbH & Co. P.O. Box
 947
 Schudel, Inc.
 Tele-Cine Inc.
 3D Television Systems Inc.
 VMI-Visual Methods Inc.

Lenses, Optical Fixed Relay

See Adv. Page

Jos. Schneider GmbH & Co.100

Angenieux Corp. of America
 D. O. Industries
 Ercona Corp.
 Fujinon Optical, Inc.
 Hitachi Denshi America, Ltd.
 Javelin Electronics
 Lenzar Optics Corp.
 Rank Precision Industries, Inc. (N.Y.)
 Jos. Schneider GmbH & Co. P.O. Box
 947
 VMI-Visual Methods Inc.

Lenses, Optical Zoom

See Adv. Page

Canon USA, Inc.43
Jos. Schneider GmbH & Co.100

ATV Research
 Angenieux Corp. of America
 Arriflex Corp.
 Buhl Optical Co.
 Canon USA, Inc. Optics Div.
 Cinema Products Corp.
 D. O. Industries
 Ercona Corp.
 Frezzolini Electronics, Inc.
 Fujinon Optical, Inc.
 Alan Gordon Enterprises Inc.
 Harris Corp. Broadcast Products Div.
 Hitachi Denshi America, Ltd.
 Javelin Electronics
 Lenzar Optics Corp.
 Panasonic Company
 Power-Optics Inc.
 Rank Precision Industries, Inc. (N.Y.)
 Schneider Corp. of America
 Jos. Schneider GmbH & Co. P.O. Box
 947
 Sharp Electronics Corp.
 Tele-Cine Inc.

Lighting, Preset Dimmer

See Adv. Page

Electronics Diversified, Inc.60
Kliegl Bros. Lighting131

AVAB America Inc.
 Berkey-Colortran Inc.
 Custom Audio Electronics
 Electro Controls
 Electronics Diversified, Inc.
 Harris Corp. Broadcast Products Div.
 Janson Industries
 Kliegl Bros. Lighting
 Packaged Lighting Systems
 Skirpan Lighting Control Corp.
 Strand Century, Inc.
 Technamics Co.
 Theatre Techniques Inc.

Lighting, TV Controls

See Adv. Page

Electronics Diversified, Inc.60
Kliegl Bros. Lighting131

AVAB America Inc.
 Berkey-Colortran Inc.
 Electro Controls
 Electronics Diversified, Inc.
 Harris Corp. Broadcast Products Div.
 Janson Industries
 Kliegl Bros. Lighting
 Packaged Lighting Systems
 SGL Waber Electric
 Sharepoint Systems Inc.
 Skirpan Lighting Control Corp.
 Strand Century, Inc.
 Theatre Techniques Inc.
 Utility Tower Co.

Lighting, TV Portable System

See Adv. Page

Berkey-Colortran Inc.10
Electronics Diversified, Inc.60
Kliegl Bros. Lighting131

AVAB America Inc.
 Belden Communications, Inc.
 Berkey-Colortran Inc.
 Cine 60, Inc.
 Electro Controls
 Electronics Diversified, Inc.
 Frezzolini Electronics, Inc.
 GTE Sylvania Inc. Lighting Products
 Group
 The Great American Market
 Harris Corp. Broadcast Products Div.
 Harwood Mfg. Co. Subs. Elgin Nat'l.
 Industries, Inc.
 Janson Industries
 Kliegl Bros. Lighting
 Lowel-Light
 Packaged Lighting Systems
 Schudel, Inc.
 Skirpan Lighting Control Corp.
 Strand Century, Inc.
 Theatre Techniques Inc.

Lighting, TV Studio System

See Adv. Page

Electronics Diversified, Inc.60
Kliegl Bros. Lighting131

AVAB America Inc.
 Bardwell & McAlister
 Berkey-Colortran Inc.
 Electronics Diversified, Inc.
 Imero Fiorentino Associates, Inc.
 The Great American Market
 Harris Corp. Broadcast Products Div.
 Harwood Mfg. Co. Subs. Elgin Nat'l.
 Industries, Inc.
 Janson Industries
 Kliegl Bros. Lighting
 Packaged Lighting Systems
 Sharepoint Systems Inc.
 Skirpan Lighting Control Corp.

Strand Century, Inc.
Theatre Techniques Inc.
Union Connector Co., Inc.
Utility Tower Co.

Lighting Hangers, Studio

See Adv. Page

Kliegl Bros. Lighting131

Automatic Devices Co.
Bardwell & McAlister
Berkey-Colortran Inc.
Walter S. Brewer Co., Inc.
Electro Controls
Janson Industries
Kliegl Bros. Lighting
Lowel-Light
Packaged Lighting Systems
Smith-Victor Corp.
Strand Century, Inc.

Lighting Transformers

See Adv. Page

Hughey & Phillips Inc.152

Decca Austin Insulators
Harris Corp. Broadcast Products Div.
Hughey & Phillips Inc.
Packaged Lighting Systems
Utility Tower Co.

Lightning Arresters

See Adv. Page

**Lightning Elimination
Assoc., Inc.138**

Decca Austin Insulators
Dielectric Communications A Unit of
General Signal
DYMA Engineering, Inc.
EEV Canada Ltd.
G C Electronics Div. Wallace Murray
Harris Corp. Broadcast Products Div.
Hy-Gain Electronics Div. of Telex
Communications Inc.
Lightning Elimination Assoc., Inc.
MCG Electronics Inc.
Multiplier Industries Corp.
Suda Seisakusho Co., Ltd.
Transtector Systems Div. Konic
International Corp.
Utility Tower Co.
Wilkinson Electronics, Inc.

Lightning Protection Systems

See Adv. Page

**Lightning Elimination
Assoc., Inc.138**
**Wilkinson Electronics,
Inc.172**

Lightning Elimination Assoc., Inc.
MCG Electronics Inc.
Multiplier Industries Corp.
Singer Products Co., Inc.
Transtector Systems Div. Konic
International Corp.
Wilkinson Electronics, Inc.

Lights, HMI Ballast

See Adv. Page

Kliegl Bros. Lighting131

Belden Communications, Inc.
Berkey-Colortran Inc.
The Great American Market
Kliegl Bros. Lighting
Mole-Richardson Co.

Lights, On Air

Broadcast Electronics, Inc.
Communications, Ltd.
Fidelipac
Harris Corp. Broadcast Products Div.

Lights, Portable, Battery and AC

See Adv. Page

Berkey-Colortran Inc.10
Kliegl Bros. Lighting131

Belden Communications, Inc.
Berkey-Colortran Inc.
Cine 60, Inc.
Cinema Products Corp.
Frezzolini Electronics, Inc.
Harwood Mfg. Co. Subs. Elgin Nat'l
Industries, Inc.
Kliegl Bros. Lighting
Lowel-Light
Mole-Richardson Co.
Multiplier Industries Corp.
Packaged Lighting Systems
Strand Century, Inc.

Lights, Portable, Kit

See Adv. Page

Berkey-Colortran Inc.10
Kliegl Bros. Lighting131

Berkey-Colortran Inc.
Cine 60, Inc.
Cinema Products Corp.
Electronics Diversified, Inc.
The Great American Market
Harris Corp. Broadcast Products Div.
Kliegl Bros. Lighting
Lowel-Light
Mole-Richardson Co.
Multiplier Industries Corp.
Packaged Lighting Systems
Smith-Victor Corp.
Strand Century, Inc.

Lights, Studio Set

See Adv. Page

Kliegl Bros. Lighting131

Bardwell & McAlister
Berkey-Colortran Inc.
Electronics Diversified, Inc.
GTE Sylvania Inc. Lighting Products
Group
The Great American Market
Harris Corp. Broadcast Products Div.
Kliegl Bros. Lighting
Mole-Richardson Co.
Packaged Lighting Systems
Sitler's Supplies, Inc.
Smith-Victor Corp.
Strand Century, Inc.

Lights, Studio Warning

Fidelipac

Lights, Tower Control

See Adv. Page

Hughey & Phillips Inc.152

Cetec Broadcast Group
Crouse Hinds Co.
Elcom Engineering Co.
Harris Corp. Broadcast Products Div.
Hughey & Phillips Inc.

**Lights, Tower Flasher --See
Tower Beacon Light Flashers**

**Lights, Tower Obstruction, Red -
--See also Tower Lights, High
Intensity Obstruction**

Cetec Broadcast Group
Crouse Hinds Co.
Flash Technology Corp. of America
Fort Worth Tower Co., Inc.
Harris Corp. Broadcast Products Div.
Hughey & Phillips Inc.
Swager Tower Corp.
Unarco-Rohn Div. of Unarco Ind., Inc.
Utility Tower Co.

Limiter Compressors

See Adv. Page

**Audio & Design
Recording Inc.111**
**Orange County
Electronics Int'l., Inc.108**
Orban Assoc. Inc.31

Allison Research, Inc.
Altec Lansing Sound Products
Audio & Design Recording Inc.
Automated Processes, Inc.
Broadcast Electronics, Inc.
Cetec Broadcast Group
dbx, Inc.
EMT Franz VGmbH
Elcom Engineering Co.
Gotham Audio Corp.
Harris Corp. Broadcast Products Div.
Inovonics
International Communications &
Control Corp.
Marti Electronics
Roger Mayer Electronics, Inc.
Modular Audio Products Unit of
Modular Devices, Inc.
Moseley Associates, Inc.
Rupert Neve, Inc.
Opamp Labs, Inc.
Orange County Electronics Int'l., Inc.
Orban Assoc. Inc.
Pacific Recorders and Engrg. Corp.
Protech Audio Corp.
QEI Corp.
RCA Broadcast Systems
ROH Corporation
Ramko Research Inc.
Spectra Sonics
Thomson-CSF Laboratories, Inc.
Track Audio, Inc. (TA)
Tweed Audio USA Inc.
United Recording Electronics
Industries
Wang Voice Comm. Inc.
Ward-Beck Systems, Ltd.
Wilkinson Electronics, Inc.

Line Surge Protectors

See Adv. Page

**Lightning Elimination
Assoc., Inc.138**

Bayly Engineering Ltd. Member of
AEG-Telefunken Group
Boston Sound & Power Systems
Cetec Broadcast Group
Delta Electronics Inc. (Va.)
Dielectric Communications A Unit of
General Signal
DYMA Engineering, Inc.
Harris Corp. Broadcast Products Div.
Lightning Elimination Assoc., Inc.
MCG Electronics Inc.
Multiplier Industries Corp.
Novadyne Inc.
Transtector Systems Div. Konic
International Corp.
Wilkinson Electronics, Inc.

Load Resistors, Coaxial

See Adv. Page

**Dielectric
Communications123**
Electro Impulse, Inc.161

Alford Mfg. Co.
Bayly Engineering Ltd. Member of
AEG-Telefunken Group
Bird Electronic Corp.
Dielectric Communications A Unit of
General Signal
Electro Impulse, Inc.
Harris Corp. PRD Electronics Div.
Maury Microwave Corp.
Micro Communications, Inc.
Rohde & Schwarz Sales Co.
Weinschel Engineering Co.

Low Frequency Extenders

See Adv. Page

Comrex Corp.166

Comrex Corp.

Maintenance Services, AM

Atlantic Research Corp.
CSI Electronics, Inc.
Communications, Ltd.
Fred A. Nudd Corp.
RMC-Radio Mfg. Co.
Soll, Inc.
Utility Tower Co.

**Maintenance Services, Cartridge
Tape**

Broadcast Electronics, Inc.
CaVox Stereo Productions

Maintenance Services, FM

Applied Video Electronics, Inc.
Atlantic Research Corp.
CSI Electronics, Inc.
Comark Industries Inc.
Communications, Ltd.
Fort Worth Tower Co., Inc.
Fred A. Nudd Corp.
RMC-Radio Mfg. Co.
Soll, Inc.
Utility Tower Co.

**Maintenance Services,
Microwave**

Atlantic Research Corp.
Comark Industries Inc.
Farinon Video
Fort Worth Tower Co., Inc.
Gabriel Electronics, Inc.
Fred A. Nudd Corp.
Nurad, Inc.
Prodelin Inc.
Utility Tower Co.

Maintenance Services, TV

See Adv. Page

**Video Systems
Network, Inc.152**

Applied Video Electronics, Inc.
Atlantic Research Corp.
C.R.V. Systems, Inc.
Centro Corp.
Comark Industries Inc.
Fort Worth Tower Co., Inc.
Merlin Engineering Works, Inc.
Fred A. Nudd Corp.
Pleasantville Labs
Soll, Inc.
Townsend Associates, Inc.
Utility Tower Co.
Varian Associates, Inc. Electron Device
Group
Video Systems Network, Inc.

MDS Equipment, 2150 MHz

Alford Mfg. Co.
Bogner Broadcast Equipment Corp.
Texscan Corp.
Varian Associates, Inc. Electron Device
Group
Varian/Beverly Micro-Link Products

Meters, Antenna Base

See Adv. Page

C. S. P. Inc.144
**Delta Electronics Inc.
(Va.)107**

C. S. P. Inc.
Delta Electronics Inc. (Va.)
Harris Corp. Broadcast Products Div.

Meters, Antenna Impedence

See Adv. Page
C. S. P. Inc.144
Delta Electronics Inc.
 (Va.)107
 Alford Mfg. Co.
 C. S. P. Inc.
 Delta Electronics Inc. (Va.)

Meters, Blanking Interval

See Adv. Page
A. F. Associates, Inc.132
 A. F. Associates, Inc.
 Auburn Instruments

Meters, Burst Phase

Dranetz Engineering Labs., Inc.

Meters, Distortion Measurement

See Adv. Page
Potomac Instruments, Inc.137
 Barker and Williamson, Inc.
 Harris Corp. Broadcast Products Div.
 Hewlett-Packard Co.
 Potomac Instruments, Inc.
 Radiometer Elec. U.S. Inc.
 TM Systems, Inc.

Meters, Field Strength AM and FM

See Adv. Page
C. S. P. Inc.144
Potomac Instruments, Inc.126
 AILTECH Div. Cutler-Hammer Los
 Angeles Operation
 Keith Anderson Co.
 Anderson Scientific
 C. S. P. Inc.
 Cetec Broadcast Group
 Engineering Associates
 Harris Corp. Broadcast Products Div.
 Heath Co.
 Mid State Communications, Inc.
 Potomac Instruments, Inc.
 Rohde & Schwarz Sales Co.
 SPI-ITT Metrix Instruments Div.
 Sencore Inc.
 TM Systems, Inc.
 Texscan Corp.

Meters, Field Strength TV-UHF

See Adv. Page
Potomac Instruments, Inc.126

AILTECH Div. Cutler-Hammer Los
 Angeles Operation
 Keith Anderson Co.
 Anderson Scientific
 Avantek, Inc.
 Blonder-Tongue Labs.
 CCA Electronics Corp.
 Engineering Associates
 The Finney Co.
 Harris Corp. Broadcast Products Div.
 Leader Instruments Corp.
 Mid State Communications, Inc.
 Potomac Instruments, Inc.
 Rohde & Schwarz Sales Co.
 SPI-ITT Metrix Instruments Div.
 Sadelco, Inc.
 Sencore Inc.
 Texscan Corp.

Meters, Flutter and Wow

See Adv. Page
Fidelipac121

Potomac Instruments, Inc. 126, 137

B & K Instruments Inc.
 EMT Franz VGmbH
 Fidelipac
 Gotham Audio Corp.
 Leader Instruments Corp.
 Potomac Instruments, Inc.
 Radiometer Elec. U.S. Inc.
 Video Research Corp.

Meters, Frequency AF

AILTECH Div. Cutler-Hammer Los
 Angeles Operation
 Amber Electro Design, Ltd.
 Elcom Engineering Co.
 Engineering Associates
 Gotham Audio Corp.
 Heath Co.
 Hickok Elec. Inst. Co.
 Ivie Electronics
 Lampkin Lab. Inc.
 Rohde & Schwarz Sales Co.
 Rycom Instruments
 SPI-ITT Metrix Instruments Div.
 Telecommunications Technology

Meters, Frequency RF

See Adv. Page
C. S. P. Inc.144
 AILTECH Div. Cutler-Hammer Los
 Angeles Operation
 B & K Precision Dynascan Corp.
 Belar Electronics Lab., Inc.
 C. S. P. Inc.
 Data Precision Corp.
 EIP Microwave
 Elcom Engineering Co.
 Engineering Associates
 Harris Corp. Broadcast Products Div.
 Harris Corp. PRD Electronics Div.
 Heath Co.
 Hickok Elec. Inst. Co.
 Lampkin Lab. Inc.
 Rohde & Schwarz Sales Co.
 Rycom Instruments
 SPI-ITT Metrix Instruments Div.
 Singer Products Co., Inc.
 Systron-Donner

Meters, Frequency Calibrating

Data Precision Corp.
 Eidson Electronic Co.
 Elcom Engineering Co.
 Lampkin Lab. Inc.
 Philips Test & Measuring Instruments, Inc.

Meters, Grid Dip

Barker and Williamson, Inc.
 Heath Co.
 Leader Instruments Corp.

Meters, Intermodulation

See Adv. Page
Potomac Instruments, Inc.137
 Amber Electro Design, Ltd.
 Heath Co.
 Marconi Instruments Div. of Marconi Electronics Inc.
 Potomac Instruments, Inc.
 Sound Technology

Meters, Line Voltage

Alco Electronic Products, Inc.
 B & K Precision Dynascan Corp.
 Dranetz Engineering Labs., Inc.
 Gralex Industries
 Motorola Communications and Electronics Inc.
 Nationwide Electronic Systems, Inc.
 Selco Products Co.
 Sencore Inc.

Meters, Modulation

Belar Electronics Lab., Inc.
 Boonton Electronics
 ESE
 Gotham Audio Corp.
 Harris Corp. Broadcast Products Div.
 Marconi Instruments Div. of Marconi Electronics Inc.
 Radiometer Elec. U.S. Inc.
 SPI-ITT Metrix Instruments Div.

Meters, Panel Replacement

See Adv. Page
Delta Electronics Inc.
 (Va.)107
 Delta Electronics Inc. (Va.)
 G C Electronics Div. Wallace Murray
 Gralex Industries
 Nationwide Electronic Systems, Inc.
 Sharepoint Systems Inc.

Meters, Peak Program

Track Audio, Inc. (TA)

Meters, Phase Angle

See Adv. Page
Potomac Instruments, Inc.137
 AILTECH Div. Cutler-Hammer Los
 Angeles Operation
 B & K Instruments Inc.
 Dranetz Engineering Labs., Inc.
 Gorman Redlich Mfg. Co.
 Harris Corp. Broadcast Products Div.
 Harris Corp. PRD Electronics Div.
 Potomac Instruments, Inc.
 SPI-ITT Metrix Instruments Div.
 Tweed Audio USA Inc.

Meters, Power

See Adv. Page
Electro Impulse, Inc.161
 Altec Lansing Sound Products
 Bayly Engineering Ltd. Member of
 AEG-Telefunken Group
 Bird Electronic Corp.
 Boonton Electronics
 Dielectric Communications A Unit of
 General Signal
 Dranetz Engineering Labs., Inc.
 Electro Impulse, Inc.
 Engineering Associates
 Harris Corp. PRD Electronics Div.
 Hickok Elec. Inst. Co.
 Lampkin Lab. Inc.
 Leader Instruments Corp.
 The Narda Microwave Corporation
 National Electrolab Ltd.
 Rohde & Schwarz Sales Co.
 Singer Products Co., Inc.
 Systron-Donner

Meters, RF

See Adv. Page
C. S. P. Inc.144
Delta Electronics Inc.
 (Va.)107
 Ballantine Labs, Inc.
 Bird Electronic Corp.
 Boonton Electronics
 CCA Electronics Corp.
 C. S. P. Inc.
 Delta Electronics Inc. (Va.)

Meters, Signal Level

AILTECH Div. Cutler-Hammer Los
 Angeles Operation
 Audio & Design Recording Inc.
 Belar Electronics Lab., Inc.
 ESE
 G C Electronics Div. Wallace Murray
 Gotham Audio Corp.

Philips Test & Measuring Instruments, Inc.
 Quad-Eight Electronics
 Rycom Instruments
 Sadelco, Inc.
 Selco Products Co.
 Sencore Inc.
 TEAC Corp of America
 Telecommunications Technology

Meters, Standing Wave

Bird Electronic Corp.
 Dielectric Communications A Unit of
 General Signal
 G C Electronics Div. Wallace Murray
 Harris Corp. PRD Electronics Div.
 Hickok Elec. Inst. Co.
 Micro Communications, Inc.
 Rohde & Schwarz Sales Co.
 SPI-ITT Metrix Instruments Div.

Meters, Tape --See Tape Meters

Meters, VITS

Television Equipment Associates

Meters, Video Level

Philips Test & Measuring Instruments, Inc.
 Selco Products Co.

Meters, Video Noise

See Adv. Page
Lenco Inc. 95
 Asaca Corp. of America
 Lenco Inc. Electronics Div.
 Rohde & Schwarz Sales Co.

Meters, Volt Ohm

B & K Precision Dynascan Corp.
 Ballantine Labs, Inc.
 California Instruments
 Data Precision Corp.
 John Fluke Mfg. Co., Inc.
 G C Electronics Div. Wallace Murray
 Heath Co.
 Hickok Elec. Inst. Co.
 Leader Instruments Corp.
 Motorola Communications and Electronics Inc.
 Rohde & Schwarz Sales Co.
 SPI-ITT Metrix Instruments Div.
 Sencore Inc.
 Soar Electronics
 Systron-Donner
 Tektronix Inc.
 Telecommunications Technology
 United Systems Corp.
 Vidaire Electronics Mfg.

Meters, VU

Amber Electro Design, Ltd.
 Audio & Design Recording Inc.
 Electro & Optical Systems Ltd.
 G C Electronics Div. Wallace Murray
 Gotham Audio Corp.
 Harris Corp. Broadcast Products Div.
 MICMIX Audio Products, Inc.
 Roger Mayer Electronics, Inc.
 Quad-Eight Electronics
 Ramko Research Inc.
 SPI-ITT Metrix Instruments Div.
 Selco Products Co.
 Sharepoint Systems Inc.
 TEAC Corp of America
 Track Audio, Inc. (TA)
 Ward-Beck Systems, Ltd.

Microphone Boom Reconditioning Services

Atlas Sound
 Television Products Co. Inc.

Microphone Cable Testers

Switchcraft Inc.

Whirlwind Audio
Whirlwind Music

Microphone Mixers

See Adv. Page

Ramko Research Inc. 28-29

AVAB America Inc.
Altec Lansing Sound Products
DYMA Engineering, Inc.
Edcor
HM Electronics, Inc.
Harris Corp. Broadcast Products Div.
LPB Inc.
Micro-Trak Corp.
Nagra Magnetic Recorders, Inc.
Quad-Eight Electronics
Ramko Research Inc.
Spectra Sonics
Transist-O-Sound Inc.

Microphone Splitters

See Adv. Page

Sescom, Inc. 163

DYMA Engineering, Inc.
Ramko Research Inc.
Sescom, Inc.
Switchcraft Inc.
Whirlwind Audio
Whirlwind Music

Microphone Stands and Booms

AKG Acoustics Div. Philips Audio
Video Systems
Altec Lansing Sound Products
Atlas Sound
BSC Inc.
Bayly Engineering Ltd. Member of
AEG-Telefunken Group
Bogen Div. Lear Siegler, Inc.
Broadcast Electronics, Inc.
Burns Audiotechnics, Inc.
Cetec Broadcast Group
Edcor
G C Electronics Div. Wallace Murray
Gotham Audio Corp.
Harris Corp. Broadcast Products Div.
LPB Inc.
Neutrik
Paso Sound Products Inc.
Sennheiser Electronic
Singer Products Co., Inc.
Strand Century, Inc.
Studer Revox America
Television Products Co. Inc.

Microphones, Boom

See Adv. Page

**Audio-Technica U.S.,
Inc. 63**

AKG Acoustics Div. Philips Audio
Video Systems
Altec Lansing Sound Products
Audiosears Corp.
Audio-Technica U.S., Inc.
Bayly Engineering Ltd. Member of
AEG-Telefunken Group
Broadcast Electronics, Inc.
Burns Audiotechnics, Inc.
Cetec Broadcast Group
Electro-Voice Inc.
G C Electronics Div. Wallace Murray
Alan Gordon Enterprises Inc.
Gotham Audio Corp.
Harris Corp. Broadcast Products Div.
Neutrik
Panasonic Company
Paso Sound Products Inc.
R-Columbia Products Co., Inc.
Sennheiser Electronic
Singer Products Co., Inc.
Superex Electronics Corp.
Telex Communications, Inc.

Microphones, Desk

See Adv. Page

**Audio-Technica U.S.,
Inc. 63**

AKG Acoustics Div. Philips Audio
Video Systems
Altec Lansing Sound Products
Applied Video Electronics, Inc.
Audio-Technica U.S., Inc.
Bayly Engineering Ltd. Member of
AEG-Telefunken Group
Bogen Div. Lear Siegler, Inc.
Broadcast Electronics, Inc.
Burns Audiotechnics, Inc.
Cetec Broadcast Group
Edcor
Electro-Voice Inc.
GBC Closed Circuit TV Corp.
G C Electronics Div. Wallace Murray
Gotham Audio Corp.
Harris Corp. Broadcast Products Div.
Neutrik
Panasonic Company
Panasonic Co. Video Systems Div.
Paso Sound Products Inc.
Sennheiser Electronic
Singer Products Co., Inc.
Sony Corp. of America
Special Instruments Lab, Inc.
Portasound Div.
Studer Revox America
TEAC Corp of America

Microphones, Floor

See Adv. Page

**Audio-Technica U.S.,
Inc. 63**

AKG Acoustics Div. Philips Audio
Video Systems
Altec Lansing Sound Products
Audio-Technica U.S., Inc.
Bayly Engineering Ltd. Member of
AEG-Telefunken Group
Bogen Div. Lear Siegler, Inc.
Broadcast Electronics, Inc.
Burns Audiotechnics, Inc.
Cetec Broadcast Group
Electro-Voice Inc.
G C Electronics Div. Wallace Murray
Gotham Audio Corp.
Harris Corp. Broadcast Products Div.
Neutrik
Panasonic Company
Panasonic Co. Video Systems Div.
Paso Sound Products Inc.
Sennheiser Electronic
Singer Products Co., Inc.
Special Instruments Lab, Inc.
Portasound Div.
TEAC Corp of America

Microphones, Hand Held

See Adv. Page

**Audio-Technica U.S.,
Inc. 63**

AKG Acoustics Div. Philips Audio
Video Systems
Altec Lansing Sound Products
Applied Video Electronics, Inc.
Audio-Technica U.S., Inc.
Bayly Engineering Ltd. Member of
AEG-Telefunken Group
Bogen Div. Lear Siegler, Inc.
Broadcast Electronics, Inc.
Burns Audiotechnics, Inc.
Cetec Broadcast Group
DYMA Engineering, Inc.
Edcor
Electro-Voice Inc.
Ercona Corp.
G C Electronics Div. Wallace Murray
Alan Gordon Enterprises Inc.
Gotham Audio Corp.
Harris Corp. Broadcast Products Div.
Neutrik
Panasonic Company
Panasonic Co. Video Systems Div.
Paso Sound Products Inc.
The Ken Schaffer Group, Inc.

Sennheiser Electronic
Singer Products Co., Inc.
Special Instruments Lab, Inc.
Portasound Div.
Studer Revox America
TEAC Corp of America
Telex Communications, Inc.
Vidaire Electronics Mfg.

Microphones, Lavalier

See Adv. Page

**Audio-Technica U.S.,
Inc. 63**
Electro-Voice Inc. 58

AKG Acoustics Div. Philips Audio
Video Systems
Altec Lansing Sound Products
Audio-Technica U.S., Inc.
Bayly Engineering Ltd. Member of
AEG-Telefunken Group
Bogen Div. Lear Siegler, Inc.
Broadcast Electronics, Inc.
Burns Audiotechnics, Inc.
Cetec Broadcast Group
Coherent Communications
Edcor
Electro-Voice Inc.
G C Electronics Div. Wallace Murray
Alan Gordon Enterprises Inc.
Gotham Audio Corp.
Harris Corp. Broadcast Products Div.
Nagra Magnetic Recorders, Inc.
Neutrik
Panasonic Co. Video Systems Div.
Paso Sound Products Inc.
The Ken Schaffer Group, Inc.
Sennheiser Electronic
Singer Products Co., Inc.
Sony Corp. of America
Special Instruments Lab, Inc.
Portasound Div.

**Microphones, Parabolic and
Shotgun**

AKG Acoustics Div. Philips Audio
Video Systems
Bayly Engineering Ltd. Member of
AEG-Telefunken Group
Burns Audiotechnics, Inc.
Electro-Voice Inc.
Ercona Corp.
Gotham Audio Corp.
Neutrik
Sennheiser Electronic

Microphones, Wireless

See Adv. Page

Cetec Vega 37
Comrex Corp. 166
Electro-Voice Inc. 58
HM Electronics, Inc. .. 178, 179
**The Ken Schaffer
Group, Inc. 179**
Sony Corp. of America 83

Bayly Engineering Ltd. Member of
AEG-Telefunken Group
Burns Audiotechnics, Inc.
Cetec Broadcast Group
Cetec Vega
Coherent Communications
Comrex Corp.
Edcor
Electro-Voice Inc.
Ercona Corp.
Alan Gordon Enterprises Inc.
HM Electronics, Inc.
Ikegami Electronics (USA) Inc.
Paso Sound Products Inc.
The Ken Schaffer Group, Inc.
Sennheiser Electronic
Singer Products Co., Inc.
Sony Corp. of America
Special Instruments Lab, Inc.
Portasound Div.
Telex Communications, Inc.

**Microwave Antenna Towers,
ENG Van**

E-N-G Corp.
Nurad, Inc.
VanLadder, Inc.
Wolf Coach Inc.

Microwave Components

UTE Microwave, Inc.

Microwave Systems, ENG

California Microwave
DYMA Engineering, Inc.
E-N-G Corp.
Farinon Video
Gabriel Electronics, Inc.
Harris Corp. Broadcast Products Div.
Hitachi Denshi America, Ltd.
Hughes Aircraft Co. Microwave
Communications Products
International Microwave Corp.
Moseley Associates, Inc.
NEC America, Inc. Broadcast Equip.
Div.
Nurad, Inc.
Prodelin Inc.
RCA Broadcast Systems
TerraCom Lorai Corp.
Weinschel Engineering Co.

Microwave Systems, STL

Anderson Scientific
Cetec Broadcast Group
Comark Industries Inc.
DYMA Engineering, Inc.
Farinon Video
GTE Lenkurt, Inc.
Harris Corp. Broadcast Products Div.
Hughes Aircraft Co. Microwave
Communications Products
International Microwave Corp.
Marti Electronics
Micro Communications, Inc.
Micro Control Associates, Inc.
Moseley Associates, Inc.
NEC America, Inc. Broadcast Equip.
Div.
Nurad, Inc.
RHG Electronics Laboratory, Inc.
Singer Products Co., Inc.
Tecco Corp.
TerraCom Lorai Corp.
Varian/Beverly Micro-Link Products

Mixers --See also Consoles

See Adv. Page

Audio Designs & Mfg. 57
Ramko Research Inc. 28-29
**Russco Electronics
Mfg. Inc. 76**
**Sigma System
Engineering..... 154**

AVAB America Inc.
Altec Lansing Sound Products
Ampro Broadcasting
Audio Designs & Mfg.
Audiotechnics, Inc.
Automated Processes, Inc.
BSC Inc.
Bayly Engineering Ltd. Member of
AEG-Telefunken Group
Bogen Div. Lear Siegler, Inc.
Broadcast Electronics, Inc.
Central Dynamics Corp.
Cetec Audio
Cetec Broadcast Group
Coherent Communications
Computer Image Video Controllers
Dytek Industries, Inc.
Custom Audio Electronics
Dage-MTL, Inc.
Delta Electronics Inc. (N.C.)
DYMA Engineering, Inc.
Grass Valley Group, Inc.
HM Electronics, Inc.
Harris Corp. Broadcast Products Div.
Howe Audio Productions, Inc.
LPB Inc.
James B. Lansing Sound, Inc.
Roger Mayer Electronics, Inc.

McCurdy Radio Ind. Inc.
 McMartin Industries, Inc.
 Micro-Trak Corp.
 Modular Audio Products Unit of
 Modular Devices, Inc.
 Nagra Magnetic Recorders, Inc.
 Rupert Neve, Inc.
 Panasonic Company
 Paso Sound Products Inc.
 Quad-Eight Electronics
 Quantum Audio Labs, Inc.
 RHG Electronics Laboratory, Inc.
 Ramko Research Inc.
 Richmond Sound Design, Ltd.
 Ross Video Ltd.
 Russco Electronics Mfg. Inc.
 Sigma System Engineering
 Singer Products Co., Inc.
 Sono-Mag Corp.
 Sphere Electronics
 Studer Revox America
 Switchcraft Inc.
 TEAC Corp of America
 Technical Audio Products Corp.
 Theatre Techniques Inc.
 Track Audio, Inc. (TA)
 Ultra Audio Pixtec
 United Recording Electronics
 Industries
 Ward-Beck Systems, Ltd.
 Weinschel Engineering Co.
 Wilkinson Electronics, Inc.

Monitors, AM System

See Adv. Page

Belar Electronics Lab., Inc.150
Wilkinson Electronics, Inc.172

Automated Processes, Inc.
 Belar Electronics Lab., Inc.
 C. S. P. Inc.
 Cetec Broadcast Group
 Gorman Redlich Mfg. Co.
 Harris Corp. Broadcast Products Div.
 Lampkin Lab. Inc.
 McKay Dymek Co.
 McMartin Industries, Inc.
 Micro-Trak Corp.
 National Electrolab Ltd.
 QEI Corp.
 ROH Corporation
 Singer Products Co., Inc.
 Sono-Mag Corp.
 Soundscribe Magnetic Recording Co., Inc.
 Telemet A Geotel Co.
 Time & Frequency Tech., Inc.
 Wilkinson Electronics, Inc.

Monitors, FM System

See Adv. Page

Belar Electronics Lab., Inc.150

Automated Processes, Inc.
 Belar Electronics Lab., Inc.
 Cetec Broadcast Group
 Eidson Electronic Co.
 Fix Tune Solid State Electronics, Inc.
 Harris Corp. Broadcast Products Div.
 Lampkin Lab. Inc.
 McMartin Industries, Inc.
 Micro-Trak Corp.
 QEI Corp.
 ROH Corporation
 Singer Products Co., Inc.
 Sono-Mag Corp.
 Soundscribe Magnetic Recording Co., Inc.
 Studer Revox America
 Time & Frequency Tech., Inc.

Monitors, FM System SCA

See Adv. Page

Belar Electronics Lab., Inc.150

Belar Electronics Lab., Inc.
 Cetec Broadcast Group
 Fix Tune Solid State Electronics, Inc.
 Harris Corp. Broadcast Products Div.
 McMartin Industries, Inc.
 QEI Corp.
 Singer Products Co., Inc.
 Time & Frequency Tech., Inc.

Monitors, Antenna Base Current

See Adv. Page

C. S. P. Inc.144
Delta Electronics Inc. (Va.)107
Potomac Instruments, Inc.126

C. S. P. Inc.
 Delta Electronics Inc. (Va.)
 Gorman Redlich Mfg. Co.
 Harris Corp. Broadcast Products Div.
 Potomac Instruments, Inc.

Monitors, Antenna Sampling

See Adv. Page

C. S. P. Inc.144
Delta Electronics Inc. (Va.)107
Potomac Instruments, Inc.126

Mobile Communication Vans, TV

See Adv. Page

The Gerstenslager Co.56

A. F. Associates, Inc.
 Atlantic Research Corp.
 Centro Corp.
 DYMA Engineering, Inc.
 The Gerstenslager Co.
 Harris Corp. Broadcast Products Div.
 Marconi Communication Systems Ltd.
 Merlin Engineering Works, Inc.
 Nurad, Inc.
 Soll, Inc.
 Video Rentals, Inc. Subs. of AF Associates
 Wolf Coach Inc.

Modulators, TV

See Adv. Page

Belar Electronics Lab., Inc.150
Dynair Electronics, Inc.165

Keith Anderson Co.
 Anderson Scientific
 Belar Electronics Lab., Inc.
 Blonder-Tongue Labs.
 Broadcast Video Systems, Ltd.
 Catel Div. United Scientific Corp.
 Dynair Electronics, Inc.
 EMCEE Broadcast Products
 Electro & Optical Systems Ltd.
 Harris Corp. Broadcast Products Div.
 Javelin Electronics
 Jerrold Electronics Corp.
 Marconi Communication Systems Ltd.
 Merrill Cable Equipment Corp.
 Phasecom Corp.
 Philips Test & Measuring Instruments, Inc.
 Rohde & Schwarz Sales Co.
 Scientific-Atlanta, Inc.
 Telemet A Geotel Co.
 Triple Crown Electronics, Inc.
 UHF Associates
 Varian Associates, Inc. Electron Device Group

Monitor Controls, Remote

Gorman Redlich Mfg. Co.

Monitor Mounts, Wall and Ceiling

Davis & Sanford Co. Inc.

C. S. P. Inc.
 Delta Electronics Inc. (Va.)
 Gorman Redlich Mfg. Co.
 Harris Corp. Broadcast Products Div.
 Potomac Instruments, Inc.
 Wide Band Engineering Co., Inc.

Monitors, Directional Antenna

See Adv. Page

C. S. P. Inc.144
Delta Electronics Inc. (Va.)107
Potomac Instruments, Inc.126

CCA Electronics Corp.
 C. S. P. Inc.
 Comark Industries Inc.
 Delta Electronics Inc. (Va.)
 Gorman Redlich Mfg. Co.
 Harris Corp. Broadcast Products Div.
 Micro Communications, Inc.
 Moseley Associates, Inc.
 Potomac Instruments, Inc.

Monitors, Frequency

See Adv. Page

Belar Electronics Lab., Inc.150

ALLTECH Div. Cutler-Hammer Los Angeles Operation
 Belar Electronics Lab., Inc.
 Cetec Broadcast Group
 Dranetz Engineering Labs., Inc.
 Eidson Electronic Co.
 Elcom Engineering Co.
 Harris Corp. Broadcast Products Div.
 Heath Co.
 Lampkin Lab. Inc.
 McMartin Industries, Inc.
 Motorola Communications and Electronics Inc.
 Philips Test & Measuring Instruments, Inc.
 Singer Products Co., Inc.
 Time & Frequency Tech., Inc.
 Versa Count Engineering
 Wilkinson Electronics, Inc.

Monitors, Microwave Radiation

The Narda Microwave Corporation

Monitors, Modulation

See Adv. Page

Belar Electronics Lab., Inc.150
Wilkinson Electronics, Inc.172

Belar Electronics Lab., Inc.
 CCA Electronics Corp.
 Cetec Broadcast Group
 Harris Corp. Broadcast Products Div.
 Lampkin Lab. Inc.
 Marconi Instruments Div. of Marconi Electronics Inc.
 McMartin Industries, Inc.
 QEI Corp.
 Singer Products Co., Inc.
 Time & Frequency Tech., Inc.
 Versa Count Engineering
 Wilkinson Electronics, Inc.

Monitors, Phase

See Adv. Page

Belar Electronics Lab., Inc.150
C. S. P. Inc.144
Delta Electronics Inc. (Va.)107
Leitch Video Ltd.69
Potomac Instruments, Inc.137

Belar Electronics Lab., Inc.
 CCA Electronics Corp.

C. S. P. Inc.
 Cetec Broadcast Group
 Delta Electronics Inc. (Va.)
 Dranetz Engineering Labs., Inc.
 Gorman Redlich Mfg. Co.
 Harris Corp. Broadcast Products Div.
 Leitch Video Ltd.
 Potomac Instruments, Inc.

Monitors, Power

See Adv. Page

Belar Electronics Lab., Inc.150
Delta Electronics Inc. (Va.)107

B & I Electronics, Inc.
 Belar Electronics Lab., Inc.
 Bird Electronic Corp.
 Cetec Broadcast Group
 Delta Electronics Inc. (Va.)
 Dranetz Engineering Labs., Inc.
 Harris Corp. Broadcast Products Div.
 Harris Corp. PRD Electronics Div.
 Holland Electronics
 Moseley Associates, Inc.
 Wide Band Engineering Co., Inc.

Monitors, Program Audio

See Adv. Page

Belar Electronics Lab., Inc.150
Comrex Corp.166
James B. Lansing Sound, Inc.93

Altec Lansing Sound Products
 Amber Electro Design, Ltd.
 Autogram Corp.
 Automated Processes, Inc.
 B & I Electronics, Inc.
 Belar Electronics Lab., Inc.
 Bogen Div. Lear Siegler, Inc.
 Cetec Broadcast Group
 Comrex Corp.
 Crown International, Inc.
 Di-Tech Inc.
 DYMA Engineering, Inc.
 Electro-Voice Inc.
 Gotham Audio Corp.
 Harris Corp. Broadcast Products Div.
 James B. Lansing Sound, Inc.
 Marconi Communication Systems Ltd.
 Marti Electronics
 Micro-Trak Corp.
 Modular Audio Products Unit of Modular Devices, Inc.
 Rupert Neve, Inc.
 Orange County Electronics Int'l., Inc.
 Protech Audio Corp.
 ROH Corporation
 Sennheiser Electronic
 Soundscribe Magnetic Recording Co., Inc.
 Spectra Sonics
 Studer Revox America
 Telemet A Geotel Co.
 Ultra Audio Pixtec

Monitors, RF Level

See Adv. Page

Belar Electronics Lab., Inc.150
Delta Electronics Inc. (Va.)107
Electro Impulse, Inc.161

Belar Electronics Lab., Inc.
 Bird Electronic Corp.
 Delta Electronics Inc. (Va.)
 Electro Impulse, Inc.
 Harris Corp. Broadcast Products Div.
 Lampkin Lab. Inc.
 Moseley Associates, Inc.
 Tektronix Inc.
 Wide Band Engineering Co., Inc.

Monitors, Set-up and Matching Equipment

Power-Optics Inc.

Monitors, Stereo

See Adv. Page

Belar Electronics Lab., Inc.150

Belar Electronics Lab., Inc.
 Cetec Broadcast Group
 Harris Corp. Broadcast Products Div.
 McMartin Industries, Inc.
 Modular Audio Products Unit of Modular Devices, Inc.
 QEI Corp.
 ROH Corporation
 Sono-Mag Corp.
 Spectra Sonics
 3D Television Systems Inc.
 Time & Frequency Tech., Inc.
 Versa Count Engineering
 Wilkinson Electronics, Inc.

Monitors, TV System

See Adv. Page

Belar Electronics Lab., Inc.150
Electrohome Ltd.36
World Video Inc.134

Belar Electronics Lab., Inc.
 Broadcast Video Systems, Ltd.
 Cohu, Inc. Electronics Div.
 Electrohome Ltd.
 GBC Closed Circuit TV Corp.
 Harris Corp. Broadcast Products Div.
 Hitachi Denshi America, Ltd.
 Javelin Electronics
 Marconi Communication Systems Ltd.
 Marconi Instruments Div. of Marconi Electronics Inc.
 Panasonic Co. Video Systems Div.
 QSI Systems, Inc.
 Tektronix Inc.
 3D Television Systems Inc.
 US JVC Corp. Professional Video Div.
 Videotek, Inc.
 World Video Inc.

Monitors, Video B&W

See Adv. Page

Cohu, Inc.72
Electrohome Ltd.36
Lenco Inc.95

Asaca Corp. of America
 Audiotronics Video Display Div.
 Bosch-Fernseh Corp.
 Cohu, Inc. Electronics Div.
 Conrac Div. Conrac Corp.
 Electro & Optical Systems Ltd.
 Electrohome Ltd.
 GBC Closed Circuit TV Corp.
 Harris Corp. Broadcast Products Div.
 Hitachi Denshi America, Ltd.
 Ikegami Electronics (USA) Inc.
 Javelin Electronics
 Lenco Inc. Electronics Div.
 Motorola Communications and Electronics Inc.
 Panasonic Company
 Panasonic Co. Video Systems Div.
 QSI Systems, Inc.
 RCA Solid State Div.
 Rohde & Schwarz Sales Co.
 Sony Corp. of America
 Tektronix Inc.
 Unimedia Corp.

Monitors, Video Color

See Adv. Page

Electrohome Ltd.36
Ikegami Electronics (USA) Inc.25
Lenco Inc.95
World Video Inc.134

Amtron Corp.
 Asaca Corp. of America
 Audiotronics Video Display Div.
 Bosch-Fernseh Corp.
 Broadcast Video Systems, Ltd.
 Conrac Div. Conrac Corp.
 Electro & Optical Systems Ltd.
 Electrohome Ltd.
 Harris Corp. Broadcast Products Div.
 Hitachi Denshi America, Ltd.
 Ikegami Electronics (USA) Inc.
 Image Magnification, Inc.
 Lectrotech Inc.
 Lenco Inc. Electronics Div.
 Panasonic Company
 Panasonic Co. Video Systems Div.
 Pleasantville Labs
 QSI Systems, Inc.
 Rohde & Schwarz Sales Co.
 Sharp Electronics Corp.
 Sony Corp. of America
 Tektronix Inc.
 US JVC Corp. Professional Video Div.
 Unimedia Corp.
 Videotek, Inc.
 World Video Inc.

Monitors, Video Pulse Cross

See Adv. Page

Electrohome Ltd.36
Lenco Inc.95
World Video Inc.134

Amtron Corp.
 Conrac Div. Conrac Corp.
 Electro & Optical Systems Ltd.
 Electrohome Ltd.
 Lenco Inc. Electronics Div.
 Panasonic Co. Video Systems Div.
 QSI Systems, Inc.
 Tektronix Inc.
 Unimedia Corp.
 Videotek, Inc.
 World Video Inc.

Monitors, Waveform

See Adv. Page

Lenco Inc.95

Broadcast Video Systems, Ltd.
 CCA Electronics Corp.
 Electro & Optical Systems Ltd.
 Harris Corp. Broadcast Products Div.
 Hitachi Denshi America, Ltd.
 Ikegami Electronics (USA) Inc.
 Lectrotech Inc.
 Lenco Inc. Electronics Div.
 Marconi Communication Systems Ltd.
 Rohde & Schwarz Sales Co.
 Sharp Electronics Corp.
 Tektronix Inc.
 Ultra Audio Pixtec

Multicarrier Systems, FM

Coastcom
 GTE Lenkurt, Inc.
 Moseley Associates, Inc.
 RMC-Radio Mfg. Co.
 Sharepoint Systems Inc.

Multimeters, Microwave

The Narda Microwave Corporation

Multiplexers

See Adv. Page

Buhl Optical Co.163

Alford Mfg. Co.
 Bayly Engineering Ltd. Member of AEG-Telefunken Group
 Blonder-Tongue Labs.
 Buhl Optical Co.
 Cetec Broadcast Group
 Coastcom
 Cohu, Inc. Electronics Div.
 Comark Industries Inc.
 Dielectric Communications A Unit of General Signal
 GTE Lenkurt, Inc.
 Harris Corp. Broadcast Products Div.

Amtron Corp.
 Laird Telemedia Inc.
 Micro Communications, Inc.
 Moseley Associates, Inc.
 Motorola Semiconductor Products Inc.
 Mu-Del Electronics, Inc.
 North Hills Electronics, Inc.
 Shively Laboratories, Inc.
 TT Electronics, Inc.
 Tektronix Inc.
 Telegen/Sofratev
 Telemation, A Div. of Bell & Howell
 TerraCom Loral Corp.
 Thomson-CSF Laboratories, Inc.
 Times Fiber Communications, Inc.
 The Zei-Mark Corp.

Music, Production

Columbia Special Products
 De Wolfe Music Library
 Thomas Valentino Inc.

Music, Sound Effects

Columbia Special Products
 De Wolfe Music Library
 Thomas Valentino Inc.

Narrow Band FM Equipment

CSI Electronics, Inc.
 Coastcom
 Dielectric Communications A Unit of General Signal
 Marti Electronics
 McMartin Industries, Inc.
 Motorola Communications and Electronics Inc.
 Panasonic Company
 Singer Products Co., Inc.
 Times Fiber Communications, Inc.

Network Joiners

Cetec Broadcast Group
 ESE
 IGM Div. of Northwestern Tech.

Networks, Matching Audio

See Adv. Page

Gerard Tech154

Altec Lansing Sound Products
 Automated Processes, Inc.
 DYMA Engineering, Inc.
 Gerard Tech
 ITI Electronics, Inc.
 Protech Audio Corp.
 Quad-Eight Electronics
 TT Electronics, Inc.
 Tech Laboratories Inc.

Networks, Matching RF

See Adv. Page

Electro Impulse, Inc.161

Alford Mfg. Co.
 CCA Electronics Corp.
 CSI Electronics, Inc.
 Cetec Broadcast Group
 Comark Communications Industries, Inc.
 Comark Industries Inc.
 Continental Electronics Mfg. Co.
 Dielectric Communications A Unit of General Signal
 ESC Electronics Corp.
 Electro Impulse, Inc.
 Micro Communications, Inc.
 Multronics, Inc.
 North Hills Electronics, Inc.
 TT Electronics, Inc.
 Wide Band Engineering Co., Inc.

Networks, Mixing

Dielectric Communications A Unit of General Signal
 Protech Audio Corp.
 Quad-Eight Electronics
 ROH Corporation
 Tech Laboratories Inc.

Networks, Phasing --See also Phasing Units

See Adv. Page

C. S. P. Inc.144
Geleco Electronics Ltd.170

CSI Electronics, Inc.
 C. S. P. Inc.
 Cetec Broadcast Group
 Collins Div. Rockwell International
 Comark Industries Inc.
 Continental Electronics Mfg. Co.
 Dielectric Communications A Unit of General Signal
 Geleco Electronics Ltd.
 Kahn Communications, Inc.
 Multronics, Inc.
 TT Electronics, Inc.

Noise Reduction Systems

See Adv. Page

Audio & Design Recording Inc.111
Dolby Laboratories, Inc.105
Microtime, Inc.13
Philips Broadcast Equip Corp.22-23

Audio & Design Recording Inc.
 BSC Inc.
 Consolidated Video Systems dbx, Inc.
 Dolby Laboratories, Inc.
 Electro & Optical Systems Ltd.
 Evertime Clock Works Inc.
 Yves Faroudja, Inc.
 Gotham Audio Corp.
 Harris Corp. Broadcast Products Div.
 Heath Co.
 Inovonics
 Kahn Communications, Inc.
 Roger Mayer Electronics, Inc.
 Micro Consultants
 Microtime, Inc.
 NEC America, Inc. Broadcast Equip. Div.
 Orange County Electronics Int'l., Inc.
 Philips Broadcast Equip Corp.
 Telemation, A Div. of Bell & Howell
 Thomson-CSF Laboratories, Inc.

Oscillator Transformers

Nortronics Co., Inc. Recorder Care Div.
 TT Electronics, Inc.
 Weinschel Engineering Co.

Oscillators, AM

Delta Electronics Inc. (Va.)
 DYMA Engineering, Inc.
 John Fluke Mfg. Co., Inc.
 Frequency Devices Inc.
 Heath Co.
 International Microwave Corp.
 Lampkin Lab. Inc.
 Marconi Instruments Div. of Marconi Electronics Inc.
 Opamp Labs, Inc.
 Philips Test & Measuring Instruments, Inc.
 Rohde & Schwarz Sales Co.
 Singer Products Co., Inc.
 Texscan Corp.

Oscillators, FM

Continental Specialties Corp.
 John Fluke Mfg. Co., Inc.
 Frequency Devices Inc.
 Heath Co.
 Marconi Instruments Div. of Marconi Electronics Inc.
 Rohde & Schwarz Sales Co.
 Texscan Corp.

Oscillators, Tone

See Adv. Page

Bald Mountain Lab151

Altec Lansing Sound Products
 Bald Mountain Lab
 Channelmatic, Inc.
 Continental Specialties Corp.
 Frequency Devices Inc.
 Gorman Redlich Mfg. Co.
 Hewlett-Packard Co.
 IGM Div. of Northwestern Tech.
 Ionic Industries, Inc.
 Modular Audio Products Unit of
 Modular Devices, Inc.
 Monroe Electronics, Inc.
 Motorola Communications and
 Electronics Inc.
 Rupert Neve, Inc.
 Opamp Labs, Inc.
 Protech Audio Corp.
 Quad-Eight Electronics
 Sphere Electronics
 TM Systems, Inc.
 Telecommunications Technology
 Wang Voice Comm. Inc.
 Ward-Beck Systems, Ltd.

Oscillators, TV

ATV Research
 Asaca Corp. of America
 Heath Co.
 Lectrotech Inc.
 Leitch Video Ltd.
 Marconi Instruments Div. of Marconi
 Electronics Inc.
 Rohde & Schwarz Sales Co.
 Tektronix Inc.

Oscilloscope Cameras

Harris Corp. Broadcast Products Div.
 Lenzar Optics Corp.
 Philips Test & Measuring Instruments,
 Inc.
 Tektronix Inc.

Oscilloscope Vector Displays

Alford Mfg. Co.
 B & K Precision Dynascan Corp.
 Broadcast Video Systems, Ltd.
 Electro & Optical Systems Ltd.
 Harris Corp. Broadcast Products Div.
 Heath Co.
 Lectrotech Inc.
 Lenco Inc. Electronics Div.
 Sencore Inc.
 Tektronix Inc.
 Ultra Audio Pixtec

Oscilloscopes, Dual Trace

B & K Precision Dynascan Corp.
 Ballantine Labs, Inc.
 Gould Inc. Instruments Div.
 Harris Corp. Broadcast Products Div.
 Heath Co.
 Hickok Elec. Inst. Co.
 Hitachi Denshi America, Ltd.
 Leader Instruments Corp.
 Lectrotech Inc.
 Motorola Communications and
 Electronics Inc.
 Philips Test & Measuring Instruments,
 Inc.
 SPI-ITT Metrix Instruments Div.
 Sencore Inc.
 Tektronix Inc.

Oscilloscopes, Rack Type

B & K Precision Dynascan Corp.
 Ballantine Labs, Inc.
 California Instruments
 Gould Inc. Instruments Div.
 Harris Corp. Broadcast Products Div.
 Hickok Elec. Inst. Co.
 Leader Instruments Corp.
 Lenco Inc. Electronics Div.
 Philips Test & Measuring Instruments,
 Inc.
 Tektronix Inc.

Oscilloscopes, Triggered Sweep

B & K Precision Dynascan Corp.
 Ballantine Labs, Inc.
 Gould Inc. Instruments Div.

Harris Corp. Broadcast Products Div.
 Heath Co.
 Hickok Elec. Inst. Co.
 Leader Instruments Corp.
 Lectrotech Inc.
 Motorola Communications and
 Electronics Inc.
 Philips Test & Measuring Instruments,
 Inc.
 SPI-ITT Metrix Instruments Div.
 Sencore Inc.
 Singer Products Co., Inc.
 Tektronix Inc.

Oscilloscopes, Wideband

Gould Inc. Instruments Div.
 Harris Corp. Broadcast Products Div.
 Heath Co.
 Hickok Elec. Inst. Co.
 Leader Instruments Corp.
 Lectrotech Inc.
 Philips Test & Measuring Instruments,
 Inc.
 SPI-ITT Metrix Instruments Div.
 Sencore Inc.
 Tektronix Inc.

Oscilloscopes with Plug-ins

SPI-ITT Metrix Instruments Div.
 Tektronix Inc.

**Parts and Components,
 Electronic Equipment**

See Adv. Page
Geleco Electronics Ltd. 170

ADC Products
 Bayly Engineering Ltd. Member of
 AEG-Telefunken Group
 Broadcast Electronics, Inc.
 Continental Specialties Corp.
 Geleco Electronics Ltd.
 Merlin Engineering Works, Inc.
 Microtran Co., Inc.
 Panasonic Company
 RCA Solid State Div.
 UTE Microwave, Inc.
 Varian Associates, Inc. Electron Device
 Group
 Varian/Beverly Micro-Link Products
 Vector Electronic Co., Inc.

Patch Panels

See Adv. Page
Switchcraft Inc. 15
Telectric Co. 160
Trompeter Electronics 66

ADC Products
 AVAB America Inc.
 Altec Lansing Sound Products
 Audio Accessories Inc.
 Audio Designs & Mfg.
 Audionics, Inc.
 Bayly Engineering Ltd. Member of
 AEG-Telefunken Group
 Berkey-Colortran Inc.
 Broadcast Electronics, Inc.
 CCA Electronics Corp.
 Comark Industries Inc.
 Dielectric Communications A Unit of
 General Signal
 DYMA Engineering, Inc.
 Dynatech Data Systems
 Gienronix Ltd.
 Harris Corp. Broadcast Products Div.
 Kliegl Bros. Lighting
 Micro Communications, Inc.
 Phelps Dodge Communications Co.
 Potomac Instruments, Inc.
 Rex Rheostat & Co., Inc.
 Shively Laboratories, Inc.
 Singer Products Co., Inc.
 Strand Century, Inc.
 Switchcraft Inc.
 TEAC Corp of America
 Telectric Co.
 Theatre Techniques Inc.
 Trompeter Electronics
 Union Connector Co., Inc.

**Phase Converters, Single to
 Three Phase**

California Instruments
 Harris Corp. Broadcast Products Div.
 Kay Industries, Inc.

Phase Enhancers, Stereo

EDCO Products, Inc.

**Phasing Units -- See also
 Networks, Phasing**

See Adv. Page
C. S. P. Inc. 144

Alford Mfg. Co.
 CSI Electronics, Inc.
 C. S. P. Inc.
 Comark Industries Inc.
 Continental Electronics Mfg. Co.
 Dielectric Communications A Unit of
 General Signal
 Eventide Clock Works Inc.
 Geleco Electronics Ltd.
 Harris Corp. Broadcast Products Div.
 Ikegami Electronics (USA) Inc.
 Kahn Communications, Inc.
 Multronics, Inc.
 TT Electronics, Inc.

**Plans, Broadcast Equipment
 Construction**

Audicon, Inc.
 Don Britton Enterprises
 C. S. P. Inc.
 Centro Corp.
 DYMA Engineering, Inc.
 Harris Corp. Broadcast Products Div.
 RMC-Radio Mfg. Co.
 Sharepoint Systems Inc.
 Suda Seisakusho Co., Ltd.

Pointers, Video Screen

Central Dynamics Corp.
 Ednalite Corp.
 Industrial Sciences, Inc. (ISI)
 Interand Corp. Telestrator Div.

Power Supplies, AC

AKG Acoustics Div. Philips Audio
 Video Systems
 Altec Lansing Sound Products
 Keith Anderson Co.
 Anderson Scientific
 B & K Precision Dynascan Corp.
 California Instruments
 Cetec Broadcast Group
 Delta Electronics Inc. (N.C.)
 Engineering Associates
 The Finney Co.
 John Fluke Mfg. Co., Inc.
 G C Electronics Div. Wallace Murray
 Heath Co.
 ITI Electronics, Inc.
 Jerrold Electronics Corp.
 Kay Industries, Inc.
 Merrill Cable Equipment Corp.
 Motorola Communications and
 Electronics Inc.
 Nagra Magnetic Recorders, Inc.
 Nova Electric Mfg. Co.
 Opamp Labs, Inc.
 Quad-Eight Electronics
 Sencore Inc.
 Singer Products Co., Inc.
 Sorenson Co. A Unit of Raytheon Co.
 Tektronix Inc.
 Topaz Electronics

Power Supplies, Precision

See Adv. Page
**Modular Audio
 Products 127**

Altec Lansing Sound Products
 B & K Precision Dynascan Corp.
 Boston Sound & Power Systems
 California Instruments

Comark Communications Industries,
 Inc.
 Computer Products Inc. Power
 Products Div.
 Engineering Associates
 Frequency Devices Inc.
 G C Electronics Div. Wallace Murray
 Harris Corp. PRD Electronics Div.
 Heath Co.
 Lectrotech Inc.
 Modular Audio Products Unit of
 Modular Devices, Inc.
 North Hills Electronics, Inc.
 Opamp Labs, Inc.
 Protech Audio Corp.
 Sorenson Co. A Unit of Raytheon Co.
 Systron-Donner
 Tektronix Inc.
 Ward-Beck Systems, Ltd.

Power Supplies, Standby

Computer Products Inc. Power
 Products Div.
 Kay Industries, Inc.
 Nova Electric Mfg. Co.
 Tech Laboratories Inc.
 Topaz Electronics

Preamplifiers, Audio

See Adv. Page

**Modular Audio
 Products 127**
Ramko Research Inc. 28-29
**Russco Electronics
 Mfg. Inc. 76**
VIF International 66

Altec Lansing Sound Products
 American Data Corp. A North
 American Philips Co.
 Audio & Design Recording Inc.
 Audio Designs & Mfg.
 Audio Interface, Inc.
 Audionics, Inc.
 Autogram Corp.
 Automated Processes, Inc.
 BGW Systems Inc.
 Bayly Engineering Ltd. Member of
 AEG-Telefunken Group
 Bell Audio Systems, Inc.
 Blonder-Tongue Labs.
 Bogen Div. Lear Siegler, Inc.
 Boston Sound & Power Systems
 Broadcast Electronics, Inc.
 Cetec Broadcast Group
 Crown International, Inc.
 Delta Electronics Inc. (N.C.)
 DYMA Engineering, Inc.
 Dynair Electronics, Inc.
 Electro Sound, Inc.
 G C Electronics Div. Wallace Murray
 Harris Corp. Broadcast Products Div.
 Heath Co.
 Holland Electronics
 Integrated Solid Systems Inc. GLI
 Brand
 International Communications &
 Control Corp.
 International Nuclear Corp.
 Kaitronics Corp.
 James B. Lansing Sound, Inc.
 Logitek Electronic Systems, Inc.
 McCurdy Radio Ind. Inc.
 MicroMartin Industries, Inc.
 Micro-Trak Corp.
 Modular Audio Products Unit of
 Modular Devices, Inc.
 Motorola Semiconductor Products Inc.
 Nagra Magnetic Recorders, Inc.
 Rupert Neve, Inc.
 Opamp Labs, Inc.
 Orange County Electronics Int'l, Inc.
 Panasonic Company
 Paso Sound Products Inc.
 Protech Audio Corp.
 QRK Electronic Products
 Quad-Eight Electronics
 RCA Broadcast Systems
 RMC-Radio Mfg. Co.
 ROH Corporation
 RTS Systems, Inc.
 Ramko Research Inc.
 Richmond Sound Design, Ltd.
 Russco Electronics Mfg. Inc.

Sescom, Inc.
Shure Brothers Inc.
Singer Products Co., Inc.
Sono-Mag Corp.
Sontec Electronics
Spectra Sonics
Sphere Electronics
Stanton Magnetics Inc.
Studer Revox America
Superex Electronics Corp.
Tape-Athon Corp.
Telex Communications, Inc.
Track Audio, Inc. (TA)
United Recording Electronics Industries
VIF International
Wilkinson Electronics, Inc.

Preamplifiers, Limiter-Compressor

See Adv. Page

Audio & Design Recording Inc.111
Orange County Electronics Int'l., Inc.108
Ramko Research Inc. 28-29

Altec Lansing Sound Products
Audio & Design Recording Inc.
Automated Processes, Inc.
DYMA Engineering, Inc.
Gregg Laboratories
Harris Corp. Broadcast Products Div.
ITI Electronics, Inc.
International Communications & Control Corp.
Roger Mayer Electronics, Inc.
Modular Audio Products Unit of Modular Devices, Inc.
Orange County Electronics Int'l., Inc.
Protech Audio Corp.
Quad-Eight Electronics
Ramko Research Inc.
Richmond Sound Design, Ltd.
Sescom, Inc.
Singer Products Co., Inc.
Sontec Electronics
Spectra Sonics
Track Audio, Inc. (TA)
Ultra Audio Pixtec
Wang Voice Comm. Inc.

Preamplifiers, Microphone

See Adv. Page

Modular Audio Products127
Ramko Research Inc. 28-29
Russco Electronics Mfg. Inc. 76

AKG Acoustics Div. Philips Audio Video Systems
Altec Lansing Sound Products
Audio & Design Recording Inc.
Audio Designs & Mfg.
Autogram Corp.
Automated Processes, Inc.
Cetec Broadcast Group
DYMA Engineering, Inc.
Edcor
Gregg Laboratories
Harris Corp. Broadcast Products Div.
Holland Electronics
ITI Electronics, Inc.
International Communications & Control Corp.
Logitek Electronic Systems, Inc.
Roger Mayer Electronics, Inc.
Micro-Trak Corp.
Modular Audio Products Unit of Modular Devices, Inc.
Nagra Magnetic Recorders, Inc.
Opamp Labs, Inc.
Protech Audio Corp.
QRK Electronic Products
Quad-Eight Electronics
ROH Corporation
RTS Systems, Inc.
Ramko Research Inc.
Richmond Sound Design, Ltd.
Russco Electronics Mfg. Inc.
Sescom, Inc.
Sontec Electronics

Spectra Sonics
Sphere Electronics
United Recording Electronics Industries

Preamplifiers, Microwave

Avantek, Inc.

Preamplifiers, Stereo

See Adv. Page

Ramko Research Inc. 28-29
Russco Electronics Mfg. Inc. 76

Audio Interface, Inc.
Automated Processes, Inc.
Cetec Broadcast Group
DYMA Engineering, Inc.
Eumig USA, Inc.
Harris Corp. Broadcast Products Div.
Heath Co.
Integrated Solid Systems Inc. GLI Brand
International Communications & Control Corp.
Logitek Electronic Systems, Inc.
Micro-Trak Corp.
Modular Audio Products Unit of Modular Devices, Inc.
Panasonic Company
Protech Audio Corp.
QRK Electronic Products
RMC-Radio Mfg. Co.
Ramko Research Inc.
Richmond Sound Design, Ltd.
Russco Electronics Mfg. Inc.
Sontec Electronics
Spectra Sonics
Wang Voice Comm. Inc.

Preamplifiers, Turntable

See Adv. Page

Modular Audio Products127
Ramko Research Inc. 28-29
Russco Electronics Mfg. Inc. 76

Ampro Broadcasting
Audio Interface, Inc.
Audionics, Inc.
Automated Processes, Inc.
BGW Systems Inc.
Broadcast Electronics, Inc.
Cetec Broadcast Group
DYMA Engineering, Inc.
Gregg Laboratories
Harris Corp. Broadcast Products Div.
Integrated Solid Systems Inc. GLI Brand
International Communications & Control Corp.
LPB Inc.
Logitek Electronic Systems, Inc.
McCurdy Radio Ind. Inc.
McMartin Industries, Inc.
Micro-Trak Corp.
Modular Audio Products Unit of Modular Devices, Inc.
Rupert Neve, Inc.
Opamp Labs, Inc.
Pinzone Communications Products Inc.
Protech Audio Corp.
QRK Electronic Products
RMC-Radio Mfg. Co.
ROH Corporation
Ramko Research Inc.
Russco Electronics Mfg. Inc.
Shure Brothers Inc.
Singer Products Co., Inc.
Sontec Electronics
Spectra Sonics
Stanton Magnetics Inc.
Track Audio, Inc. (TA)
United Recording Electronics Industries
Wilkinson Electronics, Inc.

Preamplifiers, Video

Blonder-Tongue Labs.
Gardiner Communications Corp.

International Nuclear Corp.
Kaitronics Corp.
Lenco Inc. Electronics Div.
Radiation Devices Co., Inc.

Pressurization Equipment, Transmission Line

Andrew Corp.
CCA Electronics Corp.
Cablewave Systems Inc.
Cetec Broadcast Group
Dielectric Communications A Unit of General Signal
General Cable Corp.
Harris Corp. Broadcast Products Div.
Micro Communications, Inc.

Probes, Oscilloscope

B & K Precision Dynascan Corp.
Heath Co.
Hickok Elec. Inst. Co.
Leader Instruments Corp.
Lectrotech Inc.
Philips Test & Measuring Instruments, Inc.
SPI-ITT Metrix Instruments Div.
Tektronix Inc.

Processors, Electronic Still

ADDA Corp.
Echo Science Corp.

Processors, Film Color

Allen Products Co.
Houston Fearless 76
Houston Photo Products, Inc.
Jamieson Film Co.
Kreonite, Inc.
Radmar, Inc.

Processors, Silver Recovery Unit

Eastman Kodak Co.
Houston Fearless 76
Houston Photo Products, Inc.
Leedal, Inc.

Processors, VTR

See Adv. Page

Lenco Inc. 95

Convergence Corp.
Dynasciences Div. Whittaker Corp.
Yves Faroudja, Inc.
Leitch Video Ltd.
Lenco Inc. Electronics Div.
3M Co. Mincom Div.
Versa Count Engineering

Production Systems, AM or FM Remote or Studio

See Adv. Page

Tangent Systems, Inc.136

Automated Processes, Inc.
Broadcast Electronics, Inc.
Cetec Broadcast Group
Harris Corp. Broadcast Products Div.
IGM Div. of Northwestern Tech.
MICMIX Audio Products, Inc.
Micro-Trak Corp.
Moseley Associates, Inc.
Orange County Electronics Int'l., Inc.
Pacific Recorders and Engrg. Corp.
Protech Audio Corp.
Sharepoint Systems Inc.
Singer Products Co., Inc.
Tangent Systems, Inc.

Programmed Music

Emil Ascher, Inc.
Broadcast Programming Int'l., Inc.
The ChB Studios
CaVox Stereo Productions
Cetec Broadcast Group
Command Productions Radio Broadcasting Services

Musicom, Inc.
Radio Arts
Tape-Athon Corp.
Thomas Valentino Inc.

Programmer/Comparators

See Adv. Page

The BTX Corp. 90

The BTX Corp.
ESE
PWH Electronics
Tape-Athon Corp.

Programmers, Patchboard/Thumbwheel

Cherry Electrical Products
ESE
Harris Corp. Broadcast Products Div.

Projector Lamps

GTE Sylvania Inc. Lighting Products Group
Packaged Lighting Systems
Plastic Reef Corp. of America
Riluma Co. of America
Sittler's Supplies, Inc.
Strand Century, Inc.
Varian Associates, Inc. Electron Device Group

Projectors, Film

See Adv. Page

L-W International137

Bell & Howell Audio Visual Div.
Dukane Corp. Audio-Visual Div.
Eastman Kodak Co.
Alan Gordon Enterprises Inc.
Harris Corp. Broadcast Products Div.
Kalart Victor Corp.
L-W International
Laird Telemedia Inc.
Optical Radiation Corp.
Radmar, Inc.
The Zei-Mark Corp.

Projectors, Film Cassette Loading

Dukane Corp. Audio-Visual Div.
Radmar, Inc.

Projectors, Film Rear

Dukane Corp. Audio-Visual Div.
Electro & Optical Systems Ltd.
Radmar, Inc.

Projectors, Slide

See Adv. Page

Laird Telemedia Inc.158

Buhl Optical Co.
Eastman Kodak Co.
Harris Corp. Broadcast Products Div.
Kliegl Bros. Lighting
Laird Telemedia Inc.
Mast Development Co. A-V Systems Div.
Optical Radiation Corp.
Radmar, Inc.
Spindler & Sauppe, Inc.
The Zei-Mark Corp.

Projectors, TV Large Screen

See Adv. Page

General Electric Co. 87

Conrac Systems-East Div.
Electrohome Ltd.
General Electric Co. Video Display Equip. Op.
Ikegami Electronics (USA) Inc.
Image Magnification, Inc.
Kalart Victor Corp.
Panasonic Company

Panasonic Co. Video Systems Div.
Projection Systems, Inc.
Schudel, Inc.
Sony Corp. of America

Prompters

BEI Beston Electronics, Inc.
Q-TV
Telescript, Inc.

Proof Workbook (For FCC test requirements)

Intertec Publishing Corp.

Pulse Assignment Systems

Broadcast Video Systems, Ltd.
Central Dynamics Corp.
Kaitronics Corp.
Leitch Video Ltd.
Lenco Inc. Electronics Div.

Purchasing Services, Broadcast Equipment

See Adv. Page

Collins Div. 79

Centro Corp.
Collins Div. Rockwell International
DYMA Engineering, Inc.
Industrial Marketing Advisory Services, Inc.
RMC-Radio Mfg. Co.

Quadraphonic Systems

Audionics, Inc.
Belar Electronics Lab., Inc.
Catel Div. United Scientific Corp.
Cetec Audio
Heath Co.
Rupert Neve, Inc.
Spectra Sonics

Radar, Weather

Arvin/Echo Science Corp.
Echo Science Corp.
Enterprise Electronics Corp.
TSC Development Labs.
Technology Service Corp.
Development Labs Div.
Varian Associates, Inc. Electron Device Group
Weathermat, Inc.
Weather Scan, Inc.

Radomes

Andrew Corp.
Cetec Broadcast Group
Collins Div. Rockwell International
Gabriel Electronics, Inc.
Harris Corp. Broadcast Products Div.
Micro Communications, Inc.
Nurad, Inc.
Shively Laboratories, Inc.

Receivers, AM

See Adv. Page

Delta Electronics Inc. (Va.) 107

Bell Audio Systems, Inc.
Bogen Div. Lear Siegler, Inc.
Delta Electronics Inc. (Va.)
Elcom Engineering Co.
Heath Co.
International Microwave Corp.
Kahn Communications, Inc.
Marconi Instruments Div. of Marconi Electronics Inc.
McKay Dymek Co.
McMartin Industries, Inc.
Micro Communications, Inc.
National Electrolab Ltd.
Panasonic Company
Sansui Electronics Corp.
Singer Products Co., Inc.

Receivers, Data

Coastcom
Electrohome Ltd.
International Microwave Corp.
McMartin Industries, Inc.
Moseley Associates, Inc.
Radiation Devices Co., Inc.

Receivers, EBS

Elcom Engineering Co.
Fix Tune Solid State Electronics, Inc.
Gorman Redlich Mfg. Co.
Harris Corp. Broadcast Products Div.
Logitek Electronic Systems, Inc.
McMartin Industries, Inc.
Time & Frequency Tech., Inc.

Receivers, Earth Station

California Microwave
Gardiner Communications Corp.
Harris Corp. Broadcast Products Div.
Microdyne Corp.
TerraCom Loral Corp.

Receivers, FM

See Adv. Page

Wilkinson Electronics, Inc. 172

Altec Lansing Sound Products
Bell Audio Systems, Inc.
Bogen Div. Lear Siegler, Inc.
CCA Electronics Corp.
Catel Div. United Scientific Corp.
Electrohome Ltd.
Fix Tune Solid State Electronics, Inc.
GTE Lenkurt, Inc.
Heath Co.
International Microwave Corp.
Johnson Electronics Inc.
Marconi Instruments Div. of Marconi Electronics Inc.
Marti Electronics
McMartin Industries, Inc.
Micro Communications, Inc.
Panasonic Company
RHG Electronics Laboratory, Inc.
Rohde & Schwarz Sales Co.
Sansui Electronics Corp.
The Ken Schaffer Group, Inc.
Scientific Radio Systems, Inc.
Singer Products Co., Inc.
Studer Revox America
Times Fiber Communications, Inc.
Wilkinson Electronics, Inc.

Receivers, HF

Collins Div. Rockwell International
Elcom Engineering Co.
Engineering Associates
Heath Co.
Marconi Electronics Inc. Broadcast & Communication Div.
Marconi Instruments Div. of Marconi Electronics Inc.
McKay Dymek Co.
Rohde & Schwarz Sales Co.
Scientific Radio Systems, Inc.
Singer Products Co., Inc.

Receivers, Microwave

ALLTECH Div. Cutler-Hammer Los Angeles Operation
Engineering Associates
Farinon Video
International Microwave Corp.
Marti Electronics
Micro Control Associates, Inc.
Microdyne Corp.
Moseley Associates, Inc.
Nurad, Inc.
RHG Electronics Laboratory, Inc.
Scientific-Atlanta, Inc.
Tepco Corp.
TerraCom Loral Corp.
Varian Associates, Inc. Electron Device Group
Varian/Beverly Micro-Link Products

Receivers, Multiplex

CCA Electronics Corp.
Coastcom
GTE Lenkurt, Inc.
Heath Co.
International Microwave Corp.
McMartin Industries, Inc.
Moseley Associates, Inc.
Singer Products Co., Inc.

Receivers, SCA

Contel Mfg.
Fix Tune Solid State Electronics, Inc.
Harris Corp. Broadcast Products Div.
Johnson Electronics Inc.
Marti Electronics
McMartin Industries, Inc.
Moseley Associates, Inc.
Singer Products Co., Inc.

Receivers, Time Signal

See Adv. Page

ESE 153

Catel Div. United Scientific Corp.
Datametrics Inc.
ESE
Elcom Engineering Co.

Receivers, TV Color

See Adv. Page

Electrohome Ltd. 36

Electrohome Ltd.
Heath Co.
Image Magnification, Inc.
Panasonic Company
Panasonic Co. Video Systems Div.
Pleasantville Labs
QSI Systems, Inc.
Rohde & Schwarz Sales Co.
Sharp Electronics Corp.
Sony Corp. of America

Receivers, TV Monochrome

Electrohome Ltd.
Heath Co.
Panasonic Company
Panasonic Co. Video Systems Div.
QSI Systems, Inc.
Sony Corp. of America

Receivers, 162.55 MHz Weather

Catel Div. United Scientific Corp.
Gorman Redlich Mfg. Co.
Heath Co.
Motorola Communications and Electronics Inc.
Scientific Radio Systems, Inc.
Singer Products Co., Inc.

Record Care Products

See Adv. Page

Stanton Magnetics Inc. 113

Stanton Magnetics Inc.

Recorder Amplifiers

See Adv. Page

Inovonics 164

AEG-Telefunken Magnetic Tape Recorder Dept.
Gould Inc. Instruments Div.
Harris Corp. Broadcast Products Div.
Inovonics
International Tapetronics Corp.
Taber Mfg. & Engr. Co.
Telectro Systems Corp.
Telex Communications, Inc.
Transist-O-Sound Inc.
United Research Lab Corp.
VIF International

Recorder Care Kits, Video

KAPCO Communications
Nortronics Co., Inc. Recorder Care Div.

Recorder Carrying Systems, Videotape Portable

Comprehensive Video Supply Corp.
Gruber Products Co.
Javelin Electronics
K & H Products, Ltd.
Panasonic Company

Recorder Drive Motor Power Supply Units

Merlin Engineering Works, Inc.

Recorder Modifications, Reel Servo

See Adv. Page

Recortec Inc. 5

Inovonics
Merlin Engineering Works, Inc.
Recortec Inc.
Telectro Systems Corp.

Recorder Reconditioning, Videotape

A. F. Associates, Inc.
Applied Video Electronics, Inc.
Lawhed, Ltd.
Merlin Engineering Works, Inc.
RCA Broadcast Systems

Recorder Replacement Capstan Assembly

Triple I
United Research Lab Corp.

Recorder Replacement Electronics

See Adv. Page

Inovonics 164
VIF International 66

Ampro/Scully Div. Ram Mfg. Inc.
Computer Magnetics Corp.
Inovonics
Lawhed, Ltd.
Merlin Engineering Works, Inc.
Opamp Labs, Inc.
Orange County Electronics Int'l., Inc.
Sharepoint Systems Inc.
Taber Mfg. & Engr. Co.
Telex Communications, Inc.
United Research Lab Corp.
VIF International

Recorder Replacement Motors

Ampro/Scully Div. Ram Mfg. Inc.
Broadcast Electronics, Inc.
Merlin Engineering Works, Inc.
UMC Electronics Co. Broadcast Products Div.
United Research Lab Corp.

Recorder Tape Tension Controls, Audio

Inovonics

Recorder Tape Tension Controls, VTR

See Adv. Page

Tentel 162

Merlin Engineering Works, Inc.
Microtime, Inc.
Tentel

Recorder Tape Tension Gauges

See Adv. Page

Tentel162

Nagra Magnetic Recorders, Inc.
Tentel

Recorder Velocity Error Correctors

Computer Magnetics Corp.
Digital Video Systems
Lawhed, Ltd.
Merlin Engineering Works, Inc.

Recorder V-Lock Helical Attachments

ENG Products Corp.
Merlin Engineering Works, Inc.

Recorders, Audio Cartridge

See Adv. Page

Consolidated Electronic Industries 14
Ramko Research Inc. 28-29

AEG-Telefunken Magnetic Tape Recorder Dept.
Amilon Corp.
Ampro Broadcasting
Automated Broadcast Controls
Broadcast Electronics, Inc.
Cetec Broadcast Group
Consolidated Electronic Industries
Contel Mfg.
Harris Corp. Broadcast Products Div.
IGM Div. of Northwestern Tech.
International Electro-Magnetics
McCurdy Radio Ind. Inc.
Micro-Trak Corp.
Panasonic Company
RCA Broadcast Systems
Ramko Research Inc.
Telex Communications, Inc.
UMC Electronics Co. Broadcast Products Div.
Video Research Corp.

Recorders, Audio Cassette

See Adv. Page

Ramko Research Inc. 28-29

Amilon Corp.
EDCO Products, Inc.
Heath Co.
Javelin Electronics
Micro-Trak Corp.
Panasonic Company
Radmar, Inc.
Ramko Research Inc.
Super 8 Sound, Inc.
TEAC Corp of America
Telex Communications, Inc.
Video Research Corp.

Recorders, Audio Reel

See Adv. Page

Ampro/Scully Div.....147
Otari Corp. 141, 143, 145
Studer Revox America75

AEG-Telefunken Magnetic Tape Recorder Dept.
Ampro/Scully Div. Ram Mfg. Inc.
Broadcast Electronics, Inc.
Cetec Broadcast Group
Consolidated Electronic Industries
Harris Corp. Broadcast Products Div.
International Electro-Magnetics
International Tapetronics Corp.
MCI, Inc.
McCurdy Radio Ind. Inc.
Micro-Trak Corp.
Nagra Magnetic Recorders, Inc.
Rupert Neve, Inc.
Otari Corp.
Pacific Recorders and Engrg. Corp.
Panasonic Company

Ramko Research Inc.
Studer Revox America
TEAC Corp of America
Tektronix Inc.
Telectro Systems Corp.
Telex Communications, Inc.
United Research Lab Corp.
Video Research Corp.

Recorders, Camera Tape to Film

AEG-Telefunken Magnetic Tape Recorder Dept.
Flash Technology Corp. of America

Recorders, Film Magnetic Sound

Frezolini Electronics, Inc.
Keeline Int'l.
Magnasync/Moviola Corp.
Magna-Tech Electronic Co., Inc.
Opamp Labs, Inc.
RCA Broadcast Systems
Super 8 Sound, Inc.
Wide Range Electronics

Recorders, Film Optical Sound

Opamp Labs, Inc.
RCA Broadcast Systems
Wide Range Electronics

Recorders, Magnetic Tape Logging

Amilon Corp.
B & K Instruments Inc.
Cetec Broadcast Group
EMT Franz VGmbH
Harris Corp. Broadcast Products Div.
IGM Div. of Northwestern Tech.
Magnasync/Moviola Corp.
Nagra Magnetic Recorders, Inc.
QSI Systems, Inc.
Singer Products Co., Inc.
Sono-Mag Corp.
Soundscriber Magnetic Recording Co., Inc.
Stancil-Hoffman Corp.
Studer Revox America
Telectro Systems Corp.
Telex Communications, Inc.
Video Research Corp.

Recorders, Paper Logging and Graphic

B & K Instruments Inc.
Broadcast Electronics, Inc.
John Fluke Mfg. Co., Inc.
Gould Inc. Instruments Div.
Harris Corp. Broadcast Products Div.
Heath Co.
Moseley Associates, Inc.
Phillips Test & Measuring Instruments, Inc.
Rohde & Schwarz Sales Co.
Scientific-Atlanta, Inc.
Sono-Mag Corp.
United Recording Electronics Industries

Recorders, Program Logging

Cetec Broadcast Group
Harris Corp. Broadcast Products Div.
IGM Div. of Northwestern Tech.
QSI Systems, Inc.
Soundscriber Magnetic Recording Co., Inc.
Telectro Systems Corp.
Telex Communications, Inc.

Recorders, Videotape

See Adv. Page

Arvin/Echo Science Corp. 6-7

Ampex Corp.
Arvin/Echo Science Corp.

Echo Science Corp.
Eigen Video
Oktel Corp.
Teknekron/ARG

Recorders, Video Slow Motion

See Adv. Page

Arvin/Echo Science Corp. 6-7
Eigen Video 178, 179

A. F. Associates, Inc.
Ampex Corp.
Arvin/Echo Science Corp.
Bosch-Fernseh Corp.
Echo Science Corp.
Eigen Video
Javelin Electronics
NEC America, Inc. Broadcast Equip. Div.
Oktel Corp.
Recortec Inc.
TEAC Corp of America

Recorders, Videotape Cartridge

Cinema Products Corp.
NEC America, Inc. Broadcast Equip. Div.
Panasonic Company
Panasonic Co. Video Systems Div.
RCA Broadcast Systems

Recorders, Videotape Cassette

See Adv. Page

Panasonic Co..... 49
Recortec Inc. 5
US JVC Corp..... 54-55

Bosch-Fernseh Corp.
Echo Science Corp.
Javelin Electronics
Motorola Communications and Electronics Inc.
Panasonic Company
Panasonic Co. Video Systems Div.
RCA Broadcast Systems
RCA Solid State Div.
Recortec Inc.
Sony Corp. of America
TEAC Corp. of America
US JVC Corp. Professional Video Div.
Videomedia

Recorders, Videotape Helical

See Adv. Page

Marconi Electronics Inc. 65
Panasonic Co..... 49
Philips Broadcast Equip Corp. 22-23
Recortec Inc. 5
Sony Corp. of America .38-39
US JVC Corp..... 54-55

Ampex Corp.
Bosch-Fernseh Corp.
Cinema Products Corp.
Hitachi Denshi America, Ltd.
Ikegami Electronics (USA) Inc.
International Video Corp.
Javelin Electronics
Marconi Electronics Inc. Broadcast & Communication Div.
NEC America, Inc. Broadcast Equip. Div.
Panasonic Co. Video Systems Div.
Philips Broadcast Equip Corp.
QSI Systems, Inc.
RCA Broadcast Systems
Recortec Inc.
Sony Corp. of America
US JVC Corp. Professional Video Div.

Recorders, Videotape Quad

A. F. Associates, Inc.
Ampex Corp.
Asaca Corp. of America
Merlin Engineering Works, Inc.
RCA Broadcast Systems

Recortec Inc.

Recording Services, Audiotape

Audio Magnetics Corp.
Command Productions Radio Broadcasting Services
Ray Jacobs Audio, Inc.
Media Concepts, Inc.
Tape-Athon Corp.
United Research Lab Corp.
Thomas Valentino Inc.

Recording Synchronizers

See Adv. Page

The BTX Corp..... 90

AEG-Telefunken Magnetic Tape Recorder Dept.
The BTX Corp.
Central Dynamics Corp.
EECO Inc.
Magna-Tech Electronic Co., Inc.
Nagra Magnetic Recorders, Inc.
Philips Broadcast Equip Corp.
Radmar, Inc.
Telex Communications, Inc.

Reel Storage/Retrieval Systems, Film and VTR

See Adv. Page

Storeel Corp.101
Winsted Corp.156

DYMA Engineering, Inc.
Neumade Products Corp.
Plastic Reel Corp. of America
Research Technology, Inc.
Storeel Corp.
Wallach & Associates Inc.
Winsted Corp.

Reels, Cable and Mike

See Adv. Page

Clifford B. Hannay & Son, Inc.176

D'San Corp.
E-N-G Corp.
Clifford B. Hannay & Son, Inc.

Reels, Magnetic Tape

See Adv. Page

Recording Supply Co.169

Audio Magnetics Corp.
Cetec Broadcast Group
Fuji Photo Film USA, Inc. Magnetic Tape Div.
Harris Corp. Broadcast Products Div.
Maxell Corp. of America
Memorex Corp. Professional Products Group
Nagra Magnetic Recorders, Inc.
Panasonic Company
Plastic Reel Corp. of America
Recording Supply Co.
Schuessler Case Co., Inc.
Soundscriber Magnetic Recording Co., Inc.
TEAC Corp of America
3M Co. Magnetic Audio/Video Prod. Div.

Reels, Videotape

See Adv. Page

Fuji Photo Film USA, Inc. 59

Fuji Photo Film USA, Inc. Magnetic Tape Div.
Javelin Electronics
Maxell Corp. of America
Memorex Corp. Professional Products Group
Panasonic Company
Panasonic Co. Video Systems Div.
Plastic Reel Corp. of America

QSI Systems, Inc.
Recording Supply Co.
Schuessler Case Co., Inc.
Sony Corp. of America
3M Co. Magnetic Audio/Video Prod. Div.

Reflectors, Passive

Fort Worth Tower Co., Inc.
Suda Seisakusho Co., Ltd.
Unarco-Rohn Div. of Unarco Ind., Inc.
Utility Tower Co.

Regulators, Voltage

Bayly Engineering Ltd. Member of AEG-Telefunken Group
California Instruments
Harris Corp. Broadcast Products Div.
Hitran Corp.
Kay Industries, Inc.
Microtran Co., Inc.
Motorola Semiconductor Products Inc.

Remote Antennas --See Antennas, Remote

Remote Broadcast Cue Systems

See Adv. Page
Comrex Corp. 166

Cetec Vega
Comrex Corp.
DYMA Engineering, Inc.
E.M.S Inc.
Harris Corp. Broadcast Products Div.
McMartin Industries, Inc.
Micro-Trak Corp.
Moseley Associates, Inc.
Motorola Communications and Electronics Inc.
Power-Optics Inc.

Remote Control Monitors, VIT

Marconi Instruments Div. of Marconi Electronics Inc.
Phillips Test & Measuring Instruments, Inc.

Remote Control Systems

See Adv. Page
Delta Electronics Inc. (Va.) 107
Hallikainen & Friends, Inc. 139
Kaitronics Corp. 12
Moseley Associates, Inc. 8
Time & Frequency Tech., Inc. 119
Utah Scientific, Inc. 85

American Laser Systems, Inc.
Bayly Engineering Ltd. Member of AEG-Telefunken Group
CCA Electronics Corp.
Cetec Broadcast Group
Cetec Vega
Channelmatic, Inc.
Comark Communications Industries, Inc.
Comark Industries Inc.
Continental Electronics Mfg. Co.
Delta Electronics Inc. (Va.)
DYMA Engineering, Inc.
E.M.S Inc.
Electro & Optical Systems Ltd.
Hallikainen & Friends, Inc.
Harris Corp. Broadcast Products Div.
IGM Div. of Northwestern Tech.
Image Magnification, Inc.
Image Video Ltd.
Kaitronics Corp.
Logitek Electronic Systems, Inc.
Marconi Communication Systems Ltd.
Marconi Instruments Div. of Marconi Electronics Inc.
Marti Electronics
McMartin Industries, Inc.

Micro Control Associates, Inc.
Monroe Electronics, Inc.
Moseley Associates, Inc.
Nurad, Inc.
PWH Electronics
Power-Optics Inc.
Protech Audio Corp.
Richmond Sound Design, Ltd.
Sharepoint Systems Inc.
Sono-Mag Corp.
Tele-Cine Inc.
Telecommunications Technology
Time & Frequency Tech., Inc.
Torpey Controls & Engineering Ltd.
Utah Scientific, Inc.
Vamco Engineering

Remote Pickup Receivers

See Adv. Page
McMartin Industries, Inc. 94
Moseley Associates, Inc. 8

CCA Electronics Corp.
Comrex Corp.
Farinon Video
Gorman Redlich Mfg. Co.
Harris Corp. Broadcast Products Div.
International Microwave Corp.
Marti Electronics
McMartin Industries, Inc.
Moseley Associates, Inc.
Motorola Communications and Electronics Inc.
Nurad, Inc.
Singer Products Co., Inc.
Telemet A Geotel Co.
TerraCom Loral Corp.

Remote Pickup Systems, Radio

See Adv. Page
McMartin Industries, Inc. 94
Moseley Associates, Inc. 8
Sony Corp. of America 83

Cetec Broadcast Group
Comrex Corp.
Harris Corp. Broadcast Products Div.
International Microwave Corp.
Marti Electronics
McMartin Industries, Inc.
Moseley Associates, Inc.
Motorola Communications and Electronics Inc.
Singer Products Co., Inc.
Sony Corp. of America
TerraCom Loral Corp.

Remote Pickup Transmitters

See Adv. Page
McMartin Industries, Inc. 94
Moseley Associates, Inc. 8

Comrex Corp.
Farinon Video
Harris Corp. Broadcast Products Div.
International Microwave Corp.
Marti Electronics
McMartin Industries, Inc.
Moseley Associates, Inc.
Motorola Communications and Electronics Inc.
Nurad, Inc.
Singer Products Co., Inc.
TerraCom Loral Corp.

Rental Equipment

Audicon, Inc.
Belden Communications, Inc.
Alan Gordon Enterprises Inc.
KVC, Inc.
Kliegl Bros. Lighting
Leasametric
One Pass Video
Plastic Reel Corp. of America

Power-Optics Inc.
RMC-Radio Mfg. Co.
Special Instruments Lab, Inc.
Portasound Div.
Tele-Cine Inc.
Video Rentals, Inc. Subs. of AF Associates

Reverberation Systems

AKG Acoustics Div. Philips Audio Video Systems
Altec Lansing Sound Products
Audicon, Inc.
DYMA Engineering, Inc.
EMT Franz VGmbH
Eventide Clock Works Inc.
Gotham Audio Corp.
Harris Corp. Broadcast Products Div.
MICMIX Audio Products, Inc.
Neutrik
Opamp Labs, Inc.
Orban Assoc. Inc.
Protech Audio Corp.
Quad-Eight Electronics
Quantum Audio Labs, Inc.
The Ken Schaffer Group, Inc.
Singer Products Co., Inc.
Technical Audio Products Corp.
URSA Major, Inc.
Wang Voice Comm. Inc.

Rewinders, Film

Kalart Victor Corp.
Magnasync/Moviola Corp.
Neumade Products Corp.
Plastic Reel Corp. of America
Research Technology, Inc.

Rewinders, Tape

Audico, Ltd.
Broadcast Electronics, Inc.
Magnesonics Mfg. & Sales Co.
Merlin Engineering Works, Inc.
Neumade Products Corp.
Pentagon Industries, Inc.
Plastic Reel Corp. of America
Ramko Research Inc.
Singer Products Co., Inc.

Safety Devices, Ladder

DHV, Inc.
Unarco-Rohn Div. of Unarco Ind., Inc.

Satellite, Program Distribution Services

Mutual Broadcasting System
RCA American Communications

Scramblers, Speech

Motorola Communications and Electronics Inc.
Panasonic Company

Screens, Projection Front

D. O. Industries
Da-Lite Screen Co., Inc.
Electrohome Ltd.
Raven Screen Corp.
Schudel, Inc.
Wilcox-Lange, Inc.

Screens, Projection Rear

Da-Lite Screen Co., Inc.
Raven Screen Corp.
Schudel, Inc.
Wilcox-Lange, Inc.

Semiconductors, IC's

See Adv. Page
JSH Electronics, Inc. 167

Bayly Engineering Ltd. Member of AEG-Telefunken Group
Cherry Electrical Products
Cherry Semiconductor
EEV Canada Ltd.

Electrolabs
G C Electronics Div. Wallace Murray Harris Corp. Broadcast Products Div.
JSH Electronics, Inc. A member co. of VSI Electronics
Mallory Distributor Prod. Co. Div. P. R. Mallory & Co. Inc.
Motorola Semiconductor Products Inc.
Opamp Labs, Inc.
Panasonic Company
RCA Distributor & Special Products Div.
RCA Solid State Div.
UHF Associates

Semiconductors, Rectifier General

Amperex Electronic Corp. Slatersville Div.
Bayly Engineering Ltd. Member of AEG-Telefunken Group
EEV Canada Ltd.
Electronic Devices, Inc.
Mallory Distributor Prod. Co. Div. P. R. Mallory & Co. Inc.
Motorola Semiconductor Products Inc.
RCA Distributor & Special Products Div.
Singer Products Co., Inc.
Varian Associates, Inc. Electron Device Group
Westinghouse Elec. Corp. Semiconductor Div.

Semiconductors, Rectifier High Voltage Stack

See Adv. Page
Wilkinson Electronics, Inc. 172

EEV Canada Ltd.
Electronic Devices, Inc.
Mallory Distributor Prod. Co. Div. P. R. Mallory & Co. Inc.
Motorola Semiconductor Products Inc.
RCA Distributor & Special Products Div.
RCA Solid State Div.
Singer Products Co., Inc.
Westinghouse Elec. Corp. Semiconductor Div.
Wilkinson Electronics, Inc.

Semiconductors, Rectifier Power

Amperex Electronic Corp. Slatersville Div.
Bayly Engineering Ltd. Member of AEG-Telefunken Group
EEV Canada Ltd.
Electronic Devices, Inc.
Mallory Distributor Prod. Co. Div. P. R. Mallory & Co. Inc.
Motorola Semiconductor Products Inc.
RCA Distributor & Special Products Div.
RCA Solid State Div.
Singer Products Co., Inc.
Westinghouse Elec. Corp. Semiconductor Div.

Semiconductors, Rectifier Silicon Controlled-SCR

Amperex Electronic Corp. Slatersville Div.
Bayly Engineering Ltd. Member of AEG-Telefunken Group
EEV Canada Ltd.
G C Electronics Div. Wallace Murray Motorola Semiconductor Products Inc.
Panasonic Company
RCA Distributor & Special Products Div.
RCA Solid State Div.
Singer Products Co., Inc.
Varian Associates, Inc. Electron Device Group
Westinghouse Elec. Corp. Semiconductor Div.

Semiconductors, Thyristor

Amperex Electronic Corp. Slatersville Div.
 Bayly Engineering Ltd. Member of AEG-Telefunken Group
 EEV Canada Ltd.
 G C Electronics Div. Wallace Murray
 Motorola Semiconductor Products Inc.
 Panasonic Company
 RCA Distributor & Special Products Div.
 RCA Solid State Div.
 Singer Products Co., Inc.
 Westinghouse Elec. Corp.
 Semiconductor Div.

Semiconductors, Transistor AF

Amperex Electronic Corp. Slatersville Div.
 Bayly Engineering Ltd. Member of AEG-Telefunken Group
 G C Electronics Div. Wallace Murray
 Mallory Distributor Prod. Co. Div. P. R. Mallory & Co. Inc.
 Motorola Semiconductor Products Inc.
 Panasonic Company
 RCA Distributor & Special Products Div.
 Singer Products Co., Inc.

Semiconductors, Transistor FET

Bayly Engineering Ltd. Member of AEG-Telefunken Group
 G C Electronics Div. Wallace Murray
 Mallory Distributor Prod. Co. Div. P. R. Mallory & Co. Inc.
 Motorola Semiconductor Products Inc.
 Panasonic Company
 RCA Distributor & Special Products Div.
 RCA Solid State Div.
 Singer Products Co., Inc.
 Varian Associates, Inc. Electron Device Group

Semiconductors, Transistor General

Amperex Electronic Corp. Slatersville Div.
 Bayly Engineering Ltd. Member of AEG-Telefunken Group
 G C Electronics Div. Wallace Murray
 Harris Corp. Broadcast Products Div.
 Motorola Semiconductor Products Inc.
 Panasonic Company
 RCA Distributor & Special Products Div.
 RCA Solid State Div.
 Singer Products Co., Inc.
 Westinghouse Elec. Corp.
 Semiconductor Div.

Semiconductors, Transistor RF

Amperex Electronic Corp. Slatersville Div.
 Avanteq, Inc.
 Bayly Engineering Ltd. Member of AEG-Telefunken Group
 EEV Canada Ltd.
 G C Electronics Div. Wallace Murray
 Motorola Semiconductor Products Inc.
 Panasonic Company
 RCA Distributor & Special Products Div.
 RCA Solid State Div.
 Singer Products Co., Inc.
 Varian Associates, Inc. Electron Device Group

Sensors, Tone

Cetec Broadcast Group
 Channelmatic, Inc.
 Consolidated Electronic Industries
 Frequency Devices Inc.
 IGM Div. of Northwestern Tech.
 Monroe Electronics, Inc.
 TM Systems, Inc.

Set-up Trucks

See Adv. Page

Storeel Corp.101

Cinema Products Corp.
 Harris Corp. Broadcast Products Div.
 Storeel Corp.
 Winsted Corp.

Shifters, Phase Microwave

Comark Industries Inc.
 Dielectric Communications A Unit of General Signal
 Maury Microwave Corp.
 Micro Communications, Inc.
 The Narda Microwave Corporation
 Singer Products Co., Inc.
 Systron-Donner

Slide Storage Systems

Multiplex Display Fixture Co.

Slow Scan TV Systems

See Adv. Page

Colorado Video Inc.116

American Laser Systems, Inc.
 Colorado Video Inc.
 Interand Corp. Telestrator Div.
 International Video Corp.
 Javelin Electronics
 NEC America, Inc. Broadcast Equip. Div.
 QSI Systems, Inc.

Sound Effect Systems

See Adv. Page

IGM171

Altec Lansing Sound Products
 Cetec Audio
 DYMA Engineering, Inc.
 Eventide Clock Works Inc.
 Gotham Audio Corp.
 IGM Div. of Northwestern Tech.
 MacKenzie Laboratories, Inc.
 Orange County Electronics Int'l., Inc.
 Richmond Sound Design, Ltd.
 The Ken Schaffer Group, Inc.
 Spectrum Instruments, Inc.
 Track Audio, Inc. (TA)
 URSA Major, Inc.
 Thomas Valentino Inc.

Sound Systems, Automatic Level Control

Altec Lansing Sound Products
 Moseley Associates, Inc.
 Orange County Electronics Int'l., Inc.
 Protech Audio Corp.
 Tweed Audio USA Inc.
 United Recording Electronics Industries

Sound Systems, Outdoor

See Adv. Page

James B. Lansing Sound, Inc.93

Altec Lansing Sound Products
 Argos Sound
 Atlas Sound
 Bell Audio Systems, Inc.
 Bogen Div. Lear Siegler, Inc.
 Electro-Voice Inc.
 G C Electronics Div. Wallace Murray
 Heath Co.
 James B. Lansing Sound, Inc.
 McMartin Industries, Inc.
 Micro-Trak Corp.
 Paso Sound Products Inc.
 Perma Power Electronics, Inc.
 Protech Audio Corp.
 Quad-Eight Electronics
 Richmond Sound Design, Ltd.
 The Ken Schaffer Group, Inc.
 Sharepoint Systems Inc.

Special Instruments Lab, Inc.
 Portasound Div.
 Spectra Sonics
 Whirlwind Music

Sound Systems, Portable

See Adv. Page

James B. Lansing Sound, Inc.93

AVAB America Inc.
 Altec Lansing Sound Products
 Argos Sound
 Auratone Corp.
 Automated Processes, Inc.
 Bell Audio Systems, Inc.
 Bogen Div. Lear Siegler, Inc.
 DYMA Engineering, Inc.
 Edcor
 Electro-Voice Inc.
 Heath Co.
 Integrated Solid Systems Inc. GLI Brand
 James B. Lansing Sound, Inc.
 McMartin Industries, Inc.
 Micro-Trak Corp.
 Nagra Magnetic Recorders, Inc.
 Rupert Neve, Inc.
 Panasonic Company
 Paso Sound Products Inc.
 Perma Power Electronics, Inc.
 Protech Audio Corp.
 Quad-Eight Electronics
 Richmond Sound Design, Ltd.
 The Ken Schaffer Group, Inc.
 Singer Products Co., Inc.
 Special Instruments Lab, Inc.
 Portasound Div.
 Spectra Sonics
 Tape-Athon Corp.
 Telestro Systems Corp.
 Whirlwind Music

Sound Systems, Studio

See Adv. Page

Dolby Laboratories, Inc.105
IGM171
James B. Lansing Sound, Inc.93

AVAB America Inc.
 Altec Lansing Sound Products
 Audicon, Inc.
 Auratone Corp.
 Bogen Div. Lear Siegler, Inc.
 Broadcast Electronics, Inc.
 Cetec Audio
 Cetec Broadcast Group
 Crown International, Inc.
 Delta Electronics Inc. (N.C.)
 Dolby Laboratories, Inc.
 DYMA Engineering, Inc.
 Electro-Voice Inc.
 Gotham Audio Corp.
 Hartley Products Corp.
 IGM Div. of Northwestern Tech.
 Integrated Solid Systems Inc. GLI Brand
 James B. Lansing Sound, Inc.
 Magna-Tech Electronic Co., Inc.
 McMartin Industries, Inc.
 Micro-Trak Corp.
 Modular Audio Products Unit of Modular Devices, Inc.
 Orange County Electronics Int'l., Inc.
 Panasonic Company
 Paso Sound Products Inc.
 Protech Audio Corp.
 Quad-Eight Electronics
 Richmond Sound Design, Ltd.
 The Ken Schaffer Group, Inc.
 Singer Products Co., Inc.
 Spectra Sonics
 Telestro Systems Corp.
 Ultra Audio Pixtec
 Whirlwind Music

Sound Systems, Theater

See Adv. Page

Dolby Laboratories, Inc.105
IGM171
James B. Lansing Sound, Inc.93

AVAB America Inc.
 Altec Lansing Sound Products
 Auratone Corp.
 Automated Processes, Inc.
 Bell Audio Systems, Inc.
 Bogen Div. Lear Siegler, Inc.
 David Clark Co., Inc.
 Delta Electronics Inc. (N.C.)
 Dolby Laboratories, Inc.
 DYMA Engineering, Inc.
 Electro Sound, Inc.
 Electro-Voice Inc.
 Hartley Products Corp.
 IGM Div. of Northwestern Tech.
 Integrated Solid Systems Inc. GLI Brand
 James B. Lansing Sound, Inc.
 Modular Audio Products Unit of Modular Devices, Inc.
 Rupert Neve, Inc.
 Optical Radiation Corp.
 Orange County Electronics Int'l., Inc.
 Panasonic Company
 Paso Sound Products Inc.
 Protech Audio Corp.
 Quad-Eight Electronics
 Richmond Sound Design, Ltd.
 The Ken Schaffer Group, Inc.
 Sharepoint Systems Inc.
 Special Instruments Lab, Inc.
 Portasound Div.
 Spectra Sonics
 Ward-Beck Systems, Ltd.
 Whirlwind Music

Speakers and Enclosures

See Adv. Page

James B. Lansing Sound, Inc.93

Altec Lansing Sound Products
 Argos Sound
 Atlas Sound
 Auerheimer Laboratories & Co.
 Auratone Corp.
 Bogen Div. Lear Siegler, Inc.
 Broadcast Electronics, Inc.
 Cetec Audio
 Cetec Broadcast Group
 DYMA Engineering, Inc.
 Electro-Voice Inc.
 G C Electronics Div. Wallace Murray
 Harris Corp. Broadcast Products Div.
 Hartley Products Corp.
 Heath Co.
 Integrated Solid Systems Inc. GLI Brand
 Jensen Sound Laboratories Div. of Pamcor, Inc.
 James B. Lansing Sound, Inc.
 Micro-Trak Corp.
 Orange County Electronics Int'l., Inc.
 Panasonic Company
 Perma Power Electronics, Inc.
 Quam-Nichols Co.
 Ramko Research Inc.
 Rank Hi Fi, Inc.
 Singer Products Co., Inc.
 Special Instruments Lab, Inc.
 Portasound Div.
 Spectra Sonics
 Telestro Systems Corp.
 Ultra Audio Pixtec
 United Recording Electronics Industries
 Whirlwind Music

STL Equipment

See Adv. Page

Dolby Laboratories, Inc.105
Moseley Associates, Inc.8

Time & Frequency Tech., Inc.119

Keith Anderson Co.
Anderson Scientific
Bayly Engineering Ltd. Member of
AEG-Telefunken Group
CCA Electronics Corp.
Cetec Broadcast Group
Coastcom
Contel Mfg.
Dolby Laboratories, Inc.
Farinon Video
GTE Lenkurt, Inc.
Harris Corp. Broadcast Products Div.
International Microwave Corp.
Marti Electronics
McMartin Industries, Inc.
Micro Communications, Inc.
Micro Control Associates, Inc.
Moseley Associates, Inc.
NEC America, Inc. Broadcast Equip. Div.
Nurad, Inc.
RCA Broadcast Systems
RHG Electronics Laboratory, Inc.
Radiation Devices Co., Inc.
Singer Products Co., Inc.
Tepco Corp.
TerraCom Loral Corp.
Time & Frequency Tech., Inc.
Varian/Beverly Micro-Link Products
Versa Count Engineering

Standard Converters, Digital

Marconi Electronics Inc. Broadcast & Communication Div.
Micro Consultants

Stopwatches, Digital

ESE
Heath Co.
QSI Systems, Inc.
Sharepoint Systems Inc.

Storage Racks, Film and Tape Container

See Adv. Page

Winsted Corp.156

Vulcan Binder & Cover
Winsted Corp.

Studio Design and Construction Services

See Adv. Page

Video Systems Network, Inc.152

A. F. Associates, Inc.
Altec Lansing Sound Products
Applied Video Electronics, Inc.
Berkey-Colortran Inc.
Walter S. Brewer Co., Inc.
C.R.V. Systems, Inc.
Centro Corp.
Communications Int'l.
Communications, Ltd.
DYMA Engineering, Inc.
Electro & Optical Systems Ltd.
Imero Fiorentino Associates, Inc.
Harris Corp. Broadcast Products Div.
Link Electronics Ltd.
Orange County Electronics Int'l., Inc.
RMC-Radio Mfg. Co.
Sharepoint Systems Inc.
Soll, Inc.
Spectra Sonics
Ultra Audio Pixtec
Video Systems Network, Inc.

Studio Scenery

Janson Industries
Logitek Electronic Systems, Inc.
UNI-SET Div. Kniff Woodcraft Corp.

Studio Systems, Audio

See Adv. Page

Dynair Electronics, Inc.163
IGM171

Altec Lansing Sound Products
Automated Processes, Inc.
Broadcast Electronics, Inc.
Cetec Broadcast Group
Communications, Ltd.
DYMA Engineering, Inc.
Dynair Electronics, Inc.
Eventide Clock Works Inc.
Harris Corp. Broadcast Products Div.
IGM Div. of Northwestern Tech.
Magna-Tech Electronic Co., Inc.
Roger Mayer Electronics, Inc.
McCurdy Radio Ind. Inc.
McMartin Industries, Inc.
Micro-Trak Corp.
Modular Audio Products Unit of
Modular Devices, Inc.
Opamp Labs, Inc.
Orange County Electronics Int'l., Inc.
Panasonic Company
Protech Audio Corp.
Quad-Eight Electronics
ROH Corporation
Radiation Devices Co., Inc.
Richmond Sound Design, Ltd.
Sharepoint Systems Inc.
Spectra Sonics
TEAC Corp of America
Tweed Audio USA Inc.
Ultra Audio Pixtec
Ward-Beck Systems, Ltd.
Whirlwind Music

Subcarrier Multiplex Equipment

See Adv. Page

Moseley Associates, Inc. 8

Bayly Engineering Ltd. Member of
AEG-Telefunken Group
Coastcom
Colorado Video Inc.
Farinon Video
GTE Lenkurt, Inc.
Harris Corp. Broadcast Products Div.
Johnson Electronics Inc.
Marti Electronics
McMartin Industries, Inc.
Micro Control Associates, Inc.
Moseley Associates, Inc.
RMC-Radio Mfg. Co.
Sharepoint Systems Inc.
Tepco Corp.
TerraCom Loral Corp.

Switchers, Production --See also Console listings

See Adv. Page

Beaveronics, Inc. 61
Crosspoint Latch Corp. 98
Industrial Sciences, Inc. (ISI) 102, 104
Ramko Research Inc. 28-29
Viscount Industries Ltd.168
Vital Industries Inc. BC

Alco Electronic Products, Inc.
American Data Corp. A North
American Philips Co.
Ampex Corp.
Audiotronics, Inc.
Automated Processes, Inc.
Beaveronics, Inc.
Broadcast Electronics, Inc.
Broadcast Video Systems, Ltd.
Central Dynamics Corp.
Cetec Audio
Cetec Broadcast Group
Computer Image Video Controllers
Dytek Industries, Inc.
ComTec Video Systems Mincom Div.
3M
Crosspoint Latch Corp.
DYMA Engineering, Inc.
Dynamics Div. Whittaker Corp.

Dytek Industries, Inc.
Electro & Optical Systems Ltd.
Glentronix Ltd.
Grass Valley Group, Inc.
Ikegami Electronics (USA) Inc.
Image Video Ltd.
Industrial Sciences, Inc. (ISI)
International Nuclear Corp.
J&D International, Elec. Div. Unit E-East
Javelin Electronics
Lenco Inc. Electronics Div.
Marconi Electronics Inc. Broadcast & Communication Div.
McCurdy Radio Ind. Inc.
Rupert Neve, Inc.
Panasonic Company
Panasonic Co. Video Systems Div.
ROH Corporation
Ramko Research Inc.
Richmond Sound Design, Ltd.
Ross Video Ltd.
Shintron Co. Inc.
Sono-Mag Corp.
Sony Corp. of America
3M Co. Mincom Div.
Vamco Engineering
Viscount Industries Ltd.
Vital Industries Inc.
Ward-Beck Systems, Ltd.
Yamaha International Corp.

Switchers, Routing

See Adv. Page

Beaveronics, Inc. 61
Datatek Corp. 35
Dynair Electronics, Inc. 159, 161
NEC America, Inc. IFC
Ramko Research Inc. 28-29
Utah Scientific, Inc. 85
Viscount Industries Ltd.168

American Data Corp. A North
American Philips Co.
Audio Designs & Mfg.
Automated Processes, Inc.
BEI Beston Electronics, Inc.
Beaveronics, Inc.
Broadcast Video Systems, Ltd.
Central Dynamics Corp.
Computer Image Video Controllers
Dytek Industries, Inc.
ComTec Video Systems Mincom Div.
3M
Datatek Corp.
Datatron, Inc.
Di-Tech Inc.
DYMA Engineering, Inc.
Dynair Electronics, Inc.
Dytek Industries, Inc.
EDCO Products, Inc.
E-N-G Corp.
Electro & Optical Systems Ltd.
Grass Valley Group, Inc.
Holland Electronics
Image Video Ltd.
Industrial Sciences, Inc. (ISI)
International Communications & Control Corp.
International Nuclear Corp.
J&D International, Elec. Div. Unit E-East
Lenco Inc. Electronics Div.
Moseley Associates, Inc.
NEC America, Inc. Broadcast Equip. Div.
ROH Corporation
Ramko Research Inc.
Telemation, A Div. of Bell & Howell
Telemet A Geotel Co.
3M Co. Mincom Div.
Triple Crown Electronics, Inc.
Utah Scientific, Inc.
Vamco Engineering
Videomedia
Viscount Industries Ltd.
Ward-Beck Systems, Ltd.

Switches, Coaxial

See Adv. Page

Delta Electronics Inc. (Va.)107

Dielectric Communications123

Barker and Williamson, Inc.
Bird Electronic Corp.
Blonder-Tongue Labs.
COMPAC
Cetec Broadcast Group
Comark Industries Inc.
Delta Electronics Inc. (Va.)
Dielectric Communications A Unit of General Signal
DowKey Div. Of Kilovac Corp.
Dynatech Data Systems
Electronic Inst. & Spec.
Harris Corp. Broadcast Products Div.
ITT Jennings
Javelin Electronics
Magnecraft Electric Co.
Marshall Electronics
Micro Communications, Inc.
Multronics, Inc.
Rohde & Schwarz Sales Co.
SWR Inc.
Singer Products Co., Inc.
Soll, Inc.
Systron-Donner
Texscan Corp.
Varian Associates, Inc. Electron Device Group
Weinschel Engineering Co.
Wide Band Engineering Co., Inc.

Switches, Crossbar

American Data Corp. A North
American Philips Co.
Cherry Electrical Products
Delta Electronics Inc. (Va.)
Dynair Electronics, Inc.
ITT Jennings
International Nuclear Corp.
Varian Associates, Inc. Electron Device Group

Switching Systems

See Adv. Page

Beaveronics, Inc. 61
Datatek Corp. 35
Delta Electronics Inc. (Va.)107
Dynair Electronics, Inc. 159, 161, 163

Modular Audio Products127
Utah Scientific, Inc. 85
Viscount Industries Ltd.168

American Data Corp. A North
American Philips Co.
BSC Inc.
Beaveronics, Inc.
Broadcast Video Systems, Ltd.
Central Dynamics Corp.
Cetec Audio
Cetec Broadcast Group
Computer Image Video Controllers
Dytek Industries, Inc.
Datatek Corp.
Delta Electronics Inc. (Va.)
Di-Tech Inc.
Dynair Electronics, Inc.
Dytek Industries, Inc.
GTE Lenkurt, Inc.
Glentronix Ltd.
Grass Valley Group, Inc.
Harris Corp. Broadcast Products Div.
Holland Electronics
IGM Div. of Northwestern Tech.
Image Video Ltd.
Industrial Sciences, Inc. (ISI)
International Nuclear Corp.
Javelin Electronics
Leitch Video Ltd.
Lenco Inc. Electronics Div.
Marconi Electronics Inc. Broadcast & Communication Div.
McCurdy Radio Ind. Inc.
Micro Communications, Inc.
Modular Audio Products Unit of Modular Devices, Inc.
Multronics, Inc.

Opamp Labs, Inc.
Panasonic Company
Protech Audio Corp.
ROH Corporation
Richmond Sound Design, Ltd.
Ross Video Ltd.
Sigma Electronics, Inc.
Sono-Mag Corp.
Sony Corp. of America
Tech Laboratories Inc.
Tektronix Inc.
Telecommunications Technology
Telemation, A Div. of Bell & Howell
Telemet A Geotel Co.
Utah Scientific, Inc.
Vamco Engineering
Viscount Industries Ltd.
Vital Industries Inc.
Ward-Beck Systems, Ltd.

Synchronizers, Audio/Video

The BTX Corp. 90
Philips Broadcast Equip Corp. 22-23

AEG-Telefunken Magnetic Tape Recorder Dept.
Ampex Corp.
Automated Processes, Inc.
The BTX Corp.
Central Dynamics Corp.
EECO Inc.
Leitch Video Ltd.
MCI, Inc.
Magna-Tech Electronic Co., Inc.
Philips Broadcast Equip Corp.
Plastic Reel Corp. of America

Synchronizer, Digital Video

Broadcast Video Systems, Ltd. 148
Digital Video Systems IBC
Microtime, Inc. 13

ADDA Corp.
Broadcast Video Systems, Ltd.
Consolidated Video Systems
Digital Video Systems
Electro & Optical Systems Ltd.
Grass Valley Group, Inc.
Leitch Video Ltd.
Micro Consultants
Microtime, Inc.
NEC America, Inc. Broadcast Equip. Div.
Plastic Reel Corp. of America
RCA Broadcast Systems
Thomson-CSF Laboratories, Inc.
Vital Industries Inc.

Synthesizers, FM Stereo

Ionic Industries, Inc.
Orban Assoc. Inc.
Rockland Systems Corp.

Systems Research and Development

Video Systems Network, Inc. 152

A. F. Associates, Inc.
Ampro Broadcasting
Atlantic Research Corp.
Automation Electronics, Inc. Autotron Systems, Div.
Broadcast Video Systems, Ltd.
C.R.V. Systems, Inc.
Communications Int'l.
Compact Video Sales
Dielectric Communications A Unit of General Signal
Digital Video Systems
DYMA Engineering, Inc.
Electro & Optical Systems Ltd.
Imero Fiorentino Associates, Inc.
Harris Corp. PRD Electronics Div.
International Electro-Magnetics

Lenco Inc. Electronics Div.
Link Electronics Ltd.
MPB Technologies Inc.
Marconi Communication Systems Ltd.
Pacific Recorders and Engrg. Corp.
QSI Systems, Inc.
The Ken Schaffer Group, Inc.
Sharepoint Systems Inc.
Soll, Inc.
Spectra Sonics
Telemet A Geotel Co.
3D Television Systems Inc.
UHF Associates
Video Systems Network, Inc.
Videomedia

Tape, Magnetic Recording Audio

Recording Supply Co. 169
TDK Electronics Corp. 89

Agfa-Gevaert Inc.
Ampex Corp.
Athenia Industries, Inc.
Audio Magnetics Corp.
BSC Inc.
Bonnevile Productions Div. of Bonnevile Int'l. Corp.
Broadcast Electronics, Inc.
Capitol Magnetic Products
Cetec Broadcast Group
Fuji Photo Film USA, Inc. Magnetic Tape Div.
Harris Corp. Broadcast Products Div.
Ray Jacobs Audio, Inc.
Mallory Distributor Prod. Co. Div. P. R. Mallory & Co. Inc.
Maxell Corp. of America
Memorex Corp. Professional Products Group
Nagra Magnetic Recorders, Inc.
Panasonic Company
Pentagon Industries, Inc.
Recording Supply Co.
Singer Products Co., Inc.
Sono-Mag Corp.
Soundscriber Magnetic Recording Co., Inc.
TDK Electronics Corp.

Tape, Magnetic Recording Audio Cartridge

Aristocart Div. 82
TDK Electronics Corp. 89

Ampex Corp.
Aristocart Div. Western Broadcasting, Ltd.
Audio Magnetics Corp.
BSC Inc.
Broadcast Electronics, Inc.
Capitol Magnetic Products
Cetec Broadcast Group
Contel Mfg.
Fidelipac
Fuji Photo Film USA, Inc. Magnetic Tape Div.
Harris Corp. Broadcast Products Div.
Mallory Distributor Prod. Co. Div. P. R. Mallory & Co. Inc.
Maxell Corp. of America
Memorex Corp. Professional Products Group
Singer Products Co., Inc.
Sono-Mag Corp.
TDK Electronics Corp.
Telex Communications, Inc.
3M Co. Magnetic Audio/Video Prod. Div.

Tape, Magnetic Recording Test

Fidelipac 121

Agfa-Gevaert Inc.
Ampex Corp.
Broadcast Electronics, Inc.
Fidelipac
G C Electronics Div. Wallace Murray
Gotham Audio Corp.
Harris Corp. Broadcast Products Div.

Nagra Magnetic Recorders, Inc.
Nortronics Co., Inc. Recorder Care Div.
Sono-Mag Corp.
TEAC Corp of America
Taber Mfg. & Engr. Co.
Video Cassette Services, Inc.

Tape, Magnetic Recording Video

Ampex Corp. 41
Fuji Photo Film USA, Inc. 59
TDK Electronics Corp. 89
3M Co. 53

Ampex Corp.
BSC Inc.
E. I. du Pont de Nemours & Co., Inc. Magnetic Products Div.
Fuji Photo Film USA, Inc. Magnetic Tape Div.
Javelin Electronics
Karex, Inc.
Maxell Corp. of America
Memorex Corp. Professional Products Group
Panasonic Company
Panasonic Co. Video Systems Div.
QSI Systems, Inc.
Recording Supply Co.
Sony Corp. of America
TDK Electronics Corp.
3M Co. Magnetic Audio/Video Prod. Div.
The Video Tape Co.

Tape, Recording Logging

Soundscriber Magnetic Recording Co., Inc. 178

Ampex Corp.
Harris Corp. Broadcast Products Div.
QSI Systems, Inc.
Recording Supply Co.
Singer Products Co., Inc.
Sono-Mag Corp.
Soundscriber Magnetic Recording Co., Inc.
Stancil-Hoffman Corp.
3M Co. Magnetic Audio/Video Prod. Div.

Tape, Time Announced

Fidelipac 121

Cetec Broadcast Group
Fidelipac
Harris Corp. Broadcast Products Div.
IGM Div. of Northwestern Tech.
Tape-Athon Corp.

Tape Addressors, Video

Recortec Inc. 5

R. B. Annis, Co.
Recortec Inc.

Tape Cartridge Loaders

Audico, Ltd.
Broadcast Electronics, Inc.
Electro Sound, Inc.
Neumade Products Corp.
Ramko Research Inc.
Video Cassette Services, Inc.

Tape Cassette Loaders

Audico, Ltd.
Ramko Research Inc.
Recortec Inc.

Tape Cassettes, Audio

Fuji Photo Film USA, Inc. 59
Recording Supply Co. 169
TDK Electronics Corp. 89

Ampex Corp.
Athenia Industries, Inc.
Audio Magnetics Corp.
Bonnevile Productions Div. of Bonnevile Int'l. Corp.
Fuji Photo Film USA, Inc. Magnetic Tape Div.
International Audio, Inc.
Ray Jacobs Audio, Inc.
Karex, Inc.
Mallory Distributor Prod. Co. Div. P. R. Mallory & Co. Inc.
Maxell Corp. of America
Memorex Corp. Professional Products Group
Panasonic Company
Pentagon Industries, Inc.
Recording Supply Co.
TDK Electronics Corp.
3M Co. Magnetic Audio/Video Prod. Div.

Tape Cassettes, Video

Fuji Photo Film USA, Inc. 59
TDK Electronics Corp. 89

Ampex Corp.
Fuji Photo Film USA, Inc. Magnetic Tape Div.
International Audio, Inc.
Maxell Corp. of America
Memorex Corp. Professional Products Group
Panasonic Company
Panasonic Co. Video Systems Div.
Plastic Reel Corp. of America
Recording Supply Co.
Schuessler Case Co., Inc.
Sony Corp. of America
TDK Electronics Corp.
3M Co. Magnetic Audio/Video Prod. Div.
Video Cassette Services, Inc.
The Video Tape Co.

Tape Cleaners

N.O.V.A. Corp. 160

Athenia Industries, Inc.
Chyron Corp. Video Products Div.
G C Electronics Div. Wallace Murray
Maxell Corp. of America
Memorex Corp. Professional Products Group
N.O.V.A. Corp.
Nortronics Co., Inc. Recorder Care Div.
Plastic Reel Corp. of America
TEAC Corp of America
Telectro Systems Corp.
Television Equipment Associates
3M Co. Magnetic Audio/Video Prod. Div.

Tape Conditioners, Video

Recortec Inc. 5

Chyron Corp. Video Products Div.
Compact Video Sales
Microtran Co., Inc.
N.O.V.A. Corp.
Recortec Inc.
Research Technology, Inc.
Television Equipment Associates

Tape Deck and Turntable Speed Controls

Ampro/Scully Div. Ram Mfg. Inc.
Eventide Clock Works Inc.

Harris Corp. Broadcast Products Div.
QRK Electronic Products
Telectro Systems Corp.
Triple I

Tape Decks, Magnetic --See also
Cartridge Machine listings

See Adv. Page

Ampro/Scully Div......147
IGM171

Amilon Corp.
Ampro Broadcasting
Ampro/Scully Div. Ram Mfg. Inc.
Broadcast Electronics, Inc.
Cetec Broadcast Group
Gotham Audio Corp.
Harris Corp. Broadcast Products Div.
Heath Co.
IGM Div. of Northwestern Tech.
International Electro-Magnetics
International Tapetronics Corp.
Nagra Magnetic Recorders, Inc.
Novadyne Inc.
Otari Corp.
Panasonic Company
Singer Products Co., Inc.
Sono-Mag Corp.
Studer Revox America
TEAC Corp of America
Tape-Athon Corp.
Telectro Systems Corp.
Telex Communications, Inc.
United Research Lab Corp.
Video Research Corp.

Tape Duplicators

Audico, Ltd.
CaVox Stereo Productions
Cetec Audio
Electro Sound, Inc.
Garner Industries
International Audio, Inc.
Ray Jacobs Audio, Inc.
KVC, Inc.
Magnefax, Inc.
Otari Corp.
Panasonic Company
Panasonic Co. Video Systems Div.
Pentagon Industries, Inc.
Recortec Inc.
Singer Products Co., Inc.
Telex Communications, Inc.
Video Research Corp.

Tape Evaluators, Video

See Adv. Page

Recortec Inc. 5

Chyron Corp. Video Products Div.
Kaitronics Corp.
Merlin Engineering Works, Inc.
Recortec Inc.
Television Equipment Associates

Tape Meters

See Adv. Page

Tentel162

Tentel

Tape Motion Controls, Audio

See Adv. Page

Aitken Communications Inc......172

Aitken Communications Inc.
The BTX Corp.
Tape-Athon Corp.

Tape Racks, Cartridge

See Adv. Page

Storeel Corp.101
Winsted Corp.156

Audio Magnetics Corp.
Broadcast Electronics, Inc.

Cetec Broadcast Group
Display Media, Inc.
DYMA Engineering, Inc.
Fidelipac
Harris Corp. Broadcast Products Div.
LPB Inc.
McCurdy Radio Ind. Inc.
Micro-Trak Corp.
Neumade Products Corp.
Research Technology, Inc.
Storeel Corp.
Wallach & Associates Inc.
Winsted Corp.

Tape Recording Accessories

See Adv. Page

R. B. Annis, Co......150
Recording Supply Co......169
TDK Electronics Corp...... 89
Tentel162

AEG-Telefunken Magnetic Tape Recorder Dept.
Ampex Corp.
Ampro Broadcasting
Ampro/Scully Div. Ram Mfg. Inc.
R. B. Annis, Co.
Broadcast Electronics, Inc.
Cetec Broadcast Group
Electro Sound, Inc.
Fidelipac
G C Electronics Div. Wallace Murray
Ray Jacobs Audio, Inc.
Lawhed, Ltd.
Memorex Corp. Professional Products Group
Micro-Trak Corp.
Microtran Co., Inc.
N.O.V.A. Corp.
Nagra Magnetic Recorders, Inc.
Nortronics Co., Inc. Recorder Care Div.
Panasonic Company
Pentagon Industries, Inc.
Ramko Research Inc.
Recording Supply Co.
Studer Revox America
TDK Electronics Corp.
TEAC Corp of America
Taber Mfg. & Engr. Co.
Telex Communications, Inc.
Tentel
Univex International
Vamco Engineering
Videomax Div. Orrox Corp.

Tape Splice Finders

Ampro Broadcasting
Broadcast Electronics, Inc.
Cetec Broadcast Group
Harris Corp. Broadcast Products Div.
IGM Div. of Northwestern Tech.
International Tapetronics Corp.
Research Technology, Inc.
UMC Electronics Co. Broadcast Products Div.

Tape Splicers

Audico, Ltd.
Broadcast Electronics, Inc.
Electro Sound, Inc.
Fidelipac
G C Electronics Div. Wallace Murray
Harris Corp. Broadcast Products Div.
Nagy Research Products
Neumade Products Corp.
Nortronics Co., Inc. Recorder Care Div.
Plastic Reel Corp. of America
Studer Revox America

Tape Transport Reconditioning Services

International Tapetronics Corp.
Merlin Engineering Works, Inc.
Taber Mfg. & Engr. Co.
Telectro Systems Corp.
United Research Lab Corp.

Tape Transports

See Adv. Page

IGM171

Amilon Corp.
Ampro Broadcasting
Broadcast Electronics, Inc.
Cetec Broadcast Group
Electro Sound, Inc.
Gotham Audio Corp.
IGM Div. of Northwestern Tech.
International Electro-Magnetics
International Tapetronics Corp.
McCurdy Radio Ind. Inc.
Merlin Engineering Works, Inc.
Nagra Magnetic Recorders, Inc.
Novadyne Inc.
Pentagon Industries, Inc.
Sono-Mag Corp.
Sound Dynamics, Inc.
Studer Revox America
Tape-Athon Corp.
Telex Communications, Inc.
Triple I
United Research Lab Corp.
Video Research Corp.

Telephone Answering Equipment

See Adv. Page

IGM171

Boston Sound & Power Systems
Broadcast Electronics, Inc.
Channelmatic, Inc.
IGM Div. of Northwestern Tech.
Monroe Electronics, Inc.
Panasonic Company
Soundscriber Magnetic Recording Co., Inc.
Telectro Systems Corp.
Teltek, Inc.
Wang Voice Comm. Inc.

Telephone Tone Receivers

Bayly Engineering Ltd. Member of AEG-Telefunken Group
Cetec Vega
Channelmatic, Inc.
Frequency Devices Inc.
Monroe Electronics, Inc.
TM Systems, Inc.

Telephone Tone Transmitters

Bayly Engineering Ltd. Member of AEG-Telefunken Group
Cetec Vega
Channelmatic, Inc.
Frequency Devices Inc.
Monroe Electronics, Inc.
TM Systems, Inc.
Telecommunications Technology
Teltek, Inc.

Teletext Systems

EEG Enterprises, Inc.

Teletype Noise Reducer Cabinets

DYMA Engineering, Inc.
Van San Corp.

Termination Units

See Adv. Page

Electro Impulse, Inc......161

Bird Electronic Corp.
CCA Electronics Corp.
Dielectric Communications A Unit of General Signal
Electro Impulse, Inc.
Harris Corp. Broadcast Products Div.
Holland Electronics
ITI Electronics, Inc.
Micro Communications, Inc.
Systron-Donner

Test Chart Pattern Illuminators

Glentronix Ltd.
Porta-Pattern Telecommunications Industries Ltd.

Test Charts, Camera

ATV Research
D and S Corley Ltd.
EEV Canada Ltd.
Glentronix Ltd.
Harris Corp. Broadcast Products Div.
Marconi Communication Systems Ltd.
Porta-Pattern Telecommunications Industries Ltd.
Ultra Audio Pixtec

Test Inserter/Readers, VIT

See Adv. Page

World Video Inc.134

Philips Test & Measuring Instruments, Inc.
World Video Inc.

Test Records

B & K Instruments Inc.
G C Electronics Div. Wallace Murray
Harris Corp. Broadcast Products Div.

Test Sets, Multifunction

See Adv. Page

Bald Mountain Lab151
Potomac Instruments, Inc......137

Amber Electro Design, Ltd.
Bald Mountain Lab
Dielectric Communications A Unit of General Signal
Harris Corp. Broadcast Products Div.
Harris Corp. PRD Electronics Div.
ITI Electronics, Inc.
Lampkin Lab. Inc.
Leitch Video Ltd.
Lenco Inc. Electronics Div.
Motorola Communications and Electronics Inc.
Potomac Instruments, Inc.
Sadelco, Inc.
Singer Products Co., Inc.
Systron-Donner
Telecommunications Technology
Telemet A Geotel Co.
Wang Voice Comm. Inc.

Test Sets, Vertical Interval

See Adv. Page

Marconi Instruments 45
World Video Inc.134

Lenco Inc. Electronics Div.
Marconi Instruments Div. of Marconi Electronics Inc.
Philips Test & Measuring Instruments, Inc.
Rohde & Schwarz Sales Co.
Telemet A Geotel Co.
World Video Inc.

Test Slides, Video

D and S Corley Ltd.
Eastman Kodak Co.
Harris Corp. Broadcast Products Div.
Laird Telemedia Inc.
Marconi Electronics Inc. Broadcast & Communication Div.
Porta-Pattern Telecommunications Industries Ltd.

Test Tapes, Audio

See Adv. Page

Consolidated Electronic Industries 14
Fidelipac121

Standard Tape Laboratory, Inc.156
TDK Electronics Corp. 89

Ampex Corp.
 Broadcast Electronics, Inc.
 Cetec Broadcast Group
 Consolidated Electronic Industries
 Fidelipac
 Harris Corp. Broadcast Products Div.
 Nagra Magnetic Recorders, Inc.
 Nortronics Co., Inc. Recorder Care Div.
 Pentagon Industries, Inc.
 Standard Tape Laboratory, Inc.
 TDK Electronics Corp.
 TEAC Corp of America
 Taber Mfg. & Engr. Co.

Testers, Demodulator/Detector

Philips Test & Measuring Instruments, Inc.
 Telemet A Geotel Co.

Testers, Integrated Circuit

Continental Specialties Corp.
 Heath Co.
 Tektronix Inc.

Testers, Semiconductor

B & K Precision Dynascan Corp.
 Datatron, Inc.
 Delta Electronics Inc. (N.C.)
 Heath Co.
 Hickok Elec. Inst. Co.
 Leader Instruments Corp.
 Lectrotech Inc.
 Rohde & Schwarz Sales Co.
 SPI-ITT Metrix Instruments Div.
 Sencore Inc.
 Tektronix Inc.

Testers, Tape Recorder

See Adv. Page
Fidelipac121
Tentel162

Amber Electro Design, Ltd.
 Broadcast Aids, Inc.
 Fidelipac
 Marconi Instruments Div. of Marconi Electronics Inc.
 Tentel

Testers, Vacuum Tube

B & K Precision Dynascan Corp.
 Heath Co.
 Hickok Elec. Inst. Co.
 Lectrotech Inc.
 SPI-ITT Metrix Instruments Div.
 Sencore Inc.
 Singer Products Co., Inc.

Textbooks, Communications

Alan Gordon Enterprises Inc.
 Opamp Labs, Inc.
 Howard W. Sams & Co., Inc.
 Ultra Audio Pixtec

Time Announcers

Cetec Broadcast Group
 Consolidated Electronic Industries
 Hallikainen & Friends, Inc.
 Harris Corp. Broadcast Products Div.
 IGM Div. of Northwestern Tech.
 Sono-Mag Corp.
 Stancil-Hoffman Corp.
 Tape-Athon Corp.
 Telectro Systems Corp.

Time Base Correctors, Helical Scan and Quad

See Adv. Page
Digital Video Systems..... IBC
Edutron, Inc..... 99
Microtime, Inc. 13

Sony Corp. of America 38-39

ADDA Corp.
 Ampex Corp.
 Automation Techniques, Inc.
 Consolidated Video Systems
 Digital Video Systems
 Edutron, Inc.
 Eigen Video
 Marconi Electronics Inc. Broadcast & Communication Div.
 Merlin Engineering Works, Inc.
 Micro Consultants
 Microtime, Inc.
 NEC America, Inc. Broadcast Equip. Div.
 RCA Broadcast Systems
 Siegel Electronics
 Sony Corp. of America

Timers, Blanking Interval

See Adv. Page
Marconi Instruments 45
World Video Inc.134

Marconi Instruments Div. of Marconi Electronics Inc.
 World Video Inc.

Timers, Program

See Adv. Page
Logitek Electronic Systems, Inc.125

Audico, Ltd.
 Broadcast Aids, Inc.
 D'San Corp.
 ESE
 Glentronix Ltd.
 IGM Div. of Northwestern Tech.
 Kaitronics Corp.
 Logitek Electronic Systems, Inc.
 MacKenzie Laboratories, Inc.
 PWH Electronics
 Sharepoint Systems Inc.
 Track Audio, Inc. (TA)
 Vamco Engineering
 Video Devices Co.

Timers, Videotape

See Adv. Page
Recortec Inc. 5

Convergence Corp.
 Merlin Engineering Works, Inc.
 QSI Systems, Inc.
 Recortec Inc.
 Vamco Engineering

Titling Systems

See Adv. Page
Chyron Telesystems 84
Gray Engineering Labs 21
Knox Video Products140
MPB Technologies Inc.124
Video Data Systems 16

BEI Beston Electronics, Inc.
 BJA Systems, Inc.
 Chyron Telesystems
 Gray Engineering Labs
 International Communications & Control Corp.
 Knox Video Products
 Kroy Industries Graphics Div.
 Laird Telemedia Inc.
 MPB Technologies Inc.
 Philips Broadcast Equip Corp.
 Power-Optics Inc.
 Reynolds/Leteron Co.
 Siegel Electronics
 System Concepts Inc.
 Telemation, A Div. of Bell & Howell
 Thomson-CSF Laboratories, Inc.
 3M Co. Mincom Div.
 Video Data Systems

Tool Kits (Hand Tools)

See Adv. Page
Paladin Corp.112

Arrow Fastener Co., Inc.
 G C Electronics Div. Wallace Murray
 Heath Co.
 Kager International
 Lyon Metal Products, Inc.
 Paladin Corp.
 Sono-Mag Corp.
 Suda Seisakusho Co., Ltd.
 Vector Electronic Co., Inc.

Tower Beacon Light Flashers

See Adv. Page
Hughey & Phillips Inc.152
SSAC Inc.179

Cetec Broadcast Group
 Crouse Hinds Co.
 EEV Canada Ltd.
 Elcom Engineering Co.
 Flash Technology Corp. of America
 Harris Corp. Broadcast Products Div.
 Heath Co.
 Hughey & Phillips Inc.
 Magnecraft Electric Co.
 SSAC Inc.
 Unarco-Rohn Div. of Unarco Ind., Inc.
 Utility Tower Co.

Tower Guys --See Antenna and Tower Guys

Tower Installation and Services --See Antenna and Tower Installation and Services

Tower Light Failure Alarms

See Adv. Page
Hughey & Phillips Inc.152

Harris Corp. Broadcast Products Div.
 Hughey & Phillips Inc.
 Moseley Associates, Inc.
 Utility Tower Co.

Tower Light Indicator Panels

See Adv. Page
Hughey & Phillips Inc.152

Crouse Hinds Co.
 GTE Sylvania Inc. Lighting Products Group
 Harris Corp. Broadcast Products Div.
 Hughey & Phillips Inc.

Tower Lighting Isolation Transformers

See Adv. Page
Hughey & Phillips Inc.152

Cetec Broadcast Group
 Decca Austin Insulators
 Harris Corp. Broadcast Products Div.
 Hughey & Phillips Inc.

Tower Lights, High Intensity Obstruction --See also Lights, Tower Obstruction, Red

Cetec Broadcast Group
 Crouse Hinds Co.
 Flash Technology Corp. of America
 GTE Sylvania Inc. Lighting Products Group
 Harris Corp. Broadcast Products Div.
 Hughey & Phillips Inc.
 Tri-Ex Tower Corp.
 Utility Tower Co.

Towers

See Adv. Page
Stainless, Inc.118

Allied Tower Co., Inc.
 Aluma Tower Co.
 Cetec Broadcast Group
 DHV, Inc.
 Fort Worth Tower Co., Inc.
 G C Electronics Div. Wallace Murray
 Harris Corp. Broadcast Products Div.
 Hy-Gain Electronics Div. of Telex Communications Inc.
 Kline Iron & Steel Co.
 Microlect Co., Inc.
 Motorola Communications and Electronics Inc.
 Fred A. Nudd Corp.
 Stainless, Inc.
 Suda Seisakusho Co., Ltd.
 Swager Tower Corp.
 Tri-Ex Tower Corp.
 Unarco-Rohn Div. of Unarco Ind., Inc.
 Up-Right Scaffolds
 Utility Tower Co.
 V&B Tower Const. Co., Inc. Atlas Tower Mfg.

Towers, Antenna Receiving

See Adv. Page
Stainless, Inc.118

Allied Tower Co., Inc.
 Aluma Tower Co.
 DHV, Inc.
 Hy-Gain Electronics Div. of Telex Communications Inc.
 Jerrold Electronics Corp.
 Singer Products Co., Inc.
 Stainless, Inc.
 Suda Seisakusho Co., Ltd.
 Swager Tower Corp.
 Tri-Ex Tower Corp.
 Unarco-Rohn Div. of Unarco Ind., Inc.
 Up-Right Scaffolds
 Utility Tower Co.
 V&B Tower Const. Co., Inc. Atlas Tower Mfg.

Towers, Antenna Transmitting AM

See Adv. Page
Stainless, Inc.118

Allied Tower Co., Inc.
 Aluma Tower Co.
 CCA Electronics Corp.
 Cetec Broadcast Group
 DHV, Inc.
 Dielectric Communications A Unit of General Signal
 Fort Worth Tower Co., Inc.
 Harris Corp. Broadcast Products Div.
 Hy-Gain Electronics Div. of Telex Communications Inc.
 Kline Iron & Steel Co.
 Microlect Co., Inc.
 RCA Broadcast Systems
 Singer Products Co., Inc.
 Stainless, Inc.
 Suda Seisakusho Co., Ltd.
 Swager Tower Corp.
 Tri-Ex Tower Corp.
 Unarco-Rohn Div. of Unarco Ind., Inc.
 Up-Right Scaffolds
 Utility Tower Co.
 V&B Tower Const. Co., Inc. Atlas Tower Mfg.

Towers, Antenna Transmitting FM

See Adv. Page
Stainless, Inc.118

Allied Tower Co., Inc.
 Aluma Tower Co.
 Cetec Broadcast Group
 DHV, Inc.
 Dielectric Communications A Unit of General Signal
 Fort Worth Tower Co., Inc.

Harris Corp. Broadcast Products Div.
Hy-Gain Electronics Div. of Telex
Communications Inc.
Kline Iron & Steel Co.
Microlect Co., Inc.
RCA Broadcast Systems
Singer Products Co., Inc.
Stainless, Inc.
Suda Seisakusho Co., Ltd.
Swager Tower Corp.
Tri-Ex Tower Corp.
Unarco-Rohn Div. of Unarco Ind., Inc.
Up-Right Scaffolds
Utility Tower Co.
V&B Tower Const. Co., Inc. Atlas
Tower Mfg.

**Towers, Antenna Transmitting
TV**

Allied Tower Co., Inc.
CCA Electronics Corp.
Cetec Broadcast Group
DHV, Inc.
Dielectric Communications A Unit of
General Signal
Fort Worth Tower Co., Inc.
Harris Corp. Broadcast Products Div.
Kline Iron & Steel Co.
Microlect Co., Inc.
RCA Broadcast Systems
Singer Products Co., Inc.
Suda Seisakusho Co., Ltd.
Swager Tower Corp.
Tri-Ex Tower Corp.
Unarco-Rohn Div. of Unarco Ind., Inc.
Up-Right Scaffolds
Utility Tower Co.
V&B Tower Const. Co., Inc. Atlas
Tower Mfg.

Transformers, Audio

See Adv. Page

Jensen Transformers160

AKG Acoustics Div. Philips Audio
Video Systems
Altec Lansing Sound Products
Automated Processes, Inc.
Bayly Engineering Ltd. Member of
AEG-Telefunken Group
Bogen Div. Lear Siegler, Inc.
Harris Corp. Broadcast Products Div.
Jensen Transformers
Roger Mayer Electronics, Inc.
Microtran Co., Inc.
Modular Audio Products Unit of
Modular Devices, Inc.
Opamp Labs, Inc.
Protech Audio Corp.
Quad-Eight Electronics
Sescom, Inc.
Spectra Sonics
Studer Revox America
Whirlwind Audio
Whirlwind Music

Transformers, Filament

See Adv. Page

Peter W. Dahl Co.175

Peter W. Dahl Co.

Transformers, Line Level

Altec Lansing Sound Products
Bayly Engineering Ltd. Member of
AEG-Telefunken Group
Harris Corp. Broadcast Products Div.
ITI Electronics, Inc.
Roger Mayer Electronics, Inc.
Microtran Co., Inc.
Protech Audio Corp.
Sescom, Inc.
Topaz Electronics

Transformers, Modulation

See Adv. Page

Peter W. Dahl Co.175

Peter W. Dahl Co.

Transformers, Plate Power

See Adv. Page

Peter W. Dahl Co.175

Peter W. Dahl Co.

Transformers, RF Sampling

See Adv. Page

**Delta Electronics Inc.
(Va.)107**

Delta Electronics Inc. (Va.)
Harris Corp. Broadcast Products Div.
Multronics, Inc.
North Hills Electronics, Inc.

Translator Repair Parts

See Adv. Page

**Television Technology
Corp.176**

Acrodyne Industries Inc.
Keith Anderson Co.
Anderson Scientific
Television Technology Corp.
Tepco Corp.

Translator Systems, High Power

See Adv. Page

**Television Technology
Corp.176**

Acrodyne Industries Inc.
Keith Anderson Co.
Anderson Scientific
CCA Electronics Corp.
Canadian General Electric Co., Ltd.
Dielectric Communications A Unit of
General Signal
DYMA Engineering, Inc.
EMCEE Broadcast Products
D. N. Latus & Co., Inc.
NEC America, Inc. Broadcast Equip.
Div.
Television Technology Corp.

Translator Systems, Low Power

See Adv. Page

**Television Technology
Corp.176**

Acrodyne Industries Inc.
Keith Anderson Co.
Anderson Scientific
CCA Electronics Corp.
Contel Mfg.
DYMA Engineering, Inc.
EMCEE Broadcast Products
Harris Corp. Broadcast Products Div.
Howe-Yin Research Co. Inc.
Ikegami Electronics (USA) Inc.
D. N. Latus & Co., Inc.
Marconi Electronics Inc. Broadcast &
Communication Div.
NEC America, Inc. Broadcast Equip.
Div.
Rodelco Corp.
Rohde & Schwarz Sales Co.
Scientific-Atlanta, Inc.
Singer Products Co., Inc.
Television Technology Corp.
Tepco Corp.
Versa Count Engineering

Translator Systems, TV

See Adv. Page

**Television Technology
Corp.176**

Acrodyne Industries Inc.
Keith Anderson Co.
Anderson Scientific
CCA Electronics Corp.
Canadian General Electric Co., Ltd.
DYMA Engineering, Inc.
Howe-Yin Research Co. Inc.

NEC America, Inc. Broadcast Equip.
Div.
Television Technology Corp.
Triple Crown Electronics, Inc.
Versa Count Engineering

Transmission Lines

See Adv. Page

**Dielectric
Communications.....123**

Andrew Corp.
Belden Corp.
CCA Electronics Corp.
Cablewave Systems Inc.
Cetec Broadcast Group
Comark Industries Inc.
Continental Electronics Mfg. Co.
Dielectric Communications A Unit of
General Signal
The Finney Co.
Gabriel Electronics, Inc.
Harris Corp. Broadcast Products Div.
Maury Microwave Corp.
Micro Communications, Inc.
Micro Control Associates, Inc.
Motorola Communications and
Electronics Inc.
Multronics, Inc.
Nurad, Inc.
Phelps Dodge Communications Co.
RCA Broadcast Systems
SWR Inc.
Singer Products Co., Inc.

Transmission Sets

Amber Electro Design, Ltd.
Cablewave Systems Inc.
GTE Lenkurt, Inc.

Transmission Systems, TV Audio

Comark Communications Industries,
Inc.
DYMA Engineering, Inc.
Farinon Video
Radiation Devices Co., Inc.
Spectra Sonics

**Transmission Systems, TV
Optical Carrier**

See Adv. Page

**American Laser
Systems, Inc.149
Telemet.....142**

American Laser Systems, Inc.
Canadian General Electric Co., Ltd.
Motorola Communications and
Electronics Inc.
Radiation Devices Co., Inc.
Telemet A Geotol Co.
Times Fiber Communications, Inc.

Transmitter Kits

ATV Research
CSI Electronics, Inc.
Harris Corp. Broadcast Products Div.
Heath Co.
McMartin Industries, Inc.
Sintronic Corp.

**Transmitter Modulation
Controllers, Automatic**

See Adv. Page

**Delta Electronics Inc.
(Va.)107**

CCA Electronics Corp.
Delta Electronics Inc. (Va.)
DYMA Engineering, Inc.
Harris Corp. Broadcast Products Div.
Sharepoint Systems Inc.

**Transmitter Output Controllers,
Automatic**

CCA Electronics Corp.
DYMA Engineering, Inc.
Harris Corp. Broadcast Products Div.
Moseley Associates, Inc.
Sharepoint Systems Inc.

Transmitters, AM

See Adv. Page

**CCA Electronics Corp. 74
Collins Div. 79
Continental Electronics
Mfg. Co. 167, 169,
171, 173
Marconi Electronics
Inc. 65
RCA Broadcast
Systems..... 81
Sintronic Corp.175
Wilkinson Electronics,
Inc.68, 78,
172**

Bayly Engineering Ltd. Member of
AEG-Telefunken Group
CCA Electronics Corp.
CSI Electronics, Inc.
Cetec Broadcast Group
Collins Div. Rockwell International
Contel Mfg.
Continental Electronics Mfg. Co.
Harris Corp. Broadcast Products Div.
Marconi Communication Systems Ltd.
Marconi Electronics Inc. Broadcast &
Communication Div.
McMartin Industries, Inc.
RCA Broadcast Systems
Singer Products Co., Inc.
Sintronic Corp.
Wilkinson Electronics, Inc.

Transmitters, AM Carrier

CSI Electronics, Inc.
Cetec Broadcast Group
Communications, Ltd.
GTE Lenkurt, Inc.
LPB Inc.
Singer Products Co., Inc.

Transmitters, AM Low Power

See Adv. Page

**Philips Broadcast
Equip Corp. 22-23**

CCA Electronics Corp.
CSI Electronics, Inc.
Cetec Broadcast Group
Collins Div. Rockwell International
Communications, Ltd.
Harris Corp. Broadcast Products Div.
Ikegami Electronics (USA) Inc.
International Microwave Corp.
LPB Inc.
Philips Broadcast Equip Corp.
RMC-Radio Mfg. Co.
Singer Products Co., Inc.
Wilkinson Electronics, Inc.

Transmitters, FM

See Adv. Page

**CCA Electronics Corp. 74
Collins Div. 79
Marconi Electronics
Inc. 65
RCA Broadcast
Systems..... 81
Sintronic Corp.175
Wilkinson Electronics,
Inc.172**

Bayly Engineering Ltd. Member of
AEG-Telefunken Group
CCA Electronics Corp.
CSI Electronics, Inc.
Cetec Broadcast Group
Collins Div. Rockwell International

EIMAC Div. of Varian
 GTE Lenkurt, Inc.
 Harris Corp. Broadcast Products Div.
 LPB Inc.
 Marconi Communication Systems Ltd.
 Marconi Electronics Inc. Broadcast & Communication Div.
 Marti Electronics
 McMartin Industries, Inc.
 NEC America, Inc. Broadcast Equip. Div.
 QEI Corp.
 RCA Broadcast Systems
 RHG Electronics Laboratory, Inc.
 RMC-Radio Mfg. Co.
 Rohde & Schwarz Sales Co.
 Scientific Radio Systems, Inc.
 Singer Products Co., Inc.
 Sintronic Corp.
 Solid Electronics Labs
 Sonar Radio Corp.
 Versa Count Engineering
 Wilkinson Electronics, Inc.

Transmitters, HF

See Adv. Page

Philips Broadcast Equip Corp. 22-23

Bayly Engineering Ltd. Member of AEG-Telefunken Group
 CCA Electronics Corp.
 Harris Corp. Broadcast Products Div.
 NEC America, Inc. Broadcast Equip. Div.
 Philips Broadcast Equip. Corp.
 Sintronic Corp.

Transmitters, TV

See Adv. Page

CCA Electronics Corp. 74

Marconi Electronics Inc. 65

RCA Broadcast Systems 81

Acrodyne Industries Inc.
 Keith Anderson Co.
 Anderson Scientific
 Bayly Engineering Ltd. Member of AEG-Telefunken Group
 CCA Electronics Corp.
 Canadian General Electric Co., Ltd.
 EMCEE Broadcast Products
 GTE Lenkurt, Inc.
 Harris Corp. Broadcast Products Div.
 Howe-Yin Research Co. Inc.
 Marconi Communication Systems Ltd.
 Marconi Electronics Inc. Broadcast & Communication Div.
 NEC America, Inc. Broadcast Equip. Div.
 Philips Broadcast Equip. Corp.
 RCA Broadcast Systems
 Rodelco Corp.
 Rohde & Schwarz Sales Co.
 Television Technology Corp.
 Townsend Associates, Inc.
 Varian/Beverly Micro-Link Products

Transmitters, TV Microwave

See Adv. Page

Hitachi Denshi America, Ltd. 3

EMCEE Broadcast Products
 GTE Lenkurt, Inc.
 Hitachi Denshi America, Ltd.
 Hughes Aircraft Co. Microwave Communications Products
 International Microwave Corp.
 NEC America, Inc. Broadcast Equip. Div.
 Nurad, Inc.
 RHG Electronics Laboratory, Inc.
 Tepco Corp.
 TerraCom Lorai Corp.
 Varian/Beverly Micro-Link Products

Tuners, AM

Bogen Div. Lear Siegler, Inc.
 McKay Dymek Co.
 McMartin Industries, Inc.
 Micro-Trak Corp.
 Ramko Research Inc.
 Sansui Electronics Corp.

Tuners, FM

Bogen Div. Lear Siegler, Inc.
 Collins Div. Rockwell International
 Crown International, Inc.
 Eumig USA, Inc.
 Heath Co.
 McMartin Industries, Inc.
 Micro-Trak Corp.
 Panasonic Company
 Ramko Research Inc.
 SWR Inc.
 Sansui Electronics Corp.
 Studer Revox America

Tuners, TV Audio

McMartin Industries, Inc.
 Rhoades National Corp.

Turnkey Equipment Installation Services

Applied Video Electronics, Inc.
 Atlantic Research Corp.
 Audicon, Inc.
 CCA Electronics Corp.
 Centro Corp.
 DYMA Engineering, Inc.
 EMCEE Broadcast Products
 Farinon Video
 GTE Lenkurt, Inc.
 Harris Corp. Broadcast Products Div.
 Hughes Aircraft Co. Microwave Communications Products
 Jerrold Electronics Corp.
 Link Electronics Ltd.
 Magna-Tech Electronic Co., Inc.
 Magnavox CATV Systems, Inc.
 Marconi Communication Systems Ltd.
 Microtime, Inc.
 Nurad, Inc.
 Pacific Recorders and Engrg. Corp.
 RCA Broadcast Systems
 RMC-Radio Mfg. Co.
 Times Fiber Communications, Inc.
 Ultra Audio Pixtec

Turntable Speed Control --See Tape Deck and Turntable Speed Control

Turntables, Phonograph

See Adv. Page

Collins Div. 79
Micro-Trak Corp. 177
Russco Electronics Mfg. Inc. 76

Broadcast Electronics, Inc.
 Cetec Broadcast Group
 Collins Div. Rockwell International
 EMT Franz VGmbH
 Harris Corp. Broadcast Products Div.
 Heath Co.
 LPB Inc.
 McCurdy Radio Ind. Inc.
 Micro-Trak Corp.
 Panasonic Company
 QRK Electronic Products
 RCA Broadcast Systems
 Ramko Research Inc.
 Russco Electronics Mfg. Inc.
 Singer Products Co., Inc.
 Stanton Magnetics Inc.
 Studer Revox America
 TEAC Corp of America

Used Broadcast Equipment, See also Equipment Reconditioned

See Adv. Page

A. F. Associates, Inc. 180

Lines Video Systems 84

A. F. Associates, Inc.
 Harris Corp. Broadcast Products Div.
 Lines Video Systems
 Microtime, Inc.

Vacuum Tube (Rectifier) Replacements, Solid State

Bayly Engineering Ltd. Member of AEG-Telefunken Group
 EEV Canada Ltd.
 Electronic Devices, Inc.
 Wilkinson Electronics, Inc.

Vacuum Tubes, Cathode Ray Oscilloscope

See Adv. Page

JSH Electronics, Inc. 167

Amperex Electronic Corp. Slatersville Div.
 Bayly Engineering Ltd. Member of AEG-Telefunken Group
 EEV, Inc.
 EEV Canada Ltd.
 English Electric Valve Co. Ltd.
 JSH Electronics, Inc. A member co. of VSI Electronics
 RCA Distributor & Special Products Div.
 RCA Solid State Div.

Vacuum Tubes, Cathode Ray TV Color

See Adv. Page

JSH Electronics, Inc. 167

JSH Electronics, Inc. A member co. of VSI Electronics
 RCA Distributor & Special Products Div.

Vacuum Tubes, Cathode Ray TV Monochrome

See Adv. Page

JSH Electronics, Inc. 167

Amperex Electronic Corp. Slatersville Div.
 EEV, Inc.
 EEV Canada Ltd.
 JSH Electronics, Inc. A member co. of VSI Electronics
 RCA Distributor & Special Products Div.

Vacuum Tubes, Rectifier

See Adv. Page

JSH Electronics, Inc. 167

Bayly Engineering Ltd. Member of AEG-Telefunken Group
 EEV, Inc.
 EEV Canada Ltd.
 EIMAC Div. of Varian
 English Electric Valve Co. Ltd.
 Harris Corp. Broadcast Products Div.
 JSH Electronics, Inc. A member co. of VSI Electronics
 RCA Distributor & Special Products Div.
 RCA Electro Optics and Devices
 Varian Associates, Inc. Electron Device Group
 Westinghouse Ind. & Gov't Tube Div.

Vacuum Tubes, Translator

See Adv. Page

JSH Electronics, Inc. 167

EIMAC Div. of Varian
 Harris Corp. Broadcast Products Div.
 JSH Electronics, Inc. A member co. of VSI Electronics
 RCA Distributor & Special Products Div.
 RCA Electro Optics and Devices

RCA Power Tube Marketing
 Television Technology Corp.

Vacuum Tubes, Transmitting

See Adv. Page

JSH Electronics, Inc. 167

Bayly Engineering Ltd. Member of AEG-Telefunken Group
 CCA Electronics Corp.
 Cetec Broadcast Group
 EEV, Inc.
 EEV Canada Ltd.
 EIMAC Div. of Varian
 English Electric Valve Co. Ltd.
 Harris Corp. Broadcast Products Div.
 JSH Electronics, Inc. A member co. of VSI Electronics
 RCA Distributor & Special Products Div.
 RCA Electro Optics and Devices
 RCA Power Tube Marketing
 RCA Solid State Div.
 Singer Products Co., Inc.
 Varian Associates, Inc. Electron Device Group
 Westinghouse Ind. & Gov't Tube Div.

Vacuum Tubes, Transmitting Rebuilt

See Adv. Page

Vacuum Tube Industries 163

Econco Broadcast Service Inc.
 Freeland Products Co.
 RCA Solid State Div.
 Vacuum Tube Industries

Vacuum Tubes, Video Camera

See Adv. Page

Amperex Electronic Corp. 33

EEV, Inc. 97

JSH Electronics, Inc. 167

ATV Research
 Amperex Electronic Corp. Slatersville Div.
 EEV, Inc.
 EEV Canada Ltd.
 English Electric Valve Co. Ltd.
 GBC Closed Circuit TV Corp.
 General Electric Co. ISO Div.
 Harris Corp. Broadcast Products Div.
 JSH Electronics, Inc. A member co. of VSI Electronics
 NEC America, Inc. Broadcast Equip. Div.
 RCA Distributor & Special Products Div.
 RCA Electro Optics and Devices
 Westinghouse Ind. & Gov't Tube Div.

Vector Displays, Color

Broadcast Video Systems, Ltd.
 Harris Corp. Broadcast Products Div.
 Lectrotech Inc.
 Lenco Inc. Electronics Div.
 Tektronix Inc.
 Ultra Audio Pixtec

Viewfinders, Closed Circuit Camera

Javelin Electronics
 Panasonic Co. Video Systems Div.

Voltmeters, AC

B & K Instruments Inc.
 B & K Precision Dynascan Corp.
 Ballantine Labs, Inc.
 Bayly Engineering Ltd. Member of AEG-Telefunken Group
 Boonton Electronics
 California Instruments
 Data Precision Corp.
 Dranetz Engineering Labs., Inc.
 John Fluke Mfg. Co., Inc.

Gralex Industries
 Harris Corp. Broadcast Products Div.
 Heath Co.
 Hickok Elec. Inst. Co.
 ITT Jennings
 Lectrotech Inc.
 Nationwide Electronic Systems, Inc.
 Philips Test & Measuring Instruments, Inc.
 Rohde & Schwarz Sales Co.
 Rycom Instruments
 SPI-ITT Metrix Instruments Div.
 Sencore Inc.
 Systron-Donner
 Tektronix Inc.
 Telecommunications Technology

Voltmeters, DC

B & K Instruments Inc.
 B & K Precision Dynascan Corp.
 Ballantine Labs, Inc.
 California Instruments
 Data Precision Corp.
 Dranetz Engineering Labs., Inc.
 John Fluke Mfg. Co., Inc.
 Gralex Industries
 Harris Corp. Broadcast Products Div.
 Heath Co.
 Hickok Elec. Inst. Co.
 ITT Jennings
 Lectrotech Inc.
 Nationwide Electronic Systems, Inc.
 Philips Test & Measuring Instruments, Inc.
 Rohde & Schwarz Sales Co.
 Rycom Instruments
 SPI-ITT Metrix Instruments Div.

Sencore Inc.
 Systron-Donner
 Tektronix Inc.
 Telecommunications Technology

Voltmeters, FET

B & K Precision Dynascan Corp.
 Harris Corp. Broadcast Products Div.
 Heath Co.
 Hickok Elec. Inst. Co.
 Leader Instruments Corp.
 Lectrotech Inc.
 Philips Test & Measuring Instruments, Inc.
 Rohde & Schwarz Sales Co.
 SPI-ITT Metrix Instruments Div.
 Sencore Inc.

Voltmeters, Vacuum Tube

B & K Precision Dynascan Corp.
 Boonton Electronics
 Harris Corp. Broadcast Products Div.
 Heath Co.
 ITT Jennings
 Rohde & Schwarz Sales Co.
 SPI-ITT Metrix Instruments Div.

Volt-ohm Meters See meters,
 Volt Ohm

Wattmeters

See Adv. Page
Electro Impulse, Inc.161

Barker and Williamson, Inc.
 Bayly Engineering Ltd. Member of
 AEG-Telefunken Group
 Bird Electronic Corp.
 Boonton Electronics
 CCA Electronics Corp.
 Dielectric Communications A Unit of
 General Signal
 Electro Impulse, Inc.
 Harris Corp. Broadcast Products Div.
 Heath Co.
 Hickok Elec. Inst. Co.
 Lampkin Lab. Inc.
 Micro Communications, Inc.
 Nationwide Electronic Systems, Inc.
 Radiometer Elec. U.S. Inc.
 Rohde & Schwarz Sales Co.
 SPI-ITT Metrix Instruments Div.
 Singer Products Co., Inc.

Waveguides

See Adv. Page
Dielectric Communications.....123

Andrew Corp.
 Cablewave Systems Inc.
 Comark Industries Inc.
 Dielectric Communications A Unit of
 General Signal
 Gabriel Electronics, Inc.
 Harris Corp. Broadcast Products Div.
 Micro Communications, Inc.
 The Narda Microwave Corporation
 Nurad, Inc.

Singer Products Co., Inc.
 Systron-Donner

Weather Instruments

See Adv. Page
Texas Electronics150

Harris Corp. Broadcast Products Div.
 Heath Co.
 RMC-Radio Mfg. Co.
 Scientific Radio Systems, Inc.
 Taylor Instrument Consumer Prod. Div.
 Sybron Corp.
 Texas Electronics

Weather Radar --See Radar,
 Weather

Wiring and Cabling Services

Audicon, Inc.
 Audio Accessories Inc.
 Belden Corp.
 Boston Insulated Wire & Cable Co.
 Cablewave Systems Inc.
 DYMA Engineering, Inc.
 Marshall Electronics
 Rex Rheostat & Co., Inc.
 SGL Waber Electric
 Soll, Inc.
 Sono-Mag Corp.
 Times Fiber Communications, Inc.
 Times Wire and Cable
 Union Connector Co., Inc.
 WIDL Video

Broadcast Product Manufacturers Addresses Begin on Page 228

**This
 Publication
 is Available in
 MICROFORM**

FOR INFORMATION
 WRITE:

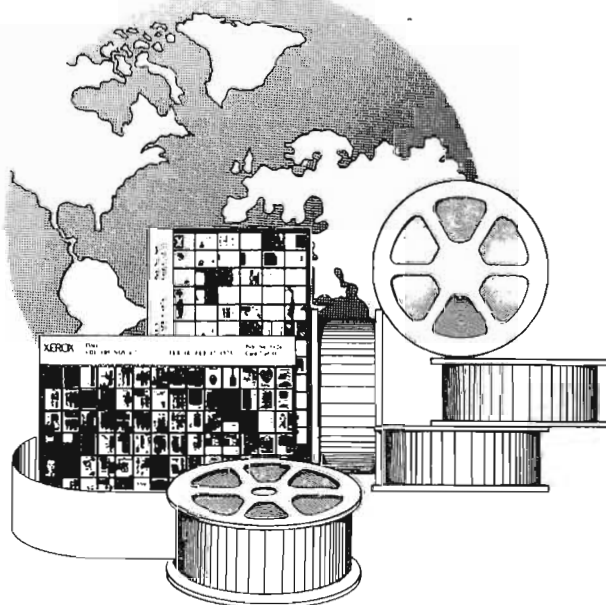

University Microfilms International

300 North Zeeb Road
 Ann Arbor, Mich. 48106
 U.S.A.

18 Bedford Row
 London, WC1R 4EJ
 England

broadcast product manufacturers' addresses

A

ADC Products, 4900 W. 78th St., Minneapolis, MN 55435

ADDA Corp., 1671 Dell Ave., Campbell, Calif. 95008

AEG-Telefunken, Magnetic Tape Recorder Dept., P. O. Box 2154, D-7750 Konstanz, West Germany

A. F. Associates, Inc., 100 Stonehurst Court, Northvale, N. J. 07647

Louis Siracusano, Arnold P. Ferolito, William Ebell (201) 767-1000

REGIONAL SALES CONTACTS:

A.F. Associates, Inc., 2465 E. Bayshore, Suite 301, Palo Alto, Calif. 94303 (415) 856-1060 Donald James

ALTECH Div. Cutler-Hammer, Los Angeles Operation, 5340 Alla Rd., Los Angeles, Calif. 90066

AKG Acoustics Div., Philips Audio Video Systems, 91 McKee Dr., Mahwah, NJ 07430

AMP Special Industries, Valley Forge, PA 19482

ATV Research, 13th & Broadway, Dakota City, Neb. 68731

AVA Electronics, 4000 Bridge St., Drexel Hill, PA 19026

AVAB America Inc., 1714 Stockton St., San Francisco, CA 94133

Acrodyne Industries Inc., 21 Commerce Drive, Montgomeryville, Pa. 18936

Adcom Communications Inc., 555 West 57th St., New York, NY 10019

Al Leon (212) 265-1760

REGIONAL SALES CONTACTS:

Adcom Communications Inc., 29-16 Connell Court, Toronto, Ont. Canada M8Z 5G7 (416) 251-3355 Peter McDonnell

Advance Industries, 2301 Bridgeport Dr., Sioux City, Iowa 51102

Advance Products Co., Box 2178, Wichita, KS 67201

Agfa-Gevaert Inc., 275 N. Street, Teterboro, N.J. 07608

Aitken Communications Inc., 214 Harrison St., Taft, Cal. 93268

Kenneth Aitken, Pres. (805) 765-5403

Alco Electronic Products, Inc., 1551 Osgood St., North Andover, Mass. 01845

Alexander Mfg. Co., Box 1645, Mason City, Iowa 50401

Richard Alexandras (515) 423-8955

Alford Mfg. Co., 15 Sixth Rd., Woburn, Mass. 01801

Allen Avionics, 224 E. 2nd St., Mineola, N.Y. 11501

Lester Jacobson (516) 248-8080

REGIONAL SALES CONTACTS:

Adtek Associates, 309 Town & Country Village, Palo Alto, Calif. 94301 (415) 323-5414 John Sessoms

Reynolds & Associates Inc., 476 N. AIA, Suite 1, Satellite Beach, FL 32937 (305) 773-4700

Ashby Associates, Inc., 4130 Linden Ave., Suite 155, Dayton, Ohio 45432 (513) 252-5627

Reynolds & Associates Inc., 11405 8th St. E., Treasure Island, St. Petersburg, FL 33706 (813) 360-1484

Reynolds & Associates Inc., 161 S.W. 75th Ave., Ft. Lauderdale, FL 33317 (305) 581-6611

Components West, Inc., Box 66581, Seattle, Wash. 98166 (206) 243-2133

Reynolds & Associates Inc., 5057 Vernon Spring Dr., Atlanta, GA 30338 (404) 393-9113

Components West, Inc., 13540 N.W. Mill Creek Dr., Portland, Ore. 97229 (503) 643-5588

Wright Co., 19104 Rhodes Way, Gaithersburg, MD 20760 (301) 840-1928

Dage Corp., International Sales, 757 Main St., Stamford, Conn. 06902 (203) 324-3123

Eastern Metro Associates, 3 Eva Lane, Plainview, NY 11803 (516) 931-1414

Electro Tech Marketing Assoc., 3525 W. Peterson Ave., Suite T7, Chicago, Ill. 60659 (312) 588-4535

Eastern Metro Associates, P.O. Box 695, E. Brunswick, NJ 08816 (201) 254-2555

Engineering Services Co., 8420 Delmar Blvd., St. Louis, Mo. 63124 (314) 997-1515

Wayland Engineering Sales, 2 Evergreen Rd., Mattick, MA 01760 (617) 655-6080

Engineering Services Co., 2425 S. Chrysler, Independence, MO 64052 (816) 254-3600

Harry J. White Co., 2425 S. Chrysler, P.O. Box 1680, Cherry Hill, NJ 08002 (609) 428-4544

Ken Haugen & Associates, Box 864, Anoka, Minn. 55303 (612) 421-3395

Bradenco Corp., 11500 Stemmons Freeway, Suite 113, Dallas, TX 75229 (214) 243-7261

J. F. Hurlbut Co., 622 Gardenia Court, Golden, Colo. 80401 (303) 279-7796

J.G. Welch Associates, 98 Fairview Crescent, Rochester, NY 14617 (716) 244-1100

J. F. Hurlbut Co., 3605 S. Bannock St., Salt Lake City, Utah 84110 (801) 969-4034

J.G. Welch Associates, 2224 Maynard Ave., Utica, NY 13502 (315) 736-7821

E. V. Roberts & Associates, Box 868, Culver City, Calif. 90230 (213) 870-9561; (800) 421-0824

Allen Products Co., 180 Wampus Lane, Milford, CT 06460

Allied Tower Co., Inc., Box 331, South Houston, Tex. 77587

Allison Research, Inc., 2817 Erica Place, Nashville, TN 37204

Altec Lansing Sound Products, 1515 S. Manchester, Anaheim, Calif. 92803

Aluma Tower Co., 1639 Old Dixie Hwy., Box 2806, Veri Beach, FL 32960

Amaray Int'l. Corp., 1901 Old Middlefield Way #11, Mountain View, CA 94033

Amber Electro Design, Ltd., 4810 Jean Talon West, Montreal, Que., Canada H4P 2N5

Amco Engineering Co., 3801 N. Rose St., Schiller Park, IL 60176

American Data Corp., A North American Philips Co., 401 Wynn Dr. N.W., Huntsville, Ala. 35805

American Laser Systems, Inc., 106 James Fowler Rd., Goleta, CA 93017

Lorraine Shallenberger (805) 967-0423

REGIONAL SALES CONTACTS:

DRF Associates, Inc., 3408 Mt. Ariane, San Diego, CA 92111 (714) 292-9431 David R. Frost

TV Specialists, 180 East 21st St., Salt Lake City, UT 84115 (801) 486-7555 Ted Bolinger

Beta Sigma, 2949 North 28th St., Phoenix, AZ 85006 (602) 955-1075 Mac Craven

Comco Electronics, 3456 W. Peterson Ave., Chicago, IL 60659 (312) 539-6116 John Montegrano

Amilon Corp., 49-12 30th Ave., Woodside, NY 11377

Amperex Electronic Corp., Slatersville Div., Box 278, Slatersville, R. I. 02876

Stanley Lovitz, Nat'l. Distributive Sales Mgr. (516) 931-6200

REGIONAL SALES CONTACTS:

Amperex Electronic Corp., Northeast Region, 230 Duffy Ave., Hicksville, N.Y. 11802 (516) 931-6200 Kipp Rabbitt

Amperex Electronic Corp., South Central Region, 13773 N. Central Expy., Suite 1228, Dallas, Tex. 75243 (214) 231-3481 Merle Arnold

Amperex Electronic Corp., Central Region, 1200 S. Wadsworth, Suite G-6, Lakewood, CO 80226 (303) 922-8434

Amperex Electronic Corp., South East Region, 1G, 3300 N.E. Expy., Atlanta, GA 30341 (404) 458-2519 Tony Seaton

Amperex Electronic Corp., North Central Region, 175 Scott St., Elk Grove Village, Ill. 60007 (312) 640-2522 Ralph E. Johnson

Amperex Electronic Corp., Western Region, 3000 Scott Blvd., Suite 115, Santa Clara, Calif. 95050 (408) 249-1134 Ted Marchner

Ampex Corp., 401 Broadway, Redwood City, Cal. 94063

Russ Ide-Audio/Video; Richard Antonio-Magnetic Tape (415) 367-2011

REGIONAL SALES CONTACTS:

Ampex, 500 Rodier Dr., Glendale, CA 91201 (213) 240-5000 Tom Nielson-Audio/Video; Stan Paris-Magnetic Tape

Ampex, 2201 Lant Ave., Elk Grove Village, Ill. 60007 (312) 593-6000 Len Hase-Audio/Video; Bob Pellino-Magnetic Tape

Ampex, 75 Commerce Way, Hackensack, NJ 07601 (201) 489-7400 Al Slater-Audio/Video; Ed Stevenson-Magnetic Tape

Ampex, 10215 Fernwood Rd., Bethesda, MD 20034 (301) 530-8800 Frank Rush-Audio/Video; Max McCollough-Magnetic Tape

Ampex, 3135 Chestnut, Suite 101, Atlanta, GA 30340 (404) 451-7112 Paul Hansik-Audio/Video; Bob Douglass-Magnetic Tape

Ampex, 1615 Prudential Dr., Dallas, TX 75235 (214) 637-5100 Frank Naulti-Audio/Video; Jerry Nevill-Magnetic Tape

Ampex, 401 Broadway, Redwood City, CA 94063 (415) 367-2011 Holt Johnson-Magnetic Tape

Ampro Broadcasting, 850 Pennsylvania Blvd., Feasterville, Pa. 19047

Ampro/Scully Div., Ram Mfg. Inc., 826 Newtown-Yardley Rd., Newtown, PA 18940

Tom Creighton (215) 968-9000

Amtron Corp., Box 1150, Aptos, Calif. 95003

Anders, Inc., 77 Wolcott Rd., Simsbury, CT 06070

Andersen Labs, Inc., Advanced Systems Div., 1280 Blue Hills Ave., Bloomfield, CT 06002

Keith Anderson Co., Box 800, Black Hawk, SD 57718

Anderson Scientific, Box 800, Black Hawk, SD 57718

Andrew Corp., 10500 W. 153rd St., Orland Park, Ill. 60462

Angenieux Corp. of America, 1500 Ocean Ave., Bohemia, N. Y. 11716

Anixter-Mark, Box 1548, Des Plaines, IL 60018

R. B. Annis, Co., 1101 N. Delaware St., Indianapolis, IN 46202

Anton/Bauer Inc., 415 Howe Ave., Shelton, Conn. 06484

Anvil Cases, Inc., 4128 Temple City Blvd., Rosemead, Calif. 91770

Applied Video Electronics, Inc., Box 25, Brunswick, Ohio 44212

Aqua-Tronics, Inc., 17040 Southwest Shaw St., Beaverton, OR 97005

Argos Sound, 600 S. Sycamore St., Genoa, IL 60135

Aristocart Div., Western Broadcasting, Ltd., 505 Burrard St., Vancouver, B.C., Canada V7X 1M6

D. Kaimokoff (604) 522-2711

REGIONAL SALES CONTACTS:

Broadcast Supply West, 2711 Locust Ave. W., Tacoma, Wash. 98466 (206) 565-2301 Irv Law

IGM/NTI, Box 943, Bellingham, WA 98225 (206) 733-4567

David Green Associates, 21 N. Wirt, Leesburg, Va. 22075 (703) 777-8660 David Green

S. Wade, 7030 East 116th St., Nobelsville, IN 46060 (317) 849-6585 S. Wade

McCurdy Radio Industries Ltd., 108 Carnforth Rd., Toronto, Ont. M4A 2L4 Canada (416) 751-6262

Colorado Magnetics, 4620 Milkweed Lane, Colorado Springs, CO 80917

Seltech Equipment, 16 York Rd., Maidenhead, Berks, England SL6 1SF

McCurdy Radio Industries Inc., 1711 Carmen Dr., Elk Grove Village, IL 60007 (312) 640-7077

Broadcast Cart Service, 1122 E. Chevy Chase Dr., Glendale, Calif. 91205 (213) 245-7708

Syntec Electronic Distributors, 5-7 Smith St., Chatswood, N.S.W. Australia 2067

Emmons Assoc., Inc., 10700 Lyndale Ave. S., Minneapolis, Minn. 55420 (612) 881-1118 Keith Emmons

L. A. Varah, 2077 Alberta St., Vancouver, B.C. Canada (604) 873-3211

Radford Associates, 3203 Lanier Dr., Atlanta, Ga. 30319 (404) 237-6097

Arriflex Corp., One Westchester Plaza, Elmsford, N.Y. 10523

Arrow Fastener Co., Inc., 271 Mayhill St., Saddle Brook, NJ 07662

Arvin/Echo Science Corp., 485 E. Middlefield Rd., Mountain View, Calif. 94043

(415) 961-7145

Asaca Corp. of America, 1289 Rand Rd., Des Plaines, Ill. 60016

T. Shigezaki (312) 298-4380

REGIONAL SALES CONTACTS:

Asaca Corp., Box 333, Londonderry, N.H. 03053 (603) 434-0890 Churchill Miller

155-B San Lázaro Ave., Sunnyvale, CA 94086 (408) 735-7350 Richard Reilly

Dyer Electronics, 31185 Ten Mile Rd., Farmington Hills, MI 48024 (313) 478-2157 Mike Dyer

Radford Associates, 3203 Lanier, Atlanta, GA 30319 (404) 237-6097 Lewis Radford
Radford Associates, 1331 Otter Creek Rd., Nashville, TN 37215 (615) 373-0231 Ralph Hucaby
Landy Associates, 1890 E. Marton Pike, Cherry Hill, N.J. 08003 (609) 424-4660 James Landy
801 Hiway 67, P.O. Box 115, Ashippun, WI 53003 (414) 474-4112 Robert Shult
Didler/Denver, 4665 Kipling, Wheat Ridge, CO 80033 (303) 422-6600 Herb Didler

Emil Ascher, Inc., 666 Fifth Ave., New York, NY 10019

Athena Industries, Inc., 2200 Industrial Way, Toms River, NJ 08753

Atlantic Research Corp., 5390 Cherokee Ave., Alexandria, Va. 22314

Atlas Sound, 10 Pomeroy Rd., Parsippany, N.J. 07054

Auburn Instruments, 1127 Olympic Way West, Seattle, Wash. 98119

Audico, Ltd., 219 Crossen Ave., Elk Grove Village, Ill. 60007

Audicon, Inc., 1200 Beechwood Ave., Nashville, TN 37212

Audi-Cord Corp., Box 611, Normal, Ill. 61761

Carl L. Martin (309) 452-9461

REGIONAL SALES CONTACTS:

Audiomedia Associates, 4657 Michoud Blvd. No. 5., P.O. Box 29264, New Orleans, LA 70189 (504) 586-0140 Corey Meyer
Autogram, P.O. Box 456, Plano, TX 75074 (214) 424-8585 Ernie Ankele
Doug Cook & Associates, 2185 Trent Rd., Columbus, OH 43229 (614) 471-4114 Doug Cook
McCurdy Radio Industries Ltd., 1711 Carmen Dr., Elk Grove Village, IL 60007 (312) 640-7011 Ron Mitchell
Media-West, Inc., P.O. Box 458, Bountiful, UT 84010 (801) 295-3308 M. J. Jones
Ring Associates, Inc., P.O. Box 188, Easthampton, MA 01027 (413) 527-4430 John Ring

Oakwood Audio Labs Ltd., 652 King Edward St., Winnipeg, Man. Canada R3H 0P2 (204) 786-6715 Ron Paley
Roscom, Inc., P.O. Box 1208, Roswell, GA 30077 (404) 992-2700 Bob Stewart
Southern Coastal Mktg. Services, 10120 Crestwood Dr., Matthews, NC 21805 (704) 847-5687 Bob Cauthen
Telesco Int'l. Corp., 1 DuPont St. S., Plainview, L.L., NY 11803 (516) 433-6210 Jerry Lainer
Champagne Sales Co., 3645 Crooks Rd., Troy, MI 48084 (313) 649-4428 Bob Champagne
Sound Dynamics, P.O. Box 32055, San Jose, CA 95152 (408) 926-3588 Ron Golic
Sono-Mag Corp., 1005 W. Washington St., Bloomington, IL 61701 (309) 829-6373 Steve Sampson
Broadcast & Communications Consultants, 1300 Hill Rd., Boise, ID 83702 (208) 342-6902 Thomas A. Hill
Miwest Broadcast Supply, 100 E. Ohio St., Chicago, IL 60611 (312) 822-0919 Dwight Herbert
Freeman & Associates, 1813 El Dorado, Garland, TX 75042 (214) 272-3200 Kenneth R. Freeman

Audio Accessories Inc., 163 Water Street, Keene, N.H. 03431

Audio & Design Recording Inc., Box 786, Bremerton, WA 98310
Nigel Branwell (206) 275-5009

Audio Designs & Mfg., 16005 Sturgeon, Roseville, Mich. 48066

Murray A. Shields (313) 778-8400

Audio Interface, Inc., Box 7369, Van Nuys, CA 91409

Audio Magnetics Corp., 2602 Michelson Dr., Irvine, CA 92716

Audionics, Inc., 10950 S.W. 5th Ave., Suite 160, Beaverton, OR 97005

Audiosears Corp., 2 South St., Stamford, NY 12167

Audio-Technica U.S., Inc., 33 Shawassee Ave., Fairlawn, OH 44313

Audiotronics Video Display Div., 530 Fifth Ave., N.W., New Brighton, MN 55112

Audio-Video Engineering Co., 65 Nancy Blvd., Merrick, N. Y. 11566
Rolf Drucker (516) 546-4239

Audiotronics, Inc., 3750 Old Getwell Rd., Memphis, Tenn. 38118

Welton Jetton (901) 362-1350

Auernheimer Laboratories & Co., 4561 E. Florence Ave., Fresno, Calif. 93725

Auratone Corp., Box 698, Coronado, Calif. 92118

Autodyne, Box 13036, Orlando, FL 32859

Autogram Corp., Box 456, Plano, Tex. 75074

Automated Broadcast Controls, 1110 Taft St., Rockville, Md. 20852

Automated Processes, Inc., 790 Park Ave., Huntington, N.Y. 11743

Automatic Devices Co., 2121 South 12th St., Allentown, PA 18103

Automation Electronics, Inc., Autotron Systems, Div., 1001 South Street, Lafayette, Ind. 47905

Automation Techniques, Inc., 1846 N. 106th E Ave., Tulsa, Okla. 74116

Avantek, Inc., 3175 Bowers Ave., Santa Clara, CA 95051

B

BEI Beston Electronics, Inc., Box 106A, Olathe, Kans. 66061

BGW Systems Inc., 13130 S. Yukon Ave., Hawthorne, Calif. 90250

B & I Electronics, Inc., Bldg. 128 Donaldson Center, Greenville, S. C. 29605

BJA Systems, Inc., 666 Davisville Rd., Willow Grove, Pa. 19090

B & K Instruments Inc., 5111 W. 164th St., Cleveland, Ohio 44142

B & K Precision, Dynascan Corp., 6460 W. Courtland, Chicago, Ill. 60635

BSC Inc., 2932 River Rd., River Grove, Ill. 60171

BSM Systems, 2646 East 37th Ave., Spokane, WA 99203

The BTX Corp., 438 Boston Post Rd., Weston, Mass. 02193

Ronald Barker (617) 891-1239

REGIONAL SALES CONTACTS:

The BTX Corp., 6255 Sunset Blvd., Hollywood, CA 90028 (213) 462-1506 Jerry Hudspeth
Dyma Engineering, 213 Pueblo Del Sur, Taos, NM 87571 (505) 758-2686 Carroll Cunningham
Meade Electric Co., Inc., 3100 South 25th Ave., Broadview, IL 60153 (312) 344-4174 Bill Wilson
Radio Service Group, Inc., 2500 Bates Rd., Montreal, Que. Canada H3S 1A6 (514) 342-4503 Jacques Bogos
Sphere Associates, 11250-14 Roger Bacon Dr., Reston, VA 22090 (703) 471-1230 Theodore Bennett
Sphere Audio Sales, 3422 Hurricane Rd., Birmingham, AL 35226 (205) 979-3561 Ray Naish
Sphere Audio Sales, 6985-B Roswell Rd., N.E., Atlanta, GA 30328 (404) 393-9474 Chris Jones

Sphere Audio Sales, 478 Devans Dr., Brentwood, TN 37027 (615) 794-0155 Wally Wilson

Bald Mountain Lab, 230 Bellevue Rd., Troy, N.Y. 12180

Robert S. Henry (518) 279-9753

REGIONAL SALES CONTACTS:

Northeast Broadcast Labs, 15 Charles St., Glen Falls, NY 12180 (518) 793-2181 Bill Bingham
JNS Electronic Industries, P.O. Box 85, Rosanna, Victoria Australia 3084
Broadcast Electronics Inc., 4100 North 24th St., Quincy, IL 62301 (217) 224-9600

Ballantine Labs, Inc., Box 97, Boonton, NJ 07005

Bardwell & McAlister, 7269 Santa Monica Blvd., Hollywood, Calif. 90046

Barker and Williamson, Inc., 10 Canal St., Bristol, PA 19007

Bayly Engineering Ltd., Member of AEG-Telefunken Group, 167 Hunt St., Ajax, Ont., Canada L1S 1P6

Beaveronics, Inc., 8 Haven Ave., Port Washington, NY 11050

John Busharis, V.P. Mktg. (516) 883-4414

Bebell Inc., 416 W. 45th St., New York, NY 10036

Belar Electronics Lab., Inc., Lancaster Ave. at Dorset, Devon, Pa. 19333

Arno M. Meyer (215) 687-5550

Belden Communications, Inc., 25 West 45th St., New York, NY 10036

Belden Corp., Box 1327, Richmond, Ind. 47374

Bell & Howell, Audio Visual Div., 7100 McCormick Rd., Chicago, Ill. 60645

Bell Audio Systems, Inc., 994 Freeway Dr. N., Columbus, Ohio 43229

Berkey-Colortran Inc., 1015 Chestnut St., Burbank, Cal. 91502

Marion M. Rimmer, John Gresch, Jeff Sessler (213) 843-1200

REGIONAL SALES CONTACTS:

Berkey Colortran, 958 Paulsboro Dr., Rockville, MD 20850 (301) 340-7405 Jim Munn
Berkey Colortran, 34 Lake Ave., Trumbull, CT 06611 (203) 261-7835 Charlie Davidson
Berkey Colortran, 2805 Cheyenne Dr., Rowlett, TX 75088 (214) 475-3211 Mel Rimmer
Berkey Colortran, 711 Oxford Rd., Waukesha, WI 53186 (414) 547-7032 Mike Gresch
Berkey Colortran, 25 Wood St., Toronto, Ont. Canada M5Y 2P9 (416) 595-0163 Tim Richardson

Bias/Data Communications Corp., 300 Directors Row, Suite 508, Memphis, TN 38131

Bic Computers, KWIX Radio, Box 619, Moberly, MO 65270

Bird Electronic Corp., 30303 Aurora Rd., Cleveland, Ohio 44139

Blonder-Tongue Labs., One Jake Brown Rd., Old Bridge, N.J. 08857

Bloomington Broadcasting, Box 8, Bloomington, IL 61701

Bogen Div., Lear Siegler, Inc., Box 500, Paramus, N. J. 07652

Bogner Broadcast Equipment Corp., 401 Railroad Ave., Westbury, N. Y. 11590

Bonneville Productions, Div. of Bonneville Int'l. Corp., 130 Social Hall Ave., Salt Lake City, Utah 84111

Boonton Electronics, Rt. 287 Smith Rd., Parsippany, N.J. 07054

Bosch-Fernseh Corp., 279 Midland Ave., Saddle Brook, N.J. 07662

John Lynch (201) 797-7400

REGIONAL SALES CONTACTS:

6300 Arizona Circle, Los Angeles, CA 90045 (213) 649-4330 Tony Magliocco

Boston Insulated Wire & Cable Co., 65 Bay St., Boston, Mass. 02125

Boston Sound & Power Systems, 3 Fredith Rd., Weymouth, Mass. 02189

Brand-Rex Co., Box 498, Willimantic, Conn. 06226

Bretford Mfg. Co., 9715 Soreng Ave., Schiller Park, IL 60176

Walter S. Brewer Co., Inc., 5424 S. Zunis Place, Tulsa, OK 74105

Don Britton Enterprises, Drawer G, Waikiki, Hawaii 96815

Broadcast Aids, Inc., 20 Red Rose Dr., Levittown, Pa. 19056

John Bostwick (215) 547-7133

Broadcast Audio Associates, 11355 Pyrites Way, Rancho Cordova, CA 95670

Broadcast Electronics, Inc., 4100 N. 24th, Box 3606, Quincy, Ill. 62301

J.T. Malone, Sales Mgr. (217) 224-9600

Broadcast Equip. Leasing Co., 3612 Blvd. of Allies, Pittsburgh, Pa. 15213

Broadcast Programming Int'l., Inc., Box 2027, Bellevue, WA 98009

Broadcast Video Systems, Ltd., 1050 McNicoll Ave., Angingcourt, Ont., Canada M1W 2L8

Bert G. Verwey (416) 497-1020

REGIONAL SALES CONTACTS:

Broadcast Video Systems, Inc., 1050 E. Dominguez, Carson, CA 90746 (213) 637-2971 John Spiker

Brown Electronic Labs, 1233 Somerset Dr., San Jose, CA 95132

Bud Industries, Inc., 4605 E. 355th St., Willoughby, Ohio 44094

Buhl Optical Co., 1009 Beech Ave., Pittsburgh, Pa. 15233

Irv Stapsy (412) 321-0076

Burns Audiotronics, Inc., 5-05 Burns Ave., Hicksville, NY 11801

C

CCA Electronics Corp., Box 5500 Broadcast Plaza, Cherry Hill, NJ 08034

David Orienti, Nat'l Sales Mgr. (609) 424-1500

REGIONAL SALES CONTACTS:

Marcom, P.O. Box 66507, Scotts Valley, VA 95066 (408) 438-4273 Marty Jackson; John Nutting; David Diels
Broadcast Communications Devices, 1400 Coleman Ave., Suite H-14, Santa Clara, CA 95050 (408) 994-6614 E. (Mac) Mahafley; Tom Barnes
Audiomedia Associates, P.O. Box 29264, New Orleans, LA 70189 (504) 586-0140 Corey Meyer

S & W Broadcast Sales, 334 Industrial State Park Bldg., Kalamazoo, MI 49006 (616) 342-4973 John Seymour, Ray Winters
 Didier/Denver, 4665 Kipling, Wheat Ridge, CO 80033 (303) 422-6666 Bill Myers, Greg Pine; Herb Didier
 Crouse-Kimzey Co., 3507 W. Vickery, P.O. Box 9830, Fort Worth, TX 76107 (817) 737-9911, John Crouse, V.P.
 Electronics Industries, Inc., 19 E. Irving Ave., Oshkosh, WI 54902 (414) 235-8930 W.P. (Bud) Tadlie
 Klopf Audio/Video Co., 3381 Successful Way, Dayton, OH 45151 (513) 236-5500 Carl Raasch; Brooke McCarter
 Broadcast Communication Associates, 105 Butternut Lane, Peachtree City, GA 30269 (404) 487-9559 Ron Baker
 Southeast Electronics, P.O. Box 2517, Jacksonville, FL 32203 (904) 356-3007 Clark Overton
 Crawford Communications, #4 Oak Ave., Wanonah, NJ 08090 (609) 468-2585 Joseph (Don) Powers
 Spinball, 1031 Southwest 74th Ct., Miami, FL 33144 (305) 261-4755 P. R. Fermain
 Broadcast Equipment Supply, P.O. Box 3141, Bristol, TN 37620 (615) 878-2531 Clifton Droke
 Peta, Inc., 5602 Baltimore Nat'l Pike, Catonsville, MD 21288 (301) 788-2550 Paul Tempe
 David Bain Associates, P.O. Box 1014, Port Washington, NY 11050 (516) 883-4818 David Bain
 Amelco S.A.C.I., Murature 620.22, R. De Escalada, Buenos Aires Argentina 242-9074-1816 Mr. J. Amondarain
 Commercial Bezerra Ltda., Rua Costa Azevedo 139, Caixa Postal 159, Manaus, Amazonas Brazil 232-5363 Mr. Francisco Bezerra, Pres.
 Comel Ltda., Apartado Aereo 1159, Medellin Colombia 312340/322846 Mr. Roger M. Herzig
 Eleegen, 132 Rue Magasin De Letat, Port-Au-Prince Haiti
 Electronics Technowave, Via Pomposa 19, Rome 00142 Italy 5406698/5404746 Mr. G. Marchioni
 Taknos Ltda., Santa Elena 1770, Santiago Chile 568390 Mr. Patricio Torm, V.P.
 E.K.W.A., 14 Mohamed Mahmoud Str Bab El-Louk, Box 145, Cairo Egypt
 Al-Manar Engineering, Tamrunya St., P.O. Box 86, Baghdad Iraq 60992-28077
 Tokyo Electron Labs., Inc., Meicho Bldg., 1-21 Nishi-Shinjuku, Tokyo 160 Japan 343-4431 Mr. Shozo Nakamura
 Hani & Ibrahim Mango Co., Ltd., P.O. Box 14, Amman Jordan 67818-67819
 Technical Appliances Co., Ltd., P.O. Box 5648, Safat Kuwait 42-2259; 42-2260
 CCA de Mexico, Medellin 94-B, Mexico, 7, D.F. Mexico (905) 511-4795 Carlos Caballero
 3881 El Vallejo, Santol Sta. Mesto, Manila Philippines 62-74-18 Mr. Isabela Pacquing
 Korea Electric Co., Ltd., P.O. Box 116, Seoul Korea 75-5415 Mr. T. Y. Wang, Pres.
 Paterson, Simon & Co., P.O. Box 1010, Kuala Lumpur Malaysia 77-5555 Mr. Moses Ting, Sales Mgr.
 Aloha Associates, Century Comm. Ctr., 1750 Kalakaua Ave., Ste. 1302, Honolulu, HI 96827 941-1574 Bob White
 Tele-Systems Ltd., Rua Angelina Videll 17, 2 ESO, Lisboa-1 Portugal Mr. Jose M. Fortunato, Pres.
 Farouk M. Midani, 55 Port Said St., Apt. 20, P.O. Box 301, Damascus Syria 22 665 10 F.M. Midani, Eng.
 Vichien Pathana Ltd., P.O. Box 1656, Bangkok Thailand Mr. V. Vichien
 Inglectric C.A., Edif. Henry Clay, 2D Piso, Palma, Miracielos, Caracas Venezuela 414396/416240 Mr. Alfredo Lopez
 Itama S.A., Poligono Industrial 'Fin de Semana', Alfonso Pena Boeuf 15, Madrid 22 Spain 205.30.76; 205.00.92; 259.33.04 Mr. Jose L. Vieguela
 Weck & Co., P.O. Box 683, Taipei Taiwan (02) 341-0707 Mr. Simon K. Hsu
 Farell & Boix Ltda., Coronel Alegre 1222, Montevideo Uruguay 78 72 46 Mr. Emilio Boix

CCS Hatfield, Communications Products, Box 14710, Phoenix, AZ 85063

CMX Systems & Videomax, Div's. of Orrox Corp., 3303 Scott Blvd., Santa Clara, Calif. 95050

Allan Behr (408) 988-2000

REGIONAL SALES CONTACTS:

CMX Systems/Orrox Corp., 3303 Scott Blvd., Santa Clara, Calif. 95050 (408) 988-2000 Darrell Vincent, Mgr.

CMX Systems/Orrox Corp., Box 355, Springhouse, Pa. 19477 (212) 371-1122 Murray Reviz, Mgr.
 The Gene Sudduth Co., 845 39th S.E., Paris, Tex. 75460 (214) 785-5764 Gene Sudduth

The CnB Studios, 3415 Beresford Ave., Belmont, Calif. 94002

COMPAC, 279-D Skidmore Rd., Deer Park, NY 11729

C.R.V. Systems, Inc., 1901 Madison Ave., Huntington, W.Va. 25704

CSI Electronics, Inc., 3800 S. Congress Ave., Boynton Beach, FL 33435

C. S. P. Inc., 203 Airport Rd., Doylestown, Pa. 18901

Jim Lucy (800) 523-6010

Cablewave Systems Inc., 60 Dodge Ave., North Haven, Conn. 06473

California Instruments, 5150 Convoy St., San Diego, Cal. 92111

California Microwave, 990 Almanor Ave., Sunnyvale, CA 94086

Cambridge Products, 244 Woodland Ave., Bloomfield, CT 06002

Nancy Hollender (800) 243-8814

Canadian General Electric Co., Ltd., 396 Attwell Dr., Rexdale, Ont., Canada M9W 5C3

Canon USA, Inc., Optics Div., 10 Nevada Dr., Lake Success, N. Y. 11042

Jack Keyes (516) 488-6700

REGIONAL SALES CONTACTS:

Canon U.S.A., Inc., 123 Paularino Ave. E., Costa Mesa, Calif. 92626 (714) 979-6000 Y. Agari
 Canon U.S.A., Inc., 140 Industrial Dr., Elmhurst, Ill. 60126 (312) 833-3070 Ken Morishima

Capitol Magnetic Products, 1750 North Vine St., Hollywood, Calif. 90028

Larry Hockemeyer, V.P. Domestic Sales, Bud Jackson, Int'l (213) 462-6252

REGIONAL SALES CONTACTS:

Capitol Magnetic Products, 1777 N. Vine St., Los Angeles, CA 90028 (213) 462-6252 Ed Grant
 Capitol Magnetic Products, 1670 NE Freeway Access Rd., Atlanta, GA 30329 (404) 321-5441 Gene Silvestri
 Capitol Magnetic Products, 1370 Avenue of the Americas, New York, NY 10017 (212) 757-7470 Tony Sanchezico
 Capitol Magnetic Products, 6401 Gross Point Rd., Niles, IL 60648 (312) 775-7101 Dick Dunlavy
 Capitol Magnetic Products, 6730 Oakbrook Blvd., Dallas, TX 75235 (214) 637-1890 John Randolph

JI Case, Davis Div., Box 9228, Wichita, Kans. 67277

Cases Inc., 1745 W. 134 St., Gardena, Calif. 90249

Catel Div., United Scientific Corp., 1400 D Stierlin Rd., Mt. View, Calif. 94043

CaVox Stereo Productions, 502 S. Isis, Inglewood, Calif. 90301

Central Dynamics Corp., 331 W. Northwest Hwy., Palatine, Ill. 60067

REGIONAL SALES CONTACTS:

Central Dynamics Corp., Eastern Region, 10 W. Main St., Elmsford, NY 10523 (914) 592-5440 R. DeBeradinis, Reg. Sales Mgr.
 Central Dynamics Corp., Midwest Region, 331 W. Northwest Hwy., Palatine, IL 60067 (312) 991-4720 L. Hargraves, Reg. Sales Mgr.

Cine 60, Inc., 630 9th Ave., New York, N.Y. 10036

Cinema Products Corp., 2037 Granville Ave., Los Angeles, Calif. 90025

Don Dunbar, Dir. of National Mktg. (213) 478-0711

David Clark Co., Inc., 360 Franklin St., Worcester, MA 01604

Clear-Com Intercom Systems, 759 Harrison St., San Francisco, Calif. 94107

Edward Fitzgerald (415) 989-1130

Centro Corp., 4848 Ronson Court, San Diego, CA 92111

Cetec Audio, Box 3941, North Hollywood, Calif. 91605

Cetec Broadcast Group, 1110 Mark Ave., Carpinteria, CA 93013

Cetec Vega, 9900 Baldwin Pl., El Monte, Calif. 91731

Paul Baughman (213) 442-0782

REGIONAL SALES CONTACTS:

R.M.S. Group, 49 Oval Ct., Suite 214, Walnut Creek, CA 94596 (415) 937-1482 Bill Stevens
 Acousta Communications, 7716 Palo Duro N.E., Albuquerque, NM 87110 (505) 294-4655 Claude Hempen
 Ted Pappas & Associates, 5218 W. Diversey St., Chicago, IL 60639 (312) 685-2338 Ted Pappas
 Sphere Associates, 11250-14 Roger Bacon Dr., Reston, VA 22090 (703) 471-7887 Ted Bennett
 J. B. Parent Co., 4986 Gateway Dr., Great N. Bldg., Medina, OH 44256 (216) 725-8671 Bob Mason
 Matrix Marketing, 7415 Greenwood Ave. N., Seattle, WA 98103 (206) 789-5990 Cliff Miller
 Sphere Audio, 478 Devens Dr., Brentwood, TN 37027 (615) 794-0155 Wally Wilson
 Wyborny Sales, 5800 Corporate Dr., Suite D6, Houston, TX 77036 (713) 772-0961 Frank Donnelly
 Tek-Rep, P.O. Box 610517, Miami, FL 33181 (305) 945-6789
 C. Harrison Associates, 6290 McDonough Dr., Suite E, Norcross, GA 30093
 Beams Co., 2318 Harding Rd., Suite 14B, Des Moines, IA 50314 (515) 255-1148
 Skor, 1821 University Ave., St. Paul, MN 55104 (612) 645-6461
 Robert Milsk Co., 22420 Telegraph Rd., Southfield, MI 48034 (313) 354-3310
 The Smith Co., 188 Brewster Rd., W. Hartford, CT 06117 (203) 523-0512

Gene Sudduth Co. Inc., South Central States, 845 39th St. S.E., Paris, TX 75460 (214) 785-5764 Gene Sudduth
 Central Dynamics Corp., Western Region, 15130 Ventura Blvd., Sherman Oaks, Calif. 91403 (213) 789-0574 Vince Lyons, Regional Sales Mgr.

Centro Corp., 4848 Ronson Court, San Diego, CA 92111

Cetec Audio, Box 3941, North Hollywood, Calif. 91605

Cetec Broadcast Group, 1110 Mark Ave., Carpinteria, CA 93013

Cetec Vega, 9900 Baldwin Pl., El Monte, Calif. 91731

Paul Baughman (213) 442-0782

REGIONAL SALES CONTACTS:

R.M.S. Group, 49 Oval Ct., Suite 214, Walnut Creek, CA 94596 (415) 937-1482 Bill Stevens
 Acousta Communications, 7716 Palo Duro N.E., Albuquerque, NM 87110 (505) 294-4655 Claude Hempen
 Ted Pappas & Associates, 5218 W. Diversey St., Chicago, IL 60639 (312) 685-2338 Ted Pappas
 Sphere Associates, 11250-14 Roger Bacon Dr., Reston, VA 22090 (703) 471-7887 Ted Bennett
 J. B. Parent Co., 4986 Gateway Dr., Great N. Bldg., Medina, OH 44256 (216) 725-8671 Bob Mason
 Matrix Marketing, 7415 Greenwood Ave. N., Seattle, WA 98103 (206) 789-5990 Cliff Miller
 Sphere Audio, 478 Devens Dr., Brentwood, TN 37027 (615) 794-0155 Wally Wilson
 Wyborny Sales, 5800 Corporate Dr., Suite D6, Houston, TX 77036 (713) 772-0961 Frank Donnelly
 Tek-Rep, P.O. Box 610517, Miami, FL 33181 (305) 945-6789
 C. Harrison Associates, 6290 McDonough Dr., Suite E, Norcross, GA 30093
 Beams Co., 2318 Harding Rd., Suite 14B, Des Moines, IA 50314 (515) 255-1148
 Skor, 1821 University Ave., St. Paul, MN 55104 (612) 645-6461
 Robert Milsk Co., 22420 Telegraph Rd., Southfield, MI 48034 (313) 354-3310
 The Smith Co., 188 Brewster Rd., W. Hartford, CT 06117 (203) 523-0512

Chyron Corp., Video Products Div., 265 Bethpage/Spagnoli Rd., Melville, NY 11747

Chyron Telesystems, 265 Bethpage/Spagnoli Rd., Melville, NY 11747

Richard P. Boyd, Dir. of Sales Mktg. (516) 249-3296

Cezar International, 491 Macara Ave. Suite 1003, Sunnyvale, CA 94086

Channelmatic, Inc., 2232 Lindsay Michelle Dr., Alpine, Calif. 92001

Cherry Electrical Products, 3600 Sunset Ave., Waukegan, IL 60085

Cherry Semiconductor, 99 Bald Hill Rd., Cranston, RI 02920

Christie Electric Corp., 3410 W. 67th St., Los Angeles, Calif. 90043

Tim Robertil (213) 750-1151

Chyron Corp., Video Products Div., 265 Bethpage/Spagnoli Rd., Melville, NY 11747

Chyron Telesystems, 265 Bethpage/Spagnoli Rd., Melville, NY 11747

Richard P. Boyd, Dir. of Sales Mktg. (516) 249-3296

Cine 60, Inc., 630 9th Ave., New York, N.Y. 10036

Cinema Products Corp., 2037 Granville Ave., Los Angeles, Calif. 90025

Don Dunbar, Dir. of National Mktg. (213) 478-0711

Chyron Corp., Video Products Div., 265 Bethpage/Spagnoli Rd., Melville, NY 11747

Chyron Telesystems, 265 Bethpage/Spagnoli Rd., Melville, NY 11747

Richard P. Boyd, Dir. of Sales Mktg. (516) 249-3296

Cine 60, Inc., 630 9th Ave., New York, N.Y. 10036

Cinema Products Corp., 2037 Granville Ave., Los Angeles, Calif. 90025

Don Dunbar, Dir. of National Mktg. (213) 478-0711

Chyron Corp., Video Products Div., 265 Bethpage/Spagnoli Rd., Melville, NY 11747

Chyron Telesystems, 265 Bethpage/Spagnoli Rd., Melville, NY 11747

Richard P. Boyd, Dir. of Sales Mktg. (516) 249-3296

Cine 60, Inc., 630 9th Ave., New York, N.Y. 10036

Cinema Products Corp., 2037 Granville Ave., Los Angeles, Calif. 90025

Don Dunbar, Dir. of National Mktg. (213) 478-0711

David Clark Co., Inc., 360 Franklin St., Worcester, MA 01604

Clear-Com Intercom Systems, 759 Harrison St., San Francisco, Calif. 94107

Edward Fitzgerald (415) 989-1130

Centro Corp., 4848 Ronson Court, San Diego, CA 92111

Cetec Audio, Box 3941, North Hollywood, Calif. 91605

Cetec Broadcast Group, 1110 Mark Ave., Carpinteria, CA 93013

Cetec Vega, 9900 Baldwin Pl., El Monte, Calif. 91731

Paul Baughman (213) 442-0782

REGIONAL SALES CONTACTS:

R.M.S. Group, 49 Oval Ct., Suite 214, Walnut Creek, CA 94596 (415) 937-1482 Bill Stevens
 Acousta Communications, 7716 Palo Duro N.E., Albuquerque, NM 87110 (505) 294-4655 Claude Hempen
 Ted Pappas & Associates, 5218 W. Diversey St., Chicago, IL 60639 (312) 685-2338 Ted Pappas
 Sphere Associates, 11250-14 Roger Bacon Dr., Reston, VA 22090 (703) 471-7887 Ted Bennett
 J. B. Parent Co., 4986 Gateway Dr., Great N. Bldg., Medina, OH 44256 (216) 725-8671 Bob Mason
 Matrix Marketing, 7415 Greenwood Ave. N., Seattle, WA 98103 (206) 789-5990 Cliff Miller
 Sphere Audio, 478 Devens Dr., Brentwood, TN 37027 (615) 794-0155 Wally Wilson
 Wyborny Sales, 5800 Corporate Dr., Suite D6, Houston, TX 77036 (713) 772-0961 Frank Donnelly
 Tek-Rep, P.O. Box 610517, Miami, FL 33181 (305) 945-6789
 C. Harrison Associates, 6290 McDonough Dr., Suite E, Norcross, GA 30093
 Beams Co., 2318 Harding Rd., Suite 14B, Des Moines, IA 50314 (515) 255-1148
 Skor, 1821 University Ave., St. Paul, MN 55104 (612) 645-6461
 Robert Milsk Co., 22420 Telegraph Rd., Southfield, MI 48034 (313) 354-3310
 The Smith Co., 188 Brewster Rd., W. Hartford, CT 06117 (203) 523-0512

Cleveland Institute of Elec., Inc., 1776 East 17th St., Cleveland, OH 44114

Coastcom, 2312 Stanwell Dr., Concord, Calif. 94520

Coherent Communications, 13733 Glenoaks Blvd., Sylmar, CA 91342

Cohu, Inc., Electronics Div., Box 623, San Diego, Cal. 92112

Al Zoller (714) 277-6700 ext. 241

REGIONAL SALES CONTACTS:

Cohu-California, Northern, 770 Welch Rd., Suite 154, Palo Alto, CA 94305 (415) 326-0280
 Cohu-Northeast, 23 E. Madison Ave., Florham Par, NJ 97932 (201) 377-6636 Lawrence W. Litchfield
 Cohu-Great Lakes, 27962 Sutherland Dr., Warren, MI 48093 (313) 739-5444 Virgil Davis

Cohu-Los Angeles, 2307 Orange Ave., Costa Mesa, CA 92627 (714) 631-4680 Wayne F. Kennedy
 Cohu-Southeast, 4100 Aldebaran Way, Mobile, AL 36609 (205) 661-9088 Darrell M. Pahl

Arnold Barnes Associates, Inc., 1300 E. Arapaho Rd., Richardson, TX 75081 (214) 783-8400 Arnold Barnes
 Bartlett Associates, Inc., 130 W. Lancaster Ave., Wayne, PA 19087 (215) 688-7325
 Perspective Measurements, 8369 Vickers St., Suite D, San Diego, CA 92111 (919) 278-8931 Dick Sjoberg
 Scientific Systems, Inc., P.O. Box 1696, Bailey, CO 80421 (303) 838-4615

Collins Div., Rockwell International, Mail Station 406-240, Dallas, Tex. 75207

James W. Ariana, Domestic Sls. Mgr. (214) 996-5424

REGIONAL SALES CONTACTS:

Rockwell Int'l., Collins Broadcast Products, R. R. 2, Westport, N.Y. 12993 (518) 962-4567 John Ring
 Rockwell Int'l., Collins Broadcast Products, Box 16, Newton, N.J. 07860 (201) 383-8797 Keith Leach
 Rockwell Int'l., Collins Broadcast Products, Rt. 2, Box 12, Glenmore Dr., Rockford, Tenn. 37853 (615) 573-9717 R. C. Evans
 Rockwell Int'l., Collins Broadcast Products, 2280 Rockcreek Trail, Birmingham, Ala. 35226 (205) 823-7048 Dave Hultsman
 Rockwell Int'l., Collins Broadcast Products, 38780 Hartwell, Sterling Heights, Mich. 48077 (313) 979-6320 D. W. Hill
 Rockwell Int'l., Collins Broadcast Products, 2000 West Branch Rd., Maple Plain, N.J. 55359 (612) 479-2633 J. L. Littlejohn
 Rockwell Int'l., Collins Broadcast Products, Rt. 1, Box 217-B, Oak Grove, Mo. 64075 (816) 443-2080 J. C. Shideler
 Rockwell Int'l., Collins Broadcast Products, 1200 N. Alma Rd., Richardson, Tex. 75080 (214) 259-1440, 690-5424 W. R. Terry Sheffield
 Rockwell Int'l., Collins Broadcast Products, 1450 W. Arroyo Dr., Yuma, Ariz. 85364 (602) 783-6380 Morris Courtright
 Rockwell Int'l., Collins Broadcast Products, 1215 S.E. 73rd Ave., Portland, Ore. 97215 (503) 254-2818 T. T. Cauthers
 Rockwell Int'l., Collins Broadcast Products, Box 2743, Fairbanks, Alaska 99707 (907) 452-6044 R. F. Cassidy
 Applied Electronics Ltd., 299 Evans Ave., Toronto, Ont. M8Z 1K2 Canada (416) 252-3761 Bob Norton
 Telvicon Ltee., 822 Halpern Ave., Dorval, Que. Canada (514) 631-9089 Raymond Quessnel
 Applied Electronics Ltd., Bay #1, 4519 12th St. N.E., Calgary, Alta. Canada (403) 277-8600 Tom Cuddy

Colorado Video Inc., Box 928, Boulder, Colo. 80306

Glen Southworth (303) 444-3972

REGIONAL SALES CONTACTS:

Colorado Video, 17 Amber Rd., Chelmsford, MA 01824 (617) 256-3381 Dick Taylor

Columbia Special Products, 51 West 52nd St., Room 861, New York, NY 10019

Columbine Systems, Inc., Box 740, Golden, CO 80401

Comark Communications Industries, Inc., Box 267, Southwick, MA 01077

Colorado Video Inc., Box 928, Boulder, Colo. 80306

Glen Southworth (303) 444-3972

REGIONAL SALES CONTACTS:

Colorado Video, 17 Amber Rd., Chelmsford, MA 01824 (617) 256-3381 Dick Taylor

Columbia Special Products, 51 West 52nd St., Room 861, New York, NY 10019

Columbine Systems, Inc., Box 740, Golden, CO 80401

Comark Communications Industries, Inc., Box 267, Southwick, MA 01077

Colorado Video Inc., Box 92

- Comark Industries Inc.**, Box 229, Southwick, MA 01077
- Comet Sales**, Box 4755, Springdale, Conn. 06907
- Command Productions, Radio Broadcasting Services**, Box 26348, San Francisco, CA 94126
- Commercial Electronics, Inc.**, 880 Maude Ave., Mountain View, Calif. 94043
Homer Hull, Dir. Mktg. (415) 969-1910
- REGIONAL SALES CONTACTS:**
*Commercial Electronics, Inc., P.O. Box 300, New York, NY 10013 (212) 734-7871 Harvey Ray
Commercial Electronics Inc., 611 Marlow Pl., Arlington, TX 76010 (817) 465-3432
Dave Lindsey
Emmons Associates, 10700 Lyndale Ave. S., Minneapolis, Minn. 55401 (612) 881-1118 Keith Emmons
Video Equipment Corp. of America, 7377 Convoy Court, San Diego, CA 92111 (714) 278-4400 Bill Bennett*
- Commercial Radio Monitoring Co., Inc.**, 103 S. Market, Lee's Summit, Mo. 64063
- Comm/Scope Co.**, Rt. 1, Box 199A, Catawba, N.C. 28609
- Communications Int'l.**, 2 Briarway, Suite B, Houston, TX 77027
- Communications, Ltd.**, 1601 N. Bristol St., Santa Ana, Calif. 92706
- Compact Video Sales**, 1104 W. Chestnut St., Burbank, CA 91502
- Comprehensive Video Supply Corp.**, 148 Veterans Dr., Northvale, NJ 07647
- Computer Business Systems, Inc.**, 167 Moore Rd., East Weymouth, MA 02189
- Computer Image Video Controllers, Dytek Industries, Inc.**, 2492 W. 2nd Ave., Denver, Colo. 80223
- Computer Labs, Div. of Analog Devices, Inc.**, 505 Edwardia Dr., Greensboro, N.C. 27409
- Computer Magnetics Corp.**, 125 W. Providencia Ave., Burbank, Calif. 91502
- Computer Management Systems, Inc.**, 6610 N. Shadeland Ave., Indianapolis, IN 46220
- Computer Products Inc., Power Products Div.**, 1400 N.W. 70th St., Fort Lauderdale, FL 33309
- Comrex Corp.**, 60 Union Ave., Sudbury, Mass. 01776
Lynn E. Distler (617) 443-8811
- Comsearch, Inc.**, 2936 Chain Bridge Rd., Oakton, VA 22124
- ComTec Video Systems, Mincom Div. 3M**, 3070 Leeman Ferry Rd. S.W., Huntsville, AL 35801
- Conrac Div., Conrac Corp.**, 600 North Rimsdale Ave., Covina, Calif. 91722
- Conrac Systems-East Div.**, 32 Fairfield Pl., West Caldwell, N.J. 07006
- Consolidated Electronic Industries**, 1925 N. Lynn St., Arlington, VA 22209
(703) 524-9811
- Consolidated Video Systems**, 1255 E. Arques Ave., Sunnyvale, Calif. 94086
- Contel Mfg.**, 1620 W. 32nd Place, Hialeah, Fla. 33012
- Continental Electronics Mfg. Co., Box 270879**, Dallas, Texas 75227
Vernon Collins (214) 381-7161
- Continental Specialties Corp.**, 70 Fulton Terr., New Haven, CT 06509
- Convergence Corp.**, 17935 Sky Park Circle #D, Irvine, Calif. 92714
- Corning Glass Works**, 3900 Electronics Dr., Raleigh, N. C. 27604
- Cox Data Services, Suite 100/Prado North**, 5600 Roswell Rd., Atlanta, Ga. 30342
- Crosspoint Latch Corp.**, 316 Broad Street, Summit, N.J. 07901
George Pires, Pres. (201) 273-1090
- Crouse Hinds Co.**, Box 4999, Syracuse, N.Y. 13221
- Crown International, Inc.**, Box 1000, Elkhart, Ind. 46515
- Custom Audio Electronics**, 2828 Stommel Rd., Ypsilanti, Mich. 48197
- D**
- dbx, Inc.**, 71 Chapel St., Newton, Mass. 02195
- DHW, Inc.**, Box 520, Mineral Wells, TX 76067
- D. O. Industries**, 317 E. Chestnut St., East Rochester, NY 14445
- D and S Corley Ltd.**, 80 Galaxy Blvd., Rexdale, Ont., Canada M9W 4Y8
- Dage-MTI, Inc.**, 208 Wabash St., Michigan City, Ind. 46360
- Peter W. Dahl Co. Inc.**, 4007 Fort Blvd., El Paso, TX 79930
Peter W. Dahl (915) 566-5365
- Da-Lite Screen Co., Inc.**, 3100 State Rd. 15 N., Warsaw, IN 46580
- Data Communications Corp.**, 3000 Directors Row, Memphis, Tenn. 38131
- Datametrics Inc.**, 340 Fordham Road, Wilmington, Mass. 01887
Robert Kieser (617) 658-5410
- REGIONAL SALES CONTACTS:**
*PM Electronics, 175 Marine St., Farmingdale, NY 11735 (516) 248-4858 Paul Milazzo
Roscor Corp., 6160 W. Oakton St., Morton Grove, IL 60053 (312) 539-7700 Paul Roston
Wiltronix, Inc., 5504 Waterway, Rockville, MD 20853 (301) 460-1454 Dwight Wilcox
Sedillo Co., 125 E. Sunnyoaks Ave., Campbell, CA 95008 (408) 374-5220 Ramon Sedillo*
- Data Precision Corp.**, Electronics Ave., Danvers, MA 01923
- Datatek Corp.**, 1166 W. Chestnut St., Union, N. J. 07083
Bob Rainey (201) 964-3656
- REGIONAL SALES CONTACTS:**
*Broadcast Communications Devices, 5526 E. LaPalma Ave., Anaheim, CA 92807 (714) 528-9505 John Baumann
H.M. Dyer Electronics, 31185 Ten Mile Rd., Farmington Hills, MI 48204 (312) 343-4300
MARCUM, P.O. Box 66507, Scotts Valley, CA 95066 (408) 438-4273
Didier/Denver, 4665 Kipling, Wheat Ridge, CO 80033 (303) 422-6600 Herb Didier
Landy Associates, 1890 E. Marlton Pike, Cherry Hill, NJ 08003 (609) 424-4660
James E. Landy
Radford Associates, 3203 Lanier Dr., Atlanta, GA 30319 (404) 327-6097*
- The Gene Sudduth Co.**, 845 39th S.E. Paris, TX 75460 (214) 785-5764 E.T. Sudduth
- Applied Electronics LTD.**, 299 Evans Ave., Toronto, Ont. Canada M8Z 1K2 (416) 252-3761
- Datatron, Inc.**, Box 11427, Santa Ana, Cal. 92711
- Davis & Sanford Co. Inc.**, 24 Pleasant St., New Rochelle, N.Y. 10802
- Decca Austin Insulators**, 71 Selby Road, Brampton Ont., Canada L6W 1K5
- Delta Electronics Inc. (N.C.)**, 145 Fayette St., Winston Salem, N.C. 27101
- Delta Electronics Inc. (Va.)**, 5730 Gen. Washington Dr., Alexandria, VA 22312
Joseph Novak (703) 354-3350
- De Wolfe Music Library**, 25 West 45th St., New York, NY 10036
- Dielectric Communications, A Unit of General Signal**, Route 121, Raymond, Me. 04071
Stanley O. Thomas (800) 341-9678
- REGIONAL SALES CONTACTS:**
*Forbes Distrib. Co., 1416 4th Avenue, South Birmingham, AL 35234 (205) 251-4101
Tucker Bros. P.O. Box 177, Crabwell, AL 35054 (205) 525-5341
Juneau Electronics, 241 S. Franklin, Juneau, AK 99801 (907) 586-2260
Electronics Plus, 823 Fourth Street, San Rafael, CA 94901
Pacific Coast Ind. P.O. Box 932, Orangeville, CA 95662 (916) 366-3698
Western Radio & TV Supply Co., 1415 India Street, San Diego, CA 92101 (714) 239-0361
AB Electronics/Communications, 1660 W. 31st Place, Hialeah, FL 33012 (305) 887-3203
Amateur Radio Center Inc., 2805 NE 2nd Avenue, Miami, FL 33137 (305) 573-8383
BFJ Sales, Inc., Bldg. 128, Sanford Airport, P.O. Box 4000, Sanford, FL 32771 (305) 323-8510
ESL, 3560 NW 34th Street, P.O. Box 420555, Miami, FL 33142 (305) 633-3973
Hialeah Electronics Distributing, 612 E. 9th Street, Hialeah, FL 33142 (305) 887-5936
Good Electronics, 956 E. Altamonte Drive Executive Center, Altamonte Springs, FL 32701 (305) 830-7230
Nurmi Electronic Supply, 1727 Donna Road, West Palm Beach, FL 33049 (305) 686-8553
ACK Radio Supply, 555 Dearing Road NW, Atlanta, GA 30309 (404) 736-5526
Southern Distributing, 3213 Milledgeville Road, Augusta, GA 30909 (404) 736-5526
Douglas Electronics, 1118 So. Staples, Corpus Christi, TX 78404 (512) 883-5103
ZZZ Electronics, 424 Armour Circle, NE, Atlanta, GA 30324 (404) 876-0631
The Antenna Farm, 7451 Switzer, Suite #107, Shawnee, KS 66203 (913) 831-2045
Singer Electronics, P.O. Box 2941, Northern City, LA 70380 (505) 982-4488
Arva-Hudson, Inc., Box 1512, Bellevue, Wash. 98009 (206) 455-0773
Ampower, 26 Just Road, Fairfield, NJ 07006 (201) 227-7720
Future Electronics, 5647 Ferrier St., Montreal, Que. H4P 2K5 Canada (514) 731-7441
Telcom Co., 4254 Glen High Road, Winston Salem, NC 27107 (919) 784-8833
Future Electronics Corp., 44 Fasken Dr., Unit 24, Rexdale, Ont., Canada M9W 1K5 (416) 675-7820
A-1 Communications, 441 Cerrino Street, Santa Fe, NM 87501 (505) 982-4488
L.A. Varah, Ltd., 2077 Alberta St., Vancouver B.C. Canada V5Y 1A4 (604) 873-3211
Browning Electronics, 5044 S. Main Street, Akron, OH 44319 (216) 896-1902
Nivel Technico, SA, Melodino 8-301, Mexico 7, D.F., Mexico (511) 17-59
Portland Radio Supplies, 1234 W. Stock Street, Portland, OR 97205 (503) 228-5103*
- Scopes of California**, 1928A So. Anaheim Blvd., Anaheim, CA 92805 (714) 772-0335
- Magestic Communications**, 4091 Discount, Memphis, TN 38101 (901) 794-9494
- Rush Electronics**, 3145 Bluff City Hwy, Bristol, TN 37620 (615) 764-0381
- G. Enterprises**, 5468 S. 1900 West, Roy, UT 84067 (801) 825-7344
- Cal Com Systems, Inc.**, 2670 Bonaventura Dr., San Jose, CA 95134 (408) 262-7200
- Jan Industrial Electronics Co.**, 401 N. Broad St., Philadelphia, PA 19108 (215) 922-1321
- Communication Wholesalers**, 1741 15th Avenue, Seattle, WA 98155 (206) 364-6410
- EME-3, Inc.**, 975 Whitmore Dr., Melbourne, FL 32935 (305) 259-2711 Karl Keck
- ABC Communications Inc.**, 1755 15th Avenue, N.E., Seattle, WA 98155 (206) 364-8300
- West Indies Sales Co., Ltd.**, 690 West 28th St., Hialeah, FL 33010 (305) 888-1676
- EME-II, Inc.**, 2522 Tangelwood Rd., Decatur, GA 30033 (404) 325-0165
- PLM Sales**, 603 Pleasant Place, Streamwood, IL 60103 (312) 628-8000
- Hurley Electronics, Inc.**, 1112 S. Casino Center, Las Vegas, NV 89104 (702) 384-5666
- C. H. Electronic Distributing**, 209 Parker Ave., Clifton, NJ 07011 (201) 478-9700
- Electronic Module**, 601 North Turner St., Hobbs, NM 88240 (505) 397-3022
- Electronic Merchandising Enterprises**, 112 Buena Vista, High Point, NC 27260 (919) 869-3335
- Digital Video Systems**, 716 Grodon Baker Rd., Willowdale, Ont., Canada M2H 2C9
John Lowry, Pres. (416) 499-4826
- REGIONAL SALES CONTACTS:**
*Digital Video Systems, 999 E. Touhy Ave., Suite 240, Des Plaines, IL 60018 (312) 298-9570
Digital Video Systems, Bldg. 900 2672 Bayshore Frontage Rd., Mountain View, CA 94043 (415) 962-9080*
- Display Media, Inc.**, 120 Laura Dr., Addison, IL 60101
- Ditch Witch, Div. of Charles Machine Works Inc.**, P.O. Box 66, Perry, Okla. 73077
- Di-Tech Inc.**, 311 Wyandanch Ave., Babylon, N.Y. 11704
- Dolby Laboratories, Inc.**, 731 Sansome St., San Francisco, Calif. 94111
(415) 392-0300
- Dolphin Productions, Inc.**, 140 East 80th, New York, NY 10021
- DowKey Div., Of Kilovac Corp.**, Box 4422, Santa Barbara, CA 93103
- Dranetz Engineering Labs, Inc.**, 2385 S. Clinton Ave., South Plainfield, N. J. 07080
- D'San Corp.**, 25-30 163rd St., Flushing, NY 11358
- Dukane Corp., Audio-Visual Div.**, 2900 Dukane Dr., St. Charles, IL 60174
- Duncan Electronics, Inc.**, 2865 Fairview Road, Costa Mesa, Calif. 92626
- E. I. du Pont de Nemours & Co., Inc., Magnetic Products Div.**, Old du Pont Airport, Bldg. 1, Wilmington, Del. 19898
- Durst US-Sickles Inc.**, Box 3396, Scottsdale, AZ 85257
- DYMA Engineering, Inc.**, Box 1697, Taos, NM 87571
C. G. Cunningham (505) 758-2686
- REGIONAL SALES CONTACTS:**
*DYMA, 505 1/2 Centinela, Inglewood, Calif. 90302 (213) 322-2050
DYMA, 926-Wistena Way, Dallas, Tex. 75080 (214) 235-8236*

Dynair Electronics, Inc., 5275 Market St., San Diego, Cal. 92114

Robert A. Jacobs (714) 263-7711

Dynasciences, Div. Whittaker Corp., Township Line Road, Blue Bell, Pa. 19422

Dynatech Data Systems, 7644 Dynatech Ct., Springfield, Va. 22153

Dytek Industries, Inc., 2492 W. 2nd Ave., Denver, Colo. 80223

E

EDCO Products, Inc., 680 Bizzell Dr., Lexington, Ky. 40504

EEO Inc., 1601 E. Chestnut Ave., Santa Ana, Calif. 92701

Geo. Swetland (714) 835-6000

REGIONAL SALES CONTACTS:

Ampex Corp., Los Angeles, (213) 240-5000

Ampex Corp., Atlanta, (404) 451-7112

Ampex Corp., Chicago, (312) 593-6000

Ampex Corp., Bethesda, (301) 530-8800

Ampex Corp., Boston, (617) 890-2040

Ampex Corp., New Jersey, (201) 489-7400

Ampex Corp., New York, (201) 736-6116

Ampex Corp., Dayton, OH (513) 254-6101

Ampex Corp., Philadelphia, (215) 887-7650

Ampex Corp., Dallas, (214) 637-5100

EEG Enterprises, Inc., 82 Rome St., Farmingdale, NY 11735

EEV, Inc., 7 Westchester Plaza, Elmsford, N.Y. 10523

Tom Soldano, RF Products and Dick Betts, Imaging Devices (914) 592-6050

REGIONAL SALES CONTACTS:

EEV, Canada Ltd., 67 Westmore Dr., Rexdale, Ont. Canada M9V 3Y6 (416) 745-9494 Bob Parkes

EEV, Inc., 15 Dunwoody Park, Suite 100E, Atlanta, GA 30338 (404) 394-9201 Harry Kozicki

English Electric Valve Co. Ltd., Waterhouse Lane, Chelmsford England CM1 2QU (0245) 61777 Mark Knight

EEV, Inc., Route 1, Anna, TX 75003 (214) 837-2464 R. Knowles

EEV, Inc., 18 Indian Hill Rd., Union, KY 41091 (606) 384-4477 Richard Bossert

EEV, Inc., 3 Buckingham Rd., Natick, MA 01760 (617) 653-8300 Dan Green

EEV, Inc., 19001 40th Place N.E., Seattle, WA 98155 (206) 363-2200 D. Rose

EEV Canada Ltd., 67 Westmore Dr., Rexdale, Ont., Canada M9V 3Y6

EIMAC, Div. of Varian, 301 Industrial Way, San Carlos, Cal. 94070

EIP Microwave, 3230 Scott Blvd., Santa Clara, Calif. 95051

EMCEE Broadcast Products, Box 68, White Haven, Pa. 18661

E.M.S. Inc., Box 2792, Castro Valley, CA 94546

EMT Franz VGmbH, Box 1520, D-763 Lahr, W. Germany

E-N-G Corp., 1009 C. Shary Circle, Concord, CA 94518

ENG Products Corp., Box 42, Scarborough, NY 10510

ESC Electronics Corp., 534 Bergen Blvd., Palisades Park, N. J. 07650

ESE, 142 Sierra St., El Segundo, CA 90245

R. M. Mayers (213) 674-3021

REGIONAL SALES CONTACTS:

Roscom Inc., P.O. Box 1208, Roswell, GA 30077 (404) 992-2700 Bob Stewart

David Bain Associates, Box 1014, Port Washington, N.Y. 11050 (516) 883-4818 David Bain

Audio Distributors Inc., 2344 S. Division, Grand Rapids, MI 49507 (616) 452-1596 Dave Veldsma

Dyma Engineering, P.O. Box 1697, Taos, NM 87571 (505) 758-2686 Carroll Cunningham

Comad Communications, 91 Kellfield St., Rexdale, Ont. M9V 5A3 Canada (416) 245-1734 Emil Adamyk

Savco, P.O. Box 427, Richardson, TX 75080 (214) 234-1841 Nathan Hughes

Broadcast Supply West, 2711 Locust Ave. W., Tacoma, WA 98466 (206) 565-2301 Irv Law

David Green Broadcast Consultant, 21 N. Wirt St., Leesburg, Va. 22075 (703) 777-8660 David Green

Midwest Corp., Nitro, WV (304) 722-2921 Midwest Corp., Cincinnati, OH (513) 742-2300

Martin Audio, 320 W. 46th St., New York, N.Y. 10036 (212) 541-5900 Ed Tompkins

Midwest Corp., Miami, FL (305) 592-5355 Allied Broadcast Equipment, 124 S. 6th St., Richmond, Ind. 47374 (317) 962-8596 Roy Ridge

Midwest Corp., Houston, TX (713) 686-9278

Ro-Cal Electronics, 731 Voice of the Theater Bldg., Pittsburgh, Pa. 15223 (412) 781-2326 Claire Rosenberger

Midwest Corp., Clarksburg, WV (304) 623-3781

Midwest Corp., Virginia Beach, VA (804) 464-6256

Midwest Corp., Beltsville, MD (301) 937-1890

Midwest Corp., Dallas, TX (214) 741-1440

Eastman Kodak Co., 343 State St., Rochester, N.Y. 14650

Echo Science Corp., 485 E. Middlefield Rd., Mountain View, CA 94043

Echolab, 175 Bedford Rd., Burlington, MA 01803

Econco Broadcast Service Inc., Rt. 2 Box 188, Woodland, Calif. 95695

Edco Products, Inc., 680 Bizzell Dr., Lexington, Ky. 40504

Edcor, 16782 Hale Ave., Irvine, CA 92714

Ednalite Corp., 200 N. Water St., Peekskill, NY 10566

Edutron, Inc., 25 Oak St., Suite 1, Roswell, GA 30075

REGIONAL SALES CONTACTS:
Signal Engr. & Sales, 720 South 23rd St., P.O. Box 10167, Birmingham, AL 35202 (205) 328-6431

Rohr Electronics, 4553 East Broadway, Tucson, AZ 85711 (602) 795-8573

Alco Paramount, 79 S. Third St., San Jose, CA 95113 (408) 297-7111

A-VIDD Electronics Co., 2210 Bellflower Blvd., Long Beach, CA 90815 (213) 598-0444

Instant Replay Equip. Co., 5520 Westlawn Ave., Los Angeles, CA 90066 (213) 870-9437

R. E. Snader & Associates, 216 E. Strawberry Dr., Mill Valley, CA 94941 (415) 383-4263

Tri-Tronics, Inc., 2921 W. Alameda Ave., Burbank, CA 91505 (213) 843-2170

Audio Video Systems, Inc., 3390 Peoria St. Ste. 306, Aurora, CO 80010 (303) 341-9994

North East Video & Sound Inc., 287 Kenyon St., Stratford, CT 06497 (203) 377-1444

Midwest Telecommunications, 3331 N.W. 82nd Ave., Miami, FL 33122 (305) 592-5355

Southeast Electronics, P.O. Box 441, P.O. Box 4441, Winter Park, FL 32793 (305) 678-4592

Southeast Electronics, 1125 Rosselle St., Jacksonville, FL 32203 (904) 356-3007

Sun Video, 8100 Ulmerton Rd., Largo, FL 33541 (813) 536-9424

Tele-Research, 1237 Old Corry Field Rd., P.O. Box 4905, Warrington, FL 32507 (904) 456-1811

Visual Systems Co., 3870 N. Peachtree Rd., Atlanta, GA 30341 (404) 457-1388

EMC Corp., 2979 Ualena St., Honolulu, HI 96819 (808) 836-1138

AA-Tronics, Inc., 3113 Rose Hill, Boise, ID 93705 (208) 343-0900

Center Video Center, 5800 W. Fullerton Ave., Chicago, IL 60639 (313) 637-1600

V-Trip, Inc., 5432 N. Second St., Rockford, IL 61111 (815) 654-9515

Centrex Audio Visual, 210 West Sixth St., Topeka, KS 66603 (913) 232-7701

Nichols Electronics, 6370 East Central Ave., Wichita, KS 67208 (316) 686-2131

Sound Electronics, 103 Arnould Blvd., Lafayette, LA 70506 (381) 984-4090

Video Index Corp., 1622 Clio St., New Orleans, LA 70131 (504) 522-0729

Midwest Telecommunications, 4700-G Boston Way, Lanham, MD 20801 (301) 577-4903

Peirce-Phelps, 10215 Fernwood Rd., Bethesda, MD 20014 (301) 530-9580

Professional Products, 4964, Fairmont Ave., Bethesda, MD 20014 (301) 657-2141

Malco Electronics, Inc., 5 Wolcott Ave., Lawrence, MA 01843 (617) 752-2500

Professional Video Systems, 1616 Soldiers Field Rd., Brighton, MA 02135 (617) 254-2101

Cruse Communications Co., 4903B Dawn Ave., E. Lansing, MI 48823 (517) 332-3579

Century Camera, Inc., 119 North Ninth St., Minneapolis, MN 55431 (612) 340-5605

Jasper Ewing & Sons, 610 N. State St., Jackson, MS 39205 (601) 354-7844

Communitorics Corp., 1907 S. Kingshighway, St. Louis, MO 63110 (314) 771-7160

Central Missouri A/V, 1000 West Broadway, Columbia, MO 65201 (314) 874-2111

Custom Video Electronics, Local Hillsborough Rd., Cedar Hill, MO 63016 (314) 285-2287

Video Electronics, Inc., 3280 Spring Mountain Rd., Las Vegas, NE 89101

New England Wholesale Supply Inc., 57 Harvey Road, P.O. Box 76, Londonderry, NH 03053 (603) 434-0323

KLR Audio/Vis. & Camera, 2929 Monte Vista Blvd. NE, Albuquerque, NH 87106 (505) 265-3562

Adwar Video, 100 Fifth Avenue, New York, NY 10011 (212) 691-0976

Tape City, Inc., 404 Park Ave. South, New York, NY 10015 (212) 679-1606

L. Matthew Miller Assoc., 205 East 42nd St. Ste. 1316, New York, NY 10017 (212) 687-1168

Communications Sys of Albany, 6 Highland Ave., Albany, NY 12205 (518) 482-4435

VideoSound, 1458 Slaterville Rd., Ithaca, NY 14850 (607) 272-2060

Kirkman Electronics, 901 W. Second St., Winston-Salem, NC 27108 (919) 722-9131

Long Engineering Co., 961 Burke St., Winston-Salem, NC 27101 (919) 725-2306

ESI Video Systems Inc., 6531 Doubletree Ave., P.O. Box 29348, Columbus, OH 43229 (614) 436-1381

Midwest Telecommunications, 1150 C West Eighth St., Cincinnati, OH 45203 (513) 651-1904

VideoSonics, Inc., 821 E. 14th Ave., Portland, OR 97214 (503) 232-4632

Dempsey Electronics, 121 Summit Drive, Irwin, Pa 15642 (412) 864-0300

Peirce-Phelps, Inc., 2000 Block N. 59th St., Philadelphia, PA 15146 (215) 879-7000

CENTEL Systems Inc., 3610 Democrat Rd., Memphis, TN 38118 (901) 365-1361

Eidson Electronic Co., Box 96, Temple, Tex. 76501

Eigen Video, Box 1027, Grass Valley, Calif. 95945

George Foster (916) 273-1341

Elcom Engineering Co., Box 10432, Santa Ana, Calif. 92711

Electro Controls, 2975 S. 300 W., Salt Lake City, Utah 84115

Electro Impulse, Inc., Box 870, Red Bank, N.J. 07701

Mark Rubin (201) 741-0404

Electro & Optical Systems Ltd., 3015 Kennedy Rd., Scarborough, Ont., Canada M1V 1E7

Electro Sound, Inc., 160 San Gabriel Dr., Sunnyvale, Calif. 94086

Electro-Voice Inc., 600 Cecil St., Buchanan, Mich. 49107

Greg Silsby (616) 695-6831

REGIONAL SALES CONTACTS:

Dick Bellow Sales, Inc., 418 Maple Hill, P.O. Box 1835, El Dorado, AR 71730 (501) 863-8325 Dick Bellow

Bi-State Marketers, Inc., 753 Bergen Blvd., Ridgely, NJ 07657 (201) 943-5888 (9) Mort Sumberg

David H. Brothers Co., Inc., 19 Old Court Rd., Baltimore, MD 21208 (301) 764-7189 Dave Brothers

Jack Carter Associates, Inc., 10825 Burbank Blvd., P.O. Box 6035, North Hollywood, CA 91603 (213) 98-13450 Jack Carter

Centennial Marketing Ltd., 8505 E. Orchard Rd., Suite 116, Englewood, CO 80110 (303) 770-0771 Marv Squire

George M. Conneen Co., Inc., 24 South Newton Street Rd., Newton Square, PA 19073 (215) 353-2441 (2) George Conneen

The Cummings Co., 1839 Fall Meadow, Missouri City, TX 77459 (713) 437-9043 Ernie Cummings

Gemini Electronics Marketing, Ernie Cummings, 1110 N. 175th Suite 106, Seattle, WA 98133 (206) 542-1116

Marcus Johnson & Associates, 400 Brookes Drive, Suite 213, Hazelwood, MO 63042 (314) 731-4110 Marc Johnson

C. L. Pugh & Associates, Inc., 2144 Riverside Drive, Columbus, OH 43221 (614) 486-9678 Ted Magnuson

Harry J. Lang & Associates, 1371 Hillcrest Dr., #303, Anchorage, AK 99503 (907) 279-5741 Harry Lang

Riley & Petchell Sales, Inc., 25700 Plymouth Rd., Detroit, MI 48239 (313) 937-3000 Tom Petchell

Wm. M. Linz Associates, Inc., 821 Skokie Wm., Northbrook, IL 60062 (312) 498-9600 Bill Linz

Skor, 1821 University Ave., St. Paul, MN 55104 (612) 645-6461 Gene Kurzwieg

Meyer & Ross, 1485 Rollins Rd., Burlington, CA 94010 (415) 348-8800 Mordy Foodym

The Smith Company, 599 New Park Avenue, W. Hartford, CT 06110 (203) 523-0512 George Smith

Maitland K. Smith, Inc., 2321 Fourth St. Suite 210, Tucker, GA 30084 (404) 939-3323 Bob Tyler

Sprock Sales, Inc., 3520 W. Broward Blvd., Ft. Lauderdale, FL 33312 (305) 587-3792 Elaine Sprock

Paul Stone Sales Company, Inc., 5174 N. Allisonville Rd., Indianapolis, IN 46205 (317) 257-4277 Paul Stone

Waxman-Currant Sales, Inc., 990 Kenmore Ave., Buffalo, NY 14216 (716) 873-0442 Alex Waxman

Electrohome Ltd., 809 Wellington St. N., Kitchener, Ont., Canada N2G 4J6

James Washburn (519) 744-7111

REGIONAL SALES CONTACTS:
Electrohome (U.S.A.) Ltd., 182 Wales Ave., Tonawanda, NY 14150 (716) 694-3332

Electro Visual Corp. of America, 3617 W. MacArthur Blvd., Suite 508, Santa Ana, CA 92704 (714) 545-6991

Electrolabs, Box 6721, Stanford, CT 94305

Electronic Devices, Inc., 21 Gray Oaks Ave., Yonkers, N.Y. 10710

Electronic Inst. & Spec., 42 Pleasant St., Stoneham, Mass. 02180

Electronics Diversified, Inc., 1675 N.W. 216th, Hillsboro, Ore. 97123

Luis Walsh (503) 645-5533

Emcor Products, GF Business Equipment, Inc., 1600 4th Ave. N.W., Rochester, MN 55901

Enclosure Corp., 4529 Adams Circle, Cornwell Heights, Pa. 19020

Engineering Associates, 7567 Rt. 49A East, Arcanum, Ohio 45304

English Electric Valve Co. Ltd., Waterhouse Lane, Chelmsford, Essex England CM1 2QU

Enterprise Electronics Corp., Box 1216, Enterprise, Ala. 36330

Equipto Storage Systems, 225 S. Highland, Aurora, Ill. 60507

Ercona Corp., 2492 Merrick Rd., Bellmore, NY 11710

Eumig USA, Inc., Lake Success Business Park 225 Community Dr., Great Neck, N.Y. 10020
Eventide Clock Works Inc., 265 West 54th St., New York, N. Y. 10019
Exact Electronics, Box 347, Tillamook, OR 97141

F

Farinon Video, 1680 Bayport Ave., San Carlos, Calif. 94070
Yves Faroudja, Inc., 199 First St., Los Altos, CA 94022
Fidelipac, 109 Gaither Dr., Mt. Laurel, N.J. 08057
Arthur Constantine (609) 235-3511

The Finney Co., 34 W. Interstate St., Bedford, Ohio 44146
Imero Fiorentino Associates, Inc., 10 West 66th St., New York, N. Y. 10023
Fisher Berkeley Corp., 5800 Christie Ave., Emeryville, Cal. 94608
Fix Tune, Solid State Electronics, Inc., One W. 30th St., New York, N.Y. 10001
Flash Technology Corp. of America, 55 Lake St., Nashua, N. H. 03060
John Fluke Mfg. Co., Inc., Box 43210, Mountlake Terrace, Wash. 98043
Fort Worth Tower Co., Inc., Box 8597, Ft. Worth, Tex. 76112
Freeland Products Co., 3233 Conti St., New Orleans, La. 70119
Frequency Devices Inc., 25 Locust St., Haverhill, Mass. 01830
Frezzolini Electronics, Inc., 7 Valley St., Hawthorne, N. J. 07506
Jack Zink (201) 427-1160

REGIONAL SALES CONTACTS:

Export Agents: Cinecraft International, Inc., 11 Caesar Place, Moonachie, NJ 07074 (201) 939-0875
In Canada: Kingsway Film Equipment Ltd., 821 Kipling Ave., Toronto Ont., M8Z 5G8 Canada (416) 233-1101

Fuji Photo Film USA, Inc., Magnetic Tape Div., 350 5th Ave., 70th Floor, New York, N. Y. 10001 (212) 736-3335
Fujinon Optical, Inc., 672 White Plains Rd., Scarsdale, N.Y. 10583

G

GBC Closed Circuit TV Corp., 315 Hudson St., New York, N.Y. 10013
G C Electronics, Div. Wallace Murray, 400 S. Wyman St., Rockford, Ill. 61101
GTE Lenkurt, Inc., 1105 County Road, San Carlos, Calif. 94070
GTE Sylvania Inc., Lighting Products Group, 100 Endicott St., Danvers, Mass. 01923
Gabriel Electronics, Inc., Box 626, Scarborough, ME 04074
Gardiner Communications Corp., 1980 S. Post Oak Rd., Ste. 2040, Houston, TX 77056
Garner Industries, 4200 No. 48th St., Lincoln, Nebr. 68504
Bruce A. Alderman (402) 464-5911

Geleco Electronics Ltd., 2 Thorncliffe park Dr., Unit 28, Toronto, Ont., Canada M4H 1H2 (416) 421-5631
General Cable Corp., 500 West Putnam Ave., Greenwich, Conn. 06830
General Electric Co., ISO Div., 316 E. Ninth St., Owensboro, Ky. 42301
General Electric Co., Video Display Equip. Op., Electronics Park 6-206, Syracuse, N. Y. 13221

Jerrold P. Gunderson, Mgr. Mktg. (315) 456-2562
Gerard Tech, Box 634, Anoka, MN 55303
Gerald Gerard (612) 421-2568

The Gerstenslager Co., 1425 E. Bowman St., Wooster, Ohio 44691
A.W. Baehr (216) 262-2015

Glenetronix Ltd., 160 Duncan Mill Rd., Don Mills, Ont., Canada M3B 1Z5
Alan Gordon Enterprises Inc., 1430 N. Cahuenga Blvd., Hollywood, Calif. 90028
Gorman Redlich Mfg. Co., 6 Curtis St., Athens, Ohio 45701
Gotham Audio Corp., 741 Washington St., New York, N.Y. 10014
Gould Inc., Instruments Div., 3631 Perkins Ave., Cleveland, Ohio 44114

Gralex Industries, 155 Marine St., Farmingdale, N. Y. 11735
Grandy, Inc., 1275 Bloomfield Ave., Fairfield, N.J. 07006
Granger Associates, 3101 Scott Blvd., Santa Clara, CA 95051
Grass Valley Group, Inc., P.O. Box 1114, Grass Valley, Cal. 95945
Gray Engineering Labs, 504 West Chapman Ave., Orange, Calif. 92668

Tom C. Clark (714) 997-4151

REGIONAL SALES CONTACTS:

Swiderski Electronics Inc., 1200 Greenleaf Ave., Elk Grove Village, IL 60007 (312) 364-1900
Joe Swiderski Sonocraft Corp., 29 West 36th St., New York, NY 10018 (212) 760-9300
Bernie Palmer Sun Video, 8100 Ulmertown Rd., Largo, FL 33514 (813) 536-9424
Carlo McDaniel Magnetic Media Corp., 8745 E. Orchard Rd., Englewood, CO 80111 (303) 770-6340
John Kelly Skaggs Video, P.O. Box 30658, Salt Lake City, UT 84125 (801) 487-4531
Sam Kichas

The Great American Market, Box 178, Woodland Hills, Calif. 91364
Gregg Laboratories, 2120 E. Howell, Suite 505-506, Anaheim, CA 92806
Groton Computer Inc., 19 Fort Hill Rd., Groton, CT 06340
Gruber Products Co., 5254 Jackman Rd., Toledo, Ohio 43613

H

HM Electronics, Inc., 6151 Fairmount Ave., San Diego, Calif. 92120
H.Y. Miyobira (714) 280-6050
REGIONAL SALES CONTACTS:
Rap Tech Inc., 1110 Altoga Court, Louisville, TX 75028 (214) 436-4111
A B and T Sales Corp., Jackson Creek Rd., P.O. Box 111, Grasonville, MD 21638 (301) 827-8046; 8909

N. Browning & Co., 207 S. Court St., Medina, OH 44256 (216) 723-1901
A B and T Sales Corp., 1000 Valley Forge Circle, King of Prussia, PA 19406 (215) 265-2028; 783-7220
Northern California Mkt., 1725 San Carlos Ave. #1, P.O. Box 697, San Carlos, CA 94070 (415) 592-8160
John B. Anthony Co., 992 High Ridge Rd., Stamford, CT 06905 (203) 322-9202, (212) 585-2027
N. Browning & Co., 133 N. Jefferson St., Dayton, OH 45402 (513) 222-3946
CB Electronic Marketing, 6429 Iris VWay, Arvada, CO 80004 (303) 422-0561
Bernard Darmstedter Assoc. Inc., 41 R. Oswego St., Baldwinville, NY 13027 (315) 638-1261
Capital Communications Ind., P.O. Box 481, Olympia, WA 98507 (206) 943-5378
Technical Systems Reps. 2065 Peachtree St. Industrial Center, Suite 215, Chamblee, GA 30341 (404) 457-0426
Filmways Audio Services, 5540 Cleon Ave., North Hollywood, CA 91601 (213) 877-9711

Forristal-Young Sales Co., 7110 Oakland Ave., St. Louis, MO 63117 (314) 645-2360
Forristal-Young Sales Co., 9010 East 50 Hwy, Kansas City, MO 64133 (816) 358-6771
Forristal-Young Sales Co., 11312 Martha, Omaha, NE 68124 (402) 333-0800
Forristal-Young Sales Co., 6400 Hickman, Le 37, Des Moines, IA 50322
Kodo Associates, Inc., 8100 Penn Ave. South, Minneapolis, MN 55431 (612) 881-1255
Riley & Patchell Sales, Inc., 25700 Plymouth Rd., Detroit, MI 48239 (313) 937-3000
Riley & Patchell Sales, Inc., 401 Chippewa, Buchanan, MI 49107 (616) 695-6365
Sproch Sales, Inc., 3520 W. Broward Blvd., Ft. Lauderdale, FL 33312 (305) 587-3792
Sproch Sales, Inc., 12 Anchor Way, Gulf Harbour, New Port Richey, FL 33552 (813) 849-6067
VF Sales, Inc., 181 Worcester Rd., Natick, MA 01760 (617) 237-6544

Hallikainen & Friends, Inc., 101 D4 Suburban Rd., San Luis Obispo, Calif. 93401

Len Filomeo (805) 541-0200

REGIONAL SALES CONTACTS:

David Green Broadcast Consultants, 21 North Wirt, Leesburg, VA 22075 (703) 777-8660
David Green Ring Associates, Inc., P.O. Box 188, Easthampton, MA 01027 (413) 527-4430
John Ring Sound Solutions, 7641 19 Mile Rd., Sterling Heights, MI 48078 (313) 979-6320
Dave Hill Videomedia, 250 N. Wolfe Rd., Sunnyvale, CA 94086 (408) 733-6500
Hank Wilkes VIF International, P.O. Box 1555, Mountain View, CA 94042 (408) 739-9740
Gordon MacKechnie

Hamilton Electronics Corp., 2003 W. Fulton St., Chicago, IL 60612

Clifford B. Hannay & Son, Inc., 402 Main St., Westerlo, N.Y. 12193

Harris Corp., Broadcast Products Div., Box 4290, Quincy, Ill. 62301
Kenneth R. Schwenk, Sls. Dir. (217) 222-8200 Ext. 3400

REGIONAL SALES CONTACTS:

Harris Corp., BPD, P.O. Box 4290, Quincy, IL 62301 (217) 222-8200
J. L. Preston, Mgr. Radio Sales, Eastern U.S.
Harris Corp., BPD, P.O. Box 4290, Quincy, IL 62301 (217) 222-8200
J. W. Ariane, Mgr. Radio Sales, Western U.S.
Harris Corp., BPD, 675 Third Ave., New York, NY 10017 (212) 986-7600
Hal Kneller Harris Corp., BPD, P.O. Box 4290, Quincy, IL 62301 (217) 222-8200
John Delisio, VP Int'l. Sales Harris Corp., BPD, 2600 Virginia Ave. NW, 8th Fl., Washington, D.C. 20037 (202) 342-3946
Lew Page, Kinsley Jones Harris Corp., BPD, 7000 Regency Sar. Blvd., Suite 200, Houston, Tex. 77036 (713) 977-2411
London T. England: Vern Kilion Harris Corp., BPD, 5839 Green Valley Circle, Suite 200, Culver City, Calif. 90230 (213) 641-5032
Tom O'Hara: Rick Stevens

Harris Systems Ltd., 212 Brunswick Blvd., Pointe-Claire, Que. H9R 1A6 Canada (514) 694-3371
Leo E. Gilbeau, Dist. Sls. Mgr.

Harris Corp., PRD Electronics Div., 6801 Jericho Turnpike, Syosset, N. Y. 11791

Hartley Products Corp., 620 Island Rd., Ramsey, N.J. 07446

Harwood Mfg. Co., Subs. Elgin Nat'l. Industries, Inc., 1800 W. Fullerton, Chicago, IL 60614

Heath Co., Benton Harbor, Mich. 49022

Hewlett-Packard Co., 1507 Page Mill Rd., Palo Alto, Calif. 94304

Hickok Elec. Inst. Co., 10514 Dupont Ave., Cleveland, Ohio 44108

Hitachi Denshi America, Ltd., 175 Crossways Park W., Woodbury, NY 11797

Mike Monk: Jack Breitenbucher-Regional Sls. Mgr. (516) 921-7200

REGIONAL SALES CONTACTS:

Atlanta: 3610 Clearview Pkwy., Doorview, GA 30340 (404) 451-9453
Dick Wheeler Chicago: 1725 33rd Ave., Melrose Park, IL 60160 (312) 344-4020
Mike D'Amore Dallas: 14169 Proton Rd., Dallas, TX 75240 (214) 233-7623
Denver: 3538 Peoria, Aurora, CO 80010 (303) 344-3156
Steve Sedoff Los Angeles: 21015 S. Figueroa, Carson, CA 90745 (213) 328-2110
Nick Piscioffa Seattle: 1051 Andover Park W., Tukwila, WA 98188 (206) 575-1680
Dick Carroll

Hitrnan Corp., Route 31, Flemington, N.J. 08822

Holland Electronics, 970 E. 92nd St., Brooklyn, N. Y. 11236

Houston Fearless 76, 833 E. Walnut St., Carson, Calif. 90746

Houston Photo Products, Inc., 655 E. 20th St., Yuma, Ariz. 85364

Howe Audio Productions, Inc., Box 383, Boulder, CO 80306

Howe-Yin Research Co. Inc., Box 3518, Fremont, Calif. 94538

Hughes Aircraft Co., Microwave Communications Products, Box 2999, Torrance, Calif. 90509

Hughes & Phillips Inc., 3050 N. California St., Burbank, Calif. 91504

C. E. Stephens, Sales Mgr. (213) 849-1104

Philip A. Hunt Chemical Corp., Roosevelt Place, Palisades Park, N.J. 07650

Hy-Gain Electronics, Div. of Telex Communications Inc., 8601 N.E. Hiway 6, Lincoln, NE 68505

I

ITT Cannon Electric, 666 E. Dyer Rd., Santa Ana, CA 92720

IGM, Div. of Northwestern Tech., 4041 Home Rd., Bellingham, Wash. 98225

Darrell Wichers (206) 733-4567

REGIONAL SALES CONTACTS:

IGM/NTI, 1301 Fraser, Suite A-12, Bellingham, WA 98225 (206) 671-3970
Carl Peterson IGM/NTI, 1925 Century Blvd., Suite 4, Atlanta, GA 30345 (404) 325-3726
Jim Drummond Dyna Engineering, P.O. Box 1697, Taos, NM 87571 (505) 758-2686
Mike Ziomko Eastern Broadcast Supply, 46 Mechanic St., Leominster, MA 01453 (617) 537-4706
Ron Degenais

MZB & Associates, 4203 Beltway Dr., Dallas, TX 75234 (214) 233-5535 Darryl Parker

ITI Electronics, Inc., 369 Lexington Ave., Clifton, NJ 07011
ITT Jennings, 970 McLaughlin Ave., San Jose, Cal. 95122

Ikegami Electronics (USA) Inc., 37 Brook Ave., Maywood, NJ 07607

REGIONAL SALES CONTACTS:

West Coast Office: 19164 Van Ness Ave., Torrance, CA 90501 (213) 328-2814
Southwest Office: 330 North Belt E., Suite 228, Houston, TX 77060 (713) 455-0100

Bennett Engineering Assoc., P.O. Box 76, Mercer Isle, WA 98040 (206) 232-3550
The Camera Mart, 456 West 55th St., New York, NY 10019 (212) 757-6977
Gray Communications Consultants Inc., 404 Sands Dr., Albany, CA 31706 (912) 883-2121

Landy Associates, 1890 E. Marlton Pike, Cherry Hill, NJ 08003 (609) 424-4660
MZB & Associates, 4203 Beltway, Dallas, TX 75234 (214) 233-5535

Midwest Telecommunications, 1150C West 8th St., Cincinnati, OH 45203 (513) 651-1904

MPCS Video Industries, 514 West 57th St., New York, NY 10019 (212) 586-3690

Peirce Phelps Inc., 2000 North 59th St., Philadelphia, PA 19131 (215) 879-7171
Roscor Co. Inc., 6160 Oaktown St., Morton Grove, IL 60053 (312) 539-7700

Skaggs Telecommunication Service, 312 Bear Cat Dr., Salt Lake City, UT 84125 (801) 487-4531

Technical Video Systems, 245 Executive Park Blvd., Winston Salem, NC 27103 (919) 768-9536

Television Engineering Corp., 519 Rudder Rd., Fenton, MO 63026 (314) 343-5660
Todd Communications, 7360 Ohmes Lane, Minneapolis, MN 55435 (612) 835-3080

Tri-Tronics Inc., 2921 W. Alameda Ave., Burbank, CA 91505 (213) 843-2170
Applied Electronics Ltd., 299 Evans Ave., Toronto, Ont. Canada M8Z 1K2 (416) 252-3761

Ikelheimer-Ernst, Inc., Fiberbit Photo Products, 601 West 26th St., New York, NY 10001

Image Magnification, Inc., 739 Airway Circle, New Smyrna Beach, Fla. 32069

Image Video Ltd., 700 Progress Ave. #16, Scarborough, Ont., Canada M1H 2Z7

Industrial Marketing Advisory Services, Inc., 2425 Wilson Blvd., Arlington, Va. 22201

Industrial Sciences, Inc. (ISI), Box 1495, Gainesville, Fla. 32602
Richard S Hajdu (904) 373-6783

REGIONAL SALES CONTACTS:

Delcom, 6109 S. 66th E. Ave., Tulsa, OK 74145 (918) 494-9500 Sam Pate
Gray Communications, 3684 Clearview Ave., Doraville, GA 30340 (404) 455-3121 Dino Nappo

Lake Systems, 55 Chapel St., Newton, MA 02134 (617) 244-6881 Frank DeMayo
Magnetic Media, 5555 N. Lamar, Suite J-115, Austin, TX 78751 (512) 451-0138 John Harms

Midwest Telecommunications, 4700 Boston Way, Lanham, MD 20801 (301) 577-4903 E. J. Midkiff

MPCS Video Industries, 514 W. 57th St., New York, NY 10019 (212) 586-3690 Marty Frange

Pacific Video, 2600 E. Katella, Anaheim, CA 92806 (714) 634-8585 Keith Hughes
Peirce-Phelps, Inc., 2000 N. 59th St., Philadelphia, PA 19131 (215) 879-7000 Phil Ghant

Hoffman Video Systems, 800 W. Pico, Los Angeles, CA 90015 (213) 749-3311 Bill Wallace

Professional Products, 4964 Fairmont Ave., Bethesda, MD 20014 (301) 657-2141 Carter Kaulman
Videoonics, 821 SE 14th Ave., Portland, OR 97214 (503) 232-4632 Bill Achatz
Roscor, 6160 W. Oakton, Morton Grove, IL 60053 Phil Roston

Video Equipment Corp., 7377 Convo Court, San Diego, CA 92111 (714) 278-4274 Bill Bennett

Technical Industries, 6000 Peachtree Rd., Atlanta, GA 30341 (404) 455-7610 Ed Matthews

Snader and Associates, 216 E. Strawberry Dr., Mill Valley, CA 94941 (415) 383-4263 Bob Snader

Technical Video, 245 Executive Park Blvd., Winston Salem, NC 27103 (919) 768-9536 Jim Holladay
Klopf Audio Video, 3381 Successful Way, Dayton, OH 45414 (513) 236-5500 Russ Johnson

Innovative Television Equipment, Inc., P.O. Box 681, Woodland Hills, Cal. 91364

Inovonics, 503-B Vandell Way, Campbell, Calif. 95008

J. B. Wood, Pres. (408) 374-8300

REGIONAL SALES CONTACTS:

Taber Mfg. & Eng., 2081 Edison Ave., San Leandro, Calif. 94577 (415) 635-3831
Accurate Sound, 114 5th Ave., Redwood City, Calif. 94063 (415) 365-2843
Mel Audio/Video, 1122 E. Chayse Dr., Glendale, Calif. 91205 (213) 245-7708

VIF International, 1151 Viscaio Ave., Sunnyvale, Calif. 94086 (408) 739-9740
Savco, Box 427, Richardson, Tex. 75080 (214) 234-1841

Inovonics, Box 1014, Port Washington, N.Y. 11050 (516) 883-4818
Joel Associates, 528 River Rd., Teaneck, N.J. 07666 (201) 836-8741

Lebow Labs, 424 Cambridge St., Allston, Mass. 02134 (617) 782-0600
Broadcast Equip. & Supply, Box 3141, Bristol, Tenn. 37620 (615) 968-7342

The Harris Co., 1779 Tiggertail Rd., Miami, Fla. 33145 (305) 854-2003
John J. Harding Ltd., 2825 Valena St., Honolulu, Hawaii 96819 (808) 841-0941

Broadcast Supply West, 2711 Locust Ave. W., Tacoma, Wash. 98466 (206) 565-2301

Integrated Solid Systems Inc., GLI Brand, 2950 Northern Blvd., Long Island City, N.Y. 11101

Interand Corp., Telestrator Div., 666 N. Lake Shore Dr., Chicago, Ill. 60611

International Audio, Inc., 2934 Malmo Dr., Arlington Hgts., IL 60005

International Communications, & Control Corp., Box 11749, Knoxville, Tenn. 37919

International Electro-Magnetics, 350 Eric Dr., Palatine, Ill. 60067

International Microwave Corp., 33 River Rd., Cos Cob, Conn. 06807

International Nuclear Corp., 608 Norris Ave., Nashville, Tenn. 37204

International Tapetronics Corp., Box 241, Bloomington, Ill. 61701
Larry Cutchens, John Schaab, Karen Ryder (309) 828-1381

International Video Corp., 453 W. Maude Ave., Sunnyvale, Calif. 94086

Intertec Publishing Corp., Box 12901, Overland Park, Ks 66212

Ionic Industries, Inc., 128 James St., Morristown, NJ 07960

Ivie Electronics, 500 West 1200 South, Orem, Utah 84057

J

J&D International, Elec. Div., Unit E-East, Interstate Industrial Park, Bellmawr, N.J. 08031

JSH Electronics, Inc., A member co. of **VSI Electronics**, Box 2898, Culver City, Calif. 90230

Ray Jacobs Audio, Inc., Box 9462, Long Beach, CA 90810

Jamieson Film Co., 6901 Forest Park Rd., Dallas, Texas 75235

Janson Industries, Box 6090, Canton, Ohio 44706

Javelin Electronics, 6357 Arizona Circle, Los Angeles, Calif. 90045

Jensen Sound Laboratories, Div. of Pemcor, Inc., 4136 N. United Pkwy., Schiller Park, Ill. 60176

Jensen Transformers, 1617 N. Fuller Ave., Hollywood, Calif. 90046
Deane Jensen (213) 876-0059

REGIONAL SALES CONTACTS:

Scenic Sounds Equipment, 97-99 Dean St., London England W1V 5RA 01-734-2812 David Hawkins
TOWA Engineering, No. 7 Azuma Bldg. 1-9 Sakama-cho, Kanada Chiyoda-ku, Tokyo 101 Japan

Syntec Pty. Ltd., 53 Victoria Ave., Chatswood, N.S.W. 2067 Australia 406-4557
Robert Sloss

Jerrold Electronics Corp., Box 487, Hatboro, PA 19040

Johnson Electronics Inc., 62 S. Hwy. 17-92, Casselberry, Fla. 32707

K

KAPCO Communications, Box 538, Morton Grove, IL 60053

KD Components, Inc., 3016 Orange Ave., Santa Ana, CA 92707

K & H Products, Ltd., Box 246, North Bennington, Vt. 05257

KVC, Inc., 215 Lexington Ave., New York, N.Y. 10016

Kager International, 1180 S. Beverly Dr., Los Angeles, Calif. 90035

Kahn Communications, Inc., 839 Stewart Ave., Garden City, NY 11530

Kaitronics Corp., 1540 Gilbreth Rd., Burlingame, Calif. 94010
Paul Tarrodaychik, V.P. Mktg. (408) 739-4262

Kalart Victor Corp., Hultenius St., Plainville, Conn. 06062

Kaman Sciences Corp., 1500 Garden of the Gods Rd., Colorado Springs, Colo. 80907

Kappa Networks, Inc., 165 Roosevelt Ave., Carteret, N.J. 07008

Karex, Inc., 1262 Lawrence Station Rd., Sunnyvale, Calif. 94086

Kay Elemetrics Corp., 12 BE Maple Ave., Pine Brook, N.J. 07058

Kay Industries, Inc., 604 N. Hill St., South Bend, Ind. 46617

Keeline Int'l., 13 Bond St., Ealing London W5, England

Kinetronics Corp., 42 Sherwood Terr., Lake Bluff, IL 60044

Kings Electronics Co., Inc., 40 Marblehead Rd., Tuckahoe, N.Y. 10707

Kliegl Bros. Lighting, 32-32 48th Ave., Long Island City, N.Y. 11101
Michael F. Connell (212) 786-7474

REGIONAL SALES CONTACTS:

Parts Dept. Inc., P.O. Box 648, Bloomfield, CT 06002 (203) 243-2517
Pekelney & Landau, 25 Knickerbocker Ave., Moonachie, NJ 07074 (201) 939-0883

Arclite Systems, Inc., P.O. Box 471, Ardsley, NY 10502 (212) 220-1022
Richard E. Nicholson, 75 W. Main St., E. Bloomfield, NY 14443 (716) 657-7512

Langemann and Vetter, Inc., 1504 Walnut Ave., Oreland, PA 19075 (215) 884-5375

The Bob Foley Co., Inc. 9609 Parallel Pkwy., Kansas City, KS 66109 (913) 299-3002

Charles Hensing Co., 4127 Beard Ave. South, Minneapolis, MN 55410 (612) 926-2264

Charlesworth-Ward-Rafferty Assoc., 10127 Manchester Rd., St. Louis, MO 63122 (314) 821-7800
Great Plains Lighting Corp., 2305 S. 33rd St., Omaha, NE 68105 (402) 348-9194
Galbraith & Kurtz, 10 N. Main St., Chagrin Falls, OH 44022 (216) 247-6866

Ed-Ward & Co., P.O. Box 09482, Milwaukee, WI 53209 (414) 461-5570
Gewin Tucker & Assoc., P.O. Box 6006, Birmingham, AL 35209 (205) 942-9322
Don Brazile Manufacturers' Agent, P.O. Box 989, North Little Rock, AR 72115 (501) 758-3488

Newman-Penter-James Co., Inc. 4790 Mendel Ct., Atlanta, GA 30336 (404) 696-1300

Richard Mix, 1120 Meigs Ave. Bldg. T-4, Jeffersonville, IN 47130 (812) 283-7901
Somar, Inc., P.O. Box 10543, Jefferson, LA 70181 (504) 733-9525
F.X. Ford & Associates, 1011 North Calvert St., Baltimore, MD 21202 (301) 837-5533

Ed C. Vaughn Co., 3 Cderonella Drive, Chapel Hill, NC 27514 (919) 383-2938
Robert Nott Co., 2712 East 5th Place, Tulsa, OK 74104 (918) 939-4541
Malcolm Mimms & Assoc., P.O. Box 90191, Nashville, TN 37209 (615) 329-3041

Architectural Lighting Assoc., 13740 Gamma Rd, Suite A, Dallas, TX 75240 (214) 387-1677

Putterman, Scharck & Assoc. Inc., P.O. Box 36508, Houston, TX 77036 (713) 664-7111
Hyllin & Assoc., 319 E. Terra Alta, San Antonio, TX 78209 (512) 828-0624
Fred Dull Assoc., P.O. Box 2082, Ashland, VA 23005 (804) 798-6777

McHugh-Rollins Associates, P.O. Box 9791, Ft. Lauderdale, FL 33310 (305) 735-5414
AARK of Alaska, 8112 East 4th Avenue, Anchorage, AK 99504 (907) 333-1736
R. C. Lurie Co., P.O. Box 10026, Phoenix, AZ 85064 (602) 267-9265

Peterson/Vine, Inc., 15230 Burbank Blvd, Suite 105, Van Nuys, CA 91141 (213) 988-8661
Harry L. Stearns, Inc., 522 N. W. 23rd St., Portland, OR 97210 (503) 227-0593
Robert Bacon, 50 East Malvern Avenue, Salt Lake City, UT 84115 (801) 484-1701

Sanborn Sales, P.O. Box 80825, Seattle, WA 98108 (206) 767-3050

Kline Iron & Steel Co., Box 1013, Columbia, S.C. 29202

Knox Video Products, 9700-B George Palmer Hwy., Lanham, MD 20801
Stan Michalski (301) 459-2106

REGIONAL SALES CONTACTS:
Wahlberg Associates, 79 Mystic St., Arlington, Mass. 02174 (617) 646-5394 Eric Wahlberg

Tichroma Tech Consultants, Ltd., 100 North Rd., White Plains, NY 10603 (617) 646-5394 Al Jones
Commercial Video Reps, 2637 N. Charles St., Baltimore, MD 21218 (301) 235-9120 Jim Fairbank
Control Assembly Corp., 1339 Sylvandell Dr., Pittsburgh, Pa. 15243 (412) 561-0293 W. E. Carter

Kodo Kawamura
Marcom, 59 Mt. Herman Rd., Scott's Valley, CA 95066 (408) 438-4273 Marty Jackson
Radford Associates, 3203 Lanier Dr., Atlanta, Ga. 30319 (404) 237-6097 Lew Radford

Dawson & Associates, 84 Belknap Beach Rd., Prospect, KY 40059 (502) 228-4898
Bruce L. Dawson
H. M. Dyer Electronics, 31185 Ten Mile Rd., Farmington Hills, Mich. 48024 (313) 628-0840 Mike Dyer

Sudduth Mfg's. Representatives, 845 39th SE, Paris, Tex. 75460 (214) 785-5764
Gene Sudduth

EMC Corp., 2979 Ualena St., Honolulu, Hawaii 96819 (808) 836-1138 Dave Caldwell

Comad Communications, Ltd. 91 Kellfield St., Unit 5, Rexdale, Ont. M9W 5A3 Canada (416) 245-1734 Emil Adamky
Lerro Electrical Corp., 3125 N. Broad St., Philadelphia, PA 19132 (215) 223-8200 Lou Lerro

EME, 112 Buena Vista, High Point, NC 27260 (919) 869-3335 George Gold All Media Sales, 1535 Foxhill Rd., Naperville, IL 60540 (312) 628-0840 Ray Sudoew
8812 Santa Fe Lane, Overland Park, KS 66212 (913) 831-0188 Jim Grunder Mile High Marketing, 1813 East 98th Pl., Thornton, CO 80229 (303) 457-2058 Chuck Jones
Fleehart & Sullivan Inc., 10109 Aurora Ave. N., Seattle, WA 98133 (206) 522-1533 Earl Fleehart

Kreonte, Inc., Box 2099, Wichita, KS 67201

Kroy Industries, Graphics Div., 1728 Gervais Ave., St. Paul, MN 55109

L

LPB Inc., 28 Bacton Hill Rd., Frazer, Pa. 19355

Harry N. Larkin (215) 644-1123

REGIONAL SALES CONTACTS:

LPB West Coast Office, 20944 Sherman Way, Canoga Park, CA 91303 (213) 340-4590 Richard W. Burden
MSC Electronics Ltd., 254 Wildcat Rd., Downsview, Ont. Canada M3J 2N5 (416) 661-4180 Dennis Hintridge

L-W International, 6416 Variel Ave., Woodland Hills, Calif. 91367

Pat Smith (213) 348-8614

Laird Telemedia Inc., 2125 S.W. Temple, Salt Lake City, Utah 84115

Ron Hymus, Sales Mgr. (801) 487-6251

Lampkin Lab. Inc., Box 9048, Bradenton, Fla. 33506

James B. Lansing Sound, Inc., 8500 Balboa Blvd., Northridge, Calif. 91329

Ronald H. Means or Bob Taylor (213) 893-8411

REGIONAL SALES CONTACTS:

JBL 3040 Charlevoix Dr., S.E. Grand Rapids, MI 49506 (616) 455-6270 Thomas Roseberry
JBL 55 Ames Court, Plainview, NY 11803 (516) 822-2488 William V. Watkins
JBL 1413 Leicester St., Garland, TX 75042 (214) 495-5415 Carl Cathcart

D. N. Latus & Co., Inc., Box 1720, Helena, Mont. 59601

Lawhed, Ltd., 388 Reed Rd., Broomall, Pa. 19008

Leader Instruments Corp., 151 DuPont St., Plainview, N.Y. 11803

Leasametric, 1164 Triton Dr., Foster City, CA 94404

Lectrotech Inc., 5810 N. Western Ave., Chicago, Ill. 60659

Leedal, Inc., 1918 S. Prairie Ave., Chicago, Ill. 60616

Lee-Ray Industries, Inc., 38 E. First Ave., Mesa, Ariz. 85202

Leitch Video Ltd., 705 Progress, Unit 46, Scarborough, Ont., Canada M1H 2X1

John Walter (416) 438-5060

REGIONAL SALES CONTACTS:

P.M. Electronics, Inc., 185 Hillside Ave., Williston Park, N.Y. 11596 (516) 248-4858 Paul Milazzo
Television Engineering Corp., 519 Rudder Rd., Fenton, MO 63026 (314) 343-5606 Jack Vines
Didier/Denver, 4665 Kipling, Wheat Ridge, Colo. 80033 (303) 422-6666 Herb Didier
Wiltronix Inc., 5504 Waterway, Rockville, Md., 20853 (301) 460-1454 Dwight L. Wilcox

Nortec West Ltd., 7056 B Farrell Rd. S.E., Calgary, Alta. T2H 0T2 Canada (403) 252-8141 Ron Hill

Nortec West Ltd., 325 West 5th Ave., Vancouver, B.C. V5Y 1J6 Canada (604) 872-8525 Bob Whitehouse

Broadcast Video Systems Ltd., 1050 McNicoll Ave. E., Unit 15, Agincourt, Ont. M1W 2L8 Canada (416) 497-1020 Bert Verwey

Advanced Automation Pty Ltd., 6 Dansie St., Greenslopes, Brisbane Australia 4120 (07) 397-2611 Keith Campbell

Broadcast Video Systems Inc., 1050 E. Dominquez St., Unit P, Carson, CA 90746 (213) 637-2971 John Spiker

Canamex Electronics, Station Q, P.O. Box 307, Toronto, Ont. Canada M4T 2M5 (416) 487-7327 Jorge Fernandez

Dagang Teknik Sdn. Bhd., No. 44A, Pesiaran Ampang Off., 4th Mile, Jalan Ampang, Kuala Lumpur Malaysia 462629 Stanley Chen

The Gene Sudduth Co. Inc., 845 39th S.E., Paris, TX 75460 (214) 785-5764 Gene Sudduth

Kim Oh & Co., C.P.O. Box 3590, Seoul Korea 22-0337 Jaong Seon Oh

Seltech Equipment Ltd., 16 York Rd. Maidenhhead, Berkshire England SL6 1SF (628) 36315 Bill Jaynes; Dave Craddock

Tresco Communications Inc., 2910 Halpern St., N. St. Laurent, Que. Canada H4S 1N7 (514) 332-3430 Claude Tresidder

Leitch Video Inc., 210 S. 8th St., Lewiston, NY 14092 (716) 754-4349 Lowell Colbus

Lenco Inc., Electronics Div., 300 N. Maryland St., Jackson, Mo. 63755

Robert N. Henson (314) 243-3147

REGIONAL SALES CONTACTS:

Lenco, Inc., Electronics Div., 13620 Littlecrest Dr., Dallas, Tex. 75234 (214) 241-0976 Lee L. Caput
Lenco, Inc., Electronics Div., 7303 Poplar Lane, Middletown, MD 21769 (301) 371-5588 Anthony R. Mattia
Lenco, Inc., Electronics Div., 1120 South 4th St., Atchison, KS 66002 (913) 367-1146 Merton L. Knold
Lenco, Inc., Electronics Div., Box 4042, Albany, GA 31706 (912) 436-4927 Thomas J. Sabiston Jr.

Lenzar Optics Corp., 1006 West 15th St., Riviera Beach, FL 33404

Lightning Elimination Assoc., Inc., 12516 Lakeland Rd., Santa Fe Springs, CA 90670

Hal Proppe (213) 944-0916

REGIONAL SALES CONTACTS:

Applied Measurements, Inc., 77 Great Road, P.O. Box 316, Acton, MA 01720 (617) 263-2766; 646-7250 (Boston)
Applied Measurements, Inc., 2349 Whitney Ave., P.O. Box 5181, Hamden, CT 06518 (203) 288-5288
Applied Measurements, Inc., RD #1, Hillside Street, North Bennington, VT 05257 (802) 442-2222

Atlas Electric Company Inc., 633 Halekauwila Street, Honolulu, HI 96813 (808) 524-5866

Walter J. Brauer & Associates, Inc., 30432 Euclid Avenue, Room 210, P.O. Box 305, Wickliffe, OH 44092 (216) 943-0601

Walter J. Brauer & Associates, Inc., P.O. Box 35, Vandalia, OH 45377 (513) 898-1224

Gordon Fixman Engineering Company, 8160 Stanford Avenue, St. Louis, MO 63130 (314) 725-5219

Leemark Engineers, P.O. Box 6175, Leawood, KS 66206 (913) 648-0124

FM Associates Limited, 5018 Mortier Avenue, P.O. Box 13705, Orlando, FL 32809 (305) 851-5710; 851-5716

F M Associates Limited, 110 Yacht Club Place, P.O. Box 996, Jupiter, FL 33458 (305) 746-2996

R. A. Mayes Company, 1445 E. Thomas Road, #218, Phoenix, AZ 85014 (602) 279-5243

R. A. Mayes Company, 256 East Casa Loma Drive, P.O. Box 456, Centerville, UT 84014 (801) 292-6781

Nomad Engineering, 6510 North Clark Street, Chicago, IL 60626 (312) 764-0403

Thibodeau Engineering, 725 South Adams, Suite L-1, Birmingham, MI 48011 (313) 642-6620

Multi-Measurements, Inc., 1 Madison Ave, Suite #06, Warmminster, PA 18974 (215) 675-3082

Knox Associates, Inc., 945 Lydia Drive, P.O. Box 8065, St. Paul, MN 55113 (612) 488-5402

R. A. Mayes Company, 11910 Central S. E., P.O. Box 11999, Albuquerque, NM, 87192 (505) 292-2330; 293-8010

R. A. Mayes Company, 725 S. Central Expressway, Suite A-100, P.O. Box 1021, Richardson, TX 75080 (214) 235-3043

R. A. Mayes Company, 1800 Commerce Street, Boulder, CO 80302 (303) 444-0782

R. A. Mayes Company, 6425 Westheimer, No. 123, Houston, TX 77057 (713) 783-3856

F M Associates Limited, 2523 Andover Drive, P.O. Box 9901, Doraville, GA 30360 (404) 451-2293

F M Associates Limited, 106 Elm Avenue, P.O. Box 156, Ramseur, NC 27316 (919) 824-2196; 824-8461

G. M. Gillett & Associates, 2507 West Viewmont Way West, P.O. Box 99035, Seattle, WA 98199 (206) 284-3344

Instrucom, Inc., 1629 K Street, N.W., Suite #500, Washington, DC 20006 (202) 223-1759

J & B Engineering Sales Company, 2420 Coliseum Boulevard, N. P.O. Box 5135, Ft. Wayne, IN 46805 (219) 483-2813

Proyeccion Dinamica Industrial S.A., Gomez Faias 56-102, Mexico 4 D. F. Mexico Miguel Cabello

Stabell Services and Company, P.O. Box 1295, Ibadan Nigeria David A Bello, Technical Director

Consolidated Trading Corporation, 1500 Rodano Street Rio Piedras, G.P.O. Box 1916, San Juan Puerto Rico 00936 Hector Hernandez

Racal Electronics (Singapore) Pte. Ltd., Room 605 Chinese Chamber of Commerce Building, Hill Street Singapore 6 39098 Kee Chin Swee, Manager

Racal Electronics South Africa Ltd., P.O. Box 1463, Pretoria 0001 Republic of South Africa 83-4141 Nanne F. Potze, Manager Agencies Division

Louis P. Schmitt Associates, P.O. Box 4862, Hilton Head, SC 29928 (803) 671-5981

Magna-Techtronics, Crows Nest, N.W. W. 2065 14 Whiting Street, P.O. Box 150, Artarmon, N.S. W. 2064 Australia F. L. Lloyd, Managing Director

Southern Television Corporation Ltd., 202 Tynte Street, P.O. Box 9, North Adelaide South Australia 5006 267-0111 John Batchelor, Chief Engineer

Ilektromagnet Bangladesh, 64 Shaheed Suhrawardy Avenue (Second Floor), Baze Kahrail, Dacca - 2 Bangladesh S. M. Abdul Hakim

Electro Equip, Rua 13 de Maio 29 - 3.0 - CJ 31, Sao Paulo Brazil Mr. A. Barbosa Kovacic, Franjo, Mining Engineer Blatine 35/Vi, Split Yugoslavia

Communications & Equipment Consultants, Ltd., Martlets', Chipperfield, Hertfordshire, WD4 9BS England Kings Langley 63378 London 01-488 3064 Ken M. Ward, Director, David Wallace

E. T. A. T. Euro-Trans-Atlantique-Techniques, 3, Boulevard Saint Martin, 75003, Paris France 272.37.97 Mr. Rene Salmona, Sales; Mr. Marc Kopaniak, President

Trans-A-Tec, Inc. U.S.A. F. T. A. T. Rep. 30 Main Street, Suite #17, Ashland, MA 01721 (617) 881-3652 Max Mayer

Middle East Consultants, 9, Giza Street, Giza, Cairo, Egypt, P.O. Box 181, Dokki, Egypt Dr. E. Nasser, Director

C. Itoh & Company, Ltd., 555 South Flower Street, Los Angeles, CA 90071 (213) 687-0610 Mark Umai

C. Itoh & Company Ltd., Osaka Head Office, Central P.O. Box 117, Osaka Japan S. Fusejima, Deputy Manager

Patrick Trading Corporation, Gen. P.O. Box 9963, Hong Kong 5-220964; 5-225406 C. S. Hsu, General Manager

Techno Gen Limited, No. 20 Farahnaz Street Palizi Aven. North Farah, Tehran Iran M. Bozorgzad, Managing Director; F. Nakjavani, Director of Marketing

Racom Electronics Company Ltd., 60, Pinkas Street, P.O. Box 21120, Tel Aviv 61210 Israel 443126-7-8 Dan Alon, M. Aviv, Manager Industrial Sales Dept.

M.S. C. Electronics Limited, 254 Wildcat Road, Downsview, Ont. Canada M3J 2N5 (416) 661-4180 N.D. LaFrenais President

D. Hintridge, Mktg. Mgr. Tony Sharpe, Sales

M. S. C. Electronics Limited, 412 Oakridge Way, S.W., Calgary, Alta. T2Z 1T 4 Canada (403) 281-3111 Wilf A. Rice, Manager Western Region

M. S. C. Electronics Limited, 2356 Bachard Carjina, Montreal, Que. J3L 4E9 Canada (514) 658-0665 Pierre Brian

Lines Video Systems, Jefferson at McDaniel, Springfield, MO 65806

Bud Lines; Cheryl McKinney; Don Ingalsbe (417) 862-5533

Link Electronics Ltd., North Way, Andover, Hants, England SP10 5AJ

Lipps Inc., 1630 Euclid St., Santa Monica, Cal. 90404

Lipsner-Smith Corp., 4700 Chase St., Lincolnwood, Ill. 60646

Logitek Electronic Systems, Inc., 3320 Bering Dr., Houston, TX 77057

L. Scott Hochberg (713) 782-4592

REGIONAL SALES CONTACTS:

10B Hillsboro, Greenfield, TN 38230 (901) 235-2943 R.W. 'Mo Mo' Moseley Geisler Broadcast Supply, 7103 Langford, Houston, TX 77074 (713) 988-0847 Bernie Geisler

H.M. Holzberg Associates, P.O. Box 322, Totowa, NJ 07511 (201) 256-0455 Herb Holzberg

TransSonic Ltd., 121 McMaster Ave., Ajax, Ont. Canada L1S 2E6 (416) 683-7881 Bill Jones

Theodore Pappas & Associates, 5218 W. Diversey, Chicago, IL 60639 (312) 685-2338 Ted Pappas

Guarantee Radio Supply, 1314 Iturbide St., Laredo, TX 78040 (512) 723-9422 Rick Reyes

Lynce Electronics Corp., 12526 Prima Vista, San Antonio, TX 78233 (512) 656-6501 Gordon Tobias

Lowel-Light, 421 W. 54th St., New York, N.Y. 10019

Lowenthal Mfg., 2076 N. Elston, Chicago, IL 60614

Lyon Metal Products, Inc., Box 671, Aurora, IL 60507

M

MCG Electronics Inc., 160 Brook Ave., Deer Park, N.Y. 11729

MCI, Inc., 4007 N.E. 6th Ave., Ft. Lauderdale, Fla. 33334

MICMIX Audio Products, Inc., 2995 Ladybird Lane, Dallas, Texas 75220

MPB Technologies Inc., P.O. Box 160, Ste-Anne-de-Bellevue, Que., Canada H9X 3L5

F.G.R. (Ross) Warren (514) 457-2035

MSI Television, 4788 S. State St., Salt Lake City, UT 84107

Mach One Digital Systems, Inc., 3515 Cahuenga Blvd. West, Los Angeles, CA 90068

MacKenzie Laboratories, Inc., 5507 N. Peck Road, Arcadia, Calif. 91006

Magnasync/Moviola Corp., 5539 Riverton Ave., North Hollywood, CA 91603

Magna-Tech Electronic Co., Inc., 630 Ninth Ave., New York, N.Y. 10036

Magnavox CATV Systems, Inc., 133 W. Seneca St., Manlius, NY 13104

Magnecraft Electric Co., 5575 N. Lynch Ave., Chicago, Ill. 60630

Magnifax, Inc., RFD 1, Rogers, AK 72756

Magnesonics Mfg. & Sales Co., Box 758, Ventura, CA 93001

Mallory Distributor Prod. Co., Div. P. R. Mallory & Co. Inc., Box 1284, Indianapolis, IN 46206

Marconi Communication Systems Ltd., Marconi House, Chemsford, Essex, England CM1 1PL

Marconi Electronics Inc., Broadcast & Communication Div., 100 Stonehurst Ct., Northvale, N. J. 07647

Fred Bones, A. V. Lummiss (201) 767-7250

Marconi Instruments, Div. of Marconi Electronics Inc., 100 Stonehurst Ct., Northvale, N. J. 07647

Keith Elkins, Tony Ramsden (201) 767-7250

REGIONAL SALES CONTACTS:

L&M Associates, 511 Victor St., Saddle Brook, N.J. 07662 (201) 843-8700 Martin Silver
CEC, 1602 S. Parker Rd., Suite 102, Denver, CO 80231 (303) 751-3252 Richard Seery

S&S Associates, 4924 Hampden Lane, Bethesda, Md. 20014 (301) 654-1434 Bill Becker

Kenneth W. Meyers Co., 1242 Remington Rd., Schaumburg, Ill. 60195 (312) 882-4808 Ken Meyers

Ken Corp., 38 Montvale, Stoneham, Mass. 02180 (617) 438-5464 Sam Kenton

Lee Associates, 817 Wheeler Ave., Huntsville, Ala. 35801 (205) 533-5896 Steve Shelley

TASCO, 606 110th Ave. N.E., Suite 204, Bellevue, Wash. 98004 (206) 453-1414 Helbert Bartels

BRADENCO, 11500 Stemmons Freeway, Suite 113, Dallas, Tex. 75229 (214) 243-7261 Bob Braden

Moxon Electronics, 1440 S. State College Blvd., Anaheim, Calif. 92806 (714) 635-7600 Jim Jordan

John Robinson, 817 Fifth St., Santa Monica, Calif. 90403 (213) 451-9019 John Ro

Measurement Consultants, Inc., Box 966, Scottsdale, Ariz. 85252 (602) 994-9519 Dave Memegay

PAC, 11920 Grandview Rd., Grandview, Mo. 64030 (816) 763-4155 Daryl Booth

Marshall Electronics, Box 2027, Culver City, CA 90230

Marti Electronics, Box 661, Cleburne, Tex. 76031

Mast Development Co., A-V Systems Div., 2212 E. 12th St., Davenport, IA 52803

Mauzy Microwave Corp., 8610 Helms Ave., Cucamonga, Calif. 91730

Maxell Corp. of America, 60 Oxford Dr., Moonachie, N. J. 07074

Roger Mayer Electronics, Inc., 225 East 57th St., New York, NY 10022

McCurdy Radio Ind. Inc., 1711 Carmen Dr., Elk Grove Village, Ill. 60007

McKay Dymek Co., Box 5000, Claremont, Calif. 91711

McMartin Industries, Inc., 4500 South 76th St., Omaha, Neb. 68127

Robert Switzer (402) 331-2000

REGIONAL SALES CONTACTS:

McMartin Industries, 3317 Barrow Hill Trail, Tallahassee, FL 32308 (904) 893-1382 Robert Beattie

McMartin Industries, 15316 Russett, Rt. 1, Pride, LA 70770 (504) 261-7507 Roland F. Coppola, Jr.

McMartin Industries, 4691 West 142nd St., Apple Valley, MN 55124 (612) 423-1489 Bill Emery

McMartin Industries, 4044 Knoll Top Court, Carmichael, CA 95608 (916) 485-2605 Richard Hanseth

McMartin Industries, 2608 Mollimar, Plano, TX 75074 (214) 596-5503 Don S. Jones

McMartin Industries, 10 Kregg Rd., Fairport, NY 14450 (716) 223-5270 Rick L. Marshall

McMartin Industries, 914 S. Lynn, Champaign, IL 61820 (217) 356-5436 John Tolleison

McMartin Industries, 2944 Carnaby St., Indianapolis, IN 46229 (317) 897-1933 Richard J. Sawicki

McMartin Industries, 13516 N.E. 89th Pl., Kirkland, WA 98033 (206) 823-1500 John Schneider

Media Concepts, Inc., 559 49th St. S., St. Petersburg, FL 33707

Memorex Corp., Professional Products Group, 1200 Memorex Drive, Santa Clara, Cal. 95052

Merill Cable Equipment Corp., Box 13741, Phoenix, Ariz. 85002

Merlin Engineering Works, Inc., 1880 Embarcadero, Palo Alto, Calif. 94303

Micro Communications, Inc., Box 4365, Grenier Field, Manchester, N.H. 03108

Micro Consultants, Box 50810, Palo Alto, Calif. 94303

Micro Control Associates, Inc., Box 13250, Arlington, Texas 76013

Micro-Trak Corp., 620 Race St., Holyoke, Mass. 01040

William Stacy, Pres. (413) 536-3551

Microdyne Corp., Box 7213, Ocala, FL 32672

Microflex Co., Inc., 3575 25th St. S.E., Salem, OR 97302

Microprobe Electronics, John Hancock Center, Suite 1532A, 875 N. Michigan Ave., Chicago, IL 60611

Microtime, Inc., 1280 Blue Hills Ave., Bloomfield, Conn. 06002

Daniel J. Sofie (203) 242-0761

REGIONAL SALES CONTACTS:

Microtime, Inc., Clearwater, FL 33516 (813) 535-5990 William E. Baird

Microtime, Inc., Newport Beach, CA 92633 (714) 645-3767 Gary P. Johnston

Microtran Co., Inc., Box 236, Valley Stream, N.Y. 11582

Microwave Power Devices, Inc., Adams Court, Plainview, NY 11803

Mid State Communications, Inc., 174 S. 1st Ave., Beech Grove, IN 46107

Miles Associates, Div. Miles Products Ltd., 240 Birmingham St., Toronto, Ont., Canada M8V 2C8

Millard Metal Service Center, Inc., Box 'O', Braintree, Mass. 02184

Miller Professional Equipment, Inc., 10816 Burbank Blvd., North Hollywood, CA 91601

Miller-Stephenson Chemical Co., Inc., George Washington Hwy., Danbury, Conn. 06810

Minneapolis Magnetics, 3104 W. Lake St., Minneapolis, MN 55416

Modular Audio Products, Unit of Modular Devices, Inc., 50 Orville Dr., Bohemia, N. Y. 11716

Julius Brick (516) 567-9620

REGIONAL SALES CONTACTS:

Richard S. Pass Associates, 9003 Eastview Rd., Philadelphia, PA 19152 (215) 464-9444 Richard Pass

Bencsik Associates, 1311 N.E. 13th Ave., Ocala, FL 32670 (904) 732-9775 Bill Bencsik

Pine Sales Corp., 570 Yonkers Ave., Yonkers, NY 10704 (914) 423-4747 Paul Pussecker

N.E.R.E.M., 64 Whittier Rd., Wakefield, MA 01880 (617) 245-4426 Owen Cook

Gra-Mar Inc., 3165 McCrory Pl., Orlando, FL 32814 (305) 894-3351 Neal Imhoof

Mole-Richardson Co., 937 N. Sycamore Ave., Hollywood, CA 90038

Monroe Electronics, Inc., 212 Housel Ave., Lyndonville, N.Y. 14098

Moseley Associates, Inc., 111 Castilian Drive, Goleta, Cal. 93017

Mark G. Fehlig (805) 968-9621

Motorola Communications and Electronics Inc., 2122 N. Palmer Dr., Schaumburg, IL 60195

Motorola, Communications and Electronics Inc., 1301 E. Algonquin Rd., Schaumburg, Ill. 60196

Motorola Semiconductor Products Inc., Box 20912, Phoenix, Ariz. 85036

Mu-Del Electronics, Inc., 2426 Linden Lane, Silver Spring, Md. 20910

Multiplex Display Fixture Co., 1555 Larkin Williams Rd., Fenton, MO 63026

Multiplier Industries Corp., 464 South 10th Ave., Mt. Vernon, NY 10550

Multronics, Inc., 730 W. McNab Rd., Ft. Lauderdale, FL 33309

Musicworks, Inc., 6238 La Pas Trail, Indianapolis, IN 46268

Mutual Broadcasting System, 1755 S. Jefferson Davis Hwy., Arlington, VA 22202

N

NEC America, Inc., Broadcast Equip. Div., 130 Martin Lane, Elk Grove Village, Ill. 60007

Robert L. Cuwin (312) 640-3792

REGIONAL SALES CONTACTS:

MZB & Associates, 4203 Beltway Dr., Dallas, TX 75234 (214) 233-5535 Darryl Parker

Marcom, P.O. Box 66507, Scotts Valley, CA 95066 (408) 438-4273 Martin Jackson

EME, 112 Buena Vista, High Point, NC 27260 (919) 869-3335 George Gold

Professional Video Systems, Inc., 1616 Soldiers Field Rd., Boston, MA 02135 (617) 254-2101 Sergio Marino

R & H Associates, P.O. Box 364, Safety Harbor, FL 33572 (813) 726-8650 Frank Fitzhenry

RIA, Inc., 50 East Malvern, Salt Lake City, UT 84100 (801) 486-8822 Bob Bacon

N.O.V.A. Corp., 5801 Uplander Way, Culver City, CA 90230

Kim Forrest (213) 641-2046

N.T.I. America, Inc., 1680 N. Vine St., Los Angeles, CA 90028

Nagra Magnetic Recorders, Inc., 19 W. 44th St., Room 715, New York, N.Y. 10036

Nagy Research Products, Box 289, McLean, Va. 22101

Nanotec, 414 Hilmen Pl., Solana Beach, CA 92075

The Narda Microwave Corporation, 75 Commercial St., Plainview, N.Y. 11803

National Electrolab Ltd., 1536 Columbia St., North Vancouver, BC, Canada V7J 1A4

Nationwide Electronic Systems, Inc., 1536 Brandy Pkwy., Streamwood, IL 60103

Neumade Products Corp., 720 White Plains Rd., Scarsdale, N.Y. 10583

Neutrik, 91 McKee Dr., Mahwah, N.J. 07430

Rupert Neve, Inc., Berkshire Industrial Park, Bethel, CT 06801

North Hills Electronics, Inc., Alexander Pl., Glen Cove, N.Y. 11542

North Wind Power Co., Box 315, Warren, Vt. 05674

Norton Associates Inc., 10 Ditomas Court, Copaugue, N.Y. 11726

Nortronics Co., Inc., Recorder Care Div., 8101 Tenth Ave. N., Minneapolis, Minn. 55427

Nova Electric Mfg. Co., 263 Hillside Ave., Nutley, NJ 07110

Novadyne Inc., 11702 Trask Ave., Garden Grove, CA 92643

Fred A. Nudd Corp., Box 1743 Rt. 104, Ontario, N. Y. 14519

Nurad, Inc., 2165 Druid Park Dr., Baltimore, Md. 21211

O

OPCOA, 330 Talmadge Rd., Edison, NJ 08817

Oak Industries, Inc., Crystal Lake, Ill. 60014

O'Connor Eng. Labs, Inc., 100 Kalmus Drive, Costa Mesa, Calif. 92626

(714) 979-3993

Oktel Corp., 490 Division St., Campbell, Calif. 95008

Onan, 1400 73rd Avenue NE, Minneapolis, Minn. 55432

One Pass Video, 900 Third St., San Francisco, CA 94107

Opamp Labs, Inc., 1033 N. Sycamore Ave., Los Angeles, Calif. 90038

B. Losmandy (213) 934-3566

Optical Radiation Corp., 6352 N. Irwindale Ave., Azusa, CA 91702

Orange County Electronics Int'l, Inc., 534 Berry St., Winnipeg, Man., Canada R3H 0R9

(204) 774-3413

REGIONAL SALES CONTACTS:

Parasound Inc., 680 Beach St., Suite 414, San Francisco, CA 94109 (415) 673-4544

Orban Assoc. Inc., 645 Bryant St., San Francisco, Calif. 94107

Jesse Maxenchs-Broadcast; Mark Mougel-Pro/Audio (415) 957-1067

Osawa & Co. (USA), Inc., 521 Fifth Ave., New York, N.Y. 10017

Otari Corp., 981 Industrial Rd., San Carlos, Calif. 94070

Steve Krampf, Michael Bernard (415) 593-1648

P

PWH Electronics, Box 435, Toronto, Ont. Canada M6H 4E3

Pacific Recorders and Eng. Corp., 11100 Roselle St., San Diego, CA 92121

Packaged Lighting Systems, Box 285 - Grant St., Walden, N.Y. 12586

Paladin Corp., 31332 Via Colinas, Westlake, CA 91361

E. L. Jones, Pres. (213) 991-4970

REGIONAL SALES CONTACTS:

Yukon Radio Electronic Inc., 3222 Commercial Dr., Anchorage, AK 99510

Powell Electronics, Inc., 800 Arcadia Dr., Huntsville, AL 35807 (205) 539-2731

Dalis Electronic Supply, 917 N. 7th St., Phoenix, AZ 85006 (602) 258-8151

Inland Electronic Supply Co., 3380 E. Ajo Way, Tucson, AZ 85713 (602) 889-5301

Scottsdale Tool & Supply, 15 N. 40th Place, Phoenix, AZ 85034

Carlton-Bates Co., 69th & Scott Hamilton Dr., Little Rock, AR 72209 (501) 562-9100

Martin Wholesale Radio Supply, 1207 West Kings Highway, Paragould, AR 72405

Brill Electronics, P.O. Box 1378, Oakland, CA 94604 (415) 834-5888

Waltronic Sales, 3350 Scott Blvd. Bldg. 4, Santa Clara, CA 95051 (408) 727-1200

Zack Electronics, 1444 Market St., San Francisco, CA 94102 (415) 626-1444

Powell Electronics Inc., 722 E. Evelyn Ave., Sunnyvale, CA 94086 (415) 739-4321
 Force Electronics, 343 S. Hindry Ave., Inglewood, CA 90301 (213) 776-1324
 Acacia Sales, 16591 Milliken, Irvine, CA 92714 (714) 549-0954
 Wassco, 410 S. Douglas St., El Segundo, CA 90245
 Wassco, 9373 Activity Rd. Suite O, San Diego, CA 92126
 WASSCO, 3001 Redhill Ave. Bldg. 1 Suite 103, Costa Mesa, CA 92626
 Integrated Electronics Co., 436 E. 58th St., Denver, CO 80216 (303) 534-6121
 Electronic Equipment Co., 4027 N.W. 24th St., Miami, FL 33142 (305) 871-3500
 E.S.L. Electronics Inc., 3560 N.W. 34th St., Miami, FL 33142
 KSM Electronics, 2207 N.W. 29th St., Oakland Park, FL 33311 (305) 793-5880
 Powell Electronics Inc., 1744 N.W. 69th Ave., Miami, FL 33166 (305) 592-3260
 Ack Radio Supply, 554 Deering Road N.W., Atlanta, GA 30309 (404) 351-6240
 Communications Dist. Corp., 120 Collins Industrial Blvd., Athens, GA 30603
 AMFAC Distribution Co. Ltd., 694 Auahi St., Honolulu, HI 96810
 Electrical Equipment Co. Ltd., 832 Queen St., Honolulu, HI
 Industrial Electronics Inc., 646 Queen St., Honolulu, HI 96810
 ADMOR Distributors Corp., 330 Cooke St., Honolulu, HI 96811 (808) 537-4501
 Joseph Electronics Inc., 8830 N. Milwaukee Ave., Niles, IL (312) 297-4200
 The EMF Company, Inc., 6135 W. Belmont Ave., Chicago, IL 60634 (312) 889-8323
 York Radio & Television, 590 N. Broadway, Decatur, IL 62525 (217) 424-0880
 H. F. Wilson Engineering Co., P.O. Box 2938, Glen Ellyn, IL 60137 (312) 469-8473
 Graham Electronics, 133 So. Pennsylvania St., P.O. Box 1726, Indianapolis, IN 46202 (317) 634-8202
 C.W.Y. Electronics, 405 N. Earl Ave., Lafayette, IN 47904
 Elx Mart Inc., 910 7th St., Bedford, IN 47421
 Hutch & Son, Inc., 300 N. Main St., Evansville, IN 47711
 Iowa Radio Supply Co., 719 Center Point Rd. N.E., Cedar Rapids, IA 52402
 Radio Supply Co. Inc., 131 S. Laura, P.O. Box 1220, Wichita, KS 67211 (316) 267-5216
 Electronic Parts & Supplies, Inc., 7214 Washington Ave., New Orleans, LA 70125 (504) 482-3126
 Shuler Supply Co., 2504 Tulane Ave., New Orleans, LA 70119
 Powell Electronic, Inc., Beltsville, MD 20705 (301) 937-4030
 Hubs Material Co., 387 Washington St., Boston, MA 02108
 Kaulman Co. Inc., 110 Second St., Cambridge, MA 02141 (617) 491-5500
 A-Line Tools, Inc., 67 So. Broadway, Lawrence, MA 01842 (617) 686-0922
 Show-Me Electronics, Inc., Highway 72 East, P.O. Box 639, Rolla, MO 65401 (314) 364-3896
 Van Sickle, 2014 S. 7th St., St. Louis, MO 63104 (314) 621-5000
 Walters Radio Supply, Inc., 3627-35 Main St., Kansas City, MO 64111 (816) 531-7015
 Electronics Supply Co., Inc., 4100 Main St., Kansas City, MO 64111
 Bernstein-Applebee Co., 3199 Mercier, Kansas City, MO 64111 (816) 756-2525
 Glacier State Electric Supply, 112 First Ave. S., Great Falls, MT 59403 (406) 761-4220
 Electronic Serv. & Distributors, 27 So. Wilson, Bozeman, MT 59715 (406) 587-4466
 Scott Electronic Supply Corp., 4040 Adams, Lincoln, NE 68504 (402) 466-8221
 EPE Corp., P.O. Box 5238, Manchester, NH 03108 (603) 669-9181
 The Drop Shop Ltd. Inc., 116 Locust St., Roselle, NJ 07203
 Walker Radio Co., 102 Granite Avenue N.W., Albuquerque, NM 87125 (505) 247-2288
 Morrison's Radio Supply, 331 Center St., Ashtabula, OH 44004
 Trice Electronics, 4701 N. Stiles, Oklahoma City, OK 73105 (405) 524-4411
 Platt Electric Supply Co., 1305 N.W. Davis, Portland, OR 97209
 Oregon Ham Sales, 409 W. First Ave., Albany, OR 97321 (503) 926-4591
 Norval Electronics, 3625 S. W. Hall Blvd., Beaverton, OR 97005
 Powell Electronics, S. Island Rd., P.O. Box 8765, Philadelphia, PA 19101 (215) 365-1900
 Aztec Wire & Cable Co., 2572 Industry Lane, Norristown, PA 19403 (215) 539-8200

Dixie Electronics Inc., 1900 Barnwell St., P.O. Box 408, Columbia, SC 29202 (803) 779-5332
 Gourley Distributing, 400 N. Main Ave., Sioux Falls, SD 57102
 Bluff City Electronics, P.O. Box 418, Memphis, TN 38101 (901) 345-9500
 MAAD, 3781 Premier Cove, Memphis, TX 38101 (901) 362-8600
 Randolph and Rice, 1213 McGavock St., Nashville, TN 37202
 Wholesale Electronic Supply, 2809 Ross Ave., Dallas, TX 75210 (214) 824-3001
 K.A. Electronic Sales, 1220 Majesty Dr., Dallas, TX 75247 (214) 634-7870
 Allied Electronics, 401 E. 8th St., Ft. Worth, TX 76102 (817) 336-5401
 M Electronic Distributing, 1414 Fredericksburg Rd., San Antonio, TX 78201 (512) 736-2481
 Space Radio Sup. Co. of Houston, 3550 East T. C. Jester, Houston, TX 77018
 Powell Electronics Inc., 2860 Walnut Hill Lane, Suite 114, Dallas, TX 75229 (214) 350-4186
 Anixter Pruzan, 18435 Olympic Ave. S., Seattle, WA 98188
 Radar Electric, 168 Western Ave. W., Seattle, WA 98119 (206) 282-2511
 AMFAC Electric Supply, 3420 E. Ferry Ave., Spokane, WA 99220
 Brock Electronics Ltd., 65 Vulcan St., Rexdale, Ontario Canada M9W 1L5 (416) 247-6261

Panasonic Company, One Panasonic Way, Secaucus, N.J. 07094
Panasonic Co., Video Systems Div., One Panasonic Way, Secaucus, N.J. 07094
 Alvin Barshop, Gen. Mgr. (201) 348-7683

REGIONAL SALES CONTACTS:
 Panasonic Co., Video Systems Div., Northeast Area, 50 Meadowlands Pkwy., Secaucus, N.J. 07094 (201) 348-7627 Michael Dollacker, Regional Sls. Mgr.
 Panasonic Co., Video Systems Div., Southeast Area, #3 Meca Way, Norcross, Ga. 30093 (404) 923-9700 Leroy Wright, Regional Sls. Mgr.
 Panasonic Co., Video Systems Div., Midwest Area, 425 E. Algonquin Rd., Arlington Hgts., Ill. 60005 (312) 364-7936 Frank Sameshima, Regional Mgr.
 Panasonic Co., Video Systems Div., Southwest Area, 1825 Walnut Hill Lane, Irving, Tex. 75062 (214) 258-2828 Terry Conner, Regional Sls. Mgr.
 Panasonic West, Inc., 8383 Wilshire Blvd., Beverly Hills, CA 90211 (213) 655-1111 Bob Karadzian, Regional Sls. Mgr.

Parsons Mfg. Corp., 1055 O'Brien Dr., Menlo Park, CA 94025
Paso Sound Products Inc., 14 First St., Pelham, N.Y. 10803
Pentagon Industries, Inc., 4751 N. Olcott Ave., Chicago, Ill. 60656
Perf-Fix, Box 3524, Santa Monica, CA 90403
Permafilm Int'l. Corp., 305 East 46th St., New York, NY 10017
Perma Power Electronics, Inc., 5615 Howard Ave., Chicago, IL 60648
Phasecom Corp., 6365 Arizona Circle, Los Angeles, CA 90045
Phelps Dodge Communications Co., Rt. 79, Marlboro, N.J. 07746
Philadelphia Resins Corp., 20 Commerce Dr., Montgomeryville, Pa. 18936
 (215) 855-8450

REGIONAL SALES CONTACTS:
 Philadelphia Resins Corp., 3030 Bridge-way, Sausalito, CA 94965 (415) 332-4670 George T. Kollock
 Philadelphia Resins Corp., 148 Wisconsin Ave., Suite 208, Waukesha, WI 53186 (414) 542-8088 Eric A. Dow
 The Heckerman Corp., 814 W. Hyde Park Blvd., Inglewood, Calif. 90302 (213) 678-2264 Fred Heckerman
 Sea-Land Industries, 2301 Dock St., Tacoma, WA 98402 (206) 572-7010 Jim Sims
 Breit's Tower Service, Dinner Key Marina, Miami, Fla. 33133 (305) 858-3143 Charles E. Breit

Philips Broadcast Equip Corp., 91 McKee Dr., Mahwah, N. J. 07430
 William E. Amos, V.P. Mktg. (201) 529-3800

REGIONAL SALES CONTACTS:
 Philips Broadcast Equip. Corp., Northeast Region, 91 McKee Dr., Mahwah, N.J. 07430 (201) 529-3800 Joseph Nigro
 Philips Broadcast Equip. Corp., 3300 Northeast Expy., Suite 1G, Atlanta, Ga. 30341 (404) 458-0171 Jim Sims
 Philips Broadcast Equip. Corp., 15611 Fish Point Rd., Prior Lake, MN 55372 (612) 447-6036 Jeffrey Clarine
 Philips Broadcast Equip. Corp., Central Region, Norelco House, 7530 Frontage Rd., Skokie, Ill. 60077 (312) 679-8600 Harry Gladwin
 Philips Broadcast Equip. Corp., Northwest-ern Region, 3760 Cahuenga Blvd., North Hollywood, Calif. 91604 (213) 766-8185 Jerry Kraus and Michael Hartt
 Philips Broadcast Equip. Corp., Southwestern Region, #1 E. Woodglen, Woodlands, Copper Canyon, Tex.

Philips Test & Measuring Instruments, Inc., 85 McKee Dr., Mahwah, N. J. 07430

Photo Research, Div. of Kollmorgen Corp., 3000 N. Hollywood Way, Burbank, Cal. 91505

Piclear, Inc., 180 E. Prospect Ave., Mamaroneck, NY 10546
 Richard Sassenberg (914) 698-0258

Pinzone Communications Products Inc., 10142 Fairmount Rd., Newbury, Ohio 44065

Plastic Reel Corp. of America, 46 Passaic St., Wood Ridge, NJ 07075

Pleasantville Labs, 1622 A Belmont St. N.W., Washington, DC 20009

Porta-Pattern Telecommunications Industries Ltd., 6822 Santa Monica Blvd., Los Angeles, CA 90038

Portac Inc., 108 Aero Camino, Goleta, CA 93017

Potomac Instruments, Inc., 932 Philadelphia Ave., Silver Spring, Md. 20910
 David G. Harry (301) 589-2662

Power-Optics Inc., 1055 W. German-town Pike, Fairview Village, Pa. 19409

Prodelin Inc., Box 131, Hightstown, N.J. 08520

Projection Systems, Inc., 517 Van Houten Ave., Passaic, NJ 07055

Protech Audio Corp., Box 638, Lake Ronkonkoma, NY 11779

Pulse Techniques Inc., 1411 Palisade Ave., Teaneck, N.J. 07666
 E. R. Shank (201) 837-2575

Q

QEI Corp., Rt. 73, Kresson, N. J. 08053

QRK Electronic Products, 1568 N. Sierra Vista, Fresno, Calif. 93703

QSC Audio Products, 1926 Placentia Ave., Costa Mesa, CA 92627

QSI Systems, Inc., 993 Watertown St., West Newton, Mass. 02165

Q-TV, 33 West 60th St., New York, N.Y. 10023

Quad-Eight Electronics, 11929 Vose St., North Hollywood, Calif. 91605

Quam-Nichols Co., 234 E. Marquette Rd., Chicago, IL 60637

Quantum Audio Labs, Inc., 1905 Riverside Dr., Glendale, Calif. 91201
 John Pritchett (213) 841-0970

REGIONAL SALES CONTACTS:
 Coast Recording Equip. Supply, 6114 Santa Monica Blvd., Hollywood, CA 90038 (213) 462-6058 Jerry Cubbage
 Allied Broadcast, P.O. Box 786, Richmond, IN 47374 (317) 962-8596 Roy Ridge
 Audio Visual Services, 5484 Jetport Industrial Blvd., Tampa, FL 33614 (813) 884-1461 Charles Baxley
 Dimension Five, Inc., 24 North 3rd St., Womelsdorf, Pa. 19567 (215) 589-5312 Charles Moore
 Marcom, P.O. Box 66507, Scotts Valley, CA 95066 (408) 438-4273 Marty Jackson
 Lake Systems, 55 Chapel St., Newton, MA 02160 (617) 244-6881 Howard Mul-linck
 Puget Sound Audio, 5105 North 46th St., Tacoma, WA 98407 (206) 759-4701 Rob Denbrook
 Reflection Audio, 10188 Central Ave., Charlotte, NC 28204 (704) 375-1053 Cal Walker

Quick-Set Inc., 3650 Woodhead Drive, Northbrook, Ill. 60062

R

R-Columbia Products Co., Inc., 2008 St. Johns Ave., Highland Park, IL 60035

RCA American Communications, 201 Centennial Ave., Piscataway, NJ 08854

RCA Broadcast Systems, Front and Cooper Streets, Camden, N.J. 08102

RCA Distributor & Special Products Div., 2000 Clements Bridge Rd., Deptford, N.J. 08096

RCA Electro Optics and Devices, New Holland Ave., Lancaster, Pa. 17604

RCA Power Tube Marketing, Lancaster, Pa. 17604

RCA Solid State Div., Rt. 202, Somerville, N.J. 08876

RHG Electronics Laboratory, Inc., 161 E. Industry Court, Deer Park, NY 11729

RMC-Radio Mfg. Co., 4700 S.W. 75th Ave., Miami, FL 33155

ROH Corporation, 4313 N.E. Express-way, Atlanta, GA 30340

RTS Systems, Inc., 1104 W. Chestnut St., Burbank, CA 91502
 Ronald A. Fuller (213) 843-7022

REGIONAL SALES CONTACTS:
 Filmways Audio Services, 5540 Cleon Ave., No. Hollywood, CA 91601 (213) 877-9711 Sales Desk
 The Camera Mart, 456 West 55th St., New York, NY 10019 (212) 757-6977 Sales Desk
 Industrial Audio/Visual, 2617 Bissonet, Houston, TX 77005 (713) 524-1956 Sales Desk
 Ria Corp., 50 E. Malvern Ave., Salt Lake City, UT 84115 (801) 486-8822 Sales Desk
 Omega Video Associates, 14326 Isis Ave., Lawndale, CA 90260 (213) 679-9021 Sales Desk
 Klop Audio/Video, 3381 Successful Way, Dayton, OH 45414 (513) 236-5500 Sales Desk
 Sound Genesis, 2001 Bryant St., San Francisco, CA 94110 (415) 285-8900 Sales Desk
 K.T. Electronics, 3306 Lime Ave., Long Beach, CA 90807 (213) 424-0979 Sales Desk

Radiation Devices Co., Inc., Box 8450, Baltimore, Md. 21234

Radio Arts, 210 N. Pass Ave., Suite 104, Burbank, CA 91505

- Radiometer Elec. U.S. Inc.**, 811 Sharon Dr., Cleveland, OH 44145
- Radmar, Inc.**, 1282 Old Skokie Rd., Highland Park, IL 60035
- Ramko Research Inc.**, 11355 'A' Folsom Blvd., Rancho Cordova, Calif. 95670
Jack M. Ducart (916) 635-3600
- REGIONAL SALES CONTACTS:**
Comex Corp., Dulles Int'l. Airport, P.O. Box 17011, Washington, DC 20041 (703) 471-4215 Jack Rickel
Electrex Co., 18680 N.E. 2nd Ave., Miami, FL 33179 (305) 945-6483 Ben Ostrovsky
Repelect, 8406 North Blvd., Tampa, FL 33604 (813) 227-5051 John Govreau
Broadcast Services, Inc., 2877 Kalakaua Ave., Honolulu, HI 96815 (808) 521-6311 Alan Roycroft
MZB & Associates, 440 N. Foster Dr., Baton Rouge, LA 70806 (504) 926-8287
Neff Communications, 9721 Singleton Dr., Bethesda, MD 20034 (301) 530-6080 Jack Neff
Telesco Int'l. Corp., 1 DuPont St. S., Plainview, NY 11803 (516) 433-6210 Jerry Lanier
Doug Cook & Associates, 2185 Trent Rd., Columbus, OH 43229 (614) 471-7311 Doug Cook
M.Z.B. & Associates, 3035 E. Skelly Dr., Suite 240, Tulsa, OK 74105 (918) 743-6673 Don Muttoni
G.E. Direct Marketing, 7 May St., East Doncaster, Victoria Australia 3109 (03) 842-5249 Claude Grech
Thomas A. Hill Broadcast Consultant, 1300 Hill Rd., Boise, ID 83702 (208) 342-6902 Thomas Hill
Champagne Sales Co., 3645 Crooks Rd., Troy, MI 48084 (313) 649-4428 Bob Champagne
Doug Cook & Associates, 1701 East 12th St., Apt. 9W, West Tower, Cleveland, OH 44114 (216) 621-4129 Bob Groomer
Oakwood Audio Labs Ltd., 652 King Edward St., Winnipeg, Man. Canada R2H 0P2 (204) 775-8231 Ron Paley
Oakwood Audio Labs Ltd., 10874 97th St., Edmonton, Alta Canada T5H 2M5 (403) 424-2186
Oakwood Audio Labs Ltd., 12-1638 Pandosy St., Kelowna, B.C. Canada V1Y 1P5 (604) 763-5222
M.Z.B. & Associates, 16502 N. Chase Dr., Suite E, Houston, TX 77060 (713) 448-0881
M.Z.B. & Associates, 4203 Beltway, Dallas, TX 75240 (214) 233-5535 Darryl Parker
Repelect, P.O. Box 7102, Tampa, FL 33603 (813) 227-5051 John Govreau
Roscom, Inc., P.O. Box 1208, Roswell, GA 30077 (404) 992-2700 Bob Stewart
Southern Coastal Marketing Svc., Inc., 10120 Crestwood Dr., Matthews, NC 28105 (704) 847-5687 Bob Cauthen
- Rank Hi Fi, Inc.**, 20 Bushes Lane, Elmwood Park, N.J. 07407
- Rank Precision Industries, Inc. (N.Y.)**, 260 No. Rte. 303, West Nyack, N. Y. 10994
- Raven Screen Corp.**, 124 East 124th St., New York, N.Y. 10035
- Recording Supply Co.**, 1233 Rand Rd., Des Plaines, Ill. 60616
Ray Kaiser (213) 297-0955
- Recortec Inc.**, 777 Palomar Ave., Sunnyvale, Calif. 94086
Sidney B. McCollum (408) 735-8821
- Reliance Plastics & Packaging Div.**, 108-18 Queens Blvd., Forest Hills, NY 11375
- Research Technology, Inc.**, 4700 Chase, Lincolnwood, Ill. 60646
- Rex Rheostat & Co., Inc.**, 149 Babylon Turnpike, Roosevelt, N. Y. 11575
- Reynolds/Leteron Co.**, 13425 Wyandotte St., North Hollywood, Calif. 91605
- Rhoades National Corp.**, Box 817, Hendersonville, Tenn. 37075
- Richmond Sound Design, Ltd.**, 1234 W. 6th Ave., Vancouver, B.C., Canada V6H 1A5
- Riluma Co. of America**, Box 366, Pacific Palisades, CA 90272
- Rockland Systems Corp.**, Rockleigh Industrial Park, Rockleigh, NJ 07647
- Rodelco Corp.**, 356 A Comac Road, Deer Park, N.Y. 11729
- Rohde & Schwarz Sales Co.**, 14 Gloria Lane, Fairfield, N.J. 07006
- Roll-A-Reel**, 7881 Reading Rd., Cincinnati, Ohio 45237
- Ross Video Ltd.**, 9 Iroquois Plaza, Iroquois, Ont., Canada K0E 1K0
- Ruslang Corp.**, 247 Ash St., Bridgeport, Conn. 06605
- Russo Electronics Mfg. Inc.**, 5690 E. Shields, Fresno, Calif. 93727
Russell C. Friend, Barbara Gaudin (209) 291-5591
- Rycom Instruments**, 9351 E. 59th St., Raytown, Mo. 64133
- S**
- SGL Waber Electric**, 300 Harvard Ave., Westville, N. J. 08093
- SPI-ITT, Metrix Instruments Div., P.O. Box 30**, 74010 Annecy, France
- SSAC Inc.**, Box 395, Liverpool, N.Y. 13088
David Lawrie (315) 622-1000
- REGIONAL SALES CONTACTS:**
Antenna & Tower Specialist, 4310 S. Barns, Oklahoma City, OK 73119 (405) 685-2314 Mark Wagstoff
Broadcast Equip. & Supply, P.O. Box 3141, Bristol, TN 37620 (615) 878-2531 Cliff Droke
Communications Facilities, P.O. Box 98, Lexington Park, MN 20653 (301) 862-1777 Samuel Leach
Lauderdale Electric Labs, 16 S.W. 13th St., Ft. Lauderdale, FL 33315 (305) 764-7755 Irene Linne
U.S. Tower Service, 677 S. Lawn Lane, Rockville, MD 20850 Norm Jeweler
- SWR Inc.**, Box 215, Goffstown, N.H. 03045
- Sadelco, Inc.**, 75 W. Forest Ave., Englewood, NJ 07631
- Saki Magnetics, Inc.**, 5770 Uplander Way, Culver City, CA 90230
F. F. Boyer, Sales Mgr. (213) 649-5983
- Howard W. Sams & Co., Inc.**, 4300 West 62nd St., Indianapolis, Ind. 46268
- Sansui Electronics Corp.**, 1250 Valley Brook Ave., Lyndhurst, NJ 07071
- Scala Electronic Corp.**, Box 4580, Medford, OR 97501
- The Ken Schaffer Group, Inc.**, 10 East 49th St., New York, N.Y. 10017
Barbara Sarubbi (212) 371-2335
- Schneider Corp. of America**, 185 Willis Ave., Mineola, N. Y. 11501
- Jos. Schneider GmbH & Co., P.O. Box 947**, D-6550 Bad Kreuznach, West Germany
REGIONAL SALES CONTACTS:
Tele-Cine Inc., 5434 Merrick Rd., Massapequa, NY 11758 (516) 798-2828
- Schudel, Inc.**, 6973 Consolidated Way, San Diego, CA 92121
- Schuessler Case Co., Inc.**, Box 39066, Chicago, IL 60639
- Scientific-Atlanta, Inc.**, 3845 Pleasantsdale Rd., Atlanta, Ga. 30340
- Scientific Radio Systems, Inc.**, 367 Orchard St., Rochester, N.Y. 14606
- Scientific Systems, Inc.**, 92 Westwood Dr., Toms River, NJ 08753
Douglas Fisk (201) 255-2230
- REGIONAL SALES CONTACTS:**
191 W. Field Ave., Clark, NJ 07066 (201) 381-1088 William MacGuire
- Selco Products Co.**, 7580 Stage Rd., Buena Park, CA 90621
- Sencore Inc.**, 3200 Sencore Drive, Sioux Falls, S. D. 57107
- Sennheiser Electronic**, 10 West 37th St., New York, N. Y. 10018
- Sescom, Inc.**, 1111 Las Vegas Blvd. N., Las Vegas, NV 89101
Franklin J. Miller (800) 634-3457; (702) 384-0993
- Setcom Corp.**, 1400 Stierlin Rd., Mountain View, CA 94043
- Shallco, Inc.**, Hwy. 301 South, P.O. Box 1089, Smithfield, N.C. 27577
- Sharepoint Systems Inc.**, 402 Tenth Ave., Haddon Heights, NJ 08035
- Sharp Electronics Corp.**, 10 Keystone Place, Paramus, N.J. 07652
- Shintron Co. Inc.**, 144 Rogers St., Cambridge, Mass. 02142
Eckhard Konkel, Peter Choi (617) 491-8700
- Shively Laboratories, Inc.**, Route 302, Raymond, Me. 04071
- Shure Brothers Inc.**, 222 Hartrey Ave., Evanston, Ill. 60204
- Siegel Electronics**, Box 33421, San Diego, CA 92103
- Sigma Electronics, Inc.**, 1830 State St., East Petersburg, Pa. 17520
(717) 569-2681
- Sigma System Engineering**, Fukuda-2 Bldg., 2-57-9, Higashi-Ikebukuro, Toshima-ku, Tokyo, Japan
- Simplex Time Recorder Co.**, Simplex Plaza, Gardner, MA 01441
Mark Kenyon (617) 632-2500
- Singer Products Co., Inc.**, 875 Merrick Ave., Westbury, NY 11590
- Sintronic Corp.**, 212 Welsh Pool Rd., Lionville, Pa. 19353
T. R. Humphrey, VP, Marketing; Joe Novik (215) 363-0444
- Sitco Antenna Co.**, Box 20456, Portland, Ore. 97220
- Sitler's Supplies, Inc.**, Box 10B, 702 E. Washington, Washington, Iowa 52353
Wm C. Sitler (319) 653-2123
- Skirpan Lighting Control Corp.**, 61-03 32nd Avenue, Woodside, N.Y. 11377
- Skotel Corp.**, 1445 Provencher, Brossard, Que. Canada J4W 1Z3
Stephen Scott (514) 676-1813
- Smith-Victor Corp.**, 301 N. Colfax St., Griffith, IN 46319
- Warren R. Smith Co.**, 110 E. Point Pleasant Ave., Ocean Gate, NJ 08740
(201) 267-6795
- Soar Electronics**, 200 13th Ave., Ronkonkoma, NY 11779
- Solid Electronics Labs**, 49 Fairfield Rd., Havertown, Pa 19083
- Soll, Inc.**, 401 East 74th St., New York, N.Y., 10021
- Sonar Radio Corp.**, 3000 Stirling Rd., Hollywood, FL 33021
- Sono-Mag Corp.**, 1005 W. Washington St., Bloomington, Ill. 61701
- Sontec Electronics**, 10120 Marble Ct., Cockeysville, MD 21030
- Sony Corp. of America**, 9 W. 57th St., New York, N.Y. 10019
Phil Stack, Video Products (212) 371-5800
- REGIONAL SALES CONTACTS:**
Sony Corp. of America, West, 700 W. Artesia Blvd., Compton, Calif. 90222 (213) 537-4300 Bob Mueller
Sony Corp. of America, Eastern, 47-47 Van Dam St., L.I.C., N.Y. 11101 (212) 361-8600 Roy Raymond
Sony Corp. of America, Northwestern, 230 W. Hill Place, Brisbane, Calif. 94005 (415) 467-4900 Joe Baylogh, Regional Mgr.
Sony Corp. of America, Southwestern, 9004 Ambassador Row, Dallas, Texas 75247 (214) 631-3431 Bill Hanlow, video
Sony Corp. of America, Southeastern, 2300 Peachford Rd., Atlanta, Ga. 30338 (404) 451-7501 Phil Harr, Regional Mgr.
Sony Corp. of America, North Central, 22791 Haslip Dr., Novi, Mich. 48050 (313) 348-3500 George Curns
Sony Corp. of America, Midwest, 6801 W. Jarvis St., Niles, Ill. 60648 (312) 792-3600 Jerry Brincombe
- Sorenson Co., A Unit of Raytheon Co.**, 676 Island Pond Rd., Manchester, NH 03103
- Sound Dynamics, Inc.**, Box 32055, San Jose, CA 95152
- Soundscribe Magnetic Recording Co., Inc.**, 85 Willow St., New Haven, CT 06511
Lawrence Acampora (203) 624-5179
- REGIONAL SALES CONTACTS:**
Richards Recording Systems, Inc., 177 Essex St., Lynfield, MA 01940 (617) 232-8300 Richard Duremus
Sound Systems Lab, 43 Cerro Crest Dr., Caranillo, CA 93010 (805) 482-5081 John Russ
Two Way Service Co., Inc., 1428 Wayne Ave., Cleveland, OH 44170 (216) 221-2235 Phil Way
Hudson's Audio Center, 7611 Memaul Ave. NE, Albuquerque, NM 87110 (505) 296-6978 Jim Hudson
- Sound Technology**, 1400 Dell Ave., Campbell, Calif. 95008
Michael S. Hogue (408) 378-6540
- REGIONAL SALES CONTACTS:**
R. A. Albrecht & Co., 4379 Orion Rd., Rochester, Mich. 48063 (313) 652-2520 Dick Albrecht
Fidelicom, Box 80644, Chambls., Ga. 30341 (404) 458-3616 Mort Litman
Henry Jonas Co., 12058 Lake City Wc., N.E. Seattle, Wash. 98125 (206) 363-9200 Henry Jonas
Kodo Associates, Inc., 8100 Penn Ave. S., Minneapolis, Minn. 55431 (612) 881-1255 Kodo Kawamura

Charles Lucas Sales Co., 4424 Mintway, Dallas, Tex. 75236 (214) 330-8181
 Charles Lucas
 Maish Sales, 500 S. Madison St., Box 548, Mulberry, Ind. 46058 (317) 296-2322
 Charles Maish
 William Menezes & Associates, Box 7070, Overland Park, Kans. 66207 (913) 649-2680 Bill Menezes
 Partridge Electronic Sales, Box 21205, Salt Lake City, Utah 84121 (801) 943-0127 Clark Partridge
 Elmark Co., 2559 Huntington Pike, Huntington Valley, Pa. 19006 (205) 947-0750 Mark Pitkow
 Repelect, 3706 Ole Ave., Box 7102, Tampa, Fla. 33603 (813) 227-5051 John Govreau
 The Irving W. Rose Group, 3333 Commercial Ave., Northbrook, Ill. 60062 (312) 291-2260 Irving Rose
 Shea Sales, 552 Prospect St., Maplewood, N.J. 07070 (201) 762-2382 Tom Shea

Special Instruments Lab, Inc., Portasound Div., 312 W. Vine Ave., Knoxville, TN 37901

Spectra Sonics, 3750 Airport Rd., Ogden, Utah 84403

Spectrum Instruments, Inc., Box 97, Hartsdale, NY 10530

Sphere Electronics, 20201A Prairie, Chatsworth, Calif. 91311

Spin Physics, Inc., 3099 Science Park Rd., San Diego, Calif. 92121

Gene Long, David Franssens-Video Product Mgr. (714) 453-5410

REGIONAL SALES CONTACTS:

Spin Physics, Inc., 1313 Northridge, Carrollton, Tex. 75006 (214) 245-1816 LeRoy Koonsman
 Spin Physics, Inc., 1969 Scott Lane, Los Altos, Calif. 94022 (415) 961-7794 Ken Thompson
 Spin Physics, Inc., 1286 Camino Palomera, Santa Barbara, Calif. 93111 (805) 964-3316 Ed Gehle
 Spin Physics, Inc., 420 Kiskonko Turn, Oxon Hill, MD 20022 (301) 839-3218 R. Kent White, Reg. Mgr.

Spindler & Sauppe, Inc., 13034 Satcoy St., North Hollywood, Cal. 91605

Stainless, Inc., Third & Montgomery Sts., North Wales, Pa. 19454
 Jess C. Rodriguez (215) 699-3770

Stancil-Hoffman Corp., 921 N. Highland, Hollywood, Calif. 90038

Standard Tape Laboratory, Inc., 26120 Eden Landing Rd. # 5, Hayward, Calif. 94545
 (415) 786-3546

Stanton Magnetics Inc., Terminal Drive, Plainview, N.Y. 11803

Pete Bidwell, Prof. Prod. Mgr. Jim Fox, V.P. Prof. Prod. W. O. Stanton, Pres. (516) 681-0200

Stantron Div., Wyco Metal Products, 6914 Beck Ave., North Hollywood, Calif. 91605

Star Case Mfg. Co. Inc., 15525 South 70th Court, Orland Park, IL 60462

Starex, Inc., Box 248, Kearney, NJ 07032

Station Business Systems, Div. Control Data Corp., 600 W. Putnam Ave., Greenwich, CT 06830

Storel Corp., Box 80523, Atlanta, Ga. 30341
 Ruth E. Schaeffer (404) 458-3280

Strand Century, Inc., 20 Bushes Lane, Elmwood Park, N. J. 07407

Studer Revox America, 1819 Broadway, Nashville, Tenn. 37203

Barry Evans; Bruno Hochstrasser (615) 329-9576

REGIONAL SALES CONTACTS:

Studer Revox America, Inc., 155 Avenue of the Americas, New York, N.Y. 10013 (212) 255-4462 Frederick C. Layn
 111 S. Drive Tower Lake, Barrington, IL 60010 (312) 381-4559 Brian Tucker
 Studer Revox America, Inc., 14046 Burbank Blvd., Van Nuys, Calif. 91401 (213) 780-4234 William Van Doren
 Rep-Tech, Inc., 1110 Alta Vista Ct., 40109, Lewisville, TX 75028 (214) 436-4111 Bobb Partridge
 McCurdy Industries, 1711 Carmen Dr., Elk Grove Village, IL 60007 (312) 640-7077 Ron Mitchell
 Harris Corp., P.O. Box 4290, Quincy, IL 62301 (217) 222-8200 N.L. Jochem

Suda Seisakusho Co., Ltd., Nikko-Bldg. 6-14-13 Ginza, Chuo-Ku, Tokyo, Japan 104

Super 8 Sound, Inc., 95 Harvey St., Cambridge, Mass. 02140

Superex Electronics Corp., 151 Ludlow St., Yonkers, N.Y. 10705

Swager Tower Corp., Box 656, Fremont, Ind. 46737

Swickegami Div., Of Spectrum Video, Burbank, CA 91502

Switchcraft Inc., 5555 N. Elston Ave., Chicago, Ill. 60630

Dean Cochrane (312) 792-2700

REGIONAL SALES CONTACTS:

Cartwright and Bean, 2400 Bob Wallace Avenue, Suite #201, Huntsville, AL 35805 (205) 533-3509
 Howe & Howe, P.O. Box 10497, Phoenix, AR 85064 (602) 264-7971
 David H. Ross Company, 1095 Industrial Rd., San Carlos, CA 94070 (415) 591-4411
 Paul F. Wiley Company, 1632 Silverlake Blvd., Los Angeles, CA 90026 (213) 663-8028
 Gordon Moss Electronics, Inc., 2231 Federal Blvd., Denver, CO 80211 (303) 455-7205
 Anderson Sales Associates, Inc., 133 Mansfield Avenue, Waterbury, CT 06705 (203) 753-2487
 Cartwright and Bean, 200 East Marks Street, Orlando, FL 32803 (305) 422-4531
 Cartwright and Bean, 1241 N. W. 75th Terrace, Plantation, FL 33313 (305) 791-3989
 Cartwright and Bean, 90 W. Wieuca Square, Suite #155, P.O. Box 52846, Atlanta, Ga. 30342 (404) 255-5262
 Dougherty Enterprises, P.O. Box 3497, Honolulu, HI 96811 (808) 847-4144
 Bob Burns & Associates, 6645 N. Oliphant, Chicago, IL 60631 (312) 775-1233
 Marketing Engineers, Inc., 2511 E. 46th St., Suite #N3, Indianapolis, IN 46205 (317) 546-1523
 Thomas L. Dowell & Associates, Inc., 524 34th Street, West Des Moines, IA 50265 (515) 225-1620
 Thomas L. Dowell & Associates, Inc., 7201 Metcalf, Overland, KS 66204 (913) 236-8200
 Cartwright and Bean, 617 W. Judge Perez Drive, P.O. Box 1188, Chalmette, LA 70043 (504) 279-4598
 Anderson Sales Associates, Inc., 160 State Street, Boston, MA 02109 (617) 227-2980
 R. C. Merchant & Co., Inc., 18411 W. McNichols Rd., Detroit, MI 48219 (313) 535-6000
 Mel Foster Technical Sales, Inc., 7389 Bush Lake Rd., Edina, MN 55435 (601) 981-1368
 Cartwright and Bean, 5250 Galaxy Drive, Suite #J, P.O. Box 37370, Jackson, MS 39207 (601) 981-1368
 Thomas L. Dowell & Associates, Inc., 8755 Big Bend Blvd., P.O. Box 23967, St. Louis, MO 63119 (314) 968-4234
 Masin-Esco, Inc., 132 W. Greenbrook Road, North Caldwell, NJ 07006 (201) 226-2550
 Trinkle Sales Inc., 1010 Haddonfield-Berlin Road, Cherry Hill, NJ 08002 (609) 795-4200; (215) 922-2080
 Gordon Moss Electronics, Inc., 418 Louisiana S.E. Suite #8, Albuquerque, NM 87108 (505) 821-6101
 Masin-Esco, Inc., 333 Jackson Avenue, Syosset, NY 11791 (516) 364-0310
 Mar-Com Associates, 2002 Teall Avenue, Syracuse, NY 13206 (315) 437-2843
 Cartwright and Bean, 625 Harwyn Drive, Charlotte, NC 28215 (704) 333-6457
 Bear Marketing, 3623 Brecksville Road, Richfield, OH 44286 (216) 659-3131

Cartwright and Bean, 560 South Cooper Street, P.O. Box 4760, Memphis, TN 38104 (901) 276-4442
 J. Y. Schoonmaker Co., Inc., 10710 Sand Hill Rd., P.O. Box 38150, Dallas, TX 75238 (214) 349-1650 Houston (713) 926-9510
 Comtec, 1715 114th Avenue, S.E., Suite #116, Bellevue, WA 98004 (206) 453-1188
 Atlas Electronics Ltd., 50 Wingold Avenue, Toronto, Ont. Canada M6B 1P7 (416) 781-6174
 Jose Arturo Fernandez, P.O. Box 415, Hato Rey Puerto Rico (809) 767-3588

System Concepts Inc., 395 Ironwood Dr., Salt Lake City, Utah 84115

Systron-Donner, 1 Systron Dr., Concord, Calif. 94518

T

TDK Electronics Corp., 755 Eastgate Blvd., Garden City, N. Y. 11530
 (516) 746-0880

TEAC Corp of America, 7733 Telegraph Rd., Montebello, Cal. 90640

TM Systems, Inc., 25 Allen St., Bridgeport, Conn. 06604

TSC Development Labs., 2217 Purdue Ave., Los Angeles, Calif. 90064

TT Electronics, Inc., 2212 S. Barry Ave., Los Angeles, Calif. 90064

S. J. Sodaro (213) 478-8224

T T E, Inc., 2214 S. Barry Ave., Los Angeles, CA 90064

Taber Mfg. & Engr. Co., 2081 Edison Ave., San Leandro, Cal. 94577

Robert H. Kearns, Mkt. Mgr. (415) 635-3831

Tangent Systems, Inc., 2810 South 24th St., Phoenix, AZ 85034

Tape-Athon Corp., Box 814, Inglewood, Cal. 90301

Taylor Instrument, Consumer Prod. Div. Sybron Corp., Arden, N.C. 28704

Tech Laboratories Inc., Bergen & Edsall Blvds., Palisades Park, N.J. 07650

Kenton Garrison, Sales Mgr. (201) 944-2221

REGIONAL SALES CONTACTS:

Held & Mollard, 3995 E. Bayshore Dr., Palo Alto, Calif. 94303 (415) 965-9321
 Spectrum Assoc., 1823 E. 17th St., Santa Ana, Calif. 92701 (213) 323-0603
 NBS Assoc., Main St., New Preston, Conn. 06777 (203) 868-0501
 Grady Duckett Sales, Box 29067, Atlanta, Ga. 30358 (404) 451-3529
 Crimson Eng. Co., Box 286, Glenview, Ill. 60025 (312) 724-1780
 W. S. Worington Associates, Box 313, Ridgewood, MD 21139 (301) 823-8759 W. S. Worington
 Norwood Scroggs Co., 2221 Arbor Hills Rd., Jackson, Mich. 49201 (517) 750-1170
 Quantum Sales, 7710 Computer Ave., Minneapolis, Minn. 55435 (612) 831-8583
 Bob Cameron, Inc., 2352 Linwood Ave., Ft. Lee, N.J. 07024 (201) 461-2595
 Floyd W. Churchill, Box 43, Haddonfield, N.J. 08033 (609) 429-7871
 Net Sales, Box 7485, Rochester, N.Y. 14615 (716) 467-4538
 L. K. Haner Assoc., Box 101, Commack, N.Y. 11725 (516) 864-2220
 A. C. Wahl & Assoc., Box 15220, Cincinnati, Ohio 42515 (513) 761-5500
 SPS Electronics, 12025 N.W. Thompson Rd., Portland, Ore. 97229 (503) 645-3769
 Waggoner-Verhill Assoc., 3550 Laketon Rd., Pittsburgh, Pa. 15235 (412) 241-5202
 Southwest Elect., Inc., 9226 Markville Dr., Dallas, Tex. 75243 (214) 690-9881
 Southwest Elect., Inc., Box 35353, Houston, Tex. 77035 (713) 729-1670

Solid State Engr., Box 355, Sta. NDG, Montreal, Que. Canada (514) 481-3313

Technamics Co., 2232 Gardner Station, St. Louis, MO 63109

Technical Audio Products Corp., 3810 148th Ave. N.E., Redmond, WA 98052

Technology For Communications Int'l., 1625 Stierlin Rd., Mountain View, CA 94043

Technology Service Corp., Development Labs Div., 2217 Purdue Ave., Los Angeles, CA 90064

Teknekron/ARG, 2121 Allston Way, Berkeley, Calif. 94704

Tektronix Inc., Box 500, Beaverton, Ore. 97077

Tele-Cine Inc., 5434 Merrick Rd., Massapequa, N.Y. 11758

Telecommunications Technology, 555 Del Rey Ave., Sunnyvale, Calif. 94086

Telectric Co., 1218 Venice Blvd., Los Angeles, CA 90006

Telectro Systems Corp., 96-18 43rd Ave., Corona, NY 11368

Teledyne Energy Systems, 110 W. Timonium Rd., Timonium, Md. 21093

Paul I. Bessert (301) 252-8220

REGIONAL SALES CONTACTS:

Warren H. Davis Co., 1810 Fair Oaks Ave., Pasadena, Calif. 91030 (213) 680-1166
 Warren H. Davis
 C. T. Carlberg & Assoc., 3177, Albuquerque, N.M. 87110 (505) 265-1579 Carl Carlberg

The Cunningham Co., 4400 Spring Valley Rd. #101, Dallas, Texas 75240 (214) 233-4303 Mike O'Shaughnessy
 Charles T. Morgan Co., Inc., 500 Maple St., Hathorne, Mass. 01937 (617) 774-3215 Steve Lunn

Davis Associates, 123, Littleton, Colo. 80120 (303) 795-1400 Donald Davis
 The Cunningham Co., 9440 Old Katy Road, Ste. 100, Houston, Texas 77055 (713) 461-4197 John Cunningham
 Communications Engineering, Inc., 3350 Mt. View Dr., Anchorage, AK 99504 (907) 272-3591 Lloyd Morris

Mechron Engineering Products Ltd., 2437 Kaladar Ave., Ottawa Ont. Canada K1V 8B9 (613) 733-3855 Ron Whiting
 Simson-Maxwell, 1380 West 6th Ave., Vancouver BC Canada V6H 1A7 (604) 736-5431 Will Affman

Alster Communications, P.O. Box 9048, Boise, ID 83707 (208) 362-1272 Russ Elsworth
 Alster Communications, 1603 N. Lincoln, Kennewick, WA 99336 (509) 735-2232 Bill Holesworth

Electro Pacific, 727 Industrial Rd., San Carlos, CA 94070 (415) 592-3114 Bob Tokarski
 Mid-South Sales Co., Inc., P.O. Box 692, Slidell, LA 70459 (504) 641-7480 Harry Hammett

Telegen/Softratev, 800 Welch Rd., Suite 354, Palo Alto, CA 94304

Telemation, A Div. of Bell & Howell, Box 15068, Salt Lake City, Utah 84115

Telemet, A Geotel Co., 185 Dixon Ave., Amityville, N.Y. 11701

Joseph F. Cali (516) 842-2300

REGIONAL SALES CONTACTS:

Telemet a Div. of Geotel, Inc., Easthill RFD #3, Brewster, N.Y. 10509 (914) 279-3231 F. Griffiths
 Telemet a Div. of Geotel, Inc. (214) 387-1389 William Culbertson

Telescript, Inc., 20 Insley St., Demarest, N. J. 07627

Television Equipment Associates, Box 260, South Salem, N.Y. 10590
 Bill Pegler (914) 763-8893

Television Products Co. Inc., 9016
Aviation Blvd., Inglewood, Calif.
90301
(213) 776-3276

Television Technology Corp., 5970 W.
60th Ave., Arvada, Co. 80003
Gregory L. Morton (303) 423-1652

Telex Communications, Inc., 9600
Aldrich Ave. S., Minneapolis, Minn.
55420

Don Merein, Mktg. Dir. (612) 884-4051

REGIONAL SALES CONTACTS:

Clark R. Gibb Co., 11100 Bren Rd. W., Minnetonka, Minn. 55343 (612) 932-3950
Clark R. Gibb

LCA Sales, 76 Main St., Tuckahoe, NY 10707 (914) 961-4700

William M. Linz Associates, Inc., 821 Skokie Blvd., Northbrook, IL 60062 (312) 498-9600 Wm. Linz

Robert Milsk Co., 2511 East 46th St., Suite Q-4, Indianapolis, IN 46205 (317) 546-5468

Kimian Sales, Inc., 1804 Sycamore St., Atlantic, IA 50022 (712) 243-1626 Bob Williams

David H. Brothers Co., Inc., 19 Old Court Rd., Baltimore, Md. 21208 (301) 764-7189 David Brothers

Fleehart and Sullivan, Inc., 10109 Aurora Ave. N., Seattle, Wash. 98133 (206) 522-1533 Earl W. Fleehart

Imtech Inc., 6862 Engle Rd., Cleveland, Ohio 44130 (216) 826-3400 Jim Eales

Koessler Sales Co., Inc., 2010 W. Burbank Blvd., Burbank, Calif. 91506 (213) 849-5716 Ace Ranslem

Wm. M. Linz Associates, Inc., 821 Skokie Blvd., Northbrook, Ill. 60062 (312) 498-9600 William M. Linz

Mouthrop Sales, Inc., 7080 Commerce Dr., Pleasanton, Calif. 94566 (415) 846-0550 David Grubbs

Michael Scott Co., Inc., 20 Walnut St., Wellesley Hills, Mass. 02181 (617) 235-0102 Michael Scott

McLoud & Raymond Co., 1562 S. Parker Rd., Suite 336, Denver, Colo. 80222 (303) 751-5305 W. Cliff McLoud

Lewis and Dunnigan Co., Inc., 104 Jamesville Rd., Syracuse, NY 13214 (315) 446-5522 Richard Dunning

J. Y. Schoonmaker Co., Inc., 10710 Sand Hill Rd., Dallas, Tex. 75238 (214) 349-1650 E. Jess Spoons

Shalco Inc., 23716 Woodward Ave., Pleasant Ridge, MI 48069 (313) 547-4771 Carl Ludwig

Technical System Reps., 2065 Peachtree Ind. Ct., Suite 215, Chamblee, Ga. 30341 (404) 457-0426 Norman R. Schneider

Telak Electronics Ltd., 100 Midwest Rd., Scarborough, Ont. M1P 3B1 Canada (416) 752-8575 Murray Balcom

World Wide Products, Inc., 10818 N.W. 6th Ct., Box 279, Miami, Fla. 33168 (305) 754-5475 Jerry Zeidman

Teltek, Inc., 1015 S.W. 117th St.,
Seattle, WA 98146

**Tentel, 50 Curtner Ave., Campbell,
Calif. 95008**
Wayne B. Graham (408) 377-6588

Tepeco Corp., Box 680, Rapid City, S. D.
57709

TerraCom, Lorai Corp., 9020 Balboa
Ave., San Diego, Calif. 92123

Texas Electronics, Box 7225, Dallas,
Tex. 75209
Sam Eason (214) 631-2490

Texscan Corp., 2446 N. Shadeland,
Indianapolis, Ind. 46219

Theatre Techniques Inc., 60 Connolly
Parkway, Hamden, Conn. 06514

Thermodyne International Ltd.,
12600 Yukon Ave., Hawthorne,
Calif. 90250

Thomson-CSF Laboratories, Inc., 37
Brownhouse Rd., Stamford, Conn.
06902

3D Television Systems Inc., 4382
Lankershim Blvd., N. Hollywood, CA
91602

**3M Co., Magnetic Audio/Video Prod.
Div.**, 3M Center, St. Paul, Minn.
55101

Joe Leon, Sales (612) 733-7732

REGIONAL SALES CONTACTS:

3M-Magnetic A/V Products, 320 Shaw Rd., So. San Francisco, CA 94080 (415) 761-1155 Ernie Heisser

3M Co., Southwestern, 2121 Santa Anna Ave., Dallas, TX 75228 (214) 324-8100 Ralph Henderson

3M-Magnetic A/V Products, 6023 S. Gardlied Ave., Los Angeles, CA 90040 (213) 726-6300 Larry Drogman

3M-Magnetic A/V Products, 15 Henderson Dr., West Caldwell, NJ 07006 (201) 575-2000 Pete VanDeventer

3M-Magnetic A/V Products, 950 N. Kings Hwy., Cherry Hill, NJ 08034 (609) 667-7062 Mike Beetem

3M-Magnetic A/V Products, 2860 Bankers Industrial Dr., Atlanta, GA 30360 (404) 447-7000 Chuck Kendall

3M-Magnetic A/V Products, 6850 Harlem Ave., Bedford Park, Chicago, IL 60501 (312) 496-6500 Dan Trasatt

3M Co., Mincom Div., 3M Center, St.
Paul, Minn. 55101

Bob Landingham, Sales & Mktg. Mgr. (612) 733-0803

Time & Frequency Tech., Inc., 3090
Oakmead Village Dr., Santa Clara,
Cal. 95051

Frank Stolten, Western Region Sls. Mgr.
William Wollenbarger, Eastern Region Sls.
Mgr. (408) 246-6365

REGIONAL SALES CONTACTS:

BCD, Inc., 1400 Coleman Ave., Suite H14,
Santa Clara, Calif. 95051 (408) 984-6614 Earl Meltaffey

BCD, Inc., 2990 E. La Jolla St., Anaheim,
Calif. 92806 (714) 630-8150 John Baummann

Didier/Denver, 4665 Kipling, Wheat
Ridge, Colo. 80033 (303) 422-6666 Herb Didier

Martin, Zienkosky, Browne & Assoc., 4203
Beltway Dr., Dallas, Tex. 75234 (214) 233-5535 Darryl Parker

Emmons Associates, 10700 Lyndale Ave.
S., Minneapolis, Minn. 55420 (612) 881-1118 Keith Emmons

Dyer Electronics, 31185 Ten Mile Rd., Farmington Hills, Mich. 48024 (313) 478-2157 Mike Dyer

Electronic Merchandising Ent., Inc., 112
Buena Vista, High Point, N.C. 27260 (919) 869-3335 George Gold

Repeat, Box 7102, Tampa, Fla. 33603 (813) 227-5051 John Covrau

Holzberg Associates, Box 322, Totowa,
N.J. 07512 (201) 256-0455 Herb Holzberg

MARCOM, P.O. Box 66507, Scotts Valley,
CA 95066 (408) 438-4273

MSC Electronics Ltd., 254 Wild Cat Rd.,
Downsview, Ont. Canada M3J 2N5 (416) 661-4180 Anthony Sharpe

Time Tech Corp., 625 W. Katella Ave.
35, Orange, Calif. 92667

Times Fiber Communications, Inc.,
358 Hall Ave., Wallingford, CT
06492

Times Wire and Cable, 358 Hall Ave.,
Wallingford, Conn. 06492

Topaz Electronics, 3855 Ruffin Rd.,
San Diego, CA 92123

Torpey Controls & Engineering Ltd.,
70 Milner Ave. Unit 5, Scarborough,
Ont., Canada M1S 3P8

**Toshiba Int'l. Corp., Broadcast Elec-
tronic Systems**, 292 Gibraltar Dr.,
Sunnyvale, CA 94086

Townsend Associates, Inc., Box 1122,
Westfield, Mass. 01085

Track Audio, Inc. (TA), 33753 9th S,
Federal Way, Wash. 98003

Tracor Inc., 6500 Tracor Lane, Austin,
TX 78721

Transit-O-Sound Inc., 728 Yosemite
Dr., Indianapolis, IN 46217

**Transtector Systems Div., Konic Inter-
national Corp.**, Box 11159, Zephyr
Cove, NV 89448

Tri-Ex Tower Corp., 7172 Rasmussen
Ave., Visalia, CA 93277

Triple Crown Electronics, Inc., 42 Ra-
cine Rd., Rexdale, Ont., Canada M9W
2Z3

Triple I, 4605 N. Stiles, Oklahoma
City, OK 73154

Trompeter Electronics, 8936 Coman-
che Ave., Chatsworth, Cal. 91311
(213) 882-1020

Tweed Audio USA Inc., 4545-E. In-
dustrial 5E, Simi Valley, CA 93063

U

UHF Associates, 90 Transport Ave.
4, Rohnert Park, CA 94928

**UMC Electronics Co., Broadcast Pro-
ducts Div.**, 460 Sackett Point Rd.,
North Haven, Conn. 06473

UNI-SET Div., Kniff Woodcraft Corp.,
449 Ave. A, Rochester, NY 14621

URSA Major, Inc., Box 18, Belmont,
MA 02178

US JVC Corp., Professional Video Div.,
58-75 Queens Midtown Exp.,
Maspeth, N.Y. 11378

Stephen Martin, East Coast Regional Sls.
Mgr. (212) 476-8300

REGIONAL SALES CONTACTS:

US JVC Corp., 2250 Lively Blvd., Elk Grove
Village, IL 60007 (312) 364-9300 Chuck Bocan

US JVC Corp., 1011 W. Artesia Blvd.,
Compton, CA 90220 (213) 537-6020 Don Thorkelson

US JVC Corp., 3400 South Loop E., Hous-
ton, TX 77021 (713) 741-3741 Ed Spalding

UTE Microwave, Inc., 3500 Sunset
Ave., Asbury Park, NJ 07712

Ultra Audio Pixtec, Box 921, Beverly
Hills, Cal. 90213

L. D. Mazzini (213) 276-2726

REGIONAL SALES CONTACTS:

Valenti Associates, 16 Saddle Club Rd.,
Lexington, MA 02173 (617) 861-0089 Fran Valenti

Adwar Video, 100 5th Ave., New York, NY
10011 (212) 691-0976 John Burris

Robert Syle Electronics, 3415 N. Washing-
ton Blvd., Arlington, VA 22201 (703) 525-7272 Robert Syle

Columbia Video, 1805 St. Johns Ave.,
Highland Park, IL 60035 (312) 433-6010 Gene Kahn

Signal Engineering, P.O. Box 10167, Bir-
mingham, AL 35202 (205) 328-6431 Wm. D. Coe

Klopf Audio-Video, 3381 Successful Way,
Dayton, OH 45414 (513) 236-5500 Ralph Johnson

Central Video, 3806 Woodland Park, N.,
Seattle, WA 98103 (206) 632-8900 Gene Hafford

Gray Communications, The 6000 Bldg.,
Suite 2508, Chattanooga, TN 37411 (615) 894-6860 Georgia Cudabac

Unarco-Rohn Div., of Unarco Ind., Inc.,
Box 2000, Peoria, Ill. 61656

Unimedia Corp., 22525 Kingston Ln.,
Auburn, Calif. 95603

Union Connector Co., Inc., Box H,
Roosevelt, N. Y. 11575

United Media, Inc., 1571-D Parkway
Loop, Tustin, CA 92680

Robert J. Ricci (714) 731-3011

**United Recording Electronics Indus-
tries**, 8460 San Fernando Rd., Sun
Valley, Calif. 91352

United Research Lab Corp., 681 Fifth
Ave., New York, NY 10022

United Systems Corp., 918 Woodley
Rd., Dayton, OH 45403

Unitel, 80 Rue d'Arcueil, 94250 Gen-
tilly, France

Univex International, Box 2000, Mon-
ument, CO 80132

Up-Right Scaffolds, 1013 Pardee St.,
Berkeley, Cal. 94710

Utah Scientific, Inc., 2276 South
2700 West, Salt Lake City, Utah
84119

Lyle O. Keys (801) 973-6840

Utility Tower Co., Box 12369, Okla-
homa City, OK 73157

V

**V&B Tower Const. Co., Inc., Atlas
Tower Mfg.**, Box 972, Vinita, OK
74301

VIF International, Box 1555, Mountain
View, CA 94042

Gordon MacKenchnie (408) 739-9740

VMI-Visual Methods Inc., Box 644,
Westwood, NJ 07675

Vacuum Tube Industries, 35 Pequit
St., Canton, Mass. 02021

Eugene Tosti (617) 828-1650

Valad Electric Heating Corp., 160
Willey St., Tarrytown, N.Y. 10591

Thomas Valentino Inc., 151 West 46th
St., New York, N.Y. 10036

Vanco Engineering, 11104-C.E. 56th
St., Tulsa, Okla. 74145

VanLadder, Inc., Box 709, Spencer,
Iowa 51301

Van San Corp., 16735 E. Johnson Dr.,
City of Industry, CA 91745

**Varian Associates, Inc., Electron De-
vice Group**, 611 Hansen Way, Palo
Alto, Calif. 94303

Varian/Beverly, Micro-Link Products,
8 Salem Rd., Beverly, Mass. 01915

Vector Electronic Co., Inc., 12460
Gladstone Ave., Sylmar, Calif.
91342

Versa Count Engineering, 553 Lively
Blvd., Elk Grove Village, Ill. 60007

Vidaire Electronics Mfg., 150 Buffalo
Ave., Freeport, NY 11520

Video Associates Labs, 2304 Han-
cock Dr. # 1-F, Austin, TX 78756

Video Cassette Services, Inc., 711
West 17th St., J6, Costa Mesa, CA
92627

Video Data Systems, 40 Oser Ave.,
Hauppauge, N.Y. 11787

Steve Seiden (516) 231-4400

REGIONAL SALES CONTACTS:

Video Data Systems, Lakeway Apts., Room
111, Greenville, TX 75401 (214) 454-8985 Debra Dunagan

Video Data Systems, 54 Harvard Rd., Fair
Haven, NJ 07701 (201) 747-5122 Tony Keator

Video Data Systems, 3835 Willowbrook
Dr., Douglasville, GA 30135 (404) 942-8669 Dave Allen

Video Data Systems, 5435 Dunbarton Dr.,
Salt Lake City, UT 84117 (801) 266-5054 Bob Hall

Video Data Systems, R.R. 1, Box 235, Lodi,
WI 53555 (608) 592-3272 Vern Ber-
trand

Video Devices Co., 3304 Silver Oak
Lane, Vista, Calif. 92083

Video Rentals, Inc., Subs. of AF Associates, 100 Stonehurst Court, Northvale, NJ 07647

Video Research Corp., Interstate Industrial Park, Riviera Beach, Fla. 33404

Video Specialties, Box 136, Solana Beach, CA 92075

Video Systems Network, Inc., 12530 Beatrice St., Los Angeles, CA 90066

Mac Brinard (800) 421-6521; (213) 871-0677

The Video Tape Co., 10545 Burbank Blvd., North Hollywood, Calif. 91601

Videomagnetics, Inc., 155 San Lazaro Ave., Sunnyvale, Calif. 94086

Videomax Div., Orrox Corp., 3303 Scott Blvd., Santa Clara, Calif. 95050

William E. Fitts (408) 988-2000

REGIONAL SALES CONTACTS:

Videomax Western Regional Manager, Box 3052, Manhattan Beach, Calif. 90266 (213) 980-7927 Rick Murphy
Videomax Corp., P.O. Box 341, Tucker, GA 30084 (404) 992-4490 James H. Drummond
Videomax Corp., 800 Riverside Dr., New York, NY 10032 (212) 947-8031 Roy Holmes

Videomedia, 250 North Wolfe Rd., Sunnyvale, Calif. 94086
(408) 733-6500

REGIONAL SALES CONTACTS:

Todd Communications, 2211 S. Washington, Grand Forks, ND 58201 (701) 746-1268 Randy Terwilliger
Video Masters, 1820 Wyandotte St., Kansas City, MO 64108 (816) 474-8530 Paul Dark
Video Systems Network, 12530 Beatrice St., Los Angeles, CA 90066 (213) 390-7575 Robert Luckenbach
Swiderski Electronics, 1200 Greenleaf Ave., Elk Grove Village, IL 60007 (312) 364-1900 Joseph M. Swiderski III
Northwest Electronics, Inc., East 730 First Ave., Spokane, WA 99220 (509) 535-7652 Richard O. Jones
Teletape Video, 76 Brewer St., London England W1R 3PH Ian Crammond
Midwest Telecommunications, 5200 Mitchelldale, Suite F28, Houston, TX 77092 (713) 686-9278 George Bates
Midwest Telecommunications, 15046 Bellway Dr., Dallas, TX, 75240 (214) 387-2755 Ron Crockett
Midwest Telecommunications, 4410 Westerville Rd., Columbus, OH 43229 Fred Higbie
RIA Corp., 2536 E. Campus Dr., Salt Lake City, UT 84121 (801) 468-8822 Robert Bacon
Technical Video Systems, 245 Executive Park Blvd., Winston Salem, NC 27103 (919) 768-9536 Jimmy Holladay
Todd Communications, 1122 Queens Way W., Nekeosa, WI 54457 Harold Dougherty
Todd Communications, 7360 Ohms Lane, Minneapolis, MN 55435 (612) 835-3080 John Klindworth
Todd Communications, 120 South 41st,

Omaha, NE 68131 Gordon Berry
BCB Electronics Sales Ltd., 98 Healey Rd., Bolton, Ont. Canada L0P 1A0 (416) 857-0790 Robert Cook
Cruse Communications, 4903 'B' Dawn Ave., E. Lansing, MI 48823 (517) 332-3579 William Cruse
Dyma Engineering, P.O. Box 1697, Taos, NM 87571 (505) 758-2686 Carroll Cunningham
Midwest Telecommunications, 4700 'G' Boston Way, Lanham, MD 20801 (301) 577-4903 Elijah Midkiff
Midwest Telecommunications, 300 First Ave. South, Nitro, WV 25143 (304) 722-2921 Chuck Sizemore
Midwest Telecommunications, 1395 Air Rail Ave., Virginia Beach, VA 23455 (804) 464-6256 Kevin Zmarthie
Midwest Telecommunications, 1804 Cargo Ct., Louisville, KY 40299 (502) 491-2888 Jerry Willingham
Midwest Telecommunications, 1150 'C' West 8th St., Cincinnati, OH 45203 (513) 651-1904 David Barnes

Videotek, Inc., 125 N. York St., Pottstown, Pa. 19464

Vikron, Inc., Box 737, St. Croix Falls, WI 54024

Viscount Industries Ltd., 105 East 69th, Vancouver, B.C., Canada V5X 2W9

Ray Renning (604) 327-9446

REGIONAL SALES CONTACTS:

Columbia Telecommunications, Inc., 2241 W. Burnside, Portland, OR 97210 (503) 223-4546
Audio Video Craft, 7710 Melrose Ave., Los Angeles, CA 90046 (213) 655-3511
Tri-Tronics Inc., 2921 W. Alameda Ave., Burbank, CA 91505 (800) 232-2141, (213) 843-2170
Vestige Video, 520 N.W. Douglas, Burleson, TX 76028 (817) 295-5072
MISSCO, 4155 Industrial Dr., P.O. Box 1059, Jackson, MS 39205 (601) 948-8600
Communitronics Corp., 1907 S. Kingshighway, St. Louis, MO 63110 (314) 771-7160
Seneca Communications, 112 Killewald Ave., Tonowanda, NY 14150 (716) 693-8444
Tele-measurements Inc., 145 Main Ave., Clifton, NJ 07014 (201) 473-8822

Vital Industries Inc., 3700 NE 53rd Ave., Gainesville, Fla. 32601

Christopher Donoyan (904) 378-1581

REGIONAL SALES CONTACTS:

Vital Industries, Inc., Midwest Div., 2644 N. 7th St., Terre Haute, Ind. 47804 (812) 466-3212 Morrell Beavers
Vital Industries, Inc., Northeast Div., 34 Autumn Lane, Hicksville, N.Y. 11801 (516) 735-0055 Robert McAll
Vital Industries, Inc., Southwest Div., Box 912, Arlington, Tex 76010 (817) 261-6855 Gordon Peters
Vital Industries, Inc., Southeast Div., Fox Hill Rd., Lynchburg, Va. 24503 (804) 384-7001 Eric King
Vital Industries, Inc., West Coast Div., 7960 West Beverly Blvd., Los Angeles, Calif. 90048 (213) 653-9438 Barry Holland

Vulcan Binder & Cover, Box 29, Vincent, AL 35178

W

WIDL Video, 5245 W. Diversey, Chicago, IL 60639

Wallach & Associates Inc., Box 18167, Cleveland, OH 44118

Wang Voice Comm. Inc., Executive Dr., Hudson, NH 03051
E. Boiger (603) 889-8550

Ward-Beck Systems, Ltd., 841 Progress Ave., Scarborough, Ont., Canada M1H 2X4

Waters Mfg. Inc., Longfellow Center, Wayland, Mass. 01778
Donald A. Russell (617) 358-2777

REGIONAL SALES CONTACTS:

Bierhaus Sales, Inc., 1013 E. 31st St., LaGrange Park, Ill. 60525 (312) 354-5100
Eltron, 7024 N. Barbados Pl., Phoenix, Ariz. 85021 (602) 997-1042
INH Component Sales, 160 Winchcombe Dr., Dayton, Ohio 45459 (513) 434-8808
Barry Sales Inc., 709 Lingco Dr. Suite 105, Richardson, TX 75081 (214) 234-0255
Dynatech, Inc., 5600 S. Syracuse Circle, Suite 308, Englewood, Colo. 80110 (303) 773-2830
Ozark Electronic Marketing, Inc., 2573 Woodson Rd., St. Louis, Mo. 63114 (314) 423-7200
Avionics Liaison Corp., Boeing Field 6770 Perimeter Rd. S., Seattle, WA 98108 (206) 767-3870
Peterson & Wolf, Box 35556, Edina, Minn. 55435 (612) 941-5400
Sales Engineers Ltd., 7580 Stage Rd., Buena Park, Calif. 90621 (714) 521-8673
Sir Associates, 442 Marrett Rd., Box 24, Lexington, Mass. 02173 (617) 862-1812
Sonny Simberkoff Assoc., Inc., 71 Valley St., South Orange, N.J. 07079 (201) 763-7900
R. P. Urban & Associates, 1119 Burton St. S.E., Grand Rapids, Mich. 49510 (616) 245-0511
The Woodworth Co., Box 2165, Redwood City, Calif. 94061 (415) 365-0252

Weathermation, Inc., 190 N. State St., Suite 328, Chicago, IL 60601

Weather Scan, Inc., Loop 132 & Hwy. 79, Olney, TX 76374

Weinschel Engineering Co., 1 Weinschel Ln., Gaithersburg, Md. 20760

Western Electronic Products Co., 107 Los Molinos, San Clemente, Calif. 92672

Westinghouse Elec. Corp., Semiconductor Div., Youngwood, PA 15697

Westinghouse, Ind. & Gov't Tube Div., Westinghouse Circle, Horseheads, N.Y. 14845

Whirlwind Audio, Box 1981, Rochester, N.Y. 14603

Whirlwind Music, Box 1075, Rochester, N.Y. 14603

Wide Band Engineering Co., Inc., Box 21652, Phoenix, Ariz. 85036

Wide Range Electronics, 2119 Schuetz Rd., St. Louis, Mo. 63141

Otto Rauhut; Arthur Brigham (314) 567-5366

Wilcox-Lange, Inc., 3925 N. Pulaski Rd., Chicago, IL 60641

Wilkinson Electronics, Inc., Box 738, Trainer, PA 19013
(215) 497-5100

REGIONAL SALES CONTACTS:

Dyma Engineering, Box 1697, Taos, N.M. 87571 (505) 758-2686 Carroll Cunningham
Lebow Labs, Inc., 424 Cambridge St., Allston, MA 02134 (617) 782-0600 James Rittenan
S.A.V.C.O., Box 427, Richardson, Tex. 75080 (214) 234-1841 Nathan Hughes
Broadcast Consultants Corp., 21 N. Wirt St., Leesburg, Va. 22075 (703) 777-8660 David Green
Electronic Industries, Inc., 19 E. Irving Ave., Oshkosh, Wis. 54901 (414) 235-8930 Bud Tedlie

Winsted Corp., 8127 Pleasant Ave. So., Minneapolis, Minn. 55420

Jerry Hoska (612) 888-1957

Wolf Coach Inc., 200 Bartlett St., Northboro, Mass. 01532

World Video Inc., Box 117, Boyertown, Pa. 19512

John A. Taylor III (215) 367-6055

REGIONAL SALES CONTACTS:

Associated Systems, P.O. Box 333, Londonderry, NH 03053 (603) 434-0731
Churchill S. Miller
Langbaum Associates, Inc., 52 Johnson's Lane, New City, NY 10956 (914) 634-1141 Art Langbaum
Wiltronix, Inc., 5504 Waterway, Rockville, MD 20853 (301) 460-1454 Dwight Wilcox
Radford Associates, 3203 Lanier Dr., Atlanta, GA 30319 (404) 237-6097 Lew Radford
Radford Associates, 1331 Otter Creek Rd., Nashville, TN 37215 (615) 373-0231 Ralph Hucahy
Sight & Sound, P.O. Box 1644, Louisville, KY 40201 (502) 584-5535 Steve Cisler
Dieder/Denver, 4665 Kipling, Wheat Ridge, CO 80033 (303) 422-6666 Herb Dieder
Dyma Engineering, Inc., Rt. 1, Box 51, Taos, NM 87571 (505) 758-2686 Mr. Carroll Cunningham
83 Russel Rd., Garden City, Garden City, L.I., NY 11530 (516) 248-4858 Paul Milazzo
System Associates, 5801 Uplander Way, Culver City, CA 90230 (213) 641-2042 Billy Seidel
Comad Communications Ltd., 91 Kelfield St., Unit 5, Rexdale, Ont. Canada M9W 5A3 (416) 245-1734 Emil Adamyk

Y

Yamaha International Corp., 6600 Orangethorpe Ave., Buena Park, Calif. 90622

Yardney Electric Corp., 82 Mechanic St., Pawcatuck, CT 06379

Winslow E. Ryan (203) 599-1100

Z

The Zei-Mark Corp., Box 182, Brookfield Center, Conn. 06805

broadcast product dealer/distributors

For your added convenience, **Broadcast Engineering** has designed this NEW Broadcast Product Dealer/Distributors section to provide close-to-home purchasing assistance. Use it, in conjunction with other sections in the 1979 Buyers' Guide, to plan new facilities, and equipment expansion or upgrading. For broadcast product dealer/distributors, this directory identifies: address and telephone, products handled and territory served.

Listings are arranged alphabetically by location. Firms listed do not include all dealer/distributors serving an area, but only those who returned **BE's** listing form.

Both a typical dealer/distributor listing, and the geographical area and product classification code keys are included on this page to assist you. We think you will find this new section, in addition to the updated Product Directory and Broadcast Product Manufacturers' Addresses section, makes this issue the most useful and comprehensive purchasing aid for the broadcast industry.

Typical listing

- | |
|--|
| (1) Jones Broadcast Sales,
2912 W. 10 St.,
(2) Kansas City, Mo. 64105
(816-842-1234)
(3) IA, KS, MO, OK, 1, 2, 5, 7, 9 |
|--|

- (1) firm name, street address
(2) city, state, zip code, telephone
(3) geographical area served and products handled (see code keys)

This firm covers Iowa, Kansas, Missouri and Oklahoma, and sells audio equipment, video equipment, tape, film equipment, and service and repair.

Key to geographical area code

AK Alaska	KS Kansas	NV Nevada	WI Wisconsin
AL Alabama	KY Kentucky	NY New York	WV West Virginia
AR Arkansas	LA Louisiana	OH Ohio	WY Wyoming
AZ Arizona	MA Massachusetts	OK Oklahoma	
CA California	MD Maryland	OR Oregon	(Abbreviations
CO Colorado	ME Maine	PA Pennsylvania	for Canadian provinces)
CT Connecticut	MI Michigan	PR Puerto Rico	ALTA Alberta
DC District of Columbia	MN Minnesota	RI Rhode Island	BC British Columbia
DE Delaware	MO Missouri	SC South Carolina	MAN Manitoba
FL Florida	MS Mississippi	SD South Dakota	NB New Brunswick
GA Georgia	MT Montana	TN Tennessee	NF Newfoundland
GU Guam	NC North Carolina	TX Texas	NS Nova Scotia
HI Hawaii	ND North Dakota	UT Utah	ONT Ontario
IA Iowa	NE Nebraska	VA Virginia	PEI Prince Edward Island
ID Idaho	NH New Hampshire	VI Virgin Islands	QUE Quebec
IL Illinois	NJ New Jersey	VT Vermont	SASK Saskatchewan
IN Indiana	NM New Mexico	WA Washington	YUK Yukon Territory

Key to product numerical code

- | | |
|---|--|
| 1 AUDIO EQUIPMENT (including recorders, microphones, mixers, consoles, cart machines, turntables, processing devices, etc.) | 5 TAPE (including video and audio recording tape, etc.) |
| 2 VIDEO EQUIPMENT (including cameras, videotape recorders, production switchers, monitors, lights, etc.) | 6 VACUUM TUBES (including video camera, transmitter, TWT, etc.) |
| 3 TEST AND MEASUREMENT EQUIPMENT (audio and video) | 7 FILM EQUIPMENT (including cine cameras, processing equipment, film projectors, etc.) |
| 4 TRANSMITTERS, ANTENNAS AND TRANSMISSION SYSTEMS (including towers, ATS, STL, MDS, etc.) | 8 VANS AND ACCESSORIES |
| | 9 SERVICE AND REPAIR |
| | 10 SYSTEM DESIGN (including studio installation, etc.) |
| | 11 USED EQUIPMENT (including leasing, rent, etc.) |
-
-

ALABAMA

Matec, Inc., (Maze TV Equip. Corp.), Box 6968, Birmingham, AL 35210 (205-956-2200) U.S.A. & Latin America 11

Signal Engineering & Sales, Inc., 720 South 23rd St.; Drawer 10167, Birmingham, AL 35202 (205-328-6431) AL, FL, GA, MS, TN 2, 4, 8, 9, 10, 11

Leeco Mid-South, Inc., 817 Wheeler Ave., Huntsville, AL 35801 (205-533-5896) AL, FL, GA, LA, MS, TN 3
See advertisement on this page

ARIZONA

Fisher-Burke Professional Audio, Box 2468, Phoenix, AZ 85003 (602-257-0225) U.S.A. 1, 3, 5, 10
See advertisement on this page

Jensen Tools & Alloys, 1230 S. Priest Dr., Tempe, AZ 85281 (602-968-6241) U.S.A. 9
See advertisement on this page

CALIFORNIA

Broadcast Communications Devices, Inc., 2990 E. LaJolla St., Anaheim, CA 92806 (714-630-8150); (213-628-9590) AZ, CA, NV, NM, OR, WA 1, 2, 3, 4, 5, 10

Martel Electronics Inc., 970 E. Orangethorpe #A, Anaheim, CA 92801 (714-871-7102) U.S.A. 1, 9

Optek, 2290 E. LaJolla St., Anaheim, CA 92806 (714-630-8280) AK, AZ, CA, CO, HI, NV, OR, WA 2, 4

Kenneth R. Meades, Box 3831, Beverly Hills, CA 90212 (213-627-6981) CA 1, 9, 10

Walter Odemer Co., 1516 W. Magnolia Blvd., Burbank, CA 91506 (213-846-2819) U.S.A. 1

Richard W. Burden Associates, 20944 Sherman Way, Canoga Park, CA 91303 (213-340-4590) AZ, CA, ID, NV, OR, UT, WA 1, 3, 4, 9, 10

Broadcast Video Systems, Inc., 1050 E. Dominguez, Unit D, Carson, CA 90746 (213-637-2971) AZ, CA, NV, OR, WA 2, 3

System Associates, 5801 Uplander Way, Culver City, CA 90230 (213-641-2042) U.S.A. and Canada 5,11; AZ, CA, NV 2,5,11

Studio Film & Tape Inc., 6670 Santa Monica Blvd., Hollywood, CA 90038 (213-466-8101) U.S.A. and Canada 3, 5

Ray Jacobs Audio, Inc., 2739 Signal Parkway, Long Beach, CA 90806 (213-595-6811) USA - mail order 5

Kallman Associates, Inc., 2525 Hype- rion Ave., Los Angeles, CA 90027 (213-660-4900) AZ, CA, NV 2, 10

Video Systems Network, Inc., 12530 Beatrice St., Los Angeles, CA 90066 (213-871-0677) North America 1, 2, 3, 5, 6, 7, 8, 9, 10, 11

Westlake Audio, 6311 Wilshire Blvd., Los Angeles, CA 90048 (213-655-0303) Worldwide 1, 3, 5, 10
See advertisement on page 71

Cara Int'l. Ltd., Box 9339, Marina Del Rey, CA 90291 (213-821-7898) U.S.A. 1
See advertisement on this page

VIF International, Box 1555, Mountain View, CA 94042 (408-739-

9740) Worldwide 1

Broadcast Cartridge Service, Box 1790, N. Hollywood, CA 91604 (213-245-7708) U.S.A. 5

Surcom Associates, 305 Wisconsin Ave., Oceanside, CA 92054 (714-722-6162) Worldwide 4
See advertisement on this page and 165

Accurate Sound Co., 114 Fifth Ave., Redwood City, CA 94063 (415-365-2843) U.S.A. and Canada 1, 5, 10, 11

Network Recording Products, 4429 Morena Blvd., San Diego, CA 92117 (714-272-2011) U.S.A. 1, 5

Schudel, Inc., 6973 Consolidated Way, San Diego, CA 92121 (714)-578-1770) Worldwide 2

Sound Genesis, 2001 Bryant St., San Francisco, CA 94110 (415-285-8900) AK, CA, HI, ID, MT, NV, OR, WA 1, 3, 5, 9, 10, 11

Sound Dynamics, Inc., Box 32055, San Jose, CA 95152 (408) 926-3588) CA, OR, WA 1, 4, 9

David Lint Associates, Inc., 3350 Scott Blvd., Bldg. #5, Santa Clara, CA 95051 (408-984-0964) AZ, CA, NV, OR, WA 1, 4, 5

Videotape Products, Inc., Box 1077; 919 Broadway, Santa Monica, CA 90406 (213-451-1604) World- wide 5

Davis Electronics Co., Box 128, Sierra Madre, CA 91024 (213-355-6909) CA, HI 4, 9

Broadcast Marketing Associates, (Formerly United Media), 155 B San Lazaro Ave., Sunnyvale, CA 94086 (408-736-3600) AK, CA, HI, ID, NV, OR, WA 1, 2, 3, 5, 7, 8, 10, 11

Sound Investment Enterprises, Box 4139, Thousand Oaks, CA 91359 CA 1

COLORADO

Colorado Magnetics, Box 713, Colo- rado Springs, CO 80901 (303-596-0684) AZ, CA, CO, ID, KS, MO, NE, NV, NM, TX, UT, WY 5
See advertisement on page 177

Didier/Denver, Inc., 4665 Kipling, Wheat Ridge, CO 80033 (303-422-6666) CO, ID, KS, MT, NE, NM, ND, SD, UT, WY 1, 2, 3, 4, 6, 10

CONNECTICUT

Redding Radio, Div. of SJ Industries Inc., Box 344, Fairfield, CT 06430 North America 1, 3, 5

Denson Electronic Corp., Box 85, Rockville, CT 06066 U.S.A. and Canada 2
See advertisement on page 114

DISTRICT OF COLUMBIA

Comex Corp., Box 17011, Dulles Int'l. Airport, Washington, DC 20041 (703-471-4215) South America 2
See advertisement on page 172

FLORIDA

Doug Holland Associates, 9035 S.W. 9th St., Boca Raton, FL 33433 (305-428-7120) FL, GA, IL, IN, IA, KY, LA, MD, MI, NE, NJ, NY, NC, OH, PA, SC, TN, TX, VT, VI, VA, WV, WI 1, 4, 5, 9, 10, 11

Pro Audio General Store, Inc., 1378 NW 100th Ave., Coral Springs, FL 33065 (305-752-0330) AL, FL, GA, LA, MS, NC, SC 1, 5



FISHER - BURKE

Professional Broadcast Audio

We specialize in sales & systems design. Fisher-Burke represents over 60 Quality Equipment Manufacturers.

Arizona's

AMPEX

Distributor.

Call 602-257-0225 P.O. Box 2468 Phoenix, Arizona 85003

Transmitting Mica Capacitors

ITT JENNINGS
VACUUM CAPACITORS
SURCOM ASSOCIATES
305 Wisconsin Avenue
Oceanside, California 92054
(714) 722-6162

PML Professional microphones from Sweden:
Dynamic, Electret Lavalier and Condenser.

Exclusive US Distributor/Importer:

CARA INTERNATIONAL LTD

P.O. Box 9339
Marina del Rey, CA 90291
Tel: (213) 821-7898

Area Representatives

San Francisco
Brian Trankle & Associates
(415) 344-1133

Nashville
Technicon, Inc.
(615) 822-3524

Chicago
Pro Audio Sales
(312) 381-4559

LEECO MID-SOUTH, INC.

Your Stocking Instrument Distributor

Data Precision
Leader Instr.
Power Instr.
Micrometric's
Ivey Elec.

817 Wheeler Ave.
Huntsville, AL 35801
Phone: 205/533-5896

B.A.A. Int'l., Box 5882, Ft. Lauderdale, FL 33310 (305-522-1000 or 485-4111) U.S.A. and Int'l. 1, 3, 4, 5, 6, 11

See advertisement on page 174

Lauderdale Electronic Labs, 16 S.W. 13th St., Ft. Lauderdale, FL 33315 (305-764-7755) U.S.A. and Canada 1, 3, 5

Image Devices Inc., Box 610606; 1825 N.E. 149th St., Miami, FL 33181 (305-945-1111; 800-327-5181) AL, AR, FL, GA, KY, LA, MS, NC, OK, PR, SC, TN, VA, ONT, QUE 1, 2, 3, 5, 7, 8, 9, 10, 11

Lita Broadcasting Distributors, Box 440752, Miami, FL 33144 (305-358-2836) U.S.A. 1,3,5,6,9,10

See advertisement on this page

Stage Equipment & Lighting, Inc., 12231 N.E. 13th Court, Miami, FL 33161 (305-891-2010) AL, FL, GA, Caribbean, Central & South America 2, 9, 10

Autodyne, Box 13036, Orlando, FL 32859 (305-855-6868) Worldwide 1, 2, 3, 5, 7, 9, 10, 11

Media Concepts, Inc., 559 49th St. S., St. Petersburg, FL 33707 (813-321-2122 or 821-2122) U.S.A. and Int'l. 1, 2, 5, 9, 10

Audio Visual Services, 5484 Jet Port Industrial Blvd., Tampa, FL 33614 (813-884-1461) U.S.A. 1, 5, 7, 9, 10, 11

Gray Communications, 5401 Southern Comfort Blvd., Tampa, FL 33614 (813-885-1411) FL, PR 1, 2, 8, 9, 10, 11

GEORGIA

Siboney Audio Visual Products, Inc., 1760 Tully Circle, N.E., Atlanta, GA

30329 (404-329-9200) AL, GA, TN, TX 1, 2, 5, 7, 9, 10, 11

Quality Media Corp., Box 7008, Columbus, GA 31908 (800-241-7878; in GA 404-324-1271) U.S.A. and Canada 3
See advertisement on page 51

C. Harrison Associates, 6290 McDonough Dr., Suite E, Norcross, GA 30093 AL, FL, GA, MS, NC, SC, TN 2, 4

ILLINOIS

Newark Electronics, 500 N. Pulaski Rd., Chicago, IL 60624 (312-638-4411) Worldwide 1, 3, 6

WIDL Video, 5245 W. Diversey, Chicago, IL 60639 (312-622-9606) Worldwide 1, 3, 5, 8

Columbia Video Systems, The Columbia Bldg., Laurel & 2nd, Highland Park, IL 60035 (312-433-6010) IL, IN, IA, MI, WI 2, 3, 5, 7, 10

Roscor Corp., 6160 Oakton, Morton Grove, IL 60053 (312-966-3010 or 539-7700) IL, IA, KY, MI, OH, WI 1, 2, 3, 5, 8, 9, 10, 11

Joseph Electronics, 8830 Milwaukee Ave., Niles, IL 60648 (312-297-4200) IL, IN, WI, Nat'l. Mail Order 1, 2, 3, 4, 5, 6, 7

MTI Teleprograms Inc., 4825 N. Scott St., Suite 23, Schiller Park, IL 60176 (312-671-1565) Worldwide 7

INDIANA

Jon Powell Associates, Inc., 3500 DePaw Blvd., Suite 3000; Box 68635, Indianapolis, IN 46268 (317-844-5060) IN 1, 2, 5, 7, 12

Allied Broadcast Equipment, 635 South E St., Richmond, IN 47374 (317-962-8596) U.S.A., Canada, Central America, Great Britain and Philippine Islands 1, 3, 4, 5, 6, 9, 10, 11
See advertisement on page 82

KANSAS

Business Communications, 1140 Cambridge Circle Dr., Kansas City, KS 66103 (913-342-4000) IA, KS, MO 11

Radio Supply Co., Inc., VTR Div., 131 Laura, Wichita, KS 67211 (316-267-5213) KS, OK 1, 2, 3, 5, 6, 9

KENTUCKY

Bruce L. Dawson & Associates, Box 115, Prospect, KY 40059 KY, Southern OH 2

MARYLAND

Neff Communications, Inc., 9721 Singleton Dr., Bethesda, MD 20034 (301-530-6080) DE, DC, MD, NJ, PA, VA, WV 1, 3, 5

Peirce-Phelps, Inc., 10215 Fernwood Dr., Bethesda, MD 20034 (301-530-9580) DC, MD, VA 1, 2, 3, 5, 7, 8, 9, 10, 11

Midwest Corporation, Communications Division, 4700-G Boston Way (Washington D.C.), Lanham, MD 20801 (301-577-4903) North America 1, 2, 4, 5, 8, 9, 10

NUS Corp., 4 Research Place, Rockville, MD 20850 (301-948-7010) DE, DC, FL, GA, MD, NJ, NY, NC, OH, PA, SC, VA, WV 11

Wiltronix, Inc., 5504 Waterway, Rockville, MD 20853 (301-460-1454) DE, DC, KY, MD, PA, VA, WV 1, 2, 3, 10

Music Sound Distributors, 7C Aylesbury Rd., Timonium, MD 21093 (301-252-9081) U.S.A. and Canada 1, 2, 5
See advertisement on this page and 121

MASSACHUSETTS

Lebow Labs Inc., 424 Cambridge St., Allston, MA 02134 (617-

782-0600) CT, ME, MA, NH, NY, RI, VT 1, 2, 3, 5, 10

Wahlberg Associates, 79 Mystic St., Arlington, MA 02174 (617-646-5394) CT, ME, MA, NH, NY, RI, VT 2

M. P. Video, Inc., 45 Kenneth St., Newton, MA 02161 (617-965-5405) CT, ME, MA, NH, RI 1, 2, 3, 5, 9, 10, 11

QSI Systems, Inc., 993 Watertown St., West Newton, MA 02165 (617-969-7118) U.S.A. 2, 3, 5

MICHIGAN

Thalner Electronic Labs, 7235 Jackson Rd., Ann Arbor, MI 48103 (313-761-4506; Area (313) ONLY 800-552-5275) MI, OH 1, 2, 3, 4, 5, 6, 9, 10, 11

Audio Distributor Inc., 2342 S. Division Ave., Grand Rapids, MI 49507 (616-452-1596) IN, MI, OH 1, 3, 4, 5, 10, 11

O'Hara Associates, 36500 Weideman, Mt. Clemens, MI 48043 (313-791-7140) MI 3

MINNESOTA

Emmons Associates, Inc., 10700 Lynedale Ave. S., Minneapolis, MN 55420 (612-881-1118) IA, MN, ND, SD, WI 1, 2, 9

Todd Communications Inc., 7360 Ohms Lane, Minneapolis, MN 55435 (612-835-3080) IA, MN, NE, ND, SD, WI 1, 2, 3, 4, 5, 7, 9, 10, 11

T. R. Pitts Co., 458 W. Sanborn St.; Box 57, Winona, MN 55987 (507-452-2629) All - MD, MN, SD, WI; Parts of - IL, IA, ME, MI 1, 2, 3, 4, 5, 8, 9, 10

MISSOURI

Television Engineering Corp., 519 Rudder Rd., Fenton, MO 63026 (314-343-5605) IL, IA, KS, MI, MN, MS, MO, NE, OH, TN 1, 2, 5, 7, 8, 9, 10

NEBRASKA

ATV Research, 13th & Broadway, Dakota City, NE 68731 (402-987-3771) Worldwide 2, 3

Lita Broadcasting Distributors

Equipment & Parts
Tubes • Microphones
Carts • Recorders

P.O. BOX 440752
MIAMI, FL 33144
(305) 358-2836

MUSIC/SOUND DISTRIBUTORS

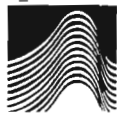

MUSIC SOUND . . .
THE PRO SALES
AND SERVICE TEAM

Professional salesmen, trained to meet the demands of professionals for fast, knowledgeable, efficient service.

MUSIC/SOUND . . . THE PRO LINES

BASF • TASCAM • AMPEX •
TEAC • MEMOREX • KLH-
BURWEN • SANYO •
TECHNICS PRO •
PANASONIC PRO •
STANTON • VICON •
BOGEN • TELEX • SHURE •
MANY MORE!

FOR PRO-LEVEL EQUIPMENT YOU NEED PRO-LEVEL SALES & SERVICE

WRITE FOR OUR **FREE!** 56-PAGE CATALOG TODAY!

MUSIC/SOUND DISTRIBUTORS
Dept. BEBG • 7C Aylesbury Road
Timonium, Md. 21093 • 301-252-9081

THE PROS . . .

NEW JERSEY

Landy Associates, 1890 E. Marlton Pike, Cherry Hill, NJ 08003 (609-424-4660) CT, DE, DC, ME, MD, MA, NH, NJ, NY, PA, RI, VT 1, 2, 3, 5, 7, 10, 11

Tele-Measurements Inc., 145 Main Ave., Clifton, NJ 07014 (201-473-8822; 212-581-9020) CT, DE, MD, NJ, NY, PA 1, 2, 3, 4, 8, 9, 10, 11

Auscom Associates, 30-16 Broadway, Rte. 4, Fairlawn, NJ 07452 (201-796-0600) CT, NJ, NY, PA 1, 2, 3, 5, 6, 9, 10, 11

Thor Electronics Corp., 321 Pennsylvania Ave., Linden, NJ 07036 (201-486-3300) Worldwide 6

Cinecraft Int'l., Inc. Export Agents, 11 Caesar Place, Moonachie, NJ 07074 (201-939-0875) Worldwide 1, 7, 9, 11

Dimension 3 Recording Co., Box 326,

New Milford, NJ 07646 (201-265-5599) USA and Canada 5

Comprehensive Video Supply Corp., 148 Veterans Dr., Northvale, NJ 07647 (800-526-0242; NJ only 201-767-7990) Worldwide 1, 2, 3, 5, 7, 9

L&M Associates, 511 Victor St., Saddle Brook, NJ 07662 (201-843-8700) CT, NJ, NY, PA 3

H. M. Holzberg Associates, Inc., Box 322, Totowa, NJ 07511 (201-256-0455) CT, DE, DC, ME, MD, MA, NH, NJ, NY, PA, RI, VT 1, 2, 3, 4, 5, 7, 8, 10
See advertisement on this page

NEW MEXICO

DYMA Engineering, Inc., Box 1697, Taos, NM 87571 (505-758-2686 or 8686) AZ, CA, CO, KS, NV, NM, OK, TX, UT 1, 2, 3, 4, 5, 6, 7, 8, 9, 10, 11

NEW YORK

Ceco Communications Inc., 2115 Avenue X, Brooklyn, NY 11235 (212-646-6300) Worldwide 6
See advertisement on page 179

Temtron Electronics Ltd., 15 Main St., East Rockaway, NY 11518 (516-599-6400; 800-645-2300) U.S.A. 5, 6
See advertisement on this page

Jules Racine & Co., Inc., 85 Executive Blvd., Elmsford, NY 10523 (914-592-4760) U.S.A. 3

Team Electronics, Inc., 24-16 Queens Plaza South, Long Island City, NY 11101 (212-937-9200) U.S.A. and Canada 6

Boynton Studio Inc., Melody Pines Farm, Morris, NY 13808 U.S.A.; in Canada-BC, MAN, NB, NS, ONT, PEI, QUE, SASK 1, 5, 8, 11

Richard W. Burden Associates, 342 Lexington Ave., Mt. Kisco, NY 10549 (914-666-3730) U.S.A. 9

Adcom Communications Inc., 555 West 57th St., New York, NY 10019 CT, NJ, NY 1, 2, 9, 10, 11
Adwar Video Corp., 100 Fifth Ave., New York, NY 10011 (212-691-0976) Worldwide 1, 2, 3, 5, 6, 9, 10, 11

Barbizon Electric Co., Inc., 426 West 55th St., New York, NY 10019 (212-586-1620) AL, CT, DE, DC, FL, GA, IL, IN, KY, ME, MD, MA, MI, MS, NH, NJ, NY, NC, OH, PA, RI, SC, TN, VT, VA, WV, WI 2

Calvert Electronics Inc., 220 East 23rd St., New York, NY 10010 (800-221-6844) Worldwide 6

The Camera Mart, Inc., 456 West 55th St., New York, NY 10019 (212-757-6977) CT, ME, MA, MI, NH, NJ, NY, OH, PA, VT 2, 7
See advertisement on page 34

Jenel Corp., Consulting & Engineering, 1675 York Ave., New York, NY 10028 (212-722-2478) U.S.A. 10

C. M. Levit Electronics, 200 Park Ave. S., New York, NY 10003 (212-777-5517) Worldwide 6

The Ken Schaffer Group, Inc., 10 East 49th St., New York, NY 10017 (212-371-2335) Worldwide 1, 3

E. Smalling III, Consulting Engineer, 1675 York Ave., New York, NY 10028 (212-722-2478) U.S.A. 10

Sonocraft Corp., 29 West 36th St., New York, NY 10018 (212-760-9300) NJ, NY 1, 2, 5, 7, 9, 10

Studio Film & Tape Inc., 630 9th Ave., New York, NY 10036 (212-977-9330) U.S.A. and Canada 3, 5

Tape City, Inc., 404 Park Ave. S., New York, NY 10016 (212-679-1606) CT, NJ, NY, Mail Order in U.S.A. 1, 2, 5, 9, 11

United Research Lab Corp., 16 East 52nd St., New York, NY 10022 (212-751-4663) U.S.A., Canada and Int'l. 1, 9
See advertisement on this page

H. M. Holzberg Associates, Inc.

P.O. Box 322, Totowa, N.J. 07511, (201) 256-0455

WE HAVE THE WINNERS!!!

Equipment for Radio & TV Broadcasting-CCTV-Cable TV-Recording Studio-Communications. Complete Radio & TV Systems. Financing, Too!!!

HAVE A HAPPY DAY!

How To Handle Emergencies

TWX 581 710-3622 Call (212) 751-4663
United Research Laboratory Corp.

Service Is Our Most Important Product
You Ask For It—You Will Get It

United Research Lab. Corp.
681 Fifth Ave., New York, NY 10022
Showroom Service, 16 E. 52 St., NY 10022

Temtronex offers big discounts to the broadcast industry for:

TUBES—transmitting, klystrons, T.W.T.'s, receiving and industrial—all types.

CAMERA TUBES—Vidicons, Plumbicons, Spectracons, Image Orthicons, Newvicons, C.R.T.'s, etc. **QUARTZ LAMPS**—50% off list.

SPECIALS—Memorex 399 2" Quad Tapes (used) \$50.00 each (150 reels); Norelco PC70 cameras fully equipped (6 each) \$18,500.00 each;

1 set of 3/8-in. plumbicons (new) \$1,425.00. RCA TMM-1 microwave transmitter and receiver \$500.00 ea.

Write or telex for other models that you need.

TEMTRONEX

15 Main St., East Rockaway N.Y. 11518
Tel.. (516) 599-6400 (800) 645-2300
Telex 125237

(See page 242 for key to listings)

R F Gain, Ltd., 100 Merrick Rd., Rockville Centre, NY 11570 (516-536-8868; 800-645-2322) Worldwide 6
See advertisement on pages 17-20

Video Tape Exchange Div. of Cine Film Exchange Inc., 855 Avenue of the Americas, New York, NY 10001 (212-695-6644) Worldwide 5
See advertisement on page 177

Listec TV Equipment Corp., 39 Cain Dr., Plainview, NY 11803 (516-694-8963) U.S.A. 1, 2

Northeast Broadcast Lab., Inc., 15 Charles St.; Box 1176, S. Glens Falls, NY 12801 (518-793-2181) CT, ME, MA, NH, NY, VT 1, 3, 4, 5, 8, 9, 10, 11

Video Components, Inc., 601 S. Main St., Spring Valley, NY 10977 (914-356-3700) U.S.A. 2

Hammond Industries Inc., 155 Michael Dr., Syosset, NY 11791 (516-364-1900) U.S.A. and Canada 1, 3

Mineroff Electronics, Inc., 946 Downing Rd., Valley Stream, NY 11580 (516-825-4702) U.S.A. 1

NORTH CAROLINA

Technical Video Systems, 245 Executive Park Blvd., Winston-Salem, NC 27103 (919-768-9536) GA, NC, SC, TN, VA, WV 2, 3, 5, 8, 9, 10, 11

OHIO

Applied Video Electronics, Inc., Box 25, Brunswick, OH 44212 (216-225-4443) U.S.A. 2, 3

Doug Cook & Associates, 2184 Trent Rd., Columbus, OH 43229 (614-471-4114) OH, W.-PA, WV 1, 2, 3, 4, 10

OKLAHOMA

Walter S. Brewer Co., Inc., 5424 S. Zunis Pl., Tulsa, OK 74105 (918-749-9894) Worldwide 2

OREGON

United Radio Supply Inc., Box 14040, Portland, OR 97214 OR, WA 3, 6

PENNSYLVANIA

Communion Medias, Tilghman at Jefferson Sts., Allentown, PA 18102 (215-437-0607) North

America 1, 3, 4, 5, 6, 7, 8, 9, 10, 11

See advertisement on page 120

LPB Inc., 28 Bacton Hill Rd., Frazer, PA 19355 (215-644-1123) CA, CT, DE, DC, GA, ME, MD, MA, NJ, NY, NC, OH, PA, RI, SC, VA, WV 1, 3, 4
See advertisement on this page

Lerro Electrical Corp., 3125 N. Broad St., Philadelphia, PA 19132 (215-223-8200) DE, NJ, PA 2, 10

See advertisement on page 115

Micro TV, Inc., River Park House, 3600 Conshohocken Ave., Philadelphia, PA 19131 (215-879-0900) U.S.A. and Canada 2

Peirce-Phelps, Inc., 2000 North 59th St., Philadelphia, PA 19131 (215-879-7171) DE, NJ, PA 1, 2, 3, 5, 7, 8, 9, 10, 11

Steinberg Electronics Inc., 2520-22 N. Broad St., Philadelphia, PA 19132 (215-223-9400) U.S.A. and Int'l. 1, 2, 6, 9
See advertisement on this page

Val-Tronics, Inc., Penn Park Bldg., Pittston, PA 18640 (717-655-5937) U.S.A. 1, 3, 4, 5, 6

See advertisement on page 164

Dimension Five Sound Co., 24 N. 3rd St., Womelsdorf, PA 19567 (215-589-5312) DE, DC, IA, NJ, NY, OH, PA, VA 1, 2, 3, 5, 9, 10

TENNESSEE

Broadcast Equipment & Supply Co., Box 3141, Bristol, TN 37620 (615-878-2531) U.S.A. 1, 4, 5
See advertisement on page 40

Audio Consultants, Inc., 1200 Beechwood Ave., Nashville, TN 37212 (615-256-6900) AL, AR, DE, DC, FL, GA, KY, LA, MD, MS, MO, NC, SC, TN, TX, VA, WV 1, 3, 5, 9, 10, 11
See advertisement on this page

Audio Consultants, Inc.
1200 Beechwood Avenue
Nashville, TN 37212

Representing over 50 lines of professional audio equipment for recording studio and broadcast applications.

Specialists in studio system design, installation, equipment sales, and service.



PROFESSIONAL RECORDING EQUIPMENT
SOUTHEASTERN REGIONAL DISTRIBUTOR

CALL US FOR ALL YOUR PROFESSIONAL AUDIO NEEDS
615-256-6900

MARTI • AMPEX • FIDELIPAC • UREI • AUDITRONICS • ORANGE COUNTY POTOMAC INSTRUMENTS • BELAR • DORROUGH • UMC/BEAUCART STANTON • BOZAK • QEI • SHURE • REVOX • CABLEWAVE • MOSELEY EDCOR • TECHNICS/PANASONIC • ELECTRO-VOICE • SENNHEISER ORBAN • ROHN • PHELPS-DODGE • OTARI • AND MANY MORE.

Manufacturers and Distributors of Professional Broadcast Equipment since 1960.
Over 60 Studio & AM/FM Transmission and Equipment Lines.

LPB® LPB Inc.
28 Bacton Hill Road, Frazer, PA 19355 (215) 644-1123

Distributors for

Sony - Panasonic Video parts and accessories

Sony magnetic tape products—Audio & Video
Sony microphones and accessories

Vidicon - Newvicon and broadcast tubes
Electro Voice - Shure microphones-mixers etc.
Belden cable and connectors

Steinberg Electronics Inc., 2520-22 N. Broad St., Philadelphia, PA 19132, Phone (215) 223-9400

TEXAS

MZB&A, 4203 Beltway, Dallas, TX 75234 (214-233-5535) AR, LA, NM, OK, TX 1, 2, 3, 4

Unarco, Midwest Communications Systems Div., 15046 Beltway Dr., Dallas, TX 75243 (214-387-2755) AR, LA, OK, TX 1, 2, 3, 4, 5, 7, 9, 10, 11

Victor Duncan, Inc., 2659 Fondren Dr., Dallas, TX 75206 (214-369-1165) U.S.A. and Canada 1, 2, 3, 5, 6, 7, 9, 10, 11

Professional Audio Services, Box 1953, Ft. Worth, TX 76101

(817-536-6254) AL, AZ, AR, CO, FL, GA, HI, IL, KY, LA, ME, MI, MN, MS, MO, NE, NV, NM, OH, OK, PA, TN, TX, UT, VI, WA, WY 1, 3, 5, 9

Gardiner Communications Corp., 1980 S. Post Oak Rd., Suite 2040, Houston, TX 77056 (713-961-7348) Worldwide 1, 2

The Gene Sudduth Co., Inc., 845 39th S.E., Paris, TX 75460 (214-785-5764) AR, LA, OK, TX 1, 2, 3
See advertisement on this page

Eidson Electronic Co., Box 96, Temple, TX 76501 (817-773-3901) U.S.A. and Int'l. 4

UTAH

RIA, Inc., 50 E. Malvern, Salt Lake City, UT 84115 (801-486-8822 or 484-1701) AZ, CO, ID, MT, NV, UT, WY 1, 2, 3, 4, 5, 7, 9, 10, 11

VIRGINIA

Broadcast Consultants Corp., Box 590, Leesburg, VA 22075 (703-777-8660) North America 1, 3, 4, 5, 6, 7, 8, 9, 10, 11

Hoppman Corp., Box 1463, Springfield, VA 22151 U.S.A. 1, 2, 7, 10

Unarco, Midwest Communications Systems Div., 1395 Airrail Ave., Virginia Beach, VA 23455 (804-464-6256) North America 1, 2, 4, 5, 8, 9, 10

WASHINGTON

TWR Broadcast Supply, Box 683, Spokane, WA 99210 (509-624-6694) ID, MT, OR, WA 1, 4, 5, 11

WISCONSIN

Electronic Industries Inc., 19 E. Irving Ave., Oshkosh, WI 54901 (414-235-8930) U.S.A. 1, 3, 4, 5, 6, 9, 11
See advertisement on page 109

CANADA

Broadcast Video Systems, Ltd., 1050 McNicoll Ave., Agincourt, Ont., Canada M1W 2L8 (416-497-1020) AL, AK, AR, CO, CT, DE, DC, FL, GA, HI, ID, IL, IN, IA, KS, KY, LA, ME, MD, MA, MI, MN, MS, MO, MT, NE, NH, NJ, NM, NY, NC, ND, OH, OK, PA, RI, SC, SD, TN, TX, UT, VT, VA, WV, WI, WY, all of Canada 2, 3

Glentronix (1977) Ltd., 160 Duncan Mill Rd., Don Mills, Ont., Canada M3B 1Z5 (416-444-8497) U.S.A. and Canada 1, 2, 3

Comad Communications, 91 Kelfield St., Unit 5, Rexdale, Ont., Canada M9W 5A3 (416-245-1734) Canada 1, 2, 3, 5, 9, 10

Caldwell A/V Equipment Co., 1080 Bellamy Rd. N., Scarborough, Ont., Canada M1H 1H2 (416-438-6230) Canada 1, 2, 3, 4, 5, 6, 7, 9, 10

Black & McDonald, 101 Parliament St., Toronto, Ont., Canada M5A 2Y7 (416-225-0175) Canada 4

Lumitrol, Ltd., 5 Walker Ave., Toronto, Ont., Canada M4V 1G3 (416-921-6060 or 921-6688) Canada 2, 10

Auvinic, 1280 Lachaine, St. Vincent De Paul, Que., Canada H7C 2N7 (514-661-5120) Canada 1, 2, 3, 5, 10

The Gene Sudduth Co., Inc.

Representatives & Distributors of Professional Electronic Equipment.

845 39th, S.E.
Paris, TX 75460
(214) 785-5764

Advertisers' Index

A. F. Associates	132, 180	Broadcast Video Systems Ltd.	148	Datatek Corp.	35
Adcom Communications	150	Buhl Optical	163	Delta Electronics	107
Aitken Communications	172	CCA Electronics Corp.	74	Denson Electronics Corp.	114
Alexander Mfg. Co.	46	C.S.P. Inc.	144	Dielectric Communications	123
Allen Avionics, Inc.	159	Cambridge Products	157	Digital Video Systems	Cover 3
Allied Broadcast Equipment	82	Camera Mart, Inc.	34	Dolby Labs	105
American Laser Systems	149	Canon U.S.A. Inc.	43	Dolphin Productions	168
Amperex Electronic Corp.	33	Capitol Magnetic Products	103	Dyma Engineering	146, 177
Ampex Corp.	41	Cara International	243	Dynair Electronics	159, 161, 163, 165
Ampro/Scully	147	Ceco Communications	179	EEV, Inc.	97
R. B. Annis Co.	150	Central Dynamics Ltd.	24	ES Enterprises	123, 153, 155
Aristocart	82	Cetec/Vega	37	Edutron, Inc.	99
Arvin/Echo	6, 7	Christie Electric	64	Eigen Video	178, 179
Asaca Corp. of America	42, 80	Chyron Corp.	84	Electro Impulse	161
Audi-Cord Corp.	62	Cine Film Exchange, Div. of		Electrohome Ltd.	36
Audio Consultants	246	Video Tape Exchange	177	Electronic Engineering Co.	
Audio & Design Recording	111	Cinema Products Corp.	11	(EECO, Inc.)	92
Audio Designs & Mfg.	57	Clear-Com Intercom Systems	106	Electronic Industries, Inc.	109
Audio-Technica U.S. Inc.	63	Cohu Electronics	72	Electronics Diversified	60
Audio-Video Engineering	157	Colorado Magnetics, Inc.	177	Electro-Voice, Inc.	58
Auditronics, Inc.	91	Colorado Video, Inc.	116	Equipto Corp.	131
BTX Corp.	90	Comex Corp.	172	Fidelipac	121
Bald Mountain Lab	151	Commercial Electronics, Inc.		Fisher-Burke Professional	
Beaveronics, Inc.	61	(CEI)	77	Broadcast	243
Belar Electronics	150	Communication Medias	120	Frezzolini Electronics	125
Berkey Colortran	10	Comrex Corp.	166	Fuji Photo Film U.S.A. Inc.	59
Robert Bosch Corp. (Fernseh Group)	47	Consolidated Electronic Industries, Inc.	14	Garner Industries	158
B.A.A. International	174	Continental Electronics		R. F. Gain Ltd.	17-20
Broadcast Aids, Inc.	179	Mfg. Co.	167, 169, 171, 173	General Electric/VDEO	87
Broadcast Electronics, Inc.	30	Crosspoint Latch Corp.	98	Geleco Electronics	170
Broadcast Equipment & Supply Co. Inc.	40	Peter W. Dahl, Inc.	175	Gerard Tech	154
		Datametrics, Inc.	144	Gerstenslager Co.	56
				Gray Engineering Labs	21

HM Electronics	178, 179	SSAC, Inc.	179
H. M. Holzberg & Associates	245	Saki Magnetics	170
Hallikainen & Friends	139	Schneider Optical	100
Clifford B. Hannay & Son	176	Scientific Systems, Inc.	178
Harris Corp. (Broadcast Products Div.)	44	Sescom Co.	163
Hitachi Denshi America Ltd.	3	Ken Schaffer Group	179
Hughey & Phillips	152	Shintron Co.	40
IGM	171	Sigma Electronics	52
Ikegami Electronics	25, 128, 129	Sigma Systems Engineering	154
Industrial Sciences, Inc. (ISI)	102, 104	Simplex Time Recorder Co.	88
Inovonics, Inc.	164	Sintronic Corp.	175
International Tapetronics Corp.	26	Sitler's Supplies, Inc.	177
JSH Electronics	167	Skotel	70
Jensen Tools, Inc.	175	Warren R. Smith Co.	164
Jensen Transformers	160	Sony Corp. of America	38, 39, 83
Kaitronics Corp.	12	SoundScriber	178
Kliegl Brothers, Inc.	131	Sound Technology	9
Knox Ltd.	140	Spin Physics	27
LPB, Inc.	32, 246	Stainless, Inc.	118
L. W. International	137	Standard Tape Lab.	156
Laird Telemedia	158	Stanton Magnetics	113
James B. Lansing Sound	93	Steinberg Electronics	246
Leeco Mid-South, Inc.	243	Storeel Corp.	101
Leitch Video Ltd.	69	Studer ReVox America, Inc.	75
Lenco Electronics, Inc.	95	Gene Suddarth Co.	247
Lerro Electrical Corp.	115	Surcom Associates	165, 243
Lita Broadcasting Distributors	244	Switchcraft, Inc.	15
Lightning Elimination Associates	138	TT Electronics	178
Lines Video Systems	84	TDK Electronics	89
Lógitex Electronic Systems, Inc.	125, 151	Taber Mfg. & Engineering	124
3M Magnetic Tape Div.	53	Tangent Systems	136
3M Mincom Div.	73	Tech Labs	164
MPB Technologies, Inc.	124	Telectric Co.	160
Marconi Electronics, Inc.	65	Teledyne Energy Systems	179
Marconi Instruments, Inc.	45	Telemet	142
McMartin Industries, Inc.	94	Television Equipment Associates	114, 127
Microtime, Inc.	13	Television Products Co.	126
Micro-Trak Corp.	177	Television Technology Corp.	176
Modular Audio Products	127	Telex Communications, Inc.	4
Moseley Associates	8	Temtronix	245
Music Sound Distributors	121, 244	Tentel	162
NEC America, Inc.	Cover 2	Texas Electronics, Inc.	150
Nova Corp.	160	Time & Frequency Technology	119
O'Connor Engineering Labs	117	Trompeter Electronics	66
Opamp Labs, Inc.	177	U.S. JVC Corp.	54, 55
Opamp Labs, Inc.	177	Ultra Audio Products	173
Orange County Electronics	108	United Media	174
Orban Associates, Inc.	31	United Research Labs	245
Otari Corp.	141, 143, 145	Utah Scientific, Inc.	85
Paladin Corp.	112	VIF International	66
Panasonic Video Systems	49	Vacuum Tube, Industries	163
Philadelphia Resins Corp.	48	Val-Tronics, Inc.	164
Philips Broadcast Equipment Corp.	22, 23	Vega	37
Piclear, Inc.	175	Video Data Systems	16
Potomac Instruments	126, 137	Video Systems Network	152
Pulse Techniques	179	Videomax, Div. of Orrox	1
Quality Media Corp.	51	Videomedia	67
Quantum Audio Labs	179	Viscount Industries, Inc.	168
RCA Broadcast Systems	81	Vital Industries, Inc.	Cover 4
RTS Systems	151	Wang Voice Communications	50
Ramko Research	28, 29	Waters Mfg. Co.	139
Recording Supply Co.	169	Westlake Audio	71
Recortec, Inc.	5	Wide Range Electronics	66
Rockwell International	79	Wilkinson Electronics, Inc.	68, 78, 172
Russco Electronics	76	Winsted Corp.	156
		World Video, Inc.	134
		Yardney Electric	162

BROADCAST engineering

Advertising Sales Offices

KANSAS CITY, MISSOURI

Helen Hull, P.O. Box 12901,
Overland Park, KS 66212;
Phone: (913) 888-4664

NEW YORK, NEW YORK

Joe Concert, 4 W. 58th Street
New York, NY 10019;
Phone: (212) 888-1977

FT. LAUDERDALE, FLORIDA

Brinker and Brinker,
2240 N.E. 53 Street,
Ft. Lauderdale, FL 33308;
Phone: (305) 771-0064

CHICAGO, ILLINOIS

Jim Reilly, 1011 E. Touhy Ave., Suite 245,
Des Plaines, IL 60018;
Phone: (312) 299-2601

SAN FRANCISCO, CALIFORNIA

John MacKay, 703 Market St., Room 1109,
San Francisco, CA 94103;
Phone: (415) 546-1040

LOS ANGELES, CALIFORNIA

Maureen Eagleton,
3055 Wilshire Blvd.,
Los Angeles, CA 90010
Phone: (213) 387-0639

LONDON, ENGLAND

John Ashcraft & Co., 12 Bear St.,
Leicester Square, London, WC2H 7AS,
England;
Phone: 930-0525

AMSTERDAM, HOLLAND

John Ashcraft & Co., John J. Lucassen,
Akerdijk 150 A, 1171 PV-Badhoevedorp
Holland;
Phone: 2968-6226

TOKYO, JAPAN

International Media Representatives, Ltd.,
2-29, Toranomon 1-chome, Minato-ku,
Tokyo 105, Japan;
Phone: 502-0656

**Perform a
death-defying act.**

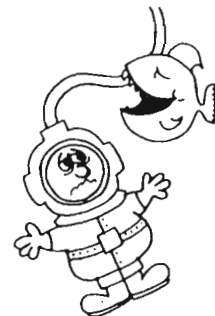

**Have your
blood pressure checked.**

Give Heart Fund
American Heart Association

professional classified services

SERVICES

VIR JAMES
CONSULTING RADIO ENGINEERS
 Applications and Field Engineering
 Computerized Frequency Surveys
 345 Colorado Blvd.
 Phone: (Area Code 303) 333-5562
DENVER, COLORADO 80206
 Member AFCCE

MIDWEST ENGINEERING ASSOCIATES
Consulting Engineers
 6934 A N. UNIVERSITY
 PEORIA, ILLINOIS 61614
 (309) 692-4233
 Member AFCEC

SMITH and POWSTENKO
 Broadcasting and Telecommunications
 Consultants
 2000 N. Street, N.W.
Washington, D. C. 20036
 (202) 293-7742

ATLANTIC RESEARCH CORPORATION
Jansky & Bailey
Telecommunications Consulting
 Member AFCCE
 5390 Cherokee Avenue
 Alexandria, Virginia 22314
 (703) 354-3400

RALPH E. EVANS ASSOCIATES
CONSULTING COMMUNICATIONS ENGINEERS
 216 N. Green Bay Road
 Suite 208
 Thiensville, WI 53082
 Phone: (414) 242-6000 Member AFCCE

Job leads
BROADCASTING JOBS!!
 Discover the new job just right for your skills and experience. High-paying, prestige positions in RADIO... TV...and all MEDIA CATEGORIES. Beginners & pros welcome—nationwide opportunities! Write today for FREE DETAILS: Job Leads Newsletter, 1680 Vine Street, Suite 820-KR, Hollywood, CA 90028.

D. L. MARKLEY & Associates, Inc.
CONSULTING ENGINEERS
 3101B W. Harmon Hwy.
 Peoria, Illinois 61604
 (309) 673-7511
 Member AFCCE

FREE CATALOG

For a free government catalog listing more than 200 helpful booklets, write: Consumer Information Center, Dept. A, Pueblo, Colorado 81009.

Advertising rates in Classified Section are 50 cents per word, each insertion, and must be accompanied by cash to insure publication. Each initial or abbreviation counts a full word. Minimum classified charge, \$4.00.

For ads on which replies are sent to us for forwarding (blind ads), there is an additional charge of \$5.00 per insertion, to cover department number, processing of replies, and mailing costs.

Classified columns are not open to advertising of any products regularly produced by manufacturers unless used and no longer owned by the manufacturer or a distributor.

TRAINING

ELECTRONICS DEGREE by correspondence. Earn A.S.E.T., then B.S.E.T. Free brochure. Grantham College, 2550 South La Cienega, Los Angeles, California 90034. 2-79-tfn

FIRST PHONE through cassette recorded lessons at home plus one week seminar in Boston, Philadelphia, Detroit, Atlanta or Seattle. Our twentieth year teaching FCC license courses. Bob Johnson Radio License Preparation, 1201 Ninth, Manhattan Beach, Calif. 90266. Telephone 213-379-4461. 8-78-tf

REI has over 5,000 successful graduates and over 95% pass the FCC 1st Class exams on first try. New FCC exams are on the way. Better not take a chance—learn electronics and pass exams too. 5 week course. Rooms at the school. Call or write for information. R.E.I., 61 N. Pineapple Ave., Sarasota, Fla. 33577. (813) 955-6922. 7-79-tfn

WANTED

WANTED: 5kw or 10kw AM transmitter to use as a standby. Prefer something no older than 10-12 years. Call John Gober, WVOK Radio, (205) 785-5111. 9-79-1t

WANTED: Pre-1926 radio equipment and tubes. August J. Link, Surcom Associates, 305 Wisconsin Ave., Oceanside, Ca. 92054, (714) 722-6162. 3-76-tf

HIGHEST PRICES PAID for 112 Phase Monitors and for clean, 12 year old or less, 1 KW and 10 KW AM Transmitters. All duty and transportation paid. Surplus Equipment Sales, 2 Thornclyffe Park Dr., Unit 28, Toronto, Ontario, Canada, M4H 1H2. 416-421-5631. 2-79-tfn

INSTANT CASH FOR TV EQUIPMENT: Urgently need transmitters, antennas, towers, cameras, vtrs, color studio equipment. Call toll free 800-241-7878. Bill Kitchen, Quality Media Corporation (In Georgia call 404-324-1271). 6-79-tfn

WANTED: Base insulator to fit Rohn 25 tower. Chester, Route 1, Box 281, Woodlawn, Tenn. 37191. 9-79-1t

MICROPHONES needed for historical archive; early RCA and Western Electric models. James Steele, National Association of Broadcasters, 477 Madison Avenue, New York, NY 10022, (212) 759-7020. 9-79-2t

WANTED: Four used cameras TK-45 or TK-760. Those interested send information to: P.O. Box 31258, Bogota, Colombia. 9-79-1t

SITUATION WANTED

AUDIO ENGINEER AVAILABLE: Education/Experience in recording, radio, reinforcement, theatre, music. Write for resume. D. L., 3077 Culver Rd., Rochester, N.Y. 14622. 9-79-1t

ONE STOP FOR ALL YOUR PROFESSIONAL AUDIO REQUIREMENTS. Bottom line oriented. F.T.C. Brewer Company, P.O. Box 8057, Pensacola, Florida 32505. 7-71-tf

HELIAX-STYROFLEX. Large stock—bargain prices—tested and certified. Write for price and stock lists. Sierra Western Electric, Box 23872, Oakland, Calif. 94623. Telephone (415) 832-3527. 1-73-tf

TRANSMITTER TUBES REPROCESSED—Save 40 to 50%. 3CX2500, 4CX5000, 4CX15000 and many others. Write for details. FREELAND PRODUCTS CO., 3233 Conli St., N.O., La. 70119, (504) 822-9222. 8-79-tfn

TOWER SERVICE: Erection. Sales. Service. Painting. Inspections. Maintenance contracts. Pioneer Tower Service, P.O. Box 253, Carrollton, Missouri 64633, (816) 542-0840. 8-78-tf

VIDICOM TO NEWVITRON—We'll update your Panasonic WV-2100P to WV-2150 quality with new Newvitron tubes. LIVE-VIDEO, Parcel 8, Suite 3A, Farmington, CT 06085, (203) 673-4611. 7-79-3t

COMPLETE E.F.P. MOBILE UNIT—3 color cameras with experienced engineer. Geared for the budgeted production. LIVE-VIDEO, Parcel 8, Suite 3A, Farmington, CT 06085, (203) 673-4611. 7-79-3t

EQUIPMENT FOR SALE

USED TK-44B CAMERA

Oral Roberts University has used RCA TK-44B camera for sale. New tubes, Schneider 11X1 TV7 zoom lens, ITE cam head, 100 ft. TV 81 cable, remote control, Houston Fearless PD-8 pedestal. 40K. Write ORU Director of Engineering, P.O. Box 3286, Tulsa, OK 74101 or phone 918-492-5535. 9-79-1t

TKP-45 W/MINI PACK CCU, Canon 10:1 zoom lens, carrying cases, & all accessories. Low hours. Excellent shape. Ross Bagwell, Sr., Cinetel Productions, 2 Forest Court, Knoxville, TN 37919, (615) 584-2232/584-0171. 9-79-1t

RCA VTY MODIFICATIONS KITS for TR4/22/50/60/61/70. Splicer (single-frame), TEP Interface, Time Code Edit Interface Kit, Audio Splice Timing Mod (Audio Insert Editor), Wideband Audio Amplifiers, most mod kits, some modules available. LAWHED, LTD., 388 Reed Road, Broomall, Pa. 19008, (215) 543-7800. 4-78-tf

REMOTE VIDEOTAPING UNITS: 20' — \$125,000.00; 40' — \$350,000.00. LATEST NETWORK EQUIPMENT, RCA VTRS, AMPEX CAMERAS, AMERICAN DATA, etc. M. Grosvenor, 3200-L S. Barrington Ave., Los Angeles, CA 90066, (213) 397-5922. 9-79-1t

GENERAL RADIO 1606-A—\$1200.00. Delta OIB-1—\$500.00. 1-208-746-2256. 9-79-1t

FOR SALE: ONE RCA FIELD INTENSITY METER, type WX2D, frequency 540 to 1600. Call 916-233-2713 or write to P.O. Box 1650, Alturas, CA 96101. 8-79-2t

USED FIDELIPAC TAPE CARTRIDGES: \$35.00 per hundred as is. New pressure pads, \$28.00 per hundred. Freight prepaid, check with order. Cart Mart, Box 3066, Fort Worth, Texas 76105, (817) 536-6437. 8-79-3t

BROADCAST CRYSTALS for AM, FM or TV transmitters, frequency change, repair or replacement of oven types. Also vacuum types for RCA, Gates, Collins, etc. transmitters. Quality products, reasonable prices and better delivery! Don't be without a spare crystal. Frequency change and service for AM and FM monitors. Over 30 years in the business. Eldson Electronic Co., Box 96, Temple, Texas 76501. Phone (817) 773-3901. 12-74-tf

HELP WANTED (CONT.)

TV Systems Engineer

This career position offers you an opportunity to design custom systems for a variety of GVG customers. The individual chosen will have a solid technical background in television systems with good basic circuit design knowledge.

Field Service Engineer, East Coast

We need an individual to provide after-sales support for our wide variety of complex systems. The position provides travel opportunities within the U.S. plus marketing and engineering career opportunities. An individual with experience designing and/or maintaining television broadcast systems is needed.

Project Engineer

An excellent career opportunity for an individual to assume responsibility for challenging research and development projects. This position requires video project experience plus a BSEE or equivalent.

The Grass Valley Group offers a state-of-the-art technical environment in a serene rural setting. We are located at the foothills of California's Sierra Nevada mountains, where you'll find a relaxed lifestyle and abundant recreational activities.

Interested and qualified individuals are invited to send a resume in confidence to Val R. Marchus, The Grass Valley Group, Inc., P.O. Box 1114, Grass Valley, California 95945. An Equal Opportunity Employer M/F/H.

The Grass Valley Group

A Tektronix Company

OPERATING TECHNICIAN for Washington, D.C. area production company. Must be familiar with audio pickup and recording techniques and have a good working knowledge of television audio systems. Reply Dept. 465, Broadcast Engineering, P.O. Box 12901, Overland Park, KS 66212. 8-79-3t

TV BROADCAST TECHNICIANS. Established public television station moving to new color facility. West Virginia University and WVU-TV has vacancies for persons experienced in master control operations, production and maintenance including all phases of transmitter and/or microwave transmitting/receiving maintenance. Send resume of qualifications and salary history to: Jack Podaszwa, Personnel Officer, West Virginia University, Morgantown, WV 26506. An Equal Opportunity/Affirmative Action Employer M/F. 8-79-2t

HELP WANTED (CONT.)

CHIEF ENGINEER NEEDED FOR NEW 100,000 WATT PUBLIC STATION. Will be responsible for all technical aspects of operation including, maintenance on transmitter, microwave, studio equipment and automation system. Will assure compliance with all F.C.C. requirements. 1st phone, B.A. in electronics and two years full-time experience required. Additional experience may substitute for degree. Experience in remote recording technique involving high quality music performance very helpful. One month vacation. Send resume to David M. Horning, General Manager, KHCC-FM, 1300 North Plum, Hutchinson, Kansas 67501. 9-79-1t

HELP WANTED (CONT.)

INDUSTRIAL VIDEO ENGINEER: Large Dallas based insurance company with in-house color TV studio, post production facilities, national 3/4" video network. In fully equipped multi-media learning center needs chief engineer with 3 to 5 years experience in industrial or broadcast TV. Must have thorough knowledge of 3-tube color cameras & 3/4" editing systems, & be willing to become part of field & studio production team. Company has excellent benefits including flexible work hours. Send resume with salary requirements to P.O. Box 2699, Dallas, TX 75221, attention: Staffing Director. Equal Opportunity Employer M/F. 9-79-1t

TELETRACK^{T.M.}

American Totalisator Has Exciting Positions In It's Newest OTB Production

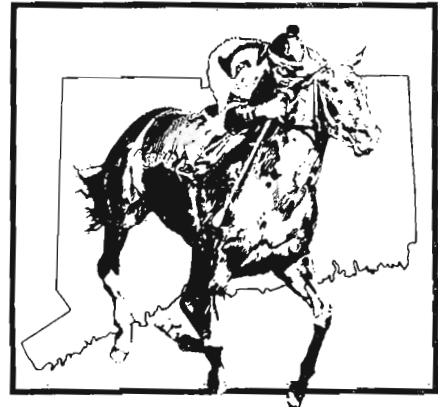

Teletrack, located in New Haven, Connecticut, combines the excitement of a most modern entertainment center with that of the actual thrill of the racetrack including full color video representation of the prime New York races live on a large screen.

With the scheduled opening rapidly approaching, we are currently seeking the following professionals to staff this new concept in sports centers.

Our current needs are:

AUDIO-VIDEO OPERATIONS MANAGERS (2)

Requirements include experience with broadcast quality professional/video tape recorders. Individual will be responsible for the production of acceptable audio/visual programs and will direct a crew of technicians engaged in video control, audio and other related technical state-of-the-art equipment.

AUDIO-VIDEO MAINTENANCE ENGINEERS (2)

Candidate must have experience with the maintenance and calibration of switchers, professional video recorders, monitors and test equipment.

AUDIO-VIDEO OPERATIONS TECHNICIANS (4)

Individual must have experience in operating broadcasting quality videotape recorder and other related equipment.

AUDIO-VIDEO PROJECTION ENGINEERS (3)

Candidate must have experience in operating and maintaining sequential Eidophor projectors.

We offer a wide range of career possibilities and a comprehensive compensation package with a full range of benefits. The opportunities to shine in our newest production are here. Interested applicants should call collect or send resume including salary history to:

Jack Monahan
(301) 666-8700



AMERICAN TOTALISATOR SYSTEMS
GENERAL INSTRUMENT CORPORATION

11126 McCORMICK ROAD • HUNT VALLEY • MD 21031

ENGINEERING MANAGEMENT

★ Network Studio Operations

The Technical Manager is involved in the production of video taped shows from pre-production meetings through final taping. Responsibilities include selecting engineering crews, setting schedules, satisfying the creative needs of the production company, and maintaining control over engineering costs.

★ Local Station Operations

The Technical Facilities Manager is responsible for the operations and maintenance of all equipment in the news technical operations center for the local station.

★ Audio/Video Systems Engineer

Position involves designing, creating and planning engineering installations for television and associated technical equipment, and facilities for use in network and local station broadcasting operations. Requires BSEE or equivalent experience, knowledgeable in state-of-the-art broadcasting techniques and equipment, plus background in engineering supervision preferred in manager position.

If you are interested in any of the above positions, please send resume in confidence to:

Mike Sweet



4151 Prospect Avenue
Los Angeles, CA 90027

Equal Opportunity Employer M/F

HELP WANTED (CONT.)

WANTED

Immediate opening for Television Studio Engineer. Minimum 3 years active broadcast studio maintenance and operation required. Associate Degree or equal in electronics and first class radio-telephone license required. Send resume to:

Personnel Department
P.O. Box 146 Substation #1
University of Texas Medical Branch
Galveston, Texas 77550

UTMB is an Affirmative Action M/F/H Employer. 9-79-11

STUDIO ENGINEER for local TV station. Studio equipment operation experience required. Send resume, Personnel Office, 3 Constitution Plaza, Hartford, CT 06115. WE ARE AN EQUAL OPPORTUNITY EMPLOYER! 9-79-11

CHIEF ENGINEER wanted for TV-Radio Station in the mid-south. Write Broadcast Engineering, Dept. 471, P.O. Box 12901, Overland Park, KS 66212. 9-79-11

BROADCAST ENGINEERING SUPERVISOR: Maintenance of UHF/cc Public TV production facility, oversight of technical staff, operations. Send resume, references, salary required. Manager, WTVP-TV, 1501 W. Bradley Avenue, Peoria, IL 61625. An equal opportunity employer. 9-79-11

HELP WANTED—TECHNICAL ASSISTANT CHIEF ENGINEER FOR TELEVISION. Immediate opening. Progressive medium market station seeks experienced assistant chief engineer with knowledge of ACR-25, RCA TK-46/76/28C and Sony E.N.G. RCA Transmitter experience also helpful. Pleasant surroundings in energy developmental area. Contact Jack Davis, Chief Engineer, KFVR TV, Box 1738, Bismarck, ND 58501. (701) 223-0900. 9-79-11

CHIEF ENGINEER: Los Angeles remote recording facility requires maintenance and operations engineer with 3 years minimum experience in VTR's, camera switchers, etc. Send resume to: TransVideo Productions, 1028 N. La Brea, Hollywood, CA 90038. 9-79-11

MAINTENANCE SUPERVISOR for large Washington, D.C. area production company. Technical school plus minimum 5 years experience. Must be familiar with all types of studio broadcast equipment. Reply Dept. 464, Broadcast Engineering, P.O. Box 12901, Overland Park, KS 66212. 8-79-31

FIELD ENGINEER: Secure employment opportunity with good benefits; fully equipped van provided for travel. Requirements: FCC 1st class; minimum two years experience with and skill in maintenance of TV electronic equipment; knowledge of computerized control system desirable. Send resume to: James Potter, Indiana Higher Education Telecommunication System, 1100 W. Michigan, Inpls., IN 46202 EER/AA employer. 9-79-11

MAINTENANCE ENGINEER for Los Angeles Television/Teleproduction facility. A strong background in studio maintenance with 3 to 5 years experience, first class license and the desire and ability for a challenging position. Salary .20K plus. Submit resume to Win Korabell, Director of Engineering, KCOP Television, Inc., 915 North La Brea Avenue, Hollywood, California 90038. Affirmative Action/Equal Opportunity Employer. 9-79-11

WANTED— A Chief Engineer to one of America's leading television stations. Top pay for top man. Must be able to handle personnel and know his stuff technically. Station heavy in remotes, ENG and studio production. We are looking for a leader who can create a healthy atmosphere and maintain a sharp operation. EOE/MF. Write Broadcast Engineering, Dept. 470, P.O. Box 12901, Overland Park, KS 66212. 9-79-11

O.K., who put the used prices on the new equipment?

It's no mistake. Here's your chance to buy brand-new 3M video gear at prices you may never see again. And each of these surplus pieces comes with full manufacturer's warranty.

Production Switcher MODEL 812
3 buses, 8 video layouts, 12 popular effects \$1,800.00
Subcarrier Distribution Amplifier
MODEL 730 \$400.00
RGB Image Enhancer MODEL 6210 \$1,500.00
Time and Temp. Generator
MODEL TT-1 \$750.00

For more information
call toll-free 1-800-328-1656.



PRODUCTION OPERATOR/MAINTENANCE ENGINEER: Indianapolis based production facility expanding. Desires experienced operator/maintenance engineer with 1st phone to operate 1", 2" tape machines, computer editor and multi channel audio mixer. Strong maintenance background in digital circuitry a must. No phone calls. Send resume and salary requirements to: Telematrix Productions, 5635 West 80th Street, Indianapolis, IN 46268, Attention: Tom Parrish. 9-79-21

FIELD SERVICE ENGINEERS—We are seeking individuals to install and maintain computer controlled video tape editing equipment. Must be familiar with digital and microprocessor based equipment and video tape recorders. Must have Associate Degree or equivalent in Electronics. Customer relations experience a definite plus. Our company offers a good starting salary and an excellent fringe benefit program. For immediate consideration, send resume with recent salary history to Gary Rosenzweig: Datatron, Inc., 1662 Reynolds Avenue, Irvine, CA 92714. 9-79-11

ASSISTANT CHIEF: WTRY/WHSB Albany, New York seeks an individual experienced in studio and transmitter maintenance and construction. Directional experience helpful. Contact Norm Avery, WTRY Rd., Schenectady, NY 12309. 9-79-21

MANUFACTURERS REPS WANTED

RAMKO RESEARCH, MANUFACTURERS OF ADVANCED BROADCAST AUDIO EQUIPMENT IS SEEKING EXCLUSIVE REPRESENTATION IN: NEW ENGLAND, NEW YORK, ILLINOIS, WISCONSIN, MINNESOTA, IOWA, NORTH AND SOUTH DAKOTA, KANSAS, MISSOURI, NEBRASKA, COLORADO, ARIZONA, NEVADA, CALIFORNIA, WASHINGTON, AND OREGON.

WE OFFER: AN ATTRACTIVE COMMISSION SCHEDULE; OUTSTANDING FACTORY BACK UP AND CUSTOMER SERVICE; EXCLUSIVE TERRITORIES; ESTABLISHED ACCOUNTS; AND AN EVER EXPANDING ADVANCED PRODUCT LINE.

IF YOU ARE INTERESTED IN A LONG TERM RELATIONSHIP AND ARE DEDICATED TO SERVICING YOUR CUSTOMERS, WE WOULD LIKE TO HEAR FROM YOU. WRITE OR CALL COLLECT AT (916) 635-3600.

RAMKO RESEARCH

1175th A Folsom Blvd. Folsom, California 95670
(916) 635-3600

TELEVISION TRANSMITTER ENGINEER: Maintenance and calibration of remote controlled BT-25L1 (CH 6) and TT-12EH (CH 13). Twenty hours per week. Mild Climate in California Northcoast. Outdoorsman's paradise. Salmon fishing, hunting, camping in Pacific Redwoods. Ideal for retired couple. Provisions for mobile home, utilities provided. Write or call Michael Felst, Director of Engineering, KVIQ-TV, Box 1019, Eureka, CA 95501. Phone: (707) 443-3061. 9-79-11

PHASER



A high performance full Frame Store TBC/Synchronizer with Freeze Frame for less than \$18,000.

We take pride in introducing the PHASER, a Frame Store TBC/Synchronizer that outperforms all the economy priced models on the market, and sells for less too.

The PHASER is a new "computer" technology system that uses software to save you money.

The PHASER offers many significant unique advantages.

- Multiple microprocessors and adaptive digital circuitry eliminate adjustments and mode switching.
- A clean "Hot Switch" between non-synchronous heterodyne and direct color signals, with full bandwidth processing.
- Automatic phase locking between multiple input signals and station reference.
- Horizontal and Vertical Blanking are never widened.
- A "smart" hands-off system that runs itself.
- The cleanest pictures anywhere.

Add to these the best features offered on competitive models, which we consider as standard, and you've got the PHASER, the undisputed leader in its class.

The PHASER is backed up by a network of conveniently located service centres, the most comprehensive warranty in the business, and a unique "No-Tweak" board exchange program when the initial one year warranty period is over.

Talk to your nearest authorized Digital dealer. He'll prove there is no other choice. Or ask us for full details: Digital Video Systems, 716 Gordon Baker Road, Willowdale, Ontario, Canada M2H 3B4. (416) 499-4826



DIGITAL

The digital video experts.

Circle (2) on Reply Card

SQUEEZOOM

is...

now with
CHROMAZOOM

FRAME SYNCHRONIZER

Locks all remote signals to house sync. Network, ENG, Remote pick-ups, and satellite signals will mix with local signals with no disturbance.

Sampling video at 4 times sub-carrier for superior technical standard and picture quality.

CHROMAZOOM

New built-in composite CHROMAKEY gives halo-free pictures with full control of size, positioning and Squeezoom manipulation.

FRAME FREEZER

Will act like having another camera in the studio for still shots. Will freeze any full frame picture. Will retain last frame of interrupted incoming signal automatically until picture is restored.

VIDEO COMPRESSOR

No matter how a slide or scene comes in, you can compress and/or change its aspect ratio as you wish, down to one picture element, and position it anywhere on the screen.

Ask for demo tape for convincing force of Squeezoom. Available in NTSC, PAL and SECAM.



One Channel

or up to

4 Channels in One



Simultaneous Live Telecast

ELECTRONIC ZOOM

See or read information not possible without zoom.

In sports, determine if ball is good, simply freeze and enlarge. Call foul plays more accurately. Zoom capability on a remote or recorded scene. Zoom while chroma key tracking.

VERY SPECIAL EFFECTS

With 2 channels or more, open new unlimited vistas of movie-type effects.

Avoid FCC violations. TV blanking standards automatically restored with squeezoom.

Record 4 pictures on one recorder and play back any one full screen with no perceptible degradation.

Display two or more ENG feeds simultaneously. Decided advantage in news, special events, sports.

Conceived, designed, and manufactured in Florida by **Vital Industries, Inc.**—makers of the VIX-114 Series Switching Systems.

Patented

MORRELL BEAVERS Midwest
2644 North Seventh St.
Terre Haute, Indiana 47804
Phone 812/466-3212

GORDON PETERS Southwest
P. O. Box 912
Arlington, Texas 76010
Phone 817/467-0051

ERIC KING Southeast
Fox Hill Road
Lynchburg, Va. 24503
Phone 804/384-7001

BARRY HOLLAND West Coast
7960 West Beverly Blvd.
Los Angeles, California 90048
Phone 714/497-4516

ROBERT McALL or BARRY ENDERS Northeast
34 Autumn Lane, Hicksville, N. Y. 11801
Phone 516/735-0055

HI TECHNOLOGY PRODUCT INNOVATORS



VITAL INDUSTRIES, INC.

MAIN OFFICE: 3700 N.E. 53rd Ave., Gainesville, Fla. 32601 U.S.A.
Tel.: Area 904-378-1581 • TWX 810-825-2370

Circle (3) on Reply Card