

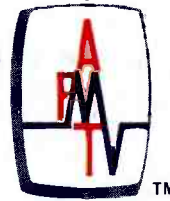

A HOWARD W. SAMS PUBLICATION



JUNE 1967/75 cents

# Broadcast Engineering

*the technical journal  
of the broadcast-  
communications industry*



# how to generate color test signals without tying up studio encoders.



Now you can save your studio encoders for the important job—program use. Do your color testing with Riker's Model 5618 Encoded Color Bar Generator.

This precision color test signal generator lets you check studio facilities, mobile installations, transmitter locations—set up video tape recorders or color monitors—all without tying up a video source from the studio.

Front panel controls permit you to select full raster or split screen presentation with color bar amplitude at 75% or 100%. Dual outputs—either Comp or Non-Comp. All-transistor circuitry ensures high signal accuracy and stability.

If you're interested in building the video test and quality control capabilities of your station, write or call Riker—the *one company* in the TV broadcast industry offering a complete line of all solid-state instrumentation for video analysis, simulation and control.

## **RIKER**

PRODUCTS FOR VIDEO ANALYSIS, SIMULATION & CONTROL

RIKER VIDEO INDUSTRIES 100 PARKWAY DRIVE SOUTH HAUPPAUGE, L.I., NEW YORK 11787 (516) 543-5200

# Introducing the most versatile vidicon camera ever built – Cohu's new 3200 series!

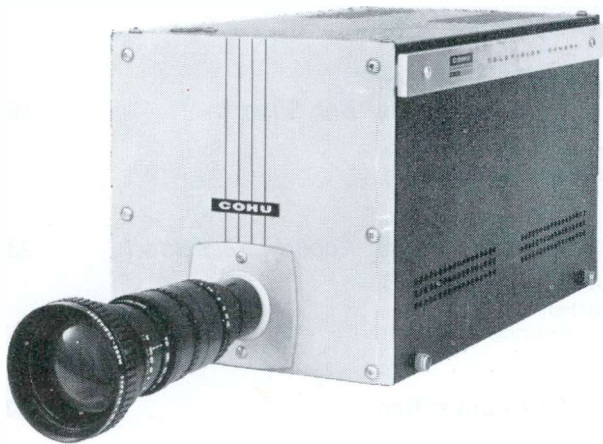

**IT'S A CCTV CAMERA** – completely self-contained. Just add a single coaxial cable to any video monitor and it's ready to operate. Want high resolution? Plug in one of four optional integrated-circuit sync generator boards for 525-, 729-, 873-, or 945-line scan patterns.



**IT'S A BROADCAST CAMERA, TOO!** Add a "mounts-in-minutes" 5-inch viewfinder and the Cohu 3200 is ideal for studio, education, or remote applications. An optional film chain adapter further enhances its versatility and provides all necessary remote controls.

For prices, delivery and full details, contact Cohu engineering representatives in major cities throughout the United States and Canada.

**COHU**  
ELECTRONICS, INC.  
SAN DIEGO DIVISION

Box 623  
San Diego, California 92112  
Phone: 714-277-6700

Circle Item 2 on Tech Data Card

**publisher**  
Howard W. Sams

**general manager**  
Donald W. Bradley

**editor**  
William E. Burke

**managing editor**  
James M. Moore

**associate editor**  
Harold E. Hale

**regional editors**  
George M. Frese, Northwest  
Howard T. Head, Wash., D.C.  
Robert A. Jones, Midwest  
Allen B. Smith, North Central  
Martin J. Taylor, Southwest  
and Latin America

**research librarian**  
Bonny Howland

**production**  
E. M. Rainey, *Manager*  
Paul A. Cornelius, Jr., *Photography*

**circulation**  
Pat Osborne, *Manager*

**advertising sales offices**  
Hugh Wallace, *Sales Manager*

**central and midwestern**  
Roy Henry  
Howard W. Sams & Co., Inc.  
4300 West 62nd St.  
Indianapolis, Ind. 46206  
291-3100

**eastern**  
Alfred A. Menegus  
Howard W. Sams & Co., Inc.  
3 West 57th St.  
New York 19, New York  
MU 8-6350

**southwestern**  
Martin Taylor  
P.O. Box 22025  
Houston, Tex. 77027  
713-621-0000

**western**  
LOS ANGELES OFFICE  
G. R. (Jerry) Holtz  
The Maurice A. Kimball Co., Inc.  
2008 West Carson St., Suites 203-204  
Torrance, California, 90501  
320-2204

**SAN FRANCISCO OFFICE**  
The Maurice A. Kimball Co., Inc.  
580 Market St., Room 400  
San Francisco 4, California  
EX 2-3365

**foreign**  
LONDON W.C. 2, ENGLAND  
John Ashcraft, Leicester Square  
Whitehall 0525  
AMSTERDAM  
John Ashcraft, Herengracht 365  
Telefoon 24 09 08  
PARIS 5, FRANCE  
John Ashcraft, 9 Rue Lagrange  
ODeon 20-87  
TOKYO, JAPAN  
International Media Representatives,  
Ltd., 1, Kotohiracho, Shiba,  
Minato-Ku, Tokyo  
(502) 0656

Copyright © 1967  
by Howard W. Sams & Co., Inc.  
BROADCAST ENGINEERING is published  
monthly by Howard W. Sams & Co., Inc., 4300  
West 62nd Street, Indianapolis, Indiana 46206.  
SUBSCRIPTION PRICES: U.S.A. \$6.00, one  
year; \$10.00, two years; \$13.00, three years.  
Outside the U.S.A., add \$1.00 per year for  
postage. Single copies are 75 cents, back  
issues are \$1.00.

the technical journal of the broadcast-communications industry



# Broadcast Engineering

Volume 9, No. 6

June, 1967

## CONTENTS

### Features

**The Utah ETV Network** *Dail Ogden and  
K. Dean Stephens* 12

A desire to present complete coverage in this mountainous state led to an unusual UHF-translator system.

**Sweep Frequency Measurements of Coaxial Cable** *Ken Simons* 18

The relative merits of three cable-measuring techniques are presented.

**A Frequency-Measurement System** *Robert L. Zuelsdorf* 23

This is the conclusion of an article concerned with the design and construction of TV-frequency-measuring equipment.

**1967 NCTA Convention** 27

A preview of the 16th annual convention is given here.

**International Broadcasting Centre-Expo 67** *M. Morais* 34

The radio and television production facilities of the exposition are described and illustrated.

### Departments

**Engineers' Exchange** 6 **New Products** 63

**Washington Bulletin** 49 **Engineers' Tech Data** 68

**Book Review** 52 **Advertisers' Index** 70

**News of the Industry** 55 **Classified Ads** 71

Refinements to make color equipment do an even better job were the subject of many exhibits at the 1967 NAB show. Our cover shows an example of the challenge the manufacturers tackled.  
(Photo courtesy of Philips Broadcast Equipment Corp.)



# How do you measure loudness?

First, you listen a lot...

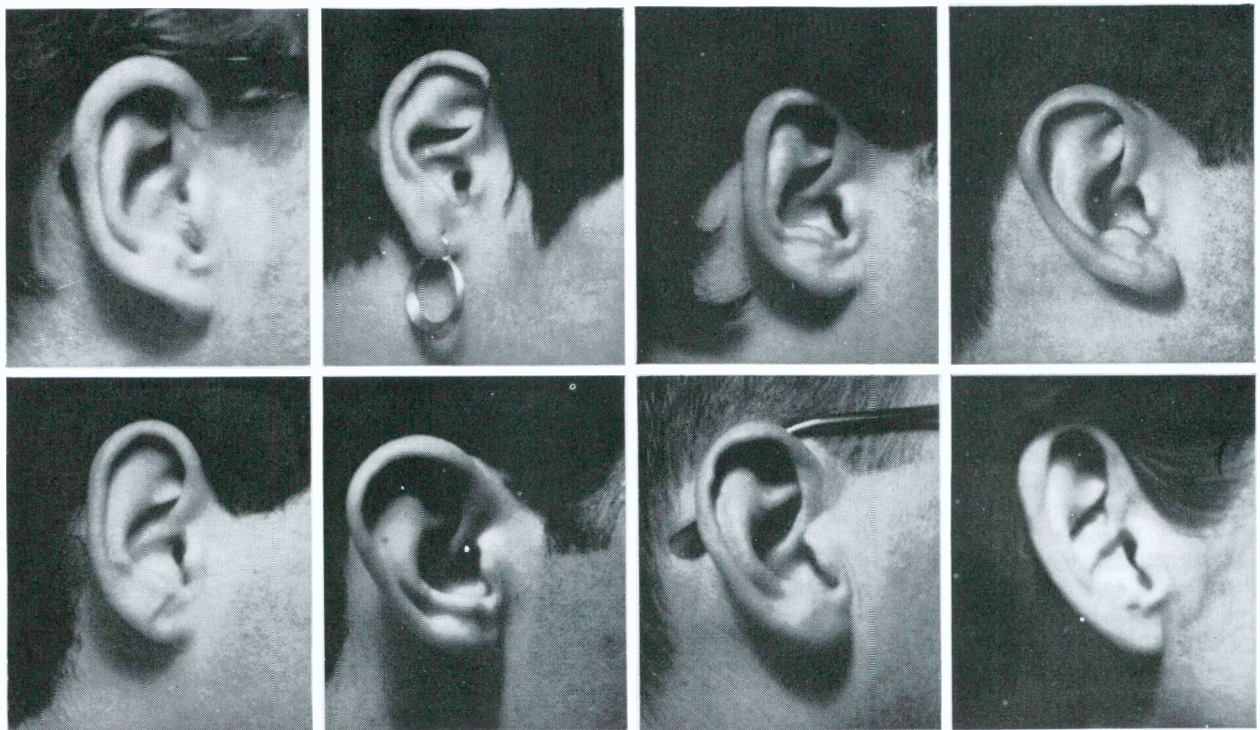

**And that's exactly what we did!** For the past several years, scientists at CBS Laboratories have been using the rigorous techniques of psychoacoustic testing to determine the nature of sensory loudness as it applies to broadcasting. From this research have come significant new data and methods for measuring sen-

sory loudness with respect to frequency content, combinations of complex signals, the "ballistic" response (including impulse and duty-cycle considerations), the signal peak factor, and other related phenomena.

A sensory loudness indicator and a new automatic control for limiting excessive loudness

are now undergoing field tests.

Write to us for further information on CBS Laboratories' loudness indicator and automatic loudness control.

PROFESSIONAL PRODUCTS

**CBS LABORATORIES**  
Stamford, Connecticut. A Division of  
Columbia Broadcasting System, Inc.

## Why are 6 FAIRCHILD CONAX'S on top of the EMPIRE STATE BUILDING?



Several New York FM and TV stations, including WNEW-TV, WPIX-FM, WPIX-TV, WOR-FM, WOR-TV, and WQXR-FM, value their transmission location on top of the Empire State Building and they also value their audience. The FAIRCHILD CONAX allows these stations to maintain high average listening levels without danger of over-modulation caused by high frequency spikes and thereby increasing fringe area coverage. The super-fast attack and release times of the FAIRCHILD CONAX makes this instantaneous control inaudible to the listener's ear.  The FAIRCHILD CONAX does not "muddy-up" the top in an effort to control it. Easily integrated into existing systems, the FAIRCHILD CONAX does not obsolete conventional compressors or limiters — it actually improves their performance.  Only the FAIRCHILD CONAX is the world accepted solution for high frequency pre-emphasis problems. Join the "1000 Club"... the satisfied users of the FAIRCHILD CONAX in recording and broadcasting throughout the world.  Write to FAIRCHILD — the pacemaker in professional audio products — for complete details.

## FAIRCHILD

RECORDING EQUIPMENT CORPORATION  
10-40 45th. Ave., Long Island City 1, N. Y.

Circle Item 4 on Tech Data Card

## Engineers Exchange

### Replacement Rectifier Tube

by Walter L. Moring  
WCSC-TV  
Charleston, S. C.

For quite a few years, there has been an excellent replacement for the 866 and 866A mercury-vapor rectifier tubes. This is the 3B28, a xenon-gas tube. The two faults which I have encountered in the 866 are arc-back and hash. With the 3B28, I have not encountered either of these problems. Arc-back in the warm-up period on a cold morning can certainly be irritating because the transmitter must then repeat the warmup cycle.

A few points in favor of the 3B28 include the following. The 3B28 is rugged. There is a smaller voltage drop across the tube. The ambient-temperature range of the 3B28 is from  $-75^{\circ}$  to  $90^{\circ}$  C, while that for the 866 is considerably more restricted. In my experience the 3B28 has given considerably longer useful life.

### Unusual Meter Readings

by Ed Tomlin,  
KWIN, Ashland, Oreg.

Recently, readings on my B&W Model 410 distortion meter began wandering off a couple of dB. Investigation showed a bad solder joint on one of the mounting lugs of C25. The can was free to move a little on its mounting plate and to introduce enough change in the operating voltages to cause the indicated variations. This is something to watch for when unusual readings appear. ▲

### MOVING?

*Don't Lose Touch . . .*

Receive BE as usual at your new address

Write: **BROADCAST ENGINEERING**

Circulation Department  
4300 West 62nd Street  
Indianapolis, Indiana 46206

# REMOTE CONTROL REELS FOR MICROPHONE CABLE

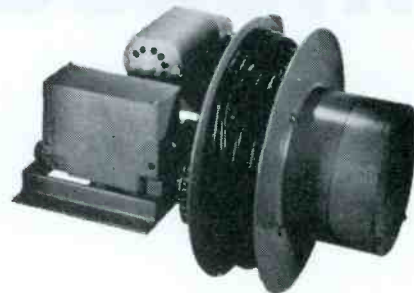

Industrial Electric's remote control reels are specially designed for retraction of microphones attached to various lengths of multi-conductor cable. 115 volt reversible chain driven motor. Gear limit switch for raising and lowering mikes. Remote operation by drum controller, push button station or relays. Available with 2 to 8 conductor slip rings.

## TAKE CARE OF YOUR CORD WITH A PORT-O-REEL!



Save time. Save wear and tear on microphone cable. Use a Port-O-Reel. Level wind. Holds 150' of cable. Cable will last longer. Can be equipped with power cord for lighting.

Write for catalog No. 61-A

The most complete line of reeling devices and collector rings in the world.



**INDUSTRIAL  
ELECTRIC  
REELS  
INCORPORATED**  
1503 CHICAGO ST.  
OMAHA, NEBRASKA 68102

Circle Item 5 on Tech Data Card

BROADCAST ENGINEERING

# THE "KEY" TO FINER DETAIL

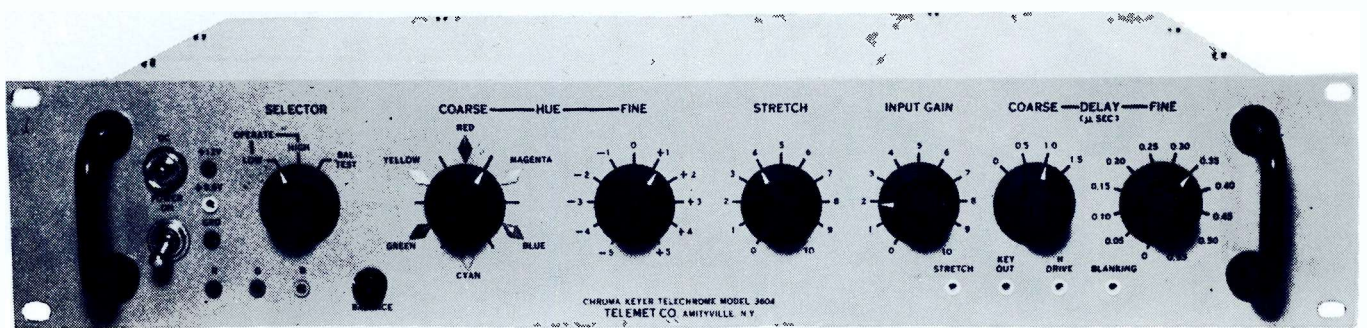

TELEMET'S NEW SOLID STATE CHROMA KEYS, MODEL 3604-A1

Telemet, pioneer of the chroma keyer, now brings you a fully transistorized unit that's easier to use and that keys on much finer detail. Remote Control (Model 3650-A1) is optional and includes: coarse line, fine line, stretch and input gain. Monochrome keying becomes more positive when using a color camera and one of the channels of the Telemet Chroma Keyer. The Keyer comes equipped with three pre-amplifiers which bridge the inputs to the encoder.

WRITE FOR COMPLETE SPECIFICATIONS



## TELEMET COMPANY

185 DIXON AVENUE / AMITYVILLE, NEW YORK 11701 / PHONE: (516) 541-3600

Circle Item 6 on Tech Data Card

# The \$73,000 Bargain

... or why the Norelco PC-70 3 Plumbicon\* tube color camera is a better buy than any 4-tube color camera.

To begin with, it's a bargain in the keep-the-sponsors-happy department. With the PC-70, performers do not turn green or magenta, even when moving against a dark background. Nor do white doves, white knights or high-flying washing machines. *The PC-70 has virtually eliminated the dangers of lag.* But 4-tube cameras invite lag. For one thing, they must use a 4-way light split which "robs" light from RGB channels to "feed" the luminance (4th) channel. For another, their optical systems are too complex (more complex optics mean still more light loss).

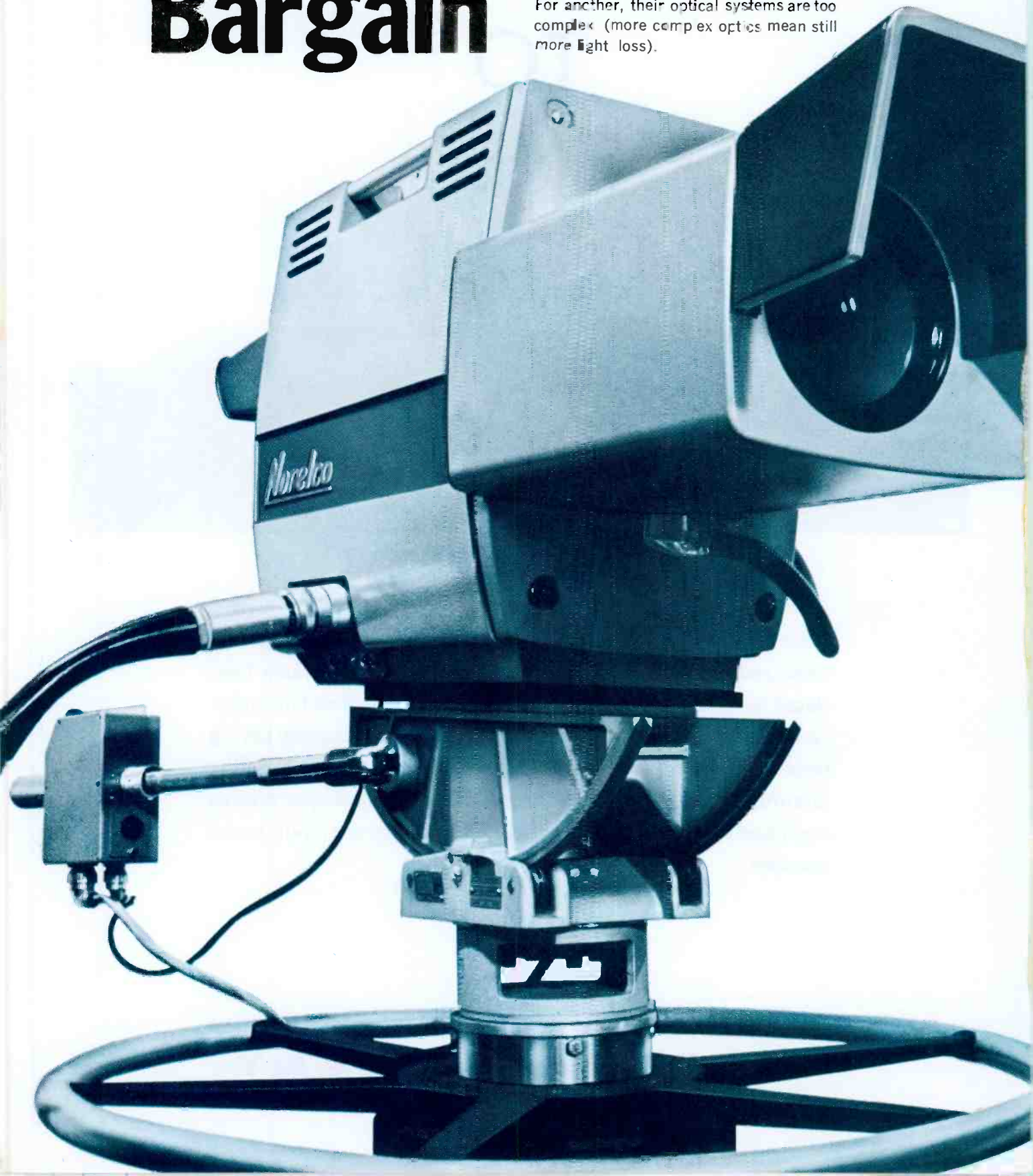



The picture speaks for itself.

The use of three tubes instead of four motivated the only original color camera design in the industry: the first practical application of the "contours-out-of-green" principle to provide sharper edges in the vertical as well as horizontal direction.

Instead of a space-consuming fourth tube and its complex associated circuitry, the PC-70 improves sharpness *electronically*—to almost any degree you desire. Because of the low frequency characteristic of the vertical aperture correction, you produce a sharper image on the *home receiver* (not just on the studio monitor), in color and monochrome. You profit from greater long-term economy . . . far less optical, circuit and operational complexity.

There are more reasons why it's the "\$73,000 bargain."

Your video-men and cameramen will find the PC-70 to be as simple to operate as an 8mm movie camera. (Well, almost.) This is a result of the 3-tube concept. Another reason: the PC-70's unique 3-way beam split prism.

Because of it, there are no shading controls to fuss with. (Some 4-tube cameras require as many as 16!) There are no set-up controls required at the camera head. All are at the Camera Control Unit where they can be adjusted in the quiet control room—instead of the hectic and noisy studio!

For your maintenance-men, the PC-70 means adjusting and maintaining one less of everything that may need their attention: optical channels, deflection yokes, focus coils, deflection and processing amplifiers. The PC-70 saves time. And time still means money.

For color or monochrome, in bright lights or shadows, in the studio or on remote, the PC-70 picture stays sharp, natural, rich in detail and easily matched from one camera to another.

The Norelco PC-70.

A bargain any way you look at it.

Write today for a detailed brochure. Contact us—or our representative, Visual Electronics. To help you verify everything we've said, we'll include our references: a list of stations that now use Norelco Color Cameras. Two of the three major networks do.



Don Ferguson, Chief Engineer,  
KXTV, Sacramento, California

*"A viewer commented recently that KXTV has the 'cleanest' picture in town. This layman summed up in a word the superior sharpness of our picture, the realistic color saturation and better signal-to-noise ratio we get with the Norelco 3 Plumbicon tube color camera. In the final analysis, it's the viewer we have to please. The Norelco camera does that, so we're pleased too: we're buying more PC-70s."*

*Norelco*

**STUDIO EQUIPMENT  
DIVISION**

**NORTH AMERICAN PHILIPS COMPANY, INC.**  
900 South Columbus Avenue, Mount Vernon, New York 10550

**RACK-MOUNTED  
ASSEMBLY**

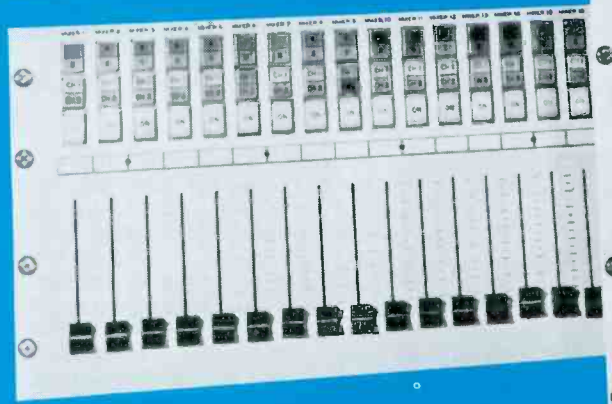
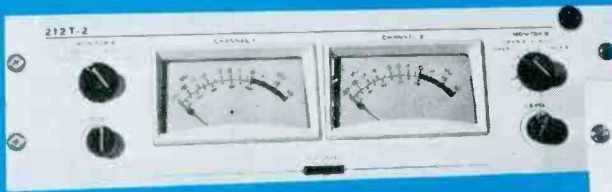
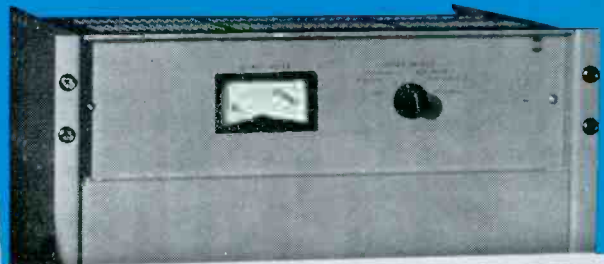

212T-2



212T-1



**Photocell Operation.** The photocell lamp completely isolates control voltage from the audio circuits for audio switching and level control. Small physical size enables the photocell to be located in active audio circuitry, thus keeping audio leads to a minimum. Switching time constant eliminates transients such as pops and clicks.



**Solid-State Amplifiers.** Solid-state amplifiers using silicon transistors are built on high quality, etched epoxy boards. Photocell operation provides switching and level control functions on the amplifier cards, not on the control panel. A selection of amplifier cards is available to meet all common input levels and impedances.

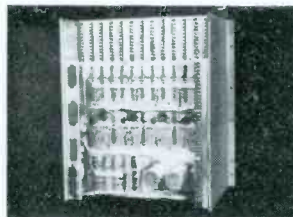

**Remote Capability.** Remote photocell location allows all audio and power supply components to be contained in a rack-mounted assembly. Because a photocell can be remotely controlled, it is suitable for distant audio switching and level control functions. Remoting active audio and power supply components in an area adjacent to the control room frees audio leads from video and sync signals present in the TV control room.



**Illuminated Pushbutton Switching.** Status is indicated either by two levels of illumination or by color changes in push buttons. Variable overall illumination is controllable to suit control room lighting conditions. Each panel has engraved push buttons with A or B input selection and Channel 1 or Channel 2 selection. Push-on, push-off buttons turn each fader on or off as required.



**New Fader Design.** New fader design eliminates problems associated with slide contact arrangements. The design provides smooth drive, free of backlash. Repair, if ever required, is very simple.



**Easy Access.** Access for maintenance is no problem. There are no hidden components. Straight forward wiring and remote control capability allow routine maintenance to be performed in an equipment room, rather than a control room area.

# You don't have to order (and pay extra for) a Custom Control Console.

## Check the features in Collins' new Audio Control System and see why.

Collins' new series of audio control systems is designed especially for television, large AM facilities and recording studios. The two systems making up the 212T Series are designated the 212T-1 and 212T-2 Audio Control Consoles. Both consist of three basic units: a control panel, a rack-mounted assembly containing the amplifiers and I/O terminals, and rack-mounted power supplies. The latter two units are common to both the 212T-1 and 212T-2.

Both systems have many features in common. The primary difference between the two systems is control panel configuration. Two different panel designs provide for a variation in the number of controls available and for flexibility in panel mounting.

*The 212T-1* provides 28 inputs to 14 faders, two program output channels, two auxiliary program outputs, two 10-watt monitor outputs, and a built-in cueing speaker. The overall panel dimensions of the 212T-1 are 15¾" high x 24" wide.

*The 212T-2* provides 32 inputs to 16 faders. The control panel is divided into two separate functional sections. A 5¼"

high x 19" wide section contains the VU meters and monitoring controls. The other section containing faders and cue switches is 10½" high x 19" wide. Both sections may be rack-mounted. The two panels are interconnected by plug-in cable assembly. When desired, the VU meter panel may be mounted at a different angle or location than that of the fader panel.

*Rack-mounted Assembly* is common to both the 212T-1 and 212T-2. The assembly can be located in an equipment room and linked by cable to the audio control panel in the studio. Sensitive audio wiring is concentrated in a card cage away from interference. All rack-mounted assembly wiring is readily accessible. Audio input and outputs are connected to terminal strips. Rugged connectors are used to couple cables to the front panel. Cable lengths can be supplied as required for any installation.

For a new descriptive brochure on the 212T Series, contact Broadcast Marketing, Collins Radio Company, Dallas, Texas 75207. Phone: (214) AD 5-9511.

COMMUNICATION/COMPUTATION/CONTROL



COLLINS RADIO COMPANY / DALLAS, TEXAS • CEDAR RAPIDS, IOWA • NEWPORT BEACH, CALIFORNIA • TORONTO, ONTARIO  
Bangkok • Beirut • Frankfurt • Hong Kong • Kuala Lumpur • Los Angeles • London • Melbourne • Mexico City • New York • Paris • Rome • Washington • Wellington

# THE UTAH ETV NETWORK

by Dail Ogden\* and K. Dean Stephens\*\*

Extremely rugged terrain dictated an elaborate UHF-translator system in order to reach all of this state's people.

On October 8, 1965, final power connections were made to a television translator site near Bryce Canyon, Utah. The culmination of over three years of planning, promotion, and rigorous engineering, the Bryce Point translator site marked the eighteenth and final University of Utah relay station so activated. It receives a seventh-generation picture from its mother station, KUED (channel 7, Salt Lake City), the signal path stretching 320 miles over seven mountain ranges.

The Bryce Point situation depicts problems typical of many small Utah communities lying outside the Salt Lake-Wasatch front area, where 80 per cent of the state's population and virtually all of its television stations are found. The remaining 20 per cent of the inhabitants reside on farms and in small hamlets scattered over the 75 per cent of the state's geography which falls outside of direct television pickup range.

A direct path between Bryce Valley and KUED is interrupted by five mountain ranges, one of them nearly 12,000 feet high. Such physically isolated villages find the procurement of adequate television signals difficult at best, and often financially out of the question. However, it is this same isolation which makes the availability of instructional as well as entertainment television so very desirable. In fact, such areas often cannot support a motion picture theater, and find it equally difficult to justify, for example, an elementary-level French teacher.

It was with the idea of making the KUED signal available to all of the state's school children and to 99 per cent of the population that the translator project was conceived in 1963. It was recognized from the start that the basic need was for a "backbone" system of primary relay sites to spread the signal over the state, for community use either by direct pickup or by means of local "secondary" translators.

Initially considered for this purpose were microwave links, community antennas in certain areas, and translators. Only the latter seemed practical and economically sound. Finally, the backbone network of eighteen relay sites was designed to provide maximum distribution of the signal to the rural population areas.

Activation of the final links in the network signified the completion of the first phase of Utah's "Statewide ETV Coverage" project. The system is already serving 95 per cent of Utah's schools and most of its population *not* located within direct Grade B television contours. Before the project is completed, local communities may install up to fifty secondary sites to operate in conjunction with those in the network. Approximately twelve of these are already in operation or are being constructed.

## Site Engineering

In 1964, KUED received a \$239,-322 federal ETV Facilities grant to construct the translator network. The grant application incorporated

data from the findings of a private firm which had been commissioned to undertake the preliminary engineering on the project. By the time of completion, changes affecting twelve of the eighteen sites were made. Six of these "paper installations" were completely relocated. In half of the cases, this was because the residents in the areas involved desired to operate their own VHF ETV translators and the University wished to operate the system totally in the UHF translator band. All other changes were made in view of cost and efficiency factors such as accessibility, weather conditions, etc.

The UHF band was selected as a carrier medium for several reasons. First, commercial translators in operation or reserved for the VHF band in some areas would force the system into the UHF range. Furthermore, even where another VHF signal could be "squeezed in," mutual interference with existing signals would be an ever-present threat.

Perhaps more important was the consideration of the future accommodation of a color signal. On paper and in practice, UHF appeared to be the superior medium with respect to passband stability (notably regarding visual/aural balance) and color-phase accuracy, signal reliability, and interference from other signals and noise.

\*Asst. Director, Radio-TV Services,  
University of Utah,  
Salt Lake City, Utah

\*\*Director of Television Research,  
University of Utah,  
Salt Lake City, Utah

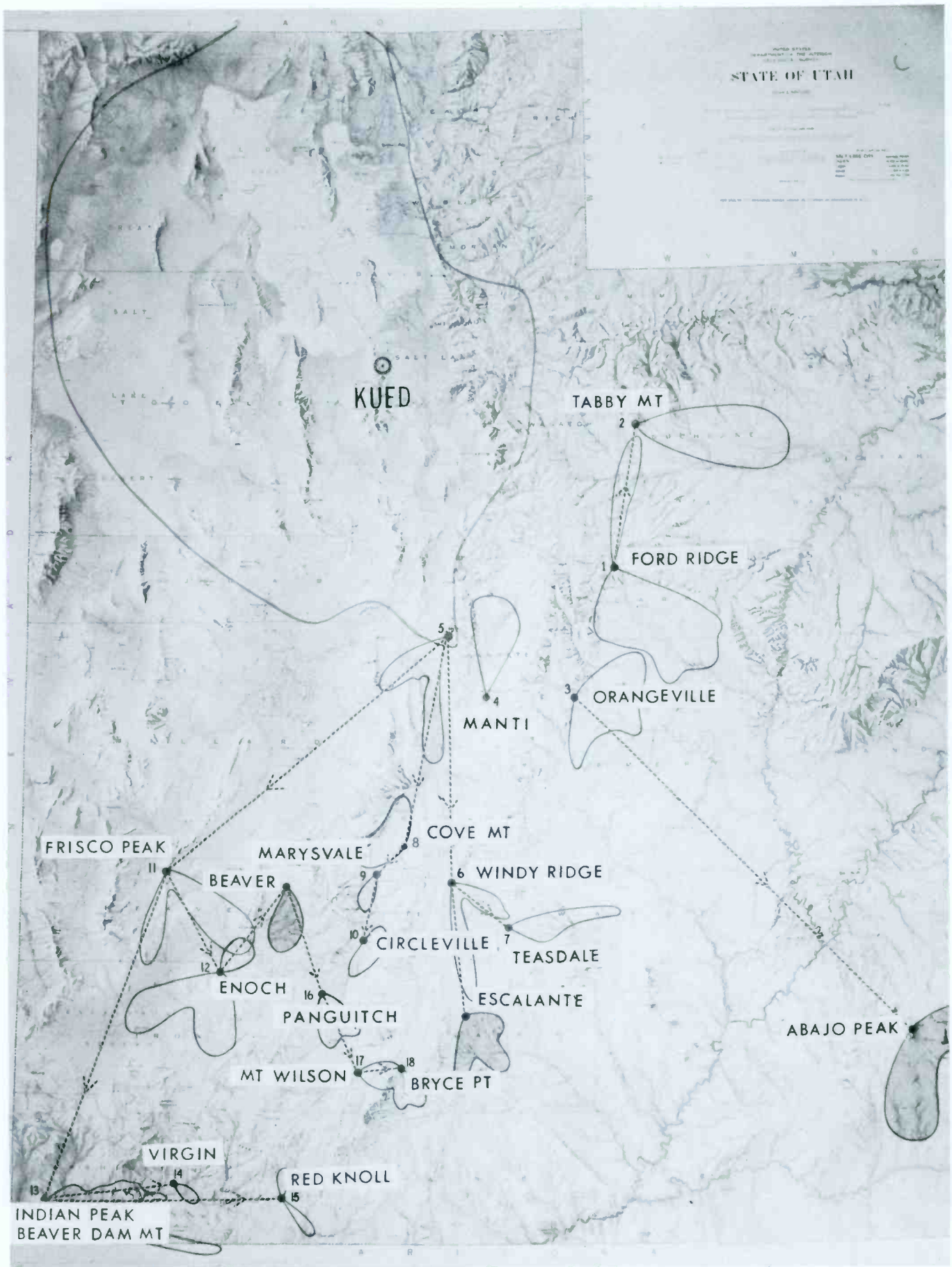

Fig. 1. Topographic map of Utah shows location and radiation pattern of each translator in the state ETV system.

Table 1. KUED Relay System

Site	Call	Principal Community	Population Prin Est Comm Total	Cost Initial Major	Co-ordinates (N lat W Long)	Descr of Site Location	Elevation: Site	XMTR Pout	Freq. Mhz	ERP Max	Type	Gain	Orlent	Pr.	ERP	Receiving Antenna(s) (Signal)	Channel Received (Location)
Tabby Mountain	K72CF	Myton	500 2500	\$11,270	1300	40° 21' 45" N 110° 47' 31" W	5 mi. W of Tablona	100W	818-824	8970W	Paraboloidal stack	105	104°	100W	8970W	8000 uv 10' dish	83 Ford Ridge
Orangeville	K80BQ	Orangeville Emery Co	600 4000	8460	1300	39° 13' 40" N 110° 08' 46" W	5 mi. W of Orangeville	100W	866-872	3600W	2 ea. Paraboloidal 6' dish	55 ea 91	58° 12° 18°	25Wea 50W	1220Wea 3600W	280 uv quod at 150'	7 Direct SLC
Cove Mountain	K72CC	Richfield Monroe	1450 3700 1000	12,475	1000	38° 38' 04" N 112° 03' 33" W	2 mi. E of Monroe	20W	818-824	172W	4 corner reflectors	10ea	226° 277° 345°	25Wea	172Wea	3000 uv 10' dish	82 Levan
Windy Ridge	K76BY	Waynes Co	75 75	12,610	1300	38° 28' 28" N 111° 48' 28" W	10 mi. NW of Lea	100W	842-848	9950W	2 paraboloids 6' 10'	85 240	138° 174°	50Wea	9530W 9950W	2800 uv 10' dish	82 Levan
Teesdale	K70DC	Torrey	130 420	11,920	1300	38° 18' 42" N 111° 00' 34" W	2 mi. W of Teesdale	100W	808-812	12800W	10' dish Paraboloidal	316 52	71° 90°	50W ea	12800W 2110W	14000 uv 10' dish	78 Windy Ridge
Marysville	K82BD	Marysville	520 760	8180	1000	38° 31' 03" N 112° 12' 18" W	4 1/2 mi. NNE of Marysville	20W	884-890	2040W	Paraboloidal stack	111	103°	20W	2040W	13000 uv 6' dish	72 Cove
Circleville	K70DD	Circleville Kingston Junction	600 1000 70 250	8585	1000	38° 12' 49" N 112° 14' 23" W	4 mi. NE of Circleville	20W	806-812	310W	3 ea paraboloidal	52ea	35° 103° 216°	6.7Wea	310Wea	15000 uv 6' dish	83 Marysville
Panguitich	K78RY	Panguitich Garfield Co	1425 1800 300	9850	1300	37° 53' 59" N 112° 28' 50" W	12 mi. N of Panguitich	100W	864-860	7140W	Paraboloidal stack	95	180°	100W	7140W	300 uv 10 element Yagi stack	7 Beaver
Bryce Point	K71BN	Tropic Cannonville Henryville	300 800	8050	1000	37° 42' 56" N 112° 04' 38" W	6 mi. N of Tropic	20W	812-818	513W	Paraboloidal	50	179°	20W	913W	2000 uv 6' dish	75 Mt. Wilson
Enoch	K76BU	Enoch Iron Co	250 3000	11,105	1300	38° 06' 16" N 112° 59' 47" W	8 mi. SW of Minersville	100W	842-848	4280W	6' dish Paraboloidal Stack	86 105	237° 187°	50W 50W	3510W 4280W	5000 uv 6' dish	71 Frisco Peak
Indian Peak	K75BP	Washington Wash Co	240 2000 1000	11,960	1300	37° 09' 15" N 113° 51' 32" W	17 mi. NNW of St George	100W	838-842	4200W	6' dish Paraboloidal Stack	81 102.5	86° 102°	50Wea	3240W 4200W	4000 uv 10' dish	71 Frisco Peak
Virgin	K83BC	Virgin	147 600	7225	1000	37° 13' 24" N 113° 12' 40" W	2 1/2 mi. NW of Virgin	20W	884-890	927W	Paraboloidal	53.8	123°	20W	927W	7000 uv 6' dish	75 Indian Peak
Ford Ridge	K83BB	Duchesne Columbia Carbon Co Emery Co	150 500 2500 230	17,880	1500	38° 45' 26" N 110° 55' 22" W	15 mi. NW of Price	100W	884-890	2400W	6' dish 6' dish Paraboloidal	120 120 55.6	14° 192° 120°	25W 25W 50W	1970W 1970W 2400W	2700 uv 10 element Yagi	7 Direct SLC
Manti	K70DO	Ms central San Pete Co Manti	4000 7000 1739	9810	1300	38° 14' 44" N 111° 35' 48" W	2 mi. SE of Manti	100W	806-812	6523W	Paraboloidal stack	79	4°	100W	6523W	1100 uv quod	7 Direct SLC
Mt. Wilson	K75BS	Bryce Flats	300 800	8350	1000	37° 0' 17' 50" N 112° 17' 50" W	9 mi. SE of Panguitich	20W	842	1515W	Paraboloidal stack	83	80°	20W	1515W	1200 uv 6' dish	78 Panguitich
Kanab (Red Knoll)	K80BY	Kanab Mt Carmel	1845 2500 125	8780	1000	37° 09' 15" N 112° 38' 20" W	9 mi. NNW of Kanab	20W	866-872	786W	Two 6' dishes	90.15ea	26° 140°	10Wea	786Wea	3700 uv 6' dish	75 Indian Peak
Frisco Peak	K71BH	Milford Buvaer Co	1500 2500	25,190	1300	38° 30' 32" N 113° 17' 21" W	18 mi. NW of Milford	100W	812-818	6780W	8' Dish 2 ea. Paraboloidal	187 50ea	187° 160° 138°	50W 25Wea	6780W 2030Wea	2000 uv 10' dish	82 Levan
Levan	K82BA	Juab Co San Pete Co	500 1000	32,560	1300	39° 39' 24" N 111° 49' 06" W	5 mi. SW of Levan	100W	878-884	4440W	Paraboloidal Stack 6' dish	111 95.5	187° 228°	50Wea	4440W 3820W	14000 uv 10 element Yagi stack	7 Direct SLC

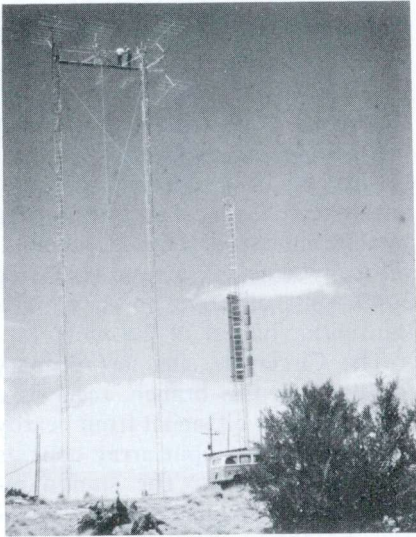

Fig. 2. View of the Orangeville site.

Another major consideration was the higher output power allowed to translators using the UHF band (100 watts total as opposed to 1 watt per lobe on VHF). Even allowing for greater path losses at the higher frequencies, overall system signal/noise figures appeared better on the whole.

Moreover, the antenna arrays at the higher frequencies present some advantages. Their small size facilitates the rugged construction that is necessary in Utah's mountain weather conditions. Also, the smaller arrays are easier to mount securely and to shelter if necessary. Antenna compactness in the UHF range was found to result in the greatest signal yield relative to cost per effective radiated watt or received microvolt, with 26-dB gains commonplace. In addition to directing high power over narrow paths, as from site to site, such antenna systems were used to great advantage in the control of signals beamed from a mountain top to two or three widely spaced communities, distributing maximum radiation to each.

### Relay Descriptions

The translator network distributes the KUED signal over the state through a system of branches; four of the eighteen primary sites receive direct radiation from the KUED transmitter location in the Oquirrh mountains west of Salt Lake City. (See Fig. 1 and Table 1.) The relay site at Ford Ridge, approximately 15 miles northwest of Price, is one of these four. Serving a four-county rural population of about 2500, it receives a 2700-microvolt

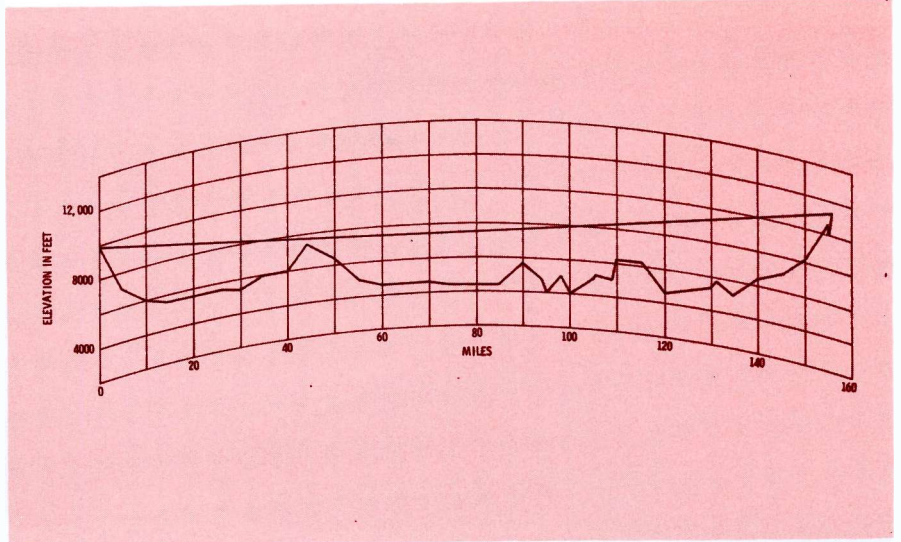

Fig. 3. Profile graph of terrain between the Orangeville site and Abajo Peak.

signal on channel 7 through a single, ten-element Yagi antenna. Its 2400-watt ERP radiation is within pickup range of several secondary translators to the south. In addition, one primary site at 14° True North is beamed a 1970-watt ERP lobe from a six-foot dish fed 25 watts. The remaining 75 watts of output power is divided among antennas generally oriented southward: a second six-foot dish fed 25 watts (1970 watts ERP), and a paraboloidal antenna fed 50 watts (2400 watts ERP).

As the site is inaccessible most of the winter, two complete translators are maintained, means being provided to engage the "standby" unit should the other fail.

The primary relay site dependent on the Ford Ridge installation is situated on Tabby Mountain, roughly 5 miles west of Tabiona. This site receives an 8000-microvolt channel-83 signal from a ten-foot dish. The signal is translated to channel 72 and directed east to population areas and to a chain of secondary translators with coverage capabilities extending into Colorado. Population within direct coverage is estimated at 2500 people who receive 8970 watts of effective power from a vertically stacked, two-paraboloid array fed 100 watts.

Roughly in the center of the state is found the Orangeville translator, another of the four KUED direct-pickup sites. Not line-of-sight, the unit receives 260 microvolts through a quad Yagi antenna array at a height of 150 feet; it beams an effective 3600-watt signal to the southeast from a six-foot dish (Fig. 2). (After construction of a new tower, a ten-foot dish will be substituted

for transmission.) This lobe, which covers Orangeville, is chiefly aimed at Abajo Peak, an almost 12,000-foot mountain over 130 miles away. This is the longest known UHF translator hop in the country. (A profile graph of the path is shown in Fig. 3.) Abajo contains a secondary translator site which serves the people of Montecello and other hamlets extending to the southeast corner of the state. The Orangeville unit also radiates two lobes of 1220 watts each, serving Emery County. In addition, the lobe at 58° relays a signal to Cedar Mountain, which in turn relays a signal to Green River. The site reaches 4000 people directly and many times that number through secondary relay links.

The third channel-7 direct-pickup site serves Manti and vicinity, and is located on a mountainside two miles southeast of that city. The 1100-microvolt VHF signal received through a quad Yagi array is fed into the 100-watt translator, which in turn radiates a 6525 watt (ERP) channel-70 signal northward from a two-paraboloid vertical stack. The population covered is approximately 7000.

North and west of Manti is found the final and most important of the KUED pickup links, at a location approximately five miles southwest of Levan. Here, a channel-7 signal of 14,000 microvolts is present; the pickup antenna consists of a stacked, ten-element array. Directly radiating to a population of only 1000, the two antenna lobes of this site relay the signal to over one-fourth of the geography of the state.

At 187° True and 228° True, these beams consist of 4440 watts



Fig. 4. Levan site shows winter maintenance facilitated with use of snowcats.

and 3820 watts of effective radiated power, respectively. The first feeds the channel-82 signal in the southward path through the central portion of the state, the latter southward and ultimately to the corner of Utah.

As was the case with several other sites, the Levan installation was placed atop a "virgin" peak—one on which property had to be leased; power line and access road right-of-way surveyed, cleared, and constructed; and an equipment shed built. (See Fig. 4.)

Relative inaccessibility, as in the case of Ford Ridge, plus the added factor of importance to so many other links in the network, made imperative the maintenance of two separate translators at Levan with appropriate fail-safe measures to activate the standby unit when output power drops below a predetermined level.

The south-going lobe from Levan feeds two other primary translator sites, one at Windy Ridge and the other at Cove Mountain. The former is located in the Fish Lake area, ten miles northwest of Loa. Serving directly a scant Wayne County population estimated at only 75, this site relays two lobes downstate, directing a 3530-watt ERP signal

from a six-foot-dish toward a primary site at Teasdale, and 9950 watts ERP from a ten-foot dish toward a secondary unit serving Escalante to the south. Utilizing a ten-foot dish, Windy Ridge receives 2800 microvolts of channel-82 radiation from Levan, reproducing on channel 76 a television signal of excellent quality.

At Teasdale, a ten-foot dish provides a 14,000-microvolt signal. Located about two miles west of town, the station serves the estimated area population of 420 from a paraboloidal antenna receiving 50 watts and radiating 2110 watts ERP. A ten-foot dish oriented toward a secondary site to the east is fed the remaining 50-watt output, beaming 12,800 watts toward Hanksville.

The Cove Mountain site, situated 20 miles northwest of Windy Ridge and likewise receiving Levan's south radiation lobe (3000 microvolts from a ten-foot dish), reradiates on channel 72, serving an estimated population of 3700 in the Richfield vicinity. Its polar pattern is produced by four corner reflectors fed 25 watts each, for an ERP of 172 watts in all directions.

The signal from Cove Mountain is picked up at a nearby primary site located approximately four miles

north-northeast of Marysville. The receiving antenna is a six-foot dish, and the signal delivered is 13,000 microvolts. This site serves about 750 people and relays the signal on channel 83 in a southerly direction toward Circleville. The transmitting antenna consists of a two-paraboloid, vertically stacked array, achieving 2040 watts effective power from a transmitter output of 20 watts.

The Circleville site, last primary translator in this branch, receives a 15,000-microvolt signal from nearby Marysville. The input array consists of a six-foot dish. The station retransmits on channel 70 to an estimated 1000 people in the Circleville area from a point four miles north-east of town. The 20-watt transmitter output is split three ways to separate paraboloidal antennas oriented to provide maximum distribution to the population and to two secondary translator sites to the southeast.

The southwest radiation leg from the Levan site serves 9669-foot Frisco Peak 106 miles away. Most remote and rugged of the eighteen sites, Frisco Peak remains inaccessible to road vehicles seven months out of the year, largely due to the northeast exposure of its only access route, which becomes a target for severe snowdrift and icing conditions. Hence, two complete translators with automatic standby activation provisions were necessitated. Moreover, no power lines run within 20 miles of the site, and the most conservative cost estimate for such a run was \$20,000. These and other factors carefully weighed, it was decided to utilize two five-kilowatt diesel generators for power, one maintained at all times in standby operation with automatic takeover capabilities. A 3000-gallon fuel tank assures continuous operation of the site's power plant to sustain a full 100-watt transmitter output for an eight-month period. (See Fig. 5.)

Located 18 miles northwest of Milford in southwestern Utah, the Frisco Peak translator radiates a channel-71 signal in each of two directions, southeast and southwest. Antennas are a ten-foot dish for receiving (2000-microvolt output), and a double-paraboloid array and an eight-foot dish for transmission. Output from the paraboloidal array is directed to the Enoch site, while Indian Peak is accommodated from



the dish (2030 and 6780 watts, respectively). Population directly served is estimated at 2500.

Eight miles south of Minersville, the Enoch translator on Minersville Ridge receives 5000 microvolts from Frisco with a six-foot dish, transmitting on channel 76 from two antennas to a population of about 3000. Fed 50 watts each, a six-foot dish and a double-paraboloid array direct 3510 and 4280 watts ERP west and south, respectively. These lobes serve numerous secondary translators including the Beaver VHF unit which serves to relay the signal to Panguitch.

Frisco's other lobe, in addition to feeding primary site Indian Peak, is within range of at least one secondary translator. Travelling over one hundred miles to the extreme southwest corner of the state, the signal available at Indian Peak is 4000 microvolts. High signal-to-noise ratio is maintained through the employment of a ten-foot dish feeding a UHF preamplifier having a 20-dB gain.

The two easterly lobes from this site serve approximately 2000 people in the vicinity of Washington, Utah, as well as other translators extending into Arizona. Among these is a pending secondary installation near St. George, which will cover a population of approximately 7000. Fifty watts of power is channeled to each of two antenna systems, a six-foot dish yielding 3240 watts ERP, and a two-paraboloid array producing 4200 watts. Oriented 16° apart, the transmitting antennas radiate a pattern extending eastward to the Virgin and Red Knoll primary relay sites.

The Virgin translator directs its 20-watt output into a single paraboloid antenna generating a 927-watt ERP southeasterly radiation pattern. It serves approximately 600 people and one secondary site, translating the channel-75 Indian Peak signal to channel 83. The receiving antenna is a six-foot dish with an output of 7000 microvolts.

Red Knoll services several secondary translators and an estimated populace of 2500, receiving 3700 microvolts from Indian Peak through a six-foot dish. The channel-80, 20-watt output signal is divided between two six-foot dishes, at 26° True and 140° True. Two 786-watt ERP lobes feed the popu-

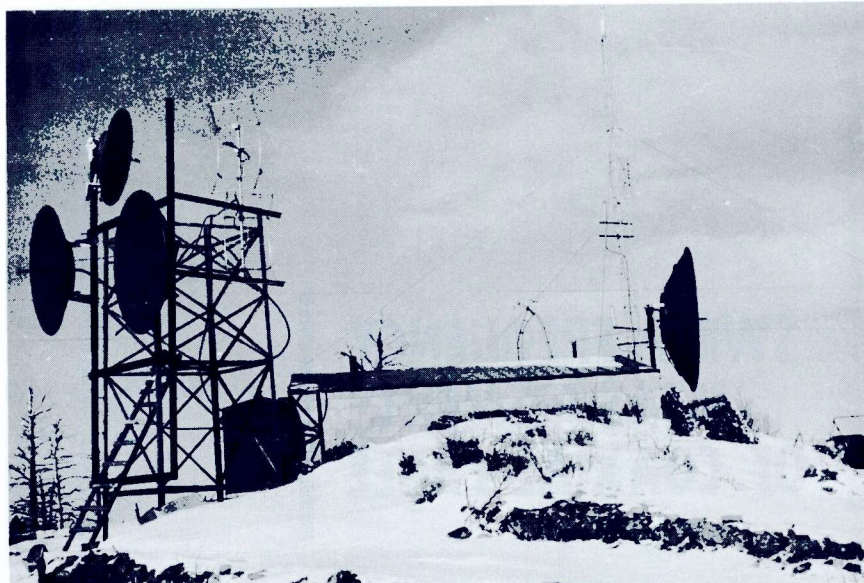

Fig. 5. Frisco Peak installation with equipment shed, antennas, and fuel tank.

lation areas of Kanab and Mt. Carmel.

A break in the otherwise total UHF relay system was necessitated because of Beaver's installation, mentioned in conjunction with the Enoch site. The Beaver townspeople preferred to finance their own translator to maintain compatibility with an existing all-VHF system. Consequently, the Panguitch primary site to the south picks up the Beaver signal on channel 7 with a ten-element Yagi stack delivering 300 microvolts, and reradiates on channel 78. One hundred watts into a vertically stacked, two-paraboloid array produces an ERP of 7140 watts in a southeast direction covering the Panguitch area population of about 1800 people, and providing a 1200-microvolt signal at Mount Wilson, about twenty miles downstate.

The latter installation employs a six-foot dish for receiving, and puts out a channel-75 signal of 1515 watts ERP from a double-paraboloid array fed 20 watts. It serves 800 residents of the Flats area directly west of Bryce Canyon National Park. The east-bound signal is picked up at Bryce Point atop Henderson rim overlooking Bryce Canyon.

This final primary site receives a remarkably high quality signal of 2000 microvolts with a six-foot dish. Transmission is accomplished through a single paraboloidal antenna, effectively transforming its 20-watt input into a 913-watt beam directed to 800 dwellers in Tropic, Cannonville, and Henryville in the

basin 2000 feet beneath.

### The Future

Thus have the benefits of ETV station KUED been extended to citizens throughout the state of Utah, all of whom share in its support as taxpayers. Through various committees and organizations, this same citizenry has a great voice in its programming and operation.

Instructional television's future in Utah looks bright. According to the Director of Educational Television for the State Department of Public Instruction, 40,000 schoolchildren made use of cooperatively available television material in the 1962-63 school year. This total has steadily risen at the rate of 20,000 per year to over 100,000 pupils in the 1965-66 period.

In many areas, however, the home viewer hasn't yet taken advantage of the newly available programming, often due to lack of UHF-receiving equipment. It is hoped that with the purchase of new sets which contain a UHF tuner, this problem will eventually solve itself, especially with TV receiver procurement only beginning in some areas. In locales like Bryce, reception was so poor that almost no television was available before installation of the primary translator sites.

In summary, with prospects of inter-station ETV links, color instructional television, and the possibility of an intermountain-states ETV network on the horizon, the rise of this new medium is painting a rosy picture of Utah's contribution to an ever-shrinking world. ▲

# SWEEP FREQUENCY MEASUREMENTS OF COAXIAL CABLE

by Ken Simons\* — Three methods used to conduct cable measurements are discussed and evaluated.

Sweep-frequency tests of coaxial cables are essential for a variety of applications, especially ETV and CATV distribution systems. There are three basic methods of making sweep-frequency tests: the measurement of transmission loss, measurement of input impedance, and measurement of reflection coefficient. Since there is a choice of testing methods, a comparison of these methods should be helpful to personnel who work with cable.

## History

The technical requirements for flexible coaxial cable were organized in Military Specification JAN-C-17, originally issued in 1944. This specification and its subsequent revisions spell out in detail the requirements for physical construction and a number of electrical parameters, including attenuation and dielectric strength of the cable. Regarding the characteristic impedance, JAN-C-17 specified the nominal impedance which was determined by a calculation involving the total measured capacitance of a reel of cable, and the delay factor measured on a short sample. For cables of relatively short length, this specification was adequate, but with the advent of CATV systems, where TV signals are transmitted through many miles of cable, the need for an additional specification was uncovered.

The problem came to light when a field engineer returned a reel of cable which, he claimed, would not pass TV channel 6. The measured attenuation of the cable, indicating an attenuation spike 50 dB deep at 87 MHz, is shown in Fig. 1. Investigation showed this effect was due to periodic discontinuities. Something in the manufacture of the cable produced variations in characteristic impedance recurring at precisely spaced intervals throughout the length of the cable. Because of this spacing, many reflections, precisely phased at a certain frequency, arrived back at the input end of

the cable, causing severe distortion of the transmission characteristic.

To prevent the recurrence of this problem, a program of factory tests was begun. The original test method involved measuring the transmission loss through each reel of cable over the frequency bands then in use. A reel of cable was rejected if the loss in these bands dipped more than 0.25 dB below the smoothed attenuation characteristic.

After this transmission-loss measurement method had been used for several years, it became evident that a more sensitive test was needed. It was found that a measurement of the input impedance at each end of a reel of cable gave a more sensitive indication of the existence of periodic reflections. Experience with the impedance-measurement method revealed two major defects: it was difficult to arrive at an accurate calibration, and the measured deviation was a critical function of cable length. Removing two or three feet from the end of the cable would change the entire pattern.

To overcome these defects, a test method was developed employing a bridge; this method allowed observation and measurement of the reflections from the cable end, eliminating uncertainty and allowing easier calibration. This reflection-measurement method has been

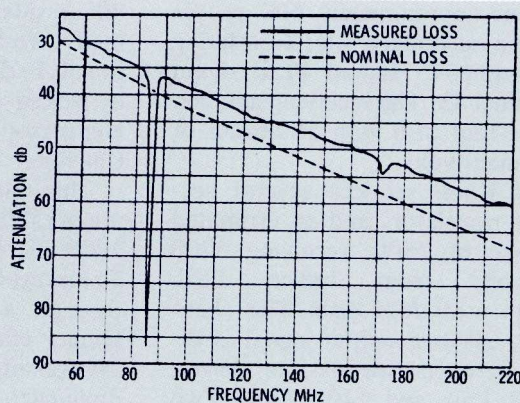

Fig. 1. Loss vs frequency for 2000 ft of defective cable.

\*Chief Engineer,  
Jerold Electronics Corp.  
Philadelphia Pa.

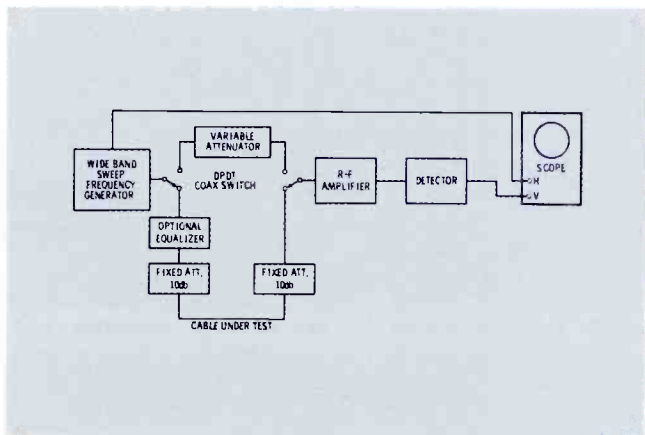

Fig. 2. Equipment connection for transmission-loss test, used by a number of cable manufacturers during the past several years and has provided a satisfactory way of controlling periodic defects.

The relative merits of the three methods of sweep-frequency cable testing can perhaps best be developed by describing each method in some detail and comparing results.

### Transmission-Loss Measurement

The equipment used in the sweep-frequency technique for measuring cable loss vs. frequency is diagrammed in Fig. 2. A wideband sweep-frequency transmission-measuring set is connected alternately to the cable under test and to a variable standard attenuator. This arrangement provides an attenuation reference line on the oscilloscope against which the loss of the cable can be compared. For accurate measurement, it is essential that the cable face a well-matched impedance at each end. Fixed 10-dB attenuators are used to establish this condition.

The loss characteristic of a particular reel of cable measured with this technique is illustrated by Fig. 3. The frequency range was chosen to include a major defect at 137 MHz. The rapid change in attenuation with frequency makes accurate measurement of the dip at 137 MHz difficult.

The measurement is simplified when an equalizer is inserted in series with the cable so that the average loss is flat and the irregularity is more clearly displayed and measured (Fig. 4). One of the defects of the transmission-loss measurement method appears on this plot. With the high end-to-end attenuation present on this reel, the single shield allowed sufficient coupling to produce ripples in the frequency characteristic.

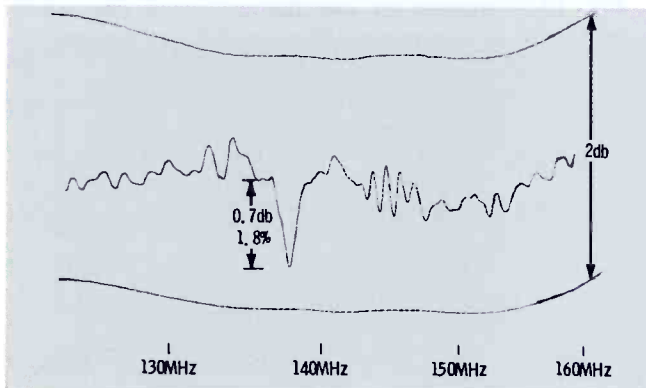

Fig. 4. Measurement for RG59/U with equalizer inserted.

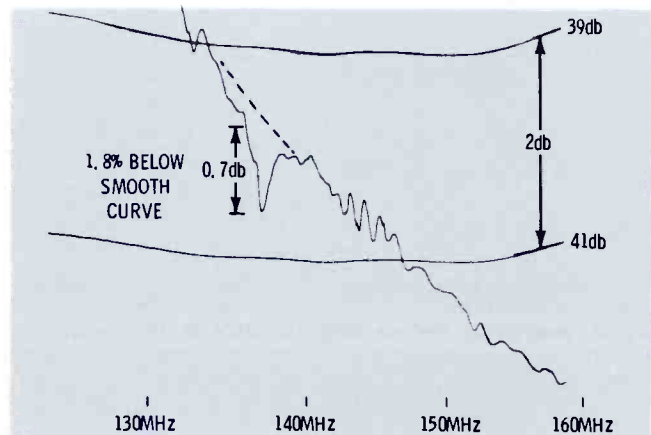

Fig. 3. Transmission-loss measurement for reel of RG59/U.

### Impedance Testing

A more sensitive test, free from this coupling problem, is obtained by using the technique illustrated in Fig. 5. The output of a wide-band generator is fed through a bridging detector to one end of the cable under test; the other end of the cable is accurately terminated. The detector measures variations in the input voltage as a function of frequency. With a well-matched source (assured by the 10-dB attenuator), the input voltage varies almost directly with the magnitude of the cable input impedance. An impedance plot made by this technique for the same reel of cable is illustrated in Fig. 6 (compare with Fig. 4).

Calibration was obtained by substituting a precise 75-ohm terminator for the cable end, and varying the attenuator above and below 10 dB by an amount corresponding to the indicated impedance levels.

### Structural Return-Loss Testing

The bridge used for reflection testing is diagrammed in Fig. 7. When the variable-standard arm of the bridge is adjusted to equal the average characteristic impedance of the cable, the bridge acts as a directional coupler with directivity in excess of 50 dB and a constant insertion loss of about 12.5 dB. The bridge is connected into a test system as shown in Fig. 8.

The variable attenuator generates a reference trace which is set to cross the cable trace at peaks of the reflection characteristic. Since the measurement is made in dB, the results are most conveniently expressed in these terms. The reflection coefficient expressed in dB is the "return loss," and the return-loss characteristic

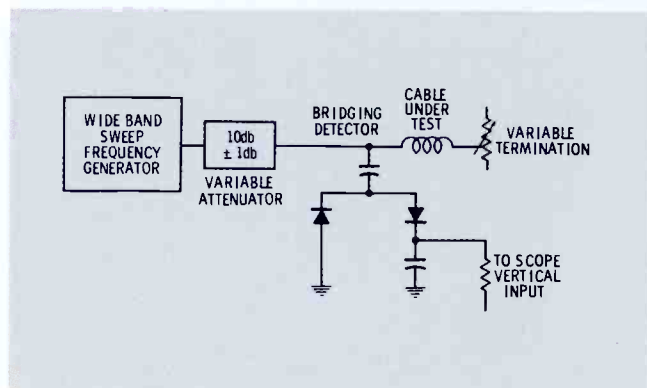

Fig. 5. Impedance test method employs bridging detector.

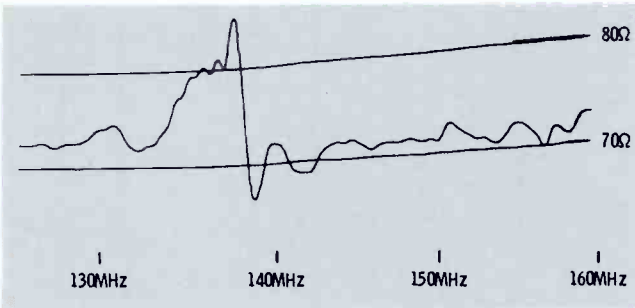

Fig. 6. Impedance test on RG59/U cable is more sensitive.

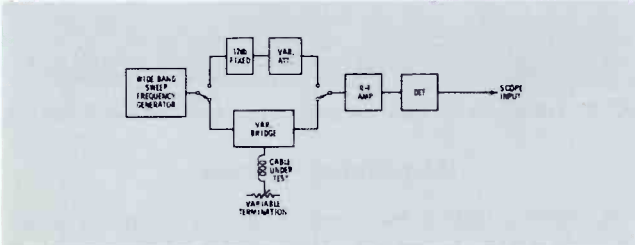

Fig. 8. Equipment setup for conducting reflection test.

of cable, due to periodic variations in its structure, has become known as the "structural return loss."

Fig. 9 illustrates a structural-return-loss plot with the characteristics of the same cable defect shown on the curves in Figs. 4 and 6.

The sensitivity of this method is demonstrated by Fig. 10. This figure is similar to Fig. 9 but shows a 15-dB increase in sensitivity. Return-loss variations as low as 50 dB (0.3% reflection) can be displayed clearly.

### Comparison of Methods

Although the defect plotted in Figs. 6 and 9 showed up clearly in all three tests, it should be noted that it was a particularly bad defect, *i.e.*, one that would cause picture distortion if it fell within a television channel. A defect which is about the worst that can be tolerated in a cable television system is illustrated in Figs. 11, 12, and 13.

Fig. 11, illustrating the transmission-loss measurement of such a defect, shows the difficulty encountered when this method is employed: even with all the scale expansion available, and with the transmission characteristic equalized, the 0.1-dB variation is difficult to

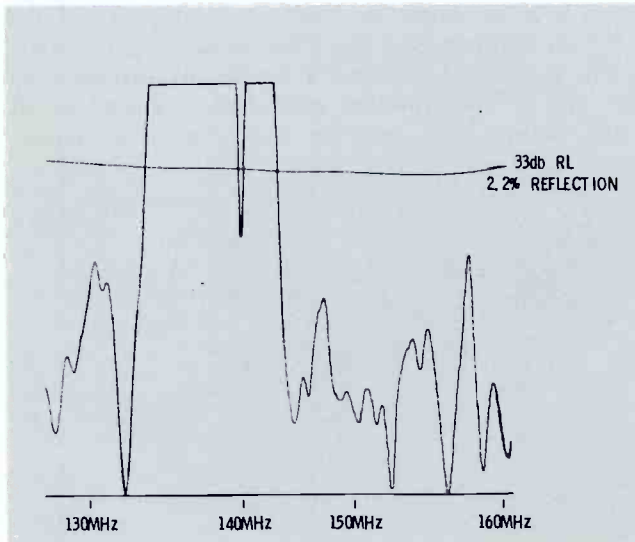

Fig. 10. Same test as Fig. 9 but with 15-dB gain increase.

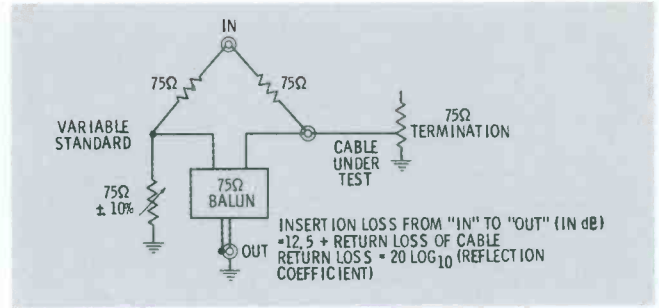

Fig. 7. Variable bridge for use in cable reflection test.

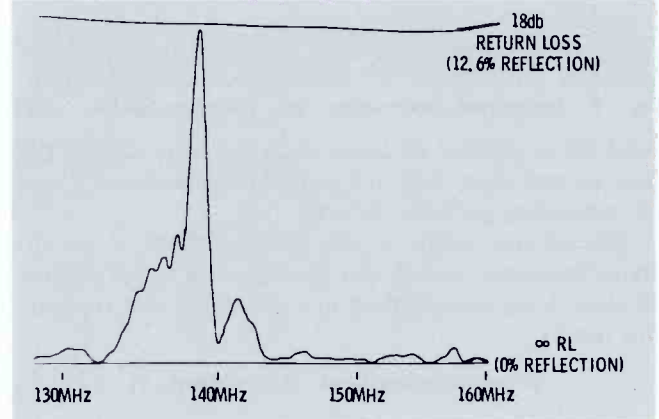

Fig. 9. RG59/U measurement obtained with reflection test.

discern and impossible to measure accurately.

Fig. 12 shows a great improvement in sensitivity obtained by impedance measurement, but also illustrates the weakness of this method in that four different measurements were obtained, depending critically on small variations in the point at which the cable was connected to the detector. The reading on this particular defect varied from 4.4% up to 12.3%, depending on the length of the connection.

The advantage of the return-loss-bridge method is shown in Fig. 13. This method gives a high degree of sensitivity, with essentially the same reading regardless of the point of connection (compare with Fig. 12).

This comparison is further illustrated by measurements made on a reel of good CATV trunk-line cable. Fig. 14 illustrates the return-loss characteristic taken over the entire TV spectrum, showing excellent structural-return-loss characteristics.

Figs. 15 and 16 display transmission-loss measurements near the worst defect. Note that the transmission-loss variation at this point can hardly be seen. None of the variations below this level could be seen or measured by this method.

Fig. 17 illustrates an impedance test of this worst

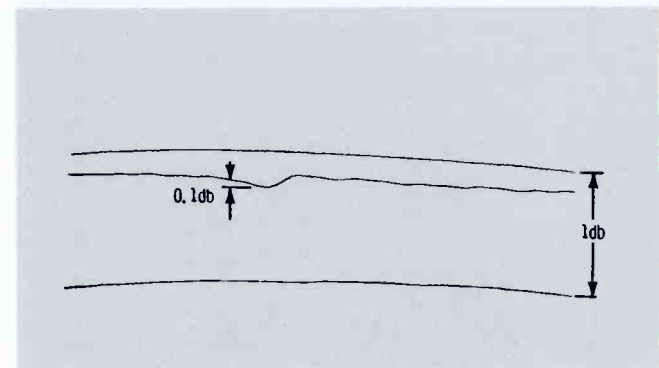

Fig. 11. Cable defect measurement by transmission method.

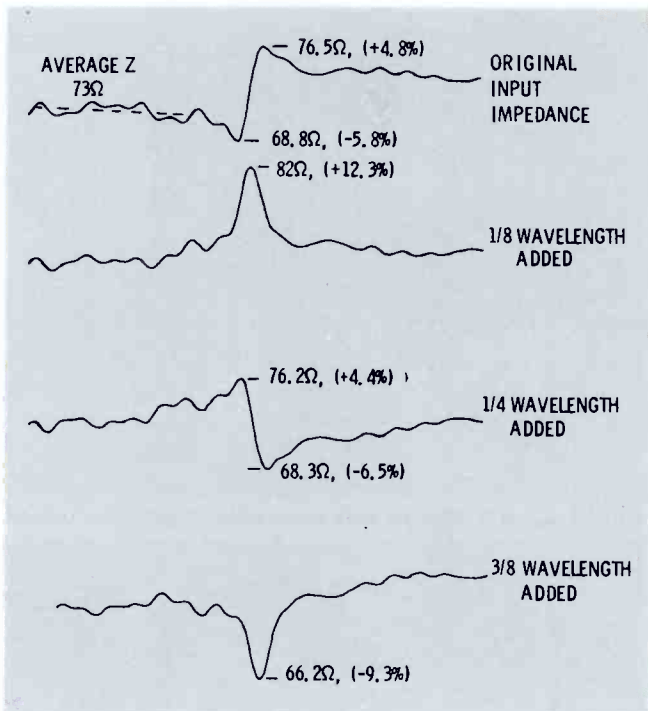

Fig. 12. Same defect as Fig. 11 using impedance method. defect, and Figs. 18 and 19 show return-loss tests in this same frequency range.

### Adjusting Bridge and Terminations

The bridge used for measuring structural-return loss of 75-ohm cable is provided with resistance and capacitance adjustments which allow matching the bridge to the average characteristic impedance of each particular reel of cable. This allows distinguishing defects in

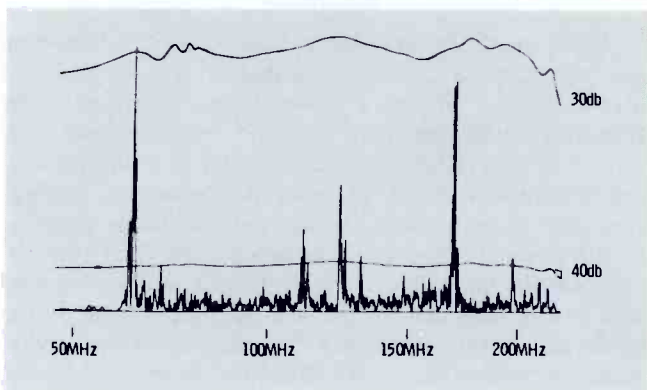

Fig. 14. Reflection test on reel of CATV trunk cable.

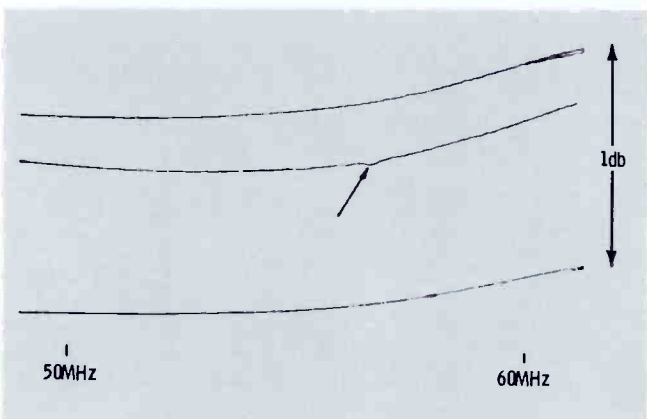

Fig. 16. Transmission test of Fig. 15 with equalization.

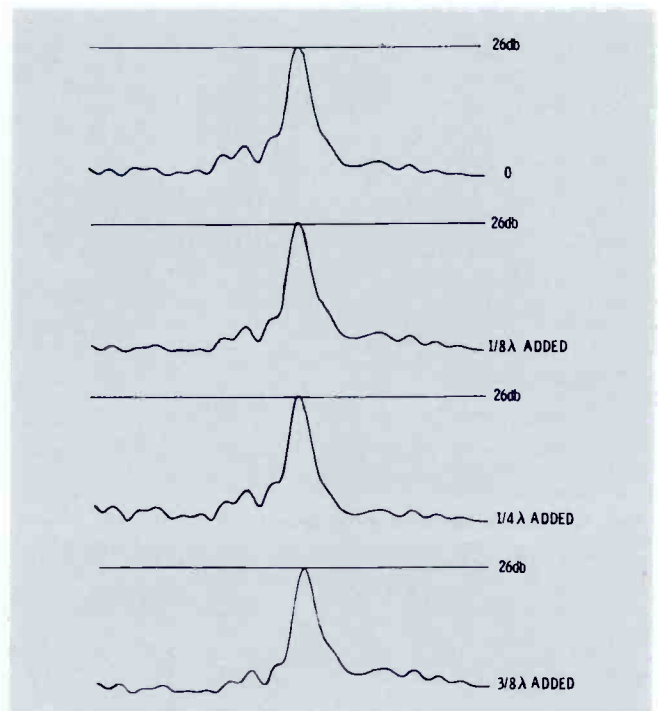

Fig. 13. Return-loss-bridge test of Figs. 11 and 12 defect.

cable due to nonstandard characteristic impedance from those due to periodic discontinuities. In measuring cable, it is most important that these adjustments be set correctly before reading return loss. The following shows the result of correct adjustment as well as the results of wrong adjustments.

Fig. 20 shows the trace obtained on a reel of high-grade CATV cable with the bridge and the far-end terminator correctly adjusted. The frequency range is from 50 to 220 MHz, and the reference line at the

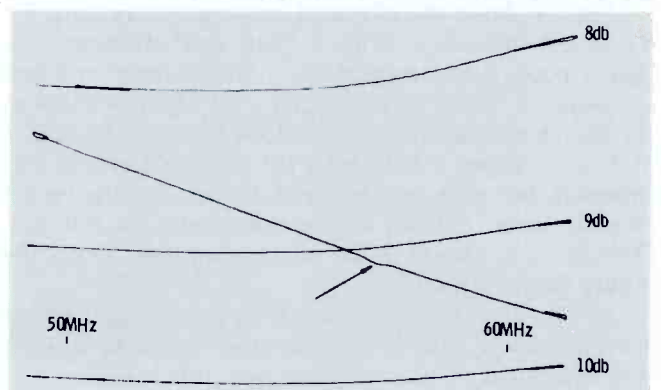

Fig. 15. Transmission test on Fig. 14 reel at worst defect.

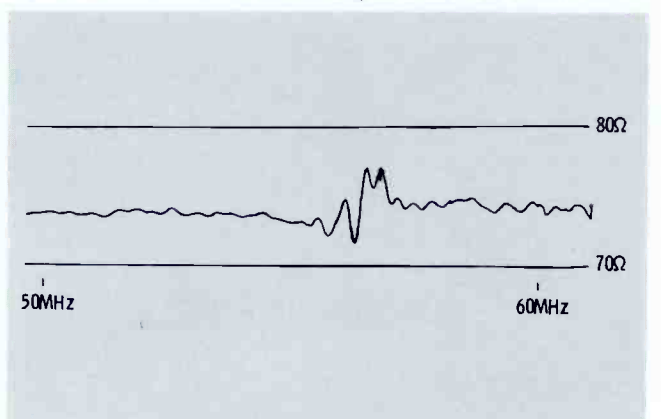

Fig. 17. Measurement from impedance test on Fig. 14 reel.

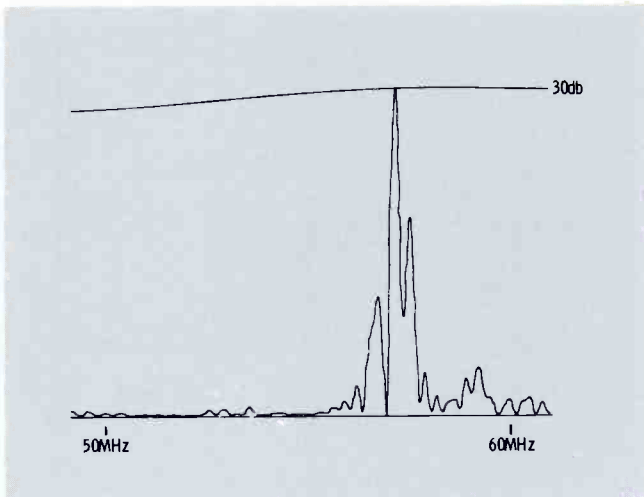

Fig. 18. Return-loss test near worst defect on Fig. 14 reel.

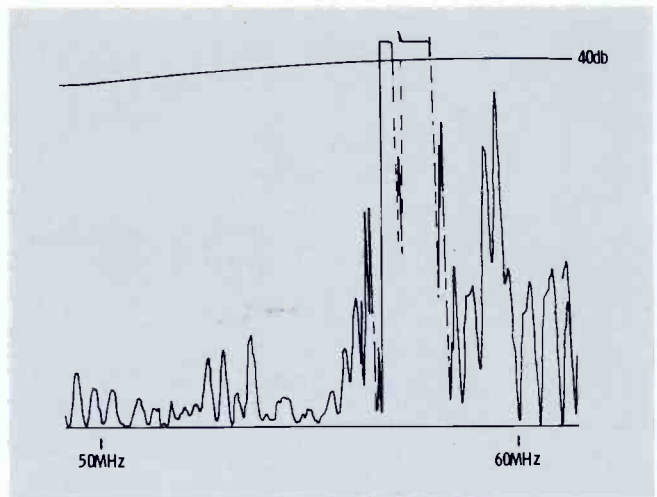

Fig. 19. Same as Fig. 18 with more gain & reference shifted.

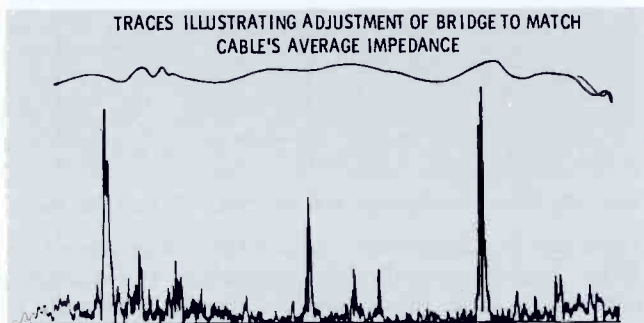

Fig. 20. High-grade CATV cable with proper adjustments.

top is set at 30-dB return loss. It is essential to set the bridge so that the minimums in the trace touch the base line as they do here. Erroneous readings are obtained if the bridge is adjusted for minimum readings of the "spikes," without considering the base line.

Fig. 21 shows the effects of incorrectly adjusting the far-end termination. With a long reel of cable, this has a major effect only at the low-frequency end and produces a "fuzzy" trace (due to the rapid oscillations in impedance caused by reflections from the far end).

Fig. 22 shows a trace with the far end correctly terminated, but with the resistance balance on the bridge slightly offset from the average impedance for this reel. The effect is a trace raised off the base line across the entire frequency range.

In Fig. 23 is shown a trace with far-end termination and resistance balance set correctly, but with a slight misadjustment of the bridge capacitance balance. This has its greatest effect at the high-frequency end, caus-

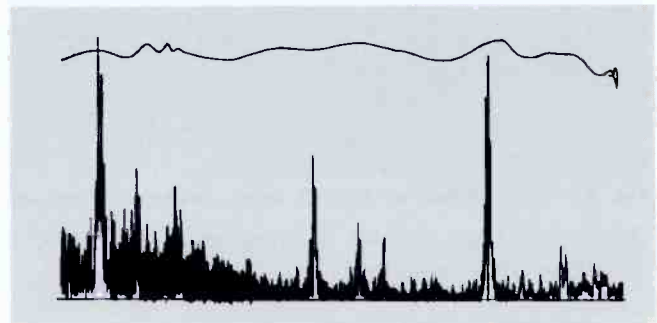

Fig. 21. Poorly adjusted termination shown by fuzzy trace.

ing a rising characteristic. This is very similar to the effect produced when the connector between the bridge and the cable end has a characteristic impedance which differs greatly from the average impedance of the reel.

### Summary

Three methods that have been used to determine the existence of electrical problems due to periodic discontinuities in cable have been described. The transmission-measurement method suffers from low sensitivity and the need for equalization. The impedance-measurement method presents difficulties in calibration and is ambiguous because of variations peculiar to the point of connection between cable and test set. In contrast, the reflection-test method, using a return-loss bridge adjusted to the average impedance of the cable under test, provides a high degree of sensitivity, ease of calibration, and freedom from ambiguous readings. ▲

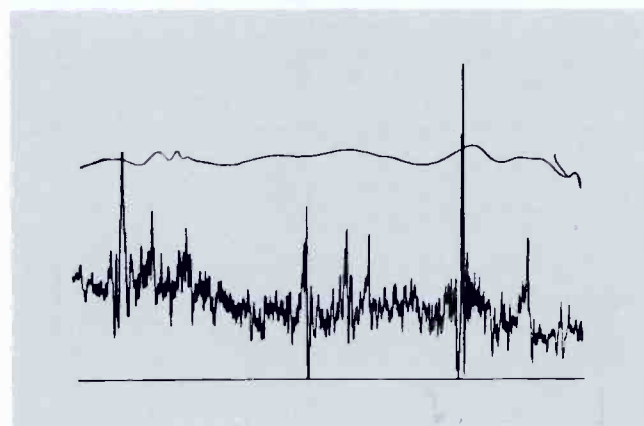

Fig. 22. Resistance balance set wrong lifts trace from base.

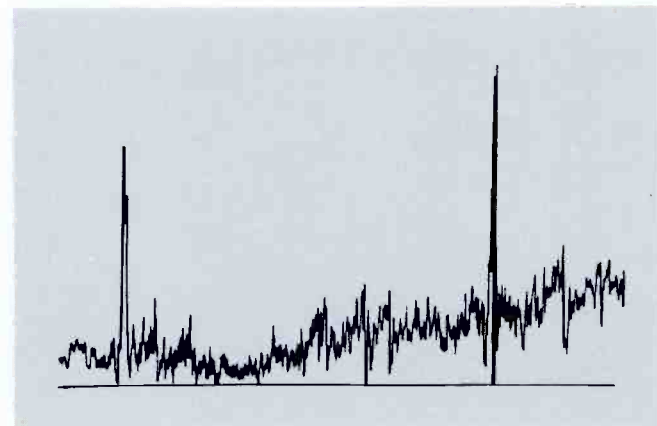

Fig. 23. Rising curve at high end; capacitance set wrong.

# A FREQUENCY MEASUREMENT SYSTEM

by Robert L. Zuelsdorf\*

The conclusion of an article which describes the design and construction of frequency-measurement equipment for TV carrier frequencies.

Part 2 of two parts

## Divider Chain

Subharmonics of the 1-MHz standard frequency are used to provide markers. Frequencies of 100 kHz and 10 kHz are most convenient to use and can be obtained from the 1-MHz reference by means of frequency dividers. There are several divider configurations which may be used. These include 10-to-1 multivibrators, a combination of 5-to-1 and 2-to-1 multivibrators, and digital methods using flip-flops. As each of these methods offers its own particular advantages, they will be examined in greater detail.

The 10-to-1 multivibrator is an astable type set up to free-run at a frequency slightly below the 10th subharmonic. In the case of a 1 MHz-to-100 kHz counter, the 1-MHz signal is fed into one base as a trigger. In operation, this base is driven into cutoff and drifts back toward the supply voltage at a rate determined by the RC time constant of the base resistor and coupling capacitor. The 1-MHz trigger pulses are superimposed on the base waveform as shown in Fig. 8. When one of these pulses exceeds cutoff bias, the stage is driven into conduction. Thus the stage is locked to the trigger pulses and produces a 100-kHz output.

One of these 10-to-1 multivibrators will give an output of 100 kHz; cascading another makes possible a 10-kHz output. Because the frequency-division ratio is high, stable operating conditions are required to maintain the 10-to-1 counting ratio. A shift of power-supply voltage or a large change in output loading could bring about a 9-to-1 or an 11-to-1 count. Replacing the single 10-to-1 multivibrator with 5-to-1 and 2-to-1 stages gives the same counting ratio with increased immunity to parameter variations. The 5-to-1 stage would be a multivibrator, while a flip-flop would be the most likely choice for the 2-to-1 counter.

A chain of flip-flops provides the greatest stability,

but at the expense of the greatest component count. Four flip-flops can be cascaded with feedback to give decade counting action.<sup>4</sup> If integrated circuits are used, both cost and component count may be kept down.

The 10-to-1 count-down multivibrator was selected for use in this frequency standard. It might be noted here that the transistor astable multivibrator has one inherent advantage over its vacuum-tube cousin. In the transistor circuit, the base resistor is returned to  $-E_{cc}$  to provide forward bias. This means that the coupling capacitor charges from  $E_{cc}$  toward  $-E_{cc}$ , going through the conduction point at approximately zero volts. The vacuum-tube coupling capacitor discharges from  $E_{bb}$  toward zero voltage, reaching the conduction point much later on the RC curve, where the slope is flatter. Thus a change in operating parameters will have a greater effect on frequency in the vacuum-tube case.

The operating frequency of a multivibrator is determined primarily by the base-resistor—coupling-capacitor time constants. In this circuit

$$E = E' \epsilon^{-t/RC} + E'' (1 - \epsilon^{-t/CR})$$

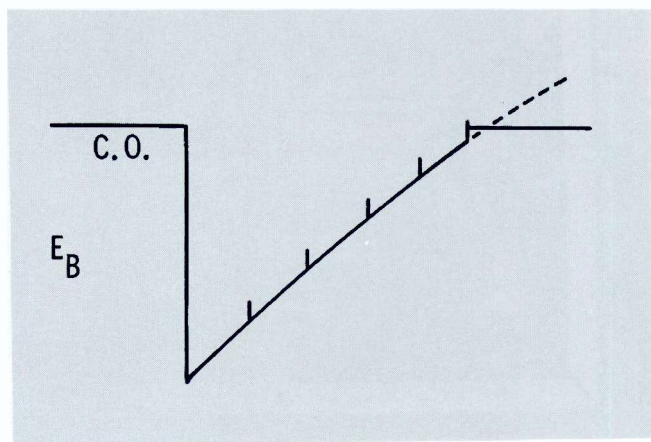

Fig. 8. 1-MHz trigger pulse superimposed on base waveform.

\*Engineering Supervisor, WKOW AM-TV, Madison, Wis.

# EIMAC

## 250 kW tetrode now ready for tomorrow's super-power transmitters

The EIMAC 4CV250,000C is the world's highest power tetrode. It is designed for service in super-power broadcast transmitters, and was developed on the foundation of technology which produced its "little brother," the hundred-kilowatt 4CV100,000C, now used by the USIA. The giant new vapor-cooled tube combines high power gain with long life. Vapor cooling is accepted as an efficient and economical method of cooling in advanced broadcast systems. As EIMAC's latest addition to its line of power tetrodes, the 4CV250,000C is ideally suited for service as an audio modulator, a pulse modulator, or a regulator, and as an rf amplifier in linear accelerators. Ready now for the super-power transmitters of the future, this 250 kW tetrode is another example of how EIMAC's experience in power tube technology paves the way for the developments of tomorrow. For a power tube to fit your needs—big or small—write Product Manager, Power Grid Tubes, or contact your nearest EIMAC distributor.

### TYPICAL OPERATION

(as a Plate-Modulated Power Amplifier  
at Frequencies below 30 MHz)

DC Plate Voltage	14 kV
DC Screen Voltage	800 V
Peak AF Screen Voltage (for 100% Modulation)	800 V
DC Grid Voltage	-800 V
DC Plate Current	29 Amps
DC Screen Current	3.6 Amps
DC Grid Current	1.8 Amps
Peak RF Grid Voltage	1200 V
Grid Driving Power	2.5 kW
Plate Output Power	292 kW

**EIMAC**

Division of Varian

San Carlos, California 94070

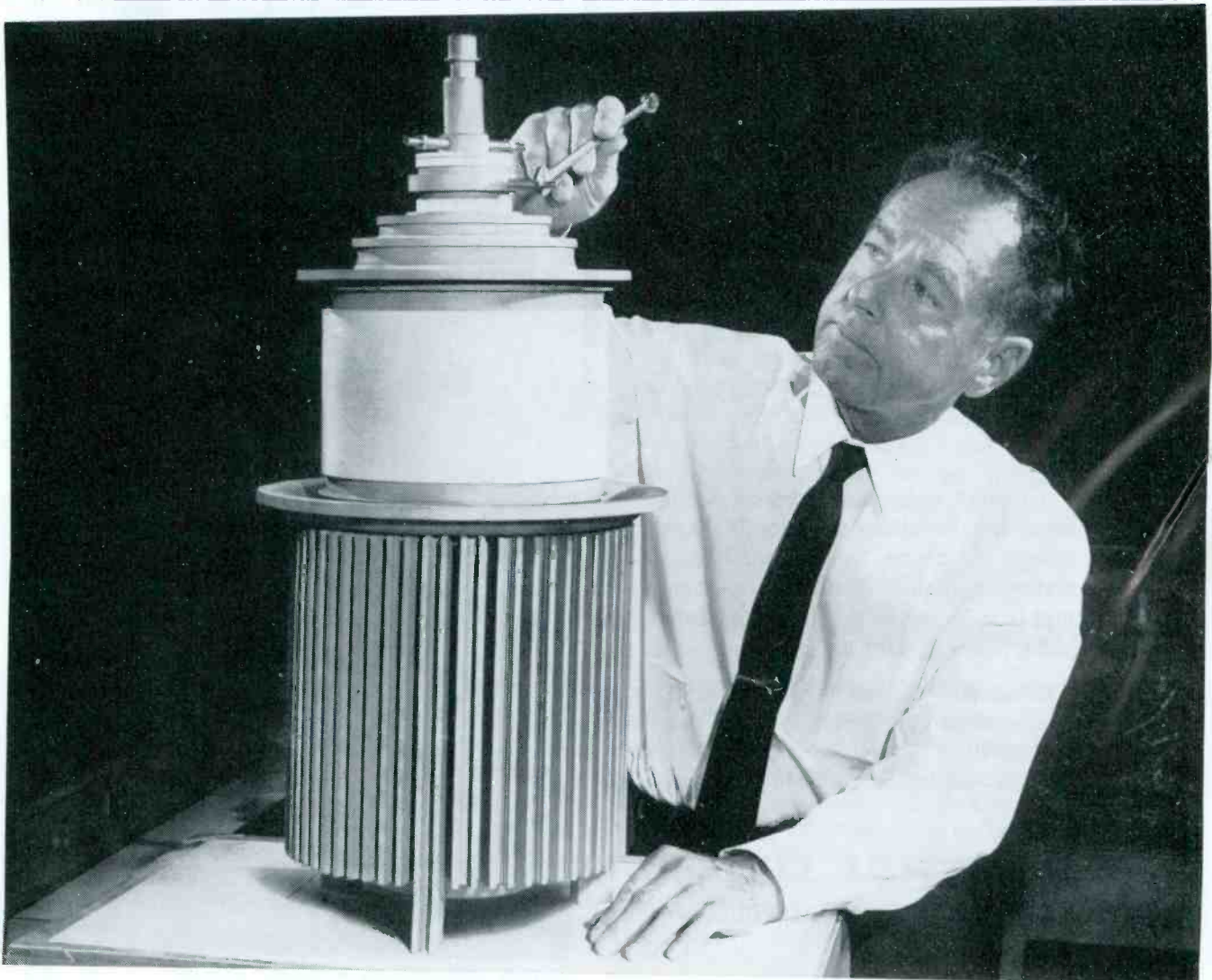

Circle Item 45 on Tech Data Card





# PREVIEW OF THE 1967 NCTA CONVENTION

Exhibit Previews  
Convention Program  
List of Exhibitors  
Technical Papers

## Previews of The Equipment Exhibits

The descriptions presented here are based on information received from the manufacturers up to press time.

### Ameco, Inc.

Booth No. 27, 69, 70, 72, 73, 74

Several new items are scheduled for a first public showing. Comprising this list are a new solid-state preamplifier, a directional tap, a Pacesetter amplifier in KS Box (telco specs), Channeleer solid-state heterodyne headend unit, Courier CCTV systems, Pacer line extender, and Amecoax CATV cable.

Items from the regular line will feature the Pacesetter series of amplifiers.

### Blonder-Tongue Laboratories, Inc.

Booth No. 21

New products will include a line of modular directional tapoffs (Models 3424 through 3429), with single and multiple outputs, available for aerial and pedestal mounting. Other first-showing items are to be a low-cost, set-match transformer Model Cablematch U/V 3413, Homer model HVB-3P subscriber distribution amplifier, and Models 3204-28/16

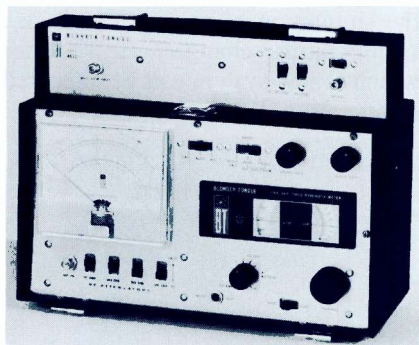

and 3204-23/12 tilted stingers (pressure-tap inserts). Another featured item will be the Model 4132 sub-channel converter (shown here) for Model FSM-2 field strength meter.

The company will show its complete line of CATV equipment from headend amplifiers through line amplifiers, tapoffs, and subscriber items.

Test results from last year's signal-to-noise and cross-modulation tests will be available at the booth.

### C-COR Electronics, Inc.

Booth No. 24, 25

To be exhibited is the Novacor

line of CATV equipment. This will include the TA-34 (\$585) and TA-40 (\$595) solid-state, all-band, trunk amplifiers; the EA-25-U (\$135) line extender amplifier; the TM-TU (\$14-\$15) Series of taps; and the BA-2 and BA-4 Series (\$495-\$515) of bridging amplifiers. Other amplifiers and preamplifiers will be shown also.

Literature will be distributed and demonstrations of the equipment will be conducted.

### Dynair Electronics, Inc.

Booth No. 85, 86, 87

This display will feature new solid-state, head-end equipment and Equa-Dyn cable transmission equipment. Items from the established line will include the TX-4A solid-state audio-video modulator and TS-100B solid-state sideband analyzer. Local origination devices to be shown are: Series-X audio-video switcher, DA-60C self-contained video distribution amplifier, PD-41C self-contained

pulse distribution amplifier, Series 1000 modular video and pulse distribution amplifiers, MINI-Series solid-state TV accessory equipment, VS-121B video switcher-fader, and the VS-6A and VS-12A monitor switchers.

Literature and price lists will be distributed in the booth, and a hospitality suite will be maintained in the Palmer House after exhibit hours.

**Entron, Inc.**

Booth No. 78 thru 83

Being presented for the first time will be a complete line of amplifier equipment with suitcase-style-housings. This will include the Model R-6T repeater, the Model RB-1T repeater plus bridge, the Model B-3 bridge, the Model D-2 distribution amplifier, and the Models E-22 and E-6C extenders. The Model E-3C in-a-line extender amplifier; the Model RPT-3100C 12-ampere, 30-volt power supply; and the Model MTU-8 series MulTees for pedestal mounting also will be introduced.

Additionally featured will be the Model P-1 solid-state preamplifier, the Model M-225 signal generator convertor, the Model G-1 pilot carrier generator series, and other CATV equipment from the regular line.

The big event for this exhibitor is to be a gala "Fifteenth 'Crystal' Anniversary" to celebrate entrance into its fifteenth year in CATV. All will be invited, and a special award will be given to the person who can produce the oldest "paid" Entron invoice.

**Hewlett-Packard**

Booth No. 216

Test instruments especially useful to CATV systems will be shown in this exhibitor's area. These include the Model 191A TV waveform monitor, the Model 6945A picture monitor, and the Model 1415A time-domain reflectometer for checking the transmission quality of coaxial lines.

**Packard Bell**

**Space & Systems Div.**

Booth No. 15

This manufacturer will display a color film-chain camera (Model 100) which sells for less than \$18,000. In addition, two black and white units, the new Model 9200 viewfinder camera and the Model

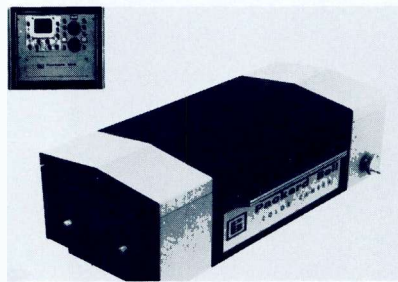

DX920 camera, both intended for use in CATV-system program origination also will be exhibited.

**Sony Corp. of America  
Industrial Division**

Booth No. L12

A number of video tape recorders will be in this booth. Other items will include portable video monitors. The VTR exhibit will present items from PV-120 and EV-200 Series, including one unit with four-hour playback capability.

**Spencer-Kennedy Laboratories, Inc.**

Booth No. L14, 15, 16, 17

To be shown are additions and improvements to the regular line of SKL Colorburst 7000 CATV equipment. In addition, "instant" radio alarm civil-emergency equipment also will be presented.

A special feature of this exhibitor will be the demonstration of advanced methods for producing system layouts. The new techniques are for use in both system design and the simulation of various conditions (temperature changes, etc.) under which a new system can be expected to operate.

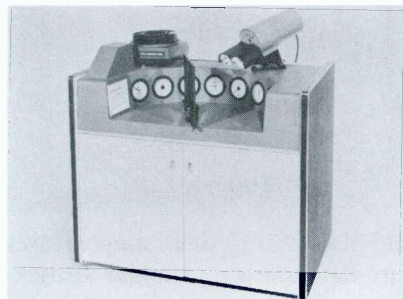

**Telemation, Inc.**

Booth No. 61, 62, 63, 64

The featured new product is the TMV-600 *Cablecaster* video control center which is a synchronous switching system for CATV local-origination video sources. The system utilizes 2:1 interlace sync derived from one master system camera. Horizontal and vertical drive pulses are fed from this source to all other cameras in the system. The unit has six video inputs, three outputs, and a

video processor to reshape sync pulses. It also provides level control for the composite waveform output. The inputs can be adapted to accept non-synchronous sources such as a VTR or tuner.

Items in the booth from the regular line will include: *Weather Channel '97'*, *Weather Channel '75'*, *News Channel*, *Chroma-Channel*, *Sav-A-Channel*, a non duplication switcher, and an optical multiplexer for 16-mm projection.

**R. H. Tyler Co.**

Booth No. L1, L2

This company will introduce a new, completely electronic (i.e., no moving parts) *Weather-Scan* unit. Another new item will be a 5-inch VU-Finder camera cabinet designed to accommodate the GE-TE-20, or equivalent, camera.

The presently available *Weather-Scan I*, *Weather-Scan II* and *Roto Scan*, for the presentation of time and weather information, also will appear in the booth.

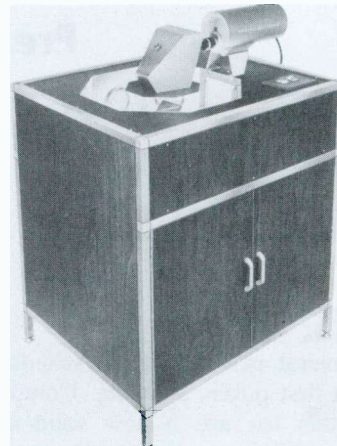

**Vikoa, Inc.**

(Formerly Viking Industries, Inc.)

Booth No. 2 thru 12

The *Weathercaster*, for local origination of weather and time, will be the featured new product of this manufacturer. The unit has provision for eight index positions: time, temperature, wind velocity, wind direction, barometer, rainfall, relative humidity, and a special six-position rotating sign holder. A new automatic switcher also will be displayed.

Other products in the booth will include the *Futura* solid-state CATV amplifier, solid aluminum-sheathed cable, tapoffs, splitters and accessories, and line extenders.

There will be demonstrations of *Futura* performance, and VIKOA turnkey services will be explained.

# PROGRAM

## 16th Annual NCTA Convention

### Sunday, June 25

5:00 PM Opening of exhibit hall and reception, courtesy of NCTA and Associate Members.

### Monday, June 26

9:00 AM Official welcome  
Panel: Future of Communications  
Annual Report of the National Chairman—Alfred R. Stern

12:30 PM Luncheon, featured speaker

2:00 PM The Legal Outlook  
Panel: FCC Regulations  
Panel: Telephone Industry and PUC relations  
(Concurrent technical sessions)

7:30 PM Jerrold Night: Reception, dinner, entertainment

### Tuesday, June 27

9:00 AM PR/Advertising/Promotion Clinic  
(Concurrent technical sessions)

12:30 PM Luncheon, featured speaker, PR & Advertising awards

2:00 PM Open for visits to exhibit hall, PR Workshop sessions  
(Concurrent technical sessions)

### Wednesday, June 28

9:00 AM Panel: Money and the CATV system  
Panel: On that extra channel . . .  
Panel: Copyright law  
(Concurrent technical sessions)

12:30 PM Luncheon, featured speaker

2:00 PM Annual NCTA Business Meeting  
(members only)

6:30 PM Chairman's Reception, in honor of new chairman

7:30 PM Annual Banquet, presentation of awards

### Cablecasting Workshop

10:00 AM-5:00 PM Monday and Tuesday—10:00 AM-Noon Wednesday. Attendees may come in anytime during these hours.

## List of Exhibitors

(Note: Booth numbers preceded by "L" are in Lower Hall)

**Aberdeen Company**  
3833 Wilshire Blvd.  
Los Angeles, California 90005  
(Booth 100)

**Advance Industries**  
705 Douglas Street  
Sioux City, Iowa 51101  
(Booth 71)

**Ameco Inc.**  
2949 W. Osborn Rd.  
Phoenix, Ariz. 85005  
(Booths 27, 69, 70, 72, 73, 74)

**American Electronic Laboratories, Inc.**  
P. O. Box 552  
Lansdale, Pennsylvania 19446  
(Booths 219, 220)

**American Pamcor, Inc.**  
P. O. Box 1776  
Paoli, Pennsylvania 19301  
(Booths 227, 228)

**Ampex Corporation**  
401 Broadway  
Redwood City, California 94063  
(Booths L20, 21)

**Amphenol Cable Division**  
**Amphenol-Borg Electronics Corp.**  
2875 S. 25th Ave.  
Broadview, Illinois 60153  
(Booth 84)

**Anaconda Astrodata Co.**  
1430 S. Anaheim Blvd.  
Anaheim, California 92803  
(Booths 65, 66, 67, 75, 76, 77)

**Benco Television Associates**  
P. O. Box 10068  
Jacksonville, Florida 32207  
(Booths 28, 29)

**Blonder-Tongue Labs**  
9-25 Alling Street  
Newark, New Jersey 07102  
(Booth 21)

**Cable Promotional Serv.**  
Box 2701  
Nashville, Tenn.  
(Booths 30, 31)

**Cal Tel Construction**  
1698 E. 25th Street  
Signal Hill, California 90806  
(Booth 217)

**CAS Manufacturing Company**

P. O. Box 47066  
Dallas, Texas 75207  
(Booths 98, 99)

**Cascade Electronics Ltd.**

Electronic Avenue  
Port Moody, B. C., Canada  
(Booth 101)

**C-Cor Electronics Inc.**

P. O. Box 824  
State College, Pennsylvania 16801  
(Booths 24, 25)

**Collins Radio Company**

Dallas, Texas 75207  
(Booths 16, 18, 19)

**Craftsman Electronics**

133 W. Seneca Street  
Manlius, New York 13104  
(Booths 91, 92, 93)

**Daniels Associates**

2093 E. 3rd Avenue  
Denver, Colorado  
(Booth L4)

**Dynair Electronics Inc.**

6360 Federal Blvd.  
San Diego, California 92114  
(Booths 85, 86, 87)

**Entron Inc.**

2141 Industrial Pkway.  
Silver Spring, Maryland 20904  
(Booths 78 thru 83)

**Ft. Worth Tower Company**

P. O. Box 8597  
Ft. Worth, Texas 76112  
(Booths 95, 96)

**Gilbert Engineering Company, Inc.**

3700 N. 36th Avenue  
Phoenix, Arizona 85019  
(Booth 102)

**Hewlett-Packard**

1900 Garden of the Gods Road  
Colorado Springs, Colorado  
(Booth 216)

**International Telemeter  
Div. of Paramount Pictures**

2000 Stoner Avenue  
Los Angeles, California 90025  
(Booth L11)

**Jerrold Electronics**

401 Walnut Street  
Philadelphia, Pennsylvania 19105  
(Booths 35 thru 57)

**Kaiser-Cox Corporation**

P. O. Box 9728  
Phoenix, Arizona 85020  
(Booths 103 thru 108)

**Lenkurt Electronics Company, Inc.**

1105 County Rd.  
San Carlos, California 94070  
(Booths L9, L10)

**Modern Talking Picture**

1212 Avenue of the Americas  
New York, New York 10036  
(Booth L18)

**Packard Bell Electronics**

**Space & Systems Div.**  
649 Lawrence Dr.  
Newbury Park, California 90022  
(Booth L5)

**Phelps Dodge Copper Products Div.**

300 Park Avenue  
New York, New York 10022  
(Booth 90)

**Plastoid Corporation**

42-61 24th Street  
Long Island City, New York 11101  
(Booth 59)

**Preformed Line Prod. Company**

5349 St. Clair Avenue  
Cleveland, Ohio 44103  
(Booth 215)

**The Pruzan Company**

1963 First Avenue South  
Seattle, Washington 98134  
(Booth 60)

**Raytheon Company**

141 Spring Street  
Lexington, Massachusetts 02173  
(Booths 26, 27)

**Rohn Systems Inc.**

P. O. Box 2000  
Peoria, Illinois 61601  
(Booths 22, 23)

**Scientific-Atlanta Inc.**

P. O. Box 13654  
Atlanta, Georgia  
(Booth 94)

**Shibaden Corporation**

58-25 Brooklyn-Queens Expressway  
Woodside, New York 11377  
(Booth L3)

**Sony Corporation of America**

516 W. Florence Avenue  
Inglewood, California  
(Booth L12)

**Specialty Products**

50 Mary Street West  
Lindsay, Ontario  
(Booth 218)

**Spencer Kennedy Labs**

1360 Soldiers Field Rd.  
Boston, Massachusetts 02135  
(Booths L14, 15, 16, 17)

**Superior Cable Corporation**

Hickory, North Carolina 28601  
(Booths 206, 207, 208)

**Sylvania Electric Products, Inc.**

Bedford, Massachusetts  
(Booths L6, L7, L8)

**Systems Engineering**

804 N. Broadway  
Sylacauga, Ala. 35150  
(Booths 88, 89)

**Tape Athon Corporation**

523 S. Hindry  
Inglewood, California 90307  
(Booth L13)

**Telemation Inc.**

2275 S. W. Temple  
Salt Lake City, Utah 84115  
(Booths 61, 62, 63, 64)

**Teleprompter-Hughes Aircraft-  
Theta Communications**

P. O. Box 90919  
Bldg. 366 MSA 320  
Los Angeles, California 90009  
(Red Laquer Room)

**Telesis Corporation**

645 N. Michigan Avenue  
Chicago, Illinois 60611  
(Booth 20)

**Times Wire & Cable Company**

358 Hall Avenue  
Wallingford, Connecticut 06493  
(Booths 32, 33, 34)

**Trans-Lux Corporation**

30-12 41st Avenue  
Long Island City, New York 11101  
(Booth L19)

**R. H. Tyler Company**

1404 15th Street  
Wellington, Texas 79095  
(Booths L1, L2)

**VIKOA, Inc.****(Viking Industries Inc.)**

400 Ninth Street  
Hoboken, New Jersey 07030  
(Booths 2 thru 12)

# TECHNICAL PAPERS

To be presented at the 1967 NCTA Convention

Sixth Floor, Palmer House

Monday, June 26

Afternoon

- |      |   |  |
|------|---|--|
| 2:00 | Noise Figure—Its Meaning and Measurement                            | Carmine D'Elio,<br>Vikoa, Inc.                     |
| 2:30 | Distortion in CATV Amplifiers                                       | Ken Simons,<br>Jerrold Electronics Corp.           |
| 3:00 | A Poor Man's TDR  | R. H. Scherpenseel,<br>Northwest Video, Inc.       |
| 3:30 | The Spectrum Analyzer   | Alan Ross,<br>Nelson-Ross Electronics              |
| 4:30 | Equipment Measurement Techniques                                    | (Author to be announced)<br>Anaconda Astrodata Co. |
| 5:00 | How to Evaluate Coaxial Cable for Maximum Utilization and Longevity | A. M. Kushner,<br>Times Wire & Cable Co.           |

Tuesday, June 27

Morning

- |       |   |   |
|-------|---|---|
| 9:00  | Short-Haul Microwave  | Harold Osaki,<br>Hughes Aircraft Co.  |
| 9:30  | TV Signal Propagation   | Tom D. Smith,<br>Antenna & Microwave  |
| 10:00 | Space Diversity Reception   | Ken J. Easton, P.E.<br>Famous Players   |
| 10:30 | CATV and The National Electrical Code and National Electrical Safety Code | James Stillwell and<br>William Karnes,<br>TeleSystems Corp.   |
| 11:00 | The NCTA Standard on CATV Amplifier Distortion                            | Engineering Subcommittee<br>of NCTA Standards<br>Committee:<br>Archer S. Taylor, Chmn;<br>K. Simons; J. Shekel; M.<br>Rodriguez; H. Blum; E.<br>Hickman |
| 11:30 | To Be Announced   | (Author to be announced)<br>Ameco, Inc.   |
| 12:00 | To Be Announced   | (Author to be announced)<br>Kaiser-Cox Corp.  |

Wednesday, June 28

Morning

- |       |   |  |
|-------|---|--|
| 9:00  | MATV Techniques for CATV Operators                                    | Fred Schultz, Blonder-Tongue Systems, Inc.         |
| 9:30  | Short Range Trends in Feeder Line Technology                          | S. W. Pai, Craftsman Electronic Products, Inc.     |
| 10:00 | Automatic Equalization as a Factor in System Level Control            | Argyle W. Bridgett,<br>Spencer-Kennedy Labs., Inc. |
| 10:30 | To be announced   |  |
| 11:00 | Temperature, Temperature Design, and Automatic Level Control for CATV | James R. Palmer,<br>C-COR Electronics, Inc.        |
| 11:30 | PERT/CPM—Uses in CATV   | Donald Stewart,<br>Superior Cable Corp.            |
| 12:00 | Underground Construction  | Panel to be announced                              |

## The Broadcast Industry

# BUYERS GUIDE

A Working Reference  
You will use everyday  
in Broadcasting

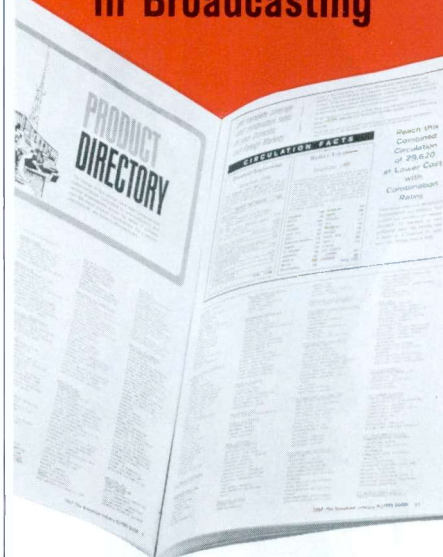

The only comprehensive listing of products and manufacturers available to the broadcast-communications industry. It's a one-source equipment guide for day-to-day information.

- \* Lists broadcast equipment manufacturers under 500 product classifications

- \* Lists broadcast equipment manufacturers alphabetically, and their products

- \* Lists company representatives, and gives their address and phone numbers

**HOWARD W. SAMS & CO., INC.**  
4300 West 62nd St. • Indianapolis, Indiana 46206

Please send me \_\_\_\_\_ copies of THE BROADCAST INDUSTRY BUYERS GUIDE @ \$1.50 each.

Name \_\_\_\_\_  
Address \_\_\_\_\_  
City \_\_\_\_\_  
State \_\_\_\_\_ Zip \_\_\_\_\_

# JERROLD'S

# ROARING TWENTIES



## GO CHICAGO NCTA SHOW

(Jerrold night—June 26th)

### JERROLD

FIRST IN CATV

Some plain talk from Kodak about tape:



# Uniform magnetic sensitivity (or the lack thereof)

Uniformity for a tape is like kissing babies for a politician. Without it, you're hardly in the running. We take uniformity in all of tape's characteristics very seriously at Kodak. Maybe it's all those years of putting silver emulsions on film that's made us so dedicated to the idea. Uniformity in terms of magnetic sensitivity is one of the most important measures of a tape's performance. Non-uniformity can result in all sorts of bad things like level shifts, instantaneous dropouts, periodic non-uniformity, output variations, distortion, and variations from strip to strip.

Testing for all these possible flaws on a tape is a simple procedure in the lab. Standard industry practice is to record a long wavelength signal (37.5 mil) at a constant input level. The signal from the playback amplifier is then filtered and the output at particular critical wavelengths is permanently charted by a high-speed pen recorder which registers variations on a chart. Instantaneous dropouts caused by foreign matter on the tape surface, for example, would look like this:

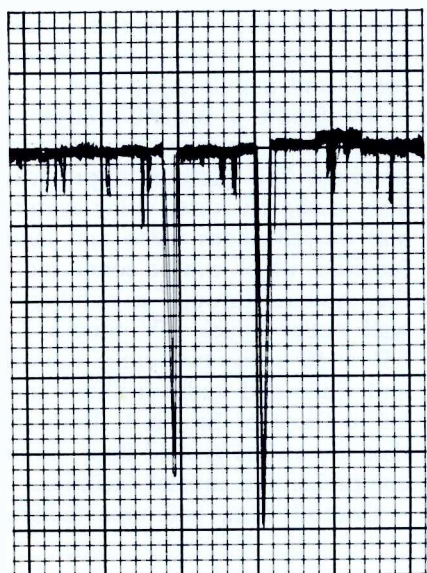

## The long and the short of it

The low frequency procedure gives a good picture of variations in oxide thickness. We take it one step further ... also test for short wavelength—1.0 mil. This helps evaluate surface smoothness and tape-to-head contact. Taken together, they aid in evaluating the level of lubrication, slitting, and oxide binder characteristics. The smoother the lines, the more uniform the magnetic sensitivity. Guess which graph below is KODAK Sound Recording Tape (the other two graphs represent quite reputable brands of other manufacture):



A.



B.

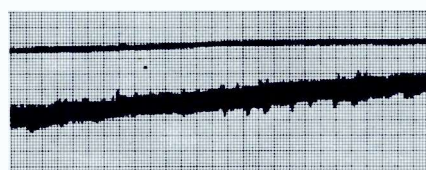

C.

## What looks good sounds good

Congratulations if you picked brand A, Kodak tape. It is notably more uniform ... doesn't vary more than  $\frac{1}{4}$  db within the reel ... no more than  $\frac{1}{2}$  db from reel to reel.

You benefit as follows:

### 1. Within-reel uniformity.

(a) Less instantaneous and short term amplitude modulation of the signal, which results in a cleaner signal on playback.

(b) Reduced drift gives less variation in frequency response.

(c) Better uniformity across the strip width (no lengthwise coating lines) results in a more nearly balanced output for stereo recordings.

### 2. Reel-to-reel uniformity.

(a) Better coating uniformity gives a more uniform low-frequency sensitivity. This allows splicing of sections of tape from one reel with tape from other reels without obvious signal level changes.

(b) Better coating uniformity also results in a minimum change in optimum bias which allows the professional to establish an operating bias nearer the optimum bias.

KODAK Sound Recording Tapes are available at most camera, department, and electronic stores. New 24-page comprehensive "Plain Talk" booklet covers all the important aspects of tape performance, and is free on request. Write: Department 940, Eastman Kodak Company, Rochester, N.Y. 14650.



# INTERNATIONAL BROADCASTING CENTRE EXPO '67

by **M. Morais\***—This elaborate installation will provide complete facilities for the production of radio and color television programs.

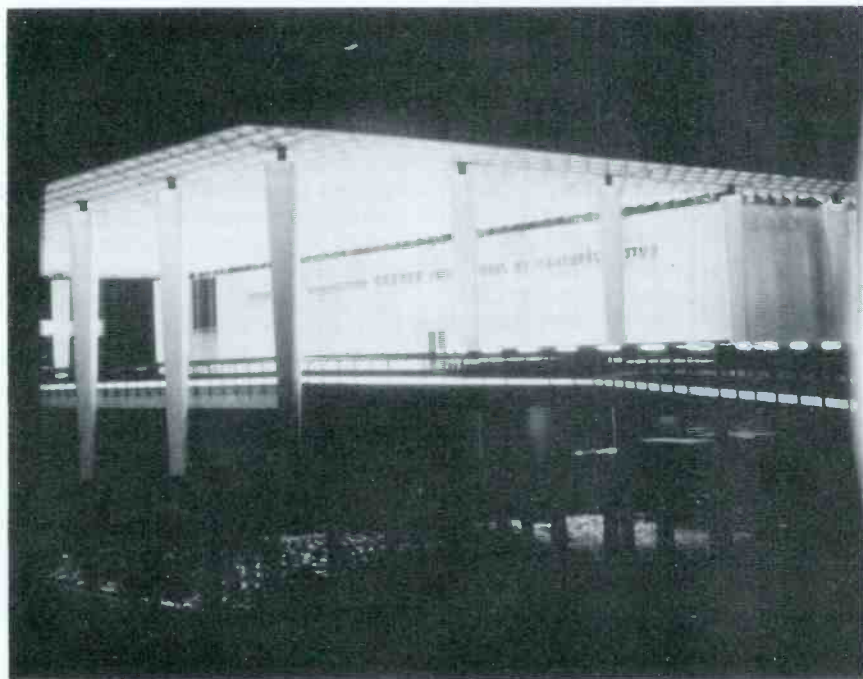

View of broadcasting center shows architectural concept of the exposition.

The year 1967 is Canada's Centennial Anniversary. The largest single event in the celebration of the Centennial is the Universal and International Exposition being held in Montreal from April 28 to October 27. This is the first official exhibition of its class (premier category Universal) to be held in North America.

The Canadian Broadcasting Corp. is participating in the Exposition by building and staffing a pavilion; this will be the International Broadcasting Centre, a radio and color television production center. Its primary purpose is to act as a service center for the broadcasters whose countries participate in Expo '67. The building also has been designed for a second function; it will serve as an exhibit where the public will be able to see television productions in progress, and, on occasion, be a part of an audience.

## The Facilities

The main facilities include two TV production studios, six interview-size radio studios, a combination radio and TV master control room, video tape room, telecine room, and mobile equipment.

TV Studio 1 is CBC's largest—70' x 110'. Seating for audiences of about 250 persons is provided. This studio has three color cameras and miscellaneous video and audio facilities, which can be connected to the systems through a number of wall outlet boxes. TV Studio 2—55' x 40'—has two color cameras and video and audio facilities similar to those of Studio 1. Both studios are on the ground floor. So are comprehensive artists' facilities.

Control, film, and tape facilities



Radio and television master-control operating desk for the entire center.

\*Supervising Engineer, Expo 67 Project, Studio Systems Department, Canadian Broadcasting Corporation, Montreal, Quebec



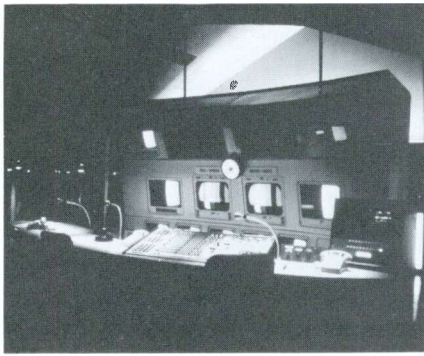

Studio 2 control room shows video monitors, mixing control installation.

are on the floor above the studios. Located here are the control rooms for Studios 1 and 2. There are a video tape room with four video tape recorders, and a telecine room with two film cameras, each fitted with two 16-mm movie projectors and one 2" x 2" slide projector. The master control room contains the basic generators (time, pulses, and test signals); all the switching equipment for program routing, monitoring, and pulse distribution; and a color slide scanner. Two maintenance rooms and a reverberation room are on this floor. There is also a TV mixing studio, planned for programs originating from video tape, film, network, or mobile units—not for live TV produced internally.

Special enclosed corridors for the public have been built approximately 19 feet above studio floor level. They are fitted with speakers and color video monitors. From here, visitors can watch the movements of artists and cameras in the studios, hear the performers, and observe production and technical personnel in control rooms.

On the fourth floor, there are six interview-size radio studios, a few offices, a conference room, two mechanical rooms, and the dimmer

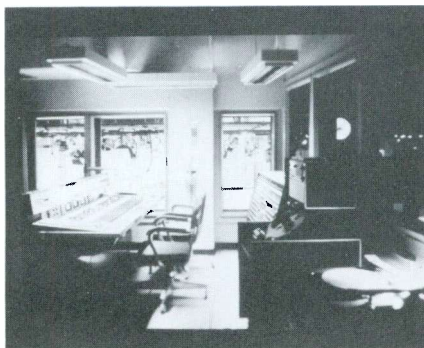

The Studio 1 audio-control board gives complete access to audio facilities.



Shown here are two of center's four video tape recorders in the VTR room.

room (above the public corridor across the middle of Studio 1).

### Video System

The overall technical system was developed with the idea of providing the maximum possible flexibility while keeping technical performance at the highest possible level. This is being achieved by centralizing the video processing equipment in master control and providing remote controls only to studios. The camera patch panel, encoders for live and film cameras, system patch, video mixers, and master control switcher are all located in adjacent racks in the master control room. Thus all video program paths are kept as short as possible.

The system patch is the heart of the system. Each connector provides for the routing of video, viewfinder mix, chroma key, and audio and control signals between a source and a studio. The following controls are provided: patch through indication at source and destination, indication of type of source at destination, selection of proper cross-points in the centralized intercom system matrix (to ensure that the source is interconnected with the selected destination), selection of



In corner of Telecine room is one pedestal; center unit is the control desk.

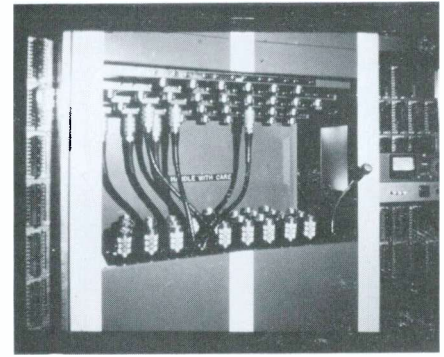

System patch-panel in the master-control room exhibits total flexibility.

synchronizing generators to ensure that all picture sources to a studio are on the same generator, remote start-stop of telecines and VTR's, and the selection of projectors and slide changes of telecines.

Three video mixers are provided in the plant. These are a 12-input unit with mix, effects, cut, and six preview outputs for Studio 1; a seven-input unit with mix, effects, cut, and six preview outputs for Studio 2; and a 12-input unit with mix, effects, cut, and three preview outputs for Studio 3.

The video switcher is an entirely solid-state vertical-interval switching system, and is composed basically of a program switcher, a preview switcher, and a viewfinder-mix switcher.

The program switcher is automatically delay-compensated; there is a constant delay, regardless of the path through which a signal is routed. The double re-entry method has been adopted for special-effects and mix busses. Special effects into mix or mix into special effects can be achieved readily. A switching of delay lines is required to keep the timing in a proper relation for mixing and special effects.

One preview bus is part of the program switcher. It is used as pre-

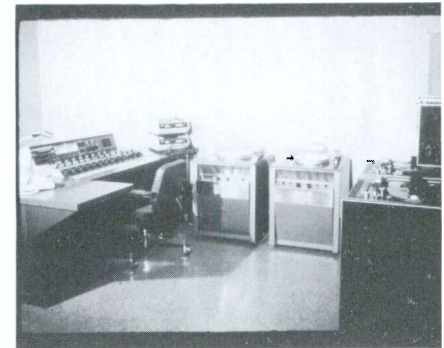

Typical view of radio-control room reveals convenient audio installation.

# Confidence builders.



General Electric PE-240  
Color-film camera



In reality, General Electric color TV cameras. The color-film PE-240... the live-color PE-250.

In our customers' minds, confidence builders. That's what General Managers and Chief Engineers of successful TV stations repeatedly tell us.

"Broadcaster confidence. That's why we bought your cameras. We looked at all the others and bought General Electric because it showed us the best pictures, the most stable and reliable performance, the most economical operation."

You get the best when you buy General Electric color TV cameras. Color you can have confidence in, cameras you can rely on.

Read about our PE-250 and PE-240 in the brochures we'll be glad to send you. And if you need more than that to build your confidence in these cameras, visit us in Syracuse where we build them. Visual Communication Products Department, Electronics Park, Syracuse, New York 13201.

GENERAL  ELECTRIC



General Electric PE-250  
Live-Color camera



set for the cut bus when it is desired to use the "take bar" to switch the video signal.

The following units are also built into the video mixers: a white reference generator, a color processing amplifier, a color black generator, a chroma-key switcher, a viewfinder-mix switching unit, and video-mixer-output switching facilities.

The color processing amplifier incorporates: regeneration of both sync and color burst; remote gain and fade-to-black facilities; removal of incoming spurious effects occurring during the blanking intervals; optional remote control of video, chroma gain, white-clipping level, black-clipping level, sync level, and sync changeover; four video outputs as well as a noncomp video output; sync blanking; and subcarrier outputs.

### Audio System

The overall audio system is similar to the video system except for the studio control equipment, which

is located in studio control rooms instead of being centralized in the master control room.

Studio 1 is equipped with an audio console having 24 low-level inputs, six submasters, and four outputs. Any one or all inputs can be selected to any one or all six submasters. Any one or all six submasters can be selected to any one or all four outputs. Variable filters can be inserted into any input channel or submaster. Four auxiliary outputs, each with a selection of any input, submaster, or output, and four monitor selectors, as required for control-room monitoring, are also provided. Sound-reinforcement selection and mixing is provided for the audience section of the studio.

Studio 2 is equipped with a similar audio console with somewhat less extensive facilities. Studio 3 is equipped with a ten-input-channel conventional audio console.

Sound-effects equipment comprising turntables, cartridge tape

units, and audio mixing facilities is located in the sound-effects control room.

Complete intercom and order-wire systems are provided to fulfill complicated communication requirements for the production of TV programs.

The six radio studios are equipped with conventional audio systems.

### Conclusion

It is interesting to know that for the realization of the Expo '67 International Broadcasting Centre technical system, the CBC had to mobilize a large portion of the Canadian Broadcast Industry. The design of the technical systems has been done by Canadian suppliers in collaboration with the Engineering office of the CBC; Canadian manufactured equipment has been selected wherever it was possible, and the installation and testing of the equipment and systems has been done by the suppliers. ▲

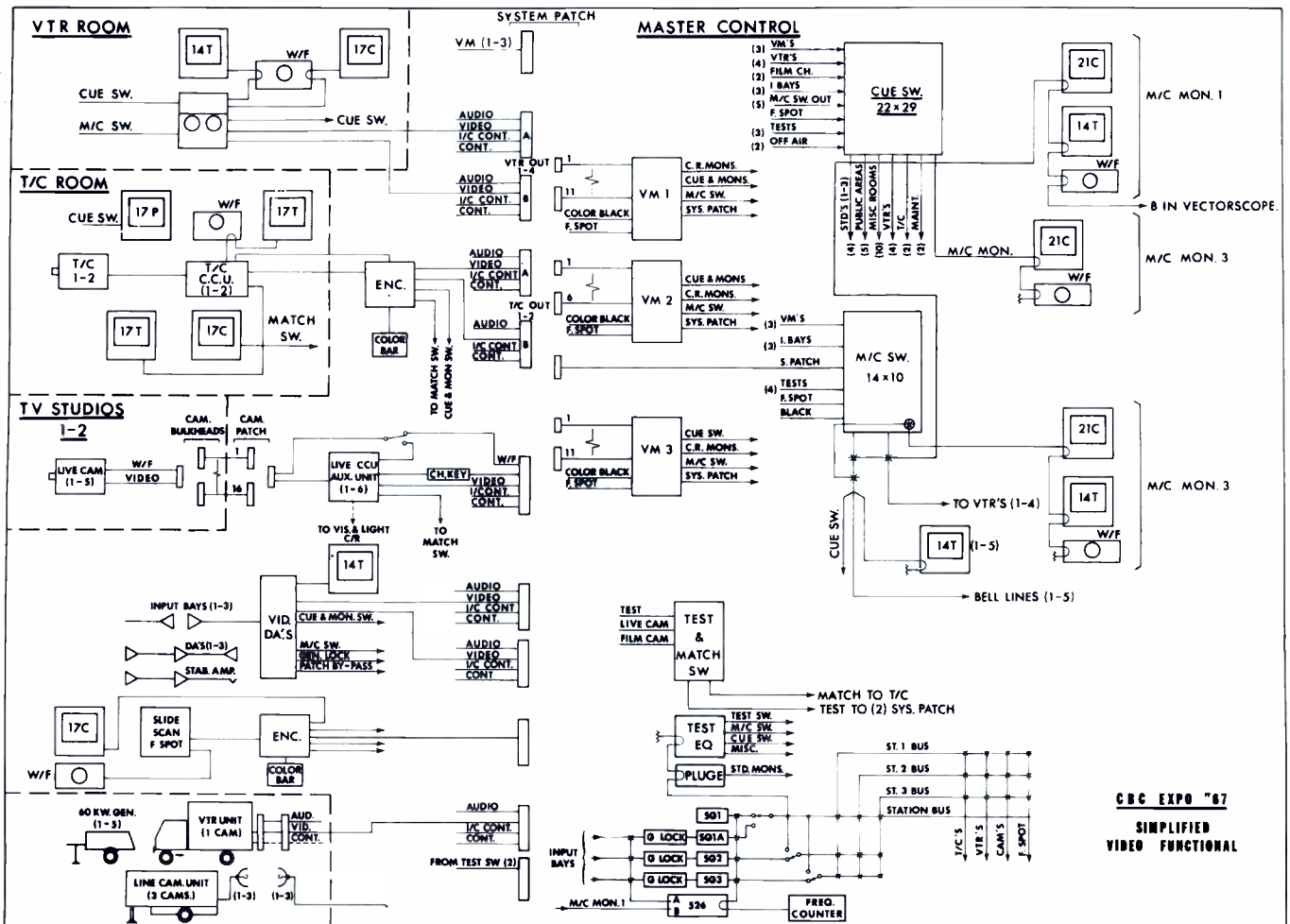

Simplified functional diagram of video systems shows interrelationship of studios, facilities, and master control.

## Frequency Measurement

(Continued from page 24)

The collector load resistor of Q17 is a potentiometer to provide marker-level control. At zero level, no drive is fed to Q18. At intermediate levels both the drive and bias are varied, while at full marker gain Q18 is driven from saturation to cutoff. Connections to the collector and emitter provide high- and low-impedance outputs. With R50 in the emitter circuit, a separate source of cutoff bias is unnecessary.

### Power Supply

The power supply is an important part of a frequency standard. It has to provide a steady output to maintain oscillator and counter stability. Decoupling must be adequate to prevent varying loads from affecting the oscillator frequency. A 25-volt, 1-ampere transformer supplies AC to the full-wave bridge. Heavy capacitive filtering follows, with separate shunt regulators for the oscillator, counters, and multipliers. An interesting feature of the shunt regulator is its constant current input with varying loads. This means that the rectifier output current is the same whether the counters and multipliers are turned on or off. The voltage also remains constant, and this fact simplifies the problem of oscillator voltage regulation.

It should be noted that instability of the oscillator supply voltage is doubly damaging. A frequency shift will occur not only because of a variation of bias and operating point, but also because of a shift of the voltage applied to the voltage-variable capacitor. Any change in supply voltage will have the same effect as varying FREQUENCY potentiometer.

A two stage zener regulator is employed to stabilize the oscillator supply voltage. A 1N3029B is used to maintain the filter output voltage at 24 volts. The second regulator element is a 1N1515 mounted on the oscillator board; this diode gives an 18-volt output. Use of two zener diodes in conjunction with the other shunt regulators insures oscillator supply-voltage stability.

### The Mixer

The 27-MHz output is produced by the multiplier chain. This is still a long way from carrier frequencies in the UHF range. The frequency must be multiplied still further so that a useful beat can be produced. This beat will be picked up on an HF receiver and compared with harmonics of the markers to determine the exact carrier frequency. The circuitry necessary to multiply and mix is built into another unit, referred to here as the mixer.

A number of different mixer configurations are possible. Two which have been employed successfully will be described. One is a tuned mixer which is useable only over a small range of frequencies; since its bandpass is sufficiently wide to cover a television channel, the narrow frequency wide coverage is no handicap in this application. The second unit is an untuned type which is useable over a wide range of frequencies.

#### Tuned Mixer

The tuned mixer is shown in Fig. 9. The heart of this unit is a coaxial line tuned near the signal frequency; this line was designed with the aid of a Smith Chart.<sup>3</sup>

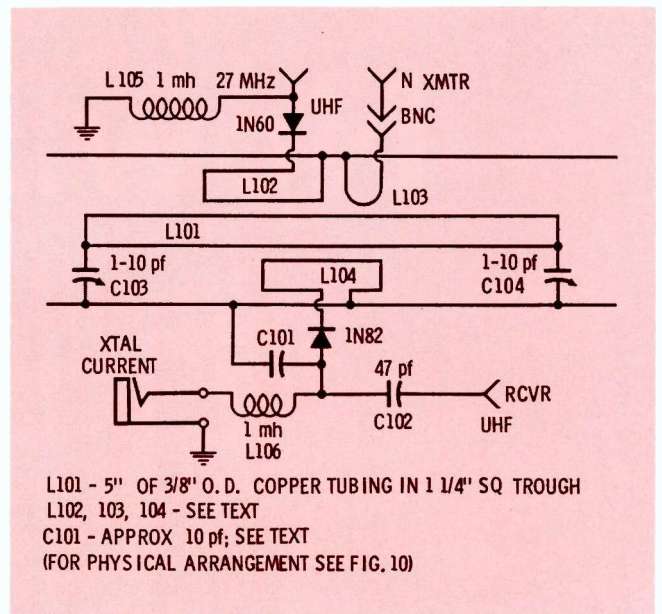

Fig. 9. Mixer coaxial line is tuned near signal frequency.

As is well known, the resonant frequency of an open half-wave line is lowered by adding shunt capacitance at one or both ends. In general:

$$\lambda = \frac{986}{f_o}$$

Where,

$$\lambda = \text{the wavelength in feet}$$

$$f_o = \text{the frequency in MHz.}$$

For WKOW-TV on channel 27,  $f_o = 550$  MHz.

$$\lambda = \frac{986}{550} = 1.8' = 21.6''$$

$$\frac{\lambda}{2} = 10.8''$$

The formula for impedance of a coaxial line with air dielectric is

$$Z_o = 138 \log_{10} \frac{D}{d}$$

where,

$$D = \text{inside diameter of outer conductor}$$

$$d = \text{outside diameter of inner conductor.}$$

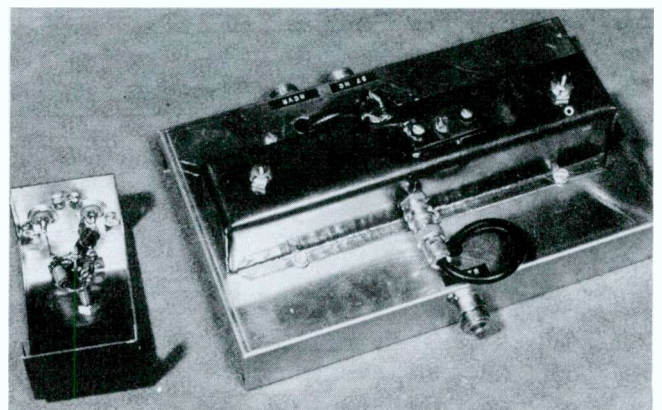
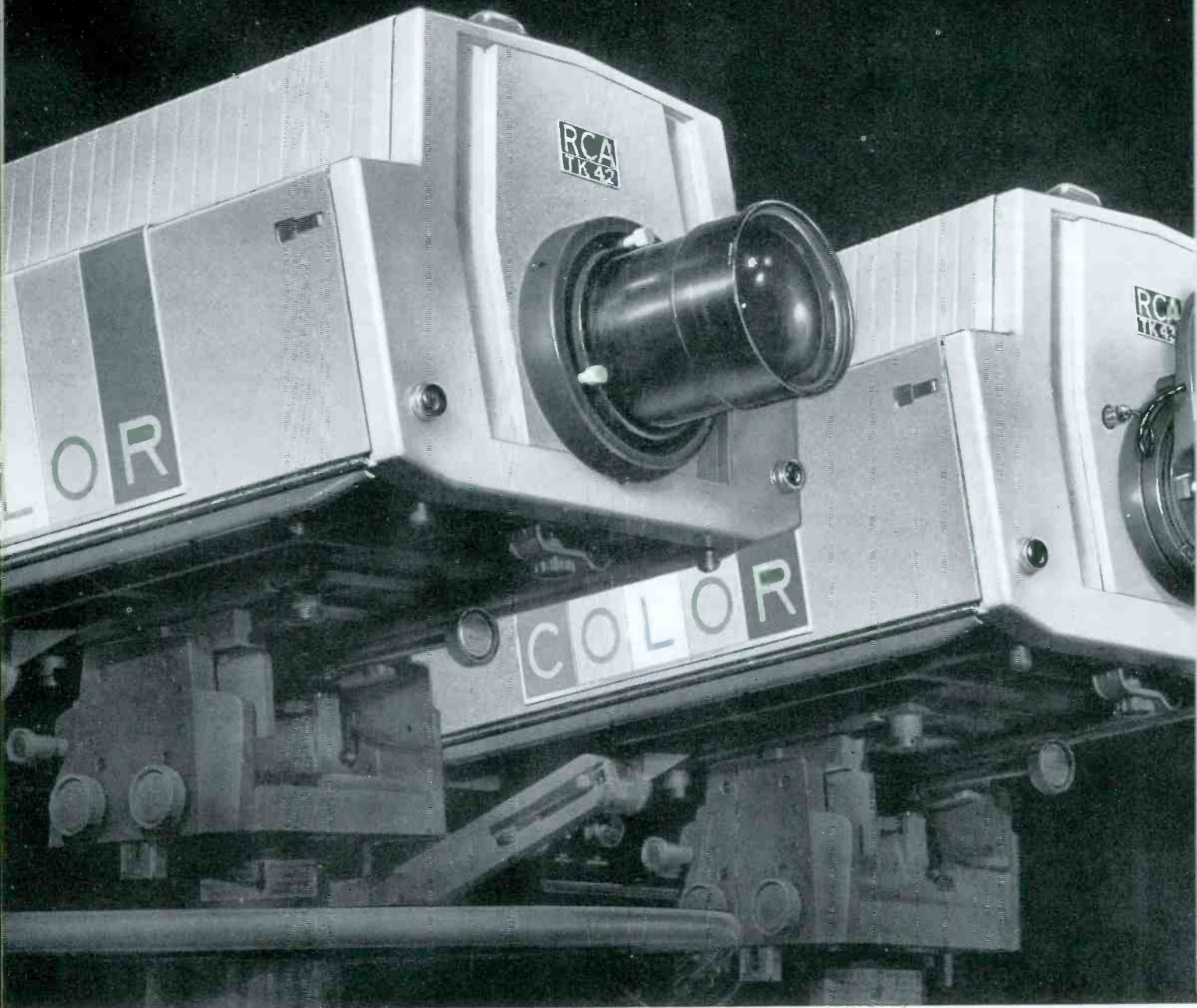

Fig. 10. Untuned mixer is at left; tuned mixer is at right.

# Now...there are



**THE TK-42 DELUXE STUDIO CAMERA** (with internal zoom) —the finest color camera ever offered—with more built-in operating and convenience features than any other. Big 4½-inch-diameter luminance channel tube (nearly 4 times larger than in other cameras) insures best detail, sharpest pictures. I.O. characteristic (the “knee”) handles wider contrast range—provides most brilliant, most exciting pictures. New Type 4536 Tube gives longer life, eliminates burn-in problems. With new field-effect transistorized preamplifiers and other circuit improvements, provides a dramatic reduction in noise level. Available in 1968—adaptor kits for use of lead-oxide tubes in chrominance channels.

**THE TK-43 DELUXE STUDIO CAMERA** (with external zoom) offers all the fine features of the TK-42 with the flexibility of a 10-to-1 lens system. Permits the use of range extenders to triple focal length—from 1.6 inches to 4.8 inches, or from 16 inches to 48 inches. Can also be used with standard fixed focal length lens. Makes one of the most versatile color cameras available. The 1967 models of the TK-42 and TK-43 incorporate many new developments providing improved color tracking, reduced noise level and lower operating cost—part of RCA’s continuing product improvement program. Available in 1968—adaptor kits for use of lead-oxide tubes in chrominance channels.

# 3 RCA "Big tube" live color cameras...

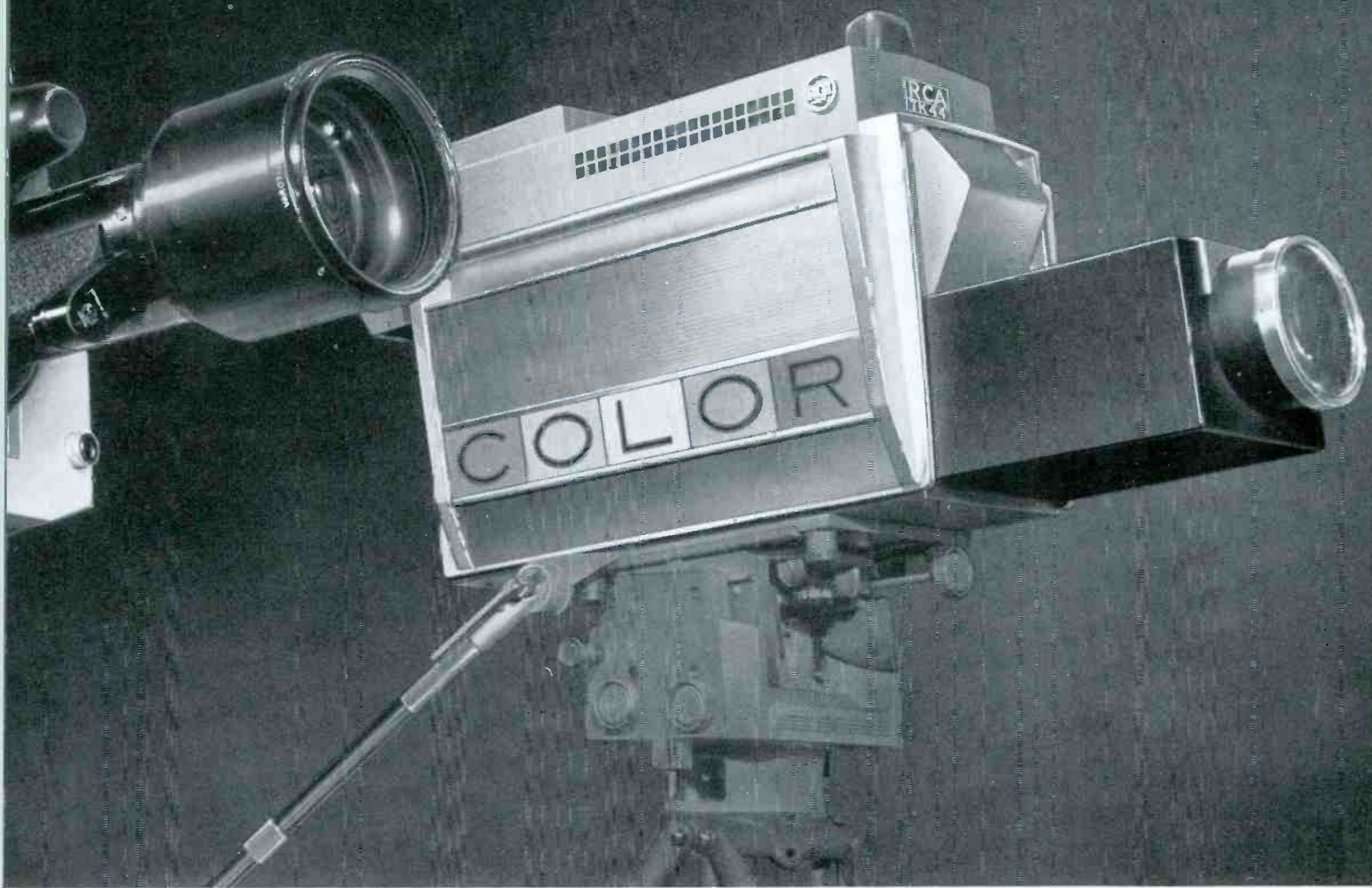

**THE NEW TK-44 "ISOCON" CAMERA**, an entirely new light-weight color camera for those who want the advantage of "big tube" detail and image orthicon performance in a smaller-size unit. Weighs only 140 pounds (exclusive of detachable viewfinder and lens). Ideal for remote pickups and other field applications as well as studio use. The revolutionary new RCA 3-inch Isocon tube in the luminance channel combines inherently low-noise characteristic with the recognized advantage of the I.O. characteristic (the "knee") in handling a wide contrast range. Chrominance channels in production models will employ three lead-oxide tubes. The best of both worlds!

Call your RCA Broadcast Representative. Or write RCA Broadcast and Television Equipment, Bldg. 15-5, Camden, N.J. 08102.



**THE MOST TRUSTED NAME IN ELECTRONICS**

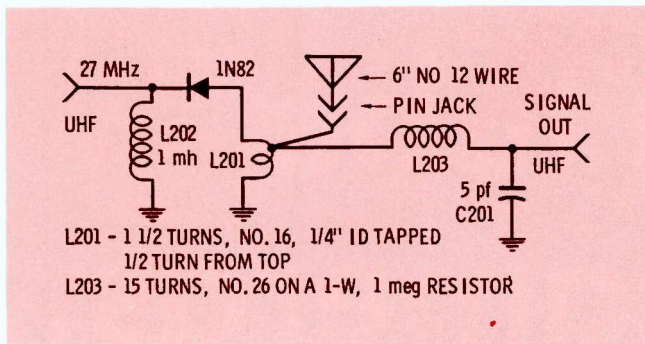

Fig. 11. Single diode in untuned mixer has dual function.

For  $D = 1\frac{1}{4}$ " and  $d = \frac{3}{8}$ "

$$Z_o = 138 \log_{10} \frac{1.25}{.375} = 72 \text{ ohms}$$

Considering practical materials, the inner conductor can be  $\frac{3}{8}$ -inch copper tubing and the outer a  $1\frac{1}{4}$ -inch U-shaped copper trough. Changing the outer cross section from round to square will raise the characteristic impedance to approximately 75 ohms. This is a good figure, since line losses are lowest and Q is highest in this range.

From the Smith Chart it is found that a shorted one-eighth-wave line will have the same resonant frequency as a shorted quarter-wave line if the shorter line is loaded at its open end with a capacitive reactance equal to its characteristic impedance. Similarly, an open quarter-wave line will "look like" an open half-wave line if both ends are loaded.

$$X_c = \frac{1}{\omega C}$$

$$C = \frac{1}{\omega X_c}$$

$$C = \frac{1}{6.28 (5.5 \times 10^8) 75} = 3.86 \mu\text{f}$$

Sufficient information is now known to lay out a practical half-wave line. A 5-inch length of  $\frac{3}{8}$ -inch copper tubing is supported at each end by a 1 - 10  $\rho\text{f}$  glass piston trimmer. This line is centered in the  $1\frac{1}{4}$ -inch copper trough. A  $\frac{1}{4}$ -inch lip is left on each side of the trough so that it may be attached to the chassis with metal screws. If the trough is made about two inches longer than the inner conductor, the ends may be bent down to complete the enclosure with little effect on tuning.

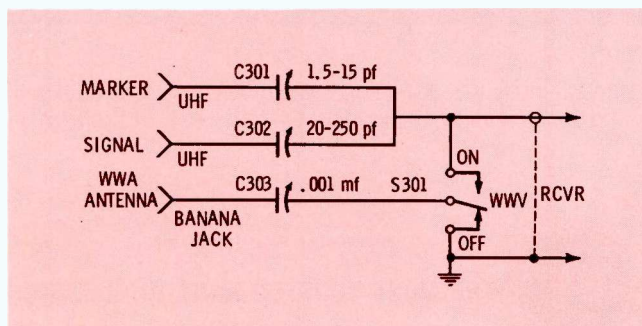

Fig. 12. Combining network is mounted on rear of receiver.

Coupling to the coaxial tank is accomplished by one-turn links near the center of the line. Input from the multiplier is fed to a 1N60 diode multiplier. The diode is located in a  $\frac{3}{8}$ -inch grommet in the side of the outer conductor. A coupling link of No. 18 wire runs parallel to the center conductor for  $\frac{3}{4}$  inch and is then bent outward at a right angle and soldered to the trough. The link is spaced  $\frac{1}{8}$  inch from the center conductor. A sample of RF from the transmission line is fed to a coaxially mounted BNC connector directly across from the multiplier diode (Fig. 10). A link  $\frac{3}{8}$ -inch long is used, and coupling may be varied by rotating the BNC connector.

Output is fed to the 1N82 mixer diode by means of a  $1\frac{1}{4}$ -inch link of No. 20 insulated wire lying against the center conductor. The input end of the 1N82 clips into a pin connector from a loctal socket; the connector is held in place by a small polystyrene block. The RF bypass (C101) is a  $\frac{5}{8}$ "  $\times$   $1\frac{3}{8}$ " piece of copper, insulated from its mounting bracket by two strips of Teflon tape. Six metal screws are used to mount the coaxial-line assembly to a  $5\frac{1}{2}$ "  $\times$  9" chassis.

Provisions are included for monitoring the mixer-crystal current; it should be in the neighborhood of 1 or 2 ma. An RF input level from the transmitter of about 0.2 volt should be adequate, and the crystal current may be adjusted by rotating the BNC connector. Care should be taken to keep the mixer current below 10 ma, or damage to the crystal may result. The coaxial line may be tuned for maximum crystal current, then peaked for best signal output.

#### Untuned Mixer

The untuned mixer (left in Fig. 10) requires fewer parts and is simpler in construction. As shown in Fig. 11, only one diode is used, functioning both as multiplier and mixer. This mixer unit depends on signal radiation rather than direct connection to the transmission line. A 6-inch length of No. 12 wire serves as the pickup antenna.

There are several different signals present in the mixer, and consideration must be given to load impedances and isolation of the important ones. For channel 27, the harmonic of interest is 540 MHz, the 20th harmonic of the 27-MHz multiplier output. This mixes with the 549.24-MHz visual carrier to produce an output at 9.24 MHz, which is fed to the receiver. The multiplier harmonic is developed across L201, while the 1-mhy choke provides DC return for the diode. Choke L203 passes the beat output to the receiver while blocking UHF signals. With the receiver used, no difficulty has been encountered from 27-MHz feedthrough. A parallel-tuned 27-MHz trap following C201 would alleviate any possible problems due to 27-MHz overload of the receiver front end.

This unit has the advantages of compact size and no transmission-line connection being necessary, but it is considerably more critical to drive levels, cable lengths, etc., than the tuned mixer. Hence, it is desirable to have a tuned mixer in operation before attempting to work with the untuned version.

A combining network as shown in Fig. 12 is mounted on the rear of the receiver. Capacitors C301 and C302 are set to give proper range of marker and signal levels.



When engineers get together,  
the conversation turns to pickups.



PHOTOGRAPHED BY FRANZ EASON AT THE CAPITOL TOWER, HOLLYWOOD.

It's an irresistible topic.  
Especially since Stanton came out with the Model 500 stereo cartridge.  
That's an engineer's pickup, if there ever was one.  
Beautiful curve—within 1 db from 20 to 10,000 Hz, 2 db from 10,000 to 20,000 Hz.  
Fantastically small moving system to trace the wildest twists in the groove.  
Light weight (only 5 grams!) to take advantage of low-mass tone arms.  
And, of course, Stanton's legendary quality control.  
No wonder engineers use the Stanton 500 for critical broadcasting  
and auditioning applications.  
And to impress other engineers with their pickupmanship.  
(Available with 0.7 or 0.5-mil diamond, \$30; with elliptical diamond, \$35.  
For free literature, write to Stanton Magnetics, Inc., Plainview, L.I., N.Y.)



These levels are also controlled by the **MARKER LEVEL** and **MULTIPLIER LEVEL** controls. Both trimmers, C301 and C302, will be set at about mid-range. A jack and switch are provided for WWV pickup for oscillator calibration.

### Operation

For operation, the system is interconnected as shown in the block diagram (Fig. 1). With the **MARKER** switch in the 1-MHz position, 5 MHz or 10 MHz is located and WWV is tuned in. The receiver should be set up to receive amplitude modulation with the **AVC** on. If the marker and WWV signals are of nearly equal level, a flutter of the receiver "S" meter will occur as zero beat is approached. The flutter speed will decrease to a slow undulation and finally stop at exact zero beat, with the needle deflected an amount depending on the phase difference and amplitudes of the two signals.

With the WWV antenna off, and tune the receiver to the beat frequency of interest. If this is 9.24-MHz, the 9-MHz marker should first be located. At this point it is best to have the **BFO** on, using a selectivity of 1 or 2 kHz. Change to a 100-kHz marker frequency and tune upward three markers to 9.30 MHz. Switch to 10-kHz markers, and, with the **BANDSPREAD** knob on the receiver, tune down 6 markers to 9.24 MHz. Be sure to count the markers carefully! Turn the **BFO** off and the **AVC** on. The **MULTIPLIER** switch is now turned on to produce a 27-MHz output. Advance the **MULTIPLIER LEVEL** control until a beat between the 9.24-MHz transmitter signal and the marker is heard, or seen

on the "S" meter. If the transmitter is exactly on frequency, it may be necessary to switch transmitter crystals or otherwise shift frequency to see or hear a beat. After checking the transmitter frequency, it is wise to recheck the oscillator with WWV as a safety precaution.

This frequency measurement system is accurate, and when it is used with care, consistent results should be obtained. However, it is emphasized that the equipment must be used with care. When counting 10-kHz markers, it is best to note where the marker of interest is on the **BANDSPREAD** dial, and continue down to the next 100-kHz interval. Switching to 100-kHz markers will still give a marker if you have counted correctly. Switch back to the 10-kHz output and count back up to the frequency of interest; then note that you have returned to the same point on the **BANDSPREAD** dial.

Be sure you are measuring the transmitter frequency and not a spurious output from the exciter, or another signal that may be getting into the receiver. Turn the carrier off and note that the beat disappears. If in doubt about the signal producing the beat, move the master oscillator **FREQUENCY** control. A change of oscillator frequency of 1 Hz will produce a 500-Hz change of beat frequency for a 500-MHz transmitter frequency. Of course, oscillator calibration will have to be compared with WWV after this check. This brings up another point: If a change of 1 Hz of oscillator frequency produces a 500-Hz frequency shift at 500 MHz, this means that a 1-Hz error when checking against WWV at 10 MHz will produce a 50-Hz error in results. This means that the setting at 10 MHz must be made with less than 1-Hz difference to obtain real accuracy in the UHF range. Again, this is not difficult, but it is important, and the comparison must be done with care.

### Conclusion

As was mentioned in the beginning, numerous variations on this design are possible. If measurement of frequencies with carrier offset is not contemplated, the 10-kHz markers could be changed to 50 kHz by changing the last counter to a flip-flop. This would make it easier to avoid confusion when locating the beat frequency. Though no problems have been encountered with these counters, the use of other configurations may suit some builders. Flip-flops in a decade arrangement would certainly offer excellent stability. While the counter design dates back a few years, the multiplier chassis replaces an earlier tube-type unit and is of recent design.

The equipment described may be duplicated, or the reader can use the material in this article as the basis for a design to suit his own particular tastes. In any case, it is hoped that the design philosophy offered herein will be of aid to anyone contemplating construction or usage of frequency-measurement equipment. ▲

### References

4. Millman and Taub, *Pulse and Digital Circuits*, New York: McGraw-Hill Book Co., 1956, p. 327 ff.
5. Gerald L. Hall, "Smith Chart Calculations for the Radio Amateur," *QST*, Jan. and Feb. 1966.
6. "432-mc Converter," *The Radio Amateur's Handbook*, 1955 to 1960 Editions, American Radio Relay League, West Hartford, Conn.



CUSTOM 12"  
also available in  
STANDARD 12" or 16"

## Shhhh... Quiet Please!

Today, critical listening is the name of the game. Audiences have become extremely "sound conscious". So are QRK Professional Turntables. "Sound Consciousness" is the reason a QRK has only 3 rotating parts and special vibration isolators. That's why a QRK offers a minus in rumble that is far below NAB minimums. And, that's not all. Add ultra-acceleration, effortless control, sustained performance with practically NO maintenance and there's only one thing you can do . . . Shhhh . . . just quietly see your Dealer today or write or call us for complete information.



**QRK ELECTRONIC PRODUCTS**

2125 N. Barton, Fresno, Calif. 93703

Telephone: 209/255-8383 or 209/229-6128

Circle Item 44 on Tech Data Card

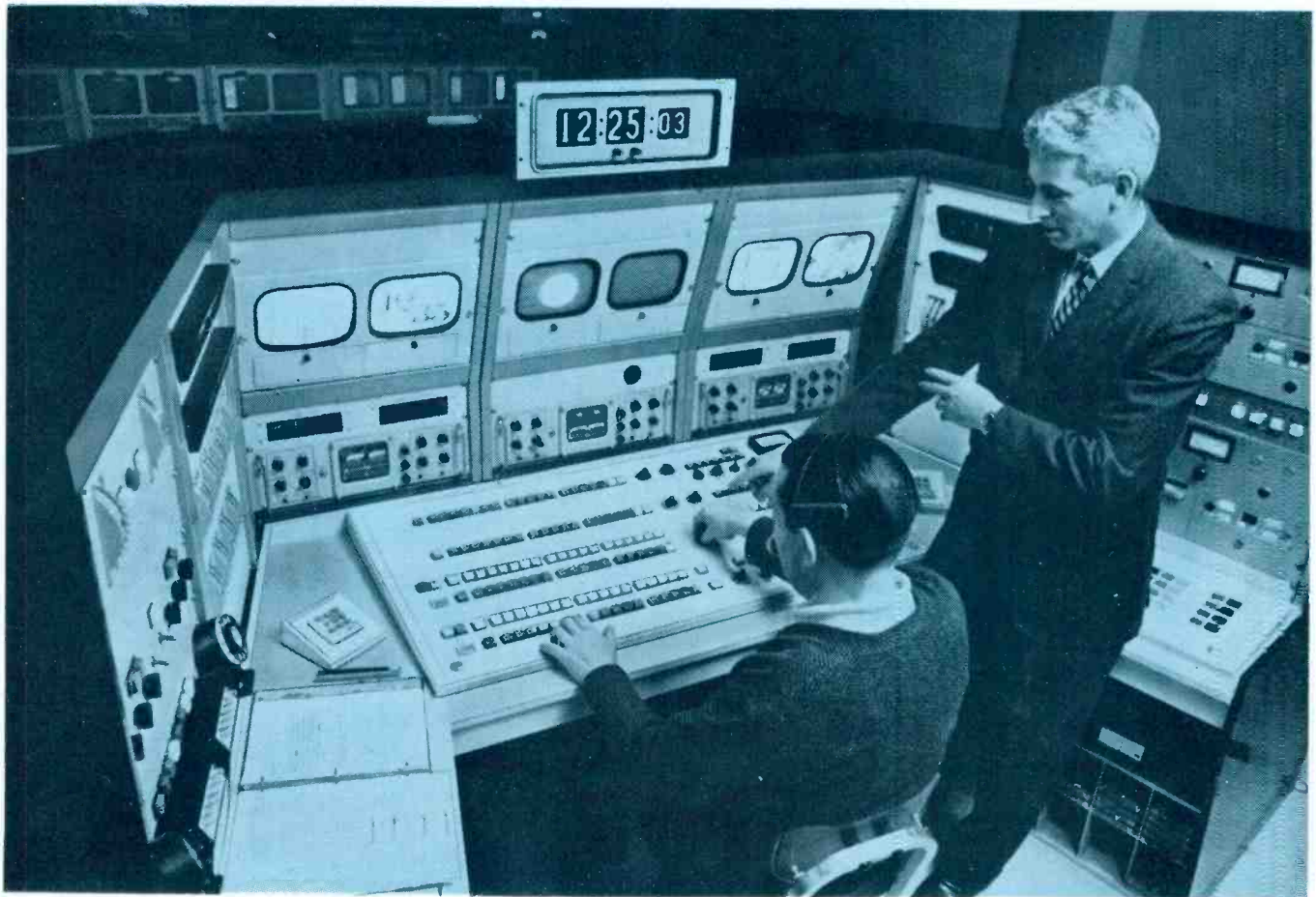

Typical of the customized concept in Visual solid-state Video Switchers is this system installed at WHYY-TV, Philadelphia. Used for switching Channels 12 and 35 WHYY's Master Control Switcher incorporates preset 16-event store, audio-follow-video and audio breakaway facilities, independent switcher busses to five VTRs, program and preview feeds, full machine control, and audio-video monitoring and preview facilities.

## CUSTOMIZED SOLID-STATE MODULAR VIDEO SWITCHERS

### another key to better color

The key to Visual Electronics' unquestioned leadership in advance-design video switching systems is our belief that there is no such thing as a "packaged" switching system in today's complex color broadcasting operation. Instead, your system is *customized* to your exact requirements. Your *customized* system is completely solid-state, including FET (Field Effect Transistor) mixing and clamp circuitry of modular design — for long, minimum-maintenance operation, unlimited accessibility, and flexibility for future expansion. Regardless of the program complexity, the number of input sources and switchable feeds, or the previewing and monitoring facilities required . . . your *customized* solid-state Visual Video Switcher is designed to meet those needs!



**VISUAL ELECTRONICS CORPORATION**

356 west 40th street • new york, n.y. 10018 • (212) 736-5840

**FIRST BY ANY STANDARD**



hp  
TDR  
shows...

42' of 75-ohm cable to a defective house tap.

50' down the line, capacitive defect caused by water in cable.

66' farther is inductive fault caused by spliced line.

110' from the splice, the cable has been deformed by sinking concrete wall.

55' from deformation is open caused by open termination.

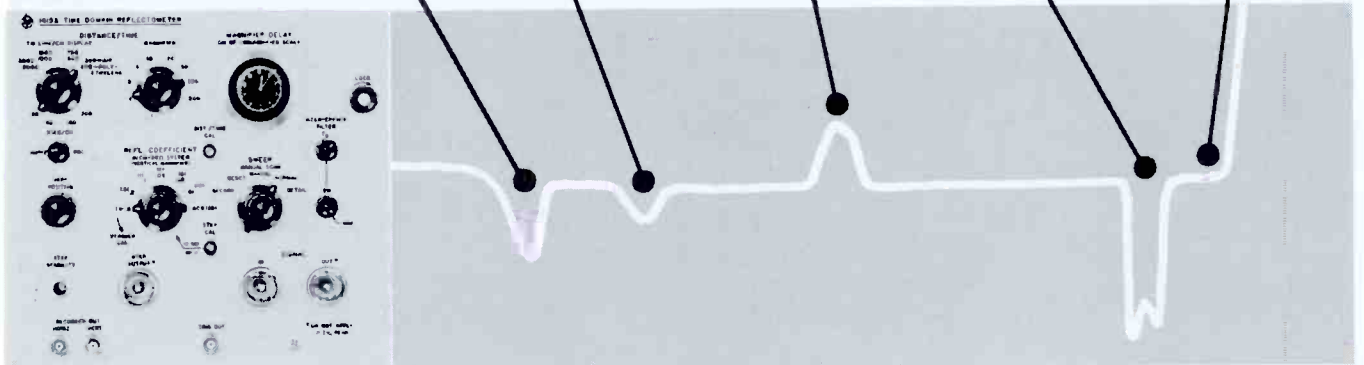

## CABLE FAULT GUESSWORK ENDS HERE

*Improve Picture Quality,  
Quickly Identify and Locate  
Cable Faults with hp TDR*

Spend your time on the air . . . not up in the air! With hp's 1415A Time Domain Reflectometer you save time and money because you can (1) quickly locate and identify cable faults, (2) detect faults *before* they can cause downtime, (3) get your system back on the air much sooner in the event of a sudden crippling fault, and (4) consistently maintain high picture quality.

When mated with an hp 140A oscilloscope mainframe, the 1415A TDR plug-in gives you a graphic picture of cable quality—and such faults as shorts, opens, loose connectors, defective tapoffs, splices and mismatched terminations with high sensitivity and resolution that detects faults separated by inches. The standard 1415A-140A system locates faults in a 600' cable to within 5 per cent of the actual distance from the test point. Option 14 can test a 3000' polyethylene cable (6000' if both ends are accessible).

The 1415A-140A is a completely self-contained system which consists of a step generator, single-channel vertical amplifier, and a time base. The system sends a step voltage into the cable, then accurately displays reflections on the CRT. A slide rule is provided for conversion to other dielectrics. Prices: TDR plug-in 1415A, \$1050; 1415A with Option 14,

\$1150; 140A mainframe, \$595; 141A mainframe with variable persistence and storage, \$1395.00.

Extensive "how to" information is available in hp Application Note 67. Complete specifications on the 1415A TDR plug-in and 140A-141A mainframes are contained in Data Sheet 140A. Ask your hp field engineer for a copy, or write to Hewlett-Packard, Palo Alto, California 94304; Telephone (415) 326-7000; Europe: 54 Route des Acacias, Geneva.

**hp140A—The Scope System that gives you**



**20 MHz Wideband • High-Sensitivity, no drift • 150 ps TDR  
12.4 GHz Sampling • Variable Persistence and Storage**

**HEWLETT**  **PACKARD**  
An extra measure of performance

See it at NCTA Show/Booth 216!

087/22

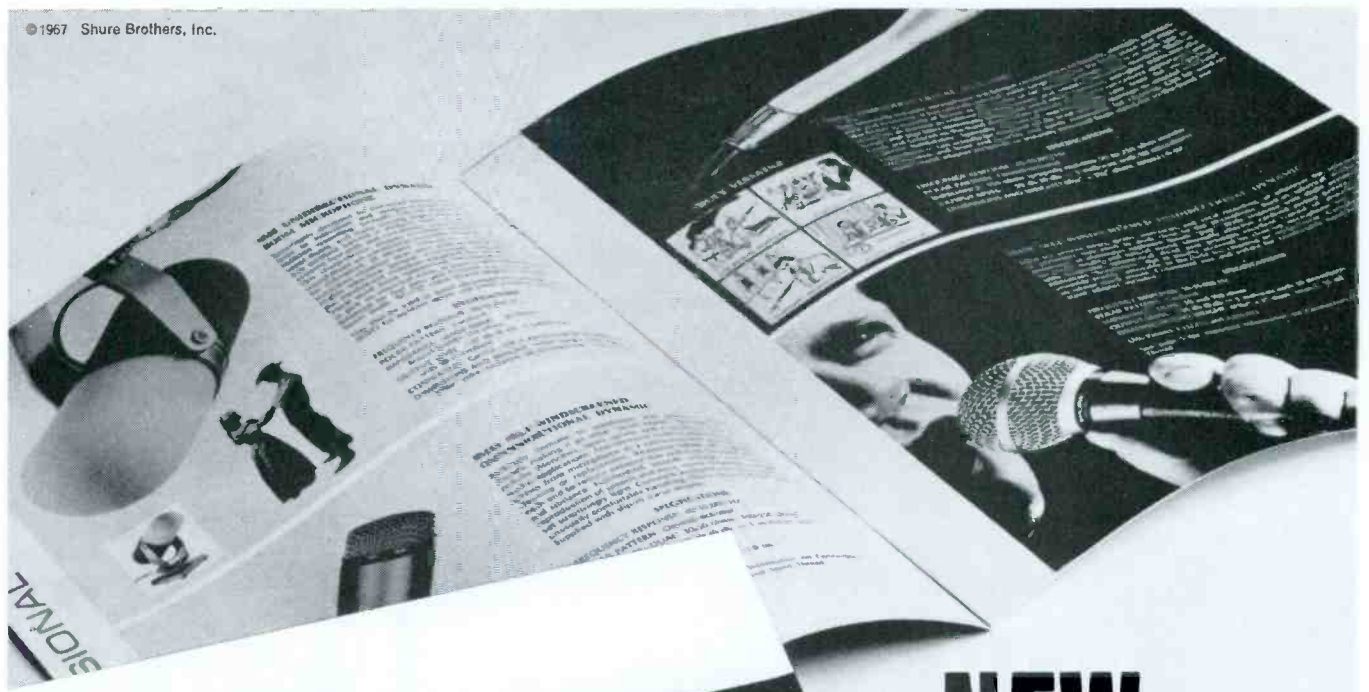

# NEW CATALOG!

SHURE BROTHERS, INC.  
222 Hartrey Ave., Evanston, Ill. 60204

Attention: MR. ROBERT CARR—Manager,  
Professional Products Division

YES! I'm interested in seeing all the new Shure Professional Microphones, Circuitry, Cartridges, Tone Arms, Etc. Send me your new catalog. (AL No. 312)

NAME \_\_\_\_\_

COMPANY \_\_\_\_\_

ADDRESS \_\_\_\_\_

CITY \_\_\_\_\_ STATE \_\_\_\_\_ ZIP \_\_\_\_\_



## difficult installations made easy

The long continuous lengths of HELIAX® coaxial cable make any type of installation possible. Whether across a vast ravine or up the tallest tower, the installed cost is less. Corrugated inner and outer conductors absorb all stress. Andrew connectors firmly anchor both conductors to eliminate electrical problems. Consult your Andrew sales engineer or write Andrew Corporation, P. O. Box 807, Chicago, Illinois, U.S.A. 60642.



870-foot self-supporting catenary installation of 5-inch HELIAX air dielectric coaxial cable (Type HJ9-50) at mountain top site of Station KBYU-TV, Provo, Utah.

**Andrew**  
CORPORATION

30 YEARS OF ENGINEERING INTEGRITY

10-66

Circle Item 13 on Tech Data Card

June 1967

We interrupt this magazine to bring you. . .

## Late Bulletin from Washington

by Howard T. Head

### Dissension Over New Propagation Curves

It appears the Commission is not likely to reach a decision in the near future concerning the adoption of new field strength vs distance curves for use in the FM and television broadcast bands (see January 1967 Bulletin). The proposed curves met with opposition from substantial segments of the broadcasting industry, and there is even disagreement concerning them among members of the Commission staff.

Many industry engineers contend the new curves do not represent a significant improvement over the existing curves, particularly those for VHF television. Filings with the Commission also emphasized the impact on the industry wherever the propagation curves are involved. Not only are they used to estimate the service areas of FM and television broadcast stations, but they are applied to such matters as selection of transmitter sites, common ownership of two or more stations, and the application of the CATV carriage and nonduplication rules. The distances to the coverage contours of television stations would generally be smaller using the new curves, in some instances by as much as five to ten miles.

The Commission also is considering a proposal to permit the use of field-strength measurements in individual FM and television cases. The present Rules provide for the acceptance of such measurements in general rule-making proceedings only. It is expected that if the Commission should adopt new curves, a proposal for the use of field-strength measurements in individual cases would be forthcoming at the same time.

### Channel 6 Stations Report Interference From FM Operations

In comments filed on the proposed new Technical Standards governing non-commercial educational FM broadcast stations (88-92 MHz, channels 201-220 -- see January 1967 Bulletin), television stations have reported numerous instances of interference to the reception of signals on channel 6 (82-88 MHz). Although the Commission's Notice had expressed the belief that most interference to channel 6 reception arose from stations in the lower part of the noncommercial educational FM band, reports were received of interference from throughout that band.

Available television-receiver measurement data indicate that the expected reduction in interference with increasing frequency separation from the television-channel band edge is largely absent. This appears to be particularly true in the case of color receivers, especially in regions where the television signal is moderately high, and cross-modulation products are likely to occur.

Several parties filing comments have proposed a temporary "freeze" on the use of the noncommercial educational FM band within the service areas of channel 6 television stations, until the nature and severity of the interference can be investigated in greater detail.

#### Television Broadcasters Oppose CATV Carriage

The National Association of Broadcasters (NAB) has opposed a group of applications filed by American Television Relay, Inc., (ATR) for a microwave system reaching from Los Angeles, California to Brownsville, Texas, a distance of 1400 miles. The ATR system would deliver the signals of the Los Angeles television stations to numerous CATV systems in Arizona, New Mexico, and Texas. A number of Texas television broadcasters joined in the NAB objections.

Television broadcasters near the Canadian border are encountering problems with respect to the Commission's CATV nonduplication Rules, which provide local television stations with 24-hour nonduplication protection from cable carriage. A substantial number of syndicated and even network programs are released in Canada prior to their release in the U.S., thus permitting CATV systems carrying Canadian stations to provide programs in advance of their showing on U.S. stations. The Commission is being urged to modify the nonduplication Rules to prohibit this practice.

#### Short Circuits

The Commission has launched an inquiry aimed at making 40 MHz of frequency space available for land mobile operation, to be carved from either the lower or upper end of the UHF television broadcast band (470-890 MHz); Commissioner Lee dissented on the ground that even the inquiry would hamper the growth of UHF television. . .The Commission is expected to act favorably on a pending EIA request for another year's waiver of the Rules restricting local-oscillator radiation from UHF television receivers; by the time the new waiver runs out, half the country's sets will have all-channel capability. . .NAB has asked the Commission to permit test and experimental operation of FM transmitters during the regular broadcast day. . .Studies by the Commission Chief Engineer have shown that sharing of the 4-gHz and 6-gHz microwave bands by earth and space services may lead to unexpected severe interference caused by common volume scattering.

Howard T. Head. . .in Washington





**Superior's new  
COMM/SCOPE DIVISION  
provides total  
CATV System capability**



Headed by Vern L. Coolidge, well-known and respected systems consultant, the Comm/Scope Division can handle all your requirements . . . from survey to subscriber. This total CATV system service includes preliminary planning, system engineering and system construction.

As investments in CATV systems become more sizeable, it becomes more and more essential to call upon people who are experienced, knowledgeable and practical.

If you're planning to build a new system; if you're rebuilding or expanding an existing system, get the facts from Comm/Scope.

*For complete information, write or call COMM/SCOPE DIVISION*



**SUPERIOR CABLE**

SUPERIOR CABLE CORPORATION • HICKORY, NORTH CAROLINA 28601  
704-328-2171

# VALUE • Integrity • Performance

LET'S GET OUR HEADS TOGETHER . . .

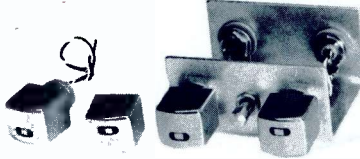

**REPLACEMENT HEADS FOR  
ATC, Collins, Gates, MaCarta,  
RCA, Sparta, Spotmaster, Tape-  
caster and other brands.**

MMI has Heads for Cart Machines



**MINNEAPOLIS MAGNETICS, INC**

2915 Huntington Avenue Minneapolis, Minnesota 55416

Circle Item 16 on Tech Data Card

## What's so hard about erecting a tower?

## You just order the steel and connect the pieces...right?

# WRONG!

There's more to it than putting pieces together like so many "TINKERTOYS." Building a tower isn't child's play. Just watch our engineers at work and you'll see what we mean. They're on the construction site from the beginning of the survey to completion of your tower—making sure every detail is perfect. But even when the job is done we don't forget you. Our engineering service is available to make periodic checks throughout the life of your tower. Our customers say it gives them a nice feeling of security. And it gives us the reputation of being the leader in tower construction.

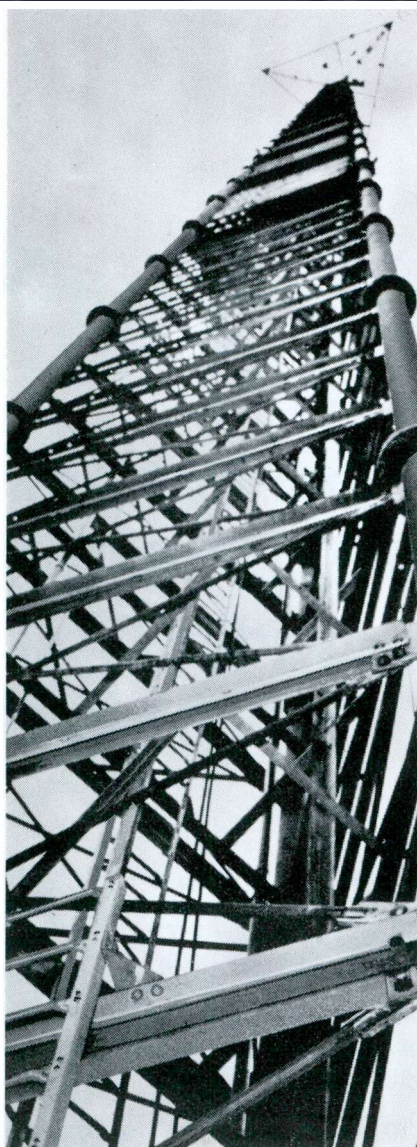

**DRESSER**

**CRANE, HOIST & TOWER DIVISION**

FORMERLY DRESSER-IDECO CO. • ONE OF THE DRESSER INDUSTRIES

879 MICHIGAN AVE., COLUMBUS, OHIO 43215

Phone area 614 299-2123 • TWX 810-482-1743

Branch: 2314 Redondo Beach Blvd., Gardena, Calif. 90247 • TWX 910-346-6338

Circle Item 15 on Tech Data Card

## BOOK REVIEW

**Transistor Circuit Analysis and Design:** John J. Corning; Prentice-Hall, Inc., Englewood Cliffs, New Jersey; 466 pages, 6" × 9", hard cover; \$14.65.

This volume has been written both for technicians and for engineers. From it the reader can learn the principles of circuit analysis and how they are employed to design transistorized devices.

The book begins with a study of semiconductor physics. This includes discussion of semiconductor materials, junction phenomena, and fundamentals of transistor action.

From the theoretical aspect the author moves to an evaluation of semiconductors as real things. This includes review of operating parameters such as voltage, current, and temperature coefficient, and leads to study of transistor static characteristics, biasing techniques, and ultimately to AC equivalent circuits.

The bulk of the work is given to actual transistor circuit design and deals with high- and low-frequency amplifiers, oscillators, pulse circuits, and power supplies.

The concluding chapter involves a number of laboratory experiments with various semiconductor devices and appropriate instruments. The object is to provide an opportunity to become familiar with the phenomena and characteristics of various semiconductor types.

In the appendix are presented a few data sheets from manufacturers. These are to acquaint the reader with the sort of material which is available to the circuit designer.

Algebra and some knowledge of electrical circuits are the requisites for putting this book to work. It has been written to provide all essential material and is easy to read and understand. At the end of each chapter are meaningful questions and answers which help the reader to determine whether he has grasped the material which he has read. ▲

# How would you shrink 180 feet of video cable into one foot?

Shrinking video cable into delay lines is really no great task. The real challenge is in maintaining bandwidth of video broadcast quality. Kappa Networks has met this challenge successfully through a new design approach which yields greater delay-bandwidth from fewer components.

Designed specifically for the video broadcast industry, Kappa Super-η (high efficiency) Delay Lines provide superior performance with the same number of components needed by conventional lines. Alternatively, if performance is held equal to that of conventional lines, Kappa Super-η need far fewer (up to 40% less) components. Consequently they can realize maximum reduction of size and cost where necessary, as well as greatest inherent reliability.

Finally, outstanding uniformity in performance is a marked feature of Kappa Super-η Video Delay Lines. This assures that prototypes are consistently typical of production quantities.



## SPECIFICATIONS: KAPPA MODEL 10A503 SUPER-η DELAY LINE

### ELECTRICAL

Delay:	(replaces 180 ft. of cable)
Impedance:	75 ohms $\pm$ 2%
Insertion Loss:	1.5 db.
K Factor:	less than 0.25% for sin <sup>2</sup> "T" pulse
Cross Talk:	less than 46 db.

### MECHANICAL

Size:	12" x 7/8" x 7/8"
Case Material:	Electro-tinned brass
Finish:	Mil-spec gray lacquer
Mounting:	(2) 6-32 threaded inserts
Price:	Under \$100
Delivery:	4 weeks

AMPLITUDE

Scale:  
0.1 db  
per  
division

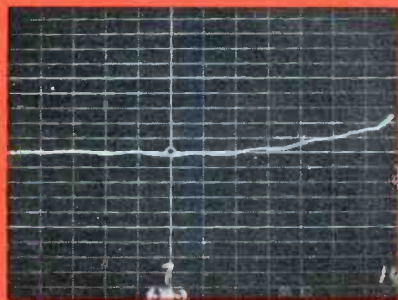

Amplitude Response: Flat within 0.1 db to 12 MHz  
Ripple: Within  $\pm$ .02 db to 12 MHz

GROUP DELAY

Scale:  
5 nano-  
secs.  
per  
division

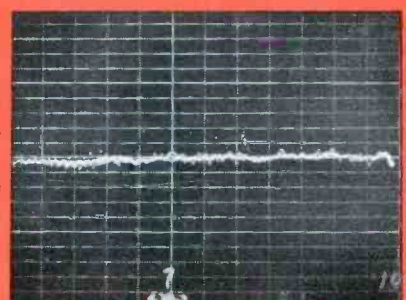

Group Delay Slope: Linear within  $\pm$  0.5% to 12 MHz  
Group Delay Ripple: Within

For prompt engineering assistance call us collect at (201) 541-4226.

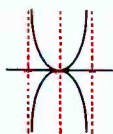

For prompt engineering assistance call us collect at (201) 541-4226.  
**KAPPA NETWORKS, INC.**

Delay Line Specialists • Manufacturing Engineers

165 ROOSEVELT AVENUE • CARTERET, NEW JERSEY 07008 • TEL. (201) 541-4226

World's largest manufacturer of broadcast quality delay lines.

chise in January, 1966. The facility is expected to cover both the Hong-kong and Kowloon areas with 2 UHF channels—one in English and the other in Chinese.

## NATIONAL

### 1000-Ft. CATV Tower

A thousand-foot tower with a 500-square-foot platform on top containing 10 television antennas has been built and tested in operation by **Andrews Towers, Inc.**, for **Community**

**Television Cable Corp.**, near Fort Myers, Florida. The triangular, solid-rod, guyed tower was welded in 20-foot sections and bolted together during normal erection procedure.

The tower was designed to withstand hurricane winds in excess of 150 miles per hour. Since all antennas had to be at the top of the tower, it was necessary to construct a modified hexagon-shaped platform some 28 feet in diameter, containing some 500 square feet of space. The platform contains a guard rail around the

perimeter and is used in servicing the antennas.

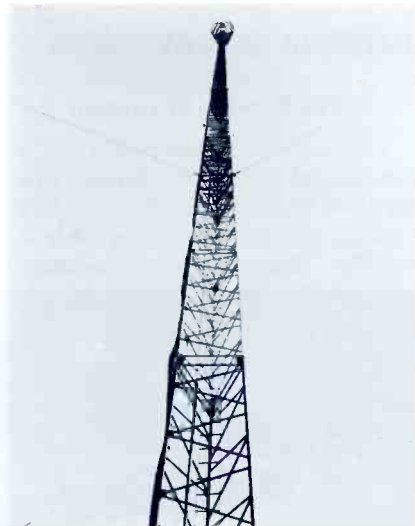

### Name Change

**Viking Industries, Inc.** has changed its name to **VIKOA, Inc.** The new name was recommended by the corporation's board of directors and approved at the stockholders' annual meeting. The name was changed to avoid confusion with other companies using the name Viking.

The company was originally incorporated as **Rego Insulated Wire Corp.** in 1960. Later, when emphasis was shifted from wire products to include active electronic equipment, the name was changed to **Viking, Inc.**

### Chairman Hyde Honored

Rosel H. Hyde, chairman of the Federal Communications Commission, has been named recipient of the 1967 Ballington and Maud Booth Award, given annually by the **Volunteers of America** for outstanding service to the nation. Presentation of the award to Mr. Hyde, who has been associated with the FCC since its creation in 1934, was made at the 71st anniversary dinner of the Grand Field Council, in Portland, Oregon.

The FCC chairman was chosen for the award for his long devotion to the advancement of electronic communications, and for his leadership in the development of educational television.

### Color Vision Theory Challenged

The classic theory that the eye sees color by means of red, green, and blue cones in the retina has been challenged. During a panel discussion on systems analysis and biological systems at the

# Spotmaster

## Multiple Cartridge Playback Units

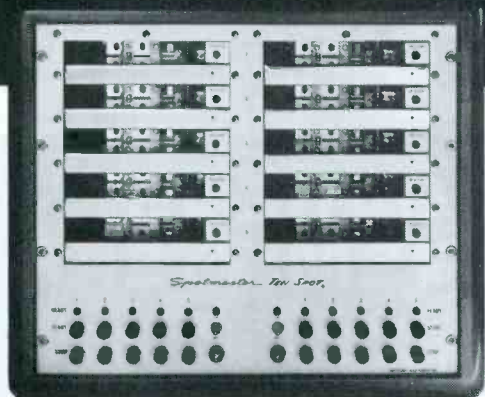

Ten • Spot Model 610B

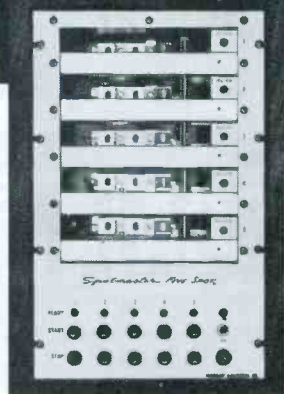

Five • Spot Model 605B

## ... bringing a new dimension to pushbutton broadcasting

Spotmaster Ten • Spot (holding 10 cartridges) and Five • Spot (holding five) will reproduce any NAB Type A or B cartridge instantly at the push of a button . . . at random or in sequence. They may be operated manually or incorporated into programmed automation systems, using one, two or three NAB standard electronic cueing tones.

The Ten • Spot is designed for 19" rack mounting while the Five • Spot is available either in an attractive walnut-finished case or with a 19" front panel containing a cartridge storage cubicle. Both are backed by Spotmaster's iron-clad full-year guarantee.

For further information about these and other Spotmaster cartridge tape units, call or write today. *Remember, Broadcast Electronics is the No. 1 designer/producer of broadcast quality cartridge tape equipment . . . worldwide!*

## BROADCAST ELECTRONICS, INC.

8810 Brookville Road, Silver Spring, Maryland 20910; Area Code 301, 588-4983



# COLOUR STARTS HERE

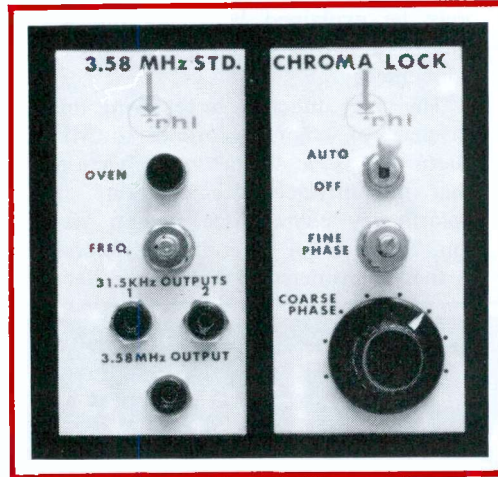

## COLOUR OSCILLATOR (Model 52520G)

Here is the origin of the colour subcarrier and the signals for frequency control of the master oscillator during colour operation. The entire precision crystal oscillator is housed in a dual cavity oven where closely controlled temperature ensures excellent frequency stability. The front panel provides a control for adjustment of oscillator frequency and a tally light indicates oven operation.

## CHROMA LOCK (Model 52520H)

In this unit the remote colour video signal is sampled, the colour subcarrier burst gated out and also fed to the sync lock module. The gated burst, applied to a discriminator, is compared to the local 3.58 MHz signal and the error voltage, if any, used to control the crystal oscillator. The Chroma Lock is controlled from the sync lock and operates only when monochrome frame lock is established.

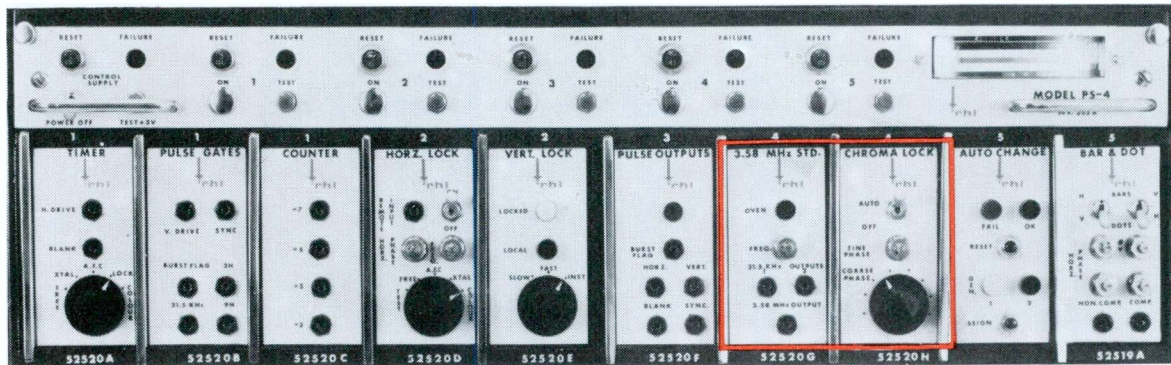

## SYNCHRONIZING PULSE GENERATORS (SG Series)

This is a complete line of pulse generating and control modules for monochrome and colour operation, in station master control, closed circuit systems and mobile operations. Computer logic techniques are employed in the all solid state circuitry. Optimum stability and trouble-free performance over long periods of time is assured by

conservative design and high quality components. Other features include low power consumption, minimum space requirement, modular plug-in construction and the inclusion of an optional bar and dot generator. The RHL SG Series of Synchronizing Pulse Generators are available as portable units.



FOR COMPLETE DETAILS AND SPECIFICATIONS WRITE

**RICHMOND HILL LABORATORIES LIMITED**

1610 MIDLAND AVENUE, SCARBOROUGH, ONTARIO

1967 IEEE International Convention. George Biernson, of the **Sylvania Electric Products, Inc.** Applied Research Laboratory presented evidence that the eye may perceive color by detecting rhythmic optical modes or patterns in the cones. Mr. Biernson likened these optical patterns to the vibrations of a drum. "When a drum is struck, complicated vibration patterns are excited over the drum head. Similarly, colors generate patterns of light energy over the cone, the patterns varying with the wavelength of the light," he explained.

"Although the retina of the eye superficially may appear similar to the photosensitive surface of a television camera, which operates on the three-color principle, the two are radically different from a feedback point of view," Mr. Biernson stated. "The

photosensitive surface of a television camera is a static device with fixed characteristics, whereas the retina of the eye is a dynamic device employing complex feedback-control processes."

"The eye, which can discriminate among 10 million colors, is superior in color detection to television or photography which distinguish only a few hundred," Mr. Biernson stated. "The greater color fidelity of the eye may be explained better by optical modes or patterns than by the three-cone theory."

The chief difficulty in resolving the mystery of color, according to Mr. Biernson, is a mistaken conviction that the three-color calculations of colorimetry characterize human vision. "What is not generally understood is that colorimetry is merely a collec-

tion of standards indirectly related to psychological reality," he continued. "In fact the standards were derived by extensive averaging of very crude experimental data."

### Fire Destroys Transmitter Facility

The five transmitters of international broadcast station **WNYW** were destroyed April 9 by fire at the transmitter site in Scituate, Massachusetts. Three replacement transmitters, one 50-kw, one 20-kw, and one 10-kw unit, were shipped to Scituate on a rush basis by **Gates Radio Co.** The 10- and 20-kw units will be used only until two 100-kw transmitters, also to be supplied by Gates, have been delivered.

Before the fire, four 50-kw HF transmitters and one 80-kw transmitter were used with high-gain an-

# Here's A Better Idea!

A NEW CONCEPT IN CARTRIDGE HANDLING!

## The SPARTAMATIC Multi-Cartridge Systems

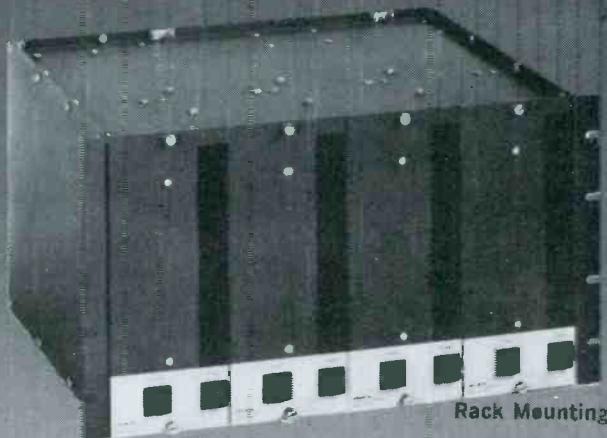

Rack Mounting

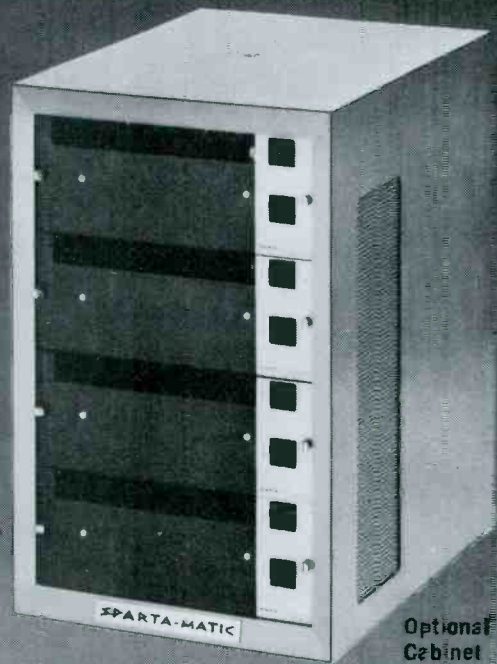

Optional Cabinet

The SPARTAMATIC MC Series is bound to change your idea of dependable cartridge playback operation. The possibility of total system failure has been eliminated. Each of the four playback modules contains a separate direct drive motor, capstan tape transport system, and separate transistorized electronics. Not one, but two DC power supplies are provided.

**INCREASED FLEXIBILITY, TOO!** The MC Series operates smoothly and quietly in either of the configurations shown above. Both monaural and stereo models are available. Add optional conveniences like remote control and automatic sequencer, second and third NAB auxiliary tone cues, and four channel audio switcher. These are ideas you can profit by! Call or write Sparta for complete information now!

# SPARTA ELECTRONIC CORPORATION

5851 FLORIN-PERKINS ROAD • SACRAMENTO, CALIFORNIA • 383-5353

Circle Item 22 on Tech Data Card

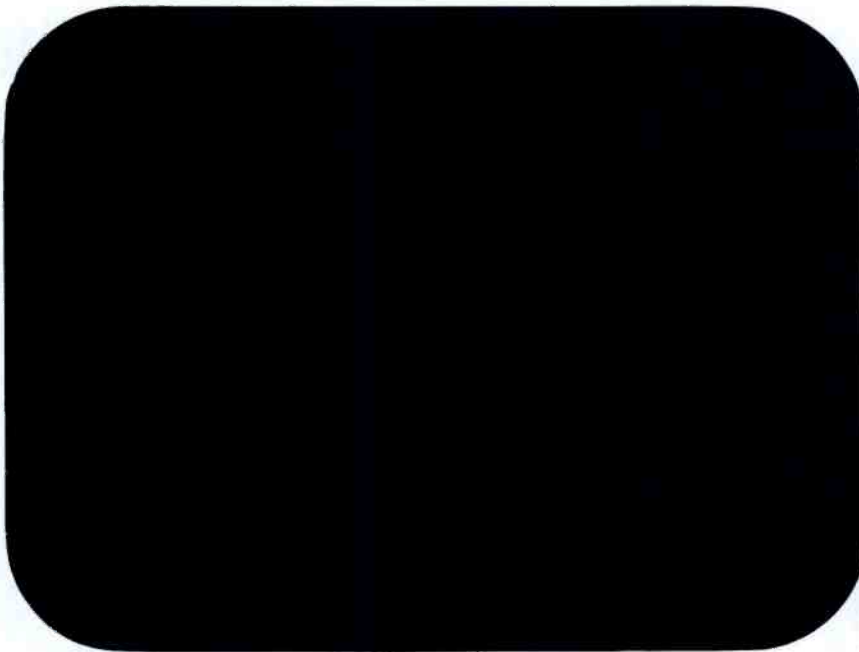

**Cold camera**

*WE TOLD  
WBAL-TV  
30 SECONDS—  
THEY NOW TELL US  
3 SECONDS  
IS PLENTY!*



**on the air in ~~30~~ seconds at WBAL-TV.**

*3*

The MTI Image Orth is a problem solver at WBAL-TV in Baltimore. Crash news programs can be on camera in seconds with a flick of the switch. No need to interrupt camera crews who might be in the middle of a taping session. Operational set-up is minimal too. Here's how WBAL-TV makes use of the MTI Image Orth.

Camera is aligned and locked in fixed position in a small announce booth studio. Few lights are used due to the excellent

low-light capabilities of the camera. And as a result, no additional air conditioning facilities are required. While desk and chair are fixed furnishings, backdrop can be quickly changed to fit any presentation situation.

WBAL-TV engineers claim camera needs little maintenance, has good depth of focus and needs trimming only once per week. Low light levels do not affect picture quality.

You might have other uses for a camera of this size and quality. If so, give us a call. We'll have a sales engineer to see you quickly—but not as quickly as the MTI Image Orth warm-up period.



**mti MARYLAND TELECOMMUNICATIONS, INC.**

York & Video Roads, Cockeysville, Md. / 301-666-2727 / World's largest manufacturer of low light level television cameras.



Performing  
**35**  
 years  
 behind  
 the scenes

### RCA BROADCAST SERVICE

Broadcasters' repair, modification, and overhaul needs are strictly behind the scenes. And RCA Service Company experts keep on providing service to keep all your broadcast equipment operating at peak performance. Take advantage of RCA's experience in AM, FM & TV servicing—on a contract or per-call basis.

Dial either of these offices for full information about fast, dependable RCA service:  
 Chicago (312) WE 9-6117  
 Philadelphia (215) HO 7-3300

If you prefer, write:  
 Technical Products Service

**RCA Service Company**  
 A Division of  
 Radio Corporation of America  
 Industrial Center, Camden, N. J. 08101



tennas to broadcast to Latin America, Africa, and Europe.

The studios for **Radio New York Worldwide** (the name by which WNYW is known) are located in the former CBS Network headquarters in New York City.

### Subsidiary Operation Suspended

Operation of the **Teletronix Division of Babcock Electronics Corp.** has been suspended, according to an announcement by the parent company. Plans to have the division's products distributed by **Broadcast Supply, Inc.** (April 1967 **BROADCAST ENGINEERING**, p. 48) have been cancelled. Inventory and manufacturing rights to the Teletronix LA-2A levelling amplifier have been sold to **Studio Electronics**.

### WWV & WWVH Time Announcements

Beginning at 2100 UT (Universal Time) on April 28, 1967, the voice announcements on the broadcasts from NBS standards stations WWV (Fort Collins, Colo.) and WWVH (Maui, Hawaii) have given the time which is current at the Greenwich Meridian in England rather than the current standard time in either local zone. This change was made to avoid misunderstandings about what is meant by Mountain Standard Time and Hawaiian Standard Time. It also was made because Greenwich Mean Time is already used by many WWV and WWVH listeners.

### ORGANIZATIONS

#### NAB

The National Association of Broadcasters has announced opposition to two proposed FCC Rules. The first is a proposition to reduce channel width from 100 kHz to 50 kHz in the 450.5-451 MHz and 455.5-456 MHz bands presently used for aural remote pickup. The proposed split would leave the same number of channels - 20 - for broadcast use but would create 20 new channels for the land-mobile service. NAB comments indicate concern over the effect the proposal would have on future growth and development of this auxiliary service. It recommended that the new channels be retained for use by commercial broadcasters.

The other proposed rule would require class-C FM radio stations to

now... a dozen tools  
 for dozens of jobs  
 in a hip pocket set!



No. 99PS-50

Really compact, this new nutdriver/screwdriver set features 12 interchangeable blades and an amber plastic (UL) handle. All are contained in a slim, trim, see-thru plastic case which easily fits hip pocket. Broad, flat base permits case to be used as a bench stand. Ideal for assembly and service work.

#### 7 NUTDRIVERS:

3/16", 7/32", 1/4",  
 9/32", 5/16", 11/32"  
 3/8" hex openings.

#### 2 SLOTTED SCREWDRIVERS:

3/16" and 9/32" tips.

#### 2 PHILLIPS SCREWDRIVERS:

#1 and #2 sizes.

#### EXTENSION BLADE:

Adds 4" reach to driving blades.

#### HANDLE:

Shockproof, breakproof. Exclusive, positive locking device holds blades firmly for turning, permits easy removal.

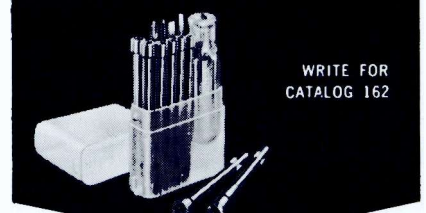

WRITE FOR  
 CATALOG 162



XCELITE, INC., 118 Bank St., Orchard Park, N. Y. 14127

Circle Item 24 on Tech Data Card  
**BROADCAST ENGINEERING**



increase power to 50 kilowatts where less power is now being radiated. The broadcast group expressed its belief that the requirement would impose "an unnecessary burden and hardship" on present licensees in the form of substantial expenditures for major equipment changes.

NAB did not oppose a 50-kw requirement for new class-C stations.

### NAEB

In comments filed with the Federal Communications Commission on a proposed rule-making by the FCC to create a table of assignments for educational FM channels 201 through 220, the National Association of Educational Broadcasters stressed the need for such a table. NAEB underscored the importance of "having a number of types of educational radio stations . . . high power, wide coverage facilities, all designed to accomplish distinctive educational goals."

NAEB, the statement continued, has been concerned for some time with the "potential inefficiencies" involved in many 10-watt operations and feels these outlets should be encouraged to expand their operations.

The association suggested that 10-watt outlets be authorized on channels specified in a nationwide Table of Assignments but which are not in use for educational FM operations at the regular authorized power.

### SMPTÉ

The 101st Technical Conference of the Society of Motion Picture and Television Engineers closed April 21 after a record attendance exceeding 3500 at the New York Hilton Hotel. There were 1600 persons registered for the paper sessions, and an additional 2000 passed through the equipment exhibit, which had 90 displays. One of the highlights of the week's conference activities was an appearance by MPPA President Jack Valenti.

Education and its use of motion pictures, television, and other audio-visual techniques were heavily emphasized in the technical conference. A full day of education papers divided between a morning and an afternoon session was scheduled. The sessions reflected the increasing importance of audio-visual aids in

education, and the development and use of film and television systems in various educational complexes.

Other sessions included papers and demonstrations of new equipment in the fields of motion pictures, television, instrumentation and high-speed photography, and on the subjects of space technology and sound. The semiannual technical conference closed with a day-long session on film and television techniques in medicine.

The next SMPTÉ Conference is set for the Edgewater Beach Hotel in Chicago, September 17-22.

### PERSONALITIES

A new broadcast sales engineer, **Jerry Bowers**, has joined the **Collins Radio Company**. Mr. Bowers will serve Georgia and all of Florida (excluding the western tip).

Another Collins Representative, **Ray Evans**, has had his territory of Arkansas, Mississippi, and Louisiana expanded to include Alabama and the western tip of Florida.

**Mr. T. J. Lyons** and **Mr. N. C. Cox, Jr.** have been assigned as regional sales managers for the **Superior**

# Help stamp out dropouts

## Clean tape heads with MS-200\*

Oxide dust on tape heads and helical scan recorders is a frequent source of dropouts. Some engineers still clean them the hard way, with Swabs, but many have found a better way: MS-200 Magnetic Tape Head Cleaner. MS-200 sprays away dust and dirt in seconds. You can even apply it safely while the tape is on the air. Finally, users report more than twice as many passes of tape between cleanings with MS-200 as with swabs. Recommended by leading tape manufacturers. Write on letterhead for literature and free sample.



**ms** miller-stephenson  
chemical co., inc.

ROUTE 7, DANBURY, CONNECTICUT  
\*U.S. and foreign patents pending

Circle Item 25 on Tech Data Card

# SUPER SOUNDS start with FAIRCHILD

start  
with



New FAIRCHILD 42 input TV Network Mixer.



## FAIRCHILD MASTER TAPE IMPROVEMENT SYSTEM

FAIRCHILD MTIS with "focused-gap" head design reduces bias-induced noise to a point where it is no greater than 2 db than the noise of virgin or bulk-erased tape. FAIRCHILD MTIS has an S/N ratio of 72 db on one track of a 4-track 1/2" tape. FAIRCHILD MTIS increases the recording level by 4 db over present standards, with the lowest harmonic, intermodulation, and cross-modulation distortion of only .5%. Only the FAIRCHILD MTIS comes in a compatible, convertible package allowing you to update your present tape transports to the highest quality "state-of-the-art" recording standards.



## FAIRCHILD CONAX

The world-accepted standard to control high frequency spillovers due to pre-emphasis. Maintain high levels even with brass and crashing cymbals in FM and recording.

## THE REVERBERTRON

The new compact reverberation system which gives your station that real big voice. With the Reverbertron you can have that Carnegie Hall effect as close as the gain control on the Reverbertron. And there's the added plus of an increase in apparent loudness of your station sound due to reverberation, as originally described by Dr. Maxfield.



## FAIRCHILD COMPACT COMPRESSOR MODEL 663

Allows creation of those up tight levels that contribute materially to presence and loudness combined with overload protection. The FAIRCHILD Model 663 Compact Compressor produces no distortion despite the amount of compression used... no thumps, no noise. The 663 provides adjustable release time and up to 20 db of compression. Model 663NL comes with unity gain and additional gain if needed with +18 dbm output.



## FAIRCHILD PROGRAM EQUALIZER MODEL 664NL



An ideal no loss equalizer for broadcast and recording. The FAIRCHILD Model 664NL allows the production of the "hot, solid commercial" sound standard with major recording studios; transforms any conventional console into 'Big Board sound'. 1 1/2" x 5 1/4" high unit provides equalization up to 10 db at 4, 6, 8, 10, or 15 KHZ and low end equalization up to 10 db. Rolloffs also provided. The Model 664NLB has equalization at 2, 3, 4, 5, and 7.5 KHZ for motion picture demands. The FAIRCHILD Program Equalizer contains equalization plus 18 dbm amplifier output. Put life into your sound with the FAIRCHILD Equalizer.

## FAIRCHILD LIMITER MODEL 670

Fast attack Stereo Limiter (50 microseconds) with low distortion and absence of thumps. Sum and difference limiting position eliminates floating stereo image. Includes regular channel A and B limiting. Dual controls, dual meters provided. Used throughout the world. Flexible release times make it indispensable in stereo recording and broadcasting.



Write to FAIRCHILD — the pacemaker in professional audio products — for complete details.

# FAIRCHILD

RECORDING EQUIPMENT CORPORATION  
10-40 45th Ave., Long Island City 1, N. Y.

Cable Corp. Mr. Lyons will serve the newly created Midwest region, and Mr. Cox will cover the Atlantic region.

## TRANSACTIONS

Electro-Voice and Gulton Industries, Inc. have reached agreement in principle on the acquisition of Electro-Voice by Gulton. The transaction is subject to the execution of a detailed agreement, to the approval of the directors of both companies, to the approval of the stockholders of Electro-Voice with respect to the entire transaction, and to the approval of the stockholders of Gulton with respect to the authorization of new preferred stock. It is presently contemplated that the transaction will be completed in July of this year.

## OBITUARY

Mr. G. Kurt Butenhoff, 36, president of Ward Electronic Industries, was killed in an automobile accident on March 19. Mr. Butenhoff had been an executive with Riker Industries, GE, and RCA, and had been with Ward from its inception. He is survived by his wife and four children. ▲

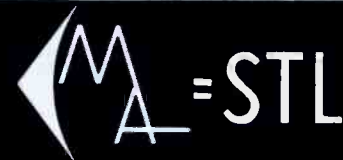

## THE MOSELEY FORMULA

Don't accept our prejudiced view. Ask owners of Studio-Transmitter Links for a recommendation.\* They will come up with a formula too . . . OURS.

\*Write us for the call letters of stations near you that own Moseley aural STL equipment.

# MOSELEY

ASSOCIATES, INC.  
135 NOGAL DRIVE  
SANTA BARBARA, CALIFORNIA  
(805) 967-0424

Circle Item 26 on Tech Data Card

Circle Item 27 on Tech Data Card

BROADCAST ENGINEERING

# NEW PRODUCTS



**Audio Tape Recorder**  
(80)

The new Teac Series R-310 tape recorder, sold by **Sparta Electronic Corp.**, has been designed to provide fully professional facilities at a cost considerably less than other machines with its features. These features include push-button operation, cue button, tape lifters, automatic shut-off, index counter, tape tension switch, and remote control facility.

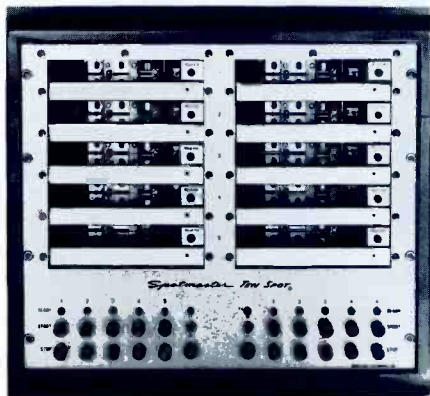

**Multiple Cartridge Reproducer Units**  
(81)

Model 610B Spotmaster Ten Spot (610B) and Five Spot (605B) multiple cartridge reproducer units have been designed by **Broadcast Electronics, Inc.** for use in broadcast stations, recording studios, and other installations requiring the use of multiple cartridges. Both units are capable of manual operation or may be incorporated into programmed automation systems making use of one, two, or three NAB standard cueing tones. Each cartridge deck is removable from the front of the unit without affecting the operation of the remaining decks. A flywheel loaded common capstan supplies tape motive force, the flywheel in turn being driven by a

heavy duty hysteresis synchronous motor. Each reproduce channel is separately equipped with cueing amplifier(s) and a program amplifier with output level adjustable to plus 4 dBm by means of locking-type controls. All amplifiers are plug-in modular units. Enclosed plug-in relays are used throughout. Prices begin at \$1,750.00.



**Graphic Equalizer**  
(82)

A new graphic equalizer featuring up to 10-dB boost or attenuation and no insertion loss is available from **Melcor Electronics Corp.** Known as Model GE-20, the unit is an active, lossless, multichannel graphic equal-

## SPOTMASTER

The all solid state AD1A

# AUDIO DISTRIBUTION AMPLIFIER



Meet the AD1A, a solid state audio distribution amplifier specifically designed for AM, FM and TV broadcast stations and recording studios. The AD1A distributes audio signals via five separate output channels (up to 25 with the addition of AD1A-X extenders), and incorporates a front-panel VU meter and monitor jack to permit visual and aural monitoring of the incoming signal at the output of the line amplifier. Response is essentially flat from 40 to 20,000 Hz, with low distortion and noise, 60 db channel isolation and 12 db peak factor. For further information, write or call today:

**Spotmaster**  
**BROADCAST ELECTRONICS, INC.**  
8810 Brookville Road  
Silver Spring, Maryland 20910  
Area Code 301 • 588-4983

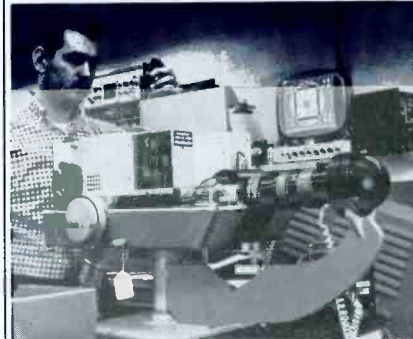

## Photo Research introduces an easier, faster, more accurate way to test TV cameras . . .

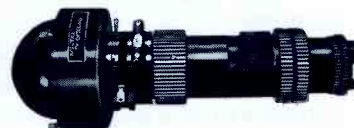

### The SPECTRA TV OPTOLINER\*

is a high resolution, precision TV camera tester that saves space by eliminating the elaborate test equipment formerly used for this operation. Now being used by RCA in their Burbank production facilities, the Optoliner attaches directly into the camera lens mount and provides microscopic alignment (within 0.002") of the slide mounted test patterns to the center of the camera lens. Ideal for use in production facilities, quality control operations or in standards labs, the Optoliner contains a constant, adjustable light source, and a special meter to indicate the exact illuminance and color temperature falling on the face of the camera tube. For more information on this simplified approach to TV camera testing, write, wire or phone today!

\*Trademark of Photo Research Corp.



Karl Freund,  
President

**PHOTO RESEARCH corp.**  
"Photometric Equipment for Science and Industry"

837 N. Cahuenga Blvd., Hollywood, Calif. 90038  
Telephone: (213) 462-6673 Cable: SPECTRA

Circle Item 29 on Tech Data Card

**Replace  
857B  
tubes  
directly  
with  
lifetime**

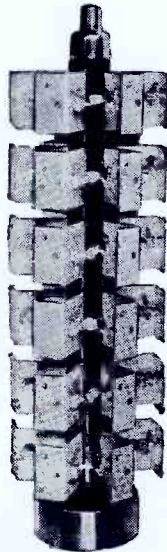

**WILKINSON**

**36-16 Silicon  
Rectifier Stacks!  
Because...**

- Wilkinson 36-16 Silicon Rectifier Stacks virtually last forever.
- Immediately repairable in minutes.
- Eliminate arc-backs, pre-heating and warm-up time.
- Eliminate filament transformer and auxiliary heaters.
- Operate from  $-85^{\circ}$  to  $+185^{\circ}\text{F}$  ambient.
- "Go-No Go" instantaneous proof of performance.

Only **\$475**

**(less than the cost of a filament transformer .. and you don't need them!)**

**SPECIFICATIONS:** Model SR-36-16 replaces tube type 857B PRV repetitive 36 KV. PRV transient 42 KV. RMS current 16 amp. Surge current 1 sec. 160 amps. Forward voltage drop 25V.

For complete details on Wilkinson Silicon Rectifier Stacks, write on your company letterhead today to:

**WILKINSON  
ELECTRONICS, INC.**

1937 MACDADE BLVD. WOODLYN, PA. 19094  
TELEPHONE (215) 874-5236 874-5237

Circle Item 30 on Tech Data Card

izer which modifies the sound characteristics of audio information in discrete frequency bands.

The complete equalizer consists of several independent plug-in channels, a mounting frame, and a 24-volt DC power supply. Since each channel operates as a separate entity, the user may employ one or any number of channels up to the seven available. The complete system is simply a cascade of the individual channels.



**Color Synchronizing Generator  
(83)**

Computer technology has been applied to a broadcast color synchronizing generator by TeleMation, Inc. This design concept provides time-base stability accomplished by utilizing a high-frequency "clock" in conjunction with fast-rise logic cir-

**SPOTMASTER  
Solid-State Portable  
REMOTE  
AMPLIFIER**



The RA-4CA is a lightweight, four-channel portable mixer amplifier specifically designed for remote broadcast or auxiliary studio use. It is completely self-contained and operates from either AC or batteries (switching automatically to battery operation if AC power fails); runs as long as 200 hours on low-cost "D" cells. It offers four microphone channels with master gain and P.A. feed, all controlled from the front panel. Lightweight construction (just 11 pounds with batteries), a convenient carrying handle and a snap-on front cover mean the RA-4CA can be easily set up to operate anywhere. For further information, please write or call today:

**Spotmaster  
BROADCAST ELECTRONICS, INC.**

8810 Brookville Road  
Silver Spring, Maryland 20910  
Area Code 301 • 588-4983

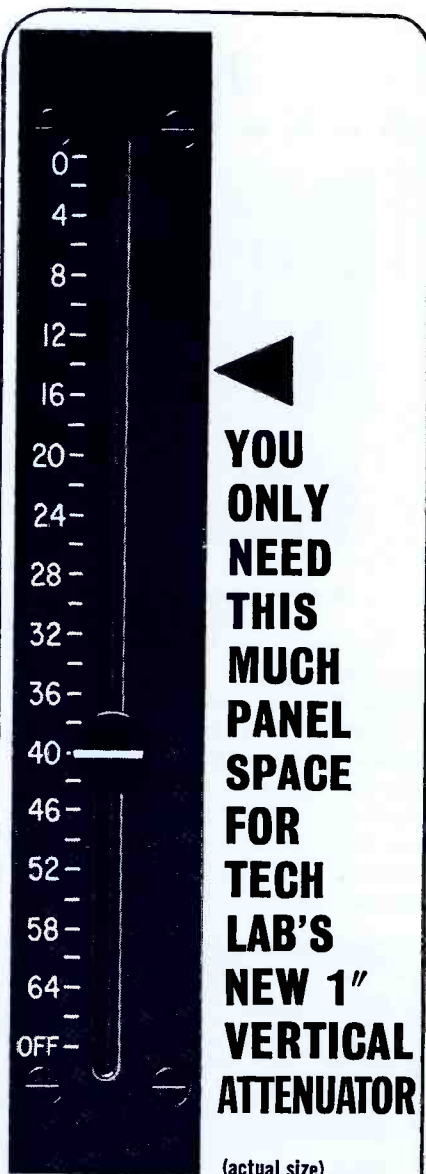

**YOU  
ONLY  
NEED  
THIS  
MUCH  
PANEL  
SPACE  
FOR  
TECH  
LAB'S  
NEW 1"  
VERTICAL  
ATTENUATOR**

(actual size)

Here's the smallest vertical attenuator made in the U.S.A. . . . another first from Tech Labs, pioneers in vertical attenuators since 1937.

It uses little panel space . . . only 1" wide x 6" long. It provides quick change of levels on multiple mixers and assures long, noise-free life. Units are available in 20 or 30 steps with balanced or unbalanced ladder or "T", or potentiometer circuits. Standard Db per step is 1.5, others on order. Impedance ranges are 30 to 600 ohms on ladders or "T's" and up to 1 megohm on pots.

Don't wait, send for complete data today!  
**Need Video or Audio Rotary Attenuators?**

All Tech rotary attenuators are precision made for extended noise-free service. Many standard designs available and specials made to your specs. Send for literature today.

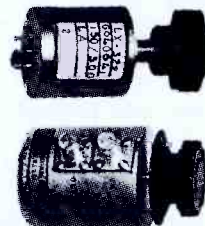

**TECH LABORATORIES, INC.**

Bergen & Edsall Bldgs., Palisades Park, N.J. 07650  
Tel: 201-944-2221 • TWX: 510-230-9780

Circle Item 31 on Tech Data Card

BROADCAST ENGINEERING

*More than ever before . . .  
the soundest sound in FM  
is the new sound of Gates*

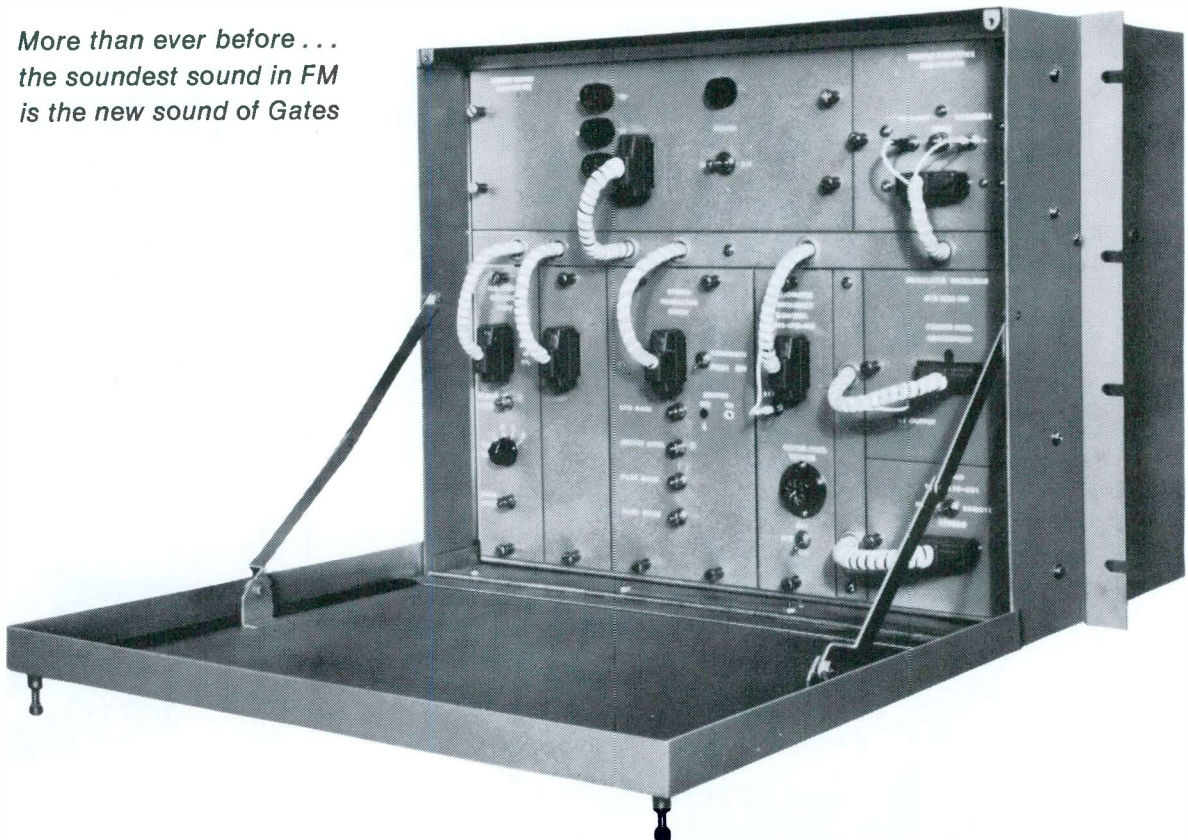

FM-250H  
250 watts

FM-1H  
1KW

FM-3H  
3 KW

FM-5H  
5 KW

FM-7.5H  
7.5 KW

FM-10H  
10 KW

FM-20H  
20 KW

FM-40H  
40 KW

## **FM BROADCASTING BREAKTHROUGH: “DCFM”(direct carrier frequency modulation) in a new 100% solid-state 10-watt exciter**

One-tube, 1KW; two-tube, 3KW; two-tube 5KW; two-tube, 10KW and three-tube, 20KW transmitters! Eight brand-new FM transmitters, all made possible through a Gates engineering breakthrough — a solid-state exciter employing “DCFM” (direct carrier frequency modulation) where modulation occurs at carrier frequency.

The new Gates exciter is self-contained, of modular construction. It is the heart of all new Gates “H” Series FM transmitters.

All “H” models are FCC-type accepted, and available for prompt delivery.

For complete descriptive brochure, write today.



# **GATES**

GATES RADIO COMPANY  
QUINCY, ILLINOIS 62301, U.S.A.  
A subsidiary of Harris-Intertype Corporation



We think we're entitled to roar about the hands-off operation of EMCEE VHF and UHF Translators. No fuss, no bother . . . EMCEE Translators almost operate themselves to improve color coverage or extend your signal to a new audience. And they're virtually maintenance-free!

The performance-proven superiority of EMCEE Translators is probably best demonstrated by the leading broadcasters who have specified EMCEE 5-to-1 for over six years.

**EMCEE Television Translators**  
1, 5, 10, 100 Watt and 1 KW  
FCC type accepted

Dept. BE-6



**EMCEE BROADCAST PRODUCTS**, a division of  
**ELECTRONICS, MISSILES & COMMUNICATIONS, INC.**  
160 E. 3rd Street, Mt. Vernon, N. Y. 10550

Circle Item 34 on Tech Data Card

cuitry. Since all transistors are clock derived, the use of monostable multivibrators is eliminated.

Specifications include, overall time-base stability better than 5 nanoseconds, and subcarrier phase jitter less than 0.5 nanosecond when compared with sync and drive pulses. A bidirectional constant-rate color genlock circuit is designed to produce negligible picture disturbance when switched "on air."

The basic monochrome generator is priced at \$1000. The color generator, including built-in color standard is \$1500; with color genlock it is \$2000.

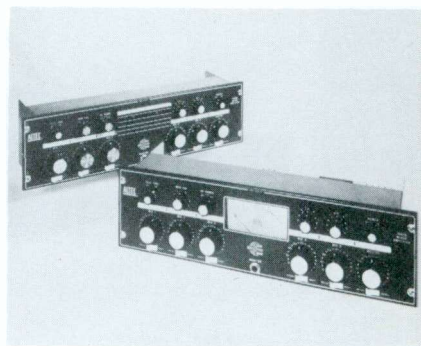

**Mixer-Amplifier**  
(84)

The solid-state 1592A mixer-amplifier has been added to the Altec

**3 NEW HEADS IN  
YOUR AMPEX**

**FOR LESS THAN \$100.00**

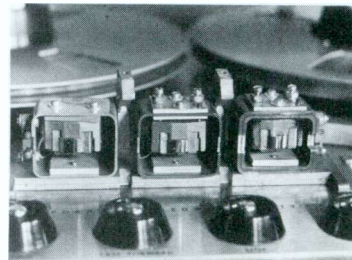

Our heads are manufactured under controlled laboratory conditions and are guaranteed to meet or better original equipment specifications. All products must pass exacting quality control tests on Ampex equipment at our plant. We will put three new full track or half track heads in your Ampex assembly for \$97.50. We will deliver your assembly back to you by return mail. We have loaner assemblies for your use if you need them. We will put four new heads in your Ampex VTR audio assembly for \$310.00. Send for Brochure.

**TABER**

Manufacturing and Engineering Co.  
2619 Lincoln Ave., Alameda, Calif.  
94105

Circle Item 35 on Tech Data Card

**BROADCAST ENGINEERING**

**Lansing** line of professional broadcast and recording equipment. Equipped to control and mix up to five independent input signals, this unit is for use in recording, broadcast, and PA applications.

Plug-in units are available for impedance matching, pre-amplification, and equalization. This allows any of the five inputs to be used for low or high impedance microphones, magnetic phonograph pickups, or high level line sources. In addition, each channel has its own speech/music switch to provide dialog equalization. A normal-bright rectifier, associated with the master gain control, provides a rise in response in the three-to-five kHz region, to improve articulation.

**"Experimenter's Kits"  
For Control Circuits**

(85)

Solid-state "Experimenter's Kits" from which to build 24 different electronic control circuits using transistors, silicon controlled rectifiers, thermistors, and photocells, are now available from **RCA**. The kits allow experimenters to build such practical electronic control devices as speed controls, electronic timers and time-delay switches, warning flashers, chargers for 6- and 12-volt batteries, light dimmers, sound-operated switches, light- and heat-activated controls, and overload and synchronous switches. A comprehensive 130-page manual, the RCA Controlled Rectifier Experimenter's Manual KM71 also is available. The manual describes the construction of fourteen single-kit control circuits and ten control circuits using two basic kits. ▲

*If you missed the  
triumphant NAB showing of our*

## New Color Camera

FOR LESS THAN \$18,000

Attend the second showing at  
**MARK HOPKINS HOTEL**  
Regency Room  
San Francisco, June 13-15

A notable color achievement

- 4-tube performance with 3-tube simplicity
- Model 100 for film chains, Model 200 for live-pick-up

Although there will be subsequent regional showings, deliveries of the Model 100 are already stretching out.

**Packard Bell**

NEWBURY PARK, CALIFORNIA 91320  
TELEPHONE (805) 498-6601



Circle Item 37 on Tech Data Card

June, 1967

**KEEP TOMORROW'S  
NEEDS IN MIND  
TODAY WITH BELAR**

**ADD-ON  
MONITOR  
SYSTEM**



The Belar ADD-ON MONITORING SYSTEM allows the broadcaster to fulfill his monitoring requirements as the needs arise. The basic unit is the FMM-1 Frequency and Modulation Monitor for monaural use, and when requirements call for SCA, add the plug in SCAM-1 SCA unit. And for stereo the FMS-1 Stereo unit completes the system.

Today's monitoring requirements make this system a must.

**BELAR** ELECTRONICS LAB.  
Delaware & Montrose Avenues  
Upper Darby, Pa. 19082

Circle Item 36 on Tech Data Card

**THE  
ADD-ON  
IS  
COMPLETE**

Pilot Frequency  
38 KC Suppression  
L + R Crosstalk  
L - R Crosstalk  
AM Noise or Inc. AM

The FMS-1 monitors and measures:

Total Modulation  
L + R Modulation  
L - R Modulation  
Pilot Amplitude  
Left or Right Channel

A stereo station must—the Belar FMS-1 monitors the 19 KC pilot frequency as well as all the modulation characteristics of FM stereo. The advanced solid-state circuitry guarantees that all FCC performance requirements for stereo monitors are exceeded so that precise, accurate proof-of-performance measurements can be made for the finest in stereo broadcasting.

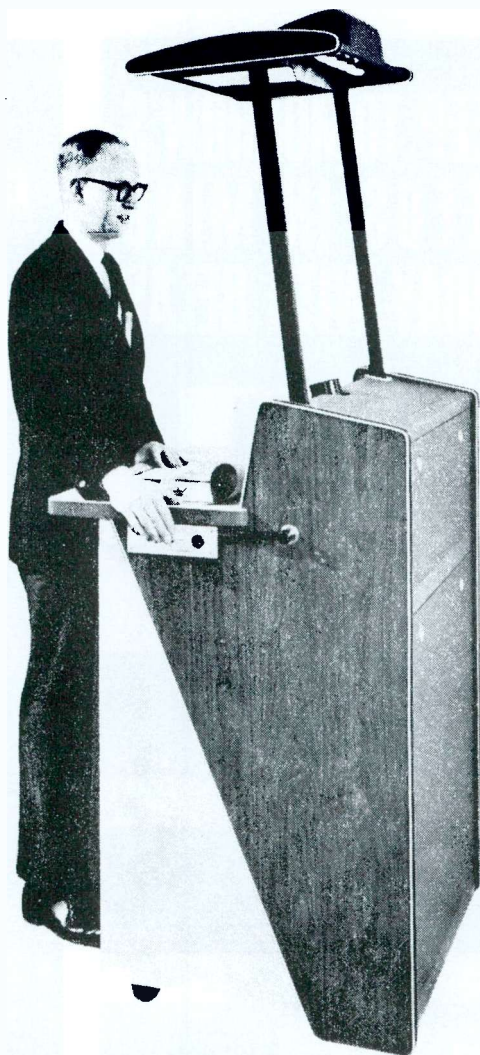

## TELECTERN\*

### 3 in 1 VERSATILITY!

- Self-contained Production Center
- Compact Briefing Console
- Overhead Camera Television System

TeleMation's newly restyled TELECTERN\* overhead camera system is designed to facilitate the art of television instruction. Simple, convenient controls allow the instructor to select video source, lighting mode and lens focal length (10:1 zoom range). A built-in 2" x 2" slide projector is also available.

The handsome, portable lectern console is sturdily constructed with walnut-finished side panels, a durable laminate work surface, and fiberglass video monitor panel. The TELECTERN\* is available in several different configurations, ranging from a basic, closed-circuit industrial model to a complete EIA broadcast system with camera chain.

\*Trademark, TeleMation

Write for details



## TELEMATION, INC.

2275 South West Temple  
Salt Lake City, Utah 84115  
Telephone (801) 486-7564

Circle Item 38 on Tech Data Card

## ENGINEERS' TECH DATA

### ANTENNAS, TOWERS, & TRANSMISSION LINES

50. CCA—Tech data sheet provides information for the CCA-FMA-6710R FM circularly polarized antenna.
51. FORT WORTH TOWER—Literature describes microwave towers, reflectors, and equipment buildings.
52. HUGHEY & PHILLIPS—"Tall Tower Lighting Specification Guide" SG-2 is offered.

### AUDIO EQUIPMENT

53. DUOTONE—Tape Care Kit [including cleaners, brush, static-free cloth, and swabs] and E-Z splice, precut splicing strips for 1/4-in. magnetic tape are subjects of offer.
54. METROTECH—Six-page brochure covers Series 500 professional tape recorders.
55. TELEX—Viking Model 230 and Magnecord Model 1021 tape recorders are illustrated, and technical data are given in publications.

### CATV EQUIPMENT

56. AEL—Technical data bulletins have been prepared to describe the Models ER-412, ER-500, and ER-750 entrance receptacles for connecting sheathed cable to line-amplifier housings, and the Model CVT-MB bracket for mounting Colorvue line amplifiers to poles.
57. TELSTA—A newly revised, illustrated 16-page catalog of tools and accessories for aerial-cable placement is offered.

### COMPONENTS & MATERIALS

58. BOSTON INSULATED WIRE & CABLE—Material concerns cables, connectors, and assemblies for all standard monochrome and color broadcast cameras now available.
59. TROMPETER—Catalog M-4 gives information on line of coax, twinax, and triax matrix and multipole, multithrow switches.

### LIGHTING EQUIPMENT

60. KIEGL BROS.—Booklet titled "Television Lighting for Quartz," Catalog TV-6, and condensed catalog refer to lighting products.

### MISCELLANEOUS

61. TEXAS ELECTRONICS—New wind direction and velocity indicator and standard line of meteorological indicating instruments are described in literature.

### POWER DEVICES

62. TOPAZ—Available is a new short-form catalog on line of inverters and converters designed for operation of VTR's and other frequency-sensitive equipment in mobile or emergency environments.



**NEW!**  
CARDIOID DYNAMIC  
MICROPHONE  
(Slim, Pop-out Type)

Provided with  
★ TONE CONTROLLER  
★ WIND SCREEN  
★ SWITCH

**UD-857A**

Designed specifically for stage, broadcast applications.

### SPECIFICATIONS

- Cartridge: DM-33
- Frequency Response: 50 ~ 15,000c/s ± 5dB
- Impedance: 600 ohm
- Sensitivity: -72dB/dyne/cm.cm (0.25mV)
- Net Weight: 430g
- Finish: Chrome hair lined

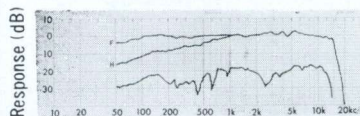

\* For catalog write to

**PRIMO COMPANY LTD.**

Chicago Illinois Office: A.P.T. No.204, 530 W.Surf. St., Chicago Illinois 60657, U.S.A. Tel. 312-472-61421

Head Office: 2043 MURE, MITAKASHI, TOKYO, JAPAN TEL 0422-43-3121-6 CABLES: "Primo Musashino Mitaka" TELEX: 2822-326 PRIMO MUS

Circle Item 39 on Tech Data Card

BROADCAST ENGINEERING



**REFERENCE MATERIAL & SCHOOLS**

63. CLEVELAND INSTITUTE OF ELECTRONICS—Pocket-size plastic "Electronics Data Guide" includes formulas and tables for: frequency vs. wavelength, dB, length of antennas, and color code.

**TELEVISION EQUIPMENT**

- 64. ALMA ENGINEERING—Off-the-shelf and custom switchers, and a quad-view video scanner are covered by data sheets.
- 65. BALL BROS.—Tech data sheet gives specifications and other information on the Mark 21 video waveform monitor.
- 66. CLEVELAND ELECTRONICS—A 52-page quick-reference step-down die-cut catalog gives complete information on vidicon, **Plumbicon**, and image-orthicon deflection components.
- 67. COHU—The 3200 Series **Plumbicon** cameras and a chroma detector are discussed in literature.
- 68. COLORADO VIDEO—Listing of specialized video devices is contained in short-form catalog.
- 69. DYNAIR—Four-page brochure contains information about the solid-state "Equa-Dyn" equipment for transmission of video up to 10,000 feet.
- 70. INT'L NUCLEAR—Subjects of Catalog 7A are video amplifiers, video switchers, and other video products.
- 71. KAPPA NETWORKS—Included with electromagnetic delay-line catalog DLL1 is a 4-page brochure which contains specifications and other information.
- 72. MARCONI—A technical description of the Mk VI photoconductive, monochrome camera for live and telecine applications is offered.
- 73. TELEMATION—Spec sheet describes the TMC-214 portable broadcast camera chain.
- 74. VITAL—Information tells about VI-500 color-stabilizing amplifier for correction of transmission irregularities and transmitter linearity, and VI-1000 processing amplifier [with built-in sync generator] for correction of monochrome and chroma signal disturbances.

**TRANSMITTERS & ASSOCIATED EQUIPMENT**

- 75. COLLINS—Printed matter relates to the 820D-1 1-KW AM transmitter, the new 831C-1 1-kw and 831D-1 2kw FM transmitters, the 54Z-1 frequency monitor, the new 900 Series of FM modulation monitors, the 54N-1 FM frequency monitor, and the 212T series of audio control systems.
- 76. GATES—Brochures describe and illustrate the new FM "H" series transmitters with outputs of 1000, 3000, 5000, 7500, 10,000, and 20,000 watts.
- 77. MOSELEY ASSOCIATES—An automatic digital transmitter logger which records up to ten transmitter parameters and prints the information in log format is the subject of Bulletin 221.

# cut holes fast!



Round—inches and mm



"Key"



Square



"D"  
Double "D"



**with Greenlee punches**

Here's the simple speedy way to cut smooth, accurate holes in metal, hard rubber, plastics, epoxy, etc.

Save hours of hard work . . . punch clean, true holes in seconds for sockets, controls, meters, and other components. Easy to operate. Simply insert punch in a small drilled hole and turn with a wrench. For use in up to 16-gauge metal. Available at leading radio and electronic parts dealers.

**GREENLEE TOOL CO**  
DIVISION OF GREENLEE BROS. & CO.

1855 Columbia Avenue, Rockford, Ill. 61101

Circle Item 40 on Tech Data Card

# RUSSCO

**HEAVY DUTY—PROFESSIONAL QUALITY**

## Broadcast Turntables

*Approved Performance*

**Unconditionally Guaranteed**  
—against defects in material or workmanship when given normal maintenance

**SOLD DIRECT —OR TO DEALERS**

**By Top Radio Stations from Coast-to-Coast!**

- Single lever controls 33 & 45 speeds, plays 45 RPM'S without adapter
- Illuminated speed indicators
- Instant acceleration to required speed in 1/10 to 1/16 of a turn
- Sold with or without arm
- Adaptable for any make tone arm

LOW PRICED **\$139<sup>50</sup> & \$169<sup>50</sup>**



SEPARATE TONE ARM MOUNTING PLATE—EASY TO INSTALL



**STEREO MODEL I-S \$96**



**MONAURAL MODEL I-M \$48**

# RUSSCO

**BROADCAST PHONO Preamplifiers**

- Fully Transistorized for years of dependable service
- Built-in audio level controls

**SPECIFICATIONS**

HARMONIC DISTORTION: less than one tenth of one percent

NOISE LEVEL: better than minus 65 DB.

OUT PUT IMPEDENCE: 150-600 ohms

RUSSCO POWER SUPPLY UNITS model 1-P supplies power for up to 4 mono units . . . price \$40

Call or write for folder

**RUSSCO Electronics Mfg.**  
6879 N. SUNNYSIDE, CLOVIS, CALIF.  
PH. 299-4692

Circle Item 41 on Tech Data Card

69

# the only switch with **CHANGEABLE** functions

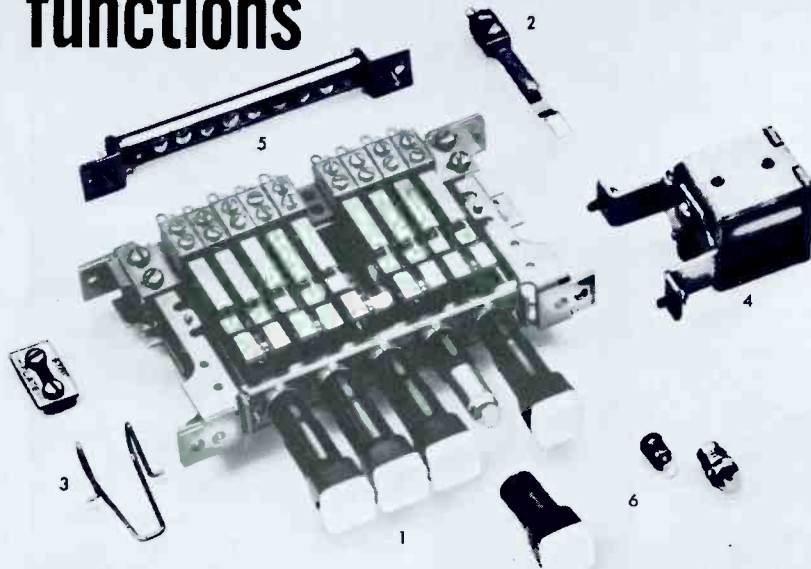

## **SWITCHCRAFT MULTI-SWITCHES**

Multiple Station Push-Button Switches

**this is all you need!**

The ultimate in dependability, simplicity—and versatility. Switchcraft's exclusive Componentized design gives you complete control over functions and operating characteristics . . . switches "grow" with the job, functions can be changed at any time—even in the field. Ideal for prototypes, R & D models . . . unsurpassed for production models whether switch functions are permanent, semi-permanent, expandable, add-on, or where unit should have re-claimable components. Since the multitude of possible functions are too numerous to mention here, such as electronic lock-up, push-lock/push-release, programming of switches, neon lighting, etc., only the basic switch functions are listed below to illustrate how Componentized design works:

1. **BASIC FRAME.** From 1 to 37 stations in **one** row! Or up to 100 stations or more in ganged assemblies. Rugged; heavy gauge welded steel. Illuminated (6V or 28V) or non-illuminated push-buttons.
2. **STACK SWITCHES.** Up to 16 switching circuits activated by any one station . . . up to 4 switching stacks per button. Long-life contacts (choice of palladium or silver) . . . famous Switchcraft quality throughout. Completely changeable, too.
3. **LATCH SPRING, STOP PLATE AND PIN.** Enable you to set up switches for 1. Interlock, 2. Non-Lock, 3. All-Lock, 4. Interlock and Non-Lock combinations, 5. All-Lock and Non-Lock combinations. And, all modes of operation are readily changeable.
4. **SOLENOID.** For automatic remote release of depressed buttons.
5. **LOCK-OUT BAR.** Prevents 2 buttons from being depressed simultaneously.
6. **BUTTONS & LAMPS.** Replaceable from front of panel. Square, round; illuminated, white, colors; blank, numbered, lettered—you name it!

Whether you need a multiple push-button switch for launching missiles or "automating" drive-ins, investigate Switchcraft Componentized Multi-Switches —for reliability and versatility.

**FOR EXPERT  
FACTORY-TRAINED  
ASSISTANCE**

Switchcraft has a unique network of local, factory-trained distributors to give you expert assistance in determining applications, recommending procedures, writing specifications, and supplying Multi-Switches from stock at factory prices. Write for the name of your Switchcraft Factory Trained Multi-Switch Distributor.

**SWITCHCRAFT**®

5355 Elston Ave., Chicago, Ill. 60630

## **Advertisers' Index**

Andrew Corp.	48
Belar Electronics Lab	67
Broadcast Electronics, Inc.	56, 63, 64
CBS Laboratories, Div. of CBS, Inc.	5
CCA Electronics Corp.	55
Central Dynamics Corp.	25
Cohu Electronics, Inc.	3
Collins Radio Co.	10, 11
Dresser Crane, Hoist and Tower Div.	53
Eastman Kodak Co.	33
Eimac Div. of Varian Assoc. Electronics, Missiles and Communications, Inc.	26 66
Fairchild Recording Equipment Corp.	6, 62
Gates Radio Co.	65
General Electric Co.	36, 37
Greenlee Tool Co.	69
Hewlett-Packard	46
Industrial Electric Reels, Inc.	6
International Nuclear Corp.	Cover 3
Jerrold Electronic Corp.	32
Kappa Networks, Inc.	53
Maryland Telecommunications, Inc.	59
Minneapolis Magnetics, Inc.	52
Miller-Stephenson Chemical Co.	61
Moseley Associates, Inc.	62
Packard Bell, Space and Systems Div.	67
Phillips Broadcast Equip. Co., Inc.	8, 9
Photo Research Corp.	63
Primo Co., Ltd.	68
QRK Electronic Products	44
RCA Electronic Components & Devices (Broadcast Tubes)	Cover 4
RCA Electronic Components & Devices (Broadcast and Comm. Prod. Div.)	40, 41
RCA Service Co.	60
Riker Video Industries, Inc.	Cover 2
Richmond Hill Labs, Inc.	57
Rohn Systems, Inc.	55
Rusoco Electronics Mfg.	69
Sparta Electronic Corp.	58
Stanton Magnetics	43
Switchcraft, Inc.	70
Superior Cable Corp.	51
Shure Bros., Inc.	47
Taher Mig. and Engineering Co.	66
Telemation, Inc.	68
Telemet Co.	7
Tech Laboratories, Inc.	64
Times Wire and Cable Co.	54
Visual Electronics Corp.	45
Wilkinson Electronics, Inc.	64
Xcelite, Inc.	60

## **Professional Services**

**VIR JAMES**  
CONSULTING RADIO ENGINEERS  
Applications and Field Engineering  
345 Colorado Blvd.  
Phone: (Area Code 303) 333-5582  
**DENVER, COLORADO 80206**  
Member AFCCE

**JAMES C. McNARY**  
Consulting Engineer  
National Press Bldg.

Washington 4, D. C.  
Telephone District 7-1289  
Member AFCCE

**CAMBRIDGE CRYSTALS  
PRECISION FREQUENCY  
MEASURING SERVICE**

SPECIALISTS FOR AM-FM-TV  
445 Concord Ave. Phone 876-2810  
Cambridge, Mass. 02138

**AMPEX HEAD ASSEMBLY RECONDITIONING SERVICE** for all Ampex professional model recorders. This professional service features precision relapping of all heads for maximum head life. Your assembly is thoroughly cleaned and guides are replaced as required. Price includes optical and electrical inspection and complete testing on Ampex equipment in our plant. Full track or half track assemblies . . . \$35.00. One to two day service. "Loaner" assemblies available if necessary. LIPPS, INC., 1630 Euclid Street, Santa Monica, California 90404. (213) EX 3-0449. tf

**CRYSTAL AND MONITOR SERVICE** — Frequency change and repair service for AM monitors including G.R., RCA, Gates, W.E., and Doolittle; also H-P 335B FM, AM monitors bought and sold. What have you, what do you need? New or regrinding of AM crystals for RCA, Gates, Billey, W.E., and J-K oven holders, repairs, etc. Fastest service, reasonable prices. Over 25 years in this business. Eldson Electronic Co., Box 96, Temple, Texas 76501, Phone 817 773-3901. 2-67-tf

**VIDEO TAPE RECORDER  
AUDIO HEAD ASSEMBLY SERVICE**  
Precision relapping of all heads and supporting posts, including cleaning and testing. Ampex head assembly with "cue" tracks, \$75.00 complete. RCA units also relapped. One to two day service. LIPPS, INC., 1630 Euclid St., Santa Monica, Calif. 90404. (213) EX 3-0449. tf

Kits serviced, shipped. Professional, reasonable. Also small broadcast rack and table units, carts, tuners, limiters. Write: 109 Pinetree, Woodbridge, Va. 4-67-tf

## Classified

Advertising rates in the Classified Section are fifteen cents per word. Minimum charge is \$2.00. Blind box number is 50 cents extra.

### EQUIPMENT FOR SALE

**CO-AXIAL CABLE** Heliac, Styroflex, Spiroline, etc. Also rigid and RG types in stock. New material. Write for list. Sierra-Western Electric Co., Willow and 24th Streets, Oakland, Calif. Phone 415 832-3527 5-66-tf

**Television / Radio / communications gear** of any type available. From a tower to a tube. Microwave, transmitters, cameras, studio equipment, mikes, etc. Advise your needs—offers. Electrofind Co., 440 Columbus Ave., NYC. 212-EN-25680. 8-64 tf

**Trimm 504 Audio Patch cords \$4.00. Audio jack panels for 19" racks, 10 pair \$8.95. Repeat coils 500-500 ohm flat to 20kc \$4.00**—Relay racks and equipment cabinets. Write for list. Gulf Electro Sales, Inc., 7031 Burkett, Houston, Texas. 4-66-tf

**Audio Equipment bought, sold, traded.** Ampex, Fairchild, Crown, McIntosh, Viking. F. T. C. Brewer Company, 2400 West Hayes Street, Pensacola, Florida. 3-64-tf

Everything in used broadcast equipment. Write for complete listings. Broadcast Equipment and Supply Co., Box 3141, Bristol, Tennessee. 11-64-tf

**RADIO AND TELEVISION STATIONS** for sale in all parts of United States. Qualified buyers may receive further details by writing to Inter-Media Communications Corporation, 246 Fifth Avenue, New York, New York 10001. 1-67-12t

# BROADCAST TV SYSTEMS ENGINEERS... Decide for yourself!

If you are a qualified broadcast TV engineer, you probably have a good job now and there are many reasons to stay where you are. You may be asking yourself, then, "Why should I consider going with F & M Systems Co.?" Let's review the reasons briefly so you can decide for yourself:

### more interesting work

At F & M, you enjoy the excitement of designing, furnishing and installing new or improved television systems. Our prime contract programs include turnkey system design and management of major network and station studio, theater, mobile, and other technical facilities. F & M assumes responsibility for integrated video, audio, switching, intercom and the other technical facility elements.

At F & M, you have the depth of organization and facilities of a large company . . . plus the varied work assignments of a smaller organization. But that's not all. You also have . . .

### outstanding opportunities for advancement

In just the last two and one half years, our engineering staff has grown six-fold. With growth like that, our engineers have enjoyed almost unlimited opportunities for personal advancement.

There is every indication that rapid growth (and excellent advancement opportunities) will continue in the future. At F & M, you can look forward to assuming greater and greater responsibilities as fast as your abilities permit.

You also get . . .

### better pay

If you qualify for one of our openings, we can probably offer you a significant increase in income right from the start. We also offer liberal relocation allowances so your pay increase is a net gain the first month.

Also, your money is likely to be worth more because living costs in Dallas are substantially lower than in many other important metropolitan areas. This, alone, is equivalent to still another raise.

But, important as it is, money isn't everything. We can also offer you . . .

### top fringe benefits\* . . .

. . . that include free life insurance and long-term disability income insurance as well as a \$100,000 business-connected travel accident policy. The company-paid hospitalization and medical insurance policy covers your dependents as well as yourself . . . and it includes attractive major medical benefits.

Add an excellent retirement plan plus liberal tuition-reimbursement provisions . . . and you have one of the best fringe-benefit plans in industry.

### Look who's talking!

F & M Systems Company is the electronics systems management and engineering division of Fischbach and Moore, a corporation with over 5,000 employees, annual sales exceeding \$100 million, and nearly fifty years of achievement. We have what it takes to back up our promises.

### Do you qualify?

There are choice permanent openings at F & M for broadcast TV engineers. Requirements include a BSEE plus experience in design, installation, testing, and/or operation of systems used in TV studios and mobile units.

We also have a number of openings for systems design engineers with experience in Telecommunications, digital data transmission, microwave communications, and telephone terminal interface.

If you qualify, don't delay another day! Send your resume (in full confidence) to R. J. Finley or call me collect at (214) 241-2121 in Dallas.

\*Specific terms defined in the group policies.

# F&M SYSTEMS CO.

■ A DIVISION OF FISCHBACH AND MOORE, INCORPORATED  
P. O. BOX 20778 AREA CODE 214, CH 1-2121 DALLAS, TEXAS 75220

An equal opportunity employer



New Spotmaster cartridge equipment, ORK turntables, all models available, will take in any trade regardless age or condition. Audiovox, 4310 S. W. 75 Ave., Miami, Fla. 3-67-tf

#### CARTRIDGE TAPE EQUIPMENT

Completely reconditioned and guaranteed. Spotmaster Model 500 Record/Playbacks, \$350.00. Model 505 Playbacks \$250.00. 30-day money-back guarantee on all equipment.

#### BROADCAST PRODUCTS COMPANY

18804 Woodway Drive, Derwood, Maryland, 20855

(301)942-1224 3-67-12t

U-shaped Broadcast Console, Collins 808-A Remote Console, 2 A.T.C. Playbacks, 1 Recording Amplifier, Meades, 10800 Dale St., Space 715, Stanton, Calif. 3-67-5t

**FOR SALE:** Large assortment tube type television equipment, cameras, switchers, sync generators, stab amplifiers, power supplies, monitors, etc. Cox Broadcasting Corporation, 1601 West Peachtree Street, N. E., Atlanta, Georgia. 4-67-4t

**"AUDIO EQUIPMENT** -- Whatever your needs, check us first. New and used. Ampex, Altec, AKG, EV, Fairchild, Neumann, Langevin, Rek-O-Kut, Uher, Viking. Send for equipment list." Audio Distributors, Inc., 2342 S. Division Ave., Grand Rapids, Michigan 49507. 6-66-tf

Two modified RCA TK-40A Color Camera Chains in working condition. Exceptional value. Immediate delivery. Write P. O. Box 18151, Tampa, Florida, 33609, or phone area 813, 253-0447, Tampa. 5-67-2t

**"First Class engineers,** maintenance background, no board work. Immediate openings. Excellent growth opportunity with independent group. Rush reply by letter to C. Dingmen, WCTC, 385 George St., New Brunswick, N. J." 5-67-2t

**TAPE EQUIPMENT** -- 1 Presto model 625 Tape transport 3 3/4 and 7 1/2 I.P.S. 14" reels. 1 Presto model series 800 tape transport 3 3/4 and 7 1/2 I.P.S. 14" reels. 2 Presto model A909 Pre-amplifiers. 2 Presto model A908 Amplifiers. 2 Presto model A908PS Amplifiers. All now in use in good operating condition. WPLM, Plymouth, Mass. 6-67-1t

**"Presto 6N disc cutter,** micro, 45 rpm, 88A amplifier. Presto 8N disc cutter, micro, 45 rpm. Concertone 10" Pro tape recorder, stereo. GRAVES RECORDING SERVICE. PO Box 1416, Eugene, Oregon, 97401." 6-67-1t

**LARGE INVENTORY ELECTRONIC TEST EQUIPMENT.** LOW PRICES. Hewlett Packard, General Radio, Tektronix, etc. All operating. List available. REX INDUSTRIAL, 759 10 Ave., N. Y. 10019. 212-757-1361. 6-67-2t

**Ampex new Model 351 full track** through Model 300 4-track SS recorder-tube type. We will convert your 3-channel Ampex Model 300-3SS to a -4SS for \$1,390.00, plus trade of old parts. Accurate Sound Company, 15 N. Tyler Street, San Angelo, Texas 76901. 6-67-2t

**AMPEX, Must Sell:** AG350-2P, \$1,950; 351-2P, \$1,600; 350-C, \$800; 860, \$175; 1260, \$250. Also, Crown 822 in case, \$1,250. Jim Shelton, 1804 Niles Rd., Austin, Texas, Ph. GL 2-6441. 6-67-1t

**FOR SALE:** 140' Self-supporting broadcast tower complete with insulators and lights. Extra heavy duty construction, all galvanized steel. Kelleys Electric, Snow Shoe, Pa. 16874 6-67-2t

**Gates RDC-10 Remote Control** Fully reconditioned Snyder Communications, Box 889, Jackson, Wyoming. 6-67-1t

**NOTICE OF PUBLIC SALE** -- Complete Schafer 1200 automation system -- including playbacks, spotter, memory unit, time machine, production unit, and associated technical equipment. On June 20, 1967 at 10:00 AM, KWAC Radio, 5200 Standard Road, Bakersfield California 93308. May be examined anytime prior at same address. Address inquiries for more details to Manager, KWAC at same address or call Area 805-327-9711. 6-67-1t

### "Arcturus" Catalog

A Trusted Name in Electronics

Since 1925

FREE Catalog. Electronic parts, tubes. Wholesale. Thousands of items. Unbeatable prices.

ARCTURUS ELECTRONICS BE

502-22 street, Union City, N. J. 07087

### EQUIPMENT WANTED

We need used 250, 500, 5K & 10K Watts AM Transmitters. No Junk. Broadcast Equipment and Supply Co. 1314 Iturbide St., Laredo, Texas 78040. 3-66-tf

Broadcast Consoles, Recorders, PA Amps, and old 6204 RCA Ribbon Mikes. Will purchase outright or trade. Contact the Maze Corporation, P.O. Box 6636, Birmingham, Alabama. 6-67-1t

### TRAINING

To advance in electronics, knowledge and ability are required. Grantham offers correspondence and resident instruction, in depth, leading to the degree of Associate in Science in Electronics Engineering. G.I. Bill approved. Credit for previous training and experience allowed. Free Catalog. Write: Dept. E-2, Grantham School of Electronics, 1505 N. Western Ave., Hollywood, California 90027. 6-67-tf

### EMPLOYMENT

Need general maintenance technician with first phone and some experience in broadcasting. Salary commensurate with radio and television maintenance experience. Send resume and phone number to George Wussow, KHSL-TV, P.O. Box 489, Chico, California 95926. 4-67-3t

**Job Headquarters** for all Radio and Television Engineers. Immediate openings exist in 9 western states and elsewhere for qualified engineer and technical personnel. All categories from trainees to experienced transmitter maintenance, chief, assistant chief, live color video maintenance and technical operations. Send us your complete resume now. The AMPS Agency, 3974 Wilshire Blvd., Los Angeles, California 90005. Telephone DU 8-3118. By Broadcasters--For Broadcasters 11-66-tf

## TELEVISION ENGINEERS

We are interested in contacting Station Engineers capable of design or field engineering. Excellent opportunities in TV Development Engineering and Systems Engineering with Sarkes Tarzian, Inc., Broadcast Equipment Division.

TV station engineering experience required, BSEE or equivalent desirable. Send resume of experience, or call, Mr. Biagio Presti, Broadcast Equipment Division, Sarkes Tarzian, Inc., Bloomington, Indiana, Area Code 812, 332-7251.



Symbol of Excellence  
in Electronics

## EXPORT SALES MANAGER

### BROADCAST COMMUNICATION EQUIPMENT

Internationally known communications broadcast equipment manufacturer with dynamic growth program has top level position open for Export Sales Manager. Must be college graduate with proven sales ability, technical background and 2-5 years' export experience. Fluency in Spanish or French desired. Salary and bonus commensurate with experience. Export sales office is located in progressive medium-size city with excellent schools and the finest of family living. Send resume or call Robert T. Fluent, Employment Manager, 123 Hampshire, (217) 222-8202.

### Gates Radio Company

A subsidiary of  
Harris-Intertype Corporation

Quincy, Illinois 62301

An equal opportunity employer (M & F)

### ENGINEER

## FIELD ENGINEER CC TV

(Color)

Excellent opportunity for professional Engineer to become associated with dynamic and product oriented firm. Will be responsible for instructing broadcast personnel in the operation and maintenance of a CC TV color camera. Requires sales oriented personality plus extensive background in color camera broadcast.

TRAVEL REQUIRED

Please contact Personnel Manager

## PACKARD BELL ELECTRONICS

### Space & Systems Div.

Lawrence & Arnold Dr.

Newbury Park, Calif.

(805) 498-3621

An equal opportunity employer

### MISCELLANEOUS

**WANTED:** "Name and address of company that reconditions tubes No. 8251/3X2500F3." D. C. Stephens, Radio Station WPRT-AM-FM, P.O. Box 31, Prestonsburg, Kentucky 41653. 6-67-1t



# Looking for a good video stabilizing amplifier?

International Nuclear's TVA1 is certainly one of the best on the market today. The TVA1 with its associated series of plug-in units offers high level performance and versatility for studio or transmitter use. It removes all low frequency disturbances such as hum, bounce and tilt by sync-tip clamping. This back porch level is precisely stabilized without affecting color signals in any way. Sync is stretched after back porch stabilization and then clipped accurately to desired level. This level may be set by means of a front panel control which can be extended to a remote location. Stripped sync is provided at one 75 ohm internally terminated output connector, at a 4 volt level. The TVA1 chassis contains a plug-in compartment which accepts up to 4 plug-in units. Among these plug-in units is the TVA1-E, providing a stripped color video channel, and the TVA1-D which provides the means of adjusting peak-white clipping, white stretch and differential phase. Other plug-in units are listed below.

## PRICES F.O.B. NASHVILLE, TENNESSEE

- Model TVA1 Stabilizing Amplifier (less plug-ins) . . . \$1,380.00
- Model TVA1-A, Manually Operated Input Amplifier Unit . . . \$310.00
- Model TVA1-B, Input Amplifier Unit, with Remote Master Gain and Chroma Panel . . . \$425.00
- Model TVA1-C Monitor Amplifier Unit . . . \$265.00
- Model TVA1-D White Stretch and Clip Unit . . . \$240.00
- Model TVA1-E Stripped Video Unit . . . \$450.00
- Model TVA1-S Remote Sync Level Control Panel . . . \$25.00



*For more complete information write or phone:*

**INTERNATIONAL NUCLEAR CORPORATION**  
*"Transistorizing the Television Industry"*

608 NORRIS AVENUE • NASHVILLE, TENN. • PHONE 615-254-3366

Circle Item 43 on Tech Data Card

**Announcing...**

**for color and  
black and white,  
the new family of  
RCA image orthicons  
with a *big difference here*  
that *shows up big here***

Now RCA brings you the "BIALKALI PHOTOCATHODE" in the new RCA-8673 and -8674 Image Orthicons. This major engineering innovation has greatly improved compatibility with its non-stick target, maintaining resolution and sensitivity over an extended tube lifetime and improving performance of existing color or black-and-white cameras. A simple change in a resistor chain provides proper voltages for a trio of these new Bialkali Photocathode Tubes. Wide-range, the 8673 and 8674 fit spectral requirements of all three channels... eliminating the need for another tube type for the blue channel.

Another big difference: the re-designed image section provides reduced distortion and freedom from "ghosts." These new tubes are available singly or as matched sets—a trio of 8673/S or 8674/S types for color service... types 8673 and 8674 for black and white. Main construction difference is in the target-to-mesh spacing. The closer-spaced 8673 enhances S/N ratio for quality performance under sufficient illumination. The 8674 has greater sensitivity under limited illumination. For complete information about the new RCA Bialkali Photocathode Image Orthicons, ask your RCA Broadcast Tube Distributor.

RCA Electronic Components and Devices, Harrison, N.J.



The Most Trusted Name in Electronics



USE THIS CHART TO SELECT REPLACEMENT TYPES FOR THE TUBES YOU ARE NOW USING

**UNDER SUFFICIENT LIGHTING LEVELS**

For color pick-up,  
If you're now using... You can replace with:  
4513/S  
7513/S  
8673/S

For black & white pick-up,  
If you're now using... You can replace with:  
4513  
7513  
7513/L  
8093A  
8093A/L  
8673

**UNDER LIMITED LIGHTING LEVELS**

For color pick-up,  
If you're now using... You can replace with:  
4415S  
4416S  
8674S

For black & white pick-up,  
If you're now using... You can replace with:  
7293A  
7293A/L  
8674

**AVAILABLE FROM YOUR RCA  
BROADCAST TUBE DISTRIBUTOR**

