

JUNE, 1962

BROADCAST ENGINEERING

®



THE TECHNICAL JOURNAL OF THE BROADCAST INDUSTRY

AUDIO SPECIAL:

Maintenance and Equipment

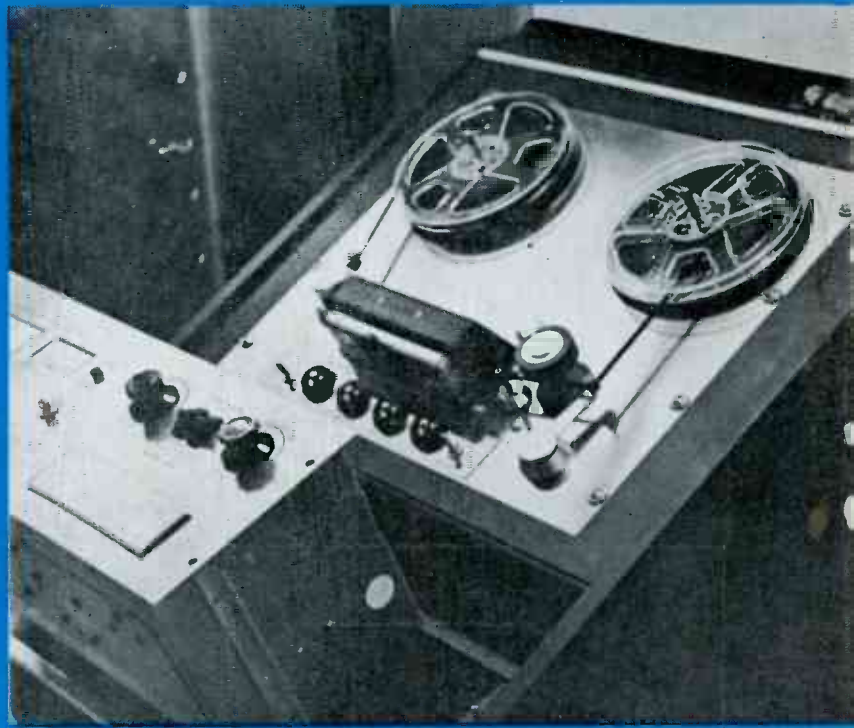

This is WGN's new Mid-America Broadcast Center . . . one of the world's largest and most modern studios for radio and TV transmission. Dedicated in June, 1951, it has more than 100,000 square feet of floor space, including three 72' x 48' TV sound stages, and two 30' x 18' radio studios.

Carl J. Meyers, center, Vice President and Manager of Operations and Engineering; and Woody Crane, left, Chief Engineer of Television, discuss WGN's wire and cable needs with Belden sales engineers, who, on behalf of Belden distributors, have just toured the new facilities.



90% of WGN TV-camera, Microphone, and Audio Cables made by Belden

Belden manufactures a complete line of wire and cable for TV and radio broadcasting, recording studios, remote control circuits and similar applications. Call your Belden electronic distributor.

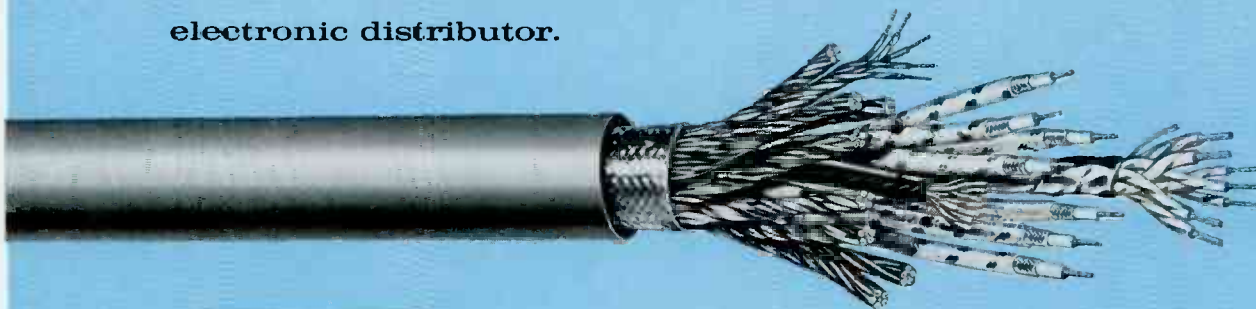

Belden

WIREMAKER FOR INDUSTRY
SINCE 1902 - CHICAGO

power supply cords • cord sets and portable cordage • electrical household cords • magnet wire • lead wire • automotive wire and cable • aircraft wires • welding cable

NEW TELECHROME TRANSISTORIZED VIDEO AND PULSE DAs & VIDEO TEST EQUIPMENT

Telemet's new line of transistorized video broadcast and test equipment features the same Telechrome standards of performance in compact units which occupy the smallest rack space possible. Space and heat dissipation problems are dramatically reduced. The five units shown below represent the beginning of a complete new line of fully transistorized equipment by Telemet.

TRANSISTORIZED VIDEO AND PULSE DAs FEATURING:

- Plug-in modules
- Individual internal power supplies
- Compensated input capacity
- 1 in-4 out per module, 32 outputs for 3½" rack space



MODEL 3200 VIDEO DISTRIBUTION AMPLIFIER. Gain up to 6 db; frequency response ± 0.5 db 10cps-10mc; differential phase less than 0.2 degrees; differential gain less than 0.3 percent



MODEL 3202 PULSE DISTRIBUTION AMPLIFIER. Output level adjustable between 3.5 and 4.5 volts; output pulse within EIA specs and constant over an input voltage range 1.5 and 5 volts; failure alarm indicates loss of output pulse

TRANSISTORIZED TEST EQUIPMENT FEATURING:

- Standard EIA output
- Simultaneous VIT output
- Internal power supply
- Portable or rack mounted models



MODEL 3501 MULTIBURST GENERATOR



MODEL 3502 STAIRSTEP GENERATOR



MODEL 3503 SINE SQUARED PULSE AND WINDOW GENERATOR

Send for complete catalog data.

TELEMET CORPORATION

AMITYVILLE, NEW YORK: 185 Dixon Avenue • Phone (516) 541-3600
SANTA ANA, CALIFORNIA: 38-41 S. Main Street • Phone (714) 546-2281

A Giannini Scientific Company





BROADCAST ENGINEERING

THE TECHNICAL JOURNAL OF THE BROADCAST INDUSTRY

VOLUME 4

JUNE, 1962

NUMBER 6

Contents

Audio Limiting and AGC Action 4

All stations use some type of level limiting amplifier and many rely on variations of this equipment to maintain and expand their AM coverage area. However, few engineers make the necessary tests to ensure that these variable gain amplifiers are really doing their jobs.

An Approach to Cleaner Sound, Part II 8

Part I of this series discussed grounding. This section goes thoroughly into shielding as a means of reducing signal contamination.

Audio Studio Maintenance, Part I 14

We have had many requests for articles on maintenance. This one, which shows an outline of a studio maintenance system which can be extended as required, is to be followed shortly by another by the same author on transmitter maintenance.

Television Tape Fundamentals, Part V 20

This part of the current series on the care and operation of TV tape records deals with testing techniques.

Departments

Industry News	18, 24
Book Reviews	26
Engineer's Exchange	30
Product News	36
Index to Advertisers	40
Classified Ads	40
Professional Services	40

ROBERT E. HERTEL, Publisher

EDITORIAL

GEO. H. SEFEROVICH, Director
 JOHN BATTISON, Consulting Editor
 D. F. BOICOURT, Production Editor
 DUDLEY ROSE, Presentation Editor

ADVERTISING

E. P. LANGAN, Director
 R. J. HANCOCK, Manager
 S. F. WILSON, Production Manager

Great Neck, New York
 PAUL AND DON WEIL
 280 Northern Boulevard
 Telephone HN. 6-0212

Chicago 1, Illinois
 WILLIAM L. MILLER, JR.
 E. F. LUKENS
 307 N. Michigan Ave.
 Telephone FRanklin 2-5944

Cleveland 16, Ohio
 DAVID H. HERTEL
 3100 Wooster Road
 Telephone EDison 1-2370

Omaha 14, Nebraska
 BOB HOPKINS
 1705 Maenner Drive
 Telephone 393-1905

Southwest
 C. H. STOCKWELL CO.
 4916 W. 64th Street
 Mission, Kansas
 Telephone RAndolph 2-4417

Los Angeles 57, California
 MAURICE A. KIMBALL CO., INC.
 2550 Beverly Boulevard
 Telephone DUckler 8-6178

San Francisco 4, California
 MAURICE A. KIMBALL CO., INC.
 580 Market Street
 Room 400
 Telephone EXbrook 2-3365

Paris 5, France
 JOHN ASHCRAFT
 9 Rue Lagrange
 ODeon 20-87.

London W. C. 2, England
 JOHN ASHCRAFT
 12 Bear Street
 Leicester Square
 WHitehall 0525

Tokyo, Japan
 INTERNATIONAL MEDIA
 REPRESENTATIVES, LTD.
 Kisha Kurabu
 14, 2-chome Marunouchi
 Telephone (502) 0656



Subscription Price: U. S. \$6, one year; Outside U. S. A., \$7. Single copies, 75 cents. Adjustments necessitated by subscription termination at single copy price.

BROADCAST ENGINEERING is published monthly by Technical Publications, Inc. Editorial, circulation and advertising headquarters: 1014 Wyandotte St., Kansas City 5, Missouri; telephone VICTor 2-5955.

Corporate Personnel: Robert E. Hertel, President; Frank D. Smalley, Executive Vice-President; E. P. Langan, Vice-President; Kenneth Long, Vice-President.

Affiliated with



HOWARD W. SAMS & CO., INC.

BROADCAST ENGINEERING



No other tape has so many candles on the cake . . .

In 1956 the new video tape recorders under development needed an extraordinary magnetic tape . . . one that could withstand unheard of pressures and temperatures, far beyond those encountered in audible range recording. No such tape existed; but in response to this technological urgency the original "SCOTCH" BRAND Video Tape was born. Another candle was lit in 1957, as "SCOTCH" Video Tape helped the television industry revolutionize programming with delayed telecasts across time zones, allowing network shows to be received at the same "clock

time" coast to coast. Now, six years later, video taped shows and commercials reach more than 90% of all U.S. TV-land, and bring a vital sense of presence into today's theatre-in-the-home. So the candles on the cake represent years of achievement, of "head start," by 3M research in video and sound recording. Late-comers have tried to meet the high level of product excellence created by "SCOTCH" Video Tape. But the light of the candles has already led 3M to new standards of excellence. Let "SCOTCH" Video Tape put this experience to work for you!

"SCOTCH" AND THE PLAID DESIGN ARE REGISTERED TRADE-MARKS OF MINNESOTA MINING & MANUFACTURING CO., ST. PAUL 1, MINN. EXPORT: 99 PARK AVENUE, NEW YORK, CANADA; LONDON, ONTARIO © 1962, 3M CO.

Magnetic Products Division **3M**
COMPANY

AUDIO LIMITING AND AGC ACTION

All stations use some type of level limiting amplifier and many rely on variations of this equipment to maintain and expand their AM coverage area. However, few engineers make the necessary tests to ensure that these variable gain amplifiers are really doing their jobs.

By Elton B. Chick
Asst. Director of Engineering
Rounsaville Radio Stations
Cincinnati, Ohio

IN ADJUSTING broadcast audio systems it is often difficult to interpret the results of automatic-gain-control and limiting amplifiers by observation of modulation monitor meters or oscilloscope patterns. Described here is a series of tests used to record audio levels, both before and after limiting and AGC action, by use of a recording milliammeter.

The desired arrangement gives an approximate graphical record of modulation percentages as indicated by the AM modulation monitor meter. This arrangement is a compromise between indicating the actual peaks and the average modulation levels. However, it is suitable as an indication of the action under study. To achieve this indication a rectifier-filter network was constructed as shown in Fig. 1, to be used with the recording milliammeter. Low current diodes, such as the IN34, were used to produce the dc for the milliammeter. To allow for the use of several recorder speeds the network was wired with short clip leads thus enabling an easy change of components. The values of C1 and C2 will depend on the recovery time desired. Fig. 2 is a photograph of the recorder in operation.

The station's audio plan is shown

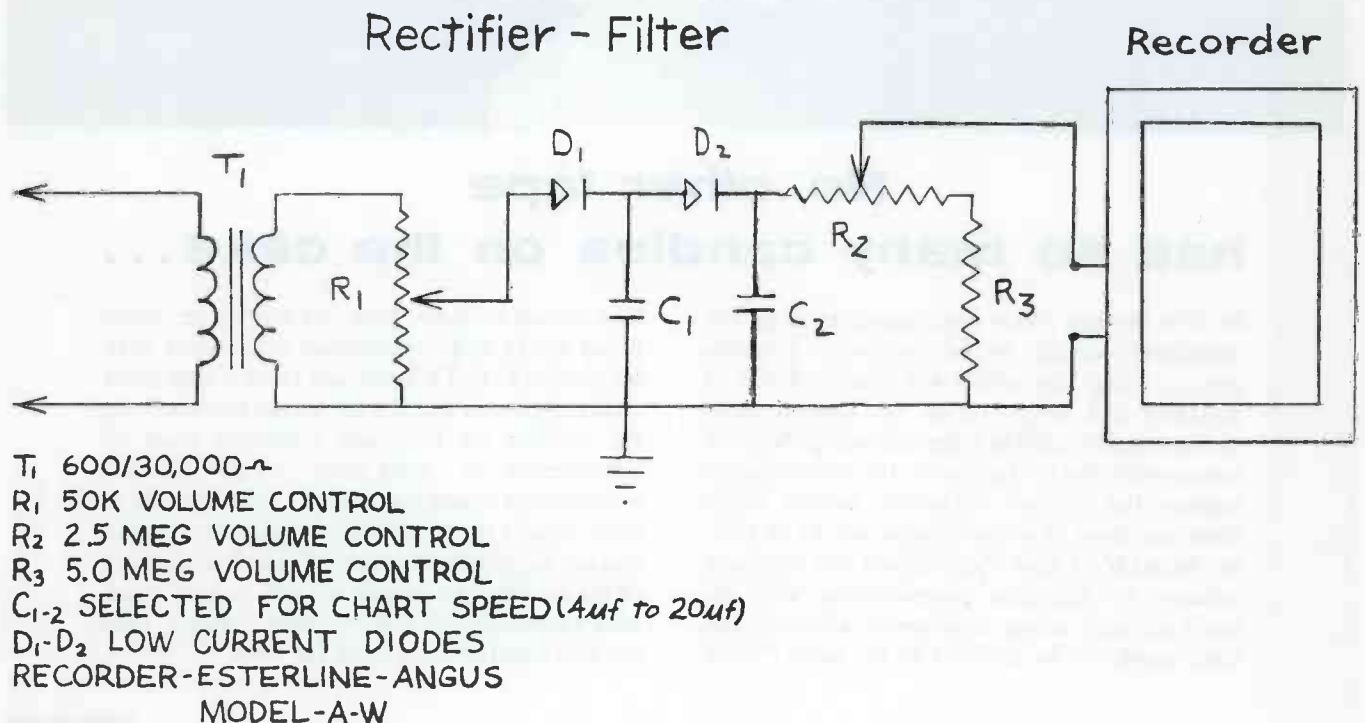

Figure 1
Rectifier-filter network for use with recording milliammeter.

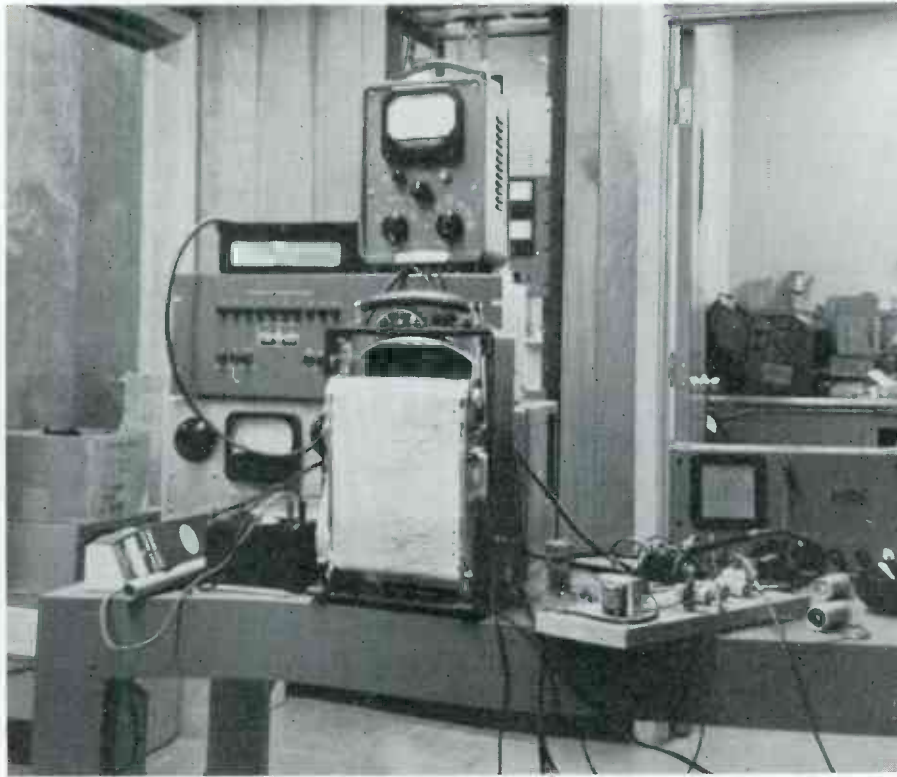

Figure 2
Recorder amplifier set-up with filter on bench on right.

in Fig. 3. Fixed attenuators were used to allow input and output controls to be operated near their mid-range positions while providing optimum input levels for each piece of equipment. The levels and losses were measured with a gain set in conjunction with an audio oscillator. With a console output of 4 dbm the signal arrives at the transmitter as a -18 dbm level. This level is further reduced to -28 dbm to provide the desired input level for the BA-25A AGC amplifier. Because this amplifier has an output of 18 dbm and has no output control, a second pad is used to provide a suitable input level for the BA-6A limiting amplifier. A third pad is used at the BA-6A output to avoid using the output control near the end of its range. After each piece of equipment was installed it was adjusted approximately to the manufacturer's specifications for normal operation, *i.e.*, a gain reduction of 5:1 and peak limiting of about 7 db.

Following installation and preliminary adjustment, a series of test recordings was made to learn what extremes the system would be required to handle. Fig. 4 shows a segment of the recorder graph which represents very poor level control by the announcer. This was one of

the most erratic 10 minute periods found in about 36 hours of operation and probably represents the extremes that could be expected. Similar periods were selected for subsequent tests.

Amplifier Operation

To investigate each amplifier

separately, recordings were made of the AGC amplifier output, as driven by the console. Next, recordings were made of the limiter output with the AGC amplifier out of the circuit. These recordings are shown in Figs. 5 and 6. Fig. 5, the AGC amplifier output, shows the peaks to average between 70 and 85 per cent modulation. Use of this amplifier alone would result in a substantial improvement of modulation control; however, the peaks frequently pass 100 per cent and this could allow serious overmodulation on certain programs. The output of the limiter, Fig. 6, shows the peaks to be held below 100 per cent modulation but their average is somewhat ragged, varying between 65 and 95 per cent modulation. By using the AGC amplifier to drive the limiter a better condition is observed. Fig. 7 shows the result of this combination. Here no overmodulation occurred and the peaks are held consistently near 85 per cent modulation.

It should be kept in mind that this recording system has some faults and does not indicate peak modulation, due to recorder stylus ballistics, meter loading, etc. It does, however, give a record of the work done by these amplifiers and for this reason is valuable to the station engineer when setting up, or checking this type of equipment.

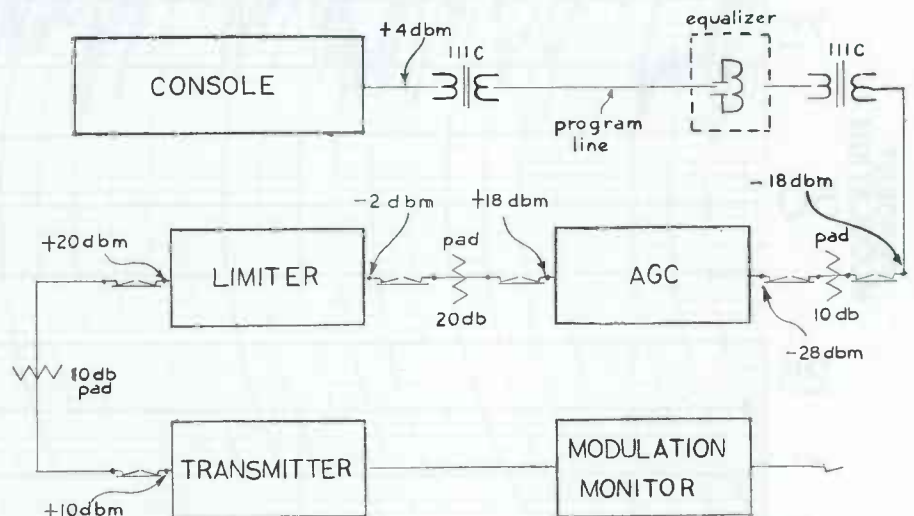

AUDIO LAYOUT

FIGURE 3

Figure 3

Block diagram of station equipment showing insertion of pads to maintain desired gain throughout test.

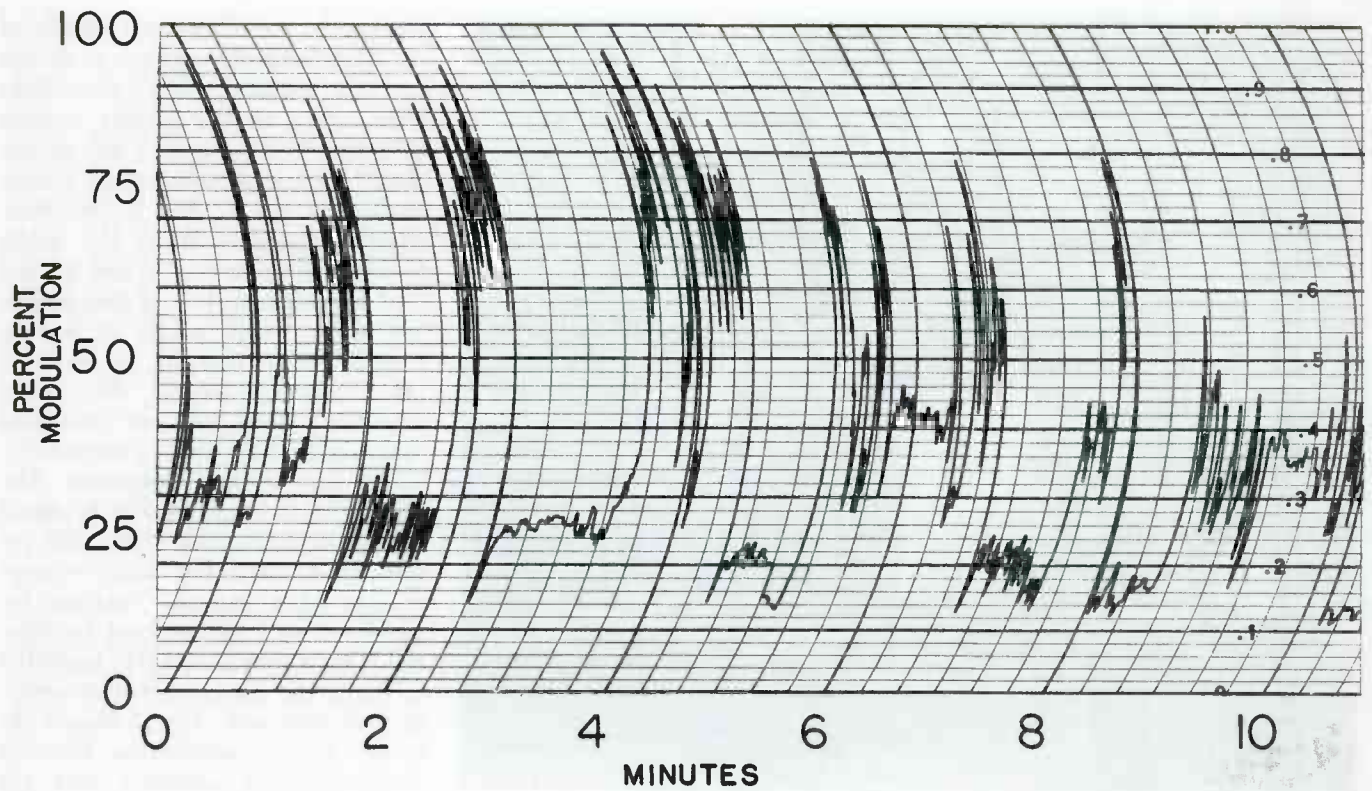

Figure 4
Recording of very poor gain riding by announcer.

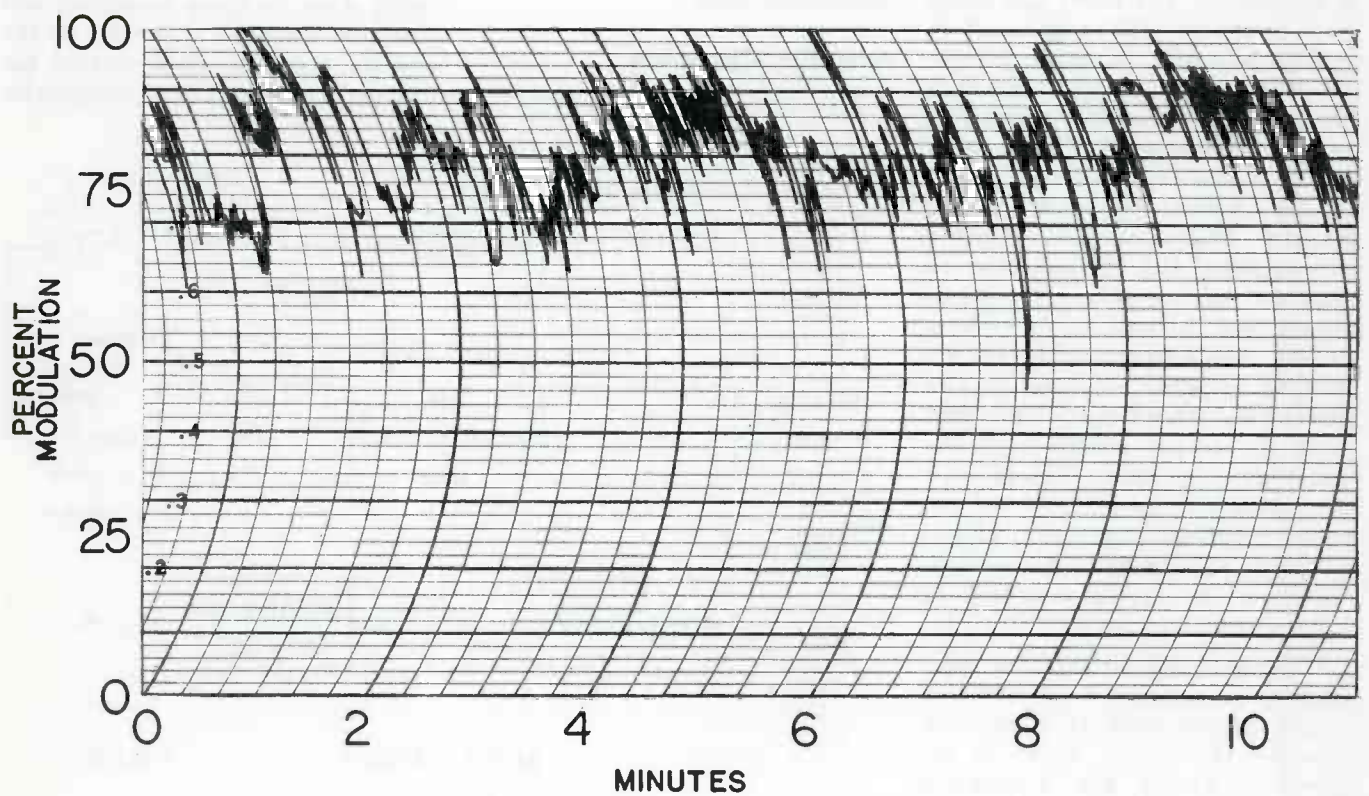

Figure 5
Recording of limiter output without AGC amplifier.

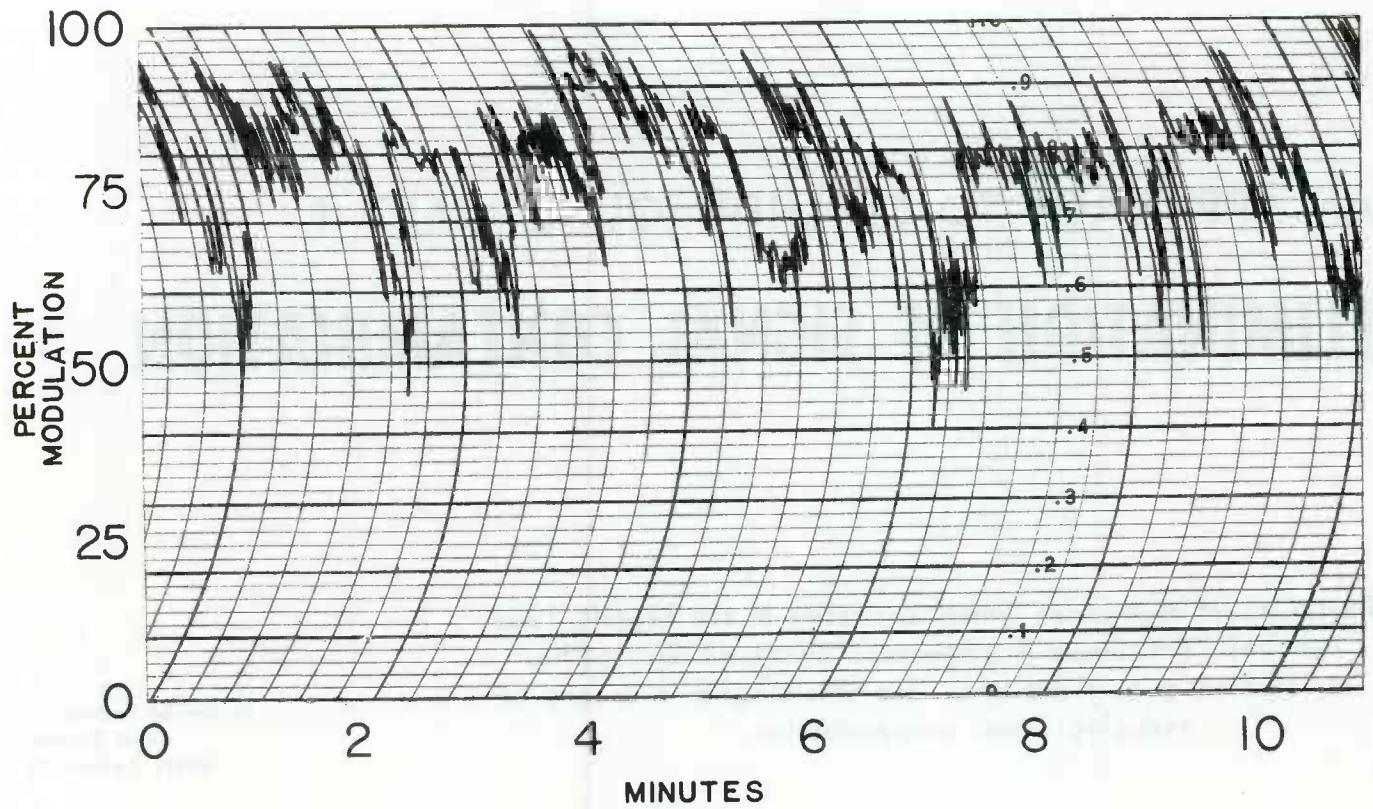

Figure 6
Recording of limiter output without AGC amplifier.

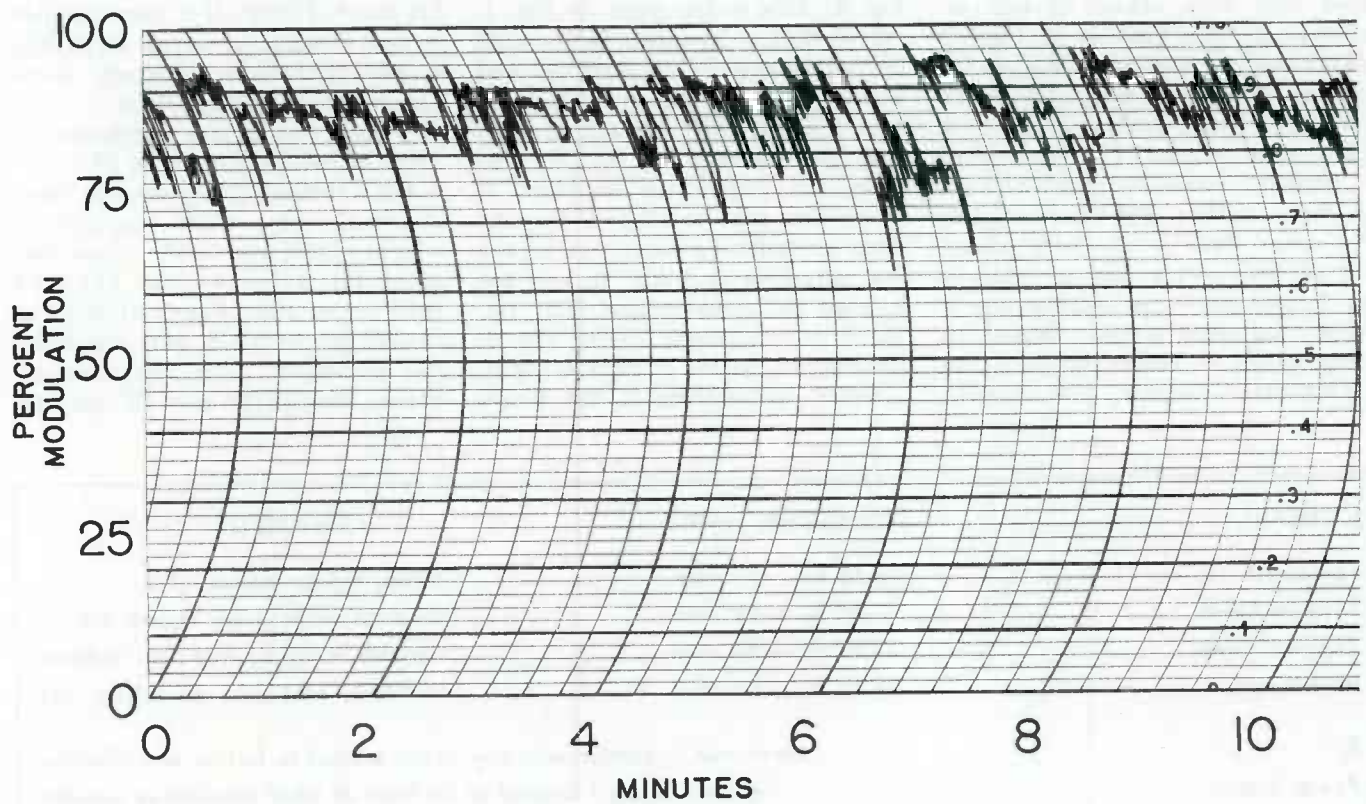

Figure 7
Limiter plus AGC amplifier. Note smoothness of operation compared with other curves.

AN APPROACH TO CLEANER SOUND—PART II

ELIMINATION OF SIGNAL CONTAMINATION

Part One of this series which appeared in the March, 1962, issue of "Broadcast Engineering" discussed Grounding. This section goes thoroughly into shielding as a means of reducing signal contamination.

By George Jennings III
Chief Engineer
WHYL Carlisle, Pa.

IN PART I of this series, we discussed grounding and its importance in the prevention of signal contamination. Let's look at *shielding*. Suppose one were asked to run an analysis on the circuits of Fig. 1: (1) There are two audio signals involved. (2) One is applied between terminals 1 and 2, in series with a 1200 ohm resistor. (3) The other is applied between terminals 3 and 4 in series with a 300 ohm resistor. No other data is available about the circuit—no component values—no frequencies—no voltage levels. Most engineers would throw up their hands in horror, go take the transmitter readings, and wonder

how they can get the RF buzz out of the number one tape recorder, or the crosstalk out of the audition bus.

Before giving up, take a look at Fig. 2. This is the same as Fig. 1, except that it is drawn to show all the little-noted and much-ignored leakage paths. Looks familiar now? The first shows the various ways electrical energy can be coupled from one circuit to another. It shows the wire resistance, R_s ; the shunt capacitive reactance, C_{sh} ; the line inductive coupling, L ; and the leakage paths to ground, C_1 , R_1 . Much as we people prefer Fig. 2, an electron sees the circuits as Fig. 1.

Since the electron is the fellow

responsible for these gremlins (the buzz in the tape-recorder, and the crosstalk in the audition bus) perhaps we'd better look at things from his point of view. If it were possible to make things as simple as in Fig. 2, we'd not have to worry much about signal contamination . . . but, of course, we're just daydreaming. That is impossible—or is it?

Let's redraw this one more time, showing only those parameters which contribute to the cross coupling. Fig. 3 still is messy, but it's a little better than Fig. 1. It looks as though we are stuck with the series line resistance (R_s) that's an inherent part of the wire. We can re-

CONDUIT	RANGE OF LEVELS	COMMENTS
Low Level.....	—70 to —40 dbm.....	Mikes, mixing busses, etc.
Medium Level.....	—40 to —10 dbm.....	Most non-mike mixer inputs, etc.
Program Level.....	—10 to +20 dbm.....	Console outputs, line apl. outputs.
High Level.....	+20 to +50 dbm.....	Monitors, recording amplifiers, etc.
RF.....	Never run in conduit with any circuit subject to further amplification.	
Power Supply.....	Separate conduit located as far from all other conduits as possible.	
Control Circuits.....	DC control circuits normally do not require conduit.	

duce it by using larger size wire, or shorter runs. The only thing we can do about the shunt leakage resistance (R_{sh}) is to use a better grade of insulation; or separate the conductors (physically or electrically). We can reduce the shunt leakage capacitive reactance by either separating the conductors, using less plate area (but this means smaller wire which raises the series resistance, and losses) or we can interpose some extra conductor between the wires; thereby converting the wire-to-wire capacitance into a wire-to-shield capacitance. If we ground this extra conductor, all leakage currents are shunted off to ground. There are two possible ways to cut down the inductive coupling (L): We can space the wires farther apart, or we can interpose some magnetic shielding between the wires to block this magnetic coupling.

Objectives of Shielding

Of the foregoing possibilities, two stand out as the most practical: Physical separation, and electrical and magnetic shielding. Now while every station engineer knows about shielding, not all use it to its best advantage. As noted in Part I, station wiring (be it audio, RF, power, or control circuits) must do three things: (1) Conduct electrical energy from one point to another; (2) confine that energy to the path provided; (3) prevent outside electrical energy from contaminating the energy inside the path. In many cases, we are in a position to sacrifice one of these requirements somewhat for the sake of the other two. For example: no one minds a little RF in the power lines, so long as it doesn't get back into the audio gear and cause problems. A mike channel, on the other hand, operates at such a low level that any loss here is intolerable. It is in cases such as this that good shielding is not only desirable but mandatory.

How Good Must Shielding Be?

To preserve a noise level at least 60 db below an equivalent 100% modulation, we must keep the noise at least 60 db below *any* signal which normally results in 100% modulation. Take an extreme but common case: that of a mike channel. Microphone levels range from a usable minimum of -90 dbm to a maximum of -25 dbm on peaks.

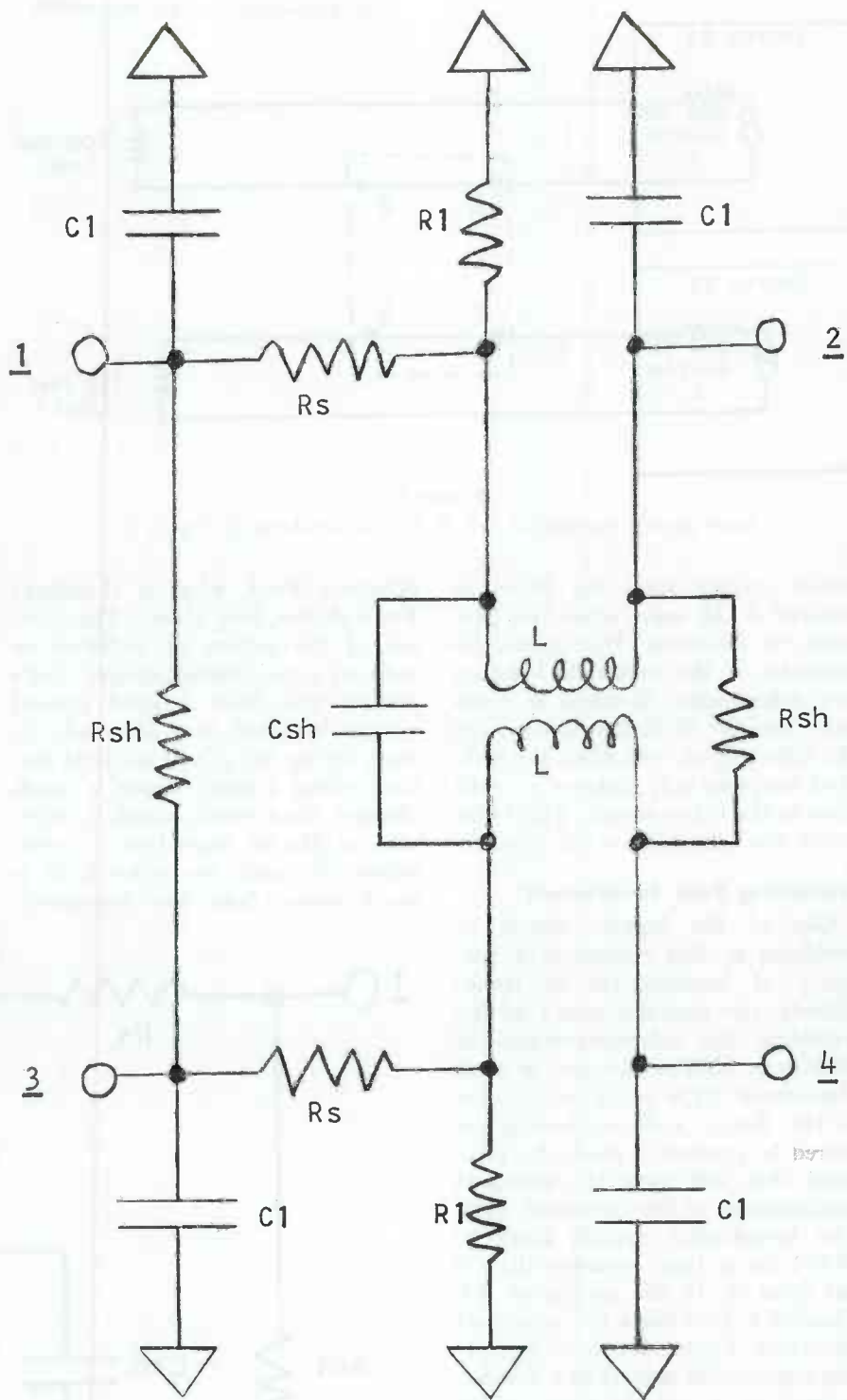

Figure 1
Circuits 12 and 34 are separate isolated wires?

A happy average seems to be about -65 dbm. To preserve a noise level of -60 db in this channel, the absolute noise in the mike channel must be at least -125 dbm! (For information purposes, -120 dbm in a 600-volt line corresponds to a voltage of about 0.7 microvolts.) This means with a transmitter output of, say, 5 KW (plus 67 db above 1.0 milliwatt) the maximum

allowable cross coupling cannot exceed -192 db!!! The same problems exist to a lesser degree with audio crosstalk, clicks, buzzes, and all the other little noises that somehow get in where they're not wanted. The key to the whole problem of signal contamination by radiated coupling is *alternating currents of any frequency will radiate from any conductor to any other conductor—*

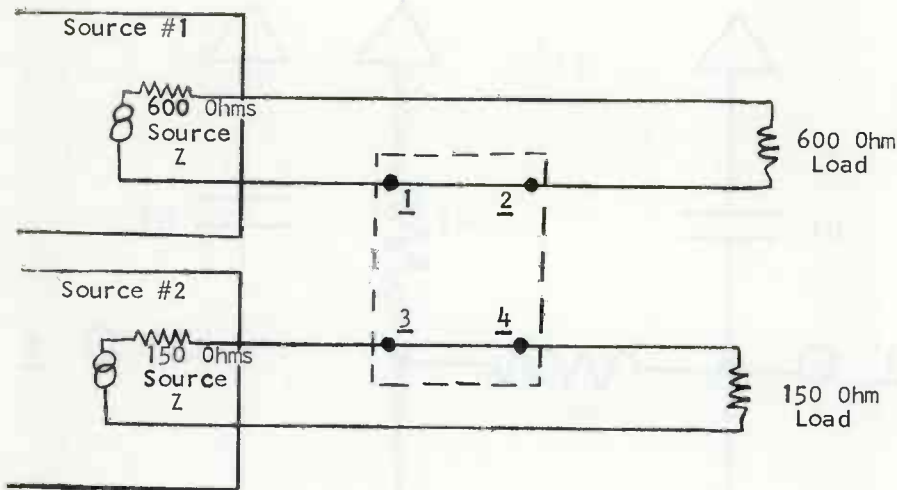

Figure 2

Inset portion numbered 1, 2, 3, 4 is circuit shown in Figure 1.

unless specific steps are taken to prevent it. In some cases this presents no problems. Who cares, for example, if the crosstalk between two microphone channels is down only 100 db? With the mike doing the radiating at -65 dbm, the radiated coupling only induces a -165 dbm in the other circuit. This is far below the allowable -125 dbm.

Protecting Your Investment

One of the biggest causes of problems in this respect is a tendency of broadcasters to ignore blithely the manufacturer's advice regarding the interconnections of their gear. Half of the cost of most "broadcast" type equipment is due to the design and engineering required to produce a piece of equipment that will meet the stringent requirements of the broadcast field. The broadcaster spends close to \$2,000 for a tape recorder that is flat from dc to the middle of TV Channel 6; that has a low noise and distortion figure. He now mounts this engineering marvel in a wooden cabinet or a console desk, which offers absolutely no shielding—the recorder picks up all sorts of buzzes, clicks, audio crosstalk, etc. He might just as well have spent \$200 for a cheap little recorder, and invested the other \$1,800 or so in a good station wiring job. All his other programs would sound cleaner, and the recorder would certainly be no worse sounding than with the deluxe model.

Practical Applications

Let's take a closer look at some of the ways shielding can be made

effective. First, what is shielding? For a starter, how about: The process of prevention of radiated or induced signal contamination? Let's assume you have a good ground system installed, and are ready to start laying out a well shielded station wiring system. Paper is much cheaper than wood, conduit, wire, etc., so plan on paper first . . . even before the nails are ordered. It is much easier (and less expensive)

to over-engineer on paper, and delete judiciously, than it is to try to piece in some last minute requirement as the carpenters are putting their paint brushes away. Once the rig is in, and commitments are made as to its scheduled use, it's hard to remodel the layout.

The first consideration is the power wiring. If you can enclose all power wiring (even the lighting fixtures circuits) in conduit, you will have reduced the hum level by about 20 to 30 db. Try it yourself. An unmounted tape playback head, or a magnetic ET cartridge makes a handy Hum Probe. Having routed the power wiring, pick the routes that are farthest away from the power conduits, and at the same time consistent with station layout, for the low level mike circuits, mixer busses, etc. Bear in mind that capacitive coupling is primarily dependent on the voltage level in the radiating circuit; and that inductive coupling is basically a current phenomenon; both increase as the frequency goes up!

The highest power levels you are likely to encounter are: (1) The

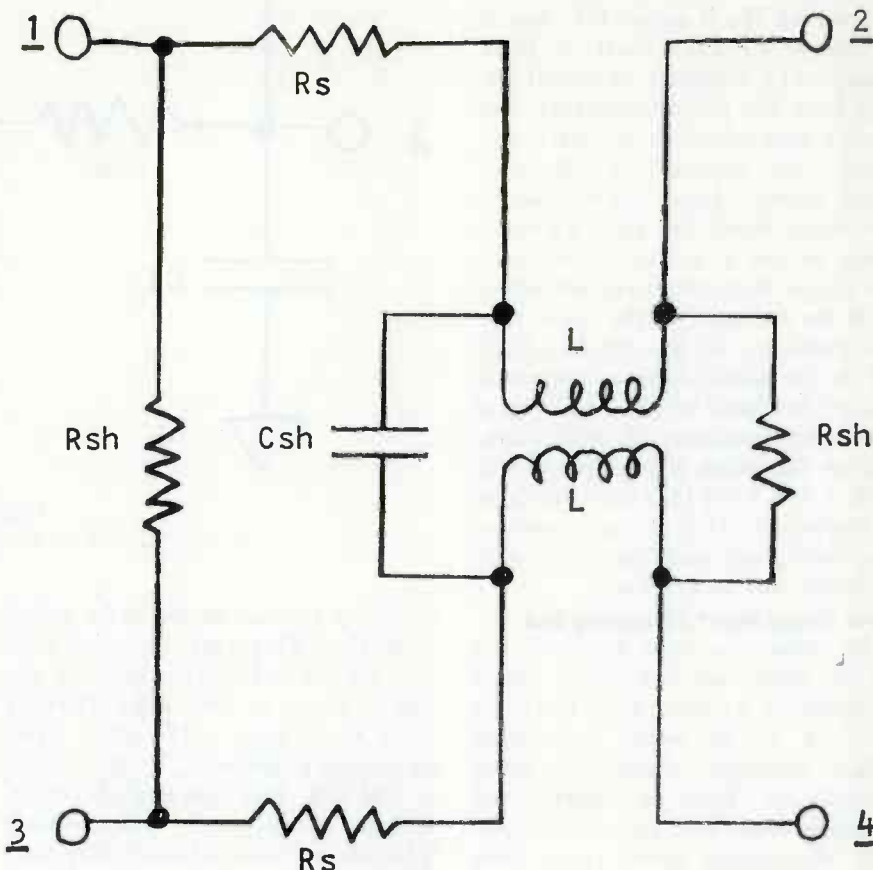
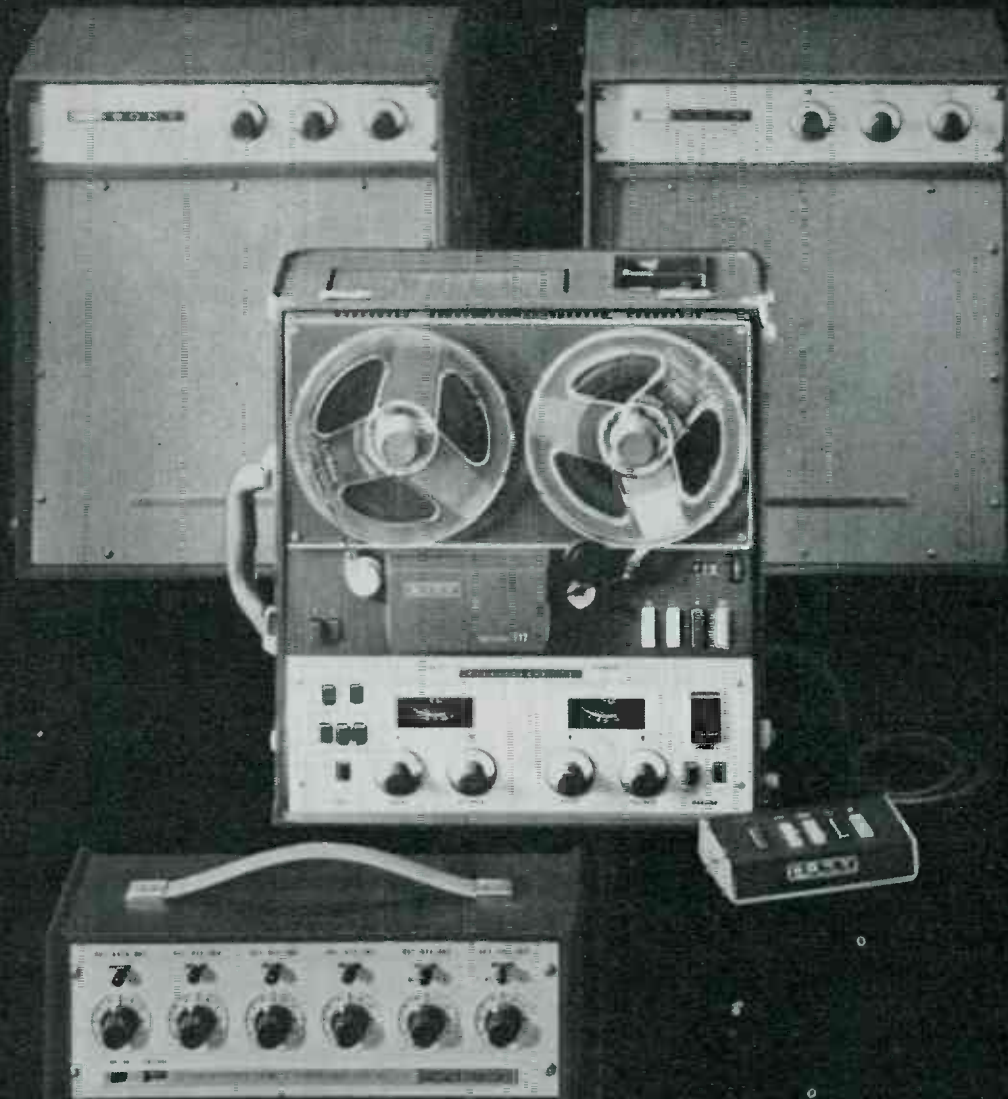

Figure 3

Parameters contributing to the coupling from Circuit 1-2 to 3-4.

all-transistorized New Sony Sterecorder 777



the first/complete/portable/all-transistorized/high fidelity PROFESSIONAL RECORDING & PLAYBACK SYSTEM

The most advanced achievement in recorder engineering to date, the superb new remote-controlled professional Sterecorder 777 series features the exclusive and patented Sony Electro Bi-Lateral 2 & 4 track playback Head, a revolutionary innovation that permits the playback of 2 track and 4 track stereophonic or monophonic tape without track width compromise—through the same head!

Included in an array of outstanding features are individual erase/record/playback heads, professional 3" VU meters, automatic shut-off, automatic tape lifters, an all-solenoid, feather-touch operated mechanism, electrical speed change, monitoring of either source or tape, sound on sound facilities, and an all-transistorized military plug-in type circuitry for simple maintenance. The three motors consist of one hysteresis synchronous drive motor and two hi-torque spooling motors.

Unquestionably the finest professional value on the market today, the 777 is available in two models, the S-2 (records 2 track stereo) and the S-4 (records 4 track stereo). Both models can reproduce 2 and 4 track tapes.* And, the Sterecorder 777 models will integrate into any existing component system. \$595 complete with portable case and remote control unit.

*Through the exclusive Sony Electro Bi-Lateral 2 and 4 track playback head.

Sony has also developed a complete portable all-transistorized 20 watt speaker/amplifier combination, featuring separate volume, treble and bass controls, mounted in a carrying case that matches the Sterecorder 777. \$175 each.

Also available is the MX-777, a six channel all-transistorized stereo/monophonic mixer that contains six matching transformers for balanced microphone inputs and recorder outputs, individual level controls and channel selector switches, Cannon XL type receptacles, a switch to permit bridging of center staging solo mike. \$175 complete with matching carrying case.

The first/complete/portable/all-transistorized/high fidelity/professional recording & playback system: \$1120 complete.

Sold only at Superscope franchised dealers. The better stores everywhere.

For additional literature and name of nearest franchised dealer write Superscope, Inc., Dept. B, Sun Valley, California.

All Sony Stereocorders
are Multiplex ready!

SUPERSCOPE

The Tapeway to Stereo

main power lines, with their pole transformers, power transformers, turntable motors, etc., contributing to the magnetic coupling of hum into anything near. (2) The transient producing fluorescent lamps, commutated motors, mercury vapor rectifiers, and tower blinker relays introducing high click and buzz levels. (3) Finally, transmitting equipment, or anything similar (local oscillators in receivers, for instance) which radiates a strong RF signal into every conductor in the area. Transmitters can easily induce 5 or 10 volts of RF into the nearest mike circuit. Fortunately, most linear mike pre-amps will ignore some RF, that is, until the tubes or bypass capacitors get weak. Then almost anything can happen, the commonest being that the circuits merely rectify the RF, extract the audio, and put it back into the program channel to repeat the cycle over and over again with fuzzy results.

Isolation

The only reasonably sure way to prevent coupling from one circuit to another is by electrical isolation. From the capacitive coupling point of view, this means braided shielded balanced lines. This means well balanced lines. Using a balanced line is exactly the same procedure as using any other balanced bridge circuit. Nulls are only obtained when the balance is exact. There are two common philosophies on how to ground this shielding: The first insists that bare shielding braid be used. The cables are laced together very tightly, with the bunched shields providing a brute force low reactance path to ground for the shield current. The second notion is to use insulated shielding, and ground the braid at one end *or* the other — but not both! — depending on which gives the least noise and crosstalk. It is interesting to note that when a mike channel is to be shielded, both methods use an insulated shield. Draw your own conclusions!

While the braid cuts down capacitive coupling, we are still faced with magnetic coupling—everyday transformer action. The two biggest aids in this department are actual physical separation and the generous use of well grounded conduit. Of course, it isn't necessary to run

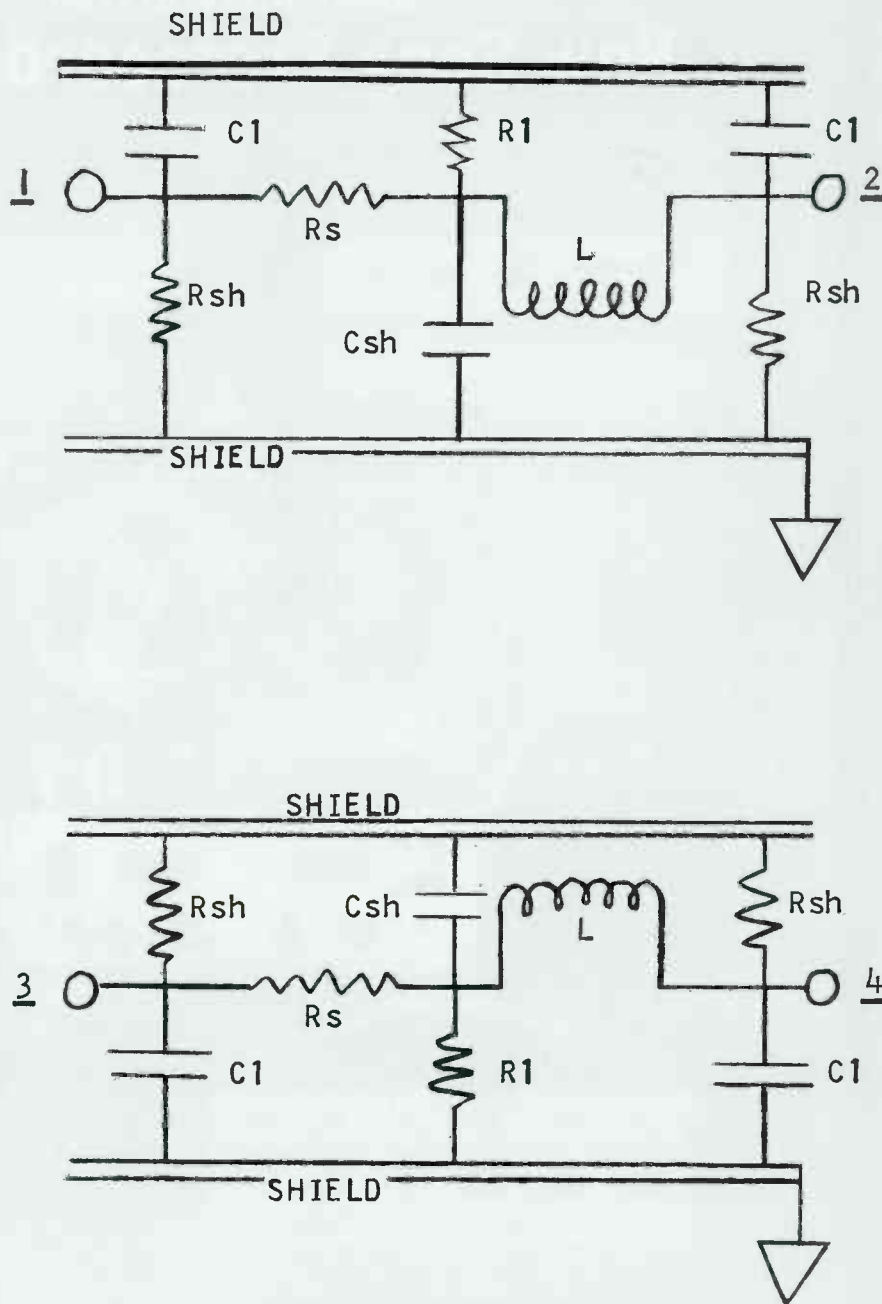

Figure 4
An electric and magnetic shield effectively separates the coupling between circuits 1-2 and 3-4.

a separate conduit for each circuit. They can be grouped judiciously in the same run. Circuits operating at about the same level and the same range of frequencies can be run together. Since the braid alone provides more than 70 db of isolation, like levels will not cause objectionable cross coupling. A good rule of thumb is to allow about a 30 db spread between levels in the same conduit, as shown in an accompanying table.

Chassis Pickup

Inasmuch as the wiring is a strictly passive and supposedly lin-

ear type of circuit, the whole object of clean wiring is to prevent contamination from getting into places where it can cause trouble: Namely the chassis of various pieces of gear! The best wiring job in the world won't cure cross coupling of noise and RF unless the chassis themselves are free of pickup! One of the best possible means of reducing chassis absorption of other undesirable signals is by the use of *enclosed racks with steel walls all the way around*. Equipment racks, aside from their appearance and efficient

(Continued on page 16)

FREE HELP FOR PLANNING

- Path Surveys and Site Selection Manual
- Profile Planning Charts
- Antenna System Calculator
- Graph Worksheets
- Protractor
- System Planning Charts
- Map Symbols Guide



PLANNING STL or INTERCITY RELAY THIS YEAR? SEND FOR RAYTHEON'S FREE PLANNING KIT!

Raytheon's Microwave System Planning Kit helps you engineer initial requirements, carry out preliminary terrain and tower surveys. It also explains topographic maps, path clearances, profile plotting, signal attenuation, FAA and FCC regulations.

In designing this Planning Kit for TV Station Chief Engineers, Raytheon experts drew on their extensive experience servicing over 1000 microwave installations in every type of terrain and climate throughout the world.

Raytheon KTR Microwave, for Intercity Relay network pick-up, is available in both 1/10th-watt and 1-watt systems to meet individual needs. These systems have proven reliability, operating unattended over extended periods in all environments.

The world's largest manufacturer of microwave tubes and equipment, Raytheon also offers TV Stations complete, no-obligation System Engineering Service.

P. S. That curious little character climbing the mountain in the illustration is none other than Ludwig Von Microwaffen — Raytheon's sight surveyor *par excellence!* Look for him in your next mailing from Raytheon.



MAIL TODAY FOR FREE PLANNING KIT

Raytheon Company, Dept. GM4-BE, Norwood, Massachusetts
Attention: H. Bannon

BE-6,

Please send free Microwave System Planning Kit.

- Planning a system. Have Engineer call.
 Keep me on mailing list. For reference only.

Name _____

Title _____

Company _____

Address _____

City and State _____



AUDIO STUDIO MAINTENANCE

We have had many requests for articles on maintenance. This one, which shows an outline of a studio maintenance system which can be extended as required, is to be followed shortly by another by the same author on transmitter maintenance

By Thomas R. Hasket,
P. O. Box 41 - 3176z
Michigan City, Indiana

THIS ARTICLE describes a detailed and comprehensive plan for maintenance of the basic audio equipment used in radio and television studios. The heart of the system is a technique which is more efficient and less expensive than the methods employed at most stations.

It seems superfluous to speak of the desirability of preventive maintenance. It also seems apparent that most engineers are aware of the need for familiarity not only with equipment function within a studio-transmitter system, but with stage or component function within each unit. It is further assumed that most engineering departments have complete manufacturers' technical manuals concerning the equipment in use.

Tools

Most stations possess adequate tools and test gear. However, cer-

tain tools and materials are needed to maintain audio equipment properly. Small hand tools are obviously necessary. The basic list includes:

- a pair of long-nose pliers.
- a pair of diagonal cutters.
- a soldering gun.
- Some solder.
- a set of Allen wrenches.
- a small camel's-hair brush.
- a penknife.
- Some clip leads (jumpers).
- a few screwdrivers.
- a few nutdrivers.
- a burnishing tool.
- a tube manual or "pindex".

No station should be without at least two items of test equipment: A good mutual-conductance type of tube tester and a 20,000 ohms-per-volt VOM. They will pay for themselves many times over in prevention of trouble and loss of air time. Other items which are very desirable are an audio-frequency oscillator, noise and distortion meter, VTVM, and an oscilloscope.

In the matter of spare parts, the largest item is tubes. If any spares at all are to be kept on hand, it would seem prudent to stock at least one of each type which is in use at the studio. However, suppose eight 12AX7's are in use. If two are needed over a weekend, when the distributors are closed, some piece of equipment is going to be out of use. Obviously, it is necessary to keep more of some types than of others. An excellent plan to follow in this respect is the so-called "FCC Spare Tube Rule," which was formerly mandatory for transmitter tube spares. For example:

Number of type 12AX7's in use	Number of spare 12AX7's to be kept in stock
1 or 2	1
3 or 4	2
5 or 6	3
7 or 8	4
9 or more	5

This ratio is based on studies of the mathematical probability of

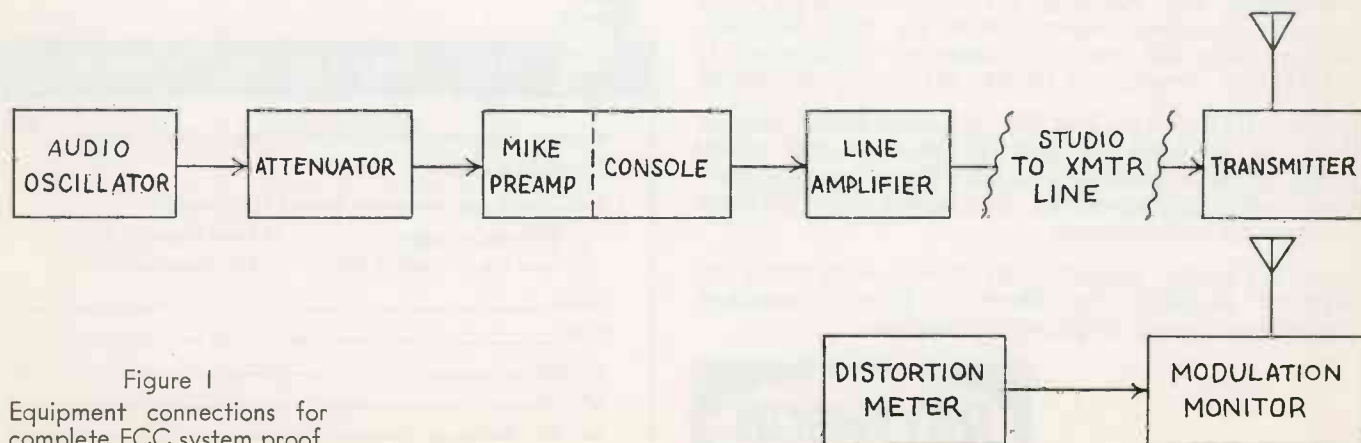

Figure 1
Equipment connections for complete FCC system proof.

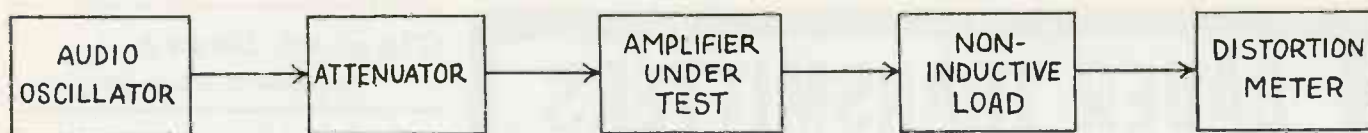

Figure 2

Equipment connections for both complete unit proof and spot proof.

more than one tube of the same type failing at or near the same time. It has been in use for many years by a great number of stations and has proven both economical and dependable.

In addition to spare tubes, other components should be on hand to meet emergency needs. A small assortment of mylar capacitors (these are better than paper) in the range from .005 to .25 (at 600 volts working) costs little but is handy in a pinch. Similarly a few dollars invested in one of those little five-drawer resistor assortments in the half-watt sizes can pay off handsomely when a test jig or emergency pad must be made up outside normal business hours. At least one or two spare styli should be available at the studio in case a playback arm develops trouble. A chipped or broken stylus point can take an entire turntable out of service if no spare is on hand.

Since all equipment accumulates dirt, a good deal of the maintenance program is devoted to cleaning or getting rid of this dirt. The following cleansing items are the minimum that should be kept in stock: Control or contact cleaner, alcohol and wooden swab sticks with cotton ends for applying the alcohol, a liquid detergent, oil, and clean, soft, lint-free rags. A very useful cleaning tool is a combination blower and vacuum cleaner. Some equipment can best be cleaned by blowing the dirt out of it; some requires vacuuming. In either case, this appliance will save much time and encourage good "housekeeping" habits by its relative ease of operation.

The units commonly requiring maintenance to be covered here are: The console, turntables (including preamplifiers), tape machines, line amplifier (or AGC-type amplifier), jack field and patch cords, and microphones. The console is the heart of the system and the workhorse in most studios. It should be given

primary attention. In fact, the procedure to be described here uses the console as the reference point for the whole maintenance program.

Planned Maintenance

Successful preventive maintenance cannot occur without a plan. A routine should be set up which distributes the work around the calendar, and even among several staff engineers. If the equipment in use is simple and only one full time man is available for maintenance, the plan may be informal and might even be memorized. It is safer to outline the maintenance program on paper. Certain tasks, performed at regular intervals, are then checked off the list as they are done. This permits all responsible parties to see at a moment's glance the immediate condition of each unit. We will explain this plan in more detail later, after we have examined certain individual techniques.

By far the most maintenance time is that spent working on purely electronic assemblies—amplifiers and their associated circuitry. Here the vacuum tube is encountered, and at this point, one should examine the tube tester and its use in the maintenance program. It is, actually, an external criterion. Tubes are designed to work in equipment—not in tube testers. The use of a tester must be viewed, then, as an artificial mode of test, because it is not the ultimate test of a tube; the equipment is.

Tube Testing

However, the tube tester should not be ignored, as it performs valuable service as a test *ahead* of the equipment itself. That means simply that if a tube will not function in the tester, it certainly will not function properly in the equipment. The primary advantage of the tube tester is that it reveals gross defects, such as a dead tube (due to an open heater or lack of emission), dead-shortened or intermittently-shortened elements, and excessive gas

within the envelope. Where other methods of testing can show that a particular amplifier or chassis contains a faulty stage, it is awkward to locate the proper tube unless a tube tester is used. All newly-purchased tubes should pass the tube tester before being tried in equipment.

Quite apart from the elemental defects previously listed, there is the matter of mutual conductance, or transconductance. Testing tubes at periodic intervals with a good mutual-conductance tube checker and rejecting those which exhibit less than 75% of the listed transconductance (for amplifiers) has been somewhat of a standard practice at many stations for a number of years. In most cases involving audio equipment this is valid, as the figure of transconductance is closely related to audio frequencies. However, this method has the disadvantage of requiring a great deal of time, as each tube must be handled separately. A shorter, faster method can be used without requiring that each tube be tested individually. The individual test should still be performed on new tubes, before installation in equipment. The transconductance test may also be used on a spot-check basis, in conjunction with the method to be described next, and as a follow-up to such method, once the faulty section has been located.

Equipment Checks

The combination of a low-distortion audio oscillator and a high-quality noise and harmonic distortion meter can be employed to make an accurate check of the operating conditions of studio audio equipment. A complete proof-of-performance run should be made once each year. This should be done in accordance with FCC rules and will include frequency response, harmonic distortion, and hum and noise. Curves will be plotted showing the

(Continued on page 28)

BAUER TRANSMITTERS

Provide Top Performance With Minimum Maintenance



1,000 WATT FM

Stereo-Ready. Simple design. Built-in load. Factory assembled or Kit Form.

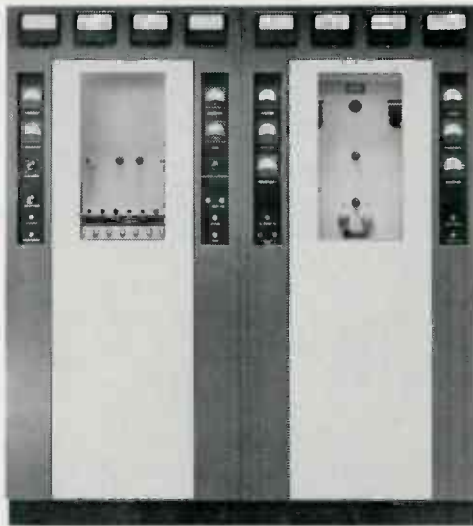

10,000 WATT AM

Ceramic tubes in PA and Modulator. 12,500 watt output capability. Lowest power consumption—high efficiency PA and modern design. Only 9 tubes—5 types.

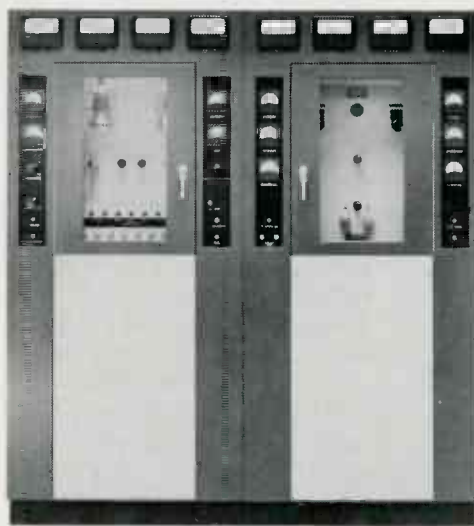

5,000/1,000 WATT AM

6,000 watt output capability. Continuous metering. Solid State rectifier system (standard in all Bauer transmitters). Fool-proof circuit protection with tally-light/overload relay system. Low power consumption—economical to operate.

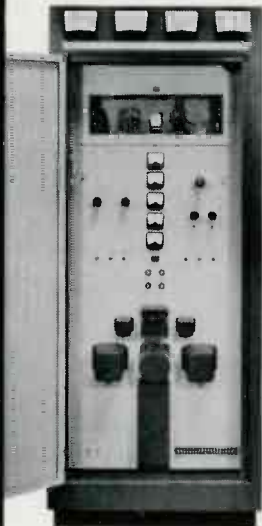

1,000/250 WATT AM

The famous Model 707. Leader in the field. Easiest to Buy. Easiest to Operate. Factory assembled or Kit Form.

WRITE FOR THE COMPLETE ENGINEERING STORY TODAY!

Bauer

ELECTRONICS CORPORATION
1663 Industrial Road, San Carlos, California • Area Code 415 591-9466

Cleaner Sound

(Continued from page 12)

utilization of floor space, make excellent magnetic and electrical shields. Rack mounting a tape recorder effectively surrounds the entire chassis with a big wall of electrical insulation. To do this, however, the rack must be well grounded. One word of caution: A rack will keep interference out; once it's in, it will also keep it in. Remember, too, that a rack that is well grounded makes a good place to mount remote pickup transmitters, etc., since it will keep any undesired radiation inside. Of course, if you then mount the mike preamps in the same rack, you might as well quit right there. You've missed the point completely!

If you simply must use those pretty mahogany veneered cabinets and those electrically useless cloth covered pasteboard portable carrying cases, at least take a tip from the radio amateur. Line the box with copper screening—it'll help some. The screening should be soldered in strips every two inches or so. Copper corrodes, and just because two screen wires cross, there is no indication they make good contact. The screening, of course, is well grounded.

Summary

Taking a look at final Fig. 4, let's see what we've accomplished: First, the leakage resistance from wire to wire (R_{sh}) has been diverted into a leakage from wire to shield. No leakage from wire to wire—no coupling here. Secondly, the shunt capacitance (C_{sh}) has been converted from a wire-to-wire-reactance into a wire-to-grounded-shield-reactance. Finally, the inductive or magnetic coupling (L) has been blocked by the magnetic shielding properties of the conduit. Having reduced all factors accounting for cross coupling between circuits, we can be reasonably sure that the cross talk and signal contamination has also been reduced. The more carefully and more thoroughly the job is planned and carried out, the better the results. There is still one other weapon we have against signal contamination—*filtering*. We'll take a look at that one next time.



Performance-proved Sylvania Gold Brand Tubes

“CUT MAINTENANCE TIME BY 75%”

DONALD B. PATTON, CHIEF ENGINEER, WKRG, MOBILE, ALA., SAYS...

“I bought a small supply of Sylvania Gold Brand Tubes and found them to be 100% interchangeable in pulse as well as video circuits. I was so impressed I bought an additional twenty... found them to be 100% interchangeable with each other.

“Sylvania Gold Brand Tubes in our sync generators have cut our required maintenance

time by 75%... no longer have to hunt for matched pairs. We are also using Sylvania Gold Brand Tubes in our camera circuits that are critical... almost impossible to detect any change in operation from the crucial first 100-hour period... reasons enough for me to specify Sylvania Gold Brand where reliability and quality are of prime importance.”

Available from your Sylvania Industrial Tube Distributor!

SYLVANIA

SUBSIDIARY OF

GENERAL TELEPHONE & ELECTRONICS



Soundproofing Problem Solved For Paris Broadcast Studio

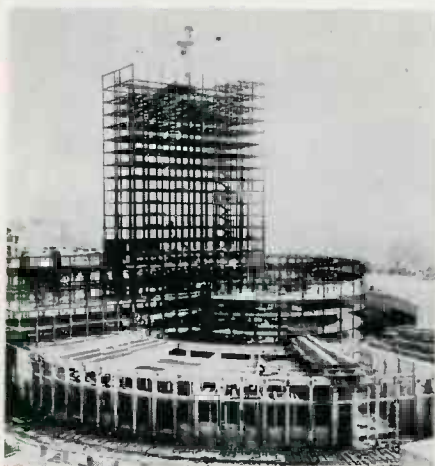

Linatex Corp. of America, Stamford Springs, Conn., has reported a new application for Linatex, that of soundproofing a broadcast studio in Paris, France. French engineers encountered a severe soundproofing problem in building the new Paris Radio and TV Building. The first

requirement was to insulate completely each of 17 studios from each other within one large multi-level steel and concrete structure. Prevention of ordinary outdoor surface noise was not too troublesome. Major concern was the relatively great amount of low-frequency sound which had to be overcome.

The basic structure is a modified low level wedge with a multi-story steel and concrete tower rising from near the apex of the wedge. The finished building is, in effect, a building within a building. The outer wall of concrete surrounds the low level studio section, and the inner wall consists of movable partitions. The plan of the French engineers mounts all inner walls and the entire tower unit on sound absorbing pads. In effect, this floats the inner building and effectively separates it from the outer construction. Sound and other vibrations

emanating from the ground are thus eliminated throughout the entire structure. Some ten tons of Linatex, which is made from pure Malayan rubber, were used on the Paris project. Two qualities in the selection of the product were its resilience and insulating value. Tests were reported to show that Linatex retained its resilience under the extremely heavy loads that were imposed, and that it was found to provide insulation of 12 db.

Moving X-Ray Images Tape-Recorded for TV

Radio Corp. of America, New York, N. Y., has reported the use of a television tape recorder to capture on magnetic tape the moving images of X-ray examinations in a new application of electronics to advance the study and diagnosis of internal body functions. Now under test at Johns Hopkins Hospital, the technique combines an RCA closed circuit TV system with an X-ray image intensifier and produces pictures on tape of a high degree of clarity and resolution. Because the tape machine is capable of immedi-

FREE HOME DEMONSTRATION!

Enjoy a free demonstration of the remarkable Electro-Voice Model 643 in the comfort of your own living room. No cost or obligation. No fuss or muss, no coupons to fill out, and no salesman will call! All you do is flick a switch!

Turn on your TV set during the next presidential news conference. Any channel. Look closely and you may see what appears to be a "bazooka" on stage next to each TV camera covering the reporters. This is the E-V Model 643 dynamic Cardiline microphone, the most directional broadcast microphone on the market!

The 643's are up to 50 feet away from the reporters, yet the sound is clear and natural in quality . . . you can hear as well at home and sometimes better than the President himself! Compare this unobtrusive pickup with the conventional hand-held microphones or "cornfields" of microphones used in the past. A dramatic demonstration that the 643 reaches farther than any other broadcast microphone available!

And there are plenty of other demonstrations. At football games and parades, 643's pick up marching bands with recording fidelity up to two city blocks away! In TV and film studios and on remotes the 643 delivers clean dialogue despite wind and noise that would spoil the "takes" from an ordinary microphone.

The E-V Model 643 is another example of the many positive contributions by Electro-Voice to professional sound pickup techniques. If your sound problems can be solved by a 7-foot microphone that "reaches" farther than any other, arrange now for a studio demonstration of the unique new 643. Ask your E-V professional microphone distributor for details today!

*New 7-Foot Long
Electro-Voice
Microphone*



Electro-Voice®

ELECTRO-VOICE, INC.

Commercial Products Division, Dept. 621V
Buchanan, Michigan

ately playing back what it has just recorded, the diagnostician or a group of consulting physicians is able to view and evaluate the patient's examination within seconds, it was stated.

In an examining room, the television camera is mounted on an image intensifier which produces a bright picture from a relatively low level of X-rays. As the examination proceeds, television pictures are relayed by cable to the tape recorder in a nearby room. At the same time, the pictures appear on a TV monitor in the examining room where they may be viewed by the physician and, in some cases, by the patient undergoing the examination.

Johns Hopkins' officials point out that television is particularly useful in diagnostic or research studies where motion is important to a determination of organic malfunction. When tapes of several examinations are spliced together, the patient's complete history can be reviewed by a number of physicians at a time convenient to the group. Also, tapes of patients with similar conditions can be joined for use in medical research.

Portable Console for Closed-Circuit TV

A new portable TV console for closed-circuit systems has been developed by Blonder-Tongue Laboratories, Inc., Newark, N. J. The mobile unit is said to be extremely useful in the growing field of educational and classroom TV, as well as in a variety of commercial applications. Called the Porta-Studio, model ST-1, the new device can be wheeled from room to room.

The unit was designed as a miniature studio for schools and industry, and contains a transistorized camera and microphone for picking up audio and video reception. A modulator combines them into a complete TV system, originating any channel from 2 to 13. Along with appropriate lighting and a 17-inch monitor, the ST-1 is said to have all the cables, connectors, switches and amplifier equipment needed to generate a full TV channel with both sound and pictures. According to the manufacturer, the device marks a major advance in classroom TV, as it can be easily op-

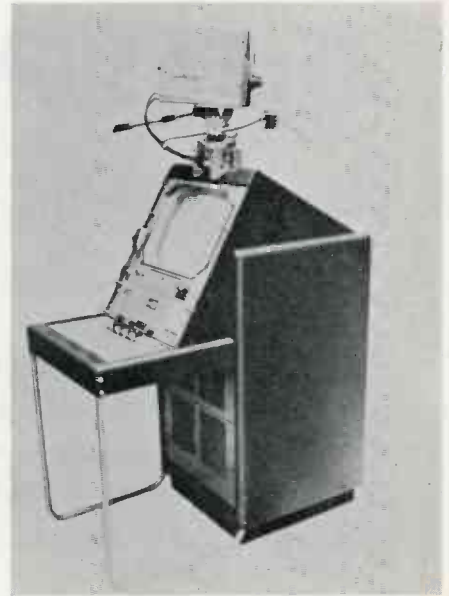

erated by one man who requires no special training. It was further stated that when the unit is plugged into any outlet in a properly designed master TV system it will originate programs that can be received by anyone on the system.



*More E-V microphones are
seen at major news events
than any other brand.*

TELEVISION TAPE FUNDAMENTALS

Part 5—Testing Techniques

This series contains excerpts from selected sections of a forthcoming book to be published in 1962 by Broadcast Engineering Notebooks, P. O. Box 10682 (Penn Hills), Pittsburgh 35, Pa. Copyright 1962 by Harold E. Ennes. All rights reserved.

By Harold E. Ennes
Maintenance Supervisor
WTAE
Pittsburgh, Pa.

PARTS 5 and 6 concern testing and maintenance techniques in general, whether applied to Ampex or RCA systems. The highlights may be summarized as follows:

1. Cleaning.
2. Tape transport tensions and general inspection.
3. Tape path de-magnetization.
4. Preventive maintenance.
 - (a) Checking amplifier gains
 - (b) Ensuring proper video head optimization
 - (c) Checking servo stability
 - (d) Centering of pulse widths and frequency controls
 - (e) Checking signal-noise ratio
 - (f) Checking frequency response
 - (g) Checking amplitude linearity

Oiling and lubrication schedules as recommended by the manufacturer for the specific system used should be faithfully executed. This is of extreme importance due to the electro-mechanical nature of the television tape system.

Thorough service records of work performed or adjustments made correlated with the elapsed hour meter are invaluable to increasing efficiency in tests and maintenance.

Cleaning

A professional job of cleaning the tape transport is of vital importance before operations, testing or maintenance procedures. Major troubles

that *can* occur from lack of cleanliness may be listed as follows:

(a) Drop outs (white flashes) due to oxide accumulation between heads.

(b) Oxide accumulation can also scratch the magnetic surface of the tape causing dots at a 960-cycle rate.

(c) Oxide in the vacuum guide or hose can cause scallop or skew due to lack of concentricity with the tape. A "wandering" type of skewing can result from oxide shedding of tape into the vacuum guide which may alternately clog and clear the air path.

(d) Contamination of the nylon bearings underneath the vacuum guide block, or a contaminated screwhead contact with the arm which is actuated by the guide servo to position the vacuum guide can cause a slightly different tip penetration each time the tape is stopped and re-started.

(e) Erratic tracking from a contaminated capstan or capstan pinch rollers resulting in tape slippage.

Naptha or Freon TF are the most widely accepted cleaning agents for video and audio heads, and all metal contacts on the tape transport. Denatured alcohol is an excellent agent for the rubber capstan pinch rollers, although the previously mentioned agents may also be used here.

Use a hypodermic-type injector to squirt naptha or Freon TF into the slip ring assembly on the head panel and rotate the shaft by hand to clean the rings and brushes. Inspect each brush to assure that the slim spring contact arm is properly seated in the brush groove.

Use lint-free tissue or a soft brush (such as a toothbrush or camel's hair) moistened with the cleaning fluid to clean the tape tension arms, erase head, all audio heads and the capstan, as well as the bearings



Figure 23
"Slanted" rf envelope of channels at the switcher output usually indicate magnetic video heads.

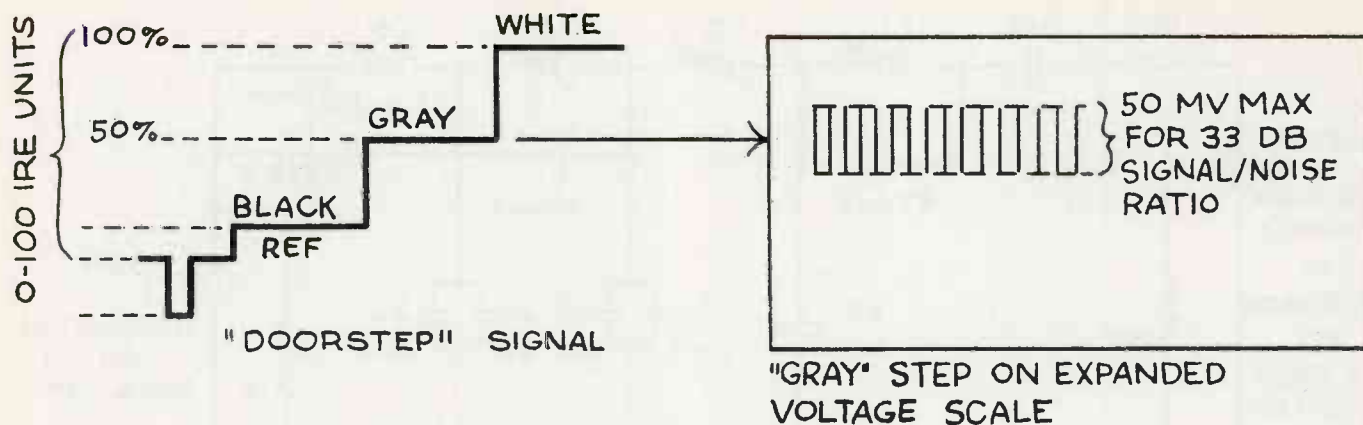

Figure 24
Fundamentals of signal/noise measurements with oscilloscope.

under the vacuum guide and the vacuum guide screw contact with the movable servo arm. (Caution: avoid using excessive wetting with the solvent which would allow fluid to enter ball bearing races).

Clean the video heads by rotating the shaft by hand while holding the moistened tissue or brush against the heads.

Use the moistened brush on the tape supporting surface of the vacuum guide while the vacuum pump is working.

Always allow ample drying time before loading with tape to avoid any possibility of softening the oxide binder.

Transport Tensions

Certain types of instability, particularly at tape start-up, can be caused by improper transport tensions. Since instability of this nature can lead the operator into an erroneous belief that servo trouble exists, tension checks should be made on a weekly basis, and before starting extensive checks of servo systems.

Mechanical tension adjustments are provided for the tape stabilizing arms and the capstan pinch roller pressure. The manufacturer's procedure should be scrupulously followed for these adjustments, and care exercised in obtaining the recommended values. An electrical "boosted torque" is provided on the takeup reel motor for approximately the first 1.5 seconds so that the tape is kept taut as the capstan is engaged. This torque, as well as the normal holdback torque on the

supply reel motor, is essential for a quick takeover of stable servo operation immediately following the time when the vacuum guide engages the tape with the head. This time is normally between 1.5 and 4 seconds, depending upon the setting of the associated time delay.

It is good operating practice before every recording or play session to start the tape both in "normal" and "fast forward" modes to ascertain that no tape loop is thrown, and that the tape motion is stopped with the tape under tension.

De-Gaussing

The tape transport should be de-magnetized at least once daily as a precautionary measure. Fig. 23 shows the usual tell-tale indication at the switcher output of magnetic fields in the tape path.

A small hand de-gausser should be energized at least four feet from the tape transport and brought slowly up to the panel. It is good practice to keep the de-gausser slowly rotating in a small circle while going over the entire tape path from supply reel to takeup reel. Start the video heads rotating (by pushing the "Override" switch on Ampex, the "Standby" button on the RCA) as the de-gausser is passed over the head panel assembly. De-gauss the audio heads with the conventional audio head de-gausser.

Before de-energizing the de-gausser, slowly pull away from the panel to at least four feet.

Needless to say (but often forgotten) no magnetic tools such as screwdrivers, Allen wrenches, etc.,

should be allowed to be stored near the transport. Always de-gauss tools before use on the equipment or storing in nearby shelves.

Amplifier Gains

An important factor in preventive maintenance procedures is in knowing the normal gains of individual amplifiers such as preamps, modulator video up to the reactance tube grid, rf gain from modulated stage to modulator output, demodulator, etc. This step in preventive maintenance should help in keeping the system signal/noise ratio within specifications, and will indicate when the need arises for tube transconductance checks and replacements.

As a specific example, measure the video head output upon playback of a "standard" tape such as the head alignment tape. This output is normally between 1 and 2 millivolts. The technician should measure the output of the head pre-amplifier and compare this peak-to-peak value to the "normal" value determined when the system is known to be properly functioning. All of these values should be recorded and available to the maintenance personnel.

The playback signal/noise ratio is an excellent indication as to when a complete run-through on individual amplifier gains (and demodulator limiting) should be made.

Before running the signal/noise measurement, it is highly important to ensure that the tape is not completely new and unpolished, nor old and worn or scratched. In other words, a tape should be used that

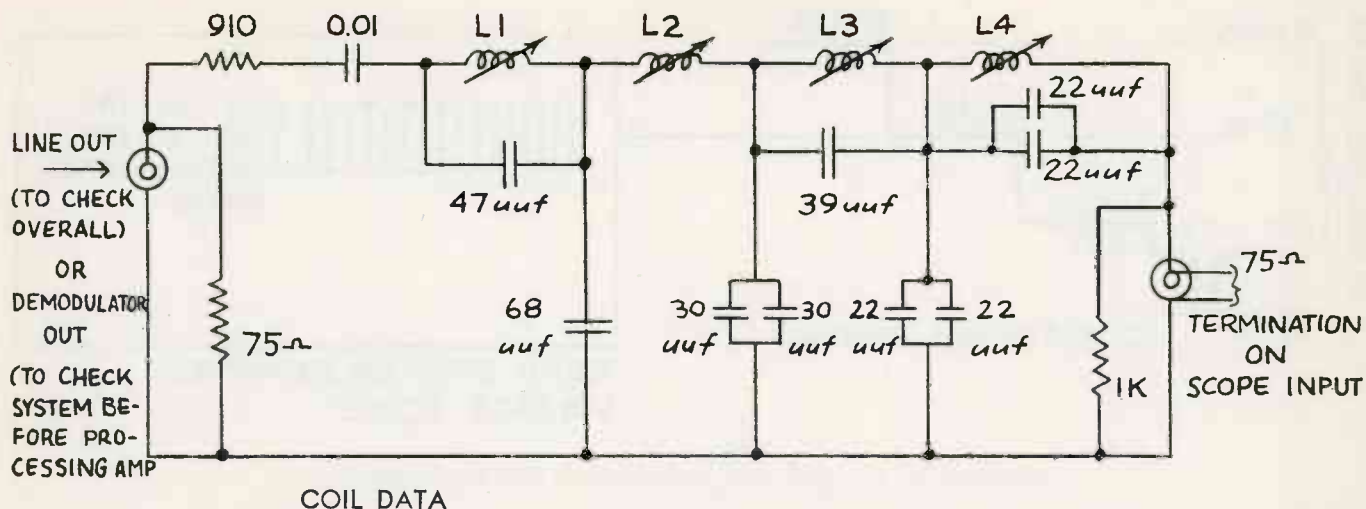

COIL DATA

Symbol	Northhill Elect.		Microtran	
	Part No.	Value (uH)	Part No.	Value (uH)
L1	1000-F	14.5 - 22	200 - 3	6.6 - 20
L2	1000-I	55 - 110	200 - 5	33 - 110
L3	1000-H	29 - 55	200 - 4	16 - 55
L4	1000-F	14.5 - 22	200 - 3	6.6 - 20

Adjust coils to obtain following characteristics:

- 6 db @ 10 kc
- 0 db @ 10 kc to 4 mc
- 6 db @ 4.2 mc
- 40 db @ 4.5 mc

Figure 25

Bandpass filter for signal-noise ratio measurements. (Constructed from readily available components. Based upon data originally supplied by Ampex Corp.)

is in the condition used for normal satisfactory recording and playback in the daily schedule. The heads should be optimized, demodulator properly balanced, switching transients minimized and critical (optimum) tracking adjustments made.

The signal-to-noise ratio (on a peak-to-peak video to rms noise basis) should never be allowed to deteriorate below 35 db on modern systems. A ratio of 40 db is now entirely realistic for well maintained systems. (Non-interchanged playback).

The simplest method of measurement is by the use of standard step signal such as "Doorstep" (Fig. 24) or, with less accuracy, the "Stair-step" adjusted to obtain the minimum number of steps possible, in conjunction with the oscilloscope, as follows:

1. With the system optimized for recording, make about 3 to 4 minutes recording of the test signal.

2. With the system optimized for playback, observe the line output on a wideband scope through a bandpass filter with essentially flat response to 4 mc but a rapid roll-off to -40 db at 4.5 mc. (Fig. 25). The output signal should be adjusted for the standard 0.714 volt p-p video (blanking to white). This is 0-100 IRE units.

3. Expand the vertical presentation of the "gray" step and measure the p-p noise level. If the "Stair-step" was used, it is also necessary to expand the time base and observe the step at the 50% point. For the 0.714 p-p video output, the maximum p-p noise level should be 50 millivolts. To convert the p-p reading to rms:

$$0.050 \times 0.35 = 0.0175 \text{ volts (rms)}$$

$$\text{Then } 0.714 / 0.017 = \text{ratio of } 42/1 \text{ or approx. } 33 \text{ db.}$$

Thus in this case the p-p video-to-rms noise ratio is 33 db, and is the basis for the statement that 50

millivolts (p-p) noise level is the maximum permissible, and indicates need for further improvement before the noise level becomes intolerable. This is to say that the 50 mv (p-p) level becomes the *warning flag* for the maintenance engineer.

When the signal/noise ratio starts to deteriorate, the limiter strip in the Demodulator should be checked to ensure that the amplitude at the limiter input can be dropped by 40 to 50 db (depending upon the specific specifications) before the output amplitude decreases.

The general condition of the Processing Amplifier can be interpreted if the "normal" range of input level to output level is known. An example of a specific tabulation:

Normal input: 1 v. (p-p)
 Minimum input: 0.5 v (p-p) for same signal/noise.
 0.25 v (p-p) just above sync breakout.

Itek INTRODUCES
**THE WORLD'S FINEST
WIRELESS MICROPHONE SYSTEM**



Designed especially for exacting broadcast industry use in or out of the studio . . . dead spots eliminated by simple, effective diversity reception and high power (400 milliwatts) . . . fidelity surpasses quality of today's finest miniature microphones . . . an Itek crystal filter and crystal control in each Receiver give you up to six channels simultaneously . . . from Itek, world's largest producer of crystal filters. Write today for brochure. You saw it at the NAB Show.

Itek Electro-Products Company
75 CAMBRIDGE PARKWAY, CAMBRIDGE 42, MASS. A DIVISION OF

Itek

General Electric Appoints New District Manager

Henry R. Owen has been appointed by General Electric's Technical Products Operation, Syracuse, N. Y., as district manager of a new office in New York City for G-E closed circuit television sales in the northeastern and Atlantic seaboard states. His office will be at 420 Lexington Ave.

Owen will be responsible for sales to commercial, industrial, educational and military customers, and will begin his new assignment following three months as a member of the closed circuit TV headquarters sales organization at Syracuse. He joined G.E. in November following seven years in studio and technical positions with CBS-TV in New York City.

Amperex Appointment to Jerome V. Sweeney

As part of its expansion program, Amperex Electronic Corp. has announced the appointment of Jerome V. Sweeney as assistant manager of distributor sales.

Before joining Amperex, Sweeney was sales coordinator on semi-conductors for four years with Sylvania Electric Products, Inc. During that period, he also engaged in promotion and advertising for the receiving tube and semiconductor departments.

Warns Against Improper Use Of Transistor Boosters

Blonder-Tongue Laboratories, Inc., Newark, N. J., manufacturer of transistorized antenna boosters and mast-mounted transistor boosters, has issued a warning to installers and do-it-yourself homeowners on the limitations and improper use of all makes of these units.

Citing the widespread confusion that has arisen over the relative merits of new transistor boosters and the traditional tube-powered models, a spokesman for the firm stressed that each was designed for particular local conditions, and pointed out that tube models performed better in areas with strong local channels, while transistor units were designed for fringe area re-



OVER 1400 SIZES AND TYPES OF IERC HEAT-DISSIPATING ELECTRON TUBE SHIELDS

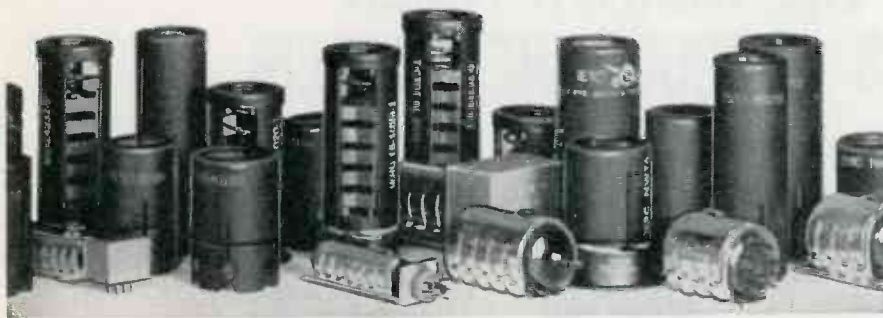

ARE EFFECTIVELY COOLING MILLIONS OF TUBES, EXTENDING LIFE AND RELIABILITY,



REDUCING DOWN-TIME AND MAINTENANCE COSTS IN THOUSANDS OF MILITARY AND



INDUSTRIAL ELECTRONIC EQUIPMENTS!

Write today for the facts on how you can improve equipment reliability with IERC Heat-Dissipating Tube Shields.

IERC  **DIVISION**

International Electronic Research Corporation
135 West Magnolia Boulevard, Burbank, California

Foreign Manufacturers: Europelec, Paris, France. Garrard Mfg. & Eng. Co., Ltd. Swindon, England

ception. "Transistor boosters are far more prone to overload than tube-powered units, especially in areas where there is a strong local channel," he cautioned. This overload, it was explained, leads to a loss of synchronization or windshield-wiper effect, with noticeable deterioration in picture quality on the screen. The Blonder-Tongue official urged the use of tube-powered boosters in such areas. "They may not be as rugged or amplify as well as transistorized units, but they can handle local channels that are relatively strong," he explained.

The company employs a patented circuit on its transistor booster to minimize overload. Despite this precaution, the unit's signal boost is so effective that overload results when it is combined with the strong nearby channel. "Installers and dealers should keep in mind that transistor boosters are primarily designed for fringe areas, where they are capable of delivering a dramatically improved picture," the spokesman said.

New Broadcast Equipment Sales Representative

General Electronic Laboratories, Inc., Cambridge, Mass., has announced the appointment of John A. Felthouse as broadcast equipment sales representative, covering Indiana, Illinois and Wisconsin.

The company's FM broadcast transmitters, FM multiplex and stereo equipment, rust remote control systems and related equipment necessary for complete broadcast installations will be handled by Felthouse from his office in Chicago, Ill.

Rohn Mfg. Expands Plant Operations

Two new buildings with total floor space exceeding 10,000 sq. ft. were put into operation at the tower manufacturing plant of Rohn Mfg. Co., Peoria, Ill., according to Dwight Rohn, president, as well as additional areas for the storage of completed tower sections. These additions to the present facilities gives total manufacturing space exceeding 100,000 sq. ft.

The expansion was made necessary in order to keep up with the increased demand for the company's communication towers, it was stated.

Solid State

Video and Pulse DISTRIBUTION EQUIPMENT

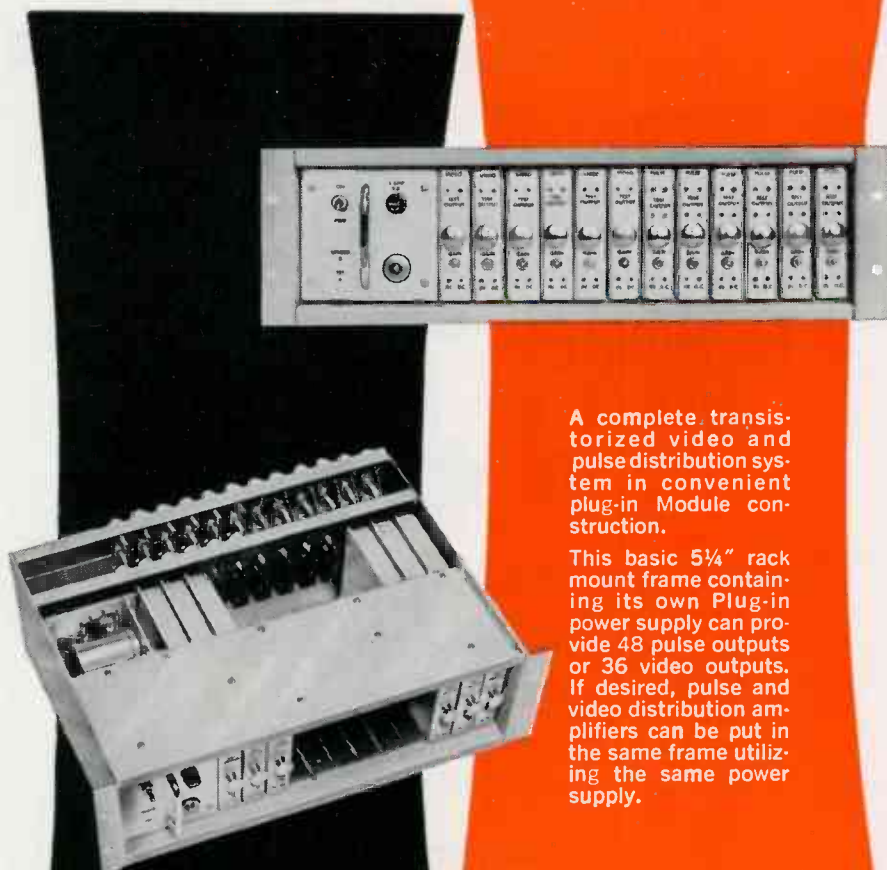

A complete transistorized video and pulse distribution system in convenient plug-in Module construction.

This basic 5 1/4" rack mount frame containing its own Plug-in power supply can provide 48 pulse outputs or 36 video outputs. If desired, pulse and video distribution amplifiers can be put in the same frame utilizing the same power supply.

- Modular Plug-In Construction
- High Input Impedance
- Identical Multiple Outputs
- Maximum Output to Input Isolation
- Plug-in Power Supply with individual voltage regulator on each amplifier
- Simple Stable Circuitry
- Designed For Reliability
- Minimum Cost per Output

For the best and most modern broadcast systems and supplies, look to **VISUAL**—your **SOURCE** for Superior Equipment from Specialist Manufacturers.

Write today for complete technical specifications.

VISUAL ELECTRONICS CORPORATION

Keeps You in View!

356 west 40th street • new york 18, n. y. • pennsylvania 6-5840

Book Reviews

Transistorized Voltage Regulators

Published by Semiconductor and Materials Division Radio Corp. of America, Somerville, N. J. 12 pages. Price: \$.25

The latest addition to RCA's Application Guide series, Transistorized Voltage Regulators, describes step-by-step design procedures and the solution to sample design problems for the three basic types of

regulating systems: series, shunt, and combination series-shunt regulators. Each of these systems can provide constant voltage, constant current, or constant impedance across the load.

The Guide covers design considerations and discusses the numerous advantages and capabilities of transistorized voltage-regulator types: small size, low cost, increased reliability and accuracy, and extensive control range.

Copies may be obtained by sending twenty-five cents to Commer-

cial Engineering, RCA Semiconductor and Materials Division, Somerville, New Jersey.

Design and Operation of Regulated Power Supplies

Catalog No. RPS-1. Published by Howard W. Sams & Co., Inc., Indianapolis 6, Ind. 112 pages. Price: \$2.95

This book, by Irving M. Gottlieb, is a down-to-earth discussion of regulated power supplies, including their design, theory of operation, and applications. It's an invaluable one-source reference on the subject for technicians, engineers and radio amateurs.

It explains the basic concepts of regulated power supplies and also why regulation is necessary. It tells about positive and negative regulation and how voltage regulator tubes, semiconductor diodes, and other components are used in various configurations to obtain the desired results. Open- and closed-loop regulators are thoroughly discussed, together with their applications and theory of operation. Component values for the various types of circuits are also given, thereby providing the reader with all the data needed to build regulated power supplies to fit his needs.

Six comprehensive chapters include: Basic Concepts of Regulated Power Supplies; Open-Loop Circuits Using VR Tubes; Open-Loop Circuits Using Zener Diodes; The Closed-Loop Regulating Circuit; Typical Closed-Loop Regulated Supplies; Special Techniques in Closed-Loop Regulators.

Two-Way Radio Booklet

"What You Should Know About Two-Way Radio," a 20-page pocket-size booklet, is now available from Section P, General Electric Communication Products Dept., P. O. Box 4197, Lynchburg, Va. The new publication (ECR-958) answers questions of potential two-way radio users concerning the initial costs of installing a basic communications system and provides information on the preliminary steps required in filing for an FCC license. It contains data on the types of frequencies in which a business or governmental agency can obtain a license and tells of the powers of equipment available for each frequency group.

McMARTIN TBM 3000 FM MONITOR APPROVED BY FCC



- The newest and most up to date Monitor on the market today.
- Immediate delivery (after thorough checkout and alignment)
- Price: \$495
- For the very finest in reliability and performance, depend on McMARTIN FM and Multiplex Monitors

FEDERAL COMMUNICATIONS COMMISSION
WASHINGTON 25, D. C.

March 26, 1962

ADDRESS ALL COMMUNICATIONS
TO THE SECRETARY

IN REPLY REFER TO:

6179

McMartin Industries, Inc.
1612 California Street
Omaha, Nebraska

Attention: Mr. Ray B. McMartin
President

Gentlemen:

On the basis of the tests conducted at the Commission's Laboratory, type approval is hereby issued to you covering the equipment listed below for operation under Part 3 of the Commission's Rules:

Kind of Equipment: Frequency Monitor (FM Broadcast)
Make: McMARTIN Industries, Inc.
Model or Type: Type TBM-3000
Frequency Range: 88 to 108 megacycles
FCC Type Approval Number: 3-113

Originality by

McMartin Industries, Inc.

1612 California Street • Omaha, Nebraska

McMartin

In Canada, Sold by: Canadian Marconi Company, Montreal 16, P. Q.

1kW OF FM STEREO

as simple as A, B, C!



A. Take the brand-new Collins 786M-1 FM Stereo Generator. *Features:* both stereo channels produced as a composite signal... stereo separation greatly exceeding FCC requirements... no on-the-air adjusting or readjusting.



B. Match the generator with the Collins 830A-2 Exciter. *Features:* accepts FM stereo directly so that no auxiliary modulators are necessary... eliminates undesirable multiplication of oscillator drift... provides monophonic and SCA audio inputs from 30 cps to 75 kc directly.



C. Mount the generator and exciter into the Collins 830D-1A FM Transmitter. *Features:* equipment designed specifically for both stereo and monaural transmission... simplicity and ease of operation... low distortion and high signal-to-noise ratio.

Result: a full kw of the finest FM stereo transmitting equipment on the market!

For more information,
contact your Collins Broadcast Sales Engineer
or write direct.

Collins Radio Company • Cedar Rapids • Dallas • Los Angeles • New York



Studio Maintenance

(Continued from page 15)

performance of the entire chain of equipment, from microphone terminals to antenna. This "complete FCC proof" is the starting point in the system of maintenance to be described herein. This method, however, breaks the chain of equipment down into its component parts and considers their *individual* performance.

Assuming that an oscillator and distortion meter are available at the station, testing should be done, and performance curves plotted on an annual basis, on each unit of equipment, beginning with the console.

Normal care should be taken with respect to proper grounding, isolation, and impedance matching. It should also be pointed out that each microphone preamplifier within the console must be tested separately, including the program amplifier and the turntable preamplifiers. The information gathered in this testing should be kept on file. The tests will consist of complete frequency response, harmonic distortion, and residual hum and noise. These unit tests should be performed in months other than when the annual FCC or system proof is being done. The various unit tests can be staggered throughout the year, to distribute the workload evenly. Each new test may be compared with previous data (and manufacturer's published information) to permit close observation of equipment performance over a period of time. The foregoing represents a long-range maintenance process.

Spot Checks

Another operation must be performed at more frequent intervals to keep close tabs on the gear. At quarterly periods, a spot proof should be made on each item of equipment, again beginning with the console. This spot proof should consist of an abbreviated series of tests directly related to both the complete unit proof and the complete FCC proof. It permits comparison of present performance with performance recorded during annual testing.

NEW! 1 KW Slim, trim, FM transmitter.
Offers exceptional performance
single-channel or multiplex.

NEW!
5 KW
Powerful FM transmitter.
HIGH in performance
—LOW in cost.

Unique SERRASOID Modulator CUTS FM Noise and Distortion

With the growing demand and inevitability of FM stereo multiplex, it becomes doubly important to produce clean signals at the transmitter.

Standard Electronics' exclusive SERRASOID modulator improves signal-to-noise ratio and linearity by shifting linear phase from 11°

to 150° through total modulation. Noise and distortion are drastically cut. FM noise is at least 65 db below 100% modulation and distortion less than 1% when modulating between 50 and 15,000 cps.

Look to STANDARD ELECTRONICS for the ultimate in performance, design and dependability.



standard electronics
PRODUCT LINE BY RADIO ENGINEERING LABORATORIES, INC.
FARMINGDALE, NEW JERSEY DIVISION
FARMINGDALE, NEW JERSEY

Send more information on the Standard Electronics  KW FM transmitter

NAME _____

STATION _____

ADDRESS _____

Ernest B. Vordermark, Chief Engineer,
WJXT, Jacksonville, Florida, says:

**“CONSISTENT QUALITY, RELIABILITY,
VERSATILITY, and LOW MAINTENANCE
I consider are mandatory to the
efficient and economical operation
of WJXT’s video monitors. For years
I have found all these benefits
only in CONRAC monitors.”**

CONRAC SERVES YOUR FOUR BASIC NEEDS FOR PEAK MONITORING EFFICIENCY

Mr. Vordermark’s appraisal of
CONRAC monitors is typical of those
discriminating chief engineers who
equip their control studios only with
the highest quality monitoring
equipment... and appreciate the lack
of maintenance problems.

**CONRAC MONITORS ARE DISTRIBUTED
BY RCA, GENERAL ELECTRIC, AMPEX,
AND VISUAL ELECTRONICS**

CONRAC **DIVISION** *Glendora, California*
GIANNINI CONTROLS CORPORATION

Telephone: AREA CODE 213-335-0541



**PROFESSIONAL
STANDARD OF
THE BROADCASTING
INDUSTRY**



... Proven by years of reliable service the world over.



728 STEREO
The professional standard. 7½ and 15 ips. Superior performance in all areas.



748 STEREO
The Olympian... champion of recorders. 3¾ and 7½ ips. 4-track play and record.



THE PT 6
The rugged, reliable "Workhorse" of the broadcast industry.

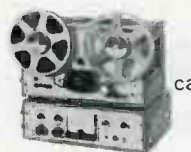

THE P 75
"The Editor"... includes all of the capabilities of the PT 6 plus extended performance and utility.

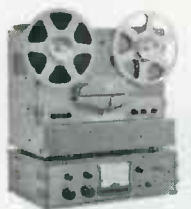

THE M 90
"Mighty" in all performance characteristics. Magnetic's finest tape instrument.

Magnetic sets the standard for Performance, Quality and Reliability in the professional sound and broadcast industry.

WRITE TODAY FOR MORE INFORMATION



**MAGNETIC SALES DEPARTMENT
MIDWESTERN INSTRUMENTS**

P. O. BOX 7509 • TULSA 35, OKLAHOMA



Engineer's Exchange

ANTENNA PROBLEM

By Thomas R. Haskett
P. O. Box 41 - 31762
Michigan City, Ind.

A couple of years ago the author was called upon to help move the studios of a small radio station licensed for non-directional 250-watt daytime operation. In addition to the speech equipment, the control room was also the location of the transmitter remote control equipment, an RF preamp which drove the frequency and modulation monitors, and a CONELRAD monitor receiver. At the old studio the control room had an outside window, and the monitor rack had been placed near this window in order

to provide sufficient RF pickup for the receivers.

The new studios, however, were located in the basement of a large hotel, and the control room was at least 20 feet from the nearest outside wall and window. Furthermore, the hotel's electrical machinery (elevators, laundry, etc.) produced quite a high noise level; the result was that the monitors had a noise-to-signal ratio of about 2! A further difficulty was the news department's inability to hear the police radio calls. The BC receiver they had used at the old setup (to tune in the police transmitter just above 1700 kc) was as noisy as the control room monitors.

PERIPHERY = ABOUT 16 FEET

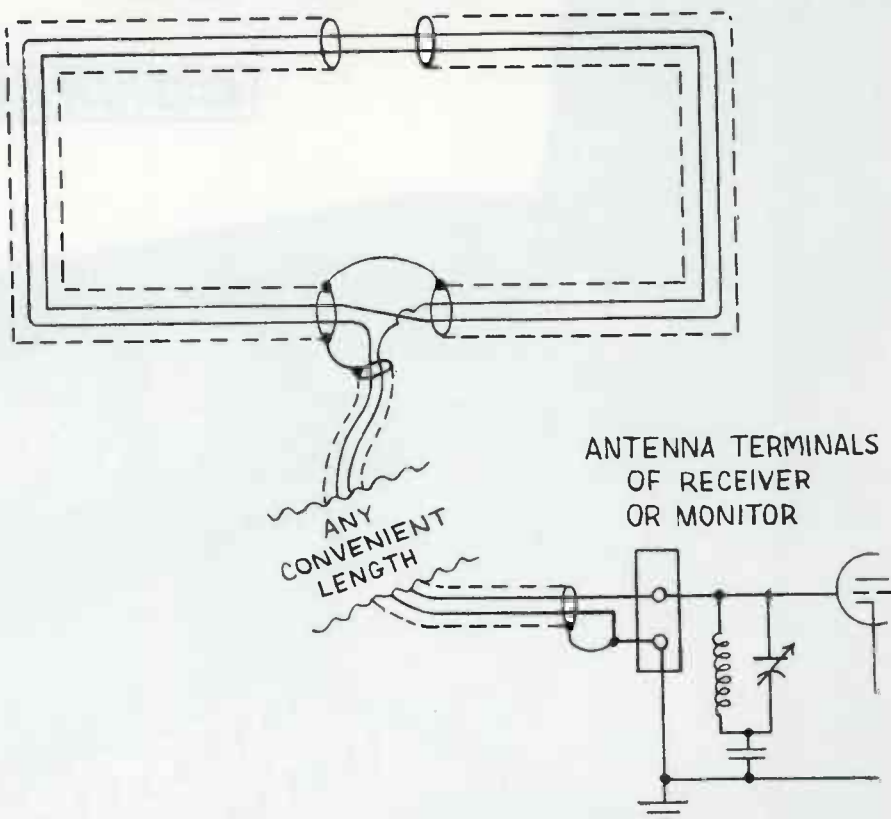

Diagram illustrates use of low-impedance, electrostatically-shielded loop antenna.

At last! A spectacular

BREAKTHROUGH in UHF TRANSLATORS by EMCEE

FA.
NCSS
be o
OCCN

diff
pare
fer p
pected.

In the
bridge
heat transfer
problems of
are a primary
consideration. In
addition the
silicon
circles give
no heat
at the
heat sink,
which is
small in
overall size,
our
nust necessarily
have a
large amount
of surface

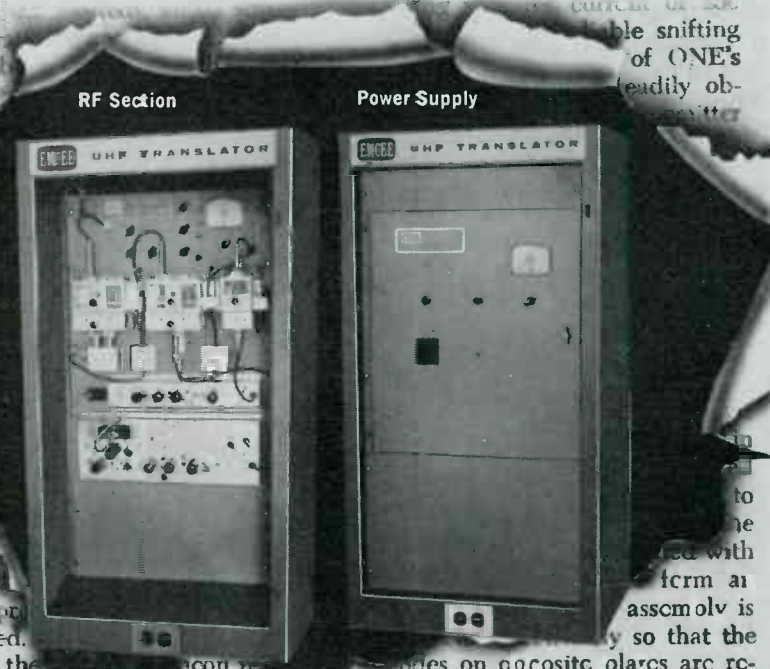

ble shifting
of ONE's
leadily ob-
mitter

to
the
with
form a
assembly is
so that the
on opposite
plates are re-
versed in po-
sitivity. The
insulating
members form
the con-
tinuous ex-
posed a "chim-
ney effect"
increases con-
vection cool-
ing of the
devices. A
bit which
passes through
the insulating
members holds
the ex-posed

The many features indicated in this new UHF concept are just a small portion of the many new advances incorporated in this new EMCEE UNIT. PLEASE NOTE THIS FACT ALONE: EMCEE offers a complete 100 Watt UHF Translator ... at a price complete competitive with what you would expect to pay for a 100 Watt Amplifier alone! If you're looking for a UHF Translator ... try EMCEE and see!

- New concept in Translator UHF Circuitry increases reliability, ease of tuning minimizes costs all along the line.
 - Full metering of all important operating parameters, including separate measurements of visual and aural powers, visual measurement is true peak sync.
 - Visual-Aural power ratio control permits easy adjustment of ratio.
 - Built-in Plate Supply and Heater Voltage regulator ends line voltage variation problems forever.
- This is just a sampling of the new features available for the first time ever in any translator.



ELECTRONICS, **M**ISSILES AND **C**OMMUNICATIONS, INC.

262 East Third Street • Mount Vernon 4, New York • MO 8-3012

Electronics, Missiles & Communications, Inc.

262 East Third Street • Mount Vernon, New York • Dept. BE-6

Gentlemen: Please rush

- Detailed specifications of the all-new EMCEE Model
- HTU-100 UHF Translator just released.
- Catalog B showing world's most complete line of VHF Translators

NAME _____

ADDRESS _____ CITY _____ STATE _____

Since the police station also operated an FM transmitter in the 150 Mc band, we purchased a crystal-controlled receiver made especially for such service. As it had a 75-ohm input, we mounted a small VHF whip outside the nearest window and ran co-ax through the ceiling to the news desk. This worked fine, and stimulated our thinking toward doing the same with the other monitors. The only trouble was that the high-impedance, unshielded long-wire antenna which we tried picked up not only more signal, but more noise, too!

An electrostatic shield filters out much noise, since noise has both electrostatic and electromagnetic components, whereas the signal from a radio transmitter (at distances greater than about a half mile from the antenna) has only an electromagnetic component. It was therefore decided to employ an electrostatically-shielded loop antenna for each monitor. Because of the distance the lead-in had to be run, it was necessary to work at low impedance. The diagram shows

the hookup we finally used for each receiver.

Ordinary low-impedance, two-conductor-plus-shield mike cable was used for both the loops and lead-ins. At the point opposite the feed point, the shield must be broken and taped apart, to avoid a shorted turn (this is actually a transformer). Otherwise the shield is isolated and carried separately from the two inner conductors, back to the receiver input. Naturally, for maximum noise reduction, the shield (and one side of the loop) should go to chassis ground, which should also be station ground. The dimensions of the loop aren't critical, nor is its shape, but the larger the area it encloses, the greater the signal pickup will be. All loops have bi-directional or "figure-eight" pickup patterns; the nulls are sharper than the lobes, but it is still wise to make

a complete electrical hookup before mounting an antenna, then orient it to see which direction gives the best pickup.

Although some receivers and monitors may be built to take a high-impedance loop or long-wire antenna, readers should *try* the low-impedance loop first; we did this and the pickup was ample. In case the signal pickup is very low, an antenna transformer must be installed to convert the low impedance of the loop up to the high impedance of the input tube's grid circuit.

The system has worked so well that the station's remote console has a low-impedance loop-equipped tuner for off-the-air monitoring "on location." The unit has been used at used-car lots, drive-in restaurants, and other high-noise level areas, and always delivers a clean signal.

CAPSTAN MOTOR SWITCH

By William C. Horton
Chief Engineer
KTMS Radio
Santa Barbara, Calif.

One major shortcoming of the older Ampex tape recorders is that the capstan drive motor rotates at all times the power switch is turned

ON. This may not be a serious matter where the machine is utilized for only occasional recording or playback; however, in a situation such as ours, where the machine is frequently subjected to as much as 18 hours use in a day, the life of the capstan drive motor is shortened

**IMMEDIATE
DELIVERY
from Stock!**



Professional Transistorized Portable Field Recorders

Exceed NAB Broadcast Standards

Assure studio quality performance
with complete independence from AC power.

Over 25 models available in two series:

TransFlyweight® Series 312: 8 lbs.; electric motor,
battery-operated. Size: 5½ x 9 x 12 inches.

TransMagnemite® Series 612: 15 lbs.; spring motor.
Operates 125 hours from rechargeable batteries.
Choice of single or multiple tape speeds, one or
two tracks. All models equipped with multi-purpose
VU meter. Full unconditional 2-year Guarantee.

Write for Literature

AMPLIFIER CORP. of AMERICA

An Affiliate of the Keystone Camera Co., Inc.

398 Broadway, New York 13, N. Y. • WO 6-2929

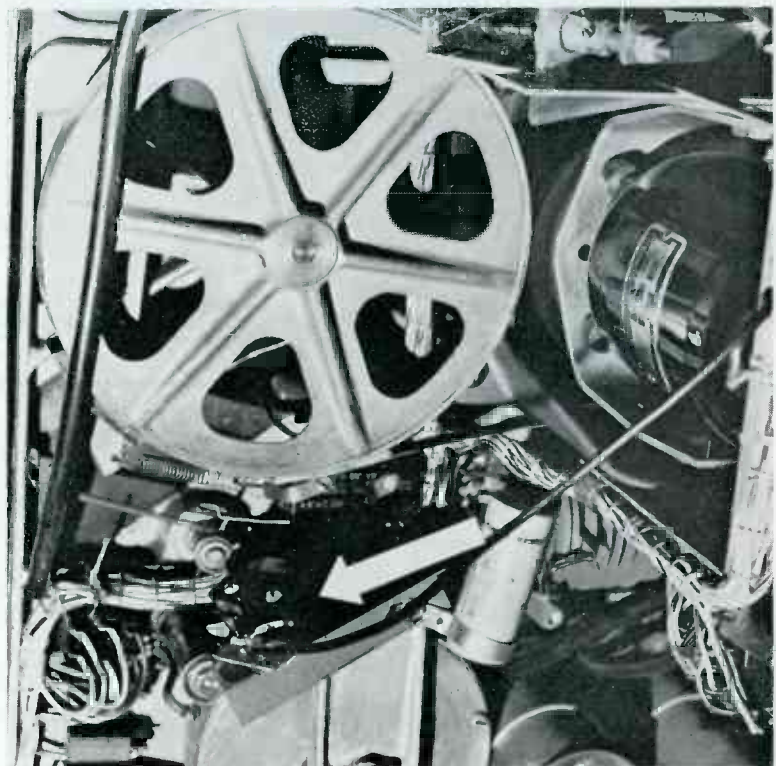

The FCC First Class Commercial License . . . Your Ticket To An Unlimited Future In Broadcasting . . .

What's your career goal in broadcasting? Whatever it is, your chances of reaching it are a whole lot better with an FCC First Class Commercial License . . . and here's why: According to FCC regulations, a great majority of the important and high-paying jobs in broadcasting can be filled *only* by men with FCC First Class Licenses. What's more, even where there's no *legal* requirement, most top stations far prefer licensed men for practically any studio, transmitter, or remote assignment. Talk to anyone who's been in broadcasting a few years. They'll invariably tell you the same thing . . . "The FCC License is a virtual necessity if you want to take advantage of every opportunity for success in broadcasting".

Cleveland Institute Guarantees A First Class Commercial License . . . Or Refunds Your Tuition

Of all Electronics home study schools, only Cleveland Institute makes this exclusive guarantee:

Completion of our Master Course prepares you for a First Class Commercial Radio Telephone License with a Radar Endorsement. If you fail the FCC examination for this license after successfully completing the Master Course, you will receive a full refund of all tuition payments. This guarantee is valid for the entire duration of your enrollment period.

Read the guarantee again. It means exactly what it says. You complete our training and get your FCC License . . . or we send you a check for your full tuition costs. You can't lose.

Special Note to Supervisors:

Perhaps you have men whom you'd like to move into more responsible positions but can't because they lack licenses. In their spare time, we can prepare these men for their FCC examinations and increase their value to your operations. If you'll write us on Company letterhead, we'll be happy to provide you with complete details on our new Participating Education Plan. Write: PEP, Cleveland Institute of Electronics, 1776 E. 17th St., Cleveland 14, Ohio.

Cleveland Institute of Electronics

1776 E. 17th St., Desk BE-6,
Cleveland 14, Ohio.

Accredited by the National Home Study Council



June, 1962

Three Free Booklets Tell How CIE Home Study Prepares You For An Unlimited Future In Broadcasting

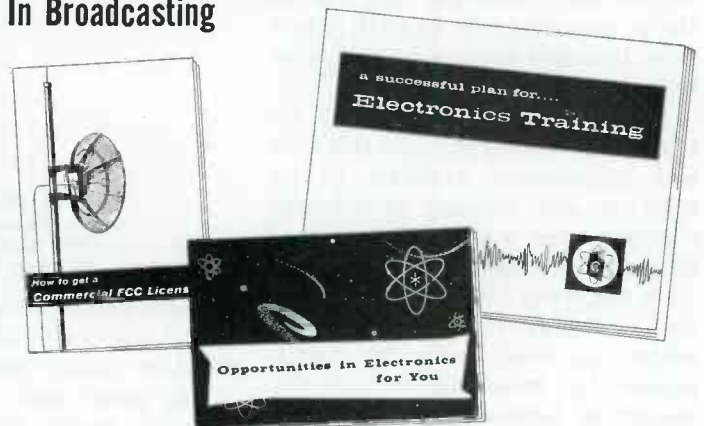

And, This Handy Pocket Electronics Data Guide FREE . . .

Conversion factors, formulas, tables and color codes at your fingertips. Yours without obligation, simply for responding NOW to this opportunity to improve your future.

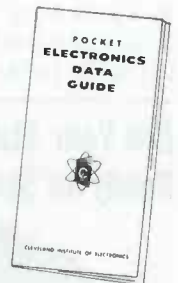

I want to know more about your electronics home study training program. Please send me your free booklets described above plus your handy pocket Electronics Data Guide. I understand there is no obligation. I have had training or experience in electronics as indicated.

— Clip Here and Mail Coupon To —

Cleveland Institute of Electronics
1776 E. 17th St., Desk BE-6, Cleveland 14, Ohio

- | | |
|---|---|
| <input type="checkbox"/> Military | <input type="checkbox"/> Broadcasting |
| <input type="checkbox"/> Radio-TV Servicing | <input type="checkbox"/> Home Experimenting |
| <input type="checkbox"/> Manufacturing | <input type="checkbox"/> Communications |
| <input type="checkbox"/> Amateur Radio | <input type="checkbox"/> Other |

I'm now working in _____

I want to know about the following area of electronics

(please print)

Name _____ Age _____

Address _____

City _____ Zone _____ State _____

BE-6

considerably. Additionally, we have found that replacement motors are not only quite expensive, but are presently difficult to find. Therefore, we concluded, any reasonably simple method to prolong the motor life would be considered seriously.

A few months ago I made a revision in both of our Model 403 machines which has completely solved this problem. A microswitch actuated by the *take-up tension arm* was mounted on the underside of the transport deck (see photo). The switch was wired into one side of the ac motor supply so that only a fully threaded tape deck will allow the capstan motor to rotate.

A Microswitch with a long actuator was employed, since this type was immediately available to us; however, any number of actuator configurations would, with a bit of figuring, do exactly the same job.

On the Series 400 Ampex machines the electrical connection to the motor can most easily be accomplished by removing the existing jumper on terminals 1 and 2 of the 60 cycle amp terminal strip (TS-501) and attaching the two-conductor cable to the switch.

Are Your Station Turntables Ready for Stereo Broadcasting?



THE ANSWER IS YES if you're using the new Fairchild 750 16" belt-driven playback turntable. The only turntable designed for stereo broadcasting! Write today for complete technical specifications on this remarkable new turntable. Price: \$485.00

Fairchild 752 Cabinet \$110.00

FAIRCHILD

RECORDING EQUIPMENT CORPORATION
10-40 45th Ave., Long Island City 1, N. Y.

Modification Increases Flexibility

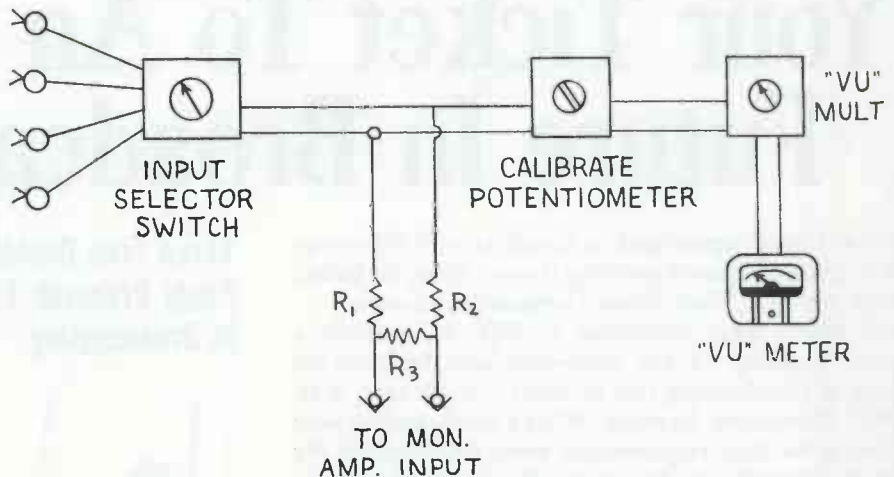

By Mike Flood, C.E.
Radio Station KWEL
1203 West Wall
Midland, Texas

With parts costing less than one dollar you can quickly make a modification to any program level metering panel such as the General Electric model 4FA 1A1 or the Gates type V-22 etc., that will allow the incoming signal to be monitored both visually with the standard VU meter and aurally with an external monitoring amplifier and speaker system.

The circuit consists of a bridging pad terminated in the proper resistance corresponding to the input

of the monitor amplifier and connected at a convenient point following the input selector switch, and preceding the meter multiplier and calibrating network. The pad provides a balanced output about 18 db below that of the signal being monitored by the meter and is not affected by any change in the setting of the attenuator. It will be readily apparent that this same circuit will provide a simple means to connect a single tape recorder or other device to a number of network, remote, or sub-master lines.

R_1 & R_2 = 4,700 ohms
 R_3 = 520, 620 for 600 ohm input or
150 ohms for 125 to 150 ohm input.

We offer payment for material used in Engineer's Exchange. Write up YOUR idea and send it in today.

SPARTA-MATIC

SETTING A NEW STANDARD FOR CARTRIDGE TAPE



- Continuous Duty Rated
- Compact, Modern, Functional Design
- Laminated Tape Heads
- Proven Reliability
- Table Top, Custom or Rack Mounting (Rack Mounting Illustrated)
- Improved Tone Burst Cueing
- Plug In Relays and Modules
- Solid State Design

Call, Write or Wire Today for Guaranteed Satisfaction Offer.

SPARTA ELECTRONIC CORPORATION

6430 FREEPORT BOULEVARD · SACRAMENTO 22, CALIFORNIA · GA 1-2070



BROADCAST ENGINEERING

RELIABLE Products from RAYTHEON

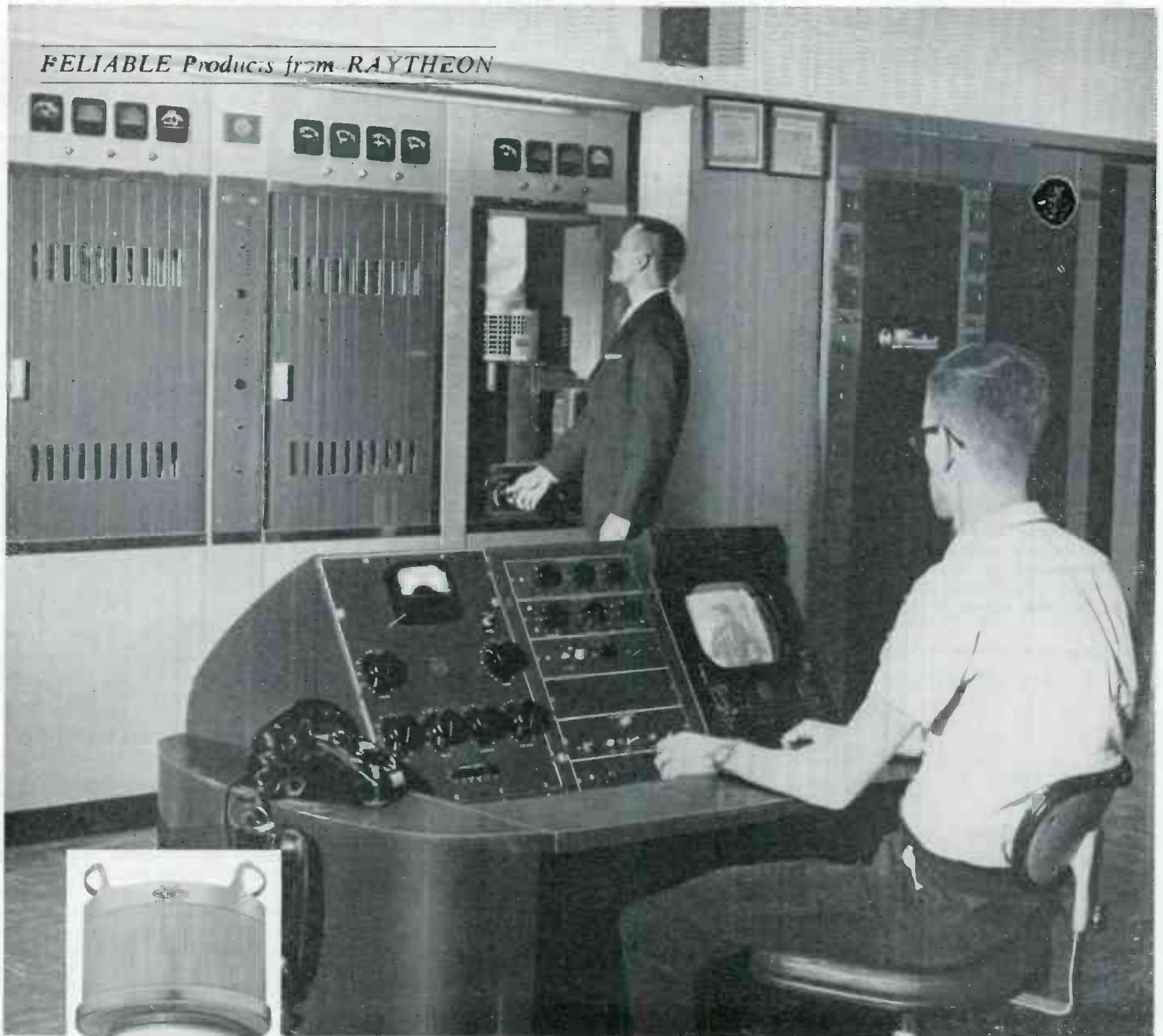

Raytheon - Machlett tubes still "like new" after 4900 hours, reports WIBW-TV, Topeka

"Like new" performance after 4900 hours — and going strong — is the record at WIBW-TV for five Raytheon-Machlett ML-7007 tubes in the visual power amplifier of its TT-50-AH transmitter. With ML-7007s, the visual transmitter maintains broad sweep — and power to spare — week after week with but routine adjustment. And the ML-

7007s require 15% less drive than new 6166s, whose life average is only 2500 hours in the vpa.

WIBW-TV, Topeka's only TV station, combines strong editorial policy with top-flight news coverage — frequently live — to exert an important influence in this Kansas community.

Available through your Raytheon distributor, Raytheon-Machlett tubes set new standards in superior performance for commercial telecasters.

DISTRIBUTOR PRODUCTS DIVISION

WESTWOOD, MASSACHUSETTS

RAYTHEON

Product News

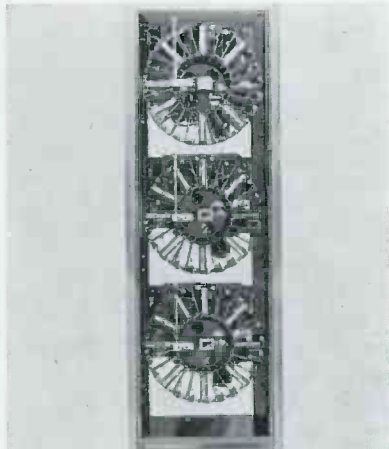

AUTOMATIC PROGRAMMING UNIT

A new concept in automatic programming of radio stations with tape cartridges has been developed by MaCarTa, Inc., 4021 Fleur Drive, Des Moines, Iowa. The Carousel allows advanced program-

ming of spots, station breaks or musical selections in groups of 24. The standard three-unit rack thus provides 72 separate messages which may be used back-to-back (or triple) practically instantaneously, the manufacturer states.

The equipment is said to be compatible with automatic tape cartridge playback equipment now being used having 1,000-cycle cue tone, and with double cue machines having a 3,000-cycle trip tone.

NEW LINE OF SG UNIVERSAL REPLACEMENT PICTURE TUBES

A new line of straight gun universal replacement picture tubes which need no ion traps has been announced by General Electric Co., Owensboro, Ky. The 30 aluminized SG tubes can be used to replace 169 existing types, of which 138 require ion traps.

Before the process of aluminizing picture tubes came into use, in order to avoid ion-burn spots in the center of tubes it was necessary to employ a bent-gun which directed the beams of ions and electrons over to the side of the gun. Then a magnet (the ion trap) was placed externally on the neck of the tube to deflect the electrons back to the center of the tube while the ions, unaffected by the magnet, remained trapped at the side.

Discovery that aluminization protected the phosphor from ion burn, as well as increas-

ing picture brightness, made a return to the straight gun practical. Although general use of the straight gun tube would have made installation easier, the replacement tube manufacturing industry continued to use the same guns that were used by the initial equipment manufacturer. It was felt that to substitute a straight gun tube in a TV set equipped with a bent gun tube would cause confusion in tube replacement.

To avoid this, General Electric will identify each of the new tubes with a label pointing out that "No ion trap is required," even though the old tube being replaced needed a deflection magnet. The prefix "SG" will be used in labeling the universal tubes. In some cases the SG type is an inch or so shorter than some of the types it can replace.



NEW POWER SUPPLY AND BATTERY ELIMINATOR

GC Electronics Co., Div. Textron Electronics, Inc., 400 S. Wyman St., Rockford, Ill., has developed a new power supply and battery eliminator, model 36-562, designed to make possible the extended operation of units without the use of batteries.

According to the manufacturer, the power supply's well-filtered source of dc/0-24 volts checks current drain, and a large capacitor filter provides less than one per cent ripple; optimum full wave rectification is accomplished through two heavy-duty silicon rectifiers. The unit features a DPST on/off switch that shuts off ac and disconnects the meter (for meter protection), and operates on 110/125 VAC, 50-60 cycles. It is recommended

For Unsurpassed Systems Capacity and Flexibility

**SPECIFY
REMOTE
CONTROL**  

Write For New
Data Sheets on:

- | | | |
|--|---|--|
| <input type="checkbox"/> FM RF AMPLIFIER | <input type="checkbox"/> 9-POSITION SYSTEM | <input type="checkbox"/> ECONOMY SYSTEM |
| <input type="checkbox"/> AM RF AMPLIFIER | <input type="checkbox"/> 24-POSITION SYSTEM | <input type="checkbox"/> PRICE LIST & BROCHURE |

**General
Electronic**

Laboratories, Inc. 195 MASSACHUSETTS AVE., CAMBRIDGE 39, MASS.

Name _____ Title _____
Station _____
Address _____
City _____ State _____

A PROFESSIONAL STEREO TONE ARM THAT "THINKS" FOR ITSELF

...designed for people who sometimes don't

One moving part, one precision bearing. Nothing delicate to add to your maintenance worries.

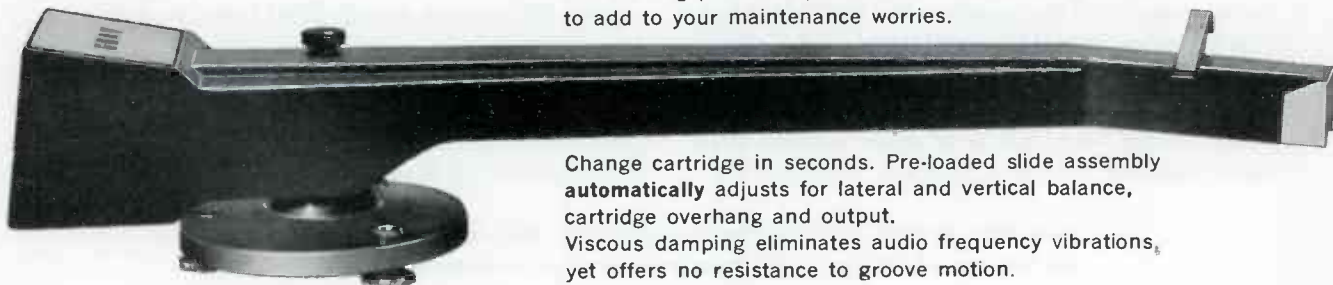

Change cartridge in seconds. Pre-loaded slide assembly automatically adjusts for lateral and vertical balance, cartridge overhang and output.

Viscous damping eliminates audio frequency vibrations, yet offers no resistance to groove motion.

GRAY 208-S \$49.50

write on company letterhead for complete technical information, specifications and application data.

GRAY  **RESEARCH AND DEVELOPMENT CO. INC.**
Box 12, Elmwood, Conn. Plant: North Mountain Road,
Newington, Conn.

for recharging nickel-cadmium batteries and can also be used to align individual stages in transistor-radios.

The set measures 5 x 5 x 1 7/8 inches and weighs 1 1/2 lb. Three built-in 18-inch leads are included; common, B+ variable, plus an extra 1 1/2-inch V tap. All leads are equipped with mini-gator clips and slip-on insulators. The unit is finished in anti-scratch scotch grain, has an 8-ft. nylon strain relief cord and stylized chrome handle.



VIDEO SIGNAL GENERATOR

A new video signal generator, producing waveforms for testing television systems in accordance with the new SMPTE standards, is being offered by CBS Laboratories, High Ridge Rd., Stamford, Conn.

The VT-1 is designed to provide all the waveforms necessary to test and adjust video tape equipment, components and systems, and may also be used to test equipment in TV transmitters and studios. According to the manufacturer, the use of semi-conductors and printed circuit boards permitted the designers to provide in a 7 x 17 x 15-inch case, capabilities ordinarily available only in equipment which would occupy a 6-ft. rack.

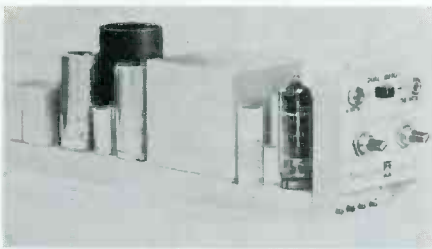

THUMP-FREE COMPRESSOR LIMITER

The new compressor-limiter model AM-5301 Leveline amplifier, for recording, background music applications and TV-broadcast use, has been announced by Langevin, Div. Sonotec, Inc., 503 S. Grand Ave., Santa Ana, Calif. The unit features 100 micro-second attack time with a compression ratio continuously variable up to 5 to 1. Distortion is 0.5 per cent 20-20 kcps at full 30 db limiting.

The device measures 3 inches high, 2 5/8 inches wide and 10 inches long, and can be used as an automatic master gain control, automatic level control for a remote line, as a peak limiter in radio-broadcast work or as a normal program amplifier by disabling limiting action and strapping power plug for 6-watts output.

The AM-5301 uses silicon diodes for rectification, and employs an additional stage of amplification over those used by most compressor-limiters, the manufacturer states. No balancing is required, and remote controls are available as standard accessories. Companion power supply is model PS-5208-A, or the Leveline can be fed from common system A and B supply.

for your tower requirements check ROHN SYSTEMS

A complete tower erection service that has these special advantages:

- ✓ DEPENDABILITY
- ✓ RELIABILITY
- ✓ COMPLETE ENGINEERING
- ✓ COAST TO COAST SERVICE

Be sure to obtain price quotations and engineering assistance for your complete tower needs from America's foremost tower erection service.



ROHN SYSTEMS, INC.

6718 W. Plank Road

Peoria, Illinois

ENGINEERS — FIELD SERVICE

The Dage Division of TRW is expanding its Field Service and R/D Groups to staff new programs on Dage's TV missile monitoring systems and machine-tool tape controls.

Field Service Engineers — TV: To carry out missile site installation, maintenance and service on Dage closed-circuit TV missile monitoring systems. Background in communications equipment, solid state circuitry or broadcast electronics helpful. Requires EE degree or equivalent experience and training.

TV Equipment Development: Design and develop circuits and systems for closed-circuit TV cameras and equipment. Background in communications, broadcasting or general electronics desirable. EE and several years related experience.

Electronic Controls: To design and develop solid state circuits for machine-tool tape controls. Background in logic systems, computer design and storage units applicable.

Dage is a small, growth type organization located in the vacationland of the Indiana Dunes on the shores of Lake Michigan.

Qualified applicants are invited to mail their resumes to W. G. Kirkwood, Box EM-211B, 23555 Euclid Ave., Cleveland 17, Ohio



DAGE

Thompson Ramo Wooldridge Inc.

An equal-opportunity employer

NEW!

BATWING TV ANTENNAS CHANNELS 2-13

Write for Sales Catalog

JAMPRO ANTENNA CO.

7500 - 14th Avenue
Sacramento 20, California



Save 30% on 4-Track Stereo Music on Tape! Empty 3 in. Plastic Reels 7c ea.



BARGAIN PRICES! Send for our FREE Tape Recorder/Blank/Prerecorded Tape Catalog #B-3

SAXITONE RECORDING TAPE

* Oxide guaranteed not to rub off or squeak—or money back. Compare ours with other "Bargain" tape. You'll find it's more than just "price" when you deal with us. We are original pioneers in the tape recorder business and our reputation means everything to us.

600' Acetate (plastic), 5"	.75
600' MYLAR 5" reel.....	.95
900' MYLAR (Polyester), 5"	.99
1200' MYLAR, 1/2 mil, 3" reel.....	1.18
1200' Acetate (plastic), 7"	1.19
1200' MYLAR, 1 1/2 mil, (Strong).....	1.68
1800' Acetate (plastic), 7"	1.79
1800' MYLAR, 1 mil, thick, 7"	1.99
2400' MYLAR, untensitized, 7"	2.89
2400' MYLAR, tensitized, 7"	2.99

Studios, Large Users Even Lower. PLUS POSTAGE.

Also—Scotch, Irish, Audio, Reeves, Ampex and Sarks-Tarjian magnetic tapes, mikes, audiocassettes, needles, etc. We'll surprise you with our quotations!

SAXITONE TAPE SALES

(Division of Commissioned Electronics Company, Inc.)
1776 COLUMBIA ROAD WASHINGTON 9, D.C.

NORELCO SPEAKER
Famous AD3800M, twin cone 8" (75-19,000 cycles) discontinued model, former list 16.00, usual net 9.90 going at 4.99 plus postage. (2 for 9.00). Other Norelco speaker sizes at bargain prices. Send for **SPEAKER SPECIFICATION SHEET**.

Product News

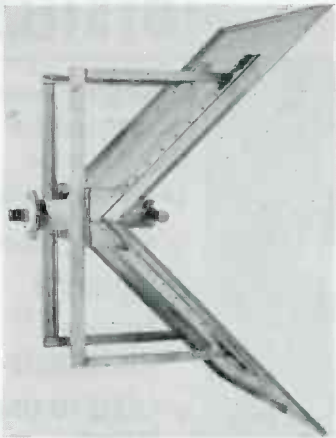

EMERGENCY UHF STANDBY ANTENNA

Jampro Antenna Co., 7500 14th Ave., Sacramento, Calif., has announced the type JAUE corner reflector antenna for UHF broadcasters available for channels 14 through 83. The backup antenna is recommended where primary coverage in one given direction is mandatory during antenna system difficulties.

Half power horizontal beamwidth is approximately 60 deg. depending on UHF channel. Power gain is 11.22 (10.5 db), and power handling capacity is 12.5 kw peak visual and 7.5 kw aural. VSWR is under 1.09 across 6 mc UHF TV channel. Separate

corners may be used, one for visual and one for aural, to provide backup against filterplexers. Both visual and aural power may be fed into one corner through a suitable diplexer. The unit is available in 3½-inch or 6½-inch inputs.

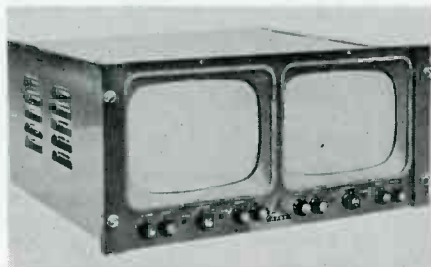

TWO NEW DAGE MONITORS

A new dual video monitor for simultaneous display of two television pictures, and a new 14-inch general purpose TV monitor have been announced by Dage Div., Thompson Ramo Wooldrige Inc., 455 Sheridan Ave., Michigan City, Ind.

The dual monitor has two 8-inch screens and independent controls combined as one unit for use in side-by-side comparisons of television broadcasting pictures, comparison of input-output microwave signals, TV studio camera control systems, and similar commercial or industrial applications. The advantages of the single unit for both monitor screens is the space saved in TV control centers, and the standard rack-mounted configuration that takes up 8¾ inches of rack panel space. Either monitor in the unit can be operated independently without cross-talk, permitting operation from different sources of video signals.

The 14-inch single video monitor is a high-resolution unit featuring electronically-regulated, low-voltage power supply to prevent picture size changes due to ac voltage fluctuations. Resolution is said to be more than 700 lines per inch, exceeding most requirements for closed circuit television systems.



SERIES 95 HEADSET

A new lightweight headset, featuring ruggedness, durability and efficient electrical design, has been developed by Collins Farley Corp., 606 W. Washington Blvd., Venice, Calif.

Using recessed earpieces and generous cushions, the phones rest on the head rather than on the ear itself, and are said to be easy to wear for long periods of time. Flexible sliding headbands automatically adjust to various head sizes and construction is of smooth, tough plastics. Vinyl-covered cords are secured internally by strain-reliefs and the entire assembly is virtually tamper-proof, the manufacturer states.

The unit is available with dynamic, ceramic or crystal transducer elements, and is supplied in both monaural and stereo models. Additional features include high sensitivity and wide range response.

COLOR PROVEN SOLID STATE VIDEO DISTRIBUTION UNIT

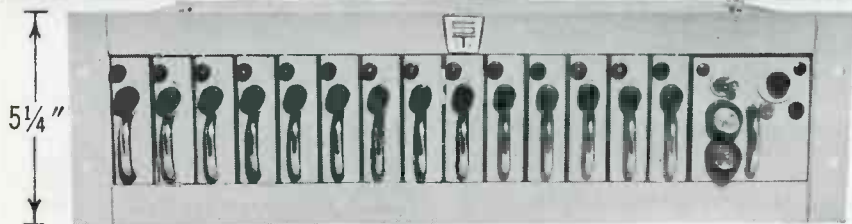

Provides 42 outputs—75 ohm sending end termination . . .
14 inputs—all bridging, connectors 83-1R type.

- 15 mc freq. response
- Diff. phase . . .0.3° max. at any APL (10%, 50%, 90%)
- Diff. gain0.02% max. at any APL (10%, 50%, 90%)

Look at the flexibility of this compact unit. You buy only the number of amplifiers you need now . . . add more later, as needed—NO ADDITIONAL SPACE REQUIRED! This one frame houses a solid state power supply furnishing power to each individual plug-in module. Each amplifier has a self-contained electronic voltage regulator.

ALL THIS IN ONLY 5¼" RACK SPACE



distribution amplifier



**SARKES
TARZIAN,
INC.**

east hillside drive
bloomington, indiana
edison 2-7251

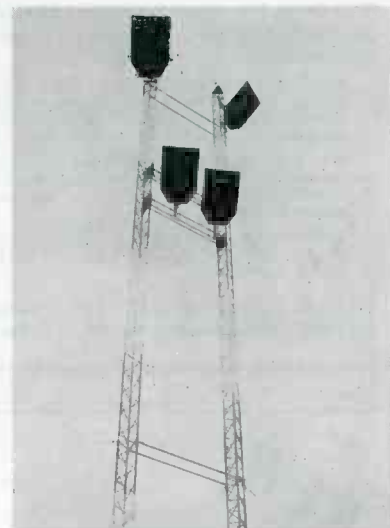

RIGID TUBE COMMUNICATION TOWERS

The addition of five complete lines of new Rigid Tube communication towers has been announced by Rohn Mfg. Co., P. O. Box 2000, Peoria, Ill.

The triangular-designed tower features all-bolted construction and is manufactured from steel tubing of variable sizes. It is designed to permit installations of antenna up to heights of 600 ft., and can supply the needs for most microwave and other communication requirements. It is available either assembled or knocked down for easy transportation.

GOTHAM AUDIO LITERATURE

Gotham Audio Corp., 2 W. 46 St., New York 36, N. Y., has announced the availability of a six-page brochure, 10-C, giving complete technical specifications and experimental data on the mounting of Westrex mono and stereo cutting heads on Neumann and Scully disk cutting lathes without the necessity for the usual advance-ball mechanism. Included is ability to vary depth of cut remotely as well as means of previewing the signal to be recorded and varying the depth of cut continuously as a function of depth amplitude.



LARGE FLEXIBLE COAXIAL CABLE

Type H8 is the latest addition to the Helix series of flexible air dielectric coaxial cables manufactured by Andrew Corp., P. O. Box 807, Chicago 42, Ill.

The nominal 3-inch, high-power, low-loss cable is suited for short or long runs in HF, FM, TV and UHF installations, and is produced in continuous, splice-free lengths of high conductivity copper, offering low VSWR performance. The corrugated con-

struction of both inner and outer conductors is designed to permit easy bending around obstructions, simplifying installation and eliminating electrical discontinuities found in broken length installations. End terminations of type H8 mate with 3/8-inch EIA standard fittings.



LOW LOSS TUNABLE TVI FILTER

Gavin Instruments, Inc., Depot Sq. & Division St., Somerville, N. J., has introduced the Maverick II, a new 50 mc tunable filter and output power indicator which will be offered to amateur and Civil Defense radio operators through electronic distributors.

The precision device was expressly designed for radio stations on 35 to 54 mc range with television interference problems. The tunable feature is said to assure an optimum impedance match between transmitter and antenna so that mismatch and power loss due to SWR will be minimized. The meter is directly calibrated in watts output from 0-50 and 0-400 watt ranges. The filter will handle up to 400 watts plate input with less than 1 db loss and at least 35 db harmonic attenuation, the manufacturer states.

The FAIRCHILD 661

AUTO-TEN®

... A NEW REVOLUTIONARY AUTOMATIC ATTENUATOR*



The new Fairchild Model 661 AUTO-TEN now becomes your "third hand" for complex mixing and level control problems. This completely transistorized automatic attenuator can perform level control functions many times faster than the speed of the human hand. The attack time of 40

milliseconds and the variable release time of from .3 seconds to 7 seconds assures greater flexibility, accuracy, and reliability. The Fairchild 661 handles impedances from 150 to 47,000 ohms without distortion or frequency discrimination and can automatically attenuate up to 60 db. The Fairchild 661 is the ultimate solution to:

- Noise reduction in film recording and multi-track tape playback
- Maintaining silence in LP spirals
- Automation of broadcast channels
- Improvement of separation in studios
- Minimizing feedback in PA systems.

Fairchild 661 AUTO-TEN \$125.00

*Patent Pending.

Write for complete descriptive literature

FAIRCHILD

RECORDING EQUIPMENT CORPORATION
10-40 45th Ave., Long Island City 1, N. Y.

500R



505R

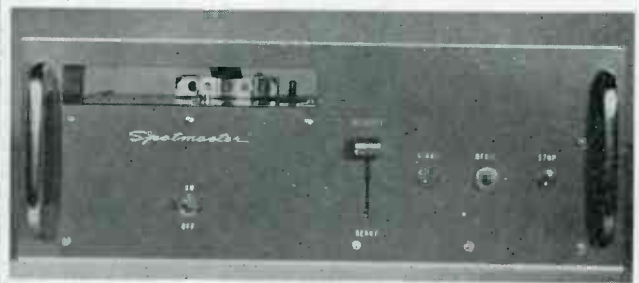

Spotmaster Rack Mount Cartridge Tape Equipment

Engineered for heavy-duty precision programming—as is all Spotmaster equipment—the 500R combination recorder-playback unit and the 505R playback unit are furnished complete with rack chassis slides ready to mount in your rack. Each unit slides in and out of the rack for ease of head and capstan cleaning, as well as other routine maintenance. All connections are made by use of convenient plugs in common use in all broadcast stations. Amplifiers and other components are conveniently placed for ease of servicing. The Model 500R is a complete recorder-playback unit and mounts in only 7" of rack space, as does the matching playback unit, Model 505R. Playback units may be mounted in multiple to provide complete facilities in one rack. Plug-in remote control and cue-trip amplifiers for automatic sequential switching available as optional extras on all playback units. Also available for immediate delivery, are the standard best selling 500 and 505 compact monophonic units. For information on our complete line of cartridge equipment contact:

BROADCAST ELECTRONICS 8800 BROOKVILLE RD., SILVER SPRING, MD. JU 8-4983

SOLD NATIONALLY BY: VISUAL ELECTRONICS CORP., 356 W. 40th St., N.Y., N.Y., Richard H. Ullman, Inc., 1271 Ave. of the Americas, N.Y., N.Y., CANADA—Northern Electric Co., Ltd., 250 Sidney St., Belleville, Ontario.

ENGINEERING AND TECHNICAL POSITIONS AVAILABLE AT ITA ELECTRONICS CORPORATION

UHF-TV TRANSMITTER DESIGN ENGINEER—3 to 5 years minimum experience with high power klystrons and associated circuitry.

SSB TRANSMITTER DESIGN ENGINEERS—3 to 5 years minimum experience, VHF frequencies, familiar with single side band techniques.

AUDIO DESIGN ENGINEERS—3 to 5 years minimum experience. Strong in transistor knowledge, solid state circuitry experience desirable but not essential.

RECEIVER DESIGN ENGINEER—3 to 5 years minimum experience in high quality, super sensitive receivers. Solid state experience desirable but not essential.

ANTENNA DESIGN ENGINEERS—3 to 5 years minimum experience in VHF, UHF or HF antennae. Knowledge of phasing equipment desirable but not essential.

ITA ELECTRONICS CORPORATION

130 E. Baltimore Avenue
Lansdowne, Pennsylvania

Classified

Advertising rates in the Classified Section are ten cents per word. Minimum charge is \$2.00. Blind box number is 50 cents extra. Check or money order must be enclosed with ad.

The classified columns are not open to the advertising of any broadcast equipment or supplies regularly produced by manufacturers unless the equipment is used and no longer owned by the manufacturer. Display advertising must be purchased in such cases.

EQUIPMENT FOR SALE

Transmission line, styroflex, heliax, rigid with hardware and fittings. New at surplus prices. Write for stock list. Sierra Western Electric Cable Co., 1401 Middle Harbor Road, Oakland 20, California. 6-61 tf

Commercial Crystals and new or replacement crystals for RCA, Gates, W. E., Bliley and J-K holders; regrinding, repair, etc. BC-604 crystals. Also A. M. monitor service. Nationwide unsolicited testimonials praise our products and fast service. Eidson Electronic Company, Box 31, Temple, Texas. 9-61 ff

One used model 518-DL, 10,000 watt FM broadcast transmitter including: 1,000 watt driver, interconnecting wiring; complete remote control system; frequency and modulation monitor. Immediate delivery. Capitol Broadcasting Company, Inc. Virgil D. Duncan, Chief Engineer, 2619 Western Blvd., Raleigh, North Carolina. Telephone 919 828-2511. 3-62 4t

Two used model 450 Ampex tape playback units 3 3/4 ips half track both direction at \$400 each. Two late model 450 Ampex tape units as above, \$600 each. One changeover panel silence sensing for item one, \$50. Five Magnecorder playback units 3 3/4 ips half track fast rewind, \$125 each. Twenty-five slightly used Browning multiplex tuner receivers \$75 each. Several used Harkins and Hershfield multiplex receivers, POR. Several used Seeburg Automatic record players 78 rpm and 45 rpm models with 100 record capacity, POR. Capitol Broadcasting Company, Inc., Woody Hayes Music Division, Woody Hayes Manager, 3207 Clark Avenue, Raleigh, North Carolina. Telephone 919, 834-8474. 3-62 4t

GOVERNMENT SURPLUS. NEW 10 CM. WEATHER RADAR SYSTEM—Raytheon. 275 KW peak output S band. Rotating yoke P.P.I. Weather Band 4, 20 and 80 mi. range. Price \$975 complete. Has picked up clouds at 50 mi. Wt. 488 lbs. Radio Research Inst. Co., 550 5th Ave., New York, New York. 5-62 8t

PHILCO MICROWAVE LINK. 7KMC System. Type CLR-6 also in stock: Repeaters, 12 and 24 channel multiplex. Large quantity. Exc. cond. Radio Research Inst. Co., 550 5th Ave., New York, N. Y. 5-62 8t

Surplus HF transmitter 2-20mc. Collins TCC Autotune. Clean. Complete. \$2,140 F.O.B. Tacoma area. Write KAYE, Puyallup, Washington. 5-62 3t

H-P Noise and Distortion analyzer 330D and H-P Audio Signal Generator 206A, perfect condition. \$750 for both. Richard Pooley, 3153 N. E. 83rd, Portland 20, Oregon. 6-62 1t

BUY, SELL OR TRADE

Will buy or trade used tape and disc recording equipment — Ampex, Concertone, Magnecord, Presto, etc. Audio equipment for sale. Boynton Studio, 10 BE Pennsylvania, Tuckahoe, N. Y. 4-62 6t

Wanted modern complete or partial radio and television transmitting facilities, also audio visual truck — Transamerican Exporters, 165 West 46 New York City. 6-62 1t

Professional Services

VIR N. JAMES

Specialty

Directional Antennas

232 S. JASMINE

DEExt 3-5562

DENVER 22, COLORADO

Member AFCCCE

JOHN H. BATTISON & ASSOCIATES CONSULTING RADIO ENGINEERS

Specializing in AM-FM-TV Applications and measurements.

934-5 Munsey Building

1329 E. St., N.W.

Washington 4, D. C.

DI 7-2330

Established 1954

Advertisers' Index

Amplifier Corp. of America	32
Battison & Associates, John H.	40
Bauer Electronics Corp.	16
Belden Mfg. Co.	IFC
Broadcast Electronics, Inc.	39
Cleveland Institute of Electronics	33
Collins Radio Co.	27
Conrac Div.	29
Dage Div. Tapco Thompson-Ramo-Wooldrige, Inc.	37
Electronics, Missiles & Communications, Inc.	31
Electro-Voice, Inc.	18, 19
Fairchild Recording Equip. Corp.	34, 39
Gates Radio Co.	IBC
General Electronic Laboratories, Inc.	36
Gray Research & Development Co., Inc.	36
IERC Div., International Electronic Research	24
ITA Electronics Corp.	40
Itek Electro-Products Co.	23
James, Vir N.	40
Jampro Antenna Co.	37
McMartin Industries, Inc.	26
Magnecord Div., Midwestern Instruments	30
Magnetic Products Division Minnesota Mining & Mfg. Co.	3
Radio Corp. of America	BC
Raytheon Co.	13, 35
Rohn Systems, Inc.	37
Sarkes Tarzian, Inc.	38
Saxitone Tape Sales	37
Sparta Electronic Corp.	34
Standard Electronics	28
Superscope, Inc.	11
Sylvania Electric Products, Inc.	17
Telemet Corp.	1
Visual Electronics Corp.	25

Achievement of a Decade and a Half of FM Engineering Research . . .

THE NEW GATES FM-20B . . . The Most *Advanced* 20,000 Watt FM Broadcast Transmitter Ever built. ■ Here is absolute, confirmed reliability in high power FM, with matchless *dimensional-sound* performance. So many new features make the difference. ■ Cascade modulation – providing lowest distortion and widest response for a whole new world of stereo. Solid state power supplies with a 3 to 1 current and 2 to 1 safety factor. New impeller design to reduce blower noise to a low whispering hum. Two 4CX10,000D tetrode tubes for long life. Remote control facilities included. A completely self-contained 20-kilowatt model – not a combination of lower powered transmitters. ■ Get the full technical story on this new *Advanced Twenty* today. Literature on request.

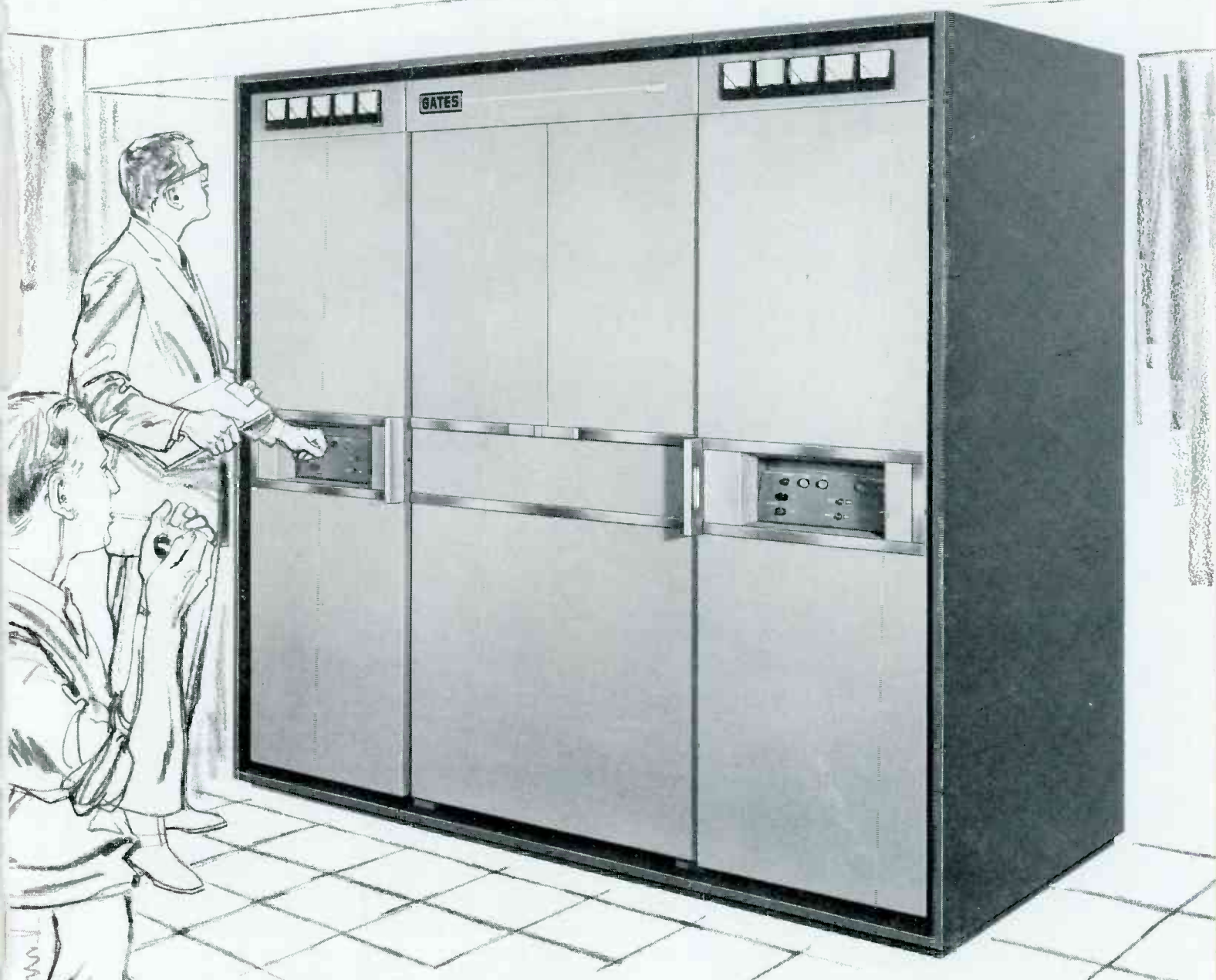

GATES

GATES RADIO COMPANY

Subsidiary of Harris-Intertype Corporation

QUINCY, ILLINOIS

**HARRIS
INTERTYPE
CORPORATION**

Offices in: HOUSTON, NEW YORK, LOS ANGELES, WASHINGTON, D.C. • In Canada: CANADIAN MARCONI COMPANY
Export Sales: ROCKE INTERNATIONAL CORP., 13 EAST 40th STREET, NEW YORK 16, N.Y., U.S.A., Cables: ARLAB



The Sign of a Matched TV System



Designed to work together electrically and mechanically, RCA Matched TV Systems assure maximum picture quality and equipment stability. RCA is the only manufacturer that designs and builds complete matched TV Systems.



The Most Trusted Name in Television