

AUGUST, 1961

# BROADCAST ENGINEERING

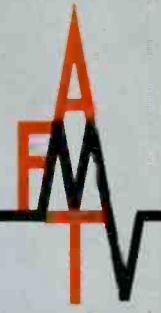

THE TECHNICAL JOURNAL OF THE BROADCAST INDUSTRY

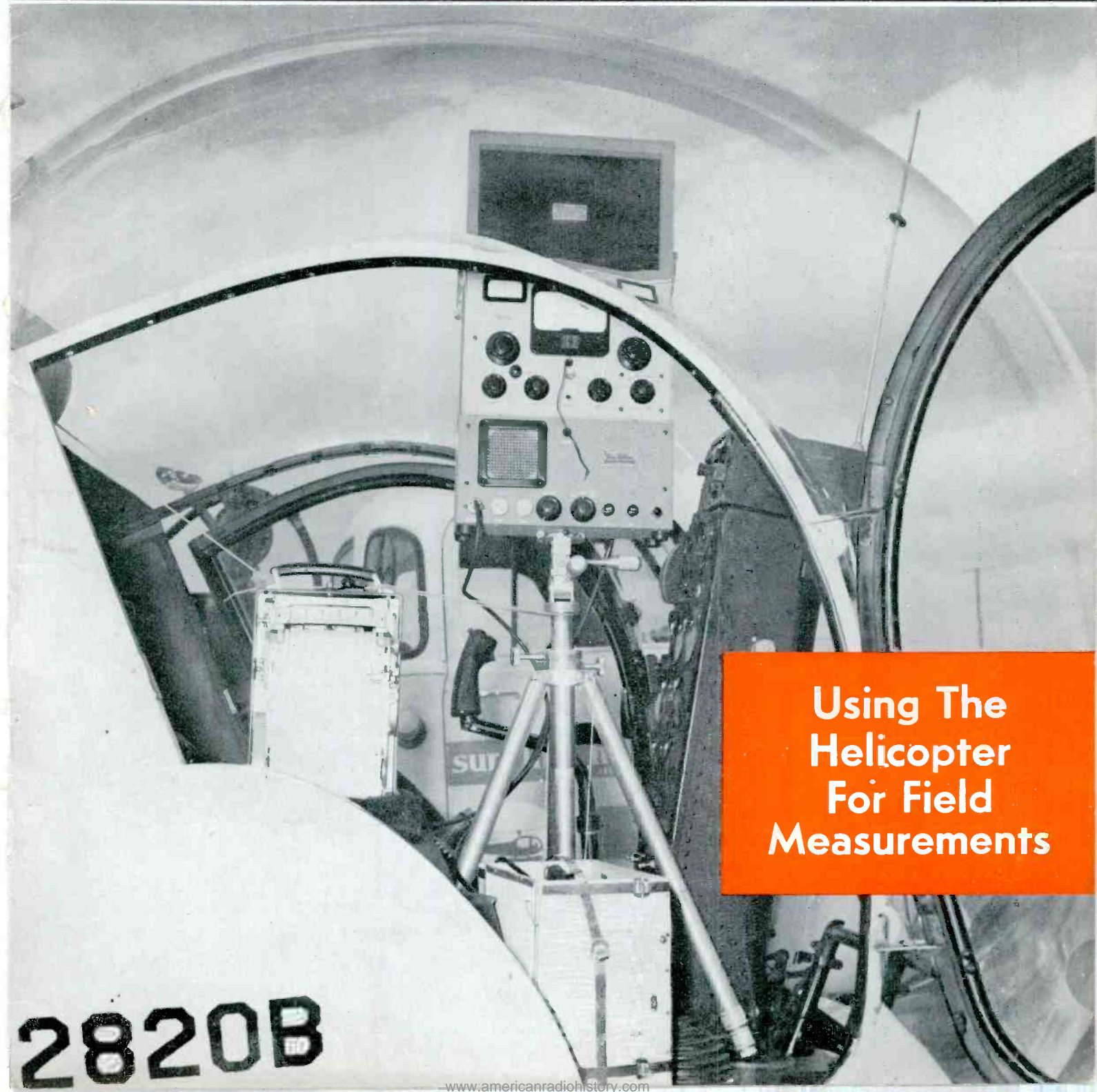

Using The  
Helicopter  
For Field  
Measurements

2820B

**NOW**

# COLOR TV

From FOTO-VIDEO

## NEWS FLASH!

United States Air Force, Pentagon, Orders \$450,000 Closed-Circuit Color TV System, Designed and Manufactured by FOTO-VIDEO To Meet Requirements of Speed and Security of Vital Information for National Defense.

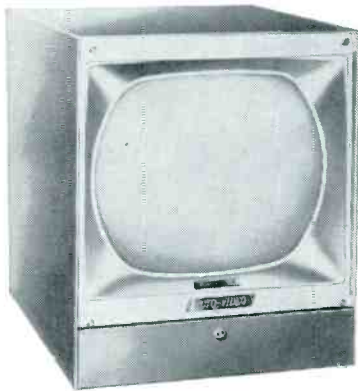

**V-298**  
21" Color TV  
Monitor  
All Modular  
Construction

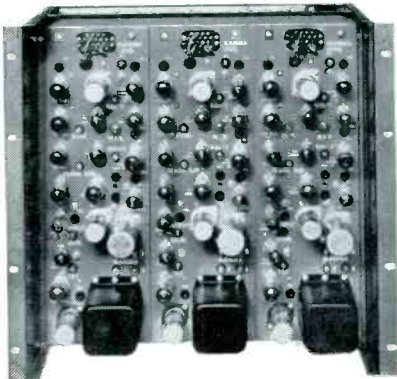
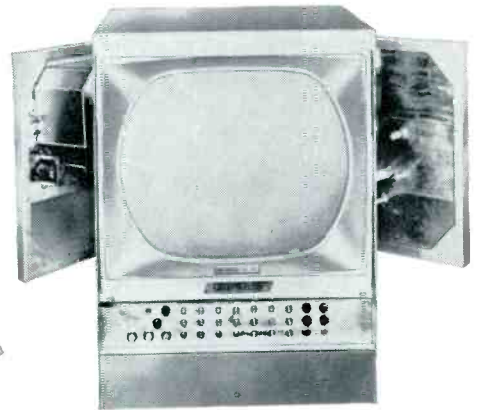

**V-225 Color Gamma  
Correctors**



**V-229 Color Matrix  
Delay**

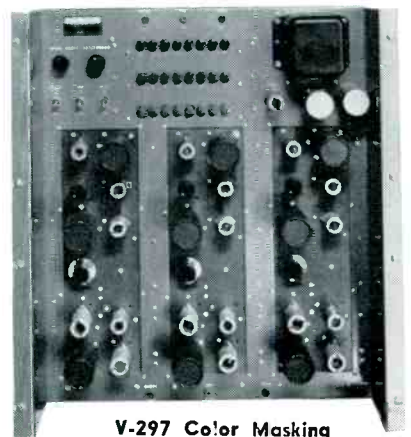

**V-297 Color Masking  
Unit**



**V-8 Color Sub-Carrier  
Generator**



**V-230 Encoder**



**V-516 Automatic Level  
Control**



**V-139 Color Sync  
Change Over**



**V-17 Color Burst Keying  
Unit**



**V-29 Color Bar  
Generator**

ALSO V-525 — 3-V Color Film Camera Chain • F-602 Color Film Slide Multiplexer • V-184 — 12 — 4 Color TV Diode Switcher • V-243 Color Stabilizing Amplifier • V-292 Color Special Effects Generator and Amplifier • F-107 — 1 Light Box and Test Chart Kit for Color • V-700 Transistorized Sync Generator • V-128 Transistorized Sync Slave

**FOTO-VIDEO Electronics, Inc. Cedar Grove, N. J. Center 9-6100**

West Coast Engineering-Sales: 1317 West 214 St., Torrance, Calif. — SPruce 5-1003  
Washington, D. C.: 2409 Menokin Drive, Alexandria, Va. — King 9-5520

(Write or Phone for Information)

# R-F LOADS and WATTMETERS

For high power VHF and UHF applications

These Loads and Wattmeters are designed for convenient and accurate measuring of TV transmitter r-f power. The load properly terminates the r-f output of the transmitter and gives a measurement of the average r-f power. Easily installed—occupies little space. A choice of ratings is available for frequencies between 54 mc and 890 mc and for many power levels. Used by leading stations for many years.

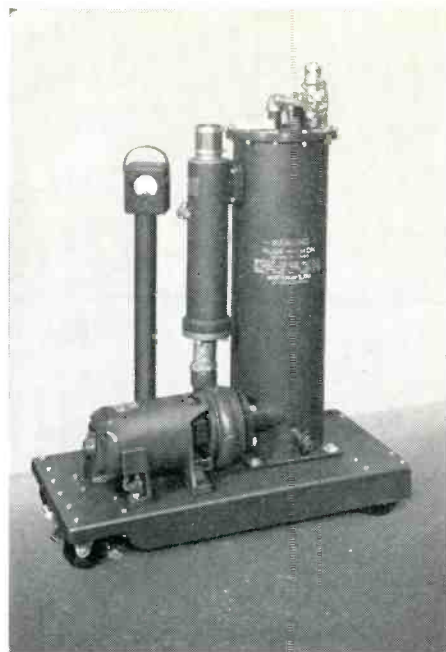

## 3 KW, 54 to 216 MC

Designed for use to 5 KW of peak power. Termination type unit, supplied for operation in 54 to 216 mc frequency range. Water cooled. Designed for wall or rack mounting (not illustrated). Type MI-19024-A

## 50 KW, 54 to 216 MC

Supplied for operation in the 54 to 216 mc frequency range. Water cooled, it has an 84 KW peak power rating (not illustrated). Type MI-19191-L/H

## 25 KW, 54 to 216 MC

A water cooled termination type unit for operation in the 54 to 216 mc range. This unit has a 40 KW peak power capacity (shown above). Type MI-19193-L/H

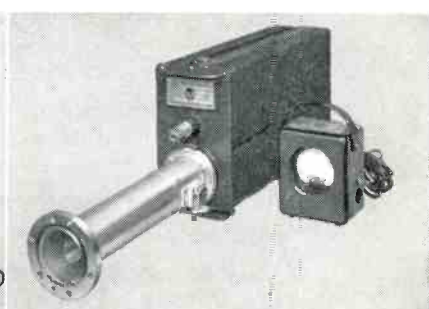
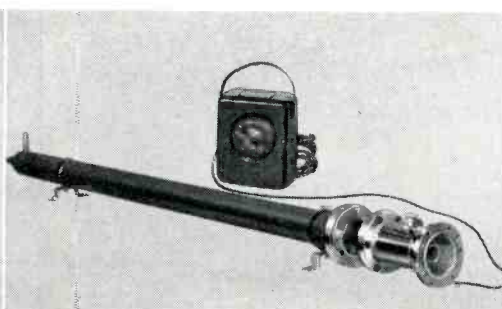
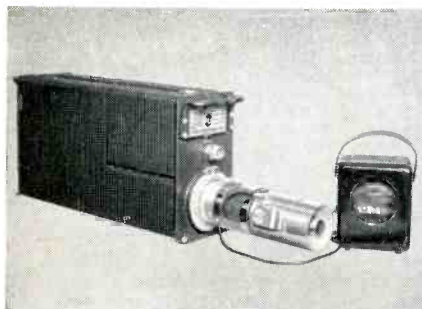

## 1200 Watt, 54 to 216 MC

A natural air-convection-cooled portable unit. Type MI-19196-L/H. Has a peak rating of 2 KW.

## 25 KW, 470 to 890 MC

A column of tap water is used for power dissipation up to 40 KW on peaks in this termination type load. Type MI-19198-A2.

## 1200 Watt, 470 to 890 MC

The type MI-19197 is designed with a peak power rating of 2 KW. (Companion unit to the MI-19196 unit shown at extreme left.)

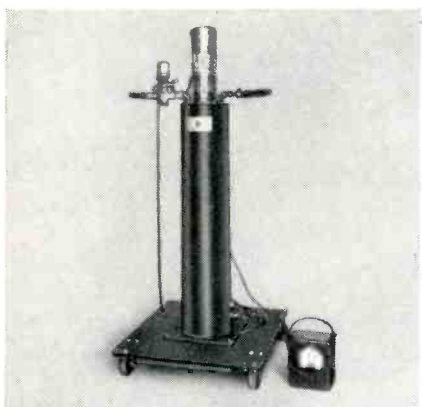

## 7.5 KW, 54 to 216 MC

A water-cooled, termination type unit, it has a peak rating of 10 KW. Type MI-27396.

### R-F LOADS AND WATTMETERS

MI Number	Ratings	Avg. Power	Usable Range	Input Imped.*	Type of Cooling
19196-L/H	54-216 mc.	1200 W	0 to 1200 W	50/51.5 ohms	Natural Air Convector
19197	470-890 mc.	1200 W	0 to 1200 W	50 ohms	Natural Air Convector
19024-A	54-216 mc.	3 KW	1.0 to 5 KW	50/51.5 ohms	Tap Water (1 GPM)
27396	54-216 mc.	7.5 KW	1.0 to 7.5 KW	50/51.5 ohms	Tap Water (4 GPM)
19198-A2	470-890 mc.	25 KW	0.1 to 25 KW	50 ohms	Tap Water (5.5 GPM)
19193-L/H	54-216 mc.	25 KW	0 to 25 KW	50/51.5 ohms	Water & Pumped Coolant (10 GPM)
19191-L/H	54-216 mc.	50 KW	0 to 50 KW	50/51.5 ohms	Water & Pumped Coolant (20 GPM)

\*Specify 50 or 51.5 ohms as required for 54 to 216 mc.

Special Loads can be supplied for other frequencies and power on a custom basis. For further particulars write to RCA, Broadcast and Television Equipment, Dept. Y-376, Building 15-5, Camden, New Jersey.



The Most Trusted Name in Television  
RADIO CORPORATION OF AMERICA



# BROADCAST ENGINEERING

THE TECHNICAL JOURNAL OF THE BROADCAST INDUSTRY ®

VOLUME 3

AUGUST, 1961

NUMBER 8

**Contents**

The Effect of SWR on Cross-Modulation of FM Multiplexed Signals . . . . . 4  
 Test procedures indicate crosstalk variables can be corrected.

Custom Designed Waveguide Switch for World's Most Powerful Transmission System . . . 8  
 Special switching system required when UHF station WDAU boosts effective radiated power by 800 per cent from 250,000 watts to two million watts.

More Notes on Field Measurements . . . . . 20  
 The techniques of using a helicopter for in-flight recording are outlined.

Mercury Rectifier Replacement with High-Voltage Semiconductor Diodes . . . . . 28  
 Various factors should be considered when converting to solid state rectification.

An American Broadcaster Views European Radio . . . 32  
 Author suggests quality and professional determination should be aim of U. S. stations.

**Departments**

F.C.C. Regulations . . . . . 36

Industry News . . . . . 40

Product News . . . . . 41

Index to Advertisers . . . . . 42

Classified Ads . . . . . 42

Professional Services . . . . . 42

**Cover Story**

The intelligent use of a new tool for Field Proofs, the helicopter. Author Elton B. Chick provides a comprehensive report in the Journal using this method. The cover photograph shows measuring gear installed in the 'copter.

**EDITORIAL**

ROBERT E. HERTEL, Editorial Director  
 JOHN L. HUMPHREYS, Associate Editor  
 D. F. BOICOURT, Managing Editor  
 DUDLEY ROSE, Presentation Editor  
 E. P. LANGAN, Advertising Director  
 S. F. WILSON, Production Manager

**ADVERTISING SALES OFFICES**

**Flushing 54, New York**  
 PAUL AND DON WEIL  
 39-01 Main Street  
 Telephone INdependence 3-9098

**Chicago 1, Illinois**  
 WILLIAM L. MILLER, JR.  
 E. F. LUKENS  
 C. E. PARKER  
 307 N. Michigan Ave.  
 Telephone FRanklin 2-5944

**Cleveland 16, Ohio**  
 DAVID H. HERTEL  
 3100 Wooster Road  
 Telephone EDison 1-2370

**Southwest**  
 C. H. STOCKWELL CO.  
 4916 W. 64th Street  
 Mission, Kansas  
 Telephone RANDolph 2-4417

**Los Angeles 57, California**  
 MAURICE A. KIMBALL CO., INC.  
 2550 Beverly Boulevard  
 Telephone DUnkirk 8-6178

**San Francisco 5, California**  
 MAURICE A. KIMBALL CO., INC.  
 681 Market Street  
 Telephone EXbrook 2-3365

**Paris 5, France**  
 JOHN ASHCRAFT  
 9 Rue Lagrange  
 ODeon 20-87.

**London W. C. 2, England**  
 JOHN ASHCRAFT  
 12 Bear Street  
 Leicester Square  
 WHitehall 0525

**Tokyo, Japan**  
 INTERNATIONAL MEDIA  
 REPRESENTATIVES, LTD.  
 Shadan Hojin, 14, 2-chome Marunouchi  
 Telephone 571-4450

Editorial, Circulation and Advertising headquarters, 1014 Wyandotte St., Kansas City 5, Missouri; Telephone VICTOR 2-5955.



Subscription Price: U. S. \$6, one year; Outside U. S. A., \$7. Single copies, 75 cents. Adjustments necessitated by subscription termination at single copy price.

Broadcast Engineering is published monthly by Technical Publications, Inc., 1014 Wyandotte St., Kansas City 5, Missouri, U. S. A.

Corporate Personnel: Robert E. Hertel, President; Frank D. Smalley, Executive Vice-President; E. P. Langan, Vice-President; Kenneth Long, Vice-President.



S-5018—replaces 5AU4, 5AW4, 5AZ4, 5T4, 5U4, 5V4  
5W4, 5Y3, 5Z4, 5931, 6087, 6106



S-5207  
replaces 6X4



S-5130—replaces 866, 866A, 3B28

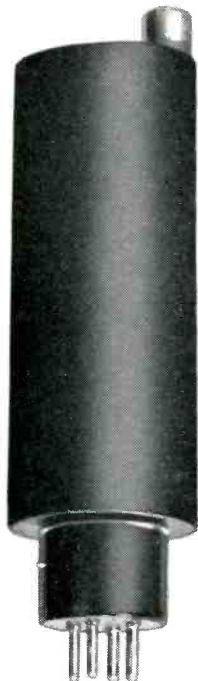

S-5367—replaces 8020



S-5343—replaces 816, 836, or 3B28  
and 866 at reduced voltage



S-5033—replaces 6AU4, 6AX4, 6BL4,  
6W4, 12AX4, 17AX4, 25W4, 6U4  
S-5019—replaces 5R4



S-5011A—replaces 80, 82, 83, 83V, 5Z3  
S-5017—replaces 0Z4, 5X4, 5Y4, 6AX5, 6X5



S-5251—replaces 5U4, 5AU4,  
5AW4, 5AZ4, 5T4, 5V4,  
5W4, 5Y3, 5Z4



S-5347  
replaces  
12BW4, 6BW4

*Illustrations  
approximately 1/2 size*



S-5344  
replaces 872A



S-5373  
replaces 8008

## Sarkes Tarzian Tube Replacement Silicon Rectifiers improve circuit performance

These standard Tarzian tube replacement rectifiers are directly interchangeable with over 95% of all popular vacuum tube rectifiers. Although they are generally smaller and more compact than the tubes they replace, their dc current ratings are as much as three times as high.

In addition, they offer the inherent advantages of solid state rectification:

1. Greater electrical stability
2. Compact, rugged construction
3. Instant operation; no warmup; no filament supply

### 4. Cooler operation

For applications requiring high efficiency, wide temperature range, and long-period, maintenance-free operation, these compact units are unmatched. They are available in production quantities, at realistic prices. Special designs and modifications engineered on request. Special tube replacement units designed by Tarzian engineers include rectifiers with peak inverse voltages to 19,000.

Write for specifications and prices of tube replacement silicon rectifiers. Application engineering service is available on request.

*Quality in volume*



## SARKES TARZIAN, INC.

World's Leading Manufacturers of TV and FM Tuners • Closed Circuit TV Systems • Broadcast Equipment • Air Trimmers • FM Radios • Magnetic Recording Tape • Semiconductor Devices

**SEMICONDUCTOR DIVISION • BLOOMINGTON, INDIANA**

*In Canada: 700 Weston Rd., Toronto 9 • Export: Ad Auriema, Inc., New York*

# The Effect of SWR on Cross-Modulation Of FM Multiplexed Signals

By A. H. Bott, Engineer  
Broadcast Transmitter Div.  
Radio Corp. of America  
Camden, N. J.

Test procedures indicate crosstalk  
variables can be corrected.

CROSSTALK performance of FM transmitters has been investigated. However, little is known about the contribution of the antenna-transmission line system to crosstalk. This report should provide some helpful information in this respect.

We are concerned with crosstalk that appears on the subchannel as a result of the modulation of the main carrier with audio material. Cross-modulation from the subchannel into the main channel is not of interest here since it is negligible for all practical purposes. Crosstalk in an FM multiplex system is due to certain imperfections in the transfer characteristics of the system. If the transfer characteristics were such as to provide a uniform amplitude response and a linear phase response over a certain band of frequencies, no crosstalk would be generated. Any practical system, however, will depart from this ideal in a manner indicated in Fig. 1. The black solid curves represent the ideal network, while the dash curves correspond

to a practical network. The amount of crosstalk will depend on the kind and the degree of departure from the ideal. In an FM or PM system the effect of amplitude variation is relatively small compared to the effect of the variation of phase versus frequency.

A practical network which departs from the ideal will have three main effects. First, while the FM carrier is frequency modulated it will create amplitude modulation. Second, the FM signal will suffer harmonic and intermodulation distortion and center frequency shift. Third, it will cause crosstalk.

Crosstalk is phase modulation of the subcarrier at the rate of the main channel modulation waveform. This phase modulation is a modulation component which is added to the subcarrier modulation. It could be compensated for by modulating the subcarrier by the same waveform with opposite polarity. This is the same as saying that phase nonlinearity in one part

of the system can be compensated by suitable networks in another part of the system, provided the unwanted waveform is of the opposite polarity in the two parts of the system.

The imperfections in the transfer characteristic are almost exclusively caused by tuned circuits, and circuits which are equivalent to tuned circuits, for instance, the antenna. Vacuum tubes will only affect the transfer characteristic if they affect tuning of the tube circuit, for instance, in an IF amplifier or limiter where a tube, loading a tuned circuit, may vary its capacity with the limiting voltage. Otherwise, tubes will not cause crosstalk by themselves. This is an over-simplification which would only apply in a system linear with respect to amplitude. A class A amplifier or an ideal mixer are such linear systems. Limiters in receivers and class C amplifiers in transmitters are amplitude-nonlinear systems.

Several measures can be taken in

## EDITOR'S NOTE:

This information was presented to engineers attending the NAB 15th Annual Broadcast Engineering Conference, May 9, 1961, Washington, D. C.

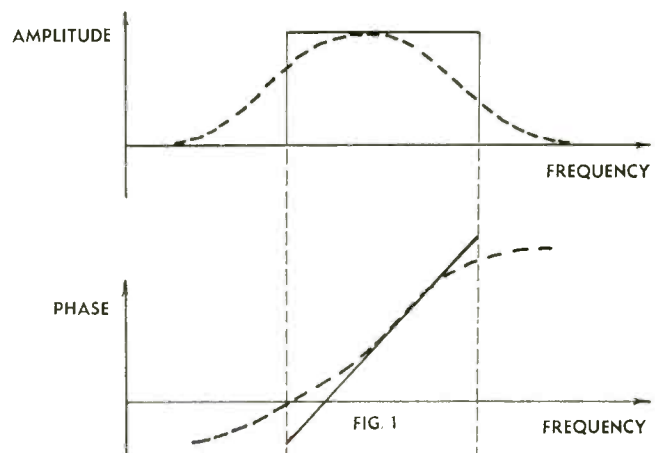

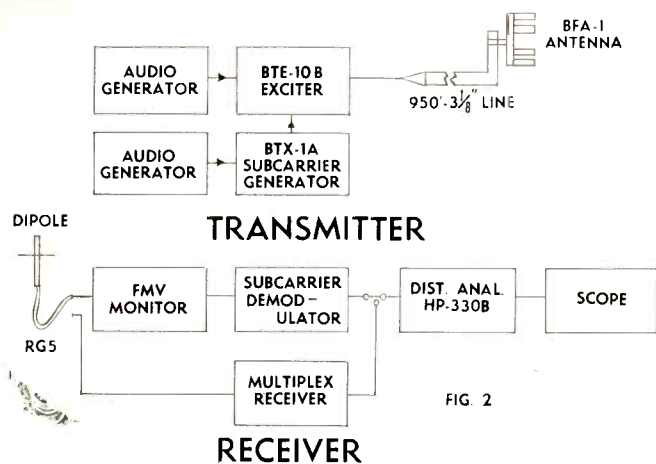

FIG. 2

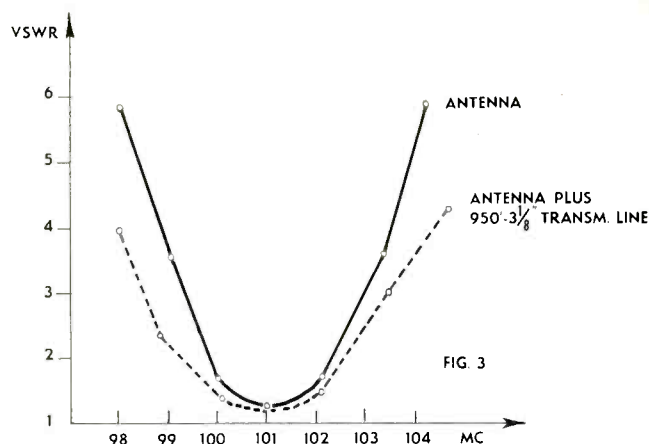

FIG. 3

the tuned circuits to more closely approximate the ideal transfer characteristic. One would be to lower the "Q" of the tuned circuit. Another method would be to use double-, triple-, or stagger-tuned circuits. Both methods have advantages and disadvantages. A method used is to lower the "Q" as far as possible. This has the advantage of a very simple tuning procedure.

Cross-modulation introduced by tuned circuits of identical "Q" will be more pronounced with lower main carrier frequencies. The rate of change of the main carrier due to the subchannel modulation does *not* change. Differently stated, the percentage of the carrier to sideband separation will increase with lower carrier frequencies.

It is to be expected that a receiver IF amplifier at a frequency of 10.7 mc will be more critical with regard to crosstalk than a circuit operating at a carrier frequency of 100 mc, such as the r-f portion of the same receiver. It is therefore desirable to have the subcarrier in a transmitter modulated on the main carrier at the highest possible frequency.

The fact that phase nonlinearity in an FM system can be compensated at different places in the system has caused a great deal of confusion, since one can never point with certainty to a specific part of the system as the faulty part. If one assumes a great amount of phase nonlinearity in a poor transmitter and an equal but opposite amount of phase nonlinearity in the receiver, the over-all system may work quite satisfactorily as long as this phase

relationship remains constant. If one would, however, replace the poor transmitter with a good transmitter, it would upset the amount of compensation and would make the whole system appear worse. This creates a very difficult situation for the operator, especially since crosstalk-measuring equipment is rarely available. Of course, it is desirable to keep the phase distortion in all parts of the system to a minimum.

A further uncertainty arises due to the difference of approximately 10 to 20 db in crosstalk performance in the transmitter and the receiver. The receiver is operated under widely varying conditions of field intensity, interference and antenna locations which all will affect crosstalk and make it difficult to pinpoint trouble. (One may get the impression that FM transmitting and receiving equipment is quite vulnerable to cross-modulation, at least relative to other imperfections. This is misleading. A system can tolerate -40 db of harmonic distortion or intermodulation products, but the same amount of crosstalk would be objectionable. If one would, for example, increase the requirement for *system* harmonic distortion to -60 db [which corresponds to 0.1%] the difficulties would be *exactly* the same as the ones encountered in FM multiplex.)

Fig. 2 shows the measuring system used to determine antenna and transmission line crosstalk. The transmitting part consists of a 10-watt BTE-10B exciter, a BTX-1A subcarrier generator and suitable audio generators. The exciter is fed

into 950 feet of 3 1/8-inch coaxial line. This line is terminated in a single section BFA antenna, mounted in a clear area. The receiving portion consists of a dipole tuned to the exciter frequency, 100 feet of RG58A/U transmission line, a suitable FM monitor, a subcarrier demodulator, distortion analyzer and oscilloscope. It should be emphasized at this point that it is always very important to observe the waveform at the output of the distortion analyzer and make sure that unwanted waveforms do not mask whatever waveform is being measured. In the receiving portion a commercial multiplex receiver could be substituted for the FM monitor and subcarrier demodulator.

The transmitting antenna was fed by the 950-foot transmission line for two reasons. First, it would more closely approximate a practical system, and second, the measurements of crosstalk would include all possible reflections created or caused by the mismatch of the antenna which might be reflected again at the exciter and reradiated with a time delay. However, the signal thus reradiated is of fairly small magnitude; furthermore, the receiver performance would enter at this point since the capture ratio undoubtedly will have an effect in discriminating against the delayed signal which is only a fraction of the magnitude of the directly radiated signal. We feel that the inclusion of the transmission line did alter the results of the measurements, but only to a slight degree.

The system capability from the exciter to the FM monitor and the

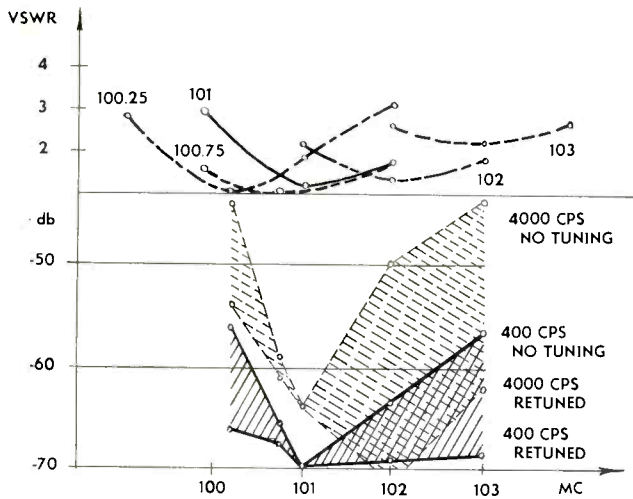

FIG. 4

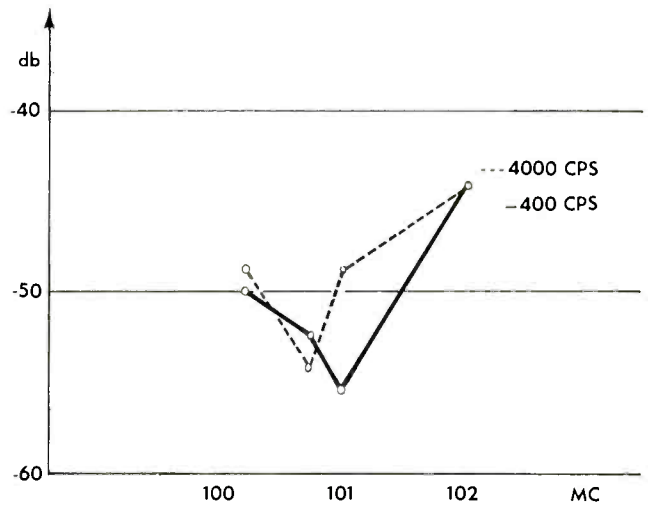

FIG. 5

distortion analyzer, *excluding* the transmission line and the antenna, permitted crosstalk measurements at a level of approximately  $-70$  to  $-75$  db.

The system was operated under the following general conditions:

The carrier frequency was 101 mc, a frequency chosen as having no local interference. The subcarrier was modulated by a 400 cps tone and deviated  $\pm 7\frac{1}{2}$  kc which represented 100% modulation of the subcarrier.

The main carrier was modulated 30% (approximately  $\pm 22.5$  kc) by a subcarrier frequency of 67 kc. In addition, the main carrier is modulated 70% by either 400 cps or 4 kc tones.

Cross-modulation is a phase-modulation process, adding deviation to the modulation already present. It is expected, as in phase modulation, that the modulation index is proportional to frequency. An increase of 2 to 3 db per octave has been confirmed experimentally.

Cross-modulation will therefore increase proportional to the main channel modulating frequency. Most multiplex receivers use low pass filters in the subchannel demodulator to eliminate noise above approximately 8 kc. This filter will also eliminate cross-modulation components above 8 kc. For this reason a high-modulation frequency of 4,000 cps was chosen to represent the highest amount of crosstalk within the audio range.

The 400 cps was chosen to represent a condition causing a small

amount of crosstalk relative to the 4 kc level. The 400 cps frequency is still high enough to allow effective removal of masking 60 and 120 cps hum.

The system used a 10 kc low pass filter at the subchannel output.

The signal-to-noise ratio of the subchannel is  $-76$  db using the FM monitor and admitting a bandwidth from 100 cps to 10 kc. Using a commercial receiver the signal-to-noise ratio is  $-62$  db in a frequency band from 200 cps to 8 kc.

Crosstalk system capability using the FM monitor is better than  $-76$  db at 50 cps, decreasing to  $-64$  db at 4 kc. Both readings are relative to 100% ( $\pm 7.5$  kc deviation) modulation of the subcarrier.

The receiver measurements were somewhat complicated by the lack of shielding of the receiver which

resulted in a strong signal pickup even with the antenna disconnected. The first r-f amplifier tube in the receiver had to be removed to bring the limiter voltage down to a normal value.

Before proceeding with the crosstalk measurements the antenna and antenna plus transmission line VSWR was measured. This is shown in Fig. 3. Without the transmission line the VSWR is not greater than 2 within a range of  $\pm 1$  mc of the carrier. With the transmission line a VSWR of 1.6 is not exceeded within the same frequency range.

The FM monitor used for the measurement can be considered a precision FM receiver. It was tunable over a wide frequency range and employs 4 i-f stages at 10.7 mc which are all single-tuned and have

(Continued on page 38)

## SUMMARY

An FM multiplex system was set up, which included a transmitter consisting of a 10-watt RCA BTE-10B Exciter, a BTX-1A Subcarrier Generator and a HP206A Audio Generator. The exciter was fed to a single bay antenna over 950 feet of  $3\frac{1}{8}$ -inch transmission line. The receiving end utilized a dipole antenna about 100 feet away from the transmitting antenna, an FM monitor and special equipment for the detection of the subchannel.

It was established that the multiplex crosstalk increased with increasing antenna and transmission line mismatch. On the other hand, realignment of the receiving equipment could reduce crosstalk to a value only slightly worse than that obtained under conditions of optimum match. Yet compensation will become more critical and difficult to achieve with increasing VSWR. It appears that emphasis should be placed not only on a low VSWR but also on the stability of the VSWR.



FULLY ONE YEAR BEFORE FCC FM STEREO APPROVAL...

# THE FIRST NEW ALTEC 250SU STEREO CONSOLE WAS ALREADY IN OPERATION



The Altec 250SU Stereo Console was developed and operating well before FCC made FM Stereo a reality. Today, many 250SU Consoles successfully serve stereo and monophonic operations in AM, FM, TV, and Recording Studios.

If you are converting to Multiplex Stereo, let the testimony of time help you select your new stereo console. It's a good way to know that the "bugs" are out... a good way to know that every important feature and convenience has been added. A few are listed below.

- **MINIATURE PLUG-IN COMPONENTS:** Preamplifiers, amplifiers, and utility input devices are of the same size to readily fit the built-in pre-wired mounting trays on the Console. These units are also available separately for special requirements.
- **INPUT LEVEL SELECTION:** The 250SU has ten input positions, each with a "bus" switch and mixer attenuator. Any of these positions may be used for high level, low level, or any combination of sources by plug-in of proper Altec input device.
- **SELECTABLE OUTPUT FUNCTIONS:** The Console comes wired for universal service with single channel, dual channel, or two/three channel operation. The desired functions are obtained by using the necessary number of Altec plug-in amplifiers.
- **HIGHEST STUDIO QUALITY:** 250SU performance exceeds FCC, NAB, EIA, and all recording standards. Plug-in components are tube operated for optimum studio quality and greatest dynamic range at lowest noise levels. The premium tubes used are pre-aged and may be tested individually by push-button facilities.
- **INTERCHANGEABLE PLUG-IN AMPLIFIERS & ACCESSORIES**
- **LOW IMPEDANCE MIXING**
- **SPEECH-MUSIC FILTER**
- **DC HEATER SUPPLY**
- **UNTERMINATED MICROPHONE INPUTS**
- **UTILITY INPUT DEVICES FOR TAPE, DISC, LINE, NETWORK, ETC.**
- **TUBE TESTING PROVISIONS**
- **EXPANDABLE TO JACK FIELDS, EQUALIZERS, ETC.**
- **1, 2, OR 2-3 CHANNEL OPERATION**
- **ILLUMINATED VU METERS**
- **COLOR CODED CONTROLS**
- **EXTERNAL POWER SUPPLY**

*For Precise Balance of Stereo Pick-Up...*

## INSIST ON MATCHED ALTEC STUDIO MICROPHONES

Each Altec 684A Omnidirectional Studio Dynamic matches the performance of any other 684A Microphone. This match in performance is also inherent in Altec 685A Studio Cardioids. Hence, any pair of 684A or 685A Microphones pro-

vides the balance essential for stereophonic operation. *An individual certified calibration curve is supplied, free of charge, with each 684A and 685A Microphone as concrete visual proof of this remarkable balance!*

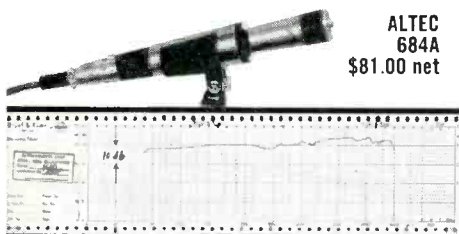

ALTEC  
684A  
\$81.00 net

Features uniform frequency response from 35 to 20,000 cycles. Incorporates new Altec "Golden Diaphragm" and exclusive sintered bronze filter that bars entry of iron dust and foreign matter. Output impedances of 30/50, 150/250 ohms selectable at cable plug.

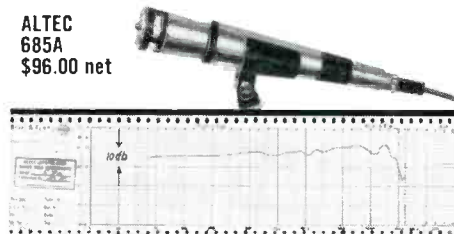

ALTEC  
685A  
\$96.00 net

Offers flat frontal response from 40 to 16,000 cycles with average front-to-back discrimination of 20 db. Incorporates new Altec "Golden Diaphragm" and exclusive sintered bronze filter. Impedances of 30/50, 150/250 ohms selectable at cable plug.

Other Altec Microphones are priced from \$36.00 to \$334.00. Ask about the exclusive Altec Microphone Exchange Policy that permits immediate replacement of inoperative units at a fraction of original cost.

*For complete specifications and technical details on the Altec 250SU Stereo Console and matched Altec Microphones, call your nearest Altec Distributor (listed in your Yellow Pages) or write Dept. B-8*

## ALTEC LANSING CORPORATION

*A Subsidiary of Ling-Temco Electronics, Inc.*

1515 SOUTH MANCHESTER AVE., ANAHEIM, CALIF. / NEW YORK • LOS ANGELES



© 1961 ALTEC LANSING CORPORATION

# Custom Designed Waveguide Switch for World's Most Powerful Transmission System

WHEN UHF station WDAU, Channel 22, Scranton, Pa., increased its effective radiated power by 800 per cent from 250,000 watts to two million watts, it became the world's most powerful television station.

Many problems were involved in this increase. On the recommendation of General Electric broadcast

engineers, it was decided to use two General Electric 25-gain antennas in combination with two G-E 23-KW transmitters.

Thus, the two-million-watt signal results when the total output of the two transmitters is fed into the 50-gain antenna. Routine and standby operations involve the use of two

antennas and one transmitter or two transmitters and one antenna to produce a million-watt signal.

To make it possible to switch from one to another available transmitter-antenna combination without delay, a special push-button switching system was designed in Syracuse, N.Y., by broadcast engineers

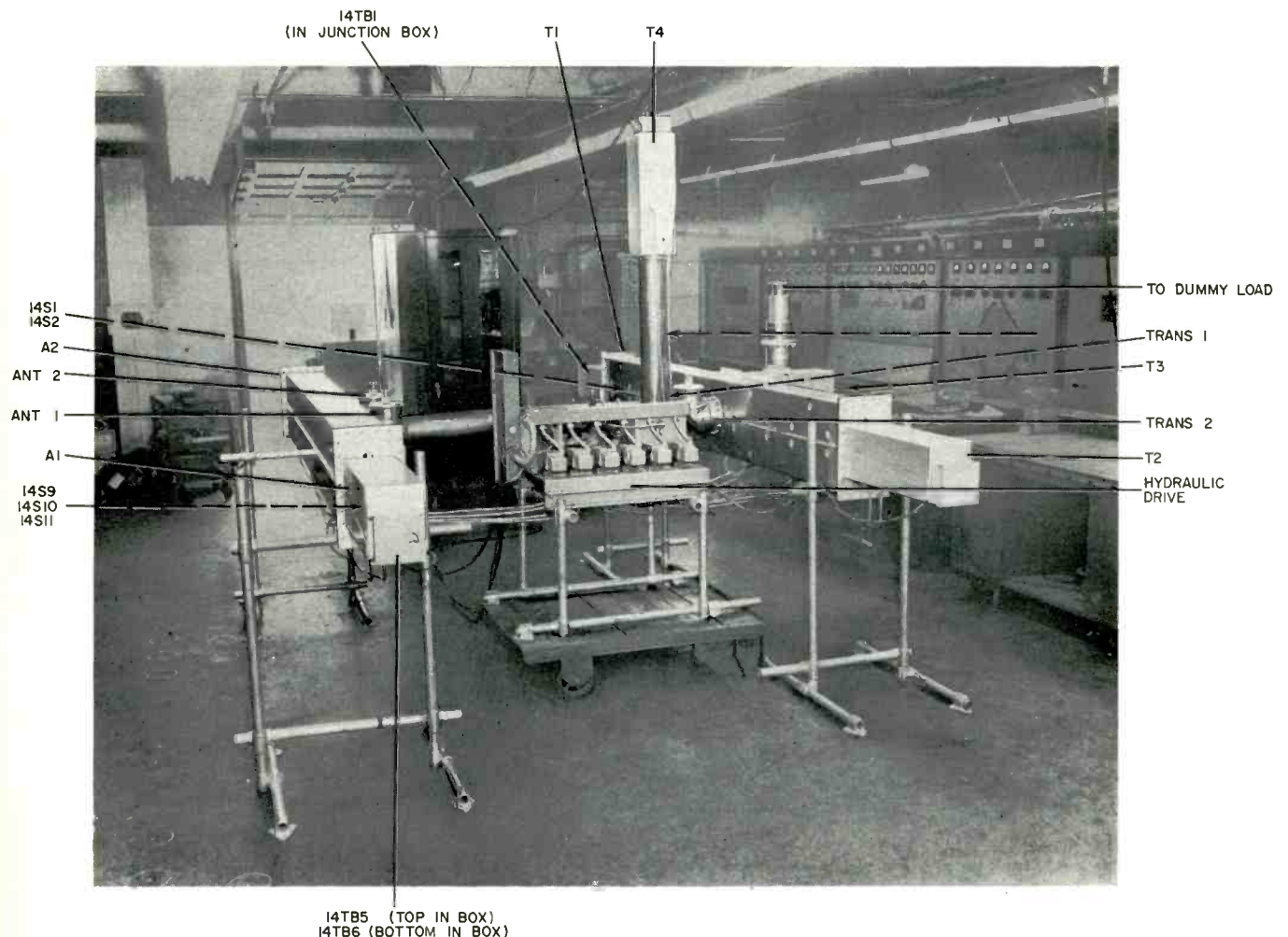

Fig. 1—Over-all view of waveguide switching unit.

By  
 K. R. Cooke  
 Chief Engineer—WDAU-TV  
 Scranton, Pa.  
 and  
 D. L. Smith  
 Antenna Development Engineer  
 General Electric Co.  
 Syracuse, N. Y.

of the Technical Products Operation of General Electric's Communication Products Department. One hydraulically-operated switching system—designed in WR 1500 waveguide—is capable of completing any one of nine possible switching combinations in 10 seconds from a remote position. This system is the only one of its type.

Fig. 1 shows the waveguide switch installed at WDAU, while Fig. 2 shows the control unit.

The nine possible switching combinations, shown schematically in Fig. 3, are as follows:

(1) Both transmitters into both antennas to give 2 megawatts ERP; (2 & 3) Both transmitters into either antenna to give 1 megawatt ERP; (4 & 5) Either transmitter into both antennas to give 1 megawatt ERP; (6, 7, 8, 9) Either transmitter into either antenna to give 500 KW ERP.

#### Choice of Circuit

Because of the power levels involved and because of the frequency (Channel 22, 518-524 mc), waveguide components are desirable. The circuit may be broken into two circuits as follows:

1. A combining circuit capable of diplexing either transmitter into a common line or of combining both transmitters into a common line.

2. A power-dividing circuit capable of diplexing the combined input into either antenna, or of dividing the combined input between both antennas.

A description of a suitable power-dividing circuit was found.<sup>1</sup> This is shown in line form in Fig. 4, while

<sup>1</sup>Ragan, George L., *Microwave Transmission Circuits*, McGraw-Hill, pp. 520 and 526.

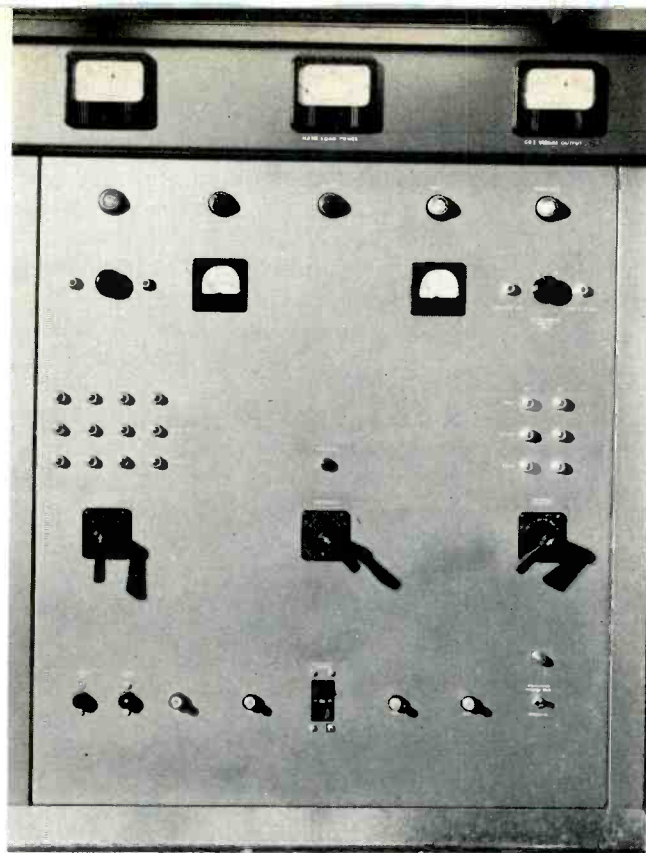

Fig. 2 — Waveguide switch control cubicle.

the power division obtainable is shown in Fig. 5.

If matched terminals are put on outputs 1 and 2, the input appears matched for any power ratio.

As shown in Fig. 5, diplexing into either antenna occurs when plungers are set to give unit power into one output and zero power into the other. Power division occurs when the plungers are in an intermediate position.

The same circuit may be used to diplex the two transmitters into a common output. In this case, the output arms are used as the input, and the input arm becomes the output.

With the plungers adjusted as shown in Fig. 6, one plunger reflects a short circuit across input number 2, which effectively de-couples it from both the output and from input number 1. The other plunger reflects an open circuit across input number 1, which has no effect, and input number 1 is then effectively connected to the output. By interchanging plunger positions, the opposite transmitter will be diplexed into the output line.

Theoretically, the same circuit could be used to combine the two inputs. From a practical standpoint, however, this is not feasible since the amplitude and phase of each transmitter would have to be ad-

justed and held so that the amplitudes were equal and the phases were in-phase. This is not practical because:

1. The transmitters are not isolated; thus the impedance the transmitter "sees" is a function of the amplitude and phase of the other transmitter.

2. There is no convenient way to monitor the phase of either transmitter.

A practical combining circuit would be one of the magic "T" circuits.

For instance, if the circuit in Fig. 6 were modified by the addition of a fourth arm (as shown in Fig. 7), this would remove the objections listed above; that is, the two inputs would be isolated from each other, while the power into a load terminating the fourth arm would be a convenient monitor of the phase and amplitude of one transmitter with respect to the other.

It should be pointed out, however, that while Fig. 7 shows a practical combining circuit, it is not an economical diplexing circuit. For instance, if one transmitter were used alone, half of the power would be dissipated in the load terminating the second output arm.

As shown in Fig. 8, this problem was overcome for both the combining and diplexing circuits by switch-

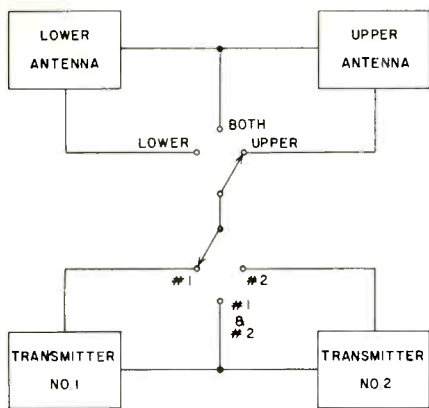

Fig. 3—Transmitter-antenna combinations.

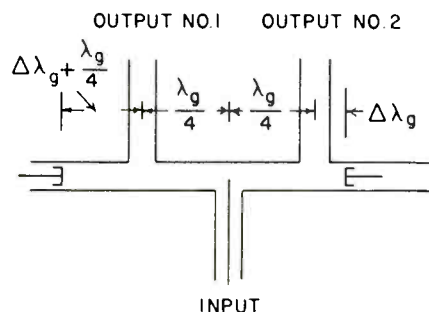

Fig. 4—Power divider.

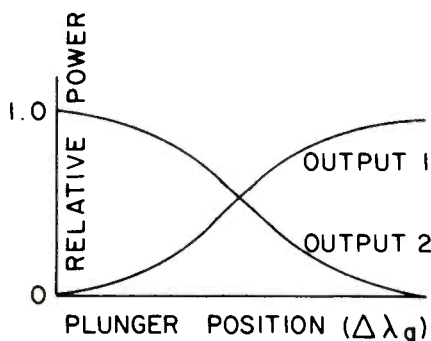

Fig. 5—Power division.

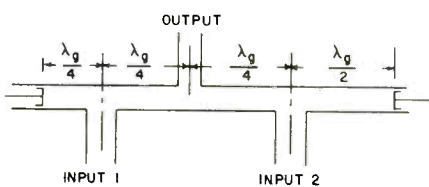

Fig. 6—Transmitter switching.

ing-in the fourth arm for the former, thus making a four-arm junction, and by switching-out the fourth arm to make a three-arm junction for the latter.

#### Analysis of the Circuit

The admittance at the junction  $y_t$ , as shown in Fig. 9, comprises the sum of three individual admittances. The individual admittances are the following:

1.  $y_r$ , which is the normalized admittance from the right-hand arm

transformed to the plane of the junction;

2.  $y_l$ , which is the normalized admittance from the left-hand arm transformed to the plane of the junction;

3.  $y_j$ , which is the normalized junction susceptance.

$y_t = y_r + y_l + y_j$ , and it is desired that  $y_t = 1$  for all power-dividing ratios.

Thus, let  $y_r = g_r + jb_r$ ;  $y_l = g_l + jb_l$ ; and  $y_j = jb_j$ .

Then in order for  $y_t$  to equal unity, the following conditions must hold: (1)  $jb_j = 0$ ; (2)  $g_l + g_r = 1$ ; and (3)  $b_l + b_r = 0$ .

Since the power division must vary from 0-100 to 100-0,  $g_l$  must take on values from 0 to 1 while  $g_r$  takes on values from 1 to 0. The Smith chart lends itself to a ready determination of the components of  $y_l$  and  $y_r$ . See Fig. 10.

In Fig. 10(A), the ordinate for  $g$  extends from 0 to 1—from the edge of the chart to the center. Power is proportional to  $g$ . Thus, if it is desired to make any given per cent of unit power (say 80 per cent) go into the left—or right—branch, then  $g_l$  is specified (say  $g_l = 0.8$ ). In this event, then, conditions for match determine  $g_r$  to be  $1 - g_l$  (say  $g_r = 0.2$ ).

Referring back to Fig. 9, it may be noted that a quarter wave toward the load, from the junction,  $y_l$  appears as  $y_l'$  and  $y_r$  appears as  $y_r'$ .

It should be pointed out here that some interesting things are known about  $y_l'$  and  $y_r'$ , such as:

$$1. y_l' = \frac{1}{y_l} \text{ and } y_r' = \frac{1}{y_r}$$

2.  $y_l' = g_l' + jb_l'$ , and with the termination  $z_0$  on the branch,  $g_l' = 1$ . Of course,  $b_l'$  is a function of the plunger position and the junction susceptance.

3. Since  $y_l'$  is on the unity-conductance-circle (i.e.,  $g_l' = 1$ ), its image  $y_l$  must be on the image of the unity-conductance circle. Therefore, since  $g_l$  is known,  $b_l$  is also known, because it is determined by the intersection of the  $g_l$  contour and the image of the unity-conductance-circle. This is shown in Fig. 10(B) and Fig. 10(C).

Fig. 10(B) shows the case for a 50/50 power split, while Fig. 10(C) shows an 80/20 power split. It may be noted that for any given power

slots open into the box on its broad face. This choke section is supported by a skirt which is a half-wavelength long and which rides on plastic buttons.

B. *Coax-to-Waveguide Transformer*—The bandwidth requirements were such as to accommodate a six-megacycle television channel. At 500 mc, this is not a very large percentage; therefore, a simple probe-type transformer was used. See Fig. 12.

Fig. 12 is a line sketch of the test setup. A long piece of WR 1500 waveguide was slotted along its broad face, and a track and carriage mounted to make a slotted line. A hole with a bolt circle for a split, the Smith chart gives the components of  $y_l$ ,  $y_r$ ,  $y_l'$  and  $y_r'$ .

Fig. 10 also points up another fact. Consider either  $y_l'$  or  $y_r'$ .

The components of either are  $y = g + j(b_1 + b_2)$ .  $g = 1$  because of the matched termination which is the load (see Fig. 9).  $b_2$  is the junction susceptance which, it may be assumed, can be matched out.  $b_1$  is the input admittance of a short-circuited stub and its magnitude depends on the plunger position.  $b_1$  is the quantity which is called  $b_l'$  or  $b_r'$  in Fig. 9. Let the input admittance of the left-hand stub be  $y = 0 + jbl$ . Let the input admittance of the right-hand stub be  $y = 0 - jbr$ . Now if  $0 + jbl$  and  $0 - jbr$  are plotted on the Smith chart, the fact evidenced is that these two points lie opposite each other; that is, they are a quarter wavelength apart. Thus it may be seen that the length of one short-circuited stub must be a quarter wave longer than the length of the other, and, furthermore, if the two plungers are ganged so that there is always a quarter wave between them, the power ratio may be changed from 0-100 to 100-0, and the components of  $y_l$  and  $y_r$  will always be such that  $g_r + g_l = 1$  and  $jb_l + jbr = 0$ . It may be remarked that if only discrete power divisions are to be used and if there is no need to switch under power, so that the VSWR may vary during the switching operation, the junction susceptance need not then be matched out, and the plunger position would be so set that  $b_l' = b_1 + b_2$ . This would require independent movement of the

Fig. 7 -- A magic tee.

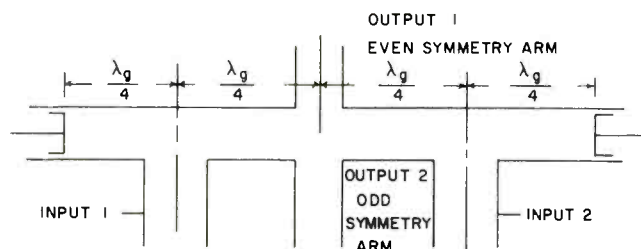

plungers, since  $b_{rl}$  and  $b_{ll}$  would no longer be opposite each other on the Smith chart, and the change in length of one stub would no longer be equal to the change in length of the other stub when power division ratios are changed.

### Synthesis of the Circuit

**A. Movable Short Circuit**—It is desirable to avoid finger contacts. A type of non-contacting or so-called choke-coupled short was designed along the lines of a typical plunger used at 3 cm in 1" x 1/2" waveguide.<sup>2</sup> The plunger was made by forming aluminum sheet metal into a box. See Fig. 11.

The choke section is a quarter-wavelength long hollow box. Two 6 1/8-inch flange was made in the broad face near one end. Provision was made to captivate the insulator of a standard 6 1/8-inch 75-ohm bullet so that one end of the bullet extended into the waveguide. A piece of standard 75-ohm inner conductor for 6 1/8-inch line slipped

<sup>2</sup>Loc. cit., pp. 482-483.

over the bullet could be moved on the bullet to vary the dimension "X" of Fig. 12. A sliding short circuit constructed as shown in Fig. 11 could be moved to vary the dimension "d" of Fig. 12.

The two parameters "d" and "X" may be adjusted to match the transformer. See Fig. 13.

The curves of Fig. 13 show that the dimensions "X" and "d" are not very critical and also that the bandwidth of such a device is adequate for a six-megacycle television channel.

The admittance of this transformer referred to the center line of the coaxial area is  $y = g + jb$ . Since the coax is match-terminated, the conductance component "g" is equal to unity. The susceptance component is made up of the junction effect and the input admittance of the short-circuited line of length "d"; that is,  $b = b_j + b_i = 0$  or  $b_i = b_j$ .

Since d is known,  $b_i$  is known, and, therefore,  $b_j$  is known. The Smith chart is useful in determin-

ing  $b_i$  from the measured d. See Fig. 14.

$b_j$  may be reduced to zero by the addition of an inductive iris in the waveguide situated at the plane of the coax and of magnitude  $+j.7$ . When this is done, d will become equal to  $\frac{\text{wavelength } g}{4}$ . See Fig. 15.

**C. Power-Dividing Tee**—The knowledge of the magnitude of the junction effect and the parameters required to cancel it (that is, x, d, and the size of the iris) permit the power-dividing circuit to be synthesized. See Fig. 16.

The power-dividing circuit consists of three tees spaced a quarter wavelength apart at the guide wavelength. Each tee consists of one coaxial arm and two waveguide arms. The coaxial arm terminates on the broad face of the waveguide, and the inner conductor of the coax extends into the waveguide as discussed above. The center tee has a symmetrical inductive iris located at the center line of the coax to cancel the junction effect. The two outer tees do not have compensating irises, because there is no requirement to maintain a match during switching.

The construction in Fig. 10 may be used to find the  $Y_1$  and  $Y_2$  shown in Fig. 16 for any desired ratio of power in the output arms. The value of  $Y_1$  or  $Y_2$  is sufficient to determine  $d_1$  or  $d_2$ . For instance,

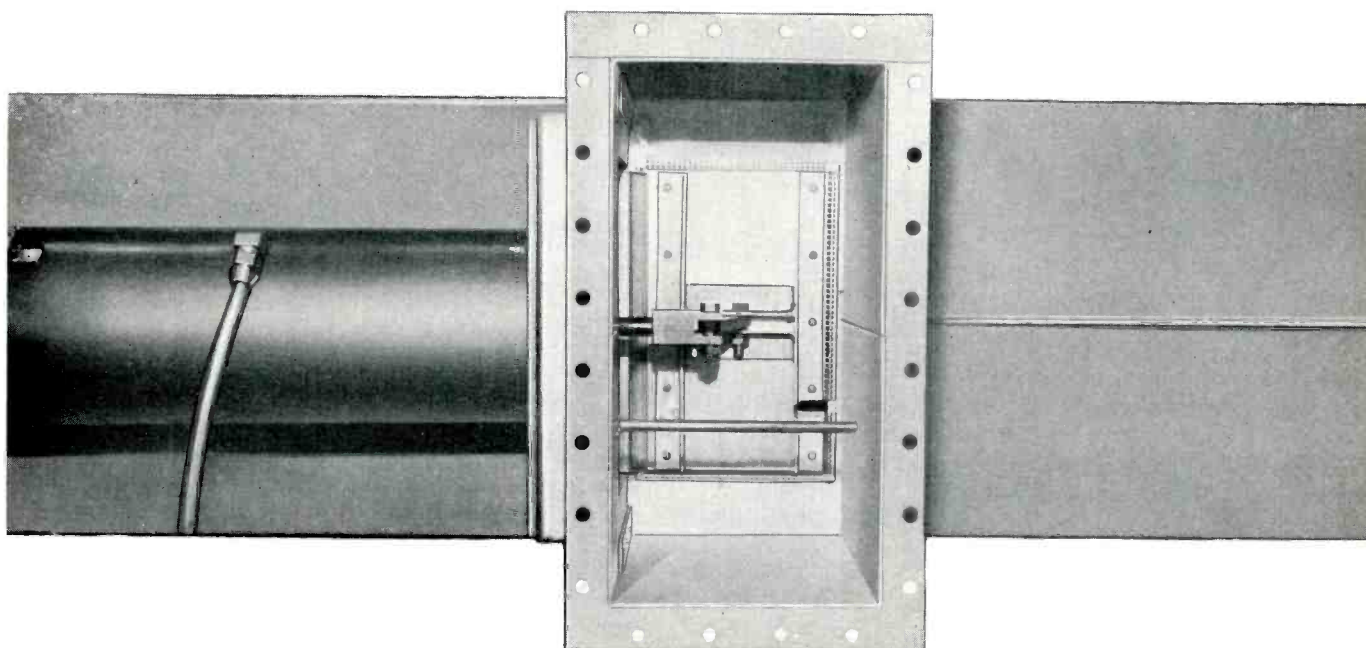

Fig. 8—Waveguide door closed.

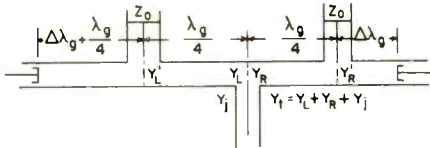

Fig. 9—Power-dividing circuit.

if a 50% power division were desired  $Y_1 = 1 + j1$ ; that is, it is desired to have  $b_1 = +j1$  at the plane of coax one and  $b_2 = -j1$  at the plane of coax two. If  $d_1 = d_2 = d_0$ , then  $b_1 = b_2 = -j.7$ . Therefore, the change in  $d$  from  $d_0$  to get the required value of susceptance may be read from the Smith chart. See Fig. 17.

It may be seen from Fig. 17 that if plunger one is pulled out to make the stub line longer by an amount  $\Delta d_1$ , the input admittance will change from  $-j.7$  to  $+j.3$ . The resultant susceptance at the plane of the coax is the sum of the input admittance of the line ( $j.3$ ) plus the junction effect ( $j.7$ ) which is equal to  $+j1$ . A movement of plunger  $d_2$  in toward the junction

to make the stub line shorter by an amount  $\Delta d_2$  will result in an input admittance of the stub line of  $-j1.7$ . When the junction effect ( $j.7$ ) is added to this, the resultant susceptance at the plane of the coax is  $-j1$ . It will be observed that the two plungers are required to move by a different amount so that they could not be ganged.

Plunger positions may be determined as described above for any power split desired. Fig. 18 is a graph of input VSWR-versus-frequency for positions of the plunger to give two different power splits.

For power divisions of 0-100 or 100-0, that is, for diplexing, the Smith chart may be used to determine the plunger positions. As a diplexer, there are two parameters of interest. These are the input VSWR and the isolation between output terminals (see Fig. 19).

**D. Power-Combining Tee**—Basically the same construction is used in the combining tee, except that provision is made to connect a fourth arm by means of a trap door. When only one transmitter is

in use, the door is closed, and the plungers are adjusted to diplex exactly as described for the dividing tee. When both transmitters are to be used, however, the plungers are adjusted so that each transmitter input tee is a matched transformer from coax to waveguide.

For a four-arm junction to behave as a magic tee, certain conditions must hold:

(1) One arm must have even symmetry with respect to the adjacent arms. The coaxial output arm is the even symmetry arm.

(2) The arm opposite to the even symmetry arm must have odd symmetry with respect to the adjacent arms. The waveguide arm connected by the trap door is the odd symmetry arm.

(3) With any three terminals match-terminated, the input VSWR of the fourth terminal must be matched. This condition may be obtained by putting a matching structure in the even and odd symmetry arms only.

The matching structure in the waveguide arm is a combination of a post and an iris. The iris is part of the main waveguide wall (see Figs. 20 and 21) and serves the double purpose of seating the trap door. It was necessary to have the iris at this place in order to locate the post behind the trap door and thus avoid mechanical interference.

The matching structure required by the even symmetry arm must be removable so that it will not upset the operation of the three-arm tee when the trap door is closed. The solution for this problem was to use a shunt stub with a movable short circuit to change its length. When no matching susceptance is required, the length is made a quarter wavelength so that it becomes merely a quarter-wave stub support. See Fig. 22.

The design of the circuits discussed in this paper has followed straightforward transmission-line theory. It has been shown that the same circuits and techniques used at very high frequencies, in this

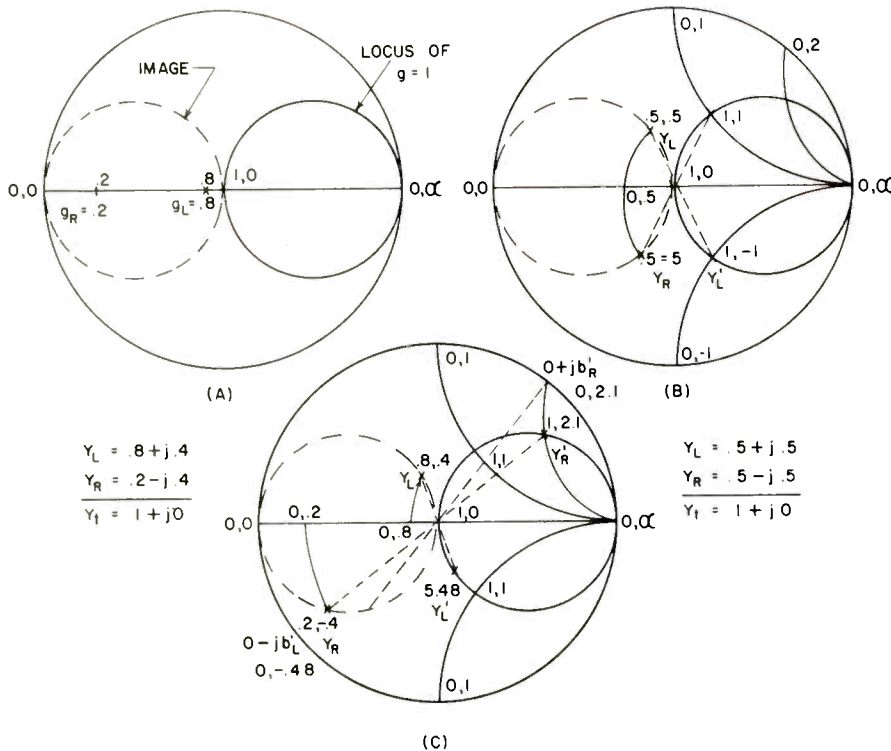
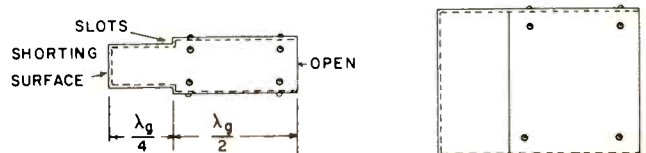

Fig. 10—Chart construction.

Fig. 11—Sliding short circuit.





# ANNOUNCES

## EXTENDED WARRANTY ON BROADCAST VIDICONS

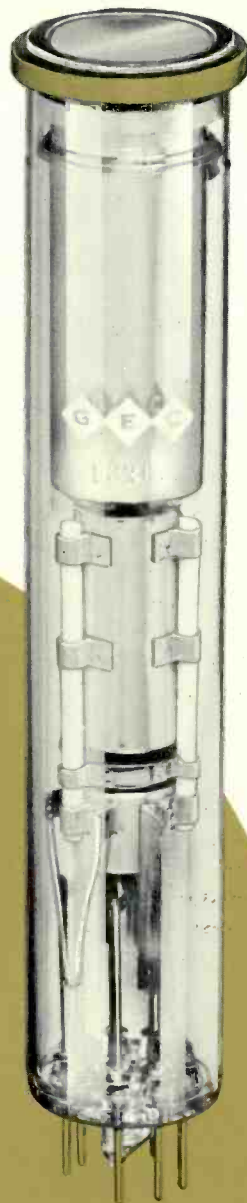

**G**old  
**E**lectrical  
**C**ontact

**Vidicons will now be  
warranted for 2,000 hours**

GEC Gold Electrical Contact Vidicons for studio applications are now carrying an extended warranty for 2,000 hours of operation. Tailor made exclusively for the broadcast industry, these new GEC Vidicons are now available for:

- Live pickup in b & w or color with or without dynamic focus.
- Film pickup in b & w or color with or without dynamic focus.
- Special purpose weather radar studio pickup.

Gold is used on the contact points eliminating formation of oxides and sulphides that create electrical contact problems. The Gold Ring immediately identifies the GEC Broadcast Vidicons covered by the new extended warranty.

GEC Gold Contact Vidicons are available exclusively for broadcast use. For further information contact your GEC Distributor, or write today to:

*... where tube research begins*



**GENERAL ELECTRODYNAMICS CORPORATION**

4430 FOREST LANE • GARLAND, TEXAS • BROADWAY 6-1161

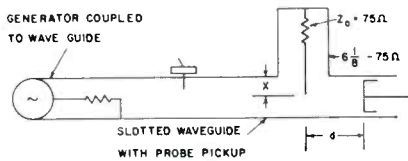

Fig. 12—Experimental setup for matching transformer.

case 10,000 mc, are equally applicable at relatively low frequencies, that is, 500 mc. As an additional example of circuit techniques, the synthesis of a second power-combining tee will be briefly described.

A second requirement for a high-power combining tee arose when another station, operating at 482-488 mc, decided to increase its power. The waveguide switch designed for WDAU, operating at 518-524 mc, was built in standard WR 1500 waveguide, but there is no need to use a standard waveguide since all of the connections are coaxial. Therefore, if a non-standard waveguide were used, it should be possible to choose dimensions such that the waveguide wavelength in the non-standard guide at 485 mc is the same as the waveguide wavelength in WR 1500 waveguide at 521 mc. In this case, all of the design work done on the waveguide switch for WDAU could be used. The use of a non-standard waveguide can have another advantage in that it can be fabricated from aluminum plate, resulting in a strong, rugged package. The completed power-combining tee is shown in Fig. 23. This tee is a magic tee. The long coaxial arm is the even symmetry arm and contains a matching transformer. The opposite waveguide arm is the odd sym-

metry arm. In this tee, no switching is involved.

**E. Composite Switch**—The composite switch is actuated by hydraulic cylinders. Five adjustable short-circuit plungers are required. Each is actuated by a ram and has preset limit stops which position the plunger in the proper place for the switching combination set up at the switching cubicle. A sixth hydraulic ram opens and closes the trap door in the transmitter combining tee.

Fig. 24 shows the composite switch as it appears installed in the station. In this photo, Ken Cooke, Chief Engineer of WDAU, is shown looking at the array of electrically-operated hydraulic valves which control the position of the individual shorting plungers through hydraulic cylinders. On his right, the two antenna output lines go out through the building wall from the power-dividing tee. On his left, the two input lines from the transmitters may be seen coming up through the grating to the power-combining tee. In the right foreground is the "fourth" waveguide arm with its trap door assembly. Opposite the waveguide arm of the tee is the "even symmetry" coaxial arm with its shunt-matching structure. The equipment in the background is a General Electric Model 4PY24B3 combination vestigial-sideband filter, slot diplexer, and power combiner. This unit combines three transmitters, two visual and one aural, to form 23 KW peak visual power and 12 KW aural power. This is one input for the waveguide switch. A similar unit is located symmetrically behind the

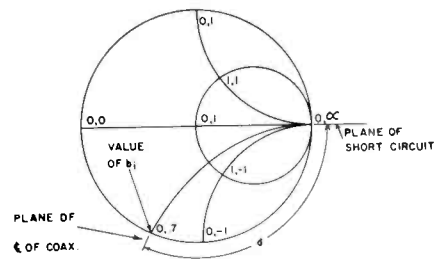

Fig. 14—Input susceptance of stub line.

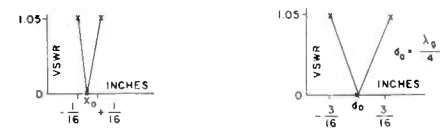

Fig. 15—Coax-to-waveguide transformer.

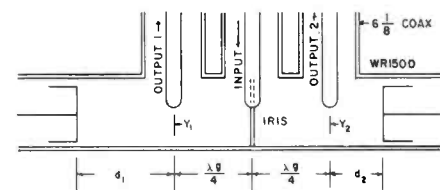

Fig. 16—Power-dividing circuit.

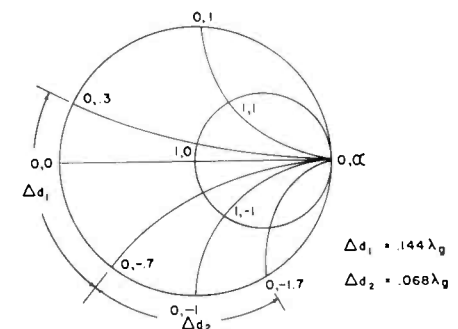

Fig. 17—Construction to determine plunger position.

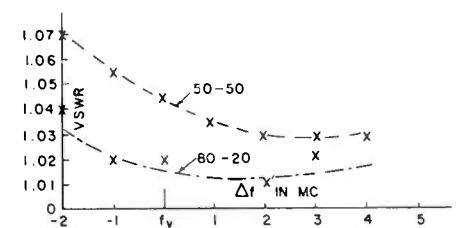

Fig. 18—Input VSWR of power divider.

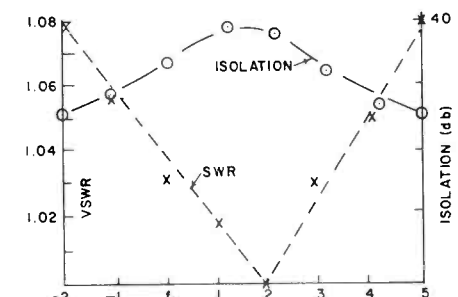
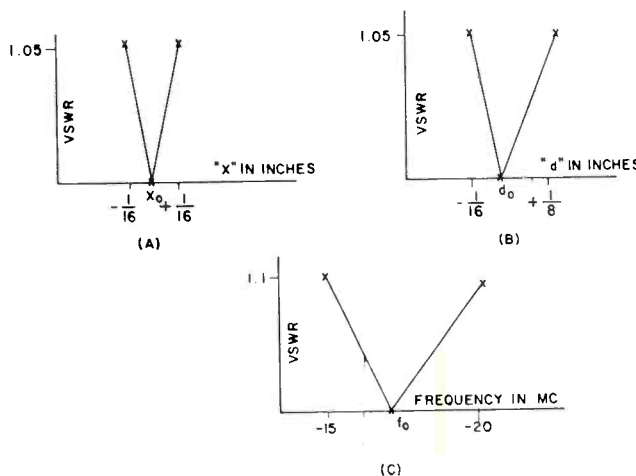

Fig. 19—Power divider used as diplexer.

Fig. 13—VSWR of 6 1/8-inch coax-to-waveguide transformer.





# A New Standard Of Quality!

# **Bauer**

## **1000/250 WATT**

## **AM TRANSMITTER**

*If you want the very best 1 kw AM transmitter available today...order the Bauer Model 707.*

*Bauer keeps pace with the fast moving field of electronics to give you a modern transmitter for the "sixties"... at a price that proves the economy of superior design.*

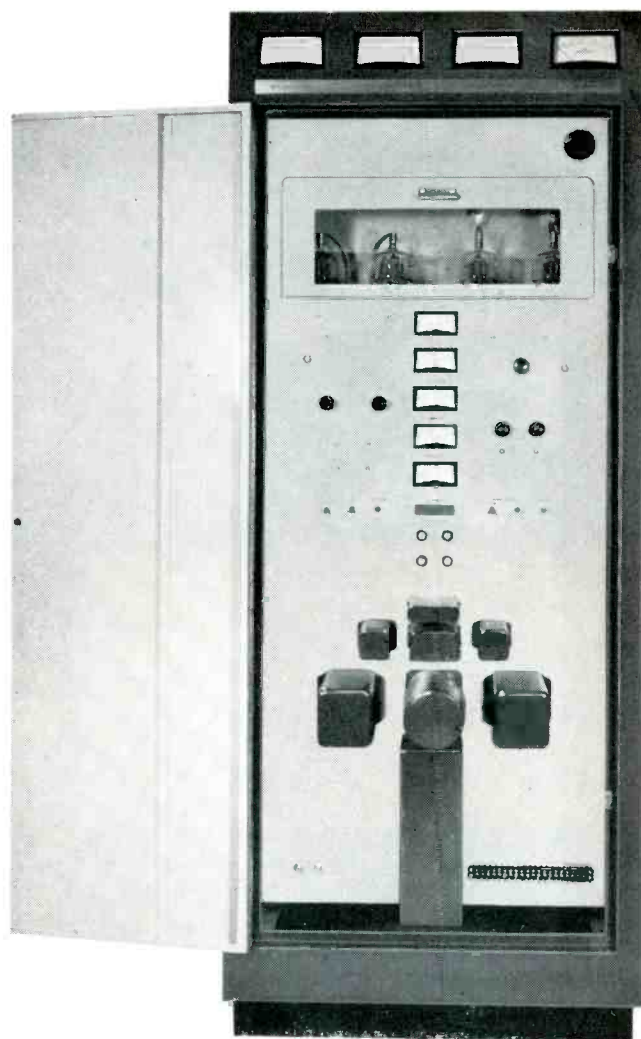

### **These Quality Features Provide Economical And Optimum Performance**

**SILICON RECTIFIERS**—In all power supplies... No more arc back... longer life... plus automatic starting and simplified control circuitry.

**CONSTANT VOLTAGE TRANSFORMER**—Maintains all filament and low voltage supplies within 1%... thereby eliminating manual adjustment and extending tube life.

**VACUUM CRYSTAL**—Maintains carrier frequency within  $\pm 5$  cps without heaters, thermostats or ovens.

**VACUUM VARIABLE CAPACITOR**—Provides highly dependable tuning of final tank circuit... a Bauer "quality" exclusive.

**BUILT-IN REMOTE CONTROL**—No need to add metering kits and power control motors with a Bauer Model 707—they are included at no extra cost.

**POWER CUTBACK**—Throw the switch (local or remote control) for 250 watts night-time... standard equipment. Instantaneous—surge free—efficient.

**PRESSURIZED CABINET**—Modern cooling system extends component operating life.

**CONTINUOUS METERING**—Of all circuits provided by nine different meters. No multi-meters!

**BUILT-IN DUMMY ANTENNA**—Furnished as standard equipment. A Bauer feature for many years!

### **THE ECONOMICAL APPROACH**

The Bauer Model 707 is also available as a kit... at a substantial savings.

**DON'T BUY A 1 KW TRANSMITTER UNTIL YOU HAVE THE BAUER STORY.**  
**WRITE TODAY!**

**Bauer** ELECTRONICS CORPORATION  
1663 INDUSTRIAL ROAD, SAN CARLOS, CALIFORNIA • LYTELL 3-0800 • AREA CODE 415

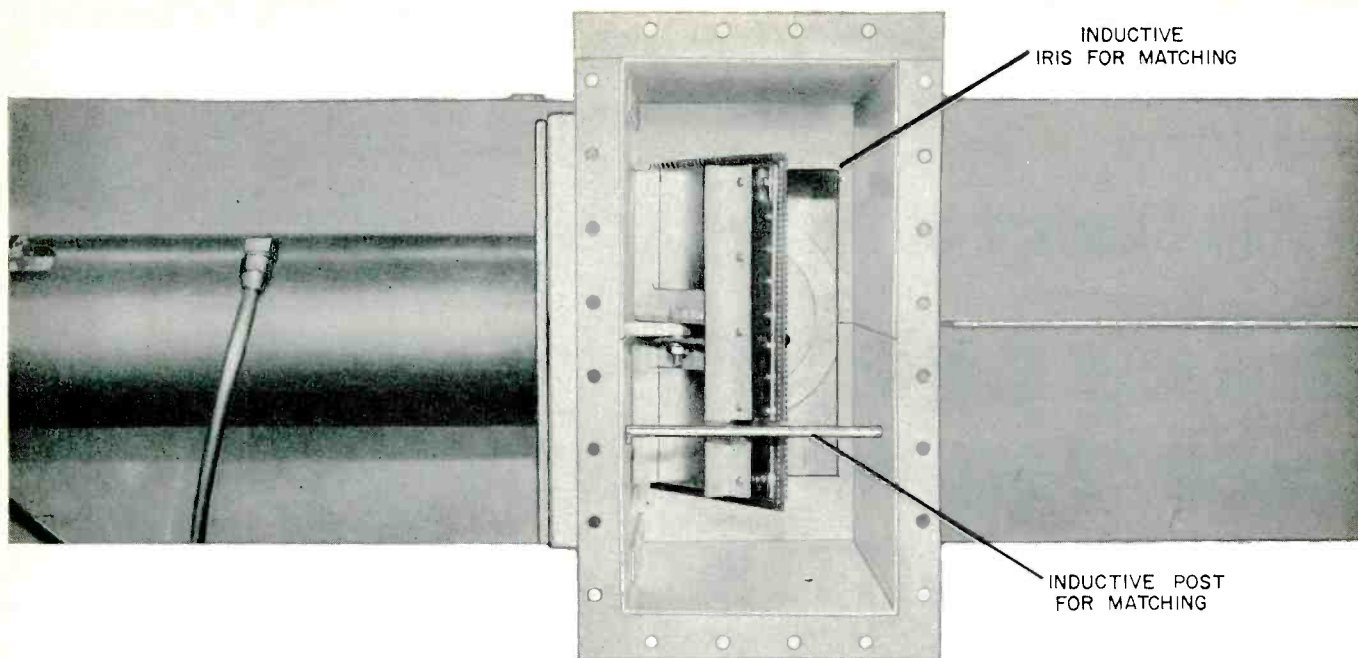

Fig. 20—Waveguide door partially open.

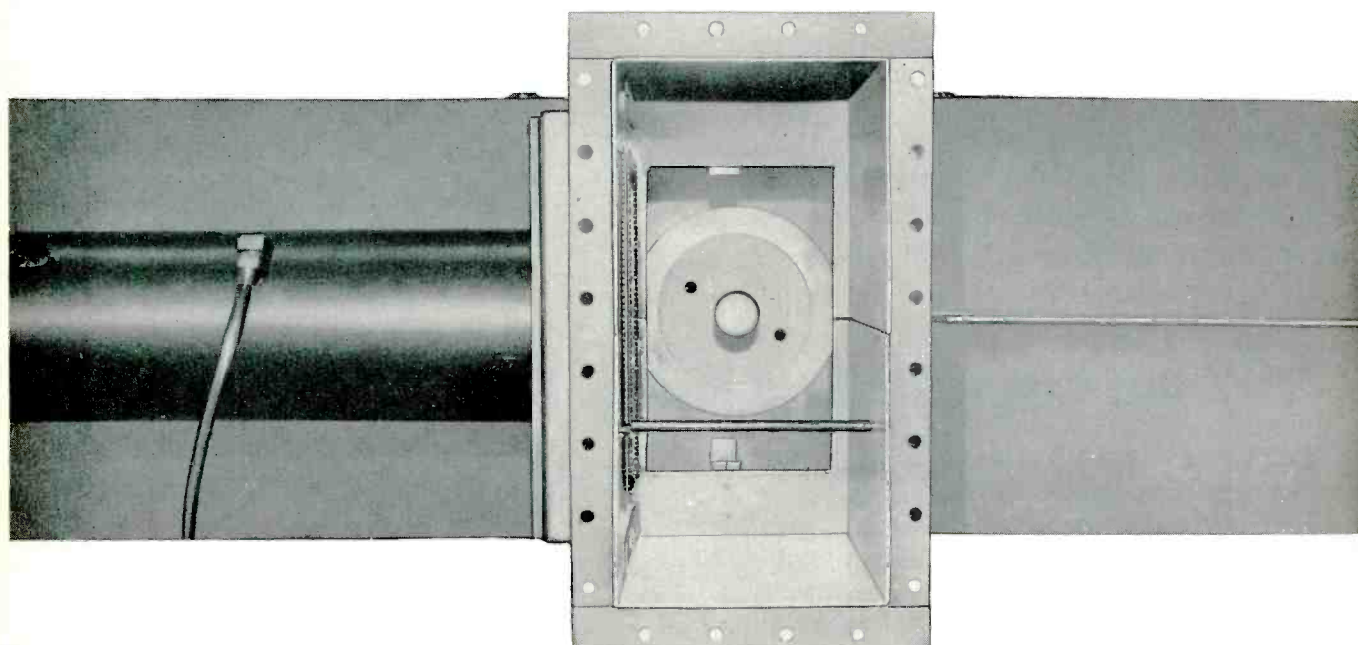

Fig. 21—Waveguide door open.

photographer to form the other input to the waveguide switch.

The photograph of the RF switching cubicle, Fig. 25, displays the routing switches and status lights. On the left, Ken Cooke has his hand on the transmitter selection switch. This is a three-position switch which selects either group one or group two transmitters or group one and group two together.

The array of neon lights immediately above the switch gives the status of the shorting plungers involved in the transmitter switching. On the right, Stan Zawislak,

WDAU's transmitter engineer, has his hand on the antenna selection switch. This is also a three-position switch which selects either the top antenna, the bottom antenna, or antennas one and two together. This switch also has an array of status lights immediately above it.

Both of these switches may be moved independently to any position at any time. This allows any desired combination to be pre-set.

The switch directly in the center is the operation switch which initiates the switching sequence. The first step in any sequence is the re-

moval of power from the transmitters. These are kept locked out until the selected combination is completely routed, and then the transmitters are re-energized. At the top of the switching panel a row of status lights indicates the "present" status of the waveguide switch. The maximum time for any switching operation is less than 30 seconds. The circuit parameters, such as VSWR, isolation, and power division were measured on the composite switch at both inputs for all combinations and found to be well within the design objectives.

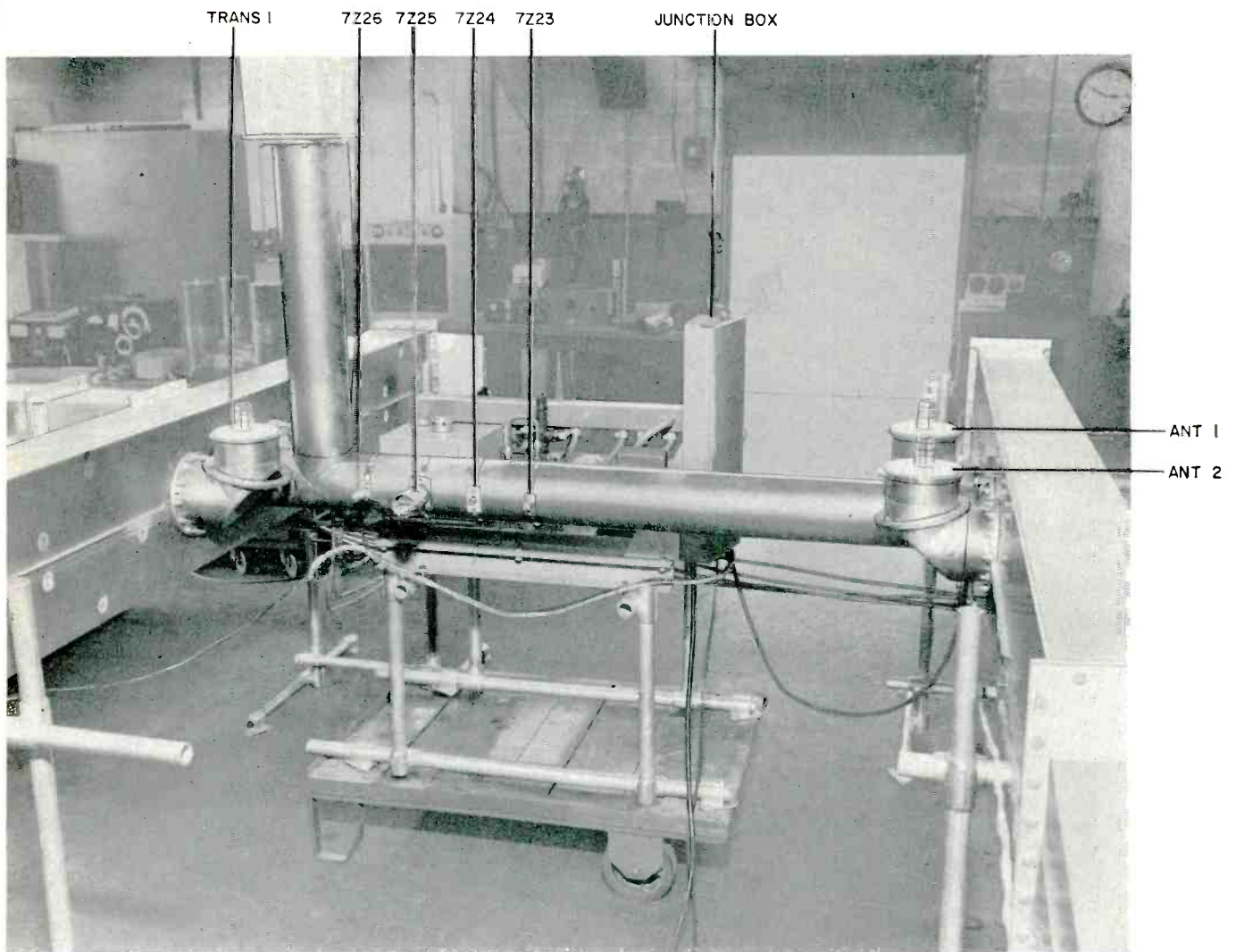

Fig. 22—Composite switch, showing shunt stub on combining tee.

Fig. 23—A magic tee power combiner. ▶

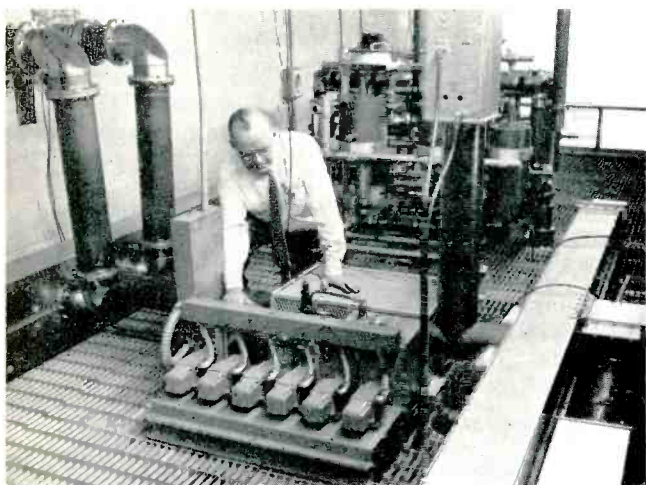
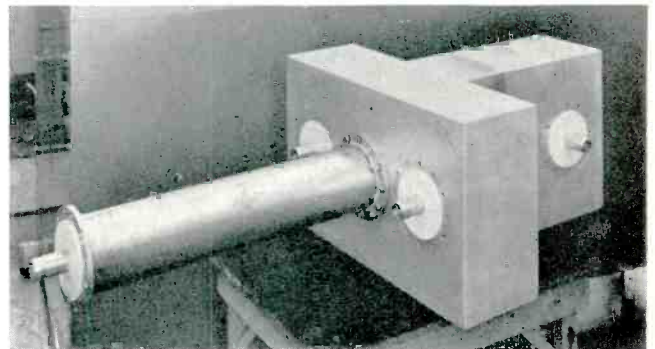
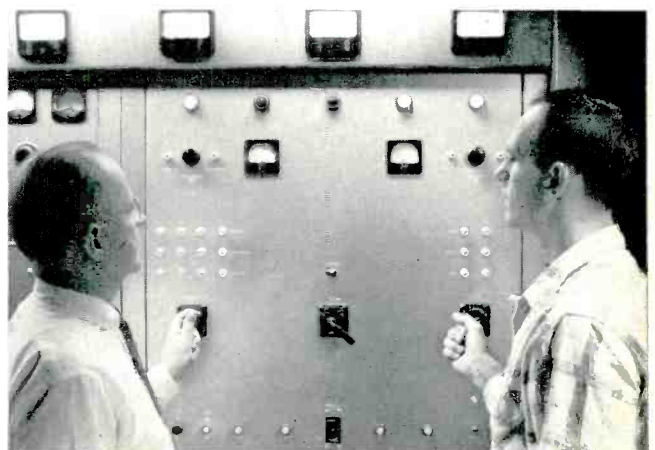

Fig. 24—Waveguide switch installed at WDAU.

Fig. 25—Waveguide switch control cubicle at WDAU. ▶



# Now...maximum power



The test site shown represents a unique facility to provide you with the most accurate possible arrangement of coverage pattern for your particular area. Nearly two miles across the valley (see cross section) is the transmitter used for testing. Computer facilities housed nearby make it possible to supply you with an antenna with fixed power distribution and phase relationship between sections, to achieve an optimum vertical null fill-in and beam tilt.

The two section antennas have gain of 9.4 (approximate), which is suitable for 50 kw transmitters at 42 kw out with 80% line efficiency. The three section antennas have power gain of 14.1 (approximate), for use with 30 kw transmitters at 28 kw out with 80% line efficiency. On channels where the gain is 14.4, up to 800 feet of 6 $\frac{1}{8}$ " line will permit maximum authorized power with a 25 kw transmitter.

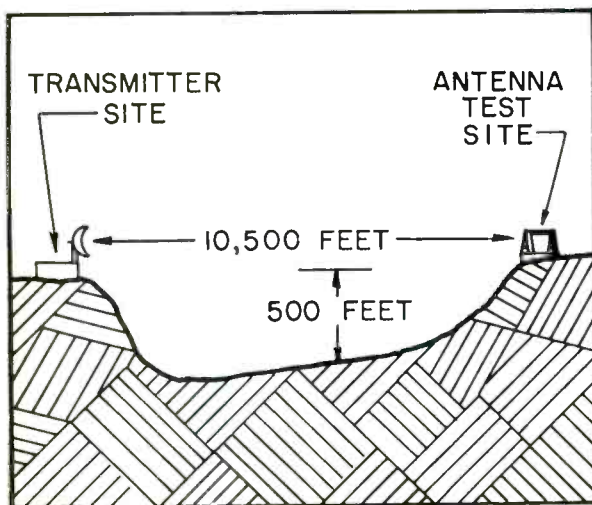

# for any channel from 7 to 13

15 new General Electric helical antenna combinations assure near optimum electrical characteristics in any transmission area with gain from 4.5 to 4.8 per bay. Two section antennas have approximate gain of 9.4; three section antennas have approximate gain of 14.1.

**TWO SECTION  
ONE LINE FEED**

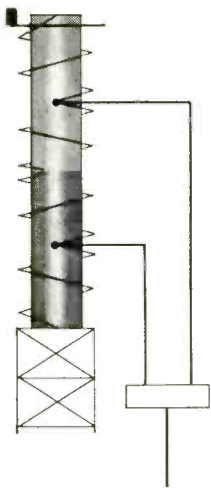

Model 4TY52A1—Chan. 7-8  
Model 4TY52A2—Chan. 9-10-11  
Model 4TY52A3—Chan. 12-13

**THREE SECTION  
ONE LINE FEED**

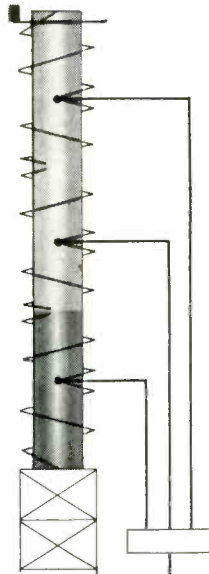

Model 4TY53A1—Chan. 7-8  
Model 4TY53A2—Chan. 9-10-11  
Model 4TY53A3—Chan. 12-13

**TWO SECTION  
TWO LINE FEED**

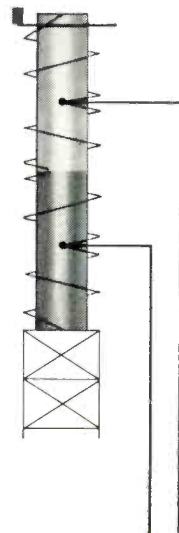

Model 4TY52B1—Chan. 7-8  
Model 4TY52B2—Chan. 9-10-11  
Model 4TY52B3—Chan. 12-13  
Model 4TY52C1—Chan. 7-8  
Model 4TY52C2—Chan. 9-10-11  
Model 4TY52C3—Chan. 12-13

**THREE SECTION  
TWO LINE FEED**

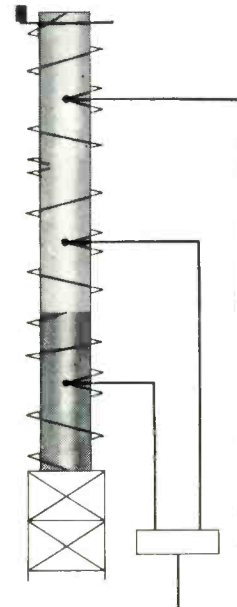

Model 4TY53B1—Chan. 7-8  
Model 4TY53B2—Chan. 9-10-11  
Model 4TY53B3—Chan. 12-13

Note all lines are actually inside mast.

The facts speak for themselves, and General Electric VHF helical antennas also provide these *additional* advantages: (1) fewer feed points and feed lines greatly reduce air leak and coupling problems (2) another antenna often can be "piggy-backed" on the helical, so two or more stations can use the same tower (3) feed lines inside mast protected from weather, shielded from RF field (4) helical can be sectionalized for emergency operation (5) no separate heating elements for de-icing; using helix as own de-icer takes less power (6) no feed lines smaller than 3/8" diameter — rugged, durable

with high load capacity (7) structurally rigid, withstands winds to 112 miles per hour; resists shifting of feed lines, eliminates pattern fluctuations in winds.

For complete information, call your local G-E Broadcast Equipment representative, or write Technical Products Operation, Section 4981, General Electric Company, Electronics Park, Syracuse, New York. In Canada: Canadian General Electric Company, Ltd., Broadcast Equipment Sales, 830 Lansdowne Ave., Toronto, Ont. Export: International General Electric Co., Inc., 150 East 42nd Street, New York, N.Y.

**GENERAL  ELECTRIC**

# MORE NOTES ON FIELD MEASUREMENTS

The techniques of using a helicopter for in-flight recording are outlined

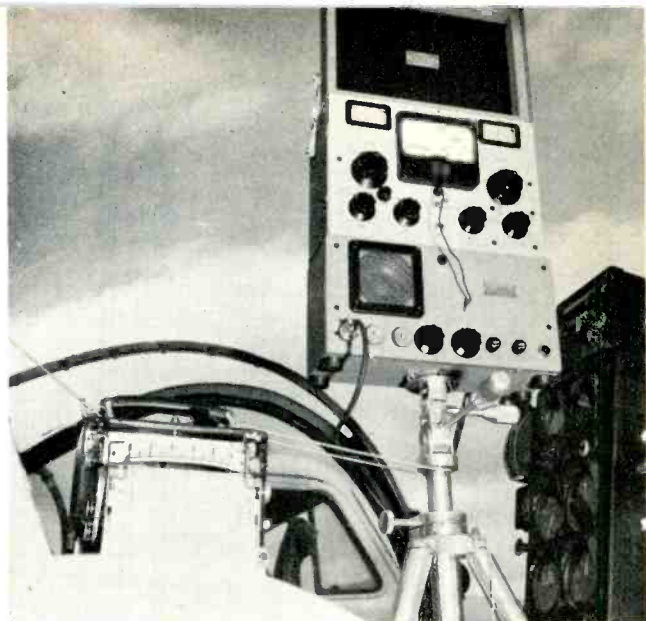

Fig. 1—Close-up of measuring and recording equipment mounted in the helicopter.

By Elton B. Chick, Assistant Director of Engineering, Rounsaville Radio, Inc., Atlanta, Georgia.

**F**IELD intensity measurements are made difficult in many parts of the country by rugged terrain. Such areas as extensive swamps and other impassable sections make ground surveys extremely difficult if not impossible. By using a helicopter a field survey can be completed more

easily, much faster and with more accurate results than may be possible on the ground.

Two approaches to helicopter measurements are, first, using the helicopter to transport a technician and his field meter to known positions along a radial line, landing and making ground measurements outside the helicopter. Second, using the helicopter for measurements in flight. Except for precautions about the helicopter's rotor blades, wearing boots in the swamp and easier navigation, the first approach is much like using an automobile for transportation.<sup>1</sup> The second method is, however, a little more involved. Here, navigation must be more accurate; air speed and ground speed become important factors, as well as mounting the measuring equipment. This article was planned to offer suggestions on overcoming some of these problems.

## DERIVATION OF TIME-DISTANCE FORMULA

### WHERE:

- $t_1$  = Flying time, in minutes, from antenna to end of radial
- $t_2$  = Flying time, in minutes, from end of radial to antenna
- $D$  = Distance in miles (length of radial)
- $X$  = Wind component acting to aid or oppose ground speed
- $R$  = Air speed (held constant at 60 mph, 1 mi/min.)

### THEN:

- (1)  $D = Rt_1 = Rt_2$  (no wind condition)
- (2) Then:  $(R + X)t_1 = (R - X)t_2$  (with wind condition)

(3) Solve for  $X$ :  $X = \frac{Rt_1 + Rt_2}{t_1 + t_2}$

Substitute in (2):  $D = \left( \frac{R + Rt_1 + Rt_2}{t_1 + t_2} \right) t_1$

Simplify:  $D = \frac{t_1 R + t_1(Rt_1 + Rt_2)}{t_1 + t_2}$  or  $D = \frac{t_1^2 R + t_1 Rt_2 + t_1 Rt_2 - Rt_1^2}{t_1 + t_2}$

(4) Or:  $D = \frac{2t_1 Rt_2}{t_1 + t_2}$

- (5) Let  $R = 1$

### THEN:

$$D = \frac{2t_1 t_2}{t_1 + t_2}$$

### Equipment Installation

When installing equipment in the helicopter, two main points to consider are safety of the installation and the accuracy with which the measurements can be made. Since all aircraft have weight and balance requirements and must be loaded properly, the equipment installation will be subject to the approval

<sup>1</sup>See Notes on Standard Broadcast Field Intensity Measurements, Broadcast Engineering, January, 1961.



**New Eimac UHF-TV klystron pushes way down!**

**costs**

Now available: Eimac's 4KM100LA, a new 25KW klystron designed for UHF-TV transmitters. It provides the lowest operating cost ever with its low unit price, long life, non-critical focusing and high gain of 30 db to replace three tetrode stages! What's more, it's a complete amplifier unit and needs no RF design work, water filters, expensive maintenance. The 4KM100LA has all this and low noise too—more than 60db below black level. No wonder Eimac klystrons are used in almost 90% of all European UHF-TV stations! And now Eimac anticipates *your* needs with this modern, cost-cutting tube.

For more data write: Power Klystron Division, Eitel-McCullough, Inc., San Carlos, Calif.  
*Eimac 4KM100LA Klystron Simultaneous Operating Characteristics.* Beam voltage: 16KV; Beam Current: 3.8A; Power Output, peak sync.: 25KW; Bandwidth: 8mc, 1db; AM Noise: greater than 60db down.



of the helicopter owner and pilot who will ascertain that flight safety rules are not violated. Every precaution should be taken to insure safety. Generally, all equipment used for measurements must be anchored securely and cables routed so as not to interfere with aircraft operation.

Figure 1 shows field measuring equipment installed in the model 47G2 Bell helicopter. Here, the field meter is mounted atop an accessory unit which is supported by an aluminum camera tripod; the recording millimeter is situated on the seat. A storage battery, to power the equipment, is located on the floor by the passenger's feet. The battery is wrapped in heavy plastic to avoid acid damage. This equipment consists of the Nems-Clarke, model 120-D, field intensity meter, the Nems-Clarke accessory unit, model 121, (dc amplifier), the Esterline-Augus, Model AW, 0-1 dc recording millimeter and the 6-volt automobile storage battery. The camera tripod, Tiltall model 4602, is held in place by short wire cables with hooks and turnbuckles. The accessory unit, with the use of a shim, mounts directly on the camera tripod and the field meter atop the accessory unit. These are matching units made by the manufacturer to mount in this manner. The recording millimeter is seated on a sponge pad on the seat between the pilot and passenger. The milliam-

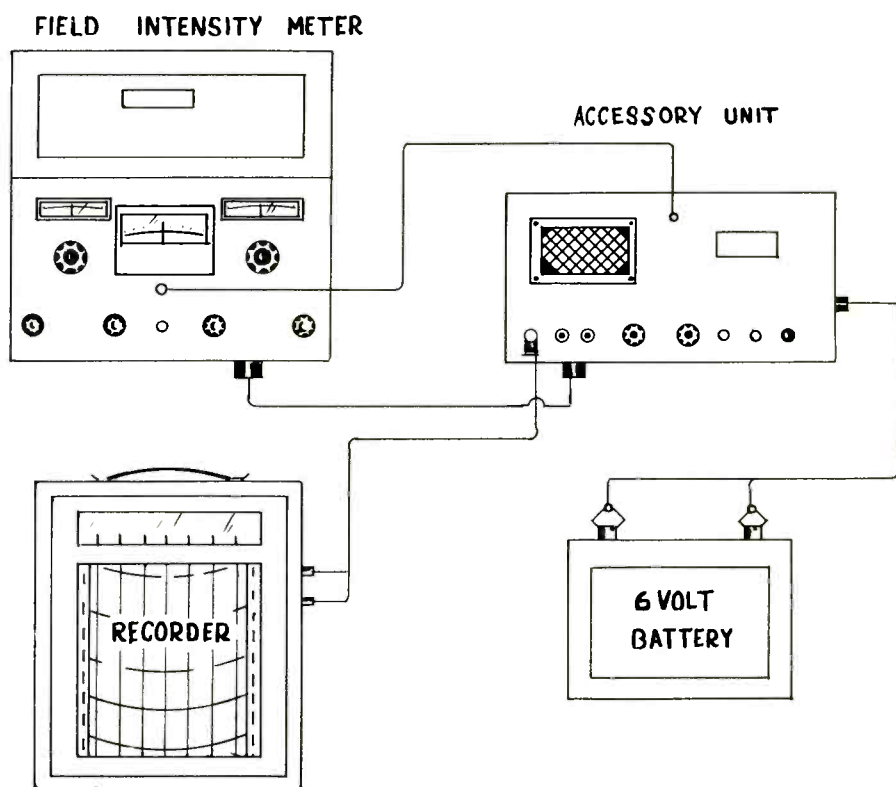

Fig. 2—A block drawing of the arrangement of equipment.

meter is held in place by a guy line between the camera tripod and the rear bulkhead of the passenger compartment. The front cover of the millimeter is removed to allow access to the chart for making notes as the graph is drawn. This arrangement of equipment has several advantages; it is easy to install, allows the technician access to all units

and does not interfere with the pilot's work. Figure 2 is a block diagram of the connections used.

### Calibration

Before beginning a flight the equipment must be calibrated. Using the field meter with the log-linear recording millimeter can be adjusted to record field strength directly; type 4305-X recorder chart is used. Calibration consists of adjusting the field meter in the same manner as for ground measurements and adjusting the accessory unit zero and calibrate controls so that field intensity is recorded as shown on the field meter scale. With careful adjustment this can be done so that the recording is within one or two per cent of the field meter indication. The recording millimeter is set-up for a chart speed of  $\frac{3}{4}$ -inch per minute and the record-stylus weight is adjusted so that flight vibrations do not cause the stylus to skip. This instrument must be reset to mechanical zero under vibration because of the greater stylus pressure. Having determined that the equipment is initially calibrated, a short flight should be made, a mile or two from the station antenna, and a final calibration

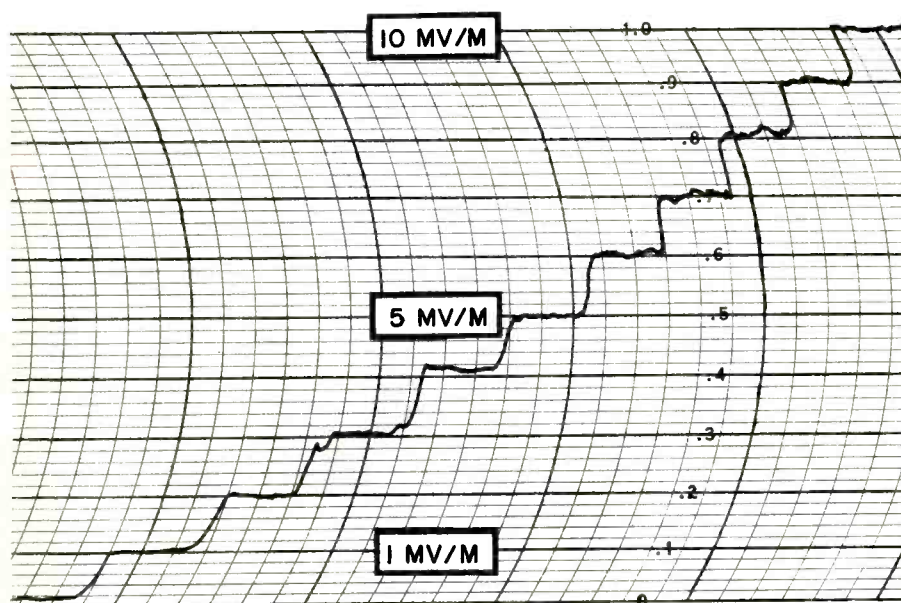

Fig. 3—A section of recorder chart showing calibration test and compliance at 1 millivolt intervals from 1 mv/m through 10 mv/m.



adjustment made on the ground before the flight begins. Figure 3 shows a graph of the calibration check, on the ground, with helicopter engine and rotor blades operating. To check the accuracy of measurements made with this arrangement several measurements were made at selected points, first, with the equipment installed and again shortly after with the field meter alone, the helicopter being removed from the spot. No perceptible difference was observed between the ground measurement and helicopter measurements. The effect of altitude is not likely to be a problem except for close-in measurements or with antennas having maximum radiation at some angle above the horizon. Figure 4 shows a recording made near enough to the antenna to show altitude effect. Here, about 1 per cent error was found at 100 feet; however, at 300 feet the error reaches 5 per cent. If special interest is taken in the close-in helicopter measurements, then some type of correction factor may have to be determined for each radial of a directional pattern. For the usual field survey, except for the close-in points, the altitude effect may be ignored provided the altitude is not too great, say less than 500 feet.

#### Measurements in Flight

Starting over the center of the array, recording on the highest field meter scale, the flight out begins. Field intensities will drop rapidly

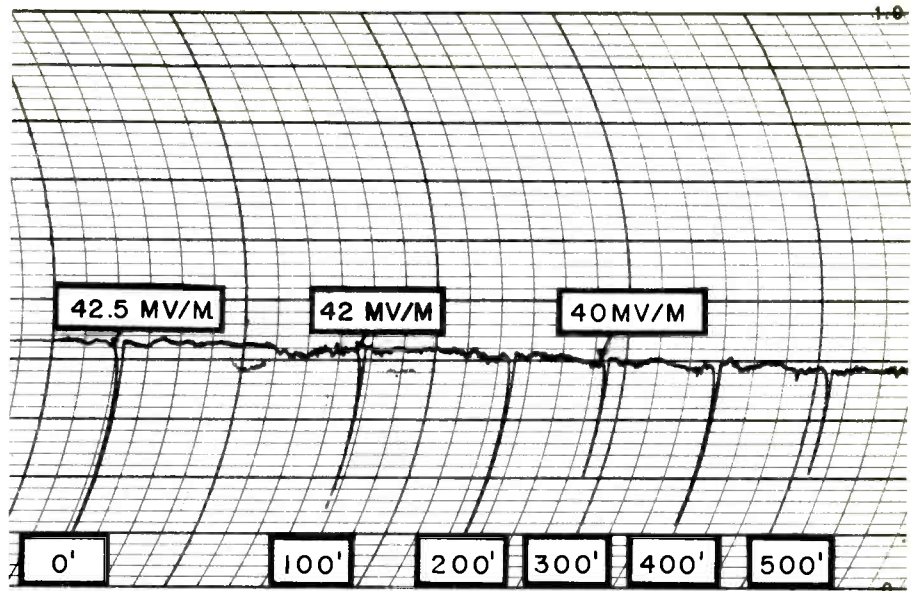

Fig. 4—Field intensity vs. altitude at a short distance from the antenna.

for the first few miles requiring frequent switching to a lower meter scale. Data recorded on the outward flight is likely to be less accurate than that recorded on the inward flight. This is because the mass of the helicopter is in the signal path and navigation over a new course is less accurate the first time. Because of these conditions the recording on the outward flight is used primarily for distance and time checks and as a secondary check on the field intensity. Once the end of the radial is reached another calibration check is made on the ground

and the inward flight can begin. The navigation on this flight can be more accurate since allowances can be made for wind drift and for check-points (landmarks) missed when going out. On the inward flight the recording is started on flying over the most distant check-point. This is marked on the recorder chart as the beginning of the radial "in" and also marked on the radial line drawn on a map. On the inward flight each check-point is noted on the recorder chart by a number and its exact position is marked on the recorder graph with a pen or by a

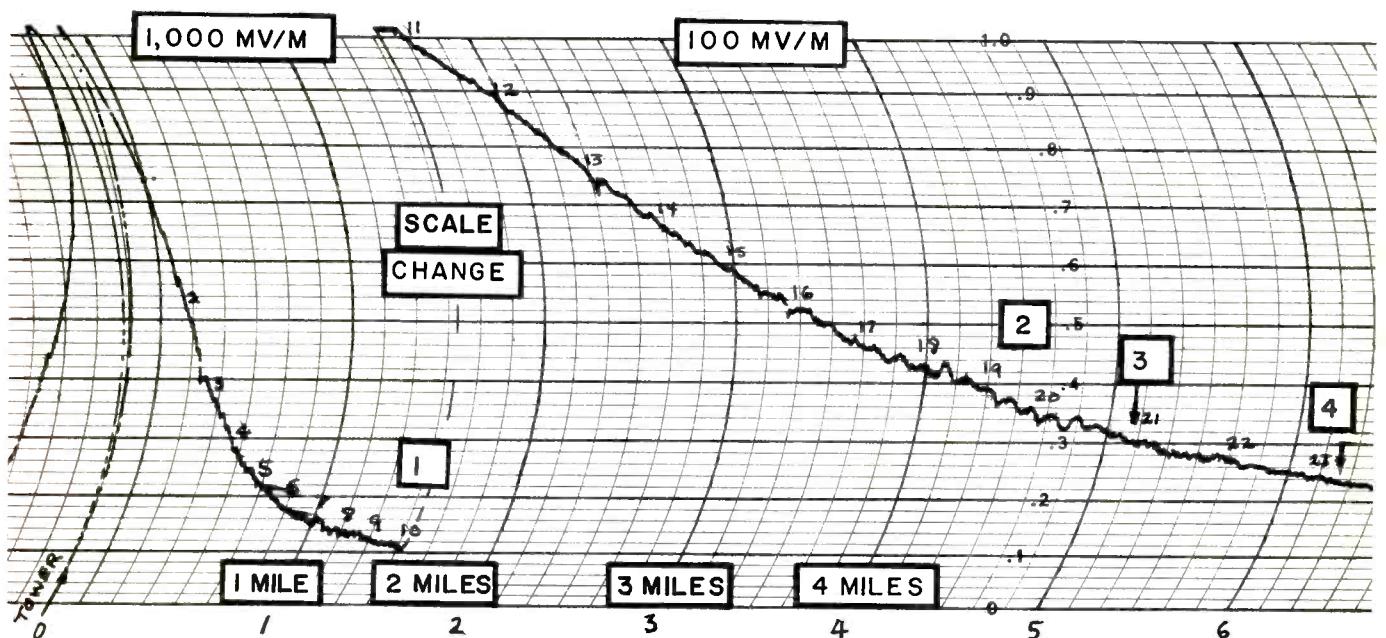

Fig. 5—A recording of field intensity vs. distance on an inward flight.

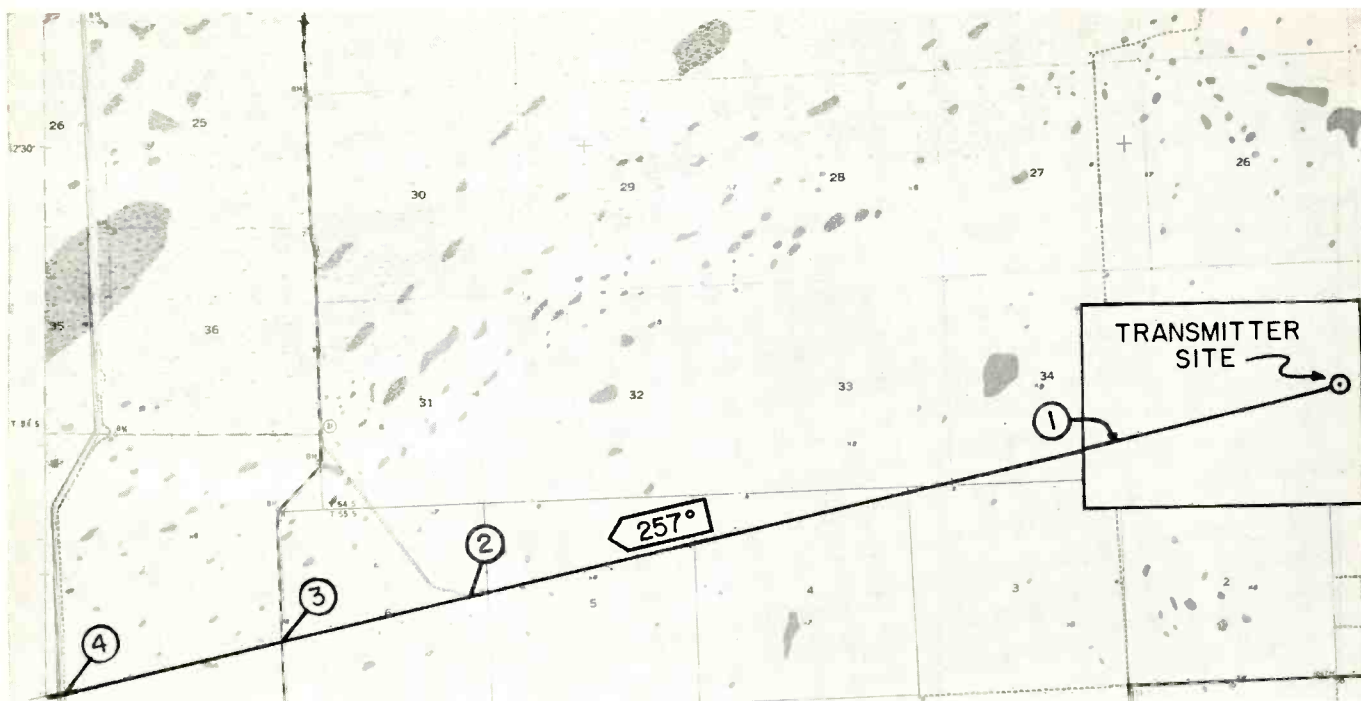

Fig. 6—A map showing the radial under test.

**Fig. 7 — A TABULATION OF DATA TAKEN FROM THE CURVE IN FIGURE 5**

POINT NUMBER	DISTANCE	MV/V
1	.162	740
2	.325	490
3	.487	355
4	.649	270
5	.812	210
6	.974	175
7	1.14	150
8	1.30	135
9	1.46	125
10	1.62	110
11	1.79	100
12	2.11	87.0
13	2.44	75.0
14	2.76	66.0
15	3.08	58.0
16	3.41	52.5
17	3.73	46.0
18	4.06	42.5
19	4.38	39.0
20	4.71	34.5
21	5.20	30.0
22	5.68	27.0
23	6.17	24.0
24	6.66	21.5
25	7.14	19.5
26	7.63	18.0
27	8.12	16.5
28	8.60	14.5
29	9.25	13.5
30	9.90	12.0
31	10.55	11.0

quick swing to zero of the recorder stylus, done by momentarily switching to a higher scale on the field meter. Figure 5 shows a portion of a recording on an inward flight and Figure 6 is a map of this section of the radial. Check-points are also noted on the radial map thus allowing a direct comparison to ground measurements where available. While in flight the passenger, in addition to marking check-points, must help with navigation and adjust the position of the field meter for maximum indication. The latter is easily done by using the tripod head as a swivel. On both the inward and outward flight the air speed is maintained as near constant as possible, preferably 60 miles per hour. Using the recorder as a clock (it is a very accurate one) and the distance flown, measured from a map, it is possible to determine very closely the helicopter's ground speed. With this information the distance to any point on the recording can be readily determined. The main errors that occur here result from inconsistent air speed and gusty wind conditions which cause the ground speed to vary from point to point along the route. If this condition arises it is necessary to determine ground speed in segments along the flight path. This is done by using the time and distance be-

tween check-points. Using three or four check-points per 10 miles is usually sufficient. The last check-point on the inward flight should be the center of the array.

In areas where no suitable check-points are available it may be necessary to erect flags or other markers along the radial. Using a surveyor's transit, on a platform, set up at the center of the array and two-way radio to direct the helicopter, it is possible to set up markers exactly on the radial by directing the helicopter with transit sightings. This method is useful out to about 12 or 15 miles in clear terrain. Once the radial line is defined in this manner its length must be measured. An easy way to do this is by flying from the antenna to the end of the radial, and back again, at a constant air speed. If the wind is steady or calm the following equation will give distance accurately:

$$D = \frac{2t_1 t_2}{t_1 + t_2}$$

Where D is distance in miles

$t_1$  is time to fly to end of radial in minutes.

$t_2$  is time to fly from end of radial to station in minutes.

Several tests of this equation yielded errors of less than 2 per cent over a 15-mile course. An alternate method of accurately maintaining a course is to use the transit

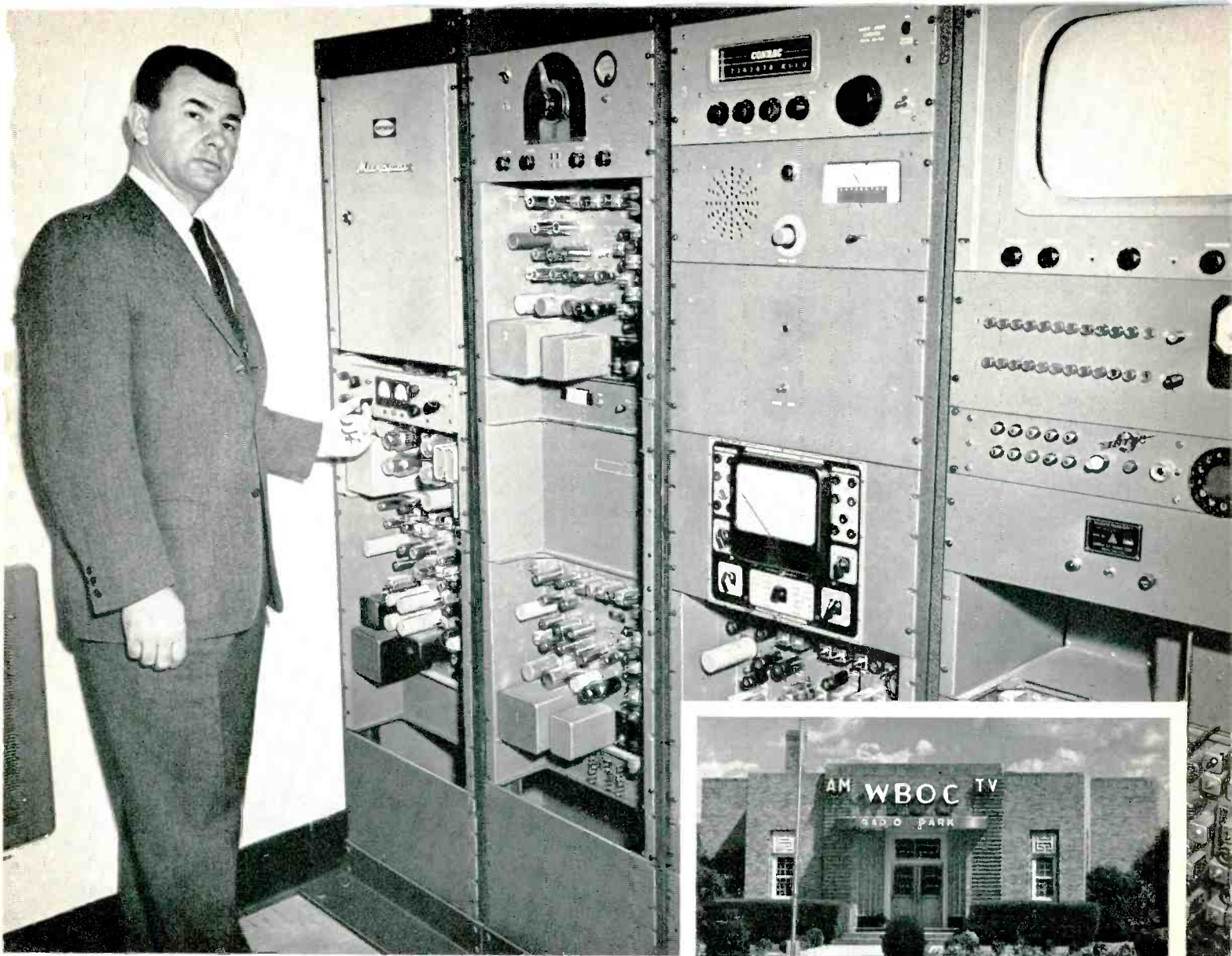

## RAYTHEON MICROWAVE INTERCITY RELAY "EXCEEDED OUR GREATEST EXPECTATIONS"

*Says Jack Ward, WBOC-TV's Chief Engineer*

"Mark us down as a satisfied customer. After 7 months of operation, can truthfully say performance has exceeded our greatest expectations. My thanks to Raytheon . . . I have never worked with a more tireless, devoted group."

Such satisfaction with Raytheon Microwave service and equipment is typical. For Jack Ward and WBOC-TV in Salisbury, Maryland, Raytheon performed the following: 1st hop on the air in 34 days; entire 2-hop, 49-mile Raytheon KTR Intercity Relay system operating in 56 days from date of order!

If your summer plans include Intercity Relay, let Raytheon custom survey your requirements. This expert service provides a complete System Engineering budget estimate, without obligation.

To learn more about this service, about Raytheon 1/10 Watt and 1-Watt KTR's unsurpassed reliability in unattended operation, and about Raytheon's low interest, long term financing, write: Raytheon Communications and Data Processing Operation, 1415 Boston-Providence Turnpike, Norwood, Massachusetts.



# RAYTHEON COMPANY

EQUIPMENT DIVISION

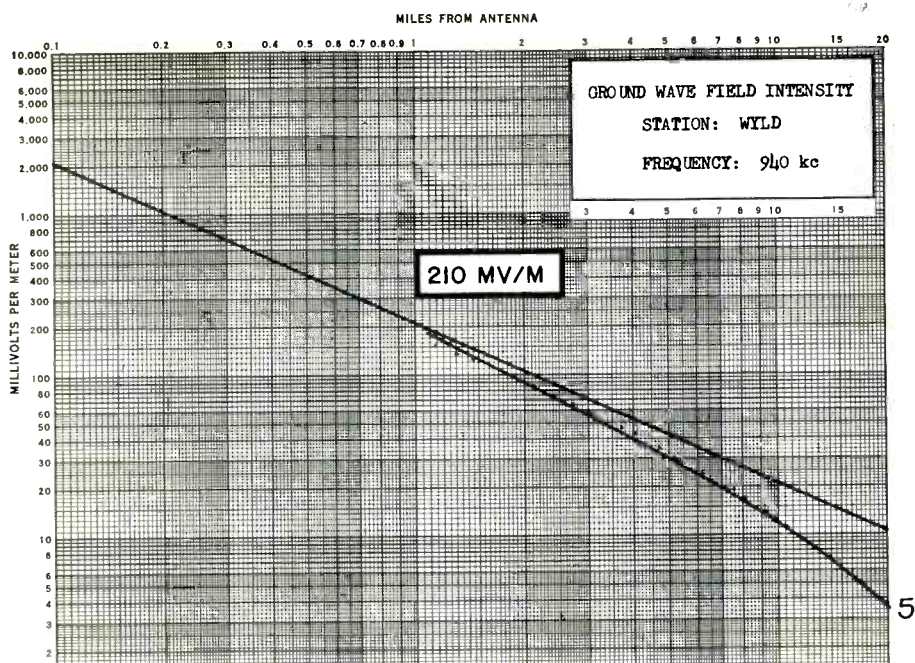

Fig. 8

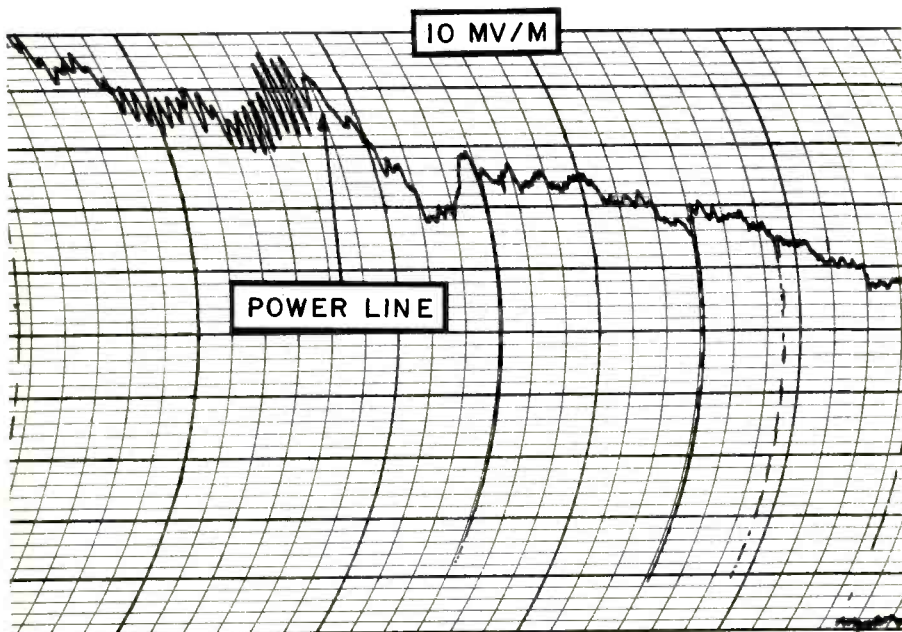

Fig. 9—A graph showing a disturbance that may be encountered in the vicinity of large power lines.



Fig. 10—A helicopter radial check-point.



Fig. 11—Aerial view of the WYLD transmitter plant surrounded by almost trackless swamp land.

set-up to direct the helicopter on every flight.

### Analysis of Data

The first step in data analysis is to compare the field intensity recording with the radial map, determine the ground speed of the flight and learn whether check-points appear at the proper intervals. If the check-point distances coincide with the proper time intervals as indicated on the recorder chart, then the ground speed is considered to be constant. Under this condition the distance to any point on the radial can be quickly calculated and the field intensity read from the recorder chart. If the ground speed, as calculated from the beginning to the end of the flight, does not allow the check-points to fall at the correct time intervals, then it must be assumed that ground speed was not constant along the entire radial. This can be due to variations in the helicopter's air speed, or gusty wind conditions. Whatever the cause, the remedy is to divide the radials into segments, between check-points, and calculate air speed in each segment. This latter condition makes the evaluation of the data more complicated, but will yield reasonable accuracy.

After the distance-time problem is solved then a number of points are selected at which it is desired to know the field intensity. Any number of points may be selected and at any desired distances. Figure 7 shows a tabulation of data taken from the recording (Fig. 5) and Figure 8 shows a plot of this data. The graph of Figure 9 shows a condition encountered in the vicinity of large power lines. The rapid swings are apparently due to reflections and were observed to be most pronounced on the station side of the line. Analysis of the measurements is completed in the usual manner by comparison to FCC charts. The radial segment plotted here closely fits the FCC curve for a conductivity of 5 at the frequency used and results in an inverse distance field of 210 mv/m. As with ground measurements, the required number of radials are completed and analyzed for a plot of the inversed distance fields and RMS value.

The author wishes to thank Mr. Paul B. Cram for help in preparing this article.

# Langevin

*"Between the Artist  
and the finest recording"*

## MX-111 STRAIGHT LINE MIXER CONTROL

The MX-111 Straight Line Mixer Control is a highly developed slide-wire unit using resistances in a ladder configuration to afford unusual facility in operation on control consoles. It is used to blend signals of various origin for music scoring, re-recording, high quality public address, radio and TV broadcasting. It requires only 1½" of horizontal panel space (1¾" with alternate escutcheon) and is 6½" long. It is the most compact unit of this type available, and extends only 2¼" below the top of the mounting surface. Several units can be operated with one hand when mounted adjacent.

### FEATURES

- 1. Smooth, Silky Operation for Easy Control** — Most important to the operator is the overcoming of friction in the mixer control. In the MX-111 precision-built mixer, a nylon bearing rides along a longitudinally honed, hardened chrome-plated shaft. Smooth operation is the result of the exceedingly low coefficient of friction; only 2 grams of pressure is required to overcome the inertia and bearing friction of the control assembly.
- 2. Low Contact Noise for Clean, Clear Signal** — A single contact brush fabricated of the same material as the resistance wire prevents generation of thermal voltages, contact oxidation and consequent noise. This brush is connected to the input circuit by a beryllium copper spring strip, eliminating the need for additional noise inducing brushes.
- 3. Exclusive Dirt and Lint Barricade for Trouble-Free Performance** — An accessible lint and dirt trap over the windings eliminates the cleaning nuisance formerly associated with this form of control. In addition, the contact portion of the winding itself is upside down, so that the tendency of foreign matter is to fall off rather than on.
- 4. Plug-in Design for Easy Maintenance** — Connections are made by an integral plug to the connecting cable socket. This permits rapid disassembly for inspection and cleaning.
- 5. Friction Adjusting Screw for Angle or Vertical Mounting** — For those recording engineers who desire less freedom of movement in the control, or for the designers who wish to incorporate a steep or vertical slope to the control panel, a friction adjusting screw on the guide shaft is accessible through the front slot on the control in which the knob assembly rides.



### SPECIFICATIONS

Circuit, Ladder; Frequency Response, Flat, within ±.5 db at all settings from 0 to 20 kc; Accuracy of Resistors, ± 2%; Input Level, Maximum: 1 watt or 25 volts rms; Slider Pressure, 20 grams; Static Friction, Within 2 grams of sliding friction; Insertion Loss, 6 db; Total Excursion, 4¾"; Impedance, Standard 600/600 ohms. Special impedance of 150/150 ohms may be obtained on order; Knob, Supplied with red knob as standard; Dimensions, 6¼" long by 15/16" wide by 2¼" high. Height with knob: 3¼"; Escutcheon Plate Dimensions, 1½" or 1¾" wide by 7" long by 3/16" thick; Panel Finish, Engraved black anodized dural; Multiple Mounting, 1½" or 1¾" centers between adjacent units according to escutcheon used.

### ORDERING INFORMATION

Model MX-111 Straight Line Mixer Control with red knob, cable socket and plug, complete with escutcheon. Weight, net, ½ lb., 1 lb. shpg. Price, Net Each \$44.00

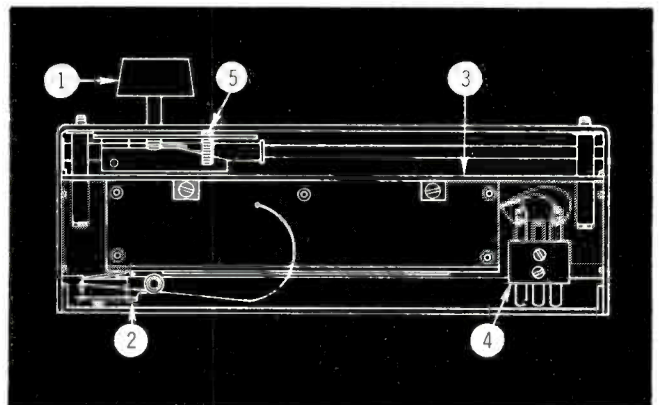

MX-111-2 2-Gang Mixer  
Price Net With  
Escutcheon \$92.50



MX-111-3 3-Gang Mixer  
Price Net With  
Escutcheon \$135.50

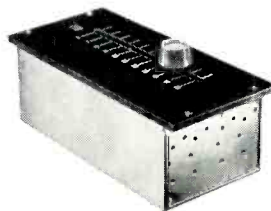

MX-111-4 4-Gang Mixer  
Price Net With  
Escutcheon \$181.00



MX-111-6 6-Gang Mixer  
Price Net With  
Escutcheon \$271.50

AVAILABLE IN 2, 3, 4, AND 6 GANGS FOR STEREO — For stereophonic controls the MX-111 is available in 2, 3, 4 and 6 gang assemblies operating from a single knob. This vastly simplifies console controls.

"Over thirty-five years of audio progress"



A Division of Sonotec Incorporated

503 SOUTH GRAND AVENUE • SANTA ANA, CALIFORNIA

FREE Write Today! \$1.00 Value—84 Page Professional Audio Equipment Catalogue covering Low-Level Amplifiers, Limiters, Power Amplifiers, Variable and Fixed Equalizers, High and Low Pass Filters, VU Meters and Panels, Plugs, Patchcords, Jacks and Jackstrips, Telephone Keys, Transformers, Precision Instrument Switches and complete line of new Langevin Attenuators, Pan-Pots, Straight Line and Rotary Mixers, VU Range Extenders and many others.





# MERCURY RECTIFIER REPLACEMENT WITH HIGH-VOLTAGE SEMICONDUCTOR DIODES

Various factors should be considered when converting to solid state rectification.

*By Robert M. Morris  
Engineering Dept.  
American Broadcasting Co.*

#### EDITOR'S NOTE:

**This paper was presented during the 15th Annual  
NAB Engineering Conference, May 8, 1961,  
Washington, D. C.**

WITH increased interest in remote control of broadcast transmitters, the requirement for trouble-free transmitter operation is imperative. Even without this stimulus, the need for reliable and failure-free transmitters in radio and television service has been evident for a long time. Studies of transmitter trouble reports from several sources have shown that probably the largest single source of outages has been mercury rectifier arrears which have averaged 35 to 40 per cent of total outages. The recent development of high voltage semiconductor rectifiers offers a means of eliminating this source of transmitter trouble and at the same time reducing tube replacement costs. Thus, while the cost of semiconductor rectifiers is higher by a factor of 3 to 10 times that of the mercury rectifiers they replace, the improved reliability and reduced tube costs make their use in existing transmitters, as well as new ones, quite advantageous.

The replacement of mercury rectifiers by silicon units has been facilitated by the recent development of

modular units with the same base and cap connections as the mercury tubes they are designed to replace. In some circuits these modules can be used as direct replacements for existing 866A, 8008 or 872 type rectifiers with no circuit changes required. In circuits operating near the upper limit of current or peak inverse voltage of the tubes or in circuits of higher plate power using 869 or 857 type rectifiers, some special protective measures will usually be required.

Silicon rectifier units, as with most rectifiers, have two basic limiting characteristics. These are peak inverse voltage rating and current ratings. Inverse voltage rating is a function of the materials of which the junction is formed and usually remains constant, other things being the same, throughout the life of the junction. Peak inverse voltage ratings of 400 to 600 volts per unit are commonly supplied.

In this respect it is interesting to note that ratings which three or four years ago would be approximately the value of the zener or

avalanche voltage of the diode are now being set at approximately two-thirds of this value by many manufacturers. Some diodes rated at 600 volts PIV have an avalanche voltage of 900 to 1,000 volts. A word of caution is in order in the testing of diodes for PIV rating. It is advisable in such tests not to apply potentials appreciably greater than the peak inverse rating since some of the higher voltage junctions have been developed to the point of having avalanche ratings in excess of the non-reversible breakdown voltage of the junction. A test to the point of showing reverse current might in such cases permanently damage the junction.

The current carrying capacity of a junction is a function of the heating of the junction due to the flow of current and of the ability of the junction and of the mounting of the unit to carry and dissipate heat. The current rating of a silicon diode is thus a function of time, temperature and of the mounting and cooling of the diode. It is customary to give a short term rating, usually

0.1 sec., and a continuous duty rating given as a function of ambient temperature and cooling.

The short term rating is important since it is the maximum current which should be permitted to flow during a fault or short circuit before fuses or breakers open the circuit. The continuous rating, of course, is the primary consideration in the selection of a type of diode and its mounting for a particular rectifier circuit arrangement and direct current output.

In high voltage rectifier units it is, of course, necessary to use several silicon diodes in series to achieve the necessary peak inverse voltage rating. Such modules of series-connected diodes are now available from several manufacturers. In these modules voltage equalizing capacitors and resistors are connected across each of the series diodes to compensate for differing capacity and resistance as a function of voltage. These capacitors are usually from 0.003 mf to 0.01 mf and the resistors from 30K to 100K ohms.

The foregoing will probably suggest that by reference to a table of factors for the particular rectifier circuit under consideration and thus determining the operating PIV and average current per rectifier section it should be possible to select a silicon rectifier module and use it satisfactorily providing a suitably high factor of safety is applied. This approach can be quite expensive; directly so if too high a factor is used, and totally so if too low a factor is chosen. There are several circuit factors which must be considered if this factor of safety and cost is to be reduced with assurance of successful performance.

First there is the factor of maximum surge or fault current. In smaller power supplies this is not a primary consideration for at least two reasons. First, the surge to continuous rating ratio is greater proportionately in the smaller diodes (a 500 milliamperere diode has a surge rating of 10 amperes); and second, the resistance of the filter choke, the transformer and other parts of the circuit is usually higher. In high power supplies such as for the final stage of a 50KW radio or TV transmitter it is necessary to consider and to control this factor.

In this, and in discussion of other factors, it will be considered that a conventional choke input filter and vacuum tube amplifier constitute the load circuit on the rectifier. The large filter condenser shunted across the rectifier output constitutes a potential cause of high transient starting currents, the effect of which is reduced by the input choke. The starting transient can also be reduced by a resistance in series with the condenser, the value of which resistance is not in excess of the reactance of the condenser at the fundamental frequency of the rectifier output (120 cycles for single phase and 180 cycles or 360 cycles for 3 phase). The starting current surge can be essentially eliminated by a charging resistance in series with the filter condenser equal to or greater than the load resistance and arranged to be shorted out by a time delay relay set for approximately one second.

A more important consideration in the matter of protection against current surges is that of protection against excessive currents due to short circuits or faults in the load circuit. Since the rectifier current rating is a function of time and current, this requires a knowledge of the protection characteristic of fuses or breakers in the supply circuit to the rectifier.

Breakers for large power supplies are usually provided with data as to their current time characteristic for operation. If the characteristic of breaker protection is not known, it would be well to consider augmenting the normal over-current protection with some form of silver-sand fuse such as the Amptrap. These, used at a value of 1.5 to 2.0 times the normal load current, will provide excellent protection against short time currents 8 to 10 times normal without danger of failure at customary overload values.

### **The steps in replacement of mercury rectifiers with silicon diode units are as follows:**

- 1.** Determine the average voltage and current, the RMS and peak inverse voltage and the ac ripple voltage for the power supply under consideration.
- 2.** Select a rectifier module or assembly with a peak inverse voltage rating twice that value determined above, with a short term (0.1 sec.) rating at least 10 times the value of average current and with an average current rating satisfactory for the load current with appropriate cooling. (A safety factor of 50 to 100 per cent in current rating is recommended).
- 3.** Select and connect to the filter reactor a thyrite varistor or other surge protecting unit appropriate to the ripple voltage of the rectifier circuit.
- 4.** Determine the need for and apply any necessary current limiting reactors, surge limiting resistors, fast-blow fuses, etc., for protection against excessive short duration currents.
- 5.** Determine the need for and apply any necessary cooling to the rectifier modules or assemblies.

Some stations have unusually "stiff" regulation of the main power supply with a stepdown transformer bank at or near the station. In such cases the regulation of the line should be determined with respect to the load of the main rectifier plate supply. This can be done by reading the ac line voltage with plate power on and off.

$$\text{Regulation} = \frac{\begin{matrix} (E & -E) & 100 \\ \text{off} & \text{on} & \end{matrix}}{E \quad \text{off}}$$

Regulation of less than four per cent, while excellent from the standpoint of transmitter performance, means the possibility of excessive transient fault currents. In such case it is recommended that additional regulation to the extent of 3 to 5 per cent in the form of current limiting reactors be provided. These reactors, available from manufacturers of heavy electric switch gear, are air core inductors (to avoid saturation) and should be connected in the primary circuit of the plate transformer.

In the matter of control of voltage transients in the rectifier circuit other factors must be considered and other measures taken. There are two conditions under which transient voltages can be created in a rectifier power supply: application of power and shut-off of power. Both can cause unusually high values of voltage. Starting transients can create potentials up to approximately twice normal peak voltage depending upon the time of circuit closure relative to the voltage cycle. Shut-off transients can be even greater in value depending upon the load circuit, the Q of the filter reactor, and the type of circuit contactor or breaker used. Vacuum type switches may cause substantially higher transients as compared to older air break contactors. Both types of transients can be effectively controlled by lowering the impedance of the filter reactor at high frequencies such as exist in the steep wavefront of a transient pulse or by lowering the impedance at voltages in excess of some normal value. This latter is believed in general to be the best method of surge protection and is easily and relatively inexpensively accomplished by the use of thyrite varistors. These units made of processed silicon carbide have a negative coefficient of resistance as

a function of voltage. This means that at an impressed potential across the varistor considered normal, the resistance may be several hundred thousand ohms and thus cause a negligible effect on the circuit across which it is connected. This resistance may, however, drop 1,000 to 1 with a potential such as might be created by a voltage transient with the result that the energy of the transient (usually stored in the transformer or reactor) is dissipated automatically in the thyrite varistor.

A typical unit such as has been used in ABC transmitter modifications has a resistance at 1,500 volts of 1.5 megohms. A voltage of 6,000 volts, however, reduces the resistance of this unit to 900 ohms. This unit connected directly across the filter reactor of a 7KV, 3 phase double Y rectifier supply effectively limits transient potentials to approximately 6KV, a value well within safe values of the associated rectifiers. It is interesting to note that while this varistor may be called upon to absorb transient energy at crest values of approximately 70KW, its normal operating dissipation is less than 2 watts.

In single phase supplies the use of thyrite is not quite as easy nor as advantageous as with 3 phase supplies due to the higher value of alternating component across the reactor relative to the average or dc output voltage. It requires a more precise selection of thyrite characteristic and usually requires greater normal dissipation in the thyrite to obtain satisfactory limiting of surge potentials. An alternative method is the use of a series connected resistance and condenser instead of the thyrite across the filter reactor. The condenser should have an ac rating approximately equal to the dc output voltage value and a capacity of 0.05 to 0.1 mfd. The resistance should be approximately half the value of the load resistance and have a dissipation rating of at least 100 watts for supplies of 2 to 3 thousand volts. Either of these methods will effectively control transient voltages in rectifier circuits although the thyrite method is believed the more effective and usually the less expensive of the two.

In order to get the most rectifier for the cost involved it will be necessary to consider the matter of cool-

ing. Most manufacturers clearly indicate that the current rating of a silicon rectifier unit is a function both of ambient temperature and the amount or type of cooling provided. In most transmitters rectifiers are or can be mounted in a cubicle with a certain amount of forced ventilation and an ambient temperature of 35 degrees C. or less. In such cases it may be both expedient and economical to mount rectifier modules designed for convection cooling with no special or additional provisions for cooling the rectifiers. This is especially true in medium power supplies or where sealed plug-in replacement units are used.

In higher power units it will probably be desirable to consider the use of modules with a moderate amount of forced cooling. Even a small amount of air circulation through a module will substantially increase the continuous current rating. It should be borne in mind, however, that this does not increase the short time current rating of the unit. A satisfactory value for both current ratings is necessary for safe trouble-free operation. One manufacturer is providing an insulating mounting for 3 modules (suitable for 3 phase supplies) and arranged with self-contained blowers and an air flow microswitch to be connected in the interlock circuit to guard against cooling failure. This housing provides approximately 150 cfm of air or 50 cfm per module.

The life of silicon rectifier units under normal conditions is believed to be essentially unlimited. There is as a practical matter, however, one factor which apparently is difficult to control which can result in early failure. This is the matter of sealing the junction against the action of moist air or water vapor. An imperfect hermetic seal can result in a junction which deteriorates rapidly, especially under conditions of high humidity. This deterioration can occur whether the unit is in operation or on the shelf and is believed to explain the mysterious failure of rectifiers stored as spares. If a rectifier has a defective seal it will probably become evident within six months or a year of manufacture. A guarantee by the manufacturer against such failure is believed necessary and appropriate.

The foregoing problem brings up



the matter of testing of semiconductor rectifiers. Several rather sophisticated methods have been described in which both forward and inverse voltage as function of current can be determined using an alternating potential applied to the unit under test. It is believed that the most important characteristic and the one which suffers if seal leakage exists is that of reverse current at rated inverse voltage. This can be easily determined by the use of a small dc supply delivering the desired inverse voltage (400V to 500V usually) with a milliammeter of appropriate scale (10-20 ma) protected against short circuit by a current limiting resistance of 20 to 50 thousand ohms.

Each cell is separately checked by this test unit and a reading of inverse current is obtained. Inverse currents on 500 ma units should not exceed approximately 100 microamps. Currents on 5 to 10 ampere units should not exceed approximately 1 milliampere. If voltage distributing resistors are connected across each cell of a module, the current through this resistor must be taken into account in making the test. If cells are found to have inverse currents higher than an allowed value they should, of course, be replaced to maintain the full peak inverse voltage rating of the module. It will probably be found unnecessary to make cell tests more often than once or twice a year after the first year of operation of a rectifier.

With these precautions it should be possible to fully modernize the power supplies of any radio or television transmitter and substantially reduce those sudden and unpredictable outages due to mercury rectifiers.

#### APPENDIX

Useful and available data relating to application of Silicon rectifiers:

**International Rectifier Corporation Engineering Handbook**, International Rectifier Corp., El Segundo, Calif.

**Semiconductor Rectifier Components Guide**, General Electric Co., Application Engineering Center, Rectifier Components Department, Auburn, N. Y.

**High Voltage Silicon Rectifier Technical Data 54-261 and Rectifier Handbook 90-000**, Westinghouse Electric Corp., Semiconductor Department, Youngwood, Pa.

**Silicon Rectifier Handbook**, Sarkes Tarzian, Inc., Semi-Conductor Div., Bloomington, Ind.

**Silicon Rectifier Selection Guide**, Transatron Electronic Corp., Wakefield, Melrose, Boston, Mass.

**Brochure Thyrite Varistors**, General Electric Co., Magnetic Materials Div., Edmore, Mich.

**Current Limiting Reactors Descriptive Bulletin 45-455**, Westinghouse Electric Corp., Transformer Div., Sharon, Pa.

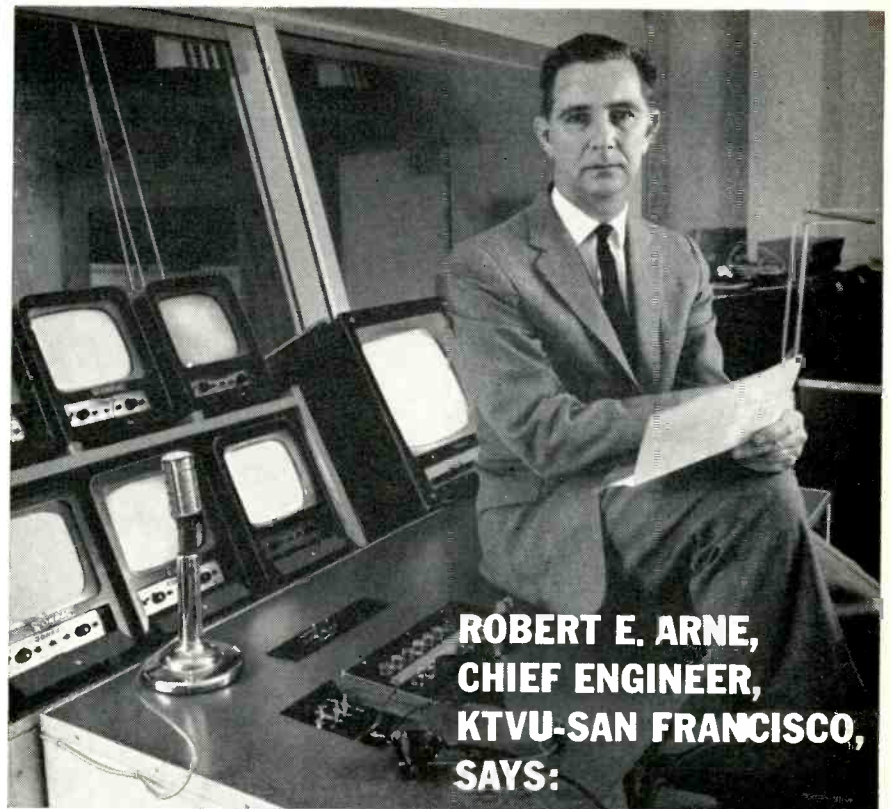

**ROBERT E. ARNE,  
CHIEF ENGINEER,  
KTVU-SAN FRANCISCO,  
SAYS:**

Mr. Arne states the Conrac case quite simply when he says: "I don't know of anyone that provides the combination of features that Conrac provides."

Conrac monitors offer uniform, dependable quality in a complete range of types and sizes for every broadcast application.

Look to Conrac for quality in video monitoring equipment.

**"CONRAC'S  
COMBINATION  
OF FEATURES  
IS UNIQUE!"**

**EVERY CONRAC MONITOR FROM 8" THROUGH 27", BROADCAST AND UTILITY, INCLUDES THESE IMPORTANT FEATURES:**

- ★ Video response flat to 10 megacycles
- ★ DC restorer with "In-Out" switch
- ★ Provision for operation from external sync — with selector switch
- ★ Video line terminating resistor and switch



**CONRAC DIVISION** Glendora, California

Makers of Fine Fleetwood Home Television Systems • Telephone: Covina, California, EDgewood 5-0541  
CONRAC MONITORS ARE DISTRIBUTED BY — RCA, GENERAL ELECTRIC, AMPEX, AND VISUAL ELECTRONICS  
CONRAC IS A DIVISION OF GIANNINI CONTROLS CORPORATION

GCC 1-26

# AN AMERICAN BROADCASTER VIEWS

## EUROPEAN RADIO

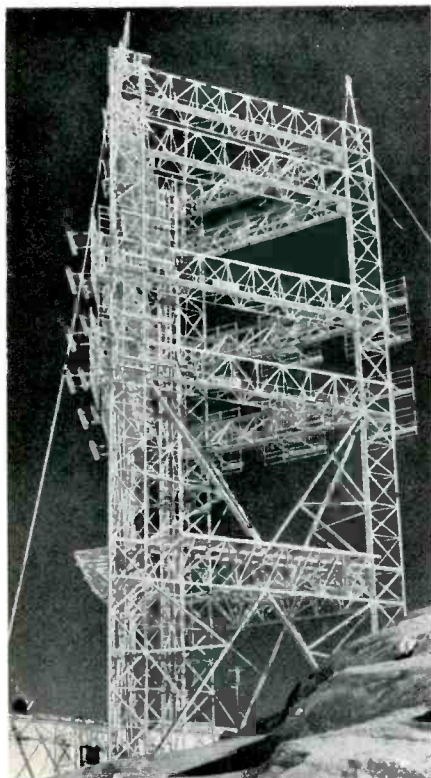

**Author suggests quality and professional determination should be aim of U.S. stations.**

*By Stephen A. Cisler, President  
WLVL-FM  
Louisville, Kentucky*

THE AMAZING recovery of Europe has developed their broadcasting systems to a new high in excellence. As an American FM station owner, with an interest in the engineering phases of broadcasting, I was able to experience a two-month trip recently through the radio facilities of Europe. This is a brief report on the highlights of what was seen and I hope it may be of some benefit to our own industry. This information reflects personal opinion gleaned from observing and talking with the engineering officials of various state radio systems abroad.

If there is one word to use in European broadcasting, it is *quality!* Broadcast engineers are highly regarded in every state system, and are sincerely dedicated to quality of equipment, maintenance, and progress. It is most apparent they occupy an important position in the staff policy planning, being much

more a part of active top management than in most American stations. Since the European systems are for the most part non-commercial, supported by taxes or license fees, the top engineers feel a sense of responsibility for the many listeners their organizations serve.

The operation of transmitters, for the most part, is delegated in many countries to the postal or telephone central authority, leaving the radio engineers free to concentrate on studio and program operations.

The first visit was to the studio facilities of Radio Moscow which are housed in several buildings in the city. Consolidation of radio and television is planned for late in 1961 in a new central building now being finished. Two of the large office and studio buildings are used for the shortwave and domestic program service. The building devoted to shortwave service is a series of small studios and control rooms in an inner circle. I was told all Russian transmissions are via tape, announcements and musical selections included. The only "live" broadcasts would be remotes from important events outside the studios, or from special concerts.

Through the halls one could see girls pushing what look like tea carts on which were piled tape boxes for various programs. All tape recordings are run at a speed of 15 ips for on-air use.

The Russian studio facilities inspected included a control room for stereophonic sound. This was a separate control room adjacent to a large orchestral studio. At the time a small symphonic group was taping several works. The stereo control room used a large desk in the German design, with light beam volume indicators. Behind the control operator, and to his right, were two large console tape recorders. Although having the appearance of professional Telefunken M-5 recorders, I was told these were of Russian manufacture, and were now being exported for sale. No one knew their cost or value. The electronics in the console cabinets were massive chassis, similar to the early Ampex model 200.

The stereo control room was used to originate multiplex transmissions two hours, twice weekly. The Russian experimental multiplex system is apparently using the Halstead method with a sub-channel frequency of 65kc. Considerable inter-

est was exhibited by the Russian engineers who wanted to know where the United States stood in getting stereo multiplex into public use. I was then shown the small multiplex converter mounted outboard in the back of several typical Russian-manufactured home receivers. These were similar to the large German style table models, and the converter was clearly an experimental model. The engineers said they were satisfied with progress up to now, but saw little likelihood of stereophonic broadcasting becoming useful soon enough to warrant stepped up development.

The playbacks of the Russian master tape recordings were excellent in quality. The tape used bore the AGFA trademark, and all tape fed from the "hub" (no top flange), a system popular in Europe. Most of the microphones observed in the studios were Neumann, Telefunken and AKG types, suspended from the ceiling, on long booms, and on short stands in great profusion.

My interpreter was a young Russian who had a gift of very fluent English from two years' study at Columbia University while his parents served on the staff of the United Nations. The Russian radio people are interested in what we are doing technically, in addition to program interest. They extended an open door to all I could find time to see in my short visit. One cannot fail to be impressed by the many workers in the state radio systems. Staffs are huge, and individuals apparently restricted to a narrow range in their jobs. Thus, many people are seen lounging in the halls or studios. Automation is not any factor here. Obviously, to handle such large staffs, rigid discipline must be observed in production, entrance to studios, and plans for programming. There was a leisurely but business-like air prevailing throughout the Radio Moscow studios and hall areas.

I visited none of the transmitters, but noted one of the television towers close to the center of the city. Two channels serve about 10 hours per day total. There is a rapidly growing network for the populous areas. Radio goes on several channels about 18 hours daily, on both AM and FM, plus many wired radio setups in small communities,

but fed from the central source. The music director told me that over 31 per cent of their music was of "foreign origin, from outside of Russia," but from my own listening it appeared most of the hours were full of talk, and usually by a woman.

From Moscow to Scandinavia is like entering another world. With appreciation for the generosity of the Soviet radio officials, our feelings were perhaps clouded by the strangeness of the city and the gloom of the rainy days and nights. But to enter Stockholm, Sweden or Copenhagen, Denmark, via jet plane was like coming into Times Square after leaving the Lincoln Tunnel. Scandinavia is a land where any American seems at home. He literally feels the good cheer of the people. He sees familiar comforts around him. So looking in on the radio systems we were met by the familiar sight of many Ampex tape recorders in Oslo, Norway, home of the Norwegian radio service.

The Norway system has the most attractive building, and is the most modern in its facilities of all the Scandinavian nations. Sweden is completing a new radio and television central building, and temporarily is quartered in an old fort. Denmark has an excellent building which it has outgrown, and will soon move into a new central structure when acoustical sound problems arising from jet plane takeoffs are corrected. These were not anticipated in the original design.

Norway does a great deal of its own studio equipment construction. It has a highly organized and superbly equipped workshop, and a large staff of capable technicians who watch maintenance in a manner that would be a real lesson to most American engineers. These men appreciate fine equipment, and take care of it. Side by side with the Ampex units in Norway studios were ten new Telefunken M-10 stereo tape recorders. There is great admiration for American audio and broadcasting equipment in every engineering office, but high duties, national obligations to their own producers, or trade-barter deals with other countries, often force our equipment outside the border. Customs charges of as much as 50 per cent on tape recorders makes much

of the U. S. equipment priced out of reach of even these systems. American technical magazines are regularly read by the staffs, and much interest was shown in our work with transistors, multiplex and other new developments. None of the Scandinavian countries were much interested in stereo, except for the Danish system which was co-operating with manufacturers on a series of tests with FM multiplex. Here, again, all said they were waiting to see what happened in the United States and Germany.

Visits to several electronic manufacturers of high quality microphones and audio equipment were made in Sweden. The production of the Pearl microphones and the DISA Elektronik audio amplifiers was observed in their factories. Obviously products of great craftsmanship, both Pearl and DISA equipment follow designs compatible with other broadcast equipment. Pearl microphones were manufactured under the same standards of such competitors as Telefunken, Neumann and AKG, and offered a wide range from inexpensive crystal types to professional laboratory condenser microphones. DISA assembles plug-in preamps, line amplifiers, light beam meters, logarithmic amplifiers, and video patch boards and video distribution amplifiers, in addition to their line of electronic testing instruments. Their factories were almost as clean as the operating rooms in a U. S. hospital!

In Denmark the Lyrec and Ortofon plants are world renowned for their excellence in producing professional recording equipment for tape and disc, plus pickup units. The Lyrec organization, moving into a large new plant, has developed an unusual digital tape counter suitable for installation on the large Ampex or Presto professional tape recorders in lieu of an idler assembly.

This accent on quality in making fine equipment carries over in the attitude of the junior and senior engineers of the state systems. Some groans were heard in Denmark about the need for newer equipment, but the vast racks of the master control rooms were spotless, and performing with good quality. Small control rooms employed Lyrec tape machines and the German design EMT professional turntables. This

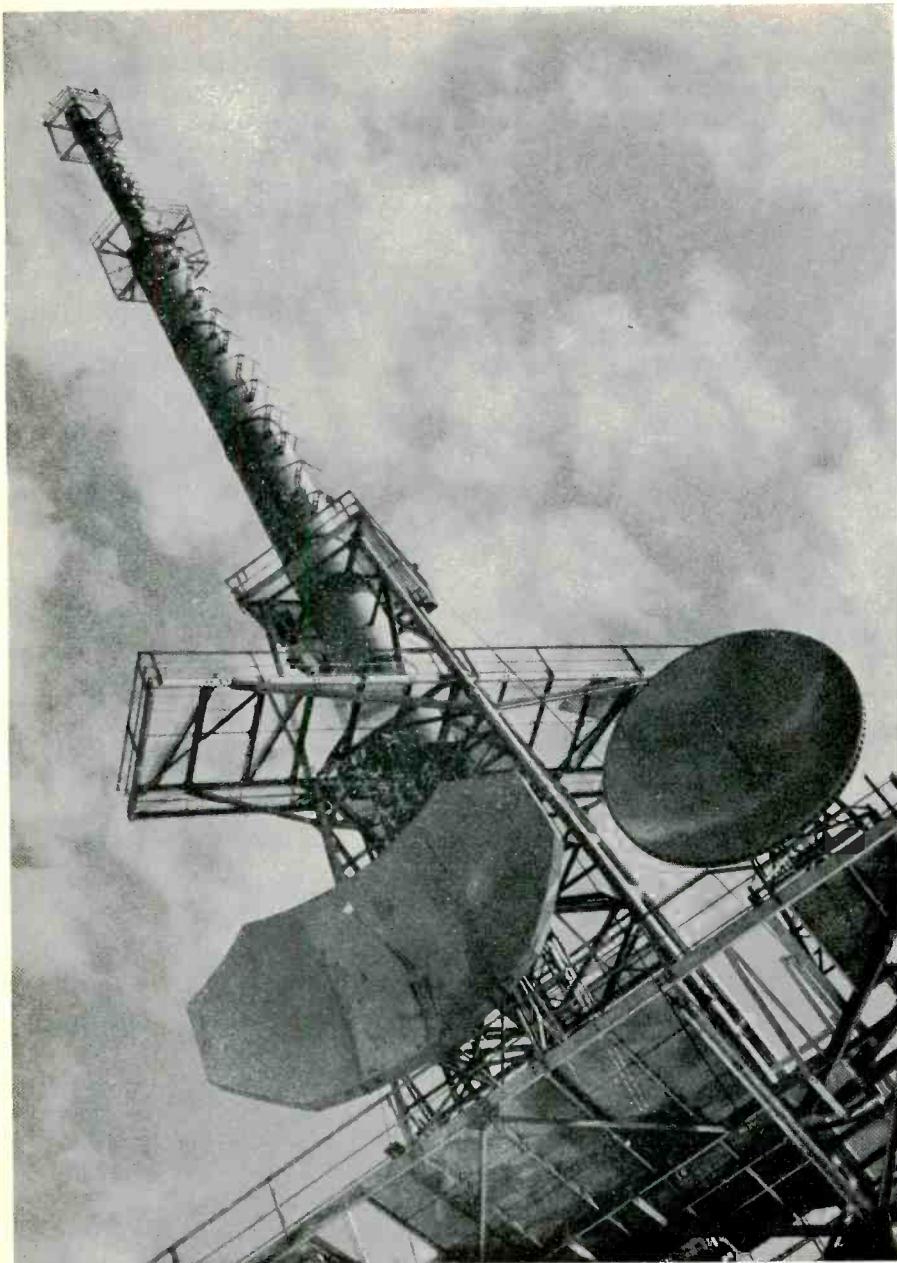

Figure 1—The 250-foot radiating tower of the Pfander transmitter in Austria. The top mast is the FM antenna; mid-section, the television antenna. Mounted on the platform are parabolic dishes to receive the communications network of the Austrian Postal Service.

German table has no equal in its beauty of workmanship and its amazing versatility of performance. It is the standard of Europe, no matter what border we cross.

Apart from those studios which were demolished by war action, most broadcasting plants are in excellent shape. We could take a lesson from the maintenance procedures carried out in European studios; but keep in mind the manpower is quite generous in quantity and quality. One main point noticed was European engineers seemed to enjoy their work, and take great pride in accomplishing a difficult

job. This zeal was one of the things that helped build early American radio, but we notice its lack in many U. S. stations today.

FM radio is occupying more and more importance in the European picture. It is estimated that more than 900 FM stations are on the air in the major European countries. Most national systems provide two AM channels, and are duplicated on FM. Here and there some independent programming on FM is being broadcast, resulting in the same effect of building the FM audience as is noted in the United States. The interference factors and severe sig-

nal attenuation present on the European AM band is a potent force behind the growth of FM. Most FM transmitters in the large cities are of 10-kw input to the antenna, and the antenna gains run from 5 to 15 in ERP ratings.

With so much FM the studio engineer interested in quality comes into his own. Now the expensive microphones and the elaborate audio systems begin to show up their unequal specifications. If there is one distinguishing characteristic of the difference between European and American broadcasting it is the accent on better quality for the audio in Europe. Installations are much more elaborate than even our networks, and the results show up in a generally superior FM signal and quality.

German audio equipment has dominated the European market. Ladder type attenuators are standard on control boards from Norway to Switzerland. Light beam volume indicators are seen in every control room. Only in Austria did one see the VU meters in wide use. In Radio Salzburg some of the control rooms still used the early models of Western Electric 25A consoles, apparently left from the war occupation. Yet, the Salzburg music hall, center of the world famous Salzburg Festival, had the most modern stereophonic sound reinforcing and recording system in Europe, just installed by Siemens & Halske of Vienna. The Berlin Free Sender station had a magnificent new studio for a great orchestra, plus a comparable control room. The New York Philharmonic orchestra on tour had just used it for rehearsal and recording.

Greatest progress and excellence of design seems to center in Germany. With their factories and radio plants demolished during the war, they had to move upwards. But the technical skill and organization of the German audio engineers has produced some startling examples of progress. These are things we can well receive back in exchange for the billions of dollars and thousands of man-days we expended to put this former enemy back on its feet.

The German radio systems support a unified engineering research through a separate organization, with costs shared by all the various

sectional radio corporations. Items selected for approval and adoption by the combined systems are then manufactured. This has led to very capable specialists in audio items such as Wilhelm Franz in Lahr, Germany, maker of the EMT (Electromesstechnik) line of superb turntables, reverberation units, amplifiers, and audio test instruments.

A visit to the Lahr factory of Mr. Franz is a revelation. This small town near the Black Forest is full of craftsmen. Mr. Franz, a former top engineer in the German Rundfunk organization, operates for the moment from an old house set back from the street. In other rooms, and in the basement and upper floors of another old building, he produces a magnificent line of high quality audio equipment he sells all over the world. He will move into a new factory sometime this fall to handle the boom in business. The secret of the EMT quality is quality control through every process of manufacture, and then some of the most exacting tests to show up every possible defect. EMT equipment represents the highest quality available for sale on the Continent. Currently, the EMT factory is working on miniaturization of audio consoles and individual units; a simple and less expensive quality turntable; and a device to permit instantaneous measurements on all phases of a large tape recorder's performance including head alignment. New microphone preamps have variable equalization controls built in the tiny panel which plugs into the front rack layout.

German broadcast transmitter manufacturing is handled by a few firms such as Telefunken, Siemens, and Rhode & Schwarz. A visit to the last named in Munich showed a big organization devoted to building high quality equipment of superb design. Construction was heavy and solid, whether a transmitter or an amplifier. Many unusual items are cataloged as standard by such firms. For instance, an FM triplexer will permit up to three 10-kw transmitters to be fed into a common antenna. You can obtain a 50- or 150-watt transmitter, suitable for unattended operation, with automatic receiver drop in, all in a single rack. These are antennas of all types, including directional FM and

TV. I noted several huge, heavy FM antennas being crated. These seemed to follow the design of the RCA pylon, but were obviously designed for more power and tougher weather conditions. Many of the transmitters are operated on remote mountain tops, unattended for days. The German transmitters have every conceivable control. Space is no object if reliability is the prime consideration, and it must be, to judge by the lavish care expended on every bolt and connection.

In Switzerland, the Revox tape recorder factory produces professional tape recorders under the name Studer, and they were able to show their newest console machine that has motor driven scissors which

emerges from a hole in the panel and quickly cuts the tape! In this factory every part is made on the premises, even motors, heads, cabinets, and such items usually sub-contracted. The Swiss radio system uses Studer machines throughout their system. In the Zurich studios, experiments in stereo recording were going on, using Ampex machines and German microphones. Nothing is being done on multiplex stereo at the moment, but FM is getting an intensive build-up, and the city houses some of the finest looking hi fi shops to be found in Europe, chiefly stocked with German and English components, and a few Swiss-made items.

(Continued on page 38)

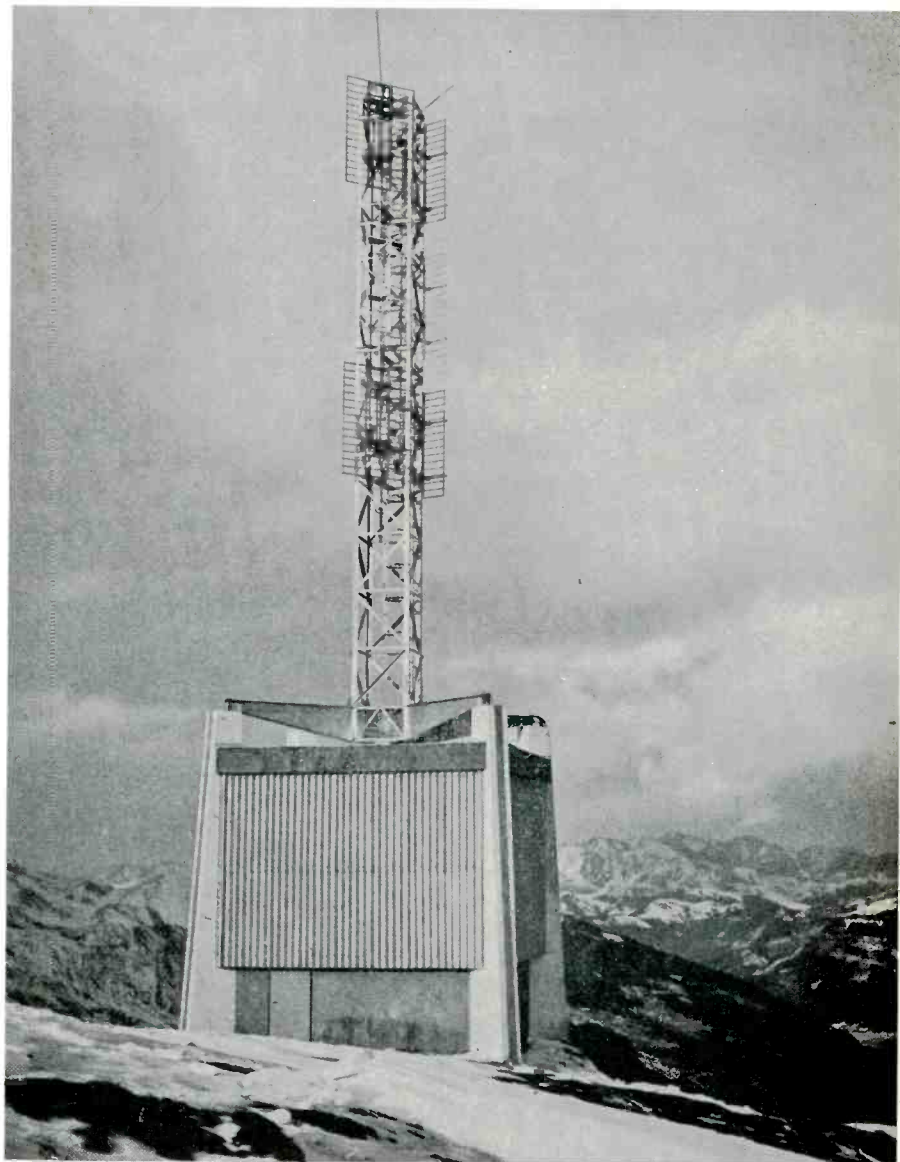

Figure 2—The remote controlled FM transmitter on the Stubnerkogel mountain near Badgastein, beaming all three state radio programs into the Gasteiner Valley, Austria.

# AMENDMENTS AND PROPOSED CHANGES OF F.C.C. REGULATIONS

## PART 4 — EXPERIMENTAL, AUXILIARY, AND SPECIAL BROADCAST SERVICES Operation of UHF Translator Signal Boosters by Licensees of UHF Translator Stations

1. On January 18, 1961, the Commission adopted a notice of proposed rule making (FCC 61-93) to amend Part 4 of its rules to permit the use of signal boosters by the licensees of UHF television broadcast translators to supplement the service provided by the translators, particularly in areas unable to obtain satisfactory direct reception of the translator's signals because of "shadowing" by terrain barriers. Interested parties were invited to comment with respect to the proposal on or before February 17, 1961, and were given an additional 10 days to reply to any such comments filed by other parties.

2. Comments were filed by Blue Mt. Television Association, Tillamook T.V. Translators, Inc., Tri-State TV Translator Association, E. B. Craney, Video Utility Company, and Mid-Columbia Community T.V. Corporation, Tilla-

mook, Craney, and Mid-Columbia merely endorsed the Commission proposal. Blue Mt. pointed out the advantages to be derived from the operation of UHF signal boosters in conjunction with UHF TV translators. Video Utility Company supported the proposed rule change but expressed the view that such devices would be relatively costly (\$2,000 to \$2,500) and suggested that a UHF-to-UHF translator might be more practical. UHF-to-UHF translators are permitted under the present rules of the Commission.

3. Tri-State TV Translator Association endorsed the proposal for permitting UHF signal boosters but recommended that this privilege be extended to VHF translators. They suggested that the Commission had refused to permit the use of VHF signal boosters when adopting the VHF translator rules because of an unwarranted concern as to the interference hazard of such operation. They alleged that nearly six years of unauthorized operation of VHF boosters

had demonstrated the feasibility of such operation on VHF channels and that if such operation can be permitted on UHF channels it should not be prohibited on VHF channels.

4. The Commission has never taken the position that signal boosters cannot be made to work on VHF channels. It is generally recognized, however, that such devices are inherently unstable electrically and unless properly designed and carefully supervised, they are a potential source of interference. The seriousness of this potential is directly related to the place in the radio frequency spectrum where they are operated and to the number and nature of the services occupying that portion of the spectrum. As we have pointed out before, the VHF television bands do not occupy a contiguous band of frequencies but are interspersed with frequency bands used by services other than television, many of which are employed for the safety of life and property. Furthermore, the range of VHF signals is somewhat greater than that of UHF signals. Finally, the occupancy of VHF channels, by TV stations and non-broadcast services, is substantially greater than in the UHF bands.

5. When these factors are weighed together, it is obvious that the hazard of harmful interference is substantially greater on VHF channels than on UHF channels. This compels us to forbid such operation on VHF channels. If the UHF band and adjacent frequencies should become extensively occupied in the future and similar considerations should obtain, we may have to delete this provision from our rules. However, under present conditions the need for the service outweighs the slight risk involved.

6. Authority for the adoption of the amendment herein is contained in sections 4(i), 303(e), (f), and (r) of the Communications Act of 1934, as amended.

7. In view of the foregoing: *It is ordered*, That effective June 30, 1961, Part 4 of the Commission rules is amended as set forth below.

Adopted: May 17, 1961.

Released: May 22, 1961.

FEDERAL COMMUNICATIONS  
COMMISSION

[SEAL]

BEN F. WAPLE,  
Acting Secretary.

Part 4 is amended as follows:

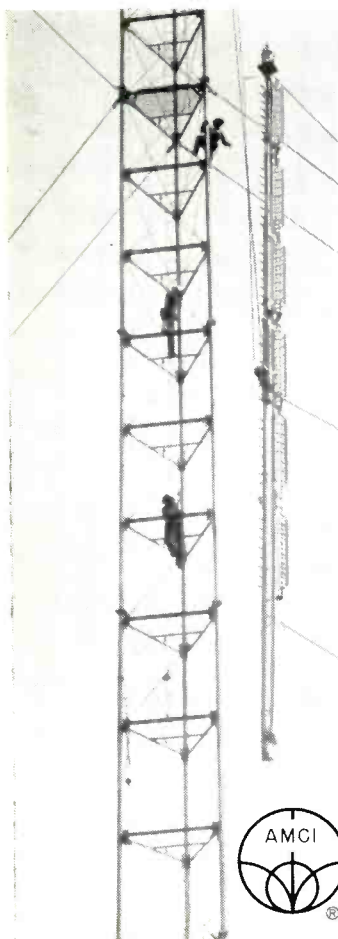

## AMCI antennas for TV and FM

- Omnidirectional TV and FM  
Transmitting Antennas
  - Directional TV and FM  
Transmitting Antennas
  - Tower-mounted TV and FM  
Transmitting Antennas
  - Standby TV and FM  
Transmitting Antennas
  - Diplexers
  - Vestigial Sideband Filters
  - Coaxial Switches  
and Transfer Panels
  - Power Dividers and other Fittings
- Write for information and catalog.



**ALFORD**  
Manufacturing Company

299 ATLANTIC AVE., BOSTON, MASSACHUSETTS

1. Add a new paragraph (e) to § 4.701. to read as follows:

**§ 4.701 Definitions.**

\* \* \* \* \*

(e) *UHF translator signal booster.* A station in the broadcasting service operated for the sole purpose of retransmitting the signals of a UHF translator station by amplifying and reradiating such signals which have been received directly through space, without significantly altering any characteristic of the incoming signal other than its amplitude.

2. Add a new § 4.733 to read as follows:

**§ 4.733 UHF translator signal boosters.**

(a) The licensee of a UHF television broadcast translator station may be authorized to operate one or more signal boosters for the purpose of providing reception to small shadowed areas within the area intended to be served by the translator.

(b) The transmitting apparatus shall consist of a simple linear radio frequency amplifier, with one or more amplifying stages, which is capable of receiving, amplifying, and retransmitting the signals of the parent translator without significantly altering any electrical characteristic of the received signal other than its amplitude. The maximum power input to the plate of the final radio frequency amplifier shall not exceed 5 watts.

(c) The amplifier shall be equipped with suitable circuits which will automatically cause it to cease radiating if no signal is being received from the parent translator system. Care shall be taken in the design of the apparatus to insure that out-of-band radiation is not excessive and that adequate isolation is maintained between the input and output circuits to prevent unstable operation.

(d) The installation of the apparatus and its associated receiving and transmitting antennas shall be in accordance with accepted principles of good engineering practice. Either horizontal, vertical, or circular polarization of the electric field of the radiated signal may be employed. If the isolation between the input and output circuits depends in part upon the polarization or directive properties of the transmitting and receiving antennas, the installation shall be sufficiently rugged to withstand the normal hazards of the environment.

(e) The operation of a UHF translator signal booster is subject to the condition that no harmful interference is caused to the reception of any station, broadcast or non-broadcast, other than the parent translator. The licensee of the UHF translator signal booster is expected to use reasonable diligence to minimize interference to the direct reception of the parent translator station.

(f) UHF translator signal boosters

may be operated unattended. Repairs and adjustments shall be made by a qualified person. The required qualifications are set forth in § 4.750 (g) and (h).

(g) An individual call sign will not be assigned to a UHF translator booster station. The retransmission of the call sign of the parent translator will serve as station identification.

(h) Applications for authority to construct and operate a UHF translator signal booster shall be submitted on FCC Form 316A. No construction of facilities or installation of apparatus at

the proposed transmitter site shall be made until a construction permit therefor has been issued by the Commission.

(i) The provisions of § 4.765 concerning posting of station license shall apply to a UHF translator signal booster except that the parent UHF translator call sign, followed by the word "Booster," shall be displayed at the signal booster site.

(j) The provisions of §§ 4.767 and 4.781 concerning marking and lighting of antenna structures and station records, respectively, apply to UHF translator signal boosters.

## on the job with McMartin

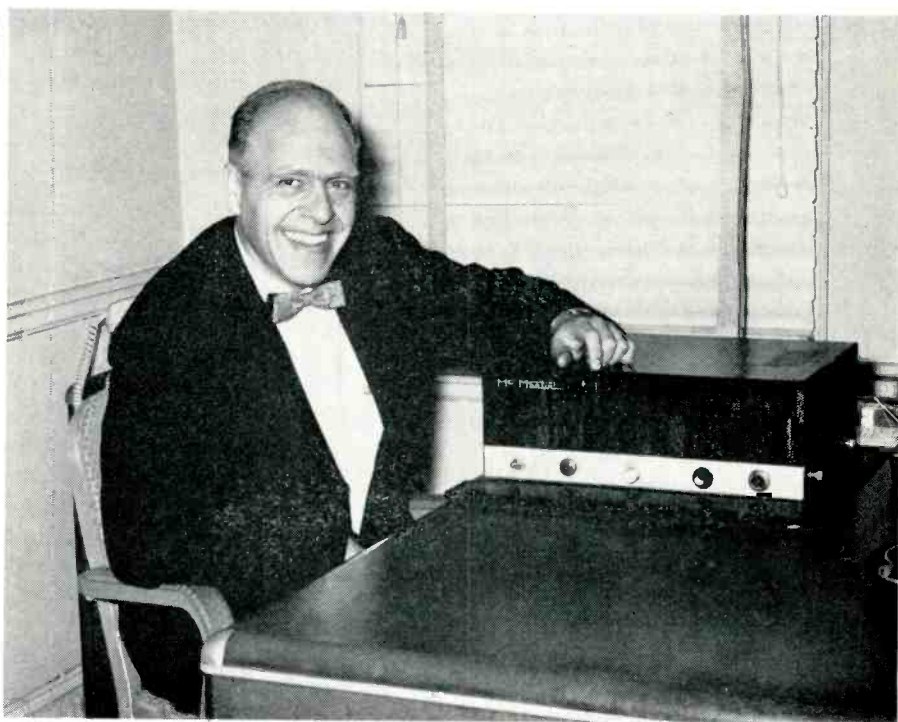

Carl Schultz and Multiplex Unit

Says Carl Schultz, Southern New England's No. 1 FM broadcaster, "We have found that the McMartin receiver surpasses any other in overall reliability and fringe area reception."

If you are looking for the multiplex receiver that provides the greatest sensitivity... is the most dependable... look to McMartin, the standard of the industry.

Continental's advanced engineering... rigid quality control... special manufacturing techniques assure receiving equipment that will deliver the finest in sound over the greatest distances. What's more, McMartin guarantees your satisfaction. Send back any unit that does not function properly (at McMartin's expense) and it will be repaired or replaced free of charge.

*an industry built by  
originality*

from **CONTINENTAL MANUFACTURING INC.**

1612 California Street • Omaha, Nebraska



## "... distortion could be in antenna or transmitter ..."

**CROSS-MODULATION** starts on page 4

low "Q" circuits. A Foster-Seeley discriminator using crystal diodes follows the i-f amplifier. The output of the discriminator is fed into a cathode follower which is followed by a three-stage a-f amplifier. The monitor had to be used with de-emphasis switched off to recover a sufficient amount of subcarrier voltage. The monitor has two indicating meters. One will indicate modulation percentage of the carrier, the other will indicate center frequency. The monitor was tuned so that the center frequency meter is in the 0 position.

The first set of measurements was made on 101 mc. The results are shown in Fig. 4. Crosstalk at 400 cps was -70 db, at 4 kc -64 db.

Next, the tuning strap in the antenna was changed. The antenna was swept and the point of optimum match was found to be 100.75 mc. The VSWR is shown in Fig. 4. With the FM monitor left untouched the crosstalk read -65 db at 400 cps, and -59 db at 4 kc. However, when the monitor was detuned approximately 10 to 15 kc, crosstalk could be reduced at 400 cps to -77.5 db and at 4 kc to -61 db. Next, the strap of the antenna was changed further to provide an optimum match at 100.25 mc. The crosstalk now was -56 db at 400 cps and -44 db at 4 kc. Further retuning of the monitor reduced crosstalk to -66 db and -54 db, respectively. The same procedure was followed at frequencies of 102 and 103 mc. In each case the antenna straps and the VSWR curves are shown at the top of Fig. 4. It is evident from this data that tuning the monitor will greatly reduce crosstalk. Returning of the monitor will shift the departure from linear phase in a way to compensate for nonlinear phase elsewhere in the system.

The distortion could be in the antenna, the transmitter, or in the receiving portion. Tuning the monitor to minimum crosstalk does represent a practical condition, since whenever a receiver is installed in the field this receiver will have to be adjusted for minimum crosstalk

by tuning the discriminator alone or perhaps the discriminator in conjunction with several i-f stages. A receiver cannot be set in the factory for minimum crosstalk. Furthermore, in a receiver crosstalk will depend greatly on the intensity of the input signal. This means that a receiver which is tuned for minimum crosstalk at a 1 mv input level will have to be retuned if that signal is changed by any substantial amount, e.g.,  $\pm 3$  db.

It is evident from Fig. 4 that crosstalk, even under most adverse conditions but with monitor retuning, is always at a very low level. It is better than -60 db over most of the audio spectrum. It is also evident that a receiver with a very limited high-frequency response will, due to this fact, provide a better crosstalk figure than a receiver with a good high frequency response. If there is a treble control in the receiver, conditions of severe crosstalk can be partially corrected by adjusting the control to reject high frequency components.

Finally, measurements were made using a commercial multiplex receiver. The results are shown in Fig. 5, which shows that the level of crosstalk has shifted up approximately 10 to 15 db. The variation of crosstalk is less pronounced in the receiver as compared to the measurements made with the monitor. The receiver was not retuned so that the values given in Fig. 5 represent a condition of widely varying antenna tuning.

The following conclusions can be drawn from the results of the measurements previously outlined:

Fairly high ratios of VSWR can be compensated for by tuning the receivers. Since the receiver has to be tuned anyway, it appears that high ratios of VSWR can be tolerated. The higher the VSWR, however, the more difficult it becomes to obtain and maintain proper compensation.

It is felt that small changes in the antenna will have a more detrimental effect in a system using a great amount of compensation (high VSWR in the antenna-transmission line system) as compared to a system requiring only moderate amounts of compensation (low VSWR in the antenna-transmission line system).

## European Radio...

(Continued from page 35)

Zurich also has the unique rediffusion system of transmitting five radio programs simultaneously over the regular telephone lines to subscribers. A small but excellent speaker amplifier is provided by the operating company. Subscribers have a choice of either Swiss national program, or two composite programs from European radio pickups in other countries, plus a channel for background music. This is a commercial service which exists side by side with the free state radio service. No commercials are sold, and you might call it the "poor man's Muzak" except for its great variety of radio programs from all over Europe.

Headquartered in Geneva, Switzerland, is the European Broadcasting Union general offices. This organization ties the many national systems into a cooperative group on technical and policy planning of common interest. Without infringing on the national program interests or overall policy, the EBU is the official spokesman for the radio broadcasters in many matters relating to operating together across the borders and language barriers. A large technical section is headquartered in Brussels, Belgium, with its own building, and nearby a monitoring station for use in frequency checks, signal measurement, and other technical purposes. At Brussels are the Eurovision offices which are a part of the EBU activities. This "little United Nations of television" is setting technical and production standards to enable European relays of television programs quickly and with less cost to the stations. It has worked out standards of communication such as English and French for standard voice cues to all countries; liaison with the postal and telephone authorities of all countries to effect the land line hookups for radio and television; and the search for standards applicable to all countries for the benefit of the art.

Some idea of their complex problem in television relay can be understood when one realizes that the Olympic Games coverage out of Rome last year called for ten separate voice channels for ten different



languages to accompany the same picture, with the picture jumping across national boundaries but the voice feed stopping where it was not native. The EBU technical office publishes in English a regular high quality magazine (E.B.U. Review) covering operating practices, new equipment, and other technical subjects.

Wide use is made of small, unattended radio transmitters all through Europe, and especially in the mountain areas where attenuation and coverage are severely hampered by the terrain. Elaborate mobile trucks, primarily for on-the-spot recording, are noted on the roads of Europe.

Mention must be made of the excellent work being done by the Armed Forces Radio System network in Germany and France. Apart from the morale to our troops, the AFN program quality is a good advertisement for the United States. In Berlin, so popular is the AFN that when it signs off an East German station immediately comes on the frequency, transmitting the same type of music and then slips in as a newscast, an obviously slanted newscast, in the same style of the Army news voices.

Electronic warfare is a real and abiding thing as one views the work of the AFN, of Radio Free Europe, and the RIAS setup in Berlin. The latter two radio operations are staffed by American engineers and management, and programmed by nationals who do amazing feats in refuting the broadcasts of other ideologies and governments. These systems have excellent equipment, and both are characterized by a top staff fully alert to their front line positions and responsibility. The Berlin operation is chiefly high power AM medium wave transmission to answer the East German radio. RFE operates in both medium wave and short wave bands to accomplish its mission from Munich into the satellites, and also uses a vast technical installation located outside of Lisbon, Portugal, to bounce a short wave signal into the Red border countries.

Due to time limitations the French, Belgium, and Netherlands radio systems were not inspected in detail. They are important to each nation as an instant means of com-

## SELF-NORMALLING JACK NEMS-CLARKE TYPE 999\*



This self-normalling jack is for use in applications where a "normal-through" condition is known to be of a semi-permanent nature. It accepts a Nems-Clarke 966-A or 967 series patch cord plug for sampling or temporary re-routing. So used, the rear jack connection is automatically terminated to 70 or 50 ohm impedance. Removal of

plug or patch card automatically restores "normal-through" condition. VSWR of less than 1.25:1 at frequencies up to 260 mc. is guaranteed. Minimum interload capacitance is achieved by wide electrical separation of parallel conductors, bringing the figure well below 60 db down at 260 mc.

\*Patent applied for.

## NEMS-CLARKE AUDIO, VIDEO & RF JACK PANELS FOR 70 OHM AND 50 OHM LINES

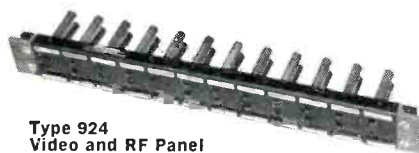

Type 924  
Video and RF Panel

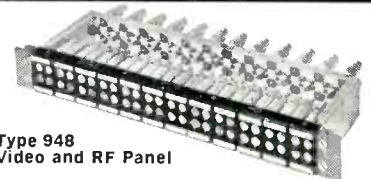

Type 948  
Video and RF Panel

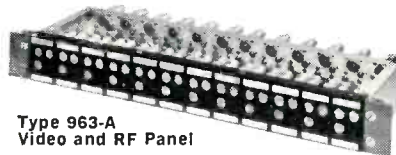

Type 963-A  
Video and RF Panel

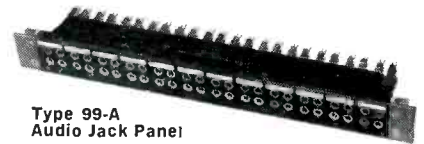

Type 99-A  
Audio Jack Panel

Featuring high quality construction and compact design to conserve rack space, Nems-Clarke Jack Panels can be supplied for use with either RCA or Western Electric equipment.

In Video and RF Jack Panels, sub-chassis can be furnished with provision for 12, 18 or 24 Amphenol connectors and plugs to permit disconnection of long lines when necessary. Heat-treated beryllium copper spring contacts assure long, maintenance-free service.

Silver and gold flash types available.

Audio Jack Panel contacts are of coin silver, with nickel plated steel jacks spaced to eliminate possibility of splitting circuits.

Patch cords and looping plugs also available.

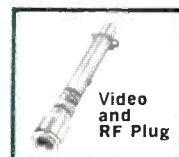

Video  
and  
RF Plug

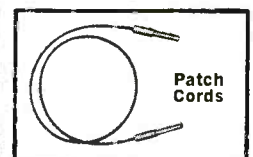

Patch  
Cords

**VITRO ELECTRONICS** A DIVISION OF VITRO CORPORATION OF AMERICA  
PRODUCERS OF NEMS-CLARKE EQUIPMENT  
919 JESUP-BLAIR DRIVE, SILVER SPRING, MARYLAND / 2301 PONTIUS AVENUE, LOS ANGELES 64, CALIFORNIA

munication, and this importance undoubtedly bolsters the staff into their high *esprit de corps*. The Belgian system has a problem of meeting two language areas—French to the south and Flemish to the north. We can only imagine the same situation applied to our own states, with Kentucky speaking one language, and Indiana across the river another, and Ohio a third!

A visit to the BBC in London included a session on a night radio program production in their light service. Control rooms are well

equipped, and many of the items are designed and built by the BBC engineering department. These include special record playing machines, monitor speakers, consoles, etc. One is impressed by the overall quality of sound and the clean maintenance observed in the BBC control rooms. The large broadcasting building in downtown London has often been described, and suffice to say that it is a beehive of activity. BBC still uses a small army of people to stage a program. The one I attended employed a mixer, tape engineer, disc engineer, producer, his secretary, and an announcer in the studio to tie the production of taped bits and discs into a coherent whole. In an American studio one man would have done all this work, albeit not as smoothly. Planning and rehearsals are still important to the BBC, and it shows in the smooth character of the simplest air work.

Television dominates the talk of English engineers, and the BBC has opened one of the world's most advanced television studios outside of London. Time did not permit us to visit the new plant, but it looked from the outside like one of the giant missile research centers in the U. S. Radio is still a big factor with the British, and it is thought that FM will ultimately supplant the AM service as more and more receivers are sold.

England being the true home of high fidelity's beginnings, one sees more good quality audio equipment for the home in this land than in all of Europe together. However, professional equipment is apparently the province of the BBC and little market exists for anything other than custom designs for export put

out by such manufacturers as Marconi, EMI, Standard Electric and others.

A closer look and listen to European quality of equipment and maintenance cannot help but improve our American systems. Technical magazines and visiting speakers and trade show exhibits can help us all achieve this forward step.

## Industry News

### G-E to Equip Washington's New Educational TV Station

Greater Washington Educational Television Assn., Inc., has awarded General Electric Co. a contract to equip its new UHF non-commercial station in the Washington area.

Channel 26 will begin telecasting Oct. 2 from studios in Arlington's Yorktown High School. Initially, the station will be equipped with a 12,000-watt UHF transmitter and a five-bay antenna at the former Arlington tower site of WTTG, Channel 5, Washington.

Studio equipment will include three of General Electric's Vidicon camera channels, two for live telecasting and one for film. In addition, G-E will supply two 16mm film projectors and a slide projector, audio control equipment, switcher, test equipment and monitors.

### Raymond Hamada Joins Houston Fearless Corp.

Houston Fearless Corp. president, Barry J. Shillito, has announced that Raymond Hamada, former vice-president of Telecomputing Corp. and general manager of its Whitaker Controls Div., has been appointed senior vice-president, operations.

for your tower requirements check **ROHN SYSTEMS**

A complete tower erection service that has these special advantages:

- ✓ DEPENDABILITY
- ✓ RELIABILITY
- ✓ COMPLETE ENGINEERING
- ✓ COAST TO COAST SERVICE

Be sure to obtain price quotations and engineering assistance for your complete tower needs from America's foremost tower erection service.

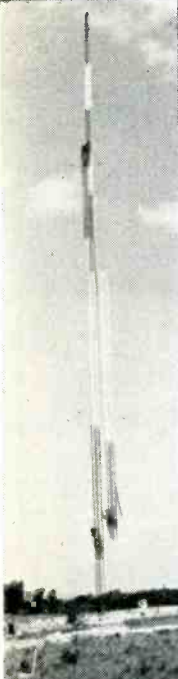

**ROHN SYSTEMS, INC.**

6718 W. Plank Road

Peoria, Illinois

from **MOSELEY ASSOCIATES**

Coming Soon

- **STEREO TRANSMISSION EQUIPMENT**

Available Now

- **FM MULTIPLEX SUBCARRIER GENERATORS**
- **RADIO REMOTE CONTROL SYSTEMS**
- **PROGRAM STL**

Modern Leasing Plans Available

**MOSELEY ASSOCIATES**

P. O. Box 3192, Santa Barbara, Calif.

4416 Hollister Ave.

WOODLAND 7-1469

Here is . . .

## Spot-O-Matic

Cartridge Tape

SE-10  
(Play and record)

SE-11  
(Playback only)



Quality — Reliability — Economy

Write **SIERRA ELECTRONIC ENTERPRISES**

6430 Freeport Boulevard

Sacramento, California

# Product News

Helpful tips on the actual use of tape recorders and the handling and splicing of tapes are also included.

## FIRST-CLASS LICENSE HANDBOOK

A new first-class radiotelephone license handbook, by Edward M. Noll, has been issued by Howard W. Sams & Co., Inc., 1720 E. 39, Indianapolis 6, Ind.

The literature is said to provide all the information needed to progress from a second to a first-class FCC radio-telephone license holder, and also to serve as an excellent reference handbook for those who have already obtained their first-class license.

The volume contains 291 questions and answers based on Element IV of the FCC examination, and is also considered a comprehensive textbook on broadcast communications.

## U-67 ALL-PURPOSE STUDIO CONDENSER SYSTEM

Gotham Audio Corp., 2 W. 46 St., New York 36, N. Y., has announced the release to the professional market of the company's first all-new microphone in four years.

The U-67 supercedes the old U-47 system, and is said to offer many new features.

## NEW BOOKLET ON TAPE RECORDING

A highly informative, attractive booklet called "207 Ways to Use A Tape Recorder" has been made available by Magnecord Sales Dept., Midwestern Instruments, Inc., P. O. Box 7509, Tulsa, Okla.

The pamphlet describes 207 ways to use tape recorders in business, professions, industry, schools, churches and the home.

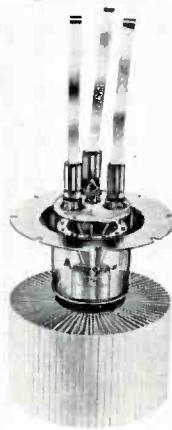

## POWER AMPLIFIER TRIODE

Amperex Electronic Corp., Transmitting Tube Div., 230 Duffy Ave., Hicksville, Long Island, N. Y., is offering the type 7900, forced air cooled triode designed for use in high frequency transmitters, particularly TV at frequencies up to 220 mc.

The unit features a specially processed platinum grid designed to result in low drive power requirements. In all other respects the tube is geometrically similar to type 7459, and is said to be the preferred tube in frequency ranges from 110 to 220 mc. It has a 4 KW plate dissipation rating and may also replace 2½ to 3 KW types, particularly in TV.

# Continental's

## ANTENNA COUPLING EQUIPMENT

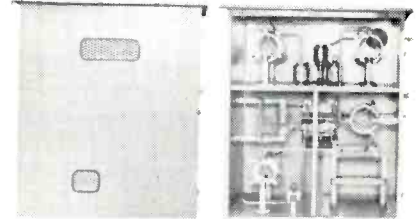

FRONT CLOSED

FRONT OPEN

Custom designed and manufactured to meet customer requirements.

write for details today!

# Continental Electronics

MANUFACTURING COMPANY

4212 South Buckner Blvd. Dallas 27, Texas

☐ SUBSIDIARY OF LING-TEMCO ELECTRONICS, INC.

## A NEW SOLID STATE VIDEO DISTRIBUTION UNIT

Requires only 5¼" Rack Space

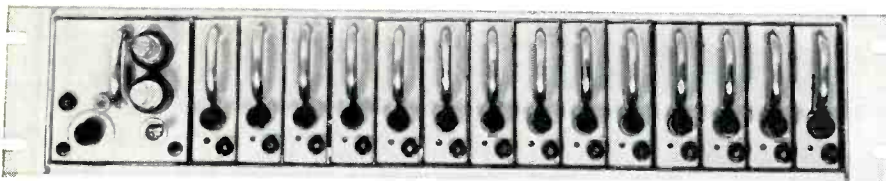

BRIDGING INPUTS (83-1R Connectors) . . . 14 CHANNELS  
42 OUTPUTS . . . 75 OHM SENDING END TERMINATION  
SOLID STATE POWER SUPPLY

### SPECIFICATIONS

DIFFERENTIAL PHASE.....	.2°
DIFFERENTIAL GAIN.....	.02%
FREQUENCY RESPONSE.....	Flat to 15 mc ± .2 db
TILT.....	.1 db (60 squarewave)
ISOLATION.....	60 db at 3.58 mc (Ref 1 V PP)
POWER REQUIREMENTS.....	2.5 watts



## SARKES TARZIAN INC

east hillside drive • bloomington, indiana  
edison 2-7251

Write for complete technical information  
Broadcast Equipment Division

PROOF OF SUPERIORITY  
NO OTHER MICROPHONE  
CAN MATCH!



LEADING NEWSWEEKLY  
MAGAZINES PICTURE E-V  
MORE OFTEN THAN THE NEXT  
FOUR BRANDS COMBINED!

Write now for catalog of  
microphones preferred by top radio, TV,  
newsreel and sound engineers!



ELECTRO-VOICE, INC.  
Commercial Products  
Div., Dept. 811V  
Buchanan, Michigan

## Special Services

### VIR N. JAMES

Specialty

Directional Antennas

232 S. JASMINE DEXter 3-5562  
DENVER 22, COLORADO  
Member AFCCE

### CHARLES E. BRENNAN

(Member AFCCE)

DONALD A. WELLER

Consulting Radio Engineers

405 E. Lincoln Ave. • Milwaukee 7, Wis.  
Humboldt 3-3370 Humboldt 3-3371

- SYNCHRONOUS MAGNETIC FILM RECORDER/REPRODUCER
- MAGNETIC TAPE RECORDERS
- NEW—THE portable MINITAPE synchronous 13 lb., battery operated magnetic tape recorder for field recording.

THE STANCILO-HOFFMAN CORP.  
845 N. Highland, Hollywood 38, Calif.  
Dept. B HO 4-7461

## Spotmaster

NO. 1

In Cartridge Tape Equipment

SPOTMASTER 500

A complete Tape Cartridge Self-cuing, Record Playback Combo Unit.  
For Details or Demonstration, Write

VISUAL ELECTRONICS, CORP.

356 W. 40th St., New York 18, N.Y.

## FM/Q ANTENNAE

THE FINEST OF ITS KIND

### SINGLE FREQUENCY AND BROAD-BAND FM RECEIVING ANTENNAE

HIGH GAIN YAGI, CUT TO YOUR FREQUENCY FOR LONG DISTANCE PICKUP. HEAVY DUTY DESIGN FEATURING ALL STAINLESS STEEL HARDWARE.

Literature on request.  
Send 30¢ for booklet on FM Antennae and FM Reception.



APPARATUS DEVELOPMENT CO.  
WETHERSFIELD 9, CONN

## Product News

### NEW DEMAGNETIZER FOR BULK SOUND RECORDING TAPE

The Magneraser, a new demagnetizer designed to produce complete erasure of recorded signal on all brands of tape and ¼-inch, ½-inch, or 16 and 35 mm. magnetic sound film, on plastic or metal reels of any size from 5 to 15 inches, has been introduced by Amplifier Corp. of America, 398 Broadway, New York 13, N. Y.

The manufacturer states that the erasing process is so efficient that, even on severely overloaded tape, the background noise level is lowered 3 to 6 db. below that of virgin, unused tape; also, that since erasure is effected on the reel, without unwinding and rewinding, there is no wear-and-tear on the tape against erase heads on the recorder.

Since the device is light and portable, it is said to be easily applicable to demagnetizing record-playback and erase heads, thereby reducing background noises and tape distortion.

The unit operates on any alternating (50 or 60 cycle) current, and furnishes the necessary gradually diminishing cyclic magnetization field which the tape normally encounters during supersonic erasure. To erase, the demagnetizer is placed on top of, and moved slowly around the reel of tape. Application to new, unused tape will help produce a recording with a greater signal-to-noise ratio, it was further stated.

Features of the demagnetizer include a momentary push-button control safety-on-off switch; size, 2½ inches high by 4 inches diameter; weight 2½ lb.; and equipped with 8-ft. line cord, molded rubber plug and operation instructions. The unit is available in two models, 200C for 100-130 volts, and 220C for 200-260 volts.

## Classified

Advertising rates in the Classified Section are ten cents per word. Minimum charge is \$2.00. Blind box number is 50 cents extra. Check or money order must be enclosed with ad.

### EQUIPMENT FOR SALE

Transmission line, styroflex, heliastax, rigid with hardware and fittings. New at surplus prices. Write for stock list. Sierra Western Electric Cable Co., 1401 Middle Harbor Road, Oakland 20, California. 6-61 tf

Used 50 KW Transmitter, Western Electric 407A-4 in good condition with spares. Priced at one-fourth less than a new transmitter. Can be handled with as little as 10% down. Broadcast Engineering, Dept. BE-4, Kansas City 5, Mo. 8-61 4t

### BUY, SELL OR TRADE

Will buy or trade used tape and disc recording equipment — Ampex, Concertone, Magnecord, Presto, etc. Audio equipment for sale. Boynton Studio, 10 BE Pennsylvania, Tuckahoe, N. Y. 4-61 6t

## Advertisers' Index

Alford Mfg. Co.	36
Altec Lansing Corp.	7
Apparatus Development Co., Inc.	42
Bauer Electronics Corp.	15
Brennan, Charles E.	42
Conrac Div.	31
Continental Electronics Mfg. Co.	41
Continental Mfg., Inc.	37
Eitel-McCullough, Inc.	21
Electro-Voice, Inc.	41
Foto-Video Electronics, Inc.	IFC
General Electric Co.	18-19
General Electrodynamics Corp.	13
James, Vir N.	42
Jampro Antenna Co.	42
Langevin, Inc., Div. of Sonotec, Inc.	27
Moseley Associates	40
Radio Corp. of America	1, IBC
Raytheon Co., Equipment Div.	25
Rohn Systems, Inc.	40
Sarkes Tarzian, Inc.	3, 41
Sierra Electronic Enterprises	40
Stancil Hoffman Corp.	42
Telechrome Mfg. Corp.	BC
Visual Electronics Corp.	42
Vitro Electronics Div.	39
Weller, Donald A.	42

## JAMPRO

ONLY FM ANTENNA

designed specifically for

MULTIPLEX STEREO

Write for full details.

## JAMPRO ANTENNA CO.

7500 14th Ave.  
Sacramento 20, California

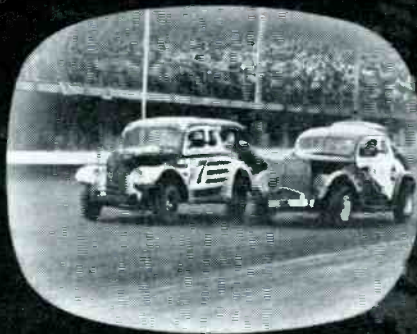

# NOW...Night TV Pickup Without Special Lighting

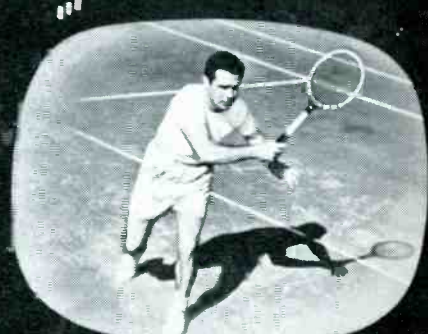
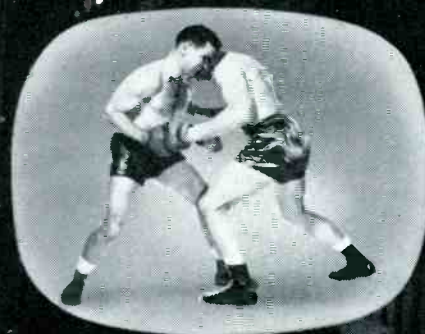

Broadcast-quality pickup at light levels never before possible with supersensitive RCA-4401V1 image orthicon

"Amazing" is the way broadcasters describe the sensitivity of the RCA-4401V1! This is the image orthicon that enabled many stations to move into profitable new fields of evening programming—such as outdoor pickup of sports, concerts, special events—that previously required costly, complex special lighting! Truly the solution to remote nighttime pickup problems, the 4401V1 actually produces a normal broadcast quality picture with illumination of only 10 footcandles on the subject itself with a lens opening of f/3.



The Most Trusted Name in Television

*The 4401V1 is but one of the broad RCA family of specialized image orthicons. Others include:*

#### **B & W TELECASTING (3" CAMERA TUBES)**

**5820A** New version of the 5820 for B & W studio and outdoor pickup is destined to be the "standard" of broadcasting.

**7293A** A field-mesh image orthicon having an image section designed to prevent highlight ghosts. Field-mesh design to improve corner focus and prevent port-hole effects.

#### **COLOR TELECASTING (3" CAMERA TUBES)**

**7523** Features special precision construction and RCA field-mesh design for high quality color and B & W pickup.

**4401** For low-light-level colorcasting—studio or outdoor. Available in matched sets of three for maximum performance.

**4415** For studio pickup of color at B & W light level.

**4416** Set of three tubes consists of two 4415's and one 4416. The 4416 has increased blue sensitivity. Both types have advantages offered by precision construction and field-mesh design. Primarily for studio application at light levels from 10 to 200 footcandles.

#### **TAPE RECORDING (4-1/2" CAMERA TUBES)**

**7295A** A field-mesh image orthicon with high resolution and very high signal-to-noise ratio. For tape and B & W studio use.

**7389A** A superior-quality field-mesh design image orthicon, with extremely high signal-to-noise ratio, for tape and exceptionally high-quality B & W studio pickup.

Whatever your station's requirements or special problems, there's an RCA Image Orthicon designed to meet them. For information in specific types, see your local RCA Industrial Tube Distributor.



...but only the "Twenty/Twenty" cleans up video distortion

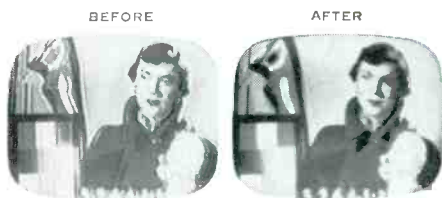

Photos, taken a few seconds apart, show how the Model 20/20 cleans up smears, overshoots, ringing and other waveform defects.

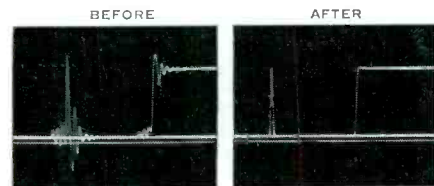

Waveform correction is illustrated by before-and-after photos of an expanded portion of Sine<sup>2</sup>-test signal. The Model 20/20 can be used with any desired test signal for pre-broadcast, or on-the-air correction.

The Model 20/20 Time Domain Equalizer is Telechrome's ingenious application of the proven "paired echo" principle to the problems of video distortion in transmission paths, studio facilities, video tape recording systems, transmitters, antenna mismatches, etc. Result: for the first time a practical, commercially-priced instrument that eliminates overshoots, ringing, smears and other waveform defects from monochrome, color, composite and non-composite signals.

Portable or rack-mounted, the Model 20/20 can be used anywhere in a television system. At the terminal end it eliminates difficulties regardless of where they originate. It is equally effective for pre-broadcast or on-the-air correction. And Telechrome's engineers have made it simple enough for easy use by anyone after only a brief demonstration. See for yourself how the Model 20/20 dramatically cleans up transmission quality, assures continuous broadcast fidelity for maximum viewer and advertiser appeal.

For a demonstration, contact H. C. Riker, Vice-President, Marketing.

**TELECHROME**

AT THE FRONTIERS OF ELECTRONICS

ELECTRONICS  DIVISION

TELECHROME MANUFACTURING CORP., AMITYVILLE, L.I., NEW YORK  
Division Offices: Lombard, Illinois • Van Nuys, California • Dallas, Texas • Washington, D.C.