

JANUARY, 1960

Covering all  
phases of...

**A**  
**FM**  
**TV**

# BROADCAST ENGINEERING

THE TECHNICAL JOURNAL OF THE BROADCAST INDUSTRY

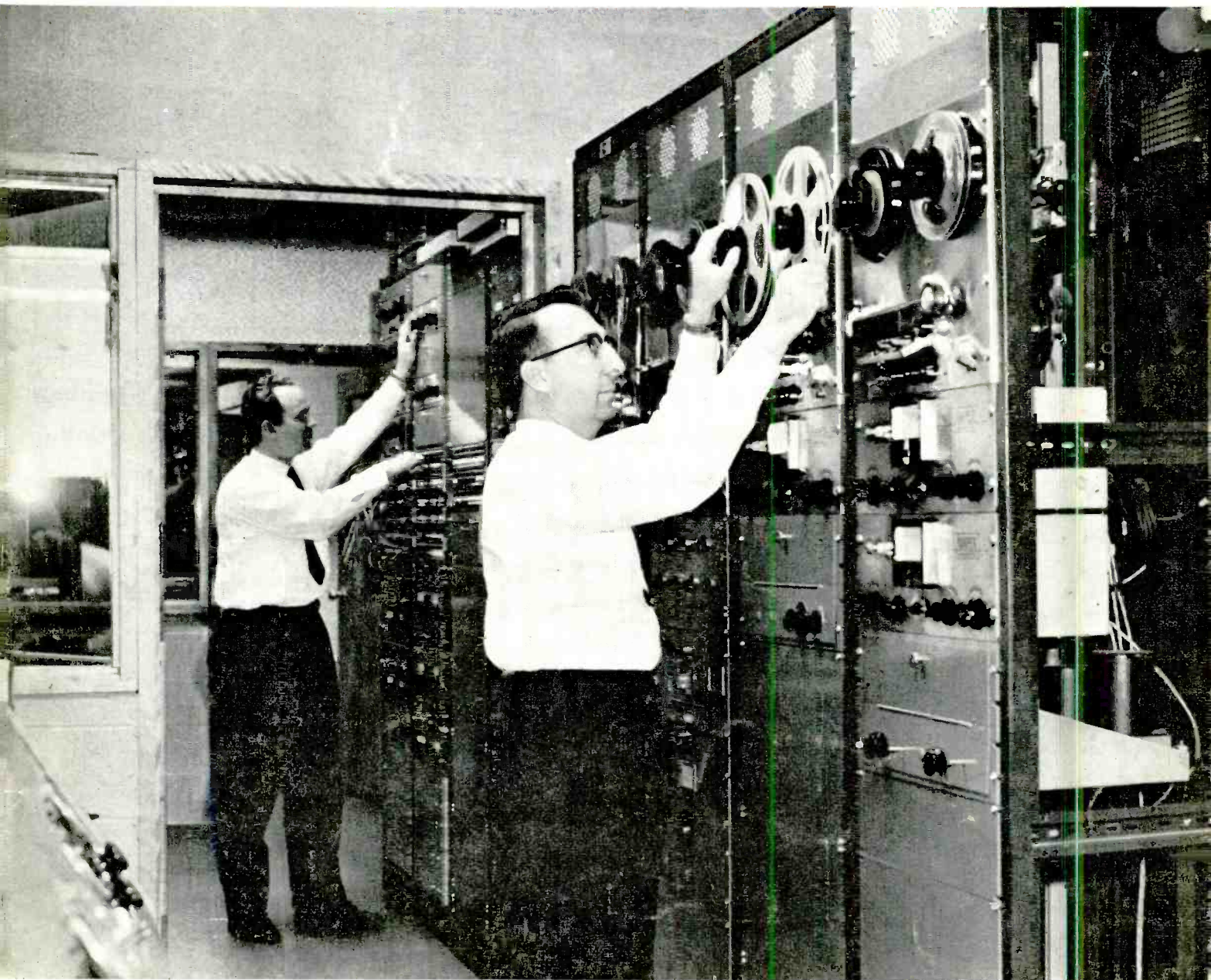

PHOTOGRAPH OF KOA'S RECORDING ROOM — TAPE GROWS IN USE BY BROADCASTERS

# FOTO-VIDEO® – NOW THE BEST VIDEO MONITOR IN THE INDUSTRY,

says one of the Nation's electronic leaders and large-scale manufacturers of closed-circuit equipment, about the new completely modularized FOTO-VIDEO product pictured below:

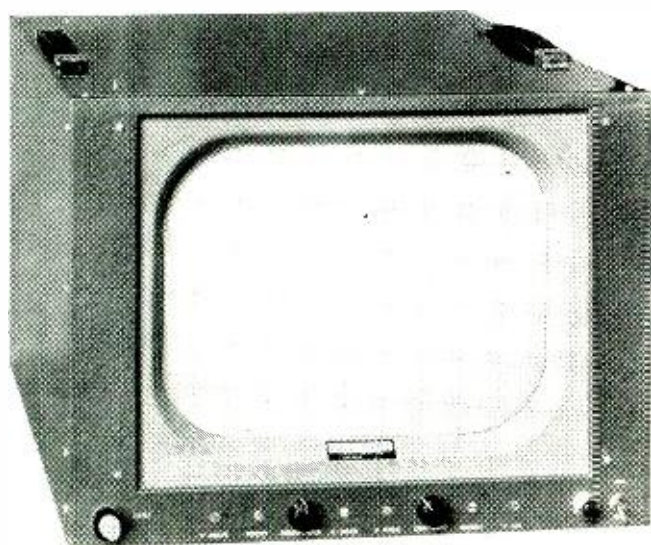

FRONT



REAR

## Outstanding Performance Features:

- Superior Definition, Brightness, and Contrast
- Excellent Focus and Interlace
- Video Flat to 8 mc.
- Positive Operation of All Controls
- Distortionless DC Restorer
- Silicon Rectifier Power Supply
- High Efficiency Linear Deflection
- Aluminized Picture Tube
- Broadcast Quality Construction with Terminal Boards
- 90° Linear Deflection
- Choice of H & V Drive, External Sync., or Composite Video Synchronization

## UNIQUE MECHANICAL FEATURES:

1. Completely modular in construction. Snap out one or more modules and snap in the replacement units. If necessary, a complete replacement of the essential working parts of the new FOTO-VIDEO monitors may be effected in a matter of seconds, by replacing all modules.
2. No "down" time for repairs and adjustments. Ease of maintenance results; anyone can do it.
3. Same modules fit any size of the new units: 14" (V-36C), 17" (V-96A), 21" (V-98A), and the 24" (V-92A).
4. All vacuum tubes and associated components, transformers, etc., mounted on their respective modules, as well as essential circuitry.
5. Sure-contact multiple plug-in connectors link the whole together through short interconnecting leads to input coaxials, switches, potentiometers, etc., mounted on rear terminal boards.
6. With (left to right—see below) low-voltage module, video amplifier, vertical amplifier module and high-voltage unit snapped out, nothing is left inside the metal case except cathode-ray tube and its mounting frame. By removing four screws the terminal board also may be removed for inspection or repair.
7. Brightness and contrast control knobs operated from front panel through metal rods to pots on rear terminal board.

REAR,  
With Two  
of the  
Four  
Modules  
Snapped  
Out.

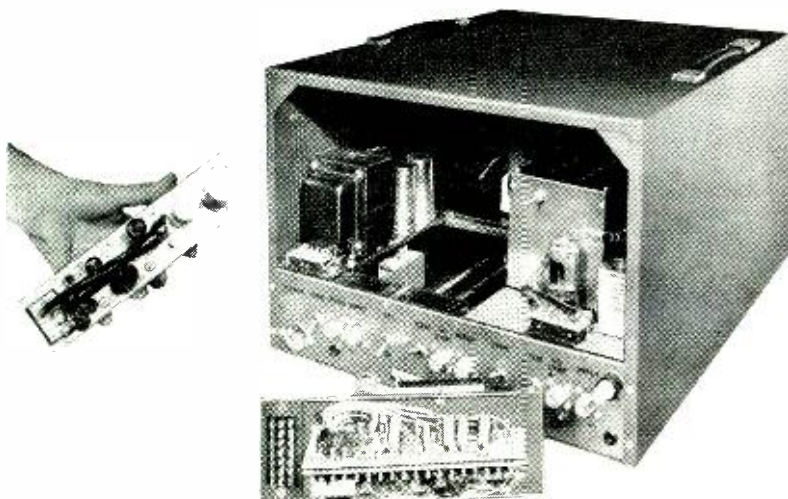

**Foto-Video** Laboratories, Inc.



(Write or Phone Collect for Complete Details)

Cedar Grove, N.J. CEnter 9-6100



# BROADCAST ENGINEERING

THE TECHNICAL JOURNAL OF THE BROADCAST INDUSTRY

VOLUME 2

JANUARY, 1960

NUMBER 1

## Contents

Sub-Carrier Generation in Multiplex Exciters . . .	6
The Development and Application of Synthetic Reverberation Systems . . . . .	8
The Effects of Transmitter Sound Power Reduction on Receiver Performance . . . . .	14
Stereophonic Broadcast Experiments at KISW-FM . . . . .	18
The Role of Tape in Radio's Rise . . . . .	20
Professor Snikrah . . . . .	22

## Departments

Amendments and Proposed Changes of F.C.C. Regulations . . . . .	28
Industry News . . . . .	37
Product News . . . . .	39
Technical Hints . . . . .	40
Classified Ads . . . . .	40
Index to Advertisers . . . . .	40

## Cover

James F. Zimmerle (left) and Jay F. Graves of radio station KOA in Denver are shown operating the recording system which is used to provide continuous network delay. The importance of magnetic recording in today's broadcasting is pointed out in the article on page 20.

### EDITORIAL

D. E. MEHL, Editor  
 D. P. BOLCOURT, Managing Editor  
 DUDLEY ROSE, Presentation Editor  
 E. P. LANGAN, Advertising Director  
 S. P. WILSON, Production Manager  
 W. J. SHAW, Circulation Director



### ADVERTISING SALES OFFICES

**Flushing 54, New York**  
 PAUL AND DON WEIL  
 39-01 Main Street  
 Telephone INdependence 3-9098

**Chicago 5, Illinois**  
 WILLIAM L. MILLER, JR.  
 E. P. LUCKENS  
 307 N. Michigan Ave.  
 Telephone FIanklin 2-5944

**Cleveland 16, Ohio**  
 DAVID H. HERTEL  
 3100 Wooster Road  
 Telephone EDison 1-2370

**Southwest**  
 C. H. STOCKWELL CO.  
 4016 W. 64th Street  
 Mission, Kansas  
 Telephone RAndolph 2-4417

**Los Angeles 57, California**  
 MAURICE A. KIMBALL CO., INC.  
 2550 Beverly Boulevard  
 Telephone DUinkirk 8-6178

**San Francisco 5, California**  
 MAURICE A. KIMBALL CO., INC.  
 681 Market Street  
 Telephone ENbrook 2-3365

**Paris 8, France**  
 JOHN ASHCRAFT  
 67 Avenue des Champs Elysees

**London W. 1, England**  
 JOHN ASHCRAFT  
 1 Berkeley Square

**Tokyo, Japan**  
 INTERNATIONAL MEDIA  
 REPRESENTATIVES, LTD.  
 Shadan Hojin, 14, 2-chome Marunouchi

Editorial, Circulation and Advertising headquarters, 1014 Wyandotte St., Kansas City 5, Missouri; Telephone VIctor 2-5655.



**Subscription Price: U. S. \$6, one year; Outside U. S. A., \$7. Single copies, 75 cents. Adjustments necessitated by subscription termination at single copy price.**

Broadcast Engineering is published monthly by Technical Publications, Inc., 1014 Wyandotte St., Kansas City 5, Missouri, U. S. A.

**Corporate Personnel:** Robert E. Hertel, President; Frank D. Smalley, Executive Vice President; E. P. Langan, Vice-President; W. J. Shaw, Vice-President; Kenneth Long, Vice-President; D. E. Mehl, Vice-President.

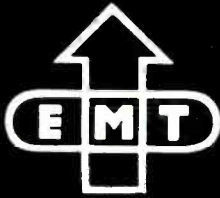

# tools of the trade . . . **MICROPHONES**

## **EMT 28 — CONDENSER MICROPHONE**

Microphone system with cardioid and omnidirectional characteristics at choice. Special low noise circuitry in the preamplifier and long life type 6072 (12AY7) tube. Easily exchangeable components. Miniature head and slender tubes in two lengths provide minimum visual obstruction for TV and stage applications.

A separate power supply accepts line voltage in the range of 110 to 240 volts. Extensive accessories are available.

### **TECHNICAL DATA**

Range: 30 · 15000 cps.

Sensitivity (200 ohms): 1 mV/μbar.

Ratio of front to rear sensitivity: 20 db.

Preamplifier size: 1-1/32" diameter by 7" long.

Cartridge size: 3/4" diameter.

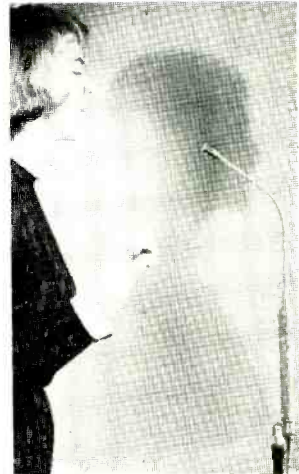
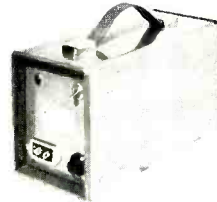

## **C 12 CONDENSER MICROPHONE**

With Remote Control of Directional Characteristics During Program Pick-Up.

The Type C 12 polydirectional condenser microphone, combined with a switch box for the remote control of its directional characteristics during program pick-up, opens many new avenues of pick-up technique.

### **TECHNICAL DATA**

Frequency range: 30 · 15000 cps.

Frequency response: 0° omnidirectional cardioid, bidirectional, 180° cardioid.

Output level: 33 db re 1 milliwatt for a sound field of over 10 dynes/sq. cm.

Sensitivity (for 200 ohms): 1 mV/μbar ±1.5 db.

Output impedance: 50 and 200 ohms.



## **EMT D 24B DYNAMIC DIRECTIONAL MICROPHONE**

Professional studio microphone, moving coil design, cardioid characteristic. Minimum visual obstruction for TV and stage use. Equipped with windscreen, switch for acoustical high-pass filter (-10 db) against rumble and effective shielding against stray fields.

### **TECHNICAL DATA**

Range: 30 - 16000 cps.

Ratio of front to rear sensitivity: 20 - 25 db.

Sensitivity: 0.2 mV/μbar.

Head size: 1-17/32" diameter by 6-3/16" long.

Weight: 7 ounces.

Finish: Gold and umber gray.

**electronic applications, inc.**

194 RICHMOND HILL AVENUE

STAMFORD, CONNECTICUT

# for T.V., Film, & Radio

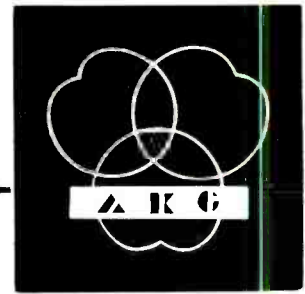

## K 50 DYNAMIC HEADSET

New construction ideas incorporated in these headphones give highest reproduction fidelity through the entire audible range. Ideal for monitoring monaural as well as stereo programs. Extremely light and comfortable (weight 3 oz.) they feature easy cleaning, very low distortion and power drain.

### TECHNICAL DATA

Range: 30 - 20000 cps.

Impedance: monaural 800 ohms, stereo 2 x 400 ohms.

Max. load: monaural 4 volts on 800 ohms, stereo 2 volts on 400 ohms on each system.

Level requirements for normal monitoring: monaural 0.5 volts, stereo 2 x 0.25 volts.

Colors: Capsules gray, headband gray, shells crystal clear



## D 19 B DYNAMIC DIRECTIONAL MICROPHONE FOR TAPE RECORDERS

With cardioid characteristic and bass cut switch, this microphone covers the entire frequency range from 40 - 16000 cps. Rising characteristic. The pronounced directional characteristic, especially in the lower frequencies means freedom from background noises.

### TECHNICAL DATA

Frequency range: 40 - 16000 cps.

Frequency response:  $\pm 3$  db. with reference to standard curve.

Sensitivity: 0.18 mV/ $\mu$ bar (2.5 mV/ $\mu$ bar at high impedance).

Impedance: 200 ohms (high impedance 50K ohms).

Directional characteristic: Cardioid.

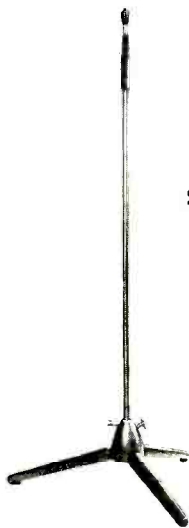

## ST 200 SHOCK-PROOF FLOOR STAND

This stand is not only insensitive to shock and vibration but is also very stable, because of the unique design of its shock-dampening elements. These consist of an arrangement of iron struts embedded in live rubber blocks. The ingenious yet simple design provides isolation against vibration and shock without having to increase the size and weight of the floor stand and affords the necessary restoring force and attenuation against torsion.

### WE ALSO SUPPLY

EMT 140 reverberation units

EMT 930 professional turntables

EMT special noise reducing audio cables

EMT wow and flutter sets

Write for professional audio bulletin describing all of our quality products.

### FOR MORE INFORMATION

Southwest: Audio Acoustics Company, 130 Fairview Drive, Arlington, Texas

West Coast: Ralph Auf Der Heide, P.O. Box 201, Altadena, Calif.

East: Harvey Radio Company, 103 West 43rd Street, New York 36, N. Y.

Harry Reizes (Rep.), 1473 Sylvia Lane, Eastmeadow, L. I., N. Y.

AKG and EMT products are imported and laboratory serviced exclusively by:

**electronic applications, inc.**

194 RICHMOND HILL AVENUE

STAMFORD, CONNECTICUT

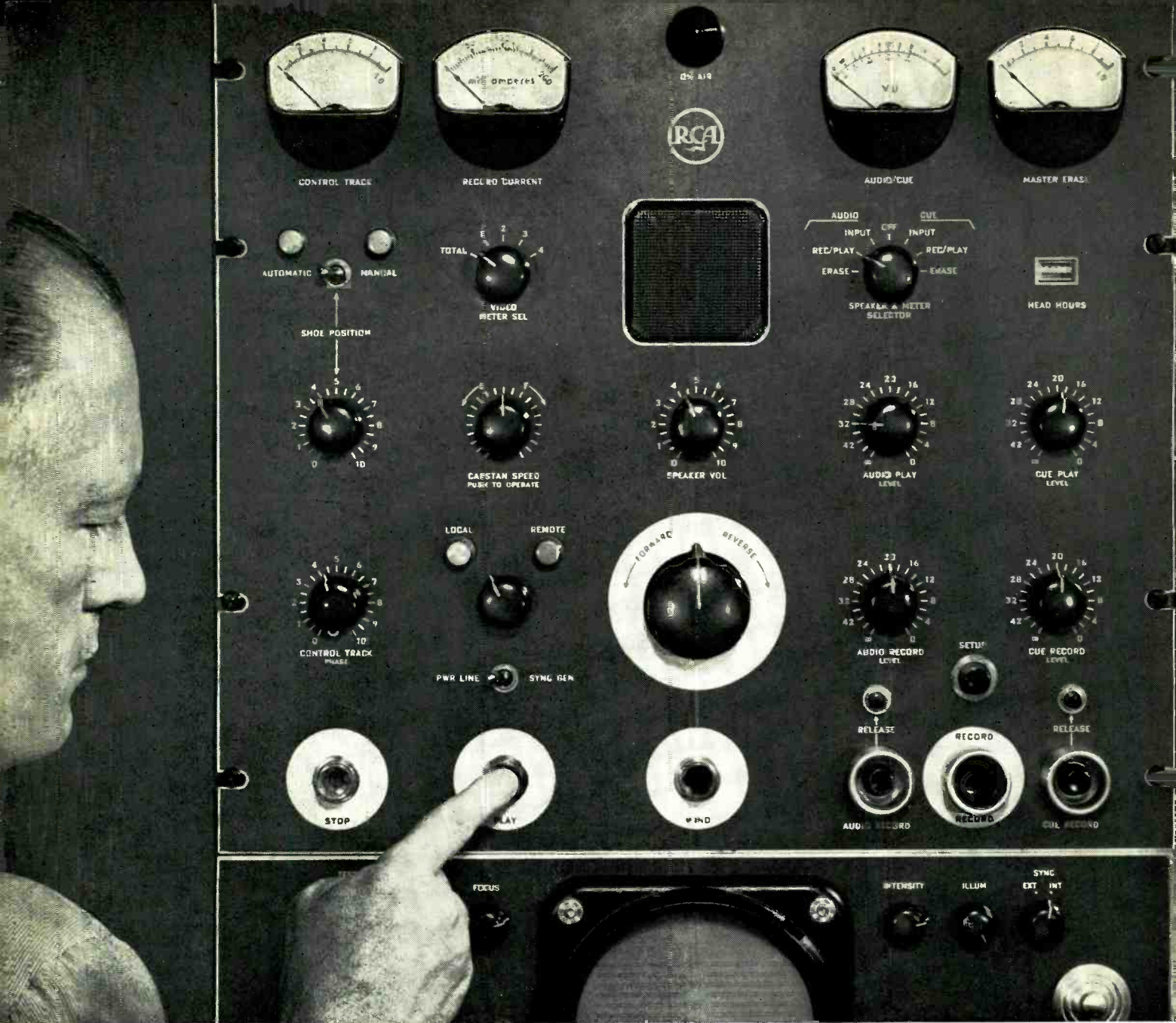

The central control panel of the RCA TV Tape Recorder puts all operating controls at your fingertips. Major control features are illustrated on the panel, zoned in 15 areas as follows: (1) Variable Speed Rewind; (2) Single Control Playback; (3) Independent Control of Video, Audio and Cue Record; (4) Local-Remote Operation; (5) Automatic Shoe Position Control; (6) Capstan Speed Control; (7) Video Head Current Indication; (8) Multi-Purpose Meter/Speaker Selector; (9) Independent Audio/Cue Record and Playback Level Controls; (10) Built-In Monitoring Speaker, and Speaker Volume Control; (11) Master Erase Current Meter; (12) Control Track Current Meter; (13) Control Track Phase Adjustment; (14) Head Hour Meter; (15) Sync Selector.

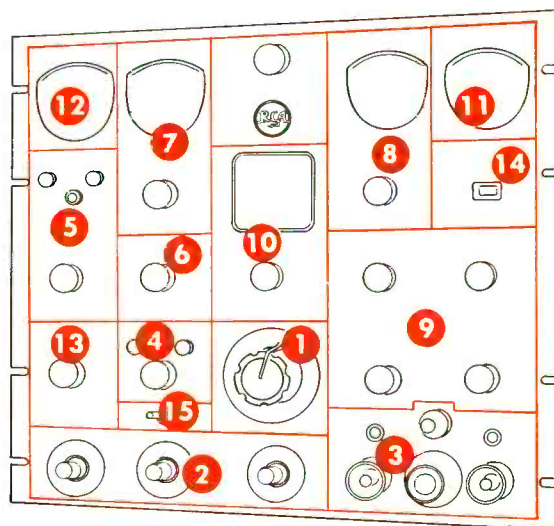

ASK ABOUT THE OTHER VITAL REASONS WHY IT PAYS TO "TAPE IT RCA"!



Tmk(s) ©

# 15 features at your fingertips... with RCA TV TAPE CONTROL CENTRAL

All operating controls on a single 19" x 17" panel!

- 1 Variable Speed Rewind**  
Fast forward, fast reverse. Rewinds 90 minute reel in 4½ minutes. Rapid cue any point on tape. Tape speed can be varied until audio or cue channels become intelligible.
- 2 Single Control Playback**  
A single push button activates playback functions. Automatically stops at the end of the tape. A stop button is provided for manual operation.
- 3 Independent Control of Video, Audio and Cue Recording**  
A set-up switch activates all electronics, placing the recorder in operation without running tape through. This enables operators to check out circuitry prior to recording or playback.
- 4 Local-Remote Operation**  
Selector switch delegates basic record/playback functions for local or remotely controlled operation.
- 5 Automatic Shoe Positioning**  
The tape shoe position is automatically controlled during playback to prevent skewing effects. In the record mode, operation is electrically switched to *manual*—head-to-tape pressure can be adjusted using calibrated dial.
- 6 Capstan Speed Control**  
Manual override of normal operating speed to permit synchronization of two machines.
- 7 Video Head Current Indication**  
Switchable to indicate recording current in each of the four heads or total current in the head assembly. Permits quick diagnosis of performance during recording.
- 8 Multi-Purpose Meter/Speaker Selector**  
Provides instantaneous check of input, record and play functions, and erase in either audio or cue channels.
- 9 Independent Audio/Cue Record and Playback Level Controls**  
Standard RCA broadcast audio amplifiers associated with these controls are interchangeable.
- 10 Built-In Monitoring Speaker, and Speaker Volume Control**  
For monitoring audio or cue channel input, record or playback output. Built-in RCA BA-24 Broadcast Monitoring Amplifier will also drive external speaker.
- 11 Master Erase Current Meter**  
Shows master erase circuit is operating by indicating current in master erase head.
- 12 Control Track Current Meter**  
Provides continuous indication of current in servo-control track head.
- 13 Control Track Phase Adjustment**  
Dual control provides coarse and vernier adjustments. Coarse adjustment is for slipping any of the four heads on to any given recorded track. Vernier adjustment is for centering the heads precisely on that track.
- 14 Head Hour Meter**  
Indicates number of hours on video heads during *actual* recording and playback.
- 15 Sync Selector**  
For locking equipment to power line or local sync generator.

*Such outstanding operating features assure the most efficient utilization of television tape equipment, reducing operating and maintenance costs. And there are many other reasons why RCA TV Tape Equipment will prove right for your requirements. So don't settle for less than the best. See your RCA Representative, or write to RCA, Dept. C-367, Building 15-1, Camden, N. J. In Canada: RCA VICTOR Company Limited, Montreal.*

**RADIO CORPORATION of AMERICA**

BROADCAST AND TELEVISION EQUIPMENT • CAMDEN, N. J.

# SUB-CARRIER GENERATION

By DWIGHT "RED" HARKINS\*

Part 2 of a discussion of the methods used to generate frequency modulated sub-carriers for subsidiary communications services in FM broadcasting.

LAST month we outlined the different systems of producing a sub-carrier by the heterodyne method. Now let's turn our attention to several interesting methods of producing a frequency modulated sub-carrier by direct methods.

First, we shall outline a procedure that is used to produce frequency modulation of an oscillation at 65 Kc. The oscillating circuit consists of several triodes in cascade which in turn are connected to feed the output back into the input in what we shall refer to as a ring oscillator.

This name comes from the fact that it is a "ring around a rosie" circuit and is nothing more nor less than an audio amplifier connected up in such a way that it becomes an oscillator. This is not uncommon in building amplifiers which are not intended to oscillate.

In this case the plate loads and coupling condensers between the stages are chosen so that the oscillation occurs at the desired frequency of, let's say, 65 Kc. A total phase shift of 720 degrees occurs.

Referring to Figure 1, we see a group of triode audio amplification stages connected in a circle so that

the whole thing oscillates. Now if anything in the oscillating circle changes, the frequency will change. In order to produce a frequency modulated signal, it is only necessary to apply a changing reactance to the grids of each of the tubes in the oscillating circle.

In Figure 2, we see a simple reactance tube circuit which is applied to the grid of each of the triodes in the ring.

Applying audio to each of the reactance tubes simultaneously causes a change in the oscillating circuit that is directly related to the audio.

The audio voltage controls the frequency of the whole oscillating array, therefore producing a frequency modulated signal.

This system has excellent center frequency stability but is limited as to the amount of frequency deviation that can be produced. Audio frequencies below 1,000 cycles will easily produce a deviation of plus or minus 5 Kc. Certain peculiarities of the circuit, however, cause the higher audio frequencies to produce in addition to a deviation of the center frequency, unusual distortion components. It has been noted that the ap-

plication of a tone of 5,000 cycles, for example, produces in addition to a frequency modulation of a center carrier an amplitude modulation component which is large enough to cause distortion in the receiver. Our development of this unique circuit was discontinued when it appeared that too many components would be required in order to obtain the necessary degree of deviation required for all applications of multiplexing.

Another interesting but as yet not commercially used application of the direct frequency modulated oscillator is the positive biased multi-vibrator. This circuit as shown in Figure 3, makes possible the frequency modulated sub-carrier to be produced from a multi-vibrator. Audio voltage causes the multi-vibrator to deviate in accordance with the amplitude of the applied audio voltage.

This circuit was invented by Mr. E. H. B. Bartelink. The original application was for the purpose of creating sub-carriers in the range of 100 to 400 Kc. using frequency modulation which in turn could be applied to open wire telephone lines for the purpose of allowing several audio communication circuits over one pair of lines.

This circuit was used in our very first sub-carrier generator used in 1955. Although capable of excellent frequency modulation in the lower audio frequencies, it was not found to have low enough distortion and ample frequency response characteristics to use for the transmission of music. For the purpose of generating a sub-carrier that is to be used for voice communication only, however, it remains the simplest and most straight forward method possible.

In summing up the various meth-

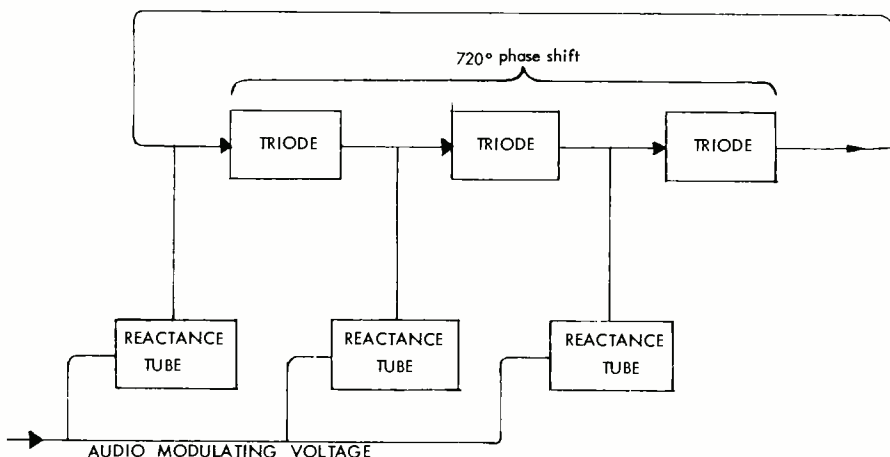

Figure 1. Block diagram of ring oscillator which is used to produce frequency modulation of an FM multiplex sub-carrier.

\*Harkins Radio, Inc., 444 East Washington St., Phoenix, Ariz.



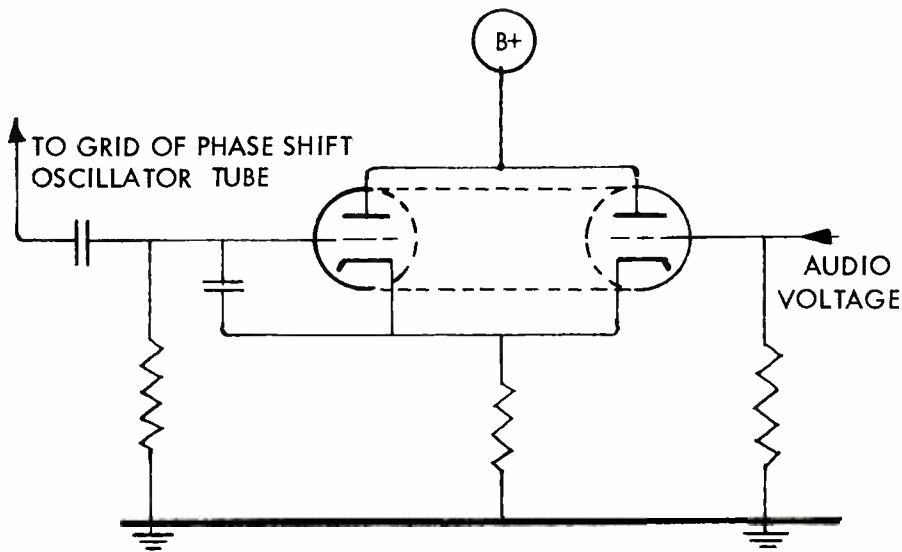

Figure 2. Diagram of reactance tube circuits which applies the audio signal to the ring oscillator.

ods of producing a sub-carrier, we have:

**(A) HETERODYNE METHODS**

1. Reactance tube controlled high-frequency oscillator heterodyned with a crystal oscillator to produce the desired sub-carrier center frequency.  
(This system requires automatic center frequency control)
2. Crystal controlled phase modulators which after considerable multiplication are heterodyned with a fixed oscillator to produce the desired sub-carrier.
3. Reactance tube controlled low frequency oscillator capable of 25 Kc. deviation and carrier stability that does not require automatic frequency control.

**(B) DIRECT OSCILLATOR METHODS**

1. A variable reactance is applied to each of many elements making up a "ring" oscillator.
2. Audio voltages are applied to a direct free running positive biased multi-vibrator.

The ultimate would be a direct system which used no frequencies other than the fundamental. Thus far, no system has been developed which will permit direct frequency modulation of an oscillator in the range below 100 Kc. of sufficient deviation without distortion for the application at hand. The desirability of eliminating all frequencies except the fundamental is apparent when it is shown that many unusual things can happen when other frequencies are present.

Whenever the sub-carrier generator uses additional frequencies besides the desired end product, the possibility of interference with other equipment is immediately present. For example, in the case of the pulse modulation system which requires a

high degree of multiplication, the generator unit will have circuits that are operating on many frequencies between 100 Kc. and 28.8 Mc. If, for example, the second doubler of the multiplier string happens to hit a frequency of 920 Kc. which is the same frequency of the AM station where the unit is installed, some very serious interference results. In our experience throughout the country, we have run into several cases where our units had to be redesigned so that the multipliers missed the frequency of equipment on the same premises. If the sub-carrier generator

had only the fundamental to contend with, no interference of this nature would ever be encountered.

Another problem with the multiplier type of sub-carrier generator is that various frequencies present in the sub-carrier generator have on occasion leaked into the FM exciter which is also full of multipliers with the result that some of the frequencies are too close to each other which in turn produces interference. As another example, we cite the case where a sub-carrier generator uses a 100 Kc. master crystal while the FM transmitter uses a master crystal close to 100 Kc. If any of the 100 Kc. present in the sub-carrier generator leaks into the main FM transmitter, all sorts of peculiar phenomena will result.

The purpose of this article is to review all of the various methods possible that can be used for generation of a sub-carrier and to point out the desirability of future development of the simplest possible generator that will produce the necessary deviation without distortion and amplitude modulation by-products. Going back to the classic illustration of FM, it would be ideal if a 65 Kc. oscillator could be deviated by a condenser microphone sufficiently to produce a swing of plus or minus 10 Kc. This would be the ideal sub-carrier generator.

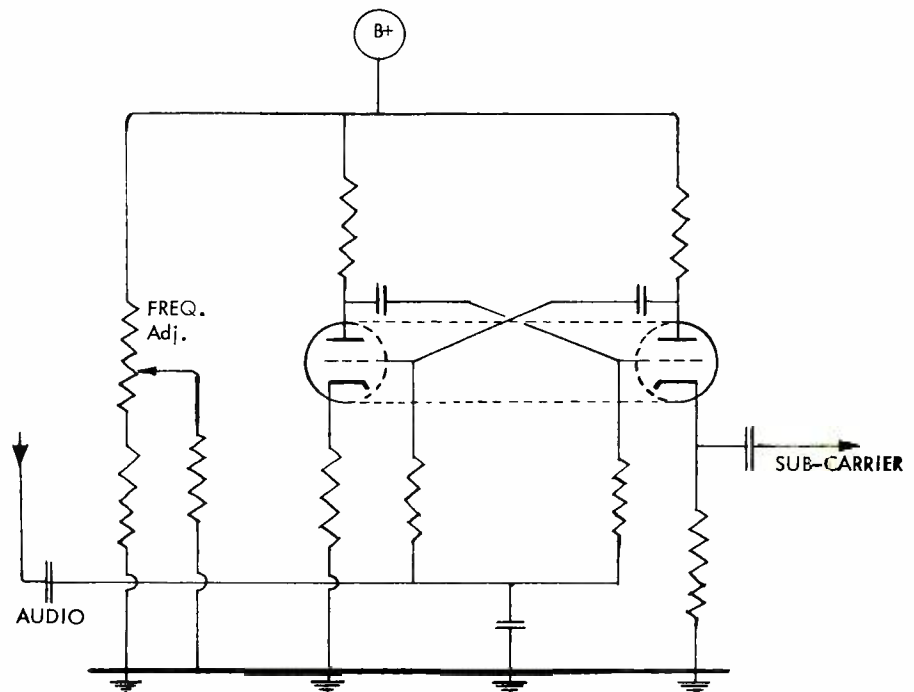

Figure 3. The positive biased multi-vibrator which produces a frequency modulated signal.

# The Development and Application of Synthetic Reverberation Systems

By LEWIS S. GOODFRIEND\* and JOHN H. BEAUMONT†

**Reverberation is an essential element of audio program material. This article traces the historical and engineering development of synthetic reverberation systems from the echo chamber through acoustical and electromechanical devices to the modern re-entrant magnetic tape reverberation generator. The use of multiple heads with electronic re-entry and the need for nonintegral spacing of heads and extremely uniform electronic frequency response in magnetic tape systems are analyzed.**

SINCE the early days of talking pictures, audio engineers have been using synthetic reverberation to increase the apparent reverberation time of program material. Such a technique permits broadcasts or recordings made in small absorbent studios to sound as if they had been made in a concert hall, a cathedral, or a cave. Today, reverberation is added to program material for motion pictures, radio, television, and phonograph records.

Early systems for adding reverberation to program signals were in general based on the use of an echo chamber; that is, a large empty room with highly reflective walls. A room of 10,000 cu. ft. volume is

capable of a reverberation time as long as ten seconds. A microphone and loudspeaker are located in the room. The signal to be modified is fed to the loudspeaker and is picked up by the microphone after being modified by the room reverberation. The input signal may be fed from a wye connection on the control console to one mixer position and to the amplifier for the chamber loudspeaker. The microphone pre-amplifier signal is fed to a second mixer position, and the amount of the reverberant signal added to the direct channel determines the effective reverberation time. This system is still in use today. It has one major advantage. It is purely acoustical reverberation that is being added to the program signal. Use of an equalizer after the reverberation channel permits the reverberant signal to be further modified to give the boomy reverberation of a cave or the balanced reverberation of the concert hall. The major disadvantage of an echo chamber is the amount of space which must be allocated for a discontinuous use.

However, in a large organization, several echo chambers may be required for use simultaneously, although for only a few minutes a day. The rest of the time they are unproductive. Also, the problem of getting sufficient sound isolation between several chambers is not easy to solve. In addition, it is common to employ several microphone positions within a chamber in order to obtain special effects. Thus, the investment in both real estate and equipment for echo chambers is often quite high.

## Prior Art

As soon as the primary requirements for an echo chamber signal were determined, smaller and less expensive means were considered for the purpose. The three major requirements for synthetic reverberation are an initial time delay, a series of delayed signals similar in structure to the original signal, and a rela-

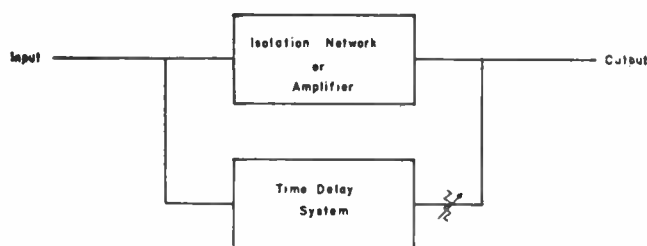

Figure 1. Basic form of reverberation generator.

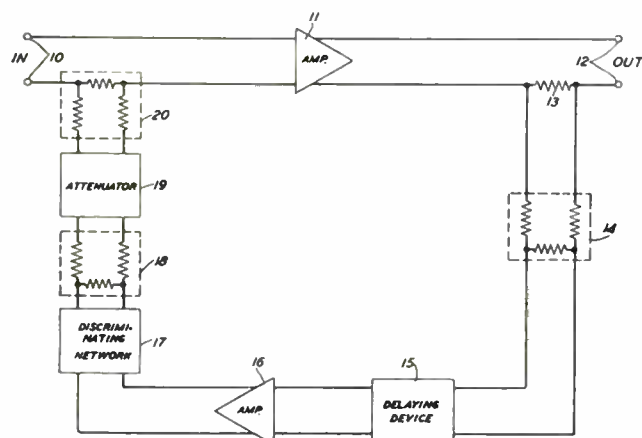

Figure 2. E. H. Schreiber reverberation generator.

\*Lewis S. Goodfriend & Associates, Montclair, New Jersey.

†Vanguard Recording Society, New York, N. Y.  
Reprinted from the October, 1959, issue of the Journal of the Audio Engineering Society.



# STRAIGHT TALK TO BROADCAST ENGINEERS

## NEW TRANSISTORIZED REMOTE MICROPHONE COMBINES A ONE-CHANNEL REMOTE AMPLIFIER AND MICROPHONE IN A HAND SIZE UNIT

By Bob Hite  
Collins Radio Company

Now, for the first time, the broadcaster can carry a complete, lightweight remote microphone and amplifier in the palm of his hand. The Collins M-60 remote microphone and amplifier assures an easy mobility never before possible in remote broadcasting.

This one-package unit can be carried in the glove compartment of a car and you can have on-the-spot news broadcasts without having unpleasant beeper-type interviews. By having a downtown 6-, 10- or 12-point loop, you can have a studio quality interview at the news source. It is possible and very economical to have one loop with a number of tie point jacks at all important news locations. In the event of a newsworthy accident, you simply plug into the nearest M-60 line block for a quality, on-the-spot report. The mobility of the M-60 at basketball games, football games, track meets, etc., is evident because it is quite feasible to locate several M-60 line jacks at the scene to allow the announcer the most convenient position for the best coverage.

The small size of the Collins M-60 is made possible only by adapting the latest techniques used in high-fidelity transistor amplifiers. The M-60 features an amplifier which operates on a par with conventional tube-type remote amplifiers. Normally, in any tube-type amplifier, at least two tube

types are used — one as a rectifier and the other for amplification. In the M-60 remote microphone there is only one type of transistor, which cuts maintenance and spare stock to a minimum.

This broadcast quality, transistorized amplifier assures the necessary gain to amplify the low level output of the microphone head, which provides the highest possible fidelity consistent with its size. To provide ruggedness it was necessary to choose the dynamic type of microphone which is capable of operating under extreme conditions without deviating in response or other characteristics.

The microphone chamber is completely sealed and isolated from the amplifier section so that the microphone diaphragm and voice coil operate under optimum conditions at all times. By incorporating special front port features, the low frequency response of the M-60 is extended beyond that normally found in a dynamic microphone of this size. The low level output of the voice coil is brought through a matching transformer into the first transistor stage of amplification. Here the weak signal is amplified to bring it up to a plus 12 dbm line level without distortion or adding any unwanted coloration.

The M-60 features six plug-in type transistors which can be easily removed or replaced in seconds. By using transistors, the

remote microphone-amplifier eliminates the usual problems associated with tubes, such as warm-up time, high power consumption, microphonics, ventilation and large space requirements. These transistors require so little power that you can expect at least 100 hours of operation from the self-contained 5.4 volt mercury cell, and they generate a negligible amount of heat. The entire amplifier assembly takes up no more space than the battery. Inserting the ear-phone plug turns on the amplifier and provides the announcer with a monitor.

The usual "rat's nest" of cables running between the conventional microphone and the remote amplifier is eliminated. This microphone cable is replaced by an internal pressure contact in the M-60. The only connecting cable necessary with the M-60 is the simple line extending from the base of the amplifier section to the remote line jack. Since this line is 600 ohms at high level, shielding is unnecessary. This means that in covering a large convention it is possible for the first time to use unlimited amounts of line between the microphone and the master control room.

The body of the Collins M-60 microphone is made of aluminum and finished in non-reflecting, blue-gray baked enamel. A modern desk stand is available for conventional desk mounting when the M-60 is used in the broadcast or recording studio.

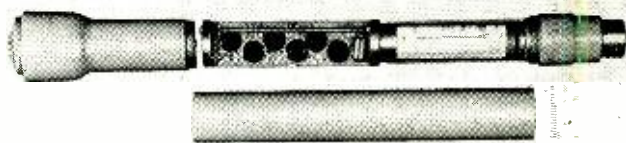
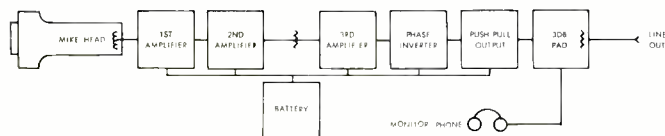

Collins M-60 Remote Microphone



COLLINS RADIO COMPANY • CEDAR RAPIDS, IOWA • DALLAS, TEXAS • BURBANK, CALIFORNIA

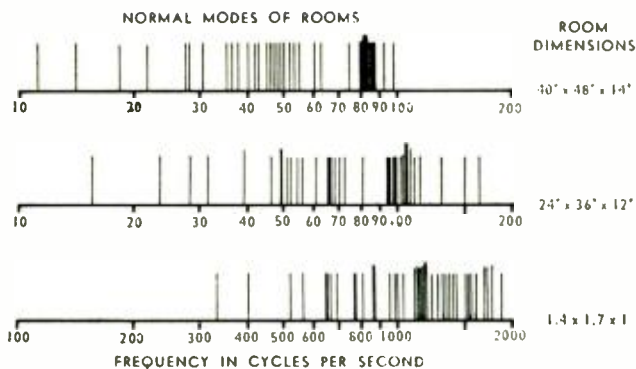

Figure 3. Lowest normal modes of chamber: (A) 40 × 48 × 14 ft.; (B) 24 × 36 × 12 ft.; (C) 1.4 × 1.7 × 1 ft.

tively smooth decay in level. Many such systems have been conceived. They basically are all illustrated by the block diagram of Fig. 1. These systems may be divided into the following general categories: three-dimensional acoustical systems, one-dimensional acoustical systems, mechanical delay systems, two-dimensional mechanical delay devices, electrical wave-delay lines, electro-optical systems, multiple-head magnetic recording devices, and finally the re-entrant magnetic tape recording system.

Some examples of these will illustrate the problems and the progress in the field.

In 1934, a patent was issued to E. H. Schreiber on the basic system as illustrated in Fig. 2. This is a loop system, and if the gain of the loop is too high it will ring just like a sound system "feeding back." A more complex echo chamber system was covered in a patent issued to A. Pfister in 1938. In the same year, Alfred N. Goldsmith was issued a patent for a system using a multiplicity of reproduce heads with a magnetic wire recording system. The complexity of the mechanical system and the inability of wire recording to provide professional recording or broadcast quality prevented the system from becoming popular.

An ingenious application of electronics and optics was patented by Peter C. Goldmark in 1940. It made use of a large flat disc, the rim of which was coated with phosphorescent materials. Recordings were made on the coated rim with a modulated light source and were picked off the rim by appropriately spaced photocells.

The exponential decay of the phosphorescent material was used to approximate the acoustical decay in a room. The mechanical and electrical complexity of the device and its limitations with respect to noise, frequency response, and distortion due to the phosphorescent material in addition to its high cost precluded its wide use.

In 1941, S. K. Wolf demonstrated the first use of magnetic recording tape in a synthetic reverberation generator.

Erase and record heads were followed by 16 playback heads. The tape was a steel ribbon. To simulate

reverberant decay the level of each signal from each playback head had to be adjusted to match a pre-selected decay curve. The cost of the system and World War II cut short experimental use of the equipment. Following the war, plastic base iron oxide recording tape was introduced into this country and no further work employing steel tape was carried out on this device.

A small box containing concave mirrors was patented in 1942 by E. W. Davis who claimed in the patent that the mirrors would reflect sound to produce "a polyphase wave pattern . . . resembling a choral effect." Unfortunately the box is too small to provide a sufficient delay, and any signal in it would suffer a considerable change in quality.

The use of ultrasonic carriers modulated by the audio signal and delayed by suitable ultrasonic delay methods was covered in a patent issued in 1943 to W. D. Phelps.

In 1947, a patent was issued to M. Parisier for a system in which a small reverberation chamber could be evacuated to control the acoustic velocity and thus the rate of decay.

Later, in 1947, a patent was issued to Barton Kreuzer in which he disclosed a method using ultrasonic signals modulated by an audio signal. The ultrasonic signal was to be inaudible and to be fed by a transducer into any space suitable for reverberation whether it was in use or not. No mention was made of the fact that air absorption severely limits reverberation time at high frequencies. H. F. Olson was issued a patent on a system of transducers and long pipes in 1950.

In addition to these systems, others—some patented and some not—were developed to produce synthetic reverberation. Among the others are the Hammond multiple, oil-damped spring system, and a variety of magnetic tape and acoustical pipe and transducer systems. None but the echo chamber and the modern re-entrant magnetic recording tape system has received wide commercial acceptance.

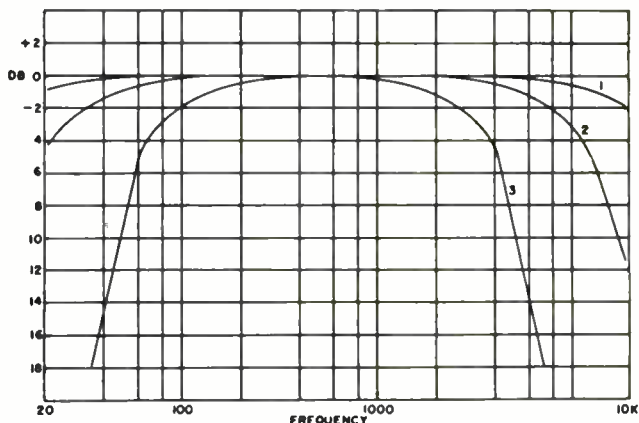

Figure 4. Frequency response of a re-entrant tape system after various numbers of signal repetitions, showing effect of inadequate uniformity of response of ordinary tape recorder.

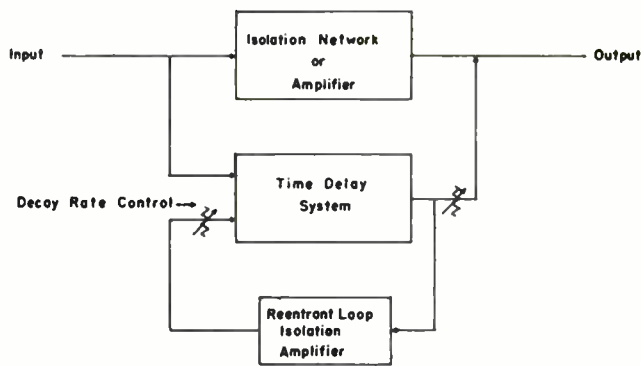

Figure 5. Re-entrant tape system, block diagram.

### Acoustical Requirements

To learn why acceptance has been so limited, one must turn to the fundamentals of acoustics. In studying the acoustics of enclosures, the equations for the decay of sound energy in a room are used.

After a sound source has been turned off, the energy in a diffuse sound field in a room at any instant can be written as

$$E(t) = E_0 e^{-bt},$$

where  $b$  is the damping constant. The equation has a form similar to that of the decay of direct current in an  $RL$  circuit, having a time constant  $1/b$  or  $4V/Ac$ .

Reverberation time is defined as the time required for the energy to drop 60 db, that is, to a value  $1/10^6$  of the initial value; or

$$[E_0/E(t)] = 10^6$$

thus

$$bT_{60} \text{ db} = 6 \log e 10$$

and

$$\begin{aligned} T_{60} \text{ db} &= (4V/Ac) \ln 10^6 \\ &= [(24 \ln 10)/1130](V/A) \\ &= (0.049V)/A, \end{aligned}$$

where  $V$  = room volume in cubic feet and  $A$  = total room absorption including air absorption.

### Modal Structure

Now where  $T$  is to be large, the total absorption,  $A$ , must be small and the volume must be large. In addition, to approximate acoustical reverberation, one must approximate the room resonances, the normal modes of decay. For a "good" live room the reverberation time must be long and the normal modes must be well-spaced. The equation defining the normal modes in a room is as follows:

$$fr, s, t = \frac{c}{2} \sqrt{\left(\frac{r}{l}\right)^2 + \left(\frac{s}{w}\right)^2 + \left(\frac{t}{h}\right)^2}$$

With two pairs of opposite walls completely absorbent, the equation reduces to  $fr, s, t = (c/2) \cdot (r/l)$ .

It is the correct modal structure that provides smooth decay and thus realism and acceptability in synthetic reverberation.

Also, it is necessary that the repetitions occur at an interval after the initial sound, usually in the range two hundredths to five hundredths of a second, succeeding intervals being shorter.

Many systems can provide merely a prolongation of sound energy through the repetition of signals after discrete time intervals or at selected frequencies; however, even signals which were produced by relatively high-quality delay devices and which prolonged the energy with many like repetitions were rejected by the recording and broadcast industries for many years. Also rejected were all of the earlier devices previously mentioned.

### Characteristics of Various Systems

Let us test several systems for continuity of energy decay and modal structure.

First let us check a large room for reverberation time and the lowest normal modes which will be generated.

The room dimensions are  $40 \times 48 \times 14$  ft.

The lowest normal modes are shown in Fig. 8 at  $A$ . Note the wide distribution. The reverberation time with plaster walls is 5.2 sec. If the walls are shellacked, the reverberation time will be 14 sec.

A small enclosure (equivalent to a converted storage closet) such as some proposed in early patents for direct reverberation or for models with ultrasonic carriers, might have dimensions of  $5 \times 7 \times 9$  ft. The three lowest modes occur at 63, 81, and 113 cps which are too high in frequency. The maximum reverberation time will be 3.6 at 500 cps with all surfaces shellacked plaster on concrete or brick. However, with air absorption at 16 kc, the reverberation time would be only 0.7 sec. for such an ultrasonic signal. Also, the first reflection will occur in less than 0.01 sec. This is why a small echo chamber sounds so poor.

### Pipes

Four pipes of 25, 55, 75, and 110 ft. in length will produce an initial delay of 22.2 msec and a maximum delay of 97.5 msec and correspond to the lowest modes of a room of  $37.5 \times 27.5 \times 12.5$  ft. Although

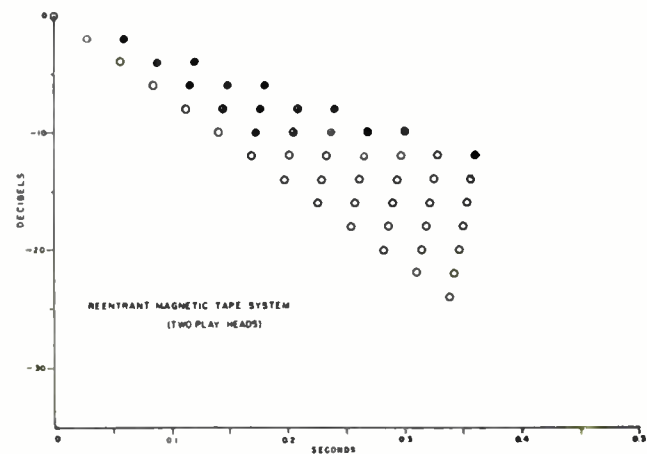

Figure 6. Effect of nonintegral head spacing in filling time intervals.

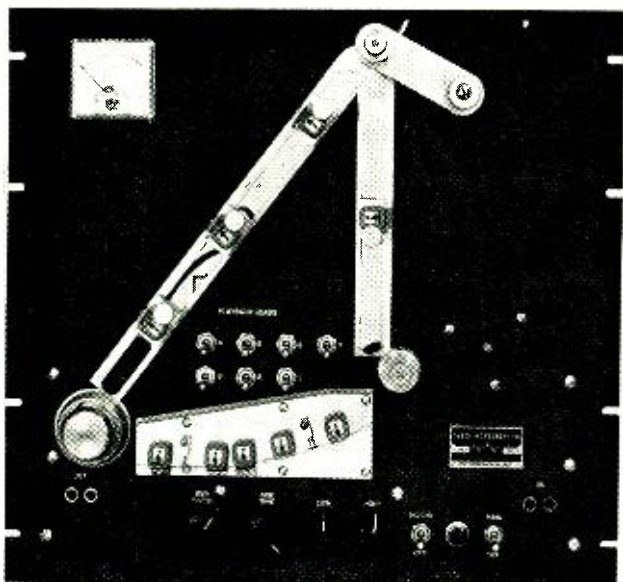

Figure 7. Reverberation generator using a tape loop and seven playback heads.

the normal modes are suitable such an arrangement does not meet the requirements for prolongation of energy since the energy is distributed in four packets and the effect is obviously not exponential but may be defined as

$$E(t) = aE_1 + bE_2 + cE_3 + dE_4,$$

where  $a$ ,  $b$ , and  $c$  are less than unity and  $E$ 's are the sound energy values at the earlier time when the source is shut off.

If the number of pipes is increased sufficiently, the system becomes quite effective, but initial and maintenance costs are prohibitive. Also, in general the delays must be of fixed duration.

### Springs and Plates

Examining a spring system, we find that the transmission velocity of usual metals is 10 to 15 times greater than that for air. Thus, to achieve an appropriate initial time delay requires excessive lengths of materials. Common spring systems and metal plate or screen systems require that the signal be reflected many more times per second than occurs in a large chamber. For example, a metal plate eight feet by three feet is equivalent to an air cavity approximately two inches by six inches. Thus, the signal has considerably more opportunity to be modified in frequency spectrum on each reflection. It should be noted that a spring provides true exponential decay but that the damping varies with frequency. This gives springs and other metallic reverberation systems a typical ringing or "metallic" characteristic.

Plate and wire screen systems are also afflicted with the same problems as springs—long decay at the expense of quality degradation and one-dimensional modal characteristic.

Some attempts have been made recently to use light metal sheets excited in their plate mode rather than their longitudinal modes. In such systems the result is highly frequency dependent and such sys-

tems tend to have a boomy quality at low frequencies for long reverberation times. They are also limited in maximum decay time to two or three seconds at all except extremely low frequencies because of the size limitation. Also, they do not provide the initial delay in the arrival of the first reflection, essential to naturalness.

To achieve realistic synthetic reverberation, one must provide characteristics similar to those in a large reverberant space which were discussed earlier: (1) A discrete time delay for the first few reflections similar to the delay achieved in a chamber (Fig. 13); (2) exponential energy decay; and (3) nonresonant decay similar to a chamber with widely spaced normal modes.

### The Re-Entrant Tape System

After World War II, it occurred to many people that modern magnetic recording tape would provide an excellent storage medium, and the time delay between recording head and playback head would provide a suitable delay for the first reflection. Attempts to use commercial tape recorders for this purpose, returning a portion of the output to the input, have not been successful. The reasons are basic. First, only one time delay is provided corresponding to a one-dimensional room, a pipe. Second, the use of the electronic equipment of a commercial tape recorder for such a re-entrant system introduces amplitude-frequency changes which, in turn, cause an unnatural ringing sound in the output, as in Fig. 9.

Thus, a new criterion must be added to that of the three earlier ones. The re-entrant system must be sufficiently uniform in response to produce hundreds of generations of copies from the original signal without quality degradation.

Considering a re-entrant system, such as that shown in Fig. 10, one can see in Fig. 4 that losses of 0.1 db at 100 and 7000 cps will become 10 db after 100 generations. Losses of 0.5 db at 40 and 12,000 cps will become 50 db after 100 generations. This is the basic problem of a re-entrant system. However, a re-entrant system with two carefully equalized play-

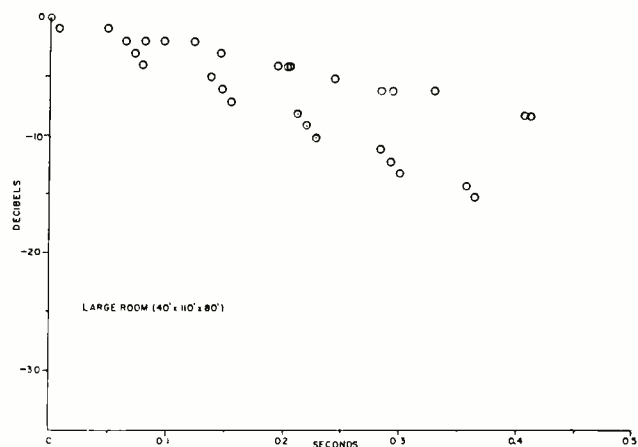

Figure 8. Reflections in an echo chamber 40 × 110 × 80 ft.

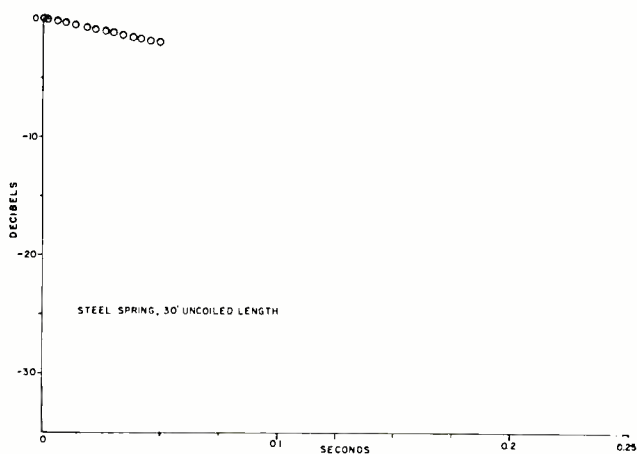

Figure 9. Operation of a steel coil spring.

back heads and suitable delays between heads should provide long smooth decays. Since the output level of such a system is an exponential function of time, the system meets this criterion.

The spacing of heads and the tape speed determine the time delays and effective normal modes. The tape speed is set at 30 ips by the demand for *extremely* uniform response in the range 100 to 10,000 cps, with only simple *RC* equalization permissible. With more complex network equalizers, it is impossible to maintain a sufficiently flat frequency response. With still higher tape speeds than 30 ips, tape and head life are greatly reduced.

We have thus determined the various criteria for a re-entrant magnetic tape recording synthetic reverberation generator. No difficulty is found in achieving such a system in practice. The basic design parameters are tape speed, frequency response, time delays, and number and spacing of playback heads.

Having fixed the tape speed at 30 ips, the spacing of heads was arranged to achieve a minimum initial time delay of 28 msec. Time delay for the second head was set at 63 msec in the prototype model which gave a delay in time between the first and second heads of 35 msec.

If a portion of the playback signals is returned to the input the nonintegral relationship between the head spacing delays provides new signals between the signals provided by the pickup heads on playing the second generation recording (Fig. 6).

Considerable experimental work has verified the design criteria. Translating these requirements into electronic and structural terms, we can state: (1) The tape and electronic system must be flat to within  $\pm 0.1$  db from 100 to 10,000 cps. (2) The tape speed shall be 30 ips. (3) The minimum record-to-playback head spacing shall be 20 msec. (4) The maximum spacing between successive playback heads shall be 50 msec. (5) The ratio of spacings of the heads shall not be integral. (6) A re-entrant record-playback system is required. (7) At least two playback heads must be used (but as many as six are permissible).

To discuss the problem of head spacing a bit further, it should be pointed out that the use of playback heads spaced by an integral ratio from the record head merely adds level to the signal but contributes no effective reverberation. The use of non-integral spacing provides additional energy in the time domain at such points as to contribute to the reverberant energy but not adding appreciably to the voltage amplitude of the signal; i.e., the decay curve is smoother.

Figure 7 shows a current version of a magnetic tape synthetic reverberation unit<sup>‡</sup> designed in accordance with these principles.

It is equipped with seven playback heads, some of which are positioned for echo effects. Their use is controlled by the toggle switches located over the central head assembly. The VU meter is used to verify input signal levels and adjust output levels to correspond to levels in the user's system. Controls are also provided to adjust the level of the reverberant signal in relation to the direct signal, and to control the rate of decay. The rate of decay control in effect controls the damping constant in the exponential equation

$$E(t) = E_0 e^{-\alpha t},$$

and so changes the effective reverberation time.

Side-by-side comparisons between an echo chamber (Fig. 8) and this re-entrant magnetic tape reverberation generator (Fig. 6) show that it can duplicate all of the useful effects of the chamber. Some chambers can sustain single tones from oscillators for extreme periods of time. Although careful adjustment of the tape generator can duplicate this effect it has no practical use, and no attempt is made to adjust production machines for this purpose. It is impossible to tell the difference between music and speech signals to which reverberation has been added by the synthetic reverberation generator and those from an echo chamber.

For comparison we show results from a steel spring (Fig. 9) and from a multiple pickup tape system without feedback (Fig. 10).

<sup>‡</sup> U. S. Patent 2,748,192.

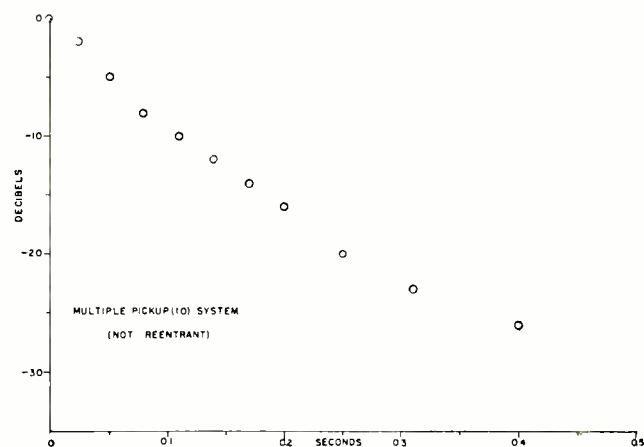

Figure 10. Operation of a non-re-entrant tape loop system using ten playback heads.

# THE EFFECTS OF TRANSMITTER SOUND POWER REDUCTION ON TV RECEIVER PERFORMANCE

The report of the Television Allocations Study Organization indicates that receiver performance would be adversely affected by TV sound power reduction.

TESTS were made on representative television receivers to determine the effects of a reduction in sound power on the performance of television receivers. The receivers used in these tests included the various types of sound detector circuits currently in use and the results obtained are therefore felt to be representative of those which can be expected in the field using new, aligned receivers of modern design, properly installed.

The following types of tests were made in order to determine the extent to which receiver performance was affected or modified by a reduction in transmitter sound power below the value currently standardized, i.e., between 50 per cent and 70 per cent of the peak visual power:

1. Thermal noise (signal-to-noise ratio)
2. Impulse noise rejection

Additionally, consideration was given to the problem with respect to:

1. Loss of service area
2. Adjacent-channel interference
3. Fine-tuning characteristics
4. Fading
5. Co-channel interference
6. Sound vs. picture performance

It has been the experience of receiver manufacturers since receivers were first put on the market that there has been an ever present demand for greater sensitivity. Users in fringe areas are in many cases willing to install receivers at considerable expense provided a good, re-

liable sound signal can be obtained even though the picture performance may be subject to fading, interference, impulse or thermal noise of a magnitude such as to cause serious picture degradation, or even a loss of picture from time to time. In such areas a reduction in sound power would result in serious impairment of service and in many cases a complete loss of service. With respect to thermal noise, the Committee 2.6 report, Figure 2, shows a loss as high as 2 db in signal-to-noise ratio for each db of sound carrier power reduction in low signal areas.

There are many areas where the impulse noise is considerably above the thermal noise level. Receivers operated in these areas would suffer a loss of tolerance to impulse noise of about one db for every db reduction in sound power. This performance loss occurs at strong signal levels as well as at weak signal levels. This is shown in Figures 3 and 4 of the committee report.

Figures 5 and 6 of the committee report show the loss of service area for the low and the high VHF bands, considering only receiver noise. This amounts to about 20 per cent on low-band channels and 10 per cent on high-band channels for a 7 db reduction in sound power.

The effects of sound power reduction on the receiver performance

characteristics studied by the committee were, in every case, adverse, except for adjacent-channel interference in a small percentage of the receivers where the resulting improvement might be short-lived for reasons mentioned in the committee report.

It is the consensus of the Panel that any reduction in sound power would be detrimental to a significant number of users of television receivers for the reasons mentioned in the report.

The question which is of concern to TASO Panel 2 and to Committee 2.6 is the extent to which receiver performance characteristics will determine the change in television transmitter service area in the event of a change in sound-to-picture power ratio.

All modern television receivers use an essentially similar system of reception of sound signals and since an understanding of the system is necessary in any study of the material of this report a short description will be given.

Both visual and aural signals picked up by the antenna system are amplified and converted to an intermediate frequency in typical superheterodyne practice with no intentional amplitude selectivity between the two carriers. Both signals are then amplified by a wide bandwidth intermediate frequency am-



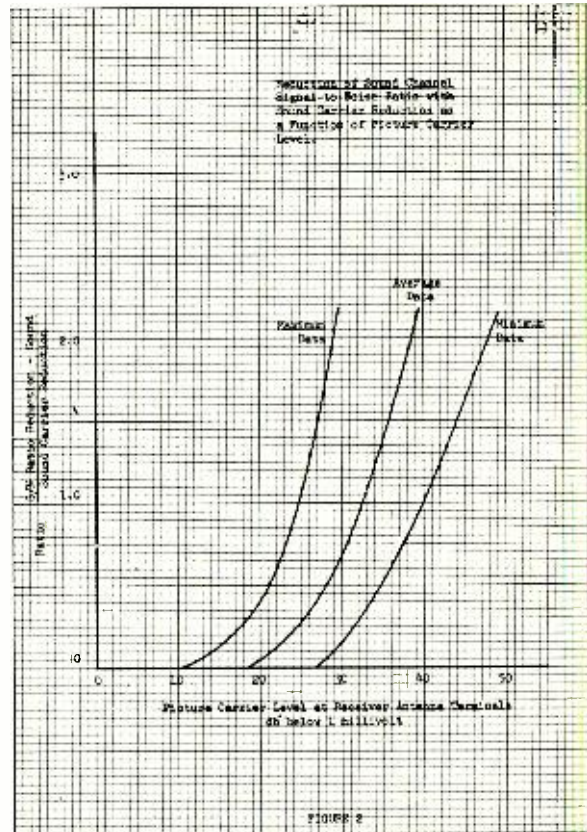
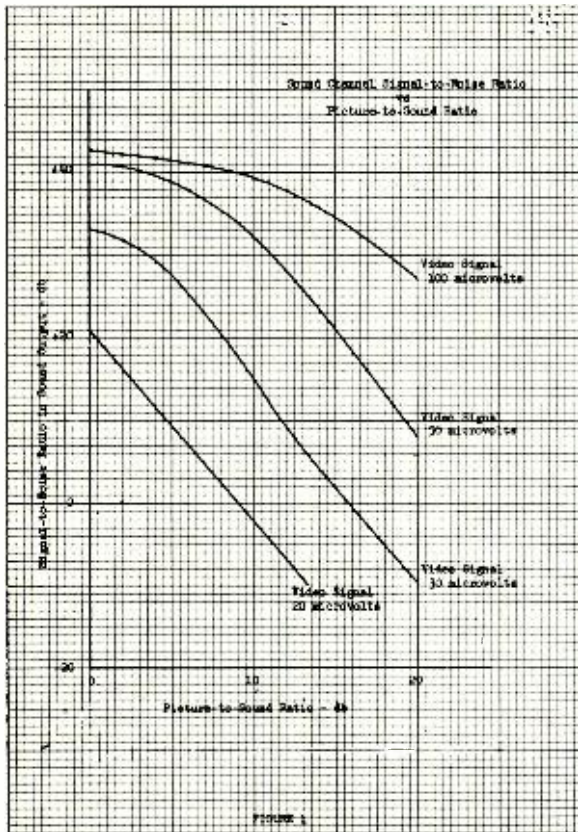

plifier system, the output of which is coupled to a second detector. The output of the second detector includes, in addition to the demodulated visual signal, the beat product of the visual and aural carriers, which is a 4.5 mc signal carrying the frequency modulation information of the sound carrier. This 4.5 mc signal is then amplified further and fed to a frequency modulation detector, which may be of several different types depending on design engineer preference. These types vary in method of operation and circuit detail but within normal variations are substantially similar in performance. In the combined picture and sound intermediate frequency amplifier, the sound signal is attenuated only enough to minimize the appearance of the amplitude modulation of the picture signal from appearing in the 4.5 mc beat signal output of the second detector and to prevent the loss in picture quality, such as contrast ratio and beat patterns. Further, it is usually necessary to provide additional attenuation at 4.5 mc in the video amplifier circuits to reduce the visibility of the beat pattern in the picture output. It is necessary to provide this attenuation *after* the sec-

ond detector, rather than in the intermediate frequency amplifier in order that the maximum sound sensitivity can be obtained from the output of the second detector. The major advantage of this method of sound reception, known as an "intercarrier" system, is that it is generally free from dependence on the local oscillator frequency setting. The frequency of the signal detector is dependent only on the frequency spacing of the transmitted visual and aural signals. This means that the television receiver viewer need not accurately set the local oscillator for good sound reception but may tune for optimum picture reception. Also, the sound system is not susceptible to serious performance degradation in the case of local oscillator drift or local oscillator frequency modulation such as may occur because of receiver hum. (It should be noted that without the use of intercarrier sound reception methods, dependence on local oscillator tuning and performance would have made the problems of UHF receiver tuner design almost intolerable.)

The present standards of television transmission provide that the aural transmission power shall be

between 50 per cent and 70 per cent of the peak visual transmitter power. The effects of a reduction in transmitted aural power, from these standards, on typical modern television receivers will now be considered.

1. *Thermal Noise Performance* — A reduction in transmitted aural power will result in poorer receiver thermal noise sound performance which will, by reduction of receiver fringe area sound performance, reduce the sound coverage of any given transmitter. To obtain experimental verification of the reduction of sound channel thermal noise performance, measurements were made on nine different receivers in the engineering laboratories of some of the members of TASO Panel 2. Four different types of FM detector systems are represented in these receivers covering every type in use today. In all cases, measurements are for one of the lower VHF channels. Figure 1 represents the data of one of these receivers which is typical of the group. Sound channel signal-to-noise ratio is plotted as a function of picture carrier signal levels. It can be seen that for each signal level there is a threshold value of picture-

to-sound ratio below which the signal-to-noise ratio degrades rapidly. Figure 2 presents a summary of these data for all the measured receivers. The loss of sound channel signal-to-noise ratio per unit reduction in sound carrier is plotted as a function of picture carrier level. In these data the average of all the receivers is presented and the data for the measured extremes are also plotted. As an example, from this curve it can be seen that with 20 microvolts of picture signal (open circuit antenna voltage delivered through a 300 ohm dummy antenna to the receiver), an average loss of about 1.5 db in signal-to-noise ratio will occur for each db of aural carrier power reduction.

These data are for new, aligned receivers of modern design. If we add the losses expected due to misalignment, tube aging and antenna orientation and mismatch, as well as transmission line losses, it is reasonable to expect that this type of signal-to-noise ratio loss would occur in the 100 to 200 microvolts-per-meter range of signal strength in a substantial number of receivers currently in the hands of the public.

Sound quieting sensitivity which takes into account only thermal noise considerations is 30 microvolts for the typical receiver in the group used to obtain these data. In the report on receivers prepared by Committee 2.1 of Panel 2, the Picture Sensitivity for 78 receivers reported varied from 4 to 150 microvolts. The distribution of sensitivity shows:

12.8%	Less than 10 microvolts
34.6%	Between 10 and 20 microvolts
19.2%	Between 20 and 30 microvolts
11.5%	Between 30 and 50 microvolts
9.1%	Between 50 and 100 microvolts
12.8%	Greater than 100 microvolts

The importance of fringe area performance may be judged by the fact that more than 66 per cent of the receivers reported picture sensitivities better than 30 microvolts.

**2. Impulse Noise Rejection Performance**—A common form of noise interference in the sound channel is that caused by automotive ignition noise, electric motor commutator noise (shavers, mixers, vacuum cleaners, etc.), arcing switches, and lightning. This form of noise is usually lumped under the general heading of impulse noise. In order to measure the effect of aural carrier power re-

duction on receiver performance in the presence of this form of noise, an interference source, such as a non-synchronous 60 cps rotating arc device was coupled through a variable attenuator into the antenna circuit of the test receiver in parallel with the desired standard visual and aural television signal. The interference noise signal input to the receiver was increased until its presence was noted in the sound output of the receiver either by aural or measured output detection. The aural signal was then reduced in steps and at each step the change in noise interference required to restore the original condition was recorded. Data were obtained on seven different commercial receivers, independently measured in the laboratories of Panel 2 members, and data for a typical receiver are plotted in Figure 3 for visual signal input levels ranging from 50 to 10,000 microvolts. Figure 4 presents a plot of data for the relative impulse noise level for constant audible interference as a function of sound-picture ratio. This is the average of all data for all seven receivers measured. A loss of tolerance to impulse noise of

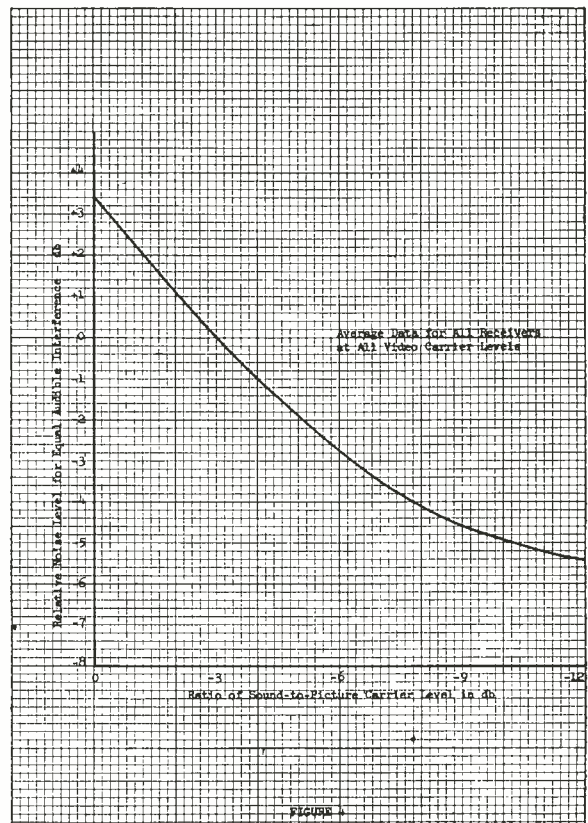
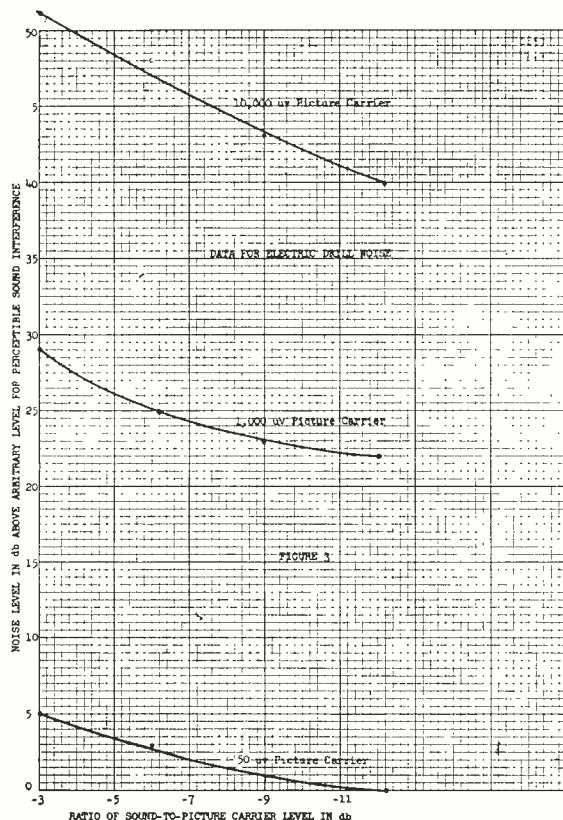

about 1 db for every db of reduction in aural power is noted. This performance loss occurs at strong signals as well as weak; the performance loss with reduction of aural power is as great at 10,000 microvolts as it is at 50 microvolts. As in the previous case for thermal noise, these data are for new, aligned receivers of modern design.

**3. Loss of Service Area**—In order to show the loss of service area resulting from a reduction of sound power, the required field strength in db above 1 uv/meter to produce 30 db quieting was determined by measurement of the quieting sensitivity for representative TV receivers under existing transmission standards and calculation of the equivalent field strength using the formula and data presented in TASO Committee 2.4's report. The average figures for antenna gain and transmission line losses were used for channels 4 and 10 which are about in the middle of the two frequency ranges. The required increase in video and sound signal levels to compensate for a reduction in sound power with respect to video power was determined to be

.57 db for each db drop in sound power. This was obtained from the average degradation in signal-to-noise ratio at the 30 db level in data furnished by the members of this Committee.

Finally, the reception range and loss of service area was determined from the FCC curves of expected field strength,  $F(50, 50)$  assuming maximum authorized power in the TV transmitter, and representative antenna heights.

The attached Figures 5 and 6 show the loss of service area for VHF channels 2-6 and 7-13 resulting from a reduction of sound power below the present minimum of 3 db below the peak video power. The service area is reduced about 20 per cent on the low VHF channels and about 10 per cent on the high VHF channels if a 7 db reduction in sound power is made.

**4. Adjacent Channel Interference**—A reduction in transmitted aural power would reduce the lower adjacent channel sound interference in those areas where it now exists by an amount equal to the sound power reduction. Examination of the receiver

report of Committee 2.1 of Panel 2 shows that receiver attenuations for the lower Adjacent Channel Sound Signal vary widely, ranging from a 14 db to 60 db, distributed as follows:

- 11.8% Less than 30 db
- 42.1% Between 30 and 40 db
- 13.1% Between 40 and 50 db
- 32.9% Greater than 50 db

Other factors which are of importance but less susceptible to a quantitative analysis include:

**5. Fine Tuning**—A reduction in transmitted sound power will result in a more critical requirement for "fine tuning" in weak signal areas, thus increasing the need for skill and judgment in adjusting the fine tuning control, a function in which most consumers are presently inept.

**6. Fading**—A reduction in transmitted sound power will aggravate the effects of fading, either natural or manmade, such as airplane flutter, on the sound performance of the TV receiver.

**7. Co-Channel Interference**—In some locations, at present both picture and sound reception is limited by co-channel interference. Co-channel picture interference can be con-

(Continued on page 38)

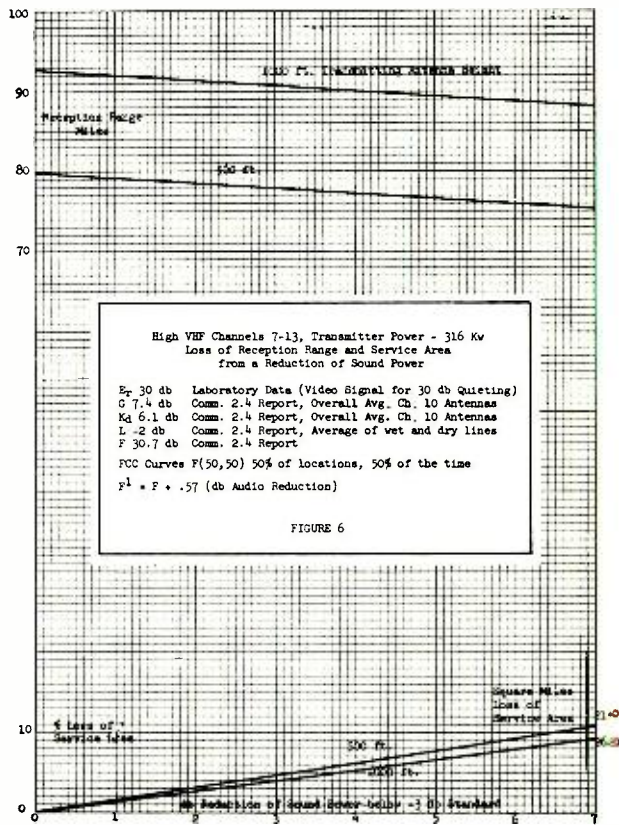
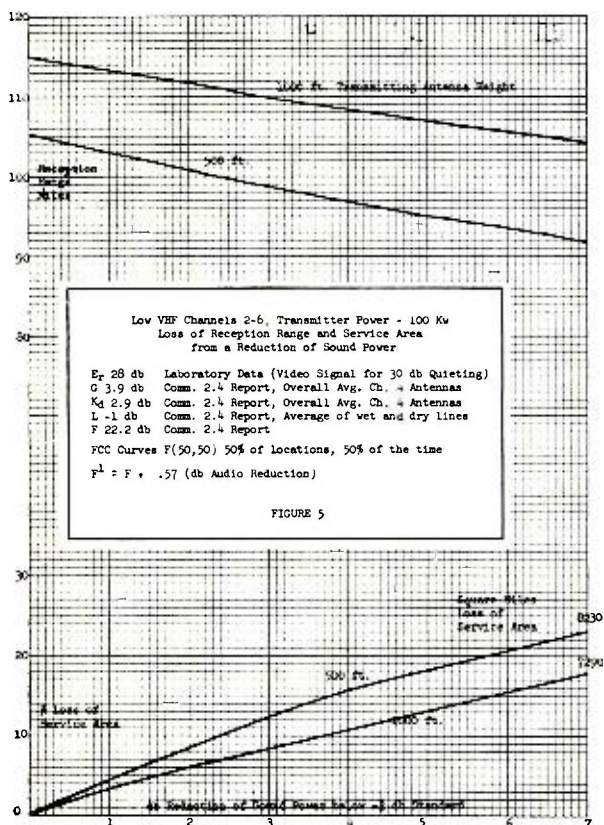

# STEREOPHONIC BROADCAST EXPERIMENTS AT KISW-FM

The system described in the August issue of *Broadcast Engineering* has now been tested on the air. Results of these tests and experiments are described in this article.

By ELLWOOD W. LIPPINCOTT\*

On Nov. 6, 7 and 8, during the third annual Hi Fi Music Show (Rigo Enterprises) held in Seattle, Wash., KISW-FM broadcast six hours daily of stereophonic programs using a method announced several months ago and published in August, 1959 (*Broadcast Engineering*).

The method as outlined had proven sound and workable on paper and some experiments had been conducted but an actual broadcast using this method had not been tried.

Equipment was built for one transmitting unit and one receiving unit. Several problems encountered had not been reckoned with until construction was under way. Due to the lack of time, 19 days in all, engineering had to go by the board and any workable method that would accomplish the desired results was followed for expediency. The results were far greater than anticipated but

much was to be desired in the way of simplification.

The transmitting unit consisted of a five-tube amplifier and switching circuit. In addition three tubes were utilized in the synchronizing circuit which would assure that both the transmitting and receiving ends would operate in exact unison or synchronization.

A switching frequency of 30,000 cycles was chosen for the simplicity and ease in adjusting with the equipment at hand.

It should be pointed out that the frequency of 30 Kc is too low for switching because, for instance, a 50-cycle tone is sampled 600 times per cycle while a 15,000-cycle tone is only sampled twice per cycle causing a reduction or attenuation of the higher frequencies. Some compensation could be accomplished by pre-emphasis.

At the transmitting end the right and left input channels were fed to the grids of the input amplifier (12-AX7). The cathodes were switched by a driver tube (12AU7) and the output of both halves of the driver were connected in parallel and fed to a cathode follower (6C4) output amplifier. The combined signals from both right and left channels were then fed to the KISW-FM audio console and broadcast as a composite signal. A 30 Kc multivibrator (12AU7) generated the switching pulses and operated the switches through a driver (12AU7).

This same 30 Kc pulse was amplified then fed to a 15 Kc multivibrator, again amplified and fed to the telephone line for synchronizing purposes.

It should be added here that time would not allow for building the necessary synchronizing equipment for

\*KISW-FM, 9201 Roosevelt Way, Seattle 15, Wash.

Figure 1

A Method of Compatible Stereophonic Broadcasting for FM Stations.

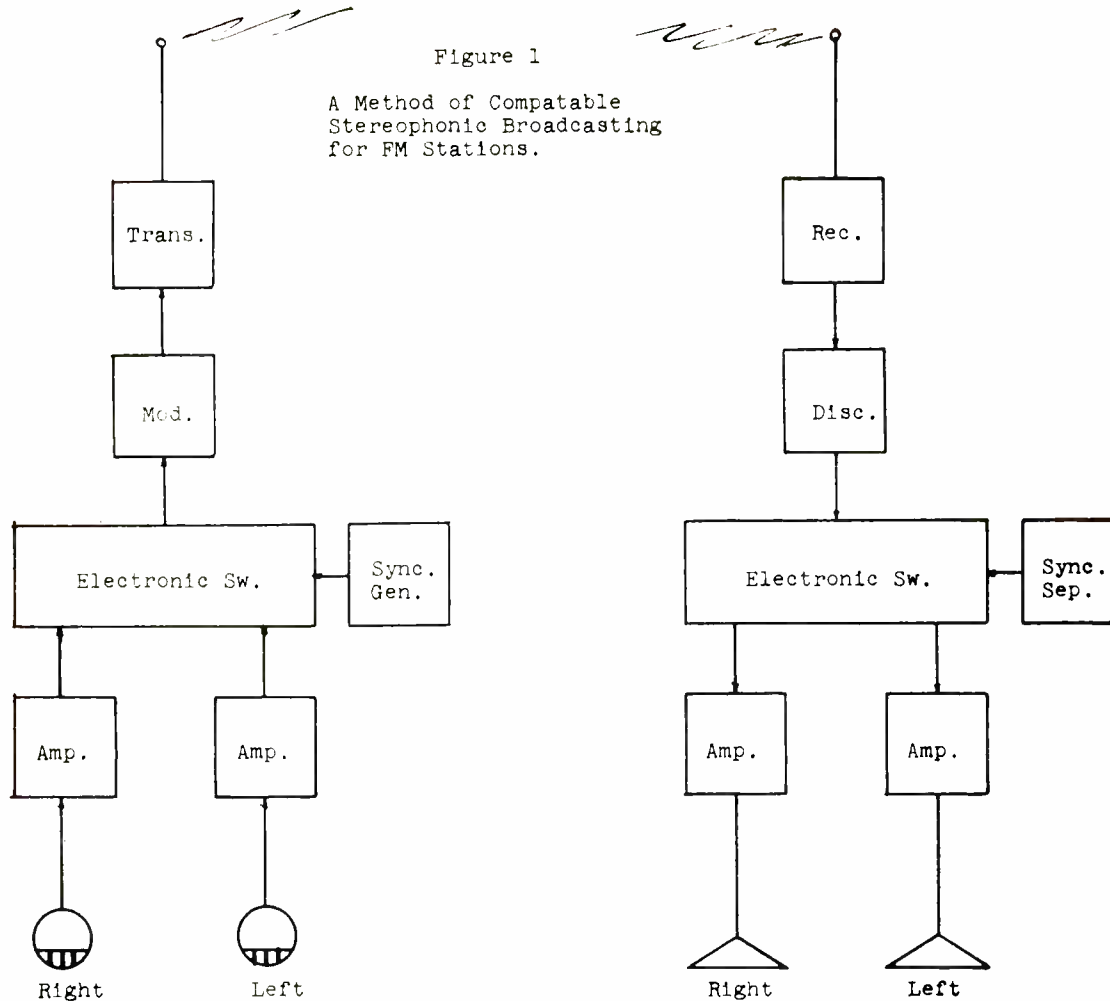

broadcasting the pulses over the air so a 15,000-cycle line was ordered from the local telephone company and used for synchronizing *only*. Both stereo channels were actually broadcast and received over the air.

At the receiving end, to eliminate transients and other "garbage" that appeared on an oscilloscope, several extra tubes were added until the final unit used in the demonstration contained six tubes in the amplifying and switching unit and one tube and two diodes in the synchronizing unit.

The discriminator output of a Scott FM tuner was fed to the two grids of the input amplifier (12AX7) connected in parallel. The outputs of these amplifiers fed two separate switcher units (12AU7s) and two driver units (12AU7s) controlled by a single multivibrator (12AU7) generating the 30 Kc switching pulses.

Synchronizing of the receiving gen-

erator with that of the transmitter was accomplished by taking the 15 Kc tone from the telephone line and feeding into a pair of diodes connected with their inputs in push-pull and their outputs in parallel thus acting as a multiplier and supplying a 30 Kc pulse. This pulse was amplified through two stages (12AU7) and fed to the grid of the receiving multivibrator thus controlling the entire system from the 30 Kc pulses generated at the transmitting end.

The two switcher outputs were fed to two separate power amplifiers and then to their respective speakers.

All equipment was completed and ready for bench testing just six days prior to the first scheduled broadcast. Bench testing required some minor changes but as a whole the results were very encouraging.

One day prior to the first broadcast the installation was completed

at the KISW-FM transmitter and the Hi Fi Music Show some eight miles distant.

At 2 p.m., Friday, Nov. 6, 1959, KISW-FM broadcast the first of six three-hour programs in compatible stereo using the system outlined. All six programs were received in stereo with no discernible loss of fidelity or signal-to-noise ratio and with no noticeable cross talk between channels.

Public acceptance and enthusiasm at the Hi Fi Music Show was beyond expectation while home listeners reported they could detect no difference between the stereo and monaural programs.

Now that the *method of compatible stereophonic broadcasting for FM stations* has been reduced to practice, further experiments will be conducted to simplify the equipment and to increase the switching frequency to about 100 Kc.

# THE ROLE OF TAPE IN RADIO'S RISE

Magnetic Tape has been an important factor in radio's growth and will continue to contribute to radio's progress in the future with the growth of stereophonic broadcasting and other new techniques.

REMEMBER those predictions about radio? How it would lie down and fold its hands helplessly before the on-rushing tide of television?

Well, it didn't happen, did it?

On the contrary, radio broadcasters are doing quite well for themselves these days. Quite well, indeed.

There are more stations on the air than ever before. And these stations are broadcasting for more hours a day than ever before. The nation has more clear channel stations; it seems that everyone is increasing his transmitter power.

Radio, as they say, goes everywhere. Its audience is everywhere—in every room of the home, in the automobile, at the ball game, on the beach. With the advent of more good music programs, including stereophonic presentations, entire new listening groups are being opened up to the radio broadcaster. Radio's audience, instead of decreasing, has mounted steadily. As a communication medium, radio now enjoys unprecedented importance.

Along with this surging to new importance, however, has developed a serious shortage of qualified personnel to staff the increasing number of stations and their expansion of programming days.

How are stations taking up the slack?

The answer is in tape.

When a station needs five qualified people and has only three, it depends on its professional tape record-

ing equipment to "spread the staff," provide a variety of voices, record programs on weekdays and play them back nights or weekends, keep the station on the air more hours per week without going to overtime for

Don Roberts, KOA (Denver) personality, starts one of the station's recorders. As part of its continuous recorder operation, the station has two recorders in the announcer's booth. While one is on playback, the other is loaded and cued. This provides split-second program timing.



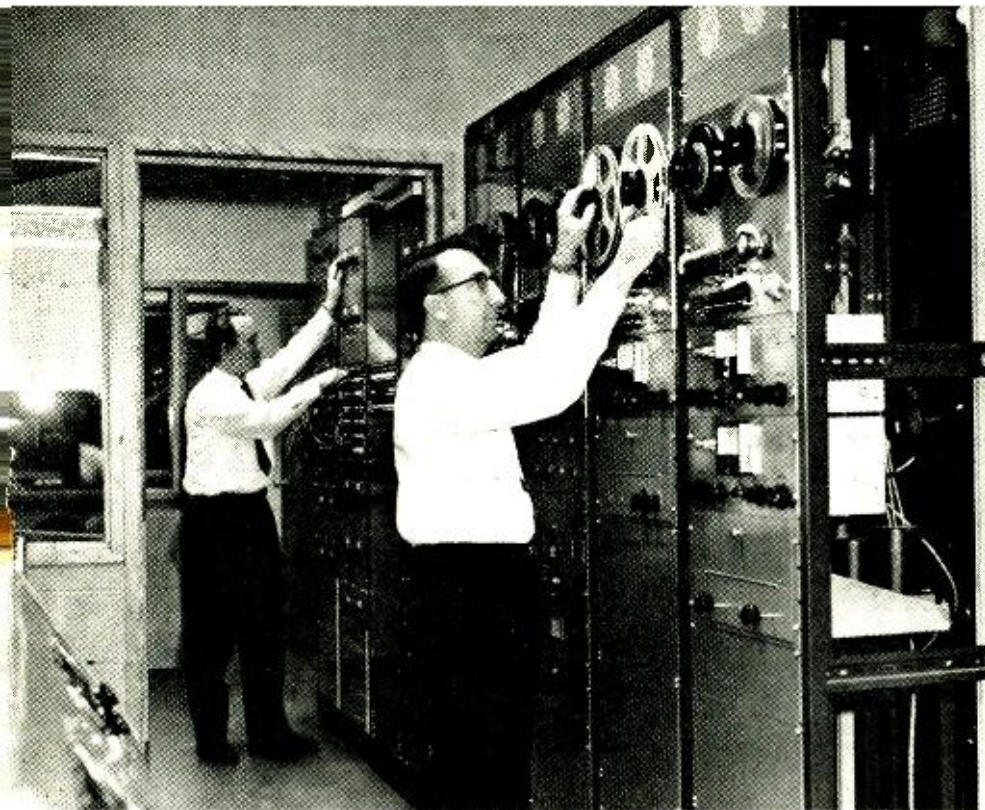

James F. Zimmerle (left), KOA engineer, patches in the network while Jay F. Graves, radio engineering supervisor, threads up one of the recorders which provide continuous service in recording and playing back the net.

the staff, make it convenient for outside participants to appear on programs, provide remote broadcasts at little expense, sell more time by offering sponsors any announcer at any time, build station audience by adding variety and interest, cut costly errors by checking copy at time of reading.

According to a survey conducted recently by Ampex Corp., stations are using their professional tape recorders as much as 50 hours a week for local program delay, plus as many as 120 spots a week.

A station in Illinois reported it keeps its professional recorders in operation continuously from 6 a.m. to 6:30 p.m. every day. And WIS (Columbia, S. C.) runs its professional recorders 12 hours a day.

The five Ampex recorders at WKRC (Cincinnati) provide a continuous FM music system from 10 a.m. to midnight daily. The fully-automated equipment also throws in voice announcements. The professional recorders at KTTN (Trenton, Mo.) run 13 hours a day.

Percy Kuhn, chief engineer for WJPR (Greenville, Miss.), said he uses his professional tape recorders all day long. "The only time we don't use them is when we go on net-

work, which is very seldom," he said. "They run on the average of about 15 hours a day."

Elmer Nelson is chief engineer at KOTA (Rapid City, N. D.) where seven Ampex units are in operation.

"A lot of our network stuff is delayed," he reported. "So we have the recorders in almost constant use, from 6 a.m. until fairly late at night."

KWJJ (Portland, Ore.) uses one of its Ampex machines for delaying the network (ABC) one hour during the daylight saving period. By arrangement of a looping mechanism, it runs 24 hours a day.

"We record the net on it and then, an hour later, we play it off," chief recording engineer Bill Rohrer reported. "We have the recorder arranged to erase the tape after it has played back its content and it records the new net right away." With a one-hour loop arrangement, KWJJ can do this continuously for an indefinite period. The recorder runs 24 hours a day.

As a part of its survey, Ampex sought information on how its professional tape recorders were holding up under such continuous heavy use. The station engineers were unanimous in their opinion that only the

professional broadcast tape recorder can meet such operational demands.

Why is this true? Dependability of the equipment is essential. Many of the stations operate without having a second recorder for backup.

Furthermore, the simplicity of the operation of the professional tape recorder is important. In today's radio station, the recorder is operated by several different individuals, often non-technical in their training. The professional tape recorder is easy to load and once loaded, it's a case of simple push-button operation.

Ruggedness also is a factor. Stations often use the recorder in a combination of studio and rough field applications. The recorder must withstand adverse climatic conditions, heat, humidity, dampness, etc.

Not to be overlooked, of course, is the matter of economy. Years of experience have proved that the fully professional recorder costs far less per hour of operation. This results from reduced maintenance, longer practical life, more accurate program timing and far higher reliability.

WFAA (Dallas) told Ampex that its 24 professional recorders do not average an hour of maintenance time per machine per month.

When asked how many hours a month the professional machines at WKRC are down for maintenance, Dore Frantz, chief engineer at the Cincinnati station, replied: "Practically none."

WJPR reported its maintenance of Ampex machines consists of cleaning the heads, checking the tubes and oiling the motors on a routine basis.

KOTA's Elmer Nelson said his staff has no maintenance worries with the professional recorders. "We watch the lubrication carefully and clean the heads about once a week. We find if they're checked on at least once a month, we have no trouble."

With widespread installation of fully professional equipment will come complete realization of the potentials for radio programming with tape.

There is great promise of commercial program production on a syndicated basis to supplement or substitute for network program service be-

(Continued on page 36)

# Automatic Payola Detector

By PROFESSOR OSCAR VON DER SNIKRAH

## NEW UNIT SOLVES BASIC INDUSTRY PROBLEM

**I**N THE EARLY DAYS of broadcasting it was considered normal operating procedure in the majority of stations for the transmitter engineer to "keep the log."

Throughout his shift, the engineer logged each commercial or reference to a commercial product at the time he heard it. The accounting department would then double check the log kept by the engineer against the original program log used at the studio.

Although this practice kept the program department always at odds with the engineering staff, it did prevent any of the practices now known as "payola."

As the complexities of the communication art of broadcasting grew with the coming of television, remote control and automatic station operation, these watchdog procedures fell by the wayside much to the chagrin of the entire industry.

Foreseeing the side effects now arising that have brought widespread investigations and severe shakeups, our secret laboratory has been working feverishly for several years to perfect the electronic payola detector.

Although we failed miserably to deliver the unit in time to prevent the government inquiry, we can report our developments at this time to safeguard the industry against future invasion.

The first experiments were patterned after the famous "lie detector" unit that electronically detected when a person was telling a lie. By attaching electrodes to various parts of the body, minute electric currents could be recorded that accurately revealed reactions of the

human nervous system when the subject had told a lie.

By application of inverse feedback principles to this method, some of the output voltage was fed back to the brain in order to give larger undistorted indications on the wave recorder. As much as 12 db. feedback was used at times to clean up the waveform.

It wasn't practical, however, as it was found no one would permit the attachment of electrodes to the announcers and entertainers, especially on TV. This and the fact that we almost lost a volunteer announcer from electrocution by the attached electrodes, led us to abandon this area of research.

Since another well known group was already perfecting a device that translated audio directly into a typewriter, we decided to collaborate with them and use some of their principles. In our case, we did not want to convert all of the audio into typewritten material but only use "selected" audio to operate an indicating meter that could easily be read by inexperienced non-technical personnel.

Through the use of special filters, the device selects well known phrases commonly used in radio commercials.

Such phrases as "be sure to buy" or "see it now" or "it costs only—" will cause the meter to register commercial content in accumulative fashion. In other words, the meter needle will move up a division for each commercial phrase, with a capacity of 100 units for full scale. Each half-hour the meter will be read and logged after which a reset button returns it to zero for the next period.

Any one of 20 different phrases will cause a unit to be registered. Exact wording of the phrases will be kept secret so that announcers cannot defeat the purpose of the unit by coining new phrases.

The logged units for each half-hour are then correlated to the program log for each day and any discrepancy will immediately appear.

At this time we are working with one of the larger computer manufacturers to develop one of their machines to use for this application.

When perfected, this system will require only three additional persons on the staff of each station and will forever take the pressure off of stations. Although arriving on the scene ten years too late for the prevention of the "payola" scandals, its future use at each station will prevent a repetition of the recent investigation.

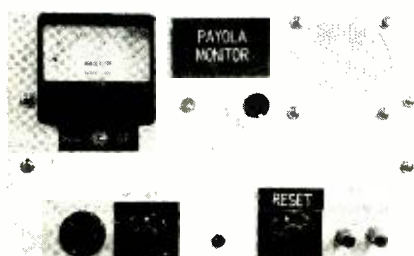
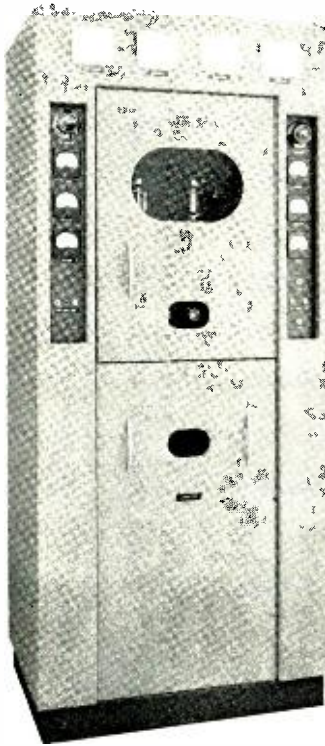

Figure 1. The Payola Monitor samples R. F. at the input to the antenna and can be remotely controlled and read if necessary. A plug in R. F. section allows it to be used in conjunction with either A. M. or F. M. transmitters. A TV model will soon be developed.



# GOING TO A KILOWATT?

You can't do BETTER than a BAUER



**FB-1000-J**

*"The transmitter  
that gives you everything  
but trouble"*

## CHECK THESE FEATURES WHEN SELECTING YOUR NEW TRANSMITTER

- ✓ MODERN TETRODE CIRCUITRY
- ✓ ONE TUNING CONTROL, VACUUM VARIABLE
- ✓ AUTOMATIC FILAMENT REGULATION
- ✓ PANEL CONTROLLED INTERNAL LOAD
- ✓ VACUUM CRYSTALS
- ✓ DIFFERENTIAL PLATE TIMER
- ✓ NINE METERS, NO "MULTIMETER"
- ✓ REMOTE ANTENNA METER POSITION
- ✓ RECESSED CONTROL PANELS
- ✓ EXCEPTIONAL TUBE LIFE
- ✓ RELIABLE UNATTENDED OPERATION
- ✓ COMPLETE ACCESSABILITY
- ✓ EASY INSTALLATION
- ✓ LOWEST INITIAL COST, LOWEST OPERATING COST AND UNSURPASSED PERFORMANCE!

Write for descriptive brochure to:

# BAUER ELECTRONIC MFG. CO.

Quality Custom Transmitters Since 1926

MEMBER WCEMA

P. O. BOX 1101, SAN MATEO, CALIFORNIA

### OTHER PRODUCTS:

- AM TRANSMITTERS, 5 and 10 Kilowatt
- HIGH LEVEL AUDIO MODULATORS.

# AMENDMENTS AND PROPOSED CHANGES OF F.C.C. REGULATIONS

## OPERATION OF LOW POWER TELEVISION BROADCAST REPEATER STATIONS Notice of Further Proposed Rule Making

1. In its Report and Order (FCC 58-1255) issued in this proceeding Dec. 30, 1958, the Commission reaffirmed its concern with the problem of inadequate television reception in small, remote communities but concluded that the limited number of channels available in the VHF television band and the hazard of harmful interference to the reception of television broadcast stations as well as other radio services on adjacent frequencies, made it desirable to limit TV repeater stations to the UHF band.

2. Reconsideration of its decision of Dec. 30, 1958, was requested in pleadings filed on Jan. 26, 1959, by Western Slope Broadcasting Co., Inc., and on Feb. 4, 1959, by the licensees of 16 television stations in California, Colorado, Idaho, Montana, South Dakota, Texas, Utah and Wyoming. In the interim the Commission has engaged in a continuing re-study of the problems associated with the licensing of low power repeater stations in the VHF band and has endeavored to re-evaluate those problems in the light of the foreseeable advantages and disadvantages which would flow from the authorization of VHF repeater operations under a number of alternative sets of technical and operating conditions. The more restricted and rigid such requirements are drawn, the greater protection they would afford against the interference and other undesirable results risked by the authorization of repeaters in the VHF band. On the other hand, the more technical and operating requirements are relaxed the lower the costs of construction and installation of such equipment. The Commission has endeavored to seek an optimum balance between extremes and believes that the requirements set out in the appended draft rules, all things considered, reflect such a balance. We have accordingly decided to invite the comments of interested parties on the proposals appended hereto. The draft rules would parallel, insofar as appropriate, the present rules covering television broadcast translator stations using authorized UHF channels.

3. One of the more difficult problems which must be met if these devices were to be permitted in the VHF television broadcast band is that of interference to television broadcast reception, interference to other radio services which occupy bands interspersed through the television

bands, and interference between translators. The first of these is usually met by limiting the maximum power and antenna height and specifying a minimum geographic separation. Except for the power limit, these measures are not practical in the present case. Elevated sites are usually needed in order to obtain a signal to rebroadcast and the transmitting apparatus must be located at the receiving site. Any predetermined geographic separation based on statistical engineering data would severely restrict the areas in which VHF translators could be located and limit the number to only a few of the several hundred devices that are already in operation. The second problem of interference to other services in contiguous bands could be met by requiring refined transmitting equipment and adequate supervision of the operation by trained radio operators. Such an operation would be costly to install and operate. The third problem could be met by applying the normal measures used to prevent interference between regular stations, i.e., limits on power, antenna height, and geographic separation. The practical limits of this are obvious.

4. We have decided to meet this problem by proposing transmitter power output limited to one watt. By thus limiting the scope of any interference which might arise we could then permit the use of elevated antennas, reduce the performance requirements for the equipment, and allow the routine operation of the apparatus to be carried on by a technically unskilled operator. Even with power so limited these devices would be capable of causing interference, and since normal geographic separations cannot be used, we propose that the licensees of these devices provide full interference protection to direct reception of all television broadcast stations, and to a limited extent to each other. By a judicious choice of channel and transmitter location the problem of mutual interference between these low power VHF translators can be minimized. Whenever it occurred, the affected licensees would be expected to settle the problem by mutual agreement and cooperation. Interference to direct reception of TV broadcast stations is likely to be more serious. Such signals are often received by UHF translators, other VHF translators, and community antenna systems, as well as a few private individuals, with antennas at elevated sites similar to those used by a VHF translator. Since these sites are suitable

for long distance reception of TV broadcast stations they are also ideal for detection of the signals of low power VHF translators on other mountains. Whenever this creates interference to direct reception of a television broadcast station, the VHF translator would have to cease causing interference.

5. There may be occasions when the limit to one watt of power would prevent a VHF translator from serving as large an area as it might desire. In such cases, the operation could be conducted on a UHF channel with higher power. The relative absence of congestion which makes the observance of minimum geographic separations feasible in the UHF band, and the fact that the UHF band is not interspersed with other radio services, permits the use of higher power in that band and UHF translators may use up to 100 watts transmitter power output.

6. The rules proposed herein would be incorporated in the present rules governing television broadcast translator stations operating in the UHF television band. At the same time the rules governing UHF translators would be modified, where necessary, to conform with the general principles governing this type of operation.

7. The rules proposed herein would not permit the use of the so-called co-channel booster amplifier. This type of device consists simply of an amplifier which receives, amplifies, and retransmits on the same channel. Although this type of device was used at many of the early unlicensed stations their faults and limitations have caused them to virtually disappear. These devices are inherently unstable electrically, and are capable of transmitting false and misleading signals when operated in the VHF television band. The Commission considers the use of such devices under the type of relaxed requirements contained in these rules, to be dangerous and not in the public interest.

8. With respect to proposed VHF translator operations in the vicinity of the Canadian and Mexican borders, the Commission cannot act unilaterally in that regard. Such operation is not contemplated under the outstanding television agreements with those countries. The Commission will initiate action looking to negotiations with the governments of Canada and Mexico with a view toward securing agreements for the operation of these devices. Meanwhile, if the proposed

Another Presto precision recording tool  
to make your job easier.

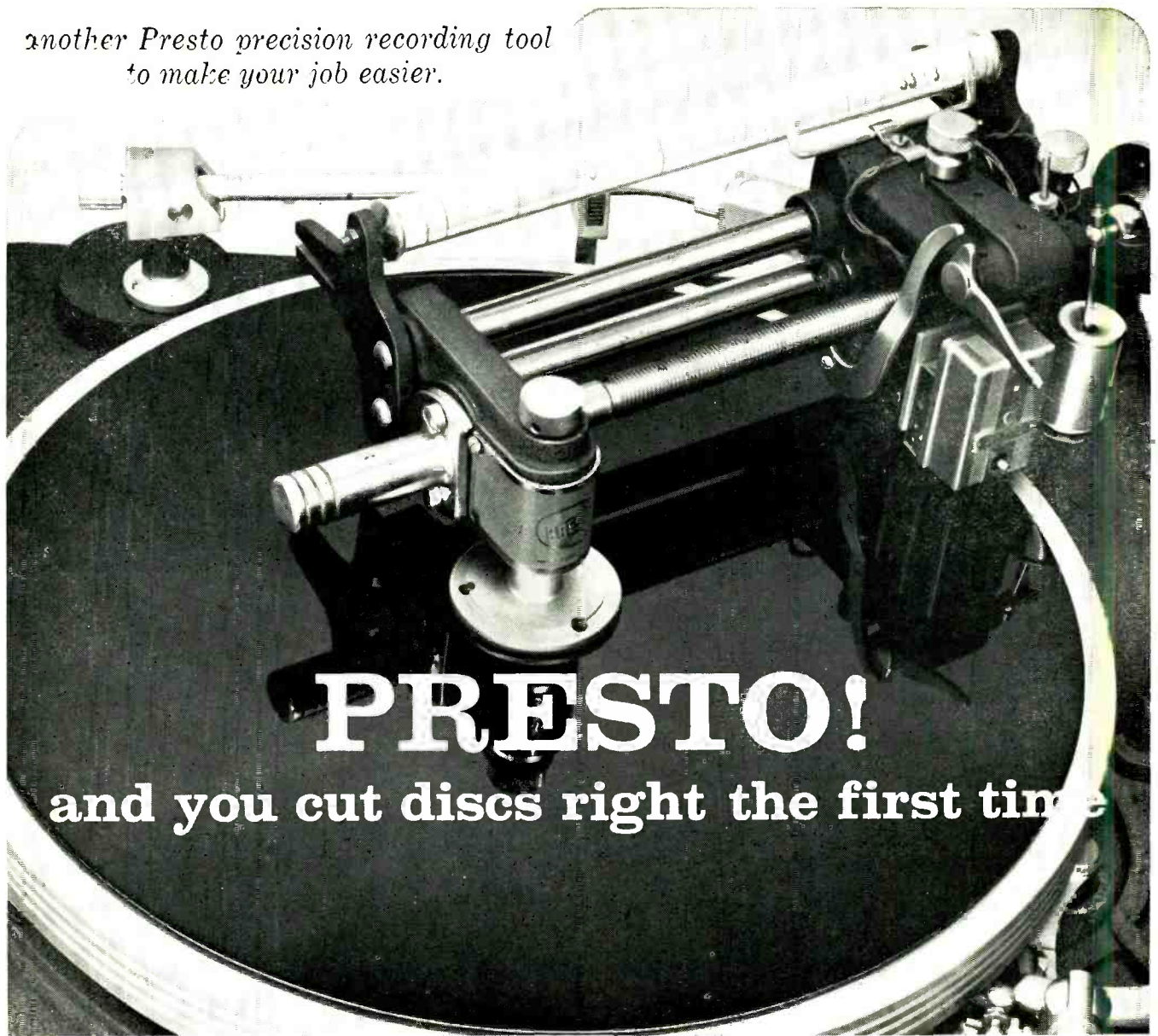

It may take two to tango, but it takes *three* to "take" that tango *properly* on a disc: Presto's 6-N Recorder, A-93 Amplifier and 1-D or S-1 System. Presto's use-proved recording instruments stand up under hard, daily service. And will for years to come. For proof, just ask anyone who's ever used a Presto (there are thousands of Presto units in use everywhere).

**6-N 3-SPEED DISC RECORDER.** 33 $\frac{1}{3}$ , 45 or 78 rpm. Ideal for work under all conditions—monophonic or stereo (with the new S-1 head). Stations and studios have found the 6-N to be the mechanism for instantaneous work (masters, too), delayed and local program recording.

**A-93 DISC RECORDING AMPLIFIER.** This power amplifier will last for... well, we've never heard of one that has been retired. Features: push-button control provides choice of equalization curves; provision for Presto radius equalizer Model 161A to compensate for changing diameter of disc; 30-watt output assures ample reserve for recording; meter monitors recording level and checks output tube currents.

**1-D RECORDING HEAD.** The best known recording head in the industry, more are in use today than all others *combined!* As long as there's monophonic recording, the 1-D will never

become obsolete. And if you send it in for reconditioning every few years or so, we'll *keep* it Presto-perfect. (Nominal charge.)

**S-1 STEREO SYSTEM** (45°-45° feedback cutting head and two 100-watt amplifiers). Stable from 30 to 20,000 c, without peaks, dips or break-up on high-frequency end. Costs *half* as much as comparable systems. An entirely new Presto-designed feedback-coupling technique permits recording at previously unattainable levels. Distortion is virtually unmeasurable and a unique suspension system provides superior cross-talk characteristics. "Studio-oriented" design permits quick change of stylus. The S-1 head fits all Presto disc-recording lathes (all others as well).

S-1 Cutting Head

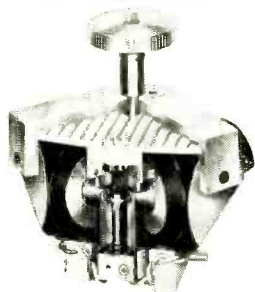

A-93 Disc Recording Amplifier



 BOGEN-PRESTO, Dept. BE-10, Paramus, N. Y.  
A Division of The Siegler Corporation.

Rush data to me on the 6N, A-93, 1-D and S-1.

Name

Address

City  Zone  State

**PRESTO**

# RAYTHEON DISTRIBUTORS

**Alabama**  
Birmingham  
Forbes Distributing Company  
Mobile  
Forbes Electronic Distributors, Inc.

**Arizona**  
Phoenix  
Radio Specialties & Appl. Corp.  
AL 8-6121  
Tucson  
Standard Radio Parts, Inc.  
MA 3-4326

**California**  
Burbank  
Valley Electronic Supply Co.  
Victoria 9-4641  
R. V. Weatherford Co.  
Victoria 9-2471

**Hollywood**  
Hollywood Radio Supply, Inc.  
HO 4-8321

**Los Angeles**  
Graybar Electric Company, Inc.  
ANGelus 3-7282  
Kierulff Electronics, Inc.  
Richmond 8-2444

**Oakland**  
Brill Electronics  
TE 2-6100  
Elmar Electronics  
Higate 4-7011

**San Diego**  
Radio Parts Company

**Santa Monica**  
Santa Monica Radio Parts Corp.  
EXbrook 3-8231

**Colorado**  
Denver  
Ward Terry Company  
AMherst 6-3181

**District of Columbia**  
Electronic Industrial Sales, Inc.  
HUDson 3-5200  
Kenyon Electronic Supply Co.  
DEcatur 5800

**Florida**  
Miami  
East Coast Radio & Television Co.  
FRanklin 1-4636

**Tampa**  
Thurow Distributors  
TAmPa 2-1885  
**West Palm Beach**  
Goddard Distributors, Inc.  
TEmpLe 3-5701

**Illinois**  
Chicago  
Allied Radio Corporation  
HAYmarket 1-6800  
Newark Electric Company  
EStE 2-2950

**Maryland**  
Baltimore  
Wholesale Radio Parts Co., Inc.  
MUIberry 5-2134

**Massachusetts**  
Boston  
Cramer Electronics, Inc.  
COpley 7-4700  
DeMambro Radio Supply Co., Inc.  
AL 4-9000  
Lafayette Radio Corp. of Mass.  
HUbbard 2-7850  
**Cambridge**  
Electrical Supply Corporation  
UNiversity 4-6300

**Michigan**  
Ann Arbor  
Wedemeyer Electronic Supply Co.  
NOrmandy 2-4457

**Detroit**  
Ferguson Electronic Supply Co.  
WOodward 1-2262

**Minnesota**  
Minneapolis  
Electronic Expeditors  
of Minnesota, Inc.  
FEderal 8-7597

**Mississippi**  
Jackson  
Ellington Radio, Inc.

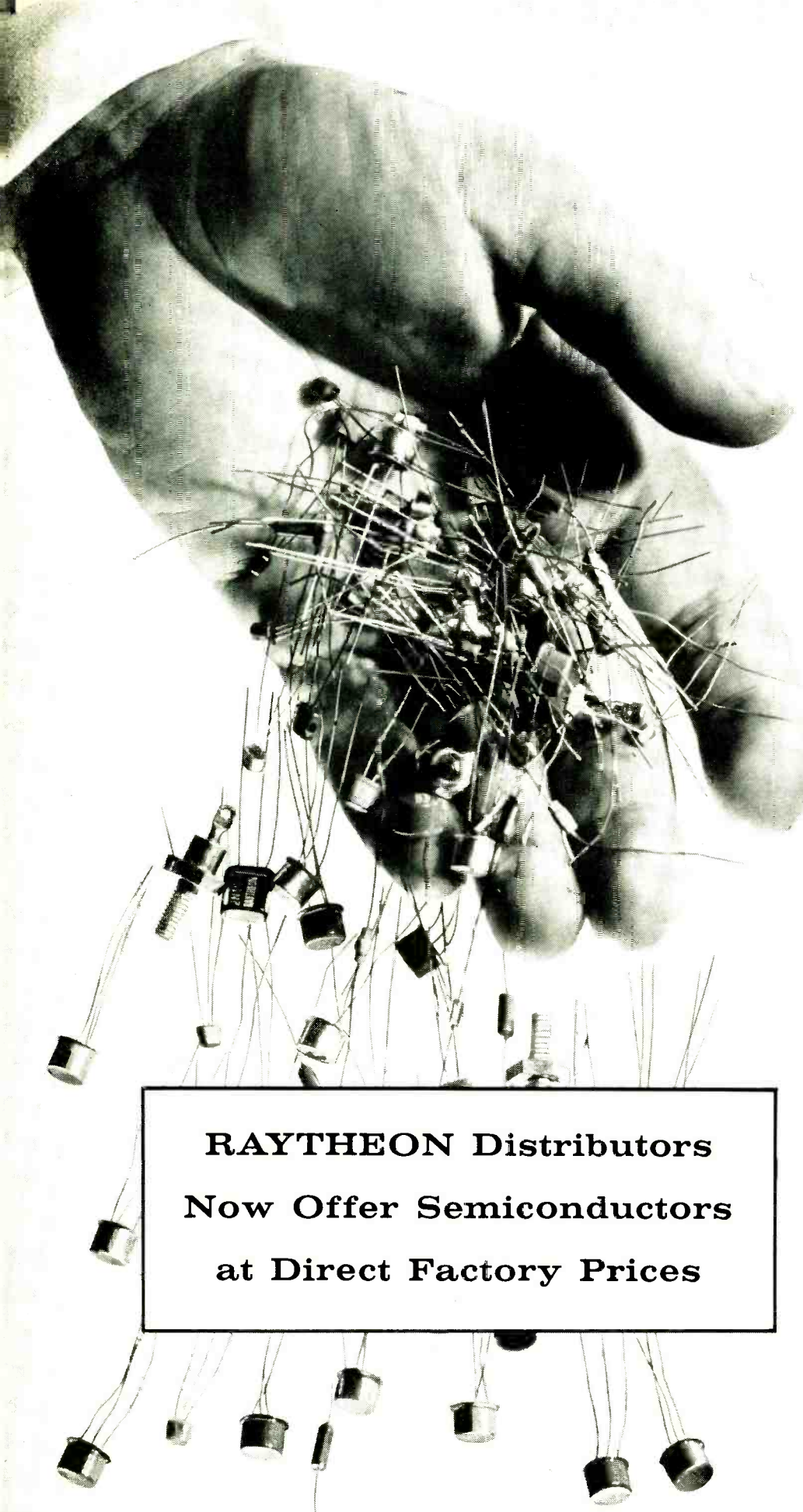

**RAYTHEON Distributors**  
**Now Offer Semiconductors**  
**at Direct Factory Prices**



RAYTHEON COMPANY • DISTRIBUTOR PRODUCTS DIVISION • WESTWOOD, MASS.

RECEIVING AND INDUSTRIAL TUBES • SEMICONDUCTOR PRODUCTS • MECHANICAL COMPONENTS  
RAYTHEON/MACHLETT POWER TUBES • VOLTAGE REGULATORS • CAPTIVE HARDWARE

# SERVING KEY MARKETS INCLUDE

**Missouri**  
Kansas City  
Burstein-Applebee Company  
BAItimore 1-1155

**New Mexico**  
Alamogordo  
Radio Specialties Company, Inc.  
HEmlock 7-0307

**Albuquerque**  
Radio Specialties Company, Inc.  
AM 8-3901

**New York**  
Mineola, Long Island  
Arrow Electronics, Inc.  
Pioneer 6-8686

**New York City**  
H. L. Dalis, Inc.  
EMpire 1-1100  
Milo Electronics Corporation  
BEekman 3-2980

**Ohio**  
Cincinnati  
United Radio Inc.  
CHerry 1-6530

**Cleveland**  
Main Line Cleveland, Inc.  
EXpress 1-1800  
Pioneer Electronic Supply Co.  
SUperior 1-9411

**Columbus**  
Buckeye Electronic Distributors, Inc.  
CA 8-3265

**Dayton**  
Srepco, Inc.  
BAldwin 4-3871

**Oklahoma**  
Tulsa  
S & S Radio Supply  
CHerry 2-7174

**Oregon**  
Portland  
Lou Johnson Company  
CApitol 2-9551

**Pennsylvania**  
Braddock  
Marks Parts Company  
ELectric 1-1314

**Philadelphia**  
Almo Radio Company  
WAlnut 2-5918  
Radio Electric Service Co.  
WAlnut 5-5840

**Reading**  
The George D. Barbey Co., Inc.  
FR 6-7451

**Tennessee**  
Knoxville  
Bondurant Brothers Company

**Texas**  
Dallas  
Graybar Electric Company  
Riverside 2-6451

**Houston**  
Harrison Equipment Company  
CApitol 4-9131

**Utah**  
Salt Lake City  
Standard Supply Company  
EL 5-2971

**Virginia**  
Norfolk  
Priest Electronics  
MA 7-4534

**Richmond**  
Meridian Electronics, Inc.  
RiChmond 5-2834

**Wisconsin**  
Appleton  
Electronic Expeditors, Inc.  
REgent 3-1755

**Green Bay**  
Electronic Exeditors, Inc.  
HEmlock 2-4165

**Menasha**  
Twin City Electronics

**Milwaukee**  
EX-EL Distributors, Inc.  
Electronic Expeditors, Inc.  
FLagstone 2-2070  
Milwaukee Electronic Expeditors, Inc.  
GRreenfield 6-4144

**Oshkosh**  
Electronic Expeditors of Oshkosh, Inc.  
BEverly 5-8930

rules were adopted, applications for VHF translators would be taken up with the appropriate government on a case-by-case basis.

9. The proposal under consideration herein contemplates authorization, pursuant to the appended rules, of new VHF translators. Repeater facilities installed prior to the issuance of a construction permit by the Commission give rise to problems under section 319 (a) of the Communications Act of 1934, which has been construed to prohibit the granting of a license authorizing the use by broadcast stations of facilities constructed before the issuance of a construction permit by the FCC. The Commission has submitted to Congress legislative recommendations directed to this problem.

10. Authority for adoption of the rules appended hereto is contained in sections 4 (i), 301, 303 (a), (b), (c), (d), (e), (f), (g), (h), (p) and (r) and 307 (b) of the Communications Act of 1934, as amended.

11. Any interested party who is of the opinion that the proposed amendment should not be adopted, or should not be adopted in the form set forth herein, may file with the Commission on or before Jan. 11, 1960, a written statement or brief setting forth his comments. Comments in support of the proposed amendment may also be filed on or before the same date. Comments or briefs in reply to the original comments may be filed within 10 days from the last day for filing said original comments. No additional comments may be filed unless (1) specifically requested by the Commission or (2) good cause for the filing of such additional comments is established.

12. In accordance with the provisions of § 1.54 of the Commission's rules and regulations, an original and 14 copies of all statements, briefs, or comments shall be furnished the Commission.

Proposed amendments to Subpart G, Part 4:

## § 4.701 Definitions.

(a) Television broadcast translator station: A station in the broadcasting service operated solely for the purpose of retransmitting the signals of a television broadcast station or another television broadcast translator station, by means of direct frequency conversion and amplification of the incoming signals and without significantly altering any characteristic of the incoming signal other than its frequency and amplitude, for the purpose of providing television reception to the general public.

(b) Primary station: The television broadcasting station radiating the signals which are retransmitted by a television broadcast translator station.

(c) VHF translator: A television broadcast translator station operating on a VHF television broadcast channel.

(d) UHF translator: A television

broadcast translator station operating on a UHF television broadcast channel.

## § 4.702 Frequency assignment.

(a) An applicant for a new television broadcast translator station or for changes in the facilities of an authorized station shall endeavor to select a channel on which its operation will not be likely to cause interference to the reception of other stations. The application must be specific with regard to the frequency requested. Only one channel will be assigned to each station.

(b) An applicant for a VHF translator station may specify any standard VHF television broadcast channel. VHF translators are not required to observe a minimum separation from television broadcast stations operating on the channel used by the translator or on an adjacent channel. However, the use of such channels by VHF translators is secondary to the use by television broadcast stations and VHF translators must provide complete interference protection to reception of existing and future television broadcast stations.

(c) An applicant for a UHF translator may specify any one of the upper 14 UHF television broadcast channels between 70 and 83 inclusive, provided that the proposed translator will not be located:

(1) Within 20 miles of a television broadcast station or city which is assigned the second, third, fourth, fifth or eighth channel above or below the requested channel;

(2) Within 55 miles of a television broadcast station or city which is assigned an adjacent channel;

(3) Within 60 miles of a television broadcast station or city which is assigned the seventh channel above or the seventh or fourteenth channel below the requested channel;

(4) Within 75 miles of a television broadcast station or city which is assigned the fifteenth channel below the requested channel;

(5) Within 155 miles of a television broadcast station or city which is assigned the same channel as the requested channel unless the proposed channel is already assigned to the city in which the translator is to be operated, in the Table of Assignments appearing in § 3.606 (b) of this chapter.

(d) The distances specified in paragraph (c) of this section are to be determined between the proposed site of the television broadcast translator station and the Post Office location in any city listed in § 3.606 (b) of this chapter unless the channel shown therein has been assigned to a television broadcast station, in which case the distance shall be determined between the proposed site of the translator and the transmitter site of the television broadcast station. Changes in the Table of Assignments of § 3.606 (b)

## TELEVISION MONITORS

To Fit Every Application

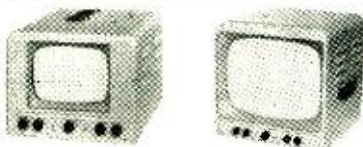

\$199.00 L59B/8"

\$189.00 L59B/17"

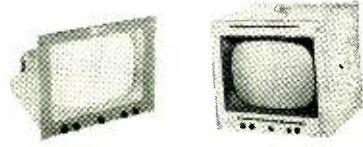

\$228.00

Rack Mounting

\$335.00

K59/21M

30 Models Available—Plug In and Single Chassis Construction. Write for Information

### MIRATEL CONELRAD EQUIPMENT

Air Alert I	\$ 99.50
Air Alert II	\$ 46.50
Program Failure Alarm	\$125.00
Audio Operated Relay	\$125.00



1080 DIONNE  
ST. PAUL, MINNESOTA

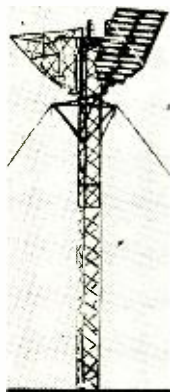

### TOWERS REFLECTORS BUILDINGS

- FIXED
- PORTABLE

Complete installations for all communications purposes



### CONSTRUCTION CO.

2723 HAWKEYE DR. SIOUX CITY, IOWA

Tower Fabricators and Erectors the World Over!

MAIL TODAY! FOR 1960 CATALOG!  
TOWER CONSTRUCTION CO.  
2747 HAWKEYE DRIVE  
SIOUX CITY, IOWA

NAME: \_\_\_\_\_

ADDRESS: \_\_\_\_\_

CITY: \_\_\_\_\_ ST: \_\_\_\_\_

of this chapter may be made without regard to existing or proposed television broadcast translator stations and, where such changes result in minimum separations less than those specified above, the licensee of an affected television broadcast translator station shall file an application for a change in channel assignment to comply with the required separations.

(e) No minimum distance separation is specified between television broadcast translator stations operating on the same channel. However, the separation shall in all cases be adequate to prevent mutual interference.

(f) Adjacent channel assignments will not be made to television broadcast translator stations intended to serve all or a part of the same area.

#### § 4.703 Interference

(a) An application for a new television broadcast translator station or for changes in the facilities of an authorized station will not be granted where it is apparent that interference will be caused. In general, the licensee of a new UHF translator shall protect existing UHF translators from interference resulting from its operation. If interference develops between VHF translators, the problem shall be resolved by mutual agreement among the licensees involved.

(b) It shall be the responsibility of the licensee of a VHF translator to correct at its expense any condition of interference to the direct reception of the signals of a television broadcast station operating on the same channel as that used by the VHF translator or on an adjacent channel, which occurs as the result of the operation of the translator. Interference will be considered to occur whenever reception of a regularly used signal is impaired by the signals radiated by the translator, regardless of the quality of such reception or the strength of the signal so used. If the interference cannot be promptly eliminated by the application of suitable techniques, operation of the offending translator shall be suspended and shall not be resumed until the interference has been eliminated. If the complainant refuses to permit the translator licensee to apply remedial techniques which demonstrably will eliminate the interference without impairment of the original reception, the licensee of the translator is absolved of further responsibility.

(c) It shall be the responsibility of the licensee of a television broadcast translator station to correct any condition of interference which results from the radiation of radio frequency energy by its equipment on any frequency outside the assigned channel. Upon notice by the Commission to the station licensee or operator that such interference is being caused, the operation of the television

broadcast translator station shall be suspended immediately and shall not be resumed until the interference has been eliminated or it can be demonstrated that the interference is not due to spurious emissions by the television broadcast translator station: *Provided, however,* That short test transmissions may be made during the period of suspended operation to check the efficacy of remedial measures.

(d) In each instance where suspension of operation is required, the licensee shall submit a full report to the Commission after operation is resumed, containing details of the nature of the interference, the source of the interfering signals, and the remedial steps taken to eliminate the interference.

#### ADMINISTRATIVE PROCEDURE

#### § 4.711 Administrative procedure.

See §§ 4.11 to 4.16 inclusive.

#### LICENSING POLICIES

#### § 4.731 Purpose and permissible service.

(a) Television broadcast translator stations provide a means whereby the signals of television broadcast stations may be retransmitted to areas in which direct reception of such television broadcast stations is unsatisfactory due to distance or intervening terrain barriers.

(b) A television broadcast translator station may be used only for the purpose of retransmitting the signals of a television broadcast station or another television broadcast translator station which have been received directly through space, converted to a different channel by simple heterodyne frequency conversion, and suitably amplified.

(c) The transmissions of each television broadcast translator station shall be intended for direct reception by the general public and any other use shall be incidental thereto. A television broadcast translator station shall not be operated solely for the purpose of relaying signals to one or more fixed receiving points for retransmission, distribution, or further relaying.

(d) The technical characteristics of the retransmitted signals shall not be deliberately altered so as to hinder reception on conventional television broadcast receivers.

(e) A television broadcast translator station shall not deliberately retransmit the signals of any station other than the station it is authorized by license to retransmit. Precautions shall be taken to avoid unintentional retransmission of such other signals.

#### § 4.732 Eligibility and licensing requirements.

(a) A license for a television broadcast translator station may be issued to any qualified individual, organized group of individuals, broadcast station licensee, or local civil governmental body upon an appropriate showing that plans for fi-

nancing the installation and operation of the station are sufficiently sound to insure continuation of the operation for the period of the license.

(b) More than one television broadcast translator station may be licensed to the same applicant, whether or not such stations serve substantially the same area, upon an appropriate showing of need for such additional stations.

(c) Only one channel will be assigned to each television broadcast translator station. Additional television broadcast translator stations may be authorized to provide additional reception. A separate application is required for each television broadcast translator station and each application shall be complete in all respects.

**§ 4.733 [Reserved]**

**§ 4.734 Remote control operation.**

(a) A television broadcast translator station may be operated by remote control provided that such operation is conducted under the following conditions:

(1) A monitoring point shall be established on premises under the control of the licensee or its agent, within the area served by the translator. It shall be equipped with a television receiver in good operating condition and suitable for observing the transmission of the translator.

(2) An operator meeting the requirements of § 4.766 shall observe the transmissions of the translator at the monitoring point within one hour after the start of any period of operation and at intervals of not more than six hours during operating. The operator shall promptly correct any condition of improper operation observed and if unable or not qualified to do so under the provisions of § 4.766 (b), shall immediately suspend operation until suitable repairs or adjustments can be made.

(3) An entry shall be made in the operating log of the station at the time each visit to the monitoring point is made showing the date and time, the condition of operation noted, and any corrective action taken.

(4) If the transmitting apparatus is installed at a location which is not readily accessible at all hours and in all seasons, means shall be provided for manually turning the transmitting apparatus off at a point which is readily accessible at all hours and in all seasons. The control circuit shall be so designed that failure of the circuit which results in loss of control from the control point will place the transmitter in a non-radiating condition.

(5) The transmitting apparatus and control point shall be protected against tampering by unauthorized persons.

(6) The transmitting apparatus shall be equipped with suitable automatic circuits which will place it in a non-radiating condition in the absence of an incoming signal.

# RCA SALES AND PRODUCT PLANNING

## BROADCAST AND TELEVISION SYSTEMS

Several immediate openings are presently available to experienced engineers with Sales or Marketing interests. Our positions offer unusual opportunities for professional advancement in two areas of responsibility.

As an **RCA PRODUCT PLANNER** you will have the opportunity to guide and encourage the development of new and exciting equipments for the Broadcast industry—including the expansion of multi-hop TV microwave systems, introduction of highly developed TV tape recorders, projectors, cameras, switching and test equipments. You will work with skilled engineers, production men, and market research specialists to aid you in guiding advanced projects from drawing board to practical reality.

As an **RCA BROADCAST and TV FIELD SALESMAN** you will have the advantage of selling this complete line of equipment and systems. In addition, you will have the assistance of the largest systems engineering and service groups in the industry allowing you to concentrate your efforts on contacting customers.

*For confidential interview please send résumé of experience and education to:*

**MR. J. R. MILLIGAN, Dept. HO-11A**  
**RCA Professional Employment**  
**Bldg. 10-1, Camden 2, N. J.**



**RADIO CORPORATION OF AMERICA**  
*Industrial Electronic Products*

### NEMS • CLARKE

## Type TRC-1

## TV Color

## Rebroadcast

## Receiver

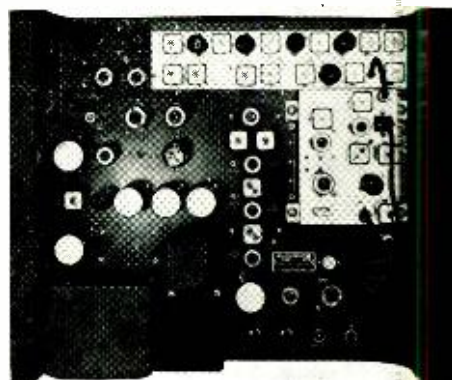

The Type TRC-1 Color Rebroadcast Receiver has been designed specifically to meet the requirements for a high-quality receiver for use in direct pickup and rebroadcast of black and white and color signals.

#### SPECIFICATIONS

<b>VIDEO CHANNEL</b>		Distortion	Less than 1%
Output terminal	75 ohms, coaxial	Noise level	50 db below -10 dbm
Level	Adjustable up to approximately 1 volt, peak to peak	<b>SYNC CHANNEL</b>	
Polarity	Sync negative	Output connection	75 ohms, coaxial
Frequency response	To 4.2 mc	Output level	3 volts, peak to peak
<b>SOUND CHANNEL</b>		Polarity	Negative
System	Separate IF (not intercarrier)	<b>MISCELLANEOUS</b>	
Output level	Adjustable from 0 to 18 dbm	Gain control	Manual or keyed automatic
Output impedance	600 ohms or 150 ohms, balanced or unbalanced	RF input connection	75 ohms, coaxial
Frequency response	30 to 15,000 cycles with standard 75-u sec de-emphasis	Crystal controlled R.F.	Employed for maximum and unattended operation
		Power supply	Self-contained
		Power requirements	117 volts, 60 cycles, 150 watt

**NEMS • CLARKE COMPANY**  
 A DIVISION OF VITRO CORPORATION OF AMERICA  
 919 JESUP BLAIR DRIVE • SILVER SPRING MARYLAND • JUNIPER 5-1000

(b) An application for a new television broadcast translator station proposing remote control operation shall be accompanied by a showing as to the manner of compliance with the requirements of paragraph (a) of this section. Any proposal to change an authorized translator from direct operation to remote control operation shall be submitted in the form of an application for modification of existing authorization accompanied by the same showing of compliance.

#### § 4.735 Power limitations.

(a) The transmitter power output of a VHF translator shall be limited to a maximum of one watt peak visual power. In no event shall the transmitting apparatus be operated with power output in excess of the manufacturers rating.

(b) The transmitter power output of a UHF translator shall be limited to a maximum of 100 watts peak visual power. In no event shall the transmitting apparatus be operated with power output in excess of the manufacturers rating.

(c) No limit is placed upon the effective radiated power which may be obtained by the use of horizontally or vertically directive transmitting antennas.

#### § 4.736 Emissions and bandwidth.

(a) The license of a television broadcast translator station authorizes the transmission of the visual signal by amplitude modulation (A5) and the accompanying aural signal by frequency modulation (F3).

(b) Standard width television channels will be assigned and the transmitting apparatus shall be operated so as to limit spurious emissions to the lowest practicable value. Any emissions including intermodulation products and radio frequency harmonics which are not essential for the transmission of the desired picture and sound information shall be considered to be spurious emissions.

(c) Any emissions appearing on frequencies more than three megacycles above or below the upper and lower edges respectively of the assigned channel shall be attenuated no less than 30 decibels below the peak visual carrier power.

(d) Greater attenuation than that specified in paragraph (c) of this section may be required if interference results from emissions outside the assigned channel.

#### § 4.737 Antenna location.

(a) An applicant for a new television broadcast translator station or for a change in the facilities of an authorized station shall endeavor to select a site which will provide a line-of-sight transmission path to the entire area intended to be served and at which there is available a suitable signal from the primary station or stations. The transmitting antenna should be placed above growing vegetation and trees lying in the direction of the area intended to be served

to minimize the possibility of signal absorption by foliage.

(b) A site within 5 miles of the area intended to be served is to be preferred if the conditions in paragraph (a) of this section can be met.

(c) Consideration should be given to accessibility of the site at all seasons of the year and to the availability of facilities for the maintenance and operation of the television broadcast translator station.

(d) The transmitting antenna should be located as near as is practical to the transmitter to avoid the use of long transmission lines and the associated power losses.

(e) Consideration should be given to the existence of strong radio frequency fields from other transmitters at the translator site and the possibility that such fields may result in the retransmission of signals originating on frequencies other than that of the primary station.

### EQUIPMENT

#### § 4.750 Equipment and installation.

(a) An application for construction permit for a new television broadcast translator station or for changes in the facilities of an authorized station shall specify equipment which has been type approved by the Commission.

(b) Type approval will be granted only after tests have been made at the Commission's Laboratory, Laurel, Maryland. Manufacturers may submit a production model for type approval and such approval, if granted, will be considered to apply to all identical models manufactured under that type number. No change, either mechanical or electrical, may be made in any type approved apparatus without prior approval of the Commission upon appropriate application therefor. Type approval may be withdrawn at any time if the apparatus fails to meet the requirements under which type approval was granted.

(c) Type approval will be granted only if the apparatus meets the following requirements:

(1) The frequency converter and associated amplifiers shall be so designed that the electrical characteristics of the incoming signal will not be altered significantly upon retransmission except as to frequency and amplitude.

(2) The overall characteristics of the apparatus shall be such that:

(i) Any emissions appearing on frequencies more than 3 megacycles above or below the upper and lower edges, respectively, of the assigned channel shall be attenuated no less than 30 decibels below the peak visual carrier power output.

(ii) This suppression shall be obtained regardless of whether such emissions are generated within the transmitting ap-

paratus or are produced by the introduction of an external signal into the input circuits of the apparatus.

(3) The local oscillator employed in the frequency converter shall be sufficiently stable that, subject to variations in ambient temperature between minus 30 degrees and plus 50 degrees Centigrade and power main voltage variations between 85 per cent and 115 per cent of the rated supply voltage, its frequency will not vary from the design frequency by more than 0.02 per cent.

(4) The overall response of the apparatus when operating at its rated power output, as measured at the output terminals, shall provide a smooth curve varying within limits separated by no more than 4 decibels within the assigned channel; *Provided, however*, That means may be provided to reduce the amplitude of the aural carrier below those limits if necessary to prevent intermodulation which would mar the quality of the retransmitted picture. The overall response, measured with respect to the peak response within the assigned channel, shall not exceed the following levels:

(i) Zero decibels on frequencies no more than 3 megacycles from the upper and lower edges of the assigned channel.

(ii) Minus 30 decibels on frequencies between 3 and 6 megacycles above or below the upper and lower edges, respectively, of the assigned channel.

(iii) Minus 40 decibels on frequencies more than 6 megacycles above or below the upper and lower edges, respectively, of the assigned channel.

(5) The apparatus shall contain automatic circuits which will maintain the peak visual power output within 2 decibels of the nominal power output when strength of the input signal is varied over a range of 30 decibels and which will not permit the peak visual power output to exceed transmitter power rating under any condition. If a manual adjustment is provided to compensate for different average signal intensities which may be encountered in various locations, provision shall be made for determining the proper setting of the manual adjustment by means of a meter or meter jack to measure direct current or voltage of appropriate circuits in the translator. If improper adjustment of the manual control could result in improper operation of the translator, a label shall be affixed at the adjustment control bearing a suitable warning.

(6) The apparatus shall be equipped with automatic circuits which will place it in a non-radiating condition when no signal is being received on the input channel, either due to absence of a transmitted signal or failure of the receiving portion of the translator. The automatic circuits may include a time delay feature to prevent interruptions in the translator operation due to signal



fading or other momentary failures of the incoming signal.

(7) The tube or tubes employed in the final radio frequency amplifier shall be of the appropriate power rating to provide the rated power output of the translator. The manufacturer shall specify the correct direct current and voltage applied to the plate of the final amplifier tube or tubes to obtain the rated power output. The apparatus shall be equipped with suitable meters or meter jacks so that the values of plate current and voltage can be measured while the apparatus is in operation.

(8) The transmitter shall be equipped with an automatic keying device capable of transmitting the call sign assigned to the station in international Morse code within 5 minutes of the hour and half hour. Transmission of the call sign shall be accomplished either by turning the visual and aural carriers on and off in the proper sequence or by super-imposing an audio frequency tone containing the telegraphic identification on the carrier radiated by the translator. The modulation level of the identifying signal shall not be less than 30 per cent of the aural signal.

(9) Wiring, shielding, and construction shall be in accordance with accepted principles of good engineering practice.

(d) (1) Any manufacturer desiring to submit a translator for type approval

shall supply the Commission with full specification details (two sworn copies) as well as the test data specified in this section. If this information appears to meet the requirements of the rules, shipping instructions will be issued to the manufacturer. The shipping charges to and from the Laboratory at Laurel, Maryland, shall be paid for by the manufacturer. Approval of a translator will only be given on the basis of the data obtained from a sample translator submitted to the Commission for test.

(2) In approving a translator upon the basis of the tests conducted by the Laboratory, the Commission merely recognizes that the type of translator has the inherent capability of functioning in compliance with the rules, if properly constructed, maintained, and operated.

(3) Additional rules with respect to withdrawal of type approval, modification of type approved equipment, and limitations on the findings upon which type approval is based are set forth in Part 2, Subpart F, of this chapter.

(e) The installation of a television broadcast translator station shall be made only by, or under the direct supervision of, a qualified electronics engineer, and any repairs or adjustment made during or subsequent to the installation, which could result in improper operation, shall be made by or under the direct supervision of an operator holding

a valid first or second class radiotelephone operators license issued by the Commission.

(f) The choice of transmitting and receiving antennas is left to the discretion of the applicant. In general, the transmitting antenna should be designed to provide maximum signal over the area intended to be served and to minimize radiation over other areas, particularly those in which interference could be caused to the reception of other stations. The Commission reserves the right to require the use of suitable directive transmitting antennas in order to permit the assignment of the same channel to two or more television broadcast translator stations located in the same general area. An application for construction permit for a new television broadcast translator station or for changes in the facilities of an authorized station shall supply complete details of the proposed receiving and retransmitting antenna systems, including an accurate plot of the field pattern of the transmitting antenna, if directive. Either vertical, horizontal, or circular polarization may be used.

**§ 4.751 Equipment changes.**

(a) No change, either mechanical or electrical, may be made in type approved apparatus except upon instructions of the manufacturer of the equipment, based upon Commission approval

# BACKGROUND MUSIC RECEIVERS . . . FOR THOSE IN MULTIPLEXING

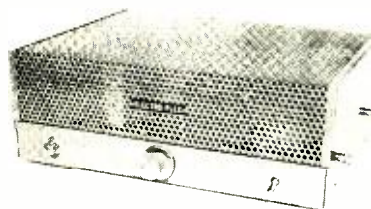

The Q-75 multiplex receiver employs 17 tubes, de luxe features. High sensitivity, 10 watts output. May also be used in Simplex operations with selective muting.

## ELECTRO nics multi PLEX



The MLX-10 is the Electro-Plex economy model. Lower in price than any other multiplex receiver. Ten tubes, 4 watts output. Save money on local installations.

### ELECTRO-PLEX HAS THE THREE IMPORTANT INGREDIENTS TO MAKE YOUR BACKGROUND MUSIC BUSINESS A SUCCESS:

**EXPERIENCE . . .** Electro-Plex personnel has over 10 years experience in background music work—were in on the initial designs of simplex receivers when FM radio was first used for this application back in 1948.

**EQUIPMENT . . . .** Currently available Electro-Plex equipment represents the latest in multiplex circuitry — the most modern approach — designed by engineering personnel with over 20 years experience in F.M.

**POLICY . . . . .** An important element at Electro-Plex. Our policy embodies a deep, personal interest in our customers and a desire to help them with their engineering and operational problem wherever possible.

**ELECTRO-PLEX Division**

**NUCLEAR ELECTRONICS CORPORATION**

**2925 N. Broad St.**

**Philadelphia 32, Pa.**

for the change granted to the manufacturer in accordance with § 4.750(b).

(b) Formal application (FCC Form 316) is required for any of the following changes:

(1) Replacement of the transmitter as a whole, except by one of an identical type.

(2) A change in the transmitting antenna system, including the direction of radiation, directive antenna pattern, or transmission line.

(3) An increase in the overall height of the antenna above ground of more than 20 feet or which will result in an overall height above ground of more than 170 feet.

(4) A change of the control point of a remotely controlled television broadcast translator station or any change in the control circuits.

(5) Any change in the location of the transmitter except a move within the same building or upon the same tower or pole, and any horizontal change in the location of the transmitting antenna in excess of 500 feet.

(6) A change of frequency assignment.

(7) A change of authorized operating power.

(8) A change of the primary TV station being retransmitted.

(c) Other equipment changes not specifically referred to above may be made at the discretion of the licensee, provided that the Engineer in Charge of the radio district in which the television broadcast translator station is located and the Commission's Washington, D. C. office are notified in writing upon completion of such changes, and provided further that the changes are appropriately reflected in the next application for renewal of license of the television broadcast translator station.

#### TECHNICAL OPERATION

##### § 4.761 Frequency tolerance.

The licensee of a television broadcast translator station shall maintain the visual carrier frequency and the aural center frequency at the output of the translator within 0.02 per cent of its assigned frequencies when the primary station is operating exactly on its assigned frequency. This tolerance shall not be exceeded, at times when the primary station is not exactly on its assigned frequencies, by more than the amount of departure by the primary station.

##### § 4.762 Frequency monitors and measurements.

(a) The licensee of a television broadcast translator station is not required to provide means for measuring the operating frequencies of the transmitter. However, only equipment having the required stability will be approved for use at a television broadcast translator station.

(b) In the event that a television broadcast translator station is found to be operating beyond the frequency tolerance prescribed in § 4.761, the licensee shall promptly suspend operation of the translator and shall not resume operation until the translator has been restored to its assigned frequencies. Adjustment of the frequency determining circuits of a television broadcast translator station shall be made only by a qualified person in accordance with § 4.750(d).

##### § 4.763 Time of operation.

(a) A television broadcast translator station is not required to adhere to any regular schedule of operation. However, the licensee of a television translator station is expected to provide a dependable service to the extent that such is within its control and to avoid unwarranted interruptions to the service provided.

(b) If causes beyond the control of the licensee require that a television broadcast translator station remain inoperative for a period in excess of 10 days, the Engineer in Charge of the radio district in which the station is located shall be notified promptly in writing, describing the cause of failure and the steps taken to place the station in operation again, and shall be notified promptly when the operation is resumed.

(c) Failure of a television broadcast translator station to operate for a period of 30 days or more, except for causes beyond the control of the licensee, shall be deemed evidence of discontinuance of operation and the license of the station will be cancelled.

(d) A television broadcast translator station shall not be permitted to radiate during extended periods when signals of the primary station are not being retransmitted.

##### § 4.764 Station inspection.

The licensee of a television broadcast translator station shall make the station and the records, required to be kept by the rules in this subpart, available for inspection by representatives of the Commission.

##### § 4.765 Posting of station and operators licenses.

(a) The station license and any other instrument of authorization or individual order concerning the construction of the equipment or manner of operation shall be posted in a conspicuous place in the room in which the transmitter is located so that all terms thereof are visible: *Provided*, That

(1) If the transmitter is operated by remote control pursuant to § 4.734, the station license shall be posted in the above described manner at the control point.

(2) If the transmitter is installed so as to be exposed to the elements and posting of the license would result in its

being so exposed, the license or a photo copy thereof may be kept in the possession of the operator in charge of the transmitter. If a photo copy is used, the original license shall be conveniently available for inspection by a representative of the Commission.

(b) The original of each station operator license shall be posted at the place where he is on duty: *Provided, however*, That if the original license of a station operator is posted at another radio transmitting station in accordance with the rules governing that class of station and is there available for inspection by a representative of the Commission, a verification card (Form 758-F) is acceptable in lieu of the posting of such license: *And provided, further, however*, That if the operator in charge holds a restricted radiotelephone operator permit of the card form (as distinguished from the diploma form), he shall not post that permit but shall keep it in his personal possession.

##### § 4.766 Operator requirements.

(a) The routine operation of a television broadcast translator station shall be carried on only by a person holding a valid Radiotelephone Operator Permit, or a First or Second Class Radiotelephone Operator license. The operator is not required to continuously supervise the operation of the transmitter but shall observe its operation either at the transmitter or at a monitoring point established pursuant to the provisions of § 4.734 within one hour after the transmitter is placed in operation each day and at intervals of no more than 6 hours during operation.

(b) Any repairs or adjustments to a television broadcast translator station which might result in improper operation of the equipment shall be made only by or under the direct supervision of a person holding a valid First or Second Class Radiotelephone Operator license issued by the Commission.

(c) The licensed operator on duty and in charge of a television broadcast translator station may, at the discretion of the licensee, be employed for other duties or for the operation of another station or stations in accordance with the class of license which he holds and the rules and regulations governing such stations. However, such duties shall in no wise interfere with the operation of the television broadcast translator station.

##### § 4.767 Marking and lighting of antenna structures.

The marking and lighting of antenna structures employed at a television broadcast translator station, where required, will be specified in the authorization issued by the Commission. Part 17 of this chapter sets forth the conditions under which such marking and lighting will be required and the respon-

sibility of the licensee with regard thereto.

#### § 4.768 Additional orders.

In cases where the rules contained in this part do not cover all phases of operation or experimentation with respect to external effects, the Commission may make supplemental or additional orders in each case as may be deemed necessary.

#### § 4.769 Copies of rules.

The licensee of a television broadcast translator station shall have current copies of Part 3, Part 4, and Part 17 of this chapter available for use by the operator in charge and is expected to be familiar with those rules relating to the operation of a television broadcast translator station. Copies of the Commission's rules may be obtained from the Superintendent of Documents, Government Printing Office, Washington 25, D. C., at nominal cost.

#### OPERATION

#### § 4.781 Station records.

(a) The licensee of a television broadcast translator station shall maintain an operating log showing the following:

- (1) Hours of operation.
- (2) Call letters, channel, and location of primary station or stations.
- (3) Time of periodic observation required by § 4.731, and operating conditions, signed by the operator making the observation.
- (4) A record of all repairs, adjustments, maintenance, tests, and equipment changes, showing the date of such events, the name and qualifications of the person performing the operation, and a brief description of the matter logged.

(b) Where an antenna structure is required to be illuminated, see § 17.38 of this chapter.

(c) The operating log shall be made available, upon request, to any authorized representative of the Commission.

(d) Station records shall be retained for a period of two years.

#### § 4.782 [Reserved]

#### § 4.783 Station identification.

(a) The call sign of a television broadcast translator station shall be transmitted in international Morse Code, by means of an automatic keying device, at the beginning and end of each period of operation and, during operation, within 5 minutes of the hour and half hour. This transmission may be accomplished either by turning the visual and aural carriers of the translator on and off in the proper sequence or by superimposing an audio frequency tone containing the telegraphic identification, on the visual and aural carriers radiated by the translator. The modulation level of the identifying signal shall not be less than 30 per cent of the aural signal.

(b) The Commission may, in its discretion, specify other methods of identification.

(c) Call signs for television broadcast

translator stations will be made up of the initial letter K or W followed by the channel number assigned to the translator and two letters. The use of the initial letter will generally follow the pattern used in the broadcast service, i.e., stations west of the Mississippi River will be assigned an initial letter K and those east of the Mississippi River the letter W. The two letter combinations following the channel number will be assigned in order and requests for the assignment of particular combinations of letters will not be considered.

#### § 4.784 Rebroadcasts.

(a) The term "rebroadcast" means the reception by radio of the programs or other signals of a radio or television station and the simultaneous or subsequent retransmission by radio of such programs or signals for direct reception by the general public.

(b) The licensee of a television broadcast translator station shall not rebroadcast the programs of any television broadcast station or other television broadcast translator station without obtaining prior consent of the station whose signals or programs are proposed to be retransmitted. The Commission shall be notified of the call letters of each station rebroadcast and the licensee of the television broadcast translator station shall certify that express author-

ity has been received from the licensee of the station whose programs are retransmitted.

(c) A television broadcast translator station is not authorized to rebroadcast the transmission of any class of station other than a television broadcast, or another television broadcast translator station.

#### TELEVISION BROADCAST TRANSLATOR STATION

In the matter of amendment of Part 4, Subpart G, rules governing television broadcast translator stations (§§ 4.736 (c) and 4.750 (c) (2) and (4) ).

At a session of the Federal Communications Commission held at its offices on the 27th day of November, 1959.

The Commission has before it for consideration §§ 4.736 (c) and 4.750 (c) of its rules and regulations relating to television broadcast translator stations.

The Commission is considering revising these standards and therefore believes it would be desirable to extend the period for compliance with the rules relating to suppression of out-of-band emissions for an additional period of one year.

Since the amendments adopted herein merely extend the date for compliance with bandwidth limits and represent a relaxation of the requirements by postponing the date for compliance, general

from the leader... EVERYTHING IN **MIKE STANDS**

**BOOM STANDS:**  
Boom lengths from 18 feet to 30 inches, in various sizes and models. Portable, semi-portable and special application.

**UPRIGHT STANDS:**  
for every requirement. From 65" to 4". Complete line of Accessories and Public Address Loudspeakers.

**ATLAS SOUND CORP.**  
1449-39 St., Brooklyn 18, N. Y.  
In Canada: Atlas Radio Corp., Toronto, Ontario

Write for free catalog to Dept. BE-1

notice of proposed rule making, pursuant to the provision of section 4 of the Administrative Procedure Act is unnecessary, and the amendments may become effective immediately.

Authority for the amendments adopted herein is found in sections 4 (i), 303 (f) and 303 (r) of the Communications Act of 1934, as amended.

In view of the foregoing: *It is ordered*, That effective November 27, 1959, § 4.736 (c) is amended to specify January 1, 1961, instead of January 1, 1960, and the notes to §§ 4.750 (c) (2) and (4) are amended to specify January 1, 1961, instead of January 1, 1960, and September 1, 1960, instead of September 1, 1959.

**CLEAR CHANNEL BROADCASTING IN  
STANDARD BROADCAST BAND  
Order Extending Time for Filing  
Comments**

1. The Commission has before it for consideration a Motion, filed on October 28, 1959, by the Clear Channel Broadcasting Service, for a six months extension of time, from final date of November 20, 1959, to final date of May 20, 1960, for the filing of comments in response to the third notice of further proposed rule making in the above-entitled proceeding.

2. In support of this Motion, CCBS states that comments have been invited on: (a) All problems considered in this proceeding prior to the third notice, as these have been brought into "sharper focus" therein, with a view toward their final resolution; (b) a specific proposal presented for the first time in the third notice, whereby nighttime operations on all of the clear channels would be modified by the assignment of unlimited time Class II stations in designated states; and (c) authorization of power in excess of the present 50 kw maximum, with consideration not limited, as heretofore, to a particular scheme of operations on clear channels. CCBS submits that extensive engineering studies are required and that an extension of time at this stage " \* \* \* will conduce to, rather than delay, an early and satisfactory termination of the case by providing the Commission with \* \* \* a complete, accurate, and contemporaneous record based on a careful compilation and expert analysis of the latest data available \* \* \*."

3. In view of the considerable scope of the proceeding, and of the presentation in the third notice of matters requiring detailed technical analysis, the Commission concurs that an extension of time is warranted. The Commission is, however, unable to conclude that six months of additional study are required, and is, instead, of the opinion that an extension of 90 days will afford ample time for preparation of comments. Additional delay would, in our view, un-

justifiably prolong the process of bringing this proceeding to the earliest possible conclusion consistent with fair opportunity for the parties to prepare and submit comments supplementing the voluminous record already compiled.

4. In view of the foregoing: *It is ordered*, That the aforementioned October 28, 1959, Motion of the Clear Channel Broadcasting Service, is granted in part, and the time for filing comments in response to the third notice of further proposed rule making herein is extended from November 20, 1959, to February 19, 1960.

**REALLOCATION OF CERTAIN FIXED,  
LAND MOBILE AND MARITIME  
MOBILE BANDS  
Second Notice of Proposed Rule  
Making**

1. Notice is hereby given of further proposed rule making in the above-entitled matter.

2. On April 3, 1957, the Commission adopted a notice of proposed rule making in this proceeding which, among other things, proposed the reallocation of 455-456 Mc and 460-461 Mc from remote pickup broadcast stations and the Citizens Radio Service, respectively, to the Domestic Public Land Mobile Radio Service, in an effort to satisfy, insofar as practicable, the stated requirements of the latter mentioned service. The Commission believed that such an allocation, in conjunction with the bands already available to the Domestic Public Land Mobile Radio Service, would have satisfied completely the stated requirements of this service except in the larger metropolitan areas for which the Commission is unable to find sufficient spectrum space to fulfill the requirements without a prohibitively adverse effect on other services. Even in those areas, however, it was anticipated that the reallocation would have afforded a significant measure of relief, since the bands which were proposed to be reallocated are immediately adjacent to the bands 454-455 Mc and 459-460 Mc which are already allocated to the Domestic Public Land Mobile Radio Service.

3. Comments submitted by the American Telephone and Telegraph Company (AT&T) supported the Commission's proposal to reallocate the bands 455-456 Mc and 460-461 Mc to the Domestic Public Land Mobile Radio Service but emphasized that the additional space would be wholly inadequate to meet their land mobile requirements in the larger cities.

4. Comments objecting to the Commission's proposal in this proceeding, with respect to frequencies available to remote pickup broadcast stations, were filed by the former National Association of Radio and Television Broadcasters (now NAB), the National Broadcasting

Company (NBC), and the Chronicle Publishing Company (KRON-TV). For the most part, these objections were directed at the proposed deletion of the 455-456 Mc remote pickup broadcast band.

5. Electronic Industries Association (EIA) filed a petition with the Commission, on July 10, 1958, which objected to the proposed reallocation of a portion of the Citizens Radio band, specifically 460-461 Mc, and requested that the Commission issue a further notice of proposed rule making dealing only with the band 460-461 Mc, to determine how this band might be allocated to provide for the public interest, convenience, or necessity. Also in a separate but related proceeding, Vocaline Company of America, Inc., filed a petition with the Commission on June 16, 1958, requesting the Commission to terminate the proceedings in Docket No. 11994 in its entirety and in Docket No. 11995 insofar as the proposed reallocation of Citizens Radio frequencies is concerned. Both of these petitions were denied by the Commission's Second Report and Order in Docket No. 11994 which was adopted July 31, 1958.

6. During September 1957, Michigan and Illinois Bell Telephone Companies were given developmental authorizations to operate an air-to-ground public radiotelephone service in the 450 Mc common carrier bands, between Detroit and Chicago, for a one-year period. These authorizations were renewed for an additional year during September 1958. During July and August 1959, these Bell companies filed applications again to renew the developmental air-ground authorizations and other affiliates sought to extend the service to the east coast, with ground stations at Pittsburgh, Washington, and New York City, utilizing an additional frequency pair in the same 454-455 Mc and 459-460 Mc common carrier bands. The National Association of State Aviation Officials has recommended to the Commission that this developmental grant be made permanent and that service be expanded.

7. Subsequent to initiation of the developmental air-ground operations, AT&T filed a petition with the Commission, on April 1, 1958, requesting that the bands 455-456 Mc and 460-461 Mc be made available to the public air-ground radiotelephone service. Comments filed by AT&T in opposition to the above-mentioned EIA and Vocaline petitions indicate that these bands would be used for both land mobile and air-to-ground operations. Comments generally supporting the granting of the AT&T petition have been filed by Aeronautical Radio Inc. (ARINC) and the AC Sparkplug Division of General Motors Corporation, and Motorola, Inc., filed comments opposing such a grant.

8. The Chicago-Detroit developmental air-ground operations tend to indicate a limited need for a permanent public aeronautical radiotelephone service. However, the extent to which air travelers, except business executives in private planes, would avail themselves of the new service under normal circumstances, in view of the ever decreasing airborne time of commercial passenger flights and the ready availability of cheaper landline facilities at all airports is not known at this time. Accordingly, the Commission believes that the reallocation of 2 Mc of much needed land mobile frequency space, even on a shared basis with the land mobile service, for this unproven service, as requested in the AT&T petition of April 1, 1958, is not justified and the subject AT&T petition is denied in the concurrent Third Report and Order in Docket No. 11995.

9. In order to meet the apparent limited need for an air-ground public radiotelephone service it is hereby proposed that provision be made to accommodate this service in those portions of the 454-455 Mc and 459-460 Mc bands which are available for assignment only to stations of communication common carriers engaged also in the business of affording public landline message telephone service, i.e., 454.40-455 Mc and 459.40-460 Mc. It is realized that such opera-

tion of the air-ground service will require close coordination to avoid disruption of the land mobile service in these bands, in view of the greater transmission coverage to and from airborne units. However, it is believed that the assignments can be arranged in such a manner that a minimum of interference will result since Commission records indicate that the present loading on these bands is very light.

10. In view of the fact AT&T has indicated that implementation of the Commission's outstanding proposal to reallocate 455-456 Mc and 460-461 Mc to the Domestic Public Service would not fill their land mobile requirement and the Commission's belief that a full 2 Mc of valuable frequency space is not required to adequately accommodate an air-ground service, the original proposal, with respect to these bands is withdrawn by the Commission's concurrent Fifth Memorandum Report and Order in Docket No. 11959 and Third Report and Order in Docket No. 11995, and the Commission proposes to reallocate the 460-461 Mc band to the Industrial Radio Services, which would absorb most of the stations now operating in this portion of the Citizens Radio band.

11. The remaining outstanding proposals in Docket 11959 to reallocate 161.645-161.825 Mc to remote pickup

and 462.525-463.225 Mc and 465.275-466.475 Mc to the Industrial Radio Services will be disposed of at a later date when appropriate.

12. In summary, the action contained herein and in the above-mentioned Orders:

a. Denies the AT&T petition of April 1, 1958, which requests reallocation of 455-456 Mc and 460-461 Mc to an air-ground public radiotelephone service.

b. Withdraws the Commission's original proposal in Dockets 11959 and 11995 to reallocate 455-456 Mc and 460-461 Mc to the Domestic Public Land Mobile Radio Service and terminates the proceeding in Docket No. 11995.

c. Proposes to provide for an air-ground public radiotelephone service in the Domestic Public land mobile bands 454-455 Mc and 459-460 Mc.

d. Proposes to reallocate 460-461 Mc to the Industrial Radio Services.

These actions, including the current proposals in this docket shown in the attached appendix are not intended to dispose of the broader considerations in Docket No. 11997 with respect to finding adequate space for the Domestic Public Land Mobile Radio Service and an air-ground public radiotelephone service.

13. The proposed amendments to the rules, as set forth below, are issued pur-

## JAMPRO ANTENNA COMPANY

7500 14TH AVENUE • BUILDING 9  
SACRAMENTO • CALIFORNIA

ANTENNA EQUIPMENT FOR  
TELEVISION AND FM BROADCASTING

- ★ SALES
- ★ SPECIAL DESIGNS
- ★ ENGINEERING
- ★ FABRICATION

JAMPRO ANTENNAS . . . *Designed and Built  
to Do a Perfect Job!*

**To Keep Up-to-Date On The Latest  
Developments in Broadcasting  
Be Sure You Are A  
Subscriber to**

**BROADCAST ENGINEERING**

## FIRST TRULY VERTICAL SLIDE ATTENUATOR! ...only 2" deep



Daven's Series 825 and 835 are the first truly vertical slide attenuators... with finger-fitting knob that moves in a straight line with finger-tip pressure. The wiper arm rides on silver alloy contacts, not on the resistor element, providing noise-free operation and extremely long life.

- Silver alloy contacts, wiper arms
- Balanced and unbalanced ladders and T-type attenuators
- In 20 and 30 steps
- With or without "Cue" position
- Complete protection against dirt and foreign objects
- Connector-type terminals on rear
- 1½" wide, 6" long, 2" deep
- Available singly, or with 3, or 4 units side by side

FOR FURTHER INFORMATION WRITE:

THE **DAVEN** CO.



LIVINGSTON  
NEW JERSEY

Today, more than ever, the Daven © stands for dependability

suant to the authority contained in sections 303 (c), (f), and (r) of the Communications Act of 1934, as amended.

14. Any interested person who is of the opinion that the proposed amendments should not be adopted may file with the Commission on or before January 11, 1960, written data, views or arguments setting forth his comments. Comments in support of the proposed amendments may also be filed on or before the same date. Comments in reply to the original comments may be filed within 10 days from the last day for filing said original data, views, or arguments. The Commission will consider all such comments and such other material and information as may be deemed necessary and relevant prior to taking final action in this matter, and if comments are submitted warranting oral argument, notice of the time and place of such oral argument will be given.

15. In accordance with the provisions of § 1.54 of the Commission's rules and regulations, the original and 14 copies of all statements, briefs or comments filed shall be furnished the Commission.

#### INTERFERENCE STANDARD

At a session of the Federal Communications Commission held at its offices in Washington, D. C., on the 18th day of November 1959:

The Commission having under consideration the desirability of making certain changes in § 3.313 (c) of its rules; and

It appearing that the last sentence of the rule provides in essence that the Commission in its discretion may assign an FM channel different from that requested in an application; and

It further appearing that the Commission at one time utilized a Table of Assignments of FM channels to particular communities, whereunder it could readily determine the availability of alternative channels in a given case; and

It further appearing that the Commission by Order released August 5, 1958, effective August 20, 1958, in Docket No. 12461 (FCC 58-777), discontinued the use of its Table of Assignments of FM channels; and

It further appearing that in view of the foregoing the Commission no longer considers it desirable to exercise the discretionary power afforded by such rule; and

It further appearing that questions have arisen as to whether the sentence in question is wholly compatible with the intent of certain other rules such as §§ 1.305, 1.310 and 1.356; and

It further appearing that any reason for perpetuation of the rule has ceased to exist; it is therefore consonant with the public interest and orderly rule making processes to delete said sentence; and

It further appearing that the amendment adopted herein reflects a change of procedure and thus prior publication of Notice of Proposed Rule Making under the provisions of section 4 of the Administrative Procedure Act is unnecessary and the amendment may become effective immediately; and

It further appearing that authority for the amendment adopted herein is contained in sections 4(i) and 303(r) of the Communications Act of 1934, as amended;

*It is ordered,* That effective November 27, 1959, the last sentence of § 3.313 (c) which provides: "In the assignment of FM broadcast facilities the Commission will endeavor to provide the optimum use of the channels in the band, and accordingly may assign a channel different from that requested in an application" is deleted.

Section 3.313 (c) will now provide as follows:

#### § 3.313 Interference standard.

\* \* \* \* \*

(c) Stations normally will not be authorized to operate in the same city or in nearby cities with a frequency separation of less than 800 kc; *Provided,* That stations may be authorized to operate in nearby cities with a frequency separation of not less than 400 kc where necessary in order to provide an equitable and efficient distribution of facilities; *And provided further,* That class B stations will not be authorized in the same metropolitan district with a frequency separation of less than 800 kc.

## ". . . a stereo broadcast is not background music . . ."

### ROLE OF TAPE starts on page 20

cause of the increasing competition in broadcasting.

And now the advent of stereophonic radio opens up whole new audiences for night-time radio.

Consider the influence stereo broadcasts can have on night-time revenues. Stereophonic sound in the home is getting a tremendous lift from our major recording companies. There is a veritable deluge of selections in stereo.

Listeners soon realize that stereo broadcasts can scarcely be regarded as "background" music. It is entertainment. The enjoyment of stereo is reserved for those hours when attentive listening is possible. Stereophonic radio performs primarily a service for the evening hours and the weekend.

The radio station will inherit the role of auditioner of new stereophonic releases. Along with the routine activity of dispensing commercially-recorded music, the stations will discover a need for a programming service which enables them to offer one-time-only stereophonic programs designed specially for radio.

Does this mean tape networking is just around the corner? Undoubtedly. Other than the commercial releases themselves, radio stations will find no better source of stereo programming than the tapes they generate themselves or trade with neighboring stations or obtain through a tape syndicate.

Cost of renting dual audio lines to get programs from a network origination point definitely discourages use of interconnection. So does the technical difficulty of obtaining two identically-matched lines for best stereo rendition. A syndication system will reach full strength through its unique suitability and feasibility for the one-time-only type of programming service in stereophonic broadcasts.

With a professional tape recorder specifically built for stereophonic broadcasting any station can convert to stereo at any time, using the AM-FM, TV-AM or any of the multiplexing systems. Quality of the playback and broadcast will be the finest available.

## SUBSCRIPTION ORDER

Please place us on your subscription list.

NAME..... TITLE.....  
FIRM.....  
ADDRESS.....  
CITY..... STATE.....

Rate: \$6 Per Year — \$7 outside U.S.A.

PAYMENT ENCLOSED

12 Issues

BILL LATER

**BROADCAST ENGINEERING, 1014 Wyandotte, Kansas City 5, Mo.**

# Industry News

## Senior Project Engineer At Audio Devices



Frank A. Comerci has joined Audio Devices as senior project engineer at the Stamford, Conn., laboratory. For the past 12 years Mr. Comerci has been in charge of the Communications and Acoustics Section at the New York Naval Shipyard in Brooklyn, N. Y. He is a member of the Audio Engineering Society, the Institute of Radio Engineers, the Acoustical Society of America and the Research Society of America. He is chairman of the sound committee of the Society of Motion Picture and Television Engineers.

## Technical Papers Invited for Audio Engineering Convention

A call for technical papers for the 1960 West Coast Audio Engineering Society Convention has been issued by Walter T. Selsted, western vice-president of the Society. The convention, expected to be the largest of its kind ever held on the West Coast, is scheduled for March 8 to 11 at the Alexandria Hotel in Los Angeles.

Preliminary session titles are: Magnetic recording devices; stereo tape reproduction and equipment; disk recording and pickups; transistor amplifiers; loudspeakers and enclosures; stereo broadcasting and studio input systems, acoustics, reverberation and ambiophonic techniques; audio measurements and analysis. Authors are urged to send titles and 25-50 word abstracts of their papers to Walter T. Selsted, Ampex Corp., 934 Charter St., Redwood City, Calif.

## New Literature Available On Peak Symmetrizer

A new four-page illustrated brochure released by Kahn Research Laboratories, Inc., 81 South Bergen Place, Freeport, N. Y., describes Symmetra-Peak, a passive network

widely used by AM, FM and TV broadcasters to increase effective power and coverage range of voice transmissions and to improve limiter and AGC amplifier performance. Folder includes specifications, customer evaluation reports and list of users.

## New Building For International Radio & Electronics

International Radio & Electronics Corp., Elkhart, Ind., has announced a new building and two new subsidiaries, Crown International, the tape recorder division, and International

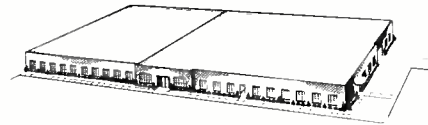

Radio, the broadcast equipment division. The new expansion program will be able to triple the output of the corporation according to company officials. Crown International supplies tape recorders to the domestic and professional field and International Radio builds broadcast transmitters and accessories.

## Flynn Named Traffic Manager For CBS Electronics

G. Warren Flynn has been named traffic manager for CBS Electronics, the electronic manufacturing division of Columbia Broadcasting System, Inc. He studied traffic management at Boston University and at the College of Advanced Traffic, Chicago, Ill.

## Day Predicts Lower TV Tape Production Costs

Further substantial cuts in production costs for taped television programs and commercials have been promised by Bob Day, manager of sales development for Ampex Professional Products Co. at the Los Angeles chapter of the Academy of Television Arts and Sciences. He predicted that the TV industry would be operating with at least 30 per cent additional below-the-line economies in tape production by next summer.

He said the savings would come through new accessories, adaptations and techniques in using the recorder. He stated that producers presently report economies ranging from 25 to 50 per cent under film.

## GPL Names Service and Support Manager



The appointment of Dr. Frank A. McMahon as manager of the service and support department has been announced by Robert Tate, director, sales and service division, General Precision Laboratory, Inc. In his new position Dr. McMahon assumes responsibility for the areas of ground support equipment, repair, spare parts, and publications as well as field service and training.

## Latest 3M Video Tape Handbook Now Available

A new 60,000-word illustrated handbook on all aspects of video tape has been issued by Minnesota Mining & Mfg. Co. The book inaugurates a 1960 information service by 3M designed to keep users and potential users of video tape abreast of all significant developments in this field. Titled "The Changing Picture in Video Tape for 1959-1960: A Review for the Television Industry" (second edition, October, 1959), the book is three times as large as the first edition. Copies may be obtained at \$1.50 each by writing Box No. 3500, St. Paul, Minn.

## Dalbke Appointed Regional Sales Manager for CBS Electronics



Warren E. Dalbke has been appointed mid-west regional manager, equipment sales, for CBS Electronics. He previously was a district manager, equipment sales. Prior to joining CBS Electronics, Mr. Dalbke was a member of Armour & Co.'s training staff. He holds a degree in industrial education from Purdue University.

## "... might have effect on television allocation ..."

SOUND POWER starts on page 14

siderably improved by operation of all transmitters on the proposed super-accurate offset. In the event of improved picture channel performance by the use of these techniques, reduction of sound channel coverage might nullify the improved picture coverage.

**8. Sound vs Picture Performance**— It is the emphatic experience of all television receiver manufacturers that the public will tolerate and be entertained by extremely marginal picture signals provided satisfactory sound signals are available. In the report of the first NTSC in 1941, it is stated, "... a given amount of interference is more disturbing in the sound than in the picture. The service area of the television system will be determined by the acceptability of the service with respect to the noise interference."

**9. Future System Development**— Technological advances and improvements could conceivably make use of the sound channel to transmit additional information. A reduction of aural power could obstruct such possible future benefits.

In summary, any proposals for sound power reduction should weigh what appears to be a minor and probably short lived advantage of adjacent channel sound interference reduction against the disadvantage of the fundamental reduction of system capability and coverage.

The reason that TASO is interested in the ratio of sound-to-picture power which is used in television broadcasting is that the choice of this ratio has an effect on the extent of the service provided by television stations and therefore might have an effect upon the television allocation problem. Mr. E. W. Allen, Chief Engineer of the FCC, has stated that the sound-to-picture power ratio could be of significance in television allocations (minutes of December 4, 1957, meeting of Panel Coordinating Committee, D278, p. 3). It should be noted that this significance extends to the general problem of television allocations and is by no means limited to considerations regarding "drop-ins".

## Industry News

### University Loudspeakers Names President



In a joint statement Alvis A. Ward and Sidney Levy announced the election of Haskel A. Blair as president of University Loudspeakers, Inc., a subsidiary of Ling-Altec Electronics, Inc. Mr. Levy is one of the co-founders of University, and is internationally prominent in the field of loudspeaker engineering. Mr. Blair has been nationally active in all phases of the audio industry.

### New RCA Plant To Be Built

A new plant for the manufacture of RCA industrial electronic products will be constructed in the Washington-Canonsburg, Pa., area, according to T. A. Smith, executive vice-president, Industrial Electronic Products, RCA. The plant is the second new Pennsylvania facility to be announced by RCA in the past two months. Plans call for the immediate construction of an administration and engineering building of 50,000 square feet. RCA anticipates that future expansion will require the construction of a manufacturing center with 130,000 square feet of floor space in the near future. The site is two miles north of Washington along the Washington-Canonsburg road.

### IT&T Introduces Printed Circuit Rectifier

International Telephone & Telegraph Corp.'s Components Division, Clifton, N. J., has introduced a series of silicon printed circuit rectifier assemblies that can be mounted in any desired configuration on high temperature printed circuit boards to facilitate equipment miniaturization while providing the high output power. The diffused-junction rectifiers employed in the assemblies are available for single and three-phase power supply applications, in half-wave, doubler, center tap and bridge circuits. They are hermetically sealed and will operate in adverse environments up to temperatures of 150 deg.

C. Basic ratings are available up to three amperes dc output and 800 volts in a single phase assembly, as well as 4.5 amperes dc in three phase assemblies. Higher voltages and currents may be obtained by putting the rectifiers in parallel and series.

### New President Elected At Audio Devices



William T. Hack has been elected president of Audio Devices Inc., New York, and William C. Speed, former president and one of the founders of the company, becomes chairman of the board. Mr.

Hack is a graduate of Princeton University with a degree in chemical engineering and also attended the Harvard Graduate School of Business Administration.

### Camera Equipment Co. Opens Branch in Hialeah, Fla.

A completely stocked and staffed branch in the Miami territory at 1335 East 10th Ave. has been opened by Camera Equipment Co. with headquarters in New York. The branch will carry a full range of professional cameras, dollies, mike booms and perambulators, lights, incandescents, arcs, spots, brutes, generators, switches, cable, and other accessories. A repair and service department will also be included.

### Engineering Scholarship Increased At George Washington University

The Assn. of Federal Communications Engineers at their spring convention voted to increase the engineering scholarship at George Washington University from \$520 a year to \$800 a year. This scholarship is awarded each year to an engineering student at George Washington University who is specializing in electrical engineering.

### Houston Fearless Moves New York Office

Houston Fearless Corp. announces the moving of their New York regional office and showrooms to the General Motors Bldg., 1775 Broadway, New York 19, N. Y. Houston Fearless, whose head office and plant are in Los Angeles, manufactures motion picture film processors, television studio equipment, and aircraft and missile components.



# Product News

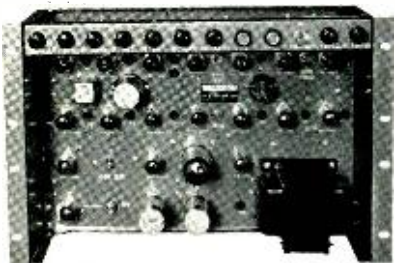

**V-6B TV RADAR BAR-DOT GENERATOR**  
Foto-Video Laboratories, Inc.  
36 Commerce Road  
Cedar Grove, N. J.

The V-6B is used to monitor and measure the geometric distortion of TV and Radar monitors. For television the precise two-frequency signal is produced as a composite video signal with or without sync. The horizontal and vertical frequencies or components are chosen by a display selector to form on a display monitor either white or black with contrasting backgrounds: horizontal and vertical bars, vertical bars alone, horizontal bars alone, or dot pattern. Both horizontal and vertical bar-dot frequency components are phase-locked to the input sync pulses, and are independent of the input frequencies or pulse width. The V-6B generator can be used with European and military 405 and 625 line systems, military and air control 875 and 945 line applications, as well as standard 525 line systems. Continuously variable H and V phase controls permit the detection of short-duration velocity errors. The operating control panel enables rapid checks of camera geometric distortion by matching the EIA linearity chart pattern independent of monitor linearity. The fine white bar-dot pattern is useful in the measurement and adjustment of the convergence of three-color cathode ray beams in tri-color picture tubes. The unit is 19 inches wide, 9 inches deep, and 12 1/4 inches high. A portable carrying case is available.



**MODEL HAB TV-FM AMPLIFIER**  
Blonder-Tongue Laboratories, Inc.  
9 Alling St., Newark 2, N. J.

A TV-FM amplifier which boosts signals up to 14 times for small master TV systems. The three tube unit features a special frame grid input circuit to provide the highest possible signal-to-noise ratio. Maximum output is 0.7 volts at 75 ohms and 1.4 volts at 300 ohms with 22 db gain on low TV and FM channels

and 24 db gain on the high TV channels. A built-in power supply operates on conventional 110-120 volt, 60 cycle current. The amplifier is protected in a steel cabinet measuring 6" x 5 3/8" x 4 3/8". It weighs 4 1/2 pounds.



**MARK VI-M ZOOMAR LENS**  
Zoomar, Inc.  
Glen Cove, L. I., N. Y.

A new manually controlled zoom lens for Vidicon Cameras has been introduced by Zoomar, Inc. Designated the Mark VI-M, the new lens which is a manually controlled version of the Mark VI remote controlled unit has a zoom range of 6:1. The lens is designed to meet the needs for operator control of closed circuit television equipment in the fields of educational and industrial television as well as in studio operations. Resolution is 800 lines, coverage 5/8 inch diagonal, dimensions 2 1/2 x 2 1/2 x 6 1/2, weight is 1 1/2 lbs.



**16 MM HIGH SPEED CAMERA**  
Camera Equipment Co.  
315 West 43rd St.  
New York 36, N. Y.

The Waddell 16 mm High Speed camera was developed to be used where high speed motion picture recording is necessary. It has a speed range of from 3 to 10,000 pictures

per second, depending on the camera model and motor combination. It accepts the normal 400 foot magazine, and is driven by either a 26 volt DC or a 115 volt AC-DC motor, depending on the model. Features include electronic flash synchronization and exposure playback for oscillograph recorders; variable height fixed aperture plate; two built-in NE2H timing lights; manual or remote camera operation; film cut-off switch which operates an independent 20 amp load relay and boresight focusing. The camera with its portable power supply and carrying cases weighs 35 lbs. The size is 8" x 7" x 7".

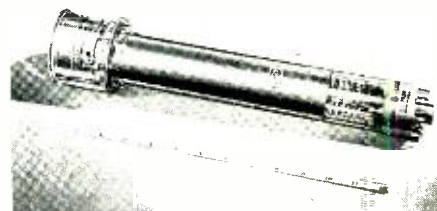

**GL-7629 IMAGE ORTHICON**  
General Electric Co.  
Schenectady, N. Y.

A new image orthicon, type GL-7629 has been introduced by the General Electric Co. The new tube is physically and electrically interchangeable with standard camera tubes. It requires from 1/10 to 1/20 the light required by standard image orthicons. It can produce pictures of usable black-and-white quality at one foot candle of scene illumination or less. The target uses electron conduction and the life of the tube is not limited by the exhaustion of charged carriers. The tube life is extended because of the lack of stickiness and burn in. Twenty-five to fifty per cent more resolution is claimed over present image orthicons.



**MODEL 680 MONITOR AMPLIFIER**  
Fairchild Recording Equipment Corp.  
10-40 45th Ave.  
Long Island City 1, N. Y.

This new amplifier designed for the recording and broadcast industries has a rated output of 80 watts and is capable of reproducing peaks in excess of 250 watts. A meter actuated by pushbuttons on the front panel is furnished to check output tube, plate current, and static and dynamic balance. Input impedance is 150/160 ohms, output impedance is 8 and 16 ohms standard with other impedances available on special order.

# Product News

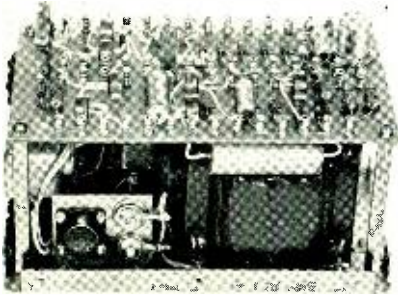

**62 AR TRANSISTORIZED POWER SUPPLY**  
**The Daven Co.**  
 Livingston, N. J.

A new AC to DC transistorized power supply with stability of plus or minus 0.1% regulation for six months has been announced by the Daven Co. The unit features reliability of better than .95 for a period of one year at eight hours per day, life expectancy of ten years, and an output impedance of less than 200 micro-ohms at DC. The unit can be used as an ultra-stable power source for precision equipment. Units can be cascaded to provide higher voltage. Output is 26 volts D. C. at 1 ampere.

# Technical Hints

## Turntable Equalizer Indicator

On many occasions the announcer-operator would put the Gray 602 record equalizer in the roll-off position when using a scratchy record and then forget to turn it back in the regular position. This has happened in the past for hours at a time and can be very detrimental to building a good listening audience.

A simple remedy, with a few hours of work, is to put a light indicator on the console or in any other easily noticed spot. Take the Gray switch box apart and remove the single section, two-pole, shorting type switch, making certain to make note of its connections beforehand. In place of this switch use a Centralab 1424 switch which has three sections, six poles, and five positions. Wire the first section the same as the original. Leave the second section unused for possible stereo use in the future. Wire the third section so that the indicator will light on all positions except the right one or NAB position.

**NORMAN F. ROUND,**  
*Chief Engineer, WCCM,*  
 Lawrence, Mass.



**5693 MODULATION MONITOR**  
**Gates Radio Co.**  
 Quincy, Ill.

The new Gates 5693 modulation monitor reads the true value of positive and negative peaks regardless of the presence of carrier shift. It will give correct peak indications on single program pulses as short as approximately 50 milliseconds and will measure the true peak amplitude regardless of waveform. The monitor compares the rectified carrier voltage with a stabilized internal reference voltage. The monitor is designed for use with remote controlled transmitters and contains compensating adjustments for telephone line variations.



**1390-B RANDOM NOISE GENERATOR**  
**General Radio Co.**  
 West Concord, Mass.

An instrument capable of generating wide-band noise of a uniform spectrum level suitable for many types of electrical and mechanical testing has been announced by General Radio. As a noise source it is useful for measurement of loudspeakers, intermodulation and crosstalk tests, simulating pulse noise in telephone line tests, noise-interference tests, dynamic range determination, and meter response tests. A gas discharge tube is used as a noise source; a magnetic field, applied to the tube, serves to eliminate oscillations usually associated with a gas discharge. Noise output is amplified in a two-stage amplifier, which has noise-spectrum

# Classified

Advertising rates in the Classified Section are ten cents per word. Minimum charge is \$2.00. Blind box number is 50 cents extra. Check or money order must be enclosed with ad.

## EQUIPMENT FOR SALE

**MIRATEL TV MONITORS** — Demonstration units, new warranty. 15-17" metal cabinet, \$215 each. 8-17" veneer cabinet \$185 each. Complete line of new units available in 8", 14", 17", 21" and 24". Write: Miratel, Inc., 1082 Dionne St., St. Paul 13, Minn. 12-59 31

shaping filters controlled by a three-stage front-panel switch. The 20-kc setting introduces a low-pass filter providing a gradual rolloff above 30 kc, the 500-kc setting inserts a low-pass filter that rolls off above 500 kc, and in the 5 Mc setting a peaking network compensates for the drop in noise output from the gas tube at high frequencies providing spectrum to 5 Mc.

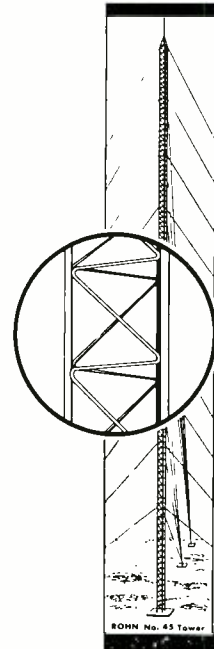

**NO. 45 COMMUNICATIONS TOWER**  
**Rohn Manufacturing Co.**  
 116 Limestone, Peoria, Ill.

This new heavy duty communications tower is suitable for heights up to 450 feet when guyed every 50 feet under normal conditions. The tower is constructed in 18 inch triangular pattern utilizing zig-zag steel bracing, all electrically welded. The entire 10 foot tower section is hot-dipped galvanized after fabrication.

# Advertisers' Index

Atlas Sound Corp.....	33
Bauer Electronic Mfg. Co.....	23
Bogen-Presto Co. ....	25
Collins Radio Co. ....	9
Daven Co., The .....	35
Electro-Plex Div., Nuclear Electronics Corp.....	31
Electronic Applications, Inc. ....	2-3
Foto-Video Laboratories, Inc. ....	IFC
Jampro Antenna Co. ....	35
Miratel Inc. ....	28
Nems-Clarke Co. ....	29
Radio Corp. of America.....	4-5, 29
Raytheon Co. ....	26-27
Telechrome Mfg. Co.....	IBC
Television Zoomar Co.....	BC
Tower Construction Co.....	28

# HAVE TELECHROME

VIDEO TRANSMISSION TEST EQUIPMENT

WILL TRAVEL



IT'S PORTABLE



**1003-C VIDEO TRANSMISSION TEST SIGNAL GENERATOR**

Produces multi-frequency burst, stairstep, modulated stairstep, white window, composite sync. Variable duty cycle. Regulated power supply.



**1004-B VIDEO TRANSMISSION TEST SIGNAL RECEIVER**

Very rapid and accurate measurement of differential phase and differential gain characteristics of video facilities. Responds to standard stairstep test signal modulated with 3.58 mc, or any differential phase or gain test signal.



**1005-A VIDEO TRANSMISSION TEST SET**

1005-A1 — Produces composite television waveforms suitable for measuring amplitude vs. frequency; differential gain vs. amplitude; dynamic linearity; differential phase vs. amplitude; high frequency transient response; low frequency transient response; low frequency phase of streaking, smears, mismatches; and other video characteristics.

1005-A2 — Supplies composite EIA Sync, blanking, horizontal and vertical drive signals and regulated B+ power for itself and 1005-A1. Features magnetic core binary counters.



**1008-A VERTICAL INTERVAL KEYS**

Permits test and control signals to be transmitted simultaneously with program material, between frames of TV picture. Any test signal (multi-burst, stairstep, color bar, etc.) may be added to the composite program signal. Test signals are always present for checking transmission conditions without impairing picture quality. The home viewer is not aware of their presence.



**1073-CR SINE SQUARED (SIN-S) — SQUARE WAVE GENERATOR**

Produces new waveform for testing TV or other pulse unit or system for amplitude and phase characteristics. Sin<sup>2</sup> — Square Wave pulse is equivalent to TV camera signal and is more sensitive than a Square Wave in indicating ringing. Video test signal adjustable for 40 volts or 1.4 volts peak to peak. Now in use by major TV networks and telephone companies.

ALSO ASK ABOUT TELECHROME SPECIAL EFFECTS GENERATOR



Waveform Generator



Remote Control Unit

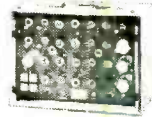

Switching Amplifier

Full Specifications & Details Available on Request

**TELECHROME**  
MANUFACTURING CORP.

AT THE FRONT ERS OF ELECTRONICS  
COLOR TV • INDUSTRIAL INSTRUMENTATION • TELEMETRY

TELECHROME MANUFACTURING CORP.  
28 RANICK DRIVE, AMITYVILLE, N. Y. Lincoln 1-3600  
Cable Address: COLORTV TWX: AMITYVILLE NY2314

Midwest Engineering Division — 106 W. St. Charles Rd., Lombard, Ill., Mayfair 7-6026  
Western Engineering Division — 13635 Victory Blvd., Van Nuys, Calif., State 2-7479  
Southwestern Division — 14207 Gaston Ave., Dallas, Tex., Taylor 3-291

# For Television Commercials

## **SUPER UNIVERSAL**

# CLOSE-UP ADAPTER

## lets you **ZOOM**



**FROM THIS**  
medium waist shot

Because advertising agencies and producers wanted it—we made a close-up adapter for the **SUPER UNIVERSAL ZOOMAR**. With the camera 4 to 6 feet from the subject, you zoom the entire range of 2½ to 16 inches with exact precision. It takes 30 seconds to mount the adapter on the **SUPER UNIVERSAL**. The wide angle shot is a medium waist shot of announcer and product. The telephoto shot fills the receiver with a pack of cigarettes . . . an area 3 inches by 4 inches.

**TO THIS!**



This is a must for producers making taped or live commercials. It has additional application for educational television.



**SUPER UNIVERSAL**

Color Corrected  
Speed f/3.9  
Zoom Range  
2½ to 40 inches  
Two converters  
Zoom Ratio 6 to 1

No counterbalancing necessary  
Self-Supporting • Change Zoom Range in a minute  
Zoomars serviced by the Engineers who build them  
Zoomars change from camera to camera in a minute  
One year guarantee and maintenance contract

For a demonstration of **ZOOMAR LENSES** on your cameras, write or call



JACK A. PEGLER

BILL PEGLER

## **TELEVISION ZOOMAR COMPANY**

500 Fifth Avenue, Room 2223 • New York 36, New York • BRyant 9-5835