

BE

November 2000
An INTERTEC®/PRIMEDIA Publication
www.beradio.com

Radio®

The Radio Technology Leader

FROM

HERE

TO HEAR

SATELLITES
CODECS
STREAMING

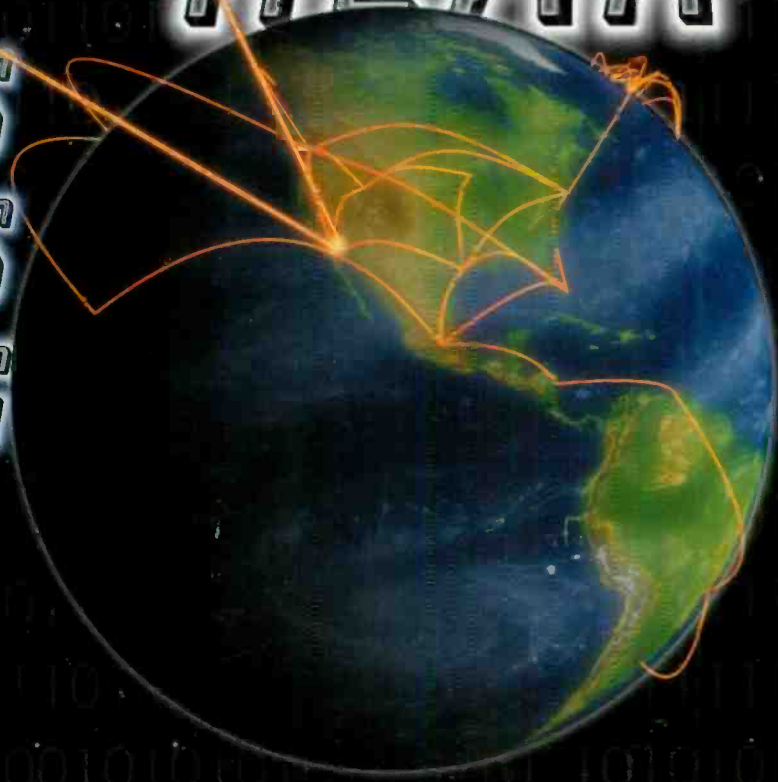

From Audioarts...



**The #1 Supplier
of Radio
Broadcast
Consoles
in America!**

This Is The Deal

Audioarts Engineering manufactures a complete line of audio consoles for every size radio station and market.

Like the brand new **RD-12/20** series—the latest in digital technology. Fully modular with three stereo busses, analog and digital inputs and outputs and hot-swappable modules.

Or the **R-17**: a modular design in a compact mainframe with everything you demand in a broadcast console: muting, tallies, machine control, rackmount power supply—and more.

The **R-5**: 12 inputs with dual source channels, exclusive Simple Phone™ telco interface, full function tape remote and more—all in an affordable package.

R-60: The #1 selling console in the U.S. Fully modular for any combination of modules, superb audio performance, LED illuminated switches, dual inputs on each channel and a wealth of complete features engineered by the Wheatstone design team.

From on-air to production, we have a console to fit your needs with *no compromise in quality or performance*.

And These Are The Dealers

Broadcast Supply Worldwide

Tacoma, WA
Phone: 800-426-8434
Fax: 800-231-7055
Email: info@bswusa.com

Broadcasters General Store

Ocala, FL
Phone: 352-622-7700
Fax: 352-629-7000
Email: bgs@atlantic.net

S.C.M.S.

Pineville, NC
Phone: 800-438-6040
Fax: 704-889-4540
Email: sales@scmsinc.com

Crouse-Kimzey:

Colorado Springs, CO
Phone: 800-257-6233
Fax: 719-392-8879
Email: ledwards@proaudio.com

Lynn, IN

Phone: 877-223-2221
Fax: 765-874-2540
Email: bpik@proaudio.com

Annapolis, MD

Phone: 800-955-6800
Fax: 410-754-9999
Email: kkaras@proaudio.com

Fort Worth, TX

Phone: 800-433-2105
Fax: 972-623-2800
Email: mbradford@proaudio.com

RF Specialties:

Concord, CA
Phone: 888-737-7321
Fax: 925-687-9991
Email: newbro@ix.necom.com

Santa Barbara, CA
Phone: 800-346-6434
Fax: 805-682-5170

Valparaiso, FL
Phone: 800-476-8943
Fax: 850-729-2744

Kearney, MO
Phone: 800-467-7373
Fax: 816-628-4508
Email: rfmo@sky.net

Southampton, PA
Phone: 888-260-9298
Fax: 215-322-4585

harrylarkin@compuserve.com

Pittsburgh, PA
Phone: 724-733-1994
Fax: 724-327-9336

Seattle, WA
Phone: 888-839-7373
Fax: 806-373-8036

Seattle, WA
Phone: 800-735-7051
Fax: 206-937-8544
Email: jerryhill@csi.com

Tel: 252-638-7000 • Fax: 252-637-1285
E-mail: sales@wheatstone.com



AUDIOARTS ENGINEERING

A Division of Wheatstone Corporation

ENCO + Orban + Harris = DAD_{PRO32} **The Only Complete Digital Audio Delivery Solution**



ENCO and Orban have combined the best features and technology of their digital audio products, and Harris now exclusively represents the new and improved DAD_{PRO32} Digital Audio Delivery System.

DAD_{PRO32} offers all of the features and functionality demanded by today's progressive broadcast facilities. Utilizing standard off the shelf non-proprietary hardware, network architecture, and operating systems, DAD is the logical choice for both Automated and Live Assist On-Air operations, Production, News, and Inventory Management. DAD supports Orban Sound Cube Technology, transparent links to the Orban Audicy Multitrack Editing System, sharing of data with other software applications for Wire Capture & Editing, Scheduling & Billing, and the Internet, as well as interface to other professional broadcast control and switching equipment. And DAD comes with free software upgrades for the first year, permitting immediate access to all of the latest features supported by rapidly emerging technology and evolving broadcast industry requirements.

Integrated LAN and WAN capabilities make DAD_{PRO32} the logical choice for groupwide, nationwide, or worldwide sharing of Audio, remote VoiceTracking, News, Schedules, and other data.

Call Harris today to discuss how the DAD_{PRO32} Digital Audio Delivery System will permit you to realize the operational efficiencies and cost savings available with the latest technology.

next level solutions

WIRELESS

BROADCAST

COMMUNICATIONS
PRODUCTS

1-800-622-0022 • www.harris.com/communications

HARRIS
Communications

Circle (104) on Free Info Card or online at www.beradlo.com

FEATURES

- 28 Radio From Above**
by Jerry Mathis
Satellites play an important role in radio.
Sidebar: Digital Satellite Radio
by Peter Jakel
- 48 Audio Codecs**
by Kent Kramer
Point-to-point audio delivery made easy
- 62 Digital Audio Consoles**
by Chriss Scherer
Completing the digital signal chain and more
- 72 Facility Showcase: Sirius Satellite Radio**
by Conrad Trautmann
Signals from the sky
- 82 Field Report: AudioSonix**
by Lee Shephard

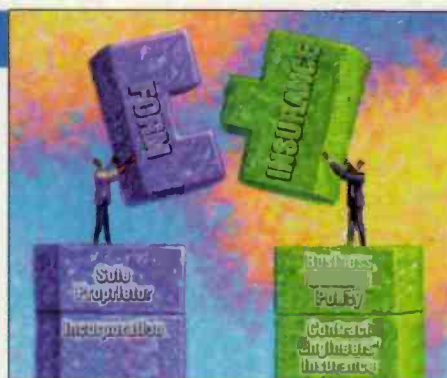

10



62

DEPARTMENTS

- 08 Viewpoint**
by Chriss Scherer
Two bits for a buck
- 10 Contract Engineering**
by Kirk Harnack
Taking care of business
- 14 Managing Technology**
by Chriss Scherer
What to put online
- 16 RF Engineering**
by John Battison
Using the OIB
- 20 Next Wave**
by Kevin McNamara
The basics of streaming media
- 24 FCC Update**
by Harry C. Martin
New CPs for AMs
- 88 New Products**
- 99 Classifieds**
- 102 The Last Byte**
by Skip Pizzi
More thoughts on S-DARS

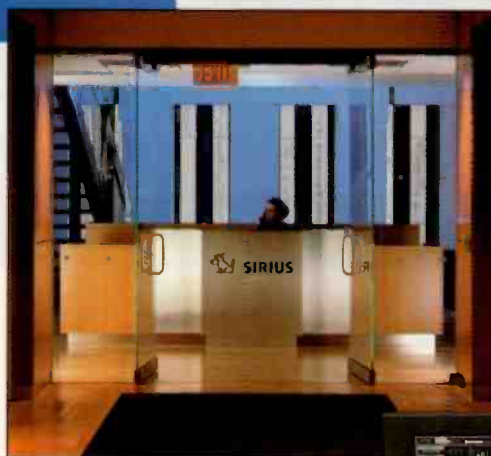

72



88

ON THE COVER: Point-to-point and point-to-multipoint audio distribution is a key element in radio. Whether the distribution is via satellite, codec or the Internet, each has certain advantages for each application. Cover design by Michael J. Knust.

All the

Punch

without the

Price

Starting below
\$200 / MONTH!

VAULTXPRESS® knocks your competition out of the "radio ring" by empowering you to sound like the heavyweights without having to pay a heavyweight price!

VAULTXPRESS® manages all your radio studio needs in a single non-proprietary PC-driven environment — combining production, automation, news, voice tracking, satellite feed interfaces, audio previewing, voice recording applications and Internet technologies. VAULTXPRESS® is built around world renowned AudioVAULT® technology, so your small radio operation will compete with the heavyweights without paying a big price!

VAULTXPRESS® offers:

- Same AudioVAULT® Software Without the Price!
- VERY User Friendly Interfaces
- Pick and Choose the Studio Software You Need
- Competitive Upgrade Packages
- Completely Open System Design — NO PROPRIETARY HARDWARE!
- Seamless Integration With Traffic and Music Systems
- Includes Software and Computers!
- In-Depth Training and 24/7 Support

**CALL 888-232-3268
TODAY FOR A LIVE
DEMONSTRATION!**

VAULTXPRESS® gives you AudioVAULT® power starting at ONLY \$200/MONTH with features such as:

- Designed specifically for smaller radio operations.
- Complete modular design allows users to pick and choose the applications they want to purchase for their unique environment.
- Works with off-the-shelf sound cards.
- Tight security feature to protect data from malicious users.
- Office application compatible.
- Strong documentation and help files.
- Play lists can be administered locally or remotely.
- Works with standard computer hardware.
- Complete automation, satellite or live-assist.
- On-screen voice-track editor.
- Drag-and-drop program log building and editing.
- Edit a program log while it's on-the-air.
- Integrates with existing billing software.
- Program scheduling tools.
- Audio and text management tools.
- Live assist and station automation tools.
- Reliable audio archiving.
- Supports rapid voice tracking.
- Complete on-air copy management solution.
- In-depth on-site training and off-site classroom instruction.

**VAULT
XPRESS**

Limited Time Offer!

Fax back this page to (217) 224-5629 or
call (888) 232-3268 TODAY!

VAULTXPRESS® **Starting Below \$200/Month!**

Name: _____

Phone number: _____

Company/Station: _____

Circle (105) on Free Info Card or online at www.beradio.com



Leaders look to BE!

Broadcast Electronics • Quincy, Illinois • 888.232.3268
www.bdcast.com • www.AudioVAULT.com

Your Online Source
for current radio broadcast news



Digital Media NET
Where the Creative Community Meets



Currents

- [Statistical Research To Measure Sirius Audience](#)
- [TI and RadioScape Partner on Eureka](#)
- [Klotz Appoints Carey VP Business Development](#)
- [Crossed Field Testing in UK](#)
- [Sabre Communications Announces Promotions](#)
- [FCC Announces Mandatory Electronic Filing](#)
- [LEDtronics Names Sales Manager](#)
- [iBiquity Digital Demos in Detroit](#)
- [Transamerica To Represent ATINA](#)
- [Sonifex Appoints New UK Sales Mgr.](#)
- [Statistical Research To Measure Sirius Audience](#)
- [Telex Sales and Marketing Appointments](#)
- [Prophet Appoints Sales Manager](#)

Web Contents

Currents

News updated daily as it happens

Product Profile

Digital audio consoles

Weekly E-Mail

Have the headlines sent to you via e-mail each week. Send a message to beradio@intertec.com.

New Products

With links to the manufacturers

Studio Spotlight

Tour a new facility

November Issue

Read it online. Plus, weekly technical tips, streaming stations, and more.



**YOUR LINK
TO NEW MARKETS
...GO BEYOND**

VADIS

A/D - D/A
Mic preamp
Routing matrix
Digital I/O interfaces
Fibreoptic network
On-air codec management
Automatic gain control
Compressor/limiter/gate
Digital mixing console
EQ (graphic/parametric)
Time switching
Level meter
Mix-minus
Delay

**KLOTZ DIGITAL - THE ARCHITECT OF
THE OPEN AUDIO-MEDIA PLATFORM
FOR INTERACTIVE BROADCASTING,
PRODUCTION AND PUBLIC-ADDRESS.**

**THIS PLATFORM COMPLETES THE LINK
TO NEW MARKETS AND INNOVATIVE
COMMUNICATION SERVICES.**

OUR EXPERIENCE FOR YOUR SUCCESS

Eliminate wiring

- reduce installation cost
- save installation time
- earlier to production & on-air

Share resources and equipment

- reduce capital investment
- cut operating costs
- greater efficiency
- powerful flexibility

Unlimited functionality

- integrate all audio functions
- combine operator tasks

Circle (106) on Free Info Card or
online at www.beradio.com

KLOTZ DIGITAL AMERICA Phone: +1-678-966-9900
KLOTZ DIGITAL FRANCE Phone: +33-1-48874681
KLOTZ DIGITAL ASIA Phone: +60-3-5193233
KLOTZ DIGITAL AUSTRALIA Phone: +61-2-95187430

KLOTZ DIGITAL AG HEADQUARTERS
Hans-Stiebsberger-Sr. 2A
D-85540 Haar/Munich
Phone: +49-89-462338-0
e-mail: info@klotz-digital.de
www.klotzdigital.com

DIGITAL

Bits are bucks

The push to digital facilities continues almost everywhere. For radio, this not only includes RF transmission but also transmission via other means. As we evolve into a digital society, one concept is being introduced that redefines how transmitted data is handled. This idea can be summed up simply by saying that bits are bucks. This is a concept that most of the media-content providers have not fully embraced but likely will sooner than later.

The way that radio succeeds commercially has always been based on a payment-per-program or pay-per-format basis. In radio's early days a single program sponsor was very common. Today, few programs have exclusive sponsorship, but the business model is very similar. I don't think I need to go into the entire cash flow process here, as I'm sure you are already familiar with the existing ideas. In its most basic form, the current plan for digital radio transmission (IBOC) follows this business model. There are plans in place to allow IBOC to be more than just an aural medium, but these new



plans will also require new listening habits.

When transmitting a digital signal of any kind, the transmission is not necessarily a single, complete unit. It is likely a collection of bits that can be part of many larger elements. The bit is the smallest unit of value. The program is no longer the unit.

Traditionally, the program has been the smallest unit. Stations that are part of multiple-station operations have felt the push to maximize revenue from each program. In most cases, this program is the station's format. The entire broadcast day is considered a unit that can be divided into smaller segments. Revenue is based on the amount billed for the individual avails for each hour and day.

In a digital world, each bit represents a unit of value. Each bit can be part of a larger whole. These bits can be audio, video, data or anything else. As the data pipeline grows, the number of available bits also increases.

Telecommunications carriers and ISPs have already begun considering their available bits as revenue units. Telcos have already established that the monthly charge for an ISDN line is less than that for a T1. Data carriers have been working under this model for some time. In this case, you are paying for the bit capacity instead of the bit usage, but it still qualifies as a bits-are-bucks idea. It's

certainly more convenient for them to charge based on capacity rather than the actual data throughput.

Radio is a newcomer into this bit arena. We control our bits and their transmission completely. IBOC continues this idea but adds new ways for these bits to be used, and newer transmission methods will bring new ways to use these bits. Future transmission technologies may not allow the complete control by the content creators that exists now. Already, Internet radio is making that obvious. Once the stream is digitized, there is no station control over the bitstream.

As wireless Internet technology becomes more common, and the wireless service providers increase their data capacities, radio may see less need to control its own transmission facilities. When this happens, the exact value of each bit will be easy to recognize. Radio will turn more to content creation and away from distribution. Each bit created will have an established value and a content creator's revenue will be based on each transmitted bit.

Chriss Scherer, editor
chriss_scherer@intertec.com

How are you adding value to your transmitted bits? Tell us at beradio@intertec.com.



All packed?

Yup.



Envoy ISDN Studio – It's All You Need.

15 kHz, low delay audio codec including built-in ISDN Terminal Adapter (and NT-1) with:

- 4 microphone channels (2 Mic/Line)
- Separate PA output
- Local cueing facility
- Ancillary data channel
- Contact closures
- Internal peak limiter and VU meter
- 3 individually adjustable headphone feeds
- Pre-stored ISDN profiles and dialing directory
- 3.5 pound, easy-to-use package

To learn more about how the Envoy can simplify your ISDN remotes, call us today!

COMREX

Circle (107) on Free Info Card or online at www.beradio.com

Comrex Corporation, 65 Nonset Path, Acton, MA 01720

Tel: (800) 237-1776 Fax: (978) 635-0401 Fax-on-demand: (978) 264-9973 Email: info@comrex.com www.comrex.com

Contract Engineering

Minding your business

By Kirk Harnack

Contract engineering is a rewarding career for most who pursue it. It's certainly challenging – from both a technical and personal perspective. My experience in contracting has taught me one very important lesson: In order to do the fun, enjoyable work, one must be prepared for it, in terms of both technical and business readiness. Technical readiness includes having a working knowledge of broadcast equipment and systems, plus having proper test equipment and skill in its use. Business readiness involves being prepared to transact normal business as well as planning for when those transactions go awry.

Sole Proprietor

Sole proprietorship is the quickest and easiest business structure to adopt. If you don't incorporate and don't have a partner, you are automatically a sole proprietor. Legally, you and your business are the same. As a sole proprietor, your profit is taxed as personal income tax, and you personally are liable for any debts or losses.

Being a sole proprietor contract engineer may not be the best choice due to the potential for liability. What if you back up over a guy anchor and bring down a 500-foot tower? What if that tower holds two FMs, one TV and some business repeaters? Even good insurance may not cover you entirely from lawsuits. As a sole proprietor, you and your company are the same, making you personally liable for mistakes and accidents.

A sole proprietorship business may need to be registered with local or state licensing departments. Business licensing differs from state to state. Some states, like California, require nearly all businesses to register. Other states have relatively few requirements. If, however, you are doing business as a sole proprietor under a trade name rather than your personal name (*Real Loud Radio Engineering*, as opposed to *R. F. Burns, Radio Engineer*), you will likely need to get a business certificate or register as a *doing business as* (DBA) company. This lets your clients, your suppliers, the government, and anyone else your business deals with, know the real owner of the business.

Incorporation

While incorporation requires more paperwork, expense and maintenance than sole proprietorship, it gives you one critical benefit - protection from liability. A corporation is a separate legal entity from the person or people that own it. It's the corporation, not the owner, that enters into business deals, owns property, borrows money, and conducts business activity. Because the corporation is involved in these business deals, you and your personal assets will, in many cases, be protected from liability if something goes wrong.

For businesses with more than one owner, incorporating can often protect you from the misdeeds of the other owners. This differs from a partnership, where each partner is personally liable for the business-related actions of the other partners.

There are other benefits to incorporating. You can gain access to various benefit plans only available to corporations. It also creates a positive image for your company and can help when raising capital, getting credit card merchant status, or doing business in a foreign country.

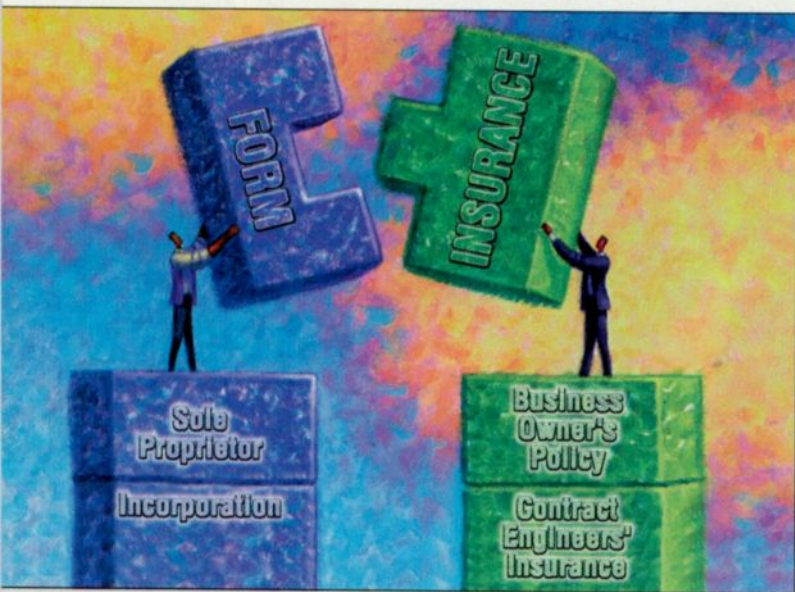

Decisions regarding the form of your business and type of insurance to carry have several elements to consider.

There are two key areas of business readiness that contract engineers need to explore and review periodically. What form of company or organization should your business assume? And, what types of business insurance are prudent to purchase?

You've likely already chosen an organizational business form. However, it's wise to review your business model every few years to see if it still makes good sense. Your legal counsel can help you change your business organizational setup to suit your current or future priorities.

The way your business is organized is important because it affects every aspect of your operation, from what you pay in taxes to the extent of your liability and your ability to raise capital. Your options for business organization include sole proprietorship, incorporation, partnership and limited liability corporations.

Burn Rubber.



Short/cut 2000
PERSONAL AUDIO EDITOR

You want speed? YOU GOT IT!

360 Systems' new **Short/cut 2000 Editor** features split-second edits for news, call-ins, and live events. Plus, you'll get industry-wide file interchange, a full slate of editing features, and unparalleled ease of use.

Call your favorite **360 Systems** dealer now — and put the pedal to the metal.

Easy Upgrade!

Now you can upgrade your existing **Short/cut editor** to the speed and power of **Short/cut 2000**. To turbocharge yours call (818) 991-0360.

Circle (108) on Free Info Card or online at www.beradio.com

Visit our website at
www.360systems.com
for full details!

360 Systems

PROFESSIONAL DIGITAL AUDIO

Contract Engineering

S Corporation. This status gives you the liability protection of a corporation, and allows you to pay taxes on the same basis as a sole proprietor or partnership (i.e., you pay tax at the personal rate, and your profits are your salary). Many tax and legal experts recommend S Corporation status for smaller entities and start-ups.

C Corporation. This status is another option for contract engineers. A C Corporation files and pays corporate income taxes directly, so it is considered a separate entity from its share-

holders and must pay taxes on income left after business expenses.

LLC. Another business structure option is a hybrid of the corporation and the partnership - the limited liability company. An LLC has the liability protection of a corporation but the tax status of a partnership. While you get liability safeguards similar to those of a corporate shareholder, you pay taxes at the personal rate on your share of the profits or use the loss to offset other income.

Insurance

This is one of the most neglected small-business responsibilities. Not having the right insurance for your contracting firm is a mistake. An accident, theft or disaster can shut down your company permanently, or at least wreak havoc on your assets.

Business Owner's Policy. A standard business owner's policy (BOP) provides coverage for property, liability, business interruption, and, in some cases, workers' compensation. The components of each BOP are different, so be sure that your policy contains all the components your business requires. BOPs were originally designed for small retail businesses, but now are available for a variety of other businesses.

Contract Engineers' Insurance. The Society of Broadcast Engineers (SBE) provides insurance coverage appropriate for many contract engineers. Its recommended Business Owner's Policy contains coverage and options most needed by active contractors, including test equipment coverage. The policies endorsed by SBE were designed specifically for contract engineers and are worth consideration.

The Insurance Information Institute in New York estimates that about 40 percent of small business owners have no insurance at all, because many believe they can't afford coverage. The truth is a contract engineer can't afford not to have adequate insurance. Without it, you're unnecessarily putting your business and income at risk.

Minding your business properly is important to staying in business. The necessary "overhead" may take away valuable time that could be spent on billing clients but is just as important. Set aside some time now to discuss your business organization model and insurance coverage with the requisite professionals.

Kirk Harnack, BE Radio's consultant on contract engineering, is president of Harnack Engineering, Cleveland, MS.

FOR MORE INFORMATION

Circle (203) on Free Info Card
or go to www.beradio.com

Get The Scoop Anywhere, Anytime

Field reporting the way it's supposed to work. Introducing the all new Scoop Reporter II portable CODEC from AETA Audio. This rugged unit combines POTS and ISDN facilities with an integrated three-channel mixer and internal battery supply. Featuring 99 user programmable presets, the Scoop Reporter II will handle two microphones and one line level input. A balanced XLR output can be used for studio producer IFB and Mix-Minus feeds from studio, or to feed the local PA. The Scoop Reporter II will operate on voltages from 85 to 240 volts at 47 to 440Hz. When AC is not available or fails, the unit will run on standard "D" cell alkaline batteries. The intuitive interface is so easy to use, your talent will be able to run a remote broadcast with no technical assistance. And with our 24-hour technical support, you'll never miss another field report. The Scoop Reporter is the all-in-one box that will get the scoop anywhere, anytime.

**D-CELL
BACKUP**

- All-in-one-box with "D" cell backup
- Supports G.711, G.722, ISO/MPEG Layer II, ADPCM and J.52
- ISDN or POTS
- Three-channel mixer
- PC programmable
- Send and receive 20kHz audio at 128kbs with ISDN
- Send and receive 7.5kHz audio with

Available through most broadcast equipment suppliers



**AETA
AUDIO**
Linking Innovation With Clarity

AETA AUDIO CORPORATION
75 Fleetwood Dr. Suite 200 - Rockaway, New Jersey 07866
Phone: (973) 659-0588 • Fax: (973) 659-9555
www.aetausa.com

Circle (109) on Free Info Card or go to www.beradio.com



Yes, it's really this easy.

Intuitive, intelligent digital delivery—
DAD_{PRO32}. Easy to learn, easy to use.
Simple to expand as you grow.
Looking is hard, the choice is easy.
DAD_{PRO32}—from ENCO Systems.

Smarter. Faster. Better.

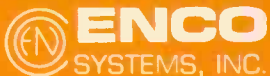

800. ENCO.SYS

www.enco.com

Circle (110) on Free Info Card or online at www.beradio.com

What's online

By Chriss Scherer, editor

By now you should have a website for your station. If you don't, you have some catching up to do. The world is online; if you're not online you're not in the game.

Simply having a website is not enough. Your station website is an extension of the station. With so much information available online, your station is a valuable source of information. Just as time spent listening is important for ratings, time spent online – called stickiness – is important to a successful website.



Of greatest importance is to update the website every day. Less-frequent updates will not attract visitors as often. Often, many of the same techniques used to encourage listeners to tune in can be applied to your website. Don't get caught creating an online space and posting an under construction graphic. There is no better way to drive visitors away.

The daily update can contain information from several station departments. Programming and promotions are obvious content suppliers, but the sales force and engineering can supply useful content too.

A real job

Maintaining the website can be a full-time job. Since the Web is a part of our lives now, it makes sense to have someone maintain your website on a regular basis. This doesn't mean giving the task to the promotions intern. Be sure the person maintaining the site understands the station, its listeners and advertisers.

Basic information such as a concert calendar, team game schedules, station remote appearances and community events are a good start.

Station engineering information can be a good source of information. Include facts like the original station sign-on date, ERP, antenna height, transmitter type and studio facilities. A virtual studio tour is another possibility. Be careful not to provide too much information.

One thing I often see missing from station websites is complete contact information. The request line and request fax are almost always there, but listeners are not the only Web visitors you will have. Contact information for the office and sales staff is very important. Likewise, include information from the station's media kit. A potential advertiser may find you. Make it easy for him to contact you as well.

What's online anyway?

Internet radio is proving to have real promise as a delivery medium. As streaming technologies continue to evolve, the quality of Internet radio will improve. Radio stations already have an audio stream available. It is not difficult to get an audio stream online (see *Next Wave*, page 20). If hosting your own audio server is not practical, there are plenty of companies that provide streaming services. These companies handle all the details and maintain the equipment. All you have to do is supply the audio stream.

Your online stream can also become a source of revenue. While the online stream can simply simulcast the air signal, the commercial inventory that is available online does not need to be given away. Sell the over-the-air inventory, but be sure your contracts stipulate that the online inventory may not be included.

At the NAB Radio Show, one technology was the source of many discussions: ad insertion. This allows you to insert a new audio ad into the audio stream in place of the commercial being played over the air.

This concept can be taken a step further with targeted ad insertion. This relies on specific demographic information from the listener. Each person listening online can hear a different commercial based on that listener's own interests. While audio streaming may not be a major source of revenue yet, it is definitely something to get into.

Your website is even of interest to the FCC. A recent rulemaking provides for portions of the Public File to be available online. (See *BE Radio* June 2000, *The Virtual Public File*.)



WE'LL PUT YOU
UP IN THE AIR

WITHOUT
LEAVING YOU
ON SHAKY
GROUND.



NPR Satellite Services provides radio broadcasters with rock solid solutions.

Affordable space segment, C- and Ku-band audio receiver options under \$1,600, and unsurpassed maintenance support—the essential components to long-term program distribution. We can start from scratch, or use your pre-existing C- or Ku-band gear. Visit us at www.nprss.org to learn more.



LINK UP WITH US®

Using the operating impedance bridge

By John Battison, P.E., technical editor, RF

Many test instruments have been developed in the history of broadcast engineering. Some have had brief lives; others simply filled the needs that many engineers recognized, but little more.

In terms of the most-used all-around test tool, the oscilloscope is the clear winner. But the *operating impedance bridge* (OIB, sometimes also called an operating inline bridge) is probably the ultimate answer to the RF engineer's prayers. Prior to the development of the OIB more than 35 years ago, the AM engineer had to lug a heavy *cold measurement* RF bridge, some type of RF signal generator and a detector/indicator to a dog house and hope that AC power was available.

Changing history

It seems rather strange that no one thought of the impedance bridge earlier in the history of radio. I've often wondered if the impact of TV and FM, with their associated coaxial applications, was what gave Charlie Wright the idea for the OIB-1, now manufactured by Delta Electronics.

The latest version is the OIB-3, which incorporates minor modifications from the original OIB-1. The OIB-2 handles up to 1kW and covers the 100kHz to 30MHz range. It is popular in the HF market.

The introduction of the receiver/generator completed the

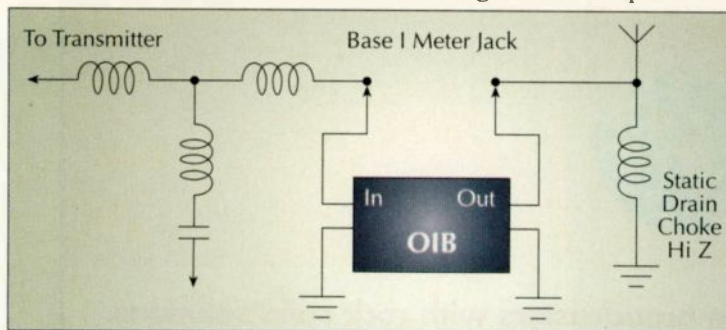

Figure 1. The OIB can be inserted in place of the base current meter.

measuring package. Delta's RG-4 and Potomac's SD31 and SX-31 combination operate on AC power or internal rechargeable batteries and cover the 100kHz to 30MHz band. Both consist of a precision oscillator plus a receiver covering the same band. The receiver becomes the detector for the RF bridge, and high variable sensitivity is obtained.

A station transmitter operating at suitably reduced power (less than 5kW) can provide the signal necessary for an OIB to adjust networks and measure antenna impedance.

It is the term *operating* that separates the *hot* bridge from the *cold* bridge. Before the OIB, engineers frequently found that a cold impedance measurement made with flea power from a signal generator differed appreciably from the impedance existing when the circuit was hot and in normal operation.

Using the OIB

The OIB is often used to measure the impedance of a new AM antenna. It is connected in series with the antenna connection to the ATU. The input connection is fed from the network output, and the output connector goes to the RF lead to the tower, as shown in Figure 1. The FCC requires that the base operating impedance be measured as closely as possible to the point where the antenna current is metered.

Many ATUs are designed with a current jack located immediately before the tower connection. The jack allows a meter to be plugged in when making readings, and a shorting plug is used when not taking antenna current readings. This is an ideal place to insert the OIB.

The most discernible difference between the OIB-1 and OIB-3 is the addition of resistance and reactance switches in the latter, which extend both ranges to 900 Ω resistance and $\pm j900$ reactance, respectively.

The OIB-3 panel layout can be seen on the next page. Most labels are self-explanatory. However, the L-C switch deserves mention. If the sign of the reactance is known beforehand, this switch should be set appropriately to L or C. Otherwise, the meter movement should be observed. If increasing the reactance dial increases the meter reading, the load is capacitive, and C should be selected. The resistance dial has a 5 Ω negative calibration to aid in checking low negative resistance.

Measuring SWR

To measure SWR, feed the bridge input from the transmitter, and connect the bridge output into the transmission line. Set the Resistance dial to the known line resistance and the Reactance dial to "0" ($R \pm j0$). Set the *Forward/Reverse* switch to *Forward* and increase the sensitivity control until a full-scale reading is obtained. Now set the switch to the *Reverse* position. The SWR can be read directly on the bridge meter.

The bridge is designed and calibrated for use at 1,000kHz. It is important to apply a small frequency correction for reactances measured at something other than 1,000kHz. This correction is shown as X/Fm_c , where X is the



Drive this...

Just as a car needs a reliable driver, so does every radio broadcast transmitter. The Crown FM series exciters, drivers and low power transmitters offer reliability unsurpassed throughout the world. Incorporating standard features as an integral part of all power levels, the quality in workmanship standard is consistent for all of Crown Broadcast products.

The exciter/driver model offers high reliability as an RF driver while maintaining the audio purity associated with FM broadcasting today. The internal low pass filter allows the exciter to be placed directly on-air in the event of a main transmitter failure.

Crown transmitters are stand alone low power units and can be configured with optional stereo generator and audio processor. Thousands of broadcasters around the world have come to appreciate the rugged, reliability of the Crown Broadcast line of transmitters.

So when making your decision on a new exciter, RF driver or low power transmitter, reliability should be at the top of your list. Crown Broadcast builds reliable transmitters from 1 watt to 2 kilowatts.

Contact Crown for reliable, efficient broadcast transmitters.

Get in the driver's seat



P.O. Box 2000 • Elkhart Indiana 46515-2000 • 219-252-8900

Fax 219-262-5399 • www.crownbroadcast.com

Circle (112) on Free Info Card or online at www.beradio.com

RF Engineering

measured reactance (the sum of adder switches and reactance dial reading), and F is the frequency measured in MHz. If the frequency is above 1,000kHz, the corrected value will be more than the dial reading. If the frequency is less than 1,000kHz, the corrected reactance will be less than the dial reading. If the adder switches were needed to obtain a null, it is important to remember to add their

values when recording the total measured figures.

When inserting the OIB into a coax line, standard coax connectors can be inserted in the input and output sockets. This is advisable if power of more than a few watts is used. Leads with heavy clips on one end and coax connectors on the other (measuring 12 or 18 inches) can be supplied, but ground-clip connections sometimes become loose, and an ungrounded OIB can be damaged – not to mention harmful to people and equipment in the area.

It is probable that DA engineers find the greatest use for the OIB. It is essential for setting up networks in phasors and ATUs. It can be inserted at the common point in a phasor, and adjustments in distant ATUs that affect the common point impedance can be observed and the necessary corrections made without shutting down the transmitter.

An unstable tower will often fluctuate between negative and positive while tuning the array. This is something that a cold bridge can't measure. The OIB's reverse measurement feature is invaluable.

To measure the negative tower, the input and output connections are reversed (with the input connected to the antenna under measurement and the output connected to the transmitter). The bridge is operated in the usual way. Remember that a negative tower is taking power *from* the antenna. The null is obtained and the R and X values are recorded with the values reversed in sign.

Very precise and highly accurate measurements can be made with an OIB. Proper use in accordance with the unit's instruction manual and safe engineering practices makes antenna adjustments much easier.



An operating impedance bridge like the OIB-3 from Delta Electronics is invaluable in adjusting antenna networks.

E-mail John at batcom@bright.net.

FOR MORE INFORMATION

Circle (201) on Free Info Card
or go to www.beradio.com

What is to become
of those who wait
to go digital?



Going digital
means
going Prophet.

Now, targeted ad insertion and Internet streaming from a name you've trusted for over a decade . . . Prophet Systems Innovations. Create new revenue opportunities for your clients with targeted Internet only ads.

Introducing—

StreamCast
Internet Radio

StreamCast
Internet Radio

CD/Extractor
Pro

AudioFormat
Converter

WANcasting
Wide Area Network

VoiceTRAC

Crystal
Ball

NexGen
DIGITAL
Broadcast

Audio Format Converter™ – Quickly and easily convert audio files for NexGen Digital™ Broadcast. Compress audio files from PCM to MPEG 1, layer 2. Configurable compression level, normalization, silence trimming, and system settings.

Crystal Ball™ – Archiving audio just got easier. Crystal Ball archives audio from as many as four stations to one computer, using Digital Audio Tapes (DAT).

Integrated Editors – Enhanced interfaces allow you to integrate SAW Pro, Cool Edit and Orban editors, automatically converting the data for use in NexGen Digital™ Broadcast.

CD/Extractor™ – Build music libraries easily. Multiple CD-ROM drive support, improved extraction speed, enhanced CDDB Internet access, comprehensive track editor and expanded configuration options.

VoiceTRAC™ – Record a four hour shift in under an hour that sounds live and local!

WANcasting™ – Transfer data across systems and stations via NexGen Digital™ Broadcast.

PSi
PROPHET SYSTEMS
Innovations

877/774-1010
www.prophetsys.com

Prophet Systems Innovations, setting the standards for digital automation in the broadcast industry.

Circle (113) on Free Info Card or go to www.beradio.com

“Our web clients rely on us to deliver the highest quality streaming audio. That’s why we chose the Aphex 2020.”

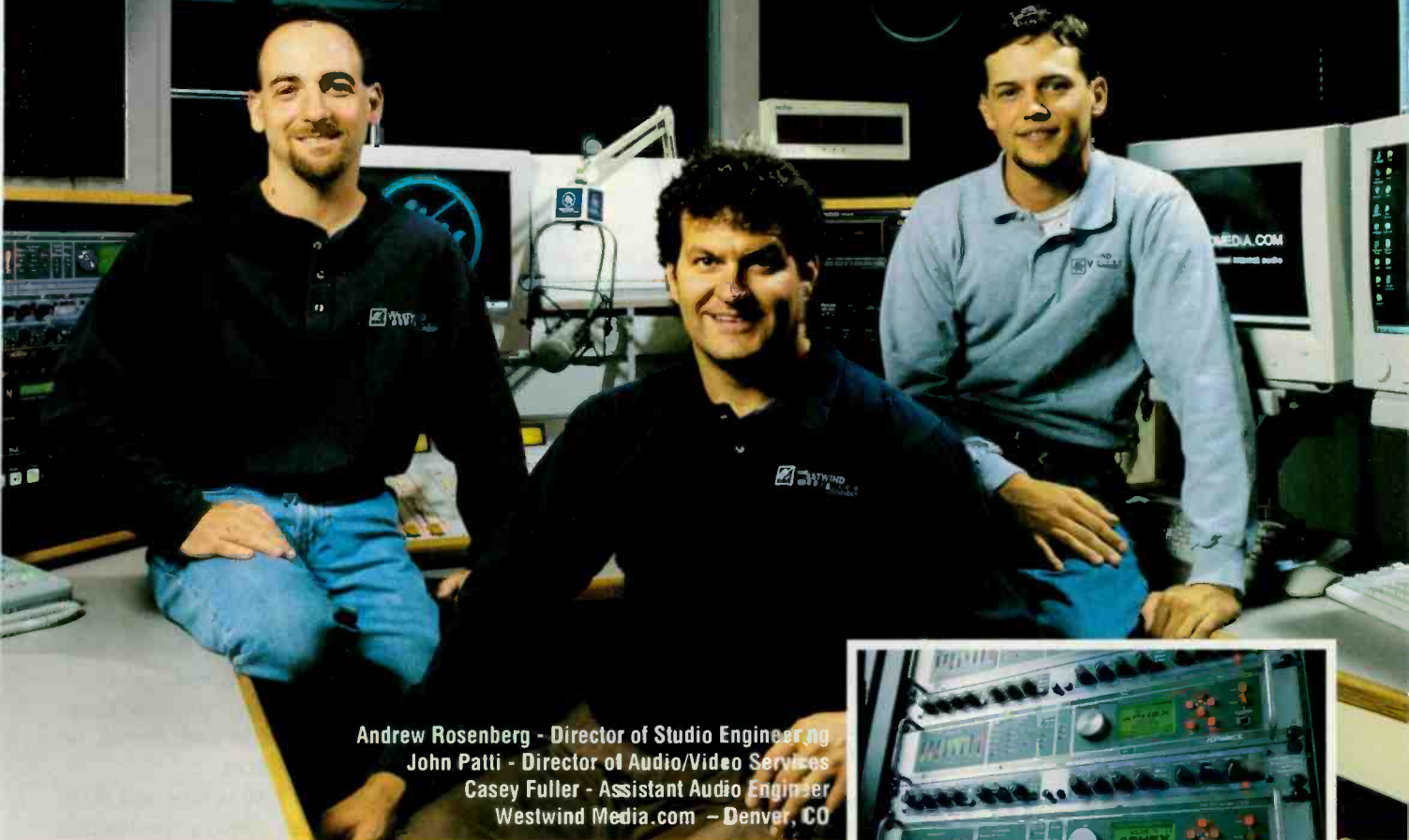

Andrew Rosenberg - Director of Studio Engineering
John Patti - Director of Audio/Video Services
Casey Fuller - Assistant Audio Engineer
Westwind Media.com - Denver, CO

Westwind Media.com is a leading digital audio provider for Internet communities such as Lycos, iVillage.com, Fidelity Investments, TheStreet.com and PeopleWeb. These clients demand the best, and Westwind’s audio engineering department ensures that level of performance...even on connections as slow as a 28.8 dial up!

“We’ve tested other processors and nothing comes close to the consistently high audio quality and loudness of the 2020”.

The Aphex 2020 is a digitally controlled analog processor that is configurable as the high quality, cost-effective, one box solution for FM, Satellite Uplink, Mastering and Webcasting.



“It was no surprise to us that the number one FM station in town also uses the 2020- it’s the best sounding processor on the air and on the Web.”

**FOR THE FINEST PROCESSING FOR FM, SATELLITE UPLINK, MASTERING AND WEBCASTING
CALL APHEX TODAY OR VISIT www.APHEX.com TO SCHEDULE A DEMO**

APHEX
SYSTEMS

Improving the way the world soundsSM

11068 Randall Street, Sun Valley, CA 91352 U.S.A
818-767-2929 Fax: 818-767-2641 www.aphex.com

Circle (114) on Free Info Card or online at www.beradio.com

Streaming audio basics

By Kevin McNamara, CNE

At one time, streaming audio or video required that you feed a signal through a codec that was attached to a dedicated digital telephone connection that would be terminated to your *streaming host provider* (SHP). The SHPs set themselves apart from *Internet service providers* (ISP) because they have access to the fastest machines and, more importantly, they have a big pipe connecting them to the Internet. Unlike the burstable data streams that are common to most Internet use, streaming media requires a continuous data flow.

Outsourcing

Selecting and using an SHP is similar to selecting and using an ISP; however, there are a few factors to consider:

- Do they offer dedicated bandwidth to the Internet for your stream? If you share bandwidth with other users, expect to have degraded performance during peak hours. Be certain of any additional charges that may be incurred should bandwidth increase beyond the allowed amount. Most SHPs will add charges if the amount is exceeded. A rule of thumb is to assume that an audio stream will require about 1.5 Mb/minute.

- Are you limited to the number of streams that can be simultaneously accessed? SHPs can, and do, limit the amount of concurrent users based on your particular plan. An on-air promo directing listeners to your site may cause it to choke and prevent them from accessing it!

- Do you have a choice of encoding schemes? There are three basic types of media decoders in use: Microsoft Media Player, RealAudio and Apple QuickTime. Media Player is provided with every current Windows operating system, and a lite version of Real Player can be downloaded for free; these are the most widely used players for streaming media applications. Some SHPs allow you to deliver all three, if desired.

- Will they provide both live and on-demand streaming? Your PD may decide that including audio clips along with the live stream is a good idea. Most SHPs will provide this as an additional cost.

- Do you have the ability to manage the server from your office? Most ISPs and SHPs give you some limited ability to manage your server from any Web browser. Keep in mind that there are two primary types of hosting servers: shared and dedicated. Most general-purpose hosting takes place on PCs that run multiple sites. This approach is economical, but can bog-down significantly during peak times. Dedicated servers host only a single client and are typically used for sites requiring peak

performance at all times. Since only your site occupies the dedicated server, the SHP may allow more direct control over its management.

- Can you extract information about who uses your site from the SHP? Perhaps one of the most valuable things about having a Web presence is its ability to deliver a wealth of information about who's out there – in real time. Derive detailed media reports from the SHP or, even better, directly from the server management console.

- What are the setup fees? These costs vary greatly and should be understood upfront.

- What are the production costs? Most ISPs and SHPs will provide complete or partial turnkey production services. You may not require these if you have in-house talent or have contracted a design house to build your site, but it's good to know what to expect in the event you need to use them.

In-house hosting

The costs for streaming audio have plummeted, and it is possible for any station to locally host a streaming server. The local streaming server costs range from about \$3,000 to more than \$15,000. Here's what you'll need:

Dedicated connection to the Internet. This is accomplished through your ISP or, preferably, being connected directly to an Internet point-of-presence provider. In all cases make sure you have as much dedicated bandwidth as possible, ideally T1 or fractional T1. Stay away from services such as frame relay, since these transport methods are not designed for real-time delivery of packets. DSL will also work; however, I don't advise using cable modem access because the actual bandwidth of the connection varies dramatically at peak hours.

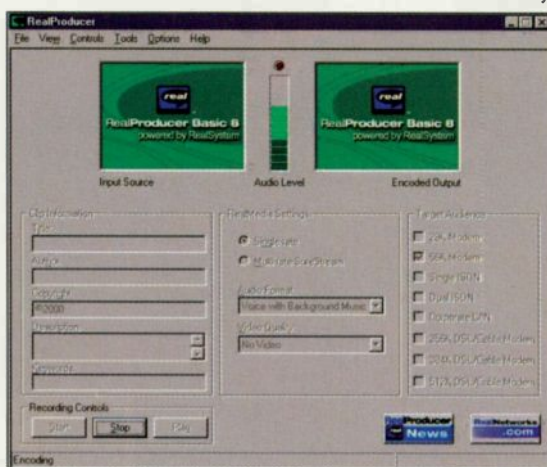

Deciding which format to stream is only one step in getting your signal online.

From here...

To hear...

Distance does
not matter
any more...



Circle (115) on Free Info Card or
online at www.beradio.com

Dune

Welcome to the world of **Dune™**, the first **ATM** based audio router designed specifically to meet the demanding requirements of audio distribution. ATM architecture allows distributed audio routing within your facility or multiple facilities across the country. The heart of the system is the ATM switch fabric. By using MAD1, AES and analog I/C units can be optically distributed up to 500 meters away... a real advantage in large facilities! Philips network based routing solutions continue to help you **Control Your World**. To learn more, call toll free 1-800-962-4267 or visit our website at www.broadcast.philips.com.



PHILIPS

Let's make things better.

Next Wave

Pentium II or higher processor. You could probably run it on less, but I wouldn't advise it. If the budget permits, consider motherboards that support multiple CPUs, which can provide a significant increase in system performance.

Lots of RAM. At least 128MB; 256MB would be better.

High-quality, multimedia-rated hard drive. These drives typically operate at 7,200 rpm and are designed to have faster access under

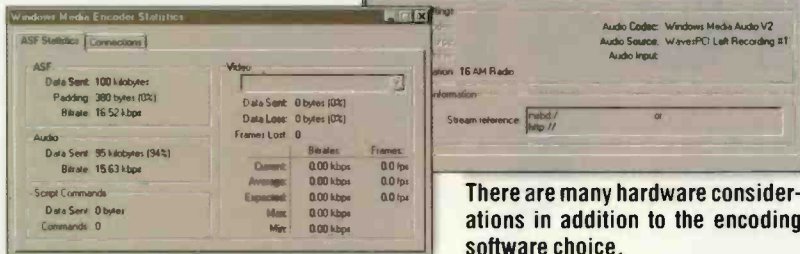

There are many hardware considerations in addition to the encoding software choice.

the heavy load of streaming data. The drive should have an SCSI interface; although many of the newer EIDE drives deliver excellent performance. Don't skimp on the drive size -- prices are very reasonable.

Good-quality audio card. Always consider using PCI-compliant audio cards, as these tend to place minimal load on system resources.

Software to support the encoding scheme desired.

Windows Media Encoder 7 and Real Networks Real Producer 8 can be downloaded for free at their respective sites. Despite being free, they have enough features and power to run a decent streaming service, given the proper hardware and a reasonably fast connection to the Internet.

For example, Media Encoder 7 will support up to 2,000 simultaneous streams, while Real Producer supports 25; however, Real Server Pro (not free) will support up to 3,000. Among others, the MP3 and WAV audio formats are supported by the encoders, while only the Real Networks products support those plus the Real Media format (RM).

Audio processing equipment. There are several manufacturers offering audio-processing systems tailored to this application.

One final thought, be careful with the selection of an operating system. These encoding packages generally only support certain systems. All of the above-mentioned encoders support the Windows platform, however, only Real Producer 8 supports Linux and most other platforms.

Kevin McNamara, BE Radio's consultant on computer technology, is president of Applied Wireless Inc., New Market, MD.

All of the Next Wave articles have been approved by the SBE Certification Committee as suitable study material that may assist your preparation for the SBE Certified Broadcast Networking Technologist exam. Contact the SBE at (317) 253-1640 or go to www.sbe.org for more information on SBE Certification.

HOW WOULD YOU LIKE YOUR MEDIATOUCH?

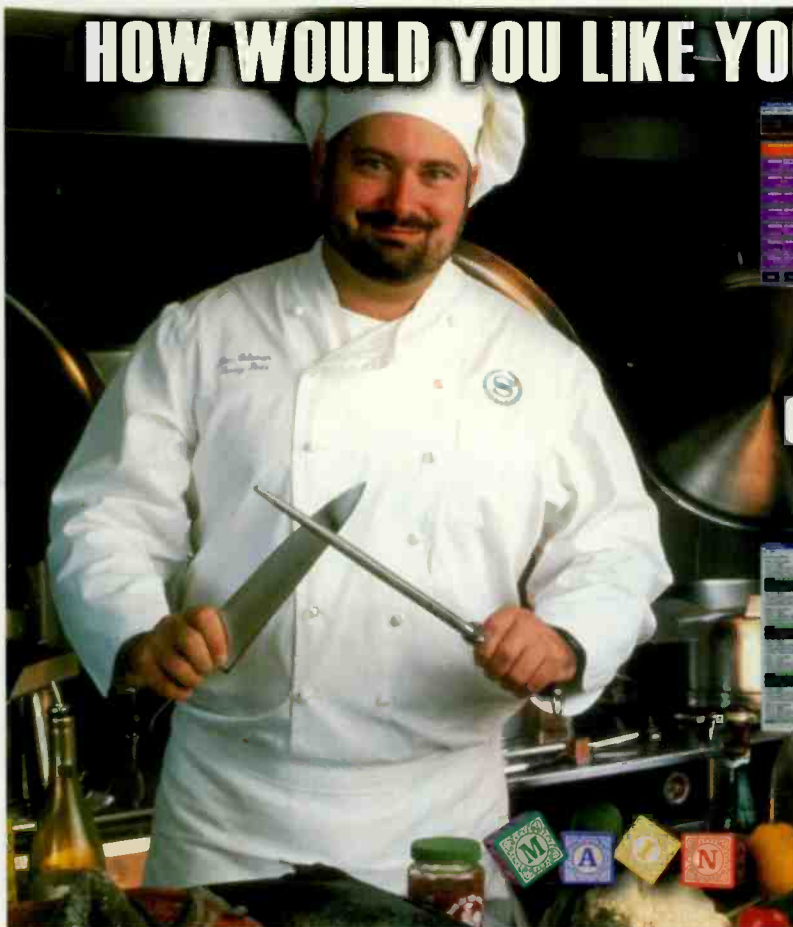

QuickPix
Cart Replacement



OpLOG 2000
Automation



iMediaLogger
Digital Logger



MediaTouch

800 665 0123

888 665 0501 www.mediatouch.net

Circle (116) on Free Info Card or go to www.beradio.com

AT CCA YOU HAVE THE POWER!



COMMERCIAL COMMUNICATION ASSOCIATES, INC. PH:770.964.3530 Fx:770.964.2222

AT CCA YOU CAN REST ASSURED THAT YOU HAVE THE POWER OF OUR COMMITMENT TO QUALITY, VALUE AND SUPERIOR SERVICE. YOU HAVE THE POWER OF HONEST PRICING THAT IS BASED ON OUR COST TO MANUFACTURE, NOT THE VOLUME OF BUSINESS THAT YOU DO WITH OUR COMPANY EACH YEAR. YOU HAVE THE POWER TO CHOOSE YOUR OWN LEVEL OF DISCOUNT. AT CCA ALL OF OUR CUSTOMERS HAVE THE POWER OF OUR RESPECT. YOU HAVE THE POWER OF A 3-YEAR WARRANTY AND 24-HR SUPPORT.



Go Blue!

and

Feel The Power.

SPECIAL DISCOUNTS FOR CHRISTIAN AND EDUCATIONAL BROADCASTERS!

GROUNDING GRID FM TRANSMITTERS
SOLID STATE/GROUNDING GRID FM TRANSMITTERS
PLATE MODULATED AM AND SHORT-WAVE TRANSMITTERS
DIGITAL SOLID STATE AM AND SHORT-WAVE TRANSMITTERS
ANTENNAS, TOWERS, TRANSMISSION LINE, INPUT EQUIPMENT,
MONITOR AND CONTROL, LTU/ATU, GENERATORS AND BUILDINGS

SEE OUR "NO HAGGLE" PRICE LIST AT WWW.CCA.WS

New AM CPs to be issued

By Harry Martin

In response to the FCC's January 24 to January 28 window for applications for new AM stations and major changes to existing AM stations, the FCC received, and has identified approximately 150 proposals that are not mutually exclusive with other window applications. These applications will be granted upon completion of the following additional processing steps:

- On or before October 23, 2000, all applicants listed as eligible for grants had to file a complete Form 301 with the appropriate filing fee;
- After acceptance for filing by the FCC's staff, a public notice that affords interested parties an opportunity to file a petition to deny within 10 days will be issued;
- Unopposed "clean" applications will then be granted, and those subject to petitions or other problems will be approved when all issues are resolved.

It is unlikely any of these AM proposals will be approved until next year.

Auctions Set for 359 FM Channels

The FCC has swept into a single auction, scheduled for February 21, 2001, the 359 new commercial channels it has allotted to various communities since the implementation of the FM new application processing freeze. The FCC's public notice, which appears at fcc.gov/wtb/auctions/auc37, lists the channels, communities and reference coordinates for each vacant allotment. In its auction notice the FCC sought comments on the proposed structure of the auction, the minimum required bids proposed in the notice for each facility and on planned bidding procedures.

The FCC will make final decisions regarding procedures and minimum bids later in the year. At the same time, the Commission will set a filing window for short-form auction applications (Form 175), which requires ownership and broadcast interests disclosures, but no engineering showings. A subsequent public notice will announce the identities of the auction applicants for each allotment and will set a deadline for filing minimum up-front payments.

The auction will begin February 21 and will not end until winning bids are received for all 359 allotments. After the winning bidders are identified, each will be required to file a complete Form 301, with the requisite application fee. If no oppositions are received in response to a subsequent acceptance-for-filing notice, the balances of the winning bid amounts will be submitted, and finally, the applications will be granted.

Porn Star Interviewers Fined \$6,000

The FCC fined an FM station \$6,000 for airing an interview with an adult video actress who uttered "indecent phrases." The radio station dispatched personnel to an adult video store where the actress was making an appearance. The station said its personnel advised the actress of the indecency restrictions and then provided her with a microphone. The actress initially began speaking about her films but then began to use profanity. The station's employees attempted to take back the microphone, but they were restrained by bystanders. The broadcast was eventually terminated at the studio, but not before the actress had uttered her vulgarities. The FCC noted that the station should have taken better precautions to prevent the airing of any indecent material, particularly in light of the interviewee's notoriety.

Can Insurance Cover a Virus?

A recent decision by a federal trial court, now on appeal, has caused a debate regarding whether or not policyholders require additional coverage for virus-related losses. The court held that a power outage that temporarily erased the custom contents of a computer memory chip, thereby disrupting company operations in several cities, should be considered sufficiently "physical" to trigger coverage under a traditional property policy covering risks of "direct physical loss or damage from any cause."

Traditional property policies were not written with computer losses in mind. Even though one court has ruled on the side of policyholders, do not assume that the same policy that covers your station for fire, flood, and other damage also covers lost data, time and revenue due to computer damage caused by viruses.

Harry Martin is an attorney with Fletcher, Heald & Hildreth, PLC., Arlington, VA. E-mail martin@fhh-telcomlaw.com.

Dateline

Annual EEO Public File Reports must be placed in the public files — and on the websites — of stations in the following states on or before December 1: Alabama, Colorado, Connecticut, Georgia, Maine, Massachusetts, Minnesota, Montana, New Hampshire, North Dakota, Rhode Island, South Dakota and Vermont.

DMN TV

It's daily industry news on your desktop!

Archived Daily Broadcasts

DMN TV- The Leading Broadcast News of the Digital Media Market

Multiple Channels of Industry Coverage

DMNTV.com is the industry's best online video news source. Daily broadcasts are available 24 hours a day, ready when you are. Don't just read about the news, see it on your desktop every business day!



Installation Profile



Al Kirschner, engineering VP of Big City Radio, was instrumental in designing the SynchroCast system.

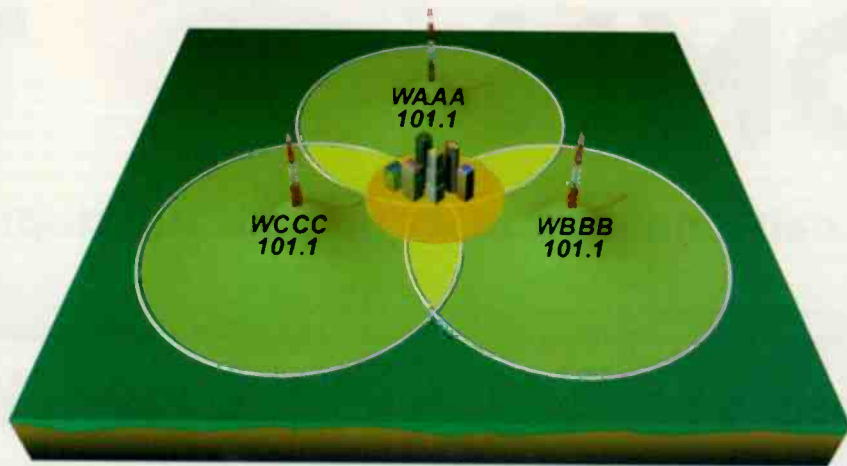

Expand Your Market With Multiple Overlapping Transmitters

Big City Radio Stations using SynchroCast:

New York (on 107.1)

WYXV
WVXY
WVYY
WVZY

Los Angeles (on 107.1)

KLYY
KLYY-FM1 (on channel booster)
K5YY
K6YY

Chicago 1 (on 103.1)

WXXY
WYXX

Chicago 2

WKIE (92.7)
WKIF (92.7)
WDEK (92.5)

Phoenix 1

KEDJ (106.3)
KEZR (106.5)
KDDJ (100.3)

Phoenix 2 (on 105.3)

KSSL
KSSL-FM1 (on-channel booster)

HARRIS

800-622-0022
fax 513-459-3899
broadcast@harris.com
www.harris.com

Intraplex SynchroCast

In the past, competing for listeners and revenue in major markets has demanded a major investment in the purchase of a station with a high-power signal. But, Big City Radio has found another, more affordable, route to compete with major stations in some of the country's largest markets. Using simulcasting, based on the Intraplex SynchroCast system, Big City has been able to become a major-market player in New York, Los Angeles and Chicago, with another station on the way in Phoenix.

It all began when Big City, (then Odyssey Communications) purchased a single suburban station in Westchester County, outside New York, and was eager to expand into the NY metro market. But, the station required more signal strength to

accomplish that and also needed to eliminate interference from competing stations on the same frequency in adjacent areas.

To solve these problems, Big City came up with the idea to buy other lower-power stations with licenses on the same frequency, and then combine them into a major market player through simulcasting.

The company purchased same-frequency stations in New Jersey and Long Island, but still faced technical challenges. Existing equipment didn't provide enough control over timing to truly synchronize the three stations' signals and deliver a quality listener experience, in part, because the equipment couldn't adjust for the delay introduced by telco T1 repeaters and line re-routing.

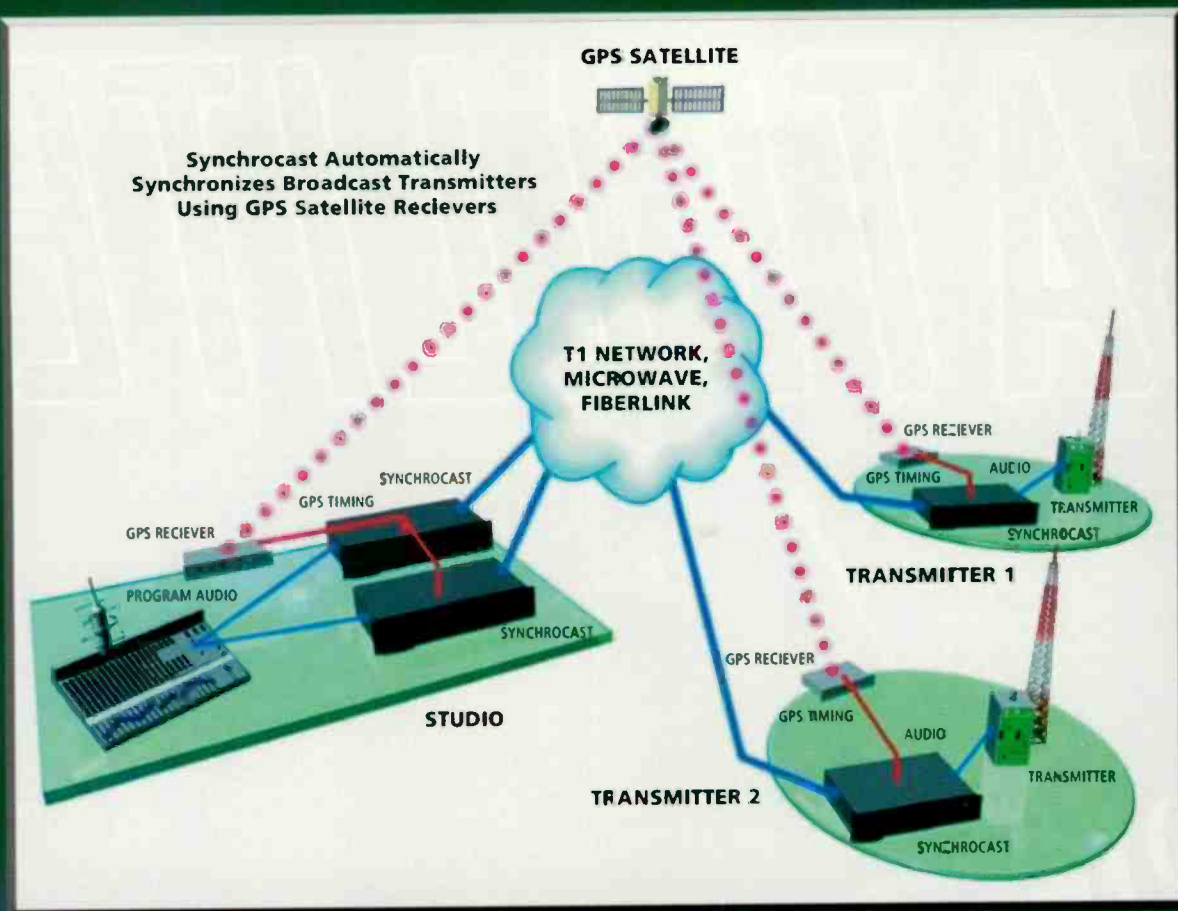

at Big City Radio

At an NAB convention, Big City found that Intraplex had developed a timing synchronization system for private two-way radio systems used by police, fire, and 911 operators that ran on a GPS-based clock. The product seemed to provide everything needed to adjust the signal timing dynamically, if the tools could work in a broadcast environment.

Big City laid out its requirements and, within months, Intraplex delivered the first prototype system for testing. With the addition of Harris Digit CD exciters to create a completely digital air chain, Big City was able to control signal timing precisely. The Intraplex SynchroCast delivered better synchronization between the carrier and stereo pilot frequencies, and allowed

Big City engineers to control the modulation levels throughout the system to create near-seamless coverage of the area.

SynchroCast sends timing reference and program audio to multiple transmitter sites over T1 lines. GPS receivers, placed at the studio and transmitter sites, provide a timing reference. Program audio and timing signals are compared with the local timing reference, and a precise amount of delay is introduced to correct the timing difference between transmitters. Once the signals are synchronized, the system operates automatically to keep the preset delay constant. SynchroCast is based on the Intraplex STL PLUS, a digital STL system.

New York served as Big City's test market for the simulcasting con-

cept; Los Angeles went online at about the same time. Today, the company owns simulcast groups in New York, Los Angeles, two groups in Chicago and is in the installation process for a new group in Phoenix.

Use of the Intraplex SynchroCast equipment has allowed Big City to create new major market stations at much lower prices than other groups have paid for full-power stations, and the technology can also be used as an on-channel booster to fill in weak signal areas without interference. For Big City's L.A. group, for example, the signal-boosting application helps provide an audible signal to almost two million potential listeners in the San Fernando Valley. ■

SATELLITE

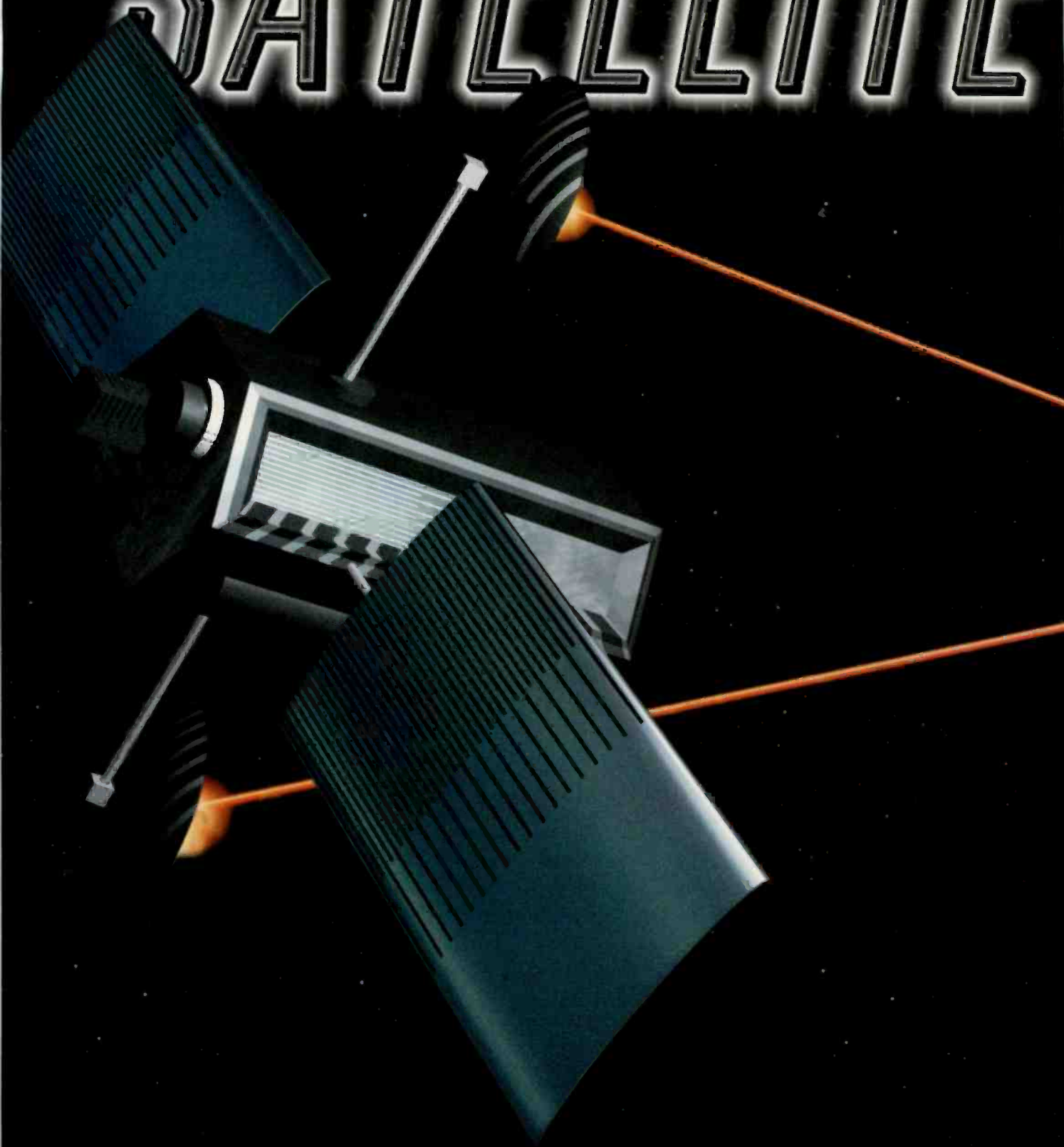

SERVICES:

Always something
new and exciting

By Jerry Mathis



*So much is happening in
the way of satellite
communications that it's
hard to keep track of it all.*

In the beginning, there was analog. It was just plain audio with different services using various bandwidths, pre-emphasis, and sometimes *companding*, the combination of compression and expansion to improve signal to noise figures. Its main problem was that it needed a definite signal-to-noise ratio to work properly, requiring a relatively high carrier power level, especially with *companding*. Audio quality was variable, to say the least. Plus, it offered no security features. Those who generated the programming had no control over who could receive it. Pirating, while not rampant, was a problem. Then Scientific Atlanta developed the *Digital Audio Transmission (DAT)* format. It overcame the problems of noisy audio by digitally encoding the audio for transmission. This eliminated the variable audio quality factor, but introduced the true nature of digital: it either worked or it didn't. The

SATELLITE SERVICES

pirating problem was temporarily solved because only a few manufacturers made DAT receivers. At that time, Scientific Atlanta and Fairchild were the only choices available.

The problem with DAT was bandwidth. A maximum of 16 15kHz audio channels would occupy an entire transponder. These could be divided into as many as 32 7.5kHz channels.

The next step was *Spectrum Efficient Digital Audio Transmission* (SE-

DAT). Using digital compression, SEDAT was able to triple the number of high-quality audio channels on one satellite transponder. It also offered an increased frequency response of 20kHz.

Along the way, Starguide Digital was born. Starguide eventually



Satellite program delivery has a long history in radio. Many stations receive signals from Satcom C-5 which will be replaced by GE-8 soon.

obtained the rights to DAT and SEDAT from Scientific-Atlanta and began marketing the Starguide receiver. It could receive both DAT and SEDAT-encoded signals and served as a bridge to the new generation of satellite audio technology.

Through Starguide's affiliation with Musicam, the Musicam encoding format was pressed into satellite service. Musicam is a modified version of the MPEG Layer II digital encoding standard. The Starguide II receivers were the first to use this new technology for broadcasters. The Starguide II receiver also solved the unauthorized use of satellite programming by requiring all reception to be permissioned. Starguide III receivers will use an upgraded version of Musicam when the transition is made to a new satellite next year.

Up in the sky

Over the last decade, satellite Satcom C-5 (and its predecessors in the same orbital slot) has been the backbone for many broadcasters' network audio needs. But C-5's time is running out; while there are no technical problems now, the satellite will soon run out of the gas used to keep it in a stationary orbit. Many rumors regarding the future of that orbital slot have floated about, and many broadcasters have been nervous about where they will continue to get their vital programming. But do not worry. It is already planned, for the second quarter of next year, that Satcom C-5 will be replaced with a

Digigram POWERED

The best sounding, most reliable digital audio systems use Digigram sound cards.

Does yours?



Digigram Inc. 2101 Wilson Boulevard, Suite 1004 Arlington, Virginia 22201
Phone: +1.703.875.9100 • Fax: +1.703.875.9161 • E-mail: input@digigram.com • Web: www.digigram.com

Circle (119) on Free Info Card or go to www.beradio.com

Tame Your Remote Demons

Vector POTS Codec

The ultimate remote broadcast machine for POTS (Plain Old Telephone Service)



HotLine POTS Codec

The broadcast industry standard for plain telephone line remotes.

Nexus ISDN Codec

ISDN doesn't need to be difficult to sound great! The Nexus is an inexpensive ISDN solution which delivers low-delay, 15 kHz audio.



COMREX
www.comrex.com

Broadcaster's General Store

2480 S. E. 52nd Street,
Ocala, FL 34480-7500
(352) 622-7700 Fax: 352-629-7000
Email: bgsbuck@atlantic.net



www.bgsfl.com

SATELLITE SERVICES

new bird, designated GE-8. The switch to the new satellite will be seamless, with no loss of satellite service anticipated. In fact, users won't even know it has occurred. GE-8 will have a signal 3dB to 4dB stronger than Satcom C-5.

One change will be apparent after switching to the new satellite. Your Starguide II receivers will no longer work. So if you haven't already done so, plan now to replace your Starguide II receiver with a Starguide III.

Many Starguide II owners have asked if these units can be upgraded to a Starguide III. The short answer is no. Although the front panel of the Starguide III looks almost identical to the II, the internal circuitry is completely different. The critical circuits are not on plug-in cards that can simply be replaced. One major difference is that the Starguide III receiver must have an input bandwidth of 25Mb, where the older Starguide receivers had an input bandwidth of 6Mb.

The smallest recommended satellite dish diameter is now 3.7 or 3.8 meters. The issue is not gain, but rather

directionality. As a rule, the larger the dish, the smaller the angle or beam-width that the dish can see in the sky. This wasn't critical a decade ago when satellites were spaced 4 degrees apart. But now they are spaced at 2 degrees. An older dish made in the 1980s might be seeing at least two and maybe three satellites all at the same time. And while you're at it, don't invest in a mesh dish. These dishes are flimsy, compared to solid dishes. They are too easily bent or warped. And the uneven surface adds phase noise to your received signal. Phase noise is a major problem when trying to receive the new *quadrature phase shift keying* (QPSK) signals. A 12-foot mesh dish, even if not warped out of shape, will not perform as well as a solid dish of the same size. Also, once any ice forms or debris settles on a mesh dish, any wind loading advantage is lost.

Why is this critical now? For one thing, plans are already in progress to

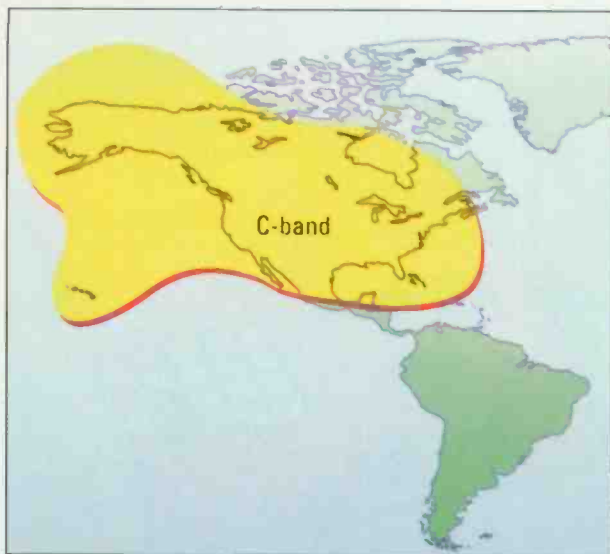

The footprint of the GE-8 satellite is identical to Satcom C5, but delivers nearly twice the output power.

MAGER SYSTEMS

The Best in Sound Furniture

Does Your Studio Furniture Look As Great As This?

Check Out Our New Turnkey Prewiring--

Since 1979 Mager Systems has been designing and fabricating exquisite custom studio furniture for the broadcast industry nationwide. Our unique award winning furniture offers true solid wood premium construction, 3D drawings and design, delivery and installation. Of course, we still offer our 10 year warranty on solid surface tops exclusively, that will long out last wood edges and laminates. Our quality furniture is very affordable, and can accommodate every budget from economy to showplace. We know the broadcast industry is changing everyday, so, if you haven't looked at Mager Systems lately, its time you checked to see what we have new to offer like **Turnkey Prewiring**. Call us today and find out why Mager Systems is the best in sound furniture.

21602 N. Central Ave., Suite 1
Phoenix, Arizona 85024
TEL: 623-780-0045
FAX: 623-780-9860
**Designed, Fabricated,
Delivered and Installed**

Even your GM and PD's will agree on this!

MarketMinder 32

MOH-1000 interface



For complete specs
www.MarketMinder32.com

Features

- 8 integrated stereo silence sensors
- Supports up to 8 stations simultaneously
- Full Text logging
- Front panel monitoring
- Plays pre-recorded Promo spots between faded transitions
- Eliminates office in-fighting for music on hold
- Remote monitoring of any/all of your stations

Product Description:

- **Music On Hold.** Allows up to 8 radio stations to be promoted on your music on hold system simultaneously by continually rotating the station being fed to the telephone system on a flexible schedule you set up. MarketMinder 32 will even play an optional pre-recorded "promo" or "commercial" during the transition from one station to the other.
- **Silence Sensing.** MarketMinder 32 has a built in 8 channel stereo silence sensor. Our system logs the time and date of each silent period detected. The system has configurable on-screen and audible alarming as well as TTL alarm outputs for interfacing externally.
- **Front Panel Monitoring.** Quickly monitor any of your stations, non-intrusively, at the touch of a button, from a convenient rack-mounted monitoring unit? MarketMinder 32 features a 1-touch pushbutton monitoring system which easily allows you to monitor all 8 stations, plus the MOH (music-on-hold) feed, and a separate auxiliary source as well.

Options:

- **Dial-Up Monitoring.** MarketMinder 32 provides easy touch-tone remote access to monitoring all of your stations. Great for music consultants, or remote monitoring by engineering or management.
- **"Bathroom Box".** Up to 8 separate remote desktop or wall-mount monitoring stations allow you to monitor any one of the ten available MarketMinder 32 outputs.



www.MarketMinder32.com

Exclusive Distributor:
STRATEGIC IT SOLUTIONS

9365 Allen Road, West Chester, OH 45069 www.StrategicIT.net
Phone: 513.860.9052 Toll Free: 877.860.9052 Email: sales@StrategicIT.net

SATELLITE SERVICES

replace satellite Satcom C1 — and in orbital slot 137 degrees West, it's right next door to Satcom C-5 at 139 degrees West. C-1 will also have a higher output power level, and hence, a greater possibility to interfere with Satcom C-5 and/or GE-8.

Available services

NSN is promoting the use of their Supercarrier audio distribution system. This service uses a multi-channel carrier on the Satcom C-5 satellite. The service is geared mainly towards major network users, such as Rush Limbaugh, Dr. Laura, Dr. Dean Edell, etc. The Supercarrier is most suited to networks that have at least 200 customers who downlink from them. Supercarrier is received on a Starguide II or III satellite receiver.

NSN also offers data and IP links on their Supercarrier services, with data rates as high as 10Mb/s. They report they have had little call for this so far, but they believe there will eventually be a demand.

Traditional uplinking and downlinking for smaller businesses and radio/audio networks is still a big business. PAS (PanAmSat) offers Ku-band service on its fleet of Galaxy satellites. Unlike large networks such as Supercarrier, Ku system users have total control over their signals, from the uplink (usually at the customers' pre-

mises) to the downlink. Service is usually partitioned by chunks of bandwidth rather than audio channels, as in the past. 64kb/s service is usually satisfactory for a mono audio signal and 128kb/s for stereo. Segments up to 384kb/s are available.

Users of these type links commonly use the Layer II coding scheme for data reduction.

NPR Satellite Services now offers both C-band and Ku-band satellite links and sells the necessary equipment as well. They lease band-

Satellites for more than just audio

By Jerry Mathis

Everyone is used to receiving audio programming via satellite now, but many satellite service providers are now offering IP services as well. NSN Networks, for example, offers INSAT data service. The basic system consists of a satellite dish and receiver, which connects to your computer. You can download data from the Internet at speeds exceeding a T1 circuit. In fact, according to NSN, T1 speed is the minimum you can expect. It's 10 times faster than ADSL and 100 times faster than ISDN.

At least two companies are offering IP uplink service as well. NSN has a companion uplink system to go with their high-speed downlink service. The uplink speed isn't necessarily as fast as the downlink — the speed ranges from 32kb/s to a maximum of 2Mb/s, depending on the package you buy. These services are intended for businesses and ISPs and are not aimed at the home IP-user market. INSAT data services use the GE-4 satellite.

Radio Shack offers satellite-to-home IP service, but its use is contingent on purchasing a computer from Radio Shack. A helpful and talkative salesman at a nearby store told me that for about \$1,248 you get a computer with a proprietary card, a 2' by 3' oval satellite dish and the associated electronics. But the service is (relatively speaking) stupendous. The upload speed is between 500kb/s and 700kb/s, and the download speed will burst as high as 5Mb/s — about the rate of a T3. The monthly service fee is \$59.95 for unlimited usage. Internet service is provided by the Microsoft Network.

As I said, this offer requires you to purchase a computer, but this requirement may change sometime next year, and the service will be offered as an aftermarket system. The satellite dish and electronics are leased, by the way, and remain the property of the satellite service provider.



ANTEX
digital
AUDIO

betterwebcasting.com

Streaming or broadcast, Antex has you covered.

The LX series of sound cards are ideal for web audio, with 20-bit digital sound quality, highly stable Windows 95/98/NT/2K software, and up to 4 inputs and 4 outputs. To find out more, visit antex.com (or betterwebcasting.com) today or call 1-800-338-4231.



Circle (123) on Free Info Card or go to www.beradio.com

**Prime
Image**

Time is CASH!

Reaping revenue for radio.



About Prime Image

You are about to discover a new way to create additional revenue from your radio station. The often-heard wish of having more time has been answered. In radio, time means revenue. Prime Image Inc. is in the time business. The company's experience in time manipulation for broadcast and video applications has gained notoriety and respect within the industry. We're glad that you are interested in learning more about Prime Image and its latest revenue-creation product, CASH.

Based near San Francisco, Prime Image is a closely controlled manufacturer of corporate, industrial and broadcast video equipment. The principals within the company have vast experience in the broadcast and video industries. The company manufactures a quality, easy-to-use line of transcoding time base correctors, synchronizers, digital standards converters, audio/video delays, desktop video products and digital program time reduction/editing equipment.

Incorporated in 1985, Prime Image takes great pride in its corporate image and integrity. Of particular importance to the company is customer service. All Prime Image products include a three-year warranty that covers round-trip express shipping charges within the United States, parts, labor, product updates, revibrating and product burn-in.

Prime Image has a manufacturing, engineering and sales office in San Jose, CA, which serves a limited, select professional distribution network worldwide. The escalating growth of the company for varied applications is handled by an elite group of professional distributors.

Bill Hendershot, president and founder of Prime Image, was awarded an Emmy for the development of the world's first digital video timebase corrector. This was the first fully digital video product. He has also been nominated for Emmy awards for the development of many other products and continues to develop state-of-the-art video and broadcast equipment.

The company's product line includes timebase correctors, video standard converters, synchronizers and audio/video delays. The experience gained in manipulating time for video has been carried over to audio applications. One Prime Image product, the Time Machine, was developed to create additional time within a video program. This same idea has been carried over to audio for the development of CASH.

While the unit is a piece of hardware, it should be considered a revenue tool and not a capital purchase. The cost of the unit can easily be covered by the revenue it creates. In very little time, the additional revenue will exceed the initial cost, and the true value of the CASH can be realized.

To help stations put CASH to use, a leasing program is available. Contact Prime Image for specific information on leasing or purchasing a unit.

In the following pages you will learn more about what CASH is, what it has done for other stations and what it can do for your station. /

Prime Image Inc.
662 Giguere Ct., Ste C
San Jose, CA 95133
(408) 867-6519
Fax (408) 926-7294
primeimagein@earthlink.net
www.primeimageinc.com

time

If time is money, what could you get for an extra radio commercial every ten minutes?

If you're in the radio business to make money (and who isn't) you need

"Cash"TM

Through an exclusive time-shifting process, Cash creates additional broadcast time to sell. It does it in real time, right on the air. It does it without reducing program content. It does it without affecting pitch or creating a "chipmunk effect." It does it in stereo or mono. It does it in variable amounts, adding from zero to five minutes, within two minutes to two hours.

Cash, from Prime Image - you don't need one unless you want to make some.



Prime Image

The Digital Video People

662 Giguere Court #C, San Jose, CA 95133 • Tel (408)867-6513 Fax (408) 526-7294 Service (408)926-5177
Primelimagein@earthlink.net • www.primelimageinc.com

CASH in action

Going into major markets

Playing in a major market is a worthy goal for any broadcaster or equipment manufacturer. CASH has made it into six of the top-ten markets with ABC Radio. These units are used at six leading talk stations on some of the program material.

Bert Goldman, vice president of engineering, radio division, noted that, "CASH works inaudibly, and when used conservatively like we do, there is no noticeable effect." Since the audio is digitized but not data reduced, there is no degradation from encoding and decoding the audio. The ABC stations are only inserting one additional minute per hour, which is very conservative since the unit is capable of inserting up to four minutes per hour.

Goldman continues, "the idea to use CASH was presented at the corporate level. The concept makes sense, and the decision was made to try it on some of our stations. This test led to the purchase of six of the units." The issue of cost was easily justified as well. "A cost analysis quickly revealed that this was something to try. Payback is extremely rapid for a major market station. In some cases, this may be less than 30 days."

An executive at ABC first saw an ad for the CASH and then asked Goldman about it. After contacting Prime Image and learning about the unit, Goldman became even more interested. "The more I learned about the unit, the more I thought it was worth a try. When I explained to the CEO what it could do, he was very excited."

The next step was to install and test CASH at a station. The test was done in New York City on the Rush Limbaugh Show. While the test was intended to be confidential, word got out and even appeared in the pages of the *New York Times*. However, Goldman summarized the test results by saying, "the initial tests had positive results and led to our final purchase of six units."

The key to a successful application is programming the unit properly and triggering the events at the right time. Once CASH is installed, each operator should be fully trained on its operation and function. Like any other piece of equipment, when it is used by a skilled operator, the results can be very profitable. /

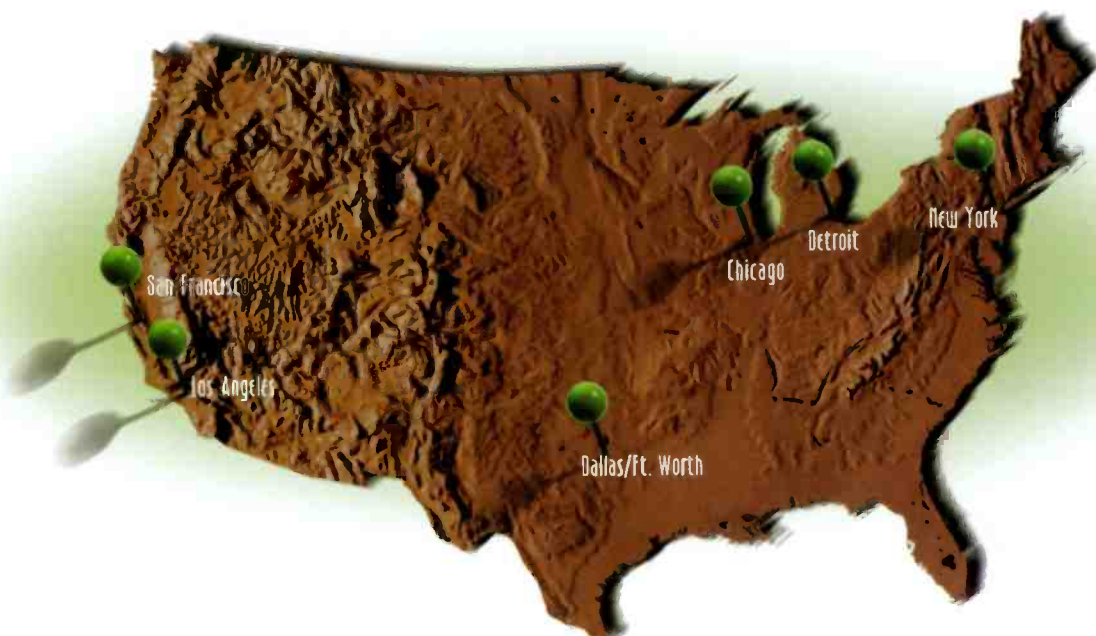

CASH in Philadelphia

Payback in days

Beasley's WWDB-FM is a full-time talk station. It now originates all its programming locally, but until recently aired several syndicated talk shows. Like most syndicated shows, local spot insertion time is limited. Dennis Begley, general manager of WWDB, was interested in a way to generate additional revenue during these shows. For his station, CASH was the answer.

"Someone on the staff saw the article in the *New York Times*," says Begley referring to the use of CASH on WABC during the Rush Limbaugh show. "It interested us, and by the next day we bought one." For WWDB, the unit was installed and quickly started generating new-found revenue for the station on two syndicated programs.

"We used the CASH rather conservatively, adding only two minutes of time per hour." At this level of time insertion, Begley says that it is impossible for a listener to tell that anything is being added to the program. He added, "the show host might be able to hear that something is different only because people know their own voices and speech."

WWDB only used CASH on syndicated shows. It works equally as well on live programming, but for WWDB, this would require

some additional installation such as direct monitor feeds for the host. At the time, this was something that the station did not want to undertake. The time constraints in syndicated shows are very tight. The CASH allows some flexibility in adding additional commercial time and new-found revenue.

The return on investment was very fast as well. WWDB added two minutes per hour, six hours a day, five days a week. These additional 60 spots averaged \$300 each. In a few days the cost of the CASH was covered and Begley quickly saw the value of the unit.

Begley particularly likes the fact that the program can be aired without losing any material. "The full show can run in its entirety and still provide extra commercial inventory," he says. "The average person cannot tell that the audio is being affected. There is no way in the world that anyone could tell."

Training the operators was not a problem. The unit was installed to operate on a single pushbutton, so instead of simply starting the commercial, one button started the commercial and began buffering the program audio.

WWDB does not air any syndicated programs right now but has plans to use CASH again very soon. /



CASH heads south

Not just for major markets

When Kent Dunn, general manager of Beasley's six stations in Augusta, GA heard about CASH from Dennis Begley, general manager of sister-station WWDB, Philadelphia, Dunn, like many others, was very interested.

In smaller markets, every ad dollar is important. CASH offers a way to create more time to generate additional revenue. When asked about the cost of the unit, Dunn replied, "Our spot rate in Augusta is considerably less than Philadelphia [see page 5], so payback on the unit will take longer than one week, but should still be less than 60 days. After that it's strictly additional revenue." This is why CASH should be viewed as a revenue tool and not a capital equipment purchase.

The Augusta group has been using CASH on WRDW-AM during syndicated programming. "We are typically inserting 60 to 90 seconds per hour during syndicated programming. This has given us a way to supplement our bottom line," adds Dunn. At this time there are no plans to use CASH on live programming since time constraints are not an issue. During live programming the station already has complete control over time on the local

level. However, if the need arises, CASH is ready to be put into service.

Dunn adds, "I'm amazed at the ability for us to create the additional time within syndicated programming without any effect on the content." Quality is important to Dunn. "We would not compromise the programming content regardless of what could be gained from it as far as available time to sell. In this case, it's the best of both worlds. We're able to get more inventory without changing the show's content in any noticeable way."

Overall, Dunn is completely satisfied with the CASH and what it can do. "We are certainly pleased with the product," states Dunn. CASH has provided an easy means to supplement WRDW's bottom line.

Dunn tried CASH on the recommendation from WRDW's Philadelphia sister station [see page 5]. Installation and operation of CASH was easy, especially since WRDW could pull from the experience already gained from the Philadelphia station. Dunn says, "It is very easy to operate — very similar to operating a profanity delay. Once it has been setup and activated it does the work for you." /



The Product

What is CASH?



There are not enough hours in the day. This phrase is uttered countless times every day. However, there are now more hours in a broadcast day thanks to CASH.

The general idea behind CASH is simple. The time during a radio program is finite. In many situations, the ability to add just one more commercial would provide substantial revenue for a station. CASH provides a simple means to create the additional time within a program that can supplement the bottom line.

Time manipulation is not always an easy concept to understand. To illustrate how easy it is to use CASH, consider this example that involves a 12-minute program with two minutes of commercials. In this example, we want to insert an additional 30 seconds for a sponsorship within the 12 minutes.

First, CASH must be programmed with the time information specific to the program. The *Program Time* is 12 minutes. The *Hold Time* for commercials is two minutes. The *Insertion Time*, that is the time that will be added to the program, is 30 seconds.

The audio path is shown in Figure 1. The Program begins at 7:00:00. At 7:00:00, the

program feeds the CASH input through the console connection. The inserted program material is played directly on the air through the audio router. A contact closure will start the CASH's buffer. This closure can be the same command that starts the inserted commercial. While the inserted 30-second commercial is playing, there is no audio coming out of the CASH because it is buffering.

At 7:00:30, the inserted commercial ends and the CASH provides audio at its output. The audio buffer, now holding 30 seconds of audio, will slowly decrease the amount of audio in the buffer during the duration of the program.

The regular two-minute commercial break is scheduled for 7:05:00. These commercials are also fed into the CASH, but at that time the unit is placed into *Hold* while the commercials are playing. This prevents the time reduction process from being applied to the commercials. The 60-second commercial will still be 60 seconds long. When the commercials end, the unit is released from its hold function, and the buffer again begins to unload.

At 7:12:00, the audio output of the CASH will have met real time. /

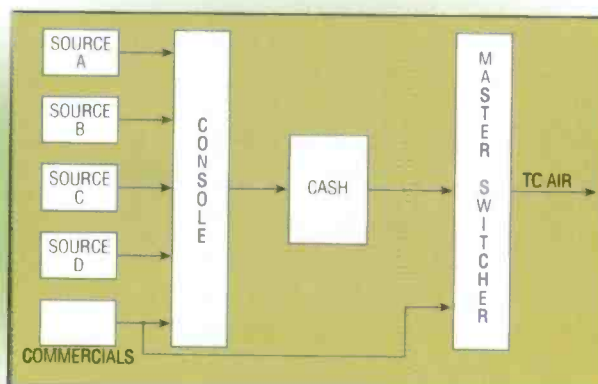

Figure 1. The audio-signal path for using CASH.



CASH Specifications

Input Level: 0 or +4dBm 600 ohm or HiZ Bal or Unbal, XLR

Output Level: 0 or +4 dBm 600 ohm Bal or Unbal, XLR

Variable Level: ± 16 dBm (clips at +20 dBm)

Frequency Response: ± 0.5 dB, 20Hz to 20kHz

Channel Separation: 96dB

S/N (A-wt-filter): 86dB

THD: 0.04%

Additional Commercial Time: 2 seconds to 4 minutes mono,
2 seconds to 2 minutes stereo

Variable Commercial Time: 0.1 second steps

Prime Image Inc.
662 Giguere Ct., Ste C
San Jose, CA 95133
(408) 867-6519
Fax (408) 926-7294
primeimagein@earthlink.net
www.primeimageinc.com



WaveForm

bringing the latest
news and information from the
broadcast marketplace FREE to
your desktop every week.

Featuring
the latest news from
the publications you respect,
WaveForm has breaking news,
product reviews, tutorials, and
techniques for professionals
involved in broadcast. This colorful,
html-enhanced newsletter also
showcases the latest news and
product demos from the leading B2B
streaming news source, DMN TV.

Featured sites:

BERadio.com

DTVBuyer.com

HDTVBuyer.com

WBEOnline.com

BroadcastEngineering.com

Sign up now!

<http://www.digitalmedianet.com/register.htm>

Digital Media **NET**
Where the Creative Community Meets



The New Standard for Digital Consoles

SATELLITE SERVICES



Numix consoles by Logitek give you all of the flexibility you need

- ◆ True DSP-based digital mixing and routing
- ◆ Combine analog and digital signals as needed
- ◆ Re-configure fader and button assignments "on the fly" - no need to re-wire anything
- ◆ Integrates nicely with digital storage systems- fader displays provide room for song titles, timing information, or other messages
- ◆ Contemporary ergonomic design keeps controls within easy reach
- ◆ "Building-Block" design allows you to specify a console with 6 to 42 fader channels
- ◆ Easy installation, clean wiring -- leave all of that extra equipment and cabling in the equipment racks

Call today for more information

5622 Edgemoor
Houston, TX 77081
800.231.5870 (North America)
tel: 713.664.4470
fax: 713.664.4479

Logitek

Digital With a Better Difference

Visit us at www.logitekaudio.com

width segments from as little as 64kb/s up to T1, using satellite Galaxy IV-R.

What's the difference between Ku-band and C-band? Aside from the obvious difference in frequency, C-band is almost immune to weather-related service interruptions, also known as rain fade. But overall, C-band is the more expensive of the two



Mesh dishes may be preferred for consumer applications but they are rarely suitable for radio broadcast use.

systems to build and operate.

A report on satellite networks would not be complete without mentioning the Christian Radio Coalition (CRC). Using Spacecom's GE-3 satellite, the CRC combined the individual networks of its members into one digital video broadcasting (DVB) MPEG-2 carrier. This allowed all of the CRC member network affiliates to standardize on one receiver, the Wegener Unity 4000, which can be used to pick up programming from all CRC member networks. The transition occurred earlier this year. I can personally attest that it was a colossal undertaking, as I was actively involved in installing dishes and receivers here at LifeTalk Radio. The CRC has effectively met the needs of religious broadcasters who want to transmit programs from many different Christian networks.

Circle (125) on Free Info Card or go to www.beradio.com

Introducing AXS 3: Scott Studios' Affordable New Digital System

With AXS (pronounced ax'-cess) 3, the 3 tells you this is the *third* generation of one of the most popular digital studio systems in radio! AXS is in its *second* decade as radio's premier satellite automation and digital cart replacement deck.

Triple Overlap: The 3 also indicates that AXS 3 is the first affordable digital system that plays *three* stereo audio recordings out to *three separate console faders* for music on hard drive. AXS 3 gives your announcers the ultimate in level control and mixing ability.

Air Studio Production Bonus: AXS 3 also has *another* stereo production output and record input. You can record and edit phone calls or spots and auto-delay news and audition them in a cue speaker while playing triple overlap on the air!

Premium SCSI LVD Hard Drives: The 3 also tells you that AXS 3 gives you a *3 year limited warranty* on hard drives. AXS 3 uses *exceptionally reliable and fast SCSI LVD 18GB hard drives* from quality manufacturers (like IBM, Seagate, and others you trust) to keep your precious commercials, jingles and other recordings *always* at your fingertips. Some other systems cut corners with slower and less reliable IDE hard drives that sometimes choke and sputter with triple overlap and music on hard drive. They also jeopardize your cash flow with less reliable drives more likely to crash.

Awesome Sound Quality: With AXS 3, your station will sound superb. AXS 3 uses only the best *non-proprietary +4 balanced 4 output* digital audio cards by Audio Science. These are also sold by most of the major brands of digital systems, but only in their top-of-the-line models costing *lots more* than AXS3.

Easy to Use: AXS 3 was *designed by jocks, for jocks*. It's 100% intuitive. AXS 3's big on-screen intro timer and separate countdown timers on every deck make pacing a snap.

If you know how to work cart decks, you know how to work AXS 3. It's so simple, everyone can run it! AXS 3 has *big* buttons. Other systems use complex multi-step mouse mazes. AXS 3 gets things done with one simple touch.

Flexibility: AXS 3 seamlessly mixes uncompressed (linear) audio and all popular MPEG II compression ratios. AXS 3 can also play MP3 songs and spots you get from other sources, but if you do this you must stay with one bit rate for all. (It's a limitation of MP3, not AXS3.)

The Music's Easy: AXS 3 is delivered with *your* music library already pre-recorded for you either in MPEG II or uncompressed at no extra charge.



Jocks love AXS 3! Scott Studios' AXS 3 works with three cart players on the right side of the AXS 3 screen. The program log (at left) automatically loads the decks, or you can insert anything from pick lists. The far left of AXS 3 has 12 Hot Keys that can play instantly at a touch.

AXS 3 comes with Scott's time-saving TLC (Trim, Label & Convert) CD Ripper software for your Program Director's computer. TLC uses a CD ROM drive to transfer 5 minute songs to hard drive digitally in 15-30 seconds.

The Best Air Studio Recording: AXS 3's built-in recorder has a *graphic waveform editor* for easy recording and editing of phone calls, spots, news or announcer lines. AXS 3's log editor lets you add new items to your schedule.

The Best Voice Tracking: AXS 3 works with Scott's optional *Voice Trax*, which you can add to your production room or air studio. Announcers will be able to hear surrounding music and spots in their headphones to match their voice to the moods and tempos of the music. During Scott Voice Trax, the level of your music is automatically lowered by AXS3.

Quality Hardware: AXS 3 uses an industrial quality Pentium III rack mount Windows computer. Jocks can use a keyboard or mouse, or optional button box or touch screen for fast control.

The Best Tech Support: Toll-free emergency phone support is available 24 hours a day, 7 days a week (including holidays). Software updates with new features are available for AXS 3 customers several times per year to stations on our annual support plan.

Easiest to Install: AXS 3 comes with a pre-wired connections to CAT5 LAN cables for snap-in installation on the AXS3 end of the wiring. Satellite control logic is also a snap with a plug-in connector. Your first two satellite audio connections for music format and news network, as well as another for your production console, are all built into AXS 3. For most music formats, there are no satellite interface cards or external switchers required. Basic connections are built into AXS3.

LAN and WAN: AXS 3 and other MPEG and uncompressed WAVE Scott Systems use the same recordings. You don't have to dub the same spot several times for several stations.

The Best Production Studios: AXS 3 is compatible with popular multi-track systems you may already have, like Sound Forge, Vegas Pro, Cool Edit Pro, Fast Edit and others. Simply add our time-saving \$500 no-dub instant LAN spot upload option.

AXS 3 is Affordable: Satellite AXS 2 systems start at \$7,995 with computer, double overlap audio card, satellite inputs, switcher and production recorder-player. Triple overlap AXS 3 adds 18GB of music on hard drive for only \$9,995 delivered. For details, check scottstudios.com, axs3.com or call 800SCOTT-77.

(972) 620-2211 FAX: (972) 620-8811
800 726 8877
(800) SCOTT-77

Scott Studios
13375 Stemmons Freeway, Suite 400
Dallas, Texas 75234 USA

SATELLITE SERVICES



With so many signals available from the sky, 2 degree-compliant antennas are crucial for reliable reception.

And finally, if you want to explore the heavens for satellites and phenomenon of many types, check out www.heavens-above.com. There you will find information on tracking (from the ground) satellites, space stations, and even something called Iridium flares. You'll have to go to the website and find out for yourself what this is all about.

Jerry Mathis is the Network Engineer for LifeTalk Radio in Vonore, TN.

One Question, Three Answers

An actual email thread, June 8-11, 2000 on broadcast.net

Thursday, June 8, 2000
To: bsi-i@broadcast.net
Subject: BSI Experiences?

We are a small AM station considering implementing BSI software to automate our station. It seems to have all the functionality that we would need. Is this a good solution? Thanks for your input.

- John

Sent: Sunday, June 11, 2000 4:50 AM
To: bsi-i@broadcast.net
Subject: Re: BSI Experiences?

John,
We started using WaveStation in January and are extremely pleased with it. It's been running glitch free.
We use it weekdays in live assist to play our spots, PSA's, etc. and on weekends in full-automation. At 1p.m. both days, we lock the door and leave. WaveStation plays programs recorded earlier, picks up some programs live from satellite...joins news live at the top of the hour...records a couple of sports updates for playback a few minutes later...fades programs out...runs fill music...fades fill music, etc.
We currently have only one computer set up for WaveStation. We will probably purchase a second one in the not too distant future.
Perhaps it's a sad commentary on life, but WaveStation is much more reliable and dependable than the human beings we used to use...and "Wave Station," as we call the system here, doesn't ask for vacations or pay raises.

By the way, we are a small town AM station also.
Bob Ketchersid
WYXI, Athens, TN

Date: Fri, 9 Jun 2000 16:55:47 -0500
To: bsi-i@broadcast.net
Subject: Re: [BSI Experiences?]

John,
We're running WaveStation on 2 stations, one is live-assist the other fully auto. While there have been bugs, most of ours have been PC related. WaveStation is a GOOD program to consider. I give it 2 thumbs up.

Tim Swanson
tmswanson@kswp.com
East Texas Christian Radio
90.9KSWP/KAVX91.9
Lufkin, Tx
kswp.com
kavx.com
Broadcasting LIVE on the

Called BSI... it's only \$999. I recommend we get BSI WaveStation. Plus their tech support is free!

JS



888-BSIUSA1

WWW.BSIUSA.COM

Broadcast Software International

Circle (127) on Free Info Card or go to www.beradio.com

Rock the airwaves

By Peter Jackel

Satellite digital radio is receiving considerable attention with the pending service launch dates from both the US service providers. Outside the US, one company, WorldSpace, is already delivering two radio services to Asia, Africa, the Middle East and parts of Europe. WorldSpace will launch a third service for Latin and South America in 2001. Listeners in Africa, the Middle East and Asia receive a signal via the AfriStar satellite, launched in 1998, and AsiaStar, launched in March 2000. The WorldSpace satellites operate in the L-band.

Listeners in the United States will be able to receive S-DARS (satellite digital audio radio service) on the S-band in their cars with one of two services. Sirius Satellite Radio launched its first two satellites on June 30 (Sirius-1) and September 5 (Sirius-2). XM Satellite Radio will launch its satellites by the end of this year. Sirius plans to be in service before the end of the year, while XM will be available in 2001.

While both service providers expect most of their listeners to be in cars, some portable radios will be capable of receiving the satellite signals. To avoid service interruptions in areas with tall buildings, XM will have 1,500 repeaters in 70 major urban markets. Sirius will have 105 repeaters in 46 cities.

Automotive companies such as Ford, Chrysler and BMW have already signed with Sirius and XM. Sony, Alpine and Pioneer are among the companies that have committed to create receivers. Investors include big names such as American Honda Motor and Hughes' DirecTV unit.

Sirius has a 100,000 square foot studio in the Rockefeller center in New York (see the Facility Showcase on page 72). XM recently completed its state-of-the-art facility that contains 82 studios and will be featured in an upcoming Facility Showcase.

Peter Jackel is the associate editor of BE Radio's sister publication, Satellite Broadband.

BSW
BROADCAST SUPPLY WORLDWIDE
Advantage

Audio Equipment for Broadcasters

- Best Price Guarantee*
- Same Day Shipping*
- Extended Hours
- Knowledgeable Sales Staff
- Flexible Terms

Production Mixer *Extravaganza*



BSW stocks a monstrous selection of production mixers from the best names in pro audio. Large or small, digital or analog, BSW has a mixer to fit your application at a great low price. Call and talk to the experts today.



Let BSW Work to Your Advantage!

We offer a best advertised price guarantee*, same day shipping of in-stock items*, sales professionals with real-world experience and sales hours from 9:00 AM to 9:00 PM Eastern Standard Time.

FREE
Pro Audio Catalog
Call BSW 800 426 8434

**To Order Call BSW 1-800-426-8434
or Visit www.bswusa.com**

Circle (12B) on Free Info Card or
online at www.beradio.com

* Call or see www.bswusa.com for details.

AUDIO CODECS

At one time, all remote broadcasts involved a long wait from the phone company while an expensive equalized circuit was engineered and installed. The alternative was a remote pickup (RPU) transmitter. While the need for a long lead time was avoided, obtaining a clear path to the receiver was not always possible. In some areas, finding an available frequency is nearly impossible. For many stations, these two options are still the normal way of doing things. In the past few years a new method has been added to the station's bag of tricks. The *codec* (shortened from encoder/decoder) has opened the door to a new level of quality for remote broadcasts, eliminating the dependence on radio links and special-order telephone circuits.

Whether you are a seasoned professional or new to broadcasting, the choice of which codec to purchase should not be a snap decision. Simply picking a specific unit because the station across town bought one might lead to more questions than answers. Before you pick out a unit, you should be fully aware of the station's needs. This is a good item to discuss with your fellow department

Sending audio from remote locations has never been easier

By Kent Kramer, CBRE

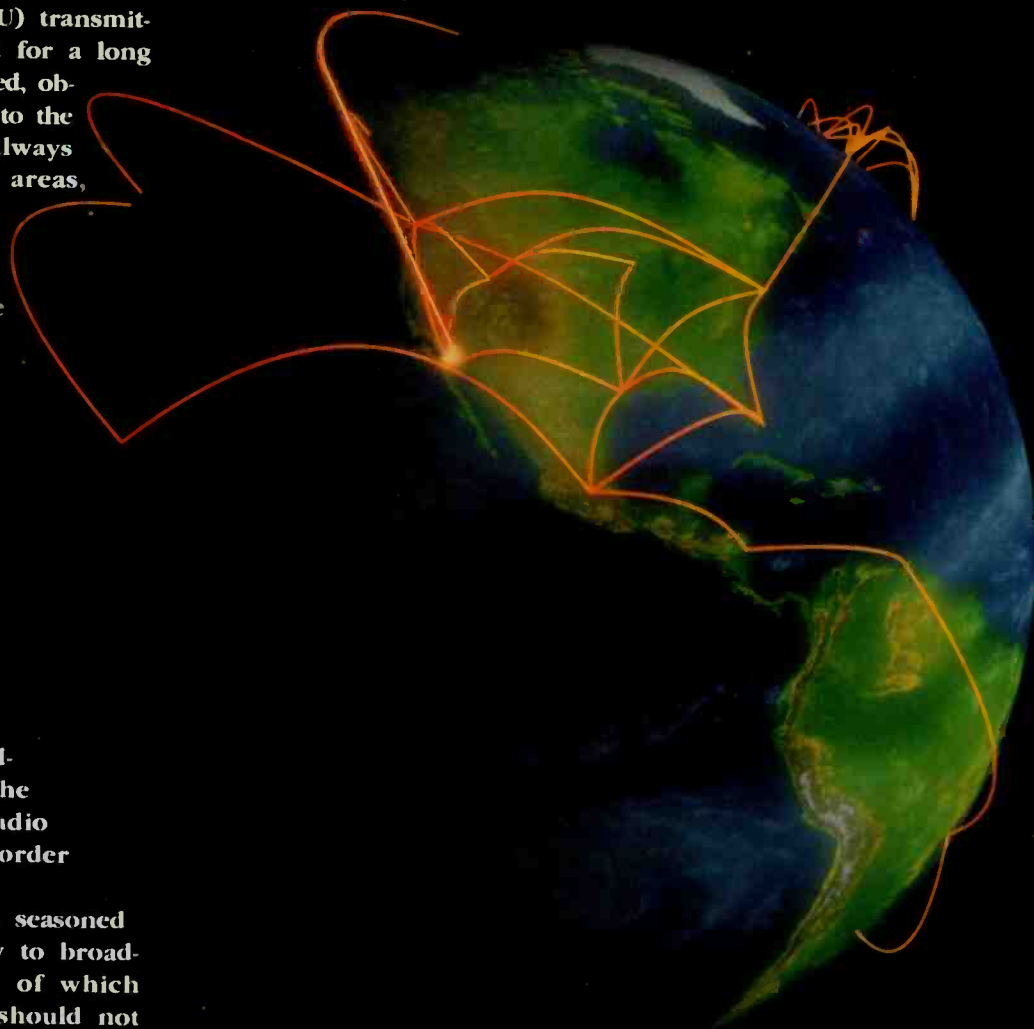

MUSICAM USA Builds the BEST codec for you...



in the field



at the studio



**from the
concert hall**



Only
\$2,800
Complete

 **RoadRunner**

- ▶ Portable Codec/mixer
- ▶ MUSICAM®-enhanced MPEG Layer 2, plus MPEG 3 and G.722
- ▶ 256 speed dial addresses
- ▶ Built-in automatic functions and remote control
- ▶ Storage for 20 terminal adapter setups
- ▶ Software upgrades via Internet



Starting at
\$3,295



PrimaLT and **PrimaLT Plus**

- ▶ MUSICAM®-enhanced MPEG Layer 2, plus MPEG 3 and G.722
- ▶ Dynamic range better than 95 dB
- ▶ 24 bit A/D and D/A converters
- ▶ 256 speed dial addresses
- ▶ Easy to use, intuitive setup
- ▶ Software upgrades via Internet
- ▶ 384 kb/s digital mastering quality audio
- ▶ Point-to-multipoint broadcast operation
- ▶ Standard AES/EBU digital I/O*
- ▶ 8 available relay contact closures and SMPTE time code*

*Prima LT Plus only



MUSICAM USA

670 N. Beers Street, Bldg. 4
Holmdel, NJ 07733 USA

Tel: 732-739-5600

Fax: 732-739-1818

Email: sales@musicamusa.com

Internet: www.musicamusa.com

MUSICAM USA is the d/b/a of Corporate Computer Systems, Inc., Holmdel, NJ, USA

Circle (129) on Free Info Card or online at www.beradio.com

AUDIO CODECS

heads. You will likely find that sales and programming have different needs for remote equipment. Most stations do several types of remotes including night clubs, car dealers, local fairs and sporting events. These all present different challenges and different requirements not only for the equipment, but also for the person engineering the remote.

It is important to look at how you will use the equipment, but it is equally important to look at the rest of your facility. How will the equipment integrate into your existing remote equipment package? Will it work with your intercom system, and will there be any problems with too much data reduction in your

the coded audio introduces just as many questions. ISDN and POTS (Plain Old Telephone Service) lines provide different levels of bandwidth to transport different methods of coding.

Side effects

One artifact of coding audio is time delay. All methods of coding introduce some finite amount of delay into the audio path. Some are on the order of a few milliseconds, while some coding methods introduce a delay long enough to make it difficult to monitor source audio

on the return path. Delay times approaching 0.25 seconds and longer are possible. The station must

provide a mix-minus so the local audio and studio backhaul can be monitored.



Many stations regularly use several types of codecs.



audio path to the transmitter? With several popular coding algorithms, care should be taken not to intermix too many different algorithms along the audio path. Stacking too many algorithms can cause degradation in the overall audio quality and can cause audible anomalies to appear in the on-air sound. On top of the decision of how to code the audio, the method of delivering



The latest generation of codecs have multiple personalities for use with POTS, ISDN and wireless services.

The first question you need to answer regards cost; not only cost of the equipment, but the cost of doing the remote. Look at the number of remotes per week—how much does the sales department charge? Are they only doing one or two live breaks per remote, or are they doing a full-music show from a night club? Does programming want or need to have full stereo audio, along with a closed-circuit station-monitor feed with IFB and a data port from the station LAN, available at the remote site? Does the promotions department need station program audio available to feed a PA system? Finally, do you have the time or manpower to go to every remote, or do you need to use non-technical personnel to operate the equipment? These

Looking to Sell Equipment Online?



**Your Internet
Storefront is Ready.
*Right Now.***

Imagine one online marketplace where you can sell professional, digital-media production equipment – without investing time and money in the sale. Now imagine that you can leverage this powerful sales tool right now – for free. That's the reality of Digibid.

Solve Inventory Problems

Sell your individual components, overstock items, discontinued products or trade-ins, demo gear and more, with no hassles or phone calls. Simply post them on Digibid and get top dollar. It's that simple.

Visit Digibid Today

Thousands of smart production professionals turn to Digibid every day. There's no better source for relevant, timely competitive intelligence and industry-equipment information. Visit today!

It's FREE to List Items for Sale

You pay a commission only after your item sells. Digibid completely handles the buyer side of the transaction. To date, we've more than 25,000 successful auctions.

How to Get Started

Just register online at digibid.com.

Get a Branded, Online Storefront

If your company is interested in a higher level of promotion and exposure, inquire about our setting up your own, branded digital marketplace, leveraging our state-of-the-art technology. We have more than 21,000 registered users and more than 90,000 unique monthly visitors.



a member of **IndustryClick™**
Where industry clicks on the Web!

E-mail: sales@digibid.com

Phone: 609-371-7833

AUDIO CODECS

answers will help determine what method of program delivery best suits the station's needs.

Once the station's needs are assessed, start looking at equipment. Usually, basic remotes will be just fine with lower bandwidth systems, while more complex remotes will require considerably more bandwidth. With more bandwidth comes more complex equipment. The more complex the equipment and the remote, the more engineering will likely need to be present to handle setup, teardown and equipment operation during the remote.

For basic remotes, POTS codecs offer the most

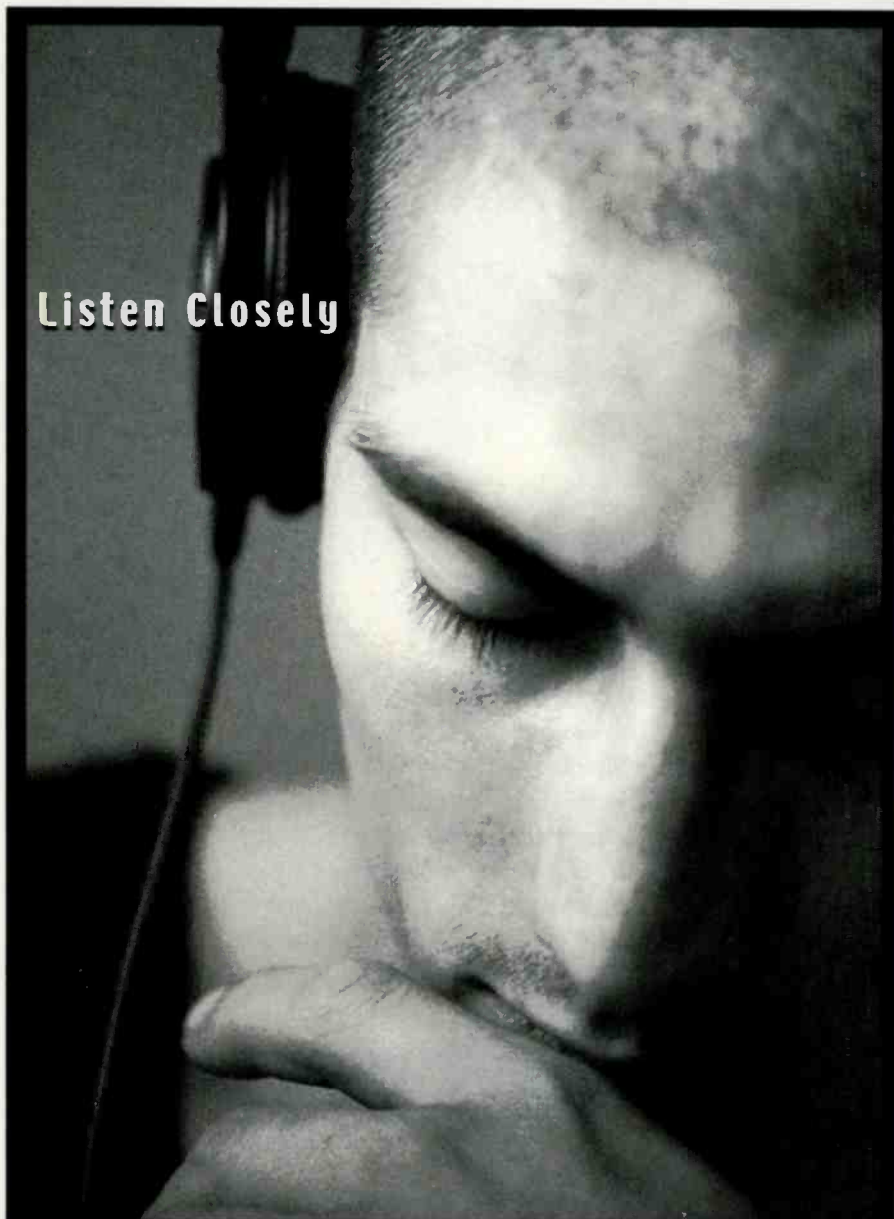

Listen Closely

Success depends on how well you listen. And how good you sound. For over a decade the designing minds at AudioScience have been responsible for more digital audio adapter innovation than anyone else in the business. So Listen Loud. Listen Clear. And demand digital audio peripherals from AudioScience. Call 302-324-5333 or visit www.audioscience.com.



A suitable enclosure is crucial to the longevity of equipment. Additional rack-mounted equipment can be used to make the remote setup more versatile.

overall flexibility in the smallest package and are usually able to transmit bi-directional mono audio up to 15kHz with a connection rate of approximately 33.6kb/s. The ability to use any standard telephone line allows almost any location in the world to be remote-broadcast ready. A slower connection rate will provide less bandwidth in the audio channel, but even at a slow modem connection, 8kHz of audio bandwidth is more than acceptable for voice-grade audio.

Getting connected

POTS codec setup is typically simple because the number of settable parameters is minimal. POTS codecs operate similar to standard computer modems, going through a short dialing and handshaking period before passing audio. Many units include a small two- or three-channel mixer that provides control over the input levels as well as headphone outputs and a local/return monitor mix. Most well-equipped POTS codecs can stand alone without any additional support equipment.

Since these units operate on a standard telephone line, even the most inexperienced operator can

Circle (130) on Free Info Card or go to www.beradio.com

ON AIR

broadcast ready

C 4500 B-BC

- the front firing on-air announcer mic of the future, specially designed for digital broadcast studios
- immune to all electrostatic and magnetic interferences from surrounding equipment
- two stage patent-pending windscreen design for superior plosive protection
- reduced proximity effect for consistent sound
- complete with professional, spider type shock mount and external pop/wind screen



A Harman International Company

AKG Acoustics, U.S.
1449 Dotson Pike - Nashville, TN 37217
Phone: 615-360-3499 Fax: 615-360-0275
E-mail: akgusa@harman.com
www.akgusa.com



Circle (13) on Free Info Card or online at www.beradio.com

PRO
AUDIO
REVIEW
PAR
excellence
2000

AUDIO CODECS

be taught how to use it in a short time. It is often a greater challenge to convey the simplicity of the operation than it is to train the operator on its use.

Higher bandwidth

For more involved remotes, ISDN provides a full 20kHz stereo bandwidth and bi-directional audio paths. With the proliferation of ISDN around the world, more complex remotes can be done from more places than ever before. What once required coordinated satellite channels and a POTS line for cueing and IFB can now be done with a

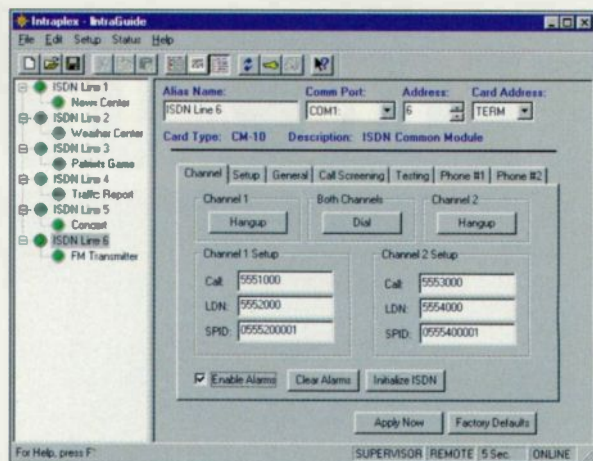

In situations where multiple codecs in the field feed the studio, equipment consolidation like that offered by the Intraplex Intralink can save space and provide additional control.

single ISDN line. Full-stereo program audio can be shipped to the studio at the same time that mono program mix-minus and cue audio are sent back to the remote site for the talent.

The one difficulty with ISDN over POTS lines is the amount of expertise involved to make it work. Orders for ISDN lines must be placed and configured to work correctly with the chosen equipment; *service profile identifier* (SPID) numbers must be entered correctly into the equipment; and protocols must be matched between the studio and remote site for the link to work properly. One incorrectly entered digit can cause the ISDN interface to communicate improperly with the phone company's central office.

A benefit of ISDN is the option to use different algorithms depending on the type of program material. Mono voice can be carried using the G.722 algorithm with a 6ms delay while still providing more than acceptable audio quality. For music remotes, MPEG-1 LayerII or LayerIII will provide better audio quality but with a longer delay. There are variations of bit rate, sampling frequency and mono or stereo settings that affect the amount of time delay. See Table 1 for a comparison of the timing differences.

Because ISDN remotes tend to be more complex, an on-site engineer is usually necessary during the remote. The high-quality audio and

REMOTE MANAGEMENT FROM ANYWHERE

CONTROL IS GOOD. IP2 IS BETTER.

IP2port uses standard TCP/IP networks and software for remote management and control of real-world devices:



- Create control panels using web browsers and receive alarm notification via e-mail.
- Access your equipment from any dedicated network or dial-up Internet connection.

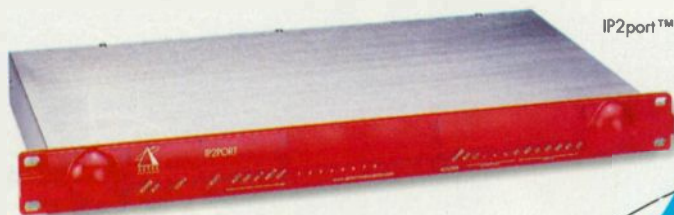

IP2port™



AZTEC
RADIOMEDIA

Digigram Group

Aztec Radiomedia America
Tel: +1 703 875 9100 - Fax: +1 703 875 9161
E-mail: america@aztec-radiomedia.com

www.aztec-radiomedia.com

Circle (132) on Free Info Card or go to www.beradio.com

New Catalog!



Need it after hours?

COMPASSXPRESS

Pro Audio, Video, Lights
800.476.9886

M-F 8am-10pm, Saturday 10am-6pm(CST)
www.compassxpress.com

FULL COMPASS

AUDIO • VIDEO • LIGHTS

1-800-356-5844
fullcompass.com

AUDIO CODECS

imbedded signalling functions make it possible to move the entire studio outside the broadcast facility for short periods of time. Some ISDN codecs have built-in mixers and internal headphone amplifiers. Codecs without these features require additional equipment. More recent ISDN codec introductions have been designed for fast and simple setup and operation.

Both styles of codec offer an auxiliary data path. The data rate is usually around 2.4kb/s to 4.8kb/s. Some units also offer virtual switch connections. These functions can be used to remotely start events such as a CD player or control equipment through the RS-232 port. The data path may be used for basic text messaging between the remote site and the studio producer, or it may be used to control a piece of equipment such as an on-air telephone system.

Another growing use of ISDN is for backup studio-to-transmitter links.

Algorithm Encoding Method	Layer III Perceptual+Huffman	Layer II Perceptual	G.722 ADPCM
Sampling Rate	Audio Frequency Response		
16kHz	—	—	7kHz
24kHz	—	8.6kHz	—
32kHz	15k-1z	—	—
48kHz	20k-1z	7.8/9.8kHz* 20kHz*	7kHz‡
Sampling Rate	Coding Delay		
16 kHz/dual	—	—	up to 45ms‡‡
24 kHz/mono	—	990ms	—
32 kHz/mono	275ms	—	—
32 kHz/dual mono	275ms	—	—
48 kHz/mono	225ms	160ms	—
48 kHz/dual mono	225ms	160ms	—
48 kHz/mono-128kb/s	—	220ms	—
32 kHz/stereo/jstereo	390ms	—	—
48 kHz/stereo/jstereo	270ms	220ms	—

Table 1. Frequency response and delay comparison for ISDN codecs. Data courtesy of Telos Systems.

* 7.8kHz at a 56 kb/s network rate, 9.8kHz at 64kb/s, 20kHz at 112 and 128kb/s.

‡ G.722 does not offer true Stereo. The two channels are not phase aligned.

‡‡ G.722 delay will vary. Spec is 35ms +/- 10ms for 45ms maximum

Delay times may vary depending upon ISDN line delay and other factors.

Frequency response is given for swept sine test; response with program material may vary owing to the dynamic nature of the coding process.

Figures are for 56 or 64kbps/audio channel. L2 Mono and discrete stereo will offer better frequency response if a 112 or 128kbps/audio channel is used.

Note that the frequency response of L2 Discrete Stereo is the same as L2 mono. In both cases the figures given are for 48kHz sample rate.



RF Specialties® Group

RF is Good for You!

EAST: Pittsburgh 724-733-1994, Philadelphia 888-260-9298
 WEST: California-North 888-737-7321, South 800-346-6434
 NORTHWEST: Seattle 800-735-7051
 SOUTHWEST: Texas 800-537-1801, 888-839-7373
 CENTRAL: Missouri 800-467-7373
 SOUTH: Florida, 800-476-8943



RF Specialties®
www.rfspec.com
 "RF is GOOD for You!"

Circle (134) on Free Info Card or go to www.beracio.com

everybody wants in on a good thing



Join the growing list of Radio Stations, Networks, Studios and Advertising Agencies who have discovered the best way to send and receive digital content.

NBN, USA Radio Networks, Business Talk Radio, KJKK, KJWL, KKBK, KLKK, KRNN, KWFM, WAFY, WANA, WCVR, WFIR, WFLY, WGCI, WGRG, WHDQ, WIKE, WIL-FM, WJGR-AM, WJYY, WKXL, Vox Radio Group, WLLN, WOMC, WORK, WVOM and many more.

Ask us how AudioSonix can create a new revenue stream for your station or broadcast group.



Download the free software at <http://www.audiosonix.com>

AudioSonix • PO Box 1127 • Olney, MD 20830-1127 • Toll Free 866 ASX-To Go

AUDIO CODECS

The almost instantaneous connect time after dialing and the full 20kHz bandwidth stereo audio can provide a full backup to traditional STLs and inter-city relay links.

Multiple personalities

The basic operation of POTS and ISDN codecs is the same. The transmission media (the phone lines) have very different characteristics, but once a signal is digitized and compressed, it is passed on to the modem. Some codecs have multi-

ple personalities that provide additional flexibility to the user. POTS and ISDN modems can be fitted into a single unit. More recently, wireless applications like PCS and GSM have proved to be viable methods as well. Stations faced with a variety of locations may take advantage of this feature.

In some cases, the extreme data reduction of a single ISDN line is not acceptable. Classical music broadcasts are typically less forgiving with aggressive encoding schemes. A vi-



Multiple ISDN lines can be bound together with a special terminal adapter or a codec that supports multiple terminal adapters.

olin can be made to sound like something completely different with the wrong mix encoding algorithms. In cases where higher audio quality is needed, the capacity of a single ISDN line is quickly exceeded. Some codecs allow multiple ISDN lines to be bound together to act as a single, larger pipeline. Instead of only 128kb/s capacity, 256kb/s or 384kb/s can be used with two or three ISDN lines.

Binding multiple lines for increased capacity is not something that most stations will routinely attempt. However, when the situation calls for the increased bandwidth, multiple ISDN lines may be a better alternative than fractional T-1.

When you make your codec purchase decision, keep in mind that at least one of the units will be going on the road. It may be in the hands of both technical and non-technical personnel. All codecs are built to withstand normal use, but remote equipment does not enjoy the same delicate lifestyle that rack-mounted studio equipment does. The attractive molded plastic case will not be very attractive once it has been dropped. Equipment designed for rack mounting may not survive the same bumps and jars once it is on the road. Be sure to include the appropriate carrying case or road hardware to protect your investment.

Kent Kramer is engineering manager for Big City Radio, Los Angeles.

FOR MORE INFORMATION

Circle (202) on Free Info Card
or go to www.beradio.com

One plug. All play.

A blue RJ-45 shielded wiring solution plug is shown against a dark background with glowing blue and yellow light trails. The plug is angled, showing its front face with the RJ-45 port and the shielded housing. The text "Studio Hub" is visible on the top surface of the plug.

Studio Hub 

The RJ-45, CAT-5 Analog/Digital
Shielded Wiring Solution.

radio
SYSTEMS

601 Heron Drive
Bridgeport, New Jersey 08014
(856) 467-8000 phone
(856) 467-3044 fax
www.radiosystems.com

Circle (136) on Free Info Card or go to www.beradio.com

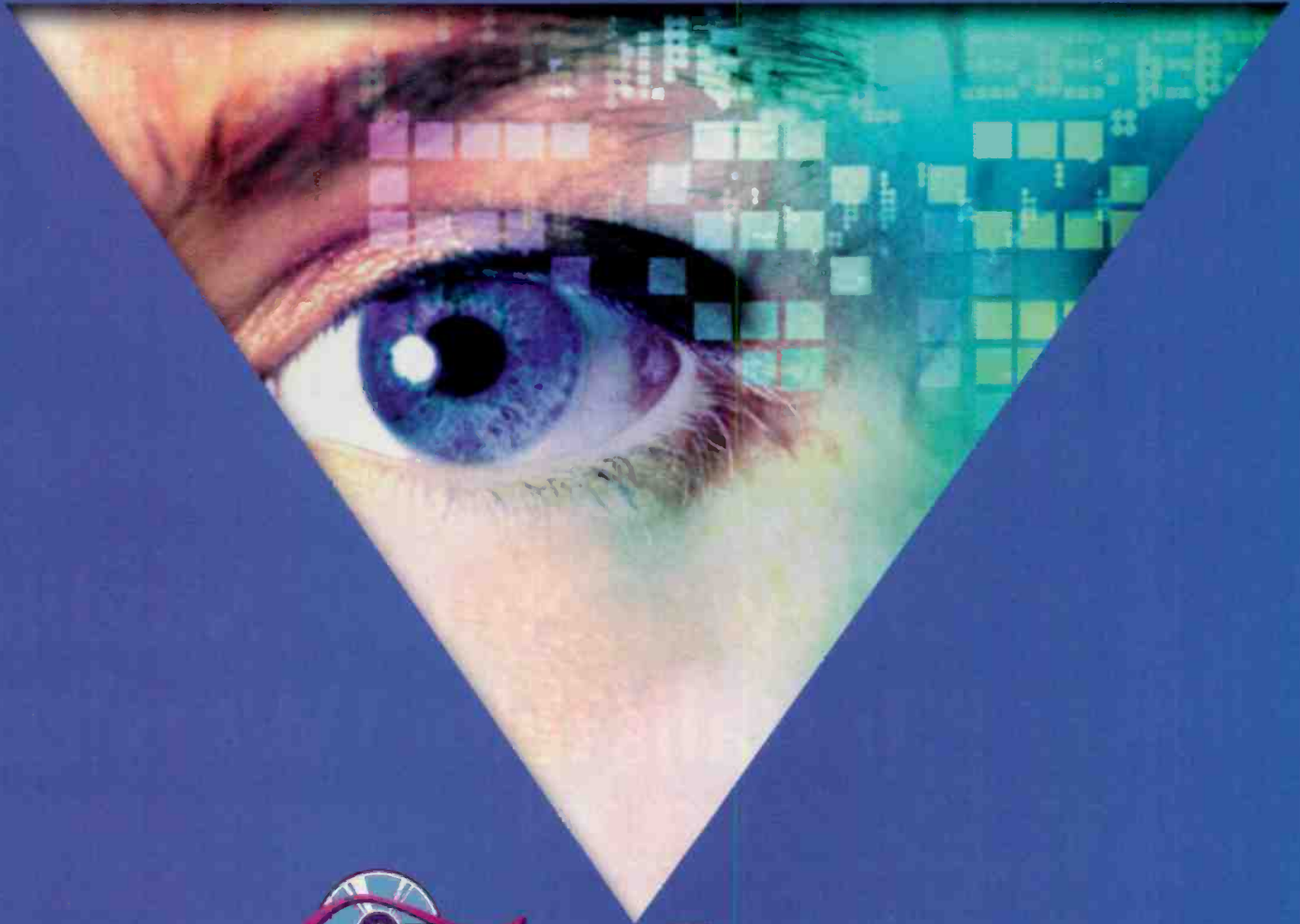

 **RADIO SHOW**
AUDIO ... VISUALIZED

SOUND
SOLUTIONS
for
INTERNET

RCS RadioShow creates your own branded Internet player. Display "Now Playing" song/artist notes and a "Buy Me" Button™ for impulse buying. Schedule interactive advertising & animated graphics like you do in Selector®. You can even play different audio spots to each Internet listener.

Circle (137) on Free Info Card or online at www.beradio.com

See it now: www.RCSWORKS.com info@rcsworks.com In USA call 914 428 4600, ext. 156





Telos

Telos Systems
 216-241-7225
 Fax 216-241-4103
 www.telos-systems.com
 info@telos-systems.com

New Century Media Installs Telos TWOx12

New Century Media, part of the Ackerley Group, purchased and installed five Telos Systems' TWOx12 Multi-line Talkshow Systems for its four-station group in Seattle. The four stations – highly-rated urban KUBE-FM, Mix 95.7 KJR-FM sports-talk KJR-AM and KHHO-AM – began broadcasting from new studios in July. Chief Engineer John Miller notes that the high call-in volume required a phone system upgrade.

Miller says that the ability of the TWOx12 to handle both ISDN and POTS made it the perfect choice for the station's applications. The stations' staffs are especially pleased with the quality of the sound and ease of use.

"The high audio quality of the ISDN lines was a dramatic improvement. The TWOx12 has a wonderful sound and everyone – including the talent – loves it. We have a high volume of calls and lots of different users, all of whom were able to operate the system in a very short time with some basic training," Miller notes.

Miller installed the TWOx12 systems in three of the four stations' control rooms (KHHO is currently

simulcasting) and in two different production studios. He explains that the stations especially like the Assistant Producer Program, which integrates easily with the stations' LAN and each of the TWOx12s, providing even more versatility. He says that users are impressed with the icons indicating the status of each call and giving information such as whether or not the call has been screened.

"We do a lot of call-ins, interviews and contests, so a reliable, high-quality system is important for us. Overall, I've had good experience with Telos products, and we liked the results with the TWOx12," Miller says.

The TWOx12 Multi-Line Talkshow System is a multi-line telephone system designed for fast-paced talkshow production. It gives users the flexibility to connect to digital ISDN telephone lines as well as traditional analog POTS lines. Its 12-line capacity offers increased flexibility for producers, unique icon-based visual call management, improved line status signaling and Caller ID support when used with digital phone lines for better control of a station's on-air environment. ■

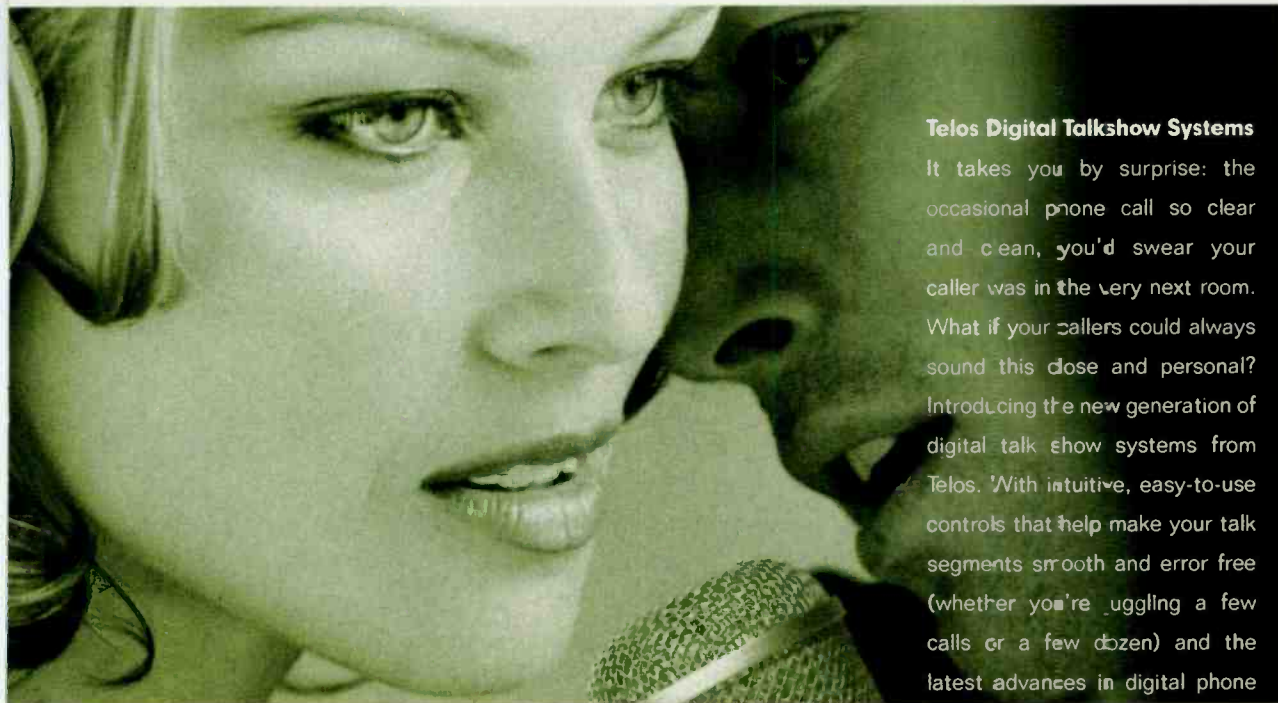

Telos Digital Talkshow Systems

It takes you by surprise: the occasional phone call so clear and clean, you'd swear your caller was in the very next room. What if your callers could always sound this close and personal? Introducing the new generation of digital talk show systems from Telos. With intuitive, easy-to-use controls that help make your talk segments smooth and error free (whether you're juggling a few calls or a few dozen) and the latest advances in digital phone hybrids from the company that invented them. Never have your callers sounded so consistently loud and crystal clear - it's the next best thing to having them there. Don't just talk to your audience... get intimate.

Talk radio is suddenly intimate

Telos Systems. Connected.



Telos TWOx12™ Integrated Talkshow System

Using POTS or ISDN lines, the TWOx12 handles up to 12 callers on two built-in digital hybrids. The intuitive phone controller tames even the wildest talk shows.

Telos
S Y S T E M S
www.telos-systems.com

TELOS SYSTEMS NORTH AMERICA: +1.216.241.7225 • TELOS SYSTEMS EUROPE: +49.81.61.42.467

Circle (138) on Free Info Card or online at www.beradio.com

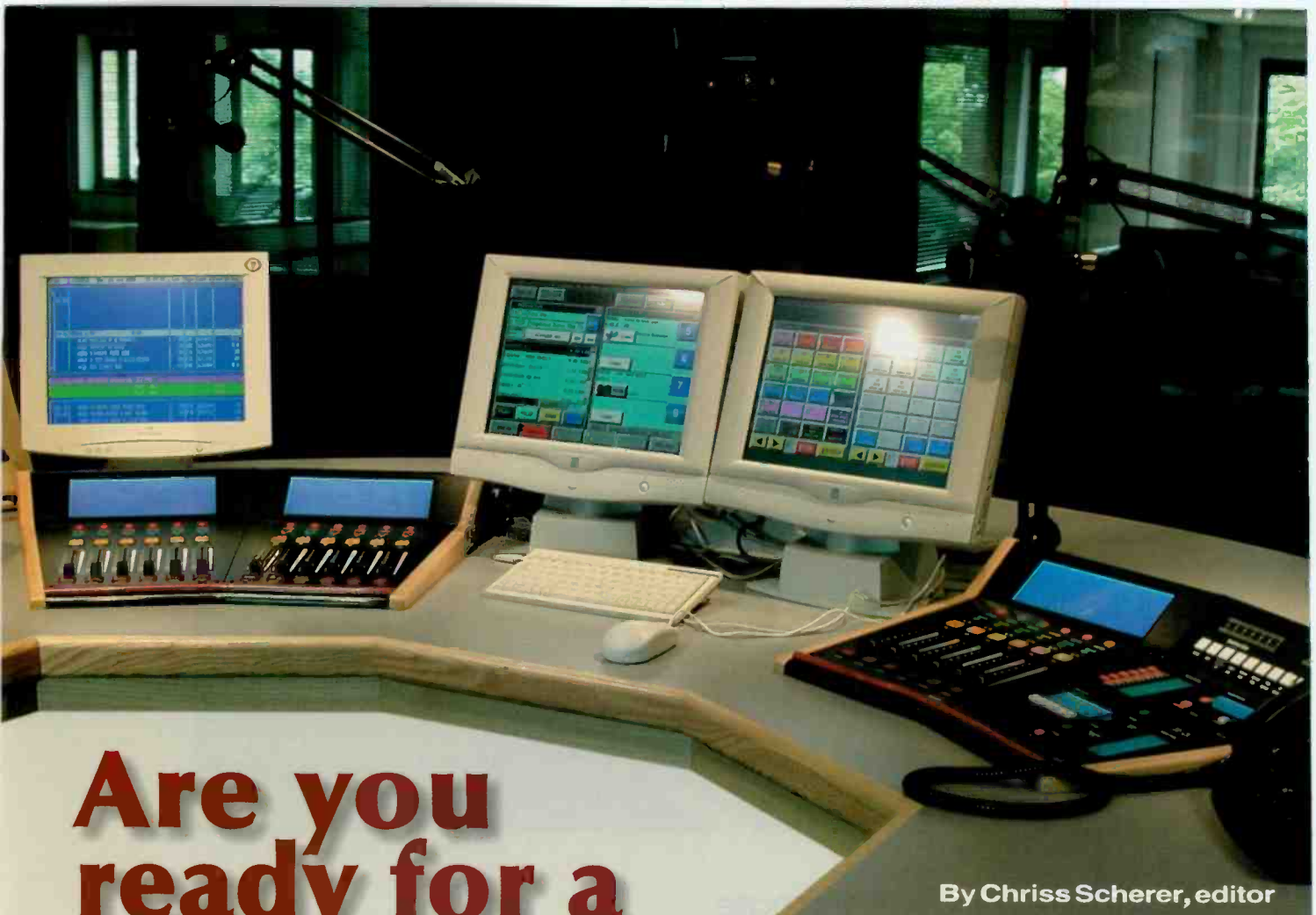

Are you ready for a DIGITAL CONSOLE?

By Chriss Scherer, editor

When you enter an on-air studio, the first piece of equipment you probably notice is the console. It is generally at the operational center of the room. Everything centers around this one piece of equipment. This final step to a completely digital signal path is being made by more and more stations. The first digital consoles didn't really offer any substantial improvements over their analog counterparts. This has changed. The basic function and appearance of digital consoles may replicate the analog roots, but the current functionality goes much farther.

On the surface

Just looking at an analog and digital console side by side, you may be

The technology has matured so that it is economically sensible to install a digital console – and also take a step toward the future.

hard pressed to distinguish which is which. Both offer multiple inputs, multiple output buses and complete monitoring facilities. Digital consoles were originally designed as a replacement to the analog model. The earliest digital console entries were more expensive than the analog versions and lacked as many features. Like any maturing technology, this has since changed.

Digital consoles can be classified

into one of two categories. One type functions just like its analog ancestor. It is a device unto itself. It may communicate with other pieces of equipment, but it functions on its own and does not offer any networking or routing capability. These consoles are direct replacements for analog consoles. We'll call these the stand-alone designs.

Photo courtesy of Logitek.

STUDER



Studer Creates Radio Broadcasting Solutions

High quality for small budgets

Studer's legendary precision engineering is now available to radio professionals in a compact and inexpensive digital package.

The On-Air 1000 is a 10-fader digital console with a large graphical user interface and intuitive ergonomics. Sharing the same operating philosophy and impressive feature set that has made the On-Air 2000 so successful, the On-Air 1000 integrates seamlessly with radio automation systems such as Studer's DigiMedia to provide the complete broadcast solution.

Over the last 50 years, Studer's name has become synonymous with reliability.

Thousands of radio broadcasters all over the world put their trust and their professional reputations in our hands. Because our technology will not let them down.

Because it is by Studer.

Studer North America

Main Office:
Toronto, Ontario M3B 2M3
Phone +1 416 510-1347
Fax +1 416 510-1294
eMail studer@mail.studer.ca

www.studer.ch



The new Studer On-Air 1000 Digital Broadcasting Console

Studer Headquarters: Switzerland -41 1 870 75 11 / Direct Subsidiaries: Austria +43 1 865 16 76 0 / France +33 1 45 14 47 80 / Germany +49 621 7 77 08-0 / UK +44 208 953 67 19 / Japan +81 3 34 65 22 11 / Singapore +65 225 51 15
Sales Offices: New York +1 917 439-5824 Nashville +1 615 300-4827 Los Angeles +1 818 841-4600

Circle (139) on Free Info Card or online at www.beradio.com

DIGITAL CONSOLE?

The second variety has added some features from other equipment types. While any digital console is basically a control surface for the DSP engine behind it, this design approach to digital consoles incorporates facility-wide signal routing. All the consoles in a facility act as a network of audio sources and control signals. We'll call this approach the network design. Stand-alone designs can be made to function like network designs by



Some digital consoles have an appearance that is markedly different from their analog predecessors. Photo courtesy of Studer.

Capture the Story SINGLE-HANDEDLY

smaller, lighter,
easier, faster...



and
just plain
better.

Available now at \$1,900

NAGRA

240 Great Circle Rd. #326 • Nashville, TN 37228 • 800 813-1663

www.nagra.com

integrating them into an audio router. Also, network-design models can be configured as stand-alone designs. Deciding which method to adopt will be determined by your long-term facility installation plans. The stand-alone designs are perfect for a limited budget or one-by-one replacement. The network designs are typically implemented across an entire facility.

Most digital console designs offer the capability to assign console switches to functions other than bus assignment or channel on/off. With so much equipment providing serial or even IP control capability, digital consoles can also have the capability to communicate with these devices. Functions akin to running macros can be programmed to trigger external events.

The console control surface of a digital console acts more like a computer keyboard than a console. Some manufacturers have even taken this one step further and offer a CRT interface. These *glass consoles*, so named because the operator uses a touch screen or mouse to control events, have been met with some resistance so far. This type of interface offers a much greater flexibility than a physical control surface because control-surface changes can be made without changing any hardware.

Common studio setups can be saved and recalled as needed. As the morning show turns over to the midday host, the source requirements may change. Instead of requiring a console as large as a jet's cockpit, the control-surface size can be reduced to provide as many faders as are needed at any given time.

Circle (140) on Free Info Card or go to www.beradio.com

SAS64000 AUDIO ROUTING SYSTEM

Elegant
Analog

Instant
Digital

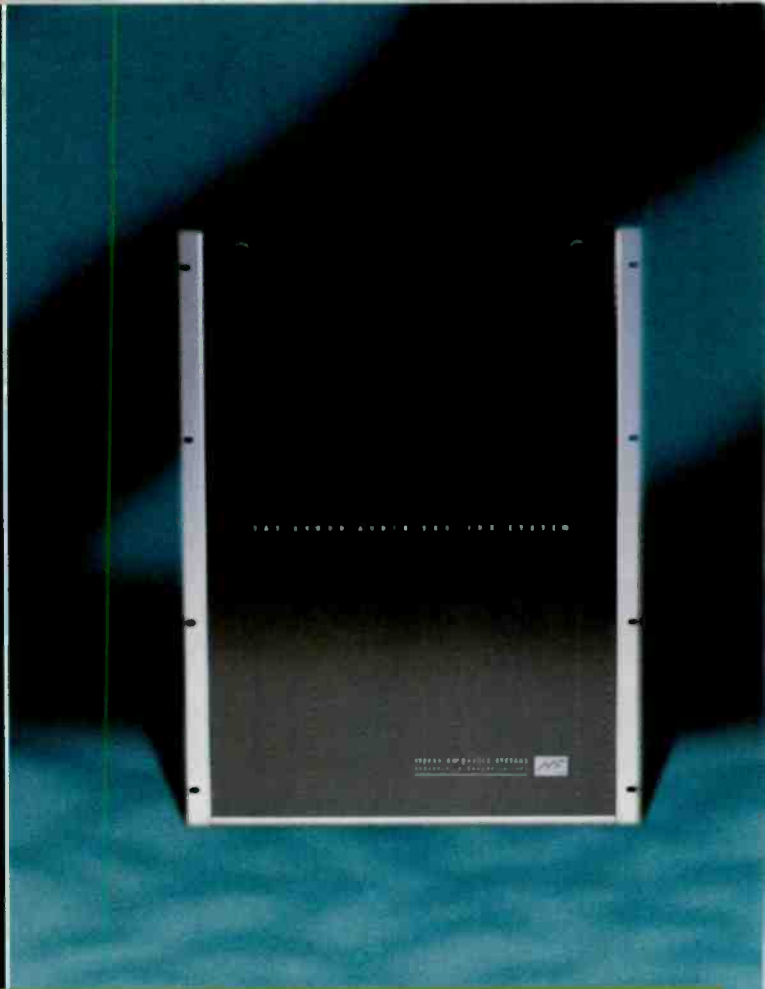

256 X 256 LARGE • MONO/STEREO • WIDE VARIETY OF CONTROL PANELS • 118dB ANALOG DYNAMIC RANGE • DISTRIBUTED MULTI-PROCESSOR ARCHITECTURE

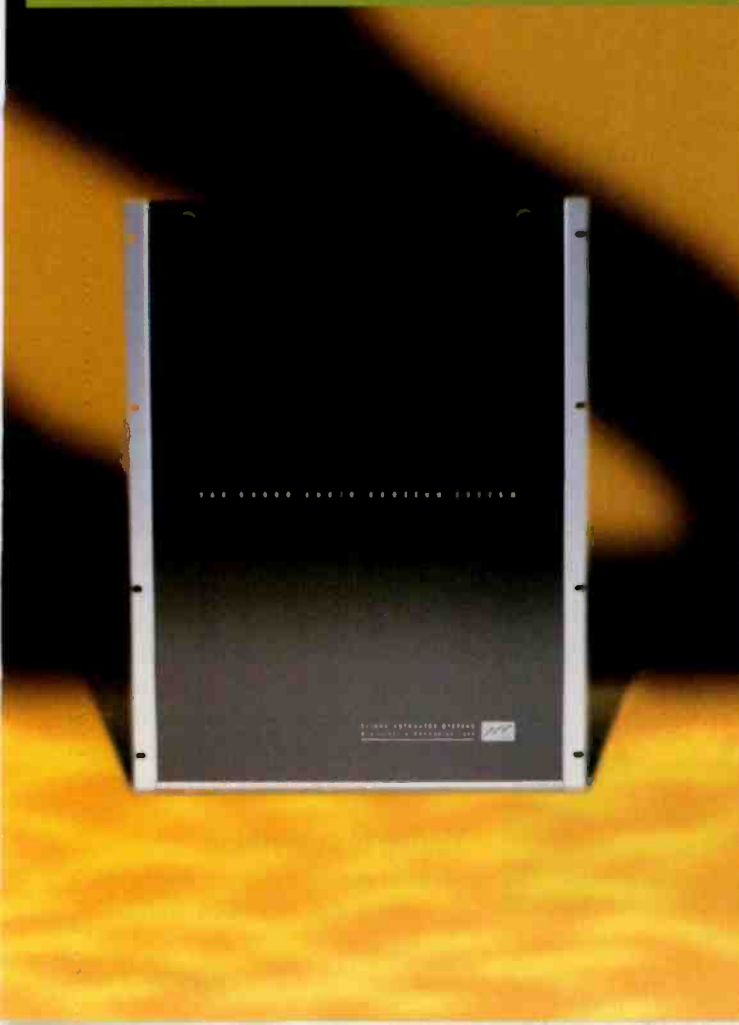

If the migration to digital is in your future, then this is the route to take. Introducing the large size, big performance analog router that also speaks fluent digital. A true hybrid that allows you to scale the number of analog and digital ports as needed now and in the future. And even better, the SAS64000 creates a forward path to AES/EBU digital audio without creating analog obsolescence.

This means you can mix your analog and digital I/O in the same router frame. Go direct analog to analog, or digital to digital. Or mix it up with 24 bit conversion analog to digital and vice versa. Either way, this unique architecture sports flawless signal integrity and non-blocking flexibility.

And it's wonderfully simple. Just plug in our new digital port expander and that's it. Welcome to digital! -co-existing richly with analog in the same framework.

There's lots more to tell. Call us: 818 840 6749. Fax us: 818 840 6751. E-mail us: sales@sasaudio.com Check the web site: sasaudio.com And of course, snail mail: 2112 North Glenoaks Blvd. Burbank, California 91504 USA

Circle (141) on Free Info Card or online at www.beradio.com



SIERRA AUTOMATED SYSTEMS
BROADCAST & COMMUNICATIONS

DIGITAL CONSOLE?

One of the most useful features of digital consoles is enhanced integration with the on-air audio delivery system. Since audio files contain much more than just audio data, there is no reason to not use this additional data to update displays. Some consoles offer an alphanumeric display on each channel strip. This display can provide the name of the audio source (CODEC1) or even the song title that is playing.

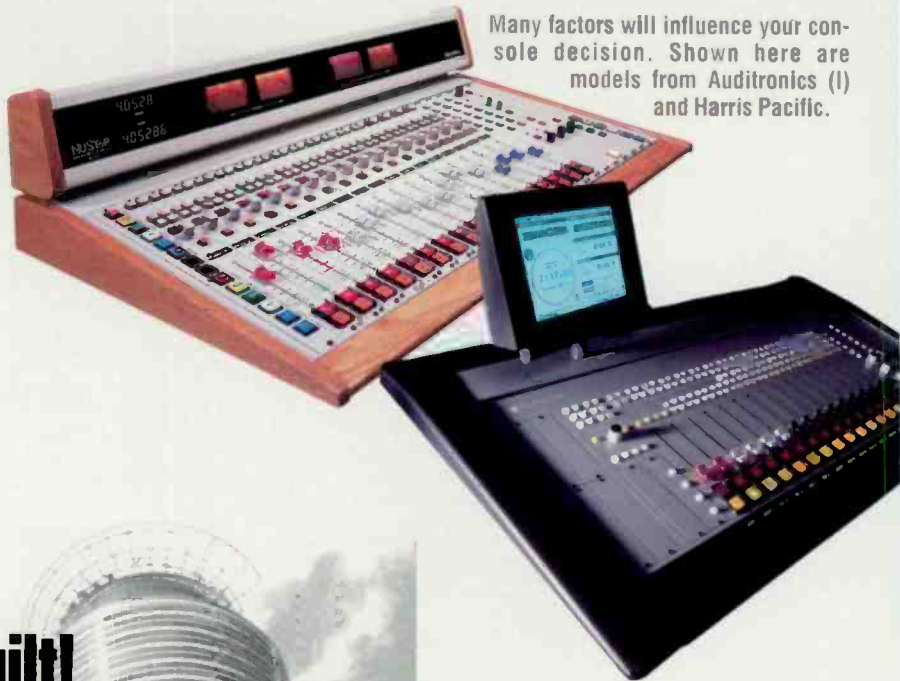

Many factors will influence your console decision. Shown here are models from Auditronics (l) and Harris Pacific.

Building SuperCarrier is Built!

Join the "New Network Neighborhood" delivering the most popular radio programming in the world.

The SuperCarrier platform delivers programming to thousands of commercial radio stations.

Featuring:

World class
MPEG audio

Receive equipment

Advanced digital
store and forward

Total network control

Decades of major
network engineering
experience.

Call on experience
and reach the
*New Network
Neighborhood*

303.925.1708
email: sales@nsn.net
www.nsn.net

NSN

A Clear Channel
Communications Company

With the coming digital transmission technology, stations are working toward creating a completely digital audio path. This digital audio path can also provide a digital data path, so the associated source information can be passed through the system. One example of this is shown in the Sirius Satellite Radio Facility Showcase on page 72. The song and artist information is passed through the facility to the listener's radio.

To determine what console is appropriate for your facility, consider elements such as the combination of analog and digital sources in the facility and what the future needs of the facility will be. Don't just look at the current operation. The total number of inputs and ability to add more later is also important. Look at how many outputs are available on each audio bus. What kind of mix-minus capability exists? With the audio delays encountered with codecs, on-air telephone calls and potential to feed more than one transmission medium, mix-minus capability is very important. Factors to consider for the console itself include modular construction, ease of installation, maintenance concerns (including serviceability while in use) and integration with other pieces of equipment.

Timing is everything

Digital audio requires a stable clock to control the sampling frequency.

Circle (142) on Free Info Card or go to www.beradilo.com

The **Ideal** Analog Console . . .

The Arrakis 1200 Series

- Ideal for On Air, Production, Talk & News
- High Performance Analog Design
- Reliable DC Control of Audio
- Fast & Easy Installation

The Arrakis Systems 1200 Series

console is the culmination of more than 20 years of analog console design & manufacture by

Arrakis Systems, inc. Three model sizes going all the way up

to 15 channels, makes the 1200 fit even large studio applications. The console can be table top or thru-table mounted, and it's low profile is attractive and useful for talk studios. The clamshell design opens

to provide quick access to the interior of the console for installation, setup, reconfiguration, or

repair. The 1200 is a blend of thoughtful design, and quality components. Better

by design due to more than 20 years of experience, the 1200 is the right choice for you . . . as it has been for hundreds of broadcasters around the world.

For more information contact BSW at: (800) 426-8434



1,200-1ES
\$4,495



1,200-10S
\$3,495



1,200-5S
\$2,295

Circle (143) on Free Info Card or
online at www.beradio.com



DIGITAL CONSOLE?

Many consoles provide sample rate converters on each input so that individual sources can be connected without the need to provide a master clock reference. This is certainly convenient, but switching between sources with different clock timings can produce some unwanted clicks and pops.

If possible, multiple sample-rate conversions should be avoided. One way to do this is to provide a master clock reference to each piece of digital equipment within the facility. This clock can be a dedicated unit,



or you can take a clock signal from one piece of equipment. Whatever source you choose, be sure it is accurate and dependable.

Using a facility-wide clock also necessitates selecting a standard sampling rate for the entire facility. Deciding which rate to use can be difficult. The current FM audio frequency bandwidth works well with a 32kHz sampling rate. CDs use 44.1kHz. Professional audio equipment is usually selectable, but 48kHz and 96kHz are common.

One obstacle for digital consoles has been the price. This is no longer the dilemma it once was. While most digital consoles are priced slightly higher than an analog counterpart, the cost is easily justified by the additional features and improved audio specifications.

There are many digital consoles available that are not



Console stylings can range from traditional to contemporary. Shown here are models from Arrakis, Klotz and Wheatstone (l to r).

SELLING EQUIPMENT?

GET IT SOLD!

It's Fast and Easy on Digibid!



www.digibid.com

Circle (144) on Free Info Card or go to www.beradio.com

RADiA

A SADI E P R O D U C T

A NEW CLASSIC

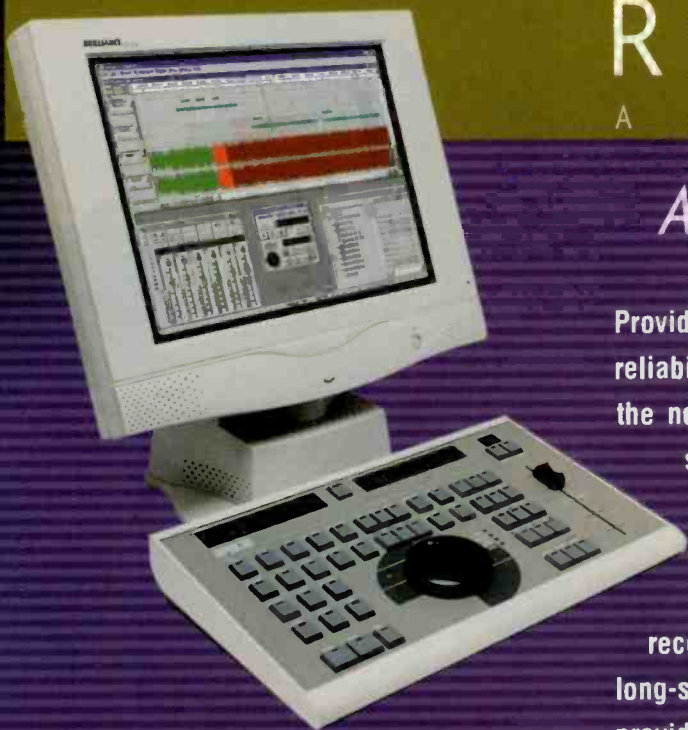

Providing a unique combination of speed, flexibility and reliability in a highly cost-effective professional package, the new SADI E RADiA workstation is unsurpassed for all serious editing applications, especially in the field of radio production.

Far from being just another PC-based hard-disk recorder, the RADiA is a genuine audio workhorse with a long-standing pedigree delivering real-world solutions to provide any facility the competitive edge.

RADiA Key Features

4 Inputs and outputs

Fully balanced analogue

AES/EBU and SPDIF digital i/o

Easy integration with all professional radio automation systems

24 replay tracks

Up to 48kHz 24-bit

PCI card or 19" rack mount turnkey hardware

Removable SCSI audio storage

The RADiA delivers all the quality and precision of digital recording combined with the speed and familiarity of analogue editing. Based on the legendary SADI E Classic, with thousands of users world-wide, the RADiA is ideal for a wide range of editing requirements.

Backed up with a full range of sophisticated plug-ins, it is no wonder that SADI E workstations are to be found in professional facilities across the world.

exact control

RADiA

digital precision

Contact us directly to find out more

www.sadie.com



THE WORLD'S FINEST AUDIO WORKSTATIONS

USA
Tel: +1 615 327 1140
Fax: +1 615 327 1699

Europe
Tel: +49 (0)711 3969 380
Fax: +49 (0)711 3969 385

United Kingdom
Tel: +44 (0)1352 648 888
Fax: +44 (0)1352 648 867

SADI E

DIGITAL PRECISION

DIGITAL CONSOLE?



Consoles like these from Soundcraft, Audioarts and Fidelipac (top to bottom) provide monitor muting and other features necessary for on-air use.

specifically designed for on-air use. These consoles offer impressive audio performance and include powerful features. While the price tags on these consoles are attractive, most are designed for live sound or recording use. They rarely provide the additional features needed in an on-air application such as monitor muting and remote equipment starts. In most cases, modifying or adapting these consoles for on-air use offsets any cost savings.



More info online!

To see what digital consoles are currently available, go to www.beradio.com and select Product Profile.

FOR MORE INFORMATION

Circle (204) on Free Info Card or go to www.beradio.com

Coaxial Dynamics'

NEW Line of
Liquid/Air
Terminations

are quickly becoming
the choice of
"Chief Engineers"
for testing, adjusting
and alignment of
R.F. Transmitters.

The NEW design
of the Coaxial
Liquid/Air Cooled Loads
gives you the capability
to handle requirements
from 1 Kw to 10 KW.



COAXIAL DYNAMICS

SPECIALISTS IN RF TEST EQUIPMENT & COMPONENTS

15210 Industrial Parkway, Cleveland, OH 44135
216-267-2233 800-COAXIAL FAX: 216-267-3142
E-Mail: coaxial@apk.net
Web Site: <http://www.coaxial.com>



Circle (147) on Free Info Card or go to www.beradio.com

NEW MULTIFUNCTION LCD

AVCOM's PSA-65C Portable Spectrum Analyzer

Microprocessor Controlled, 1-1250MHz In One Sweep!

AVCOM's newest Portable Microwave Spectrum Analyzer, model **PSA-65C**, incorporates a microprocessor and attractive multifunction, backlit LCD, with an expanded frequency range from less than 1MHz to over 1250MHz, for the amazing price of \$ 2930.

AVCOM's new **PSA-65C** is a low cost general purpose spectrum analyzer that's loaded with standard features including FM audio demodulator, AM detector and digital frequency lock. The **PSA-65C** covers frequencies thru 1250 MHz in one sweep with a sensitivity greater than -95 dBm at narrow spans. The **PSA-65C** is ideally suited for 2-way radio, cellular, cable, satellite, LAN, surveillance, educational, production and R&D work. Options include new 1250 MHz frequency extenders, BNG-1000A tracking (noise) generator, log periodic antennas, carrying case (AVSAC), and more.

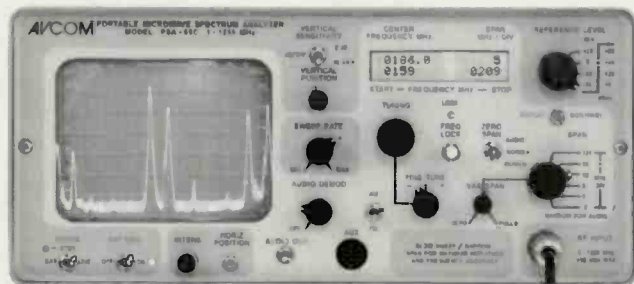

AVCOM

500 SOUTHLAKE BOULEVARD
RICHMOND, VA 23236 USA
804-794-2500 FAX: 804-794-8284

Phone, fax or write for more information or to order.
Visit our website at www.AVCOMofVA.com.

Circle (146) on Free Info Card or go to www.beradio.com

**MILLION DOLLAR
SOUND FOR
UNDER \$4,000***

Introducing Omnia-3, the all-digital audio processor that offers all the clarity, punch and raw power of the original Omnia. At an amazingly affordable price.

Omnia-3 includes standard features not found anywhere else—like 48kHz sampling, three-band processing, digital audio inputs and outputs, integrated composite clipper, and a removable PC card that simplifies software changes.

Impressive features aside, it's the sound that will blow you away. No other audio processor sounds as good as Omnia. That's why leading broadcasters the world over choose Omnia to boost ratings and crush the competition.

For this much power—on the dial and in the marketplace—you'd expect to pay twice the price. But now, you don't have to.

For the name of your Omnia dealer, contact us at +1 216.241.3343 or visit our web site at www.omniaaudio.com.

With Omnia, you lead. And others follow.

Talos Company

2101 SUPERIOR AVENUE CLEVELAND, OH 44114

TEL: +1 216.241.3343 FAX: +1 216.241.4133

E-mail: info@omniaaudio.com

CUTTING EDGE EUROPE

JOHANNISSTRASSE 6 D-85354 FREISING GERMANY

TEL: +49 81 61 42 467 FAX: +49 81 61 42 402

E-mail: info@omniaaudio.com

*\$3,580 (US) MSRP for Omnia-3fm modl. Prices may be slightly higher outside the U.S. due to duties, freight and other costs.



Circle (148) on Free Info Card or
online at www.beradio.com

Sirius Satellite

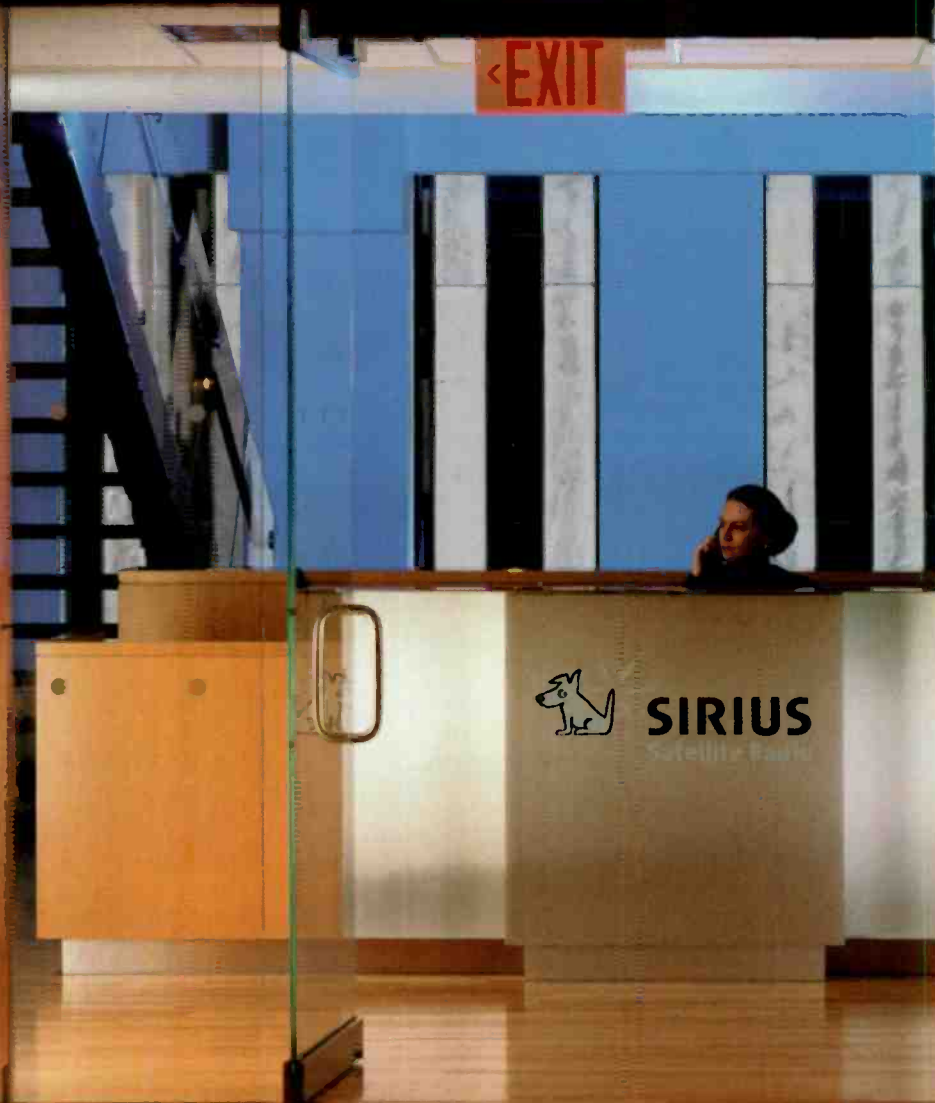

The lobby of the New York studios of Sirius Satellite is rather conservative at first glance. Once inside, it is easy to see that this is a very state-of-the-art facility. The Telemetry, Tracking and Control Room (inset right) makes it obvious that this is not a regular radio station.

Radio

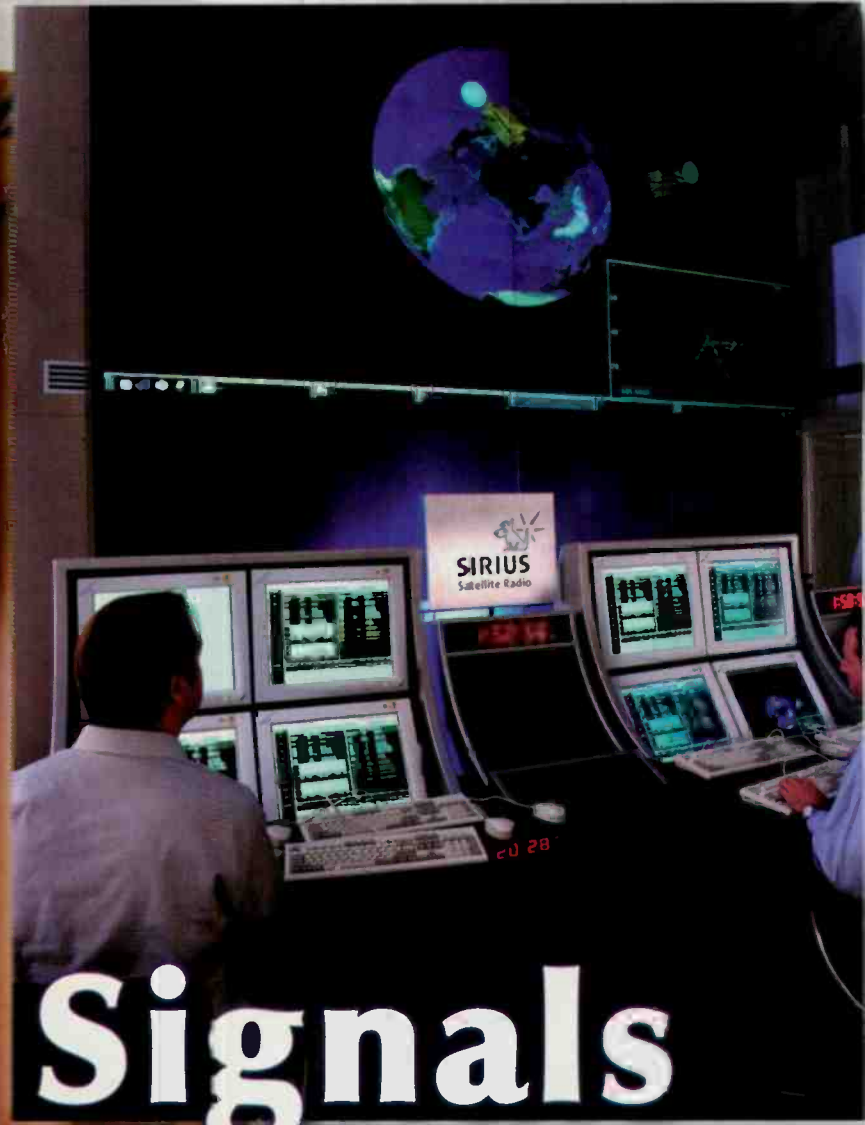

Signals from the sky

By Conrad
Trautmann, CSRE

Many of us have experienced the effects of consolidation. Owners are squeezing as many stations as they can into as little space as possible. Six, seven, eight or even more stations are broadcasting from one building. But can you imagine running 100 stations from a single location?

Sirius Satellite Radio



The performance studio can accommodate live performers while an audience observes from the reception area.

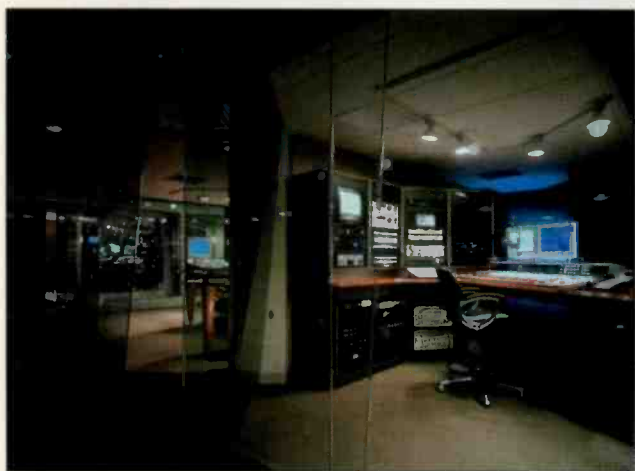

The control rooms have been set up to work with any of the 100 channel formats.



Some studios have two consoles for on-air or production applications.

teners in automobiles nationwide.

What does it take to create the programming for such a venture? We'll look at the studios for both live and recorded programming, the equipment used to route audio within the facility and how it gets to your new satellite radio.

Open the door

Let's start with 100,000 square feet of floor space on the 36th and 37th floors of the McGraw-Hill building at 1221 Avenue of the Americas in Manhattan. Add the architectural design of NY's own HLW architects. Stepping off the elevator and through the glass doors, you are amazed when you walk into the two-story reception area. A hardwood floor flanked by chrome and glass rooms on either side makes for an impressive greeting.

Looking to the right, you'll see what looks like mission control at NASA (and isn't far from it in its function). A three-seat console is clearly visible from the waiting area, and above it is a very large monitor that displays a signal from the computer console screen or any other video source that is selected. The room, officially named *Telemetry, Tracking and Control* (TT&C), has a direct link to the earth stations in Panama and Equador that control

That's exactly what Sirius Satellite Radio is about to do. By the end of this year, Sirius will broadcast 100 different radio channels from its studios in the Rockefeller Center area of New York City. Audio and associated data will be broadcast, via satellite and approximately 100 terrestrial repeaters, to lis-

RADIO AND TV RADIATING SYSTEMS

STRETCH YOUR BUCKS
WITHOUT LOSING QUALITY

FM Antennas

Medium power circular polarization

SGP-1	\$690	4Kw
SGP-2	\$2,690	8Kw
SGP-3	\$3,595	10Kw
SGP-4	\$4,500	10Kw
SGP-5	\$5,300	10Kw
SGP-6	\$6,100	10Kw

FM Antennas

Educational circular polarization

MP-1	\$250	0.6Kw
MP-2	\$680	0.8Kw
MP-3	\$980	0.8Kw
MP-4	\$1,280	0.8Kw
MP2-4	\$1,820	2Kw
MP3-5	\$2,270	3Kw
MP3-6	\$2,740	3kw

FM Antennas

Low power circular polarization

GP-1	\$350	1.5Kw
GP-2	\$1,350	3Kw
GP-3	\$1,900	5Kw
GP-4	\$2,600	6Kw
GP-5	\$3,150	6Kw
GP-6	\$3,700	6kw

Other power configurations contact OMB America



3100 NW 72 Ave # 112

Miami, Fl. 33122

Tel:305-477 0974

Fax:305-4770611

ombusa@bellsouth.com

www.omb.com

Sirius Satellite Radio



The rack room houses all the audio processing, audio servers and encoding equipment for the entire facility.

the satellites' orbits. Although the three satellites that Sirius will use will be flown by Loral for their first year of service, the long-term goal will be to control everything from the TT&C room.

Across from TT&C, and similar in

size, is a glass-enclosed room that serves as a performance studio. Equipped with sound treatment and professional television-style lighting, the room has a slightly live sound to it

and is used primarily for acoustic performances. Another performance studio exists within the studio area for acoustic and electric performances.

The facility has a total of 22 phys-



The computer monitors, keyboards and mice are switched to work with several computers.

Simply Grab that Caller
and put 'em On-the-Air



innkeeper 1 Digital Hybrid

Desktop List
Price \$780.00



- The perfect hybrid for analog telephone lines.
- True separation of send and receive audio.
- DSP automatically adapts to line conditions.
- 19" rack mount or 11" desktop version.
- Optional desktop keypad.

JK Audio Remote Broadcast Gear

800-JK Audio (815) 786-2929 www.jkaudio.com
800-552-8346 Fax: (815) 786-8502

Circle (150) on Free Info Card or go to www.beradio.com

Split It!!

USDA is a handy 2-in, 4-out stereo "mini-DA" that can *combine* or *split* audio signals for distribution. Mix stereo to mono, get *both* stereo *and* mono outputs from a stereo source. Gain trims for each output. Great space with lots of headroom.

Keep one on hand!

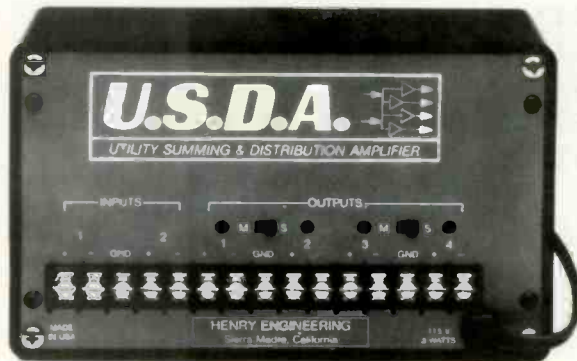

HENRY ENGINEERING

503 Key Vista Drive
Sierra Madre, CA 91024 USA
TEL (626) 355-3656 FAX (626) 355-0077
FAX-on-Demand Doc #103 (626) 355-4210
<http://www.henryeng.com>



We Build Solutions.

Circle (151) on Free Info Card or go to www.beradio.com



Mark Kalman, vice president of the National Broadcast Studio, supervised the facility construction.

ical studios that are all on a six-inch raised floor. Unlike traditional radio, Sirius radio's 100 channels will be largely pre-produced. Voice tracking and pre-recording special programming for air at a later time will be the primary method of creating the individual channels. That said, any of the studios can be routed to any channel live, and the studios are equipped as any radio station air or production room would be. Wheatstone D-600 digital audio consoles are the centerpiece of each studio and are set into rounded-edge furniture built by Long Island's Forecast Consoles. Add Panasonic SV-series DAT machines, Denon 961-FA CD players, Telos Systems telephone hybrids, 360 Systems Shortcuts, Genelec monitor speakers, and Eventide broadcast delays, and you have the equipment that many stations use in their own on-air and production environments. Interroom communication is handled by an RTS/Telex intercom system, audio editing is done with Avid's Pro-tools system on WindowsNT. The Pro-tools workstations are networked to their own storage network for production element archiving.

Also used is a full range of microphones, including Electro-Voice RE20s in the air studios, Neuman U87s, AKG 414s and a wide range of specialty mics for drums. All the mics are processed with Symetrix 628s. Commscope 7538 is the cable used for all the digital audio routing.

There is also a Leitch 16 x 16 switcher that routes audio within a studio, which also solves an impor-

tant problem: it converts the remaining analog signals in each room to digital. The entire facility is all-digital. This was a big step according to vice president of the National Broadcast Studio, Mark H. Kalman. Between the studios, audio is routed by an NVision NV 3512 512 x 512 AES audio router.

This router is integral to the Sirius facility in its ability to route AES-18 signals, which require more bandwidth than typical AES-3 signals. The AES-18 signals, created by a Quancom rack-mounted unit, carry both audio and RS-232-

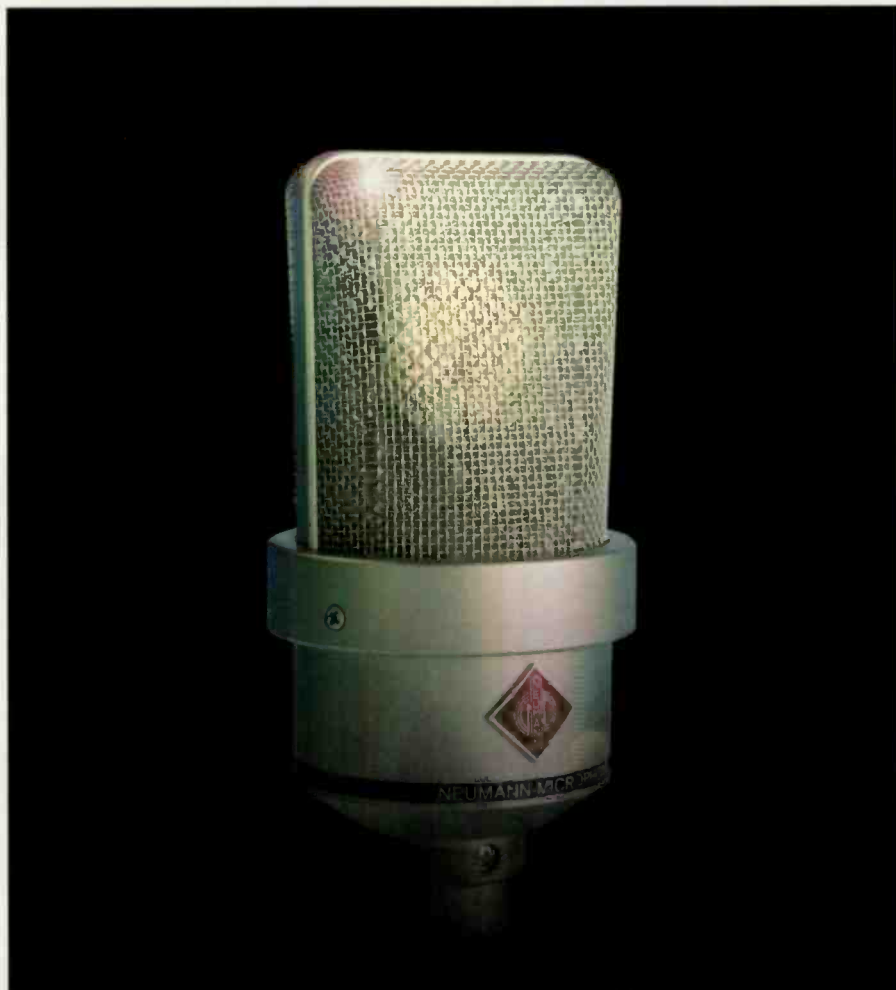

**your voice is your life.
spend it wisely.**

www.neumannusa.com/103



Neumann/USA the TLM 103
Telephone: 860.434.5220 • FAX: 360.434.3148

POWER AMPLIFIERS



from 150 watts

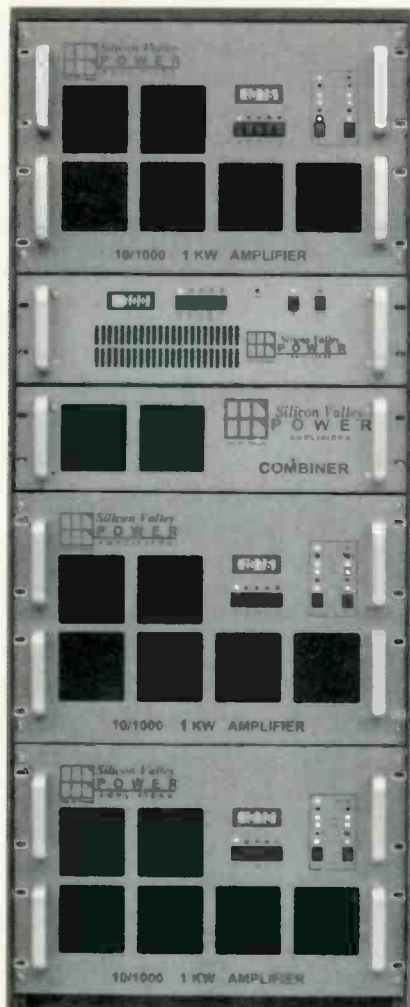

to 3 kilowatts

Reliable, rugged, cost-effective

Our amplifier modules can be found in many transmitters made by Harris Broadcast Continental Electronics, CCA, CBC etc.

Call us for repairs or replacements.

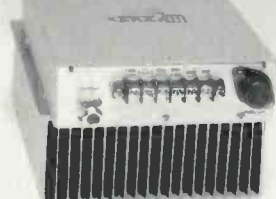

**Silicon Valley
POWER
AMPLIFIERS**

The RF People Phone 408 986 9700 Fax 408 986 1438

Circle (153) on Free Info Card or go to www.beradio.com

Sirius Satellite Radio



The computer monitors can be lowered into the furniture when not in use.

encoded data. This gives Sirius the ability to encode music and audio with data information that can be

signals are all synchronized to a reference clock to prevent pops and clicks. Timing is critical within the facility and over the terrestrial repeater network. Everything is time-synchronized to rubidium-standard clocks linked to GPS. The router is fully redundant, like many of the other systems in the facility.



The monitors on their way down and out of sight (left). The operator has a clear siteline once the monitors are lowered (right).

read by computers internally for control of equipment like the switchers and also streamed right out of the facility to the end user for an RDS-like readout on the receiver.

The router is wired with coaxial cable and is terminated with ADC coax patch panels. Very much like TV, these higher-bandwidth digital

Audio storage and automation

Another item that can't be left out in the studio design is the Prophet Systems NexGen digital audio storage and automation system. Approximately 60 Prophet worksta-



tions are spread out among the facility in studios and offices. In the studios, wireless computer keyboards and mice are installed for a clean look and ease of use. Channel programmers have the ability to edit logs and listen to their channel's audio right at their desks. Voice tracking is possible from anywhere in the world. The Prophet also integrates with the Pro-Tools system, using a drop-box style utility to save audio to the on-air delivery system.

The Prophet system includes fully redundant Hewlett-Packard RAID array hard drive systems. The RAID drives are hot-swappable, and the Prophet can automatically switch to the redundant system in the event of a failure with the first. Plus, each workstation has an 18GB hard drive, which stores approximately three days of audio on its own, in the event the entire RAID system fails. Running on a network backbone on Novell 5.0 and using WindowsNT as the workstation operating system, the Prophet



The production studios will see extensive use as the satellite service launch date nears.

uses 112 rack-mounted workstations in the equipment room to deliver audio to the multiplexer. Cybex Autoview commanders help save space by switching keyboard, mouse and monitor among all of the computers. The system was designed to automatically switch to the next available computer in the event of a failure. With 100 channels, that leaves 12 spares. 4.2TB (terabytes – that's 4,200GB) of audio storage is available. All audio is recorded uncompressed (no data reduction). Considering that the transmission process will use Lucent's PAC audio compression, the goal is to start off with absolutely the best quality to minimize transcoding losses.

The outputs of these machines are then run to their own dedicated Orban 6200 DAB digital audio processor. Each processor will be adjusted for the individual format. It was pointed out to me that the competition for dial loudness does not exist, but the listening environment and the wide dynamic range of some of the source material require some gain reduction and compression.

“Video killed the radio star”



Witness the Resurrection...

www.musicmusicmusic.com

Breathing life back into radio...

- Database
- Music on Your Web Site
- Ready To Go Radio

Gerri Rockstein
 Director, Broadcast Division
geri@musicmusicmusic.com
 phone (416) 537-2165
www.musicmusicmusic.com

Sirius Satellite Radio



The facilities have already been through shakedowns in preparation for the first broadcast.

To simplify adjusting 100 audio processors, the RS-232 port of each unit was brought out to a Chase IOLan rack-mount unit. The Chase gives each processor its own IP address on the facility's computer network, thereby making remote control of the processors from a more desirable listening environment a breeze.

Audio from the Orban processors feeds the Lucent Statistical Multiplexer. The multiplexed signal is then delivered to three different

paths. The first STL path is a fiber link to the Vernon Valley uplink site. The second path is a microwave link to Warwick, NY, and then fiber from there to the uplink site. Finally, there is a V-SAT uplink on the building that can be downlinked at the uplink facility. In all, there are seven dishes on the roof of the building: two 7.2-meter dishes and five 3-meter dishes. All are at-

with a traditional radio repeater, it's impossible to receive and re-transmit on the same frequency, which is why Sirius cannot downlink from the main satellite and then re-transmit using the terrestrial repeater. The V-SAT will provide a dedicated audio link to the terrestrial site, and that signal will then be broadcast to fill in holes from points that lack line-of-site reception to the car radio (such as buildings in a city). To eliminate the effects of multipath, the receiver uses a summing design. The receiver will watch for two signals from the three available satellites

(spaced 120 degrees apart), a primary and a four-second delayed signal. The buffer in the receiver will sum these signals together and use whatever it can to achieve a clean output. Add in the terrestrial repeaters for tough areas, and the result should be clean, digital sound from coast to coast.



Each studio must be able to handle a variety of needs.

tached to the building steel and are rated for winds of 125 miles per hour.

Interestingly, the V-SAT equipment is used to transmit the signal to the network of terrestrial repeaters. As

Conrad Trautmann is a regular contributor to BE Radio. He is based in New York City.

Photos on pages 77 through 80 were taken by Chris Tobin.

World Class FM Antennas

We at Armstrong constantly strive to bring you the best RF products, the best 24/7 support and the best prices ...because you deserve nothing less!

That is why our FM antennas are designed to provide maximum signal coverage and the ultimate in signal penetration. Built to withstand even the bleakest weather conditions, our bays are constructed of 100% heavy-duty brass for long life and superior performance.

When you think antennas, **Think Armstrong.**
We're not just a transmitter company.



Marcellus, NY Tel 315-673-1269 Fax 315-673-9972
e-mail: sales@armstrongtx.com

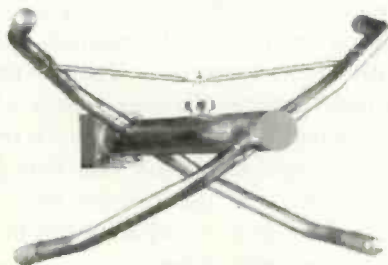

FMA-737

Available in numerous configurations and power levels, including directional patterns, at amazingly competitive prices.



Sirius Equipment List

360Systems DigiCart
 AKGC-414BUJS
 Aphex9000R
 Aphex9001PS
 Aphex9251
 Aphex9301A
 Aphex9621
 Aphex9651
 ATI20021-501
 ATIP10002
 AudioAccessories Patch Bays
 AudioPrecision P1DD
 AudioScience ASH4215
 AudioScience ASH4601
 BenchmarkIFA-7
 BenchmarkPS-11
 BenchmarkRM-1
 BeyerdynamicDT-108
 BeyerdynamicDT-109
 BeyerdynamicG-500
 BeyerdynamicGST-500
 BostonAcoustics361
 CalzoneCase001-004
 CalzoneCase001-007
 CanareWireandCable
 Commscope7538
 CrestV-450
 CybexComputerInterfaces
 DBX900A
 DBX905
 DBXBP-900A
 DenonACD-25FSM

DenonACD-26HM
 DenonACD-27MS
 DenonDM3
 DenonDMD-1300P
 DenonDN-790R
 DenonDN-961FA
 DenonDNC630
 DenonDNM-1050R
 DenonDNR-M10
 DenonDMD-2500P
 DenonRC-158
 DenonRC-650
 DenonRC-700
 DenonRM-356
 DenonTU-1500RDP
 DigiDesignProTools
 Dorough2804D
 Dorough280S
 Electro-Voice309A
 Electro-VoiceRE-20
 Electro-VoiceRE-50B
 ESEES-171A
 ESEES-243

ESEES-2695
 ESEES-370
 ESEES-370OptionM
 EventideBD500-100
 EventideDSP-4500
 ForecastConsolesStudioFurniture
 Foster6301-BEAV
 FurmanHDS-6
 FurmanHR-6
 Genelec1029AM
 Genelec1080AM
 Genelec1081APM
 Genelec1082AM
 JBLControl25
 LeitchClocks
 LeitchAudioRouter/Switcher
 LexiconPCM-91
 LogitekAE32
 LuxonKM-1
 MackieCR1604VLZ-C
 MackieII-18
 MarantzCDR620
 McCurdyATS-1000

MiddleAtlanticAccessories
 NeumannU87/SetZ
 NeutrikNA3MPW
 NVision3512SA
 Ormmount75STPA
 OtbarOptimodCD6200
 OtbarOptimodDAB6200
 OtariIX-5050Billi
 OtariZA-52L
 PanasonicSV-3800
 PSINexGenSystem
 Quantec1218
 Quantec1220
 RAMKTS-2000
 RAMMBB-1
 RaneHC-6
 RTSKP-96-7
 ShureSM-58LC
 SonyMDR-7506
 SoundcraftSpiri328
 SpiritRW5599
 Symtrix628
 TascamDA-98
 TascamD-AP1
 TechnicsSL-1200MKII
 TelosOne+OneHybrid
 Telos1A2Interface
 TekosZephyr
 WardbeddMP-20
 WheatstoneD-600
 WhirlwindInterfaces
 WheelerAMP2-DA



SIRIUS

BROADCAST TOWERS

AM • FM • TV

As one of the largest tower manufacturers in the country, we designed and manufactured more than 2,000 towers last year for hundreds of satisfied customers.

Call to see why Sabre is "Built to a Higher Standard."



"Built to a Higher Standard"

Sabre Communications Corporation • 2101 Murray Street • P.O. Box 658 • Sioux City, IA 51102
 Phone (712)258-6690 • Fax (712)258-8250

1-800-369-6690 • www.sabrecom.com

CH17-00

Circle (156) on Free Info Card or go to www.beradio.com

the Only
 Complete
 Solution...

for state of the art
 Expandable Transmitter
 Control Systems.
 as many as 8 transmitter sites
 can be controlled in Real-Time

NEW!
DATALINE™
 with modem and voice support



**ELECTRONIC
 ASSOCIATES
 INC.**

(915)595-3103
 web: www.elecassoc.com

Circle (157) on Free Info Card
 or go to www.beradio.com

AudioSonix

By Lee Shephard

Of all the magic that I've seen over the years, the ability to send broadcast quality audio anywhere in the world via the Web is way up there on my top ten list. Being with a company that delivers corporate news and information to radio stations, this development has given us options that we had no idea would be here so soon. I think radio stations were surprised too, but now that more and more commercials are arriving over the Internet, it's gotten their attention too. As advertising agencies realize that their deadlines can be extended by shipping MP3 commercial spots via the Web, this method will soon become the standard delivery system.

File transfers

At News Broadcast Network we began bouncing MP3 files between our three studios almost two years

Performance at a glance

- Uses standard computers
- Automatic reception of deliveries
- Pending delivery notification via e-mail
- File tracking
- No browser required
- Supports all operating systems through optional browser interface
- Economically priced

ago and quickly realized that it had its downside. First, despite the data compression, MP3 files are a bit heavy. Most of our 60-second productions are close to 1MB, which is not a problem for most e-mail boxes, but modem connections can take five minutes or longer to transfer one spot. DSL would solve this problem, but DSL is not available everywhere.

AudioSonix came to my rescue. Frankly, I didn't fully realize I had been released from MP3 e-mail jail until I had been using the program for a few days. No longer did I have to fear opening my e-mail and having a 3- or 4MB download begin. With AudioSonix, MP3 files are held until it is convenient for me to download them. There is even an automatic download feature that can be set to download at any designated time.

Also, I no longer have to worry about limiting the number of audio files I send at any given time for fear of overloading someone else's system. Recipients can download the files as they need them, when they need them. The audio files sit on the AudioSonix server until

they are retrieved. The only point of caution is to not put too many files in one package. When a package is downloaded, *all* the files in that particular package are loaded onto the recipient's computer. You can also easily send text files along with audio files. I usually include only one or two MP3 files plus some text in each package. With the group-management options built into the AudioSonix software, the same package can be sent to an unlimited number of locations with a single click.

No PC? No problem

Non-PC users can send and receive files via the AudioSonix website. From the site, you can login, create packages, send packages, receive packages, track deliveries and check the status of your account. The packages you send can be received in the AudioSonix software or from the Media Management Web interface.

The smallest package holds up to 1.5MB, or about 90 seconds of audio, and costs \$5. My only disappointment with AudioSonix is not with the company itself, but with the fact that I wish more stations were signed up with accounts

waiting for my spots. Instead, I find myself spending time trying to convince them to download the software (1.5MB). The receiving software is free. The charge is only for *sending* files. The stations and networks that receive our files via the system have nothing but praise for its efficiency.

Thanks to AudioSonix, I think my 56K modem and I are going to be roommates for a long time to come.

Lee Shephard is a vice president of News Broadcast Network based in Falls Church, VA.

Editor's note: Field Reports are an exclusive BE Radio feature for radio broadcasters. Each report is prepared by well-qualified staff at a radio station, production facility or consulting company. These reports are performed by the industry, for the industry. Manufacturer support is limited to providing loan equipment and to aiding the author if requested.

It is the responsibility of BE Radio to publish the results of any device tested, positive or negative. No report should be considered an endorsement or disapproval by BE Radio.

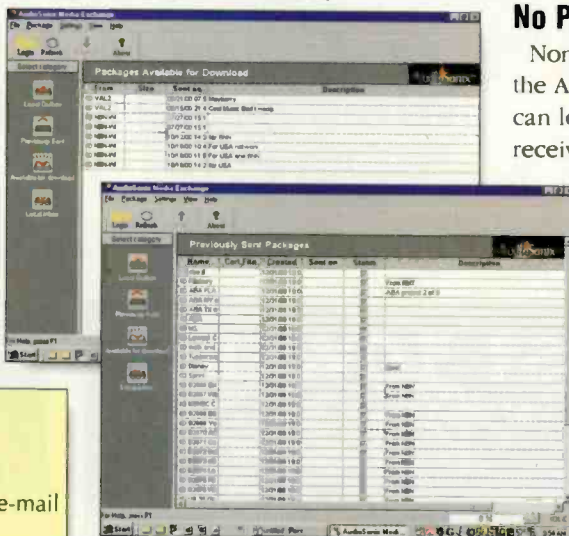

compression, MP3 files are a bit heavy. Most of our 60-second productions are close to 1MB, which is not a problem for most e-mail boxes, but modem connections can take five minutes or longer to transfer one spot. DSL would solve this problem, but DSL is not available everywhere.

FOR MORE INFORMATION

Circle (205) on Free Info Card
or go to www.beradio.com

Windows to the Web



www.logitekaudio.com

Logitek Electronic Systems: Manufacturer of digital audio consoles plus a full line of audio meters. Visit our website for information on the NUMIX, ROC-5 and ROC-10 digital audio consoles. You'll also find information on our DSP-based audio meters, offering a range of displays while conforming to IEC standard ballistics. Logitek — digital with a better difference!



www.omt.net

OMT Technologies: MediaTouch by OMT Technologies provides radio stations with state of the art digital audio systems for live assist or full automation use. With over 14 years of broadcast experience, MediaTouch has innovative software solutions starting as low as \$995. Surf to MediaTouch, see our exciting new products and find out how our clients sound better and save money with our unsurpassed quality, reliability and support.



www.managementdata.de

Management Data Media Systems AG: One of the market leaders in the development and implementation of partial or full systems for digital broadcasting operations. In 1999, Management Data Media Systems introduced the new D'ACCORD III product range, a streamlined, updated system with improved features for recording, editing, storing, archiving and playing of digital audio files.



www.arrakis-systems.com

Arrakis: Manufacturers of studio systems including the popular DigiLink computer-based audio storage and playback systems, Arrakis analog consoles, Colorado Revolution digital and analog audio consoles, and broadcast studio furniture. The website features an online interactive catalog, station equipment calculator, an equipment list price generator and a section to download the latest software versions and patches.

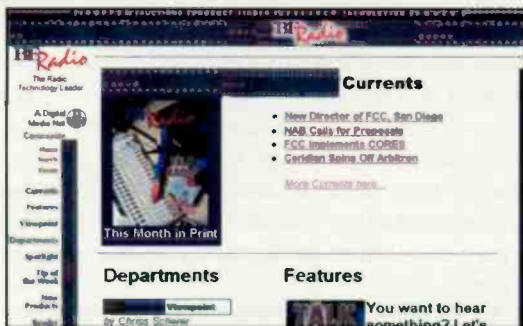

www.beradio.com

BE Radio magazine: BE Radio gives radio station managers and engineers the information they need to make critical equipment purchase decisions. The magazine is published 12 times a year and distributed to over 14,000 qualified subscribers in North America. The website features Currents (all the news updated daily), The Studio Spotlight and the Tip of the Week in addition to the quality information available in each issue.



www.antex.com

Antex Electronics: If you're looking for the most versatile, best-sounding sound cards for broadcast applications, it's time to look at Antex. Browse through Antex's complete line of analog and digital-ready products, read independent product reviews, get in-depth technical information, check out high-end applications of Antex products in the Sound Advice newsletter and buy products securely online. Already a customer? Download drivers, software, owners manuals and more.

New Products

Digital audio workstation Fairlight USA

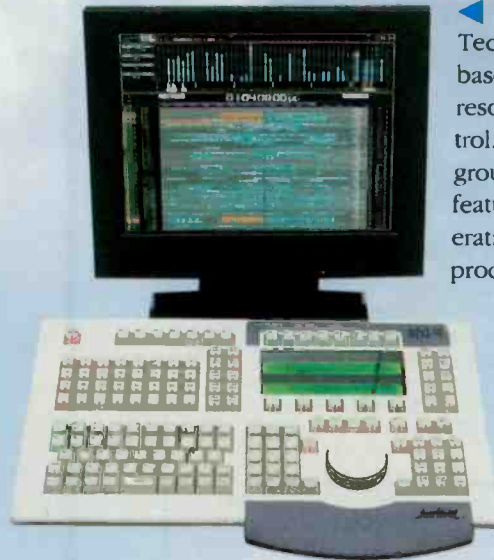

► **MFX3.48:** Featuring Fairlight's QDC Technology, MFX3.48 provides a SHARC-based DSP platform with integrated high resolution graphics and dual processor control. MFX3.48 is purpose-built from the ground up, using a system architecture that features a multi-tasking real-time disk operating system adapted for digital audio processing. The system supports a multi-layered, object-based editing environment. Video machine control is incorporated within the editing functionality. MFX3.48 employs SCSI and disk technologies and drops in and out of record at 24-bit resolution, 48 kHz sample rate, on all 48 tracks simultaneously, switching back to monitoring previously recorded tracks. MF3.48

achieves this performance using a single data drive.

800-4-FAIRLIGHT; fax 323-465-0080
www.fairlightesp.com.au; mail@fairlightesp.com.au
Circle (259) on Free Info Card or go to www.beradio.com

Condenser microphone Audix USA

▼ **CX-211:** With a frequency response of 20Hz to 20kHz, the CX-211 features a brass housing, steel mesh grill screen, and a black satin finish. A cardioid condenser microphone with a one-inch gold vapor diaphragm, bass roll-off and 10dB pad, the CX-211 requires



phantom power of 48 volts to 52 volts. The CX-211 is oriented so the sound signal enters through the front end of the microphone, allowing for additional rejection of ambient noise. This is coupled with the microphone's ability to handle sound pressure levels in excess of 145dB. Optional accessories include a 2-channel phantom power supply (APS-2).

800-966-8261; www.audixusa.com
info@audixusa.com

Circle (253) on Free Info Card
or go to www.beradio.com

On-air and production console Studer

► **On-Air 1000:** The console comes with 10 channel faders and two master faders, two stereo bargraph meters, two phase correlators, and a monitoring and talkback feature set. The operation concept of the On-Air 1000 is based on the Touch'n'Action concept of the On-Air 2000. Besides the integrated memory, PC cards can be inserted to store preferred microphone settings or console snapshots or both. The On-Air 1000 comes fully equipped and offers machine control interfaces like time sync, clock sync, serial interfaces and two telephone-hybrid controls. Seamless integration with a radio automation system via serial protocol results in a complete broadcast unit. A choice of two models makes the On-Air 1000 suitable for digital and analog environments: one version offers more analog inputs, while the other features more digital inputs.

416-510-1347; fax 416-510-1294; www.studer.ca; studer@mail.studer.ca
Circle (270) on Free Info Card or go to www.beradio.com



DAW software SADiE

SADiE4: This software runs on Windows 95/98, Windows NT and Windows 2000. The software includes a number of features and functionality, such as the optional CEDAR DeCrackle plug-in. Another optional feature of the SADiE4 is the DDP Image File. A standard feature of the SADiE4 enables multiple files to be batch imported into the system at fast speeds. An additional standard feature of the SADiE4 is the increased playlist functionality with clip placing options available on the right mouse menu and as an auto-place option. Another SADiE4 feature is the ability to support a range of DVD-RAM drives for back-up, asset transfers and file interchange with devices such as the DEVA portable recorder.

615-327-1140; fax 615-327-1699
www.sadie.com; sales@sadie.com

Circle (266) on Free Info Card
or go to www.beradio.com

Where's the mic?

Did you find the mic on the cover?
Details on the next Find-The-Mic contest are coming
next month. You could win a Neumann KMS 105.

Cool Edit 2000 plug in Syntrillium Software

Direct-X Support: A free plug-in that enables Cool Edit 2000 to use DirectX plug-ins. Registered Cool Edit 2000 users can use effects from companies like Waves, TC Works, Arboretum, and other manufacturers of DirectX plug-ins. Cool Edit 2000 offers high-speed MP3 encoding, more than twenty built-in effects, 24/96 support, resampling, real-time effects preview, and other features. The DirectX Support Plug-In is available for free download directly from Syntrillium's web site at www.syntrillium.com/cooledit.

888-941-7100; fax 480-941-8170
www.syntrillium.com; sales@syntrillium.com

Circle (271) on Free Info Card
or go to www.beradio.com

CD storage sleeves Case Logic

▶ **ProSleeves:** These storage sleeves replace jewel boxes. They allow four times as many CDs to be stored in the same amount of space. ProSleeves are available in two formats: as a single-sided sleeve with a pocket for liner notes on the back or as a double-sided sleeve that allows for two CDs to be protectively stored. Both feature a tab pocket on the top for CD spine labels. ProSleeves can be purchased in bulk quantities from a 30-pack to a 400-pack, as well as in 60-capacity CD travel cases. Case Logic has also re-introduced the PF-200, a stackable three-drawer filing system that supports the ProSleeve product. The PF-200 is available through www.caselogic.com.

877-227-3347; www.caselogic.com; info.center@caselogic.com

Circle (256) on Free Info Card or go to www.beradio.com

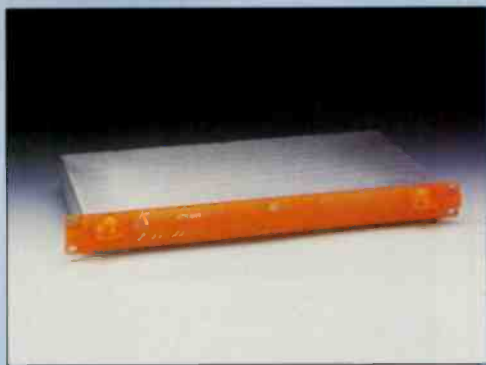

Digital audio player Aztec Radiomedia

◀ **HitPlayer:** This device can select audio from a locally programmed playlist or according to remote commands received over the Internet via Aztec Radiomedia's enhanced IP2 technology. IP2 provides an embedded Web server that permits open administration via common

browsers, Internet standard file transfer protocol (FTP) and simple network management protocol (SNMP) services. HitPlayer can send e-mail notification of events or alarms. Using a PC, the user can connect to HitPlayer via the Internet or local Ethernet TCP/IP networks for control and real-time updating. A variety of standard audio connections are supported.

703-875-9100; fax 703-875-9161

www.aztec-radiomedia.com; contact@aztec-radiomedia.com

Circle (254) on Free Info Card or go to www.beradio.com

16-track editor Soundscape

R.Ed/16: This editing tool is a fully featured 16-track version of R.Ed that has AES/EBU and 1x TDIF as standard, and a 24/96 XLR analog option for up to 12 inputs and 16 outputs with a full range of sync options including LTC, VITC, video sync and RS-422 on the optional timecode board. This unit also offers a possible 250GB of IDE-based storage.

805-658-7375; fax 805-658-6395
www.soundscape-digital.com
us-sales@soundscape-digital.com

Circle (268) on Free Info Card
or go to www.beradio.com



Amplifiers QSC Audio

◀ **Powerlight 2 series:** This line of amplifiers includes four models ranging in power from 900W to 1850W per channel, all in 2RU chassis that are 14" deep and 21 lbs. Each of these models is available in three versions: a base model, an "A" version and a "D" version. Base models are for systems using external signal processing. For those looking for integrated solutions, "A" versions offer internal analog signal processing, while "D" versions include full DSP capability.

714-957-7100; fax 714-754-6174; www.qscaudio.com; info@qscaudio.com

Circle (265) on Free Info Card or go to www.beradio.com

New Products

Software update Gentner

► **GSC3000 software:** Enhancements for the GSC3000 remote facilities management system have been released. Software version 1.9 and a network module allow users to access the system through wide area networks and corporate intranets. The network module uses TCP/IP to make information on a host computer available to all other networked computers. Security features ensure that only authorized personnel can gain access.

800-945-7730; fax 801-977-0087; www.gentner.com; bcastinfo@gentner.com
Circle (260) on Free Info Card or go to www.beradio.com



Online ad insertion BroadcastAmerica.com

Ad Stripping: BroadcastAmerica.com is developing both a wireless Internet distribution platform and an Internet-only ad stripping platform, which will allow stations to insert new commercials into their audio stream and earn additional revenue in the process. These technologies will result in increased listenership to BroadcastAmerica.com's affiliate radio stations, and increased revenue sharing for Internet-only ad replacements.

207-321-5100; fax 207-321-5200
www.broadcastamerica.com
info@broadcastamerica.com
Circle (255) on Free Info Card
or go to www.beradio.com



Monitor speaker system Westlake Audio

◀ **Lc3w12:** Measuring 15"W x 25"H x 15.5"D, the Lc3w12 is comprised of a 12-inch woofer, a six-inch midrange and a one-inch dome tweeter with a 100 watt continuous-power handling capacity and sensitivity of 91dB at 1M for 2.83V input. The Lc3w12's frequency response is rated at 40Hz-18kHz with an impedance level of 4Ω nominal/3Ω minimum with dual-banana, five-way binding posts and bi-wire/bi-amp capability. At

107 lbs., the Lc3w12 comes finished in a black utility paint and includes a one-year warranty.

805-499-3686; fax 805-498-2571
www.westlakeaudio.com
mgroup@westlakeaudio.com
Circle (272) on Free Info Card
or go to www.beradio.com

BACKUP FM TRANSMITTER

Inexpensive insurance against a main transmitter failure.

300 Watts • 600 Watts • 1.2 Kilo-watts

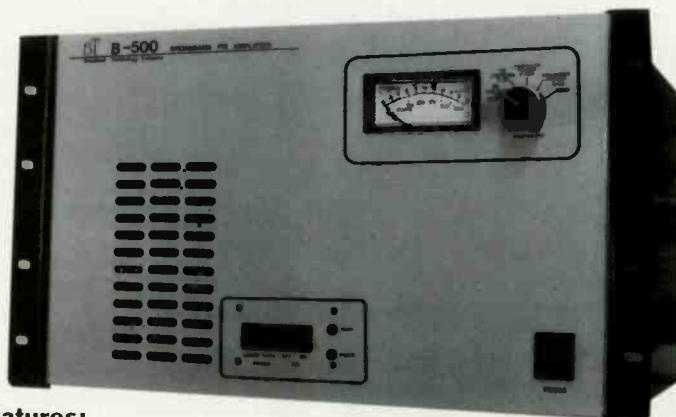

Features:

- 100% solid state
- No tuning required
- Rugged power supply
- VSWR, current & temperature overloads
- Power trim standard
- Full remote control capability, with outputs for all main parameters
- Compact 10" rack mount design

www.broadcasttech.com

Broadcast Technology Company

P.O. Box 751 • Lamar, CO 81052 • (719) 336-3902 • Fax (719) 336-9473

Circle (158) on Free Info Card or go to www.beradio.com

Stand-alone encoder Digigram

Multichannel Digital Audio Encoder: Digigram's encoder is a stand-alone application that can also be used as a fully integrated plug-in with the Xtrack suite of multitrack digital audio editing tools, now offered free of charge. This encoder can be used for DVD authoring, digital television and other applications. Combining the software with Xtrack and Digigram PCX sound cards offers an integrated solution to a variety of Dolby Digital requirements. PC-based Xtrack is designed to take advantage of the power of Digigram sound cards, but can also be used with any standard WAVE sound card under Windows.

703-875-9100; fax 703-875-9161
www.digigram.com
input@digigram.com

Circle (258) on Free Info Card
or go to www.beradio.com

New Products

Relay switch box

William Weisinger Engineering Service

Remote AC Relay Box: This relay box switches two (parallel) AC receptacles (about 5-10 amps) with a dry closure (using about 12vdc/26mA built-in) and may offer an optional wet (5VDC/5mA) closure for TTL users. It uses a two-conductor barrier strip for the remote start and a standard three-conductor AC cord that plugs in anywhere. The device was originally designed as a companion for the FM Alert Receiver but can be used to remote-start anything that operates on 115VAC with wires and a switch, other 115VAC transformers, tally lights and boom-box skimmers.

330-626-2469; fax 330-626-2469; www.wwes.org

Circle (274) on Free Info Card or go to www.beradio.com



Condenser microphone

AKG

◀ **C 4500B-BC:** A condenser microphone with transformerless output, the AKG C 4500B-BC is immune to electromagnetic fields. Its all-metal housing and double-screening of all acoustically open sections of the microphone provide shielding capability. The C 4500B-BC offers a front-end firing capsule position, electro-magnetic screening, internal pop-filter and does not require additional outboard processing. A 120Hz roll-off filter is integrated into the C 4500B-BC, while a -20 dB pre-attenuation pad allows users to replace dynamic microphones without changing the adjusted gain structure on associated equipment. The low self noise and high overload point

of the AKG C 4500B-BC offer a dynamic range of more than 135dB.

615-360-0499; fax 615-360-0275

www.akg-acoustics.com
akgusa@harmon.com

Circle (250) on Free Info Card
or go to www.beradio.com

Low-power transmitter

LPB

FM-50: This low power transmitter is an unlicensed on-site marketing system featuring an ultra-stable electronics package, a digitally synthesized tuner, easy frequency selection and a simple mounting system. The device is FCC-certified and frequency-agile. Other features include simple activation, intuitive installation, a durable outdoor enclosure, a strong locking mechanism and a 50-foot radius coverage area. A digital audio system is available, and the unit is compatible with a variety of audio sources.

610-644-1123; fax 610-644-8651
www.lpbinc.com; lpbinc@aol.com

Circle (262) on Free Info Card
or go to www.beradio.com

FM power amp

SBS

PA250: An FM power amplifier with a wideband design, the PA 250 requires no tuning. One of the most novel features of the unit is the heat-dissipating fresh-air-tunnel with dual intelligent fans. These provide cooling to the specially designed heat sink in a stream of air that needs no filtering. No active components are in the air flow, thus keeping sensitive areas unsoiled. The PA 250 uses an efficient power-supply design, combining a toroidal transformer and switch mode regulator. Woven mat PTFE circuit boards, bonded to the heat sink/ground plane, are used to achieve thermal stability at the surface mounted component level.

352-622-7700; fax 352-629-7000
www.bgsfl.com

Circle (267) on Free Info Card
or go to www.beradio.com



Mission Critical

PMD680

PC Card Recorder

Digital. Reliable.

Computer ready.



In the field, you depend on your equipment. Failure is not an option. That's why so many pros carry Marantz Professional portable recorders. Our new PC Card recorder extends this legacy into the digital domain.

Circle (159) on Free Info Card or go to www.beradio.com

www.superscope-marantzpro.com

New Products

Portable RAM recorder Denon Electronics

► **DN-F20R:** This portable, flash field recorder accepts up to 192MB CF media. Features include a selectable sampling rate of 24kHz or 48kHz, a selectable bit rate of 16kbps to 128kbps (MPEG) and two memory-card slots. The unit supports MPEG-1, MPEG-2 and linear PCM (.WAV). Capabilities include stereo or mono recording, seamless continuous recording or playback from drive to drive and duplication of media from drive to drive. The DN-F20R can make two master recordings at once. Up to 9,990 tracks are possible within 10 subfolders. Additional features include a built-in monitor speaker, stereo XLR mic inputs, a mic limiter, level attenuator, low-cut filter switches, RCA inputs and outputs and a headphone jack with volume control.

973-396-0810; fax 973-396-7459; www.del.denon.com;
Circle (257) on Free Info Card or go to www.beradio.com



Dehydrator Andrew

► **PMT200 DryLine:** A fully automatic device that covers systems with volumes from 0.01 to 1700 liters (0.01 to 60ft³), this dehydrator enables low- and medium-volume systems to be pressurized with equipment that functions without the need for bypass kits and ancillary airtanks. For remote sites, the PMT200 is an alternative to bottled gas and desiccant dehydrators. The unit minimizes the maintenance associated with nitrogen tanks and manually regenerative systems. The system forces air through a membrane drying cartridge to produce a dewpoint better than -45 degrees C (-50 degrees F).

800-DIAL-4-RF; fax 708-349-5444; www.andrew.com
Circle (251) on Free Info Card or go to www.beradio.com



Console setup software Wheatstone Corp

V-DIP software: The control surface of each input module on Wheatstone's digital consoles can be automated via the V-DIP technology, and each channel's 8-character display will indicate title, cut number or router source selected. Yet even with the V-DIP protocol, the console's main controller retains the ability for local/remote override should an operator require manual control during other dayparts. The V-DIP software allows users to configure a Wheatstone digital console from the convenience of a laptop. The V-DIP Software eliminates the need for setting dipswitches manually during console configuration and has been designed into the D-700, D-70, Auditratics 220 and the D-600 digital consoles.

252-638-7000; fax 252-637-1285
www.wheatstone.com
sales@wheatstone.com

Circle (273) on Free Info Card
or go to www.beradio.com

Braided jumper cable assemblies Spinner GmbH



► **Cable assemblies:** A selection of braided jumper cable assemblies from Spinner North America, manufactured with RG-214 and RG-223 (RG-142) cables, feature soldered inner and outer conductors, injection molded boots and factory guaranteed specifications for a variety of wireless uses. With operating frequencies ranging to 2.4GHz, these IP-68 rated assemblies are available with BNC, SMA, TNC, N and 7-16 connectors in straight and right angle configurations. VSWR ratings are 1.08:1 at 1GHz and 1.12 at 2GHz (with N male connectors) along with tight bending radii and Halogen-free flame retardant jackets.

770-263-6326; fax 770-263-6329
www.spinnerna.com; sales@splnerna.com
Circle (269) on Free Info Card
or go to www.beradio.com

Model RFC-1/B Remote Facilities Controller

it's the most affordable, fully-featured transmitter remote control system available. It's flexible. It's expandable. it has a well-deserved reputation for being very reliable. and it's not difficult on the eyes. what other reasons do you need?

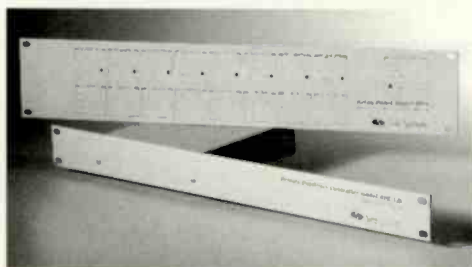

FEATURES

- transmitter control from any telephone
- 8-64 channels of telemetry and control
- programmable control by time and date
- automatic adjustments based on telemetry
- optional printer and modem adapters
- programmable telemetry alarms
- full-featured, affordable, reliable
- Integrated rack panel

 Sine Systems

nashville, tennessee • 615.228.3500 voice • 615.227.2393 fax-on-demand • www.sinesystems.com

visit our web site for more information on our products

Circle (160) on Free Info Card or go to www.beradio.com

New Products

LED flashlight lamps

LEDtronics

▶ **9 mm LED Lamps:** These flashlight lamps fit almost any two- or three-cell flashlight. Depending upon the model, these LED lamps integrate either one or three 5mm discrete LEDs into a standard 9mm-flange base. Due to LEDs' low power draw, batteries last up to 240 continuous hours. Red and Green bulbs are ideal for instrument, chart or equipment-inspection illumination under darkened conditions while maintaining night vision. Red and green LED lamps do not change their transmission characteristics or fade with use. LEDtronics' infrared bulbs provide illumination for security surveillance with infrared cameras, goggles and night scopes.

800-579-4875; fax 310-534-1424; www.ledtronics.com
Circle (261) on Free Info Card or go to www.beradio.com

IBOC-ready AM transmitter

Armstrong Transmitter

▶ **X-500AM:** This 500W digital IBOC-ready solid-state AM transmitter that features 90 percent PA efficiency, 80 percent overall efficiency (powerline to RF output); an optimized multiphase modulator (flat group delay, low source impedance); 150 percent positive modulation capability; a compact design that is UPS-shippable; and hot pluggable modules. The device is designed to accept digital IBOC signals. The transmitter also includes three preset power levels, full remote control capability, 600W RF modules for extra reliability and headroom, and high-efficiency switching power supplies.

315-673-1269; fax 315-673-9972
www.armstrongtx.com
sales@armstrongtx.com
Circle (252) on Free Info Card
or go to www.beradio.com



Transmitter remote control Electronic Associates

▶ **DataWorks:** This control operates using a dedicated data interface to a control site or as a stand-alone unit and includes standard voice, data and pager access and operating modes. It includes a multi-purpose interface that will operate as a dial-in channel using the DataWorks remote access program or a touchtone interface with speech responses (optional). The interface mode is sensed automatically. In addition, the multi-purpose interface may be directed to automatically call out to selected phone numbers with announcements describing the condition or problem that caused the call. Up to eight different phone numbers are stored. Users may program up to 16 custom voice messages using the voice dictionary.

915-595-3103; fax 915-590-6637
www.elecassoc.com; info@elecassoc.com
Circle (275) on Free Info Card
or go to www.beradio.com

Audio router

Little Labs

▶ **AES Digital Audio Mastering Router:** This router has been cosmetically and electronically refined from the original model. The router uses a 4-layer circuit board, and all AES ins and outs are transformer coupled and



internally ground liftable. All AES outputs if not selected are properly terminated. Switching pops are eliminated. High sample rates and 24-bit digital audio with no sacrifice in performance are possible. All flags and clocks remain intact while passing through this router.

323-851-6860; fax 323-851-6860; www.littlelabs.com
Circle (263) on Free Info Card or go to www.beradio.com

TIE LINE™

DIGITAL AUDIO CODEC

We've Moved! Here's
TieLine America's new
phone number!

317-259-8000

TieLine America, P.O. Box 80003, Indianapolis, IN 46280-0003

You can still visit us on the web at:

www.buytieline.com

Circle (161) on Free Info Card or go to www.beradio.com

Reader Feedback

Download quality

Hi Chriss,

I enjoyed your Viewpoint called *Future Delivery* (September 2000). I have just a few comments. I have downloaded approximately 500 cuts from Napster and the quality is quite good in almost all cases. My personal standard is quality suitable for headphones or plugging my Rio player into my car audio system. Almost all the cuts on Napster are encoded at 128kb/s.

In my personal encoding experience with a Fraunhofer encoder, 128kb/s is quite adequate for almost all recorded material. Occasionally I find a cut that just doesn't sound right at this rate, in which case using 160kb/s almost always solves the problem. If I have something really important, I use 256kb/s which sounds just great!

It is interesting to note that at 128kb/s, we are discarding about 90 percent of the WAV file data. A lot of radio stations run MP3s on the air and they don't sound all that bad. Keep in mind that satellite radio will be *heavily* data compressed, and it won't be lossless.

I like Napster for those cuts that just can't be found in a record store, such as bootlegs and oldies.

Jim Somich
President
MicroCon Systems
Broadview Heights, OH

More on IBOC

I have heard informed people suggest that the ability to transmit 5.1 channel surround audio (such as Dolby Digital) could be the value-added feature that could make DAB successful. In sessions at NAB2000 I brought this up to a panel of engineers presenting points of view on IBOC/DAB and the translation of their response amounted to "Huh?, We're just doing stereo with ancillary data." This is more evidence that radio broadcast as we know it could be headed the way of the dinosaur with the NAB and the US broadcast engineering community blazing the trail.

I'm sure Skip has thought of 5.1 and if he does not mention it there is a good reason. What am I missing?

Lewis Downey
KUER-FM, University of Utah
Salt Lake City, Utah

Lewis,

I appreciate your comments. Although I'm not sure I agree that 5.1 channel audio would be the killer application for IBOC, but it would certainly make a

nice feature. Unfortunately, it's not technically possible under current IBOC designs. FM IBOC is considering 96kb/s or at most, 128kb/s as a data rate for its audio payload, and AM IBOC will use 48kb/s. The lowest data rate in common use for compressed 5.1-channel audio today is 384kb/s (Dolby AC-3), which is obviously well above the range of possibility for IBOC.

As a reality check, consider that last year CEA suggested 5.1-channel audio (knocked down to 288kb/s) in its elegant but ultimately ill-fated MMBS proposal for reclaimed UHF-TV spectrum. This COFDM-based service was optimized for robust mobile reception, and it required a channel bandwidth of 1.5MHz of clear spectrum for each 5.1-channel audio program plus 64kb/s of aux data. It's certainly a stretch to think that this kind of service could be squeezed into a 200kHz channel that was still carrying analog FM. That's not to say that coding techniques can't eventually improve to this point, but today it's a pipedream. Of course, if there's one thing the last few years have taught us in the area of perceptual coding, it's "Never say never."

Read on,
Skip Pizzi
executive editor

I read Skip Pizzi's comments in *What's wrong with DAB?* (September 2000) and must take exception. True, the proposed iBiquity IBOC system is not intended for dual programming of the analog and digital signals. Why would we want to double the number of audio services in each band?

You can hear the major radio groups struggle to find commercially successful formats for all the frequencies they own now. Does radio want to follow the lead of cable TV appealing to splinter audiences?

If the marketplace cries for additional outlets why don't we have sub-carrier buttons on our FM car radios? Broadcasters don't need more struggling formats.

Expansion of services will drive IBOC. At the NAB Radio Show I saw a prototype receiver displaying album covers, artist info and banner ads.

I heard about interactive links using cellular technology to place orders. These are the quantitative changes IBOC brings to radio. This new revenue source will prompt management to invest in IBOC.

AM IBOC brings another quantitative change to medium wave. AM stations now have the ability to compete with FM for the music formats. Medium and



small markets can now have a choice of formats other than rock and country.

Skip lamented that iBiquity brings us the same old song in a digital package. CDs are only a digital version of analog vinyl; we play the same music. PCs are only digital versions of typewriters and manual adding machines; we print the same letters and spreadsheets.

There is a ground swell growing for iDAB. I know of stations delaying replacement of failing equipment in expectation of an IBOC standard. When management of a Christian AM station in North Pole, AK, asks me to come up and talk with them about IBOC, there is interest. I am writing this on a plane flying over the Gulf of Alaska. It looks like 2001 will be the year for IBOC. Very likely we will see IBOC excitors at the spring NAB Convention.

Maybe IBOC is not the final pinnacle for radio. IBOC may well be only another step in the evolution of radio broadcasting, but for now it's the best technology the local radio broadcaster can put his arms around. How many reading this would rather return to local country bands performing live and to home-grown sermons on the radio?

Walt Lowery
District Sales Manager - Radio
Harris Corporation
Mukilteo, WA

Walt,

Thanks for your letter. As always, your comments are thoughtful, heartfelt and articulate. Nevertheless, I remain steadfast in my opinion that broadcasting needs more channels if it is to survive. Quantity has always beaten quality in electronic media transitions. New content draws listeners. Broadcasters need to get over their legacy fixation on high market shares. Moreover, the Internet is making audiences less tolerant of pre-fab, limited-choice content.

Regarding subcarriers, they are very popular in most major markets for foreign language audio services. You don't see the radios in the stores, but the availability of desired content motivates people to hunt the receivers down. The popularity of Internet and satellite radio will grow because of the new services they carry (including such non-English language and data services). The only players that don't seem to want more services are existing broadcasters. What does that indicate? Putting private interest ahead of public interest is antithetical in broadcasting. Pride comes before a fall.

I have always agreed with your point that AM radio could be helped by IBOC more than FM, but have you listened to AM IBOC? In some cases it's better than today's average analog AM signal, but it certainly doesn't match today's FM audio quality. Again, a small, purely qualitative step, which could be lost on most consumers.

You are also quite correct that progress has to be

incremental if you want mass audiences to follow. But when a change such as the Internet hits the mass market, it's a tough act to follow with small, incremental shifts in legacy systems. Your analogies to past developments are off the mark here: The CD wasn't just a better-sounding LP, and certainly the PC is a lot more than just a digital typewriter or adding machine. That's like

saying the F-16 is an updated Kitty Hawk. Perhaps a counter-metaphor for my view of IBOC is that it takes more to make a passenger jet than putting wings on a bus.

Nobody wants to move backward, but we have to move forward sensibly and efficiently. A change of IBOC's magnitude is difficult and won't be taken lightly by broadcasters or the CE industry. Given that level of effort, I just don't feel that IBOC goes far enough or provide

sufficient ROI in either the capital or sweat equity that will be required. Nor will its moderate advances provide sufficient appeal to attract (or retain) audiences in large numbers. If broadcasters are set to make a big change, it had better be worth it. If not, the attempt to become more competitive may ricochet into a major misstep that drags the industry into a steeper decline.

Read on,
Skip Pizzi
executive editor

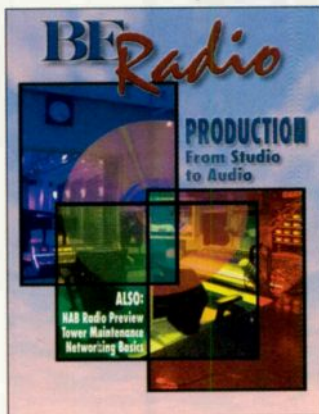

Interested in Digital Audio Workstations?

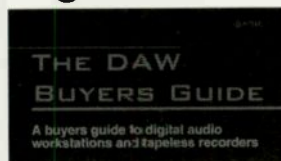

If you need to know what's on the market, **The DAW Buyers Guide** is your answer!

How many trade shows, magazines, telephone calls and Internet searches would it take to find everything that's out there? Then how long would it take to compile all that information into an easily comparable format? And then what about all that missing info?

Don't worry - we've done the hard work for you!

The DAW Buyers Guide from independent consultants SYPHA includes details of over 300 digital audio workstations and tapeless recorders and covers not only existing systems, but those yet to be launched.

It's comprehensive, it's invaluable and it's only \$34.95 + shipping and handling. For more details contact SYPHA Tel +44 20 8761 1042; Fax +44 20 8244 8758; email sypha@compuserve.com.

The DAW Buyers Guide is available through NAB Publications, www.nab.org/nabstore, or direct from SYPHA and other booksellers worldwide.

"Remember that time is money."

— Benjamin Franklin

When you must, must have precision timing

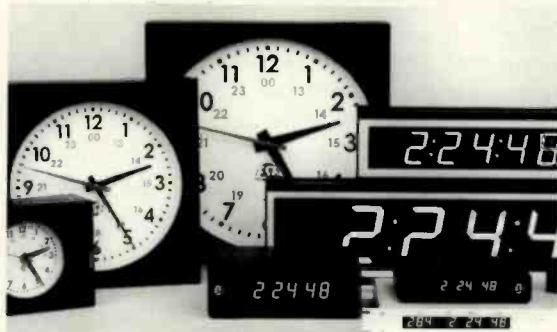

When you require the best, most accurate in precision timing look only to ESE. Designed for "Precision Timing", ESE Master Clocks & Accessories have been the industry standard for over 27 years.

Whether using GPS, WWV, Modem, Crystal or line frequency accuracy — all ESE Master Clocks can drive digital or analog slave clocks, as well as interface with video and/or computer based systems. Call for more details.



142 Sierra Street • El Segundo, CA 90245 USA
 Phone: (310) 322-2136 • Fax: 310.322.8127
www.e-se-web.com

Circle (163) on Free Info Card or online at www.beradio.com

DSI Satellite.com

THAT'S YOUR FINAL ANSWER!



Mounts Available:

AZ-EL, Polar, H-to-H
 Gibraltar-dual Powered AZ-EL

	Sizes		
* Feed Horns			
* LNB's			
* Multi-Cable	60cm	1.8m	3.7m
* Receivers	90cm	2.4m	3.9m
* Controllers	1.0m	2.7m	4.2m
* Antenna Covers	1.2m	3.0m	4.5m
* De-Icing Systems	1.4m	3.3m	5.0m
* Custom Fabrications			

Quantity Discounts!

Call For Pricing!
 600 N. Marquette Rd
 Prairie du Chien, WI 53821
1-800-627-9443

Fax: 608-326-4233

Web-site: www.dhsatellite.com E-mail: dhsat@mhct.net

Circle (164) on Free Info Card or online at www.beradio.com

TRANSCOM CORP.

Serving the Broadcast Industry Since 1978

VISIT OUR NEW INTERNET SITE AT
www.fmamtv.com

SEND YOUR E-MAIL REQUESTS TO: transcom@fmamtv.com

Fine Used AM & FM Transmitters. Authorized Representatives for all major equipment manufactures. Let us send you a customized quote!

	100 W	FM	1985	Harris FM 100K
				Solid State Single Phase
FM TRANSMITTERS	1	KW	FM	1981 Harris FM 1K
	2	KW	FM	1996 BE FM 2C Solid State Single Phase
	2.5	KW	FM	1984 Harris FM 2.5K Single Phase
	2.5	KW	FM	1980 Harris FM 2.5K Single Phase
	2.5	KW	FM	1976 Collins 831D Single Phase
	5	KW	FM	1995 Harris Platinum 5, PT5 Solid State
	5	KW	FM	1985 Harris FM 5K
	5	KW	FM	1984 Harris FM 5K
	5	KW	FM	1967 Collins 830E
	6	KW	FM	1994 Henry 6000D
	10	KW	FM	1974 Harris FM10H/K
	20	KW	FM	1980 Harris FM20K
	20	KW	FM	1988 CCA FM 20,000G
30	KW	FM	1995 QEI FMQ 30,000 B-1 Single Phase	
AM TRANSMITTERS	400W	AM	1996	Nautel Ampfet 400 Solid State
	5 KW	AM	1977	Collins 828E-1
	5 KW	AM	1982	Continental 315R-1
	5 KW	AM	1980	CSI T-5-A
	5 KW	AM	1993	Harris "Gates 5" Solid State
	10 KW	AM	1975	Continental 316F
	25 KW	AM	1985	CSI T-25-A
	25 KW	AM	1989	Nautel Ampfet 25 Solid State
	50 KW	AM	1978	Continental 317C-1
	50 KW	AM	1982	Harris MW-50B

P.O. Box 26744, Elkins Park, PA 19027

800-441-8454 • 215-938-7304 • FAX No. 215-938-7361

Circle (165) on Free Info Card or online at www.beradio.com

Affordable Custom Broadcast Furniture



Delivered and installed by

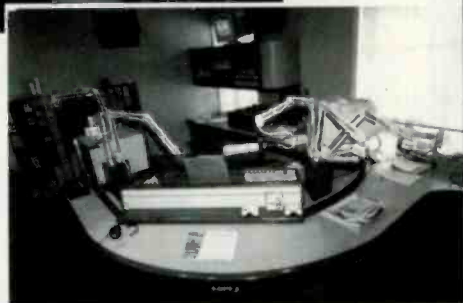

STUDIO TECHNOLOGY

32 Pennsylvania Avenue,
Malvern, PA 19355

TEL: 610-640-1229 • FAX: 610-296-3402

email: sales@studiotechology.com
www.studiotechology.com

Circle (166) on Free Info Card or online at www.beradio.com

BROADCAST ENGINEERING CONSULTING SOFTWARE

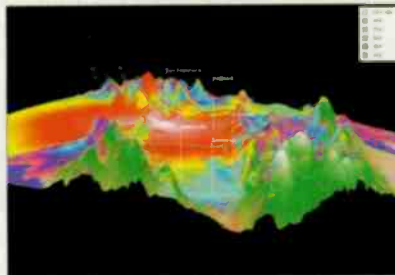

Longley-Rice over 3-D Terrain

Professional software packages for preparing FCC applications & plotting coverage. For Windows & NT.

- Create "real-world" coverage maps & interference studies with Longley-Rice, TIREM, PTP, FCC & other models using polygon map features.
- Search for AM, FM, TV, DTV, & LPTV channels with graphics oriented programs and FCC databases.
- Plot STL paths in 3-D using 3-Arc second terrain databases...and more!

VSoft
COMMUNICATIONS
Broadcast Communications Software
and Engineering Consulting

800-743-3684 • www.v-soft.com

Circle (167) on Free Info Card or online at www.beradio.com

Buy simplicity,
reliability and service.

EAS
Price \$1750.00

Equipment in-stock
for immediate delivery.

Phone 740-593-3150

GORMAN-REDLICH MFG. CO.
257 W. Union St. Athens, Ohio 45701

FAX 740-592-3898

Now available
with
optional DTMF
control
via a phone line.

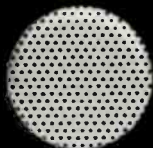

SCAN FACILITY: 1214798 13:17:20:51
DECODER: Scanning
ENCODER: Ready * PRINTER NOT CONNECTED
Manual

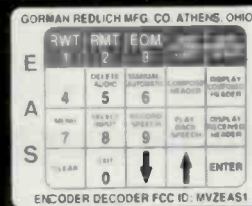

- 5 two-way RS-232 inputs/outputs for computer, remote signboard & character generator
- 6 audio inputs on standard models. All audio inputs & outputs are transformer isolated from encoder-decoder board
- Automatic interruption of program audio for unattended operation
- 4 line 40 character LCD display with LED backlighting
- 20 key keypad to program unit, set modulation level, set input levels

- Will handshake with automation equipment
- 2 year warranty
- 2 minutes of digital audio storage
- 25 pin parallel printer port for external printer
- 52 terminals on the rear to interface with other equipment by removable plugs
- BNC fitting with 600 OHM balanced audio out for second transmitter

Web Site: www.gorman-redlich.com • E-mail: jimg@gorman-redlich.com

• Also available: weather radios, antennas for weather radios, crystal controlled synthesized FM digitally tuned radios, remote signboards, cables for interconnection, Character generators.

The CircuitWerkes AC-12 Telephone Autocoupler Bay

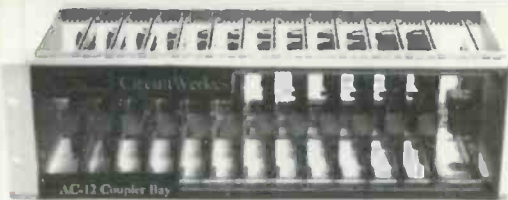

Get up to 12 couplers in a neat, compact chassis

- Auto answer & disconnect.
- 2 audio busses for mass feeds.
- Individually card selectable buss or auxilliary audio I/O.
- The aux. audio jack is ideal for multiple IFB feeds, etc.
- Ring counter answers on user set ring number.
- Momentary or latching dry contact outputs at pickup.
- Remove & install cards without affecting the rest.
- LED indicators for ring, clipping, power & online.
- Check out our Internet web site for more info and technical manuals.

The AC-12 rack-mounted coupler bay is the best way to eliminate a wall or cabinet full of yesterday's couplers. Our unique dual audio busses eliminate the tedious and messy wiring associated with mass feeds. Each card can also individually either send or receive telco audio, making it perfect for IFBs, etc. Best of all, a loaded AC-12 lists for about \$200 per coupler.



CircuitWerkes

3716 SW 3rd Place
Gainesville, Florida 32607
(352) 335-6555 / fax 380-0230
<http://www.circuitwerkes.com>

Circle (169) on Free Info Card or online at www.beradio.com

If You Can
Make It Here ...
You Can Make It
Anywhere!

Photo by John Lyons

6016 FM Antenna Condé Nast Building New York City

Shively Labs

(207) 647-3327
888-SHIVELY
www.shively.com
sales@shively.com

Circle (170) on Free Info Card or online at www.beradio.com

Switcher tools

Designed by broadcast engineers for broadcasters, our audio and digital audio switchers offer excellent sonic quality, removable I/O connections, contact closures and serial remote control capabilities and flexible mounting accessories.



SS 12x4

Active crosspoint switching/routing with 12 stereo inputs and 4 stereo outputs.



10X1

Passive switching/routing with 10 stereo inputs and one stereo output or vice-versa.



SS 8.2

Active crosspoint switching with 8 stereo inputs, 2 stereo plus 2 mono outputs.



8x1 DAS

Routes any one of eight AES/EBU digital inputs to split outputs.



8X2D

Active crosspoint switcher with 8 stereo inputs, 2 stereo and 2 mono outputs



6X1G

Passive switching/routing with 6 stereo inputs and one stereo output, or vice-versa.



3X2B

Active crosspoint switcher with 3 stereo inputs and 2 stereo outputs.

Check out our web site for
product information, list pricing
and a list of distributors!



SS 3.1

Passive switching/routing with 3 stereo inputs and one stereo output or vice-versa.



SS 2.1/BNC

Passive switching/routing with 2 composite audio, video, or AES/EBU inputs to 2 composite audio, video, or AES/EBU outputs, or vice-versa.



SS 2.1/TERM

Passive switching/routing with two stereo inputs to one stereo output or vice-versa.

Internet: www.broadcasttools.com E-mail: bt@broadcasttools.com

Voice: 360 . 428 . 6099
Fax: 360 . 428 . 6719

BROADCAST
tools inc.

Making Business Easier



John Harper is the Owner/President of WMEL Radio in Melbourne, FL.

BE Radio

The Radio Technology Leader
www.beradio.com

"BE Radio is on top of what's happening with technology in the industry. It helps me stay focused and make determinations as to what equipment I should

be buying in the next few years.

"Overall, BE Radio is an excellent publication. I like the fact that it's specifically geared toward radio."

Wherever there's entertainment, there's an Intertec Publication

www.intertec-entertainment.com

An INTERTEC®/PRIMEDIA Publication

Photo by John Caracappa



CLASSIFIED BE Radio

PROFESSIONAL SERVICES

RUSS BERGER DESIGN GROUP INC

INDEPENDENT CONSULTANTS
SPECIALIZING IN:
RECORDING & BROADCAST FACILITY DESIGN & PLANNING,
ARCHITECTURAL ACOUSTICS,
NOISE & VIBRATION CONTROL,
& TECHNICAL SYSTEMS DESIGN

4006 BELTLINE SUITE 160 DALLAS TEXAS 75001
972/661-5222 FAX 972/934-3935

Harnack Engineering, Inc.
Accurate Engineering for Broadcasters

Kirk Harnack
(800) 366-7618
kirk@harnack.com
www.harnack.com

Applied Wireless, Inc.
... providing options.

PO Box 925
New Market, MO 21774
tel.: 301.865.1011
fax.: 301.865.4422
email: kevinmc@appliedwirelessinc.com
www.appliedwirelessinc.com

Kevin McNamara
President & CEO

Your Best Source for FCC Rules!

Rules covered:
1, 11, 17, 25, 26, 27, 73, 74, 79, 101

Pike & Fischer, Inc.
Available in loose-leaf print, disk, and CD-ROM.
Call 800-255-8131.

SERVICES

Consulting Communications Engineers EMC Test Lab

- FCC Applications and Field Engineering
- Frequency Searches and Coordination
- ARI-FM-CATV-ITIS-LPTV
- EMC Test FCC and European (IEC)

OWL ENGINEERING, INC.
E-mail: info@owleng.com 1-800-797-1338 Fax (763)785-4631
3899 Hastings ST NE, Blaine, MN 55449 (763)785-4115 Member AFCCE

ERI® ELECTRONICS RESEARCH, INC.

REGISTERED PROFESSIONAL ENGINEERS
STRUCTURAL ANALYSIS
ERI Incorporated
1943
TOWER REINFORCING

ERI® 812-925-6000
7777 Gardner Road
Chandler, IN 47610
www.ERInc.com

JOHN H. BATTISON P.E.
CONSULTING BROADCAST ENGINEER,
FCC APPLICATIONS AM, FM, TV, LPTV
Antenna Design, Proofs, Fieldwork
2684 State Route 60 RD #1
Loudonville, OH 44842
419-994-3849 FAX 419-994-5419

FOR SALE

VIF IDLERS
HOLD DOWN KNOBS
SEQUOIA ELECTRONICS
(800) 848-4428 Fax (408) 363-0957

D.L. MARKLEY & Associates, Inc.
CONSULTING ENGINEERS
2104 West Moss Ave.
Peoria, Illinois 61604
(309) 673-7511
FAX (309) 673-8128
Member AFCCE

EDITORIAL

Chris Scherer, CSRE, *Editor*
Skip Pizzi, *Contributing Editor*
John H. Battison, P.E., *Technical Editor, RF*
Cindy Holst, *Associate Editor*

BE Radio

www.beradio.com
beradio@intertec.com

ART

Michael J. Knust, *Art Director*

BUSINESS

Dennis Triola, *Group Publisher*
Rachelle Thomas, *Marketing Director*
Vicki Inman, *Advertising Coordinator*
Mary Mitchell, *Classified Advertising Coordinator*
David Williams, *Corporate Circulation Director*
Gayle Hutchens, *Circulation Manager*
Customer Service: 913-967-1711 or 800-441-0294

TECHNICAL CONSULTANTS

Harry C. Martin, *Legal*
Kevin McNamara, CNE, *Computer Technology*
Kirk Harnack, *Contract Engineering*
Russ Berger, *Broadcast Acoustics*
Donald L. Markley, P.E., *Transmission Facilities*
Yasmin Hashmi, *International Correspondent*
Stella Plumbridge, *European Correspondent*

MEMBER ORGANIZATIONS

Sustaining Members of the following:

- Acoustical Society of America
- ARMA
- Audio Engineering Society
- Society of Broadcast Engineers
- Member, American Business Media
- Member, BPA International



Intertec Publishing Corporation

Cameron Bishop, *President & CEO*
Ron Wall, *Chief Operating Officer*
John Torrey, *Vice President, Entertainment Division*
Tom Cook, *Director of Editorial Development*
Stephanie Hanaway, *Div. Dir. of Marketing*
Doug Coonrod, *Corporate Creative Director*

PRIMEDIA Business-to-Business Group

David G. Fern, *President/CEO*

PRIMEDIA Inc.

Tom Rogers, *Chairman and CEO*
Charles McCurdy, *President*
Beverly C. Chell, *Vice Chairman*

BE RADIO (ISSN 1081-3357) is published monthly and mailed free to qualified recipients by INTERTEC, 9800 Metcalf, Overland Park, KS 66212-2215. Non-qualified persons may subscribe at the following rates: USA and Canada, one year, \$45.00; all other countries, one year, \$60.00 (surface mail), \$100.00 (air mail). Single copy price, \$10.00. Periodicals postage paid at Shawnee Mission, KS, and additional mailing offices. Canada Post International Publications Mail (Canadian Distribution) Sales Agreement No. 0956244. POSTMASTER: Send address changes to *BE Radio*, P.O. Box 12937, Overland Park, KS 66282-2937.

BE Radio is edited for corporate management, technical management/engineering and operations and station management at radio stations and recording studios. Qualified persons also include consultants, contract engineers and dealer/distributors of radio broadcast equipment.

Intertec Publishing makes portions of our subscriber lists available to carefully screened companies that offer products and services directly related to the industries we cover. Any subscriber who does not want to receive mailings from third-party companies should contact the Intertec subscriber service department at 800-441-0294 or 913-967-1707.

PHOTOCOPY RIGHTS

Authorization to photocopy items for internal or personal use, or the internal or personal use of specific clients, is granted by INTERTEC provided that the base fee of U.S. \$2.25 per copy, plus U.S. \$00.00 per page is paid to Copyright Clearance Center, 222 Rosewood Drive, Danvers, MA 01923. The fee code for users of the Transactional Reporting Service is ISSN 1081-3357/2000\$2.25+\$00.00.

For those organizations that have been granted a photocopy license by CCC, a separate system of payment has been arranged. Prior to photocopying items for educational classroom use, contact CCC at 978-750-8400.

Organizations or individuals with large quantity photocopy or reprint requirements should contact Reprint Management Services, 717-399-1900. Microfilm copies of *BE Radio* are available by calling/writing Bell & Howell Info & Learning, 300 N. Zeeb Rd, P.O. Box 1346, Ann Arbor, MI 48106-1346. Phone: 313-761-4700 or 800-521-0600.

CORRESPONDENCE

Editorial and Advertising: 9800 Metcalf, Overland Park, KS 66212-2215. Phone: 913-341-1300, Edit. Fax: 913-967-1905. Advt. Fax: 913-967-1904.

© 2000 by INTERTEC. All rights reserved.

INTERTEC
PUBLISHING
A PRIMEDIA COMPANY

Sales Offices

NATIONAL & INTERNATIONAL

Steven Bell

9800 Metcalf Avenue
Overland Park, KS 66212-2215
Telephone: (913) 967-1848
Fax: (913) 967-7249
E-mail: steven_bell@intertec.com

REGIONAL MARKETING MANAGER

Anna Bannister

9800 Metcalf
Overland Park, KS 66212-2215
Telephone: (913) 967-1947
Fax: (913) 967-1905
E-mail: anna_bannister@intertec.com

CLASSIFIED ADVERTISING

Brian Huber

Telephone: (800) 896-9939
(913) 967-1732
Fax: (913) 967-1735
E-mail: brian_huber@intertec.com

LIST RENTAL SERVICES

Lisa Dinkel

Telephone: (913) 967-1872
Fax: (913) 967-1897
E-mail: lisa_dinkel@intertec.com

EDITORIAL REPRINTS

Reprint Management Services

Telephone: (717) 399-1900
Fax: (717) 399-8900

Coming in the
December issue of

BE Radio

The Radio Technology Leader

Radio Online

Creating Content • Netcasting

Readers' Picks

A rundown of the products that have received the greatest reader response for more information.

RF Engineering

Care and feeding of transmission lines

Next Wave

The computing future

Contract Engineering

Getting new business

Managing Technology

Staffing the station

ALSO:

FCC Update, The Last Byte
and the Find-the-Mic contest.

Advertiser Index

	Page Number	Reader Service Number	Advertiser Hotline	Advertiser Website		Page Number	Reader Service Number	Advertiser Hotline	Advertiser Website
360 Systems	11	108	818-991-0360	www.360systems.com	JK Audio	76	150	800-JK-AUDIO	www.jkaudio.com
AETA Audio Corporation	12	109	973-659-0555	www.aetausa.com	Klotz Digital Ag	7	106	678-966-9900	www.klotzdigital.com
AKG Acoustics Inc	53	131	615-360-0499	www.akg-acoustics.com	Logitek	44	125	800-231-5870	www.logitekaudio.com
Antex Electronics	34	123	310-532-3092	www.antex.com	Mager Systems	32	121	623-780-0045	www.magersystems.com
Aphex Systems Ltd	19	114	818-767-2929	www.aphex.com	Mgmt Data Media Syst	103	102	540-341-8807	www.mdata-us.com
Armstrong Transmitters Corp	80	155	315-673-1269	www.armstrongtx.com	Mediatouch	22	116	204-786-3994	www.mediatouch.net
Arrakis Systems Inc	67	143	970-224-2248	www.arrakis-systems.com	Musicam	49	129	732-739-5600	www.musicamusa.com
Audioscience	52	130	302-324-5333	www.audioscience.com	MusicMusicMusic	79	154	416-537-2165	www.musicmusicmusic.com
Audiosonix	57	135	802-728-0044	www.audiosonix.com	Nagra USA	64	140	615-726-5191	www.nagra.com
Avcom of Virginia	70	146	804-794-2500	www.avcable.com	Neumann/Sennheiser	77	152	860-434-5220	www.neumannusa.com
Aztec Radiomedia	54	132	703-875-9100	www.aztec-radiomedia.com	NPR Satellite Services	15	111	202-414-2620	www.nprsat.org/nprss
Broadcast Electronics, Inc.	5	105	217-224-9600	www.bdcast.com	NSN Network Services	66	142	303-925-1708	www.nsn.net
Broadcast Software Intl	46	127	888-BSI-USA1	www.bsiusa.com	OMB America	75	149	305-477-0974	www.omb.com
Broadcast Supply Worldwide	47	128	800-426-8434	www.bswusa.com	Philips Broadcast Television	21	115	800-962-4287	www.broadcast.philips.com
Broadcast Technology Company	90	158	719-336-3902	www.broadcasttech.com	Prime Image	35-42	175	408-867-6519	www.primeimageinc.com
Broadcast Tools Inc	98	171	360-854-9559	www.broadcasttools.com	Prophet Systems Inc	18	113	877-774-1010	www.prophetsys.com
CCA Electronics	23	117	770-964-3530	www.cca.ws	Radio Computing Services	59	137	914-428-4600	www.rcsworks.com
Circuitwerkes	98	169	352-335-6555	www.circuitwerkes.com	Radio Systems	58	136	856-467-8000	www.radiosystems.com
Coaxial Dynamics	70	147	216-267-2233	www.coaxial.com	RF Specialties	56	134	816-628-5959	www.rfspec.com
Comrex Corp	9	107	978-263-1800	www.comrex.com	Sabre Communicatons	81	156	712-258-6690	www.sabrecom.com
Comrex Corp	31	120	978-263-1800	www.comrex.com	Studio Audio Digital (Sadie)	69	145	435-364-8888	www.sadie.com
Crown Broadcast	17	112	219-262-8900	www.crownbroadcast.com	Scott Studios Corp	45	126	800-726-8877	www.scottstudios.com
D H Satellite	96	164	608-326-8406	www.dhsatellite.com	Shively Labs	98	170	207-647-3327	www.shively.com
Digigram USA	30	119	703-875-9100	www.digigram.com	Sierra Automated Systems	65	141	818-840-6749	www.sasaudio.com
Digital Media Net	25		714-384-3058	www.DigitalMediaNet.com	Silicon Valley Pwr Amplifier	78	153	408-986-9700	www.svpa.com
Digital Media Net	43		714-384-3058	www.DigitalMediaNet.com	Sine Systems	92	160	615-228-3500	www.sinesys.com
Electronic Associates	81	157	915-595-3103	www.elecassoc.com	Strategic IT Solutions	33	122	513-860-9052	www.strategicit.net
Enco Systems Inc	13	110	248-476-5711	www.enco.com	Studer Professional Audio AG	63	139	411-870-7511	www.studer.ch
ESE	96	163	310-322-2136	www.eseweb.com	Studio Technology	97	166	800-676-0216	www.studiotechology.com
Full Compass Systems	55	133	800-356-5844	www.compassxpress.com	Superscope Technologies Inc	91	159	630-820-4800	www.marantz.com
Gorman Redlich Mfg Co	97	168	740-593-3150	www.gorman-redlich.com	Telos Systems	60,61	138	216-241-7225	www.telos-systems.com
Harris Corp	3	104	513-459-3400	www.harris.com	Telos Systems	71	148	216-241-7225	www.telos-systems.com
Harris Corp	26,27		513-459-3400	www.harris.com	TieLine America	93	161	317-259-8000	www.buytieline.com
Henry Engineering	76	151	626-355-3656	www.henryeng.com	Transcom Corporation	96	165	800-441-8454	www.trcorp.com
Industry Click	51	124	609-371-7759	www.digibid.com	V-Soft Communications	97	167	319-266-8402	www.v-soft.com
Industry Click	68	144	609-371-7759	www.digibid.com	Wheatstone Corporation	2	101	252-638-7000	www.wheatstone.com
Intertec Publishing	95,99		800-228-8606	www.intertec.com	Wheatstone Corporation	104	103	252-638-7000	www.wheatstone.com

Request free information with the Free Info card or go to www.beradio.com.

Learning to love the Deathstar, part 2

By Skip Pizzi, executive editor

Last month this column examined the coming of satellite radio and how it might affect the terrestrial radio environment. This time we'll consider how terrestrial radio might *benefit* from the launch of *S-DARS* (Satellite Digital Audio Radio Service).

First, consider that *S-DARS* proponents have long claimed that satellite radio listening would not substantially reduce terrestrial radio listening because *S-DARS*' primary audiences had already given up on local radio, and were largely cassette or CD users in the car. If this proves true, the ultimate result could actually be a net *benefit* to terrestrial radio. Because *S-DARS* receivers will also include AM and FM bands, if current non-listeners are brought back to the radio by *S-DARS*, they might occasionally tune over to the terrestrial bands as well. Thus *S-DARS* could actually *increase* local radio's audiences – or at least wash out some of the loss of existing listeners with new ones.

S-DARS could actually increase local radio's audiences in unexpected ways.

Much has been made about *S-DARS* being a digital service, implying that its audio quality will be superior to terrestrial radio. In reality, a considerable amount of data compression will be used by *S-DARS* services, which may render them indistinguishable in audio quality from FM radio for most listeners.

Nevertheless, terrestrial broadcasters might consider some movement toward more

voice-oriented programming on FM, such as all-news, news/talk and sports/talk.

Enhanced services

Because *S-DARS* radios will necessarily be addressable (to enforce subscriptions), the service will have the ability to deliver private messages or other customized data. It is not yet clear whether this type of service will be offered or highly developed by *S-DARS* service providers, but if so, this is an area where terrestrial radio will have difficulty competing directly.

The closest terrestrial radio can offer is RBDS service. Car radios that include *S-DARS* might also feature RBDS (as do some of today's high-end mobile receivers). By driving consumer demand for advanced receivers, *S-DARS* may provide the solution that RBDS has sought for so long in the US. Terrestrial broadcasters will then want to dust off their RBDS encoders and serve their audiences with localized data.

Finally, consider that the market is moving toward a "mobile media platform" that will bundle services that we think of today as separate: AM/FM radio (perhaps with RBDS and IBOC), cellular/PCS, GPS, *S-DARS*, CD/DVD, video games, mobile Internet browsers, etc. Just as today the AM/FM/cassette is considered a standard, singular device in the car, the mobile multimedia platform of tomorrow will likely be thought of as a monolithic system, with various tiers of quality and features. Terrestrial broadcasters should mine their important lode in this environment, tailoring programming and data offerings to cater to such a well-connected listener. This implies a smart wireless web presence and plenty of cross-promotion and partnerships with the other service and product providers for this integrated marketplace.

There is clearly life after *S-DARS* for the creative broadcaster. It won't be business as usual, but in some ways it could be even better than today.

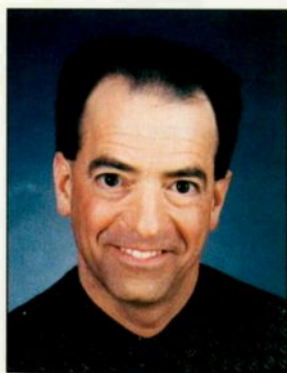

How terrestrial can compete

Last month we compared the cable TV transition to *S-DARS*, noting that most of the new cable TV channels did not duplicate the service of existing broadcast stations, choosing instead to focus on narrower pursuits (such as full-time movies, news, weather, sports, educational content, etc.) In sharp contrast, however, *S-DARS* services will generally compete head-to-head with local radio formats. Although this appears to make *S-DARS* a more direct threat to local radio, it's a two-edged sword: if a terrestrial broadcaster produces a quality product in its format and satisfies its audience, it can keep listeners from turning to *S-DARS*, since they won't find much programming that's different there.

Then, assuming programming quality is roughly equivalent, the most obvious remaining differences between *S-DARS* and terrestrial radio will be the fewer (or no) commercials on *S-DARS*, and the localized content of terrestrial radio. Oh, and of course, the subscription fee for *S-DARS*. Terrestrial broadcasters should therefore maximize their local advantage wherever possible, and minimize their commercial loads whenever possible. A "listener education" campaign stressing the value of local and *free* radio service could also help.

Control

Convergence

Connection

Management Data is a global developer and integrator of broadcasting systems for radio, television and the Internet.

We don't just sell products
We offer solutions

bringing people & technology closer together

Circle (102) on Free Info Card or online at www.beradio.com



MANAGEMENT DATA
MEDIA SYSTEMS INC

ndata-us.com

6193 Finchingfield Rd. Warrenton VA 20187 Tel 540.341.8550 Fax 540.341.8565

FOCUSED ON QUALITY

AUDIOARTS AUDIO CONSOLES



OUR MISSION — Make the BEST. And with thousands and thousands of our radio consoles already out there, we KNOW what you NEED. Choose from our extensive line of analog and digital consoles; take advantage of WHEATSTONE'S experience. Contact your local AUDIOARTS dealer — or visit our website!



AUDIOARTS ENGINEERING