

# The Bell System Technical Journal

April, 1932

---

## A New Key West—Havana Carrier Telephone Cable \*

H. A. AFFEL, W. S. GORTON and R. W. CHESNUT

A new submarine cable has recently been laid between Key West and Havana in order to furnish more telephone facilities between the United States and Cuba. The cable has a single central conductor with concentric tape return and employs the newly developed material paragutta for insulation. A carrier telephone system provides three telephone channels. As ultimately developed a still greater number of facilities may be made available over the cable.

IN January 1931, telephone service was inaugurated over a new submarine cable to Cuba, spanning the hundred-mile or more stretch of deep water between Key West and Havana. Telephone service to Cuba dates back about 10 years earlier when three continuously loaded cables were laid between Key West and Havana. These cables and their associated terminal apparatus were completely described in a paper <sup>1</sup> by Martin, Anderegg, and Kendall, presented to the Institute at its midwinter convention in 1922. The new cable, like the earlier ones, is owned by the Cuban-American Telephone and Telegraph Company, an organization controlled jointly by the American Telephone and Telegraph Company and the Cuban Telephone Company for the purpose of providing telephone facilities between the United States and Cuba.

In the past decade the communication art has advanced in many respects so that three telephone circuits are provided by carrier operation, using high frequencies, over this single improved type cable which is not much larger than one of the three earlier cables.

The three telephone channels now made available are connected to carrier telephone channels operating on open-wire lines northward to Washington and thence over four-wire cable circuits to New York where they terminate as New York-Havana circuits. The telephone circuits derived from the three older cables now terminate at Miami or Key West, where they may be switched to other distant points.

The new cable was designed to satisfy economically the initial need

\* Presented at A. I. E. E. Midwinter Convention, Jan. 25-29, 1932, New York, N. Y.

<sup>1</sup> "Key West—Havana Submarine Telephone Cable System," *A. I. E. E. Trans.*, Vol. 41, p. 1, 1922.

for more circuits by an adaptation of standard carrier apparatus. (The design was made sufficiently liberal so that when still more facilities are required certain further development work should make it possible to obtain them over the same cable.) From a transmission standpoint, the feature of most interest is the unusually low receiving levels at which operation is successfully carried on.

### *The Cable*

The new cable, which has been designated the 1930 cable, is the longest deep sea telephone cable in existence and is also unique in being the longest telephone cable circuit without intermediate repeaters and without inductive loading. It is somewhat longer (3.7 nautical miles \*) than the longest of the 1921 cables and is operated over a far wider frequency range. The new cable operates at frequencies up to about 28,000 cycles per second, and can operate up to a still higher frequency, whereas the old cables are operated only up to 3,800 cycles per second. The longest deep sea carrier frequency cable before the laying of the present cable was that connecting Tenerife with Gran Canaria in the Canary Islands. This cable<sup>2</sup> is non-loaded and is intended to utilize approximately the frequency range now utilized by the new cable but is much shorter, being only 39.7 nautical miles in length.

### *Paragutta*

The feature of the new cable which has enabled this great improvement to be attained is the insulation, which is of paragutta. This material was developed at the Bell Telephone Laboratories and is composed of deproteinized rubber, deresinated balata, and wax. It has been described in detail by A. R. Kemp.<sup>3</sup> Heretofore submarine cables having waterproof insulation, with the exception of the Catalina Island cables<sup>4</sup> which are insulated with a special rubber mixture, have almost invariably been insulated with gutta percha, or balata, or a mixture of these substances. Paragutta has better electrical properties than any of these materials.

Some idea of the improvement represented by paragutta can be had from Table I which lists the significant a-c. electrical properties

\* One nautical mile = 6087 feet (1855 meters).  
= 1.1528 statute miles.

<sup>2</sup> "Tenerife-Gran Canaria and Algeciras-Ceuta Submarine Cables," K. E. Latimer and J. R. Vezey, *Electrical Communication*, Vol. 9, p. 226, 1931.

<sup>3</sup> "Paragutta, a New Insulating Material for Submarine Cables," *Journal of the Franklin Institute*, Vol. 211, p. 37, 1931.

<sup>4</sup> "Carrier Current Communication on Submarine Cables," H. W. Hitchcock, *A. I. E. E. Transactions*, Vol. 45, p. 1169, 1926.

of representative submarine cable insulations. It is evident from these figures that the use of paragutta effects a considerable reduction in the size of a cable for a given attenuation, not only for telephone cables but also for telegraph cables. This decrease in size is due both to the smaller dielectric constant and to the smaller leakance.† The smaller dielectric constant is equally effective in reducing the size of both loaded and non-loaded cables. The smaller leakance is especially

TABLE I  
COMPARATIVE ELECTRICAL PROPERTIES OF GUTTA PERCHA AND PARAGUTTA INSULATIONS OF SUBMARINE CABLES AT 22 KILOCYCLES PER SECOND UNDER SEA BOTTOM CONDITIONS

	Dielectric Constant	Ratio of Leakance to Capacitance
Gutta Percha (telegraph cable) . . . . .	3.3	4040
Gutta Percha as used in 1921 Key West-Havana Cables. . . . .	3.1	—
Gutta Percha as used in Tenerife-Gran Canaria and Algeciras-Ceuta Telephone Cables * . . . . .	2.92	3815
Paragutta (Key West-Havana 1930 Cable) . . . . .	2.67	229

\* Electrical Communication, Vol. 9, p. 217, 1931.

important in the case of loaded cables. The decrease in size due to the use of paragutta varies, of course, with the size of the cable. Some idea of its amount may be obtained from the fact that a cable insulated with gutta percha of the sort used in the 1921 cables would weigh 45 per cent more and cost about 65 per cent more than the new cable,

The use of this new material in the manufacture of a cable gave rise to numerous problems, one of which deserves particular mention, namely that of jointing the paragutta. A new technique of jointing was developed which not only produces good joints in paragutta-insulated cable but also produces better joints in gutta percha-insulated cable than can be made by the conventional process which has been in general use since gutta percha cables were first manufactured.

*Cable Design*

The 1930 cable is similar in type to the 1921 cables except that it is not loaded. It is provided with copper return tapes<sup>5</sup> and also with a thin copper tape under the return tapes for protection against marine organisms. The principle of the electrical design of the cable was to strike an economic balance between all of the factors affecting the attenuation and thus to secure a cable of the desired attenuation at the lowest possible cost. The result of this procedure is a core structure having a much greater thickness<sup>6</sup> of insulation compared

† The term leakance, as used here, includes all energy losses in the dielectric.  
<sup>5</sup> "Transmission Characteristics of the Submarine Cable," Carson and Gilbert, *Journal of the Franklin Institute*, Vol. 192, p. 705, 1921.  
<sup>6</sup> British Patent No. 343093, May 7, 1931.

with the diameter of the central conductor than is the case with low-frequency cables, either telephone or telegraph. The particular factor contributing to this result is the large skin effect, which occurs prin-

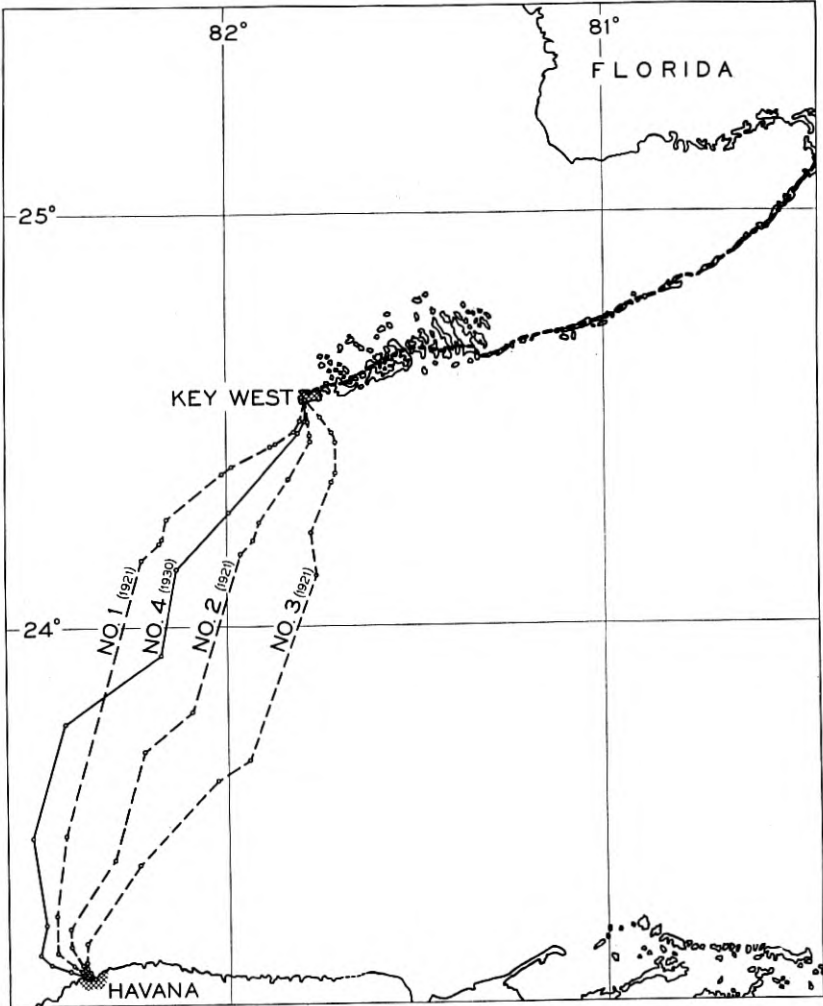

Fig. 1—Submarine telephone cables between Key West and Havana, and U. S. land line connection.

cipally in the central conductor but also appreciably in the return tapes. The ratio of the a-c. to the d-c. resistance increases at a rapid rate if the central conductor and return tapes are made heavy in an attempt to reduce the weight of the insulation. At carrier frequencies

the effect of the armor wire is negligible from the attenuation standpoint. Magnetic modulation due to the presence of the armor wire was investigated carefully and likewise found to be negligible. The lay, or pitch, of the copper return tapes was made much longer <sup>7</sup> than was the case in the 1921 cables. This brought about a substantial decrease in the effective resistance of the tapes themselves and reduced the eddy-current losses which are due to the helical nature of the return tapes.

In all matters of mechanical design accepted cable practice was followed. A discussion of some of the mechanical features of cable design, as well as some account of the general submarine cable problem,

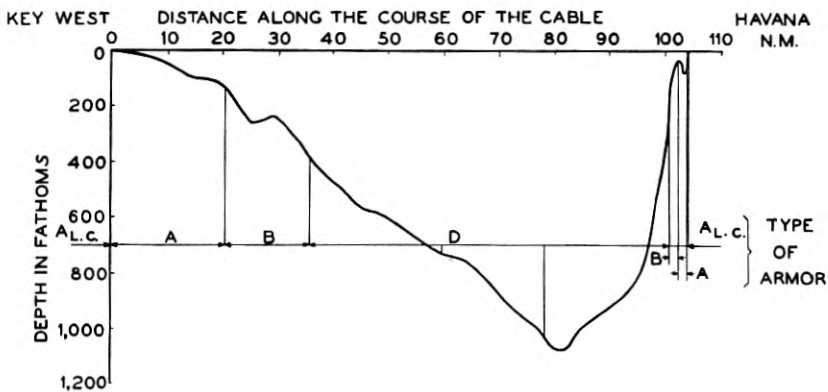

Fig. 2—Depth of water along route of cable.

has been given by Martin, Anderegg, and Kendall in the paper above referred to.

The new cable is 108.6 nautical miles (125.2 statute miles) in length. It was manufactured by the Norddeutsche Seekabelwerke-A.G. of Nordenham, Germany and laid by their cable steamer "Neptun." Its route is shown in Fig. 1, and the profile of the route in Fig. 2. The maximum depth attained is 1080 fathoms (6480 feet). The particulars of the core structure are given in Table II and those of the armor in Table III. Cross-sections of the various types of cable are shown in Fig. 3. A photograph of three of the types is shown on Fig. 4. The attenuation of the cable and its characteristic impedance are shown in Figs. 5 and 6, respectively. The attenuation is characteristic of a non-loaded cable in that it increases rapidly at low frequencies but less rapidly at high frequencies whereas the reverse is true, in a

<sup>7</sup> U. S. Patent No. 1700476, January 29, 1929.

general way, of the loaded cable. This is shown by the attenuation curve of one of the 1921 cables which is given in Fig. 5 for comparison. The d-c. properties of the laid cable are shown in Table IV.

TABLE II  
CORE STRUCTURE OF KEY WEST-HAVANA CABLE NO. 4

Central Conductor	
Central Wire.....	Diameter .138 in.
Surrounds.....	6 tapes .0142 in. $\times$ .079 in.
Weight of Whole.....	505 lbs./n.m.
Diameter of Whole.....	.167 in.
Impregnating Compound.....	.0024 in. thick
Insulation	
Weight (Including Compound).....	677 lbs./n.m.
Outer Diameter.....	.614 in.
Fabric Tape.....	.010 in. thick
Protective Tape (Copper).....	1 in. $\times$ .004 in. with 10% overlap
Weight.....	209 lbs./n.m.
Return Conductor.....	6 tapes .319 in. $\times$ .019 in.
Weight.....	845 lbs./n.m.
Outer Diameter.....	.681 in.
Ozokerite Tape	
Outer Diameter.....	.704 in.

TABLE III  
ARMOR FOR KEY WEST-HAVANA CABLE NO. 4

Type of Armor	Length Laid n.m.	Armor Wires		Weight of Completed Cable		Outer Diameter of Cable (Inches)
		No. of Wires	Diameter (Inches)	(1) Wet (lbs.)	(2) In Water (per n.m.)	
A <sub>l.c.</sub> .....	.40	13	.300	29300	21660	1.93
A.....	21.94	12	.300	24000	17380	1.81
B.....	17.50	16	.200	16140	11000	1.57
D.....	68.79	22	.104 e.w.t.	8990	5115	1.30

l.c. = lead covered.  
e.w.t. = each wire taped.

TABLE IV  
CONDUCTOR RESISTANCE, DIELECTRIC RESISTANCE AND D-C. CAPACITY OF KEY  
WEST-HAVANA CABLE NO. 4 AS LAID

Conductor (Central) Resistance.....	242 ohms
Dielectric Resistance.....	1090 megohms
Capacity.....	22.52 microfarads

One respect in which the present cable differs from the 1921 cables is that it has a single-core termination instead of an unbalanced-type twin-core termination.<sup>8</sup> Experience with the 1921 cables has shown

<sup>8</sup> "Extraneous Interference on Submarine Telegraph Cables," J. J. Gilbert, *Bell System Technical Journal*, Vol. 5, p. 404, 1926.

that there is no advantage from the standpoint of the reduction of atmospheric and other extraneous interference to be had from the use of an unbalanced twin-core termination in a cable provided with copper return tapes. A balanced twin-core termination would be effective in reducing interference but certain disadvantages would be

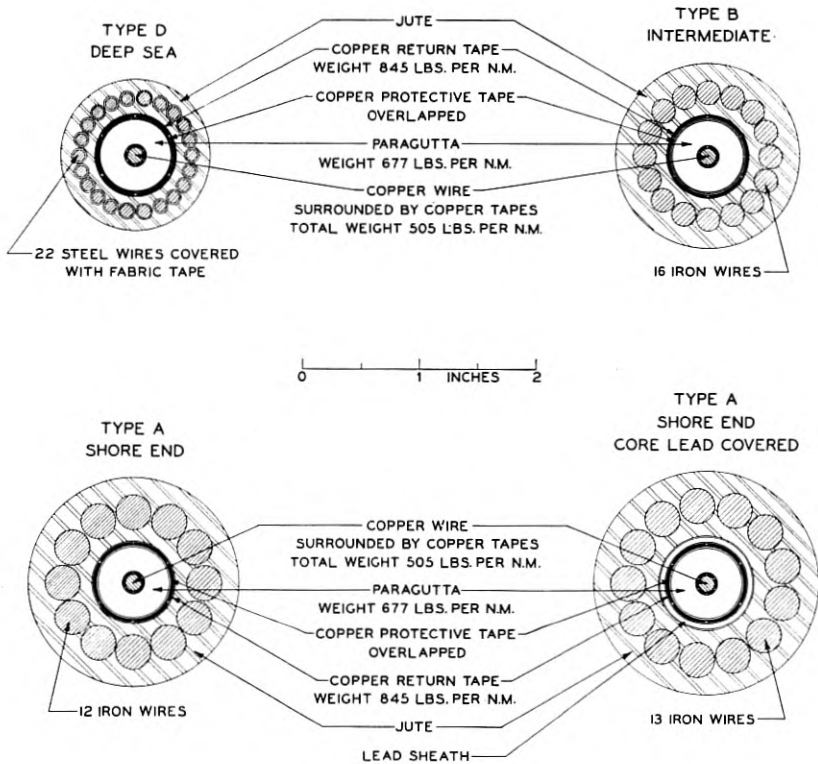

NOTE:—THE WEIGHTS GIVEN ARE IN POUNDS PER NAUTICAL MILE (1.153 STATUTE MILES).

Fig. 3—Cross-sections of the various types of cable.

connected with its use. Very little shielding beyond that naturally furnished by the sea water is needed and that additional amount is furnished by a wrought iron pipe enclosing the cable between the cable hut and the level of the lowest tides.

### Carrier System

As noted previously, in providing carrier apparatus to make use of the high-frequency transmission properties of the new cable, an effort

was made to use existing standard types of equipment as far as possible. The three telephone channels are now obtained by an adaptation of carrier apparatus ordinarily<sup>9</sup> used for long-distance transmission over open-wire lines.

The six frequency bands (one for each direction for the three channels) are allocated as shown in Fig. 7. A d-c. telegraph channel is also indicated. This figure likewise shows the frequency allocation of the one telephone and four telegraph channels (three carrier and

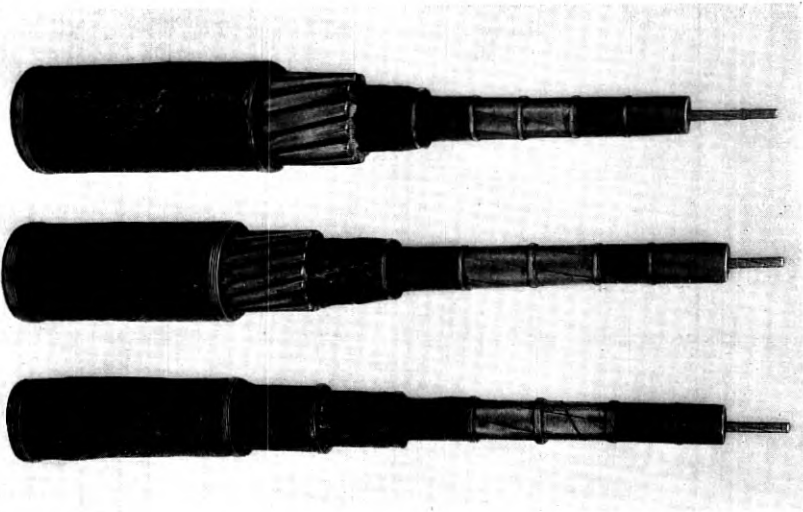

Fig. 4—Shore end (core not lead covered), intermediate, and deep sea types of cable.

one direct current) now carried over each of the three older cables. It will be noted that the band width of the new telephone channels is considerably greater than that of the old ones, thus furnishing higher quality speech transmission. In addition, a considerable range of frequencies remains unused on the new cable. This range may be developed when additional message telephone, broadcasting, or telegraph facilities are needed.

In adapting the existing type carrier apparatus for operation over the new cable, the problems consisted chiefly in (a) providing for satisfactory transmission over a circuit of considerably higher attenuation than the apparatus was originally designed for and (b) providing the

<sup>9</sup> "Carrier Systems on Long Distance Telephone Lines," Affel, Demarest and Green, *A. I. E. E. Transactions*, Vol. 47, p. 1360, 1928.



necessary transformers to connect together the parts of the circuit having different impedances.

The carrier apparatus is installed in existing telephone offices at Key West and Havana. In each case the office is somewhat over one mile from the cable hut at the water's edge. The submarine cable circuit is connected to the apparatus in the offices through pairs of wires in an underground cable of the paper-insulated lead-covered type, which also carries the circuits of the older cables. In Fig. 8

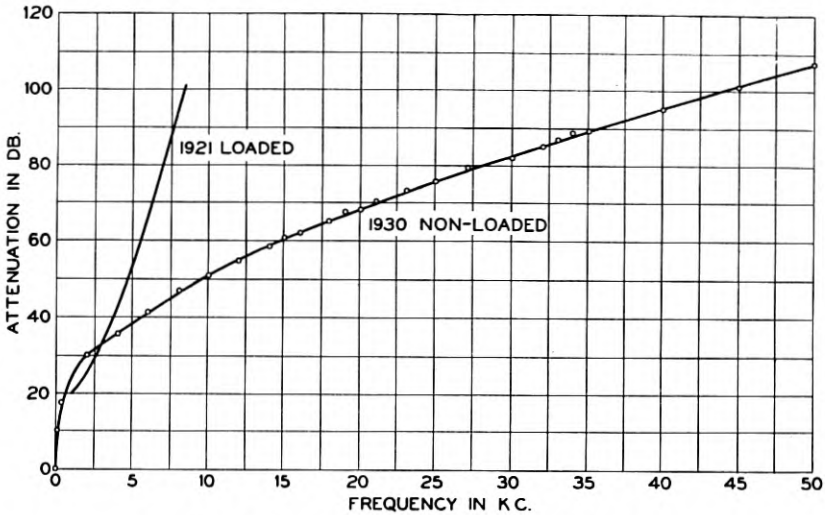

Fig. 5—Attenuation of 1921 and 1930 cables.

are shown schematically the connections of the whole cable communication system. The arrangements are practically identical at the two terminals except for differences incident to the fact that different frequency bands are transmitted in the two directions.

Certain coils and condensers are located at the cable hut. A transformer connects the unbalanced 50-ohm submarine cable to the balanced-to-ground 130-ohm pair in the lead-covered cable. The other coils and condensers form a "composite set" which connects the submarine cable to a second pair in the lead-covered cable in order to transmit direct current. This may be used as a d-c. telegraph channel or as an insulation testing circuit.

The carrier equipment in the telephone office may be considered in two categories: (a) that which is derived from standard open-wire carrier systems as described in the paper previously referred to, and (b) that which is additional and special for this installation.

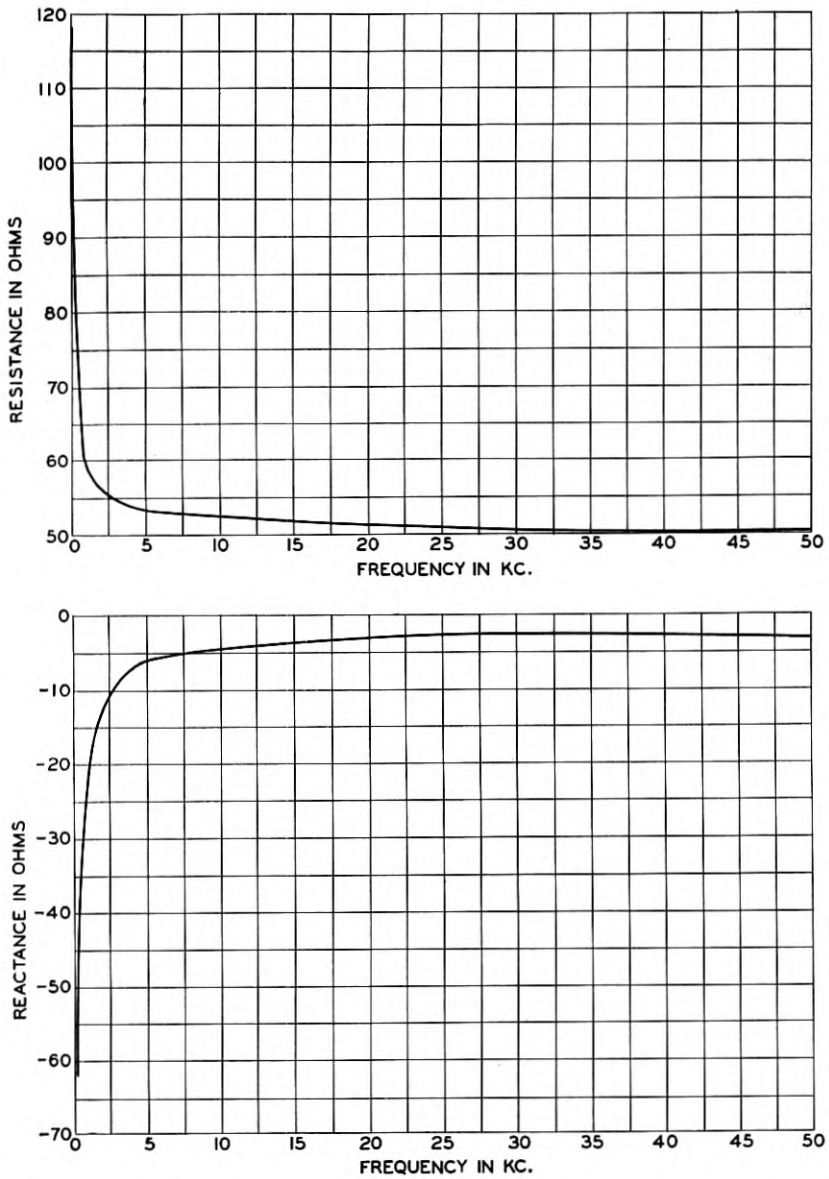

Fig. 6—Impedance of 1930 cable, terminated in its characteristic impedance at Havana, as measured at Key West.

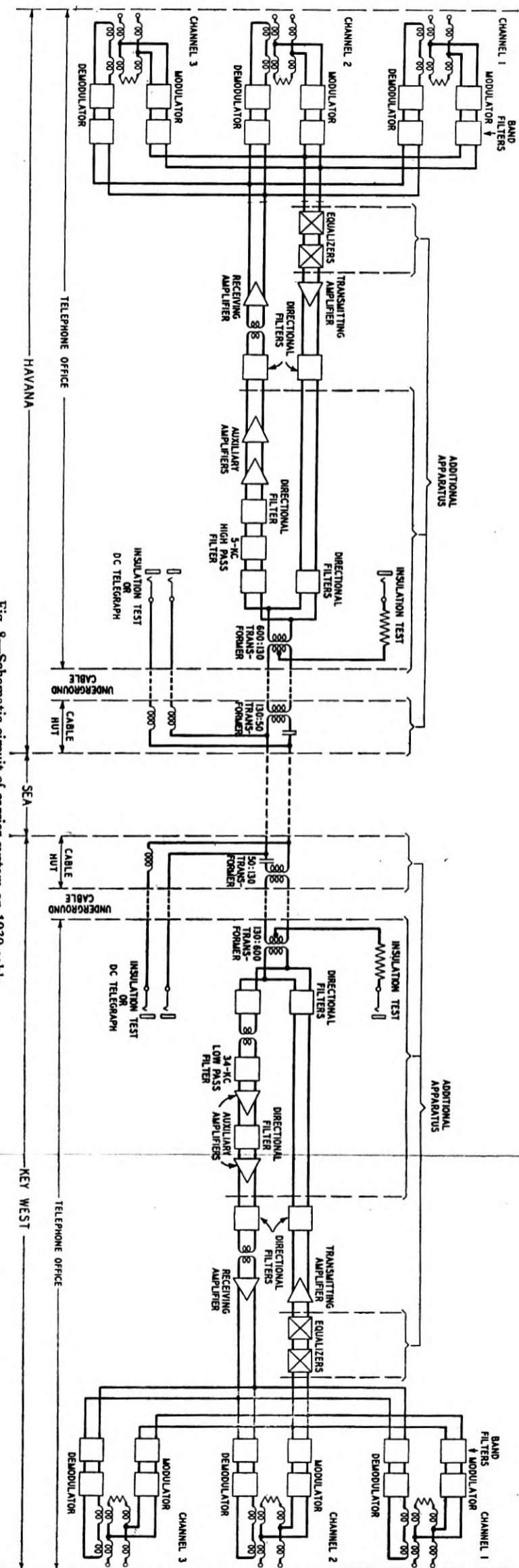

Fig. 8—Schematic circuit of carrier system on 1930 cable.

The additional equipment consists chiefly of added receiving amplifiers and directional filters to care for the greater gain and selectivity needed to operate at the higher attenuation. It includes also equalizers which correct for the varying attenuation of the cable with frequency and a transformer to connect the 600-ohm apparatus to the 130-ohm pair in the underground lead-covered cable. Also, at Key West, a 34-kc. low-pass filter was added to suppress interference from a local radio station having a frequency of about 100 kc. At Havana, a 5-kc. high-pass filter was added to suppress certain relatively low-frequency noises picked up by the circuits in the underground cable.

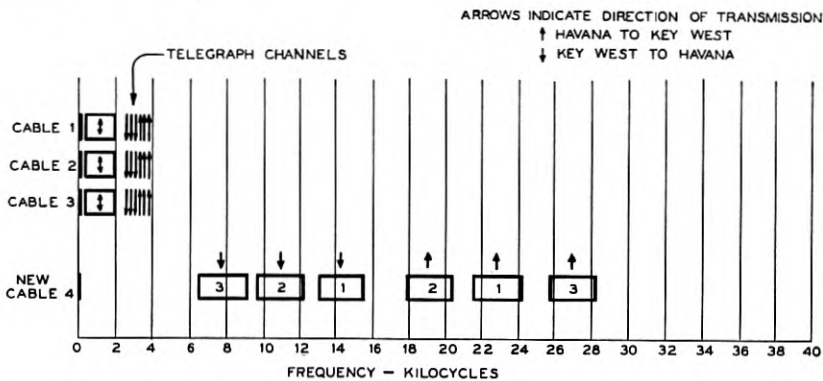

Fig. 7—Frequency allocation of communication channels on Key West-Havana cables.

A photograph of the apparatus installed in the Key West office is shown in Fig. 9. It will be noted that this consists of four “bays” of apparatus, the three nearer of which are practically the same as the carrier equipment ordinarily supplied on long-distance telephone circuits. The fourth bay has the special amplifying and equalizing equipment previously mentioned. A rear view, Fig. 10, shows the interior of one of the special amplifiers, including certain of the special impedance-correcting transformers. Apparatus of a similar nature is installed at Havana.

*Certain Transmission Problems*

Fig. 11 shows the relative energy of the carrier-frequency speech currents as they traverse the circuit from Havana to Key West. In this direction the higher carrier frequencies are employed. Starting from the left of the diagram, the toll switchboard point, which is taken as zero level, the current of a channel suffers a loss of 9 db in a re-

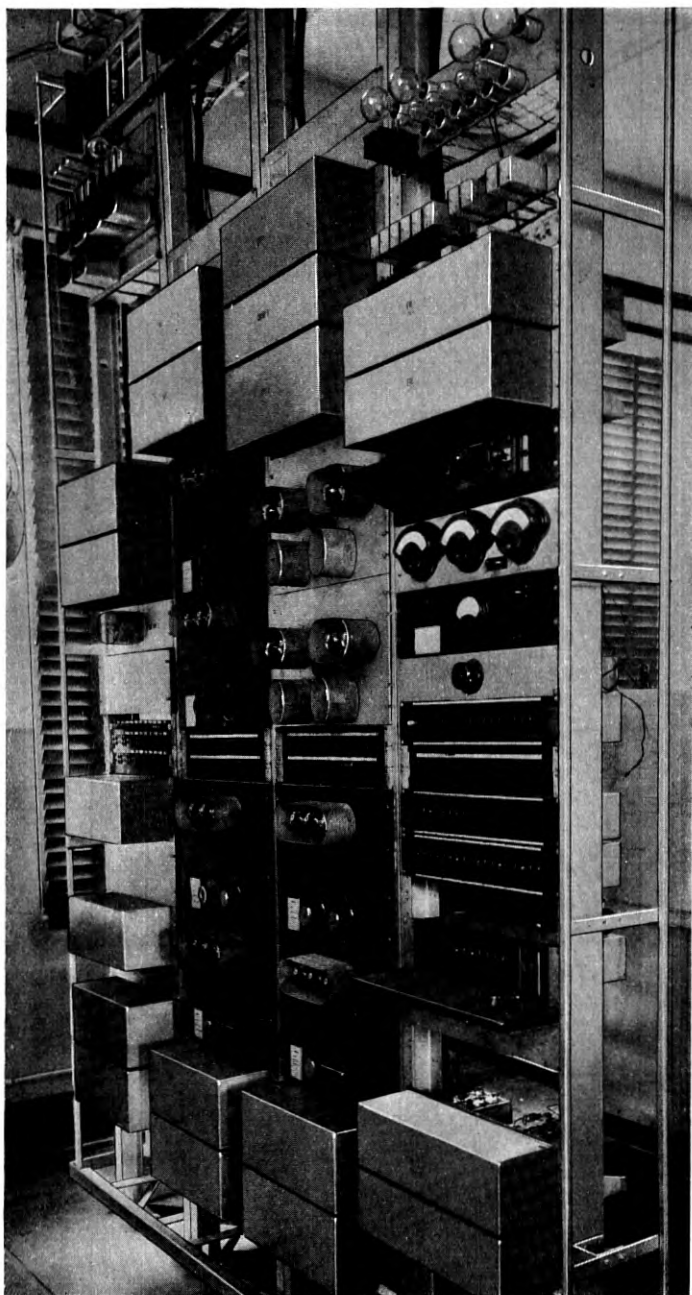

Fig. 9—Carrier terminal apparatus at Key West.

sistance attenuator which is introduced in the circuit to give flexibility in control. This loss can be reduced in value to improve transmission in the case of connections to distant points. As the speech currents enter the carrier apparatus they receive, in addition to the frequency

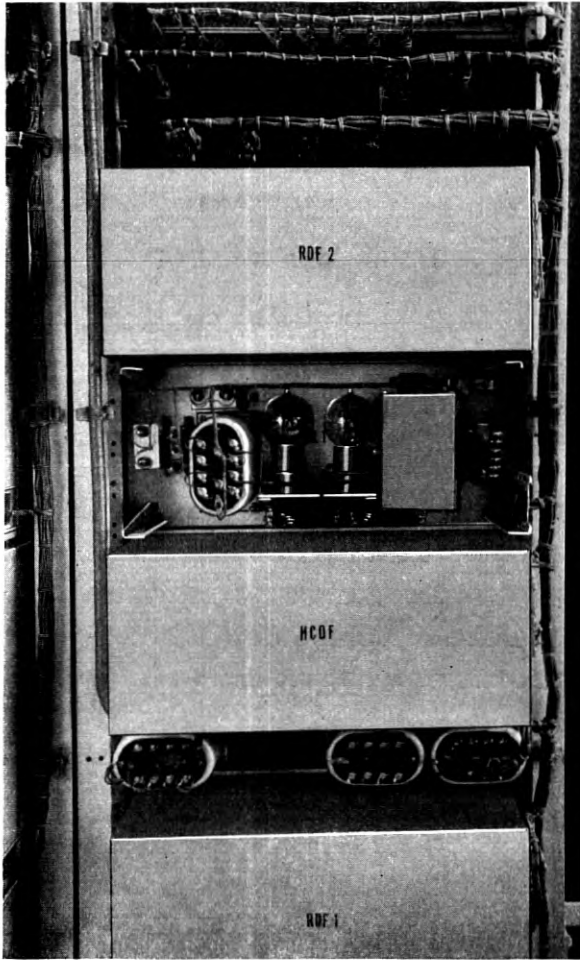

Fig. 10—Rear view of carrier terminal apparatus at Key West showing special amplifier and transformers.

change, an amplification of from 5 to 10 db in the modulator unit and from 10 to 20 db in the transmitting amplifier. The highest frequency channel receives the highest gain and leaves the common transmitting amplifier at a level about 20 db higher than at the toll switchboard.

From here the currents leave for Key West by way of the underground cable, the cable hut, and the submarine cable.

The highest frequency channel is attenuated somewhat over 80 db by the time it reaches the receiving apparatus at Key West. Here it is stepped up about 70 db by the amplifiers, from the output of which it suffers a few db loss in the demodulator circuit and 9 db loss in the receiving attenuator circuit. If the connection is continued to another toll office, such as Miami or New York, this attenuator is adjusted to give a 9 db loss between the hybrid coil at Key West and the receiving toll switchboard in question.

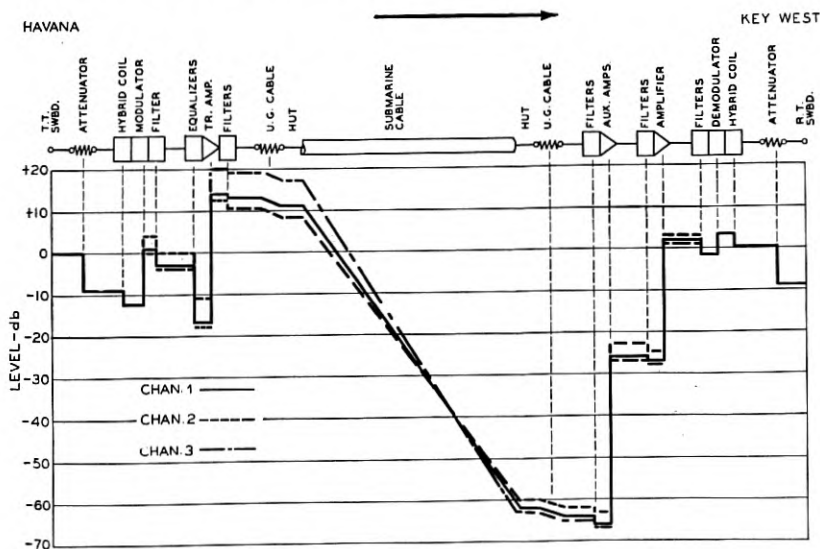

Fig. 11—Relative transmission levels in circuit from Havana to Key West.

The problem of satisfactory transmission of the speech currents in this path involves several specially critical points. The transmitting amplifier must amplify to the high levels required without modulating sufficiently to produce troublesome new frequencies falling within its own group of frequency bands. New frequencies produced by the amplifier and falling outside this group are suppressed by the directional filters and cause no trouble. Additional possible sources of modulation are the directional filters and impedance matching transformers. They must transmit the high level currents coming from the amplifier but must not modulate them sufficiently to produce troublesome new frequencies falling within the oppositely directed group of bands. The latter are at an exceedingly low level and so the modula-

tion in these circuit elements must be kept extremely small. Some ordinary resistances, mica condensers, etc., have been found to have enough modulation to be serious. Ordinary iron core transformers are likely to be very bad. Special design was required to reduce the modulation in the impedance matching transformers to tolerable limits.

#### *Noise Prevention*

As noted previously, at the receiving end the important problem is naturally to keep the low level receiving circuit free from interference. In taking the necessary precautions along these lines, a large number of sources of noise were investigated. These included crosstalk from other carrier telephone or telegraph systems, high-frequency oscillations set up by d-c. telegraph apparatus in the vicinity, radio stations, power wires, submarine telegraph cables, and many minor sources.

Space requirements prevent a complete discussion of this work but a tabulation of a few of the remedial measures may be interesting.

- Special filters in all telephone office power supply sources.

- Special shielding arrangements in the construction of the receiving amplifiers.

- Series "choke" coils in all the d-c. telegraph circuits which enter the underground cable.

- D-c. telegraph apparatus in the office with special "spark-killer" and high-frequency suppression units.

- Frequency limiting apparatus in the Commercial Cable Company's submarine telegraph circuit.

- Frequency limiting filters in the carrier telegraph circuits of the 1921 cables.

- Special shielding to reduce induction from the other carrier telephone equipment in the terminal offices.

- Improvement in the balance (to ground) of some of the apparatus previously installed.

- Various special grounds in the apparatus and cable circuits both at the telephone office and in the cable hut.

Of particular interest was the case where the Commercial Cable Company's submarine telegraph circuits from Havana to New York, a communication facility of low inherent frequency range, interfered with the carrier channels, having frequencies up to 28 kc., by induction in the underground cable through which both circuits passed. In this case, by the generous cooperation of the Commercial Cable Company, frequency limiting equipment was added to their cable transmitter.



The application of these various measures served to reduce the total noise manifest at Key West and Havana by a factor of from 40 to 60 db so that as now operated the noise from all other sources is of the same order of magnitude as that picked up in the submarine cable itself, which is extremely small at the high frequencies. It approaches that of the Johnson effect<sup>10</sup> or so-called resistance noise, in which the conductor itself acts as a source of voltage fluctuations which are distributed uniformly over the whole frequency spectrum. The Johnson effect presents a definite lower level limit to all communication circuits.

#### *Future Possibilities*

The present arrangements do not represent the ultimate possibilities in communication facilities which the new cable affords. As previously noted, if traffic requirements continue to grow, so that more facilities are required, a wider frequency range may be employed and additional channels obtained. Certain further development work will be required and it is believed that at least three more telephone channels can be provided. In addition, if telegraph circuits are required, carrier telegraph systems may be operated in place of one or more of the telephone channels. For example, if the ultimate capacity of the cable is a total of six telephone channels, a possible arrangement would be to employ two of these telephone channels for carrier telegraph circuits. The cable may then carry simultaneously a total of four telephone messages and 24 or more two-way telegraph messages.

<sup>10</sup> "Thermal Agitation of Electricity in Conductors," J. B. Johnson, *Physical Review*, July 1928, p. 97-109.

# Cellulose Acetate Treatment for Textile Insulation— Engineering Development

By E. B. WOOD and D. R. BROBST

The development of a cellulose acetate lacquer treatment for textile insulated wire has made available an improved type of wire for telephone central office use. The desired improvement in electrical characteristics is obtained when the textile fibers are laid down and covered by the cellulose acetate film.

The accompanying graphs show the comparative electrical characteristics at various humidities, of wires insulated with commercial and purified cotton and silk servings, before and after treatment with cellulose acetate lacquer.

## INTRODUCTION

THE improved standards of transmission required for present-day telephone communication have greatly increased the importance of improved electrical characteristics for telephone central office wire insulation. At the same time the tremendous growth of telephone systems, together with the increase in complexity of central office equipment due to the introduction of dial switching apparatus, has increased the quantity of insulated wires required to such an extent that the use of comparatively cheap materials is a matter of large economic importance. Silk and cotton yarns applied in the form of wrappings or braidings have been the standard materials for telephone central office wire insulation for many years. These materials in proper combinations and supplemented in certain cases by enamel and impregnating waxes provide sufficient dielectric strength to withstand the comparatively low voltages employed to operate telephone apparatus. This type of insulation also fulfills certain controlling mechanical requirements, in that it occupies small space, is not easily damaged by normal handling and can be applied in a large number of color combinations. On the other hand, there are disadvantages attendant upon the use of textile insulation, the most serious of which is the wide variation in insulating properties of such materials under different conditions of atmospheric humidity and temperature, caused mainly by changes in the moisture content of the materials.

The efforts which have been made to improve textile insulation in this respect have had a two-fold objective, namely, to provide at moderate cost a super-quality insulation for use where it is important to have the best electrical characteristics obtainable, and to improve

cotton sufficiently to permit its use instead of silk as far as possible for general purposes. The latter has considerable direct economic importance because of the large difference in cost of insulating silk and cotton and the quantities of the materials involved.

Within the past three years, two methods of improving the electrical characteristics of textile insulation have been brought into commercial use. The first is the purification of silk and cotton whereby electrolytic impurities such as sodium and potassium salts inherent in the commercial materials are removed by a simple and inexpensive washing process.<sup>1</sup> The second is the treatment of textile insulated wire with cellulose acetate, which is the subject of discussion in this paper and the contemporary paper "Cellulose Acetate Treatment for Textile Insulation-Development of the Manufacturing Process" by Messrs. C. R. Avery and H. Kress.

Cellulose acetate became of interest in connection with insulation problems several years ago, when it was investigated in the form of artificial silk for use as a substitute for natural silk in wire and cable insulation. At that time, the material was found to possess excellent electrical characteristics and satisfactory stability, but it did not prove to be economically satisfactory as a general substitute for silk because the physical characteristics of the yarn made its use on standard high speed insulating machinery difficult. Application of the material in the form of a lacquer to cotton or silk insulation appeared to offer more promise and has proven advantageous, as will appear from the following discussion. The treatment, as now applied to telephone central office wire insulation, consists in the formation of a coating of the material on the textile insulated conductor, by passing the conductor through an acetone solution of pure cellulose acetate and subsequent evaporation of the solvent. Pure cellulose acetate without the addition of a plasticizer is used, because thus far it has been found more satisfactory than a compounded material as regards the controlling requirements for central office wire insulation, namely good electrical characteristics, slow burning properties and stability. Therefore, this discussion is confined to the characteristics and use of the pure material.

#### PROPERTIES OF CELLULOSE ACETATE

In the investigation of a material to be used for insulating purposes, it is necessary to examine the processes by which the material is manu-

<sup>1</sup>"The Predominating Influence of Moisture and Electrolytic Material upon Textiles as Insulators," R. R. Williams and E. J. Murphy, *A. I. E. E. Transactions*, April, 1929. "Purified Textile Insulation for Telephone Central Office Wiring," H. H. Glenn and E. B. Wood, *A. I. E. E. Transactions*, April, 1929.

factured to determine whether there is anything inherent in these processes which would affect the use of the product. This is particularly pertinent in the case of an insulating material which is to be used for a period of twenty years or more, as in a telephone exchange.

The manufacture of cellulose acetate is described briefly by the following operations:

In the first or acetylation process, cellulose fibers, usually cotton, are treated with glacial acetic acid and acetic anhydride, together with a catalyst such as sulphuric acid, until the fibers are completely acetylated and pass into solution. The acetate obtained at this stage is brittle, of low tensile strength and insoluble in the commercial solvents. Therefore, the solution is subjected to a hydrolizing process in which water is added and the mixture allowed to stand until hydrolysis has been carried to the point at which the cellulose acetate becomes acetone soluble. The acetyl content is somewhat reduced in this step and serves as an index to the extent of hydrolysis. The solution is then poured into water and the cellulose acetate precipitated, after which it is given a purification treatment until the mass is free from acid and then dried in warm air.

The completed product is a porous, flaky mass, white in color, which, when dissolved in acetone, gives a solution nearly colorless but with a slight amber tinge.

From the above outline of the processes of manufacture, the importance of the acetyl content of the product is obvious. If the acetyl content is too high, the material is not soluble in acetone and if the acetyl content is too low, the hydrolysis has been carried too far and the acetate becomes partly soluble in water. Such an acetate would be unsatisfactory for insulation on account of inferior electrical characteristics under humid atmospheric conditions.

By changes in control of the acetylation and hydrolizing processes various kinds of cellulose acetate may be obtained which, with the same general composition and acetyl content, give different viscosities of solution when dissolved in a solvent. For example, films for experimental purposes have been made from cellulose acetates which vary in viscosity as much as a hundred fold with the same proportions of cellulose acetate and solvent. For lacquer and films, a low viscosity acetate is employed, while for plastics, cellulose acetates of high viscosity are usually specified.

For use as insulation, it is necessary that the acetate be stable throughout the life of a telephone exchange. In other words, it must retain its good electrical characteristics and transparency for a period of twenty years or more though exposed, as it will be, to variations of

temperature, indoor sunlight exposure and atmospheric moisture. From the standpoint of stability, especially as regards a possible increased rate of deterioration with time, it is important that the material shall be essentially free from impurities which might be introduced in the acetate manufacturing process.

Cellulose acetate film has very desirable electrical properties characterized by high dielectric strength, low conductivity and low a-c. capacitance and conductance. It absorbs much less moisture than silk, cotton or wool. It has a specific gravity of about 1.25 and a dielectric constant of from 5.5 to 6.0 at 1,000 cps. under atmospheric conditions of 70° F. and 50 per cent relative humidity.

The acetate film is strong and tough and not easily injured by handling. The transparency of the film is such that the colored threads used in the color scheme for identification purposes in telephone wires and cables can be readily seen through the acetate coating.

Cellulose acetate film is very stable under normal conditions and when exposed to artificial aging tests. Tests made in the Laboratories with acetate film exposed to high humidities and high temperatures for several years indicated that there was very little deterioration of the film in its electrical or other physical properties. The electric characteristics of the film were not appreciably affected by this exposure and no discoloration of the film was apparent.

As compared to cellulose nitrate, cellulose acetate is a much more desirable material on account of its slow-burning characteristics, and the fact that the gases given off on the combustion of the acetate are comparatively non-toxic. From these standpoints the hazards involved in the use of the nitrate preclude its use in the telephone central office. Acetate film does not turn yellow with age to the same extent as the nitrate film.

Pure cellulose acetate film is somewhat hard and brittle. This is, of course, a disadvantage because it tends to make the treated wire less flexible than wire with untreated insulation which introduces new problems in the handling of the treated wire. A large amount of work has been done with a view to obtaining a plasticizer for cellulose acetate which will add the property of flexibility to the film without affecting the desirable characteristics which the pure acetate film now possesses. The problem of obtaining such a plasticizer is difficult inasmuch as the general tendency of such materials is to impair the electrical characteristics, lower the tensile strength, and increase the inflammability of the film when used in amounts sufficient to produce a film of desired flexibility.

## TREATMENT OF TEXTILE INSULATED WIRE

The cellulose acetate treatment of wire consists essentially in passing the textile insulated conductor through a thin solution of cellulose acetate dissolved in acetone, then through a wiping die to remove the excess lacquer and finally into a heated drying chamber where the solvent is evaporated. This process is repeated several times, usually six, to build up a film of satisfactory thickness and smoothness. The application of heat in the drying process is necessary for two reasons. First, the evaporation of the solvent tends to lower the temperature of the wire considerably and if the temperature falls below the dew point of the surrounding air, moisture will condense on the wet lacquer film, causing it to turn white and opaque. In the second place, the evaporation of the solvent must be rapid in order that the speed of the wire through the lacquering machine may be such as to make application of the treatment to large quantities of wire commercially practicable.

In the earlier stages of the investigation, the insulated wire was thoroughly dried before being treated to eliminate the moisture in the textile. In addition, the wire was treated under vacuum with the object of thoroughly impregnating the whole textile covering and preventing entrance of moisture into the textile after the impregnating process was completed. However, it was found that even with vacuum impregnation, the cellulose acetate did not penetrate the insulation to an appreciable depth, although the solvent appeared to penetrate to the conductor and thoroughly wet the insulating materials. Also, it was found that the coating of cellulose acetate did not prevent the entrance of moisture into the textile to any appreciable extent.

In consideration of these facts, it was concluded and confirmed by tests that the improvement in electrical characteristics of cellulose acetate treated wire under conditions of high humidity is due mainly to the barrier of high resistance lacquer film interposed in the leakage paths formed by moisture in the textile insulation. It may be seen from Fig. 1 that the fibers of untreated cotton insulation project in all directions, and in a twisted pair, interweave to increase the effective area of contact between the conductors and provide a medium for direct leakage paths when moisture is present. With the fibers smoothed down and covered by the application of several layers of lacquer film, the effective area of contact is decreased and any leakage which takes place must be either through or across this relatively high resistance film. In confirmation of this conclusion, it has been found by repeated tests, that a very reliable indication of the improvement in electrical characteristics which may be expected in a treated wire is

obtained by observing the extent to which the textile fibers have been laid and covered by the lacquer film. If the surface of the wire is smooth and practically free from projecting fibers as is shown in the photograph, the wire may be expected to exhibit normal improvement.

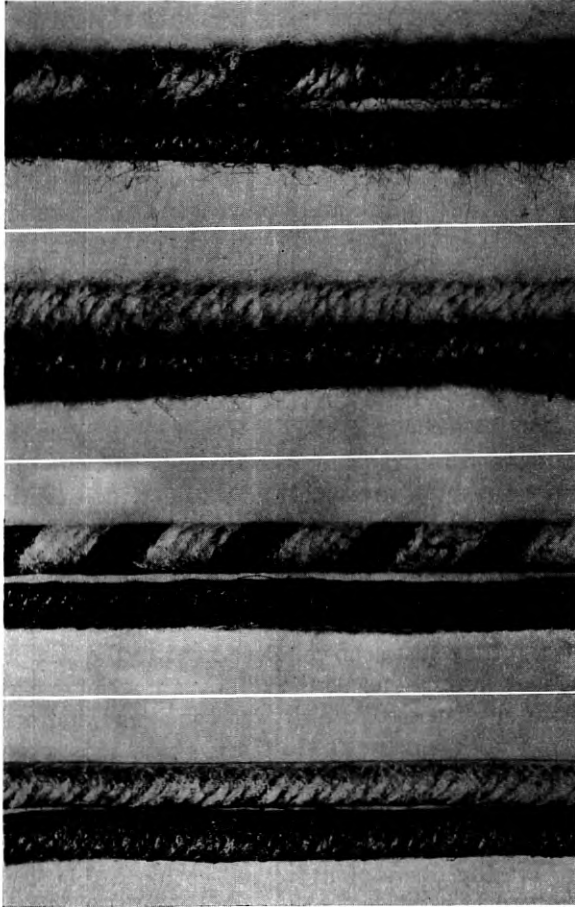

Fig. 1—Textile insulated 22-gauge wires before and after treatment with cellulose acetate. The cellulose acetate covering prevents direct contact between textile fibres of adjacent wires and reduces current leakage.

For example, when textile insulated conductors are twisted and then treated with cellulose acetate, practically no improvement in electrical characteristics of the pair is obtained, because the interlocking fibers of the two conductors which provide the direct leakage paths are not separated. A similar effect has been observed in the treatment of coils

wound with textile insulated wire. If the treatment is applied to the wire before winding, the desired improvement in stability of the constants is obtained. Coils treated after winding, however, show very little improvement since the lacquer does not penetrate but merely provides a superficial covering of film which does not exclude moisture or break up the interlocking fibers between turns.

It has been found that increasing the thickness of the lacquer film, beyond that required to cover the fibers and provide a smooth surface, results in relatively small additional improvement in the insulation. This is of economic importance since, with proper methods of application, a relatively thin film may be practically as effective as a thick one requiring a considerably greater quantity of material, and a rapid check on the quality of the product can be made by visual inspection of the surface condition of the treated insulation.

#### ELECTRICAL CHARACTERISTICS OF TREATED WIRE

The accompanying graphs show a comparison of the electrical characteristics of untreated and treated cotton and silk insulation, respectively, for a cycle of relative humidity ranging from 65 per cent to 90 per cent and back to 65 per cent at a constant temperature of 85° F. The comparison is given for both commercial and purified materials as a matter of general interest, although purified textiles are now used exclusively in Bell System central office wire insulation. The graphs are plotted from data on samples of wire insulated with silk and cotton taken at random from stocks of commercial and purified materials and treated with cellulose acetate under conditions of regular production. The values given by the graphs should not be considered as applying quantitatively to any standard type of central office wire but are intended to show, on a comparative basis, the extent to which the commercial and purified materials have been improved by treatment with cellulose acetate, and the rather remarkable improvement in the characteristics of commercial textiles by both purification and cellulose acetate treatment.

Perhaps the comparison of greatest general interest is that of insulation resistance, Figs. 2 and 3, since it is important in any electric circuit that the insulation shall be capable of preventing undue energy loss from direct current leakage. From these graphs, it is seen that the insulation resistance of commercial cotton may be improved from 100 to 300 fold by treatment with cellulose acetate and in the order of 500 to 2,000 fold by purification plus acetate treatment depending upon the relative humidity. Thus, as indicated by insulation resistance, acetate treated purified cotton becomes a comparatively high



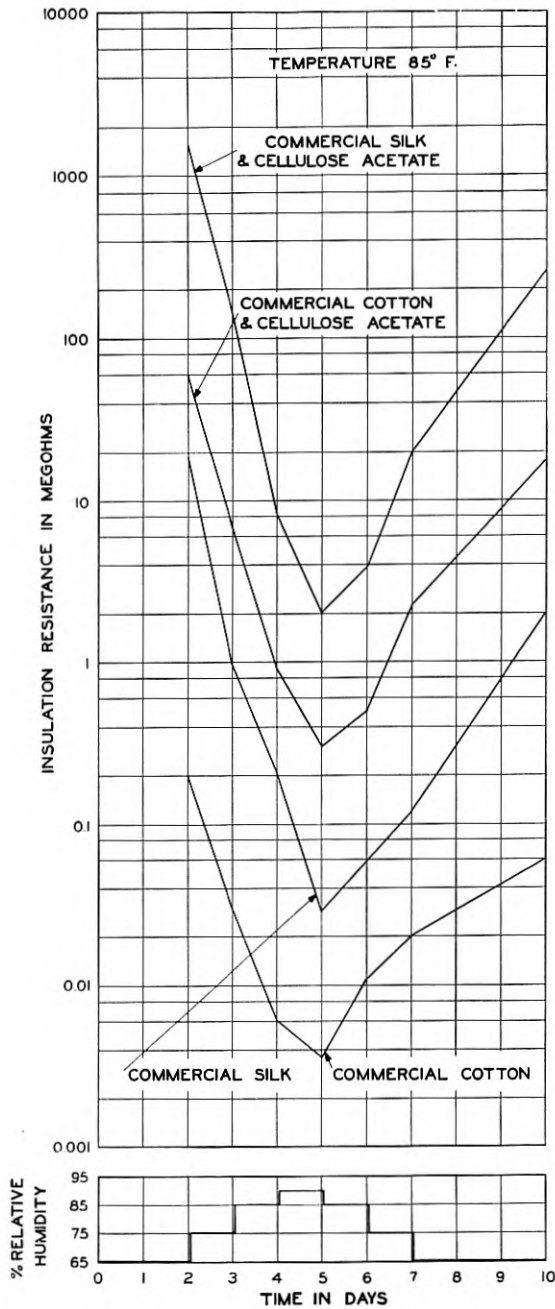

Fig. 2—D-C. insulation resistance of 50 feet of twisted pair 22-gauge wire insulated with double servings of equal thickness.

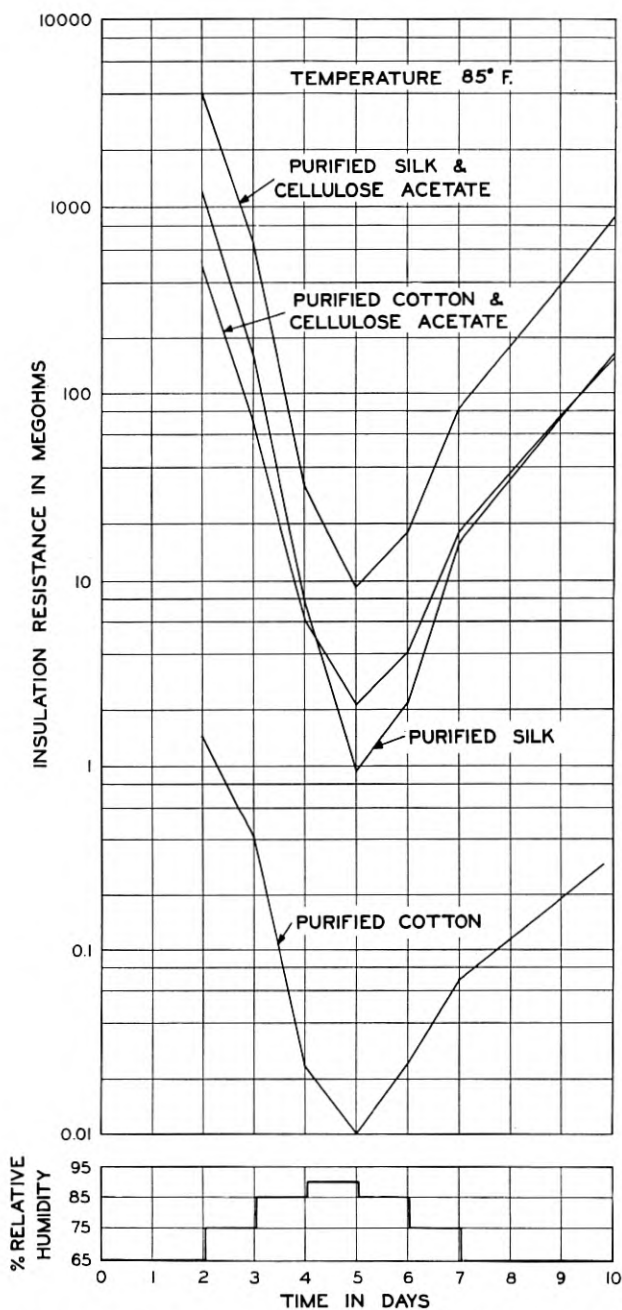

Fig. 3—D-C. insulation resistance of 50 feet of twisted pair 22-gauge wire insulated with double servings of equal thickness.

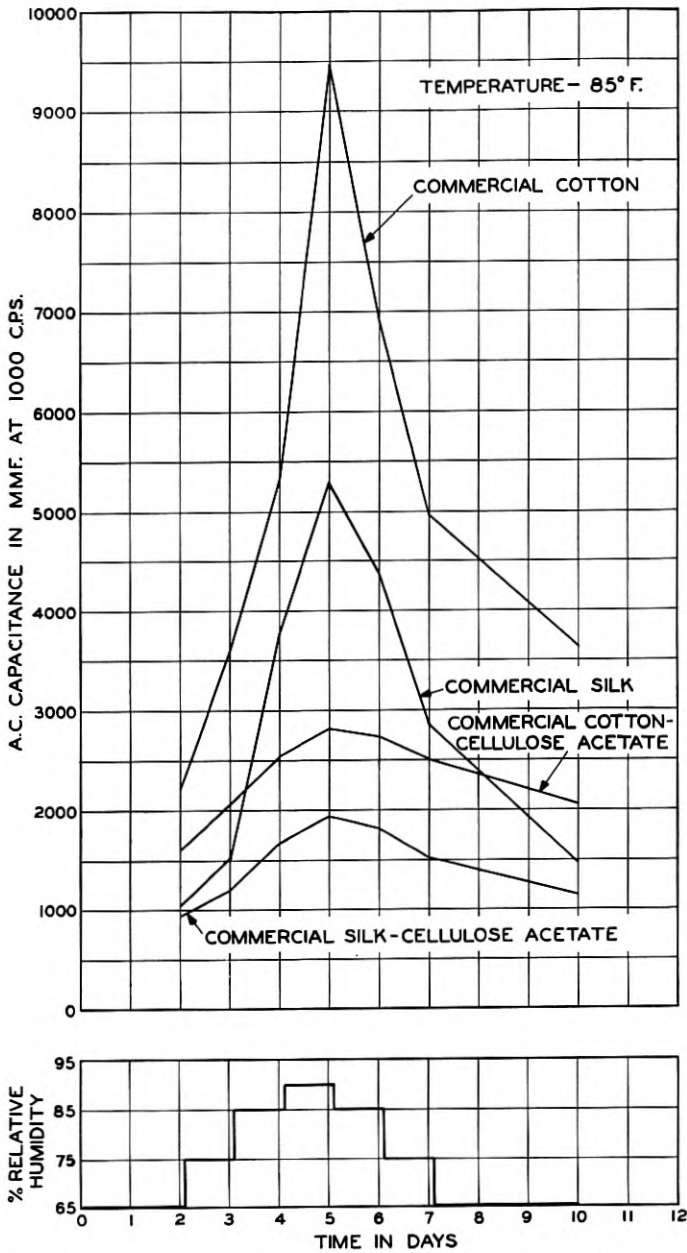

Fig. 4—A.C. capacitance of 50 feet of twisted pair 22-gauge wire insulated with double servings of equal thickness.

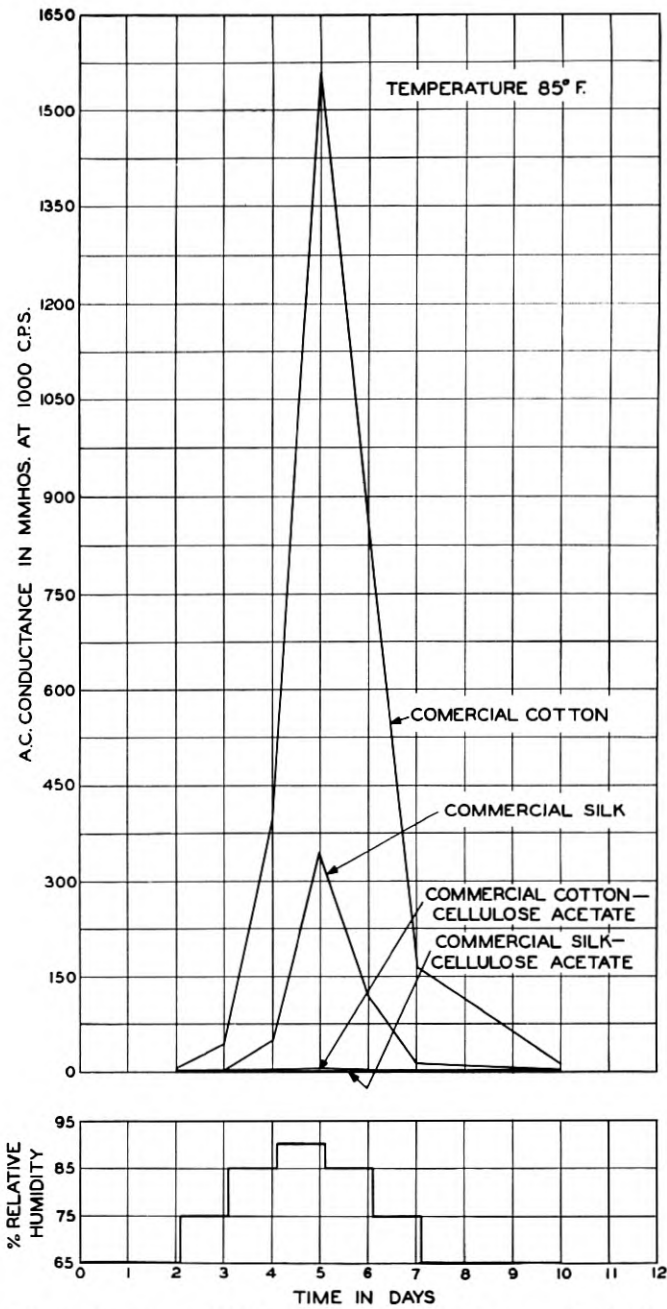

Fig. 5—A.C. conductance of 50 feet of twisted pair 22-gauge wire insulated with double servings of equal thickness.

grade insulation suitable for many purposes where more expensive combinations of silk and cotton have been required heretofore.

From the telephone transmission standpoint, the a-c. characteristics of capacitance and conductance are of particular importance because they determine the loss in transmission of energy at voice and carrier frequencies, which must be kept at a minimum to maintain high quality of telephone communication. A comparison of a-c. capacitance and conductance at a frequency of 1,000 cycles for commercial and purified

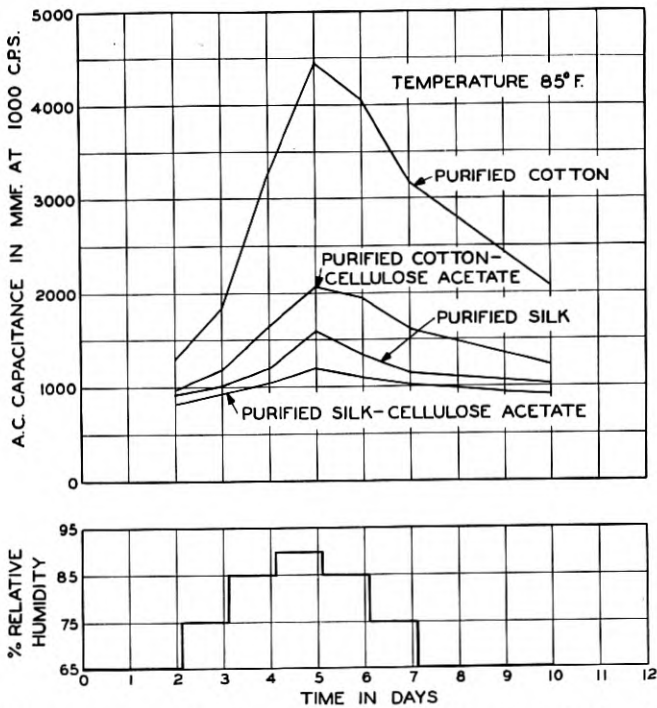

Fig. 6—A-C. capacitance of 50 feet of twisted pair 22-gauge wire insulated with double servings of equal thickness.

silk and cotton with and without cellulose acetate treatment is shown in Figs. 4, 5, 6 and 7. The data represented by these graphs converted into transmission loss units are shown in Figs. 8 and 9. These data derive their main significance from the large reduction in capacitance and conductance at the higher humidities, and the fact that it is the variation of these transmission loss characteristics which is of the greatest importance from the telephone transmission standpoint. Losses, if fixed in value, can be compensated for, but if they are subject to wide variations such as those illustrated by the samples of

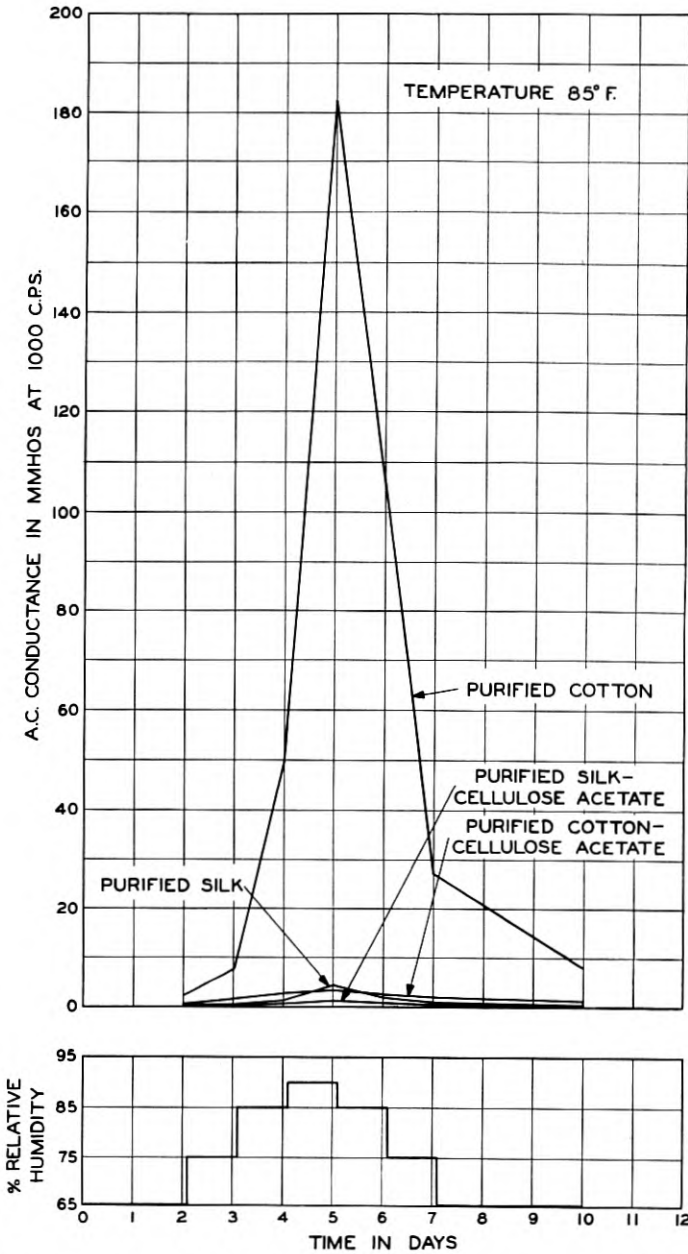

Fig. 7—A-C. conductance of 50 feet of twisted pair 22-gauge wire insulated with double servings of equal thickness.

untreated commercial textiles, the matter of compensation becomes difficult or entirely impracticable.

In addition to maintaining transmission losses at a minimum, it is required in certain toll apparatus that the capacitance and conductance

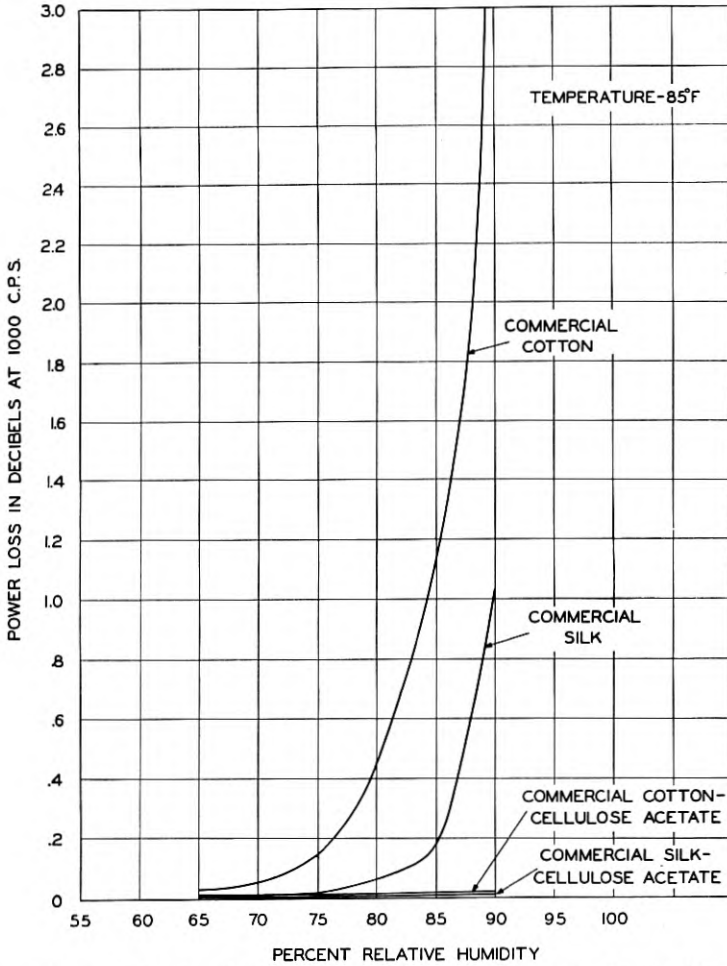

Fig. 8—Transmission loss in 50 feet of twisted pair 22-gauge wire insulated with double servings of equal thickness.

of the parts of the electric circuits be balanced to prevent interference between adjacent circuits which would increase the noise level and impair the quality of voice transmission. Such circuits are usually wired with four-conductor wire and it is required that the characteristics of the insulation and the spacing of the conductors shall be suffi-

ciently uniform to preserve an electrically balanced circuit. From Figs. 4, 5, 6 and 7, it is seen that the capacitance and conductance of commercial silk and cotton insulation are greatly reduced by cellulose acetate treatment and that the purified materials are also improved

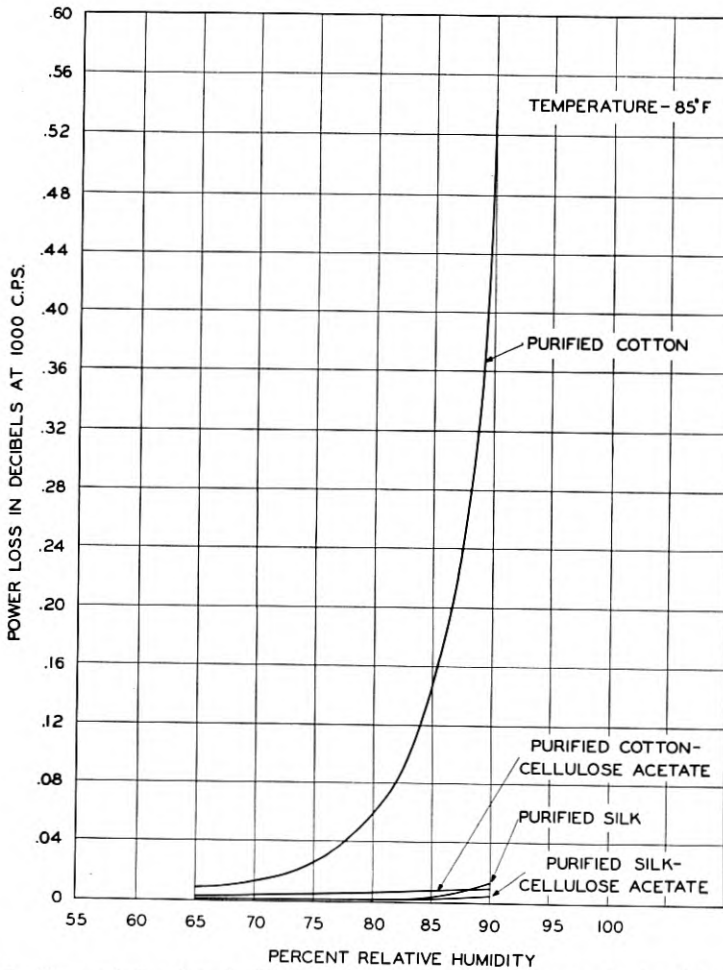

Fig. 9—Transmission loss in 50 feet of twisted pair 22-gauge wire insulated with double servings of equal thickness.

considerably in that respect. It is evident, therefore, that the addition of cellulose acetate treatment to purified textile insulation will result in greater uniformity in the electrical characteristics of the product than is possible by use of purified insulation alone, since the effects of any lack of uniformity in the purified material, due to variable results



in the purifying process, will be practically nullified by the acetate treatment.

An interesting example of how cellulose acetate treatment improves the electrical balance of a circuit is given in Fig. 10, which shows the capacitance unbalances between phantom and side circuits in a four-conductor wire for toll use. The capacitance unbalance is the main cause of electrical interference between the two circuits mentioned above and it is desirable to have this value as low as possible. Although there are some differences in design in these two types of wire, practically all the improvement is due to the acetate insulation.

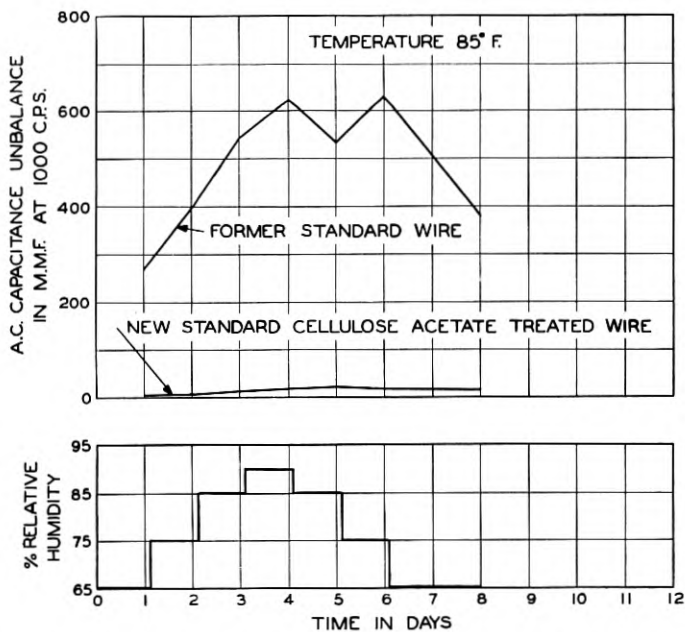

Fig. 10—A.C. capacitance unbalance between the phantom and side circuits of 50 feet of quadded 22-gauge wire.

#### APPLICATION TO APPARATUS

Advantages in the use of cellulose acetate treated insulation are derived from several sources of which the most important is the improvement in electrical characteristics of cotton and silk, as illustrated by the foregoing graphs. For example, this improvement is sufficient in many cases to permit the substitution of cotton for silk, with a resulting substantial reduction in cost. In other cases, silk has been retained and a cable of much higher quality has been made available

for use in toll equipment where the best electrical characteristics obtainable are needed.

The improved electrical characteristics of cellulose acetate treated insulation also make possible the elimination of enamel in a large amount of wire and cable where it has formerly been required to prevent excessive current leakage under conditions of high humidity. This is of economic importance because of the difficulty of removing the enamel preparatory to soldering the wire to terminals, and the precautions necessary to prevent trouble from faulty soldered connections, which increase considerably the cost of installation and maintenance of apparatus.

In distributing frame wire the use of cellulose acetate treated insulation has been found to be particularly advantageous. This type of wiring cannot be installed permanently in cabled form, as is the practice with practically all other types, because of controlling equipment and service conditions, and in order to guard against fire hazard from a large mass of loose wiring, the insulated conductor has, heretofore, been covered with a cotton braid impregnated with flameproofing salts. These salts, because of their hygroscopic and electrolytic nature, have a deleterious effect on the electrical characteristics of the insulation under humid conditions and introduce the danger of excessive leakage and corrosion, particularly near terminals. Exhaustive tests have proved that cellulose acetate treated insulation, without the addition of flameproofing salts, will be as satisfactory as the old type with respect to safety, and the elimination of salts has made it possible to design a wire which is greatly superior to the old type electrically, considerably less expensive to manufacture and smaller in size.

Another advantage in cellulose acetate treatment is its effect in preventing unwrapping and fraying of the textile at terminals. With the old standard wires, fraying is prevented by impregnating the insulation near the ends with wax. This wax treatment is undesirable in that it adds to the flammability of the insulation, tends to obscure the marking colors and collects dust. Cellulose acetate treatment binds the insulation against fraying and provides a smooth glossy surface which does not collect dust readily.

These examples serve to illustrate the more important factors in favor of cellulose acetate treated wire with regard to its application in telephone apparatus. On the other hand, this type of wire has a tendency to be somewhat stiff and springy with the result that its behavior in the operations of twisting, stranding and forming into cables differs considerably from that of the old untreated types. This has made necessary the development of modified manufacturing and

installation methods in connection with these operations and, in certain cases, the observance of special precautions. For examples, in the operation of twisting to form pairs, triples and quads, it is necessary to avoid appreciable stretching of the conductors, as this would crack and loosen the acetate film and impair the appearance of the wire. Fortunately, cracking of the film does not affect the electrical characteristics appreciably, so long as it is not severe enough to permit interlinkage of textile fibers, as discussed in a previous paragraph.

The first application of cellulose acetate treated wire on a regular production basis was made early in 1930, although considerable quantities were installed for service trials in commercial apparatus in 1927. In order to take advantage of the improved electrical characteristics where they are of greatest value, cables and wire used in the toll plant are being changed to employ the new insulation first. Supplementing this program, consideration is being given to extending the use of acetate treated insulation to include wire aggregating annual requirements of the order of three billion feet for the local plant. Application of the new type wire is being made gradually in order that manufacturing and installation methods and technique may be further developed as required in connection with this program.

## Cellulose Acetate Treatment for Textile Insulation— Development of the Manufacturing Process

By C. R. AVERY and H. KRESS

Equipment was developed and a plant constructed for coating textile insulated wire with a film of cellulose acetate. The wire is treated at a speed of 240 feet per minute. Recovery of more than 85 per cent of the acetone used as a solvent is effected with carbon adsorbers. Thorough precautions have been taken to prevent fire and explosion and to render them harmless if they should occur.

### INTRODUCTION

**I**N the telephone plant of the Bell System a large quantity of textile insulated wire is employed for wiring the switchboards and connecting them to the incoming lead covered cables. The insulation on this wire varies with its use in the plant, common constructions in the past being tinned copper wire insulated with two servings of silk and one of cotton, or, where the requirements are not so exacting, enameled wire with two servings of cotton.

The constant demand for better electrical characteristics in telephone circuits has led the engineers of Bell Telephone Laboratories to seek an improved insulation for this wire as discussed in the contemporary paper, "Cellulose Acetate Treatment for Textile Insulation, Engineering Development," by E. B. Wood and D. R. Brobst. The old design wire was affected by the variation in the dielectric properties of the textile insulation with its moisture content which in turn varied with the surrounding humidity. It was found that the application of a thin film of cellulose acetate to the textile insulation considerably stabilized its properties.

The action of the cellulose acetate coating is illustrated in Fig. 1. When the surface of untreated wire is magnified, it is evident that it is a mass of extending fibers and when two conductors lie adjacent, these fibers interlace. Under humid conditions the textile becomes moist and the interlacing fibers afford a path for current leakage. The moist fibers also have a considerably higher dielectric constant than the dry fibers and the electrical capacitance between adjacent wires is increased, therefore, with high humidity. In the lower half of the figure, the treated wire is shown, with the fibers ironed and sealed down by the cellulose acetate process. It is not claimed that the film is free from cracks, for cracks do form in the subsequent twisting and forming operations permitting moisture to enter, but no matter how

moist the textile may become, no direct path for the leakage of current is formed as the fibers are separated from one another by two films of cellulose acetate.

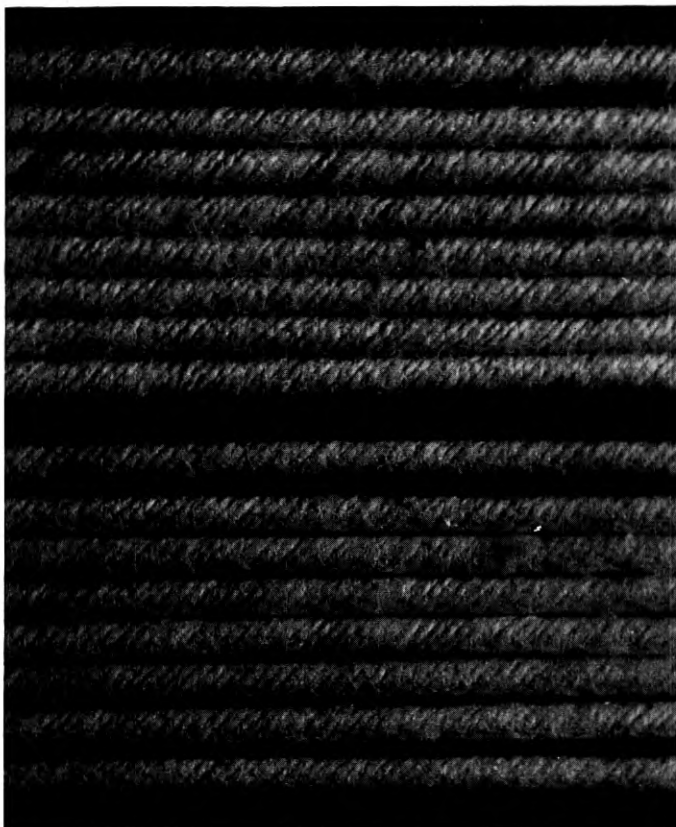

Fig. 1—Textile insulated wire before and after treatment with cellulose acetate. (Enlarged 4 diameters.)

#### DEVELOPMENT OF PROCESS

Extrusion of a coating as thin as wanted, about 0.0015 inch, appeared to be out of the question. Even if it were possible the coating would not adhere firmly enough to prevent cracking off when the wire is twisted or otherwise roughly handled. The study of method was therefore confined to coating the textile insulated wire from a solution. Several solvents for the flake cellulose acetate were considered but acetone was adopted, at least for the time being, as it was known to have the desired characteristics and would simplify the problems involved. The solution would have to be low in viscosity to produce

the thin coating desired and therefore the quantity of acetone used would be high. This made it economical to recover the acetone after it had been driven off from the coated wire.

It was quickly established that the procedure should include several passes of the wire through the cellulose acetate solution with the excess

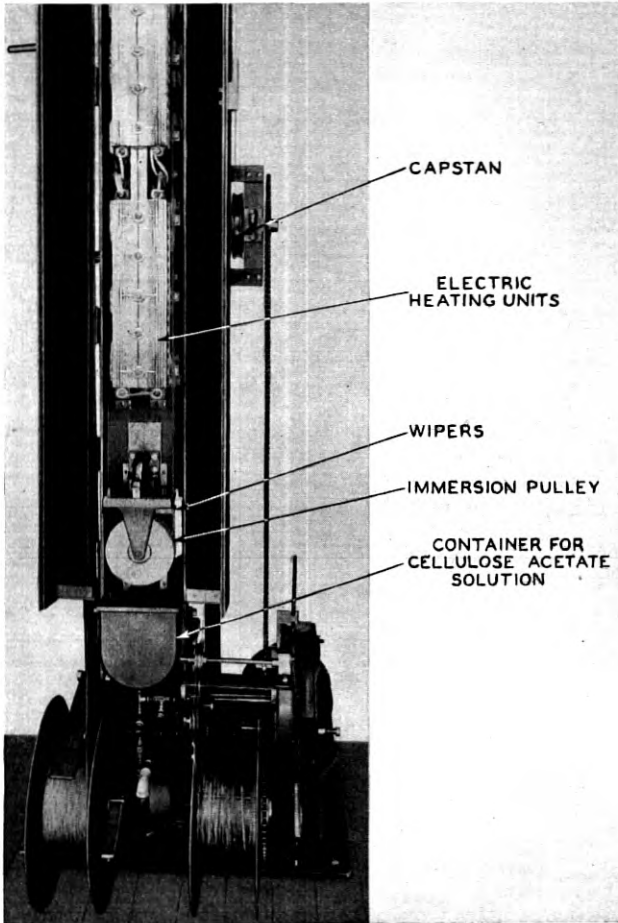

Fig. 2—An experimental machine for treating textile insulated wire with cellulose acetate. The immersion pulley with wiper dies are shown raised for threading.

solution removed and the coating dried after each pass. The source of drying heat was optional and for experimental purposes electrical heating elements were used. The temperature of drying was limited by the tendency of the coating to blister. A rapid circulation of air quickened the rate of drying and with a sufficiently long drying chamber, a high rate of wire travel seemed possible.

An early experimental machine is shown in Fig. 2. At the bottom are the supply reel and the motor driven take-up reel. The cellulose acetate solution is in the small tank near the bottom. The wire passes around the immersion pulleys, shown raised for threading, then past wipers into the drying chamber, over an upper pulley, and down, for a total of four passes, which was later increased to six passes.

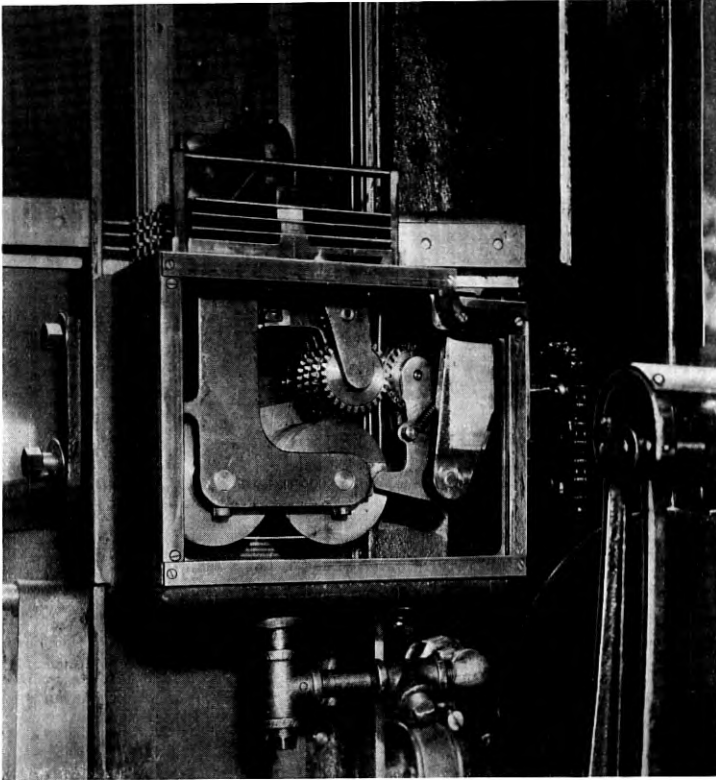

Fig. 3—A later experimental machine, equipped with rotating dies for removing the excess cellulose acetate and pressing down the textile fibers.

It was found that stationary wipers quickly became clogged by a mixture of lint from the textile serving and half dried cellulose acetate solution, and the rotating dies shown in Fig. 3 were designed. These dies are the heart of the machine and their construction and adjustment were found to be critical. It was necessary that they should allow wire splices and enlarged places in the textile insulated wire to pass, and to permit this the right hand dies were carried on spring arms allowing them to back away. They were driven in the same

direction as the wire travel but at one-third the speed. The slower speed causes a wiping action on the wire, ironing down the fibers, but still tends to feed wire splices through the dies. The size of the grooves must be proportioned exactly for each gauge of wire, the first pass being the largest. This is necessary so the extending fibers will be gathered in rather than caught between the dies and cut off. Dur-

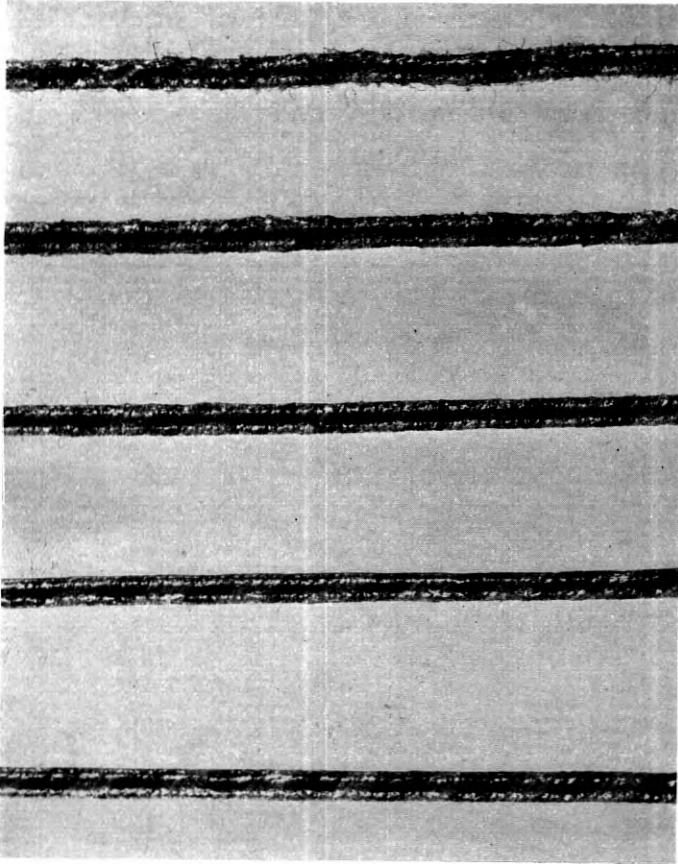

Fig. 4—An enlargement showing the gradual pressing down of the textile fibers and smoothing of the cellulose acetate coating as the wire receives the successive applications.

ing the next three passes these fibers are gradually ironed down, as illustrated in Fig. 4, while the fifth and sixth passes are largely for smoothing down and sizing. Adjustments were provided for lining the dies up with the wire so the pressure on both sides of the wire would be equal, resulting in an even coating. Means were provided



for quickly removing the dies for cleaning as it was expected that soaking them in acetone would be necessary at frequent intervals.

The density and viscosity of the cellulose acetate solution have an important bearing on the process. It was desirable to use as little acetone as possible as this would hasten the drying operation and with less acetone in the process, less acetone would be lost.

To obtain the maximum effect from the film of cellulose acetate, it was desirable that the coating be as free from extending fibers and as smooth as possible. Passing the coated wire while still plastic over pulleys so arranged that the entire circumference of the wire would come in contact with the pulleys, was found to produce a polishing effect.

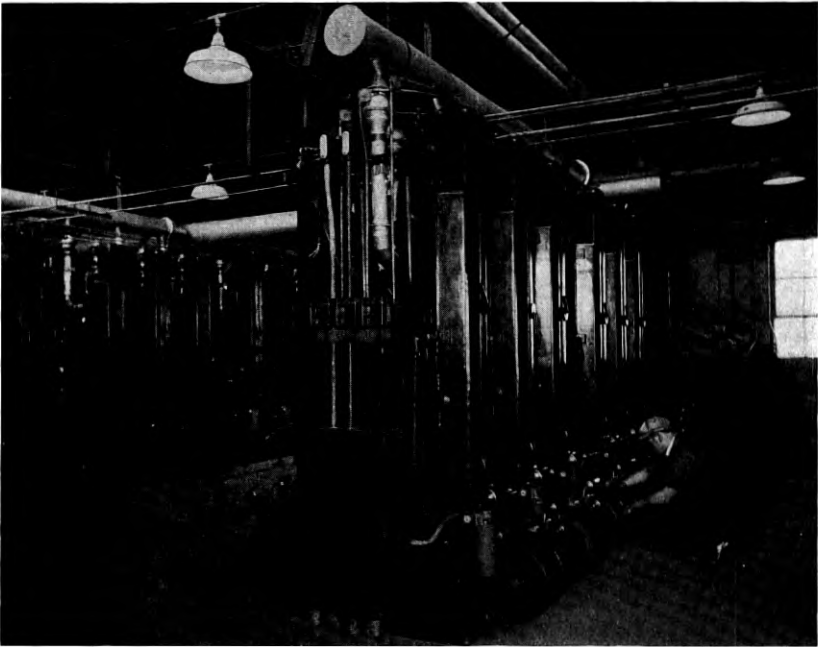

Fig. 5—An installation of machines for treating textile insulated wire with cellulose acetate.

#### COMMERCIAL INSTALLATION

With the essentials of the cellulose acetate coating process determined, the design of a commercial machine was undertaken. Figs. 5 and 6 show a number of these machines which, it will be seen, are in many ways similar to the experimental machine previously illustrated. Each head is separately driven by a two-speed electric motor and there

is a second motor for circulating the air within the head. The main drive motor is connected so that it rotates the wiping dies continuously so they will not freeze up, and the take-up reel and the capstan are operated through a hand clutch. Six passes of wire were decided upon as giving better control of the coating than afforded by four passes. Electric heating elements were selected as being compact and

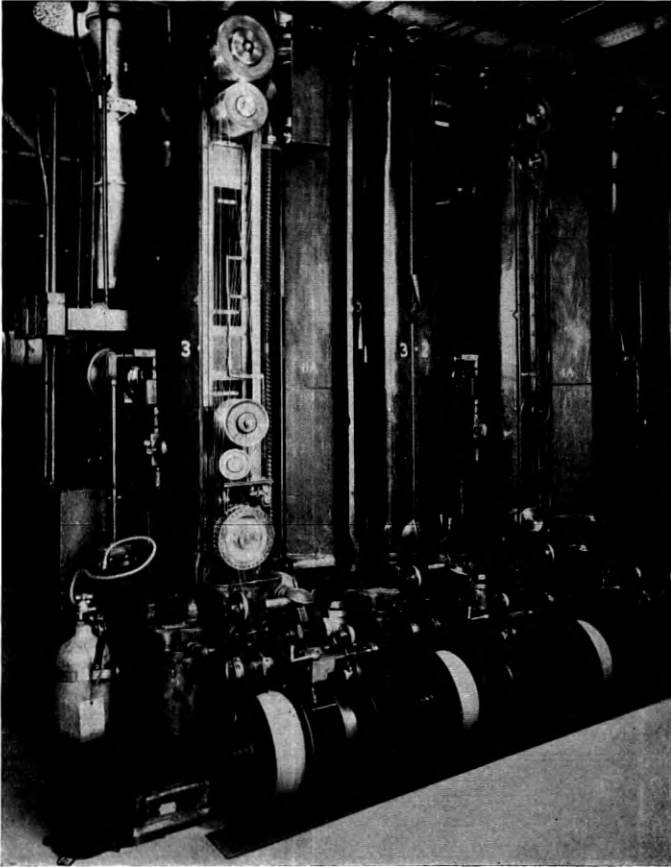

Fig. 6—Cellulose acetate wire coating machine.

easily controlled. In the schematic view, Fig. 7, are shown the method of air supply, the circulation of the air within the drying chamber, and the exhausting of the acetone-air mixture.

In making a commercial installation of the new machines, it was necessary to go into the questions of preparing and circulating the cellulose acetate solution, recovering the acetone, and making the

entire process as safe as possible from the hazards that are always present when using a solvent such as acetone.

Fig. 8 illustrates the general arrangement of the equipment. Two buildings are used instead of one to separate the large quantities of solution present in the mixing room from the room in which the coating machines with their electrical equipment are located. The acetone is pumped from the underground storage tanks to the mixers. The cellulose acetate is weighed out from bins and added to the mixers and the

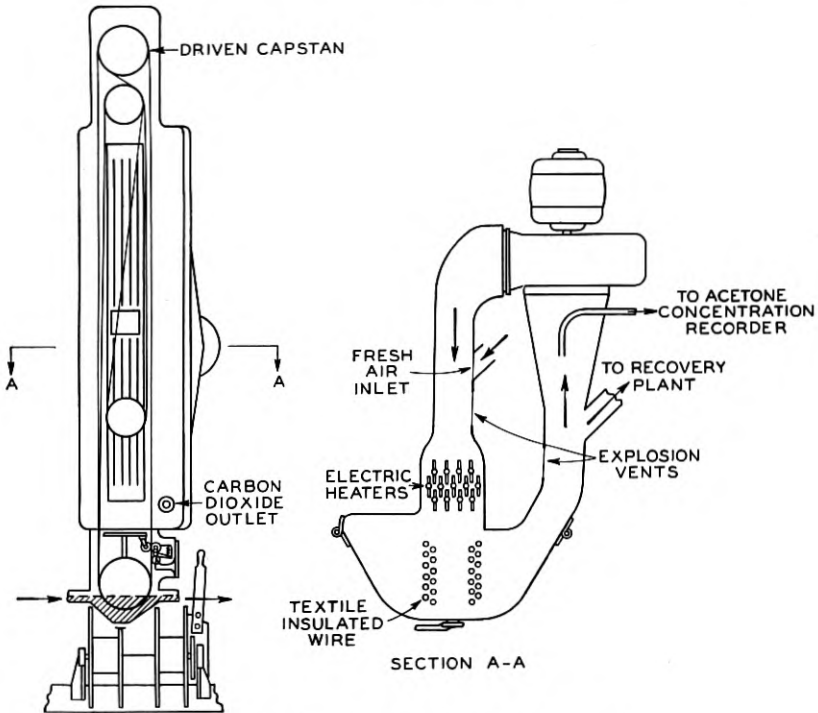

Fig. 7—Schematic view of one coating head.

whole stirred for several hours until fully dissolved. One gallon of acetone is used to ten ounces of cellulose acetate. The solution is then pumped continuously from the mixers to the machines. From the machines it flows to a sump by gravity and from the sump is forced back to the mixers. The reasons for circulating the cellulose acetate solution are to keep it homogeneous, to keep the amount of solution in or near the machines as small as possible, and to permit control and maintenance of its viscosity at one location instead of in the individual dope pots.

It was found that the viscosity of the solution had to be maintained within close limits, as the weight of film left on the wire changes with the viscosity. To continuously indicate the viscosity, a constant amount of solution is pumped through an orifice and the back pressure developed is measured by a pressure gauge, the gauge being calibrated for viscosity. Deviations from the required viscosity are corrected by the addition of acetone or a more concentrated solution that is kept in readiness.

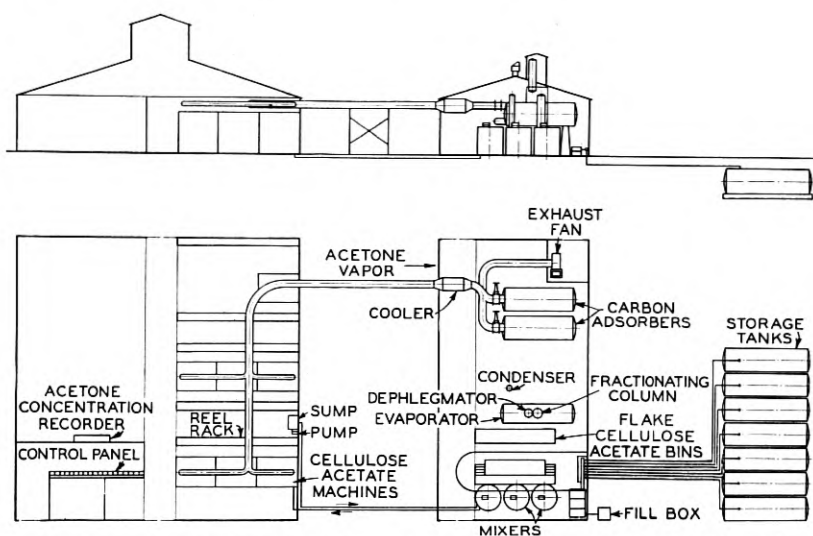

Fig. 8—Schematic of the wire treating plant at the Kearny, New Jersey works of the Western Electric Company.

To keep the amount of acetone solvent low for the required viscosity, the temperature of the solution is kept at about 86° F. Although a higher temperature would require the use of even less solvent, it would increase the loss by evaporation. To maintain the desired temperature, a water coil was installed in the mixer, the water in turn being heated by steam. This indirect method was used instead of installing steam coils directly in the mixer as the latter would result in boiling the cellulose acetate solution and the coils would become heavily coated with cellulose acetate. The mixers are equipped with standard propeller type agitators driven through gear reduction by totally enclosed motors.

During the drying operation the acetone is evaporated giving a mixture of air and acetone vapors within the drying chambers. This mixture would be explosive if the concentration of acetone vapors were

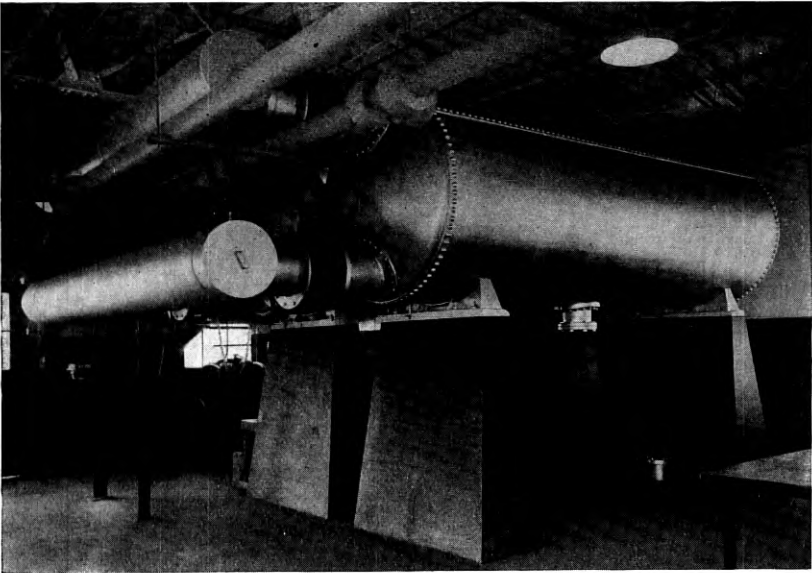

Fig. 9.—Charcoal adsorbers for removing the acetone vapors from the exhaust from the treating machines.

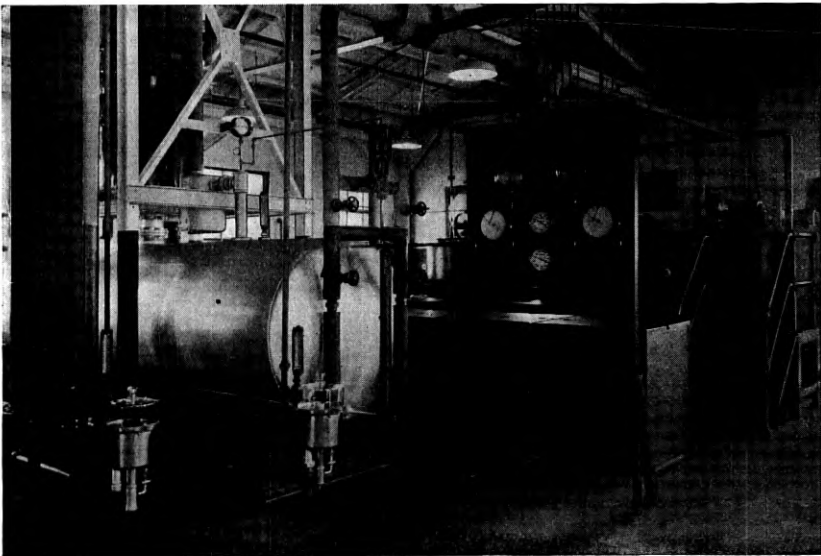

Fig. 10.—Equipment for the distillation of acetone.

allowed to get between approximately 2.5 per cent and 13 per cent by volume and at the concentration of 5 per cent an explosive force of as high as 75 pounds per square inch might result. To eliminate the possibility of a vapor explosion, enough of the mixture is constantly drawn away through an exhaust duct so that the concentration of acetone will not exceed 1.5 per cent. The vapors are conducted back to the building in which the mixing was performed and the acetone is recovered.

The acetone recovery system shown in Figs. 9 and 10 consists of activated carbon adsorbers, a condensing tower, and a dehydrating plant. The air and acetone mixture coming through the exhaust header from the coating machines passes through a water cooler to the carbon adsorbers where the acetone is adsorbed and the air is exhausted through the roof. After about an hour's operation, the carbon in one of the tanks has adsorbed as much acetone as it can without allowing a portion of it to pass through and the air valves are switched to pass the acetone air mixture through the other adsorber. Steam at low pressure is then admitted to the first adsorber and the acetone is driven off. The steam and acetone vapors are condensed, giving a condensate that averages about half water and half acetone. This flows by gravity to one of the outside underground storage tanks where it is held until it can be dehydrated. When a supply of water-acetone has accumulated, it is pumped to the evaporator and the dehydrating is performed in the usual way. The recovered acetone flows by gravity to another of the underground tanks for reuse. Samples are taken at intervals to insure that the dehydration is complete, that no foreign materials are present and that no breakdown of the acetone has occurred. More than 85 per cent of the acetone purchased is recovered.

There were, of course, other types of recovery systems available, but for our purpose the carbon adsorption process was most economical. Scrubbing with water or other absorbing mediums would not give as high a percentage of recovery and would be more expensive to install and operate. Freezing out the acetone would not be as economical with the low concentration of acetone-air mixture that it was felt must be maintained to afford safety from explosion.

#### PRECAUTIONS AGAINST FIRE

Throughout the engineering of this installation, the greatest precautions were taken against possible fire and explosion. Double forty-mesh screens were installed close to the junction of the vent pipes with the underground tanks. The mixing tanks were equipped with explosion reliefs consisting of .002 inch thick sheet aluminum. The tanks

were vented to the recovery system, with a fire screen installed in the vent line. Attached to the mixing tanks is a carbon dioxide fire extinguishing system. One opening is within the tank and another one is above the explosion relief. This carbon dioxide system will be released automatically if a quick rise in temperature occurs within the mixer and it can also be operated through a hand pull box on the outside of the building. Operation of the carbon dioxide system in the mixers or in any other place in the cellulose acetate plant causes all electric power in both buildings to be turned off instantly, sounds a siren and calls the fire department.

To avoid the possibility of static sparks while loading the flake cellulose acetate into the mixer, a humid atmosphere is obtained by injecting steam. The danger is further lessened by the avoidance of metal in the container used for carrying the flake acetate.

In the coating machines themselves, precautions have been taken both to prevent fires and to render them harmless if they should occur. A temperature well above 1,000° F. is required to ignite acetone and the electric heating elements are operated at about half this temperature. The temperature of the drying chamber is controlled by a pyrometer which turns on or shuts off the electric heating current as required. As a further safeguard, a second temperature control, set at a slightly higher temperature, is arranged to act if the first one fails, shutting off the current and sounding a gong. Here again a carbon dioxide fire extinguishing system is permanently attached with an outlet in each drying chamber. Automatic discharge would be difficult to control because of the temperature conditions in the chamber and the carbon dioxide is controlled entirely from hand pull boxes. Hand CO<sub>2</sub> equipment is also available in convenient locations. Explosion vents covered with aluminum foil are located in the rear of each unit.

However, as previously mentioned, there is no danger of explosion of the acetone-air mixture in the drying chamber if the percentage of acetone is maintained at less than the amount that will propagate flame, about 2.5 per cent. Acetone-air analysis instruments of a standard make are permanently installed, taking readings from each of the drying chambers and from various points in the exhaust lines. These instruments operate on the basis of difference between the thermal conductivities of air and of atmospheres containing various amounts of acetone vapor. Two platinum coils, heated by a constant electric current, form two arms of a Wheatstone Bridge. Around one of these coils is room atmosphere, containing whatever moisture and other impurities it may, while around the other coil are the gases drawn

from the drying chamber, cooled down to the same temperature, containing acetone vapors in addition to the constituents of the room atmosphere. The different thermal conductivities of the gases around the two coils cause a difference in temperature and therefore a change in resistance of the platinum coils which causes a reading on the galvanometer. The instrument is calibrated to read directly in per cent acetone. If a reading greater than the allowed maximum of 1.8 per cent concentration is encountered, a gong is sounded and the head is immediately switched to half speed until the trouble is located and remedied. The percentage of acetone concentration can be varied by increasing or decreasing the amount of room air drawn through the machine to the recovery system.

To avoid all sparks in the main rooms, where some acetone vapor may exist, a separate control room with entry from the outside only is provided. Lead covered cables running through sealed ducts connect the machines with the control room and all fuses and relays are in this room. Switches on the machines are oil immersed or fully enclosed and gas tight. A magnesite floor is provided to prevent the striking of sparks from reels or tools that may be dropped and brass floor plates are used instead of steel for the same reason.

Although the present installation is well protected from fire and explosion, there are still a number of characteristics of acetone that are not well known, and it is probable that more exact knowledge would make it possible to achieve safety in future installations at less expense. A study is therefore under way in cooperation with the Bureau of Mines at Pittsburgh to determine these unknown characteristics of acetone. Among the unknown quantities are the exact lower limit of acetone vapor concentration that is explosive under conditions such as are encountered in our drying chambers, the effectiveness of various relief openings, the probability of ignition from various sources, especially static sparks, and the force of explosions possible from various concentrations.

#### RECENT DEVELOPMENTS

A new coating machine has been developed that operates at a higher speed, is simpler to operate and is still better safeguarded against fire and explosion. It consists of eight coating units on a common base, four units being on each side. Instead of electrical heating elements in each coating unit one steam heater supplies hot air to a number of machines. The temperature is automatically controlled at the heater, leaving the operator free to watch the supply and take up of the wire. A wire speed of 240 feet per minute has been obtained compared to



150 feet per minute with the electrically heated machines. With an overall efficiency of 90 per cent, the production per head is 13,000 feet per hour.

Ample explosion reliefs have been included in the new machines. For the chamber itself, a diaphragm of aluminum foil that will rupture leads to an open space between the machines. On the top of the air ducts above the machines, vents are located that will relieve any explosive pressure in this part of the system before it reaches dangerous proportions.

Although the coating of textile served wire with cellulose acetate is being performed successfully, it is felt that the ultimate design of machine or maximum efficiency have not been reached. There is promise in the possibility of using more viscous solutions of cellulose acetate, thus reducing the amount of acetone to be evaporated and recovered. Other solvents than acetone are to be tried. Higher machine speeds may be found possible and operating methods will be developed that will increase the uniformity of the product.

## The Development of a Handset for Telephone Stations\*

By W. C. JONES and A. H. INGLIS

A number of factors contribute to the difficulties involved in the design of a telephone handset which gives as good service performance as a deskstand. The handset transmitter, for example, not only is used in a wider range of positions but also is moved much more frequently, so that wider variations are experienced in its characteristics.

Further difficulties are introduced by the close physical connection of the receiver and transmitter, in that "howling" tends to be set up.

The handset has been developed so that it overcomes all these difficulties and is interchangeable with the deskstand in existing telephone plant without important reaction on either transmission or signaling performance.

MANY interesting development problems are presented in the design for general use of a handset which provides the convenience of this arrangement of a telephone set without a sacrifice in the performance of the system. It is the object of this paper to discuss some of these problems and to describe their solution as embodied in the handset now being furnished by the Bell System.

The idea of mounting a telephone transmitter and receiver on a common handle to form a handset was conceived early in the development of the telephone. In 1878, only a few years after the invention of the telephone, handsets of the type shown in Fig. 1 were in use by operators in the Gold and Stock exchange in New York City.<sup>1</sup> Variable resistance transmitters of the Edison type were used in these handsets. This transmitter employed a relatively insensitive lamp black resistance element which was soon superseded by the more sensitive granular carbon type in order to permit the extension of telephone service to greater distances. The basic ideas underlying the variable resistance transmitter and the many advantages of granular carbon over the numerous other materials which have been tried have been discussed elsewhere.<sup>2</sup> It is sufficient to point out here that the large amplification afforded at low cost by a well designed granular carbon transmitter makes it unlikely that any other structure will offer successful competition in general telephone application for some time to come.

When an attempt was made to use granular carbon transmitters with handsets it soon became evident that a satisfactory design in-

\* Presented at A. I. E. E. Midwinter Convention, Jan. 25-29, 1932, New York, N. Y.

<sup>1</sup> "Beginnings of Telephony," F. L. Rhodes, Harper and Brother, 1st Edition, p. 153.

<sup>2</sup> "The Development of the Microphone," H. A. Frederick, *Journal of the Acoustical Society of America*, July 1931, Part 2, p. 17; *Bell Telephone Quarterly*, July 1931.

volved more than the mounting of the available types of transmitters and receivers on a common handle and that considerable development of the instruments as well as the means for coupling them would be required before a handset suitable for general use were obtained. For this reason, the telephone system in this country has in general been built up around the wall set and the deskstand which permitted the utilization of the available transmitters and receivers to best advantage.

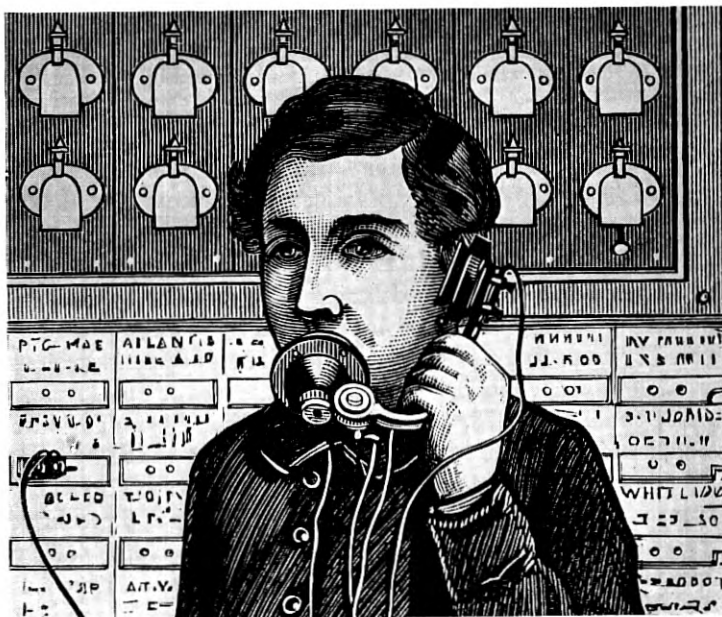

Fig. 1—Operators handset used in 1878.

A number of factors contribute to the difficulties involved in the design of a handset which gives as good service performance as a deskstand. Some of these are due to a difference in the conditions of use of the two instruments and some are due to the necessary differences in structure. A consideration of these differences will afford a background for the subsequent description of the line of attack followed in providing a satisfactory handset.

#### *Difference in Usage*

The controlling differences in service conditions are due to the fact that the handset permits the user much more freedom than the desk-

stand. The handset transmitter, accordingly, is not only used in a wider range of positions but is also moved much more frequently with the result that, in general, much wider variations are experienced in its transmission characteristics and resistance. If the transmitter is not suitably designed these variations may be sufficiently large to render the transmission of a handset unsatisfactory, and to interfere with the operation of associated relays and other signalling apparatus.

The more severe use to which the handset is subjected also has a tendency to materially accelerate changes in the contact surfaces of the carbon and the electrodes. These changes are evidenced principally by increased carbon noise and resistance which affect both transmission and signalling and appreciably shorten the useful life of the transmitter unless proper design measures are taken to reduce these aging effects.

#### *Differences in Structure*

It is undesirable in any telephone set, designed for use by the general public, to require the user to perform any switching operation in changing from talking to listening. For this reason, practically all commercial telephone sets are of the so-called "invariable" type, in which the transmitter and receiver are at all times connected to the line while the set is being used.<sup>3</sup> Part of the output of the transmitter, therefore, is transmitted to the receiver of the local telephone set. This electrical connection between the transmitter and receiver of the same set is known as the "sidetone" path, and the resulting sound in the receiver as "sidetone." In addition to this electrical coupling between the instruments, there is acoustical coupling through the air and in the case of the handset mechanical coupling through the handle. If the amplification afforded by the transmitter is greater than the aggregate losses in the sidetone path, the receiver, the air and the handle, sustained oscillation or "howling" may be set up. Any such condition, is, of course, not only unpleasant but fatal to transmission. It has been found necessary, in fact, to keep well below the howling point to avoid serious transmission impairment due to transient oscillations.

In the case of the deskstand, the sidetone path and the air path provide the only coupling between the instruments and the losses are of sufficient magnitude that howling does not occur even with the most efficient transmitters and receivers. In the case of the handset, however, the handle may add appreciably to the coupling. Without proper design of the handle, instruments, and means for mounting the instru-

<sup>3</sup> "Transmission Circuits for Telephonic Communication," K. S. Johnson, D. Van Nostrand Co., 4th printing, p. 105.

ments on the handle this additional coupling is often sufficient to cause howling.

Since with the deskstand a flexible cord forms the only connection between the transmitter and receiver, the user is always able to hold the receiver to his ear and at the same time to speak with his lips directly in front of the transmitter. The handset handle, however, definitely establishes the distance between the two instruments. If it

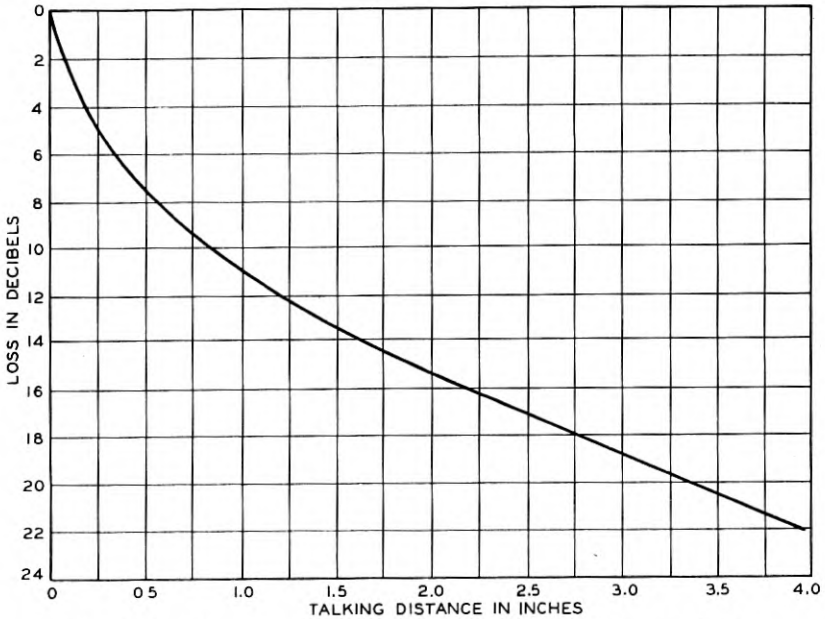

Fig. 2—Loss in transmitter output with distance from the mouthpiece.

is too short, many users are unable to hold the receiver on the ear when the transmitter is in front of the lips. This difficulty has often been avoided by making the handle long enough to accommodate any user. If this is carried to an extreme, the distance between the transmitter and the lips is greater than necessary, and introduces an avoidable transmission loss for the majority of users. As may be seen from the curve shown in Fig. 2, this loss may be quite large and warrants every effort to minimize it.

If the convenience of the handset is to be fully realized, it is important that the handle be shaped to fit comfortably in the hand and that the complete handset be sufficiently light to avoid fatigue on the part of the user. These structural limitations add a further problem in design.

### DESCRIPTION OF THE HANDSET

While many incidental problems have required solution during the development of the present handset, which is shown with its mounting in Fig. 3, this design is largely the result of a systematic attack on the



Fig. 3—Station handset and its mounting.

more fundamental problems that have been discussed. In describing the handset, therefore, particular attention will be given to those features which are of importance in the solution of these problems. Some of the most important and interesting of these are embodied in the transmitter.

### TRANSMITTER

Referring to the cross-sectional view of the handset, Fig. 4, it will be observed that the various parts of the transmitter are assembled in a die cast aluminum housing to form a unit which mounts in a threaded brass bushing in the handle. One electrical connection is made through this bushing, the other through a contact which engages a spring in the base of the housing. The molded phenol plastic mouth-piece, dome and spacing ring, which form the external parts of the

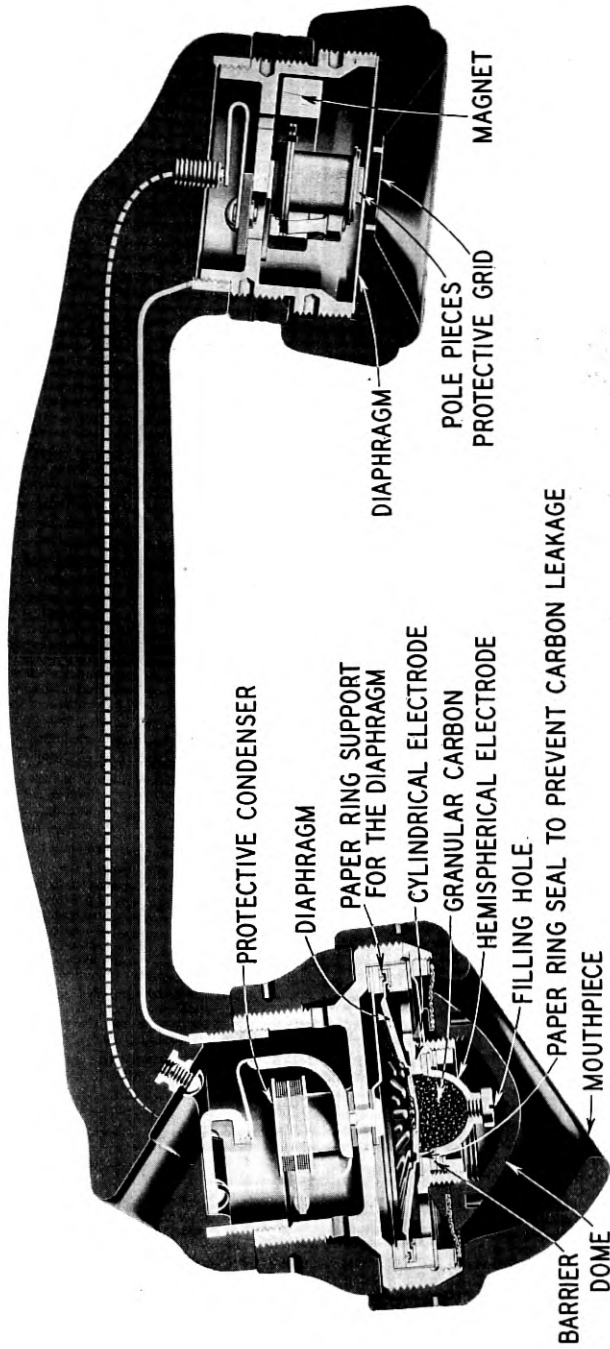

Fig. 4—Cross section of the station handset.

transmitter, insulate the metal parts in the electrical circuit so that they cannot come into contact with the user. The spacing ring also serves to lock the transmitter to the handle and align the mouthpiece with the axis of the handle.

*Effect of Angular Position on Resistance*

The carbon chamber of the transmitter is often referred to as a "barrier" type and differs radically from the conventional form of "direct action" resistance element, which has been employed for years

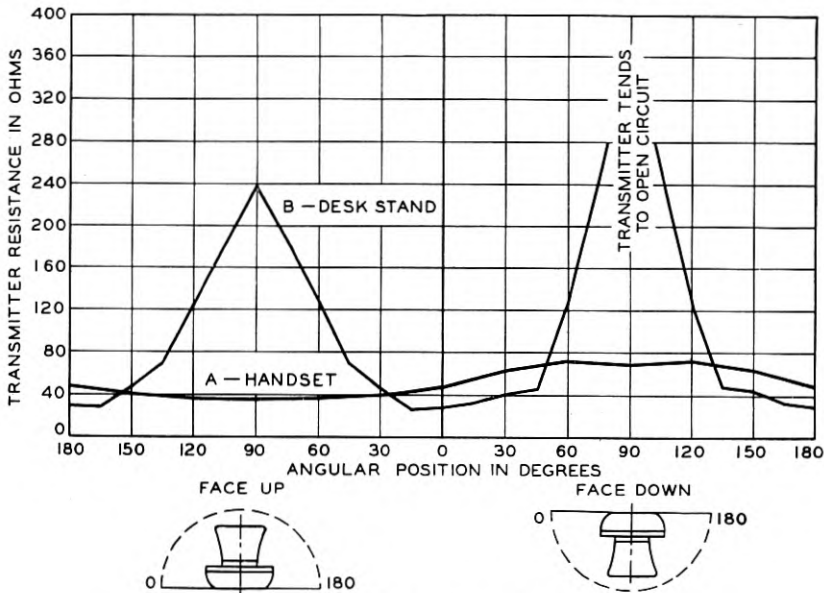

Fig. 5—Effect of position on transmitter resistance.

in deskstand transmitters. In the direct action type the movable member not only transmits the acoustic forces on the diaphragm to the carbon but also serves as an electrode. Both electrodes of the barrier type are stationary and a thin layer of phenol varnish insulates the diaphragm from the carbon. A ceramic barrier<sup>4</sup> separates the electrodes from one another and defines the current path through the carbon. The electrode surface adjacent to the diaphragm is cylindrical in shape, the other hemispherical. Both are gold plated. By adopting this electrode arrangement good contact is maintained be-

<sup>4</sup>"Manufacture of Thin Porcelain Parts of Close Dimensional Tolerances," L. I. Shaw, A. O. Johnson and W. J. Scott, *Journal of Ceramic Society*, Nov. 1931, pp. 851-854.



tween the carbon granules and the electrode surfaces and between the granules themselves, in all of the positions in which the transmitter is likely to be held while in use. This uniformity of contact pressure makes the resistance of the transmitter nearly independent of angular position as shown by Curve A, Fig. 5.

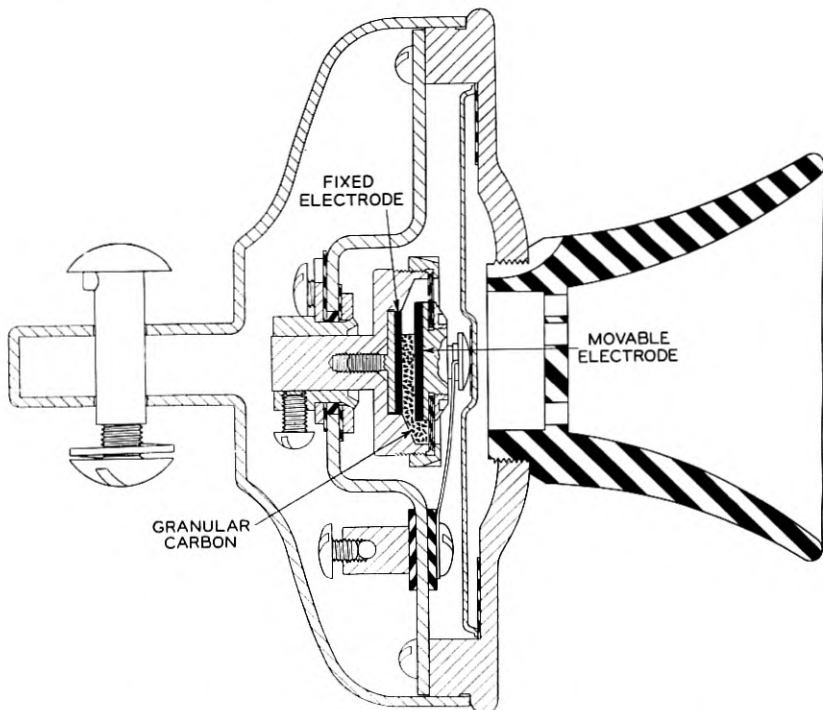

Fig. 6—Cross section of a typical deskstand transmitter.

The substantially uniform resistance of the present handset transmitter in various positions represents an outstanding improvement over that obtained with a typical deskstand transmitter such as that shown in cross-section in Fig. 6. Referring to curve B, Fig. 5, it will be observed that the resistance of this transmitter is markedly dependent upon angular position, two prominent peaks occurring where the electrodes are practically horizontal and the carbon falls away from the surface of the upper electrode. This is typical of the performance of the older types of transmitters employing the conventional form of direct action structure. While this characteristic is not important in

deskstand service it renders this type of transmitter unsuitable for the more severe conditions encountered in the use of a handset.

### *Effect of Angular Position on Carbon Noise*

Another transmitter characteristic which is likely to be influenced by the position in which the handset is held is carbon noise. In addition to the adsorbed gas on the surface of the granule there is also an appreciable amount of gas absorbed in the pores in its surface.<sup>5</sup> When a voltage is impressed on the transmitter the temperature<sup>6</sup> of the

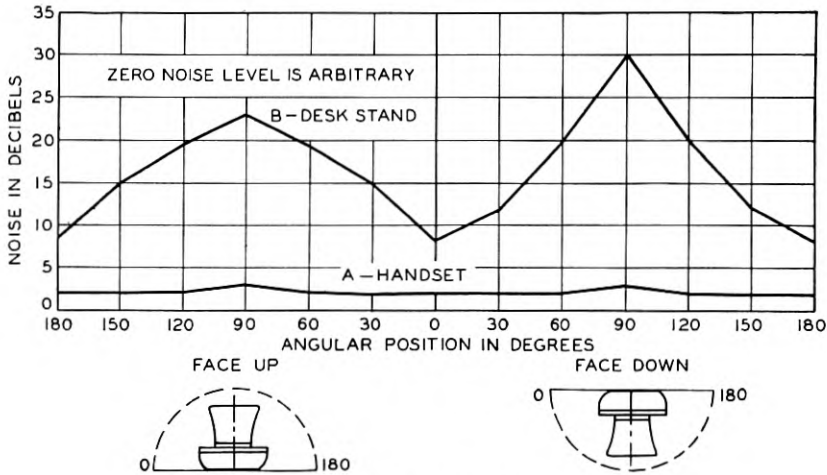

Fig. 7—Effect of position on carbon noise.

points of contact between the granules is increased and a certain amount of the gas is driven off, forcing the granules apart and giving rise to non-periodic changes in resistance. These disturbances result in noise in the receiver which tend to mask incoming speech. It is evident that a given efflux of gas will produce a larger change in resistance when the contact forces are low than when they are high. Hence, if as a result of turning the transmitter through the various angles in which it is likely to be used, the contact pressure is lowered and the resistance raised, a sufficient increase in temperature may occur to cause a vigorous evolution of gas and increased noise. It would, therefore, seem reasonable to expect that, inasmuch as the contact

<sup>5</sup> "The Effect of Gases on the Resistance of Granular Carbon Contacts," P. S. Olmstead, *Journal of Physical Chemistry*, Jan. 1929, pp. 69-80.

<sup>6</sup> "Über Kontaktwiderstände besonders bei Kohlekontakten," Von Ragnar Holm, *Zeitschrift für Technische Physik*, Sept. 1922, pp. 290-294, Oct. 1922, pp. 320-326, and Nov. 1922, pp. 349-357.

pressures and the resistance of the handset transmitter are substantially independent of angular position, the change in noise with position would be practically negligible. That this condition is realized is evident from the data shown in Fig. 7. Not only is the average carbon noise negligible even under severe conditions of service, but the maximum variation of the noise in any position of the transmitter is only about one db. On the other hand, the noise developed by a typical deskstand transmitter in the optimum position is approximately five

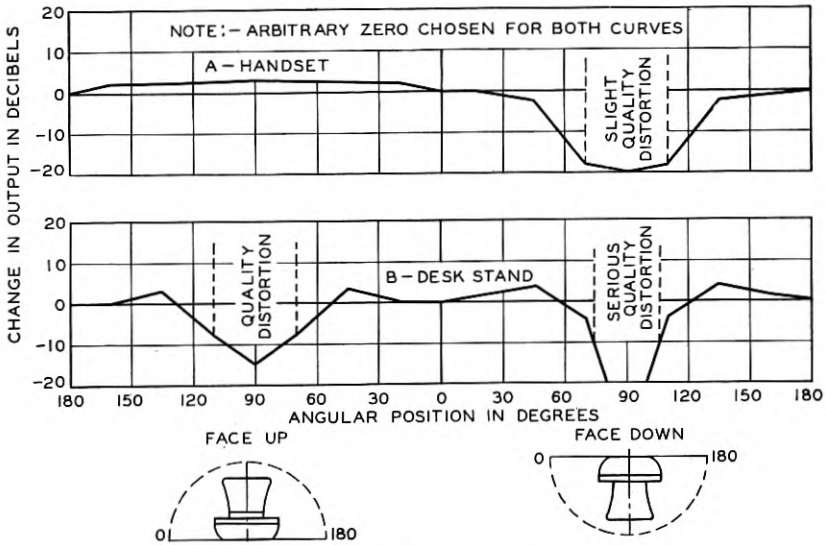

Fig. 8—Effect of position on transmitter output.

db higher, and in its worst position nearly thirty db higher than the noise produced by the handset transmitter. Noise of such a magnitude would constitute an appreciable transmission impairment.

#### *Effect of Angular Position on Output*

One of the unique features of this new handset transmitter is the fact that the carbon chamber is located in front rather than in back of the diaphragm as has been customary in the past. By adopting this arrangement the carbon granules are held in intimate contact with the diaphragm in all of the positions in which the handset is likely to be held and uniform output and faithful reproduction of the speech sounds obtained. There are, however, angular positions in the region of 90 degrees face down where the carbon tends to fall away from the diaphragm, but as is shown by curve A, Fig. 8, the resultant loss in the

output and the degradation of the quality are limited to a rather narrow range of positions in which the handset is seldom held. A loss in output and a serious impairment of quality occurs when the usual type of deskstand transmitter is held in the positions which would frequently occur if it were used for handset service. This effect is shown by curve *B*, Fig. 8.

#### *Response*

The diaphragm of the transmitter is made from thin duralumin formed into a truncated cone with radial stiffening ribs. This reduces the effective mass to about one-tenth that of the deskstand transmitter and provides sufficient rigidity to insure vibration as a unit throughout the frequency range of interest. A number of impregnated paper rings each approximately four ten-thousandths of an inch in thickness support the edge of the diaphragm. The dimensions of the recess into which these rings assemble are so chosen that they separate slightly from one another. This construction provides a resilient support for the diaphragm and adds a certain amount of mechanical resistance due to the viscosity of the air films between adjacent layers of paper and the friction between the layers. An appreciable improvement in response results from the lower mass and stiffness and the higher damping. The range in response of the handset transmitter in the frequency range from 300 to 3000 cycles per second, is about 20 db as compared with approximately 40 db for the deskstand transmitter over the same frequency range. The more uniform response of the handset transmitter causes a marked improvement in articulation over that obtained with the deskstand instrument.

#### *Aging*

As previously mentioned, after a granular carbon transmitter has been in use for a time, changes take place which often cause an increase in resistance and carbon noise and a loss in sensitivity. These changes in the contact conditions have been traced to two principal causes, the abrasive action of one granule on another, and the deterioration of the surface of the granules due to high temperatures resulting from excessive contact voltage. The former is usually referred to as "mechanical aging," the latter as "electrical aging."

The aging of the deskstand transmitter is primarily electrical, for although it is picked up occasionally and moved from one location to another on the desk or table, it is not in general subjected to shocks or jars which cause an appreciable motion of the carbon granules. Be-

cause of the more severe service conditions, the predominant factor in the aging of the handset transmitter is mechanical.

Laboratory aging tests equivalent to about four years of handset service under severe conditions, indicate an increase in carbon noise of only 6 to 8 db above the initial value. Neither before nor after aging is the noise produced by the handset transmitter of practical importance.

The output of the handset transmitter is decreased somewhat and the average resistance increased to about double its initial value as the result of aging. The relatively small change of resistance with position in this design, however, effectively prevents the frequent occurrence of resistances sufficiently high to interfere with the operation of signalling apparatus in circuit with the transmitter. In this respect the new design represents a notable improvement over earlier types of instruments.

The method adopted for filling the handset transmitter contributes materially to keeping the aging rate low. In most of the transmitters which preceded the present instrument, the carbon occupied only about three-quarters of the volume of the carbon chamber. This allowed the granules to move freely and caused rapid aging. Obviously, the movement of the granules would be reduced to a minimum if the chamber were filled full of carbon. Inasmuch as the space occupied by a given weight of granular material is dependent upon the configuration of the granules, it is evident that a full filling cannot be obtained merely by pouring carbon into the chamber. Definite means, therefore, must be provided for bringing the carbon into a minimum volume state if a full filling is to be obtained.

A machine has been designed for this purpose which vibrates the transmitter during the filling operation. This settles the carbon in much the same way as if the transmitter were held in the hand and tapped. The carbon chamber cannot only be filled full of carbon in this way, but the effect of differences in the volume of the chamber, due to the commercial variations in the size of the parts, is eliminated.

It has been found that the loss in sensitivity which results from filling a transmitter in this manner is relatively small. There is, however, one feature of a full filling, often referred to as "mechanical packing," which is objectionable and has led to a filling slightly less than full. If the diaphragm of a transmitter which has been filled full by the method described, is displaced sufficiently to permit the granules to change their configuration, the volume of the filling will increase and the diaphragm will not return to its original position. A marked increase in contact pressure and lowered sensitivity takes place. When

mechanical packing of this nature occurs, the initial sensitivity can be restored only by tapping the transmitter until the granules assume their original configuration. By filling the chamber about 5 per cent less than full, it has been found possible to avoid this packing without effecting an appreciable increase in the initial resistance and noise or the aging rate.

### *Breathing*

In many granular carbon transmitters, variations in resistance and sensitivity of considerable magnitude occur from changes in the dimen-

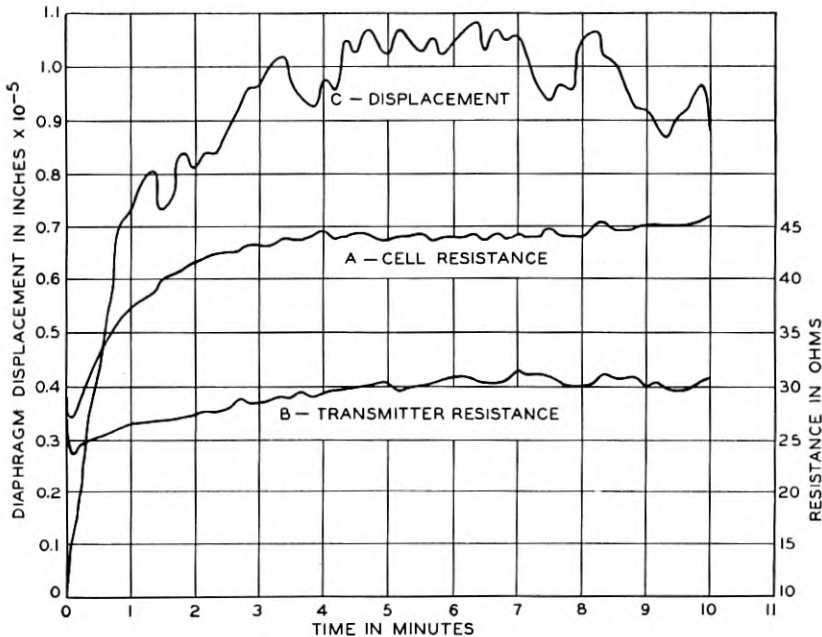

Fig. 9—Transmitter breathing.

sions of the various parts of the carbon chamber, caused by the heating effect of the direct current. These changes in resistance usually take place rather slowly and often extend over a period of several minutes. It is customary to refer to them as "breathing." In a handset transmitter, it is particularly important to eliminate any sources of variation of this kind, since they are likely to be more serious in their effects.

Interesting means of breathing control have been provided. If the diaphragm is removed and a block of lavite substituted, the resistance after being connected in circuit changes with time in the manner shown by curve A, Fig. 9. The large increase in resistance is caused by the

expansion of the walls of the chamber and a reduction in the contact pressure between the granules. An increase of this magnitude would be objectionable in commercial use, for it would not only make it more difficult to meet the resistance requirements but would also increase the contact voltages, especially in aged instruments, to a point where undesirable carbon noise would result. To counteract the effect of the expansion of the walls of the carbon chamber, the portion of the diaphragm in contact with the carbon is coned slightly, so that, as the walls expand, the diaphragm moves inward sufficiently to maintain substantially constant contact pressures between the granules. The extent to which this feature is effective in reducing breathing is shown by curve *B*, Fig. 9.

#### *Cohering*

In common with a number of other materials, granular carbon is susceptible to cohering. When cohering occurs the resistance and sensitivity of the carbon are lowered and remain so until the transmitter is subjected to mechanical agitation. Experience has shown that cohering will greatly reduce the output of the handset transmitter and that fairly loud talking or a sharp mechanical shock is required to restore it to its initial sensitivity. Not infrequently cohering results from breaking the circuit connecting the transmitter to the battery, as for example, when the subscriber depresses the switch in the mounting in order to attract the attention of the operator. A study of the electrical conditions responsible for cohering under these circumstances has shown that the distributed capacity and the inductance of the component parts of the station set are such that transient oscillations of a frequency of several thousand kilocycles per second are set up by the breaking of the circuit. Further investigation has shown that the transmitter can be protected from the cohering effect of these oscillations, without introducing a transmission loss at voice frequencies, by connecting a condenser of a few thousandths of a microfarad capacity across the transmitter to by-pass these transient currents.

In the case of the deskstand transmitter, these cohering effects have not been important for several reasons. Probably the principal one is that the mechanical impact incident to switchhook operation is carried directly to the transmitter and prevents appreciable cohering.

#### *Carbon Preparation*

Substantial improvements in the technique of granular carbon manufacture have been made in conjunction with the development of the new transmitter. Roasting processes have been adopted which sub-

ject each granule to substantially the same heat treatment and produce carbon of unusually uniform electrical properties. Uniformity is further insured by the use of a magnetic separator to remove granules having an undesirably high iron content, and the removal in an air stream of flat, wedge-shaped particles which tend to cause carbon leakage in the transmitter by working their way between the layers of paper which form the closure between the carbon chamber and diaphragm.

Measures of this kind have been of particular value, not only in bettering the transmission characteristics of the individual transmitter, but in securing a uniform commercial product. Without these improvements, indeed, it is doubtful if the production of the transmitter could be maintained at the high rate now required without a sacrifice in the average quality of the product.

#### RECEIVER

The parts of the handset receiver are assembled in a die cast aluminum housing, and form a unit which mounts in a threaded bushing in the handle in much the same manner as the transmitter unit. One connection to the winding is made through the threaded portion of the case, the other through a contact spring in the base. The cap and spacing ring are made of phenol plastic and thoroughly insulate the metal parts so that the user cannot come in contact with any portion of the receiver which forms a part of the electrical circuit. The spacing ring also serves as a lock ring for holding the receiver on the handle. A grid in the cap prevents damage to the diaphragm from the projecting portions of the mounting. The layout of the holes in the grid is such that a dent in the diaphragm caused by inserting a pencil or other sharp object through the grid, will not occur at a point over the pole faces and interfere with the operation of the receiver.

While in general the design of this receiver follows conventional lines, the choice of materials and the design of the magnetic circuit have resulted in an increase in efficiency of several db as compared with the deskstand receiver. It has not been considered desirable, however, to make use directly of this increase in efficiency for several reasons.

Although greater receiving efficiency raises the intensity of the incoming speech, it also increases the intensity of any noise present on the line or picked up as sidetone. Since, therefore, the ratio between the received speech and the noise is not improved, the general reception would be little benefited by an increase in receiving efficiency alone. Furthermore, the increased sidetone causes an effective loss in transmitting level by causing the speaker to lower the intensity of his speech.



The higher efficiency of the handset receiver is, however, of appreciable indirect value, and has been used in two ways, at the same time maintaining the same intensity of the received speech as is obtained with the deskstand.

By lowering the impedance to about half that of the deskstand receiver, the loss in the sidetone path and the transmitting efficiency of the set have been increased. The lower sidetone tends to increase the speaker's talking level, giving a further effective gain in transmitting efficiency. The reduction in the room noise appearing in the sidetone also results in an effective receiving gain as compared to the deskstand.

The separation between the diaphragm and the pole pieces has been increased so as to minimize the "freezing" of the diaphragm on the pole pieces, which is likely to occur when clamped diaphragm receivers are subjected to sudden changes in temperature of considerable magnitude.

#### ASSEMBLED HANDSET

The dimensions and proportioning of the handle and the assembled handset are the result of rather extensive investigation. They represent an effort both to meet the technical requirements and to produce a mechanically rugged structure, light in weight and comfortable to hold, as well as attractive in appearance and in harmony with the mounting.

#### *Prevention of Howling*

One of the major objections to the handset in the past has been the tendency to howl. While a certain degree of howling control can be realized in the electrical coupling by the design of the station circuit, such control cannot be depended upon to take care of extreme circuit conditions where the coupling is greatest and howling most likely to occur.

From an economic standpoint, moreover, it is desirable that the handset should be completely interchangeable with the deskstand without the necessity for changes in the set or other parts of the telephone plant. If this is to be realized, the handset must be so designed as to be inherently free from the danger of howling under any conditions encountered.

Mechanical disturbances set up by the receiver produce transverse vibration in the handle which moves the transmitter as a whole. The solid phenol plastic handle employed in the present handset has a relatively high resonant frequency and provides a comparatively inefficient medium for the transmission of mechanical disturbances from

the receiver to the transmitter in the frequency range where the instruments respond most readily.

A further and perhaps a major factor in eliminating the danger of howling is to be found in the characteristics of the transmitter. The



Fig. 10—Use of gauge for head measurements.

response of a transmitter to bodily movement of the whole structure is of course very different from its response to acoustical pressures, and depends largely on the mechanical impedance of the diaphragm and its supporting structure. The extremely light and highly damped diaphragm of this transmitter is ideally suited for minimum response to mechanical vibration.

Under the worst conditions encountered, a margin of at least 15 db is realized with this structure which effectively eliminates howling as a limiting factor in the general use of the handset.

### Determination of Dimensions

Particular effort has been made to proportion the handset so that the transmitter mouthpiece may be as near as possible to the lips of the

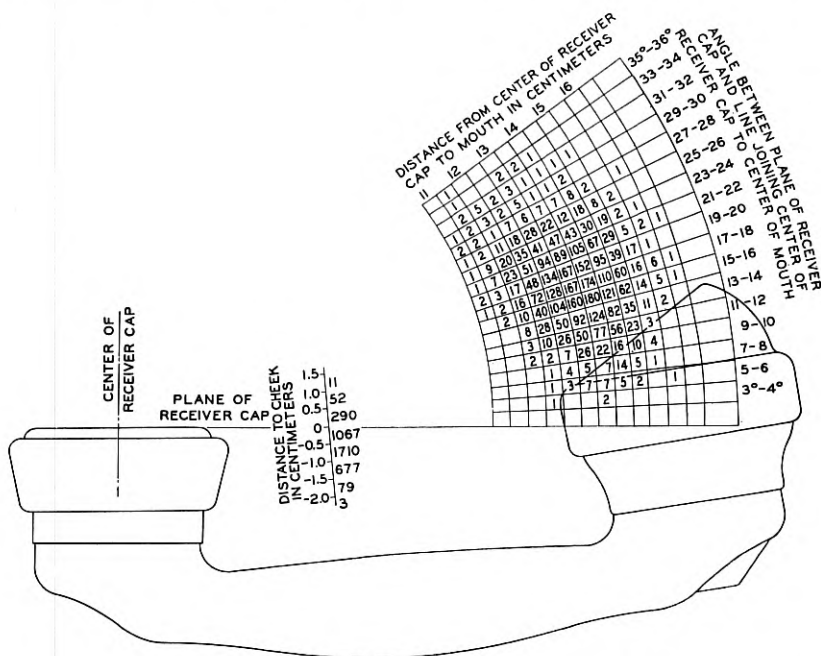

Fig. 11—Distribution of the head measurement data.

talker, thereby avoiding unnecessary transmitting loss. Care has been taken also to provide adequate clearance between his hand and cheek. In determining the proper dimensions of the handle and assembly, about 4000 measurements of head dimensions were made. The subjects selected for these measurements included both sexes and the various races in about the proportion indicated by the census figures.

The head measurements were made with a special gauge as shown in Fig. 10. The receiver cap was held to the ear and the pin placed in contact with the cheek. The slider was moved along the calibrated bar until it touched the lips. A record was made of the dimensions which determined the position of the center of the lips relative to the

center of the receiver cap and the clearance between the handset handle and the cheek.

The data obtained are shown graphically on Fig. 11 together with an outline of the handset drawn to the same scale. All except about 3 per cent of the persons shown on the chart can use the handset by holding the receiver to the ear in a normal manner. The others can be accommodated by a slight shift of the receiver on the ear. The effect of such a shift on received speech, for a small number of persons, is unimportant in comparison with the large improvement in transmitting performance for the great majority which results from the decrease in the average distance of the mouthpiece from the lips.

#### PERFORMANCE IN SERVICE

Since the initial introduction of the handset, close contact has been maintained with its performance by tests and observations under actual service conditions, and by the examination of instruments returned from service.

It has been shown by these observations that, although the output of the handset transmitter as used by the subscriber is on the average lower than that of deskstand transmitters of the most efficient types, the improved response and articulation are an adequate compensation for the lower level. The transmission performance of the handset as rated by the repetitions,<sup>7</sup> has been found to be as good as that obtained with the deskstand.

Undesirable variations in transmission and resistance with change in position, excessive carbon noise, and howling, all of which have heretofore presented serious obstacles to the adoption of a handset for general use, have been successfully overcome in the design which has been described. It has been found practicable to use this handset interchangeably with the deskstand in the existing telephone plant, without important reactions on either transmission or signalling performance.

That the design, in addition, meets the desires of the public for the convenience of a hand telephone set is best evidenced by the steady increase in demand to more than one million a year at the present time.

<sup>7</sup> "Rating the Transmission Performance of Telephone Circuits," W. H. Martin, *Bell System Technical Journal*, Jan. 1931, pp. 116-131.

## Precision Methods Used in Constructing Electric Wave Filters for Carrier Systems

By G. R. HARRIS

Electric wave filters are used extensively in carrier telephone and telegraph systems. In order that such systems may be operated efficiently and economically, the requirements placed on the filters they employ are occasionally so severe in nature that new methods in design or construction must be developed to make the commercial production of the filters possible. The band filters for the Type "C" Carrier Telephone System are cases in point. This paper sets forth the requirements which were met in the design of the filters for this system, and describes a new manufacturing adjustment made necessary by these requirements. This feature consists essentially of an inductance continuously variable over a small range above and below its nominal value; the adjustment is not used to set the coil inductance at its specified value, but to locate correctly the series or parallel resonance of the mesh of which the coil is a part. The bridge and associated apparatus developed to facilitate this adjustment are also described.

ONE of the most important fields of usefulness of the electric wave filter in the Bell System is found in carrier current telephone and telegraph systems. A carrier telephone system transmits several messages over the same line by employing several carrier currents of frequencies higher than those in the ordinary voice band, and modulating these carriers with the messages to be transmitted. The messages are then transmitted over the line as side bands of their respective carriers, and are demodulated to their original voice frequencies at the receiving end.

Usually only one side band of a carrier is transmitted in order to reduce the frequency space required for each channel. Each message as it appears on the line occupies its own portion of the frequency spectrum, distinct from that occupied by any other message, and is transmitted without interference from other messages; but in order that the operations of modulation and demodulation may be carried on without interference and in order that unwanted side bands may be suppressed, it is necessary that each modulator and demodulator be equipped with some apparatus which will pass all the side band frequencies making up one message and reject all others. Electric wave filters are the instruments used for this purpose, since they possess the property of passing currents of certain chosen frequencies with very small loss, and of offering high attenuation to other chosen frequencies.

The theory of electric wave filters as used in carrier systems has been discussed in previous articles in this *Journal*, notably "Physical

Theory of the Electric Wave Filter" by G. A. Campbell, which appeared in the November, 1922 issue, and "Theory and Design of Uniform and Composite Electric Wave Filters" by O. J. Zobel, in the issue for January, 1923. It is not the purpose of the author to discuss further the theory of wave filter design or operation, but rather to discuss some of the problems that arise when an attempt is made to construct filters which must meet certain requirements of a carrier system with a very small margin of variation, and to describe the methods of solution adopted. It is assumed that the reader is familiar with the general principles of electric wave filter theory.

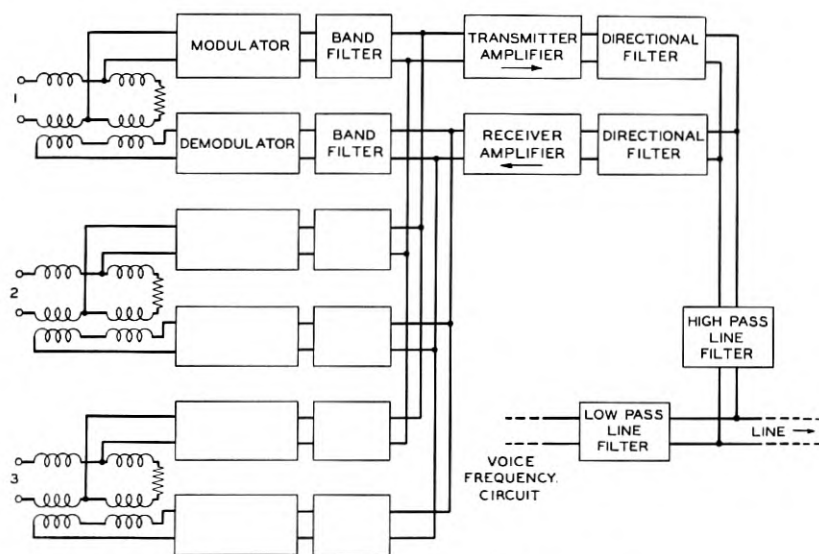

Fig. 1—Type "C" system terminal arrangement.

Different carrier systems require different numbers and designs of filters. A carrier system designed to provide three two-way telephone channels would have six band filters at each terminal. These filters would be of a type that passes all frequencies between certain upper and lower frequency limits, and provides a high attenuation or loss to all frequencies below and above these limits. A simplified diagram of such a terminal arrangement is shown in Fig. 1.

In addition to the band filters, a pair of directional filters is required at each terminal to separate the three incoming from the three outgoing channels. This directional filter pair is composed of a low-pass and a high-pass filter, which as their names imply, pass respectively all frequencies from zero up to the predetermined cut-off point and

attenuate those above this point, or pass all frequencies above the cut-off point and attenuate all those below. The cut-off points of this pair of filters are so arranged that the passing region of the low-pass filter includes the three lower frequency channels and the passing range of the high-pass filter includes the three upper frequency channels. The location of the various filters in the frequency spectrum is shown in Fig. 2.

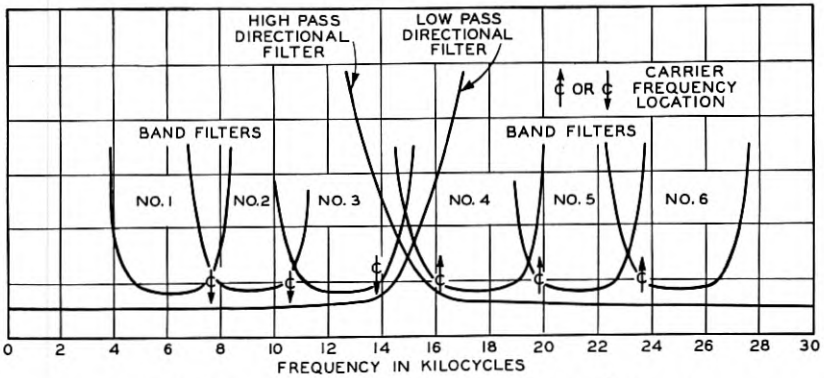

Fig. 2—Frequency spectrum of type "C" normal system.

If the carrier system is long enough to require repeaters, additional directional filters must be employed. These filters are required because repeaters must amplify frequencies going in both directions. The arrangement of the repeater is shown in Fig. 3.

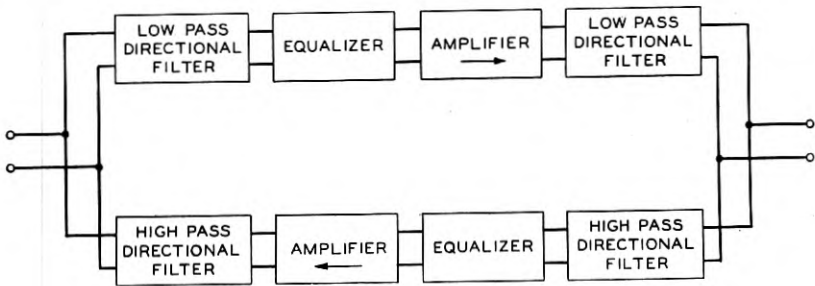

Fig. 3—Schematic of type "C" repeater.

This paper will be concerned with the filters for the Western Electric Type "C" Carrier Telephone System,<sup>1</sup> since the requirements placed on the apparatus for this system raised certain problems in filter

<sup>1</sup> H. A. Affel, C. S. Demarest and C. W. Green, "Carrier Systems on Long Distance Telephone Lines," *Bell Sys. Tech. Jour.*, July, 1928.

design and construction which had not then been satisfactorily solved. The highest frequency to be used in this system was determined, of course, by the limitations of wire transmission as the frequency increases. The lowest was set chiefly by the desire to avoid interference from carrier telegraph systems on other wires of the same pole line. Between these limits, the six bands (three two-way channels) had to be located. At the same time it was desirable to provide a second system, with a frequency allocation offset or "staggered" with respect to the first, to permit operation of carrier systems on pairs in close proximity where the normal crosstalk would not permit operation of the same systems. This is shown graphically on Fig. 4. The cross-

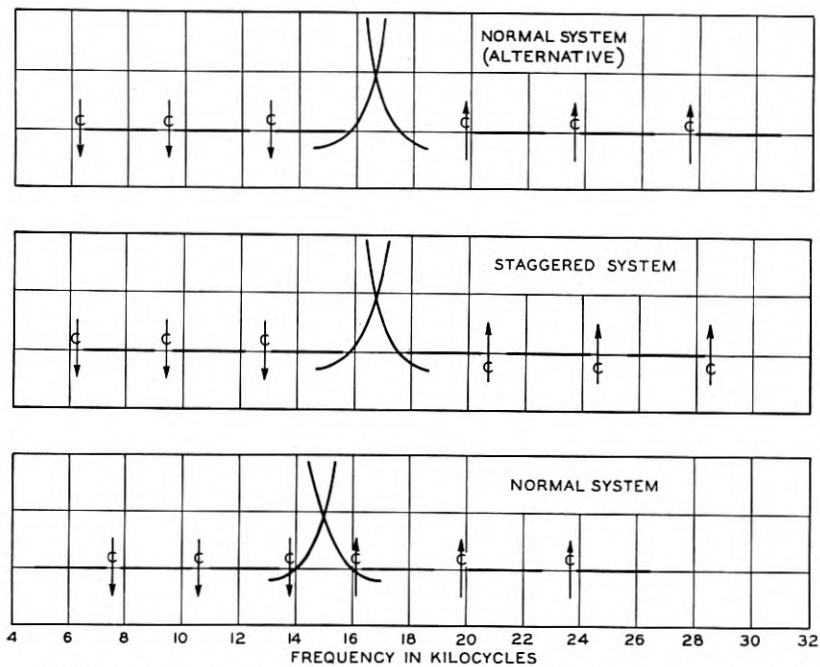

Fig. 4—Frequency spectra of type "C" normal and staggered systems.

talk advantage thus obtained is rather critical with respect to the overlap between interfering channels. These two factors, first, interference between channels in the same system and, second, interference between channels in adjacent staggered systems, emphasized the need for a high degree of precision in the location of the individual bands.

The theoretical requirements of the filters, although severe, were met without any departure from conventional design practices. The calculated attenuation characteristics satisfied the minimum loss



requirements and did not exceed the maximum loss requirements in the transmitting bands. The margins, however, were not very great.

It is evident, therefore, from Fig. 5, that a very small shift in the frequency location of the loss characteristic of a filter would throw it outside the required limits. The shift which would cause this to happen was, in fact, so small,  $\pm 125$  cycles, that the manufacture of these filters by methods currently in use resulted in enough rejections at the factory to warrant the development of a more precise method.

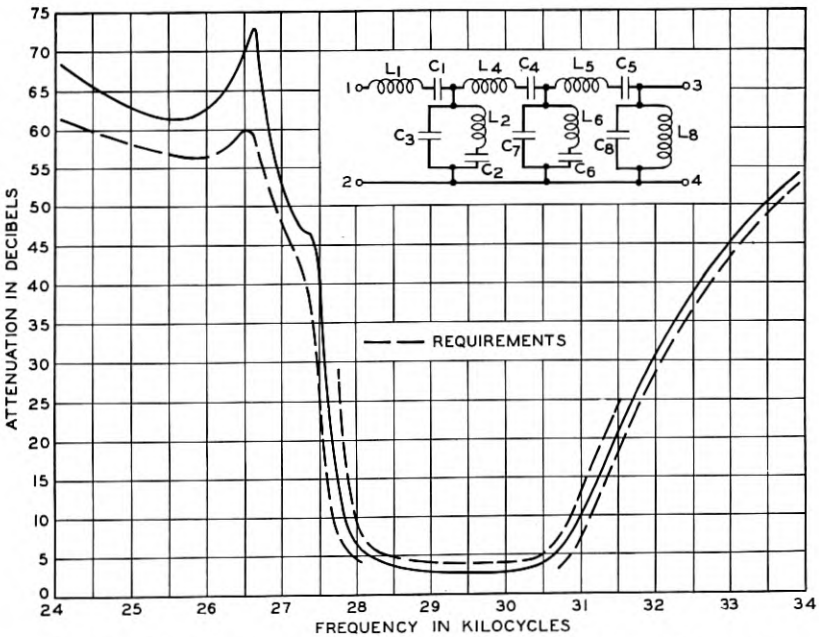

Fig. 5—Attenuation characteristic of 38-N filter, showing requirements.

The attenuation characteristic of a manufactured filter seldom conforms exactly with that desired because of manufacturing tolerances which must be allowed in its component elements. The inductances and capacitances of the coils and condensers which make up a filter differ somewhat from their specified values for several reasons. The precision of their adjustment can be no greater than the precision of the circuits in which they are measured. It is usually less than this figure because the coils and condensers used in precision filters are potted in a moisture-proofing compound, after adjustment, and this potting produces a small change in the capacitance of the condensers and the distributed capacitance of coils which is not uniform and can-

not be allowed for exactly in advance. Coil adjustment is limited by another factor, as well; the adjustment of a single coil must be made in units of one turn. For these reasons it is very difficult to adjust condensers to better than about  $\pm 0.3$  per cent, and coils to better than a little over  $\pm 1$  per cent.

The effect of the variation in element values may be manifested in several ways. In a simple half-section low-pass filter, for example, the cut-off frequency

$$f_c = \frac{1}{2\pi\sqrt{LC}}$$

where  $L$  and  $C$  are the values of the series inductance and shunt capacitance. A variation in  $L$  or  $C$  will produce a change in the cut-off frequency proportional to the change in the element value. Changing the cut-off frequency is, of course, equivalent to shifting the whole attenuation characteristic upward or downward in frequency. A change in an element value also produces a change in the filter impedance. Suppose that in a network composed of a number of series and shunt arms, the impedance of one arm of the network,  $Z_q$  is increased by an amount  $\Delta Z_q$ . The current through that branch is  $I_q$ . The change in impedance is approximately equivalent to introducing a voltage  $e$  in the circuit.

$$e = -I_q \Delta Z_q.$$

If  $E$  is assumed to be the voltage in series with the terminal impedance  $Z_s$  at the sending end of the network, and  $I_s$  is the input current,

$$-\frac{I_q \Delta Z_q}{\Delta I_s} = \frac{E}{I_q}$$

from the reciprocity theorem. But

$$\frac{\Delta I_s}{I_s} = -\frac{\Delta Z}{Z + Z_s},$$

where  $Z$  is the input impedance of the network, and  $\Delta Z$  is the change in  $Z$  produced by the impedance change in the arm  $Z_q$ . Furthermore,

$$E = (Z + Z_s)I_s.$$

Therefore

$$E = -I_s^2 \frac{\Delta Z}{\Delta I_s}.$$

And

$$\Delta Z = \Delta Z_q \left( \frac{I_q}{I_s} \right)^2.$$

As a filter is usually designed to match two fixed impedances between which it must operate, a change in its impedance caused by element variation will produce a mismatch between the filter and its terminating impedances which will result in reflection loss in the transmitting region. However, the reflection loss arising from impedance deviation caused by element variation is usually much less troublesome than the shift in the attenuation characteristic produced by this variation.

A more complicated type of filter, such as the symmetrical "Constant  $k$ " band pass section exhibits a more involved relation between the cut-off frequencies and the values of the elements.  $L_1$  and  $C_1$  are the series arm inductance and capacitance, while  $L_2$  and  $C_2$  are the inductance and capacitance in the shunt arm.

$$\left. \begin{matrix} f_2 \\ f_1 \end{matrix} \right\} = \frac{1}{2\pi} \left[ \sqrt{\frac{1}{L_1 C_2} + \frac{1}{L_1 C_1}} \pm \sqrt{\frac{1}{L_1 C_2}} \right].$$

In the equation as written  $L_2$  does not appear explicitly, but as in this type of section  $L_1 C_1 = L_2 C_2$  the equation may be written with  $L_2 C_2$  as the denominator of the second term in place of  $L_1 C_1$ , if desired. Therefore, three  $LC$  products influence each cut-off frequency; three resonant frequencies, therefore, must be held constant if the cut-offs are not to vary. The mid-band frequency of this section is given by the equation

$$f_m = \frac{1}{2\pi} \sqrt{2 \left[ \frac{1}{L_1 C_1} + \frac{1}{L_2 C_2} \right]},$$

from which it is seen that two  $LC$  products,  $L_1 C_1$  and  $L_2 C_2$ , must be held constant if  $f_m$  is not to vary.

Element variation may cause a shift in the cut-off points and thus a displacement of the attenuation or impedance characteristic of any type of section, but it may have another effect on the characteristics of  $M$  type sections. An  $M$  type section provides a peak of attenuation at some finite frequency, which is determined, in most sections of this type in common use, by a single pair of elements; either a series resonant combination shunted across the filter or a parallel resonant combination in a series arm. Variation in either of the elements determining the location of the peak will cause a shift in the location of this peak proportional to the element variation. Changes in these elements would affect the cut-offs of the section as well as the peak or peaks, but it may happen that variation in the opposite direction of other elements in the section will result in negligible shift of the cut-offs, while the peaks are shifted noticeably. Thus the attenuation characteristic of an  $M$  type section may be distorted as well as displaced by element variation.

The critical region of the type "C" system band filter requirements was the slope of the attenuation characteristic from the cut-off to the peak nearest the carrier side of the transmitting band. The system was designed to transmit one sideband only, and the band filters were required to suppress the carriers at least 15 db. The transmitted sideband for each filter extended from 250 to 2750 cycles from the carrier, so that in every case the filter had to offer at least 15 db suppression to the carrier frequency, which was only 250 cycles away from the edge of the transmitting band. Where the carrier frequency was

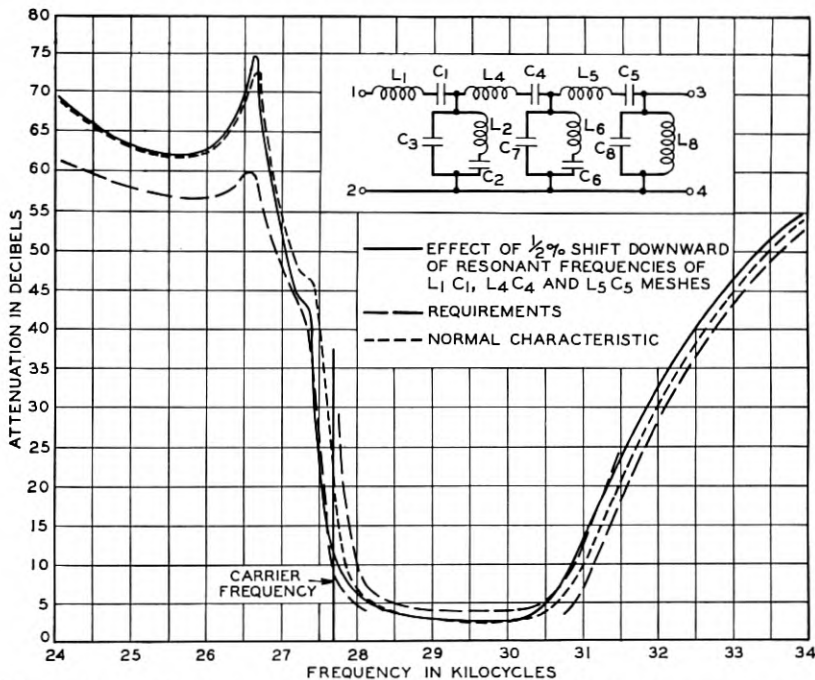

Fig. 6—Attenuation characteristics of 38-N filter, showing effect of element variation.

25 kc., the separation was only 1 per cent. This requirement necessitated very steep slopes of the attenuation characteristic, especially for the higher frequency filters; at these slopes a frequency shift of 1/2 per cent produced a change in attenuation of 9 or 10 db, as may be observed in Fig. 6.

As the precision of adjustment for condensers was three or four times that for coils, it was obvious that some improvement in coil construction or adjustment would have to be made. Furthermore, since the important limiting factors in the adjustment of both coils

and condensers were the precision of the bridge standards and the bridge operating technique in the shop it seemed unlikely that more precise location of the filter characteristics could be obtained until these factors were improved. However, another way was found. It has been pointed out in preceding paragraphs that critical points, such as cut-off points and attenuation "peaks" are usually dependent upon the resonant frequency of a pair of elements, or perhaps of several pairs. It is much more important that these critical frequencies be correctly located; that is, that the  $L$ - $C$  product of the elements be of the correct value, than that either element alone be of the correct value. Therefore, if some way could be found of adjusting a combination of elements associated together in a filter so that the  $L$ - $C$  product would be of the correct value, a considerable improvement in the precision of the attenuation characteristic location might be expected. If the elements could be adjusted so that a negative deviation in condenser capacity, for example, could be compensated for by a positive deviation in coil inductance, the  $L$ - $C$  product, and therefore the resonant frequency, would be correct, and the effect of the individual element deviation would be greatly minimized, though not entirely eliminated. Either an adjustable coil or an adjustable condenser would make this procedure possible; and, as such a resonant frequency adjustment could be made to the precision of an oscillator calibration, or about 0.05 per cent, if necessary, the errors of inductance and capacity bridge standards, as well as initial adjustment error and variation due to potting would be eliminated at the resonant frequency, and their effects minimized greatly at other frequencies.

Development was therefore started on an adjustable type of inductance. As the simplest and most inexpensive coil was, of course, the most desirable, efforts were made to modify the solenoidal air core coil used in previous carrier filters. One scheme considered was to mount a small copper vane in such a way that it could be moved into or out of the field of the coil; the eddy-currents in the vane set up a small counter field that neutralized a part of the field of the main coil and thus reduced its inductance. Another method made use of a small "pancake" wound coil mounted vertically on the side of the main coil so that it could be moved up or down, into or out of the field of the main coil. This small coil was short-circuited, and therefore produced an effect similar to that of a copper vane. The model finally adopted, however, although using the same principle of adjustment, was made in a somewhat different form. A rectangular rotor was constructed to fit around the main coil. This rotor was pivoted to the main coil on its short sides and could be rotated through an

angle of approximately  $60^\circ$  about its horizontal axis. On this rotor was wound a large number of turns of small gauge wire, and the winding was short-circuited. A coil of this type is shown in Fig. 7. The coupling between the rotor in its horizontal position and the main coil is very small, and therefore the effective inductance between terminals is practically that of the main coil. However, if the rotor is rotated in such a way that its plane becomes more nearly parallel

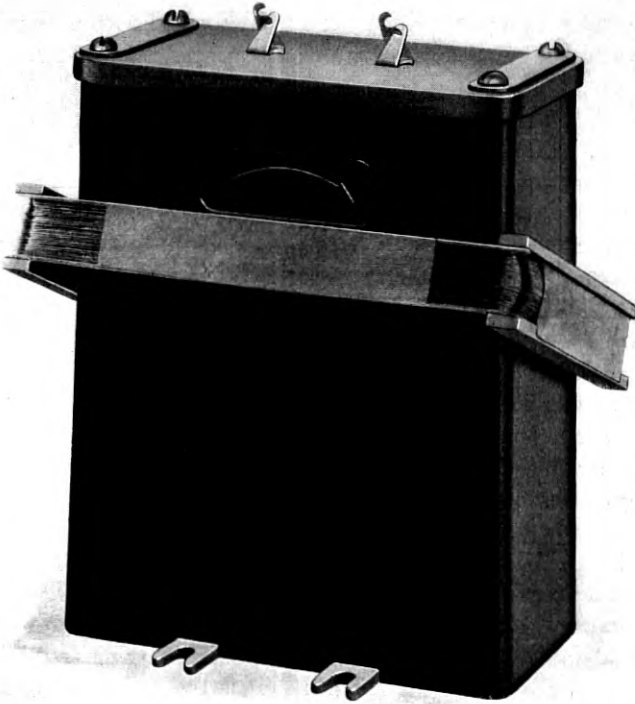

Fig. 7—Photograph of "AA" coil.

with that of the main coil the coupling between it and the main coil is increased, and the effective inductance of the whole is reduced. It is possible to vary continuously the inductance of a coil of this design over a range of about  $3\frac{1}{2}$  per cent.

When coils of this type and their associated condensers are connected together as they would appear in a filter, their resonant frequency or frequencies are located by an adjustment of the coil or coils in the mesh. If the mesh contains more than one adjustable coil, more than

one resonant frequency may be located. As many of these resonant frequencies may be located in this way as there are adjustable elements in the mesh. Since the condensers are not adjustable, all of the frequencies of series and parallel resonance in a complex mesh, will not, in general, be capable of adjustment. If the mesh is composed of  $n$  condensers and  $m$  coils, and the difference between  $m$  and  $n$  is not more than 1 (if this condition is violated the mesh can be reduced to an electrically equivalent one containing a smaller number of elements), the number of resonant and anti-resonant frequencies is clearly  $(m + n - 1)$ . However, since the number of adjustments possible is equal only to the number of coils,  $m$ , the number of frequencies which cannot be exactly located is  $(n - 1)$ , or one less than the number of condensers. This condition is not very objectionable in practice as the mesh configuration is usually chosen to be of a form which permits the more important critical frequencies to be adjusted. In a four-element mesh, the largest usually encountered in an ordinary filter structure, two of the three resonant frequencies may be adjusted, and furthermore, the adjusted frequencies may be any two of the three; in most cases the adjustment of two frequencies is sufficient.

The frequency adjustment is actually made on a bridge circuit, the schematic of which is shown in Fig. 8. Two of the bridge arms are, of course, ratio arms; the mesh to be adjusted is connected in circuit as a third arm, and the fourth arm is a variable resistance. For series resonance adjustment, the desired frequency is impressed on the bridge, and the inductance of the adjustable coils varied so that the impedance of the mesh becomes a pure resistance, which is balanced by an adjustment of the resistance in the opposite bridge arm. For a parallel resonance measurement, a resistance of 10,000 ohms is shunted across the mesh being adjusted, and the coil varied until the reactance component of the mesh impedance vanishes, when the resistance of the 10,000 ohms in parallel with the resistance of the mesh can be balanced in the fourth bridge arm.

This frequency adjustment of filter arms involved a change in filter manufacturing procedure. Ordinarily the coils and condensers for the filter are individually adjusted, then mounted, wired, and the filter finally tested as a whole, but an additional step is required in the construction of filters employing adjustable coils. It is necessary to adjust the resonant frequencies of meshes after the elements are mounted, but before the filter is finally wired and tested, and furthermore, it is necessary to adjust these elements under exactly the same conditions that obtain during filter operation if the full benefit of the adjustable feature is to be realized. This requirement presented a

difficulty, as the filters for the type "C" carrier system are assembled in copper boxes or shields as shown in Fig. 9 and are completely soldered all around, including the lid. This type of assembly was made necessary by the requirements on cross-talk between filters mounted next to each other on a vertical rack. The cross-talk between two filters mounted side by side was required to be 135 db below the signal currents, or, in other words, the ratio of the desired signal to the cross-talk had to be a little over 5,000,000 : 1. The chief cause of

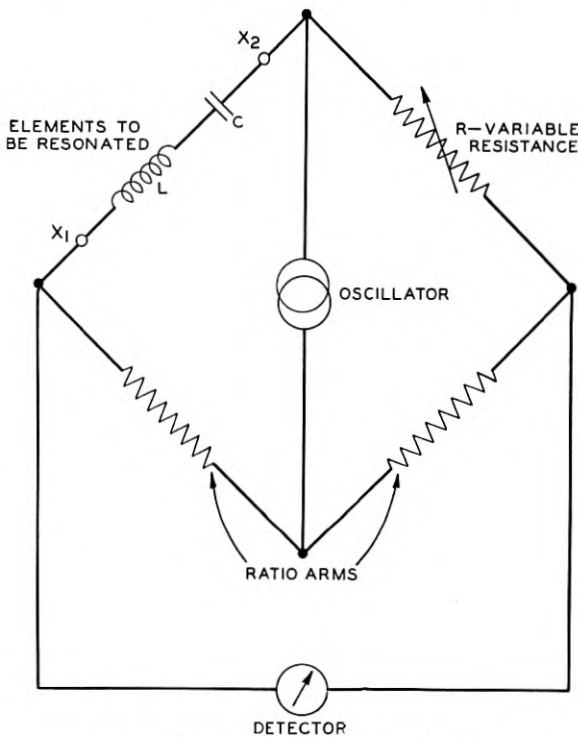

Fig. 8—Simplified schematic of L-C bridge.

such cross-talk between two pieces of apparatus is electromagnetic coupling between them; to reduce this coupling eddy-current shielding is employed. Eddy-current shielding is accomplished by surrounding the source of a varying electromagnetic field—a coil, say, or the coils in a filter—by some metal, such as copper, brass or aluminum, which has good conductivity.

To make clear the effect of a shield on an inclosed inductance, a brief discussion of shielding may be of interest. If a coil through which



an alternating current is flowing is enclosed in such a shield, one part of the flux lines from the coil will encounter the shield; the remaining part will not. Let every line  $\Delta\varphi$  of the flux which encounters the shield be divided into components perpendicular to the shield and parallel to it. If  $\theta$  is the angle between such a line and the plane of the shield, the component perpendicular to the shield, which is effective in setting up eddy currents in it is  $\Delta\varphi \sin \theta$ . The other component,  $\Delta\varphi \cos \theta$ , makes no coupling with this shield, and sets up no eddy currents. To every line  $\Delta\varphi \sin \theta$  the shield presents a certain inductance

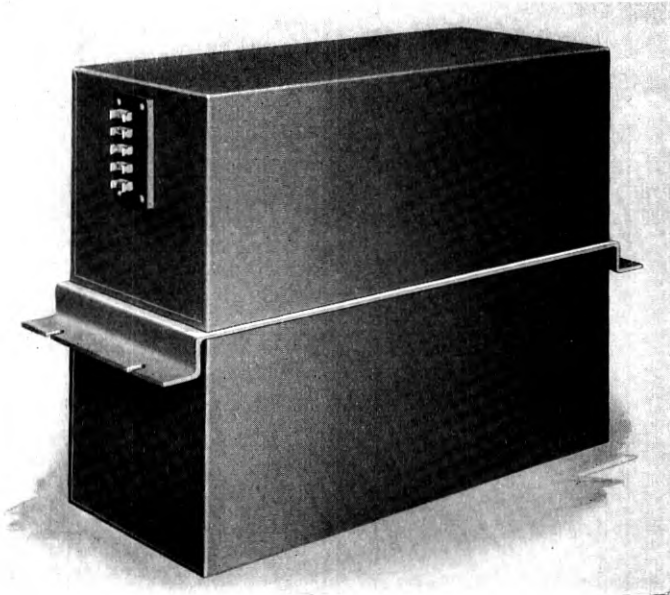

Fig. 9—Photograph of filter in soldered shield.

and resistance, and the average inductance and resistance presented to all the linking lines may be taken as the inductance and resistance of the shield. The equivalent circuit of a coil surrounded by a shield may be indicated, then, as a coil  $L_1$  of two sections coupled to a second coil  $L_2$ , in parallel with a resistance  $R_2$ . This parallel circuit is the equivalent circuit of the shield. The coil  $L_1$  has a total inductance equal to that of the coil in the shield, and is considered to be divided into two sections, the first of which, "A," makes no coupling at all with  $L_2$ , and the second, "B," which makes perfect coupling with  $L_2$ . If  $K$  is the coefficient of coupling between the coil  $L_1$  as a whole and  $L_2$ ,

the portion "B" of  $L_1$  is equal to  $K^2L_1$ . Now let a current  $I_1$  be assumed to be flowing in  $L_1$  and,  $I_2$  in  $L_2$ . The mutual inductance between the coil and the shield is  $-K\sqrt{L_1L_2}$ . If  $e_1$  is the voltage drop across the portion "B" of  $L_1$

$$\begin{cases} e_1 = j\omega K^2 L_1 I_1 - j\omega K \sqrt{L_1 L_2} I_2 \\ 0 = j\omega L_2 I_2 + R_2 I_2 - j\omega K \sqrt{L_1 L_2} I_1, \end{cases} \quad (1)$$

from which

$$e_1 = \frac{I_1 K^2 R_2 L_1 \omega}{R_2^2 + L_2^2 \omega^2} (L_2 \omega + j R_2).$$

Suppose  $R_2 = 0$ , which would be the case if the shield were made of a perfect conductor. Then  $e_1 = 0$ . If, however,  $R_2$  is assumed to be infinite,  $e_1 = I_1 j\omega K^2 L_1$ , the voltage which would appear if the shield were not present. Since the portion "B" of  $L_1$  is the only inductance coupled with the shield, it is the only source of a field which might extend beyond the shield. Therefore, when  $R_2$  is 0, and  $e_1$  the voltage across "B" is also 0, there is no energy in the field, and it obviously cannot make coupling with anything beyond the shield. This condition would obtain for perfect shielding, but  $R_2$ , of course, is never zero in practice.

When  $R_2$  is finite, " $e_1$ ," the voltage across "B" is finite, and a certain amount of energy is transferred to the equivalent circuit of the shield. Part of this energy is dissipated in the equivalent resistance of the shield, and the remainder is stored in the field of the equivalent inductance.

The reactance, or " $j$ " term of Equation 1 is a measure of the energy stored in the shield and is, therefore, also a measure of the field which may exist outside the shield. As the flux is proportional to the ampere-turns, and the reactance is proportional to the square of the turns, the square root of the ratio of this reactance value when  $R_2$  is infinite to its value when  $R_2$  is finite is the average ratio of the flux  $\varphi_0$  with no shield present to the flux  $\varphi_s$  with the shield present.

$$\frac{\varphi_0}{\varphi_s} = \sqrt{\frac{1}{\frac{R_2^2}{R_2^2 + L_2^2 \omega^2}}} = \sqrt{1 + \frac{\omega^2}{P^2}}, \quad (2)$$

where  $P = \frac{R_2}{L_2}$ .

The efficacy of the shielding in reducing the external field is therefore seen to be dependent upon the frequency, and a parameter "P," the ratio of resistance to inductance of the shield itself. As the voltage induced in some coil beyond the shield is proportional to the flux, the

reduction in cross-talk caused by shielding may be written

$$a = 20 \log_{10} \frac{\varphi_0}{\varphi_s} = 10 \log_{10} \left( 1 + \frac{\omega^2}{P^2} \right). \quad (3)$$

In the 1/32 inch copper shields ordinarily used for filters, the parameter "P" has been found to have values from 1250 at 500 cycles to 2500 at 15000 cycles.

From Equation 1, the change in impedance,  $\Delta Z$  of the coil, caused by the presence of the shield, may be written

$$\Delta Z = + \frac{[\omega^2 K^2 L_1 L_2 R_2]}{\omega^2 L_2^2 + R_2^2} - j\omega \frac{[\omega^2 K^2 L_1 L_2^2]}{\omega^2 L_2^2 + R_2^2}. \quad (4)$$

This change is made up of a decrease in reactance and an increase in the effective resistance of the coil. The percentage change in both resistance and reactance may be written

$$\frac{\Delta R_1}{L_1} = - \frac{\omega^2 K^2 P}{P^2 + \omega^2}, \quad (5)$$

$$\frac{\Delta L_1}{L_1} = - \frac{\omega^2 K^2}{P^2 + \omega^2}, \quad (6)$$

and

$$\frac{\Delta R_1}{\Delta L_1} = - P. \quad (7)$$

The percentage change in the inductance of the solenoidal air-core coils mounted inside ranged from 2 per cent to 4 per cent, depending upon the proximity of the coil to the shield. Since these changes depended upon the distance of the coils from the shield, slight variations in the winding diameters of the coils caused variation in the magnitude of this cover effect, so that although this change in inductance was taken into account by specifying inductance values for the filter coils 2 to 4 per cent higher than indicated by the design computations, the corrections were only approximate. No such correction was, of course, necessary for the condensers; the condensers, therefore, as measured outside the filter shield, were still correct, but the coils under the same conditions, measured higher than specified values. It was obvious that the resonant adjustment should not be made with the coils outside their shields, as the approximate nature of the cover correction would vitiate the precision of the adjustment, but it was equally obvious that it would be very difficult to make a coil adjustment inside the soldered cans, as the elements would then be inaccessible.

As mentioned above, the purpose of the filter shielding was to reduce the cross-talk between filters mounted side by side; the effect of the shield upon the coil inductances was an unwelcome incidental. When the coil adjustment was considered, however, the shielding effect of the copper can was of no interest, but its effect on inductances was of paramount importance. Efforts were made to devise a dummy shield which would simulate the standard filter shield in its effect upon the inductances of the coils mounted inside but in which the coils would be readily accessible for adjustment. As it was expected that the adjustable coil would enable resonant frequencies to be located at their desired values within limits of  $\pm 0.1$  per cent, it was necessary that any dummy shield developed for use in the adjusting process should reproduce on the coils the effect of the filter shield to at least this figure. In the ideal case, it would have been desirable that the difference between the dummy or adjusting shield and the standard shield be no greater than the difference between two standard shields.

Several different designs of adjusting shields were tried in the attempt to realize this ideal. The model finally adopted was constructed in the following manner: A box of the same height and width but slightly shorter than the standard shield was built, open at one end. Laboratory tests showed that for coils placed inside the shield near the closed end, the reduction in inductance caused by the shield was almost entirely unaffected by conditions at the other end of the shield. The far end could be closed or left open with an effect which was negligible in comparison with the total inductance change caused by the shield. This condition, of course, held only for coils in the closed end or at a distance of at least three coil diameters from the open end of the shield. Since the maximum number of solenoidal coils mounted on a panel in the type "C" system filters was four, it was necessary only that the adjusting shield simulate the standard for two coil positions, as a filter panel could be turned end for end and the other two coils inserted in the shield after the first two coils were adjusted. The method of adjustment employed was the same for all the preliminary models as for the final design. Small holes were drilled in the top of the shield corresponding to the standard coil locations in the filters, and through these holes the coils were adjusted by means of hard rubber rods with small buttons at their ends. For each coil position a pair of these rods was provided, so arranged that one could be rested on each of the long sides of the coil cradles. Then, by pushing on one rod or the other, the operator could move the cradle to the desired position.

The adjusting shield as finally constructed, and as now used both by the Bell Laboratories and by the Western Electric Company, consists of two of the open shields previously described, mounted on an angle iron frame with the open ends facing each other, as illustrated in Fig. 10. The two shields, which are separated by a distance great

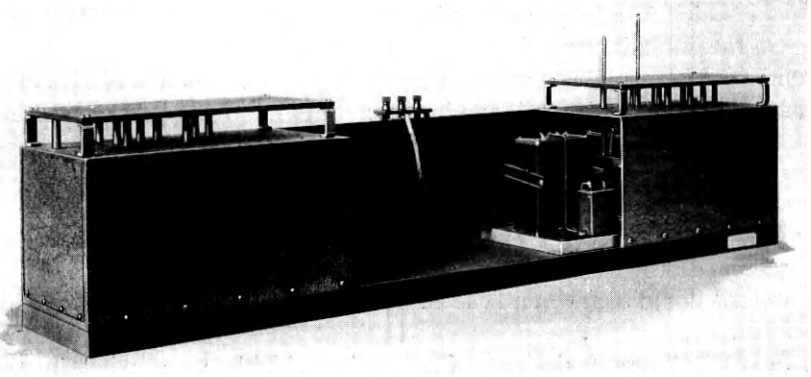

Fig. 10—Photograph of apparatus adjusting shield.

enough to allow the filter assembly to be inserted between them, are equipped with a number of adjusting tools sufficient to adjust coils in any of the standard positions. The right hand shield was arranged to accommodate only the coils mounted on the right of the sub-panel center line, and the left hand shield was arranged to care for the coils mounted on the other half of the panel. Resonant frequency adjustments made in the shield have been checked to within a maximum of about  $\pm 0.05$  per cent against the frequency of the same combination in a standard soldered shield.

The shield is used with a special bridge and associated oscillator and detector, designed for the purpose. The bridge is very similar to the standard current bridges employed for measuring impedances at carrier frequencies, and the complete circuit is shown in Fig. 11.

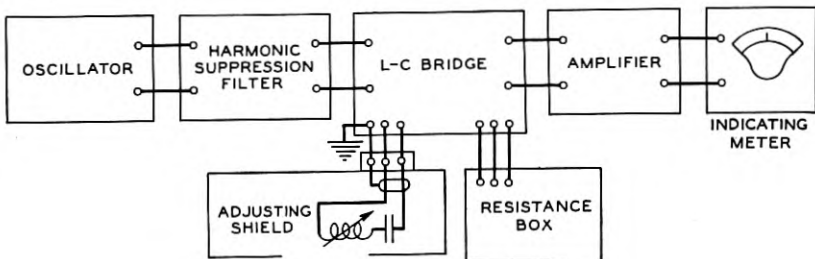

Fig. 11—L-C circuit arrangement.

A complete circuit for resonant frequency adjustment is set up at the Kearny, N. J. Works of the Western Electric Company where carrier filters are manufactured. There, after the coils and condensers in the filter are mounted upon their sub-panel (or panels), but before they are wired, the assemblies are brought over to the resonant frequency adjusting circuit, familiarly known as the  $L-C$  circuit. The sub-panel is placed in one end of the adjusting shield and the coils on that end of the sub-panel are adjusted in the manner previously outlined, after which the sub-panel is brought over to the other end of the shield, and the remaining coils are adjusted. After the coil rotors have been set at the positions for correct adjustment, they are locked by tightening the four screws which hold the coil terminal strip in place. The coil top presses down on the wedges (one of which is visible in Fig. 7) on each side of the coil case, and these wedges in turn clamp the rotor bearings firmly. Then the sub-panels are removed from the circuit, wired, and assembled in their shields.

This method of obtaining increased precision in filter manufacture was first employed in the band filters and equalizers for the Type "C" Carrier Telephone System. Previously, the  $\pm 1$  per cent limit on solenoidal air-core coils, the  $\pm 0.3$  per cent limit on mica condensers, and the additional  $\pm 0.7$  per cent variation in the effect of the filter shield in the coil inductance, caused by variation in the coil diameter, variation in the shield dimensions, and variation in mounting location, which added up to  $\pm 2$  per cent  $L-C$  variation, imposed a  $\pm 1$  per cent limit on the precision of frequency location. When the  $L-C$  method of adjustment is employed, the resonant frequency of a coil and condenser combination may be adjusted to  $\pm 0.05$  per cent, the precision of oscillator calibration, plus the  $\pm 0.1$  per cent limit on the adjustment process, or  $\pm 0.15$  per cent. In the laboratory it is possible to adjust the resonant frequency of an element combination to limits closer than  $\pm 0.1$  per cent, but the  $\pm 0.1$  per cent limits were set in the shop in order that production might proceed without undue delay occasioned by the process of adjustment. The  $\pm 0.7$  per cent tolerance caused by variation in coil diameter, shield dimensions and coil location is reduced to a variation of  $\pm 0.1$  per cent in  $L-C$  product, or  $\pm 0.05$  per cent in frequency; the difference between the adjusting shield and a filter shield caused by the variation in dimensions of filter shields. The precision of manufacture of filters using the  $L-C$  method of adjustment is, therefore,  $\pm 0.15$  per cent, the limits for the adjusting process, plus  $\pm 0.05$  per cent, the margin for variation in filter shield dimensions, or  $\pm 0.20$  per cent in frequency.

At 30 kc., this figure represents a variation in the location of the attenuation characteristic of  $\pm 60$  cycles. However, variations in the effective resistances of the filter coils, and variations in the reflection loss caused by small changes in the filter impedance produce changes in the attenuation of a filter which must be taken into consideration. The sum of these variations amounted to about  $\pm 15$  cycles. The  $\pm 60$  cycle precision at 30 kc., the highest frequency of the type "C" system, became, therefore,  $\pm 75$  cycles; a figure well within the  $\pm 125$  cycle maximum shop limit required by the system, and considerably less than the  $\pm 300$  cycle limits formerly obtainable.

The adoption of this method of filter construction has made it possible to realize in commercial manufacture the high precision of characteristic location which was formerly limited to laboratory construction.

## Cathode Sputtering—A Commercial Application\*

By HAL F. FRUTH

The theory of cathode sputtering with the advantages and limitations in the application of this process is discussed, followed by a description of the commercial equipment and methods for applying gold electrode surfaces to diaphragms of certain types of microphones.

By proper design of the vacuum chamber and the inside parts, a fairly uniform discharge current density and a uniform deposit is obtained. A constant sputtering rate is produced by the use of a bleeder valve which maintains a proper residual pressure. Adherence and continuity are obtained by the use of a special cleaning process.

An extensive bibliography on cathode sputtering is included.

### INTRODUCTION

ALTHOUGH the process of electrostatic deposition of metals by high voltages in a partial vacuum, commonly known as cathode sputtering, has been known for more than a half century, it has heretofore found but little commercial application. Rather extensive use of it has, however, been made in physics research laboratories for such purposes as the production of highly reflecting surfaces on mirrors and prisms, for spectrometers, interferometers, etc., and the making of extremely thin metal films for fundamental studies in atomic structure and electron theory. Sputtering has also been used in the manufacture of very fine conducting quartz fibres for suspensions in sensitive instruments such as quadrant and string electrometers, galvanometers, and electrocardiographs, and, to some extent, for etching certain metals.

In the following paragraphs it is intended to give a brief explanation of the process and a description of a commercial application in the production of diaphragms for certain microphones.

### THEORY

Some fifty years ago, various investigators working on high voltage discharges in vacuo discovered that disintegration of the cathode occurs for nearly all metals and that the removed metal is deposited in a very fine state of subdivision on nearby objects. Various theories have been formulated as to the mechanism of this phenomenon. Some investigators have attempted to explain it by stating that it is a type of electrical evaporation where the electrical potential is analogous to the temperature potential in ordinary thermal evaporation. More plausible theories, recently advanced, are that the metal atoms or particles

\* *Physics*, April, 1932.



leave the cathode as a result of positive ion bombardment, either as a result of single impacts or by cumulative action. This does not seem to hold for all metals and residual gases, and it has been suggested that in some cases sputtering is due to the absorption of radiation produced when the gas ions are stopped at the cathode.

There has also been a great deal of controversy as to the structure of the sputtered film. Most of the more recent evidence indicates that the films are of a crystalline nature.

#### ADVANTAGES OF SPUTTERING OVER OTHER METHODS OF METALLIZING

In general, cathode sputtering cannot compete with the more common processes of metallic deposition, but in many special cases it can be employed where other methods are inapplicable. This is especially true (*a*) when metals are to be deposited upon non-conductors, (*b*) when the surfaces to be metallized would be injured by contact with chemical solutions or high temperature, (*c*) when either a very thin continuous metal coat or a very smooth, highly reflecting coat is desired, (*d*) when metals are to be deposited that are very difficult to deposit in any other manner, such as silicon, tellurium, or selenium, (*e*) when a metal is to be deposited upon another metal far removed from it in the electrochemical series, such as gold or platinum upon aluminum or magnesium. In such cases, electrolytic corrosion is very apt to occur in the presence of moisture or traces of electrolyte.

#### COMMERCIAL APPLICATION

Cathode sputtering has been used commercially by the Western Electric Company with excellent results in the manufacture of diaphragms for carbon broadcasting transmitters, illustrated in Fig. 1. This type of microphone consists essentially of a tightly stretched duralumin diaphragm located between two chambers containing granular carbon. The manner in which the double button type of microphone is connected to the amplifiers of the broadcasting, public address, or sound picture system is schematically shown in Fig. 2. Those parts of the diaphragm which come in contact with the carbon are covered with gold, a metal which has been found to be ideally suited for microphonic purposes. It is exceedingly important that the gold coating be continuous and remain adherent, for if the carbon should make contact in a number of places with the duralumin, it is quite likely that the microphone would be noisy and therefore unfit for use.

When the gold spots were formed by the plating process previously used, considerable trouble was experienced because of such defects

as blisters, peeling, and pin holes probably due largely to electrolytic corrosion. The substitution of the sputtering process has practically eliminated such defects. Some additional advantage over electrolytic plating is that a thinner continuous film can be deposited, making it possible to stretch the diaphragm to a higher natural frequency with less tension. This decrease in tension has resulted in a smaller frequency loss due to fatigue. The introduction of the sputtering process has, therefore, not only improved the quality of the microphone, but lengthened its life.

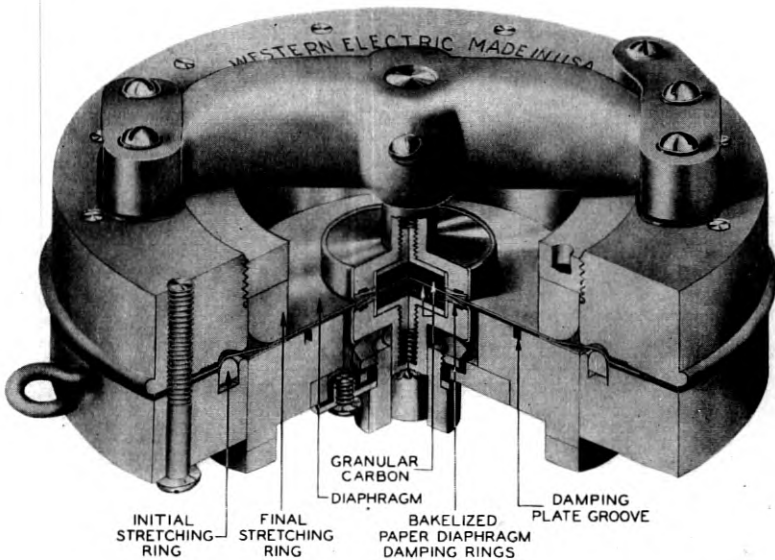

Fig. 1—Cross-sectional view of the two-carbon-chamber, stretched-diaphragm microphone.

#### EQUIPMENT AND METHOD

In order to apply a satisfactory gold electrode surface to the duralumin diaphragm by cathode sputtering commercially, it was necessary to develop a special cleaning process for the diaphragms and suitable equipment with multiple sputtering electrodes.

To insure proper continuity and adherence of the gold to the duralumin, the glossy roll finish on the duralumin is broken up by means of a brass wire scratch brush to give a matte surface. The diaphragms are then scrubbed in acetone, rinsed in ether, and rubbed dry with filter paper to remove all traces of oil or grease. Great care is then

taken to keep the spot to be coated free from all contaminations before sputtering.

The unit developed for commercial sputtering is shown in operation in Fig. 3. A two-gallon bell jar fitted upon a heavy ground pyrex

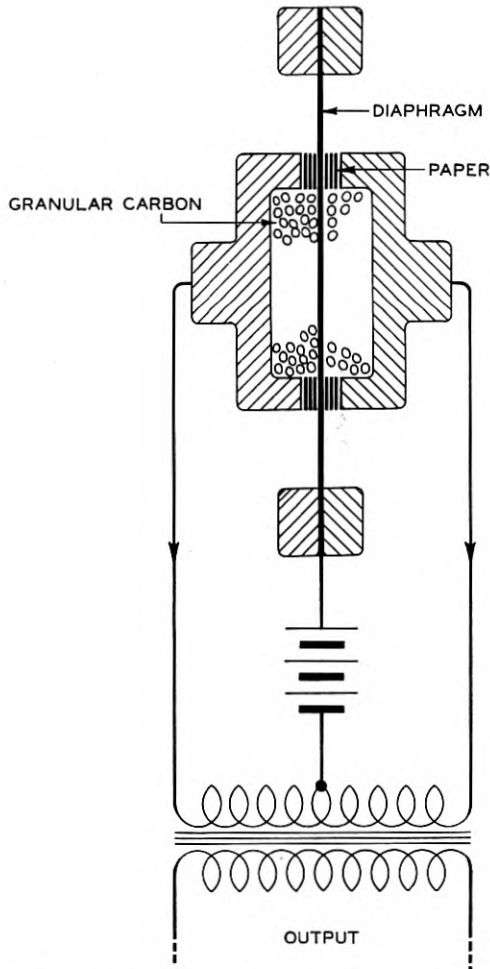

Fig. 2—Schematic diagram of conventional electrical connections of the microphone in a push-pull circuit.

glass plate contains six glass-covered aluminum cathodes, the exposed parts of which are fitted with renewable gold discs (Fig. 4). An adjustable aluminum stand to hold the diaphragm fixture and shield is placed upon the plate directly below the cathodes. The shield covers

all of each diaphragm except a central circular spot about  $3/4''$  in diameter. A vacuum is produced by means of a Megavac pump connected to the bell jar by  $5/8''$  pyrex glass tubing, which is made as short as possible to facilitate rapid pumping. In the vacuum system are a small rotating McLeod gauge, a trap, a bleeder valve, and an anode. The anode consists of a 20-turn,  $1/2''$  helix of No. 14 aluminum

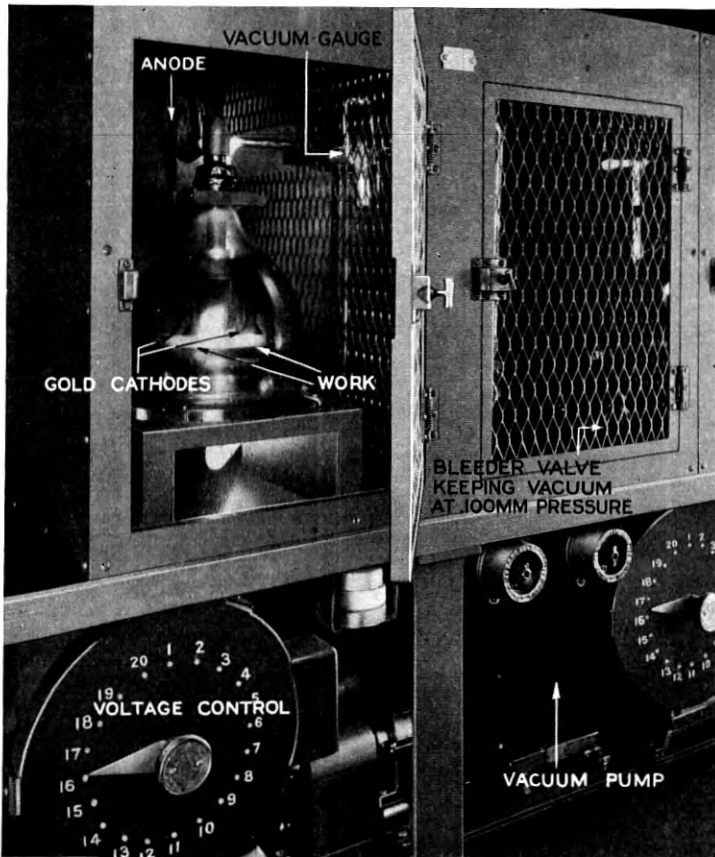

Fig. 3—A complete sputtering unit.

wire sealed into a one-inch tube at some distance from the bell jar. The end of the helix is shielded against high current density by a flanged piece of glass tubing. This type of anode has a life of at least two thousand hours.

In order to maintain a constant residual gas pressure, the pump is operated continuously and air is allowed to leak in slowly through the

bleeder valve which is located near the pump. This practice was found necessary in order to overcome variations in pressure due to the early evolution of gases and the later cleanup usually accompanying electrical discharges in vacuo. The valve is of rugged construction as shown in Fig. 5 and consists of a standard No. 0 taper pin about  $2\frac{1}{2}$  inches long, very closely lapped into a bronze bushing. A pressure of  $.100 \pm .005$  mm. is readily maintained by this method. After a new

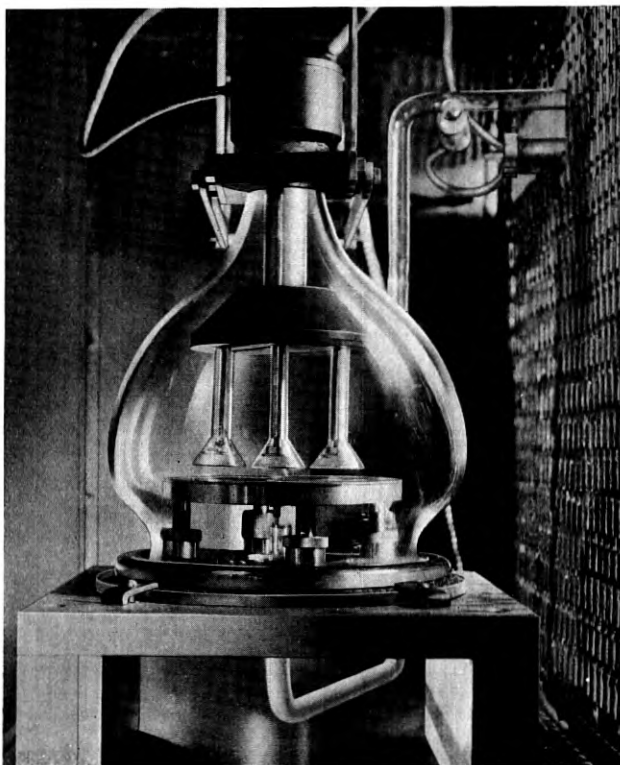

Fig. 4—The sputtering chamber, showing multiple electrodes, diaphragm holder and shield.

charge has been placed in the bell jar, the bleeder valve is temporarily cut off by closing a stop cock so that the required vacuum can be more quickly obtained. By this means, sputtering can be started in about four minutes after the bell jar has been placed in position.

The discharge is produced by means of a  $\frac{1}{2}$  kva transformer which steps up the voltage from 110 to 10,000 volts and is regulated by means of a rheostat in the primary. Safety for the operator is insured by

having all high tension leads and terminals enclosed in an expanded metal cage. The door operates a switch in the primary circuit, so that as the door is opened, the circuit is broken.

In order that equal amounts of metal might be evenly deposited on each of the six diaphragms, it was necessary to determine experimentally the relative spacing of the electrodes, and the shape and the size

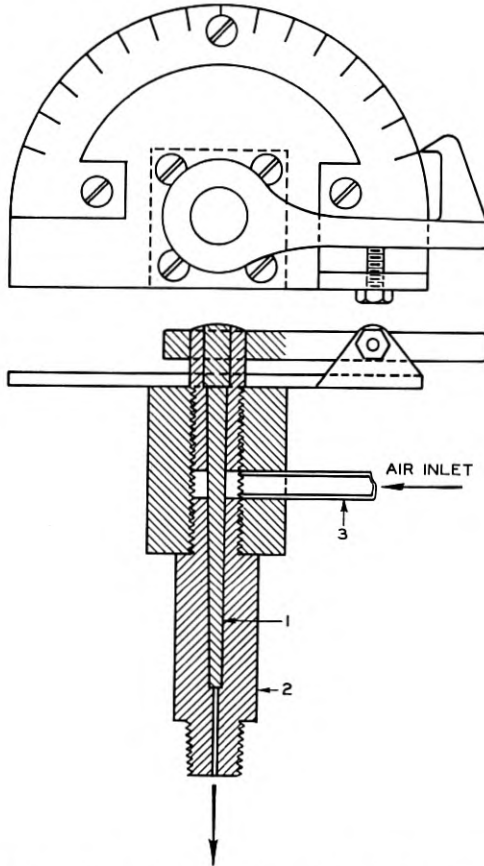

Fig. 5—Detailed construction of the bleeder valve.

of the shields, stands, and bell jar which would give a uniform current distribution. The best results were obtained by placing the diaphragms  $5/8''$  from the cathodes, which are arranged symmetrically, by maintaining the pressure at  $.10 \pm .05$  mm., by having a  $1/2''$  hole in the center of the diaphragm holder and shield, and a one inch clearance between their outer rims and the bell jar.

In commercial practice a single operator runs three units simultaneously and produces about 90 broadcasting microphone diaphragms a day. These diaphragms require a gold spot on both sides which necessitates breaking the vacuum and turning the parts over. The time not occupied in loading the fixtures and operating the equipment is taken up in preparing diaphragms for sputtering, marking, and packing the finished product. It requires about forty minutes to deposit from three to five mg. of gold per spot. Although this deposit is not more than .001 mm. thick, it is very continuous, adherent, and altogether suitable as a microphonic electrode surface (Fig. 6).

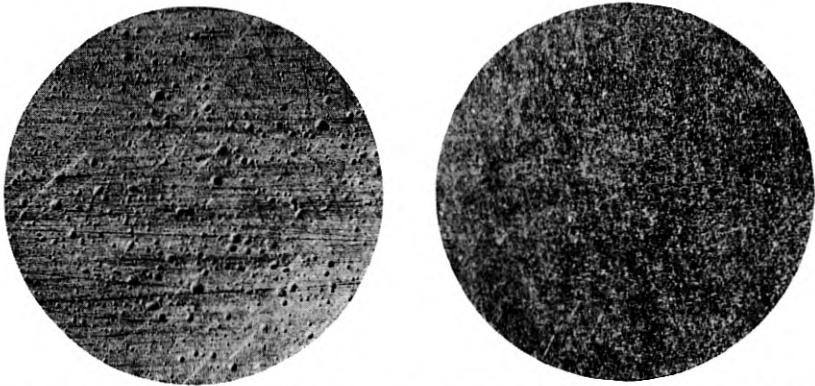

Fig. 6—Typical magnified gold surfaces after three months' service. The spot on the left was produced by electrolytic plating and shows many blisters; the one on the right was produced by sputtering.

This equipment has been in successful operation for a number of years in the production of microphone diaphragms.

#### BIBLIOGRAPHY

- W. R. Grove, *Phil. Trans.*, 1852, I.  
 J. P. Gassiot, *Proc. Roy. Soc.*, 9, 146, 1858.  
 Plucker, *Pogg. Ann.*, 103, 90, 104, 116, 105, 70, 1858.  
 Gassiot, *Rep. of Brit. Assoc.*, 2, 38, 1861; *Fortschr. der Phys.*, II, 505, 1862.  
 Wright, *Amer. Journ. of Sc. (Silliman)*, 13, 49; 14, 169, 1877.  
 Puluj, *Wien. Ber.*, 81, II, 864, 1880.  
 Fr. Wachter, *Wied. Ann.*, 17, 903, 1882.  
 E. Wiedemann, *Wied. Ann.*, 20, 756, 1883.  
 Hittorf, *Wied. Ann.*, 21, 126, 1884.  
 A. Kundt, *Wied. Ann.*, 27, 59, 1886 und B. Dessau, *Wied. Ann.*, 29, 353, 1886.  
 W. Crookes, *Proc. Roy. Soc.*, 50, 88, 1891.  
 Moser, *Wied. Ann.*, 42, 639, 1891.  
 G. Granquist, *Ofvers. Svensk. Vetensk. Ak. Forh.*, 54, 575, 1897.  
 G. Granquist, *Ofvers. Svensk. Vetensk. Ak. Forh.*, 55, 709, 1898.  
 Wehnelt, *Wied. Ann.*, 67, 425, 1899.  
 A. C. Longdon, *Phys. Rev.*, 11, 40, and 84, 1900.  
 J. Patterson, *Cam. Phil. Soc. Proc.*, 11, 118, 1901.  
 J. J. Thompson, *Cam. Phil. Soc. Proc.*, 11, p. 120, 1901.

- Goldstein, *Verh. d. D. Phys. Ges.*, 1902, 237.  
 W. Wien, *Phys. Zeitschr.*, **3**, 440, 1902.  
 G. C. Schmidt, *Ann. d. Phys.*, **9**, 703, 1902.  
 J. Tafel, *Ann. d. Phys.*, **11**, 613, 1903.  
 L. Houllévigüe, *Jour. de Phys.*, **4-S**, 2, 1903.  
 G. C. Schmidt, *Ann. d. Phys.*, **13**, 622, 1904.  
 J. Tafel, *Ann. d. Phys.*, **14**, 206, 1904.  
 L. Holborn und L. Austin, *Wissensch. Abhandl. d. Phys.-techn. Reichsanstalt*, Bd. IV, 101, 1904.  
 S. Valentiner und R. Schmidt, *Ann. d. Phys.*, **18**, 187, 1905.  
 J. J. Thomson, *Proc. Cambridge Philos. Soc.*, XIII, 212, 1905; *Chem. C.-B.*, I, 891, 1906.  
 Ch. Maurain, *C. r.* **141**, 1223, 1905.  
 J. Stark, S. 433, "Electricity in Gasses."  
 J. J. Thomson, S. 468, "Conduction through Gases."  
 W. Ramsay, *Proc. Roy. Soc.*, **77**, 148, 1906; *Zeitschr. f. Phys. Ch.*, **55**, 537, 1906.  
 V. Kohlschutter und R. Muller, *Zeitschr. f. Elektroch.*, **12**, 365, 1906.  
 V. Kohlschutter, *Zeitschr. f. Elektroch.*, **12**, 869, 1906.  
 L. Houllévigüe, *Jour. de Phys.*, **6**, 596, 1907.  
 V. Kohlschutter und Th. Goldschmidt, *Zeitschr. f. Elektroch.*, **14**, 221, 1908.  
 Th. Goldschmidt, Inaug.-Dissert. Strasburg i.E. 1908.  
 Fr. Fischer und O. Hahnel, *Zeitschr. f. Elektroch.*, **14**, 366, 1908.  
 V. Kohlschutter, *Zeitschr. f. Elektroch.*, **14**, 417, 1908.  
 Fr. Fischer und O. Hahnel, *Zeitschr. f. Elektroch.*, **14**, 433, 1908.  
 V. Kohlschutter, *Zeitschr. f. Elektroch.*, **14**, 437, 1908.  
 V. Kohlschutter, *Zeitschr. f. Elektroch.*, **14**, 681, 1908.  
 B. Walter, *Z. Electrochem.*, **14**, 695, 1908.  
 F. Fisher, O. Haehnel, *Z. Electrochem.*, **14**, 677, 1908.  
 Fr. Fischer, *Zeitschr. f. Elektroch.*, **15**, 512, 1908.  
 J. Stark, *Zeitschr. f. Elektroch.*, **14**, 754, 1908.  
 J. Stark, *Zeitschr. f. Elektroch.*, **15**, 509, 1909.  
 J. Stark, Univ. Berlin, *Z. Electrochem.*, **15**, 1909.  
 Pfund, *Phys. Rev.*, **28**, 324, 1909.  
 J. Stark, *Z. Electrochem.*, **15**, 509, 1909.  
 V. Kohlschutter, *Z. Electrochem.*, **15**, 316, 1909.  
 L. Houllévigüe, *Compt. Rendus*, **148**, 1320, 1909 and 1237, 1910.  
 V. Kohlschutter, *Z. Electrochem.*, 930, 1910.  
 V. Kohlschutter, *Zeitschr. f. Elektroch.*, **17**, 393, 1911.  
 H. V. Dechend und W. Hammer, *Zeitschr. f. Elektroch.*, **17**, 235, 1911. (*Ber. d. Naturf. Ges. zu Freiburg i.B.*, **18**, 127); *Vgl. auch Jahrb. d. Rad. und Elektr.*, **8**, 83, 1911.  
 Kohlschutter, *Jahrbuch. d. Radioakt.*, **9**, 355, 1912.  
 H. B. Williams, *Phys. Rev.*, **2**, 402, 1913.  
 O. Steehman, *Phys. Rev.*, **6**, 330, 1913.  
 C. W. C. Kaye, *Proc. Phys. Soc. Lon.*, **25**, 198, 1913.  
 C. Bergholm, *Am. Physik*, **43**, 1-23, 1914.  
 W. Planck, *Phys. Zeit.*, 563, 1914.  
 W. F. G. Swann, *Phil. Mag.*, **28**, 467, 1914.  
 A. M. Tyndall and H. G. Hughes, *Phil. Mag.*, **27**, 415, 1914.  
 B. Pogany, *Phys. Zeit.*, **15**, 688, 1914.  
 Nicholson, *Phys. Rev.*, **3**, 1, 1914.  
 H. B. Williams, *Phys. Rev.*, **4**, 517, 1914.  
 B. Pogany, *Phys. Zeit.*, **17**, 251, 1916.  
 W. Reinders and L. Hamburger, *K. Akad. Amst. Proc.*, **19**, 958, 1917.  
 R. W. King, *Phys. Rev.*, **10**, 292, 1917.  
 Fabry and Bursson, *Jour. de Phys.*, June, 1919.  
 J. A. Becker, L. F. Curtiss, *Phys. Rev.*, **15**, 457, 1920.  
 J. J. Thompson, "Rays of Positive Electricity," p. 121, 1921.  
 H. Kahler, *Phys. Rev.*, **18**, 210, 1921.  
 F. Gross, *Z. Phys.*, **6**, 376, 1921.  
 Kingdon and Languivuir, *Phys. Rev.*, **20**, 107, 1922.  
 F. Gross, *Z. Phys.*, **16**, 40-5, 1923.  
 K. H. Kingdon, *Phys. Rev.*, **21**, 210, 1923.



- Kingdon and Langmuir, *Phys. Rev.*, **22**, 148, 1923.  
 Res. Staff G. E. (London), *Phil. Mag.*, **45**, 98, 1923.  
 K. Lauch, *Ann. d. Phys.*, **74**, 55, 1924.  
 S. S. MacKeown, *Phys. Rev.*, **23**, 85, 1924.  
 L. R. Ingersoll and S. S. de Vinney, *Phys. Rev.*, **26**, 86, 1925.  
 J. Mazur, *Bull. Acad. Polonaise*, **81**, 1925.  
 H. Dewhurst, *Phys. Soc.*, **39**, 39, 1926.  
 A. Guntherschutze, *Zeit. f. Phys.*, **36**, 8, 563, 1926.  
 L. A. Fourdes, *Ind. Assoc. Cult. Sci. Proc.*, 323, 1926.  
 A. Guntherschutze, *Zeit. f. Phys.*, **38**, 8, 575, 1926.  
 E. Blechaschmidt, *Ann. d. Phys.*, **81**, 999, 1926.  
 A. V. Hippel, *Ann. d. Phys.*, **80**, 7, 672, 1926.  
 F. Joliot, *Compt. Rend.*, **196**, 1926.  
 "Cathode Disintegration," *Engineering*, p. 410, 1927.  
 F. W. Warburton, *Phys. Rev.*, **30**, 673, 1927.  
 B. Steinberg, *Phys. Rev.*, **29**, 352, 1927.  
 A. Andant, *Rev. d'Optique*, **6**, 364, 1927.  
 A. Andant, *Rev. d'Optique*, **6**, V. 81, 1043, 1927.  
 T. Baum, *Zeit. f. Physik*, **40**, 9, 686, 1927.  
 A. Ferry, *Jour. de Phys.* **9**, 39, 1928.  
 A. Ferry, *Compt. Rend.*, **187**, 1928.  
 H. Nagaoka and T. Fretagami, *Imp. Acad. Tokyo Proc.*, **4**, p. 20, 1928.  
 L. R. Ingersoll and L. O. Sordahl, *Phys. Rev.*, **32**, 649, 1928.  
 R. S. Bartlett, *Phil. Mag.* **5**, 848, 1928.  
 L. R. Ingersoll and J. D. Hanawalt, *Phys. Rev.*, **34**, 972, 1929.  
 T. Asada and K. Quasaborth, *Zeit. f. Phys. Chem.*, **143**, 5-6, 1929.  
 Sophie Dembenska, *Zeit. f. Phys.*, **54**, 1 and 2, 1929.  
 F. Smith, *U. S. P.*, **1**, 710, 747, 1929.  
 A. Knapp, *Am. Cer. Soc. Jour.*, **13**, No. 11, 1930.  
 L. R. Ingersoll, *Nature*, **126**, 204, 1930.  
 L. Van Atta, *Rev. Sci. Inst.*, **1**, 687, 1930.  
 F. Joliot, *Compt. Rend.*, **190**, 627, 1930.  
 E. Perucca, *Ann. d. Phys.*, **4**, 2, 252, 1930.  
 C. H. Cartwright, *Rev. Sci. Inst.*, **1**, 758, 1930.  
 F. Joliet, *Ann. d. Phys.*, **15**, 418, 1931.  
 Klemeniewicz and Waswicz, *Zeit. f. Phys.*, **71**, 11 and 12, 817, 1931.

## A Voice and Ear for Telephone Measurements

By A. H. INGLIS, C. H. G. GRAY and R. T. JENKINS

An artificial voice and ear have been developed which are sufficiently close simulations of the real voice and ear in their principal physical attributes to justify their use in both shop and laboratory tests of telephone transmitters and receivers.

The artificial voice and ear have certain advantages in that they can be exactly specified and reproduced and can be used in determining physical characteristics of instruments which are difficult or impossible to obtain with real voices and ears.

**T**HE performance of telephone transmitters and receivers is dependent not only upon their physical characteristics but also upon the reactions of the users to these instruments. Observations of the results obtained by subscribers under known conditions of practical telephone use take both these factors into consideration. Tests of this kind, however, are not suited to the needs of laboratory development and study of instruments where data regarding their physical characteristics are required. In such instances data, to be of greatest value, should be taken under conditions which include those factors of actual service having an important bearing on the performance of the instruments.

Among the most important of such factors are the voice and ear. For making many of the laboratory tests, therefore, it has been necessary to employ actual human voices and ears in order to insure that all of their physical characteristics have been included in the test. This procedure, however, due to uncontrollable variations in individuals, requires a large expenditure of time and effort to insure the precision desired. Furthermore, certain instrument tests, such as response-frequency characteristics, are either impossible or difficult to make with the real voice or ear.

These disadvantages, inherent in the use of the human voice and ear, have been recognized for a long time. Numerous attempts have been made to employ voice and ear substitutes for instrument testing, and in cases where uniformity of instruments rather than their design has been of primary importance, as in shop acceptance tests, such substitutes have been of great value. That their use in engineering design problems has not been more extensive has been due to the inability to make them meet certain fundamental requirements.

It has been the aim, therefore, in the design of the artificial voice and ear to be described, to overcome previous objections to the use of

such substitutes so that they may be used with confidence in general testing and physical measurement of telephone transmitters and receivers. The requirements which an artificial voice and ear must meet to insure proper performance are outlined below.

#### REQUIREMENTS FOR AN ARTIFICIAL VOICE

An ideal artificial voice must be able to reproduce human speech without introducing any change in frequency, amplitude or directivity over the entire range of intensities possible in speech. Furthermore, it should react to changes in acoustic load in the same manner as does the human voice under ordinary conditions. Such requirements, of course, must be reduced to a more specific and practical form to enable the construction of a physical piece of apparatus.

It is useful to consider the artificial voice as consisting of two parts, the mouth and the source of power. Practical considerations point immediately to the use of some form of electro-acoustic transducer for the mouth, and any of several sources of electrical power. In the production of speech there is required as a source of power either a high quality transmitter or a phonograph record and reproducing system. For purposes of physical measurement and analysis, a source of single-frequency power, such as an oscillator, is needed.

If it be assumed that the frequency composition of the actual human voice is automatically included with either of the sources of speech mentioned, and that proper frequency weighting will be introduced in the single-frequency source when desired by means of suitable electrical networks, the practical requirements for the artificial mouth may then be stated specifically as follows:

- (1) It should introduce no amplitude distortion within the range of speech frequencies.
- (2) It should be capable of delivering an acoustic output without non-linear distortion over the range of intensities possible for the human speaking voice.
- (3) The distribution of the sound field about the mouth at every frequency and distance should be the same as that of the human mouth.
- (4) The introduction of objects such as transmitters in the sound field should react on the output of the mouth and distort the field in the same way as they do when introduced in the field of the human mouth.
- (5) It should be completely specifiable and reproducible as well as constant in performance.

## REQUIREMENTS FOR AN ARTIFICIAL EAR

In considering a substitute for the human ear, the general requirement is that it shall respond, as does the human ear, to sounds of various frequencies, amplitudes and lengths of duration. Furthermore, its reaction on the source of sound, whether that sound be produced by a receiver held against it or by a source at a distance from it, shall be the same as that of the human ear.

As in the case of the artificial voice, the artificial ear may conveniently be considered as consisting of two parts, the ear coupler and the measuring equipment. Based on the above general considerations, the ear coupler should meet the following more specific requirements:

- (1) It should have the same impedance at every audible frequency as a real ear, either in the open air or with the receiver held to it.
- (2) The pressures developed in the ear coupler should be the same at every audible frequency as the pressure developed in a real ear.

For the measuring equipment, the requirements are as follows:

- (1) For steady state conditions it should be capable of giving an indication at every audible frequency proportional to the pressure in the coupler over a range of pressures as great as that experienced by a real ear.
- (2) It should respond to sound of short duration as does a real ear.
- (3) It should be possible to change the response to various frequencies in any manner required by means of suitable electrical networks.
- (4) It should respond to complex sounds as does the real ear.

The artificial ear should be completely specifiable, reproducible, and constant in performance.

At the present time it is not possible to meet rigidly all of these requirements, either for an artificial voice or ear. Development work has progressed to a point where it can be stated that the requirements have been met sufficiently well to enable the production of both an artificial voice and ear which are close simulations of the real voice and ear and which will be satisfactory as substitutes in almost all of the laboratory or shop tests for which a real voice and ear have been largely used.

## DESCRIPTION OF THE ARTIFICIAL VOICE

The schematic arrangement of the artificial voice referred to is shown in Fig. 1. As indicated, electrical energy may be supplied

from any one of several sources through the electrical network and amplifier to the electro-acoustic transducer. For single-frequency measurements a heterodyne oscillator provides a convenient means for obtaining the desired testing currents. As a source of speech, advantage can be taken of recent developments in phonograph technique which make it possible to record and reproduce speech practically without distortion.<sup>1</sup> This affords a very satisfactory source of speech for the artificial voice. In certain special instances where it is desired to make measurements with human voices under closely controlled conditions, a high quality transmitter is used as the input element of the artificial voice.

To insure proper operation under both steady-state and transient conditions the electrical network employed in the artificial voice is of

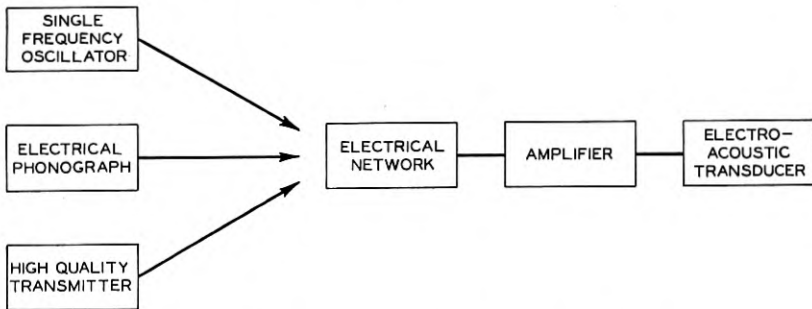

Fig. 1—Schematic arrangement of artificial voice.

the constant-resistance type.<sup>2</sup> In this network is included compensation for deviation from uniformity of response of the electro-acoustic transducer. Additional compensation may be provided in case the input to the artificial voice is from a source of constant output with frequency and it is desired to weight the single frequency output of the artificial voice in accordance with the distribution in speech<sup>3</sup> of pressure with frequency.

The amplifiers employed have high gain and high output capacity. They provide, without introducing distortion, the maximum amount of electrical energy that may be required to obtain the desired acoustical output from the artificial mouth.

<sup>1</sup> "Vertical Sound Records—Recent Fundamental Advances in Mechanical Records on Wax." Presented by H. A. Frederick at Swampscott, Mass., Oct., 1931, before the Soc. of Motion Picture Engineers.

<sup>2</sup> "Distortion Correction in Electrical Circuits with Constant Resistance Recurrent Networks," Otto J. Zobel, *Bell System Technical Journal*, July, 1928.

<sup>3</sup> "Some Physical Characteristics of Speech and Music," Harvey Fletcher, *Bell System Technical Journal*, July, 1931.

The unit employed as an artificial mouth is shown in Fig. 2 mounted on a stand in such a manner that it may be rotated through an angle of approximately  $180^\circ$  as a matter of convenience in certain types of testing. It is a modification of a loud speaking receiver of large power capacity.<sup>4</sup> As one of the requirements in the design of a substitute for

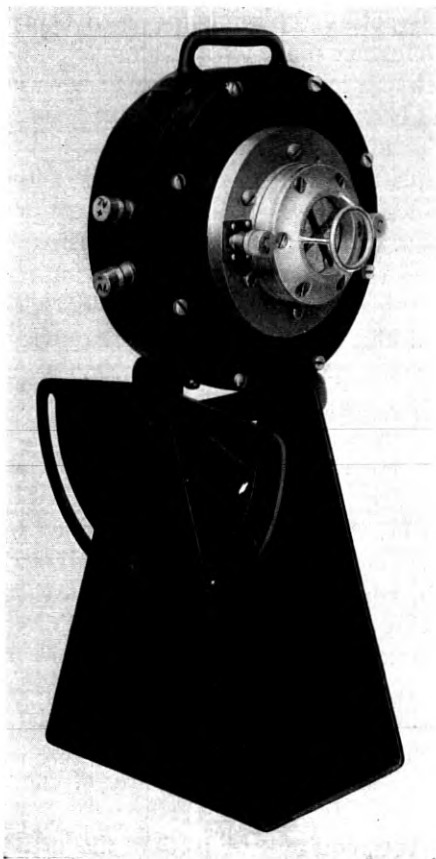

Fig. 2—Artificial mouth.

the human voice is that the distribution of the sound field of the artificial voice must be similar to that of the human voice, it is necessary to make the opening or sound radiating surface of the artificial mouth comparable in size with that of the human mouth. To meet this need the horn coupling ordinarily associated with this

<sup>4</sup> "A High Efficiency Receiver of Large Power Capacity for Horn-Type Loud Speakers," E. C. Wentz and A. L. Thuras, *Bell System Technical Journal*, January, 1928.

type of receiver is removed, the throat insert of the receiver modified and a simple structure mounted in place of the horn coupler having an opening effectively that of the human mouth. In this structure is mounted an acoustic-resistance element. This has a mechanical resistance<sup>5</sup> of approximately 41.0 mechanical ohms per cm.<sup>2</sup> and below 5000 c.p.s. a reactance of less than 10 per cent. There is mounted on the structure replacing the horn coupler, a guard ring which serves as a reference plane for measurements of distance between the artificial mouth and instruments under test. The location of this reference plane has been empirically determined so as to correspond to the plane of the lips of a human mouth.

At low frequencies the radius of the opening of the mouth is small compared to the wave-length. Hence in effect a point source of sound is approached. Under these conditions the radiation resistance is small. As the frequency increases the radiation resistance increases until the wave-length has decreased to a value approximately three times the radius of the opening. At this frequency and above, the radiation resistance is approximately constant at about 41.0 ohms per cm.<sup>2</sup> The output impedance of the artificial mouth is high with respect to the radiation impedance at low frequencies. Inasmuch as the impedances are not matched except at the higher frequencies the output power should be approximately proportional to the radiation resistance. However, this relationship is modified by the resonances of the instrument. The acoustic resistance reduces these resonances and also serves to reduce the reaction on the artificial mouth which might arise by placing an instrument close to and directly in front of it.

The response-frequency characteristic of the mouth measured at the guard ring is shown in Fig. 3. In order that this response may be uniform over the important speech frequency range of 100 to 7500 c.p.s. the characteristic shown in Fig. 3 is equalized with the network indicated in Fig. 1. The resulting response of the artificial voice is shown in Fig. 4.

Another important requirement is that the artificial mouth shall be capable of delivering without non-linear distortion sound outputs corresponding to what may be termed loud talking for human beings. Because it is desirable to operate at frequencies as low as 100 c.p.s. it is necessary to supply a comparatively large amount of electrical energy to the artificial mouth. To accomplish this an amplifier has been employed as indicated in Fig. 1 which makes it possible to obtain

<sup>5</sup> "Methods of High Quality Recording and Reproducing of Music and Speech Based on Telephone Research," J. P. Maxfield and H. C. Harrison, *Bell System Technical Journal*, July, 1926, p. 506.

sound pressures of 16 bars at the plane of the guard ring at all frequencies between 100 and 7500 c.p.s. without appreciable harmonics. Speech may be transmitted about 15 db above the average intensity employed in commercial telephone conversations without noticeable distur-

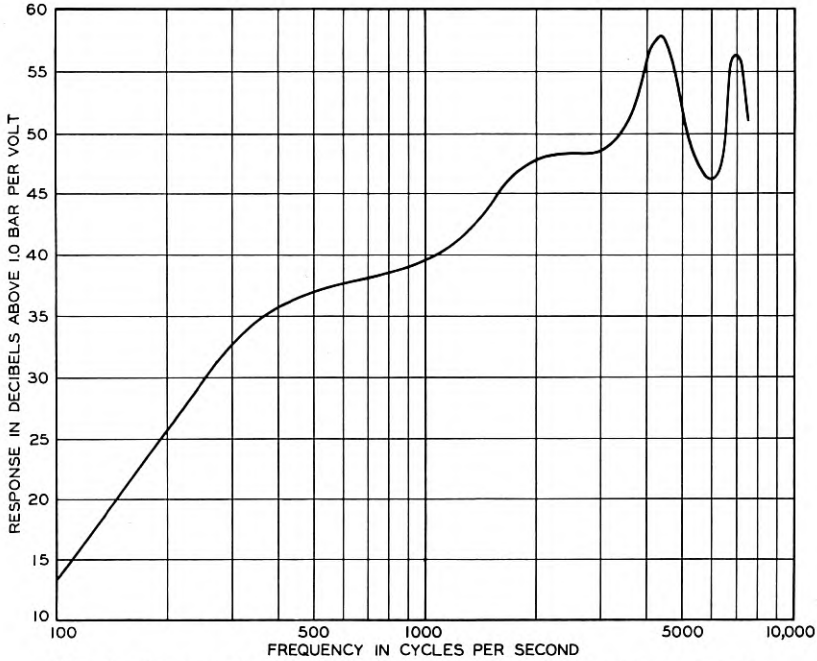

Fig. 3—Response-frequency characteristic of electro-acoustic transducer without equalizer.

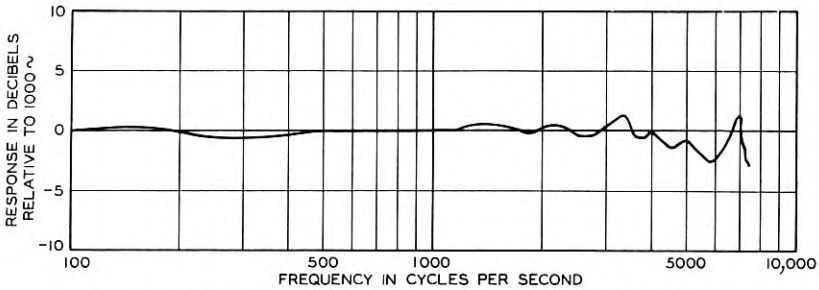

Fig. 4—Response-frequency characteristic of artificial mouth.

tion. Very few conversations are carried on at an intensity greater than this.

Measurements have been made of the magnitude of the harmonics present in the output of the artificial voice under conditions of high



sound pressure at 100 c.p.s. where maximum amplitudes of vibration are encountered. Only odd harmonics are present, the greatest in magnitude, the third, being about 15 db below the fundamental at the highest pressure used. At other frequencies or lower intensities, the harmonics are of even less importance. At the average intensity employed in telephone conversations no appreciable harmonics whatever are present. The results of these measurements are shown in Fig. 5.

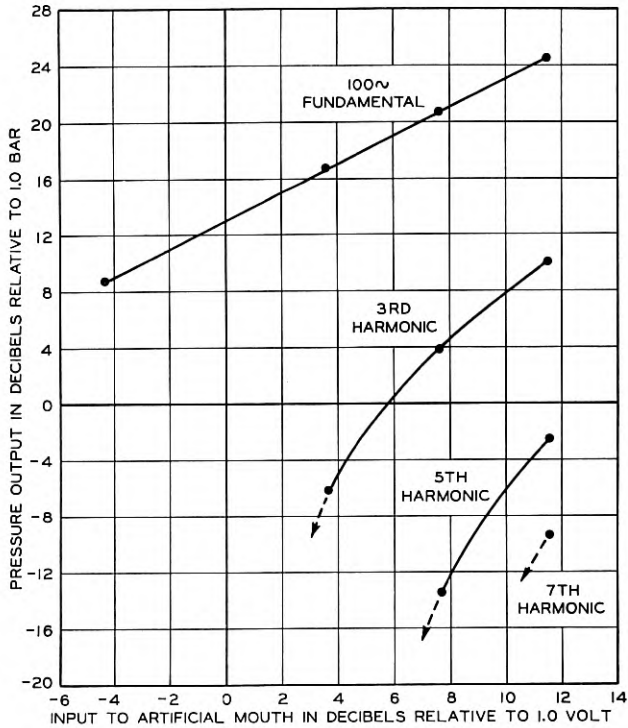

Fig. 5—Harmonics in output of artificial mouth.

It has been mentioned that the sound field distribution of the human and artificial voices should be alike. One method of determining agreement in this respect has been to measure the output of several different types of transmitters when the instruments were placed at various distances from both the artificial mouth and the human mouth. Eight persons, four men and four women, were employed in the actual voice tests, to call the testing phrases, "Joe took father's shoe bench out" and "She was waiting at my lawn." These phrases include all of the important speech sounds and are

brief and easy to say. The speech output of these same individuals calling the above phrases was recorded by the process mentioned.<sup>1</sup> After adjusting the output of the artificial voice for the close talking position with a condenser transmitter,<sup>6</sup> tests were made on the various instruments interspersing both instruments and voices to reduce testing errors and minimize changes in instrument characteristics between tests. The results of individual tests on a given type of instrument with both the human and artificial voices varied over approximately the same range. The average results for all tests for each type of instrument for each distance and for both the human and

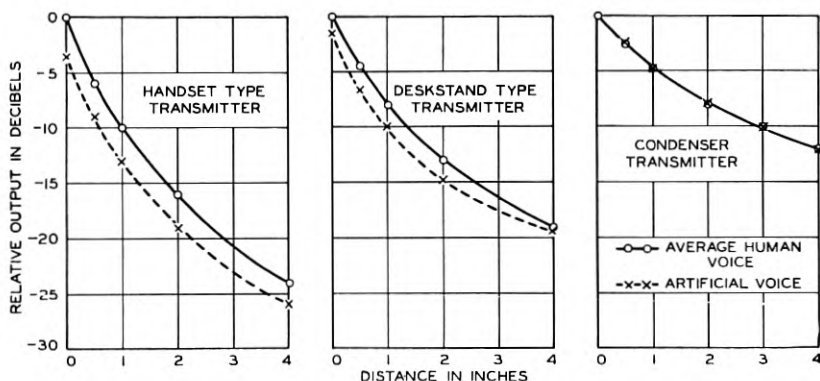

Fig. 6—Distance loss characteristics.

artificial voices are shown in Fig. 6. These data show reasonably close agreement between the artificial voice and human voice, both as regards the general level and slope of the distance loss characteristics. In the practical application of the artificial mouth to telephone instrument studies the minor discrepancies shown may be minimized by the use of correction factors. A further investigation is being made of the sound field distribution of the artificial mouth in comparison with that of human mouths.

Tests were made to determine the effect on telephone instruments of the size and shape of the artificial mouth. Response-frequency measurements were made, a deskstand and a handset transmitter being used, each modified to include in the plane of the diaphragm a small condenser transmitter. The latter was used in order that any variation of carbon instruments might be eliminated. Sound pressure was obtained from each of four types of artificial mouth. Three of these employed a long pipe with an inside diameter of about 0.7 inch.

<sup>1</sup> Loc. cit.

<sup>6</sup> "Electrostatic Transmitter," E. C. Wentz, *Phys. Rev.*, May, 1922.

In one case no baffle or reflecting surface of any kind was used at the pipe opening. In the other cases it was terminated (1) in a replica of a human head molded of soft rubber (2) in an 8-inch square baffle. The fourth type used was the artificial mouth with acoustic resistance shown in Fig. 2. The variation in pressure measured for these various conditions is shown on Fig. 7. It will be noted that except for the

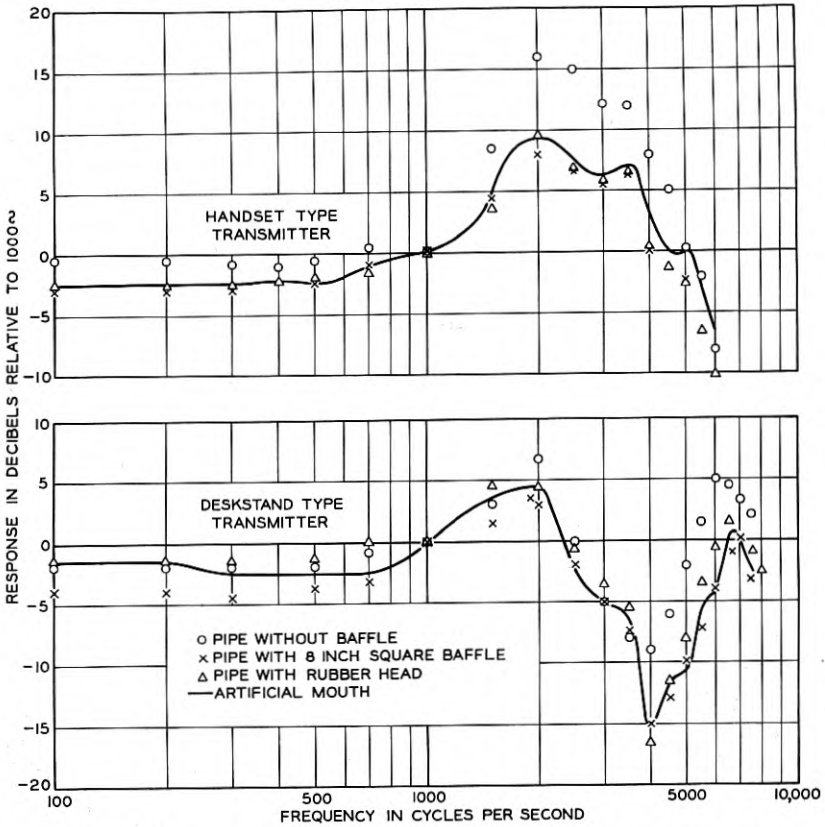

Fig. 7—Effect on station transmitters of variation in size and shape of artificial mouth.

extreme condition of the pipe without termination, good agreement is obtained for the various response-frequency characteristics, indicating that the shape of the artificial mouth is not critical provided the opening is of the proper order of magnitude and is effectively in a baffle commensurate with the size of the human head. The measurements described above were made with the plane of the mouthpiece of the instruments in a representative position with respect to the plane

of the mouth opening. To determine the effect of increasing the distance between the transmitter and the mouth, measurements were made with the deskstand type of instrument with results as shown in Fig. 8.

Measurements were made of the distortion of the sound field from each of the four types of mouth mentioned which was caused by the introduction of different types of transmitter in the field. The effects were measured immediately to one side of the mouthpiece. It will be seen from Fig. 9 that for frequencies below 2000 cycles there is good agreement for all types of mouth and both types of instrument. Above 2000 c.p.s. variations appear, but in general the largest differences occur as before for the extreme form of artificial mouth, namely, the pipe without termination.

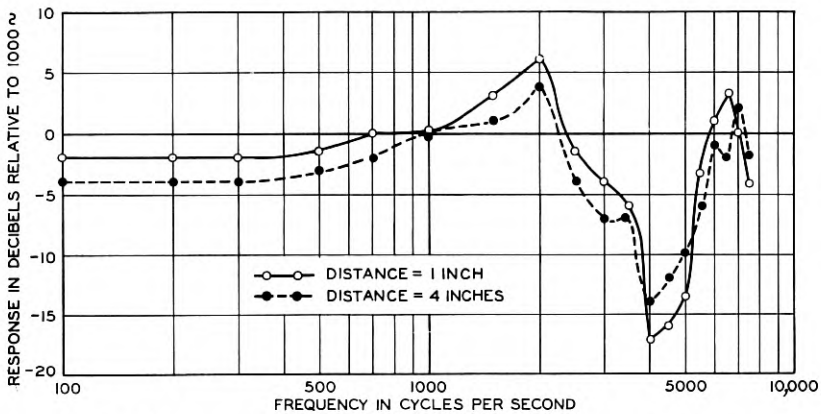

Fig. 8—Effect on station transmitters as distance from mouth is varied.

Summarizing the results obtained with the artificial mouth described, although the general requirements have not been completely satisfied, a rather close approximation has been realized. The response-frequency characteristic does not vary more than  $\pm 1.0$  db from 250 to 3000 c.p.s. nor more than  $\pm 2.0$  db from 100 to 7500 c.p.s. The mouth is capable of delivering an output of an intensity equivalent to loud talking without appreciable non-linear distortion. The distribution of the sound field is similar to that of the real mouth. As judged by tests on several different forms of mouth of quite different sizes and shapes, the indications are that the introduction of objects in the sound field of the artificial mouth chosen distorts that field in about the same manner as occurs with the real mouth. Speech reproduced by the artificial voice sounds natural. Comparative

articulation tests of direct speech from an individual and its reproduction by the artificial voice agree within a few per cent. The design can be definitely specified and reproduced with accuracy and it is rugged in structure and constant in performance.

General experience in the use of this artificial voice over about a year's time has indicated that it may be used satisfactorily in forms of transmitter testing which have heretofore required the human voice.

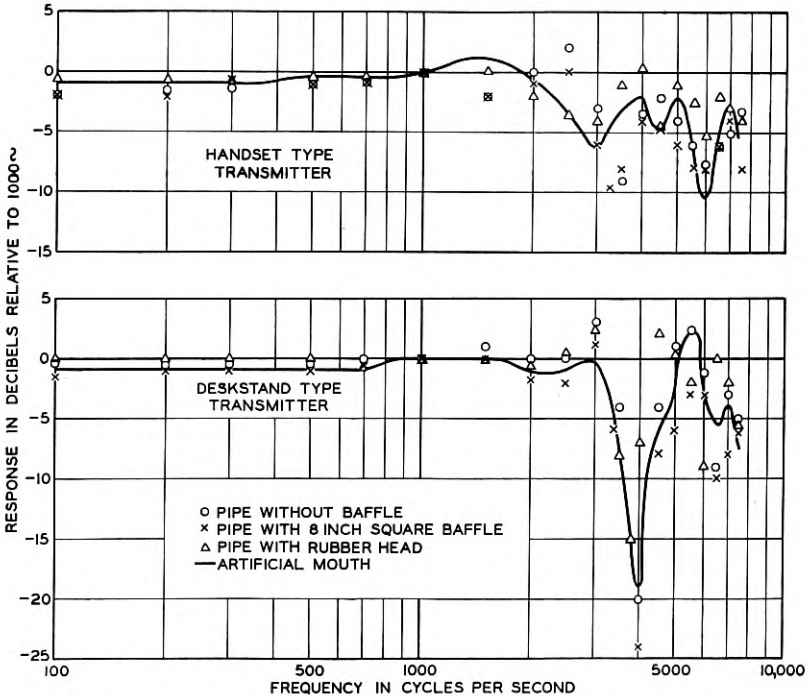

Fig. 9—Effect of introducing station transmitters in sound field of artificial mouth.

#### THE ARTIFICIAL EAR

The human ear is limited in its utility generally to relative or comparative measurements, and is not well adapted for measurement of absolute pressure or velocity. At best, measurement with real ears is a laborious procedure. In general, it has been found necessary to take a large number of observations with many ears, since a measurement with one ear is unreliable. One of the principal reasons for this unreliability is the difficulty not only of securing a particular coupling of a receiver held to the ear, but of duplicating this coupling in subsequent measurements.

The output of a receiver coupled to the ear is governed by several factors, among which are: enclosed volume, leakage around the cap, constriction of the ear canal and the yielding of walls and tympanum. Resonances in the enclosed volume are also generally present, associated with the dimensions of the chamber. The effects of the acoustic load of an ear coupled to a receiver are, in general, increased damping, higher resonant frequency and a dropping off of the receiver response at low frequencies. The receiver response also shows peaks due to resonances in the enclosed chamber.

Largely as a matter of convenience, couplers of simple construction imposing a stiffness load have been frequently used for receiver calibrations. It has been recognized that calibrations made in this way do not agree with the performance realized when the receiver is held to the ear and this has led to the development of an artificial ear which will permit the measurement of receivers of any type under conditions closely simulating those under which they are used.

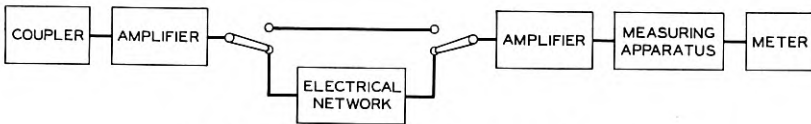

Fig. 10—Schematic arrangement of artificial ear.

The schematic arrangement of this artificial ear is shown in Fig. 10. It comprises: a special coupling device designed to present the same acoustic load to a receiver as does a typical human ear, a small condenser transmitter serving as the measuring element in the coupler, and means for amplifying and measuring the voltages generated by the condenser transmitter. For certain purposes arrangements are provided for introducing an electrical network of the constant-resistance type<sup>2</sup> having a response-frequency characteristic corresponding to that of the equal loudness curve<sup>7</sup> of human hearing at the desired sensation level.

The coupler is shown in Figs. 11 and 12. The cap of the receiver under test rests upon a molded soft rubber insert which has the internal contour of the auricle. Soft rubber was selected because of its yielding qualities which are of importance in two respects: it permits the receiver under test to be sealed to the coupler without the aid of such substances as petroleum jelly, and it can be readily molded to have the desired shape. In this rubber insert is an acoustic leak consisting

<sup>2</sup> Loc. cit.

<sup>7</sup> "A Direct Comparison of the Loudness of Pure Tones," B. A. Kingsbury, *Phys. Rev.*, April, 1927.

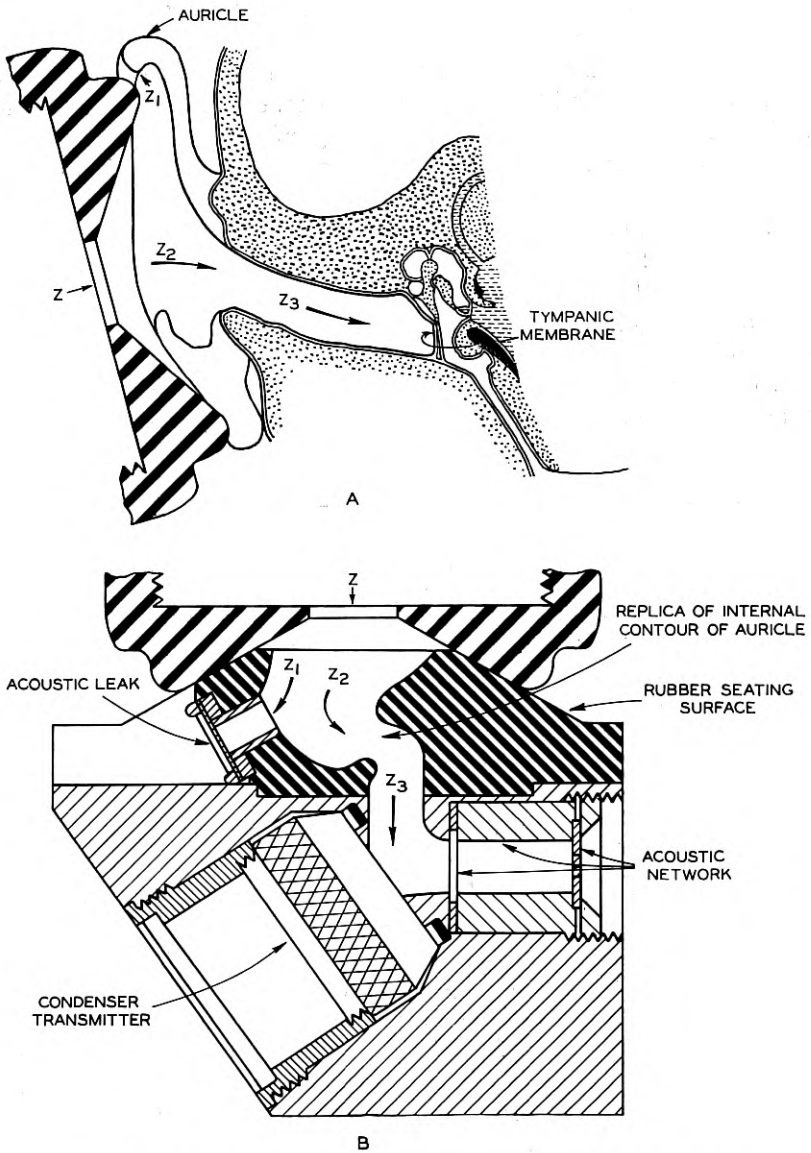

Fig. 11—Sectional views of human ear and artificial ear coupler.

of a tube terminated by an acoustic resistance. The purpose of this leak, which has both mass and resistance, is to simulate the leak between a receiver cap and a typical human ear. The molded rubber insert is attached to a rigid structure in which a chamber has been

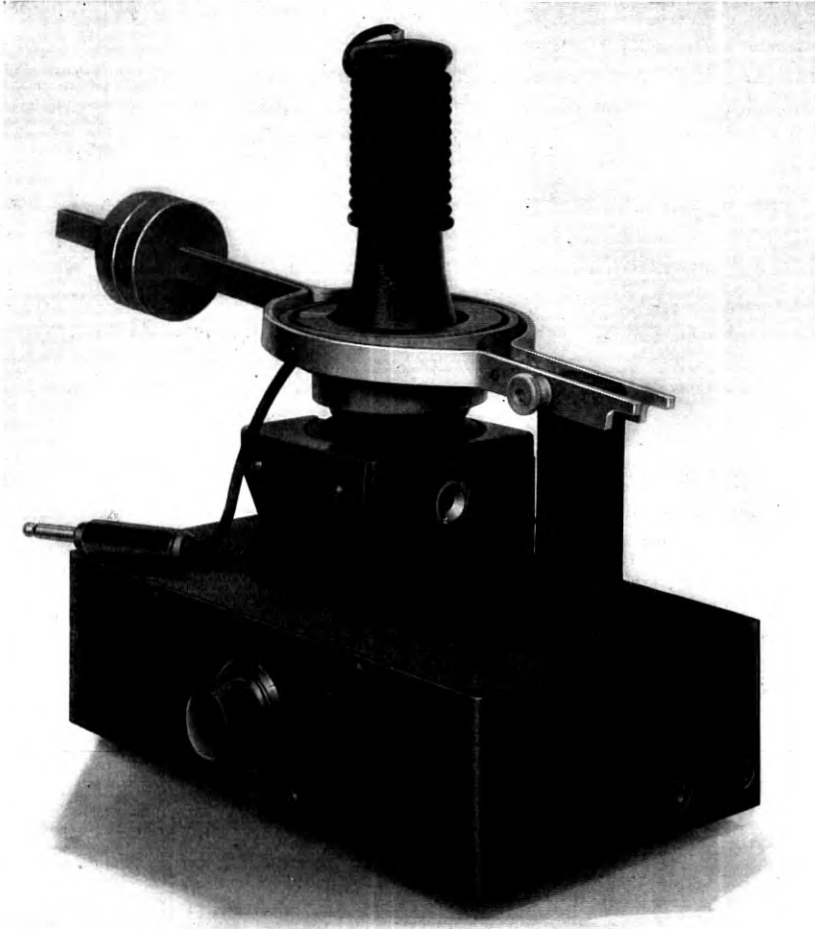

Fig. 12—Artificial ear coupler.

provided to simulate the size and, to some extent, the shape of the auditory canal of a human ear. The diaphragm of the small condenser transmitter has been placed in the wall of this chamber to measure the pressures developed. The chamber is terminated by an acoustic network having mass, stiffness and resistance components of



the same order of magnitude as those observed looking into the auditory canal of a human ear. In considering Fig. 11, it should be noted that, due to the irregular contour of the auricle, one sectional drawing cannot adequately portray the shape of the opening in the molded soft rubber insert.

The box shown in Fig. 12, in which the artificial ear is mounted, houses a two-stage amplifier for use with the small condenser transmitter. The mechanical structure around the receiver is used for centering it on the coupler and to hold it in position at a definite pressure, the force, of course, always exceeding the weight of the receiver.

The magnitude of the impedance ( $Z$ ) indicated in Fig. 11 was measured looking through the aperture of a conventional type of receiver cap held in a normal manner to the ear by each of 14 men. As might be expected, wide variations were observed between individual ears, particularly for the lower frequencies. Considerable variation was also observed on repeated tests on an individual. Table I shows the magnitude and range for both the resistance and reactance

TABLE I  
ACOUSTIC IMPEDANCE OF EARS LOOKING THROUGH APERTURE OF RECEIVER CAP

$f$	Observed Range of Measurements for 14 Male Human Ears		Artificial Ear			
	Resistance	Reactance	Resistance		Reactance	
			(1)	(2)	(1)	(2)
100....	1 to 70	-300 to +24	21	16	-295	+15
300....	1 to 80	-195 to +60	14	56	-112	+59
400....	1 to 200	-115 to +92	11	149	-72	+5
800....	1 to 107	-111 to +10	15	15	-45	-45
1200....	3 to 18	-36 to +30	11	11	-24	-24
2300....	1 to 21	-21 to -5	5	5	-15	-15

(1) With no leak.

(2) With typical leak between receiver cap and ear.

components of the acoustic impedance observed in the measurements made at several frequencies. Supplementing these data is Fig. 13 which shows the acoustic resistance and reactance for typical human ears with and without a leak between the receiver cap and the ear, together with similar data on the artificial ear. It will be noted that the various impedance curves for comparable conditions of the human and artificial ears are quite similar in shape. There is, however, some discrepancy in the magnitudes of the impedance for comparable

conditions. In view of the large range in the impedance values obtained for different individuals and at different times the discrepancies indicated are of doubtful importance. In this connection it should be noted that a wide range in impedance values could be obtained readily on the artificial ear merely by changing the constants of the acoustic networks. In view of the fact that a fixed condition of the artificial ear is desirable for many practical purposes the chief requirement as regards the impedance characteristics under discussion is that they closely approximate the impedance characteristics of a typical ear.

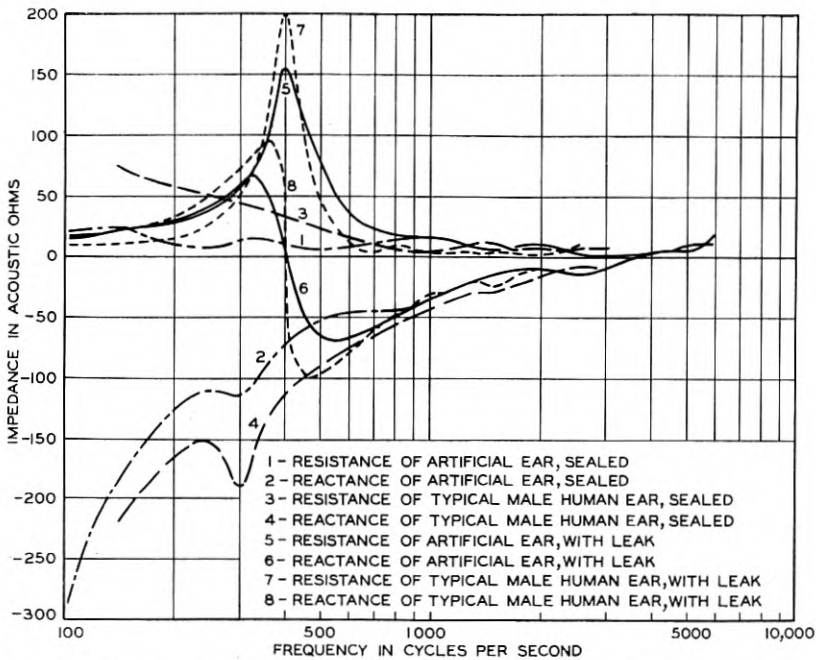

Fig. 13—Acoustic impedance of ears as viewed through aperture of receiver cap.

Considerably more data on human ears than are now available appear to be required before an artificial ear with more typical impedance characteristics than those shown can be designed.

In Fig. 14 additional acoustic impedance data on a typical male human ear and on the artificial ear are shown, the measurements in this case being made looking into the auditory canal. Table II presents data supplementing Fig. 14. As in the previous measurements, wide variations were encountered between different ears at any given frequency. The agreement between the artificial ear

TABLE II  
ACOUSTIC IMPEDANCE OF EARS LOOKING INTO AUDITORY CANAL

$f$	Observed Range of Measurements for 7 Male Human Ears		Artificial Ear	
	Resistance	Reactance	Resistance	Reactance
200....	50 to 250	-1134 to -633	60	-610
400....	20 to 250	-760 to -254	80	-385
800....	35 to 136	-300 to -130	15	-145
1200....	60 to 91	-180 to -20	20	-80
2000....	8 to 70	-155 to -50	20	-27
3000....	15 to 60	-140 to +50	22	+15

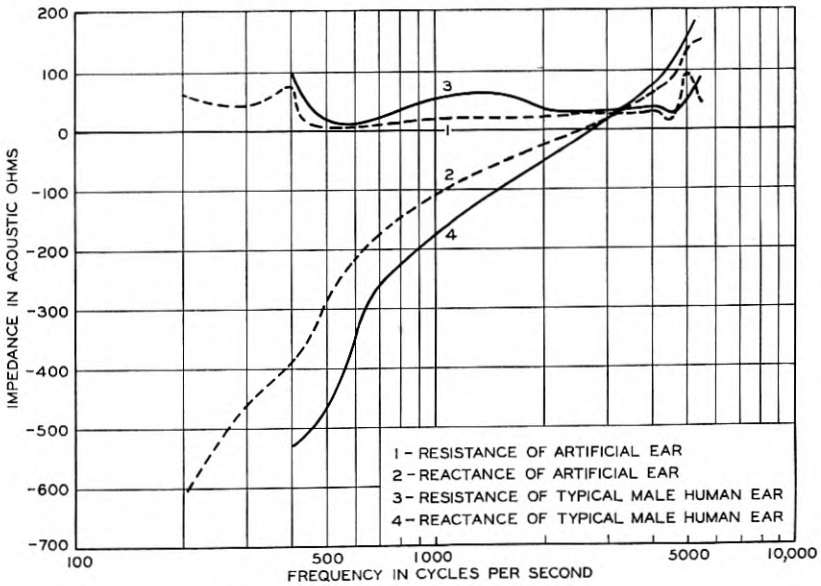

Fig. 14—Impedance characteristic of auditory canal.

results and the human ear measurements is as close as seems warranted by the available data.

The acoustic impedance data presented are important from the standpoint of insuring that the receiver under test on the artificial ear operates under nearly the same load conditions as it does on a human ear. It is also important that the response-frequency characteristic of a receiver obtained on the artificial ear compare well with that obtained on the human ear. In this connection two widely different types of receiver have been studied; one, a moving coil receiver such as is used in the Master Reference System for Telephone Trans-

mission,<sup>8</sup> and the other, a deskstand type receiver. Measurements of the response characteristics of these two types of receiver have been made on male human ears as described in the Appendix. The results obtained, together with similar measurements on the same receivers on the artificial ear, are shown in Figs. 15 and 16. Over most of the frequency range rather good agreement is found between the human ear and artificial ear measurements, the discrepancies in most cases being relatively unimportant.

Electrical impedance measurements were made on two commercial types of receiver whose impedances at resonance are relatively sensitive to changes in acoustic load. These measurements were made with

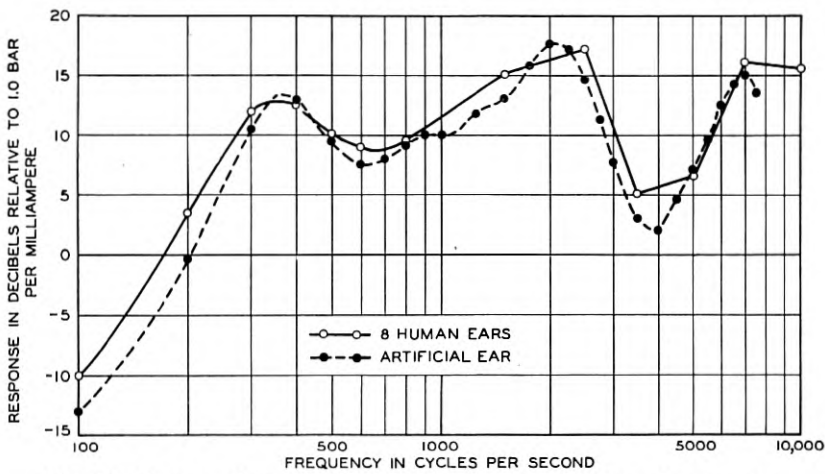

Fig. 15—Response-frequency characteristic of moving coil receiver on ears.

the receiver in free air and when held to the human ear and to the artificial ear. The results are shown in Table III. The values of

TABLE III  
ELECTRICAL IMPEDANCE DATA FOR DIFFERENT TYPES OF RECEIVERS WITH VARIOUS LOADS

Load Condition	Type of Receiver	Natural Frequency (f <sub>0</sub> )	Damping Constant (Δ)
Air .....	Deskstand	854	122
Artificial Ear .....	“	1009	208
Observed Range on Male Human Ears..	“	777-1062	141-258
Air .....	Handset	808	122
Artificial Ear .....	“	967	355
Observed Range on Male Human Ears..	“	818-1048	226-524

<sup>8</sup> “Master Reference System for Telephone Transmission,” W. H. Martin and C. H. G. Gray, *Bell System Technical Journal*, July, 1929.

natural frequency ( $f_0$ ) and damping ( $\Delta$ ) as obtained from motional impedance circles for the measurements on human ears vary over a wide range. The results obtained on the artificial ear closely approximate those obtained on what may be considered a typical normal male ear.

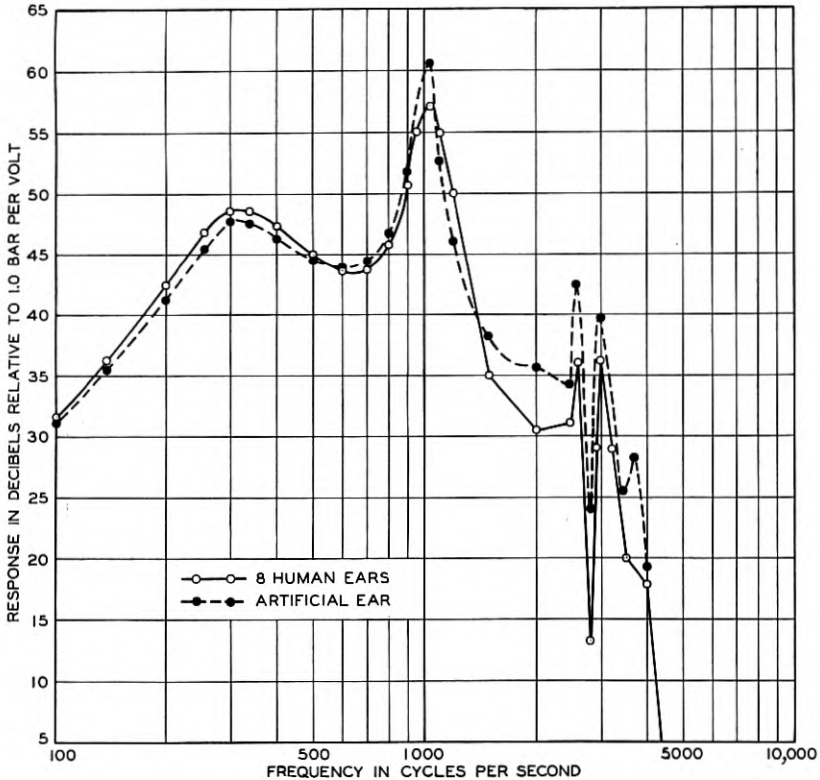

Fig. 16—Response-frequency characteristic of deskstand receiver on ears.

The artificial ear coupled through a suitable amplifier is terminated in measuring apparatus similar to that employed in the sound meter.<sup>9</sup> The indicating instrument used responds to impulses of short duration (under .2 second) in a manner approximating the response of the actual ear to sounds of similar duration. The rectifier, of the copper-oxide type, obeys over its useful range, essentially a square law. By the addition of a suitable loudness weighting network similar to

<sup>9</sup> "Indicating Meter for Measurement and Analysis of Noise," T. G. Castner, E. Dietze, G. T. Stanton, and R. S. Tucker. Presented at the Northeastern District Meeting of the A. I. E. E., Rochester, N. Y., April 29–May 2, 1931.

that used in the sound meter, the artificial ear may be used to obtain a measure of the relative loudness produced by different receivers. Other weighting networks may be used to enable a direct meter reading of other desired characteristics.

While any single design of artificial ear can, of course, simulate only a single ear condition, there appears to be no reason why a structure of the type described cannot be made to simulate any ear by proper changes in the dimensions of the passage and values of the acoustic impedances without sacrifice of stable performance or the ability to specify and reproduce it. As far as data on the characteristics of human ears are at present available, the particular design described gives a good approximation, both in its effect on the receiver and in its own frequency characteristics, of a typical male ear. There is indication that this artificial ear, in addition, may offer an equally satisfactory substitute for the real ear in the measurement of open sound fields. A further study of this possibility is being made.

#### GENERAL APPLICATIONS OF THE ARTIFICIAL VOICE AND EAR

Equipment of the kind described offers many advantages, both in laboratory investigation and in shop testing of instruments, as compared with the methods that have been used heretofore. The artificial voice and ear described have, of course, the advantages of exact specification and control of the testing conditions, and of rapidity in obtaining data which have been the principal arguments for the use of previous voice and ear substitutes. In addition, instruments tested by these new means are under nearly normal operating conditions.

In laboratory investigations and development of instruments the artificial voice, makes it possible to carry out tests, such as response-frequency measurements with the same instrumentalities as are used for speech tests. This is, of course, impossible with the real voice. When used in conjunction with a high quality transmitter it permits either the variation of talking intensity without change in quality, or the maintenance of a constant output intensity from the artificial mouth, even though the actual speaker's voice may be varied over a wide range. Applications of this kind in exercising over a caller's voice, control of which he himself is incapable, are invaluable in many laboratory investigations.

As applied to shop inspection practices, the desirability is obvious of having a single testing means for all transmitters and receivers regardless of type, which is identical in principle with the means of testing used in the laboratory. The results of measurements made on instruments, whether in laboratory, factory or repair shop, can be

directly compared and the results used to great advantage in the engineering and maintenance of the telephone plant.

A further valuable application of the artificial voice and ear is as an adjunct to a reference telephone system. At the present time uncontrollable differences in technique and testing personnel at various points where it may be desirable to employ such reference systems involve discrepancies difficult to eliminate or explain. The use of the artificial voice and ear with suitable phonograph records makes it possible to have identical testing means at any point desired.

Further experience with the artificial voice and ear will undoubtedly open up new possibilities and applications for these instrumentalities and enable more accurate investigation of instruments with less expenditure in effort and time.

## APPENDIX

### RESPONSE-FREQUENCY CHARACTERISTICS OF RECEIVERS ON THE HUMAN EAR

In Figs. 15 and 16 are shown response-frequency characteristics of receivers on the human ear. One method by which such characteristics may be determined is shown schematically in Figs. 17-A and 17-B. With the auricle projecting through an aperture (provided for purposes of definite location of the ear) toward the sound source as shown, the pressure at each frequency produced at the tympanum or as near to it as possible is measured by means of the calibrated transmitter and search tube.

With the pressure measured and the search tube removed from the ear, the observer listens to the sound from the source, as shown in Fig. 17-Ba. Then he listens to the receiver to be calibrated as shown in Fig. 17-Bb. The electrical input to the receiver is adjusted until the observer judges the sensation to be equal to that from the source. This then gives the pressure produced by the receiver for a given frequency and for a given input to the receiver.

#### *The Search Transmitter and Its Calibration*

The purpose of the search transmitter is to furnish an instrument of small external dimensions to meet the following requirements:

1. It must admit of calibration at single frequencies in terms of electrical output per unit pressure at the mouth of the tube.
2. It must be small enough to admit of insertion into the ear canal without material distortion of the sound field in the latter.

The tube used in the measurements is associated with a condenser transmitter.<sup>6</sup> One end of this tube, having a relatively large opening is acoustically coupled to the transmitter diaphragm. The calibration of the transmitter is made with the aid of a Rayleigh Disc, in a highly damped sound-proof box, as shown in Fig. 18. The sound source is a loud speaking receiver of large power capacity,<sup>4</sup> terminated with an

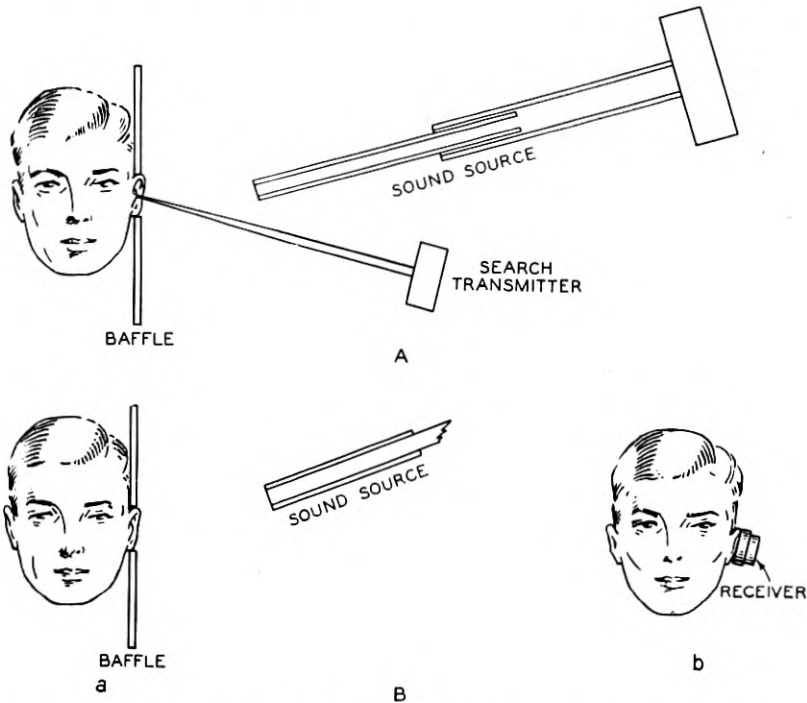

Fig. 17—Diagrammatic arrangement employed in receiver calibrations on human ears.

adjustable tube. With the mouth of the tube as origin, an approximately spherical progressive sound wave is produced. From the disc deflection, the particle velocity and hence the alternating sound pressure is determined in the space occupied by the disc. The search transmitter (the bulk of it wrapped in felt) is placed with its mouth as near the disc as possible, and its voltage output is measured.

The search transmitter calibration is made under conditions conforming to the following essential requirements:

<sup>6</sup> Loc. cit.

<sup>4</sup> Loc. cit.



- (a) The presence of the search transmitter does not appreciably affect the deflection of the disc.
- (b) The output of the transmitter is determined solely by the position of the mouth of the tube in the sound field; i.e., it is independent of the angle at which the tube may be pointing, and of any rotation about its axis.
- (c) The output of the transmitter with the mouth of the tube closed must be small compared to that with the mouth open.
- (d) The form of the sound wave must be such that the relation between the velocity and pressure at the mouth of the tube is known.

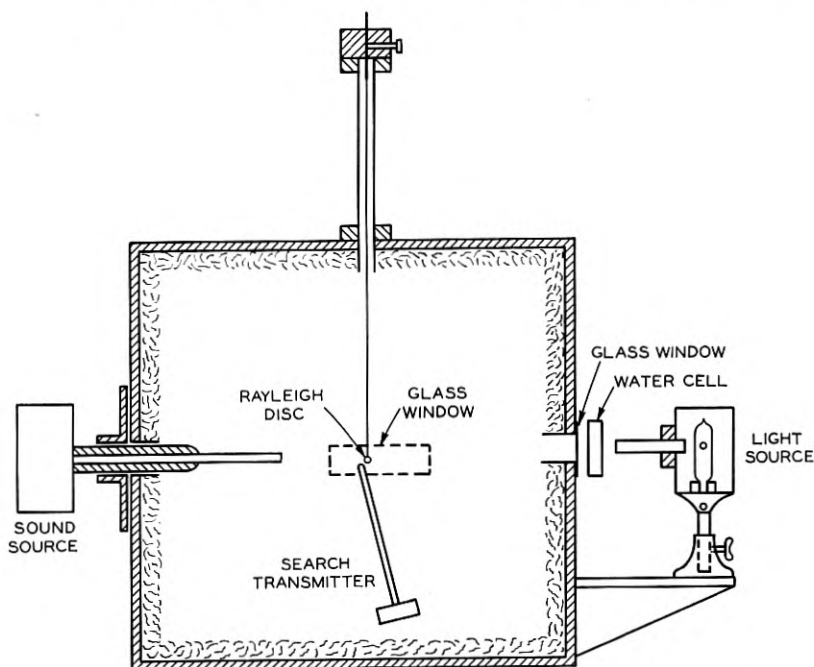

Fig. 18—Search transmitter calibration by means of Rayleigh disc.

#### *Measurement of Pressure in Ear Canal Without Receiver*

Pressure measurements are made as far inward in the canal as consistent with perfect safety to and comparative comfort of the subject. Most ears show a distinct bend in the canal accompanied by a flange which is mainly responsible for obstructing the view of the tympanum. It has been found possible to make measurements at a distance of from 0.5 cm. to 1 cm. past that flange, toward the tympanum. It is doubtful if measurements can be made at a point

much closer when all circumstances are considered, e.g., the frequency range to be covered and the importance of incurring no risks whatever.

The region inward beyond this bend is apparently one of rather uniform pressure, usually higher than in the outward positions of the canal, so that there is little chance of a measurement being made at the pressure node of a distinct standing wave pattern. This probably is accounted for by the irregularity of the passage and the character of the canal walls.

#### *Receiver Calibration*

At each frequency, response measurements were made on eight ears as described, and the average computed. The results are shown in Fig. 15.

When the response-frequency characteristic of one receiver has been determined by the method described, any other receiver may be calibrated by a direct comparison. The response-frequency characteristic on the ear shown in Fig. 16 was obtained in this manner.

## Abstracts of Technical Articles from Bell System Sources

*A New High Vacuum System.*<sup>1</sup> J. A. BECKER and E. K. JAYCOX. A new high vacuum pumping system is described in which oil is used in a diffusion type pump, and a trap containing activated coconut charcoal replaces the usual liquid air trap. The system is capable of attaining a pressure of  $2 \times 10^{-8}$  mm. Hg. A high degree of vacuum can be attained at least as quickly as with a mercury diffusion pump and liquid air trap. The system is especially adapted to maintaining a low pressure for several days in apparatus which cannot conveniently be sealed off from the pumps.

*Phenomena in Oxide Coated Filaments II. Origin of Enhanced Emission.*<sup>2</sup> J. A. BECKER and R. W. SEARS. Various theories have been advanced regarding the mechanism of emission of electrons from oxide coated filaments. These theories postulate that: (1) the active layer is (a) at the outer oxide surface, (b) at the core-oxide interface; (2) the thermionic electrons come from (a) the adsorbed barium, (b) the oxide just underneath the adsorbed layer; (3) the current is carried through the oxide coating by (a) an entirely electrolytic process, (b) thermionic electrons which come from the core, diffuse through the pores of the coating and form a space charge therein, (c) electrolytic conduction through the oxide crystals and thermionic conduction between crystals, (d) electronic conduction, a small portion being carried by ions. A number of experiments were designed to test these various hypotheses. These experiments show that: (1) When barium is brought to the outer surface of the oxide, either by electrolysis or evaporation from an external source, the emission increases at first, passes through a maximum and then decreases. This change in activity is similar to that for barium on tungsten. (2) When oxygen is brought to the surface of the oxide of an activated filament, the activity decreases rapidly at first and then more slowly. (3) In these two respects, a filament with a core made of an alloy called "Konel" and consisting of nickel, cobalt, iron and titanium acts just like filaments with other cores. (4) When the oxide was stripped from a Konel core filament, the activity decreased by a factor of 6000. (5) The emission-limited current is independent of the area of the core

<sup>1</sup> *Rev. Sci. Instruments*, December, 1931.

<sup>2</sup> *Phys. Rev.*, December 15, 1931.

provided that the area of the outer oxide surface remains constant. (6) The conductivity of the oxide varies with the time of sending current through the oxide. (7) The conduction current in the oxide obeys Ohm's law and does not saturate even though its value is hundreds of times larger than the saturated emission. (8) The oxide acquires a positive potential with respect to the core regardless of whether the space current is limited by space charge or by emission. This potential varies linearly with the space current drawn to the plate and is of the order of a few tenths of a volt. (9) The emission for the optimum amount of barium on the oxide surface depends upon the previous treatment of the oxide. From these results we conclude that: (1) The active layer is at the outer oxide surface. The activity depends on the concentration of barium and oxygen on this surface and also upon the amount of metallic barium dispersed through the oxide. The core material does not directly affect the emission but it does greatly affect the ease with which free barium is produced by heat treatment or electrolysis. (2) The thermionic electrons originate in the oxide just underneath the adsorbed barium. (3) Most of the current through the oxide is conducted by electrons, a small portion being carried by barium and oxygen ions.

*Barkhausen Effect: Orientation of Magnetization in Elementary Domains.*<sup>3</sup> RICHARD M. BOZORTH. Brief mention is made of previously published work on the nature of the discontinuities in magnetization discovered by Barkhausen in 1919. Including the recent results described in this note, the experimental data now indicate that changes in the magnetization of ferromagnetic materials occur in the following way: The material is composed of small regions or "elementary domains" (of the order of  $10^{-8}$  cm.<sup>3</sup>), each of which is generally magnetized to saturation in a different direction. As the strength of the applied magnetic field increases, the magnetization in some of the domains changes suddenly from saturation in one direction to saturation in another direction associated with less potential energy. The change in each domain gives rise to a single click in the telephone receiver which terminates the apparatus usually used to observe the effect. In annealed materials in which the crystal grains are much larger than the domains, the direction of magnetization within each domain depends on the orientation of the crystal grain in which it is situated, and coincides with its direction of easy magnetization as determined by separate experiments on large single crystals.

<sup>3</sup> *Phys. Rev.*, January 15, 1932.

*The Rapid Record Oscillograph in Sound Picture Studies.*<sup>4</sup> A. M. CURTIS, T. E. SHEA, and C. H. RUMPEL. This paper describes a special oscillograph which was designed for making rapid records in sound picture studies. The oscillograph is briefly described, and illustrations are presented of records obtained in making the following studies: microphonic action of vacuum tubes; noise levels in amplifiers; investigations on rectifiers; studies on light valve clash; action of the biasing current of light valves as used in noiseless recording by the variable density method; acoustical studies showing the rise and decay of transients; loud speaker selection with regard to load carrying capacity and mechanical flutter investigations of reproducer sets.

*Vertical Sound Records—Recent Fundamental Advances in Mechanical Records on "Wax."*<sup>5</sup> H. A. FREDERICK. This paper describes recent progress which has been made in laboratory studies of mechanical records of sound cut on a wax disk. Both theoretical and experimental investigations indicate that a phonograph record, cut with vertical undulations instead of the more usual lateral undulations possesses fundamental advantages. The principal improvement comes from a marked increase in the volume and frequency range over which faithful reproduction may be obtained. A higher volume level can be recorded for the same groove spacing and speed. More playing time can be provided with a given size of record and volume level since, for these conditions, both the groove spacing and speed may be reduced. Improvements in methods of processing the stampers and in the record material give a large reduction in surface noise and hence a corresponding increase in the volume range. With these improvements the frequency range which can be reproduced satisfactorily can be extended nearly an octave to 8000 to 10,000 cycles. Other improvements incidental to the improvements noted above are great improvement in the quality of reproduction obtainable directly from a soft "wax" record and a great extension in the life of the hard record.

*Effect of Shore Station Location Upon Signals.*<sup>6</sup> R. A. HEISING. Experiments are described for ascertaining the attenuation suffered by the unreflected wave in traversing relatively small amounts of land between the seashore and hypothetical inland sites. The results show 8 to 12 db attenuation for 1 mile inland with greater attenuation thereafter for unfavorable terrain. Swampy ground produces small attenuation. The classical theory of wave transmission past a straight

<sup>4</sup> *Jour. S. M. P. E.*, January, 1932.

<sup>5</sup> *Jour. S. M. P. E.*, February, 1932.

<sup>6</sup> *Proc. I. R. E.*, January, 1932.

edge used in optics is applied to explain the reduction. Coexisting phenomena are mentioned.

*Oxidation Studies of Rubber, Gutta-Percha, and Balata Hydrocarbons.*<sup>7</sup> A. R. KEMP, W. S. BISHOP, and P. A. LASSELLE. The oxidation mechanism of rubber and gutta-percha hydrocarbons has been studied. Rubber hydrocarbon in sheet form oxidizes more slowly and less completely than precipitated gutta-percha, which is believed to be due to the smaller surface exposure of the former material. Gutta-percha hydrocarbon in finely divided form oxidizes to a fairly definite degree in oxygen at room temperature, corresponding to a weight increase of about 38 per cent. The length of the autocatalytic induction periods for rubber and gutta-percha varies over a wide range and is shortened by heating the hydrocarbon in high vacuum before oxidation and by exposure to light.

The rate of oxidation of gutta-percha in air, as compared with oxygen, is reduced in proportion to the oxygen concentration, and the induction period is correspondingly increased.

Carbon dioxide, water, formic acid, and formaldehyde are identified in the volatile oxidation products, and their relative amounts determined. Six to eight per cent of the hydrocarbons are converted to volatile oxidation products. The percentage unsaturation of both rubber and gutta-percha hydrocarbons is reduced in proportion to oxygen absorbed. The ratio of hydrogen to carbon decreases as a result of oxidation.

The solid oxidized products are of such a nature that they cannot be resolved into crystalline materials. They are amorphous acid substances, free from aldehyde and ketone groups. They contain a small amount of peroxides; and the acidity, saponification value, and other properties indicate that most of the oxygen is combined in the form of hydroxyl, carboxyl, and lactonic groups. The mechanism of oxidation of rubber and gutta-percha appears to be the same, and the possibility of a chain mechanism to explain the facts is discussed.

*Modern Developments in Precision Clocks.*<sup>8</sup> A. L. LOOMIS and W. A. MARRISON. A discussion of precision clock requirements is given in terms of the general equations of motion of an oscillator and extended specifically to the gravity pendulum and the crystal oscillator types.

One of the largest sources of error in pendulum clocks is due to

<sup>7</sup> *Ind. and Engg. Chem.*, December, 1931.

<sup>8</sup> Presented at A. I. E. E. Midwinter Convention, Jan. 25-29, 1932, New York, N. Y., as a part of the Symposium on Time and Time Services. To be published in full as *Monograph B-656, Bell Telephone System Technical Publications*, and available upon request to Bell Telephone Laboratories, New York, N. Y.

variations in amplitude. The amount of this effect is given, and the usual methods for reducing it by keeping the pendulum swing small are discussed. A method which is being used successfully by Mr. Loomis for controlling the amplitude at a fixed value is described.

The effect of atmospheric pressure on the rate is discussed and it is shown that the four chief rate controlling factors involved can be made to annul each other at a critical pressure for a given pendulum.

Factors that affect the length of a pendulum, such as temperature coefficient of the material, aging, etc., and some factors that affect the restoring forces, are discussed since they affect the period directly.

The effect of the phase of applied driving force in an oscillator is also an important factor. In the case of a pendulum the impulse should be delivered at the instant when the velocity is maximum, that is, at the center of the swing. If it is applied earlier, the rate is momentarily increased, and conversely.

A brief description is given of the Shortt clock, which has established an enviable record for timekeeping in some of the world's outstanding time observatories. The installation of three of these clocks in The Loomis Laboratory at Tuxedo Park, N. Y. is described and illustrated.

The crystal clocks used in Bell Telephone Laboratories, N. Y. City, are described briefly, as well as some of the outstanding features of their use. These "oscillators" were built primarily as a precise standard of frequency, but have been found in addition to serve exceedingly well as timekeepers.

Performance data are given for the crystal clocks, for the three Shortt clocks in The Loomis Laboratory, and for clocks in a number of representative national time observatories.

In addition a brief account is given of a continuous comparison which is being made between the crystal clocks in Bell Telephone Laboratories and the Shortt clocks in The Loomis Laboratory.

*The Nature of Metals in Relation to their Properties.*<sup>9</sup> EARLE E. SCHUMACHER. The methods of extracting metals from their ores and fabricating them constituted the art of metallurgy in the older sense, an art whose development has closely paralleled the rise of civilization. The modern science of metallurgy, on the other hand, concerns itself to a large extent with the explanation as to why metals behave as they do and in particular why the methods employed in the art produce the effects they do. This science, as distinct from the art, is of comparatively recent origin. It is, indeed, only since the development of the tools used in modern research, notably the microscope and x-ray,

<sup>9</sup> *Scientific Monthly*, January, 1932.

that important steps have been made toward the analysis of metallic structure. Rapid progress has been made in the last twenty years and today there is available a vast fund of information in regard to the nature of metals in relation to their properties.

Two of the most important properties of a metal are its hardness and strength. These properties are closely related and in general the magnitude of one indicates the magnitude of the other. The development of the relationship between the nature of a metal and the hardness and strength constitutes one of the most interesting chapters in the science of modern metallurgy.

*Noise Measurement.*<sup>10</sup> S. K. WOLF and G. T. STANTON. The instrumental measurement of noise presents difficulties that have in the past generally defeated its successful accomplishment. While noise exists in a physical state and certain of its quantities are susceptible to direct measurement, the magnitude of a noise is evaluated through the interpretation of the human ear. The ear is non-linear in its evaluation of the various factors of noise. The degree and nature of the ear's non-linearity to the principal factors is discussed, with respect to the chief interpretative impression, that of loudness.

Audiometric measurements approached a more proper evaluation of noise, but in addition to dependency upon human judgment, were only approximate, and represented comparisons of physiological effects of noise rather than true noise values.

An instrument is described that measures intensity expressed in terms of loudness, evaluated for frequency and duration, and which combines portions of a complex wave shape in a suitable manner. The characteristics of the meter and the ear are compared. The readings are in decibels above a zero reference point near the threshold of audibility. The selection and meaning of this scale is explained. Where it is desired to analyze the pitch or frequency of a noise, an analyzer attachment permits either band or single-frequency analysis. Some limitations in its use in making noise measurements are discussed.

<sup>10</sup> *Jour. S. M. P. E.*, December, 1931.



## Contributors to this Issue

H. A. AFFEL, S.B. in Electrical Engineering, Massachusetts Institute of Technology, 1914; Research Assistant in Electrical Engineering, 1914-16. Engineering Department and the Department of Development and Research, American Telephone and Telegraph Company, 1916-. Mr. Affel has been engaged chiefly in development work connected with carrier telephone and telegraph systems.

C. R. AVERY, B.S. in Mechanical Engineering, University of Michigan, 1918; M.S., 1920. Western Electric Company at Chicago, New York, and Kearny, New Jersey, 1920-. As a development engineer, Mr. Avery has helped establish efficient methods of manufacture for enameled wire, paper and textile insulated wire, and telephone cable.

D. R. BROBST, E.E., Lehigh University, 1917; First Lieutenant, Coast Artillery Corps, U. S. Army, 1917-19; Engineering Department, Western Electric Company, 1922-25; Bell Telephone Laboratories, 1925-. Mr. Brobst's work has been connected with the development of central office wire and cable.

R. W. CHESNUT, A.B., Harvard University, 1917; War Department of French Government, 1917; U. S. Army, 1917-19; Engineering Department, Western Electric Company, 1920-25; Bell Telephone Laboratories, 1925-. Mr. Chesnut has been engaged in the development of carrier telephone and long-wave radio systems.

HAL F. FRUTH, B.A., M.A., St. John's College, Minnesota, 1914; M.S., University of Minnesota, 1922; Ph.D., University of Michigan, 1926; Research Assistant and Physics Instructor, University of Minnesota, 1920-22; Physics Instructor, University of Michigan, 1922-25; Physicist, Western Electric Company, Development Department, 1925-. Dr. Fruth has been engaged in development of manufacturing processes for mica condensers, microphones, resistances, wire enameling and gas burner design.

W. S. GORTON, A.B., Johns Hopkins University, 1908; M.A., 1910; Ph.D., 1914. Instructor in Electrical Engineering, Massachusetts Institute of Technology, 1911-13; Physicist, Brady Urological Institute, Johns Hopkins Hospital, 1914-17; Associate Physicist, Bureau of Standards, 1917-19; Western Electric Co., 1919-25; Bell Telephone Laboratories, 1925-. Dr. Gorton has worked on voice-operated tele-

phone repeaters and on the development and manufacture of submarine telegraph and telephone cables.

C. H. G. GRAY, B.Sc., Massachusetts Institute of Technology, 1918; Instructor in Electrical Engineering, Massachusetts Institute of Technology, 1918-19; Engineering Department, Western Electric Company, 1919-25; Bell Telephone Laboratories, 1925-. Mr. Gray has been engaged in the development and application of machine testing methods for the inspection of transmitters and receivers.

GORDON R. HARRIS, B.S., Carnegie Institute of Technology, 1927; Bell Telephone Laboratories, 1927-. Mr. Harris has been engaged in the development of filters for carrier telephone and telegraph systems.

A. H. INGLIS, B.A., Yale University, 1914; Western Electric Company, 1914-17; American Expeditionary Forces, 1917-19; American Telephone and Telegraph Company, Department of Development and Research, 1919-. Mr. Inglis has been engaged principally in the development of telephone instruments and sets.

R. T. JENKINS, B.S. in Electrical Engineering, Cooper Union, 1917; E.E., 1920. Engineering Department, Western Electric Company, 1916-25; Research Department, Bell Telephone Laboratories, 1925-. Mr. Jenkins' work has been largely in connection with transmission testing methods and apparatus, and with electro-acoustic calibrations.

W. C. JONES, B.S. in E.E., Colorado College, 1913; Western Electric Company, 1913-25; Bell Telephone Laboratories, 1925-. As Transmission Instruments Development Engineer, Mr. Jones has specialized in the development and application of instruments for the transmission of speech and music.

H. KRESS, M.E., Staatliche Hoehere Maschinenbauschule, Frankfurt Am Main, 1926. After graduation, Mr. Kress engaged in engineering work in Germany. In 1929, he joined the Western Electric Company as a development engineer and his work has dealt principally with textile insulated wire.

E. B. WOOD, B.S., Princeton University, 1915; M.A., Princeton, 1916; Teaching Staff, Cascadilla School, 1916-17; Captain, Coast Artillery Corps, U. S. Army, 1917-19; Teaching Staff, Pratt Institute, 1919-20; Engineering Department, Western Electric Company, 1920-25; Bell Telephone Laboratories, 1925-. Mr. Wood's work has been connected mainly with the development of central office wire and cable and humidity testing equipment.