

# The Bell System Technical Journal

April, 1930

## Developments in Communication Materials<sup>1</sup>

By WILLIAM FONDILLER

The subject of engineering materials is one of increasing importance, as is evidenced by the expenditure of over a half billion dollars annually in new construction by the Bell System. This has led to the concentration of the research and engineering work on materials in a group devoted particularly to this field of activity. Studies of the chemical and physical properties of materials must be combined by the materials engineer with a knowledge of the operating requirements of telephone apparatus.

The paper covers broadly the materials used in communication engineering and gives instances in which the needs of the telephone plant imposed requirements which were not satisfied by commercially available materials. Some of the instances cited are phenol fiber having improved resistance to arcing for use in sequence switches; a composite molded plastic for use in terminal strips; textile materials for central office wiring treated to improve their electrical insulating quality and non-ferrous metals of more uniform characteristics. Problems involving the use of duralumin for radio broadcasting transmitters and the light valve used in sound pictures are also described. Particular emphasis is laid on the benefits resulting from the continuous research in magnetic materials which have produced successively—powdered electrolytic iron cores for loading coils, permalloy, and recently perminvar.

Summing up, the work on materials has resulted in benefits along two general lines:

1. Improvement in quality of commercial materials.
2. Discovery or development of valuable new materials.

THE subject of this paper, "Developments in Communication Materials," perhaps needs some definition with the rapid addition of new fields to the pioneer arts of telegraphy and telephony. Today we must include high frequency wire telegraphy and telephony by means of carrier currents, radio, telephotography, television and, in a sense, sound pictures. All of these modes of communication of intelligence are characterized by the use of electrical means for the transfer of the signal, sound or scene to distant points, or their recording.

Up to about ten years ago the average manufacturer left to his designing engineer the problem of selecting and testing the materials which were to be embodied in a design, and he in turn was dependent on the manufacturers of raw materials as to the variety and quality of the materials available. Without depreciating the ability or initiative of manufacturers of engineering materials, it will be evident that the special needs of a particular industry would, in general, not be as fully appreciated by an outside manufacturer as by an engineer working

<sup>1</sup> Presented before A. I. E. E. on November 13, 1929.

on these problems. Thus it has come about in the Bell System, as with other large consumers of materials, that the investigation of materials has been organized as a distinct branch of research and engineering activity. Studies of the chemical, physical and metallurgical properties of materials are embraced in this work. In general the materials engineer should not only be well versed in materials, but should also have a good knowledge of the operating characteristics of the apparatus to be designed. Thus he can discuss the materials side of the problem with the designing engineer on equal terms and make his contribution to the best advantage. The importance of a thorough knowledge of materials in the telephone business will be appreciated from the fact that, during 1929, it is estimated that about \$590,000,000 will be spent for additions to the Bell System plant.

In telephony the general introduction of the dial system has imposed more severe requirements than heretofore because of the need for the utmost in reliability of performance of the large number of switches, relays, etc., which are required to operate automatically with a minimum of maintenance. In the central office small size of apparatus constitutes a very important consideration, not only because of building space required, but the mass and travel of the automatic switches have an important effect on the speed with which connections can be established and hence on economy of operations. Thus, close control of the quality of materials and the need for small, compact apparatus are important design considerations.

In a brief survey of progress in the development of materials, it will be necessary to select a few typical items of interest. The items selected deal primarily with the telephone problem as this is, at the present time at least, the largest single factor in the communications group. The subject may be divided broadly into insulating materials and metallic materials.

#### INSULATING MATERIALS

##### *Phenol Fiber*

Considering first sheet insulating material, we have been using the term "phenol fiber" to cover such materials as bakelite-dilecto, mica, formica and similar fibers made by various manufacturers. Phenol fiber is used extensively in telephone apparatus. One of its applications is in the sequence switch which has insulators alternating with conducting segments, as shown in Fig. 1. The sequence switch, which is used in the dial system, draws out an arc when in operation which sometimes causes carbonization of the insulators. In some cases a hole was burned through the insulator and in other cases the arc was

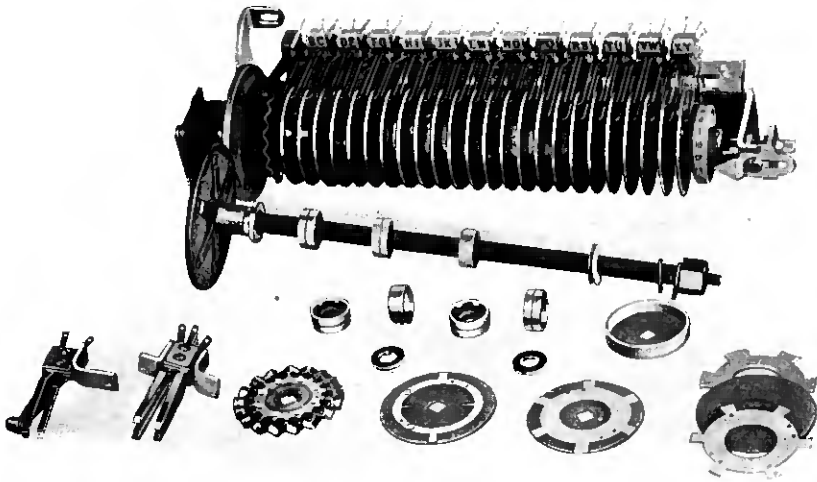

Fig. 1—Sequence switch, used in dial system.

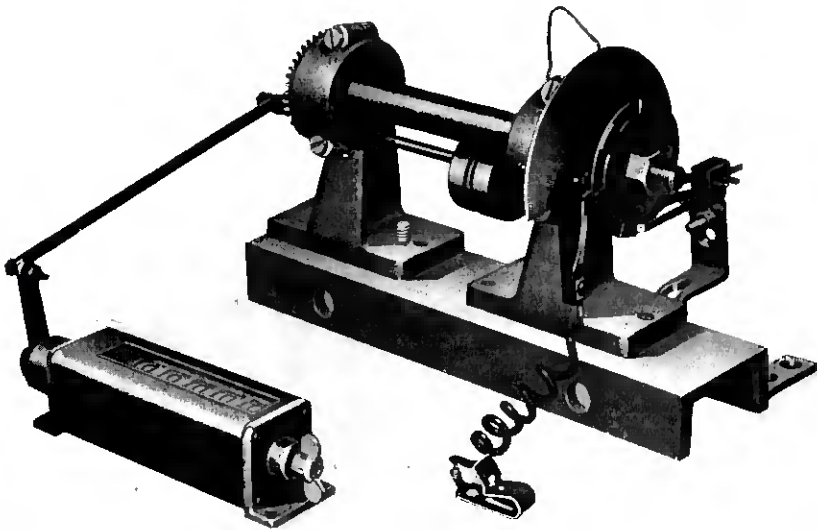

Fig. 2—Detail of apparatus for arcing test of phenol fiber.

sustained over the insulation to such an extent that the circuit was not broken at the proper moment. An examination of the various grades of phenol fiber commercially supplied indicated that they varied widely as to their resistance to arcing. Fig. 2 shows testing apparatus designed to evaluate this characteristic.

The sample under test was made into a sequence switch cam and rotated on the fixture at a speed of 10 r.p.m. The set is wired to give a circuit condition comparable with that causing failure in service, except that slower speed and higher voltage are used to accelerate the test. The position of the rear brush is so adjusted that after the material has become carbonized through an arc of 15 degrees or a hole has been burned through the insulation, the machine would be stopped by means of a circuit breaker, shown in Fig. 3. This instrument makes the

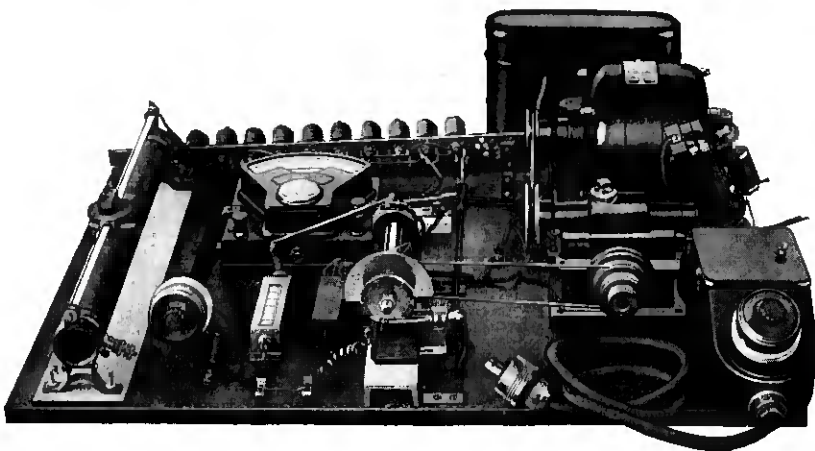

Fig. 3—Assembly of apparatus for arcing test.

failure value independent of the operator's judgment, and has proven so satisfactory that it has been employed for specification purposes.

Fig. 4 shows insulators tested by this instrument; those at the top having been rejected, and those at the bottom being satisfactory. An improvement of 20 to 1 in arcing characteristics was obtained. This was brought about by close cooperation with the Bakelite Research Laboratories, which developed a special grade of resin to be used in the manufacture of this material. In this case the materials engineer developed a method of test for evaluating the particular quality desired which enabled the supplier to improve his product in the desired respect.

Even though resistant to moisture in the ordinary sense, phenol fiber absorbs a certain amount of moisture depending on the quality of the material furnished. As this moisture is given up, the material

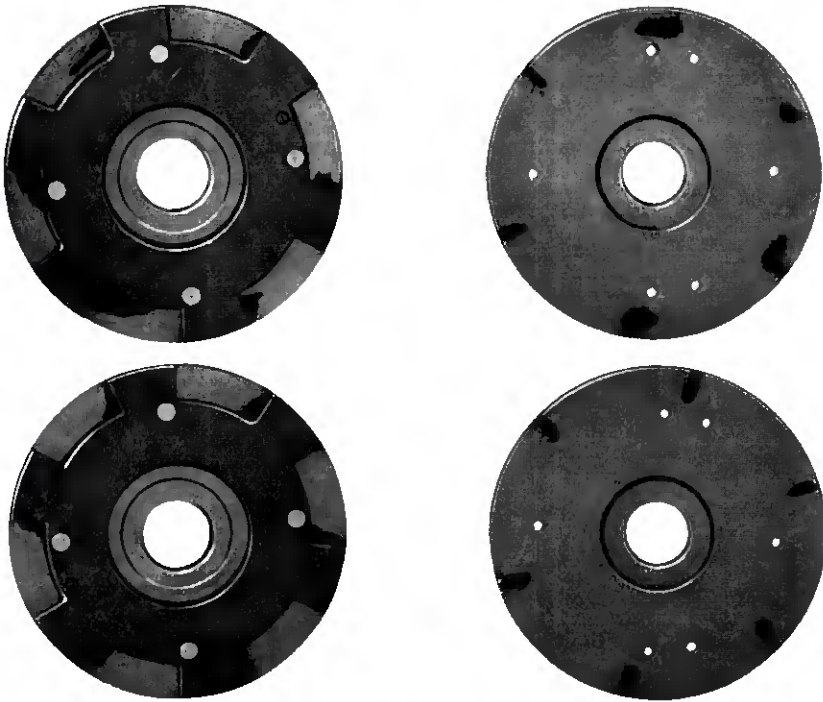

Fig. 4—Insulators subjected to arcing test.  
Top—Failure value, 20 rev.  
Bottom—Failure value, 1200 rev.

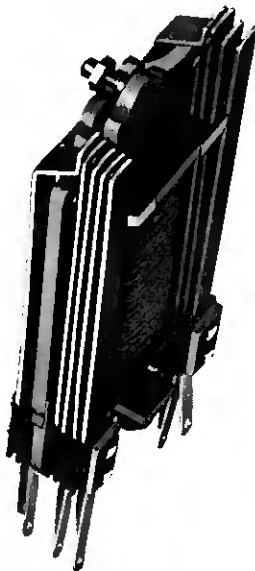

Fig. 5—Telephone relay showing phenol fiber insulators between contact springs.

tends to shrink. If the fiber is not sufficiently hard as manufactured, it will also flow under pressure.

In telephone relays of a commonly used type, illustrated by Fig. 5, the contact springs are insulated from each other by thin sheets of phenol fiber, and any material change in dimensions of these insulators, due to moisture absorption or cold flow, will alter the spacing of the contacts, thus throwing the relay out of adjustment. To measure these tendencies on materials used in spring pile-ups, we use the method illustrated by Fig. 6. It will be seen that a Brinell machine, usually

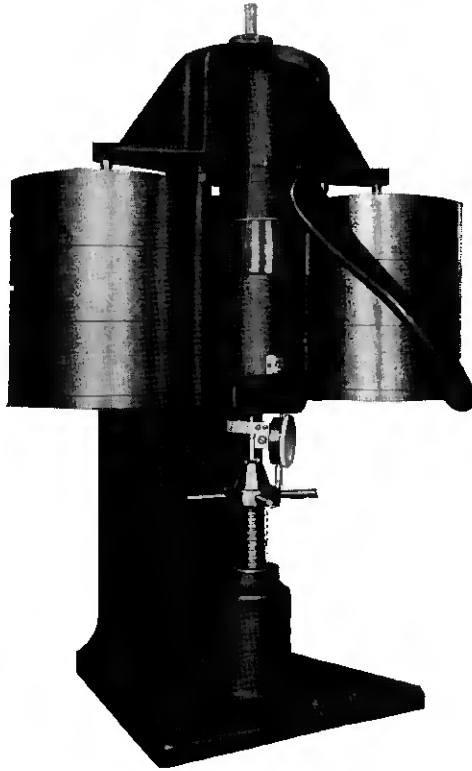

Fig. 6—Modified Brinell machine for flow-test of insulator laminations.

employed for metals testing, has been modified to use a flat-ended plunger resting on a pile of insulating material. The test material is first cut into pieces  $\frac{1}{2}$ " square and then subjected to atmospheric conditions which would cause it to take up an amount of moisture comparable to that expected under manufacturing conditions. The pieces are then stacked and a pressure of 2,000 pounds per square inch applied. The testing apparatus is installed in a heat insulated box

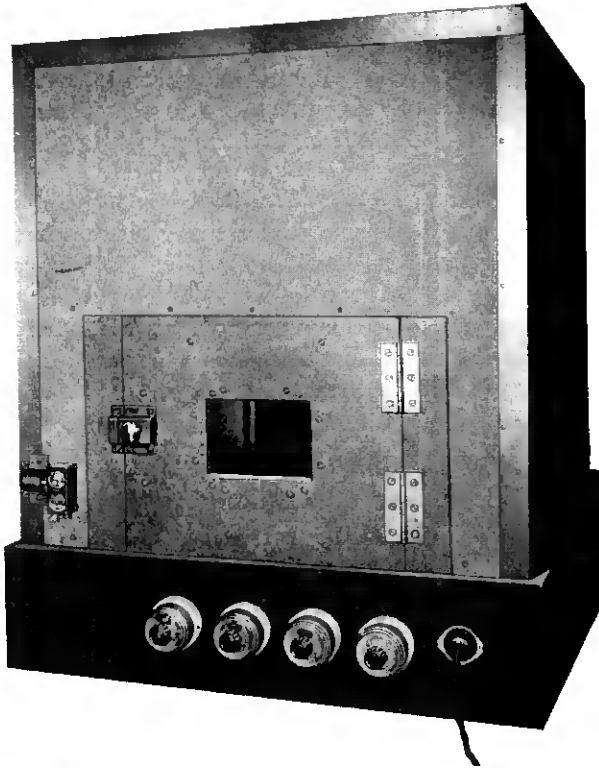

Fig. 7—Flow-test apparatus of Fig. 6 enclosed for temperature control.

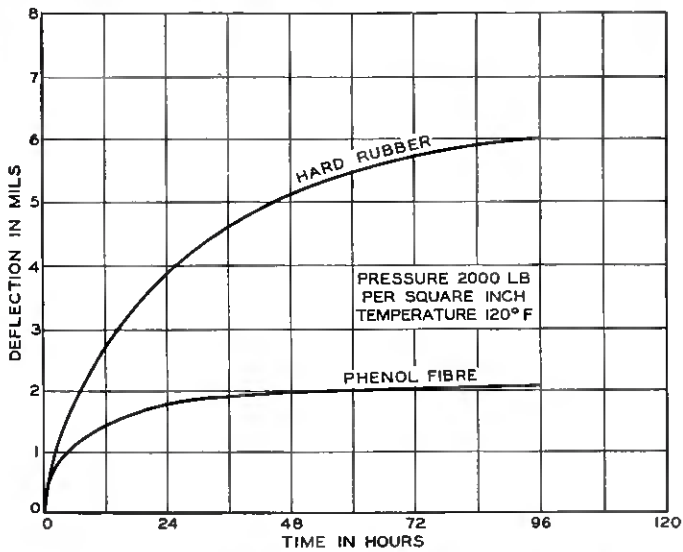

Fig. 8—Flow-test results for hard rubber and phenol fiber.



shown in Fig. 7, so that the temperature throughout the 24 hour test may be maintained at 120° F. corresponding to the maximum likely to be experienced in service. The amount of shrinkage or flow is measured on the dial previously shown. Fig. 8 shows the relative performance of hard rubber and phenol fiber under the conditions of this test.

#### *Molded Plastics*

In recent years there has been great activity on the part of manufacturers of molded plastics to develop improved molding compounds, and we have endeavored to keep informed of new developments by examining new compounds as they became available. An interesting problem presented itself in the application of suitable molding compounds to a device known as a test strip, shown in Fig. 9. It will be

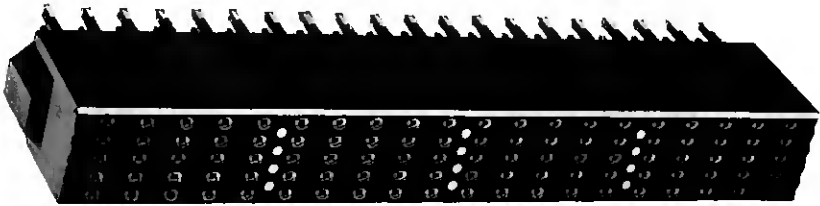

Fig. 9—100 point test strip used in switchboards.

seen that it consists of a number of metal terminals mounted flush on the face of the strip and projecting at the back to provide soldering lugs for the central office wiring. In operation it is necessary to touch a metal contact plug to the appropriate test strip contact which will produce an audible signal in the operator's receiver. In passing the plug over "live" terminals an arc is drawn out, which is accentuated by a habit of some operators of running their pencils along the grooves leaving a conducting path. Such arcs caused permanent conducting paths in the surface of the bakelite, despite the adoption of strenuous cleaning routines. The need for a better insulating material for this use became even more urgent with a demand for a test strip having 200 terminals instead of 100 in the same space.

Studies of compounds having such base materials as cellulose-nitrate, shellac, hard rubber, casein, and cellulose-acetate showed the last mentioned to give desirable arcing resistance. Foreign conducting material on the surface was burned off by the arc; the products of combustion of the small amount of cellulose acetate actually burned by such an arc are largely volatile, and the residue is non-conducting.

The compound used was found not to be sufficiently heat resistant to be satisfactory for the body of the test strip. The problem was solved by using it as a veneer on the test face of the bakelite strip.



This face is farthest from the heated ends of the terminals, is free from mechanical strain and is therefore not damaged by soldering operations. Since it was the practice to mold this test strip using several partially cured preforms, the veneer construction was introduced with only a slight increase in cost. The cellulose acetate has nearly the same molding temperature as the phenol plastic, so that the composite test strip could be molded in one operation. Fig. 10 shows the appearance

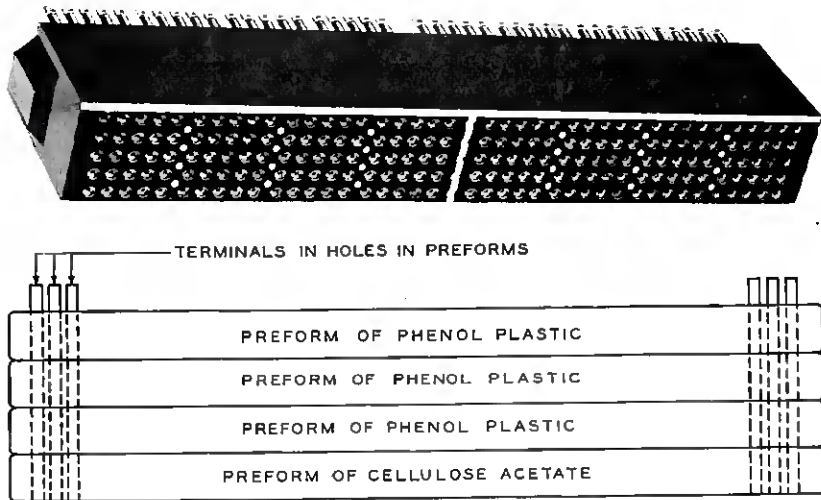

Fig. 10—Method of molding composite 200 point test strip.

of the modified test strip and the method of molding.

### Textile Insulation

Another development was in the improvement of textile insulation which was recently described before the Institute.<sup>2, 3</sup> It is mentioned here only in passing, because of its great commercial importance.

As a result of several years of study in the laboratory, it was found that the insulating quality of textiles depended on (1) the kind of fiber; (2) impurities present in the fiber; (3) moisture. The salts of sodium and potassium were found to be highly detrimental from an insulation standpoint. A very great improvement was effected by a washing treatment of the textile. Thus it has been possible to make

<sup>2</sup> "The Predominating Influence of Moisture and Electrolytic Material Upon Textiles as Insulators," R. R. Williams and E. J. Murphy, *Trans. A. I. E. E.*, Vol. 48, 1929.

<sup>3</sup> "Purified Textile Insulation," H. H. Glenn and E. B. Wood, *Trans. A. I. E. E.*, Vol. 48, 1929.

cotton an acceptable substitute for silk as wire insulation, as well as to improve greatly the insulating properties of silk. In one instance, central office distributing frame wire, of which the Bell System uses about five hundred million conductor feet annually, it was found possible to use double silk insulated conductor of treated thread where formerly triple silk insulation was required. An actual improvement in insulation was effected at the same time that a considerable economy resulted.

## METALLIC MATERIALS

### *Non-Ferrous Metals*

Telephone apparatus uses about 30,000,000 lbs. yearly of brass, bronze and nickel silver as structural members, springs and bearings. Because of space limitation the parts are necessarily small, many are formed into irregular shapes; spring parts must maintain accurate adjustment and have long fatigue life; certain other parts must resist wear. Experience with commercial grades of brass indicated wide variations under existing specifications and unsatisfactory means of testing the quality. At first blush there may not appear to be any connection between the temper of a metal spring and the grade of telephone service furnished, but looking at the matter broadly we were convinced that the stakes were large enough to warrant our launching an investigation of non-ferrous metals with the object of arriving at a better purchasing specification. Accordingly the Bell Telephone Laboratories initiated a joint study with the Western Electric Company and the American Brass Company which has extended over a period of several years. The results of this work have been described in considerable detail in appropriate papers before the American Society for Testing Materials.<sup>4, 5</sup>

This has resulted—

1. In a more accurate knowledge of the physical properties of brass, phosphor bronze and nickel silver.
2. Development of improved methods of test.
3. Preparation of better purchasing specifications with resulting improved control of the quality of the materials.

As an instance of the benefits derived, the work on hardness testing may be cited. For many years the scleroscope had been used as a rapid means of controlling the quality of sheet metal but trouble was frequently encountered because results could not be readily duplicated on

<sup>4</sup> "Physical Properties and Methods of Test for Sheet Brass," H. N. Van Deusen, L. I. Shaw and C. H. Davis, *Proc. Amer. Soc. for Testing Materials*, 1927.

<sup>5</sup> "Physical Properties and Method of Test for Sheet Non-Ferrous Metals," J. R. Townsend, W. A. Straw and C. H. Davis, *Proc. A. S. T. M.*, 1929.

different instruments and it was necessary to allow rather wide limits on each temper resulting in considerable overlapping of the temper tolerances. While tensile strength is usually considered the reference test for cold worked metal, it is necessary to have a test which can be used for more rapid inspection. As a result of our study we were able

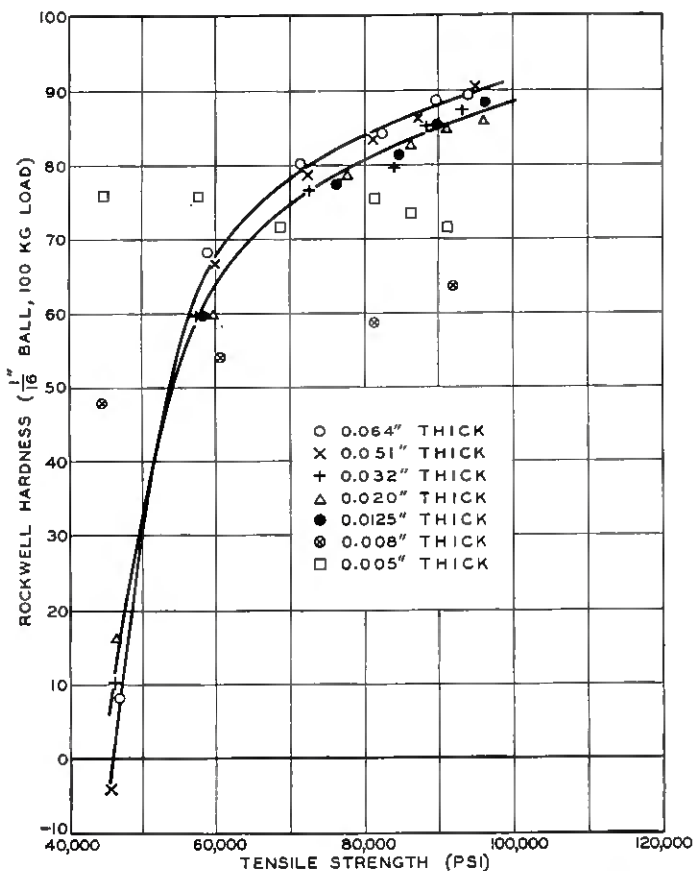

Fig. 11—Relation between tensile strength and Rockwell hardness—sheet brass.

to develop means for maintaining the Rockwell hardness tester to an accuracy within 2 points compared with 8 or 10 points on the scleroscope. Fig. 11 shows the relation between tensile strength and Rockwell hardness for a rolling series made up by the American Brass Company under carefully controlled manufacturing conditions. This rolling series covered all ranges of hardness and thickness of sheet metal generally used in telephone apparatus. The tension test is used

as a reference test and is resorted to only when the Rockwell test indicates the material to be close to the limiting values specified.

Work has been completed, resulting in the preparation of improved specifications for leaded brass, annealed brass, nickel silver and phosphor bronze and a similar investigation of rod stock in all grades of these metals is now under way. It is interesting to note in passing

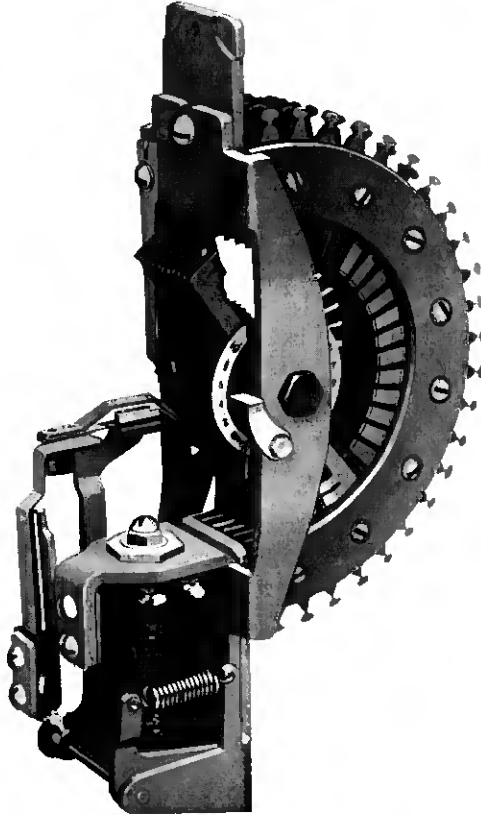

Fig. 12—Rotary selector used in dial system.

that in the course of our investigations we determined that the endurance limit of non-ferrous metals is only half that established for ferrous metals, averaging approximately  $\frac{1}{4}$  of the ultimate strength.<sup>6</sup>

For one of the rotary selectors used in the panel dial system we developed a leaded phosphor bronze sheet containing approximately 3 per cent of lead which proved very valuable in terms of increased

<sup>6</sup> "Fatigue Studies of Non-Ferrous Sheet Metals," J. R. Townsend and C. H. Greenall, *Proc. A. S. T. M.*, 1929.

life of the switch. This selector consists of an arrangement of closely spaced terminals referred to as the "bank" and a set of rotating brushes contacting with the bank terminals as shown in Fig. 12. Experience in the field indicated that under severe service conditions these selectors have a comparatively short life. As a result of our studies we replaced the brass brushes in the rotor with phosphor bronze, and the brass terminals of the bank with leaded phosphor bronze, a combination which has given approximately four times the life obtainable with brass parts, with corresponding maintenance savings. The reduced wear seems to be due in part at least to a lubricating effect of the lead constituent in the bank terminals.

Aluminum alloys have had considerable application to telephone apparatus not only in die castings but in sheet form as diaphragms in certain of the new developments in telephone transmitters and receivers. One of the most interesting of the aluminum alloys is duralumin, an alloy of aluminum, copper, silicon and magnesium. This material has about one-third the specific gravity of steel and like steel can be increased in strength by heat treatment in the manufactured form. Our first application of duralumin was as a stretched diaphragm in radio broadcasting transmitters. Here it was necessary to obtain material with as small a mass as possible and with the necessary strength to allow stretching to give a high natural period essential for good quality transmission. The material used in this case was 1.7 mils thick and had a tensile strength between 70,000 and 80,000 pounds per square inch.

Probably one of the most difficult applications of sheet duralumin is to the light valve used in the film method of sound picture recording. The light valve is an electromechanical device actuated by amplified speech currents, and consists of a loop of duralumin tape supported in a plane at right angles to a magnetic field. A view of the light valve is given in Fig. 13 which shows the tape held by two wind-lasses,  $AA^1$ , at one end, and wrapped over a spring-supported pulley  $B$  at the other. This places the tape under considerable tension. The tape is 6 mils wide and .5 mil thick. The central portion of the loop is supported on insulating bridges just above the face of the pole piece which constitutes the armature of an electromagnet.

Viewed against the light, the valve appears as a slit 2 mils wide by 256 mils long. In operation the amplified speech current is passed through the duralumin tape which, reacting with the magnetic field of the electromagnet causes variations in the width of the slit controlled by the variations in the speech current. The light beam directed toward the film is thus modulated by the slit in accordance with the variations

of the speech current. In order to avoid distortion, severe requirements were imposed on the straightness of the edges of the tape, and on the strength, in order to permit stretching to give a natural period in excess of 7,000 cycles per second. To obtain these properties special heat treatments and methods of rolling the material had to be developed.

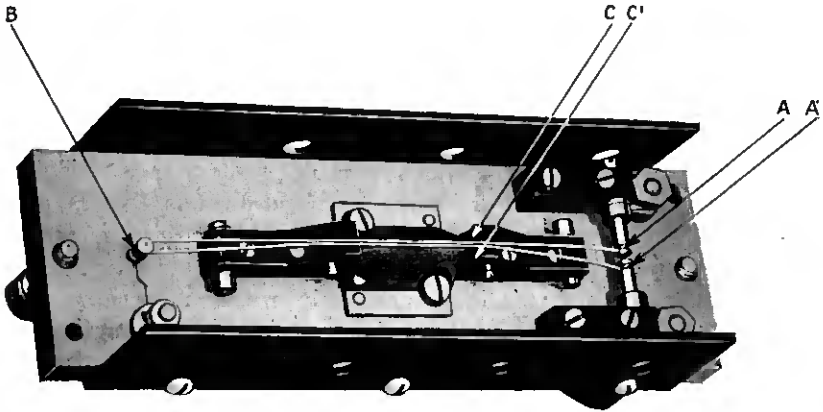

Fig. 13—Light valve used in recording of sound pictures.

*AA'*—Wind-lasses.

*B*—Pulley supported by spring.

*CC'*—Insulating bridges.

#### *Ferrous Metals*

Some interesting problems have been encountered in the use of ferrous metals in telephone apparatus, particularly in the operator's calling dial. Considerable trouble was encountered from slippage of the dial governor resulting from premature wear or breakage of the tips of the pawls or the teeth of the pinion. These parts had been made out of low carbon steel which had been found satisfactory for the subscriber's dial. The operator's dial, however, being used for a greater number of times, presented a more severe condition and case hardening was applied to obtain better wear resisting properties. This treatment was found to be unsatisfactory because the parts have thin sections and the combined weight of the two parts amounts to only 2 grams. Case hardening either produced too deep a case giving brittleness or too shallow a case which soon wore through. A nickel-chrome steel, originally developed for the automotive industry was finally adopted for the pawl and pinion combined with a special heat treatment. It was thus possible to obtain a useful life of 8 million operations as compared with an average of  $\frac{1}{2}$  million operations for the steel formerly used. This is another instance in which an increase

in first cost resulted in appreciable savings in annual cost of the device, considered from the operating companies' standpoint.

#### *Ferro-Magnetic Metals*

Up to about 15 years ago, telephone engineers used the magnetic materials in their designs which had been originally developed for the power industry, viz., magnetic iron and silicon steel. An exception was the use of 4. mil hard drawn steel wire for loading coil cores where extremely low permeability was desired.

The increasingly severe requirements imposed by compositing and phantoming of telephone circuits and the introduction of vacuum tube

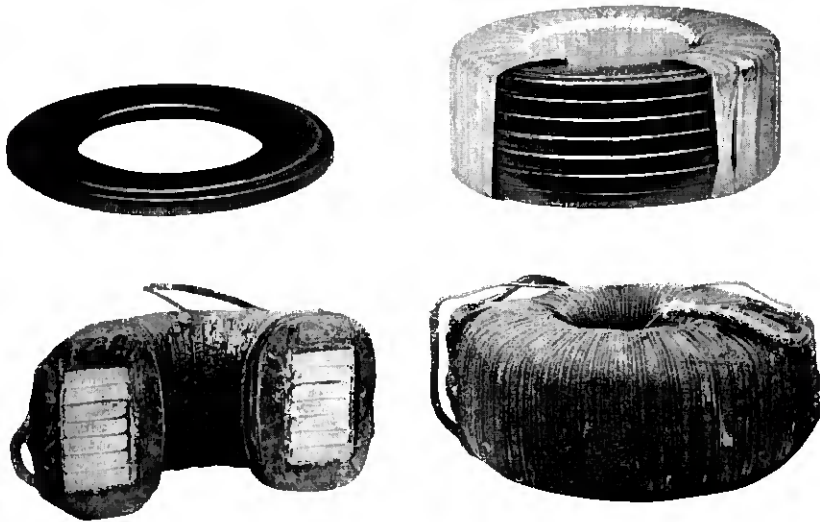

Fig. 14—Loading coils showing core rings of highly compressed powdered iron.

repeaters, made necessary the development of materials which would more adequately meet the new requirements. It was in 1915 that the Western Electric Company first produced compressed powdered electrolytic iron cores for loading coils. The construction of such powdered iron core coils is illustrated by Fig. 14. Electrolytically deposited iron is ground to a fine powder; the particles are covered with an insulating film and then compressed at a pressure of 200,000 lbs. per square inch to form rings as shown in the figure. This material was sensational in the improvements which it afforded over the core materials theretofore available as it combined with extremely high resistivity, high stability of A.C. permeability under conditions of powerful superposed or residual D.C. magnetization. The change in



A.C. permeability resulting from the temporary application of large magnetizing forces did not exceed 2 per cent as compared with changes of the order of 30 to 40 per cent commonly found in previously available materials.

The next important step was the discovery of permalloy, a nickel-iron alloy having extremely high permeability which had its first application in the loading of submarine telegraph cables. This material with its extremely low hysteresis loss and high induction for feeble magnetizing forces, has since been applied extensively in the design of transformers, relays, receivers, and other telephone apparatus. Fig. 15

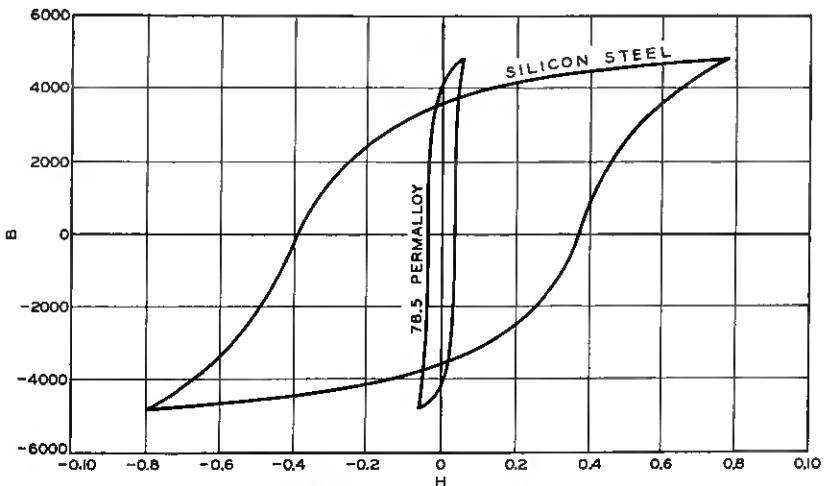

Fig. 15—Hysteresis loops of silicon steel and permalloy.

shows comparative hysteresis loops for permalloy and silicon steel. The much smaller hysteresis loss of permalloy, approximately one-seventh of that of the silicon steel sample is indicative of its greatly reduced tendency to remain magnetized after the removal of a magnetizing force, a property which is of great importance in the operation of quick release types of relays. In transformers and in continuously loaded cable, the very high permeability at small magnetizing forces of this material, strikingly shown in Fig. 16, is of great value. It is the high permeability of permalloy that made it possible to load telegraph cables successfully and thereby attain a threefold increase in telegraph speed. In transformers such as those used in vacuum tube amplifiers, the high permeability permits the designer either to achieve equivalent quality with a much smaller apparatus volume or, in the same space, to furnish equipment of better quality. The latter result is shown by the curves of Fig. 17 which indicate how transformer performance at

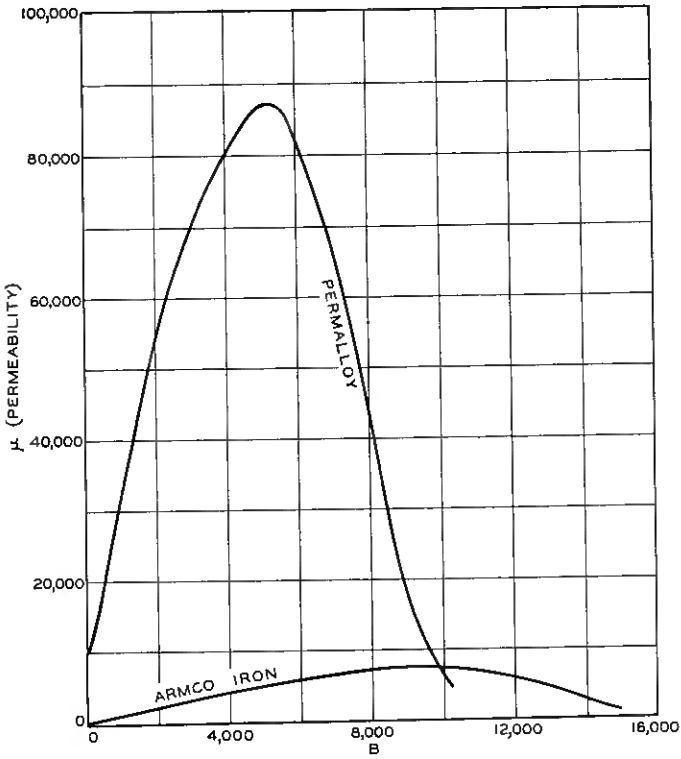

Fig. 16—Permeability curves of soft iron and permalloy.

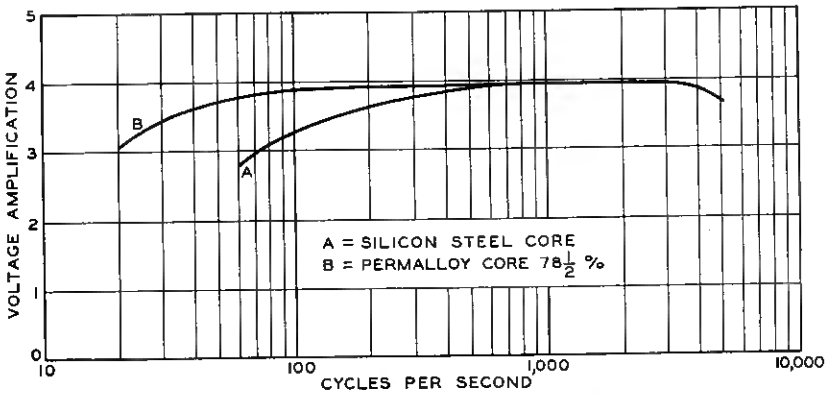

Fig. 17—Showing improvement in quality of voice frequency amplifier due to permalloy core transformers.

very low frequencies is improved by the use of permalloy. Sheet permalloy has been followed by compressed powdered permalloy<sup>7</sup> and this by perminvar,<sup>8</sup> the newest member of the magnetic alloy family.

Compressed powdered permalloy has replaced the powdered iron as it has all of the desirable properties of the latter and to an even greater degree. By virtue of higher permeability combined with lower hysteresis loss, it has made possible the design of smaller coils of superior performance characteristics. As an illustration the two loading coils of Fig. 18 are shown, the smaller of these being the electrical equivalent

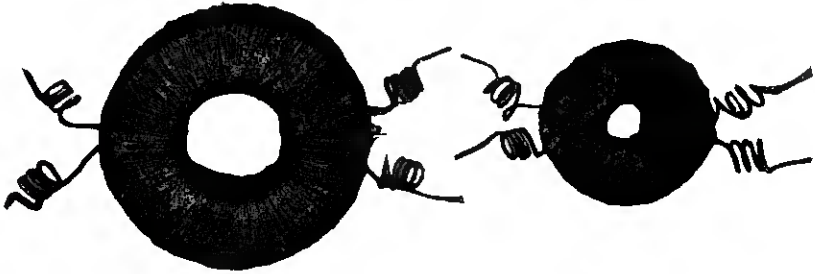

Fig. 18—Relative size of powdered iron (left) and powdered permalloy (right) loading coils.

of the larger in all respects and in some its superior. In general the reduction in coil size made possible by the use of powdered permalloy in place of powdered iron amounts to about 75 per cent giving very substantial savings in manufacturing costs, handling problems and installation space required.

Perminvar is remarkable in an entirely unique respect. Its permeability is not exceptionally high, being of the same order as that of ordinary soft iron at moderately low magnetizing forces, but it is exceptionally constant with respect to magnetizing forces. This is shown in Fig. 19 from which it will be noted that there is substantially no change in permeability up to a force of about 2 gauss whereas over this same range, the permeability of soft iron undergoes a change of more than 2,000 per cent. Up to somewhat smaller magnetizing forces, perminvar has a vanishingly small hysteresis loss. Fig. 20 depicts this loss for perminvar. It is to a material of constant permeability and low hysteresis loss that the transformer designer turns when he has a difficult requirement as to low modulation to meet. Unfortunately, while perminvar has these properties over a limited range of magnetiza-

<sup>7</sup> "Compressed Powdered Permalloy, its Manufacture and Magnetic Properties," W. J. Shackleton & I. G. Barber, *Trans. A. I. E. E.*, Vol. 17, 1928.

<sup>8</sup> "Magnetic Properties of Perminvar," G. W. Elmen, *Jour. of Franklin Institute*, Vol. 206, 1928.

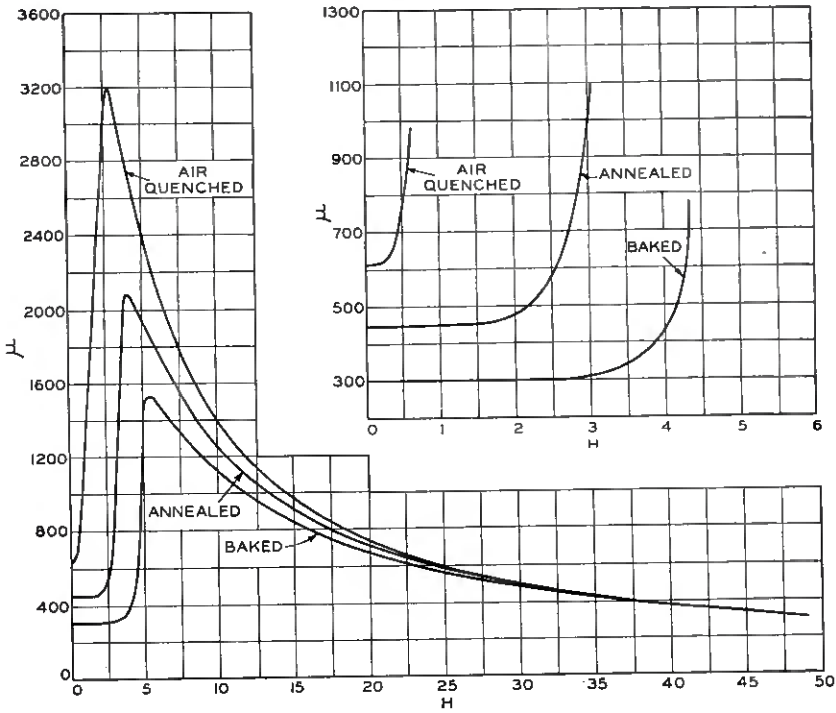

Fig. 19—Permeability curves for permivar.

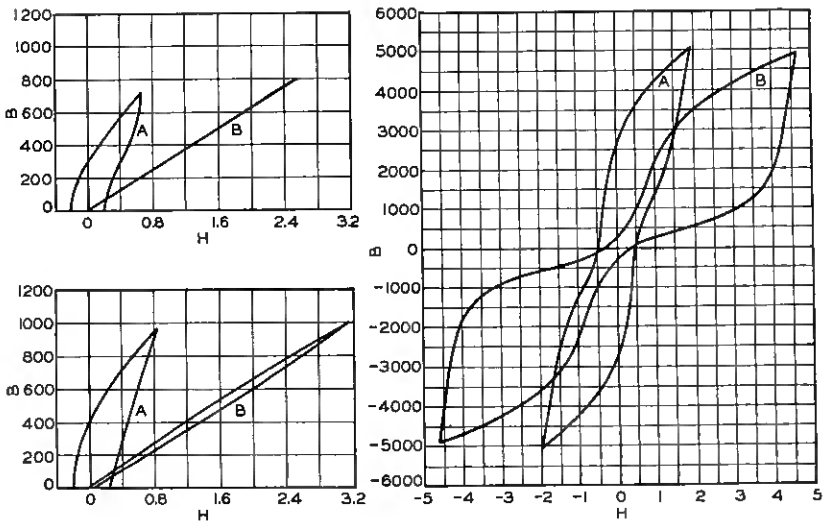

Fig. 20—Hysteresis loops for permivar.  
 A—Air quenched.  
 B—Baked.

tion, if this range is exceeded they are lost and so it is necessary that it be used within suitable limits.

These materials have been described in technical papers before various scientific societies and are not, therefore, discussed in detail here.

As indicating the wide scope of magnetic performance that is demanded of materials for use in communication apparatus, some of the necessary properties are listed below:

High permeability—at very feeble and at high inductions.

High saturation value of induction.

Low residual magnetization.

Low hysteresis loss at feeble and moderate magnetizations.

Low eddy-current losses over the frequency range from 0 to 80,000 cycles.

High constancy of permeability over a wide range of magnetization.

Small effect on A.C. permeability at feeble currents with superposed or residual D.C. magnetization.

Certain of these requirements are imposed from the simultaneous transmission of D.C. telegraph currents, speech currents and carrier frequency telephone or telegraph currents through the transformers, loading coil or other iron-core apparatus in the circuit. Interference between channels, due to magnetic modulation in the cores, must be kept at an extremely low value for satisfactory quality of transmission.

Summing up our work on materials, the results have been along two general lines: (1) improvement in quality of commercial materials and (2) development of new materials. As regards the first, we have worked in close cooperation with material suppliers whose progressive attitude has made possible certain of the advances described. The more striking advances have been due to the discovery of new or improved materials in our laboratories, the savings from which have amply justified the program of continuous research which has been the Bell System policy for a number of years. To take a single instance, the field of magnetic alloys—probably the first to which we applied intensive effort,—a single invention, the powdered electrolytic iron core resulted in savings of such magnitude as to far overshadow the cost of the investigational work. As already noted, this material has since been superseded by the powdered permalloy core which represents an equally great advance.

There is one point which should be emphasized and that is, that the most economical material is not necessarily the cheapest one. Treated textiles cost more per pound than ordinary textiles; permalloy costs more per pound than silicon steel. In these particular instances so

much less material is required to obtain the desired result that there is a net saving in cost of manufacture. The true criterion of relative economy, however, takes into account not alone the cost of manufacture, but the serviceability of the device throughout its operating life. Hence the designer, if he be free to decide on purely engineering grounds, will make his decision as to the best materials to use on the basis of the lowest annual charge over a period of years, thus taking into account the important item of maintenance cost.

## Transoceanic Telephone Service—Short-Wave Transmission

By RALPH BOWN<sup>1</sup>

The discussion relates to the transmission problems involved in short-wave radiotelephony over long distances and the transmission bases for design of the systems used in commercial transatlantic service. Choice of operating frequencies, amounts of transmitter power, directive transmitting and receiving antennas, automatic gain controls in receivers, and voice-operated switching devices are all factors which may be invoked to aid in solving these problems. The way in which they have been applied in the transatlantic systems and the results which have been obtained are set forth briefly.

**T**RUNK circuits between London and New York which furnish telephone service between these two cities and also permit successful conversation by means of toll wire extensions between the United States and Europe more generally are being carried over both long waves and short waves. It is the purpose of this paper to consider the transmission side of the new short-wave circuits which the American Telephone and Telegraph Company and the British General Post Office have made available for this service. In doing this we shall proceed from the more general considerations, relating to wave-lengths and communication channels, through a discussion of the principles governing the general design of the system, into a brief summary of practical performance results.

The frequency range so far developed for commercial radio use is roughly 20 to 30 million cycles wide, extending from about 10 kilocycles to perhaps 25,000 kilocycles per second. There are two parts of this whole spectrum suitable for transoceanic radiotelephony—the long-wave range which is relatively narrow, extending roughly from 40 kilocycles to 100 kilocycles, and the short-wave range which in its entirety is much broader, extending from about 6000 kilocycles to 25,000 kilocycles.

It is evident that the long-wave region, including perhaps only 50 kilocycles, offers opportunity for development of relatively few telephone channels, particularly in view of the fact that it is in use by a number of telegraph stations. Also it must be borne in mind that for telephony these waves are suitable for only moderate distances of the order of 3000 miles and for routes in the temperate zones where static

<sup>1</sup>Presented at the Winter Convention of the A. I. E. E., New York, N. Y., Jan. 1930.



interference is moderate. The first transatlantic radiotelephone circuit opened in 1927 was a long-wave circuit (58.5–61.5 kilocycles). In providing the next few channels for the initial growth of the service the opportunity to determine the utility of short waves was embraced.

The short-wave range is vastly wider in kilocycles but, nevertheless, has its limitations as to the number of communication facilities it affords. For a given route of a few thousand miles a single frequency gives good transmission for only a part of the day. For example, from the United States to Europe a frequency of about 18,000 to 21,000 kilocycles (17 to 14 meters) is good during daylight on the Atlantic. But in the dawn and dusk period a frequency of about 14,000 kilocycles (22 meters) is better. For the dark hours something like 9000 kilocycles (33 meters) gives best transmission and for midnight in winter an even lower frequency near 6000 kilocycles (50 meters) is advantageous. Thus, in considering the short-wave range in terms of communication circuits, we must shrink its apparent width materially to take account of the several frequencies required for continuous service.

At the present time the frequency spaces between channels are much greater than the bands of frequencies actually occupied by useful transmission. This elbow room is to allow for the tendency of many stations not to stay accurately on their nominal frequencies but to wander about somewhat. But in spite of this allowance, cases of interference are common and one of the activities which must be carried on in connection with a commercial system is the monitoring of interfering stations and the accurate measurement of transmitting frequencies to determine the cause of the conflict. To permit intensive development of the frequency space offered by Nature the greatest possible constancy and accuracy of frequency maintenance in transmitting sets will be required.

The fact that channels have been assigned (within wide bands set aside for a particular service) with little regard to the geographical location of stations may result in neighboring channels having much stronger signals than those in the channel being received. When this is so, a severe requirement is placed on the selectivity of the receiver to prevent interference.

#### INTERCONNECTING WITH WIRE CIRCUIT EXTENSIONS

The skeleton of a radiotelephone circuit is in its essentials very simple. It consists merely of a transmitter and a receiver at each end of the route and two oppositely directed, one-way radio channels between them. These two independent channels must be arranged at the terminals to connect with two-wire telephone circuits in which

messages in opposite directions travel on the same wire path. The familiar hybrid coil arrangement so common in telephone repeaters and four-wire cable circuits might appear to solve this problem, were there not difficulties peculiar to the radio channels. In the short-wave case large variations in attenuation occur in the radio paths within short intervals of time. These would tend to cause re-transmission of received signals at such amplitudes that severe echoes and even singing around the two ends of the circuit would occur unless means were provided to prevent this.

To overcome these fundamental transmission difficulties, an automatic system of switches operated by the voice currents of the speakers has been developed.<sup>2</sup> These devices cut off the radio path in one

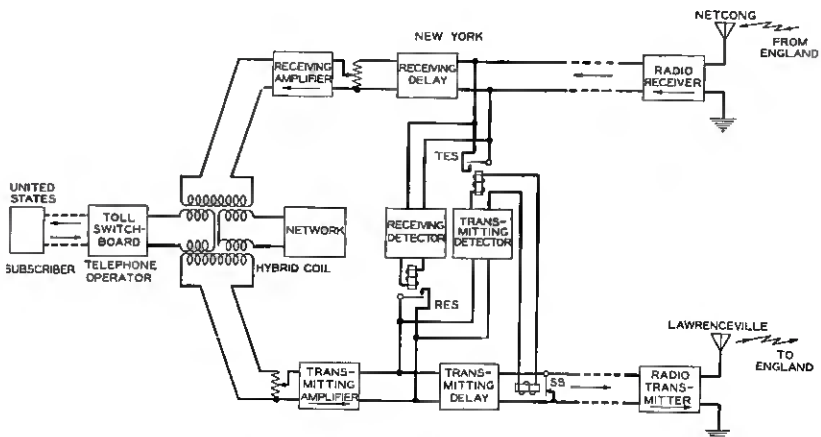

Fig. 1—Circuit diagram illustrating operation of voice-operated switching device.

direction while speech is traveling in the reverse direction and also keep one direction blocked when no speech is being transmitted. The operation is so rapid that it is unnoticed by the telephone users. Since this system prevents the existence of singing and echo paths, it permits the amplification to be varied at several points almost without regard to changes in other parts of the system, and it is possible by manual adjustment to maintain the volumes passing into the radio link at relatively constant values, irrespective of the lengths of the connected wire circuits and the talking habits of the subscribers.

Fig. 1 gives a schematic diagram of the United States end of one of the short-wave circuits showing the essential features of a voice-operated device which has been used. This kind of apparatus is

<sup>2</sup> For detailed description of this system see "The New York-London Telephone Circuit" by S. B. Wright and H. C. Silent, *Bell System Tech. J.*, Vol. VI, October, 1927, pp. 736-749.

capable of taking many forms and is, of course, subject to change as improvements are developed. The diagram illustrates how one of these forms might be set up. This form employs electro-mechanical relays. The functioning of the apparatus illustrated is briefly as follows: the relay TES is normally open so that received signals pass through to the subscriber. The relay SS is normally closed to short circuit the transmitting line. When the United States subscriber speaks his voice currents go into both the Transmitting Detector and the Transmitting Delay circuit. The Transmitting Detector is a device which amplifies and rectifies the voice currents to produce currents suitable for operating the relays TES and SS which thereupon short circuit the receiving line and clear the short circuit from the transmitting line, respectively. The delay circuit is an artificial line through which the voice currents require a few hundredths of a second to pass so that when they emerge the path ahead of them has been cleared by the relay SS. When the subscriber has ceased speaking the relays drop back to normal.

The function of the Receiving Delay circuit, the Receiving Detector, and the relay RES is to protect the Transmitting Detector and relays against operation by echoes of received speech currents. Such echoes arise at irregularities in the two-wire portion of the connection and are reflected back to the input of the Transmitting Detector, where they are blocked by the relay RES which has closed and which hangs on for a brief interval to allow for echoes which may be considerably delayed. The gain control potentiometers shown just preceding the transmitting and receiving amplifiers are provided for the purpose of adjusting the amplification applied to outgoing and incoming signals.

The relief from severe requirements on stability of radio transmission and from varying speech load on the radio transmitters which this system provides permits much greater freedom in the design of the two radio channels than would otherwise be possible.

### THE RADIO CHANNELS

One of the first questions which comes up in considering the design of a radio system is the power which can be sent out by the transmitter. The word "can" is used advisedly, rather than "should," since in the present art the desideratum usually is the greatest amount of power that is technically possible and economically justifiable. There are few radio systems so dependable that increased power would not improve transmission results. At very high frequencies the generation of large powers is attended by many technical difficulties but fortunately the radiation of power can be carried out with much greater

efficiency than is feasible at lower frequencies. At 18,000 kilocycles (about 16 meters) a single half-wave radiator or doublet is only about 25 ft. long and it is possible to combine a number of them, driven in phase by a common transmitter, into an antenna array which concentrates the radiated power in one geographical sector. In that direction the effectiveness may be intensified 50 fold or more (17 db) and waste radiation in other directions reduced materially. Thus, one of the transmitters at Lawrenceville, New Jersey, used in the short-wave transatlantic circuits when supplying 15 kw. radiates in the direction of its corresponding receiving station as effectively as would a non-directive system of about 750 kw.

The transmitting antennas also give some directivity in the vertical plane, increasing the radiation sent toward the horizon and decreasing that sent at higher angles. It is not yet certain that vertical directivity is always advantageous and this effect has not been carried very far.

At the receiving station the radiated power has dwindled to a small remnant which must be separated from the static as far as possible and amplified to a volume suitable for use in the wire telephone plant. Here again directive antenna arrays are of value. A receiving antenna system sensitive only in a narrow geographical sector, and that lying in the direction from which the signal arrives, excludes radio noise from other directions and thereby scores a gain of perhaps 40 fold (16 db) in the power to which the signal can be amplified without bringing noise above a given value. It also scores against noise which arises in the tubes and circuits used for amplification, since the combined action of the several antennas of the array delivers more signal to the initial amplifier stage where such noises originate.

Thus, it is evident that transmitter power, transmitting directivity, receiving directivity, and quiet receiving amplifiers are of aid in providing signal transmission held as far as possible above the radio noise. In a well designed system the relative extents to which these aids are invoked will depend upon economic considerations as well as upon the technical possibilities of the art.

There is one other type of noise than that provided by Nature which is of particular importance at short waves,—electrical noise from the devices of man. One of the worst offenders is the ignition system of the automobile. The short-wave transoceanic receiving station at Netcong, New Jersey, is so located that automobile roads are at some distance, particularly in the direction from which reception occurs. Service automobiles which produce interference cannot be allowed near the antenna systems unless their ignition systems have been shielded. Also, electrical switching and control systems incidental to the power,

telegraph, and telephone wire systems at the station are shielded or segregated.

At both the transmitting and receiving stations at least three antenna systems are supplied for each circuit, one antenna for each of the three frequencies normally employed. The design and arrangement of these are dictated by the requirements flowing from their uses. The purpose of the transmitting antenna is to concentrate as much power as possible in one direction. The purpose of the receiving antenna is to increase reception from the desired direction and to cut down reception at all other angles. In the former the forward-looking portion of the characteristic is of greatest importance, while in the latter the rearward characteristics need greatest refinement.

### TRANSMISSION PERFORMANCE

In short-wave telephone systems the width of the sidebands is so small a percentage of the frequency of transmission that tuning characteristics of the antennas and high-frequency circuits are relatively broad and impose little constriction on the transmission-frequency characteristic. A flat speech band is easy to obtain over the range of approximately 250 to 3000 cycles employed for these commercial circuits. This relieves the short-wave circuits from many of the problems of obtaining sufficient band width which are troublesome in designing long-wave systems.

Short-wave transmission is subject to one frailty which particularly hampers its use for telephony. This is fading. Where fading is of the ordinary type, consisting of waxing and waning of the entire transmitted band of frequencies, automatic gain control at the receiving station is of value and is employed in the transoceanic circuits under discussion. The amplification in the receiver is controlled by the strength of the incoming carrier and is varied inversely with this strength so as to result in substantially constant signal output. Obviously this control can be effective only to the extent that the signal seldom falls low enough to be overwhelmed by radio noise.

When fading is of the selective type, that is, the different frequencies in the transmitted band do not fade simultaneously, the automatic gain control system is handicapped by the fact that the carrier or control signal is no longer representative of the entire signal band.

Selective fading is believed to result from the existence of more than one radio path or route by which signals travel from transmitter to receiver. These paths are of different lengths and thus have different times of transmission. Wave interference between the components arriving over the various paths may cause fading when the path lengths change even slightly.

If the path lengths differ by any considerable amount, for example, a few hundred miles, the wave interference is of such a character as to affect the frequencies across a band consecutively rather than simultaneously.

With the presence of selective fading there comes into being the necessity of guarding against rapid even though small variations in the transmitted frequency, since if such variations are present a peculiar kind of quality distortion of the telephone signal results.

The varying load which speech modulation places on the transmitter circuits tends to cause slight variations in the instantaneous equivalent frequency which are known as "frequency modulation" or "phase modulation" depending on their character. To prevent this effect the control oscillator must be carefully guarded against reaction by shielding and balancing of circuits and the design must be such as to preclude variable phase shifts due to modulation in subsequent circuits of the transmitter.

It is apparent that if there are two paths of different lengths, two components which arrive simultaneously at the receiver may have left the transmitter several thousandths of a second apart. If the transmitter frequency has changed materially during this brief interval trouble may be expected. The trouble actually takes the form of a distortion of the speech as demodulated by the receiving detector.<sup>3</sup>

Defects in short-wave transmission due to radio noise, minor variations in attenuation, fading, and distortion are nearly always present to some extent and, when any or all are severe, cause a certain amount of lost service time. These interruptions are of relatively short duration and, furthermore, there is enough overlap in the normal times of usefulness of the several frequencies available, so that shifting to another frequency may give relief. There is, in addition, a kind of interruption which from the standpoint of continuity of service is more serious. At times of disturbance of the earth's magnetic field, known as "magnetic storms," short-wave radio transmission is generally subject to such high attenuation that signals become too weak to use and sometimes too weak to be distinguishable. These periods affect all the wavelengths in use and may last from a few hours to possibly as much as two or three days in extreme cases. They are followed by a recovery period of one to several days in which transmission may be subnormal.

Severe static may cause interruption to both long- and short-wave services at the same time but the short waves are relatively less affected by it and are usually able to carry on under static conditions which

<sup>3</sup> For a discussion of this phenomenon see "Some Studies in Radio Broadcast Transmission" by Bown, Martin, and Potter, *I. R. E. Proc.*, Vol. 14, No. 1, p. 57.



prevent satisfactory long-wave operation. On the other hand severe fading or the poor transmission accompanying a magnetic disturbance may interrupt short-wave service without affecting the long waves adversely,—in fact magnetic disturbances often improve long-wave transmission in the daytime. The service interruptions on the two types of circuits are thus nearly unrelated to each other and have no definite tendency to occur simultaneously. This is the principal reason why both long-wave circuits and short-wave circuits appear essential to reliable radiotelephone service.

On routes which are very long or which cross tropical areas which result in static sources facing the directive receiving antennas, long

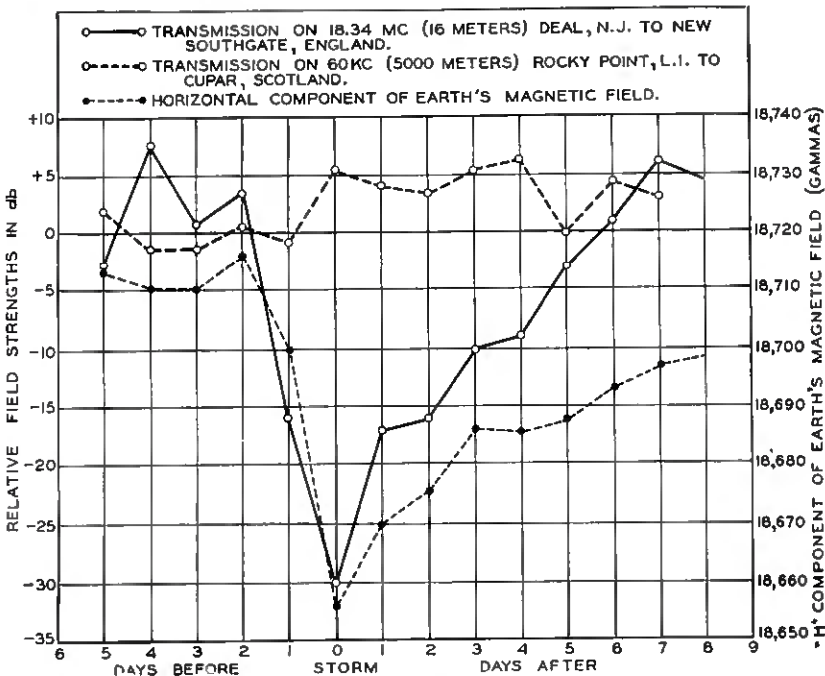

Fig. 2—Effect of magnetic disturbances on radio transmission.

waves cannot as yet be successfully employed and short waves alone are available. However, experience tends to indicate that on North and South routes such as between North and South America, the interruptions associated with magnetic storms are less severe and of shorter duration.

The cycle of events which accompanied a particularly severe magnetic storm<sup>4</sup> in July, 1928, is shown graphically in Fig. 2. The light

<sup>4</sup> Data regarding other magnetic disturbances are given in a paper by C. N. Anderson, entitled "Notes on the Effect of Solar Disturbances on Transatlantic Radio Transmission," *I. R. E. Proc.*, Vol. 17, No. 9, September, 1929.



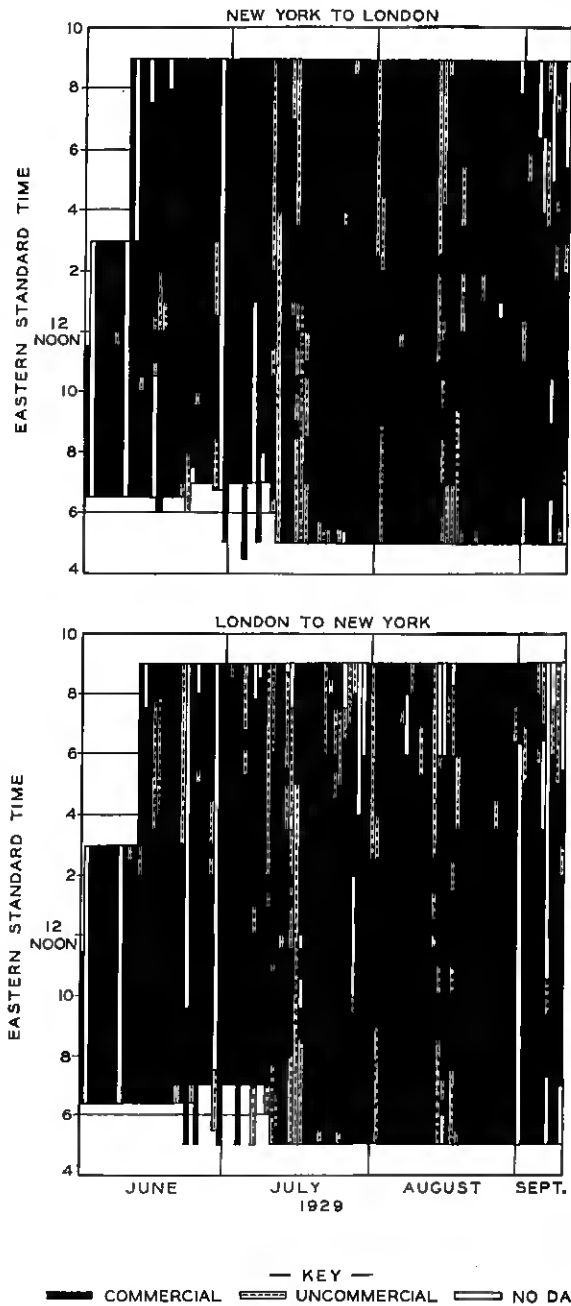

Fig. 3—Chart showing transmission performance of a short-wave transatlantic telephone circuit.

dotted curve shows the variation in the horizontal component of the earth's field. The heavy solid line follows the daily averages of the short-wave received signal field. It is apparent that the disturbance took two days to reach its peak and the recovery to normal took nearly a week. The heavy dotted line shows received field on long waves (60 kilocycles) and indicates that transmission was improved slightly at the same time the short waves were suffering high attenuation.

The experience with transatlantic telephone service on short waves covers a period of nearly three years, there having been available a one-way channel from the United States to England used as an emergency facility for the first year and a half, a two-way circuit for the next year, and two circuits since June, 1929. It is only in this later period, however, that a circuit has been available operating regularly with the amounts of transmitter power and antenna directivity which have been mentioned.

The performance of the two one-way channels forming this circuit is charted in Fig. 3. The charts are plotted between hours of the day and days in the year so that each unit block represents one hour of service time. The solid black areas are time in which commercial operation could be carried on. The dotted strips are uncommercial time. The blank areas are for time in which, for one reason or another, the circuit was not operating and no data were obtained. Perhaps the most outstanding feature of these charts is the tendency of the lost time to fall in strips over a period of two or three days. These strips coincide approximately for both directions of transmission. The principal ones are about July 10 and 15 and August 2 and 17. These are characteristic of the interruptions accompanying magnetic disturbances of the kind which occur at irregular intervals of a few days to several weeks. They are, of course, not as severe as the disturbance illustrated in Fig. 2.

It is apparent that for these three summer months this new circuit gave a good account of itself and furnished commercial transmission for something like 80 per cent of the time that service was demanded of it. In these same months the long-wave system suffered its greatest difficulty from static, and we have concretely illustrated the mutual support which the two types of facilities give each other.

It should not be inferred from these data that the short-wave transatlantic radio links furnish 80 per cent of the time talking circuits as stable and noise free as good wire lines. Under good conditions they do provide facilities which compare favorably with good wire facilities. On the other hand they may at times be maintained in service and graded "commercial" under conditions of noise or other transmission defects for which wire lines would be turned down for correction, since

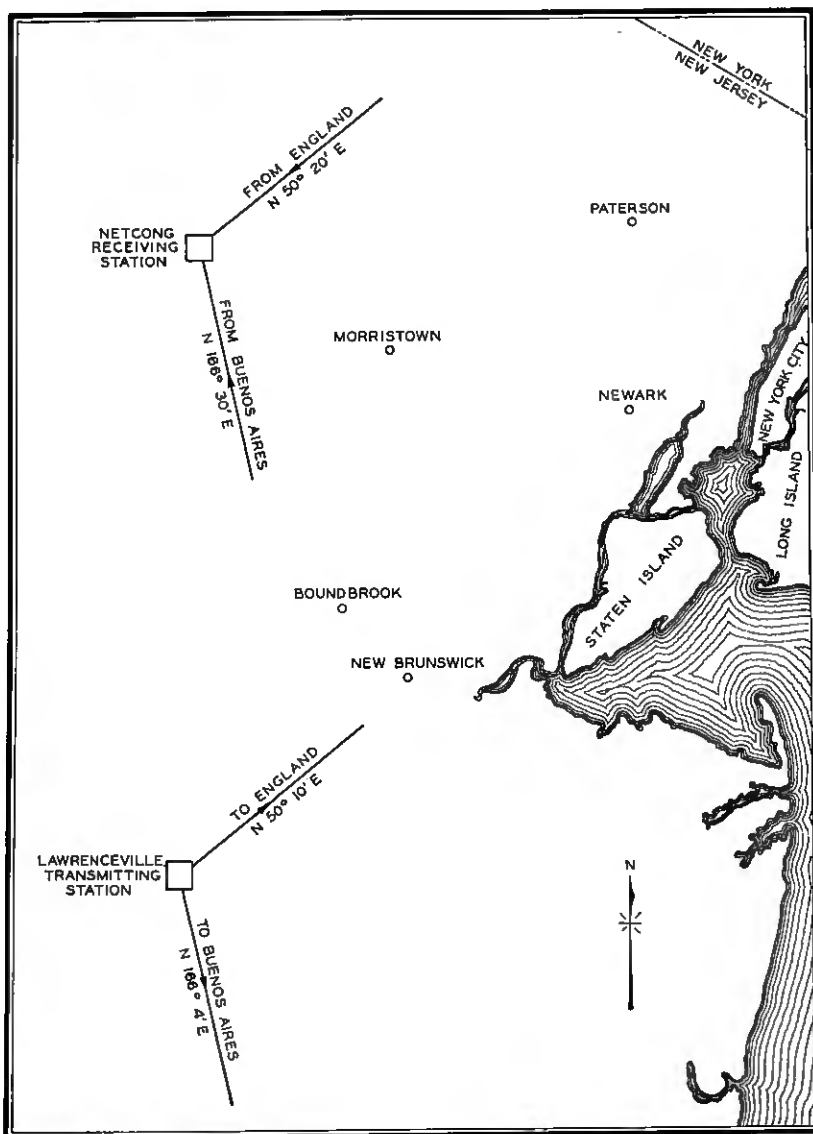

Fig. 4—Map showing transmission considerations affecting location of stations.

the obviously undesirable alternative is to give no service at all until conditions have improved again. The present development effort is largely directed toward improvements which will insure not only a greater degree of reliability against interruptions but which also will improve the grade of service as a whole.

In the foregoing little has been said about the stations and plant since a description of these and the operation of them are treated in two companion papers by Messrs. Cowan and Oswald. It may be well, however, to view the physical scene broadly as set forth on the accompanying map, Fig. 4.

The geographical arrangement of the transmitting and receiving stations was governed among other things by transmission considerations. The two stations were placed about 50 miles apart because this is approximately the distance for minimum signal and at a lesser or greater distance the signals from the American transmitter might be strong enough to offer some interference to receiving the English or South American stations on adjacent channels. For the same reason they were placed at considerable distances from the transmitters and receivers of other communication agencies. The Netcong receiving station lies to the north of the Lawrenceville transmitting station so as not to be in paths of strong signals from the directive antennas which face northeast toward England and southeast toward South America. This configuration also places the transmitter outside the sensitive angles of the directive receiving antennas.

## Transoceanic Telephone Service—Short-Wave Equipment

A. A. OSWALD<sup>1</sup>

The application of short-wave radio transmission to transoceanic telephone circuits is developing apparatus and stations designed specifically to meet the needs of these services. This paper describes from the radio point of view the important technical features and developments incorporated in the new transmitting and receiving stations of the American Telephone and Telegraph Company located respectively at Lawrenceville and Netcong, New Jersey, and it outlines some of the radio problems encountered in the station design.

\* \* \* \* \*

SHORTLY after transatlantic telephone service was opened in January, 1927 the long-wave radio circuit between New York and London was supplemented, first by an experimental short-wave radio link in the west-east direction and later by a short-wave link in the east-west direction.<sup>2</sup> From this beginning, as an auxiliary to the long-wave circuit, the short-wave system has been improved steadily so that its average performance throughout the year now more nearly approaches that of the long-wave system and it has become an important part of the transoceanic facilities. The relative merits of the two systems, their combined usefulness, and their transmission features are the subject of another paper and will not be discussed here. For the present purpose it will be sufficient to note that there are now in operation between New York and London, one long-wave and three short-wave two-way circuits and that within a few weeks a short-wave circuit will be available between New York and Buenos Aires.

The radio transmitting units for the New York end of these four circuits are located at the new station which the American Telephone and Telegraph Company has recently established at Lawrenceville, New Jersey. The receiving units are concentrated at Netcong, New Jersey. The factors entering into the selection of these station locations are outlined in another paper and therefore need not be mentioned further. This paper is limited in scope to a necessarily brief description of the transmitting and receiving systems and apparatus, a discussion of technical features in the station layouts, and an outline of the major problems encountered in the station design. Comprehensive treatment of individual units is properly left for other entire papers. It will be convenient to deal with the transmitting and receiving sta-

<sup>1</sup> Presented at the Winter Convention of the A. I. E. E., New York, N. Y., Jan., 1930.

<sup>2</sup> O. B. Blackwell, A. I. E. E. JOURNAL, May 1928. B. S. T. J. April 1928.

tions separately and in each case to consider briefly the system and apparatus of one channel before describing the general station plan.

### TRANSMITTING SYSTEM

The four channels at Lawrenceville are equipped with independent transmitters using certain auxiliary apparatus in common. Each channel involves a radio transmitter with its associated power plant and wire equipment, and a group of directive antennas designed and adjusted for the specific wave-length assignments of the channel.

The general method of transmission, with the exception of directional sending, is the same as that employed for program broadcasting stations in that the radiated signal contains the carrier and both sidebands. Systems in which one or more of these components are suppressed at the transmitter appear to offer further means of improving short-wave transmission, and the necessary apparatus for the practical application of such systems when operating at frequencies in the order of 20,000

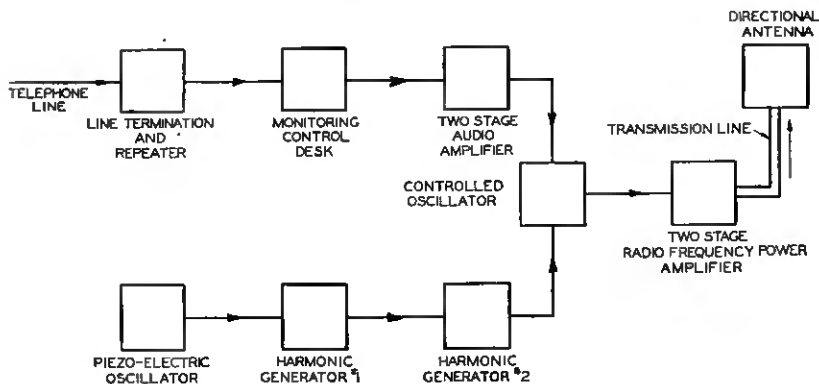

Fig. 1.—Block schematic of transmitting system.

kilocycles is undergoing development. However, throughout the development of the transmitters as now installed at Lawrenceville the possibility of future major modifications in the method of transmission has been kept in mind. For this reason the modulator-amplifier system was adopted. In this system the signal which is to be radiated, is prepared by modulation processes at relatively low power levels and thereafter amplified the requisite amount. The amplifier and its power plant, representing a large proportion of the investment in equipment, can be continued in service with no appreciable alterations, even though the system of transmission and the modulating apparatus undergo radical changes.

The general scheme of transmission is shown in Fig. 1. After passing through the line terminal and control apparatus, which includes

standard repeaters, the voice currents are further amplified and employed to modulate the plate voltage of an oscillator consisting of two 250-watt tubes connected in a push-pull circuit and oscillating at the frequency of the carrier which is to be transmitted. The frequency of such an oscillator, if not carefully controlled, will wander outside of the assigned frequency band, thus causing interference with other services and it will also suffer variations during the modulation cycle which contribute to fading phenomena encountered at the distant receiving station. In order to reduce these effects the oscillator is held in step at the desired carrier frequency by means of a second oscillator which is electrically removed from the reactions normally influencing and tending to vary the frequency of the controlled oscillator. Every precaution is taken to maintain accurately the frequency of the second oscillator and among other things it is governed by a piezo-electric quartz crystal whose temperature is regulated closely.

Since it is impractical to use crystals cut sufficiently thin to oscillate directly at frequencies in the range 10,000 to 20,000 kilocycles, thicker crystals of lower frequency are used in combination with harmonic generators which multiply the crystal frequency first by two or three and then by one or two as the case requires. By virtue of the wide differences between the input and output frequencies of the harmonic generators these intermediate steps tend to isolate the crystal oscillator from the other radio circuits and thus aid in stabilizing the frequency.

The modulated radio frequency output of the controlled oscillator is applied to the grids of a two-stage power amplifier employing water-cooled tubes designed for operation at these frequencies. The first stage contains two tubes and the second stage contains six. The tubes are arranged in push-pull circuits, the entire system being carefully balanced to ground. The carrier output power from the last stage is 15 kw. With 100 per cent modulation this corresponds to 60 kw. at the peaks of the modulation cycle. In other words, a radio telephone amplifier of this type, rated at 15 kw. when provided with a sufficiently large d-c. power source, could be used as a 10,000-kilocycle continuous wave generator of 60 kw. capacity.

The radio signal delivered by the amplifier is conveyed to the antenna by means of a 600-ohm open wire transmission line. The antenna itself is both a very efficient radiator and a highly directive one.

#### TRANSMITTING EQUIPMENT

At the transmitting station the apparatus for each channel comprises, (1) wire terminal equipment and repeaters, (2) a voice frequency control



desk, (3) the radio transmitting set containing the oscillators, modulators, and power amplifier, (4) a power control board, (5) rectifying apparatus and filters for supplying direct current at 10,000 volts, (6) motor-generators for providing various circuits with direct current, (7) water circulating pumps, tanks, and cooling units.

The wire terminal equipment and repeaters at the transmitting station are standard units mounted on relay racks beside the voice frequency testing apparatus common for all channels.

The voice frequency control desk provides facilities by which the attendant can monitor the incoming voice currents and the outgoing radio signal. Means are provided for observing the volume of these signals. Oscillators are provided for the purpose of quickly checking the performance of the system during line-up periods and for sending Morse signals over the radio link when required. The control desk

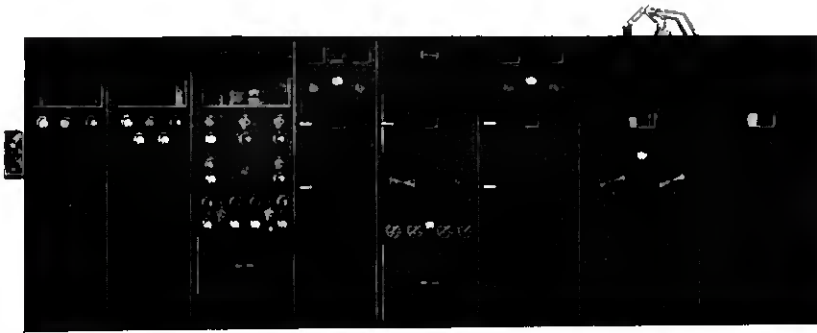

Fig. 2—Front view of short-wave radio transmitter of type used at Lawrenceville.

is also equipped with apparatus for direct telegraph communication with the technical operator at New York.

The radio transmitter consists of seven independently shielded units mounted on a common sub-base to form a single assembly, 4 ft. by 20 ft. by 7 ft. high. Some of the units are subdivided into several small shielded compartments. Very effective electrical screening or shielding between the various parts of a short-wave transmitter is essential. Otherwise stray fields introduce unwanted feedback couplings which produce distortion effects and spurious oscillations. Fig. 2 is a front view of the transmitter. Beginning at the left there are two units for speech amplification, one for radio frequency generation and modulation, one unit each for the first stage, the interstage circuit and the last stage of radio-amplification, and a double-sized unit for the output circuit. It is interesting to note that the over-all length of this as-

sembly is as much as five eighths of a wave-length at the highest frequency in its operating range, which is 9000 to 21,000 kilocycles. Each transmitter is required to operate at several assigned frequencies within this range and to change in a few minutes from one to another. This is done by changing coils and varying condensers in the oscillator and amplifier circuits and switching to different quartz crystals. Except in cases where two assigned frequencies are in harmonic relationship, it is necessary to provide a crystal for each of the frequencies. The crystals are mounted in an oven and continuously maintained at  $50 \text{ deg.} \pm 0.05 \text{ deg. cent.}$  by recording regulators. In order to avoid long interruptions to service in the event of a crystal failure or other circumstance requiring the opening of the oven and the subsequent re-establishment of temperature equilibrium, the ovens and crystals are provided in duplicate.

The electrical problems which are encountered by the engineer designing a power amplifier for these high frequencies arise largely from the inherent stray or distributed capacities and inductances which are far less important at lower radio frequencies. For example, between the anodes of the amplifier circuit there exist capacities, which are composed of capacities within the tube itself, the direct capacities between the tube water jackets, the mounting plates and the like. The total value of this composite capacity in the last stage is approximately 100 m.m.f. This value cannot be appreciably reduced by any change in design which now seems desirable. The reactance of 100 m.m.f. at 20,000 kilocycles is about 80 ohms. Thus the engineer is confronted at the outset with a generator (the tubes) which has an internal impedance in the order of 2000 ohms but across whose terminal is shunted inherently an 80-ohm reactance. Fortunately, this obstacle can be surmounted by introducing resonance effects but nevertheless it places very important limitations on the design of the associated circuits. These problems become more difficult with increase of either power or frequency. Increase in power requires higher voltages and currents and thus larger elements, spaced farther apart. The augmented bulk increases both stray capacities and unwanted inductance of leads. Higher frequencies increase the magnitude and therefore the relative importance of these effects.

The power control board has nine panels equipped with the necessary instruments and apparatus for controlling and distributing all power to the transmitter. The motor-generators, pumps, fans, oil circuit breakers, and other apparatus are remotely controlled from this point. A system of relays and signal lamps provides protection and indicates the location and general nature of any trouble. With the exception of

the application of high-voltage direct current, the entire system starts up and shuts down in the proper sequence in response to the manipulation of a master control switch.

Direct current at 10,000 volts is supplied to the anodes of the power amplifier tubes by a transformer and rectifier using six standard two-electrode thermionic tubes. The rectified current is filtered separately for each stage of the amplifier. This is necessary to prevent distortion by interstage modulation caused by the common impedance of the rectifier. Effects of this nature become important as the requirements placed on unwanted modulation products become more stringent.

#### TRANSMITTING ANTENNAS

The antennas at Lawrenceville all have comparatively sharp directional properties. Such antennas are readily realized when dealing with radio waves of very short wave-lengths. Although the fundamental principles involved in producing these directional effects have been known for many years, economic limitations effectively prevented their application to transmitting antennas for long wave-lengths. These limitations are altered immensely in the case of antennas for short wavelengths and, when the useful propagation properties of short waves became known, great stimulus was given to the development of antennas for directional sending and receiving. The same type of antenna can be used, of course, for both purposes but, since the objectives when sending and receiving are somewhat different, the tendency has been to develop arrangements adapted to each case.

Directional transmission is a very large subject and will only be touched upon sufficiently to describe in a very general way the antennas at Lawrenceville. There are many possible arrangements and combinations and the engineers must choose from these the ones most suitable for their purpose. In general all of the schemes depend upon producing interference patterns which increase the signal intensity in the chosen direction and reduce it to comparatively small values in other directions.

One of the methods of obtaining a sharply directive characteristic is to arrange a large number of radiating elements in a vertical plane array, spacing them at suitable distances and interconnecting them in such a manner that the currents in all the radiating members are in phase. A simple way of accomplishing this result and the one which is now being employed at Lawrenceville depends upon the manner in which standing waves are formed on conductors. It is generally known that current nodes and current maxima will recur along a straight conductor whose length is an exact multiple of one half the wave-length

of the exciting e.m.f. and that the phase difference between successive current maxima is 180 deg.<sup>3</sup> Such a conductor when folded in a vertical plane as shown in Fig. 3 and with its length adjusted slightly to compensate for the effects of folding, satisfies the aforementioned requirements for producing directional radiation. The arrows in Fig. 3 indicate the relative directions of current flow and the dotted line indicates

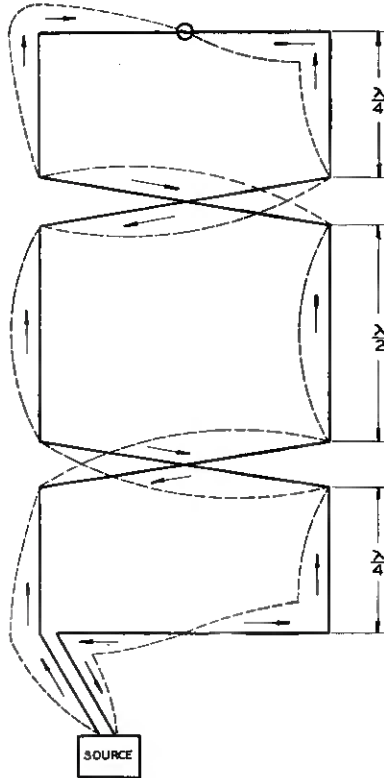

Fig. 3—Conductor bent to form one section of simple directive antenna. The type used for transmitting at Lawrenceville.

the current amplitudes along the conductor. It will be noted that the instantaneous currents in all the vertical members are in the same direction and that in the cross members their directions are opposed. Due to these current relations and the physical positions of the elements, the cross members radiate a negligible amount of energy whereas the vertical members combine their effects for the directions perpendicular

<sup>3</sup> This assumes of course that the conductor is in space free from objects affecting its electrical properties and that the ends are free or properly terminated to produce reflections.

to the plane of the conductor. In other directions destructive interference reduces the radiation from the vertical members. The system is equivalent to four Hertz oscillators driven in phase, and arranged in two groups one half wave-length apart, the two oscillators of each group being placed one above the other. Both computation and experiment have shown that with this system of radiation there is an improvement of approximately 6 db. In other words the same signal intensity in the chosen direction is obtained with one fourth of the power required by a one-element radiator. A second similar conductor system placed directly behind the first in a parallel plane one quarter wave-length away, will be excited parasitically from the first conductor and will act as a reflector, thereby creating a unidirectional system. It has been found that the reflector further reduces by 3 db the power required to maintain a given signal intensity in the desired direction, thus bringing the total gain for the system up to 9 db. This is also in agreement with the theoretical computations.

It is obvious that the system in Fig. 3 can be extended vertically to include more radiating elements by increasing the length of the conductor and it can be enlarged horizontally by placing several units alongside each other, care being taken to obtain the desired phase relations by transmission lines of the proper length. In this way large power savings may be effected. At Lawrenceville the maximum gain is about 17 db (a power ratio of 50) over a vertical halfwave oscillator. The enlarged system lends itself readily to mechanical support and forms so-called exciter and reflector "curtains" which are suspended between steel towers appropriately spaced. Aside from other considerations, which will be mentioned in connection with station layout, the size of the antenna is influenced by the complex and variable nature of the wave propagation through space. At present this determines the degree of directivity which is most useful for the average conditions.<sup>4</sup>

The closed loops of each unit corresponding to Fig. 3 greatly facilitate the removal of sleet. In addition to loading the antenna mechanically, ice, having a dielectric constant of 2.2 at these high frequencies, adversely affects the tuning. At Lawrenceville sleet is removed by heating the wires with current at 60 cycles. This is accomplished without interfering with the service by employing one of the less familiar properties of a transmission line. The same property also is used to effect impedance matches wherever the transmission lines are branched. If a line, exactly one quarter wave-length long, of surge impedance  $Z_0$  is terminated with a load  $Z_R$ , the sending-end impedance  $Z_s$  is equal to

<sup>4</sup>J. C. Schelleng, "Some Problems in Short Wave Telephone Transmission." Presented to the Institute of Radio Engineers at a meeting Nov. 6, 1929.

$Z_o^2/Z_R$ . If  $Z_R$  is a pure resistance the sending-end impedance is a pure resistance. Hence a quarter wave-length line may be used to connect two circuits of different impedances and these impedances may be matched by controlling the value of  $Z_o$ , either by varying the diameter of the conductors or their spacing. Likewise, if  $Z_o$  is fixed and  $Z_R$  is made very small, then  $Z_s$  will be extremely large.

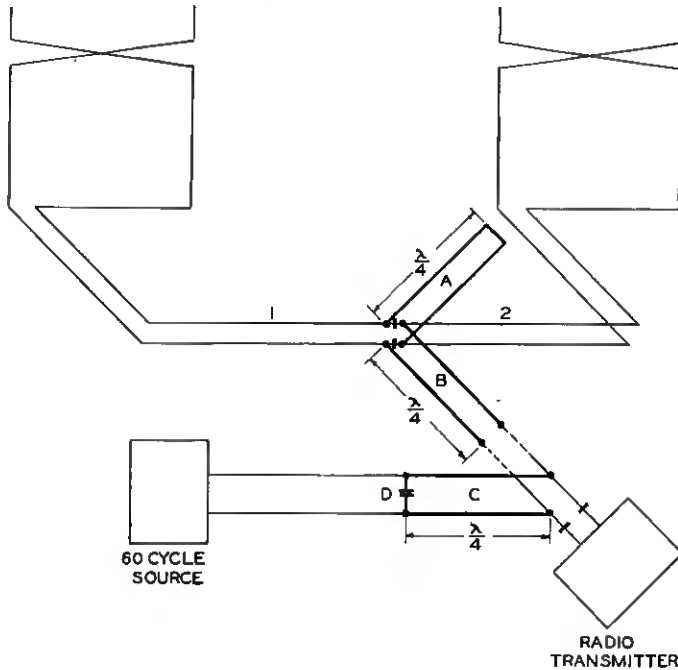

Fig. 4—Antenna sleet-melting circuit.

In Fig. 4 two units of the type shown in Fig. 3 are excited through transmission lines 1 and 2 of equal length in order to give the correct phase relations in the radiating elements. The lines are joined in parallel by condensers of low impedance at radio frequencies and they are connected in series for 60-cycle currents by the quarter wave-length line *A* which, being short-circuited at the one end, presents a very high impedance to radio frequency currents at the other end and therefore behaves like an anti-resonant circuit. The quarter wave-length line *B* serves as a transformer and is adjusted to match the impedance at the junction of lines 1 and 2 with that of the radio transmitter. The quarter wave-length line *C* is effectively short-circuited for radio frequencies by the condenser *D* and acts the same as *A*. These quarter

wave lines consist of short lengths of pipe mounted on frames under the antenna curtains as shown in Fig. 5.

#### TRANSMITTING STATION

Among the first radio problems encountered in the design of a transmitting station for several channels are those concerning the size, shape, and number of antennas, their directions of transmission, their

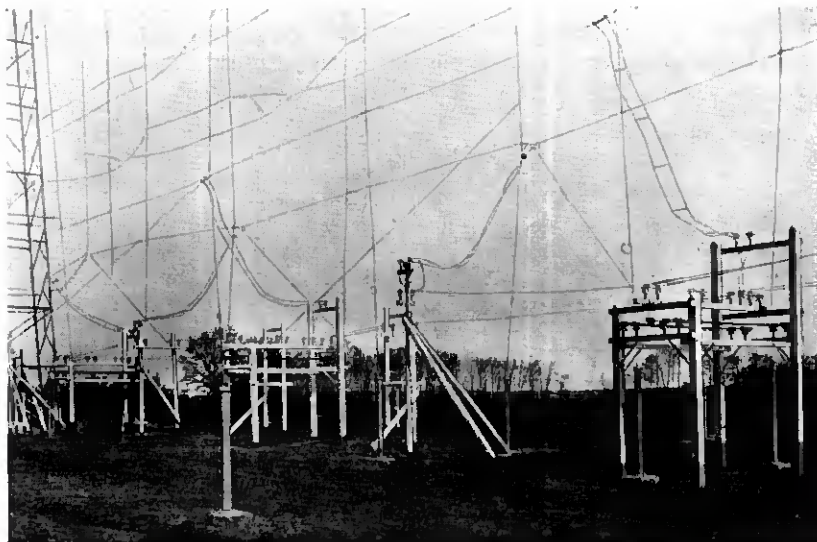

Fig. 5—Section of antenna system at Lawrenceville, showing lower portion of curtains and quarter wave transmission lines used as transformers and anti-resonant circuits.

relative positions from the point of view of mutual interference, and their grouping around the transmitters.

The number of antennas required for each channel is determined by the hours of operation and the average grade of service which the system is expected to render. For service covering a large portion of each day several wave-lengths are necessary. Transmitters Nos. 1, 3, and 4 at Lawrenceville each are assigned three frequencies. No. 2 has five assignments in order to improve the likelihood of at least one channel being available throughout the entire day at all seasons.

The size and shape of the antennas are, of course, determined by the directivity wanted, by the type employed, the frequency assignments, and by considerations of cost. They are governed also by the necessity of connecting several antennas to the same transmitting set. This involves both the spacing and arrangement of antennas to avoid



adverse mutual reactions and it requires that attention be given to the losses in the connecting transmission lines, which are by no means negligible. Operating economies suggest concentrating all the transmitters at one point but the cost per kilowatt hour of modulated high-frequency power must be taken into account when considering the use of long transmission lines. It should be recognized, of course, that in the early applications of a comparatively new art, it is impossible to approach anything like accurate evaluation of all the factors entering into economic balances and furthermore very considerable weight needs to be given to the probable future trend of developments.

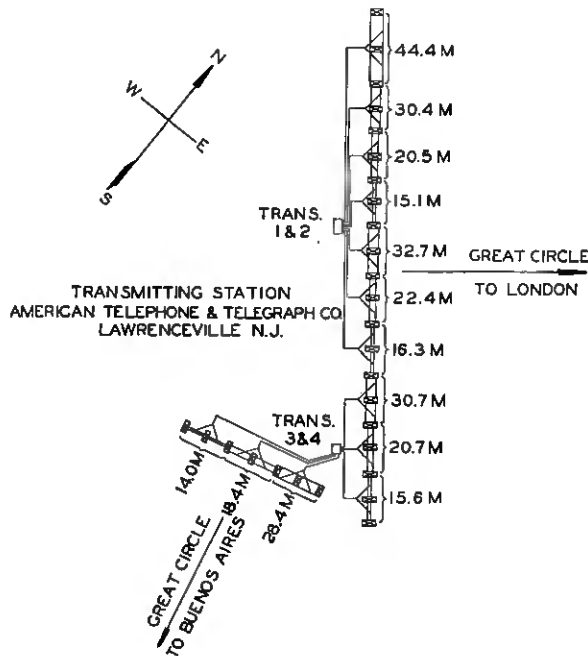

Fig. 6—Arrangement of antennas at Lawrenceville transmitting station.

At Lawrenceville all of the antennas for the three channels to England are arranged in a straight line about one mile long. The direction of this line is perpendicular to the great circle path to Baldock, England, where the signals are received, (Fig. 6). The antennas for the fourth channel are similarly arranged in a line 1500 ft. long and they are directed for transmission to Buenos Aires, Argentine.

Placing several antennas in a single line reduces the cost of the supporting structure, and all the antennas have a clear sweep in the direction of transmission. By locating them in proper sequence with re-

spect to wave-lengths it is possible without objectionable interference, to place the antennas end-to-end and thus use supporting towers in common. Due to the wide difference in wave-length between adjacent antennas and their right-angle position with respect to the line of transmission, their proximity has no appreciable effect different from that of the towers. The proper selection of tower spacing in respect to wave-lengths makes it possible to erect a uniform supporting structure. This has the advantage of flexibility and will permit future alterations of either the location or size of a given antenna. At present, each antenna occupies the space between three towers.

In order to avoid undue loss in the transmission lines the radio transmitters are grouped in two buildings. The buildings each contain two transmitters and are identical in layout, in so far as the radio equipment is concerned. Building No. 1 has additional space for the central wire terminating and testing equipment. This apparatus is contained in an electrically screened room which effectively prevents high-frequency fields from interfering with the proper functioning of the apparatus.

#### RECEIVING SYSTEM

Short-wave reception is characterized by less difficulty with static than that encountered with long waves. On the other hand it suffers interference from sources such as the ignition systems of passing airplanes and automobiles, which ordinarily do not disturb long-wave systems. Frequently the incoming radio waves suffer wide and rapid swings in intensity and there are variations in the apparent direction of arrival. On account of the extremely high frequencies the apparatus and antenna structures are very different from those for the long waves; otherwise the general schemes of reception are similar, directional effects and double detection methods being employed for both.

The radio wave is collected by means of a directional antenna array whose prime function is to improve the ratio between the desired signal and unwanted noise or other interference. This it does in two ways: *viz.*, (1) by increasing the total signal energy delivered to the receiver and (2) by discriminating against waves whose directions of arrival differ from the chosen one. Increasing the total energy collected from the incoming message wave permits the detection of correspondingly weaker signals because there is an apparently irreducible minimum of noise inherent to the input circuits of the first vacuum tube in the receiver<sup>5</sup> and this noise establishes a lower limit below which signals cannot be received satisfactorily. Since, under many conditions, the

<sup>5</sup> J. B. Johnson, *Physical Rev.*, July 1928.

directions of arrival of static and other disturbances including unwanted radio signals are random, it is obvious that sharp directive discrimination aids very materially in excluding them from the receiver. On the other hand, the antennas are not sharply resonant systems and they do not distinguish between waves from substantially the same direction and closely adjacent in frequency. This duty is left to the circuits of the radio receiver.

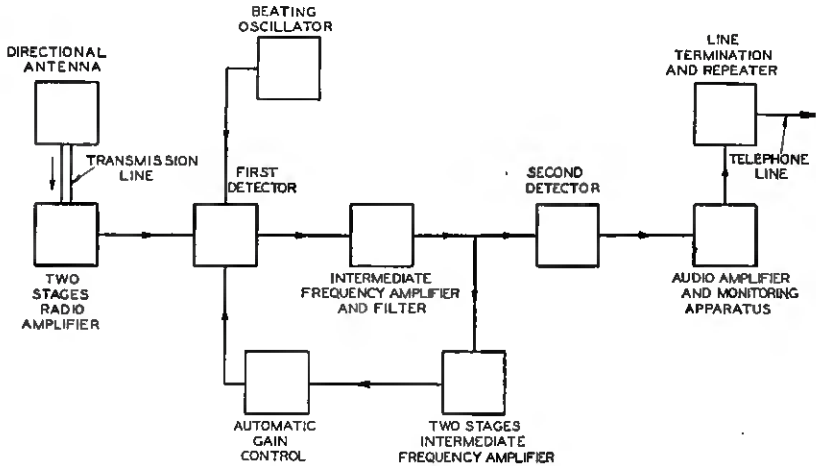

Fig. 7—Block schematic of receiving system.

Having collected the signal with a directional antenna the energy is conveyed to the receiving set by means of concentric pipe transmission lines of small diameter. The use of concentric conductors simplifies the prevention of direct signal pick-up by the lines, it reduces losses and prevents external objects from influencing the transmission properties, thus allowing the line to be buried in the ground or placed a few inches above the surface where it will have no appreciable adverse effect on the antenna performance.

Referring now to Fig. 7, the radio currents arriving over the transmission line are first amplified by two stages of radio amplification involving tuned circuits which discriminate further in favor of the wanted signal. The signal delivered by the radio amplifier is at a suitable level for efficient demodulation and is applied to the grid of the first detector. By means of a beating oscillator whose frequency is suitably adjusted, the first detector steps the signal carrier frequency down to a fixed value of 400 kilocycles from one in the range 9000 to 21,000 kilocycles which depends, of course, on the distant transmitting station assignment. The intermediate frequency signal at 400 kilo-

cycles then passes through a combination of amplifiers and filters which further exclude the unwanted interference. The wanted signal reaches the second detector where it is demodulated and the voice currents reproduced. The latter are then amplified and applied to the telephone lines.

A portion of the output from the intermediate amplifier which would normally go to the second detector grid, is diverted and further amplified. It is then supplied to a device which automatically tends to maintain the receiver output volume constant by controlling the bias potential of the first detector grid circuit. The time constants are adjusted so that this gain control does not respond to the normal variation in signal power corresponding to speech modulation. Otherwise of course, there would be serious distortion effects. This device partially offsets the ill effects of wide fluctuations in signal intensity but it does not overcome the deterioration in signal quality which usually accompanies the low field strengths during such fluctuations.

#### RECEIVING EQUIPMENT

At the receiving station the apparatus for each channel comprises (1) the radio receiving set, (2) a power plant for the receiver, (3) wire terminating equipment and repeaters. The latter are located at a central point in the station along with certain voice frequency testing apparatus used in common by all channels and supplied with power from a common source.

A radio receiving set which embodies the above described system and of the type installed at Netcong is shown in Fig. 8. It consists of a large number of individually shielded units mounted on panels and assembled on three self supporting racks of the type commonly employed in the telephone plant. This permits the use without modification of certain standard pieces of equipment, such as jack strips, fuse panels, meter panels, audio frequency filters, and the like. It also permits the removal and repair or substitution of units with a minimum of delay. The set is required to receive signals at three fixed frequencies in the range 9000 to 21,000 kilocycles. This involves connections with three antennas through three separate transmission lines. The tuning of the antenna and transmission line terminations are rather lengthy processes requiring precise adjustments. In order to facilitate quick changes from one operating frequency to another without intricate tuning operations, the first stage of radio amplification is provided in triplicate and the switching is done between the first and second stage. Thus the antennas are permanently connected to the set and their adjustments remain undisturbed. The circuits of the second

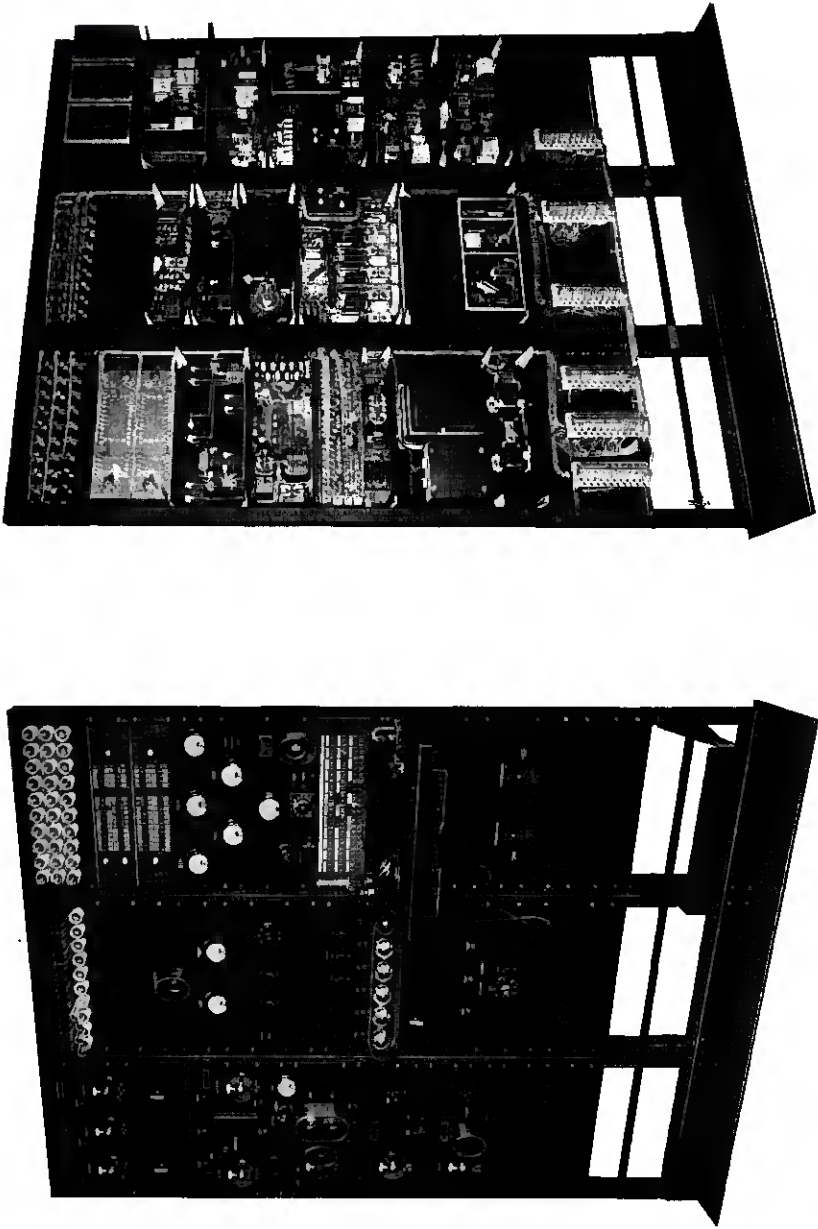

A Fig. 8—Short-wave radio receiver, (A) front view, (B) rear view. B

stage require tuning when the frequency is changed. Hence to tune the receiver on any one of the assigned frequencies the attendant merely moves the dials of the second stage to predetermined settings, switches the grid circuit to a first stage which is already tuned and connected with the proper antenna and he adjusts the beating oscillator to obtain an intermediate frequency of 400 kilocycles. Screened grid tubes are used for the first two stages of amplification. A key shelf is provided with telephone and telegraph facilities. The power plant consists of standard 24-volt and 130 batteries, rectifier charging units and automatic regulators.

#### RECEIVING ANTENNAS

In discussing antennas for directional sending it was mentioned that an identical antenna could be used for receiving purposes, but since the requirements in the two cases are not the same, quite different structures have been developed, although the methods of obtaining directivity are alike. In the sending case the reduction of random radiation ceases to be profitable when the increment thus added to the energy, which is radiated in the direction of the distant receiving station, is a relatively small part of the total. In the receiving case, although the response to the wanted signal may not be increased appreciably by further improvement in the directive pattern, the reduction in noise and interference from random directions justifies additional improvement. Expressed another way, the objective in the transmitting case is a high gain compared to a nondirectional antenna, whereas in the receiving case the objectives are, first, a high average signal-to-noise ratio and, second, a gain sufficient to override the noise inherent to the receiving set. Satisfying the first accomplishes the second.

Improvement of the average directional discrimination means a nearer approach to ideal conditions. Whereas steel towers, sectionalized cables, guys and the like, when properly located relative to the conductors of a sending antenna, do not cause any appreciable power loss, their presence near the receiving antenna may prevent the realization of the extreme directive properties which are wanted. Moreover, there is need for much greater rigidity in the positions of the conductors. For this reason the antennas at Netcong are supported on wooden frames constructed like large crates.

Due to the variable conditions surrounding the propagation of short waves in space, the vertical angle of arrival of the signal wave at the receiving station frequently changes considerably throughout a twenty-four hour period and is not always the same from day to day. In

order to combat this variable condition, it appears desirable to select an antenna arrangement which does not have sharp directional properties in a vertical plane passed through the horizontal direction of arrival. The type of antenna selected for Netcong meets this requirement by having only a single horizontal row of quarter-wave vertical elements in one plane. Another solution, of course, would be to provide several antennas of different characteristics and to shift about from one antenna to another as the conditions warranted.

Fig. 9 is a general view of one of the Netcong receiving antennas. Like the transmitting antennas, the conductors are arranged in two parallel planes one quarter wave-length apart in order to obtain a unidirectional system. The conductor in each plane is bent and ter-

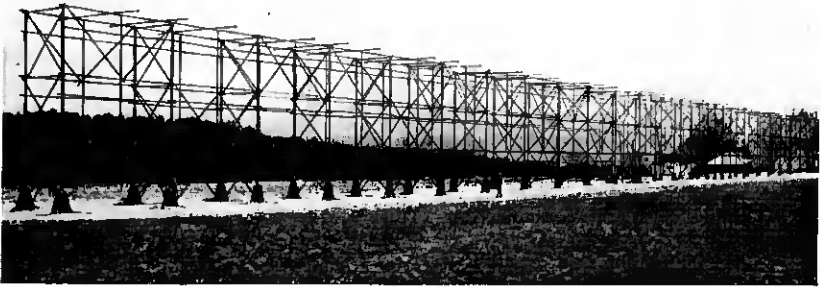

Fig. 9—One of receiving antennas at Netcong. (24.7 meter wave-length.)

minated as indicated in Fig. 10 but is much longer than that shown. The vertical members are marked *A*. As in the transmitting case the directional effect depends upon the manner in which standing waves occur along the conductor. A signal wave arriving broadside to the array, induces voltages in the vertical members which are identical in phase and amplitude.

Because the vertical members are interconnected alternately at the top and bottom by members of one quarter wave-length and the last horizontal members are one eighth wave-length, the net effect of the induced voltages is the establishment of standing current and voltage waves along the conductor. The receiver is connected at a voltage anti-node and the current which flows through it is proportional to the sum of the voltages induced in the vertical members. In the case of



a signal wave arriving from the horizontal directions parallel to the plane of the array, the voltages in the vertical members are in successive quarter-phase relationships, no standing waves are produced, and no current flows through the receiver. Because current nodes occur at the center of each horizontal member, the loss by reradiation from these members is negligible. This is an important feature which contributed to the selection of this type of antenna for Netcong.

The size of the antenna is determined largely by the manner in which the signal waves arrive although costs cannot be wholly neglected. The useful length is limited by the fact that random fading occurs at distances as short as ten wave-lengths and it is doubtful if an antenna this long would realize the computed improvement. The cost per decibel gained is small for the initial steps, but it mounts very rapidly as the length of antenna increases. The height also is limited by cost

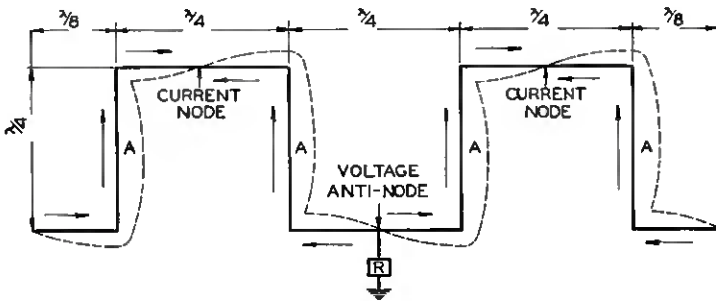

Fig. 10—Diagram of simple directive receiving antenna.

and by the necessity of allowing for considerable variation in the vertical angle of arrival as discussed in a previous paragraph.

The antennas at Netcong are six wave-lengths long and the lowest conductors are about 10 ft. off of the ground. The gains over that of a half wave vertical antenna are in the order of 16 db (power ratio of 40). The average improvement in signal-to-noise ratio is of the same order. There are certain null points toward the sides and rear for which the ratio of directional discrimination is very large.

The transmission lines are constructed of inner and outer copper tubes respectively 3/16 in. outside diameter and 5/8 in. inside diameter. The tubes are held concentric by toroidal shaped insulators made of Isolantite, a ceramic product similar to porcelain and well adapted for high-frequency voltages. This same material is used for insulating purposes throughout the transmitting and receiving antennas. Transmission lines are supported a few inches above the ground and are connected to earth at short intervals. The lines vary in length from

200 to 1500 ft. One of the interesting problems in connection with their design is the provision of means for allowing variation in length with temperature. Ordinary expansion joints introduce difficulties with electrical contacts and impedance irregularities. To avoid these the lines are made 10 per cent longer than otherwise necessary and they follow a sinuous course which permits the necessary bending. Sharp turns are not permissible because experiments have shown that they cause reflection disturbances. The measured loss in 1000 ft. of line at 20,000 kilocycles is 2 db.

#### RECEIVING STATION

The radio problems encountered in the layout of the receiving station, in general, include most of those already mentioned in connection with the transmitting station, but their solution in some instances is quite different. In addition there are requirements imposed by sources of radio noise both within the station itself, and in the surrounding area which is beyond the control of the station.

The number of antennas is determined, of course, by the frequency assignments of the distant transmitting station. Where two assignments are within 100 kilocycles it is possible to use the same antenna for both, but thus far, this has not been done at Netcong.

The size of the antennas is not limited appreciably by the length of transmission lines because other factors make it necessary to separate them rather widely. On this account and also because the receiving apparatus and its power plant are small, comparatively inexpensive units, it is economical to place the receivers in small buildings centrally located with respect to the group of antennas for one channel. In this case the lengths of transmission lines are not controlling factors and the dimensions of antennas are governed primarily by the considerations previously outlined when describing the individual antenna. The small height of the antenna permits them to be placed in the line of reception of other antennas spaced ten wave-lengths or more away and of widely different frequencies such as those of one channel. Antennas adjusted for the same order of frequency are separated more than this. On the other hand, to avoid adverse reactions no two are placed adjacent and end-to-end as at the transmitting station. The end-to-end separation at Netcong is in the order of four wave-lengths. The areas surrounding antennas are cleared of trees and kept free of all overhead wires or conducting structures to avoid reflection effects which disturb the directional characteristic of the antenna systems.

The locations of antennas are also influenced materially by the necessity of avoiding interference from the ignition systems of internal

combustion engines. This imposes a requirement that the station site be isolated from air routes and roads carrying heavy traffic. The antennas are placed as far as possible from secondary roads which cross their line of reception.

The layout at Netcong is shown in Fig. 11. There are thirteen antennas arranged in four groups with a receiver building for each group. A headquarters building located at the road entrance contains the wire terminating equipment, line repeaters, and voice frequency

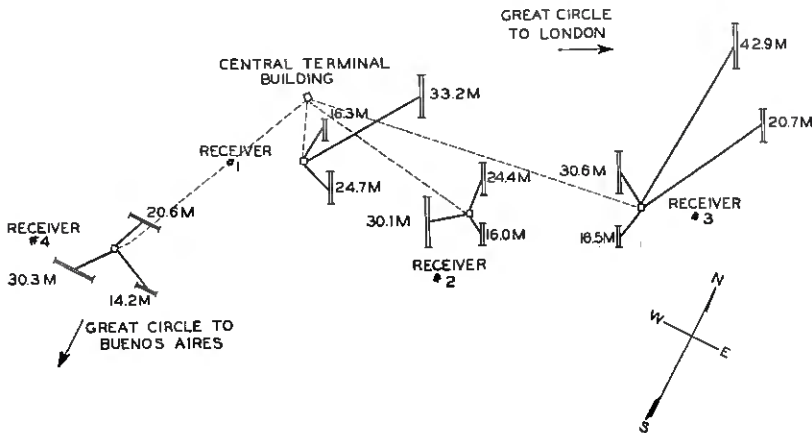

Fig. 11—Arrangement of receiving antennas at Netcong receiving station.

testing apparatus. The power plant at each receiver and the entire central terminal apparatus at the headquarters building are placed in electrically shielded rooms to prevent radio noise disturbances emanating from them and reaching the receivers directly or via the antennas.

The radio stations described herein are pioneer commercial applications in the development of short wave telephone transmission. Although progress has been rapid and far-reaching our knowledge of the behavior of short waves is by no means complete. It is reasonable, therefore, to expect that the future holds many improvements and that the information obtained by further fundamental investigations may materially alter both our views of the transmission phenomena and our ideas of what the apparatus and stations should be.

# The Words and Sounds of Telephone Conversations

By NORMAN R. FRENCH, CHARLES W. CARTER, JR.,  
and WALTER KOENIG, JR.

This paper presents data concerning the vocabulary and the relative frequency of occurrence of the speech sounds of telephone conversation. Tables are given showing the most frequently used words, the syllabic structure of the words, the relative occurrences of the sounds, and, for each vowel, the percentage distribution of the consonants which precede and follow it. Comparisons are made with the vocabulary and relative occurrence of speech sounds in written English.

## INTRODUCTION

CONVERSATION resembles other forms of communication in its use of symbols, in themselves merely physical phenomena, but which combined in sequence are by convention endowed with meaning. The elementary symbols used in conversation are the acoustic disturbances called speech sounds. A language is characterized by the speech sounds which it uses and by the combinations of speech sounds which form syllables and words. The physical description of a language involves a statement of the characteristics of the individual sounds and also of the frequency of occurrence of each sound and combination of sounds. The latter or statistical aspect of conversation is treated in this paper.<sup>1</sup>

Studies of the relative frequency of English speech sounds have been made previously, but they have been confined, so far as the writers have ascertained, to the analysis of written matter. Of these an extended investigation is that made by Godfrey Dewey.<sup>2</sup> For pedagogical purposes in connection with difficulties in spelling and in developing methods of shorthand writing, which seem to have been the aims in the previous studies, written matter is the natural point of departure.

There are obvious differences between English when read aloud from printed matter and English used as a medium of conversation, which might be expected to produce differences between analyses based on the two forms. Written matter is permanent and, to some degree, self-conscious; it receives qualification by dependent clauses and preposi-

<sup>1</sup> Some of the results of this study were presented at the May, 1929, meeting of the Acoustical Society of America. See French and Koenig, *Journal A. S. of A.*, October, 1929, p. 110.

<sup>2</sup> "Relative Frequency of English Speech Sounds," *Harvard Studies in Education*, IV. Harvard University Press, 1923.

tional phrases and it makes use of synonyms and a vocabulary more or less ample according to the writer's fancy and ability. In conversation attention seems to be paid more to the thought than the form of expression, with the exception, perhaps, that certain modes acceptable in writing may be considered as too formal for conversation. It is doubtful, however, that conversation should be described as more concise than written matter. The sentences are, indeed, likely to be shorter. They are often incomplete, in fact. But often in conversation even a single statement is completed only after a number of fumbling attempts, an oral manifestation of crystallizing thought, whereas in written matter the final expression alone would appear. In repetition of a thought, synonyms are less likely to be found in conversation than in written matter. Dependent clauses are less frequent than in written matter. Qualification and description often take the form of separate sentences, so that those words characteristic of involved construction tend to be less prominent in conversation, while the framework words, such as the auxiliary verbs and pronouns, are more intensively used. These differences, which tend to restrict the vocabulary, will be found reflected in the comparisons given later in this paper.

The material for the present study was obtained from telephone conversations over typical toll circuits terminating in the city of New York. The process of noting the words of the conversations was carried out in the following manner: During one week the observer recorded nothing but the nouns used, during another week she recorded only verbs, and during a third week only adjectives and adverbs. This routine was repeated until observations had been made on 500 conversations for nouns, 500 conversations for verbs, and 500 conversations for adjectives and adverbs. Three other classes of words were recorded: prepositions and conjunctions, pronouns, and articles; but for these classes approximately 150 conversations in each case were judged to be sufficient.

Certain classes of words were, for various reasons, omitted entirely. These are names, titles, exclamations, letters, numbers and the nameless sound which may be transliterated as "er" or "uh," so frequently punctuating a haltingly expressed sentence. A more comprehensive method, but based on a much smaller number of conversations, indicates that the ratio of the total number of occurrences of words in the omitted classes to the number of occurrences of the words discussed in this paper is about one to four. Within the omitted group the division is roughly as follows: proper names and titles, 20 per cent; exclamations and interjections, such as "yes," "no," "well," "yeah," "uh-huh," "oh," "all right," "hello," "good-by," laughter

and profanity, 40 per cent; letters and numbers, 25 per cent; and the sound "er," 15 per cent.

The words which were obtained by the process of sampling conversations for specific parts of speech are not, of course, identical with those which would have been obtained had the entire conversation been recorded. The representativeness of the most frequent words, which largely determine the relative frequency of the speech sounds, was investigated by a later test in which a different observer recorded the verbs from 250 conversations. These results will be discussed later, but it may be pointed out here that the word list obtained by the two observers corresponded so closely that it is felt that the samples of parts of speech were recorded with sufficient accuracy and were sufficiently large to justify taking the words obtained as a good representation of the main body of telephone conversation.

The kinds of conversations encountered are shown in Table I. The great preponderance of business calls is reflected, as will be shown later,

TABLE I  
TYPES OF TELEPHONE CALLS ON WHICH OBSERVATIONS WERE MADE

<i>a. Material</i>	
Business Calls.....	89.0 per cent
All other Calls.....	11.0 per cent
<i>b. Speakers</i>	
Two Men.....	86.5 per cent
Two Women.....	10.4 per cent
Man and Woman.....	3.1 per cent

in the vocabulary. If a smaller percentage of the calls had been business in nature and if a larger percentage had been between women the vocabulary would probably have been different. Whether any marked change would have been found is open to some doubt when it is recalled that business may cover a wide range of topics and that in the 1,900 conversations from which samples were taken there may have been as many as 3,800 different speakers. Evidence will be given, however, which indicates that the relative frequency of the speech sounds would have been changed very little.

### WORDS

The number of conversations on which observations were made was regulated to some extent by the ratio of the number of total words to the number of different words recorded in each class. In the early stages of observing many of the total words recorded were different, making this ratio low, but as the observations continued fewer and fewer new words were encountered. In Figure 1 curves are given

which show, for two classes of words, the way in which the number of different words in each class varied as the total number of words in that class increased. To take the nouns, of the first 200 about half were different, of the first 1,000 about a third were different, of the total of 11,660 nouns recorded about one tenth were different. An extrapolation of the curve indicates that the observations would need

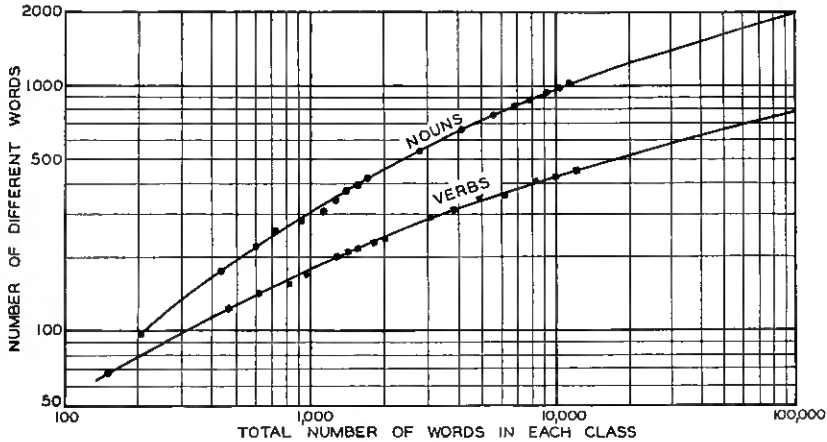

Fig. 1—The number of different words occurring in a given total number of words, for nouns and for verbs.

to be increased tenfold from this point in order to double the number of different nouns. Approximately the same extension of the observations would be required to double the number of different verbs. In neither case, however, could a material change in the relative occurrence of the speech sounds be expected if the observations were so extended. This will be shown below.

Table II shows the total number of words and the number of different words for each part of speech separately. The verbs and auxiliary verbs, which were recorded together, have been separated in the table. The numbers of total words for the other three minor classes have been found by multiplying the observed figures by the ratio of 500 to the actual number of conversations (about 150) on which observations were made for these classes. The numbers of different words for these classes are not similarly increased since virtually all the possible different words were obtained in the observations. In finding the number of different words the various forms of the words, such as the plural form of the nouns, the different tenses of the verbs, and the comparative and superlative forms of the adjectives, have not been counted as separate words, although they were recorded and are



TABLE II  
OCCURRENCE OF PARTS OF SPEECH

Parts of Speech	Number of Words		Ratio Total to Different
	Total	Different	
Nouns.....	11,660	1,029	11.3
Adjectives and Adverbs.....	9,880	634	15.6
Verbs.....	12,550	456	27.5
Auxiliary Verbs.....	9,450	37	255.
Pronouns *	17,900	45	398.
Prepositions and Conjunctions *	12,400	36	344.
Articles *.....	5,550	3	1850.
	79,390	2,240	35.4

\* Derived from data on less than 500 conversations.

treated separately in the analysis for speech sounds. An exception to this is that each form of the auxiliary verbs "be," "can," "may," etc., was counted as a separate word.

It is of interest to find that of approximately 80,000 words so obtained, only 2,240, or less than 3 per cent, are different words. If each of the modifications of a word is counted as a different word the number of different words is increased to 2,822; but even on this basis less than 4 per cent of the total words are different words. Even among the nouns the number of different nouns is only a tenth of the total number of nouns. The five minor parts of speech shown in the last four lines of Table II form only 5 per cent of the different words and yet make up 57 per cent of the total words. The nouns, which constitute 46 per cent of the different words, contribute only 15 per cent of the total words. Such figures indicate clearly that conversation is based on a framework built up of a relatively small number of different words, arranged in many patterns, which supports the more variegated words which convey most of the meaning.

A more detailed idea of this framework is given by Tables III-*a* and III-*b*, which contain a list of the words which were observed in at least 1 per cent of the conversations. In Table III-*a* the words are arranged in order according to the total number of times they were recorded. This is approximately, but not quite, the same as the order of the number of conversations in which they occurred as may be seen by examining the numbers following each word. In Table III-*b* the same words are arranged alphabetically, for ease in reference. The list comprises 737 words out of the 2,240 different words recorded. The importance of the list lies in the fact, as will be shown later, that these words almost completely determine the relative frequency with which the elementary

TABLE III-a

## WORD LIST—NUMERICAL ORDER\*

*Words which Occurred in One Per Cent or More  
of the 500 Telephone Conversations Analyzed*

Column A: Total number of times the word (or some form of it) was used.  
Column B: Number of conversations in which the word occurred.

A		B	A		B	A		B
3,990	I	467	336	what	193	170	anything	100
3,540	you	499	330	morning	191	170	my	97
3,110	the	496	326	an	178			
2,060	a	487	321	just	211	168	night	107
2,046	on	458	317	over	208	159	call, n.	111
1,942	to	472	296	be	175	157	your	100
1,792	that	397				156	little	117
1,605	it	417	295	or	178	146	stuff, n.	92
1,506	is	419	295	take	207	146	won't	115
1,363	and	391	276	am	172	140	last, a.	106
			274	come	168	140	she	50
1,360	get	393	274	make, v.	169	139	all	100
1,305	will, aux.	402	273	give	172	139	better	103
1,190	of	396	268	very	165			
1,170	in	408	264	send	172	139	number, n.	80
1,115	he	297	262	as	125	138	out	90
1,100	we	294	259	right, a.	173	137	try	100
913	they	253				133	ask	101
887	see	328	247	order, n.	119	133	sell	81
883	have	367	243	good	149	131	not	96
823	for	330	241	minute	155	130	those	100
			241	price	123	125	only	84
753	know	325	238	here	157	121	business	83
640	don't	301	234	car	88	120	office	83
638	do	302	230	had	151			
618	are	293	229	time	165	118	late	94
599	want	297	228	can't	132	118	no, a.	77
597	go	280	226	much	160	117	all right	74
553	tell	264				115	pretty	92
518	with	263	224	there	144	115	shipment	80
496	me	283	222	week	120	113	back, a.	79
486	him	223	215	let	148	112	look, v.	85
			214	letter	112	112	mean, v.	82
480	about	266	209	any	140	112	off	67
476	at	238	200	did	144	109	hear	85
474	think	232	199	more	134			
473	this	240	195	didn't	142	108	ship, v.	68
458	day	251	193	talk, v.	131	108	way	81
418	thing	235	193	today	124	106	his	70
410	say	211				105	dollar	66
396	can, aux.	221	190	other	128	105	too	77
386	call, v.	200	186	company	111	105	wire, n.	78
379	would	207	186	fine, a.	122	104	haven't	83
			184	could	124	104	then	88
370	them	170	183	same	127	103	how	78
358	was	194	179	put	114	103	who	74
339	now	216	178	wait, v.	135			
338	from	196	176	has	114	98	buy	60

\* In ambiguous cases the part of speech is denoted as follows: noun, n.; verb, v.; adjective or adverb, a.; auxiliary verb, aux.; preposition, prep.

TABLE III-a (Cont'd)

A		B	A		B	A		B
97	man	67	64	some	43	43	chance	37
97	wouldn't	79	63	been	53	43	coffee	8
96	before	79	63	but	54	43	every	36
96	first	71	63	contract	31	42	stock, n.	33
96	market	51	63	out of	25	42	than	33
93	something	67	63	sample, n.	37			
92	month	70	63	these	57	41	feel	30
92	well, a.	71				40	different	30
89	case	47	61	few, a.	50	40	meet	28
			61	ton	27	40	reason, n.	32
89	find, v.	72	61	train, n.	33	40	show, v.	30
88	by	75	60	best	52	40	which	33
88	probably	69	60	everything	47	40	yesterday	35
87	afternoon	62	60	may	50	39	pound, n.	21
87	line	60	60	thank	56	38	doing	34
87	name, n.	52	59	check, n.	35	38	keep	28
86	like, v.	71	58	along, prep.	33			
86	sure	72	58	job	44	38	old	22
86	yet	67				37	awful	31
85	fellow	70	58	tonight	40	37	bag	24
			58	up, prep.	42	37	certainly	28
85	pay, v.	55	57	home	35	37	difference	31
84	talk, n.	67	57	our	47	37	information	29
84	write	61	56	another	46	37	matter, n.	31
83	new	62	56	away	45	37	must	30
83	next	61	56	should	43	37	phone, n.	35
83	were	66	55	expect	49	37	seem	33
82	understand	63	54	around	54			
82	when	69	54	copy, n.	36	36	boy	31
79	people	59				36	hand, n.	31
78	year	53	54	idea	38	36	hour	30
			53	bad	46	36	house	27
77	us	63	53	couldn't	47	36	mind, n.	30
76	soon	63	52	bill, n.	39	35	early	26
75	place, n.	55	52	nice	38	35	figure, v.	24
73	money	56	52	tomorrow	36	35	oil, n.	18
72	guess, v.	63	52	word	45	35	question, n.	31
71	after	54	51	big	42	35	quite	32
71	hold, v.	60	51	where	42			
71	through	46	51	whole	40	34	ahead	27
69	isn't	52				34	point, n.	27
69	leave	54	50	cent	31	34	wonder	28
			49	figure, n.	32	33	offer, n.	20
68	coal	27	49	glad	39	33	speak	31
68	might, aux.	59	49	ship, n.	28	33	unless	33
68	work, v.	50	48	report, n.	29	32	bid, n.	24
67	again	62	47	suppose	41	32	deliver	24
67	her	30	46	into	42	32	less	23
67	its	67	45	boat	22	32	possible	24
67	so	53	45	couple	38			
67	their	63	45	high	34	31	believe	25
66	long	55				31	check, v.	28
65	because	47	45	ought	37	31	low	22
			45	trouble	33	31	situation	25
65	use, v.	50	44	barrel	20	31	touch, n.	29
65	work, n.	49	44	delivery	36	31	why	25
64	listen	55	43	anybody	40	30	basis	21

TABLE III-a (Cont'd)

A		B	A		B	A		B
30	fix, v.	21	24	hope, v.	19	18	steel	10
30	move	23				18	trip, n.	17
30	ready	25	24	near	23	18	wasn't	18
			24	piece	16	17	above	13
30	receive	22	24	start, v.	22	17	accept	14
30	sorry	25	24	wrong	20	17	against	13
30	town	22	23	busy	17	17	amount	15
29	between	29	23	ever	22	17	appointment	14
29	does	27	23	foot	13	17	cable	10
29	dope, n.	24	23	lot	19	17	cover, v.	14
29	mail, n.	22	22	card	9			
29	many	25	22	forget	18	17	definite	13
29	moment	26				17	goods	13
29	need, v.	22	22	friend	14	17	plant, n.	9
			22	special	15	17	possibility	15
29	paper	17	22	wire, v.	18	17	size	12
29	telegram	19	21	balance, n.	15	17	somebody	17
29	telephone, n.	27	21	change, n.	15	17	still, a.	16
29	though	29	21	loan	5	17	story	12
28	able	26	21	mail, v.	16	17	ticket	9
28	customer	22	21	welcome, a.	21	17	within	17
28	instruction	20	20	account, n.	16			
28	note, n.	24	20	agreement	8	16	handle, v.	14
28	ring, n.	23				16	like, a.	16
28	room	19	20	anyhow	17	16	part, n.	15
			20	cut, v.	18	16	quote	14
28	sale	25	20	exactly	17	16	tank	7
27	arrange	23	20	happen	15	16	truck	13
27	bring	24	20	list, n.	13	15	along, a.	13
27	doesn't	23	20	message	11	15	also	11
27	done	23	20	most	15	15	answer, n.	15
27	maybe	26	20	record, n.	18	15	board	8
27	never	23	20	stop, v.	18			
27	order, v.	24	20	terrible	13	15	cargo	8
27	really	25				15	clean, v.	14
27	share, n.	10	19	address, n.	15	15	clear, a.	14
			19	department	16	15	cocoa	9
27	stay	23	19	far	15	15	cost, v.	15
27	wish, v.	22	19	hold, n.	17	15	date	14
26	book	17	19	load, v.	16	15	interest, n.	9
26	inch	7	19	meeting	9	15	item	10
26	machine	14	19	nearly	19	15	station	8
26	proposition	21	19	plan, n.	12	15	spend	11
26	railroad	19	19	position	15			
26	run, v.	20	19	rate	11	15	worry, v.	14
26	short	21				14	already	14
25	bank	12	19	straight	15	14	arrangement	11
			18	anyway	16	14	bid, v.	11
25	change, v.	22	18	cheap	13	14	club	7
25	city	18	18	even	17	14	extra	11
25	hasn't	25	18	imagine	17	14	fact	14
25	help, v.	19	18	lunch	18	14	finish, v.	10
25	material	14	18	pier	10	14	full	12
24	absolutely	21	18	possibly	14	14	help, n.	10
24	care, v.	24	18	quotation	13			
24	down	20	18	small	17	14	hotel	11
24	hard	22				14	open, a.	12

TABLE III-a (Cont'd)

A		B	A		B	A		B
14	operator	10	12	real	11	10	sheet	8
14	particular	13	12	satisfactory	11	10	street	8
14	perfectly	12	12	several	11	10	territory	5
14	profit	11	12	somewhere	12	10	together	8
14	read	11	12	steamer	10			
14	report, v.	12	12	warehouse	8	10	transfer, n.	8
14	second, n.	12				10	warm	7
14	set, n.	8	11	afraid	11	10	whatever	10
			11	almost	11	10	woman	5
14	sign, v.	12	11	arrive	10	10	yourself	10
14	stand, v.	14	11	both	10	9	build	7
14	surely	14	11	box, n.	7	9	care, n.	6
14	turn, v.	11	11	cold, n.	6	9	careful	9
13	across	13	11	complete, v.	8	9	certain	8
13	answer, v.	9	11	concern, n.	10	9	charge, v.	8
13	bond	8	11	confirm	7			
13	building	11	11	definitely	10	9	color	8
13	charge, n.	8				9	complete, a.	8
13	condition	12	11	detail	10	9	conference	7
				drawing	8	9	decide	9
13	connection	12	11	funny	11	9	end, n.	7
13	deal, n.	12	11	light, a.	7	9	express, n.	7
13	direct, a.	11	11	mile	8	9	game	8
13	drop, v.	12	11	motor	7	9	hospital	6
13	further	11	11	personally	8	9	immediately	7
13	general, a.	8	11	quality	10	9	large	8
13	himself	13	11	rather	11			
13	insurance	11	11	use, n.	10	9	mention	7
13	interested	10				9	necessary	9
13	least	12	10	air	6	9	outside	9
			10	awfully	10	9	personal	9
13	luck	12	10	bother, v.	9	9	remember	8
13	notify	6	10	carload	9	9	sit	8
13	offer, v.	12	10	cold, a.	7	9	sometime	9
13	party	12	10	crazy	8	9	statement	9
13	person	13	10	dinner	7	9	suggestion	8
13	quick	13	10	double	7	9	supply, v.	7
13	test, n.	8	10	easily	9			
13	without	13	10	either	9	9	true	9
12	agree	11				9	up, a.	8
12	always	10	10	enough	10	9	weren't	7
			10	everybody	10	9	willing	7
12	appreciate	11	10	explain	9	9	wise	7
12	bed	10	10	final	6	8	additional	8
12	brother	11	10	freight	8	8	advise	7
12	close, v.	11	10	having	10	8	agent	6
12	consider	9	10	head	9	8	agreeable	7
12	else	12	10	important	10	8	anxious	7
12	expense	10	10	kind, n.	9			
12	fair	12	10	limit, n.	8	8	average, n.	7
12	great	11				8	beyond	8
12	loss	10	10	load, n.	8	8	carry	7
			10	mark, n.	8	8	certificate	5
12	original	10	10	particularly	9	8	close, a.	8
12	per cent	8	10	positively	10	8	each	8
12	pick, v.	11	10	power	5	8	easy	7
12	policy	6	10	service	10	8	engineer	5

TABLE III-a (Cont'd)

A		B	A		B	A		B
8	except	8	7	locate	7	6	offhand	6
8	fill	8	7	lovely	6	6	operate	6
			7	mind, v.	7	6	opportunity	6
8	firm, a.	5	7	mother	7	6	package	6
8	girl	6	7	once	5	6	practically	6
8	guarantee, n.	7	7	ours	7	6	promise	6
8	heavy	6				6	realize	5
8	look, n.	8	7	phone, v.	6	6	represent	6
8	middle, a.	7	7	proper	7	6	shall	6
8	mistake, n.	7	7	sake	6	6	simple	6
8	news	7	7	satisfied	7			
8	ordinary	6	7	side	7	6	straighten	6
8	owe	6	7	state, n.	6	6	such	6
			7	store, n.	5	6	thanks	6
8	plan, v.	8	7	supply, n.	7	6	touch, v.	6
8	push, v.	6	7	throat	5	6	unload	5
8	quantity	6	7	wonderful	6	5	advisable	5
8	reasonable	7				5	allow	5
8	regular	8	7	yard	5	5	approval	5
8	reply, n.	7	6	advice	6	5	catch	5
8	sail, v.	7	6	afford	5	5	conversation	5
8	second, a.	7	6	appear	5			
8	settle	7	6	argument	6	5	correct	5
8	shape	8	6	begin	6	5	crowd	5
			6	broker	5	5	difficulty	5
8	simply	8	6	bunch	5	5	disappointed	5
8	single	7	6	cancel	5	5	discuss	5
8	suggest	8	6	claim, v.	5	5	doctor	5
8	sweet	7				5	estimate, v.	5
8	weather	5	6	clear, v.	5	5	grade	5
8	weight	5	6	collect	6	5	holiday	5
8	whether	7	6	competition	5	5	increase, v.	5
8	world	8	6	cost, n.	5			
7	actual	5	6	dandy, a.	6	5	inform	5
7	ago	5	6	dealer	5	5	insist	5
			6	delay, v.	6	5	instead	5
7	apparently	6	6	depend	6	5	intend	5
7	available	5	6	fairly	6	5	interesting	5
7	buyer	5	6	form, n.	5	5	mix	5
7	clean, a.	7				5	operation	5
7	cover, n.	7	6	impossible	5	5	pardon, n.	5
7	desk	7	6	indeed	6	5	payment	5
7	evening	7	6	inquiry	6	5	reach	5
7	event	7	6	issue, n.	5			
7	evidently	7	6	lay	6	5	reduction	5
7	exact	7	6	lose	5	5	return	5
			6	mark, v.	6	5	show, n.	5
7	favor	7	6	memorandum	6	5	sort, n.	5
7	follow	7	6	notice, n.	6	5	specification	5
7	indicate	6	6	notice, v.	6	5	surprised	5
7	life	7				5	until	5

TABLE III-b

## WORD LIST—ALPHABETICAL ORDER \*

Words Which Occurred in One Per Cent or More  
of the 500 Telephone Conversations Analyzed

Column A: Total number of times the word (or some form of it) was used.  
Column B: Number of conversations in which the word occurred.

A		B	A		B	A		B
	A		18	anyway	16	10	bother, v.	9
2,060	a	487	7	apparently	6	11	box, n.	7
28	able	26	6	appear	5	36	boy	31
480	about	266	17	appointment	14	27	bring	24
17	above	13	12	appreciate	11	6	broker	5
24	absolutely	21	5	approval	5	12	brother	11
17	accept	14	618	are	293	9	build	7
20	account, n.	16	6	argument	6	13	building	11
13	across	13	54	around	54	6	bunch	5
7	actual	5	27	arrange	23	121	business	83
8	additional	8	14	arrangement	11	23	busy	17
19	address, n.	15	11	arrive	10	63	but	54
6	advice	6	262	as	125	98	buy	60
5	advisable	5	133	ask	101	7	buyer	5
8	advise	7	476	at	238	88	by	75
6	afford	5	7	available	5			
11	afraid	11	8	average, n.	7		C	
71	after	54	56	away	45	17	cable	10
87	afternoon	62	37	awful	31	386	call, v.	200
67	again	62	10	awfully	10	159	call, n.	111
17	against	13				396	can, aux.	221
8	agent	6		B		6	cancel	5
7	ago	5	113	back, a.	79	228	can't	132
12	agree	11	53	bad	46	234	car	88
8	agreeable	7	37	bag	24	22	card	9
20	agreement	8	21	balance, n.	15	24	care, v.	24
34	ahead	27	25	bank	12	9	care, n.	6
10	air	6	44	barrel	20	9	careful	9
139	all	100	30	basis	21	15	cargo	8
5	allow	5	296	be	175	10	carload	9
117	all right	74	65	because	47	8	carry	7
11	almost	11	12	bed	10	89	case	47
58	along, prep.	33	63	been	53	5	catch	5
15	along, a.	13	96	before	79	50	cent	31
14	already	14	6	begin	6	9	certain	8
15	also	11	31	believe	25	37	certainly	28
12	always	10	60	best	52	8	certificate	5
276	am	172	139	better	103	43	chance	37
17	amount	15	29	between	29	25	change, v.	22
326	an	178	8	beyond	8	21	change, n.	15
1,363	and	391	32	bid, n.	24	13	charge, n.	8
56	another	46	14	bid, v.	11	9	charge, v.	8
15	answer, n.	15	51	big	42	18	cheap	13
13	answer, v.	9	52	bill, n.	39	59	check, n.	35
8	anxious	7	15	board	8	31	check, v.	28
209	any	140	45	boat	22	25	city	18
43	anybody	40	13	bond	8	6	claim, v.	5
20	anyhow	17	26	book	17	15	clean, v.	14
170	anything	100	11	both	10	7	clean, a.	7

\* In ambiguous cases the part of speech is denoted as follows: noun, n.; verb, v.; adjective or adverb, a.; auxiliary verb, aux.; preposition, prep.



TABLE III-b (Cont'd)

A		B	A		B	A		B
15	clear, a.	14	195	didn't	142	7	favor	7
6	clear, v.	5	37	difference	31	41	feel	30
12	close, v.	11	40	different	30	23	foot	13
8	close, a.	8	5	difficulty	5	85	fellow	70
14	club	7	10	dinner	7	61	few, a.	50
68	coal	27	13	direct, a.	11	49	figure, n.	32
15	cocoa	9	5	disappointed	5	35	figure, v.	24
43	coffee	8	5	discuss	5	8	fill	8
10	cold, a.	7	638	do	302	10	final	6
11	cold, n.	6	5	doctor	5	89	find, v.	72
6	collect	6	29	does	27	186	fine, a.	122
9	color	8	27	doesn't	23	14	finish, v.	10
274	come	168	38	doing	34	8	firm, a.	5
186	company	111	105	dollar	66	96	first	71
11	complete, v.	8	27	done	23	30	fix, v.	21
9	complete, a.	8	640	don't	301	7	follow	7
6	competition	5	29	dope, n.	24	823	for	330
11	concern, n.	10	10	double	7	22	forget	18
13	condition	12	24	down	20	6	form, n.	5
9	conference	7	11	drawing	8	10	freight	8
11	confirm	7	13	drop, v.	12	22	friend	14
13	connection	12				338	from	196
12	consider	9		E		14	full	12
63	contract	31				11	funny	11
5	conversation	5	8	each	8	13	further	11
54	copy, n.	36	35	early	26			
5	correct	5	10	easily	9		G	
15	cost, v.	15	8	easy	7			
6	cost, n.	5	10	either	9	9	game	8
184	could	124	12	else	12	13	general, a.	8
53	couldn't	47	9	end, n.	7	1,360	get	393
45	couple	38	8	engineer	5	273	give	172
7	cover, n.	7	10	enough	10	8	girl	6
17	cover, v.	14	5	estimate, v.	5	49	glad	39
10	crazy	8	18	even	17	597	go	280
5	crowd	5	7	evening	7	243	good	149
28	customer	22	7	event	7	17	goods	13
20	cut, v.	18	23	ever	22	5	grade	5
			43	every	36	12	great	11
	D		10	everybody	10	8	guarantee, n.	7
			60	everything	47	72	guess, v.	63
6	dandy, a.	6	7	evidently	7			
15	date	14	7	exact	7		H	
458	day	251	20	exactly	17			
13	deal, n.	12	8	except	8	230	had	151
6	dealer	5	55	expect	49	36	hand, n.	31
9	decide	9	12	expense	10	16	handle, v.	14
17	definite	13	10	explain	9	20	happen	15
11	definitely	10	9	express, n.	7	24	hard	22
6	delay, v.	6	14	extra	11	176	has	114
32	deliver	24				25	hasn't	25
44	delivery	36		F		883	have	367
19	department	16				104	haven't	83
6	depend	6	14	fact	14	10	having	10
7	desk	7	12	fair	12	10	head	9
11	detail	10	6	fairly	6	109	hear	85
200	did	144	19	far	15	8	heavy	6

TABLE III-b (Cont'd)

A		B	A		B	A		B
1,115	he	297		K		112	mean, v.	82
25	help, v.	19				40	meet	28
14	help, n.	10	38	keep	28	19	meeting	9
67	her	30	10	kind	9	6	memorandum	6
238	here	157	753	know	325	9	mention	7
45	high	34				20	message	11
486	him	223		L		8	middle, a.	7
13	himself	13				68	might, aux.	59
106	his	70	9	large	8	11	mile	8
71	hold, v.	60	140	last, a.	106	36	mind, n.	30
19	hold, n.	17	118	late	94	7	mind, v.	7
5	holiday	5	6	lay	6	241	minute	155
57	home	35	13	least	12	8	mistake, n.	7
24	hope, v.	19	69	leave	54	5	mix	5
9	hospital	6	32	less	23	29	moment	26
14	hotel	11	215	let	148	73	money	56
36	hour	30	214	letter	112	92	month	70
36	house	27	7	life	7	199	more	134
103	how	78	11	light, a.	7	330	morning	191
			86	like, v.	71	20	most	15
	I		16	like, a.	16	7	mother	7
			10	limit, n.	8	11	motor	7
3,990	I	467	87	line, n.	60	30	move	23
54	idea	38	20	list, n.	13	226	much	160
18	imagine	17	64	listen	55	37	must	30
9	immediately	7	156	little	117	170	my	97
10	important	10	10	load, n.	8			
6	impossible	5	19	load, v.	16		N	
1,170	in	408	21	loan	5			
26	inch	7	7	locate	7	87	name, n.	52
5	increase, v.	5	66	long	55	24	near	23
6	indeed	6	112	look, v.	85	19	nearly	19
7	indicate	6	8	look, n.	8	9	necessary	9
5	inform	5	6	lose	5	29	need, v.	22
37	information	29	12	loss	10	27	never	23
6	inquiry	6	23	lot	19	83	new	62
5	insist	5	7	lovely	6	8	news	7
5	instead	5	31	low	22	83	next	61
28	instruction	20	13	luck	12	52	nice	38
13	insurance	11	18	lunch	18	168	night	107
5	intend	5				118	no, a.	77
15	interest, n.	9		M		131	not	96
13	interested, a.	10	26	machine	14	28	note, n.	24
5	interesting, a.	5	29	mail, n.	22	6	notice, v.	6
46	into	42	21	mail, v.	16	13	notice, n.	6
1,506	is	419	274	make, v.	169	339	notify	6
69	isn't	52	97	man	67	139	now	216
6	issue, n.	5	29	many	25		number, n.	80
1,605	it	417	10	mark, n.	8			
15	item	10	6	mark, v.	6		O	
67	its	67	96	market	51	1,190	of	396
			25	material	14	112	off	67
	J		37	matter, n.	31	33	offer, n.	20
			60	may	50	13	offer, v.	12
58	job	44	27	maybe	26	6	offhand	6
321	just	211	496	me	283	120	office	83

TABLE III-b (Cont'd)

A		B	A		B	A		B
35	oil, n.	18	18	possibly	14	183	same	127
38	old	22	39	pound, n.	21	63	sample, n.	37
2,046	on	458	10	power	5	12	satisfactory	11
7	once	5	6	practically	6	7	satisfied	7
125	only	84	115	pretty	92	410	say	211
14	open, a.	12	241	price	123	14	second, n.	12
6	operate	6	88	probably	69	8	second, a.	7
5	operation	5	14	profit	11	887	see	328
14	operator	10	6	promise	6	37	seem	33
6	opportunity	6	7	proper	7	133	sell	81
295	or	178	26	proposition	21	264	send	172
247	order, n.	119	8	push, v.	6	10	service	10
27	order, v.	24	179	put	114	14	set, n.	8
8	ordinary	6				8	settle	7
12	original	10		Q		12	several	11
190	other	128				6	shall	6
45	ought	37	11	quality	10	8	shape	8
57	our	47	8	quantity	6	27	share, n.	10
7	ours	7	35	question, n.	31	140	she	50
138	out	90	13	quick	13	10	sheet	8
63	out of	25	35	quite	32	108	ship, v.	68
9	outside	9	18	quotation	13	49	ship, n.	28
317	over	208	16	quote	14	115	shipment	80
8	owe	6				26	short	21
				R		50	should	43
	P					40	show, v.	30
6	package	6	26	railroad	19	5	show, n.	5
29	paper	17	19	rate	11	7	side	7
5	pardon, n.	5	11	rather	11	14	sign, v.	12
16	part, n.	15	5	reach	5	6	simple	6
14	particular	13	14	read	11	8	simply	8
10	particularly	9	30	ready	25	8	single	7
13	party	12	12	real	11	9	sit	8
85	pay, v.	55	6	realize	5	31	situation	25
5	payment	5	27	really	25	17	size	12
79	people	59	40	reason, n.	32	18	small	17
12	per cent	8	8	reasonable	7	67	so	53
14	perfectly	12	30	receive	22	64	some	43
13	person	13	20	record, n.	18	17	somebody	17
9	personal	9	5	reduction	5	93	something	67
11	personally	8	8	regular	8	9	sometime	9
37	phone, n.	35	9	remember	8	12	somewhere	12
7	phone, v.	6	8	reply, n.	7	76	soon	63
12	pick, v.	11	48	report, n.	29	30	sorry	25
24	piece	16	14	report, v.	12	5	sort, n.	5
18	pier	10	6	represent	6	33	speak	31
75	place, n.	55	5	return	5	22	special	15
19	plan, n.	12	259	right, a.	173	5	specification	5
8	plan, v.	8	28	ring, n.	23	15	spend	11
17	plant, n.	9	28	room	19	14	stand, v.	14
34	point, n.	27	26	run, v.	20	24	start, v.	22
12	policy	6				7	state, n.	6
19	position	15		S		9	statement	9
10	positively	10	8	sail, v.	7	15	station	8
17	possibility	15	7	sake	6	27	stay	23
32	possible	24	28	sale	25	12	steamer	10
						18	steel	10

TABLE III-b (Cont'd)

A		B	A		B	A		B
17	still, a.	16	71	through	46	222	week	120
42	stock, n.	33	17	ticket	9	8	weight	5
20	stop, v.	18	229	time	165	21	welcome, a.	21
7	store, n.	5	1,942	to	472	92	well, a.	71
17	story	12	193	today	124	83	were	66
19	straight	15	10	together	8	9	weren't	7
6	straighten	6	52	tomorrow	36	336	what	193
10	street	8	60	ton	27	10	whatever	10
146	stuff, n.	92	58	to-night	40	82	when	69
6	such	6	105	too	77	51	where	42
8	suggest	8	31	touch, n.	29	9	whether	7
9	suggestion	8	6	touch, v.	6	40	which	33
9	supply, v.	7	30	town	22	103	who	74
7	supply, n.	7	61	train, n.	33	51	whole	40
47	suppose	41	10	transfer, n.	8	31	why	25
86	sure	72	18	trip, n.	17	1,305	will, aux.	402
14	surely	14	45	trouble	33	9	willing	7
5	surprised	5	16	truck	13	105	wire, n.	78
8	sweet	7	9	true	9	22	wire, v.	18
			137	try	100	9	wise	7
	<i>T</i>		14	turn, v.	11	27	wish, v.	22
						518	with	263
295	take	207		<i>U</i>		17	within	17
193	talk, v.	131				13	without	13
84	talk, n.	67	82	understand	63	10	woman	5
16	tank	7	33	unless	33	34	wonder	28
29	telegram	19	6	unload	5	7	wonderful	6
29	telephone, n.	27	5	until	5	146	won't	115
553	tell	264	58	up, prep.	42	52	word	45
20	terrible	13	9	up, a.	8	68	work, v.	50
10	territory	15	77	us	63	65	work, n.	49
13	test, n.	8	11	use, n.	10	8	world	8
42	than	33	65	use, v.	50	15	worry, v.	14
60	thank	56				379	would	207
6	thanks	6		<i>V</i>		97	wouldn't	79
1,792	that	397				84	write	61
3,110	the	496	268	very	165	24	wrong	20
67	their	63					<i>Y</i>	
370	them	170		<i>W</i>				
104	then	88						
224	there	144	178	wait, v.	135	7	yard	5
63	these	57	599	want	297	78	year	53
913	they	253	12	warehouse	8	40	yesterday	35
418	thing	235	10	warm	7	86	yet	67
474	think	232	358	was	194	3,540	you	499
473	this	240	18	wasn't	18	157	your	100
130	those	100	108	way	81	10	yourself	10
29	though	29	1,100	we	294			
7	throat	5	8	weather	5			

speech sounds occur. They form 96 per cent of the total occurrences of the words. It is to be noticed that no word was observed to occur in all the conversations.

Of the 1,503 different words not shown on the list, 819 were observed only once and 320 only twice. It is quite likely that if the

observations were repeated this part of the list would be duplicated very imperfectly, since these words, while in general well-known, tend to be technical or specific, hence dependent on particular types of subject matter. All except ten of the omitted words are nouns, verbs, adjectives or adverbs.

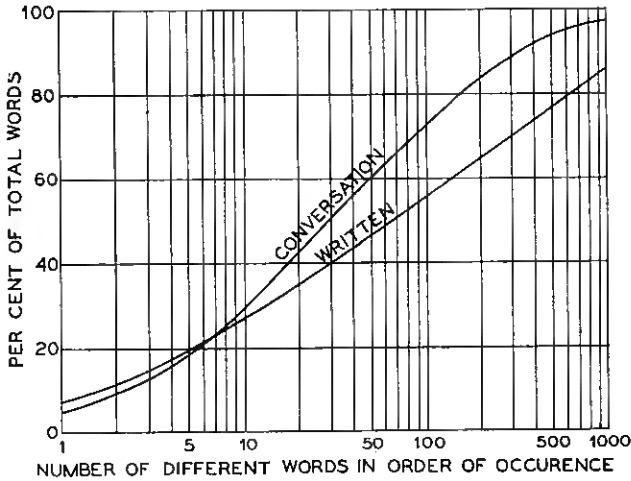

Fig. 2—The cumulative curve obtained when the different words are arranged in order of occurrence.

The importance of a relatively small number of different words which are used very frequently is shown graphically in Fig. 2. The curves shown are cumulative, giving the percentage of the total words contributed by the different words when arranged in the order of their occurrence. The curve labeled "Written" is based on the list given in the study by Dewey, cited above. The economy exercised in conversation, or the poverty of conversational expression, according to the point of view, contrasts sharply with written English. In conversation 30 words account for half the total, in written English 69 words; in conversation 155 words form 80 per cent of the total, in written English 640.

The 50 most common words in telephone conversation and in written English are shown in Table IV, arranged in their order of frequency of occurrence. These words form 60 per cent of the total in conversation and 46 per cent in written English. There are 29 words which are common to the two lists. The personal nature of telephone conversation is shown in the two words which head the list. The most striking difference between the two is the large number of active verbs which occur in the list for conversation: "get," "see," "know," etc.,

TABLE IV  
 FIFTY COMMONEST WORDS IN TELEPHONE CONVERSATION  
 Compared with Written English

	Telephone Conversation	Written English		Telephone Conversation	Written English
1.	I	the	26.	GO	HIS
2.	you	of	27.	TELL	BUT
3.	the	and	28.	with	they
4.	a	to	29.	me	ALL
5.	on	a	30.	HIM	OR
6.	to	in	31.	ABOUT	WHICH
7.	that	that	32.	at	will
8.	it	it	33.	THINK	from
9.	is	is	34.	this	HAD
10.	and	I	35.	DAY	HAS
11.	GET	for	36.	THING	ONE
12.	will	be	37.	SAY	OUR
13.	of	was	38.	CAN	an
14.	in	AS	39.	CALL	BEEN
15.	he	you	40.	would	NO
16.	we	with	41.	THEM	THEIR
17.	they	he	42.	was	THERE
18.	SEE	on	43.	NOW	WERE
19.	have	have	44.	from	SO
20.	for	BY	45.	what	MY
21.	KNOW	NOT	46.	MORNING	IF
22.	DON'T	at	47.	an	me
23.	DO	this	48.	JUST	what
24.	are	are	49.	OVER	would
25.	WANT	we	50.	be	WHO

The 21 words not common to both lists appear in capital letters.

12 in all. None of these appears among the 50 commonest words of written English. Three nouns, "day," "thing" and "morning," appear in the conversational list, none in the other. Only one conjunction is found in the conversational list, while five appear in the list for written English.

When the first 100 words in telephone conversation are compared with the first 100 in written English two somewhat unexpected facts emerge. In telephone conversation 14 out of the first 100 are words of more than one syllable; in written English there are ten. Four two-syllable words appear among the first 50 telephone words; the first 59 of written English are monosyllables. A more striking difference concerns the origin of the words. Among the first 100 telephone words there are 11 which are derived through old French from the Latin; in written English there are only two from the Latin. Six of the 11 words occur in the first 65 telephone words, while the first word of Latin origin in written English is the 70th. The telephone words of Latin origin are, in order of occurrence: "just," "very," "order," "minute,"

“price,” “car,” “letter,” “fine,” “company,” “stuff,” “number”; in written English these words are “people” and “very.” The predominance of business words in this list for telephone conversation suggests the influence of trade between England and France in the Middle Ages.

More detailed comparisons may be drawn from Table V, which lists the first 25 nouns, the first 25 verbs and the first 25 adjectives and

TABLE V  
 TWENTY-FIVE COMMONEST WORDS BY PARTS OF SPEECH  
 Compared with Written English

Nouns		Verbs		Adjectives and Adverbs	
Telephone Conversation	Written English	Telephone Conversation	Written English	Telephone Conversation	Written English
day	man	get	say	now	not
thing	time	see	make	just	all
MORNING	WAR	know	come	very	no
ORDER	PEOPLE	want	take	RIGHT	SO
MINUTE	day	go	know	good	WHEN
PRICE	YEAR	tell	go	HERE	any
CAR	thing	think	see	MUCH	more
time	way	say	get	THERE	now
WEEK	WORLD	call	give	any	UP
LETTER	COUNTRY	take	think	more	out
COMPANY	PART	make	LIKE	TODAY	other
NIGHT	business	come	tell	other	only
CALL	LIFE	give	USE	FINE	GREAT
STUFF	FACT	SEND	call	SAME	SOME
NUMBER	LINE	LET	want	little	HOW
business	GUN	TALK	GOVERN	LAST	very
OFFICE	case	PUT	STAND	BETTER	SUCH
SHIPMENT	HOME	WAIT	ask	all	FIRST
way	CENT	TRY	SEEM	out	good
WIRE	POWER	ask	SHOW	not	EVERY
DOLLAR	PRESENT	SELL	look	only	THEN
man	HOUSE	look	NEED	LATE	little
MARKET	LOSS	MEAN	SAVE	no	here
month	month	HEAR	WORK	ALL RIGHT	just
case	PEACE	SHIP	BELIEVE	PRETTY	WELL

The words not common to both lists appear in capital letters.

adverbs, for both telephone conversation and written matter. Among the nouns only eight are common to the two lists. The effects of business are apparent in the telephone list. On the other hand, the nouns of the written English list reflect the fact, pointed out by Dewey, that the list was obtained from a study made soon after the war. Among the verbs 15 words are common to the two lists and those which differ are concentrated at the end. Approximately half the adjectives and adverbs appear in both lists. The nouns from telephone conver-



sation shown in this table form 2.4 per cent of the different nouns and 40 per cent of the total nouns; the verbs form 5.5 per cent of the different verbs and 72 per cent of the total verbs; while the adjectives and adverbs form 3.9 per cent of the different adjectives and adverbs, but 48 per cent of the total.

An examination of the origin of the words in Table V shows that the influence of Latin on the frequently used words is largely confined to nouns. Eleven of the first 25 nouns of telephone conversation, and eight of the first 25 nouns of written English come from the Latin. Among the first 25 telephone nouns, aside from the eight nouns mentioned above among the first 100 words, there are: "office," "market" and "case"; among the first 25 nouns of written English the following are of Latin origin: "people," "country," "part," "fact," "cent," "power," "present" and "peace." Only one of the first 25 telephone verbs comes from Latin: "try," and three of those in written English: "use," "govern" and "save." Among the adjectives and adverbs there are found in the telephone list: "just," "very" and "fine," as above, and in the written English list the word "just" is added to "very," which was in the first 100 words.

Referring once more to the small number of different words found it may be pointed out that this shows how difficult it would be to estimate the size of vocabularies by recording spoken words. The 80,000 words of this study are equivalent to a complete record of seven hours' conversation, taking a rate of 200 words per minute. As noted before, the number of different words was only 2,240, even though the conversations covered a wide range of topics by many different speakers. To increase this number notably, the curves of Figure 1 indicate that the observations would need to be very extended, since the rate at which new words appear has already become very low. For example, if the conversations were to go on continuously for a week at the above rate a total of 2,000,000 words might be expected. By extrapolating the curves of Fig. 1, and using a similar curve for adjectives and adverbs, which lies between the curves shown, it may be estimated that only about 5,000 of these words would be different words. Extrapolation is a rough tool, but even with its inaccuracies in mind, the conclusion seems safe that to measure a vocabulary by recording spoken words involves the risk of gross underestimation unless the observations are exceedingly prolonged.

It is suggested that teachers of languages may find the 737 words in Tables III-*a* and III-*b* to be of practical use in their profession. Presumably the progress of a student in speaking a foreign language would be materially assisted by a thorough knowledge, early in his course,

of the words which are met with great frequency. The present methods of teaching the spoken language no doubt approximate to this, as a result of experience. It is suggested that the present word list, which contains the words used so frequently as to form 96 per cent of the total number observed in this study, provides a guide for the selection of important words to be taught. Additions are needed to the list as it stands, in order to care for certain obvious situations not encountered in telephone conversation concerning, for example, hotels, restaurants and trains. With these points in mind, the list given has the advantage of being founded on a study of actual conversation.

SYLLABLES

As a preliminary to analysis of the words into their component sounds the words were divided into syllables. With regard to the fact that the study concerned conversation the division was made on phonetic lines, which, as unabridged dictionaries show, differ from the orthographical divisions. Likewise a few words such as "every," "preference," "average" and the like were divided into two syllables, according to the usual colloquial pronunciation.

TABLE VI  
THE SYLLABIC STRUCTURE OF CONVERSATIONAL VOCABULARY

Parts of Speech	Per Cent of Words Having Number of Syllables Shown						Average Number of Syllables
	1	2	3	4	5	6	
Nouns.....	53.3	33.8	9.7	2.7	0.47	0.03	1.63
Verbs.....	81.9	15.0	2.8	0.3	—	—	1.21
Adjectives and Adverbs.....	57.8	30.7	8.0	2.8	0.66	0.02	1.58
Minor.....	94.8	4.7	0.6	0.1	—	—	1.06
All Words.....	82.0	13.8	3.2	0.86	0.15	0.01	1.23

In Table VI a summary is given of the syllabic structure of words, based on the total occurrence of the words. It may be noticed that words longer than two syllables make up only a trifle more than 4 per cent of the words observed. Nouns tend to be more polysyllabic than other classes, but even so the nouns having more than two syllables occur so infrequently as to form only 13 per cent of all the nouns observed.

The types of phonetic syllables which are found range in complexity from a single vowel through various combinations of consonants with a vowel. The relative number of the different types is shown in Table VII. The letters V and C represent "vowel" and "consonant,"

TABLE VII  
 TYPES OF PHONETIC SYLLABLES IN TELEPHONE CONVERSATION  
*Relative Occurrence per Hundred*

Type	Occurrence
V	9.7
VC	20.3
CV	21.8
CVC	33.5
VCC	2.8
CCV	0.8
CVCC	7.8
CCVC	2.8
CCVCC	00.5
	100.0

respectively, and the letters CC are used to denote a compound consonant form, that is, two or more consecutive consonants. It may be seen that the typical syllable is of the CVC type, closely followed in importance by the CV and VC types. The syllables having two or more consecutive consonants form about one seventh of the total.

#### SPEECH SOUNDS

The analysis of the words into their constituent sounds was attended by certain difficulties which should be borne in mind in considering the tables which follow. It was not feasible to record the original words phonetically, just as they were pronounced by the telephone subscriber. Instead the words were recorded and their phonetic values assigned later. In so doing the dictionary was not adopted as an authority for the pronunciation since in the informality of conversation, even among educated persons, there are elisions and changes of stress which cause departures from the dictionary standard. Certain very common words, for example, receive various treatments in conversation, depending on their situation in the sentence, the emphasis desired and the speed of talking. The word "and" may be pronounced as spelled, but quite often it is reduced to "nd" or even "n." The prepositions "to" and "of" are similarly varied. Altogether about 40 common words were found, of this type, each of which seemed subject to several different pronunciations, even in speech which would not be regarded as unduly careless. These were all from the minor classes: auxiliary verbs, pronouns, prepositions and conjunctions. The modification, in general, is such as to give the vowel its unstressed value. In the analysis these different forms are included, the weighting for each modification necessarily being a matter of judgment. The remaining words were each assigned a single pronunciation, selecting that which we regarded as being the typical pronunciation

heard in reasonably enunciated conversation among educated persons in New York. The departures from dictionary standards are largely confined to the vowels. As a result the analysis is affected to some degree by the speech habits of the writers.<sup>3</sup> It is regrettable that some arbitrariness should be introduced, but this seems to be a difficulty common to discussions of vowel sounds. Some of the difficulty is avoided by making separate classifications for vowels for which the pronunciation is indefinite, such as the vowels in unstressed positions. The articles "the," "a" and "an" were omitted entirely from the analysis on account of the large number of variant pronunciations to which they are subject.

The results of the analysis into speech sounds are shown in Table VIII. Three divisions are given: vowels, initial consonants and final consonants, based on the division into phonetic syllables. The method followed was: first, to divide the words into phonetic syllables, second, to assign phonetic symbols to the sounds and third, to weight each sound by the total number of times the word was recorded. The sounds are identified in the table, where necessary, by key words.

No difficulties were encountered in analysis of the consonants, but a few special points which arose in assigning the vowel qualities may be noted. The key word "pot" is used to denote a vowel sound which is pronounced differently by many natives of New England and those whose habits of speech were formed elsewhere.<sup>4</sup> With these New Englanders the sound tends toward the quality of the vowel in "pawm," although shorter in duration. The same New Englanders make a real distinction between the vowel of "pot" and the vowel of "palm." By many speakers elsewhere no such distinction is made and the two are lumped into a single intermediate sound which is neither the New Englander's "pot" nor "palm." To avoid confusion the class denoted by "pot" has been made to include "not" and many other monosyllables of the same ending, as well as "on," "job," "stock," etc., which grouping is believed to be homogeneous on either basis. The few words of the class of "palm" which were encountered have been included under "par." The class denoted by "par" may be subdivided into: "par," 1.24; "palm," 0.07. The class denoted by "palm" would be somewhat larger if the class which we may denote by "path," such as "can't," "last," "ask," etc., had not been classified under

<sup>3</sup> For the benefit of phoneticians who may be interested it may be stated that the writers are residents of Greater New York of more than six years' standing, that their boyhoods were spent in Maine, Illinois and New Jersey, respectively, and their college years at Maine and Princeton, Harvard and Oxford, New York University and Harvard, respectively; this seems a background sufficiently varied to bring to light many of the principal variants of American speech.

<sup>4</sup> Just what the geographical lines may be, the writers do not pretend to know. A phonetic map would be of interest.



cerning the quality of a vowel which precedes "r." Likewise it was found expedient to make a number of classifications of vowels in unaccented positions.

Since the figures of Table VIII are likely to find application as weighting factors it is convenient to have them add exactly to 100 per cent, consequently they are given to two places of decimals. An estimate of the representativeness of these figures may be obtained from the data presented in Table IX, which were worked out from

TABLE IX  
COMPARISON WITH CHECK TEST  
*Relative Occurrence of Consonants in Verbs*

Sound	First Observations	Check Test	Difference	Sound	First Observations	Check Test	Difference
B	1.02	1.02	.00	S	10.31	9.67	-.64
D	4.46	4.83	+.37	T	16.97	17.39	+.42
F	1.73	2.18	+.45	V	2.36	2.20	-.16
G	11.15	9.40	-1.75	W	4.87	4.54	-.33
H	1.40	1.66	+.26	Y	.55	.53	-.02
J	.22	.23	+.01	Z	1.09	1.44	+.35
K	8.90	8.74	-.16	CH	.32	.75	+.43
L	7.70	7.94	+.24	SH	1.35	1.17	-.18
M	4.45	3.96	-.49	TH'	2.53	2.85	+.32
N	6.87	7.10	+.23	TH''	.05	.06	+.01
P	3.34	3.47	+.13	ZH	.00	.00	.00
R	3.97	3.88	-.09	NG	4.39	5.00	+.61
					100.00	100.00	

observations mentioned before, conducted by a different observer at a different time, but on the same set of toll circuits. Records were made only of verbs, and for 250 instead of 500 conversations. The vocabulary collected in the check test resembled that of the first observations closely. Arranging the words in the order of occurrence, the first 17 words of the first observations are also the first 17 of the check test, although the order is not repeated exactly. In the first observations the first few words run: "get," "know," "see," "want," "go," "tell," "think" and "say"; in the check test the order is: "get," "see," "know," "want," "tell," "think," "go" and "say." Table IX shows the analysis of the words as to the simple consonants, lumping initial and final consonants together. Only one of the differences is greater than 1 per cent and all but three are less than 0.5 per cent. One check test is not sufficient for a final statement, but judging by these results the observing method and the samples taken seem to justify considering the figures of Table VIII as representative as far as the figures in the

digits position for most of the sounds and as to order of magnitude for the infrequent sounds.

The effects of restricting the word list in various ways are shown in Figure 3. The first line shows graphically the relative occurrence per

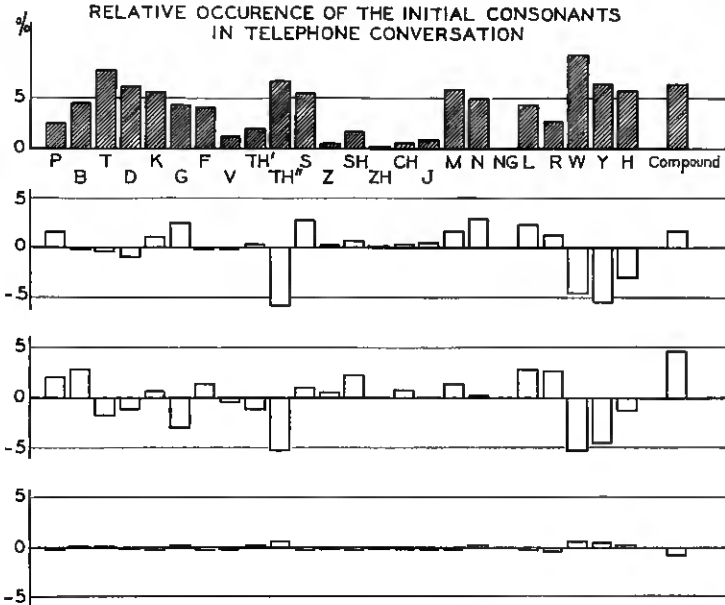

Fig. 3—The relative occurrence of initial consonants—effects of restricting the word list.

Line I—Relative occurrence of initial consonants for all words.

Line II—Differences resulting from omission of minor parts of speech (118 words).

Line III—Differences resulting from omission of the 100 commonest words.

Line IV—Differences resulting from omission of the 1,500 least common words.

hundred for initial consonants as in Table VIII. If the minor parts of speech are excluded before the analysis, which eliminates only 118 different words, but nearly half the total words, the resulting changes are shown on the second line. Notable decreases occur for "th," "w" and "y," which may largely be traced to the omission of "that," "they," "this," etc.; "will," "with," "would," etc.; and "you," respectively. These elisions enhance the relative contributions from "get," "see" and "know." When the 100 most common words are omitted there are also large changes, as shown by the third line. Since 50 of the 100 most common words are of the minor parts of speech the similarity of this line to the second is not surprising. The omission, on the other hand, of the 1,500 least common words, namely, those omitted from the vocabulary of Table III, changes the distribution by negligible amounts as shown in the fourth line. Since, then, the 737



commonest words seem to determine the relative frequency of the sounds of conversation, the writers are encouraged to believe that if this study were repeated on telephone calls of which a greater proportion were social rather than business in nature the analysis into sounds would be changed very little. Likewise the conclusion is drawn that if the study were prolonged tenfold so as to double the number of different words no material change in the relative frequency of the sounds would be found.

TABLE X

RELATIVE OCCURRENCE OF SPEECH SOUNDS IN TELEPHONE CONVERSATIONS  
*Nouns, Verbs, Adjectives and Adverbs*

<i>Vowels</i>		<i>Initial Consonants</i>		<i>Final Consonants</i>	
pen.....	10.63	S.....	8.34	r.....	14.64
pin.....	7.56	N.....	7.94	t.....	13.53
pane.....	7.19	T.....	7.55	n.....	9.99
pole.....	6.38	M.....	7.40	l.....	8.62
pawn.....	5.96	G.....	6.87	ng.....	5.10
peel.....	5.78	K.....	6.70	k.....	4.96
pine.....	5.40	L.....	6.65	m.....	4.50
pun.....	5.25	D.....	5.25	s.....	3.89
pot.....	4.59	W.....	4.86	d.....	3.66
pan.....	4.01	B.....	4.38	z.....	2.42
pull.....	2.49	R.....	4.11	p.....	2.00
pout.....	1.83	P.....	4.06	v.....	1.94
pair.....	1.58	F.....	3.88	f.....	1.28
par.....	1.53	SH.....	2.42	th''.....	.82
pool.....	1.39	TH'.....	2.41	ch.....	.81
purrr.....	1.33	H.....	2.38	b.....	.73
pew.....	.49	J.....	1.33	g.....	.66
poise.....	.35	Y.....	1.25	sh.....	.57
		V.....	1.21	j.....	.24
	73.74	TH''.....	.97	th'.....	.07
		CH.....	.87	zh.....	.02
<i>Unaccented Vowels</i>		Z.....	.55	h.....	—
differ.....	5.79	ZH.....	.03	w.....	—
receive.....	5.73	NG.....	—	y.....	—
possible.....	4.82				
about.....	3.96		91.86		80.45
wanted.....	2.54	<i>Compounds</i>		<i>Compounds</i>	
people.....	1.76	PR.....	1.69	nt.....	3.37
notion.....	1.66	ST.....	1.39	st.....	2.07
	26.26	TR.....	1.11	nd.....	1.66
		PL.....	.58	nk.....	1.32
	100.00	HW.....	.49	ld.....	1.31
Total number... 50,161		KW.....	.44	rz.....	.98
		BL.....	.37	ks.....	.82
		SP.....	.30	kt.....	.73
		KL.....	.29	rd.....	.64
		GR.....	.27	ns.....	.54
		Others.....	1.21	Others.....	6.11
			8.14		19.55
			100.00		100.00
			40,107		37,493



nection with Fig. 3, line 2. The vowel weighting reflects the enhanced importance of the "e" in "pen" from the verbs "get," "tell," "send" and shows a considerable reduction in the vowel in "pool," largely from the loss of "you" and "to." The unstressed vowels, especially as in "about" are also diminished. Among the final consonants the largest change is a reduction in "z," which results from the elimination of "is," "was," "as," etc. Comparing the distributions of Table VIII and Table X as a whole, however, both show about the same degree of non-uniformity; the maximum and minimum weightings do not differ greatly.

One more type of analysis is given in Table XI. In this case the sounds of each word are weighted by the number of conversations in which the word occurred, instead of by the total number of times the word was used. This seems to be a somewhat radical change in method, involving, as it does, a considerable reduction in the weighting of the words at the head of the list. When the effect of eliminating the first 100 words entirely, shown in Fig. 3, line 3, is recalled, large changes might be expected. Actually the result is remarkably similar to the figures of Table VIII. The relatively diminished importance of "you" and "to" is seen in the vowel list, of "you" again among the initial consonants, and of "it," "that" and "get" in the list of final consonants. The range covered by the relative weightings is still much the same as in Tables VIII and X.

#### COMPARISONS WITH WRITTEN ENGLISH

Some of the differences between the vocabularies of telephone conversation and written English have been pointed out. The effects of these differences may be seen in the relative occurrence of the sounds as shown by Figures 4, 5 and 6 for vowels, initial consonants and final consonants, respectively, using the analysis based on all the words (except articles). The upper line in each case is a graphical representation of the corresponding data of Table VIII, after certain changes have been made to put them on the same basis as the tables given by Dewey for written English. In the case of the consonants the only change needed was omission of the compound consonants. In the case of the vowels it was necessary to combine some of our classifications, since Dewey made but 17 distinctions among the vowels. We believe the combinations made are those followed by Dewey himself, as ascertained from examples given by him in his text. The phonetic symbols given in Figure 4 are those used by him. The combinations made were as follows: "pen" and "wanted"; "pane" and "pair"; "pin," "possible" and "receive"; "pun" and "purr"; "about," "differ," "people"

and "notion." The comparisons are made with Table XVI of Dewey's book, which does not include "the," and from which we have subtracted the article "a."

The outstanding differences between the vowel frequencies in telephone conversation and written matter are the excess in conversation of "about," "pine," "pool" and the deficiencies in "pan," "pin"

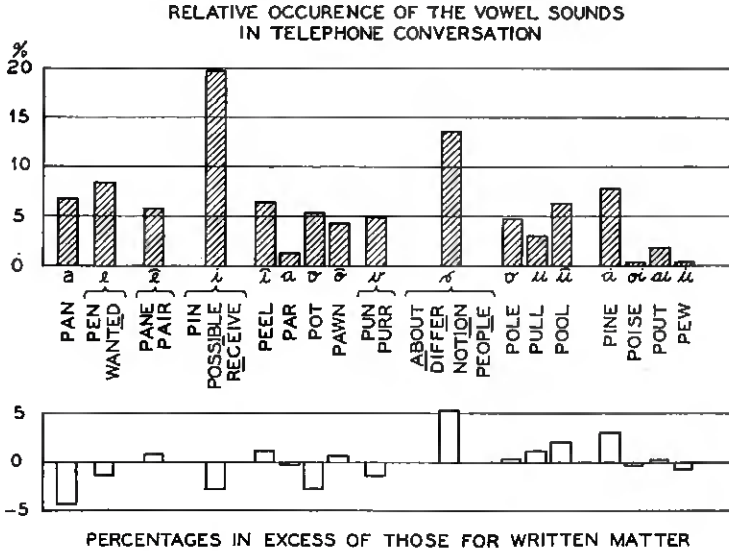

Fig. 4—Comparison with written English—relative occurrence of the vowels.

and "pot." The greater occurrences of "pine" and "pool" are almost entirely accounted for by the greater use of the words "I" and "you." The deficiencies mentioned do not, on analysis, seem to depend on one or two words, but rather on the whole vocabulary, except that of the increase in the unstressed vowel denoted by "about" nearly 1.7 per cent comes from the vowels of words which in the study of written English were classified under "pan."

Among the initial consonants (Fig. 5) the greatest change is in the occurrence of "y," which is much more frequent in conversation. This again is largely caused by the pronoun "you." Much of the increase in "g" may be traced to the greater use of "get" and "go." The sounds "w" and "t" are the most frequent sounds in written English, as well as in conversation.

Figure 6 shows that in the case of the final consonants the sounds "t" and "l" are notably more frequent in conversation than in written

matter. The increase in "t" arises almost entirely from "that," "it" and "get" which combined have a contribution about 4.9 per cent larger in conversation than in written matter. About half the increase

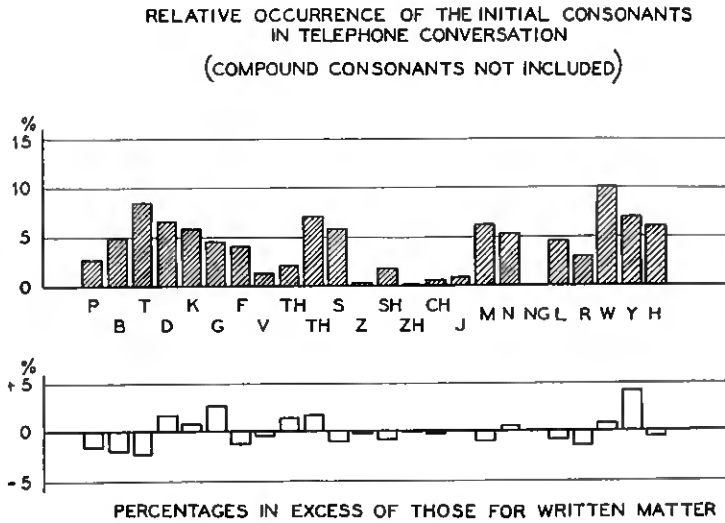

Fig. 5—Comparison with written English—relative occurrence of the initial consonants.

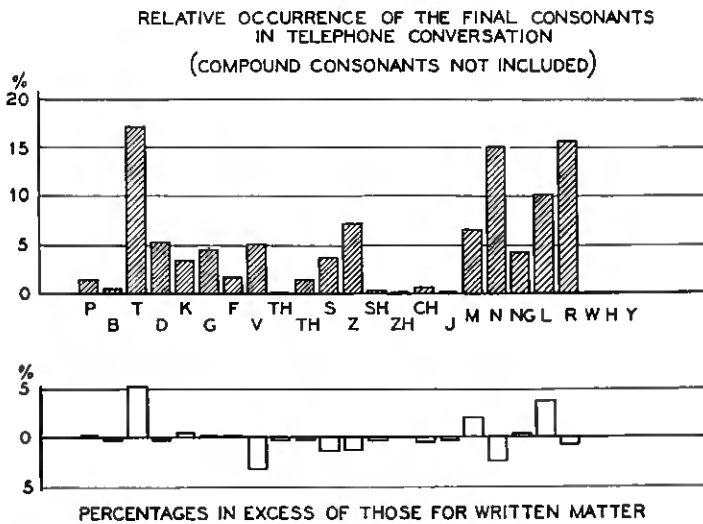

Fig. 6—Comparison with written English—relative occurrence of the final consonants. in "l" is attributable to the words "will" and "tell." Some of the deficiency in "v" may be traced to the word "of" which has a contribution 1.8 per cent greater in written matter. On the other hand the

words "have" and "give" together contribute 1.1 per cent more to conversation, so that the net difference in "v" is to be traced to small accretions from the whole vocabulary rather than a few specific words.

#### RELATIVE OCCURRENCE OF COMBINATIONS OF SOUNDS

A more elaborate analysis of the phonetic syllable is given in Table XII, which shows, for each vowel, the frequency of occurrence of the consonants preceding the vowel and also of the consonants which follow the vowel. The complete word list (except articles) was used as a basis. The cases in which no consonant occurs in front of the vowel are included, as well as the cases in which there is no following consonant. These figures are shown as a double column under the key word denoting the vowel sound. In each double column the figures on the left apply to initial consonants and on the right to final consonants. The figures are given in per cent, so that each column adds to 100. The consonants are grouped by phonetic classes. The table is to be read as follows: of the syllables in which the vowel sound is that in "pan," 28 per cent begin with "th" (as in "that"), 26 per cent have no initial consonant, 16 per cent begin with "h," 7 per cent with "k," 6 per cent with compound consonants, 5 per cent with "b," etc.; while 29 per cent end with compound consonants, 27 per cent with "t," etc. Where no figure is entered the occurrences were less than 0.5 per cent; where a dash is shown no combinations of the kind indicated were observed. If the figures are taken by rows instead of columns no meaning can be attached to them before they are multiplied by the relative occurrence of the different vowels.

In studying this table it is to be remembered that because the different vowels have very different frequencies of occurrence the subdivided data shown in different columns cannot be considered as equally representative. Syllables having the vowel as in "pin," for example, were present, as shown in Table VIII, to the number of  $0.1027 \times 92,522$ , or 9,500. The syllables in this class which begin with "t" are shown in Table XII to be 1 per cent, representing 95 occurrences. In the class having the vowel of "poise," however, there were only 176 examples, so that the 37 per cent of these syllables beginning with "p" result from only 65 occurrences.

It is to be seen that only one vowel, "pool," is preceded by a particular sound more than 50 per cent of the time, this sound naturally being "y." Six vowels are preceded by particular sounds more than 25 per cent of the time. The sounds of "pair," "purr," "par" and "differ" must be followed by "r," a blank, or a compound consonant beginning with "r," as a result of the way in which the analysis was

	PEEL	PIN	PANE	PAIR	PEN	PAN	PURR	PUN	PAR	POT	PAWN	POLE	POOL	PULL	PEW	POISE	POUT	PINE	RE- CEM- EABLE	POSS- IBLE	WANT- ED	DIFF- ER	ABOUT	PEO- PLE	NO- TION
P	2	3	1	1	1	1	8	7	2	2	2	1	7	1	1	37	3		3	2	3	8	4	1	P
T	1	3	4	9	4	4	3	3	4	4	6	1	17	25	3	2	4	11	9	2	3	17	1	1	T
k	1	19	4	24	7	27	1	15	25	4	16	4	7	7	6	2	40	11	1	5	22	1	5	1	K
B	4	4	4	4	3	5	1	15	2	2	7	3	7	5	5	2	2	2	9	1	4	4	2	2	B
D	3	4	1	4	4	5	1	2	1	2	1	1	2	2	22	31	2	9	1	2	10	1	2	1	D
G	2	6	5	3	1	5	1	3	12	12	15	2	7	35	5	1	3	9	1	14	1	2	1	1	G
F	1	2	1	2	2	1	21	1	4	3	15	2	4	28	1	1	5	1	1	3	11	1	1	1	F
TH	1	1	1	1	1	1	1	1	1	1	1	1	1	1	1	1	1	1	1	2	1	1	1	1	TH
S	15	2	5	10	4	2	11	6	2	2	1	4	2	1	1	5	3	4	2	1	3	1	3	2	S
SH	3	3	2	3	2	1	1	1	1	1	1	1	1	6	1	1	1	1	1	1	1	1	2	1	SH
CH	1	2	1	2	1	1	1	1	2	1	1	1	1	3	3	1	1	1	1	1	1	1	4	2	CH
V	3	4	2	27	4	26	1	17	1	1	1	1	1	1	1	6	1	1	1	1	6	15	1	1	V
TH	1	3	3	17	9	1	1	7	1	1	4	1	1	1	1	1	1	1	1	4	5	1	1	1	TH
Z	2	5	1	1	1	1	1	4	1	1	2	6	1	3	5	7	1	1	1	1	16	23	1	2	Z
ZH	1	1	1	1	1	1	1	1	1	1	1	1	1	1	1	1	1	1	1	1	1	1	1	1	ZH
J	1	1	1	1	1	1	1	1	1	1	1	1	1	1	1	1	1	1	1	1	1	1	3	1	J
M	13	3	10	7	1	2	1	11	15	14	2	2	1	1	2	1	4	6	1	16	1	1	2	1	M
N	1	5	2	1	2	7	1	24	3	1	1	1	2	1	42	3	22	4	6	4	1	1	5	1	N
NG	1	3	16	2	1	15	6	4	9	21	6	1	3	3	1	4	4	1	1	7	9	2	4	17	NG
L	2	4	7	4	3	2	1	1	1	4	4	1	1	4	1	1	1	1	1	15	2	1	1	1	L
R	2	4	8	3	9	2	1	1	1	5	3	3	3	4	1	22	4	7	12	13	5	1	9	1	R
W	10	1	3	3	1	1	37	4	72	13	42	1	1	12	2	1	2	1	1	16	1	4	1	1	W
Y	22	10	9	2	3	1	1	1	1	1	1	1	62	6	1	1	1	1	1	1	1	1	1	1	Y
H	24	4	1	2	16	1	8	1	4	6	1	2	1	1	1	1	1	1	1	1	1	1	1	1	H
BLANK	39	3	2	15	26	1	5	28	39	46	29	15	87	5	20	18	58	36	56	48	47	56	68	75	BLANK
COMPOUND	1	61	52	7	3	20	63	12	16	15	3	9	3	3	88	22	36	54	98	12	3	4	66	1	COMPOUND
COMPOUND	5	4	9	6	4	29	29	16	23	9	26	3	3	2	2	43	10	6	4	1	1	9	1	9	COMPOUND

TABLE XII  
DISTRIBUTION OF CONSONANTS PRECEDING AND FOLLOWING EACH VOWEL SOUND



made, similarly for the "l" of "people" and the "n" of "notion." Aside from these no single consonant occurs as often as 50 per cent of the time after a particular vowel. With five vowels a particular consonant ends the syllable more than 25 per cent of the time. In nearly every case the most frequent combinations can be traced directly to the first 50 words of the vocabulary. Five vowels are preceded by blanks more than 50 per cent of the time and eight are followed by blanks in more than 50 per cent of the cases. The combinations of different vowels with compound consonants vary considerably in importance, ranging in the final position from practically none with the vowel of "pew" up to the vowel of "pun," which is terminated by a compound consonant 63 per cent of the time.

#### CONCLUSION

In concluding, a brief review is presented of the main points of interest. The paper has for its basis a list of 80,000 words obtained from telephone conversations. This list has been studied with respect to the number of different words contained in it, the relative occurrence of the different speech sounds and the combinations of sounds which form syllables. In so far as the authors know this is the first study of this type based on conversations as contrasted with written matter.

Perhaps the most striking aspect of the word list is the small number of different words contained in it, only 2,240 out of the total of 80,000. Of these 2,240 words 819 occur only once. The balance, or 1,421 words, constitute practically 99 per cent of the total words recorded; of these the 121 different words which constitute the minor parts of speech form 45,000 of the total occurrences. The pronouns "I" and "you" together occur over 7,500 times.

This intensiveness with which a small number of words is used in conversation is considerably greater than in the written English analyzed by Dewey. In conversation the 155 most frequently used words make up 80 per cent of the total occurrences; to reach the same percentage in the written English analyzed by Dewey 640 words must be included. The frequently used words of conversation are characterized, as compared with written English, by the greater prominence of certain active verbs, such as "get," "see," "know," etc., 12 of which occur in the first 50 words of conversation, while there are none in the first 50 words of written English. The most frequent words of conversation differ from written English also in the greater number of words of Latin origin which appear frequently in conversation: 11 from the first 100 of the list for conversation, as compared with two from the first 100 of written English.

The word list is characterized by a large percentage of monosyllables. Over four fifths of the 80,000 occurrences are of this type, a result largely brought about by the frequent repetition of the minor parts of speech, among which 95 per cent are monosyllables. When the words are analyzed into phonetic syllables about one fifth are found to be of the type vowel-consonant, about one fifth consonant-vowel, and a third of the type consonant-vowel-consonant.

The relative occurrences of the different speech sounds were obtained by assigning phonetic values to the sounds of the phonetic syllables and weighting each by the total number of times it was used. Twenty-five categories are used for the vowels. Seven of these are for vowels in unaccented positions, which make up, altogether, about 25 per cent of the vowels. The relative occurrences of the individual sounds differ greatly for different vowels. The range extends from about 10 per cent for the vowel of "pin," and about 8 per cent for the vowel of "pine," down to 0.3 per cent for "pew" and 0.2 per cent for "poise." Among the initial consonants 94 per cent are single sounds, and the remaining are compounds of two or more successive consonants. The range extends from about 9 per cent for "w," and about 8 per cent for "t" down to about 0.3 per cent for "z" and the slightest trace, .02 per cent for "zh." The most frequent compound initial consonant is "pr," with an occurrence of 1 per cent. Among the final consonants the compounds are somewhat more prominent, forming 16 per cent. The most frequent final consonant is "t," 14 per cent, the next is "r," 13 per cent, the range extending down to 0.1 per cent for "zh." The most frequent compound final consonant is "nt," 4.4 per cent, and the next is "nd," 2.6 per cent.

Considering the marked differences between the word lists for conversation and for written English, a comparison of the relative frequency of the speech sounds in the two cases is perhaps more remarkable for the likenesses than the differences. About the same range of percentages is covered in both cases. Certain sounds do show marked differences. Among the vowels the unaccented vowel denoted by "about" is more frequent in conversation and the vowel of "pan" less frequent. The initial "y" and the final "t" are also more frequent in conversation. Many of the differences can be traced directly to one or two words which in their frequent use are typical of conversation.

In considering the occurrence of speech sounds in telephone conversations from the point of view of their contribution to the ease or difficulty of carrying on conversations it seemed of interest to determine how the occurrence of the speech sounds was affected by changing the list in certain ways. Omission of the minor parts of speech changes the

relative occurrence of a number of the sounds materially, although the general range of percentages covered is changed very little. Omission of the 1,500 least common words has a negligible effect. When the words are weighted by the number of conversations in which they occurred, out of 500, instead of by their total occurrence, the effect on the distribution of sounds is surprisingly small, considering the radical change in method.

While the analysis into speech sounds for purposes connected with the design of telephone circuits was the real goal of this study, it is hoped that the information concerning both words and sounds will be of service also to those working in the fields of phonetics and philology.

## The Reciprocal Energy Theorem

By JOHN R. CARSON

This paper gives a simple theorem determining relative transmission efficiencies in a two-way transducer, and showing that the conditions for equal efficiencies of transmission in the two directions are simply those for maximum output and maximum reception of energy. The theorem is then applied to radio communication and a second theorem stated and proved by which the ratio of the transmitting efficiencies of any two antenna systems is expressed in terms of their receiving efficiencies. The paper closes with a mathematical note on a generalization of Rayleigh's Reciprocal Theorem.

**T**HE Reciprocal Theorem, originally enunciated by Rayleigh, which has proved so useful to communication engineers, may be stated, with sufficient generality for engineering purposes, as follows:

*Let an e.m.f.  $E_1'$ , inserted in any branch, designated as No. 1, of a transducer,<sup>1</sup> produce a current  $I_2'$  in any other branch No. 2; correspondingly let an e.m.f.  $E_2''$  inserted in branch No. 2 produce a current  $I_1''$  in branch No. 1; then*

$$I_1''E_1' = I_2'E_2''$$

and when  $E_1' = E_2''$  the currents in the two branches are equal.

The engineer, however, is primarily interested in energy rather than current relations, whereas the theorem says nothing explicitly regarding energy relations and relative efficiencies in two-way transmission. It is, however, a simple matter to deduce from it quite general and useful formulas relating to relative transmission efficiencies. In the present paper there will be formulated and proved a reciprocal energy theorem for the general transducer, after which it will be applied to the question of antenna transmission efficiency in radio communication.

Consider a transducer having two sets of accessible terminals 1,1 and 2,2. With terminals 2,2 closed by an impedance  $z_2 = r_2 + ix_2$ , let the driving point impedance, as measured from terminals 1,1 be denoted by  $Z_{11} = R_{11} + iX_{11}$ ; similarly with terminals 1,1 closed by an impedance  $z_1 = r_1 + ix_1$ , let the driving point impedance, as measured from terminals 2,2 be denoted by  $Z_{22} = R_{22} + iX_{22}$ . Now with the terminals closed by the impedances  $z_1$  and  $z_2$ , let an e.m.f.  $E_1$  be inserted in series with the terminal impedance  $z_1$ ; then the current  $I_{11}$ , delivered to the transducer at the sending terminals 1,1 is

<sup>1</sup>A transducer is defined as a complete transmission system which may or may not include a radio link, which has two accessible branches, either of which may act as the transmitting branch while the other acts as the receiving branch. These branches may be designated as operating branches.

$$I_{11} = \frac{E_1}{Z_{11} + z_1} \quad (1)$$

and the current  $I_{12}$ , received by the terminal or load impedance,  $z_2$ , is given by

$$I_{12} = \frac{E_1}{Z_{12}} \quad (2)$$

Here  $Z_{12}$  is the transfer impedance of the transducer for the specified terminations.

The power  $P_{11}^0$  developed by the generator of e.m.f.  $E_1$  is

$$P_{11}^0 = (R_{11} + r_1) |I_{11}|^2 = \frac{R_{11} + r_1}{|Z_{11} + z_1|^2} E_1^2 \quad (3)$$

The power  $P_{11}$  delivered to the transducer is

$$P_{11} = R_{11} |I_{11}|^2 = \frac{R_{11}}{|Z_{11} + z_1|^2} E_1^2 \quad (4)$$

and the power  $P_{12}$  delivered to the load impedance  $z_2$  is

$$P_{12} = r_2 |I_{12}|^2 = \frac{r_2}{|Z_{12}|^2} E_1^2 \quad (5)$$

Now reverse the direction of transmission; that is insert an e.m.f.  $E_2$  in series with the terminal impedance  $z_2$ ; corresponding to equations (3)–(5) we have then

$$P_{22}^0 = \frac{R_{22} + r_2}{|Z_{22} + z_2|^2} E_2^2 \quad (6)$$

$$P_{22} = \frac{R_{22}}{|Z_{22} + z_2|^2} E_2^2 \quad (7)$$

$$P_{21} = \frac{r_1}{|Z_{21}|^2} E_2^2 \quad (8)$$

As a consequence of the Reciprocal Theorem the transfer impedances are equal; that is

$$Z_{21} = Z_{12} \quad (9)$$

From the preceding we get at once the following expressions for the ratios of the powers delivered to the load impedances;

$$\frac{P_{12}}{P_{21}} = \frac{r_2}{r_1} \left( \frac{E_1}{E_2} \right)^2$$

$$= \left( \frac{r_2}{r_1} \right) \left( \frac{R_{22} + r_2}{R_{11} + r_1} \right) \left| \frac{Z_{11} + z_1}{Z_{22} + z_2} \right|^2 \frac{P_{11}^0}{P_{22}^0} \quad (10)$$

$$= \left( \frac{r_2}{r_1} \right) \left( \frac{R_{22}}{R_{11}} \right) \left| \frac{Z_{11} + z_1}{Z_{22} + z_2} \right|^2 \frac{P_{11}}{P_{22}}. \quad (11)$$

From (10) it follows that for equal total generated powers, the relative transmission efficiency in the two directions is given by

$$\eta^0 = \frac{P_{12}}{P_{21}} = \left( \frac{r_2}{r_1} \right) \left( \frac{R_{22} + r_2}{R_{11} + r_1} \right) \left| \frac{Z_{11} + z_1}{Z_{22} + z_2} \right|^2, \quad (12)$$

while on the basis of equal powers delivered to the transducer, the relative transmission efficiency is, by (11)

$$\eta = \frac{P_{12}}{P_{21}} = \left( \frac{r_2}{r_1} \right) \left( \frac{R_{22}}{R_{11}} \right) \left| \frac{Z_{11} + z_1}{Z_{22} + z_2} \right|^2. \quad (13)$$

Now in correctly designed communication transmission systems, the terminal impedances are so proportioned with reference to the characteristics of the transducer itself as to secure maximum output and maximum transfer of power from generator to load; the required condition is that the terminal impedances  $z_1$  and  $z_2$  be the 'conjugate image impedances' of the transducer; analytically stated

$$z_1 = R_{11} - iX_{11} \quad \text{and} \quad z_2 = R_{22} - iX_{22}.$$

Introducing these relations into (12) and (13), we have

$$\eta^0 = \eta = 1 \quad (14)$$

and the relative transmission efficiencies are the same in the two directions. We thus have the following propositions:—

*If a transducer is terminated in its conjugate image impedances—the condition for maximum output and maximum transfer of power—the efficiency of transmission is the same in the two directions.*

We shall now apply the preceding to the derivation of a simple formula which enables us to determine the relative transmission efficiencies of any two long wave radio antennas.<sup>2</sup>

Consider any antenna, designated as No. 1, and let it be acting as

<sup>2</sup> As pointed out in the paper on "Reciprocal Theorems in Radio Transmission," *Proc. I. R. E.*, the Reciprocal Theorem does not hold rigorously in radio transmission if the earth's magnetic field plays an appreciable part in the transmission phenomena. Consequently the formula and proposition which follow apply rigorously only to long wave transmission; they are probably, however, approximately correct for short wave transmission except in the neighborhood of the critical wave-length 214 meters. See a paper by Nichols and Shelling, "Propagation of Electric Waves over the Earth," *B. S. T. J.*, April 1925.

a transmitter to a reference antenna, designated as No. 3, which is located at any desired point 3. Let  $E_{13}$  denote the intensity of the (vertical) electric field produced at point 3 by antenna No. 1. Then the current induced in the receiving branch of No. 3 will be  $\alpha_3 E_{13}$ , the parameter  $\alpha_3$  being the receiving sensitivity of antenna No. 3. The power  $P_{13}$  transferred from 1 to 3 is then

$$P_{13} = r_3 \alpha_3^2 E_{13}^2,$$

where  $r_3$  is the equivalent resistance of the receiving branch of antenna No. 3.

Now reverse the direction of transmission; we have

$$P_{31} = r_1 \alpha_1^2 E_{31}^2.$$

We now suppose that the terminal impedances are adjusted for maximum output and maximum transfer of power and that the power  $P_{11}$  developed by No. 1 when transmitting is equal to the power  $P_{33}$  developed by No. 3 when transmitting. Then it follows at once from the reciprocal energy theorem, that  $P_{13} = P_{31}$ , and

$$\left( \frac{E_{13}}{E_{31}} \right)^2 = \frac{r_1 \alpha_1^2}{r_3 \alpha_3^2}.$$

Now replace antenna No. 1 by any other antenna, designated as No. 2; we then have from the foregoing

$$\left( \frac{E_{23}}{E_{32}} \right)^2 = \frac{r_2 \alpha_2^2}{r_3 \alpha_3^2}.$$

By virtue of the terminal impedances specified,  $r_1 = R_1$  and  $r_2 = R_2$  where  $R_1$  and  $R_2$  are the resistances of the two antennas as measured from their operating terminals. Consequently, since  $E_{32} = E_{31}$ , we have

$$\left( \frac{E_{13}}{E_{23}} \right)^2 = \eta_{12} = \frac{R_1 \alpha_1^2}{R_2 \alpha_2^2} = \frac{R_1 h_1^2}{R_2 h_2^2},$$

where  $h_1$  and  $h_2$  are the equivalent heights of the two antennas.

The ratio  $\eta_{12}$  will be termed the 'relative transmission figure of merit' of the two antennas No. 1 and No. 2 with respect to transmission between any two specified points. For directional antennas, the parameters  $\alpha_1$  and  $\alpha_2$  will depend on the direction of transmission; that is, the location of the receiving with respect to the transmitting point.



The foregoing may be summed up in the following proposition.

*The relative transmission figure of merit of any two antennas with respect to transmission from a given transmitting point to a given receiving point is equal to the ratio of their resistances as measured from their operating branches, multiplied by the square of the ratio of their receiving sensitivities with respect to transmission from the receiving point to the transmitting point.*

This theorem has a considerable field of practical utility. For example it enables us to deduce the relative transmitting properties and efficiency of any antenna system from its receiving efficiency. It has already been so applied in one actual case of large importance.

#### NOTE ON THE RECIPROCAL THEOREM

The proof of the Reciprocal Theorem, as given originally by Lord Rayleigh, was applicable only to 'quasi-stationary' transducers, that is transducers which obey the simple laws of electric circuit theory. In the July 1924 issue of the *Bell System Technical Journal* the writer stated and proved a generalized theorem subject, however, to the restriction that the permeability  $\mu$  of the medium shall be everywhere unity. The theorem referred to is

*Let a distribution of impressed periodic electric intensity  $\mathbf{F}' = \mathbf{F}'(x, y, z)$  produce a corresponding distribution of current intensity  $\mathbf{u}' = \mathbf{u}'(x, y, z)$ , and let a second distribution of equi-periodic impressed electric intensity  $\mathbf{F}'' = \mathbf{F}''(x, y, z)$  produce a second distribution of current intensity  $\mathbf{u}'' = \mathbf{u}''(x, y, z)$ , then*

$$\int (\mathbf{F}' \cdot \mathbf{u}'') dv = \int (\mathbf{F}'' \cdot \mathbf{u}') dv,$$

*the volume integration being extended over all conducting and dielectric media.  $\mathbf{F}$  and  $\mathbf{u}$  are vectors and the expression  $(\mathbf{F} \cdot \mathbf{u})$  denotes the scalar product of the two vectors.*

Later Pleijel<sup>3</sup> stated the theorem for unrestricted values of  $\mu$ . In discussing reciprocal theorems in the June 1929 issue of the *Proc. I. R. E.* the writer expressed some doubt as to the validity of Pleijel's proof (which is entirely different from my own). Subsequent study, however, has convinced me that except for minor and easily remedied errors, the proof is entirely sound. Later the writer discovered that the restriction  $\mu = 1$  can easily be removed from his own original proof as will now be shown.<sup>4</sup>

<sup>3</sup> "Two Reciprocal Theorems in Electricity," *Ingenjors Vetenskaps Akademien* Nr. 68, 1927.

<sup>4</sup> Another and somewhat different extension of the proof has been derived by my associate Dr. W. H. Wise.

If  $\mu \neq 1$  everywhere and if we write

$$\mathbf{w} = \mathbf{u} + \text{curl } \mathbf{M} = \lambda \mathbf{E} + \text{curl } \mathbf{M} \quad (1')$$

equation (8) of my paper becomes<sup>5</sup>

$$\frac{1}{\lambda} \mathbf{w} + \frac{i\omega}{c} \int \frac{\mathbf{w}}{r} \exp\left(-\frac{i\omega r}{c}\right) dv = \mathbf{G} + \frac{1}{\lambda} \text{curl } \mathbf{M} \quad (2')$$

and correspondingly equation (9) becomes

$$\begin{aligned} \int \{ \mathbf{w}' \cdot \mathbf{G}'' \} - (\mathbf{w}'' \cdot \mathbf{G}') \} dv \\ + \int \frac{1}{\lambda} \{ \mathbf{w}' \cdot \text{curl } \mathbf{M}'' \} - (\mathbf{w}'' \cdot \text{curl } \mathbf{M}') \} dv = 0. \quad (3') \end{aligned}$$

If now in (3') we replace  $\mathbf{w}$  by  $\mathbf{u} + \text{curl } \mathbf{M}$  and note that  $\mathbf{u}/\lambda = \mathbf{E}$ , (3') reduces to

$$\begin{aligned} \int \{ (\mathbf{u}' \cdot \mathbf{G}'' \} - (\mathbf{u}'' \cdot \mathbf{G}') \} dv \\ - \int \{ (\mathbf{G}' \cdot \text{curl } \mathbf{M}'') - (\mathbf{G}'' \cdot \text{curl } \mathbf{M}') \} dv \\ + \int \{ \mathbf{E}' \cdot \text{curl } \mathbf{M}'' \} - (\mathbf{E}'' \cdot \text{curl } \mathbf{M}') \} dv = 0. \quad (4') \end{aligned}$$

Finally since  $\mathbf{E} - \mathbf{G} = -\frac{i\omega}{c} \mathbf{A}$ , (4') reduces to

$$\begin{aligned} \int \{ (\mathbf{u}' \cdot \mathbf{G}'' \} - (\mathbf{u}'' \cdot \mathbf{G}') \} dv \\ - \frac{i\omega}{c} \int \{ (\mathbf{A}' \cdot \text{curl } \mathbf{M}'') - (\mathbf{A}'' \cdot \text{curl } \mathbf{M}') \} dv = 0. \quad (5') \end{aligned}$$

But

$$\begin{aligned} \int (\mathbf{A}' \cdot \text{curl } \mathbf{M}'') dv &= \int (\mathbf{M}'' \cdot \text{curl } \mathbf{A}') dv \\ &= \frac{1}{4\pi} \int \frac{\mu - 1}{\mu} (\mathbf{B}'' \cdot \text{curl } \mathbf{A}') dv \\ &= \frac{1}{4\pi} \int \frac{\mu - 1}{\mu} (\text{curl } \mathbf{A}'' \cdot \text{curl } \mathbf{A}') dv, \end{aligned}$$

so that the second integral of (5') vanishes and

$$\int \{ (\mathbf{u}' \cdot \mathbf{G}'' \} - (\mathbf{u}'' \cdot \mathbf{G}') \} dv = 0, \quad (6')$$

which is equation (9) of the original paper. The rest of the proof of the theorem is now simply that of the original paper.

It will be observed the theorem is stated for the current  $\mathbf{u} = \lambda \mathbf{E}$ ; that is the conduction (plus polarization) current. Ballantine<sup>6</sup> in

<sup>5</sup> The paper itself must be consulted for the significance of the symbols and the method of attack and proof.

<sup>6</sup> June 1929 issue of *Proc. I. R. E.*

discussing this subject states that the theorem holds for the current  $\boldsymbol{w} = \lambda \boldsymbol{E} + \text{curl } \boldsymbol{M}$ . This cannot be true in general, however, because from the foregoing in order that the theorem should hold for the current  $\boldsymbol{w}$ , it is clearly necessary that

$$\int \{(\boldsymbol{F}' \cdot \text{curl } \boldsymbol{M}'') - (\boldsymbol{F}'' \cdot \text{curl } \boldsymbol{M}')\} dv = 0.$$

This is only true in the exceptional cases where the impressed force is derivable from a potential; that is,  $\text{curl } \boldsymbol{F} = 0$ , or else  $\boldsymbol{F} = 0$  where  $\boldsymbol{M} \neq 0$ .

# The Approximate Networks of Acoustic Filters

By W. P. MASON

The approximate equivalent electrical networks of acoustic filters are developed in this paper, from the lumped-constant approximation networks for electric lines. In terms of this network, design formulæ have been developed for all single band pass filters. It is possible, from these formulæ, to determine the physical dimensions of an acoustic filter necessary to have a given attenuation and impedance characteristic.

THE original theory of acoustic filters given by Stewart<sup>1</sup> is based upon the representation of such filters by means of lumped constants in the form of a  $T$  network. More recently, the writer<sup>2</sup> has presented a theory of acoustic filters, showing that they are equivalent to a combination of electric lines. Lines, as an approximation, can be represented by networks with lumped constants, and hence an acoustic filter has a lumped-constant approximation network, which should represent the filter well at low frequencies. It is here shown that the network proposed by Stewart is a first approximation to the network of electric lines given in the former paper.<sup>2,3</sup> This first approximation represents the low pass filter well at low frequencies, but does not very adequately represent the band-pass filters. Accordingly, a second approximation is developed. All of the single band-pass filters have been analyzed and design formulæ are given for them in terms of the second approximation network.

## THE APPROXIMATE LUMPED-CONSTANT NETWORKS OF ACOUSTIC FILTERS

An acoustic filter, as developed so far, consists of a main conducting tube, and a side branch. In a symmetrical filter, the side branch is connected to the main conducting tube half-way between the two ends, as shown on Fig. 1. The type of filter obtained depends primarily on

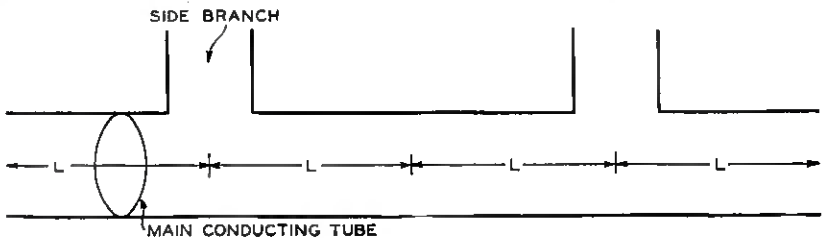

Fig. 1

<sup>1</sup> Stewart, *Phys. Rev.*, 20, pp. 528-551, 1922. *Phys. Rev.*, 25, pp. 90-98, 1925.

<sup>2</sup> Mason, *Bell System Technical Journal*, 6, pp. 258-294, 1927.

<sup>3</sup> This fact has also been pointed out by Stewart, *Journal of the Optical Society*, July 1929, and by Lindsay, *Phys. Rev.*, 25, pp. 652-655, 1929.

what type of side branch is used, the resonances of the latter determining the frequencies of maximum suppression.

The equivalent electrical circuit for an acoustic filter, was shown in a previous paper<sup>2</sup> to be two lines shunted by the impedance of the side branch. This representation is shown on Fig. 2. To obtain a lumped-

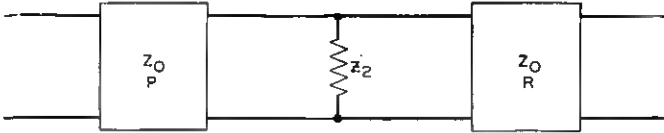

Fig. 2

constant representation for this network, it is necessary first to consider the lumped-constant representation of a line, which is discussed below.

A. *Lumped-Constant Representation of a Line*

In a previous paper<sup>2</sup> it was shown that the propagation constant of a tube is given by the equation

$$P^2 = \frac{-\omega^2}{c^2} \left[ \left( 1 + \frac{P_0}{S} \sqrt{\frac{\gamma'^2}{2\omega\rho}} \right) - \frac{iP_0}{S} \sqrt{\frac{\gamma'^2}{2\omega\rho}} \right], \tag{1}$$

while the characteristic impedance is given by the expression

$$Z = \frac{\rho c^2 P}{j\omega S}. \tag{2}$$

In these equations  $\omega$  is  $2\pi$  times the frequency,  $c$  the velocity of sound,  $P_0$  the perimeter of the tube,  $S$  its area,  $\rho$  the density of the medium and  $\gamma'^2$ , a constant related to the viscosity, which for air has the value  $4.25 \times 10^{-4}$  in c.g.s. units.

A tube is the analogue of an electric line with distributed resistance, inductance, and capacity. No quantity corresponding to leakance is present. To determine the values of these quantities, use is made of the well known equations for a line

$$Z = \sqrt{\frac{R + j\omega L}{G + j\omega C}}; \quad P = \sqrt{(R + j\omega L)(G + j\omega C)}, \tag{3}$$

where  $R$ ,  $L$ ,  $G$  and  $C$  are respectively the distributed resistance, inductance, leakance, and capacity of the line per unit length. Comparing

<sup>2</sup>Loc. cit.

(3) with (1) and (2), it is found that

$$\begin{aligned}
 R &= \frac{P_0}{S^2} \sqrt{\frac{\gamma'^2 \rho \omega}{2}}, \\
 L &= \frac{\rho}{S}, \\
 C &= \frac{S}{\rho c^2}, \\
 G &= 0,
 \end{aligned}
 \tag{4}$$

neglecting small correction terms. These are the equivalent distributed constants per unit length of the pipe expressed in acoustic impedance units.

The representation of lines with distributed constants by means of networks containing lumped constants has received considerable attention.<sup>4</sup> With three impedances, either the  $T$  or  $\pi$  network representation shown on Fig. 3, can be used.

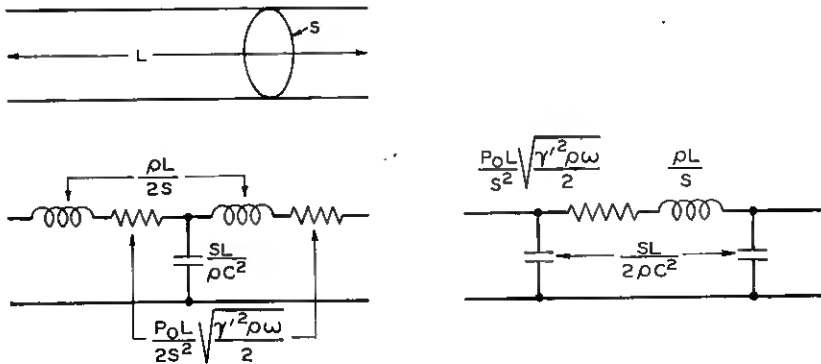

Fig. 3

The impedances of short or open circuited lines can be represented approximately by fewer elements than three. The first approximation for a short circuited line is an inductance and resistance equal to the sum of the distributed inductances and resistances of a line, while the first approximation for an open circuited line will be a capacity equal to the distributed capacities of the line. These approximations hold for very low frequencies. The second approximation for open and short circuited lines can be obtained with three impedances, as shown

<sup>4</sup> A. E. Kennelly "Artificial Electric Lines, 1917."

K. S. Johnson "Transmission Circuits for Telephone Communication, 1925," page 151.

on Fig. 4. These representations follow directly from the  $T$  or  $\pi$

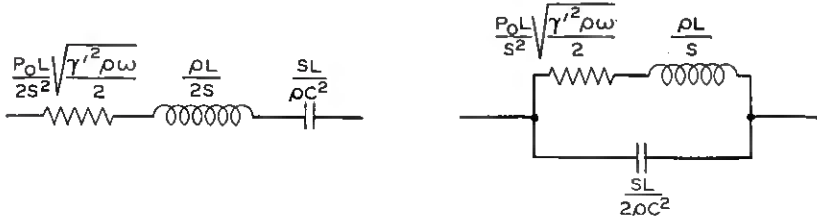

Fig. 4

network representation shown on Fig. 3, by open or short circuiting the  $T$  and  $\pi$  networks, respectively.

*B. Lumped-Constant Representation of an Acoustic Filter*

In his theory of acoustic filters, Stewart has represented an acoustic filter by the network shown on Fig. 5, where  $Z_2$  is the impedance of the

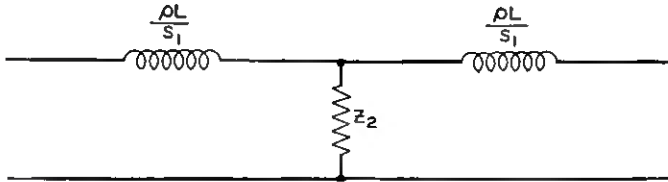

Fig. 5

side branch. Stewart has represented the side branch impedance, by either one or two elements, depending on the side branch, and the main branch by a single inductance, equal to the sum of the distributed inductances of the tube. This corresponds to the first approximation of the representation of a line by lumped constants. This representation gives good results for the low pass filter, but does not represent, very adequately, the band-pass filters.

The best second approximation for an acoustic filter, employing two elements to represent the main conducting tube, is shown on Fig. 6.

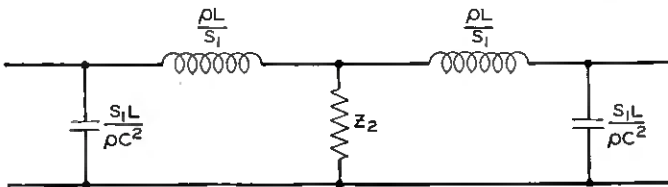

Fig. 6



The main conducting tube is represented by an  $L$  network containing the total distributed capacity of the tube in the shunt arm, and the total distributed inductance of the tube in the series arm. The side branch impedance shunts the two  $L$  networks at their center.

The propagation constant and characteristic impedance of this structure are given by the expressions

$$\cosh P = 1 - \frac{2\omega^2 L^2}{c^2} + \frac{j\omega\rho L}{Z_2 S_1} \left( 1 - \frac{\omega^2 L^2}{c^2} \right),$$

$$Z = \frac{\rho c}{S_1} \sqrt{\frac{1 + \frac{j\omega\rho L}{2Z_2 S_1}}{\left[ 1 - \frac{j\rho c^2 \left( 1 - \frac{\omega^2 L^2}{c^2} \right)}{\omega L S_1 (2Z_2)} \right] \left[ 1 - \frac{\omega^2 L^2}{c^2} \right]}}, \quad (5)$$

where  $S_1$  is the area of the main branch.

If these equations are compared with those given in the former paper,<sup>2</sup> it is seen that they are approximately those obtained by taking the first two terms of the expansions of the trigonometrical functions. The characteristics of the filter are not very readily seen from equation (5), but can be readily found by transforming the network shown on Fig. 6, into the much more general lattice network shown in Fig. 7.

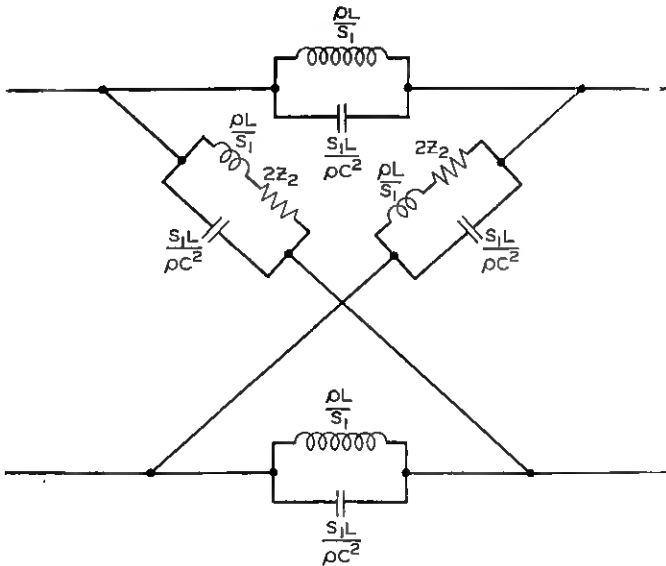

Fig. 7

That the network shown on Fig. 7 is the equivalent in characteristic impedance and propagation constant of that shown on Fig. 6, can readily be verified by substituting the impedances of the lattice network into the formulæ for a lattice network

$$Z = \sqrt{Z_A Z_B}; \quad \cosh P = \frac{Z_B + Z_A}{Z_B - Z_A}, \quad (6)$$

where  $Z_A$  is the impedance of one of the series arms, and  $Z_B$  that of one of the lattice arms. A lattice network has a pass band when the reac-

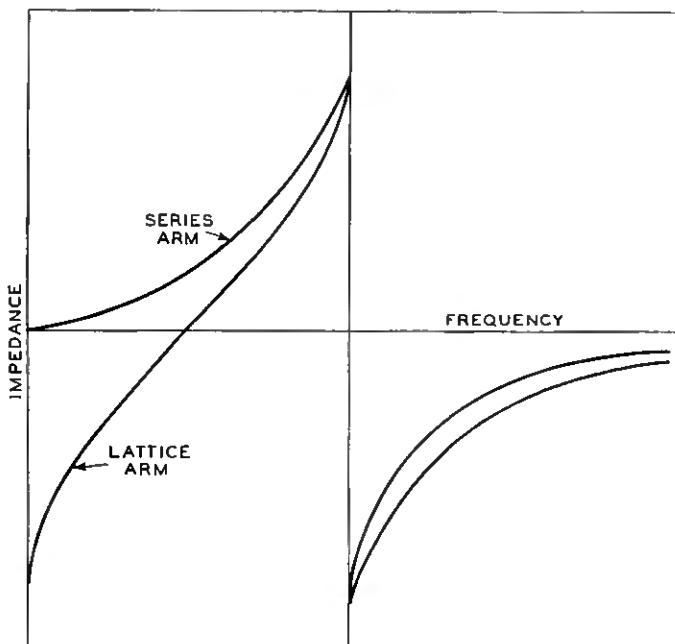

Fig. 8

tance of the series arm is of opposite sign to that of the lattice arm. When the reactances of the two arms have the same sign, an attenuation band results, while when the reactances of the two arms are equal, an infinite attenuation constant results, since here the lattice will be a balanced Wheatstone bridge.

For example, suppose that a side branch impedance, equivalent to an inductance and capacity in series, is used. The impedance of the lattice arm has two zero impedance points—one of which is at an infinite frequency—and two infinite impedance points—one of which is at zero frequency—as shown on Fig. 8. The impedance of the series arm

is that of an anti-resonant circuit, as shown on Fig. 8. There are two possible impedance characteristics for the series arm, in relation to the lattice arm, which will give a single band filter. One of these is obtained by letting the series arm have an infinite impedance when the lattice arm has a zero impedance, which results in a low pass filter. The second relation—which is that shown on Fig. 8—is obtained by letting the series arm have an infinite impedance when the lattice arm has an infinite impedance. The pass band is between zero frequency, and the frequency at which the lattice arm resonates.

In a similar manner, the other types of acoustic filters can be analyzed.

### C. Side Branch Impedances

The possible types of side branches can be divided into two classes, those which are entirely enclosed, and those which are open to the air. The first kind are characterized by a series capacity, while the second kind always have a shunt inductance.

One of the simplest side branch impedances is a short tube open on the end. The first approximation to this side branch is an inductance, as shown on Table I, No. 1, equal to the total distributed inductance of the tube. This approximation holds well if the product of the tube length by the frequency, is not too large. A longer tube, open on the end, can be represented by an inductance and capacity in parallel as discussed in Section A and shown on Table I, No. 2. A tube closed on the end can be represented by an inductance and capacity in series as shown on Table I, No. 4.

When these tubes are used as side branches, an additional factor comes in—an end correction. That is, the side branch must be considered as extending into the main branch for a distance proportional to the radius, because a motion of air in the direction of the side branch, occurs in the main branch. The value of this effect has been investigated by Rayleigh, who found that this effect can be calculated by increasing the length of the tube by a length equal to .785 times the radius. Another correction applies to an open ended tube, which has been determined experimentally as .57 times the radius. Hence the length of an open ended tube must be considered as

$$l' = l + (.785 + .57)r.$$

A straight tube can give all the combinations of side branch impedances, but one of its dimensions is necessarily limited, namely the area. For the area cannot become larger than the area of the main tube, since otherwise it could not be connected to the main tube. By







<p><b>ELEMENT</b></p>  $L = \frac{\rho l'}{S}$ <p><b>VALUES OF CONSTANTS</b></p> $l' = l + 1.355r$ $S = \pi r^2$	<p><b>STRUCTURE NO. 1</b></p> 	<p><b>ELEMENT</b></p>  $L = \frac{\rho l'}{2S} \quad C = \frac{l'S}{\rho C^2}$ <p><b>VALUES OF CONSTANTS</b></p> $l' = l + 0.785r$ $S = \pi r^2$	<p><b>STRUCTURE NO. 4</b></p> 
<p><b>ELEMENT</b></p>  $L = \frac{\rho l'}{S} \quad C = \frac{l'S}{2\rho C^2}$ <p><b>VALUES OF CONSTANTS</b></p> $l' = l + 1.355r$ $S = \pi r^2$	<p><b>STRUCTURE NO. 2</b></p> 	<p><b>ELEMENT</b></p>  $L = \frac{\rho l'}{2S} \quad C = \frac{l'S}{\rho C^2}$ <p><b>VALUES OF CONSTANTS</b></p> $l' = \sqrt{\left[ \frac{\log\left(\frac{r_1+r_2}{2r_1}\right) + \frac{0.46}{t}}{T} \right] \left[ (r_2^2 - r_1^2)T + \frac{r_1^2 t}{2} \right]}$ $S = \pi \sqrt{\frac{(r_2^2 - r_1^2)T + \frac{r_1^2 t}{2}}{\log\left(\frac{r_1+r_2}{2r_1}\right) + \frac{0.46}{t}}}$	<p><b>STRUCTURE NO. 5</b></p> 
<p><b>ELEMENT</b></p>  $L = \frac{\rho l'}{S} \quad C = \frac{l'S}{2\rho C^2}$ <p><b>VALUES OF CONSTANTS</b></p> $l' = \sqrt{\frac{2[S_1(l_1^3 + 3l_1^2 l_2) + \frac{S_1^2}{S_2}(3l_1 l_2^2) + l_1^3 S_2]}{3(S_2 l_1 + l_2 S_1)}}$ $S = \sqrt{\frac{2S_1^2 S_2 [S_1 S_2 (l_2^3 + 3l_1^2 l_2) + 3S_1^2 l_1 l_2^2 + S_2^2 l_1^3]}{3(S_2 l_1 + l_2 S_1)^3}}$	<p><b>STRUCTURE NO. 3</b></p>  $l_1' = l_1 + 0.785r_1 \quad S_1 = \pi r_1^2$ $l_2' = l_2 + 0.57r_2 \quad S_2 = \pi r_2^2$	<p><b>ELEMENT</b></p>  $L = \frac{\rho l'}{2S} \quad C = \frac{l'S}{\rho C^2}$ <p><b>VALUES OF CONSTANTS</b></p> $l_1' = l_1 + 0.785r_1 \quad S_1 = \pi r_1^2$ $l_2' = l_2 \quad S_2 = \pi r_2^2$	<p><b>STRUCTURE NO. 6</b></p> 

TABLE I

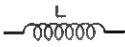
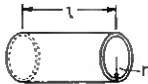
using other types of side branches, this difficulty can at least be partially eliminated. For example, a concentric tube closed on the end is, to a first approximation, equivalent to an inductance and capacity in series, and it can be made to have a larger area relative to the main branch tube, than can the straight tube.

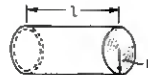
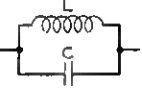
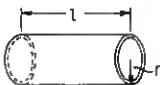
The choice of the forms of the structures to give the simplest impedance elements, is large. For example, Stewart represents a shunt inductance and capacity in parallel, by a concentric tube closed on the end, and a straight tube open on the end, joined together to the main conducting tube at a common point.<sup>5</sup> Other methods for representing two elements are shown on Table I. In these structures, the equivalent length and equivalent areas have been calculated corresponding to these values for a straight tube. These elements have been calculated by calculating the impedances looking into the structures and taking the second approximations.

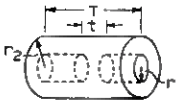
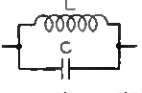
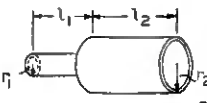
#### *D. Design Formulæ for Acoustic Filters*

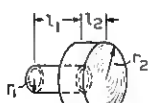
Using the side branch impedances shown in Table I, in the lattice network shown by Fig. 7, the resulting characteristics can readily be obtained. A large number of multiband characteristics can be secured by using various combinations of side branches, but only five single band filters (to the degree of approximation considered here) have been found. The attenuation characteristics of these filters and the design formulæ for them are shown on Table II. In designing a filter, it is usual to obtain the dimensions in terms of the singular frequencies which determine the action of the filter. One other parameter appears,  $Z_0$ , which represents the characteristic impedance of the filter at the mean frequency of the band i.e.  $f_m = \sqrt{f_1 f_2}$ . It is usual to match, approximately, the impedance terminations of the filter to the value  $Z_0$ .

All of these filters have been calculated for side branch tubes, of constant cross section but any of the other side branches shown on Table I can be used by employing the equivalent values of  $l'$  and  $S$  shown there.

The frequency  $f_a$  appearing in the filter No. 1 has no significance for the attenuation constant. It determines the frequency at which the characteristic impedance equals infinity. Considering the loss caused by inserting the filter between two impedances equal approximately to  $Z_0$ , an additional loss occurs at the frequency  $f_a$ , due to a mismatch of the impedance of the filter and the terminating impedances. Filter No. 4 of Table II is similar to No. 3 except that it has twice the attenuation constant. It is then equivalent to two sections of the No. 3 filter.

<sup>5</sup> See for example *Journal of the Optical Society*, July 1929, page 18.

STRUCTURE					
ATTENUATION CHARACTERISTIC					
EQUIVALENT ELECTRICAL STRUCTURE					
VALUES OF:					
$f_1$	0	0	$\frac{C}{2\pi L \sqrt{1 + \frac{2l'S_1}{LS_2}}}$	$\frac{C}{2\pi L \sqrt{1 - \sqrt{1 - \frac{2L^2}{l'^2}}}}$	$\frac{C}{2\pi L \sqrt{1 + \frac{l_1 S_1}{LS_3} + \frac{l_1 l_1 S_2}{S_3 L^2}}}$
$f_2$	$\frac{C}{2\pi \sqrt{(\frac{L}{S_1} + \frac{l'}{S_2}) \frac{l' S_2}{2}}}$	$\frac{C}{2\pi} \sqrt{\frac{1 + \frac{l' S_2}{2LS_1}}{\frac{l_1 S_2}{S_1} (1 + \frac{l' S_1}{LS_2})}}$	$\frac{C}{2\pi L}$	$\frac{C}{2\pi L} \sqrt{1 + \sqrt{1 - \frac{2L^2}{l'^2}}}$	$\frac{C}{2\pi \sqrt{\frac{l'^2}{2} + \frac{L l_1 l_1}{LS_3 + \frac{l_1 S_1}{S_2}}}}$
$f_\infty$	$\infty$	$\frac{C}{2\pi L} \sqrt{\frac{1 + \frac{l' S_2}{2LS_1}}{1 + \frac{2l' S_1}{LS_2} - \frac{LS_1}{l' S_2}}}$	$\infty$	$\infty$	$\frac{C}{2\pi L}$ AND $\infty$
$f_a$	$\frac{C}{2\pi L}$				
$Z_0$	$\frac{\rho C}{S_1} \sqrt{1 + \frac{l' S_2}{2S_1 L}}$	$\frac{\rho C}{S_1} \sqrt{\frac{1}{1 + \frac{l' S_2}{2S_1 L}}}$	$\frac{\rho C}{S_1} \sqrt{\frac{1 + \frac{2l' S_1}{LS_2}}{\sqrt{1 + \frac{2l' S_1}{LS_2} - 1}^2}}$	$\frac{\rho C}{S_1} \sqrt{\frac{l'^2}{2(l'^2 - 2L^2)}}$	$\frac{\rho C}{S_1} \sqrt{1 + \frac{2l_1 S_1}{LS_3} \sqrt{\frac{l'^2}{2L^2} + \frac{l_1 l_1}{LS_3 + \frac{l_1 S_1}{S_2}}}}$
$Z$	$\frac{\rho C}{S_1} \sqrt{\frac{\frac{f^2}{f_0^2} (1 - \frac{f^2}{f_0^2})}{1 - \frac{f^2}{f_0^2}}}$	$\frac{\rho C}{S_1} \sqrt{\frac{\frac{f^2}{f_0^2} (2 - \frac{f^2}{f_0^2} - 2 \sqrt{1 - \frac{f^2}{f_0^2}})}{1 - \frac{f^2}{f_0^2}}}$	$\frac{J \rho C}{S_1} \sqrt{\frac{\frac{f^2}{f_0^2}}{(\frac{f^2}{f_1^2} - 1)(\frac{f^2}{f_2^2} - 1)}}$	$\frac{J \rho C}{S_1} \sqrt{\frac{\frac{f^2}{f_0^2} (1 + \frac{f^2}{f_1^2})}{(\frac{f^2}{f_1^2} - 1)(\frac{f^2}{f_2^2} - 1)}}$	$\frac{J \rho C}{S_1} \sqrt{\frac{\frac{f^2}{f_0^2} (1 - \frac{f^2}{f_0^2})}{(\frac{f^2}{f_1^2} - 1)(\frac{f^2}{f_0^2} - 1)}}$
DESIGN FORMULAE FOR:					
$L$	$\frac{C}{2\pi f_a}$	$\frac{C}{2\pi f_0 [1 - \sqrt{1 - (\frac{f_0^2}{f_a^2})}]}$	$\frac{C}{2\pi f_2}$	$\frac{C}{\pi \sqrt{2(f_1^2 + f_2^2)}}$	$\frac{C}{2\pi f_\infty}$
$S_1$	$\frac{f_1 \rho C}{Z_0 f_a}$	$\frac{\rho C f_0 [1 - \sqrt{1 - (\frac{f_0^2}{f_a^2})}]}{Z_0 f_2}$	$\frac{\rho C f_2}{Z_0 (f_2 - f_1)}$	$\frac{\rho C (f_1^2 + f_2^2)}{2Z_0 (f_2^2 - f_1^2)}$	$\frac{\rho C f_2 f_\infty}{Z_0 (f_\infty^2 - f_1 f_2)}$
$l'$	$\frac{\sqrt{2} C}{2\pi f_a}$	$\frac{\sqrt{2} (1 - \frac{f_0^2}{4f_a^2} - \sqrt{1 - \frac{f_0^2}{f_a^2}})}{2\pi f_0 [1 - \frac{f_0^2}{2f_a^2} - \sqrt{1 - \frac{f_0^2}{f_a^2}}]}$	—	$\frac{C \sqrt{f_1^2 + f_2^2}}{2\pi f_1 f_2}$	$\frac{C}{\sqrt{2} \pi f_\infty}$
$S_2$	$\frac{(f_a^2 - f_0^2) \rho C \sqrt{2}}{f_1 f_a Z_0}$	$\frac{2 [f_0^2 - f_a^2 (1 - \sqrt{1 - \frac{f_0^2}{f_a^2}})]}{Z_0 f_2 \sqrt{2f_0^2 (1 - \frac{f_0^2}{4f_a^2} - \sqrt{1 - \frac{f_0^2}{f_a^2}})}}$	—	$\frac{4\rho C f_1 f_2 (f_1^2 + f_2^2)^{3/2}}{Z_0 (f_2^2 - f_1^2)^2 (f_2 - f_1)}$	$\frac{\rho C \sqrt{2} f_2 f_\infty (f_\infty^2 - f_1^2)}{Z_0 (f_\infty^2 - f_1 f_2) (f_2^2 - f_1^2)}$
$\frac{l'}{S_2}$	—	—	$\frac{Z_0 (f_2^2 - f_1^2) (f_1 + f_2)}{4\pi \rho f_1^2 f_2^2}$	—	—
$\frac{l_1}{S_3}$	—	—	—	—	$\frac{Z_0 (f_2^2 - f_1^2) (f_\infty^2 - f_1 f_2)}{4\pi \rho f_2 f_1^2 f_\infty^2}$

TABLE II

## Contemporary Advances in Physics, XX

### Ionization of Gases by Light

By KARL K. DARROW

The subject of this article, the ionization of gases by ultraviolet light, is a narrow but singularly inviting department of modern physics. The obstacles to experiment are so great that they are only now being overcome by the latest improvements in laboratory technique; nearly all the valuable data are of recent acquisition, and the period of discoveries is not yet past. Some of the results afford excellent confirmation of present atomic theory; others are still obscure and challenging.

THE subject of this article is more narrowly restricted than those of many others of the series. It is narrower even than the title might imply; for by "ionization" I mean for the present only the detachment of the most loosely bound electron of a molecule or an atom, and by "light" only the waves of the visible spectrum and that adjoining range of wavelengths to which the name of ultraviolet is customarily confined. Either of these limitations is implicit in the other; for though most molecules are fashioned with electrons bound with varying degrees of tightness, and the removal of any one thereof is an act of ionization, it is beyond the power of such light-waves to abstract any except the loosest. Perhaps it will be found instructive if for so definite and circumscribed a problem I relate the methods of experiment, the data of the experiments, the simple theory, and the artifices which have been conceived to reconcile the theory and the data, sometimes with success and at other times in vain.

Most of the really valuable data are of recent acquisition, for there are difficulties hampering the attack upon the problem, which the progress of laboratory technique is only gradually clearing away. Consider, for instance, the question of providing the light. It is desirable to be able to illuminate the gas with monochromatic light of any wavelength, photons of any energy. When ionization by electrons is being studied, one varies the energy and the wavelength at will by varying the voltage impressed on the electrons. With light, this is not within our power; one has to take the quanta as they are supplied by a luminous source.

If the spectrum of the source consists of bright lines widely separated, the ionization which any of them alone produces may be measured, and the energy of the quanta is very narrowly defined. On the curve of ionization *vs.* frequency, then, every spectrum line supplies an



experimental point of which at least the abscissa is certain. But at the frequencies between the lines, there is no way of getting information; and many a published curve is traced by guesswork right across the regions of major importance where data are essential, simply because Nature left those regions vacant of lines in the spectrum of the mercury arc!

If on the other hand the source has a continuous spectrum or one crowded with bright lines, the device for resolving or filtering the light will transmit to the ionizable gas photons not of a single wavelength, but of a range of many Angstroms—dozens or scores of Angstroms, perhaps even a hundred. A single measurement may be, and usually is, plotted as if it belonged to the central wavelength of the transmitted band; but actually the ionization results from waves of all the wide range, and not even from a uniform distribution of energy across the range, but from a distribution affected by the qualities both of the source and of the resolving apparatus. With chemical filters, *i.e.* with coloured absorbing liquids, bands of transmitted light may be formed in various parts of the spectrum. They are likely to be broad and hazily bounded, and limited in number; but the liquid filters are inexpensive and easy to handle, and in tracing backward the sequence of observations on any one substance, one often finds that the very earliest were made with filters. Monochromators—which is to say, spectroscopes—form bands of which the central wavelength and the width may be varied at will. This sounds ideal; but in practice, of course, the narrower the transmitted range of wavelengths, the scantier the transmitted energy; and one must compromise as best one may between a band too narrow to produce a measurable degree of ionization, and one so broad that it is hard to apportion the credit for the effect which it produces among the frequencies which make it up. It will be evident that the ideal curve, drawn through experimental points scattered thickly all through the spectrum and each corresponding to a single wavelength, is difficult of attainment and even of approach!

As the atmosphere of the earth prevents us from observing the spectra of the stars at shorter wavelengths than some  $280m\mu$ , so the opacity of all terrestrial solids prevents us from projecting quanta of smaller wavelength than  $125m\mu$ , into an enclosure. Indeed, it is only from fluorite and only from occasional samples of fluorite that one can make windows which are transparent so far out; the next best and much the commoner substance, quartz, ceases to transmit at about  $145m\mu$ . We are thus almost entirely debarred from observations on the noble gases and on the common diatomic gases, which is deplorable.

The desired photons being successfully fired into the gas, the next problem is that of distinguishing the ionization they may cause in it from whatever other liberation of charge they may effect in striking walls, electrodes, or any of the other furniture within the tube. Light of sufficient frequency to ionize a gas will usually be able to produce an outflow of electrons from almost any metal. One takes of course the elementary precaution of designing one's tube in such a way, that the beam of light traverses it from entrance-window to exit-window without touching any electrode; but the disparity of the effects is nevertheless so great, that a modicum of scattered light may evoke more electrons from the metal than the primary beam in all its strength detaches from atoms of the gas. Some experimenters use alternatively two electrodes of very unequal size, expecting that a current due to ionization of the gas will be the same in magnitude whichever they use as cathode, while a current due to light falling on the electrodes will be greater when the larger is the cathode. Some vary the density of the gas, assuming that if the current is proportional to density it must be due to the effect which they seek; but it would also vary as the density, if instead it consisted of electrons expelled from the electrodes by light proceeding from excited atoms of the gas. Some finally have so designed their apparatus that they perceive positive ions only; this seems to be the safest way.

Like Hughes,\* I will divide the data according to the character of the gases to which they refer: the common or "permanent" (chiefly diatomic) gases first, then mercury, finally the alkali metals.

The *permanent gases* can be disposed of in short order, for our knowledge in this field is scanty, though surprising. Measurements of ionization by electron-impacts, and what little has yet been deduced from spectra, agree in indicating that for all of them (with the slight exception of nitric oxide NO) the ionizing-potential is greater than 10 volts. Translating this figure into wavelengths of light, we infer that only photons of smaller wavelength than  $125m\mu$  can ionize such a molecule in a single impact. Therefore light which is able to traverse any window of solid substance should be unable to ionize any permanent gas (except NO); in other words, any such gas enclosed in a tube should be immune to ionization by any radiation entering from outside. Yet there is unimpeachable evidence that air, and oxygen and nitrogen separately, and possibly hydrogen and iodine, are ionized by light which has penetrated fluorite. The threshold for these gases must

\* A. L. Hughes, *Ionization of Gases and Vapors by Light* (Washington University Studies, 1929). I have benefited much by this article, and also by that of F. L. Mohler, *Recombination and Photoionization* (Reviews of Modern Physics 1, 216-227 (1929)).

therefore lie on the long-wave side of  $125m\mu$ . For air it is presumed to lie between this and  $145m\mu$ , since a plate of quartz holds back the ionizing rays. The discrepancy between these and the expected thresholds may not seem large, but it is important. Naturally one has recourse to the idea of a two-stage ionization, occurring when two quanta in succession are absorbed by the same molecule—an idea which, we shall see, is frequently invoked in other cases. If this is valid, the ionization should increase as the square of the intensity of the light. There seem to be no data bearing on this point. To quote from Hughes, "further investigations in this field are badly needed."<sup>1</sup>

With *mercury* the situation is much more definite, but for those who like to have simple theories verified completely it is no more satisfactory.

The spectrum of the mercury atom is well mapped and well interpreted, and the ionizing-potential for electron-impacts has been determined over and over again. From both of these it follows that ionization by single photons should be possible only at wavelengths smaller than 1188Å. However it is certain that the light of the famous resonance-line of mercury, 2537Å, is able to ionize the vapor of the element whence it proceeds.<sup>2</sup>

This seems the natural equivalent of the well-known fact that when mercury atoms are bombarded by a sufficiently dense electron-stream, ionization begins at the resonance-potential. The quanta of the wavelength 2537Å have 4.9 equivalent volts of energy. Such a photon strikes an atom, and excites it transferring it from the normal into a certain excited state, denoted by the symbol  $2^3P_1$ ; a second comes along and likewise is absorbed, bringing the energy of excitation of the atom up to twice 4.9 equivalent volts; this amount falls short of the ionizing potential by only 0.6, and a third photon more than supplies what is required. So runs the simple interpretation; but we shall see that only the first of these steps is confirmed by further experiment, and that the rest of the process must happen in some other way, though the way is far from clear.

<sup>1</sup> For references to the literature I refer to Hughes (*l.c.*) Among the latest papers are those of A. L. Hughes (*Proc. Camb. Phil. Soc.*, **15**, pp. 483-491 (1910)); F. Palmer (*Phys. Rev.* **32**, pp. 1-22 (1911)); E. B. Ludlam (*Phil. Mag.* (6) **23**, pp. 757-772 (1912)); W. West, E. B. Ludlam (*Proc. Roy. Soc. Edinb.*, **45**, pp. 34-41 (1925)). Some of the early work on air was confused by what appears to have been a photoelectric effect of particles of colloid size ("nuclei" or *Kerne*) produced by the action of ultraviolet light on impurities in the air—one of the once-popular and now forgotten problems of physics.

<sup>2</sup> Literature: G. F. Rouse and G. W. Giddings, *Proc. Nat. Acad. Sci.*, **11**, pp. 514-517 (1925); **12**, pp. 447-448 (1926). F. G. Houtermans, *ZS. f. Phys.*, **32**, pp. 619-635 (1925). Twenty years ago W. Steubing (*Phys. ZS.*, **10**, pp. 787-793 (1909)) observed that light coming from a mercury arc and passing through quartz was able to produce a current in a tube containing mercury vapor; but his result has been impugned.

It was the beautiful experiment of Rouse and Giddings which confirmed that the first of the steps is the entry of the atom into the  $2^3P_1$  state; for they showed that ionization of the gas occurs only when the impinging quanta have just the energy required for that transition, not when they have a little less or even a little more. This they were able to show because of the phenomenon of "self-reversal." When a luminous gas becomes dense and hot, the lines of its emission-spectrum broaden; for the atoms perturb one another, the energy-values of their stationary states are changed by various amounts, and the frequencies of many of the quanta which emerge are appreciably shifted upwards or downwards from the original or "standard" values appropriate to isolated atoms. If in addition the region of density and heat is surrounded by another where the gas is cooler and more rarefied, the atoms in this outer zone, being relatively unperturbed, will be able to absorb the quanta having the standard frequencies, but not those others of which the frequencies are shifted. In technical language, the "core" of the line is absorbed; only the "wings" pass through; the line exhibits "self-reversal." In the spectrum of the ordinary mercury-vapor lamp, the line 2537 is notably self-reversed. Cooling the lamp with flowing water or an air-blast, however, abolishes the effect; the line shrinks to its normal narrowness, the wings disappear, but the photons of the core are able to escape from the tube. Any action therefore which is performed by the light of a cooled mercury-vapor lamp, but ceases when the cooling is suspended, must be due to quanta having energies adjusted exactly to the values which are able to excite isolated atoms of mercury. Rouse and Giddings found that ionization of gaseous mercury is precisely such an action.<sup>3</sup>

We cannot so readily conclude that the second step in the ionization-process is the absorption of a second 4.9-volt quantum. It would be rather of an odd coincidence, if there were an excited state of the mercury atom differing in energy from the  $2^3P_1$  state by just so much as this latter differs from the normal state—not, however, an impossible coincidence. Another and a stronger argument is furnished by the fact that when quanta of various wavelengths shorter than 2537—including some which could transfer the atom from the  $2^3P_1$  into other known excited states—are projected into the gas along with 2537, the rate of ionization is not augmented. If none of these can help the electron to escape, it is not so likely that a second quantum of precisely the wavelength 2537 can achieve it. Moreover the duration of the

<sup>3</sup> There was still a residual current in the irradiated tube when the cooling of the lamp was discontinued; but it depended on the size of the cathode in such a way as to suggest that it was due to light falling on that electrode (cf. page 343). \* Houtermans later verified this result.

$2^3P_1$  state is known to be so short (of the order of  $10^{-7}$  second) that under the actual conditions of some of the experiments an atom would not often meet two quanta in such quick succession that at the advent of the second it would still be in the  $2^3P_1$  state into which the first had put it. In other words, the number of  $2^3P_1$  atoms in the gas at any moment is too small.

This last would be a serious obstacle to any theory, but for the fact that the mercury atom possesses another stationary state slightly below the  $2^3P_1$ , the which is *metastable*. This is the  $2^3P_0$  state, of 4.7 equivalent volts; its mean duration may amount to something like a hundredth of a second. Now collisions of mercury atoms in the  $2^3P_1$  state with atoms of certain other kinds, argon notably, may cause the former to pass over into  $2^3P_0$ . This is an instance of "collisions of the second kind." When mercury-vapor is mixed with a much larger quantity of argon and is illuminated with 2537 light, the number of  $2^3P_0$  atoms is at any moment much greater than the number of  $2^3P_1$  atoms would be, if the argon were absent; further, it is proportional to the amount of argon.

Now F. G. Houtermans found that the rate of ionization, in mercury mixed with argon and irradiated by 2537, is proportional to the amount of argon. Therefore, in one stage of its progress from a normal atom to an ion, the mercury atom must be in the  $2^3P_0$  state. It enters this state from the  $2^3P_1$  because of a collision with an argon atom. How does it leave? by absorption of a second 4.9-volt quantum? Two of the considerations of the last paragraph but one speak against this idea, and Houtermans thinks that the  $2^3P_0$  atom collides with another which is in the  $2^3P_1$  state, and there is an interaction—this would be another sort of "collision of the second kind"—in which one of them adds to its store of energy all or most of what the other possesses. So it arrives within an equivalent volt or so of the state of ionization; if one were to take over all the energy of excitation of the other, it would have  $4.7 + 4.9 = 9.6$  equivalent volts, out of the 10.4 required. Still a third step seems to be essential.

The reader may have wondered that I have as yet said nothing about the dependence of ionization on intensity of light, for evidently the former should increase as the cube of the latter if the process is a three-stage one as I have sketched. The matter has been tested by experiment; the answer was unexpected, for the ionization varies as the square of the light—as though the process were of two stages.<sup>4</sup> We

<sup>4</sup>This simple result was obtained only over certain ranges of temperature and pressure of the vapor, but these were precisely the ranges where both are low, and we should expect the result to be most reliable and least subject to confusion by secondary effects. As the pressure rises so does the exponent  $n$  in the relation *ionization* = (*intensity*) <sup>$n$</sup> .

cannot suppose that the atom after its second gulp of energy picks up the remaining 0.8 volt in a collision with a fast-moving ordinary atom, for at normal temperatures such fast-moving atoms would be excessively rare. Houtermans suggests that when a  $2^3P_0$  and a  $2^3P_1$  atom collide with one another, they unite to form an ionized molecule  $Hg_2^+$ . This is far from being the only case in which a molecule is invoked as the *deus ex machina* to help out with an otherwise untenable theory.

We turn now to the alkali metals, or rather to the three heavier among them, caesium, rubidium, and potassium. With these it is more nearly possible to get a full view of the situation. The phenomena are not confined to spectrum ranges in or beyond the remotest attainable fringes of the ultra violet. Indeed, in these four cases, even the wavelength where ionization by *single* impact should begin is well within reach, being in the nearer ultra violet; 2412A for Na, 2856 for K, 2968 for Rb and 3183 for Cs. Ionization currents are provoked by light at even greater wavelengths; this resembles the case of mercury irradiated by 2537, and is equally perplexing, indeed more so. They are however much greater, near or beyond the limiting wavelength for one-stage ionization; and there, we seem to be witnessing the simplest process of all. With caesium, rubidium and sodium, the data in this range conform to simple theories in a gratifying way. I will consider these first, and then the most mysterious case of all, that of potassium.

The vapor pressures of the alkali metals increase with atomic number, and for rubidium and caesium are great enough to permit the methods employed with the gases mentioned above: which is to say, that stationary vapor of known density may be illuminated by light of known intensity, and the amount of ionization be measured absolutely by drawing off all the ions. This I denote as the "absolute" method. There is another, the "method of space-charge annulment." The tube containing the vapor contains also a hot-filament cathode and some form of anode, and the filament is kept so hot, the P.D. between it and the anode kept so low, that the electron-borne current between cathode and anode is limited by its own space-charge. When positive ions are formed in the vapor, as in these experiments they are by light, a fraction of the negative space-charge is annulled, and the current increases. The change in the current is a measure of the number of positive ions formed. Nothing of the sort results if light falls on solid objects in the tube and ejects electrons, an insensitiveness which is a great advantage of the method. For positive ions it is a very sensitive method; one finds such statements as "each positive ion formed causes a million extra electrons to flow from cathode to anode,"

and Foote and Mohler, who were the first to apply this method to ionization by light, perceived the effect at pressures of mercury vapor as low as .002 mm. Hg. It does not permit of absolute measurements; but one may use it to make accurate measurements of the relative ionizing-power of light of any number of wavelengths, and then standardize them *en bloc* by a determination at a single wavelength with the absolute method.

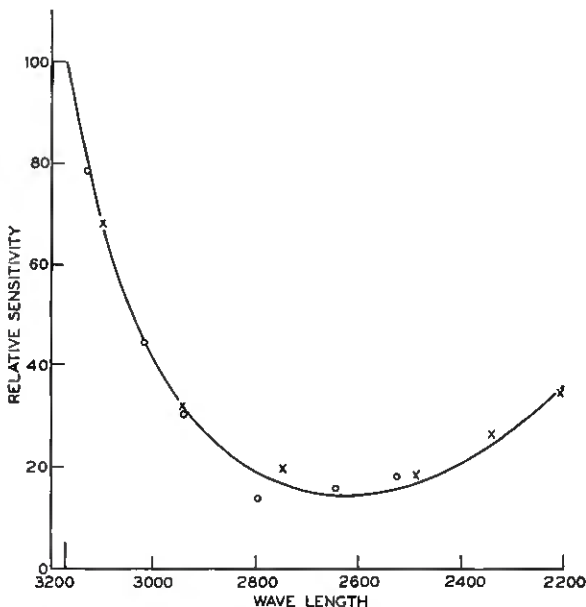

Fig. 1—Ionization by light plotted as function of wavelength for caesium (Critical wavelength: 3184Å). (F. L. Mohler, C. Boeckner).

I now reproduce two of the most recently published curves of ionization vs. wavelength: Fig. 1 for caesium, from F. L. Mohler and C. Boeckner;<sup>5</sup> Fig. 2 for rubidium, from E. O. Lawrence and N. E. Edlefsen.<sup>6</sup> It is the downward trend of these curves from the limiting wavelength towards shorter waves which interests us now. Ionization by light of a given intensity is most abundant when the quanta have just the energy required to detach the electron, and no more. The more the energy of the photon exceeds the strictly necessary value, the less it is likely to be captured and have its energy spent for ionization.

The various theories, except for one, predict a steady downward trend; one in particular, that of R. Becker, supplies the broken curve

<sup>5</sup> *Bur. Stand. Journ. Res.*, 3, pp. 303-314 (1929).

<sup>6</sup> *Phys. Rev.*, (2) 34, pp. 233-242 (1929).



of Lawrence and Edlefsen's figure (relative ordinates have no significance, it is only the trends of the curves which should be compared).

Mohler and Boeckner also measured the actual number of ions produced by light of known intensity in a known quantity of gas, using of course the absolute method, and expressing their results in the following way. Suppose a thin stratum of gas, of thickness  $dx$  and area  $A$ . Denote by  $N$  the number of atoms per unit volume of the

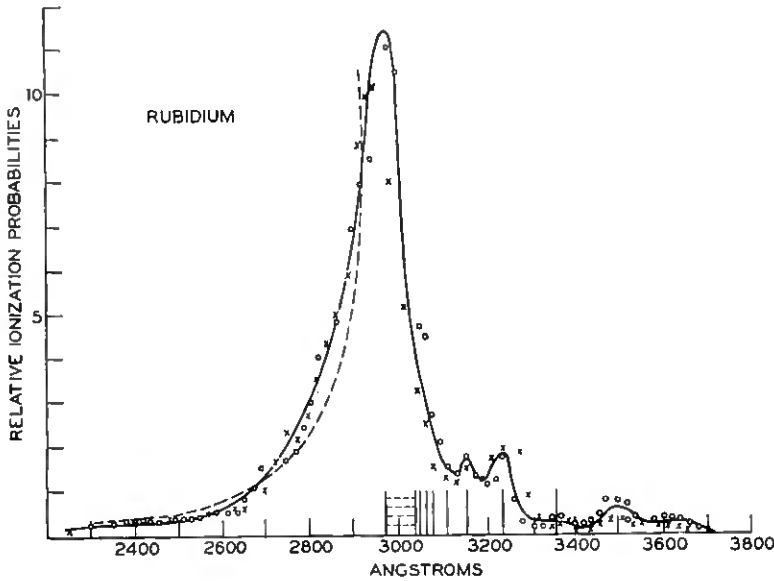

Fig. 2—Ionization by light plotted as function of wavelength for rubidium (Critical wavelength at 2968A). Circles and crosses correspond to different densities. (E. O. Lawrence, N. Edlefsen.)

gas; then  $NAdx$  will stand for the number in the stratum. Denote by  $Q$  the total number of photons striking the stratum in unit time; suppose that they fall upon it perpendicularly, and are evenly distributed over its area. The number of ions formed in the stratum in unit time,  $I$  will be proportional to  $NAdx$  and to  $Q/A$ . Write:

$$I = kNQdx$$

the coefficient  $k$  is the quantity of which the experiments are designed to reveal the value. (We should not be entitled to expect this to be constant, if more than a small fraction of the quanta were spent in ionization; but in the practical cases we may.) The values which they give are  $(2.3 \pm 0.2) \cdot 10^{-19}$  for caesium and  $1.1 \cdot 10^{-19}$  for rubidium,

at the limiting frequency in each case. Earlier E. M. Little<sup>7</sup> had got a value two orders of magnitude lower for caesium; this difference has not been reconciled. These values will later be compared with those to which the theories lead.

The upturn in the curve of Fig. 1 on the shortwave side of 2600A may serve<sup>8</sup> as an introduction to the case of *potassium*. Adjourning therefore the discussion of the righthand part of the curve of Fig. 2, I take up next this strange and singular case.

The first who plotted an ionization-vs-wavelength curve for potassium was E. O. Lawrence.<sup>9</sup> The vapor-pressure of potassium being low, he so designed his tube that the beam of light passed across the vertically-rising jet of gas distilling from a pool of highly-heated metal. This expedient was used by all the other physicists who worked upon potassium, and was at one time held responsible for the curious results, until finally Mohler and Boeckner confirmed the previous data by measurements on stagnant vapor. The ionization-current was collected by electrodes placed on either side of the jet and away from the light; so the method is fit to give the relative ionizing-powers of light of various wavelengths, though not an absolute measurement, the density in the jet being unknown. Lawrence's monochromator provided beams of light extending over some 80A of the spectrum.

Few data can have been more unexpected, indeed more positively unwelcome, than those which he obtained; for what they intimated was, that ionization begins, or at least *the sharp increase of ionization occurs, at a wavelength definitely too small*. It seems as though a photon could not ionize a potassium atom without having definitely *more* than the necessary energy; a conclusion which would be in disaccord with fundamental theory, and with the (subsequent) experiments upon rubidium and caesium.

New experiments upon potassium gave comfort to the theory, but also demonstrated the anomaly which Lawrence had discovered.<sup>10</sup> The

<sup>7</sup> *Phys. Rev.*, (2) **30**, pp. 109-118, pp. 963-964 (1927).

<sup>8</sup> However it does not appear in the corresponding curve obtained by Lawrence and Edlefsen.

<sup>9</sup> *Phil. Mag.*, **50**, pp. 345-359 (1925). There had been four precursors: S. H. Anderson, L. A. Gilbreath, R. C. Williamson, R. Samuel (for the references, see Hughes, *l.c.*). The earliest two reported ionization at wavelengths where it now seems unlikely that true ionization of the vapor would have been perceptible; the others used chemical filters and so were unable to plot a curve, but seem to have observed the weak ionization produced between 2800 and 3100A.

<sup>10</sup> Such a proof would relieve us from one of the greater difficulties of the "molecule" hypothesis—the necessity of assuming that ionization of a  $K_2$  molecule by light is an event thousands of times as probable as that of a K atom, for in potassium vapor under the actual conditions free atoms are believed to be a thousand times more abundant than molecules, and yet the ions which we are ascribing to the latter are much more plentiful. R. W. Ditchburn and F. L. Arnot (*Proc. Roy. Soc.*, **123**, pp. 516-536 (1929)) found nothing but  $K^+$  ions in the ionized vapor, thus disposing of the notion that the process might consist in the detachment of an electron from a thenceforward stable  $K_2$  particle.

curve which I display as Fig. 3 is taken from the latest paper,<sup>11</sup> but the marked points comprise those of Lawrence's first article (large circles) and those obtained in the interim by R. C. Williamson.<sup>12</sup> The monochromators used in these late researches gave narrower wave-

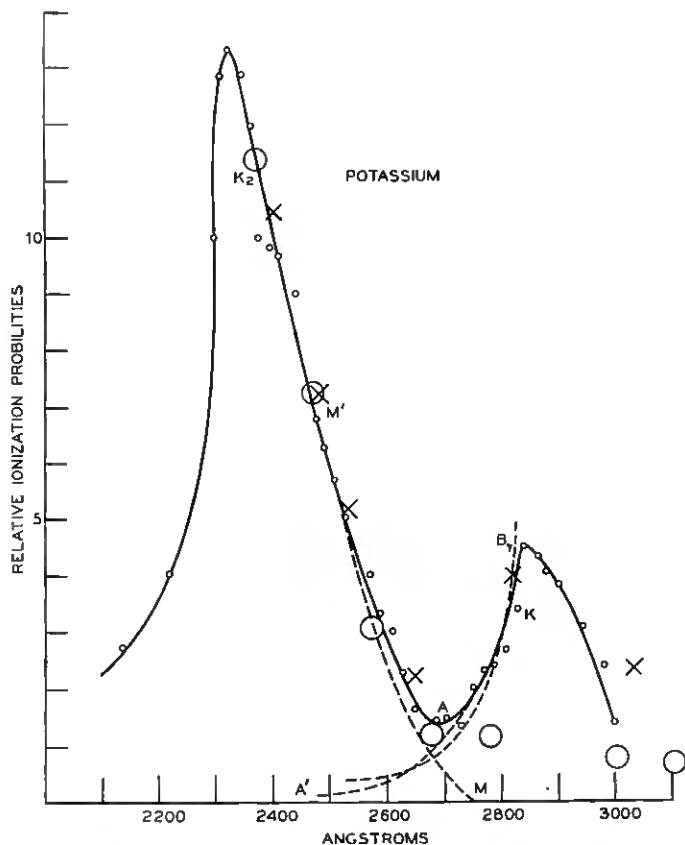

Fig. 3—Ionization by light plotted as function of wavelength for potassium (Critical wavelength: 2856Å). Circlets, crosses and large circles correspond to different sets of observations by Lawrence & Edlefsen, Williamson & Lawrence. (E. O. Lawrence, N. Edlefsen.)

length-bands than those used formerly, and so revealed the small peak at the proper limiting-frequency which had eluded Lawrence at the outset. The much more prominent peak at shorter waves remains outstanding. The data, be it mentioned, are here reduced to equal intensities of light for the various wavelengths.

<sup>11</sup> Lawrence & Edlefsen, *Phys. Rev.*, (2) **34**, pp. 1056-1060 (1929).

<sup>12</sup> *Proc. Nat. Acad. Sci.*, **14**, pp. 793-799 (1928).

The molecule was invoked at once as the *deus ex machina*; the ionization beginning beyond the proper wavelengths was supposed to be ionization of molecules, with or without dissociation. So long as the threshold was thought to be near 2600 or 2550, this idea was fortified by the following calculation. Suppose that a photon of wavelength 2555Å has just the energy required to split a  $K_2$  molecule into a K atom, a  $K^+$  ion, and a free electron; and that a photon of 2856Å has just the energy required to split a K atom into a  $K^+$  ion and a free electron. One easily sees that then the difference between the energies of these two photons would be just the energy required to split a K molecule into two neutral K atoms. The difference amounts to 0.5 equivalent volt. This figure agrees<sup>13</sup> with independent estimates of the value of the latter quantity, which is the heat of dissociation of  $K_2$ . The force of this agreement has just been weakened by the curve of Fig. 3, showing as it does that the ionization in question begins near 2700Å—weakened, but not destroyed, for the ions produced by waves shorter than 2555 might be explained in a way which the reader will easily imagine after the next two paragraphs. The other alternative is, to hope that quantum mechanics will presently prove that the ionization-vs-frequency curve for the potassium atom ought to display both the maxima which are found.

Return now to the curve of Fig. 2 for rubidium. On the long-wave side of the limiting-frequency there is a series of peaks; they lie at the frequencies of the various members of the principal series of lines in the Rb spectrum. Even more striking peaks of this sort were earlier obtained with caesium by Foote, Mohler, and R. L. Chenault;<sup>14</sup> the relevant part of one of their curves is shown as Fig. 4.

Palpably these are phenomena of the same sort as one meets when mercury is irradiated by 2537; and they signify an ionizing-process of two or more stages, the first of which is excitation by the absorption of a photon. There is probably no need to suppose more than two stages; the energy received by the atom from the photon is always much more than half of what is required to ionize. It is supposed by those who have obtained the data that the process is completed by an impact of fast-moving atom, one of those which by virtue of Maxwell's distribution have the necessary excess of energy over the relatively modest mean value corresponding to the actual temperature. The relative heights of the peaks would then be determined partly by the relative abundance of atoms having the necessary energies, and partly by the relative probabilities of the corresponding types of excitation, which

<sup>13</sup> R. W. Ditchburn, *Proc. Camb. Phil. Soc.*, **24**, pp. 320-327 (1928).

<sup>14</sup> *Phys. Rev.*, (2) **26**, pp. 195-207 (1925); **27**, pp. 37-50 (1926).

are quantities with which the theories deal. According to Foote, Mohler and Chenault, these relative heights are in fair accordance with the theories. The actual heights, however, depend on the mean duration of the excited states. I do not know whether it has been proved that these last long enough to permit the explanation.

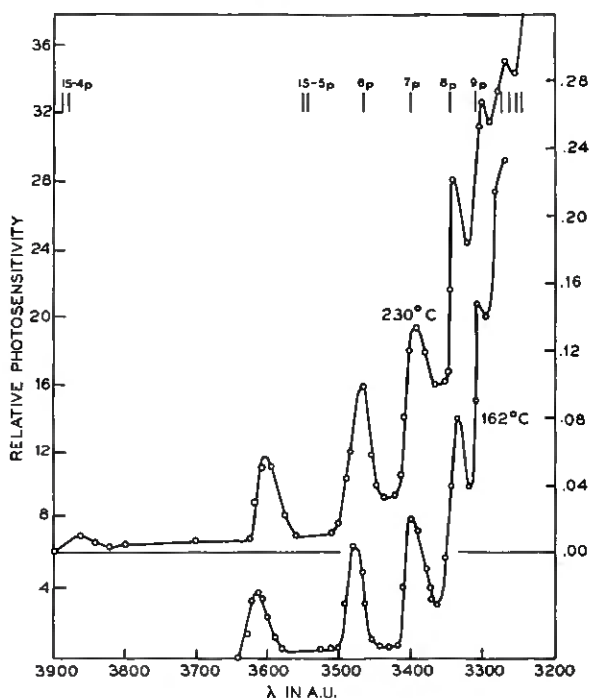

Fig. 4—Ionization of caesium vapor by light, at wavelengths greater than the critical (3184A). (Mohler, Foote & Chenault.)

Since the quanta spent in ionization vanish from the light, the transmitted beam when spread into a spectrum reveals absorption at their frequencies. These absorption-spectra supply all that is known as yet about the process of ionization by light in sodium and in atomic hydrogen and valuable additions to the data for the three heavier alkali metals.

It will be remembered that the lines of a line-series in an absorption-spectrum occur because the photons of the corresponding frequencies can be absorbed by atoms in a particular initial state (normal or excited) which thereupon pass over into higher states of excitation; that as the lines converge upon the limit of the series, the corresponding terminal states approach that of ionization; that the limiting or

convergence-frequency itself, multiplied by  $h$ , give the energy required to ionize an atom from that initial state which is common to the entire series.

Thus photons having the convergence-frequency of any series are *just* able to detach an electron from an atom in the corresponding state. Consequently photons having any greater frequency have energy sufficient to detach an electron, and give it some kinetic energy in addition. Now we are not aware of any "quantum" limitations on the amount of energy which a freed electron may receive. We thus infer that light of any frequency superior to a convergence-frequency will be able to ionize atoms and to be absorbed in doing so, and that there will be a continuous region of absorption in the spectrum extending upwards from the limit of each series. For such a region I will use the terms *continuous band* and *continuum*.

Bohr drew this inference in the first of his epoch-making papers on the interpretation of spectra. He was able then to point to only one example; a continuum beyond the limit of the principal series of sodium, observed by R. W. Wood.<sup>15</sup> Afterwards J. Hartmann<sup>16</sup> searched the spectrograms of the stars, and in those of the so-called "hydrogen stars" he found a continuous band beyond the limit of the Balmer series. This, be it noted, is the sign of ionization of hydrogen atoms initially not in the normal, but in a certain excited state. The continua beyond the principal series of the alkali metals, however, are due to ionization of normal atoms. Those of sodium and potassium were studied by Holtzmark;<sup>17</sup> those of caesium and rubidium have been discerned (Harrison, *l.c. infra*); and the former two were measured, that is to say the variation of absorption-coefficient with frequency was measured, for sodium by G. R. Harrison<sup>18</sup> and B. Trumpy,<sup>19</sup> and for potassium by R. W. Ditchburn.<sup>20</sup>

Obviously if the fundamental theory is correct, absorption is proportional to ionization, and the curves representing the two as functions of wavelength should coincide everywhere if scaled to coincide at any one point; and measurements of either should make the other nugatory. Unfortunately it is difficult to measure the absorption properly, perhaps impossible to do it with anything like the precision feasible with the other measurement.<sup>21</sup> Harrison managed to get smooth absorption-

<sup>15</sup> *Phil. Mag.*, (6) **18**, pp. 530-534 (1909).

<sup>16</sup> *Phys. ZS.*, **18**, pp. 429-432 (1917).

<sup>17</sup> *Phys. Rev.*, **20**, pp. 88-92 (1919).

<sup>18</sup> *Phys. Rev.*, (2) **24**, pp. 466-477 (1924).

<sup>19</sup> *ZS. f. Phys.*, **47**, pp. 804-813 (1928).

<sup>20</sup> *Proc. Roy. Soc.*, **117**, pp. 486-508 (1928).

<sup>21</sup> Mohler and his colleagues state that with an amount of ionization tenfold greater than that which is observed with caesium at the series-limit, a stratum of the gas at 230° would have to be *nine metres* deep to give a 50 per cent absorption.

curves (obtained of course by applying the densitometer to the spectrogram) with sodium. On the other hand, the experiences of Ditchburn with potassium are not encouraging. Not only did he have to shoot a jet of rapidly-distilling vapor across the beam of light, but he was obliged to swamp it in a vast excess of nitrogen—partly to keep the metal from boiling away in a rush, partly it seems to prevent the vapor from attacking the quartz windows. The curves are very crinkly, and it is difficult to tell what share of the absorption should be credited to molecules and what to atoms.

Nevertheless Ditchburn was able to deduce a value of the coefficient  $k$  having the same order of magnitude— $10^{-19}$ —as those which Mohler and Boeckner had obtained with caesium and with rubidium when they were measuring, not the disappearance of photons from the beam, but the advent of ions in the gas. Mohler and Boeckner themselves observed the absorption of light in caesium, and they found for  $k$  the value  $4 \cdot 10^{-19}$ ,—a good agreement, but they qualify it with the words “subject to great uncertainty because of the low value of the total absorption.” Let it be pointed out in closing, that agreements such as these are proof that in this region of the spectrum, photons ionize when they are absorbed, and absorption is due to ionization. To physicists familiar with the new atomic theories, this seems self-evident, and scarcely worth the proving; but it is not self-evident, and there was a time, not many years ago, when such a proof would have been a sensational event.



## Motion of Telephone Wires in Wind

By D. A. QUARLES

This paper deals with the position of equilibrium of a loop of wire in a steady transverse wind and with the swinging of such a loop in one or more gusts of wind. In the first part, the loop is assumed to be inelastic and to swing as a rigid body. Under these conditions, nomograms are given from which may be read the deflection of loops of wire .104" or .165" in diameter as a function of steady wind velocity. The maximum additional swing of such a loop with a single gust and with a succession of gusts of given peak velocities may also be read from the nomograms. A chart is also included giving the effect of wind velocity on the sag of .104" and .165" hard drawn copper wires at tensions and span lengths common in the telephone plant.

UNTIL recent years, most of the important open wire toll circuits of the Bell System had the two wires of a pair spaced 12 inches apart. This wide spacing, with the consequent high mutual inductance between the several pairs on a pole line, limited the use of the lines for multiplex transmission with high frequency or "carrier" currents. A reduction in the separation of the wires of a pair with the retention of the present center-to-center spacing of the pairs was one of the measures which offered the opportunity of increasing the message carrying capacity of a pole line. The controlling factor in limiting such a reduction in spacing was the hazard of the wires of a pair swinging together in the wind thus interrupting or impairing the transmitted messages.

About two years ago the 12-inch spacing was reduced to 8 inches in some cases. This was considered to be as great a change as could be safely taken from a mechanical point of view, based on the available data. These data consisted in part of experiments made on an experimental line and in part of an analysis of the performance of certain working wires in the telephone plant which, for various reasons, had been installed on a close spaced basis.

It was realized that if the wires of pairs could be placed even closer together, materially lower crosstalk between the circuits would result, thus increasing the circuit capacity of open wire lines, and therefore effecting economies. Accordingly, a comprehensive investigation of the wire spacing problem was begun. As some of the factors involved in a theoretical determination of the chance of two parallel wires swinging together in the wind were rather obscure and difficult of evaluation, it was decided to attack the problem experimentally. A field site was selected some distance from New York, where the terrain and weather conditions were suitable for such an investigation, and an experimental station was constructed and appropriately equipped.

Some time will be required, however, before definite conclusions can be drawn from the experimental work of this new laboratory.

As an aid in the interpretation of the experimental results, certain theoretical work has been done on the dynamics of a wire loop swinging in the wind. It is this phase of the problem that is dealt with in this article.

In the first part of this discussion, the wire loop is treated as an inelastic, rigid body.<sup>1</sup> As it was later found that under the conditions applying in our problem there was a considerable increase in the sag of the wire due to the wind, an investigation was made of the magnitude of the correction required when the elasticity of the wire is taken into account, the results of which are given in the latter part of this article.

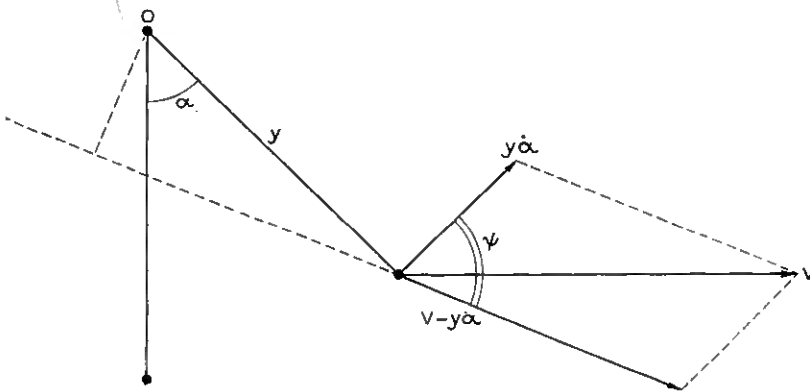

Fig. 1.

Consider an element of the wire, shown in Fig. 1 in cross-section, swinging about axis  $O$ , at a radius  $y$ . The wind is assumed horizontal and transverse to the axis. The sag  $a$  is also assumed small compared with the span length so that to a sufficient approximation the length of the wire is equal to the length of the span and the surface of the wire opposing the wind is independent of the angle of deflection ( $\alpha$ ) of the wire in the wind.

The velocity of the element of wire relative to axes fixed with respect to the earth is  $y\dot{\alpha}$ . The wind velocity relative to the same coordinate

<sup>1</sup>An article entitled "The Behavior of Overhead Transmission Lines in High Winds" by Professor E. H. Lamb, which appeared in the October 1928 Journal of the Institution of Electrical Engineers, gives an analysis of the inelastic, rigid loop problem which has been followed in general outline in the present treatment. There is disagreement, however, with one of the fundamental assumptions upon which Professor Lamb's analysis is based and our formulæ are therefore generally at variance with those derived in his article.

Mr. R. L. Peek, Jr. of Bell Telephone Laboratories, working independently, arrived at results in agreement with those given in the present article.

system is  $V$  and the wind velocity relative to the wire at any instant is therefore the vector difference  $V - y\dot{\alpha}$  which has the magnitude

$$\sqrt{V^2 + (y\dot{\alpha})^2 - 2Vy\dot{\alpha} \cos \alpha}.$$

It is assumed that the wind pressure against this element is proportional to the square of this vector and acts along its direction. The moment about the axis of the wind pressure on the element  $ds$  is therefore given by:

$$k[V^2 + (y\dot{\alpha})^2 - 2y\dot{\alpha}V \cos \alpha]y \cos \psi ds,$$

where  $k$  is the ratio of wind pressure per unit length to square of velocity. Evaluating  $\cos \psi$  and noting that  $y\dot{\alpha}$  is small compared with  $V$ , this reduces to:

$$kdsyV^2 \cos \alpha \left[ 1 - \frac{y\dot{\alpha}}{V} \left( \cos \alpha + \frac{1}{\cos \alpha} \right) \right].$$

Putting

$$y = a \left( 1 - \frac{X^2}{C^2} \right)$$

and

$$ds = dx$$

and integrating, the total moment of wind pressure is

$$\frac{4}{3}kV^2aC \cos \alpha - \frac{16}{15}kVa^2C\dot{\alpha} (\cos^2 \alpha + 1).$$

If the line through the supports is inclined to the horizontal by angle  $\gamma$  this expression becomes:

$$\frac{4}{3}kV^2aC \cos \alpha \cos \gamma - \frac{16}{15}kVa^2C\dot{\alpha} (\cos^2 \alpha + 1) \cos^2 \gamma$$

The dynamic equation for the motion of the loop then becomes:

$$\ddot{\alpha} + \frac{kV}{m}(1 + \cos^2 \alpha)\dot{\alpha} + \frac{5g}{4a} \sin \alpha = \frac{5kV^2 \cos \alpha}{4ma \cos \gamma},$$

where  $m$  is the mass of unit length of wire.

Static equilibrium is then given by:

$$\tan \alpha = \frac{kV^2}{mg \cos \gamma}.$$

Proceeding with the analysis, an equation is found for small motions

about any position of equilibrium (deflection  $\alpha$ ) of the form

$$\ddot{\varphi} + 2\epsilon\dot{\varphi} + n^2\varphi = 0,$$

where

$$\epsilon = \frac{(1 + \cos^2 \alpha) kV}{2m},$$

and

$$n^2 = \frac{5g}{4a \cos \alpha}.$$

For cases of practical interest in this investigation  $n^2 > \epsilon^2$  and the motion about equilibrium is periodic and of period

$$T = \frac{2\pi}{\sqrt{n^2 - \epsilon^2}} = 2\pi \sqrt{\frac{4a \cos \alpha}{5g}}.$$

where  $a$  is the sag in feet and  $g$  the acceleration of gravity in feet per second per second. The ratio of the period of small oscillations about equilibrium to the period when  $\alpha$  is zero is given by  $T/T_0 = \sqrt{\cos \alpha}$ .

The damping as measured by the ratio of successive half swings,  $\lambda$ , is given by

$$\log_e \lambda = \frac{\pi\epsilon}{\sqrt{n^2 - \epsilon^2}} \doteq \frac{\pi}{n} \epsilon$$

If a wire, held at a deflection  $\alpha$  by a steady wind  $V$ , is subjected to a gust of wind having maximum velocity  $V_1$ , the additional throw of the wire will depend on the duration of the gust and may in general be either greater than or less than the increase in steady deflection which  $V_1$ , if sustained, would produce. The maximum throw will be given by a gust of most favorable duration and  $\mu_{ms}$  has been defined as the ratio of this maximum throw to the increase in deflection that would result if the peak velocity were sustained. Similarly, for a periodic succession of gusts, there is a most favorable timing which in general will produce displacements greater than would a wind which sustained the velocity of the gust peaks. The ratio of the throws produced by a most favorably timed succession of gusts to the increase in deflection which would result if the peak velocity of the gusts were sustained, has been defined as  $\mu_{mp}$ .

The formulæ derived above have been applied to the practical conditions of the telephone line problem,<sup>2</sup> where our interest is centered in hard drawn copper wire, commonly of .104'' or .165'' diameter, with spans ordinarily from 90 to 200 feet and sags commonly from 7'' to 20''

<sup>2</sup> This work was carried out in the Bell Telephone Laboratories by Mr. V. Nekrassoff.

though occasionally considerably greater. The method, which will be described in more detail elsewhere, was to reduce the expressions for wind pressure per unit length of wire,  $F$ , angular displacement  $\alpha$ , periods of small oscillations,  $T$  and  $T_0$ , damping constant  $\lambda$ , and the effects of single and periodic gusts,  $\mu_{ms}$  and  $\mu_{mp}$ , to explicit functions of the wind velocity in miles per hour, the diameter of the wire in inches, sag of the wire in inches and trigonometric functions of the deflection of the loop  $\alpha$  and inclination of the loop  $\gamma$ . The factor  $k$  does not appear directly in the equations, having been replaced by fractional powers of wind velocity and wire diameter derived from the experimental results of Relf.<sup>3</sup>

The following nomograms have been constructed by this method. Nomogram No. 1 (Fig. 2) gives the steady deflection  $\alpha$  of a span of wire inclined to the horizontal at an angle  $\gamma$  and the force in pounds per linear foot of wire for a normal wind of velocity  $V$ . It also gives the ratio of the period of small oscillations about the equilibrium position to the natural period about the vertical position, this ratio depending only on  $\alpha$ . The actual value of the period in seconds may be read on nomogram No. 2 (Fig. 3).

By the use of nomogram No. 3 (Fig. 4), the damping constant  $\lambda$ , and the gust ratios  $\mu_{ms}$  and  $\mu_{mp}$  may be computed from the sag  $a$ , the wind velocity  $V$  and the diameter  $D$ .

These nomograms in short give the numerical solution for our problem for wires of the two diameters assumed, namely .104" and .165".

Two major assumptions should be noted, first, that the wire loop swings in a plane and second, that the wire is inelastic. The first assumption has a certain justification in that each element of wire if independent of adjacent elements would be in equilibrium in the same deflected angle  $\alpha$  as is found for the loop as a whole. Expressing this in another way—if it be assumed that the wind is uniform along the span there would be no forces, considering only first order effects, to distort the loop out of a plane.

The second assumption is not so readily justified, in fact the sag of the wire may be greatly affected by the wind pressure. The equilibrium deflection  $\alpha$  is, however, independent of the sag of the wire and is found to be the same when the elasticity of the wire is taken into account as that derived for an inelastic wire.

Considering only the case where the line through the supports is horizontal ( $\gamma = 0$ ), we define  $2r$  as the unstressed length of wire in the loop and note that this may be either greater or less than the span length  $2c$  depending upon the tension at which the wire is suspended.

<sup>3</sup> British Advisory Committee for Aeronautics—Report No. 102.

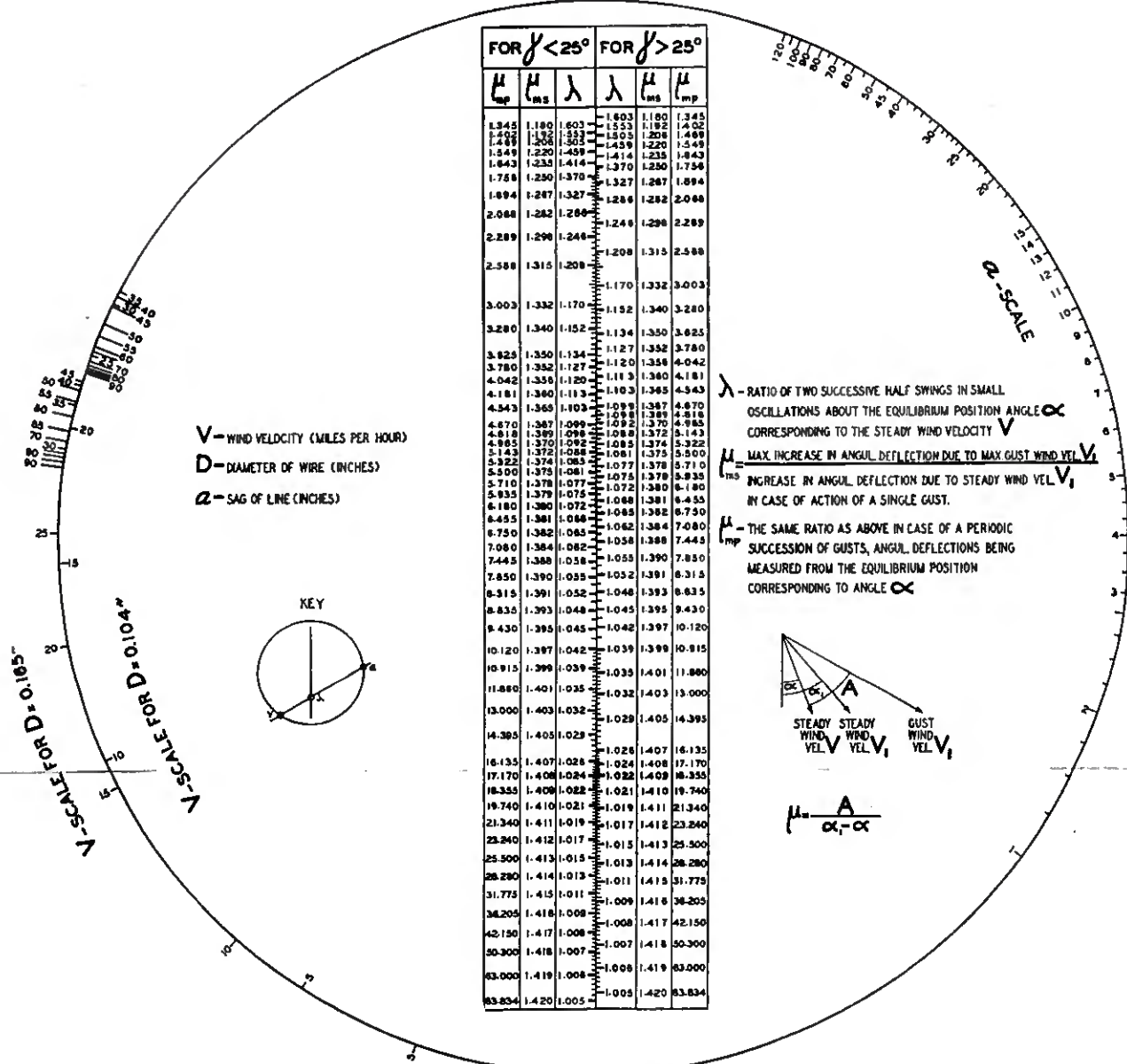

Fig. 4—Chart 3. Circular Alignment Nomogram Representing Resulting Effects of Periodic Gusts of Wind Superimposed on a Steady Wind.

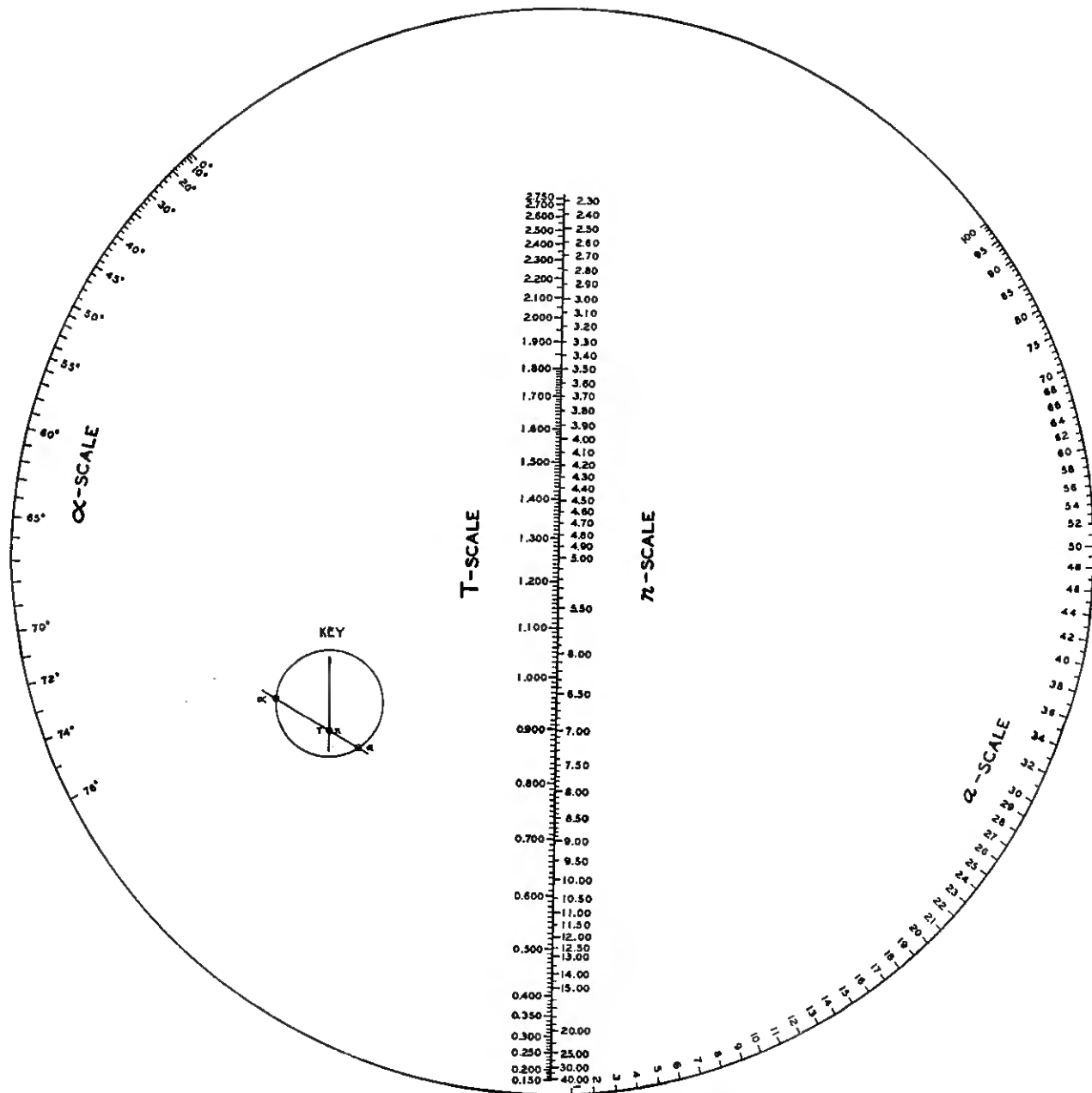

Fig. 3—Chart 2. Steady Wind Circular Alinement Nomogram Representing the Solution of

$$T^2 = \frac{4\pi^2}{15g} a \cos \alpha,$$

where

$T = \frac{2\pi}{\pi}$  = Period of Small Oscillations of Wire Loop (in Seconds) about its Equilibrium Position.

$\alpha$  = An Angle Corresponding to Equilibrium Position of Wire Under the Influence of Steady Wind Velocity  $V$  (see Nomogram No. 1).

$a$  = Sag of Wire (in Inches).

$g$  = Gravity Acceleration (32.16 Feet per Sec<sup>2</sup>).

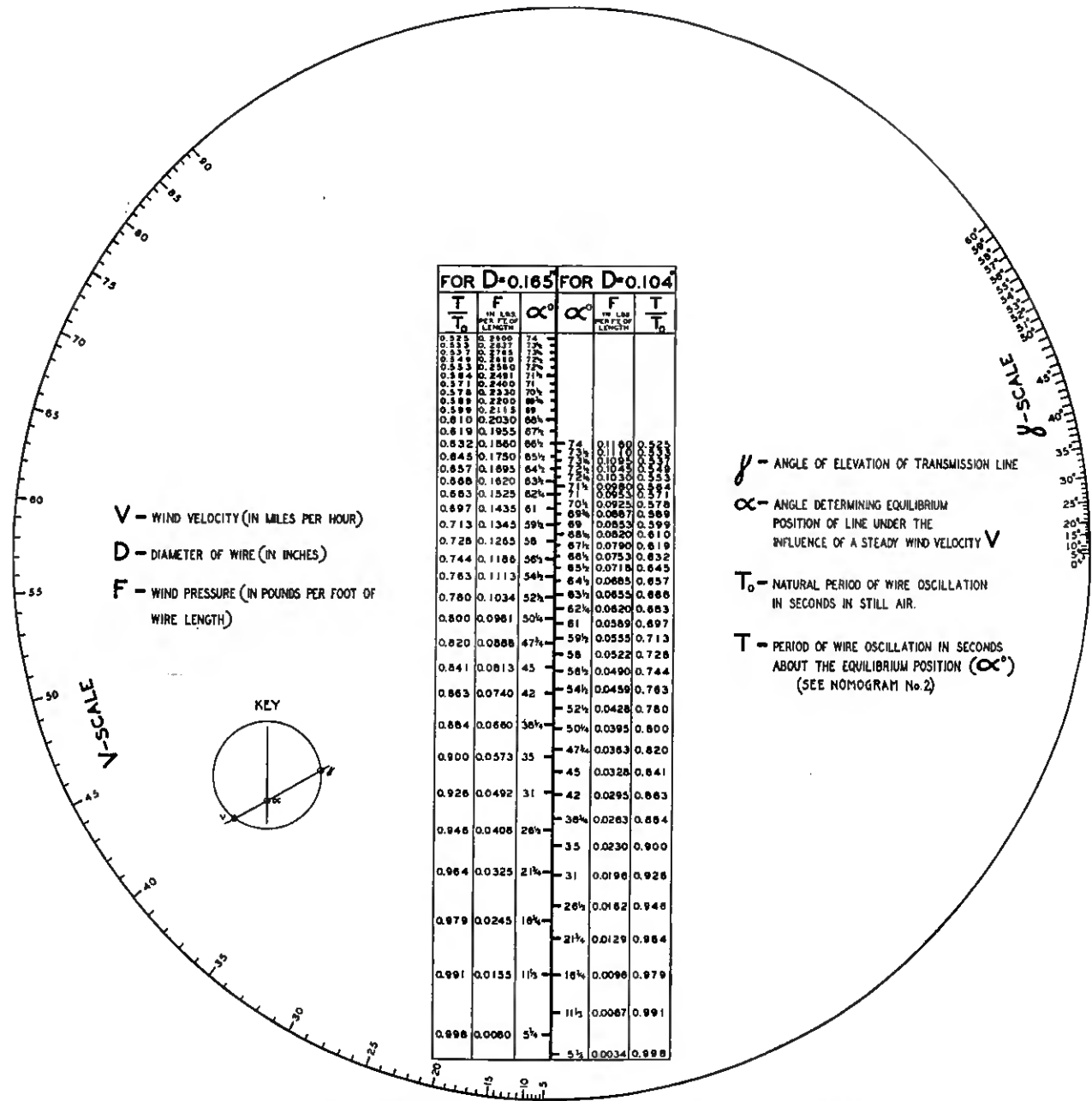
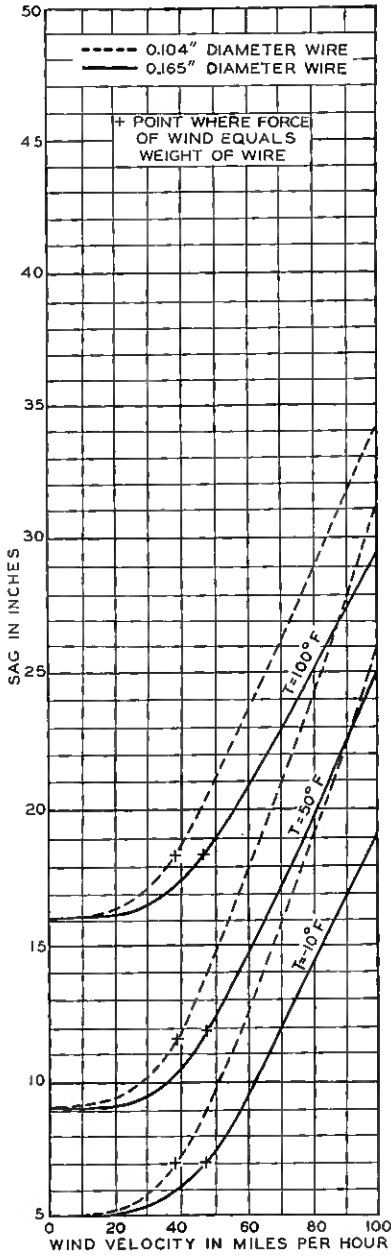

Fig. 2—Chart 1. Steady Wind Circular Alignment Nomogram for  $F$ ,  $T/T_0$  and  $\alpha^\circ$  Representing the Solution of Equation

$$tg \alpha = \frac{0.00422 \sqrt{F \cdot 0.0009}}{(100D)^2 \cdot \cos \gamma}$$





SPAN OF 130 FEET

Fig. 5-A.

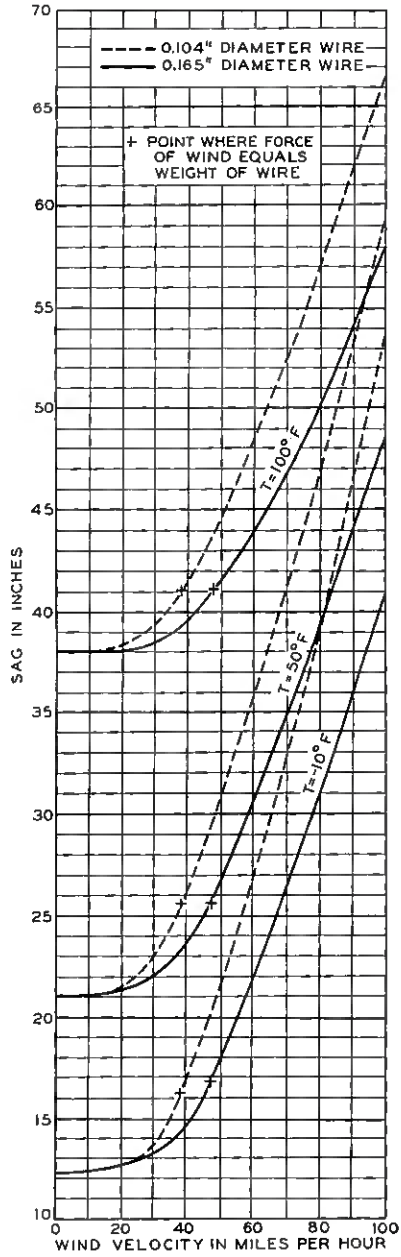

SPAN OF 200 FEET

Fig. 5-B.

If  $E$  is the modulus of elasticity in pounds per square inch cross-section,  $D$  the diameter in inches,  $a$  the sag in feet and  $m$  the weight of wire per linear foot, the approximate relationship<sup>4</sup> is:

$$a^3 + \frac{3c}{2}(c-r)a = \frac{3mc^4}{\pi D^2 E}.$$

As only horizontal winds normal to the line of supports are being considered, the wind pressure when the loop is in equilibrium is horizontal. The weight of the wire being vertical the two forces add at right angles, their resultant being the square root of the sum of their squares. This resultant lies of course in the plane of equilibrium of

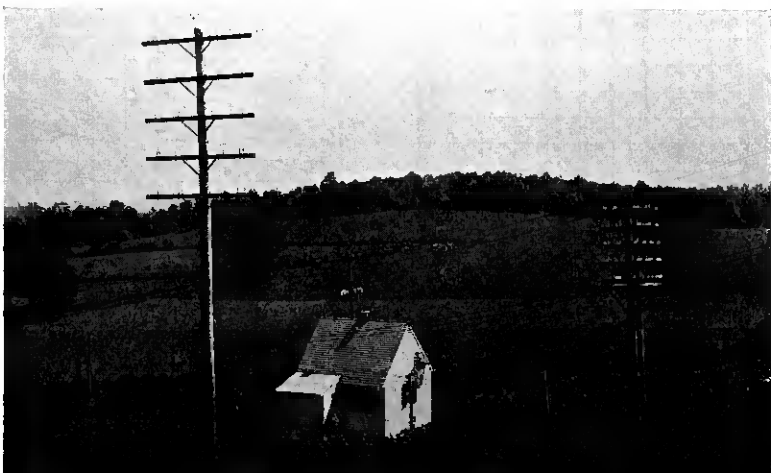

Fig. 6—Test House and Line.

the loop. The wind pressure component is about equal to the gravity component for a velocity of 38 m.p.h. in the case of .104" wire and about 47 m.p.h. in the case of .165" wire. The effective weight of the wire under these conditions would be greater by a factor of  $\sqrt{2}$  than the true weight. In general,  $m$  in the above formula is the effective weight of the wire per unit length.

A wire having a sag of 5' in a 130' span with a temperature of  $-10^{\circ}$  F. would have a sag of about 9' at  $50^{\circ}$  F. and about 16' at  $100^{\circ}$  F. due to thermal expansion. The sag of such a wire would be increased by wind pressure as shown in Fig. 5-A, the wind being given in true normal velocity. The figure shows the increase to be most marked for low temperatures and small diameters as would be expected. Similar

<sup>4</sup> Due to Mr. J. A. Carr of Bell Telephone Laboratories.

results are shown in Fig. 5-*B* for a span of 200'. Both indicate the marked increase of sag under not uncommon wind conditions.

While the above formula and charts give a fairly definite picture of the effect of elasticity on the solution of the problem of static equilibrium, the much more complex problem of the motion of an elastic loop in a varying wind has not been attacked.<sup>5</sup> The necessity for such additional refinements can probably not be determined until the field experiments above referred to have progressed to the point where fairly comprehensive data are available for analysis and for a check of the theoretical conclusions arrived at in this paper.

<sup>5</sup> An article by Karl Wolf in *Zeitschrift für Angewandte Mathematik und Mechanik* of April 1927 treats certain aspects of the dynamics of an elastic loop, with particular reference, however, to power lines. As yet, no attempt has been made to apply the results of this work to our particular problems.

# Economic Quality Control of Manufactured Product<sup>1</sup>

By W. A. SHEWHART

That we cannot make all pieces of a given kind of product identically alike is accepted as a general truth. It follows that the qualities of pieces of the same kind of product differ among themselves, or, in other words, the quality of product must be expected to vary. The causes of this variability are, in general, unknown.

The present paper presents a scientific basis for determining when we have gone as far as it is economically feasible to go in eliminating these unknown or chance causes of variability in the quality of a product. When this state has been reached, the product is said to be *controlled* because it is then possible to set up limits within which the quality may be expected to remain in the future. By securing control, we attain the five economic advantages discussed in Part III.

## I INTRODUCTION

### 1. *What is the Problem of Control?*

WHAT is the problem involved in the control of quality of manufactured product? To answer this question, let us put ourselves in the position of a manufacturer turning out millions of the same kind of thing every year. Whether it be lead pencils, chewing gum, bars of soap, telephones or automobiles, the problem is much the same. He sets up a standard for the quality of his product and then tries to make all pieces of product conform with this standard. Here his troubles begin. For him standard quality is a bull's-eye, but like a marksman shooting at such a target, he often misses. As is the case in everything we do, unknown or chance causes exert their influence. The problem then is: how much may the quality of a product vary and yet be controlled? In other words, how much variation should we leave to chance?

To make a thing the way we want to make it is one popular conception of control. We have been trying to do this for a good many years and we see the fruition of this effort in the marvelous industrial development around us. We have accepted the idea of applying scientific principles but now a change is coming about in the principles themselves which necessitates a new concept of control.

A few years ago we were inclined to look forward to the time when a manufacturer would be able to do just what he wanted to do. We shared the enthusiasm of Pope when he said "All chance is but direction thou canst not see," and we looked forward to the time when we would see that direction. In other words, emphasis was laid on the *exactness*

<sup>1</sup> Paper presented before A. A. A. S. on December 28, 1929, at Des Moines, Iowa.

of physical laws. Today, however, the emphasis is placed elsewhere as is indicated by the following quotation from a recent issue, July, 1927, of the journal *Engineering*:

"Today the mathematical physicist seems more and more inclined to the opinion that each of the so-called laws of nature is essentially statistical, and that all our equations and theories can do, is to provide us with a series of orbits of varying probabilities."

The breakdown of the old orthodox scientific theory which formed the basis of applied science in the past necessitates the introduction of certain new concepts into industrial development. Along with this change must come a revision in our ideas of such things as a controlled product, an economic standard of quality and the method of detecting lack of control or those variations which should not be left to chance.

Realizing, then, the statistical nature of modern science, it is but logical for the manufacturer to turn his attention to the consideration of available ways and means of handling statistical problems. The necessity for doing this is pointed out in the recent book on the "Application of Statistics in Mass Production," by Becker, Plaut and Runge. They say:

"It is therefore important to every technician who is dealing with problems of manufacturing control to know the laws of statistics and to be able to apply them correctly to his problems."

Another German writer, K. H. Daeves, writing on somewhat the same subject says:

"Statistical research is a logical method for the control of operations, for the research engineer, the plant superintendent, and the production executive."

This statement is of particular interest because its author has for several years been associated with the application of statistical methods in the steel industry.

The problem of control viewed from this angle is a comparatively new one. In fact, very little has been written on the subject. Progress in modifying our concept of control has been and will be comparatively slow. In the first place, it requires the application of certain modern physical concepts and in the second place, it requires the application of statistical methods which up to the present time have been for the most part left undisturbed in the journals in which they appeared. This situation is admirably summed up by the magazine *Nature* of January, 1926, as follows:

"A large amount of work has been done in developing statistical methods on the scientific side, and it is natural for any one interested in science to hope that all this work may be utilized in commerce and industry. There are signs that such a movement has started, and it would be unfortunate indeed if those responsible in practical affairs fail to take advantage of the improved statistical machinery now available."

## 2. Object

The object of this paper is the presentation of a scientific basis for interpreting the significance of chance variations in quality of product and for eliminating causes of variability which need not be left to chance, making possible more uniform quality and thereby effecting certain economies.

## 3. Nature of Control

Let us consider a very simple example of our inability to do exactly what we want to do and thereby illustrate two characteristics of a controlled product.

Write the letter *a* on a piece of paper. Now make another *a* just like the first one; then another and another until you have a series of *a*'s, *a, a, a, a, . . .* You try to make all the *a*'s alike but you don't; you can't. You are willing to accept this as an empirically established fact. But what of it? Let us see just what this means in respect to control. Why can we not do a simple thing like making all the *a*'s just alike? Your answer leads to a generalization which all of us are perhaps willing to accept. It is that there are many causes of variability among the *a*'s: the paper was not smooth, the lead in the pencil was not uniform and the unavoidable variability in your external surroundings reacted upon you to introduce variations in the *a*'s. But are these the only causes of variability in the *a*'s? Probably not.

We accept our human limitations and say that likely there are many other factors. If we could but name all the reasons why we cannot make the *a*'s alike, we would most assuredly have a better understanding of a certain part of nature than we now have. Of course this conception of what it means to be able to do what we want to do is not new; it does not belong exclusively to any one field of human thought; it is a commonly accepted conception.

The point to be made in this simple illustration is that we are limited in doing what we want to do; that to do what we set out to do, even in so simple a thing as making *a*'s that are alike requires almost infinite knowledge compared with that which we now possess. It follows, therefore, since we are thus willing to accept as axiomatic that we cannot do what we want to do and that we cannot hope to understand why we cannot, that we must also accept as axiomatic that a controlled quality will not be a constant quality. Instead a controlled quality must be a *variable* quality. This is the first characteristic.

But let us go back to the results of the experiment on the *a*'s and we shall find out something more about control. Your *a*'s are different from my *a*'s; there is something about your *a*'s which makes them yours

and something about my *a*'s that makes them mine. True, not all of your *a*'s are alike. Neither are all of my *a*'s alike. Each group of *a*'s varies within a certain range and yet each group is distinguishable from the others. This distinguishable and, as it were, constant variability *within limits* is the second characteristic of control.

#### 4. *Definition of Control*

For our present purpose a phenomenon will be said to be controlled when, through the use of past experience, we can predict, at least within limits, how the phenomenon will be expected to vary in the future. Here it is understood that prediction within limits means that we can state, at least approximately, the probability that the observed phenomenon will fall within the given limits.

In this sense the time of the eclipse of the sun is a predictable phenomenon. So also is the distance covered in successive intervals of time by a freely falling body. In fact, the prediction in such cases is extremely precise. It is an entirely different matter, however, to predict the expected length of life of an individual at a given age; the velocity of a molecule at a given instant of time; the breaking strength of a steel wire of known cross section; or numerous other phenomena of like character. In fact, a prediction of the type illustrated by forecasting the time of an eclipse of the sun is almost the exception rather than the rule in scientific and industrial work.

In all forms of prediction an element of chance enters. The specific problem which concerns us at the present moment is the formulation of a scientific basis for prediction, taking into account the element of chance, where, for the purpose of our discussion, any unknown cause of a phenomenon will be termed a *chance* cause.

## II. SCIENTIFIC BASIS FOR CONTROL

### 1. *Three Important Postulates*

What can we say about the future behavior of a phenomenon acting under the influence of unknown or chance causes? I doubt that, in general, we can say anything. For example, let me ask: "What will be the price of your favorite stock thirty years from today?" Are you willing to gamble much on your powers of prediction in such a case? Probably not. However, if I ask: "Suppose you were to toss a penny one hundred times, thirty years from today, what proportion of heads would you expect to find?" your willingness to gamble on your powers of prediction would be of an entirely different order than in the previous case.



The recognized difference between these two situations leads us to make the following simple postulate:

*Postulate 1. All chance systems of causes are not alike in the sense that they enable us to predict the future in terms of the past.*

Hence, if we are to be able to predict the quality of product at least within limits, we must find some criterion to apply to observed variability in quality to determine whether or not the cause system producing it is such as to make possible future predictions.

Perhaps the natural course to follow is to glean what we can about the workings of unknown chance causes which are generally acknowledged to be controlled in the sense that they permit of prediction within limits. Perhaps no better examples could be considered than those which influence length of human life and molecular motion, for it often appears that nothing is more uncertain than life itself, unless perhaps it be molecular motion. Yet there is something certain about these uncertainties. In the assumed laws of mortality and distribution of molecular displacement, we find some of the essential characteristics of control within limits.

#### A. Law of Mortality

The date of death always has seemed to be fixed by chance even though great human effort has been expended in trying to rob chance

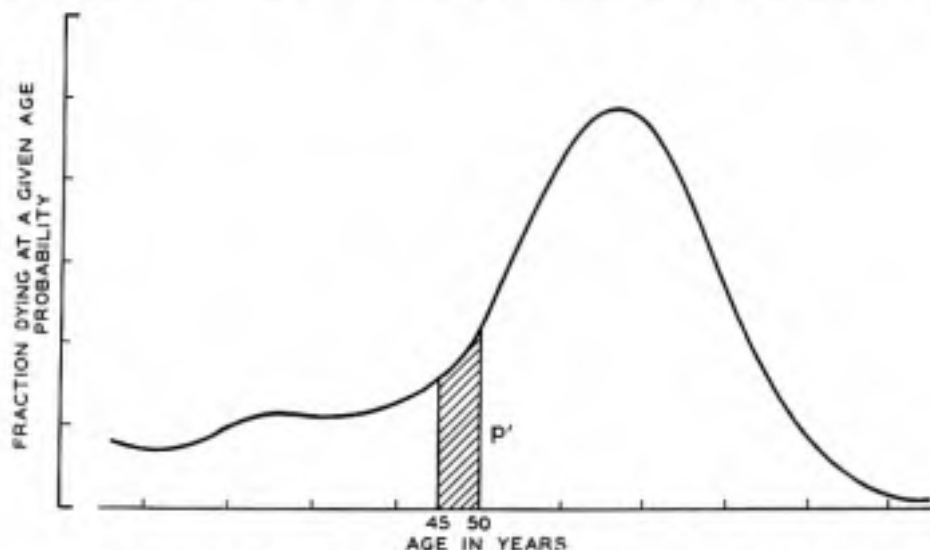

Fig. 1—Law of mortality—law of fluctuations controlled within limits.

of this prerogative. We come into this world and from that very instant on are surrounded by causes of death seeking our life. Who knows whether or not death will overtake us within the next year?



If so, what will be the cause? These questions we cannot answer. Some of us are to fall at one time from one cause, others at another time from another cause. In this fight for life we see then the element of uncertainty and the interplay of numerous unknown or chance causes.

However, when we study the effect of these chance causes in producing deaths in large groups of individuals, we find some indication of a controlled condition. We find that this hidden host of causes produce deaths at an average rate which does not differ much over long periods of time. From such observations we are led to believe that, as we approach the condition of homogeneity of population and surroundings, we approach what is customarily termed a "Law of mortality" such as indicated schematically in Fig. 1. In other words, we believe that in the limiting case of homogeneity the causes of death function so as to make the probability, let us call it  $dy$ , of dying within given age limits, such as forty-five to fifty, constant: That is, we believe these causes are controlled. In other words, we assume the existence of a kind of statistical equilibrium among the effects of such an unknown system of chance causes expressible in the assumption that the probability of dying within a given age limit, under the assumed conditions, is an *objective* and constant reality.

#### *B. Molecular Motion*

Just about a century ago, in 1827 to be exact, an English botanist, Brown, saw something through his microscope that caught his interest. It was motion going on among the suspended particles almost as though they were alive. In a way it resembled the dance of dust particles in sunlight, so familiar to us, but this dance differed from that of the dust particles in important respects—for example, adjacent particles seen under the microscope did not necessarily move in even approximately the same direction, as do adjacent dust particles suspended in the air.

Watch such motion for several minutes. So long as the temperature remains constant, there is no change. Watch it for hours, the motion remains characteristically the same. Watch it for days, we see no difference. Even particles suspended in liquids enclosed in quartz crystals for thousands of years show exactly the same kind of motion. Therefore, to the best of our knowledge there is remarkable permanence to this motion. Its characteristics remain constant. Here we certainly find a remarkable degree of constancy exhibited by a chance system of causes.

Suppose we follow the motion of one particle to get a better picture of this constancy. This has been done for us by several investigators,

notably Perrin. In such an experiment he noted the position of a particle at the end of equal intervals of time, Fig. 2. He found that



Fig. 2—A close-up of molecular motion appearing absolutely irregular, yet controlled within limits.

the direction of this motion observed in one interval differed, in general, from that in the next succeeding interval. He found that the direction of the motion presents what we instinctively call absolute irregularity. Let us ask ourselves certain questions about this motion.

Suppose we fix our attention on the particle at the point *A*. What made it move to *B* in the next interval of time? Of course we answer

by saying that a particle moves at a given instant in a given direction, say  $AB$ , because the resultant force of the molecules hitting it in a plane perpendicular to this direction from the side away from  $B$  is greater than that on the side toward  $B$ ; but at any given instant of time there is no way of telling what molecules are engaged in giving it such motion. We do not even know how many molecules are taking part. Do what we will, so long as the temperature is kept constant, we cannot change this motion in a given system. It cannot be said, for example, when the particle is at the point  $B$  that during the next interval of time it will move to  $C$ . We can do nothing to control the motion in the matter of displacement or in the matter of the direction of this displacement.

Let us consider either the  $x$  or  $y$  components of the segments of the paths. Within recent years we find abundant evidence indicating that these displacements appear to be distributed about zero in accord with what is called the normal law. That is to say, if  $x$  represents the deviation from the mean displacement, zero in this case, the probability  $dy$  of  $x$  lying within the range  $x$  to  $x + dx$  is given by

$$dy = \frac{1}{\sigma\sqrt{2\pi}} e^{-(x^2/2\sigma^2)} dx, \quad (1)$$

where  $\sigma$  is the root mean square deviation.

Such evidence as that provided by the law of mortality and the law of distribution of molecular displacements leads us to assume that there exist in nature phenomena controlled by systems of chance causes such that the probability  $dy$  of the magnitude  $X$  of a characteristic of some such phenomenon falling within the interval  $X$  to  $X + dX$  is expressible as a function  $f$  of the quantity  $X$  and certain parameters represented symbolically in the equation

$$dy = f(X, \lambda_1, \lambda_2, \dots, \lambda_n) dX, \quad (2)$$

where the  $\lambda$ 's denote the parameters. Such a system of causes we shall term *constant* because the probability  $dy$  is independent of time. We shall take as our second postulate:

*Postulate 2—Constant systems of chance causes do exist in nature.*

To say that such systems of causes exist in nature, however, is one thing; to say that such systems of causes exist in a production process is quite another thing. Less than ten years ago it seemed reasonable to assume that such systems of causes existed in the production of telephone equipment. Today we have abundant evidence of their

existence. The practical situation, however, is that in the majority of cases there are unknown causes of variability in the quality of a product which do not belong to a constant system. This fact was discovered very early in the development of control methods, and these causes were called *assignable*. The question naturally arose as to whether it was possible, in general, to find and eliminate causes of variability which did not form a part of a constant system. Less than ten years ago it seemed reasonable to assume that this could be done. Today we have abundant evidence to justify this assumption. We shall, therefore, adopt as our third postulate:

*Postulate 3—Assignable causes of variation may be found and eliminated.*

Hence, to secure control, the manufacturer must seek to find and eliminate assignable causes. In practice, however, he has the difficulty of judging from an observed set of data, whether or not assignable causes are present. A simple illustration will make this point clear.

### 2. When Do Fluctuations Indicate Trouble?

In many instances the quality of the product is measured by the fraction non-conforming to engineering specifications or as we say the fraction defective. Table 1 gives for a period of 12 months the ob-

TABLE 1

Apparatus Type A				Apparatus Type B			
Month	$n$ No. Insp.	$n_1$ No. Def.	$p = n_1/n$ Fraction Def.	Month	$n$ No. Insp.	$n_1$ No. Def.	$p = n_1/n$ Fraction Def.
Jan.....	527	4	.0076	Jan.....	169	1	.0059
Feb.....	610	5	.0082	Feb.....	99	3	.0303
Mar.....	428	5	.0117	Mar.....	208	1	.0048
Apr.....	400	2	.0050	Apr.....	196	1	.0051
May.....	498	15	.0301	May.....	132	1	.0076
June.....	500	3	.0060	June.....	89	1	.0112
July.....	395	3	.0076	July.....	167	1	.0060
Aug.....	393	2	.0051	Aug.....	200	1	.0050
Sept.....	625	3	.0058	Sept.....	171	2	.0117
Oct.....	465	13	.0280	Oct.....	122	1	.0082
Nov.....	446	5	.0112	Nov.....	107	3	.0280
Dec.....	510	3	.0059	Dec.....	132	1	.0076
Average....	483.08	5.25	.0109		149.33	1.42	.0095

served fluctuations in this fraction for two kinds of product designated here as Type A and Type B. For each month we have the sample size  $n$ , the number defective  $n_1$  and the fraction  $p = n_1/n$ . We can

better visualize the extent of these fluctuations in fraction defective by plotting the data as in Fig. 3-a and Fig. 3-b.

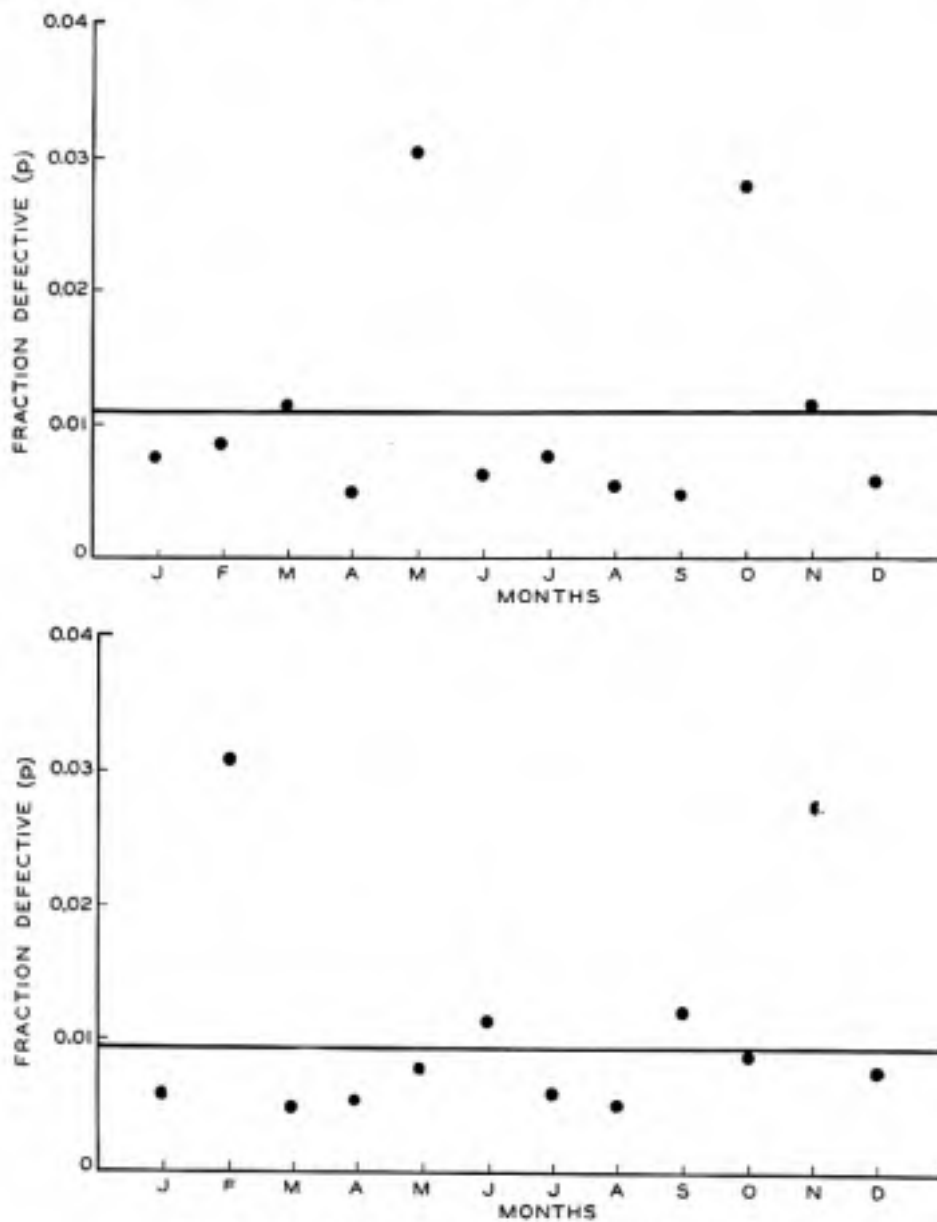

Fig. 3—Should these variations be left to chance?

- a. Apparatus Type A.  
b. Apparatus Type B.

What we need is some yardstick to detect in such variations any evidence of the presence of assignable causes. Can we find such a

yardstick? Experience of the kind soon to be considered indicates an affirmative answer. It leads us to conclude that it is feasible to establish criteria useful in detecting the presence of assignable causes of

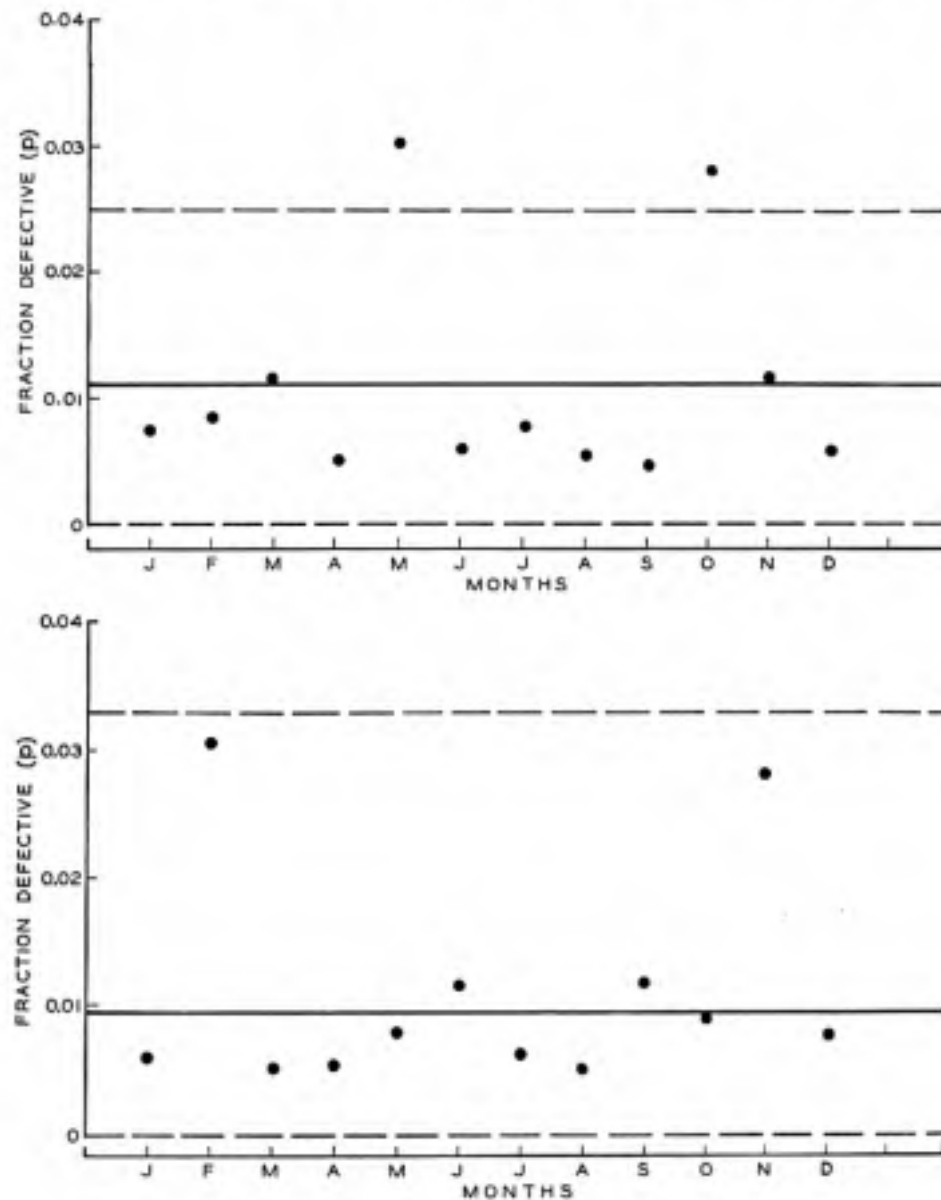

Fig. 4—Should these variations be left to chance?

a. No.

b. Yes.

variation or, in other words, criteria which when applied to a set of observed values will indicate whether or not it is reasonable to believe

that the causes of variability should be left to chance. Such criteria are basic to any method of securing control within limits. Let us, therefore, consider them critically. It is too much to expect that the criteria will be infallible. We are amply rewarded if they appear to work in the majority of cases.

Generally speaking, the criteria are of the nature of limits derived from past experience showing within what range the fluctuations in quality should remain, provided they are to be left to chance. For example, when such limits are placed on the fluctuations in the qualities shown in Fig. 3, we find (see Fig. 4) that in one case two points fall outside the limits and in the other case no point falls outside the limits. Upon the basis of the use of such limits, we look for trouble in the form



Fig. 5—Art plus modern statistical machinery makes possible the establishment of such limits.

of assignable causes in one case but not in the other. However, to be of really practical interest, we should be able to answer the following question: Can we expect to be able to find and eliminate causes of variability *only* when deviations fall outside the limits? First, let us see what statistical theory has to say in answer to this question.

Upon the basis of postulate 3, it follows that we can find and remove causes of variability until the remaining system of causes is constant or until we reach that state where the probability that the deviations in quality remain within any two fixed limits (Fig. 5) is constant. However, this assumption alone does not tell us that there are certain limits within which all observed values of quality should remain provided the causes cannot be found and eliminated. In fact so long as the limits are set so that the probability of falling within the limits is less than



unity, we may always expect a certain percentage of observations to fall outside the limits even though the system of causes be constant. In other words, the acceptance of this assumption gives us a right to believe that there is an objective state of control within limits but in itself it does not furnish the practical criterion for determining when variations in quality, such as given in Fig. 3, should be left to chance.

Furthermore, we may say that mathematical statistics as such does not give us the desired criterion. What does this situation mean in plain every day engineering English? Simply this: such criteria, if they exist, cannot be shown to exist by any theorizing alone, no matter how well equipped the theorist is in respect to probability or statistical theory. We see in this situation the long recognized dividing line

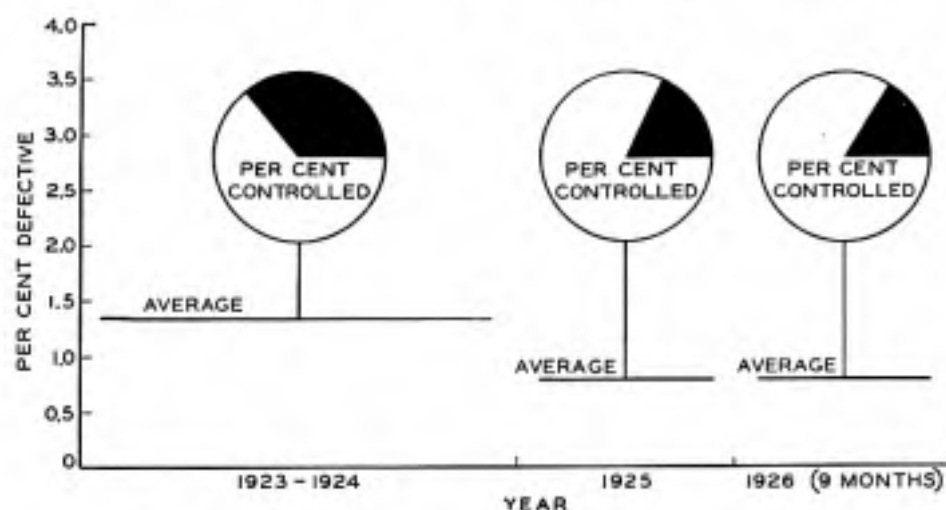

Fig. 6—Evidence of improvement in quality with approach to control.

between theory and practice. The available statistical machinery referred to by the magazine *Nature* is, as we might expect, not an end in itself but merely a means to an end. In other words, the fact that the criterion which we happen to use has a fine ancestry of high-brow statistical theorems does not justify its use. Such justification must come from empirical evidence that it works. As the practical engineer might say, the proof of the pudding is in the eating. Let us therefore look for the proof.

### 3. Evidence that Criteria Exist for Detecting Assignable Causes

A. Fig. 6 shows the results of one of the first large scale experiments to determine whether or not indications given by such a criterion applied to quality measured in terms of fraction defective were justified by experi-



ence. About thirty typical items used in the telephone plant and produced in lots running into the millions per year were made the basis for this study. As shown in this figure during 1923-24, these items showed 68 per cent control about a relatively low average of 1.4 per cent defective.<sup>1</sup> However, as the assignable causes indicated by deviations in the observed monthly fraction defective falling outside of control limits were found and eliminated, the quality of product approached the state of control as indicated by an increase of from 68 per cent to 84 per cent control by the latter part of 1926. At the same time the quality improved; in 1923-24 the average per cent defective was 1.4 per cent whereas by 1926 this had been reduced to .8 per cent. Here we get some typical evidence that, in general, as the assignable causes are removed, the variations tend to fall more nearly within the limits as indicated by an increase from 68 per cent to 84 per cent. Such evidence is, of course, one sided. It shows that when points fall outside the limits, experience indicates that we can find assignable causes, but it does not indicate that when points fall within such limits, we cannot find causes of variability. However, this kind of evidence is provided by the following two typical illustrations.

TABLE 2  
Electrical Resistance of Insulations in Megohms.  
Should Such Variations be Left to Chance?

5045	4635	4700	4650	4640	3940	4570	4560	4450	4500	5075	4500
4350	5100	4600	4170	4335	3700	4570	3075	4450	4770	4925	4850
4350	5450	4110	4255	5000	3650	4855	2965	4850	5150	5075	4930
3975	4635	4410	4170	4615	4445	4160	4080	4450	4850	4925	4700
4290	4720	4180	4375	4215	4000	4325	4080	3635	4700	5250	4890
4430	4810	4790	4175	4275	4845	4125	4425	3635	5000	4915	4625
4485	4565	4790	4550	4275	5000	4100	4300	3635	5000	5600	4425
4285	4410	4340	4450	5000	4560	4340	4430	3900	5000	5075	4135
3980	4065	4895	2855	4615	4700	4575	4840	4340	4700	4450	4190
3925	4565	5750	2920	4735	4310	3875	4840	4340	4500	4215	4080
3645	4190	4740	4375	4215	4310	4050	4310	3665	4840	4325	3690
3760	4725	5000	4375	4700	5000	4050	4185	3775	5075	4665	5050
3300	4640	4895	4355	4700	4575	4685	4570	5000	5000	4615	4625
3685	4640	4255	4090	4700	4700	4685	4700	4850	4770	4615	5150
3463	4895	4170	5000	4700	4430	4430	4440	4775	4570	4500	5250
5200	4790	3850	4335	4095	4850	4300	4850	4500	4925	4765	5000
5100	4845	4445	5000	4095	4850	4690	4125	4770	4775	4500	5000

B. In the production of a certain kind of equipment, considerable cost was involved in securing the necessary electrical insulation by means of materials previously used for that purpose. A research program was started to secure a cheaper material. After a long series of preliminary experiments, a tentative substitute was chosen and an

<sup>1</sup> Jones, R. L., "Quality of Telephone Materials," *Bell Telephone Quarterly*, June, 1927.

extensive series of tests of insulation resistance were made on this material, care being taken to eliminate all known causes of variability. Table 2 gives the results of 204 observations of resistance in megohms taken on as many samples of the proposed substitute material. Reading from top to bottom beginning at the left column and continuing throughout the table gives the order in which the observations were made. The question is: "Should such variations be left to chance?"

No *a priori* reason existed for believing that the measurements forming one portion of this series should be different from those in any other portion. In other words, there was no rational basis for dividing the

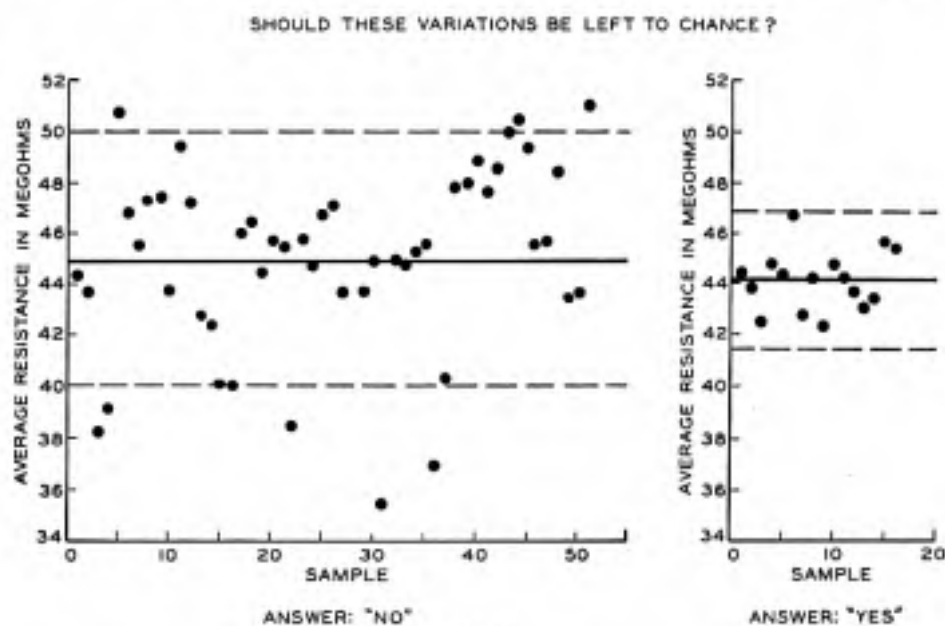

Fig. 7.

total set of data into groups of a given number of observations except that it was reasonable to believe that the system of causes might have changed from day to day as a result of changes in such things as atmospheric conditions, observers, and materials. In general, if such a change is to take place, we may readily detect its effect provided we divide the total number of observations into comparatively small sub-groups. In this particular instance, the size of the sub-group was taken as four and the black dots in Fig. 7-a show the successive averages of four observations in the order in which they were taken. The dotted lines are the limits within which experience has shown that these observations should fall, taking into account the size of the sam-

ple, provided the variability should be left to chance. Several of the observed values lie outside these limits. This was taken as an indication of the existence of causes of variability which could be found and eliminated.

Further research was instituted at this point to find these causes of variability. Several were found and after these had been eliminated, another series of observed values gave the results indicated in Fig. 7-b. Here we see that all of the points lie within the limits. We assumed, therefore, upon the basis of this test, that it was not feasible for research to go much further in eliminating causes of variability. Because of the importance of this particular experiment, however,

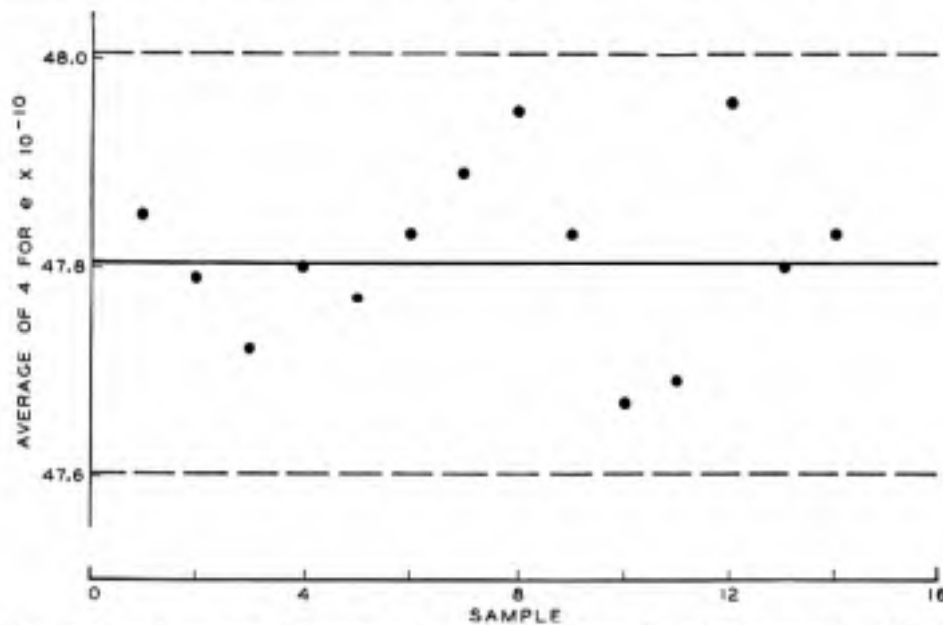

Fig. 8—Variations that should be left to chance. Does the criterion work? "Yes."

considerably more work was done, but it failed to reveal causes of variability. Here then is a typical case where the criterion indicates when variability should be left to chance.

C. Suppose now that we take another illustration where it is reasonable to believe that almost everything humanly possible has been done to remove the assignable causes of variation in a set of data. Perhaps the outstanding series of observations of this type is that given by Millikan in his famous measurement of the charge on an electron. Treating his data in a manner similar to that indicated above, we get the results shown in Fig. 8. All of the points are within the dotted limits. Hence the indication of the test is consistent with the accepted conclusion that those factors which need not be left to chance had been eliminated before this particular set of data were taken.

#### 4. Rôle Played by Statistical Theory

It may appear thus far that mathematical statistics plays a relatively minor rôle in laying a basis for economic control of quality. Such, however, is not the case. In fact, a central concept in engineering work of today is that almost every physical property is a *statistical distribution*. In other words, an observed set of data constitutes a sample of the effects of unknown chance causes. It is at once apparent, therefore, that sampling theory should prove a valuable tool in testing engineering

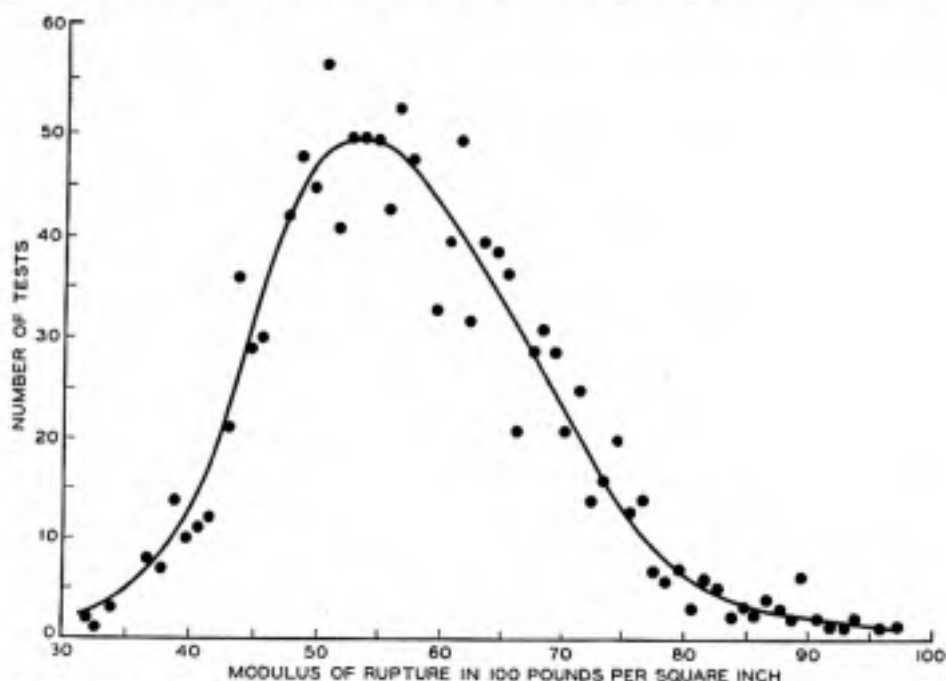

Fig. 9—Variability in modulus of rupture of clear specimens of green sitka spruce typical of the statistical nature of physical properties

hypotheses. Here it is that much of the most recent mathematical theory becomes of value particularly in analysis involving the use of comparatively small numbers of observations.

Let us consider, for example, some property such as the tensile strength of a material. Provided our previous assumptions are justified, it follows that after we have done everything we can to eliminate assignable causes of variation, there will still remain a certain amount of variability exhibiting the state of control. Let us consider an extensive series of data recently published by a member of the Forest Products Laboratories<sup>2</sup> (Fig. 9). Here we have the results of tests for tensile strength on 1304 small test specimens of sitka spruce, the kind

<sup>2</sup> Newlin, J. A., *Proceedings of the American Society of Civil Engineers*, September, 1926, pp. 1436-1443.

of material used in aeroplane propellers during the war. The wide variability is certainly striking. The smooth solid curve is an approximation to the distribution function for this particular property representing at least approximately a state of control. The importance of going from the sample to the smooth distribution is at once apparent and in this case a comparatively small amount of refinement in statistical machinery is required.

Suppose, however, that instead of more than a thousand measurements we had only a very small number, such as is so often the case in engineering work. Our estimation of the variability of the distribution function, representing the state of control, upon the basis of the information given by the sample would necessarily be quite different from that ordinarily used by engineers (see Fig. 10). This is true even though

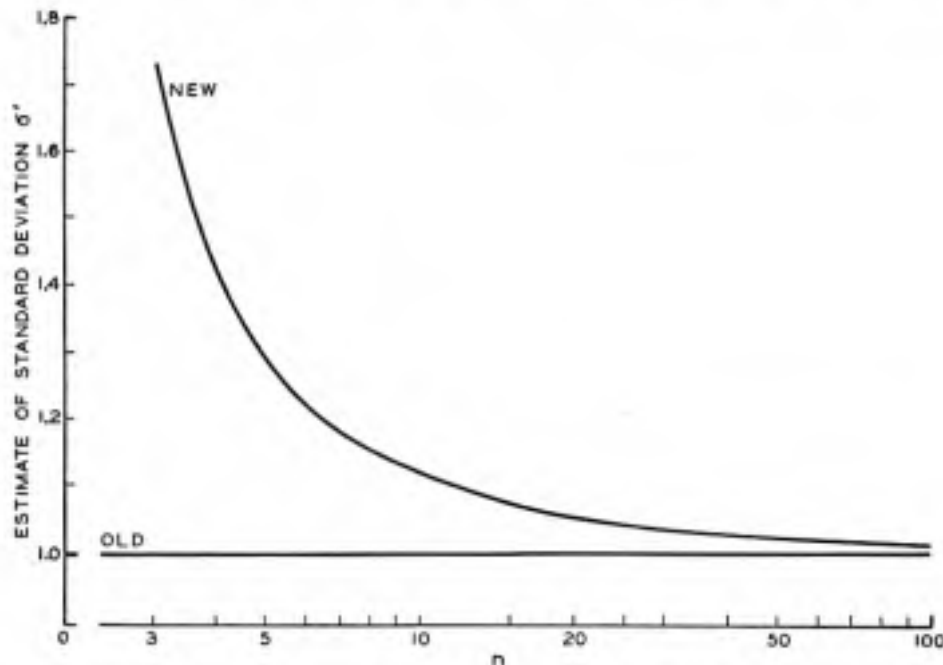

Fig. 10—Correction factors made possible by modern statistical theory are often large.—Typical Illustration.

we make the same kind of assumption to begin with as engineers have been accustomed to do in the past. This we may take as a typical example of the fact that the production engineer finds it to his advantage to keep abreast of the developments in statistical theory. Here we use new in the sense that much of modern statistical machinery is new to most engineers.

## 5. Conclusion

Based upon evidence such as already presented, it appears to be practicable to set up criteria by which to determine when assignable causes of variations in quality have been eliminated so that the product may then be considered to be controlled within limits. This state of control appears to be, in general, a kind of limit to which we may expect to go economically in finding and removing causes of variability without changing a major portion of the manufacturing process as, for example, would be involved in the substitution of new materials or designs.

## III. ADVANTAGES SECURED THROUGH CONTROL

## 1. Reduction in the Cost of Inspection

If we can be assured that something we use is produced under controlled conditions, we do not feel the need for inspecting it as much as

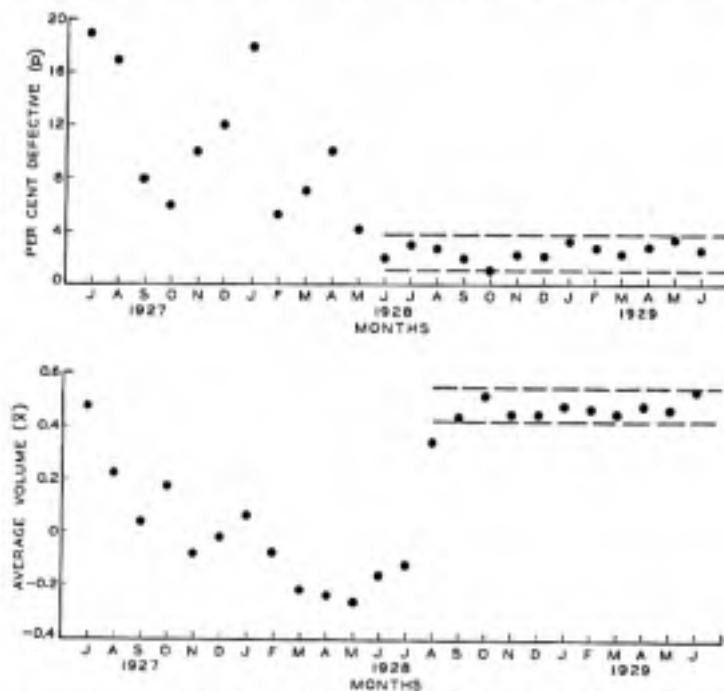

Fig. 11—Approach to stable equilibrium or control as assignable causes are weeded out, thus reducing the need for inspection.

we would if we did not have this assurance. For example, we do not waste our money on doctors' bills so long as we are willing to attribute the variability in our health to the effects of what in our present terminology corresponds to a constant system of chance causes.

In the early stages of production there are usually causes of variability which must be weeded out through the process of inspection. As



we proceed to eliminate assignable causes, the quality of product usually approaches a state of stable equilibrium somewhat after the manner of the two specific illustrations presented in Fig. 11. In both instances, the record goes back for more than two years and the process of elimination in each case covers a period of more than a year.

It is evident that as the quality approaches what appears to be a comparatively stable state, the need for inspection is reduced.

### *2. Reduction in the Cost of Rejections*

That we may better visualize the economic significance of control, we shall now view the production process as a whole. We take as a specific illustration the manufacture of telephone equipment. Picture, if you will, the twenty or more raw materials such as gold, platinum, silver, copper, tin, lead, wool, rubber, silk, and so forth, literally collected from the four corners of the earth and poured into the manufacturing process. The telephone instrument as it emerges at the end of the production process is not so simple as it looks. In it there are 201 parts, and in the line and equipment making possible the connection of one telephone to another, there are approximately 110,000 more parts. The annual production of most of these parts runs into the millions so that the total annual production of parts runs into the billions.

How shall the production process for such a complicated mechanism be engineered so as to secure the economies of quantity production and at the same time a finished product with quality characteristics lying within specified tolerances? One such scheme is illustrated in Fig. 12. Here the manufacturing process is indicated schematically as a funnel, at the small end of which we have the 100 per cent inspection screen to protect the consumer by assuring that the quality of the finished product is satisfactory. Obviously, however, it is often more economical to throw out defective material at some of the initial stages in production rather than to let it pass on to the final stage where it would likely cause the rejection of a finished unit of product. For example, we see to the right of the funnel, piles of defectives, which must be junked or reclaimed at considerable cost.

It may be shown theoretically that, by eliminating assignable causes of variability, we arrive at a limit to which it is feasible to go in reducing the fraction defective. It must suffice here to call attention to the kind of evidence indicating that this limiting situation is actually approached in practice as we remove the assignable causes of variability.

Let us refer to the information given in Fig. 6 which is particularly significant because it represents the results of a large scale experiment

carried on under commercial conditions. As the black sectors in the pie charts decrease in size, indicating progress in the removal of assignable causes, we find simultaneously a decrease in the average frac-

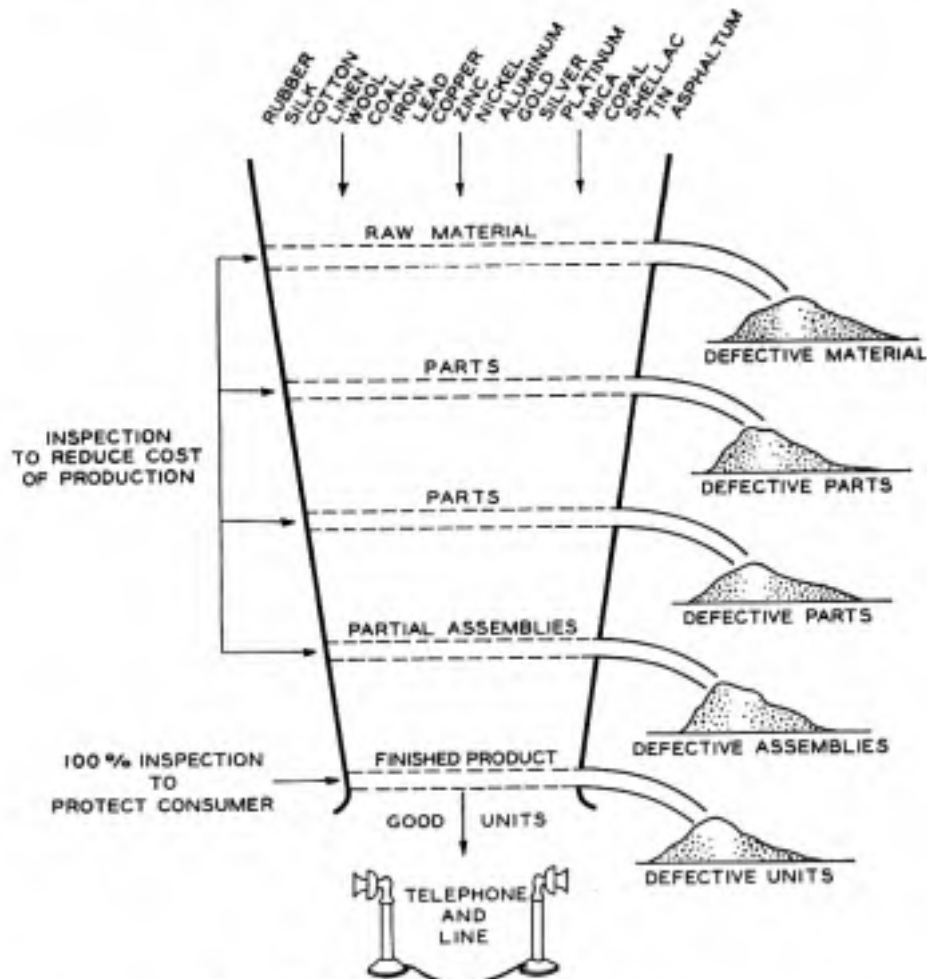

Fig. 12—An economic production scheme.

tion defective from .014 to .008. Here we see how control works to reduce the amount of defective material. However, this is such an important point that it is perhaps interesting to consider an illustration from outside the telephone field.

Recent work of the Food Research Institute of Stanford University shows that the loss from stale bread constitutes an important item of cost for a great number of wholesale as well as some retail bakeries. They estimate that this factor alone costs people of the United States millions of dollars per year. The sales manager of every baking cor-



poration is interested, therefore, in detecting and finding assignable causes of variation in the returns of stale bread provided that by so doing he may reduce to a minimum the loss arising in this way.

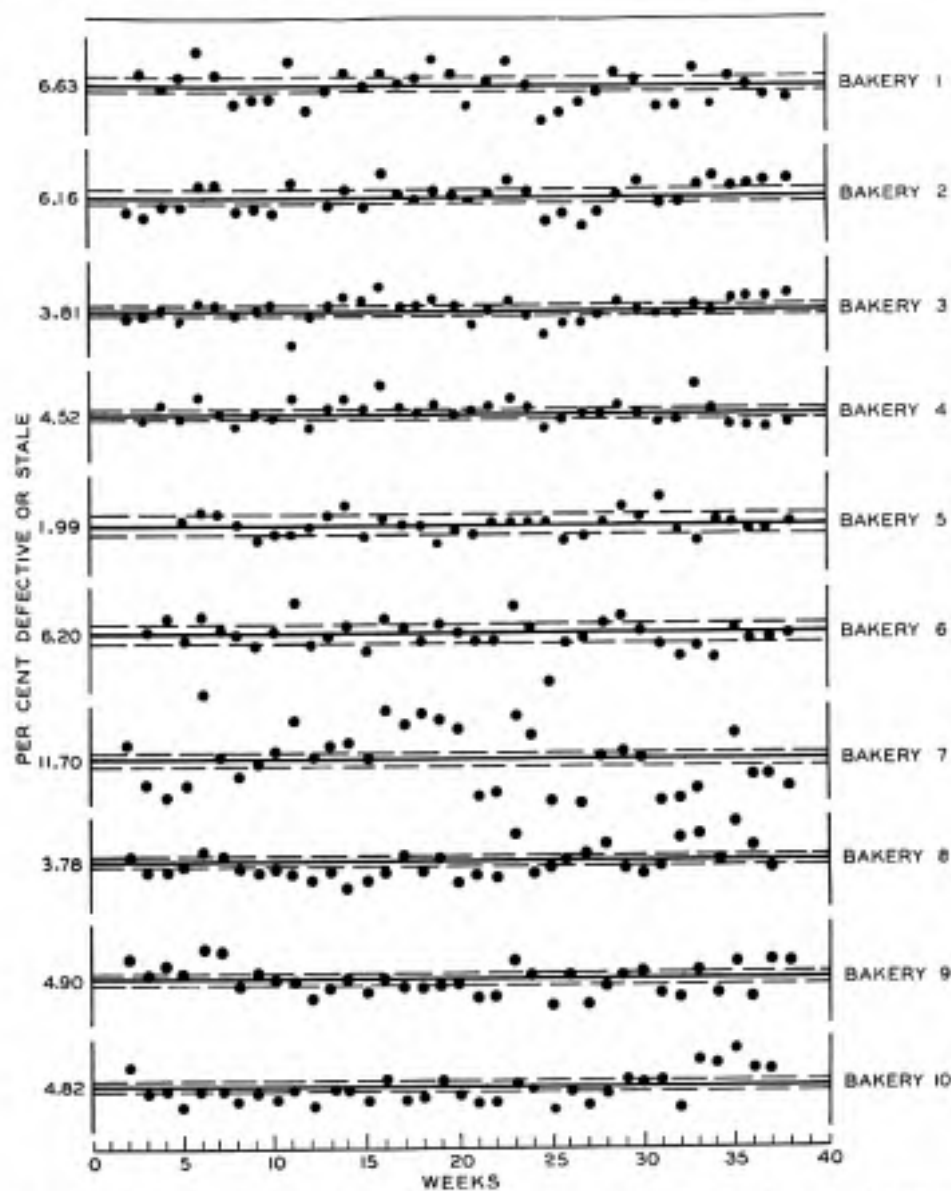

Fig. 13—Results showing how control effects a reduction in the cost of rejections.

Some time ago it became possible to secure the weekly record of return of stale bread for ten different bakeries operating in a certain metropolitan district. These observed results are shown graphically in Fig. 13. At once we see that there is a definite lack of control on the

part of each bakery. The important thing for us to note, however, is that the bakery having the lowest percentage return, 1.99 per cent, also shows better control than the other bakeries as judged by the number of points falling outside the control limits in the period of 36 weeks.

### 3. *Attainment of Maximum Benefits from Quantity Production*

The quality of the finished product depends upon the qualities of raw materials, piece parts and the assembling process. It follows from simple theory that so long as such quality characteristics are controlled, the quality of the finished unit will be controlled, and will therefore exhibit *minimum variability*. Other advantages also result. For example, by gaining control, it is as we have already seen, possible to establish standard statistical distributions for the many quality characteristics involved in design. Very briefly, let us see just how these statistical distributions, representing states of control, become useful in securing an economic design and production scheme.

Suppose we consider a simple problem in which we assume that the quality characteristic  $Y$  in the finished product is a function  $f$  of  $m$  different quality characteristics,  $X_1, X_2, \dots, X_m$ , representable symbolically by Equation (3).

$$Y = f(X_1, X_2, \dots, X_m). \quad (3)$$

For example, one of the  $X$ 's might be a modulus of rupture, another a diameter of cross section, and  $Y$  a breaking load. Engineering requirements generally place certain tolerances on the variability in the resultant quality characteristic  $Y$ , which variability is in turn a function of the variabilities in each of the  $m$  different quality characteristics.

As already stated, the quality characteristic  $Y$  will be controlled provided the  $m$  independent characteristics are controlled. Knowing the distribution functions for each of the  $m$  different independent variables, it is possible to approximate very closely the per cent of the finished product which may be expected to have a quality characteristic  $Y$  within the specified tolerances. If it is desirable to minimize the variability in the resultant quality  $Y$  by proper choice of materials, for example, and, if standard distribution functions for the given quality characteristics are available for each of several materials, it is possible to choose that particular material which will minimize the variability of the resultant quality at a minimum of cost.

### 4. *Attainment of Uniform Quality Even Though Inspection Test Is Destructive*

So often the quality of a material of the greatest importance to the individual is one which cannot be measured directly without destroying

the material itself. So it is with the fuse that protects your home; with the steering rod on your car; with the rails that hold the locomotive in its course; with the propeller of an aeroplane, and so on indefinitely. How are we to know that a product which cannot be tested in respect to a given quality is satisfactory in respect to this same quality? How are we to know that the fuse will blow at a given current; that the steering rod of your car will not break under maximum load placed upon it? To answer such questions, we must rely upon previous experience. In such a case, causes of variation in quality are unknown and yet we are concerned in assuring ourselves that the quality is satisfactory.

Enough has been said to show that here is one of the very important applications of the theory of control. By weeding out assignable causes of variability, the manufacturer goes to the feasible limit in assuring uniform quality.

#### 5. *Reduction in Tolerance Limits*

By securing control and by making use of modern statistical tools, the manufacturer not only is able to assure quality, even though it cannot be measured directly, but is also often able to reduce the tolerance limits in that quality as one very simple illustration will serve to indicate.

Let us again consider tensile strength of material. Here the measure of either hardness or density is often used to indicate tensile strength. In such cases, it is customary practice to use calibration curves based upon the concept of functional relationship between such characteristics. If instead of basing our use of these tests upon the concept of functional relationship, we base it upon the concept of statistical relationship, we can make use of planes and surfaces of regression as a means of calibration, thus in general making possible a reduction in the error of measurement of the tensile strength and hence the establishment of closer tolerances. It follows that this is true because, when quality can be measured directly and accurately, we can separate those samples of a material for which the quality lies within given tolerance limits from all others. Now, when the method of measurement is indirect and also subject to error, this separation can only be carried on in the probability sense assuming the errors of measurement are controlled by a constant system of chance causes. It is obvious that, corresponding to a given probability, the tolerance limits may be reduced as we reduce the error of measurement.

Fig. 14 gives a simple illustration. Here the comparative magnitudes of the standard deviations of strength about the two lines of regression and the plane<sup>3</sup> of regression are shown schematically by the

<sup>3</sup> For definition of these terms see any elementary text book on statistics.

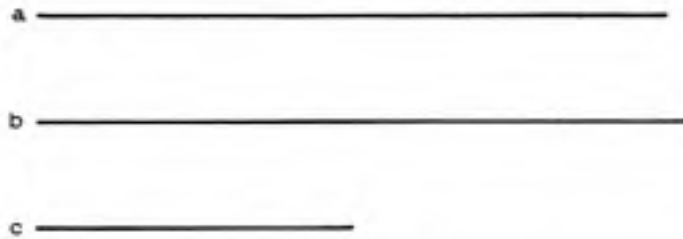
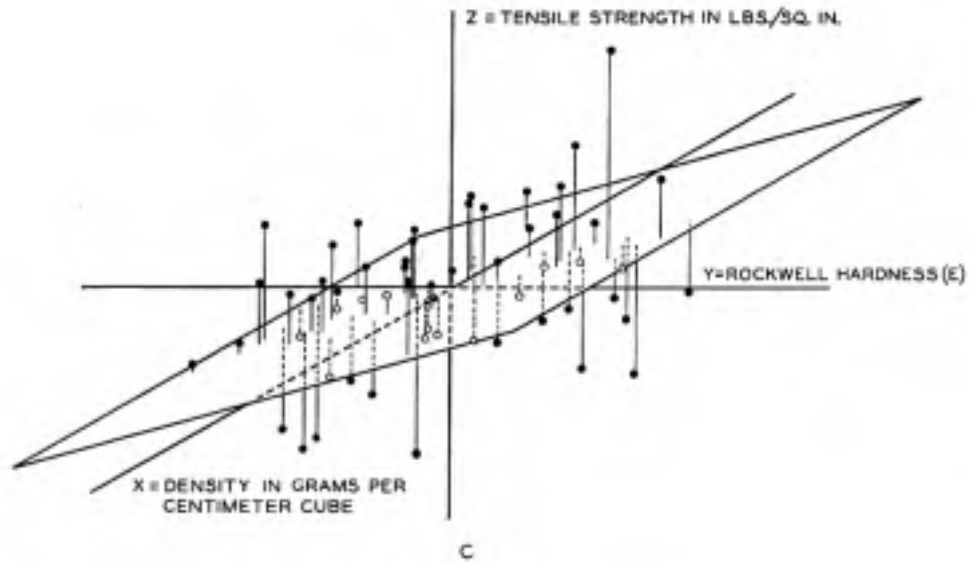
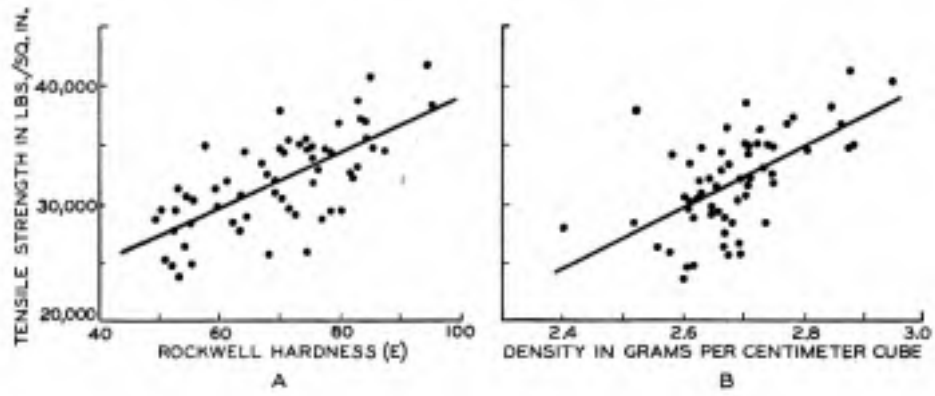

Fig. 14—How control makes possible improved quality through reduction in tolerance limits.

lines in Fig. 14-d. The lengths of these are proportional to the allowable tolerance limits corresponding to a given probability. Customary practice is to use the line of regression between tensile strength and hardness. Note the improvement effected by using the plane of regression. By using the hardness and density together as a measure of tensile strength in this case, the tolerance limits on tensile strength corresponding to a given probability can be reduced to approximately one-half what they would be if either of these measures were used alone.

#### IV. CONCLUSION

It seems reasonable to believe that there is an *objective state of control*, making possible the prediction of quality within limits even though the causes of variability are unknown. Evidence has been given to indicate that through the use of statistical machinery in the hands of an engineer artful in making the right kind of hypothesis, it appears possible to establish criteria which indicate when the state of control has been reached. It has been shown that by securing this state of control, we can secure the following advantages:

1. Reduction in the cost of inspection.
2. Reduction in the cost of rejections.
3. Attainment of maximum benefits from quantity production.
4. Attainment of uniform quality even though inspection test is destructive.
5. Reduction in tolerance limits where quality measurement is indirect.

## Optimum Reverberation Time for Auditoriums

By WALTER A. MACNAIR<sup>1</sup>

The suggestion is made that the sound damping material in an auditorium should be such that the loudness of tones will decay at the same rate for all frequencies. To attain this the reverberation time at 80 cycles must be twice what it is at 1000 cycles.

The change of optimum reverberation time with volume is shown to be derivable from a single hypothesis.

### I. REVERBERATION TIME VS. FREQUENCY

THERE is very little published data in regard to the change in reverberation time with frequency in auditoriums which are considered near ideal. It is often mentioned by engineers and physicists that to secure the best acoustical results, the reverberation time should be the same for all frequencies in any one room. This specifies that the sensation level shall decay at the same rate for all frequencies of interest.

It seems more reasonable, however, to specify that the loudness of all pure tones shall decay at the same rate for all frequencies since it is the loudness of a tone which takes into consideration not only the energy level but also its ultimate effect upon one's brain. In Fig. 1<sup>2</sup> are plotted data which show the relation between the loudness as judged by a considerable number of observers and the sensation level. It will be seen that for frequencies between 700 and 4000 cycles per second these two quantities are equal to each other so that the two points of view mentioned above demand identical conditions throughout this frequency band. Outside of this band, however, any change in the sensation level gives a greater change in the loudness, as may be seen.

The maximum loudness in which we are interested at present is about 73.<sup>3</sup> In the figure the curves may be replaced by straight lines which represent fair approximations to the observed data up to this loudness. This family of straight lines may be represented by the expression

$$L_t = A_f S_t, \quad (1)$$

where  $A_f$  is the slope of the line adopted to fit the data for the fre-

<sup>1</sup> Presented before Acoustical Soc. of Amer., Dec., 1929. Jour. Acou. Soc. Amer., Jan., 1930.

<sup>2</sup> This is Fig. 108 from "Speech and Hearing" by H. Fletcher.

<sup>3</sup> This is the loudness that the source chosen in Part II of this paper will produce in a room of 1000 cubic feet having a reverberation time of 0.8 seconds.

quency  $f$ . The values of  $A_f$  chosen from this figure are given by the next, Fig. 2. This approximation simplifies our calculations very much and introduces errors which are not intolerable.

Referring back to Fig. 1, if we wish to adjust the absorption of the room so that the loudness of all pure tones will decay at the same rate, say for the moment 60 units per second, it is seen that the sensation level must drop 60 db per second for frequencies between 700 and

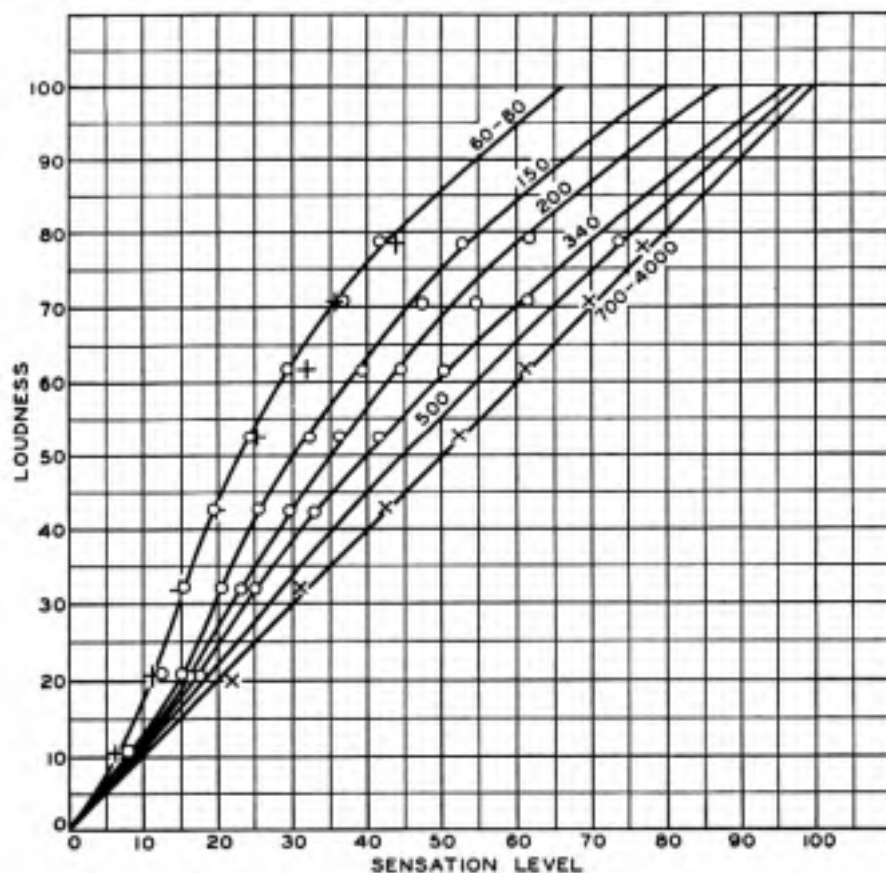

Fig. 1.—Loudness of pure tones.

4000 cycles and for other frequencies the sensation level must drop  $60/A_f$  db per second; or in other words, the reverberation time for frequencies between 700 and 4000 cycles should be one second and outside of this band it should be  $A_f$  seconds. Fig. 2, then, which is a plot of  $A_f$  vs. frequency now becomes also an illustration of the shape of the reverberation time vs. frequency curve which a room should have in order that the loudness of pure tones of all frequencies shall decay at the same rate.



According to Sabine's well known formula the reverberation time is inversely proportional to the number of absorption units in the room so that, if we assume this, we may immediately infer the shape of the curve which represents the number of absorption units necessary at any frequency, referred to the amount required at 1000 cycles, to obtain our required condition. These values are plotted in Fig. 3. If it should happen that the greater part of the sound absorption in a room is caused by one particular kind of surface, then the curve in Fig. 3 is the shape of the absorption curve that this material should have.

A pertinent observation on which every one seems to agree is that if

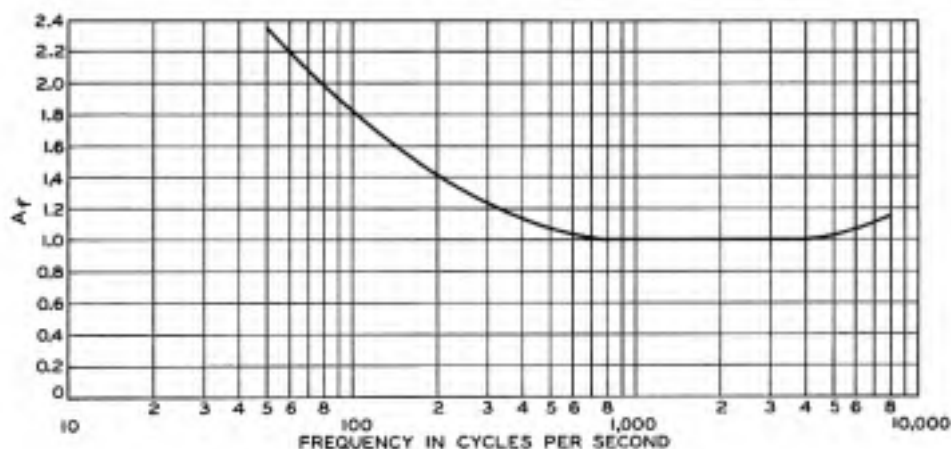

Fig. 2.—Values of  $A_f$  vs. frequency.

an auditorium has an unusually long reverberation time and consequently is of little use, when empty, it attains excellent acoustic conditions when filled with a large audience. In these cases a very large part of the absorption is caused by the audience. The absorption of an average audience has been measured by W. C. Sabine<sup>3</sup> and his results are also plotted in Fig. 3. The close agreement between this curve and the one we have obtained from our hypothesis gives considerable confidence in our general viewpoint.

## II. REVERBERATION TIME vs. VOLUME

It is generally accepted that the best acoustical conditions in a room are obtained when the reverberation time is adjusted to a definite value known as the optimum reverberation time. Observations reported in literature agree that the value of the optimum reverberation time in-

<sup>3</sup> "Collected Papers on Acoustics," page 86.



creases with the size of the room in the way shown in Fig. 4 where the curves are the choices reported by Watson,<sup>4</sup> Lifschitz,<sup>5</sup> and Sabine.<sup>6</sup> These experimental results have served as the basis of successful adjustment and design of many auditoriums. One naturally seeks the factor which determines a choice of reverberation time of two seconds for a million cubic feet theatre and on the other hand a choice of near one second for a 10,000 cubic foot music room. It is our purpose now to point out the factor which apparently does this.

We will set down a condition which we believe to be this factor and then will show that the requirements demanded by it agree quite

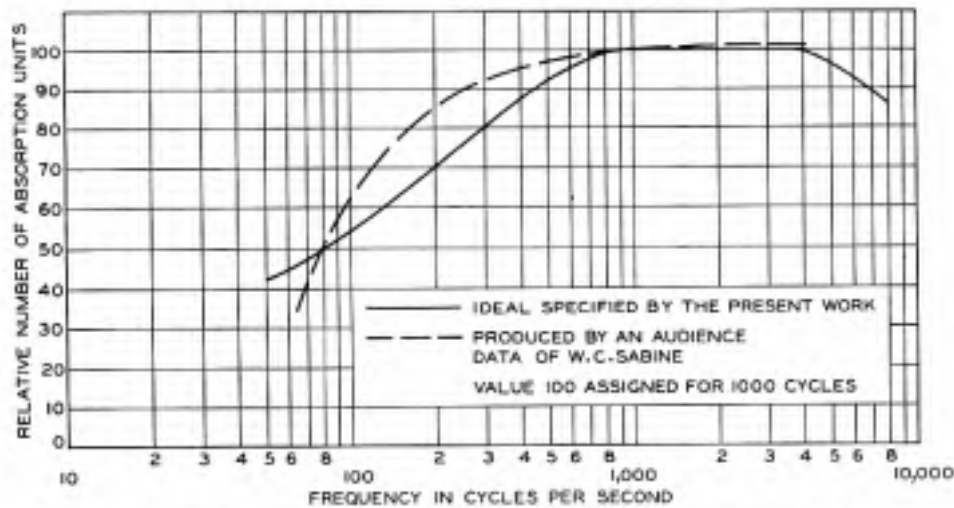

Fig. 3.—Relative number of absorption units vs. frequency.

closely with the empirical results illustrated in Fig. 4 and mentioned above. The condition is

$$\int_{t_0}^{t_1} L_t dt = -K, \quad (2)$$

in which  $t_0$  is the time a sustained source of sound  $\bar{E}$  is cut off,  $t_1$  the time the sound becomes inaudible,  $L_t$  the loudness of the sound at any instant  $t$ , and  $K$  a constant. As shown in Fig. 1, the loudness of a one thousand cycle note is equal to the sensation level, that is,

$$L_t = S_t \text{ for 1000 cycles.}$$

<sup>4</sup> Watson, *Architecture*, May, 1927.

<sup>5</sup> Lifschitz, *Phys. Rev.*, 27, 618, 1926.

<sup>6</sup> Sabine, *Trans. of S.M.P.E.*, XII, 35, 1928.

Since, during the time of decay,  $S_t$  decreases uniformly with time, and therefore  $L_t$  also, then for a thousand cycle note, evaluating our integral we have

$$L_{t_1} T_1 = 2K \quad (3)$$

or

$$S_{t_1} T_1 = 2K,$$

where

$$T_1 = t_1 - t_0.$$

This last expression is practically in the form in which this condition was first stated by Lifschitz.<sup>5</sup> In (3) there are three unknowns and a fourth is implied, namely, the power of the source,  $\bar{E}$ .

We now turn our attention to finding the relation between the volume of a room and the reverberation time dictated by the stated condition. Following P. E. Sabine let us take the rate of emission of the source,  $\bar{E}$  to be  $10^{10}$  cubic meters ( $35.3 \times 10^{10}$  cubic feet) of sound of threshold density per second. Now<sup>7</sup>

$$T_1 = \frac{4V}{ca} \log_4 \frac{4 \times 35.3 \times 10^{10}}{c \cdot a},$$

where  $V$  is the volume of the room in cubic feet.

$c$  is the velocity of sound, 1120 feet per second.

$a$  is the number of absorption units in sq. feet and<sup>8</sup>

$$L_{t_0} = S_{t_0} = 10 \log_{10} \frac{4 \times 35.3 \times 10^{10}}{c \cdot a}.$$

If we should substitute these values in (3) we would obtain a relation between  $V$ ,  $a$ , and  $K$  which must be satisfied when condition (2) is satisfied. In other words, this relation would specify the amount of absorption, for a one thousand cycle note, a room should have if it complies with (2).

If we assume Sabine's well known formula, namely,

$$T = \frac{.05V}{a},$$

where  $T$  is the reverberation time in seconds we may express this relation in terms of  $V$ ,  $T$ , and  $K$  with the result

$$10.40 + \log T_{op} - \log V = \frac{(2K)^{1/2}}{1.283T_{op}^{1/2}}, \quad (4)$$

<sup>7</sup> See Crandall "Theory of Vibrating Systems and Sounds," page 211.

<sup>8</sup> See Crandall "Theory of Vibrating Systems and Sounds," page 210, and the definition of sensation level.

where  $T_{op}$  is the value of  $T$  imposed by our condition (2) for a thousand cycle tone.

Referring to Fig. 4 it will be seen that all three observers agree rather closely that the reverberation time for an auditorium of 1,000,000 cubic feet should be 2.0 seconds. This value refers to a tone of 512 cycles, the customary frequency used for experimental observation. It has been shown above that the reverberation time for

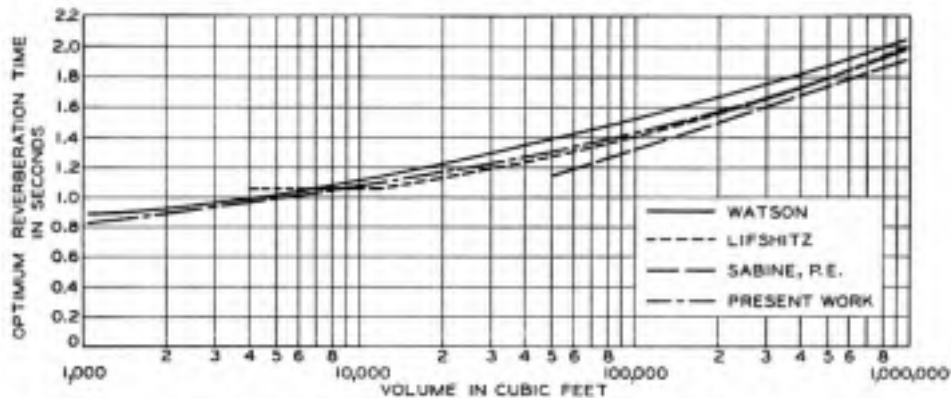

Fig. 4.—Optimum reverberation time vs. volume in cubic feet for 512 cycles.

1000 cycles should be 92.5 per cent of the reverberation time for a 512 cycle tone, so that the 2.0 seconds above corresponds to 1.85 seconds for 1000 cycles. We can evaluate  $K$  in (4) by adapting this latter value of  $T_{op}$  for a volume of 1,000,000 cubic feet. This gives  $K = 32.6$ . Substituting this value in (4) we obtain

$$\log V = 10.40 + \log T_{op} - \frac{6.35}{T_{op}^{1/2}} \quad (5)$$

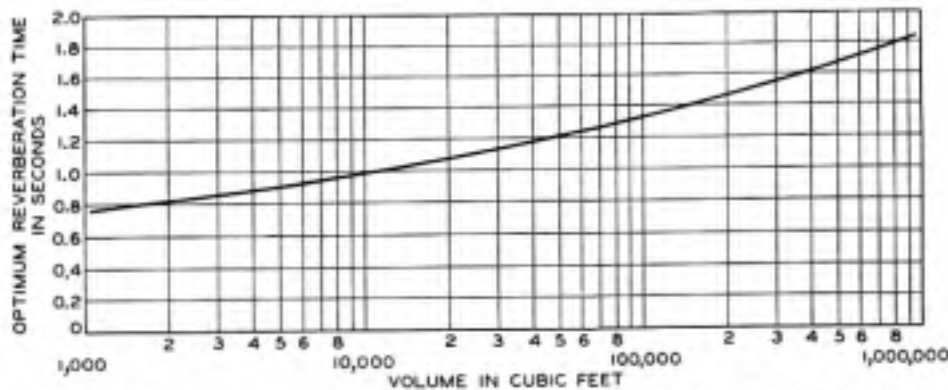

Fig. 5.—Optimum reverberation time vs. volume in cubic feet for 1000 cycles.

From (5) we may obtain  $T_{op}$  for 1000 cycles for any volume. See Fig. 5. As mentioned above these values of  $T_{op}$  are 92.5% of  $T_{op}$

for 512 cycles so that these latter may be easily deduced for comparative purposes. These values are plotted to give curve number 4 in Fig. 4. It is seen that this curve agrees very well with those showing the choices of competent judges.

### III. THE MORE GENERAL HYPOTHESIS

Equation (2) may be written as follows, since we have assigned a value to  $K$ :

$$\int_{t_0}^{t_1} L_s dt = -32.6 \quad (6)$$

and it will be remembered that we have considered  $L_{t_0}$  to be the loudness set up by a certain standard source. Allowing  $V$  to vary with  $f$  constant (1000 cycles) we have obtained a relation between the optimum reverberation time and volume of rooms for 1000 cycles. We wish to point out now that exactly this same condition (6) with  $V$  constant and  $f$  variable, will give the same results that we have obtained in Part I of this paper with the only further requirement that for other frequencies than 1000 cycles the strength of the source  $\bar{E}$  shall be such that the loudness  $L_{t_0}$  set up in the room at the frequency considered shall be exactly the same as the loudness which our standard source would set up at 1000 cycles.

In Part I of this paper our stated condition was that the loudness of all pure tones shall decay at the same rate for all frequencies. Since we have specified that the loudness at the time  $t_0$  shall be the same for all test frequencies and also that the loudness at the time  $t_1$  shall be zero for all frequencies, it is quite evident that the above integral can have the same value at all these frequencies only when the loudness decays at the same rate for all frequencies concerned. In other words, this condition stated as an integral specifies exactly the same requirement on the decay of loudness that we expressed in our statement early in Part I of this paper.

### IV. CONCLUSIONS

To recapitulate, we have set down an equation, together with a specification of the strength of the virtual source in each case, from which we obtain the value the reverberation time for any frequency tone should have in any sized room according to the condition which apparently controls the choice of observers.

One naturally turns to see what meaning may be attached to this significant expression, namely, the integral of the loudness taken

throughout the time of decay to inaudibility. Since this integral has the same value for all auditoriums which are considered ideal, it implies that one's brain is a ballistic instrument which is concerned with not only the maximum value of loudness but also with the effect of loudness integrated throughout a considerable interval of time.

## Abstracts of Technical Articles from Bell System Sources

*Phenomena in Oxide Coated Filaments.*<sup>1</sup> JOSEPH A. BECKER. A theory of the changes in activity in oxide coated filaments is proposed. From a comparison of the behavior of these filaments and filaments with composite surfaces such as thorium on tungsten, caesium on tungsten, and caesium on oxygen on tungsten it appears probable that oxide coated filaments owe their high activity to adsorbed metallic barium. The changes in emission from a coated filament produced by changes in plate potential and by currents sent into or drawn from it, are ascribed to electrolysis of the oxide. When electrons are sent into a coated filament barium is deposited on the surface and the activity increases until an optimum is reached beyond which the activity decreases. When current is drawn from the oxide, oxygen is deposited on the surface. If the oxygen is beneath the adsorbed barium, it increases the activity; if it is above the barium, it decreases the activity. Both barium and oxygen diffuse readily from the surface into the oxide and vice versa. This theory is tested, confirmed, and extended by numerous experiments.

An experimental technique is employed by which relative rates of evaporation of small amounts of electropositive and electronegative materials can be determined with considerable precision. The same technique might be useful in a number of similar investigations. Metallic barium or oxygen which evaporate from a coated filament are allowed to deposit on one side of a flat tungsten ribbon whose thermionic activity is followed. When the plausible assumption is made that an optimum activity is obtained when the tungsten is covered with a single layer of electropositive material, the relative rates of evaporation can be converted to absolute rates. This technique is also employed to determine the factors which control the evaporation of oxygen from a coated filament.

*Estimation of the Volatile Wood Acids Corrosive to Lead Cable Sheath.*<sup>2</sup> R. M. BURNS and B. L. CLARKE. The detection of volatile acids in the air drawn from creosoted wood conduit corrosive to lead cable sheath made desirable the development of a suitable method for the extraction and estimation of volatile wood acids. Such a method consists in the condensation of the volatile constituents of wood sawdust removed under reduced pressure and titration of the conden-

<sup>1</sup> *The Phys. Rev.* Nov. 1929.

<sup>2</sup> *Indust. and Eng. Chem.*, Jan. 1930.

sate using a modified differential potentiometric electrode. Acidity data have been obtained for Douglas fir, western hemlock, southern yellow pine, western pine, spruce, redwood, cedar, and oak, and a correlation is attempted between these acidities and the observed corrosive character of the woods.

*Electron Waves.*<sup>3</sup> C. J. DAVISSON. This paper is a brief review of the experiments made on the diffraction of electrons by crystal during the first two years following the discovery of this phenomenon, and an indication of the paths along which future experimentation may be expected to proceed.

*Television in Colors by a Beam Scanning Method.*<sup>4</sup> HERBERT E. IVES and A. L. JOHNSRUD. It has been recognized ever since the practical achievement of television, and indeed before, that television might be achieved in colors by utilizing the principles used in three-color photography. The requirements in the two cases are very closely parallel. Three-color photography had to wait for its practical achievement, on photographic materials sensitive to all colors of the visible spectrum. The parallel requirement in the case of television is for photoelectric cells similarly color sensitive. The requirements of television as to primary colors to be used for the synthesis of the colored image are relatively more difficult of fulfillment than in the case of color photography because in television we need not merely colored light sources, but light sources which shall be capable of following the variations of the television signal current with high speed. If, however, these two requirements, namely color sensitive photoelectric cells and high speed-colored lights, are met, television in color could conceivably be realized by utilizing any one of a number of devices for analyzing and recombining images which have been successfully applied in three-color photography.

*Air Transport Communication.*<sup>5</sup> R. L. JONES and F. M. RYAN. The successful operation of an air transportation system depends in no small degree on the communication facilities at its command. Rapid and dependable communication between transport planes in flight and the ground is essential. Two-way radio telephony provides this necessary plane-to-ground contact.

The design of a radio telephone system for this service requires quantitative knowledge of the transmission conditions encountered in

<sup>3</sup> *Jour. The Franklin Inst.*, Nov. 1929.

<sup>4</sup> *Jour. Opt. Soc. of Amer.*, Jan. 1930.

<sup>5</sup> *Jour. A. I. E. E.*, Jan. 1930.



plane-to-ground communication. An experimental investigation of these conditions over the available frequency range has been carried out and the results are described.

A complete aircraft radio telephone system designed for the use of air transport lines and an airplane radio receiver designed for reception of government radio aids to air navigation are also described.

*A Study of Noise in Vacuum Tubes and Attached Circuits.*<sup>6</sup> F. B. LEWELLYN. The noises originating in vacuum tubes and the attached circuits are investigated theoretically and experimentally under three headings: (1) shot effect with space charge, (2) thermal agitation of electricity in conductors, (3) noise from ions and secondary electrons produced within the tube.

A theoretical explanation of the shot effect in the presence of space charge is given which agrees with experiment insofar as a direct determination is possible. It is shown that the tubes used should be capable of operating at full temperature saturation of the filament in order to reduce the shot effect.

In the computation of the thermal noise originating on the plate side of a vacuum tube, the internal plate resistance of the tube is to be regarded as having the same temperature as the filament.

Noise produced by ions within the tube increases as the grid is made more negative.

With tubes properly designed to operate at temperature saturation it is possible to reduce the noise on the plate side to such an extent that the high impedance circuits employed on the grid side of the first tube of a high gain receiving system contribute practically all of the noise by virtue of the thermal agitation phenomenon.

*On the Nature of "Active" Carbon.*<sup>7</sup> H. H. LOWRY. Practically all investigators have used for their measure of "activity" the adsorptive capacity of the carbon (charcoal) under certain arbitrary conditions. In several previous papers data have been given which indicate that the adsorptive capacity of carbon is increased by any process which increases either the total surface per unit weight or the degree of unsaturation of the surface atoms, or both. No exceptions to this generalization have been encountered. Since the adsorptive capacity is dependent on two factors which may be independently varied, it seems hardly logical to continue its use as a measure of the activity of carbon. Since it is generally recognized that the forces effective in adsorption processes are a result of the unsaturation of the surface

<sup>6</sup> *Proc. The Inst. Radio Engineers*, Feb. 1930.

<sup>7</sup> *Jour. of Phys. Chem.*, Jan. 1930.



atoms, the ratio of the adsorptive capacity to the total adsorbing surface would appear to be much more satisfactory for a measure of the activity.

The data shown graphically in this paper show that starting with a given raw material, i.e., an anthracite coal, an increase in the temperature to which the material is heated above 1000° decreases the adsorptive capacity per unit pore volume. It is pointed out that the pore volume may be considered a measure of the extent of adsorbing surface and that the activity of an adsorbent carbon (charcoal) should be measured by the amount of gas adsorbed per unit area of its surface. The data, therefore, indicate that the activity of a charcoal is independent of the atmosphere in which it is prepared and dependent only on the maximum temperature to which it is heated. At any temperature between 900 and 1300° an increase in the adsorptive capacity is most probably accompanied by a proportional increase in the extent of the adsorbing surface. For example, although the adsorptive capacity of the samples prepared at 1100° ranged from 1.8 to 23.1 c.c. carbon dioxide per gram at 0° and atmospheric pressure, the actually measured values of activity ranged from 0.201 to 0.295, while the weighted average for all the samples prepared at the same temperature was 0.27: the variations observed are believed to be due to the limitations, which have been discussed, of the measure of the surface area rather than to a real difference in the activity.

*The Operation of Modulators from a Physical Viewpoint.*<sup>8</sup> E. PETERSON and F. B. LLEWELLYN. The mathematical expressions which occur in the treatment of non-linear devices as circuit elements are interpreted in terms of a graphical physical picture of the processes involved. This picture suggests, in turn, several useful ways of applying the equations in cases where the driving forces are so large that the ordinary power series treatment becomes prohibitively cumbersome. In particular, the application has been made in detail to the calculation of the intermediate-frequency output to be expected from a heterodyne detector having an incoming radio signal and locally generated beating oscillator voltage applied on its grid and a circuit of finite impedance to the intermediate frequency attached to its plate.

*A Study of the Output Power Obtained from Vacuum Tubes of Different Types.*<sup>9</sup> H. A. PIDGEON and J. O. McNALLY. Economical operation of the large number of tubes involved in the Bell System makes necessary the adoption of common supply voltages. This requires that

<sup>8</sup> *Proc. The Inst. Radio Engineers*, Jan. 1930.

<sup>9</sup> *Proc. The Inst. Radio Engineers*, Feb. 1930.

repeater tubes of various types be designed to operate at a fixed plate voltage. For this reason the design of amplifier tubes to give as large a power output as possible at the operating plate voltage is of considerable importance.

In the case of three-electrode tubes it is possible from theoretical considerations to compute, approximately, the electrical parameters a tube must have in order to give the maximum output power of a given quality obtainable under fixed operating conditions.

The electrical characteristics and output of fundamental, second, and third harmonics of two of the more common telephone repeater tubes are given.

It is of considerable interest to determine whether greater power output of comparable quality can be obtained from tubes containing more than one grid. Since no sufficiently exact theoretical analysis of multi-grid tubes is yet available to permit the determination of the parameters of optimum tubes, a comparative experimental investigation of a number of such structures has been undertaken. The electrical characteristics and output of fundamental, second, and third harmonics of several such experimental tubes are given. The power output of multi-grid tubes and of three-element tubes is compared. The reasons for the comparatively large power output of certain types of multi-grid tubes are discussed.

*Effect of Small Quantities of Third Elements on the Aging of Lead-Antimony Alloys.*<sup>10</sup> EARLE E. SCHUMACHER, G. M. BOUTON, and LAWRENCE FERGUSON. The data presented in this paper definitely show that small quantities of certain elements when added to lead—1 per cent antimony alloys have a very marked effect on the rate at which antimony is precipitated from supersaturated solid solution. Some suggestions of the mechanism of this change can be had from a consideration of the experimental findings in conjunction with the pertinent equilibrium diagrams.

Although the literature shows that the third elements studied are insoluble in lead in the solid phase, no results have been reported on alloys containing these elements in very low concentrations. Even though they should be insoluble in lead, antimony may so change the lead lattice that they become soluble in lead-antimony. Furthermore, since these elements form either compounds or solid solutions with antimony, there are forces of attraction between them which may be strong enough to carry small quantities of the third elements, along with the antimony, into solid solution in the lead. The resulting ter-

<sup>10</sup> *Indust. and Eng. Chem.*, Nov. 1929.

nary solutions, by their different energy relations, may cause the observed effects on the rate of precipitation of antimony.

*The Tube Method of Measuring Sound Absorption Coefficients.*<sup>11</sup>  
E. C. WENTE. The general principles underlying the tube method of measuring sound absorption can be derived conveniently from the analogous equations for the electrical transmission line. These equations show that the actual method of measurement is capable of many modifications, some of which have already been adopted by various experimenters. However, if reliable results are to be obtained, it is important that the apparatus be so designed that the propagation along the tube be rectilinear and the attenuation small, and that the tone be kept free from harmonics.

In the tube method the absorption is measured at perpendicular incidence, whereas in the reverberation method it is measured at random incidence. A theoretical study of the absorption of sound by porous materials as a function of the angle of incidence shows that in some cases there may be a considerable discrepancy between the values obtained by the two methods. The tube method may also give impracticable results for materials which are to be used in the form of large panels and absorb sound largely by virtue of inelastic bending rather than because of their porosity.

<sup>11</sup> *Jour. of the Acoust. Soc. of Amer.*, Oct. 1929.

### Contributors to this Issue

RALPH BOWN, M.E., 1913, M.M.E., 1915, Ph.D., 1917, Cornell University, Captain Signal Corps, U. S. Army, 1917-19; Department of Development and Research, American Telephone and Telegraph Company, 1919-. Mr. Bown has been in charge of work relating to radio transmission development problems. He is a Past President of the Institute of Radio Engineers.

JOHN R. CARSON, B.S., Princeton, 1907; E.E., 1909; M.S., 1912; American Telephone and Telegraph Company, 1914-. Mr. Carson is well known through his theoretical transmission studies and has published extensively on electric circuit theory and electric wave propagation.

KARL K. DARROW, B.S., University of Chicago, 1911; University of Paris, 1911-12; University of Berlin, 1912; Ph.D., University of Chicago, 1917; Western Electric Company, 1917-25; Bell Telephone Laboratories, 1925-. Dr. Darrow has been engaged largely in writing on various fields of physics and the allied sciences. Some of his earlier articles on Contemporary Physics form the nucleus of a recently published book entitled "Introduction to Contemporary Physics" (D. Van Nostrand Company). A recent article has been translated and published in Germany under the title "Einleitung in die Wellenmechanik."

WILLIAM FONDILLER, B.S., College of the City of New York, 1903; E.E., Columbia University, 1909; M.A., Columbia University, 1913; Engineering Department, Western Electric Co., Inc., 1909-25; Bell Telephone Laboratories, Inc., 1925-. Mr. Fondiller's work has related to the development of transmission apparatus, such as loading coils, filters, transformers, etc. and is now Assistant Director of Apparatus Development of Bell Telephone Laboratories, Inc. In this capacity he is responsible for the design of telephone apparatus and investigations of materials.

NORMAN R. FRENCH, A.B., University of Maine, 1914; A.M., 1916; Instructor, Physics Department, University of Maine, 1914-16; Instructor, Princeton University, 1916-17; General Staff, A.E.F., 1917-18; Commanding Officer, Flash and Sound Ranging Sections, Army Engineers' School, A.E.F., 1918; American Telephone and Telegraph Company, Department of Development and Research, 1919-. Mr. French's work has related chiefly to loading, submarine cables and transmission quality.

CHARLES W. CARTER, JR., A.B., Harvard, 1920; B.Sc., Oxford, 1923; American Telephone and Telegraph Company, Department of Development and Research, 1923-. Mr. Carter's work has had to do with the theory of electrical networks and with problems of telephone quality.

WALTER KOENIG, JR., A.B., Harvard, 1923; Instructor and Research Assistant, Harvard, 1923-24; American Telephone and Telegraph Company, Department of Development and Research, 1924-. Mr. Koenig has been engaged chiefly in studies relating to transmission quality.

W. A. MACNAIR, B.Sc., Colgate Univ., 1920; Ph.D., Johns Hopkins Univ. 1925; National Research Fellow in Physics, 1925-27; Bell Telephone Laboratories, 1929-.

W. P. MASON, B.S., University of Kansas, 1921; M.A., Columbia, 1924; Ph.D., Columbia, 1928. Engineering Department, Western Electric Company, 1921-25; Bell Telephone Laboratories, 1925-. Mr. Mason's work has been largely in transmission studies.

A. A. OSWALD, B.S., Armour Institute of Technology, 1916; E.E., 1927. Western Electric Company, Engineering Department, 1916-24; Bell Telephone Laboratories, Inc., 1925-. Mr. Oswald's work has been concerned with the development of long and short wave transatlantic and ship-to-shore radio-telephone systems; and, during the War, of systems for airplane radio-communication and radio-control.

D. A. QUARLES, A.B., Yale University, 1916; U. S. Army, 1917-19; Engineering Department, Western Electric Company, 1919-25; Bell Telephone Laboratories, 1925-. Mr. Quarles was earlier engaged in transmission studies of circuits and networks. More recently he was in charge of inspection engineering on apparatus products. As Assistant Director of Apparatus Development, he is now engaged in development work on Outside Plant products.

WALTER A. SHEWHART, A.B., University of Illinois, 1913; A.M., 1914; Ph.D., University of California, 1917; Engineering Department, Western Electric Company and Bell Telephone Laboratories, 1918-. Mr. Shewhart is making a special study of the application of probability theories to inspection engineering.

