

# *Mechanized Memory and Logic— What Electronics Can Do*

**J. H. FELKER**  
*Special Systems Engineering*

**The terminology of electronic switching—with its “barrier-grid memory tubes” and “transistorized logic circuits”—may seem strange to people who are familiar only with present-day telephone equipment. Despite its seeming complexity, however, electronic switching promises a wholesale simplification of telephony. Laboratories engineers believe that in the future it will be a faster and more economical way to provide telephone service.**

In many magazines and newspapers you may see claims about the “magic” of electronics. As telephone people, we are not interested in magic, but we are interested in the capabilities of electronics, because electronics will penetrate into areas of the telephone business that either have never been mechanized before or have been mechanized by other means. Perhaps we can sharpen our appreciation of the part electronics can play by first examining the characteristics that cause people to associate words like “magic” with it.

Looking for fundamentals, we may inquire, “What puts the magic into modern electronics?” The answer comes in two parts: (1) the ability to develop tremendous but stable amplification, and (2) the ability to perform complex operations in millionths of a second. The first of these is familiar to telephone people, for it is the basis of our modern telephone transmission plant. Electronic ampli-

fiers are the muscles of our transmission system. The second is being applied extensively in new switching systems now under development.

The automatic tracking radars developed at Bell Laboratories and manufactured by Western Electric are a splendid example of these two abilities of electronics. The Nike guided missile system, Figure 1, naturally excites a writer to the use of words like “magic” and “giant brain” when he attempts to describe its performance. Without the magic of almost unlimited amplification, the radar would never be able to hear the radio echo which bounces off an airplane many miles away and spreads out into space, because only an extremely small fraction of the energy returns to the radar antenna. This small echo is amplified billions and billions of times and is strengthened to where it can drive motors which cause the radar antenna to follow the enemy plane as it goes across the sky.

At the proper instant a missile is launched by the Nike system, and here the system shows its brain power. By exploiting the ability of electronics to perform complex operations in microseconds, an electronic computer guides the missile toward the target. Even if the target should attempt to evade the missile, the very high speed computer takes

these speeds the machine could perform as many operations in a minute as a man could by working night and day for an entire lifetime. Such speed results in great economic advantages for electronics.

We can develop some insight into the fundamentals of time sharing by analyzing the case of the chessmaster, who sometimes plays and wins as many as 30 games of chess simultaneously. Now he doesn't really make the individual moves of these games simultaneously. He moves quickly from board to board and takes on each opponent in turn. He has memorized the positions of the pieces and the previous history of each game, and all he has to do is detect the new move made by an opponent. He rapidly decides upon his next move, executes the move, and then goes to the next board. Note what this chessmaster has been doing. First of all, the whole secret of his success is his ability to remember a tremendous amount of information. In fact, he carries around with him a memory of all the games. The other ingredient in his success is the ability to make decisions very rapidly. As a result, his 30 opponents are, in effect, engaged continuously. We can do this kind of time sharing in telephony with modern electronics.

Imagine now a central office which has a built-in "chessmaster". This electronic wizard plays a game with each telephone customer who wants service. His goal is to meet the service needs of each customer. The "boards" the "telephone-master" uses are the lines of 10,000 or so telephones that come into the office. The "telephone-master" continuously scans these lines to determine if service is requested. He remembers what progress he has made in carrying out the wishes of each of the customers, and he makes decisions on what his next move with each customer should be. He does all these things so rapidly that every telephone user thinks he has the undivided attention of the central office equipment.

The chessmaster used both memory and logic, and it is primarily because memory and logic have been mechanized in modern electronic computers that people compare these machines to the human brain. Since mechanized memory and logic will be at the center of future telephone switching systems, it is important to understand their fundamentals and applications.

We may call to mind one example of mechanized memory from the folklore of the wild West. Every time a gun-fighter killed a man he cut a notch on the stock of his gun. Any time he wanted to refresh his memory he could go to the "mechanized mem-

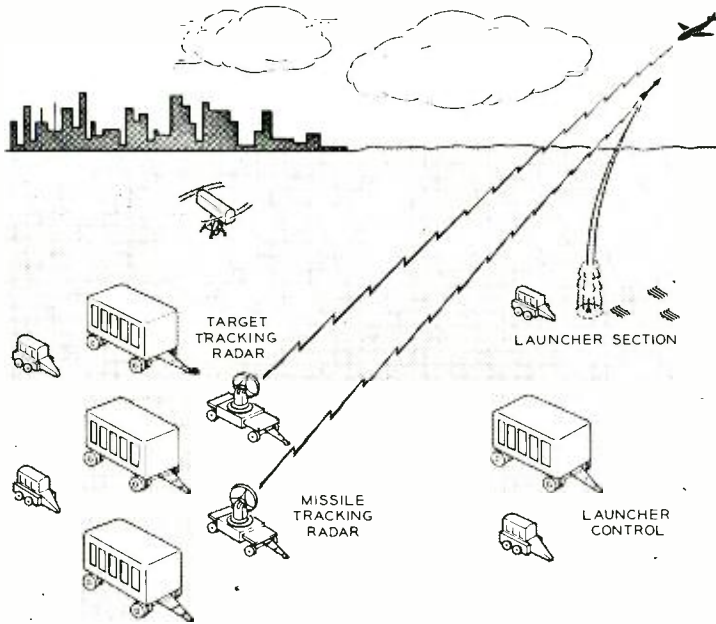

Fig. 1—The Nike missile system.

account of the evasion, and the missile proceeds inexorably to the interception.

Since the telephone plant is not a radar system and since telephone customers do not need to be connected together in microseconds, how shall the second magic-giving characteristic of electronics be exploited in the telephone plant? The answer is, "Through time sharing". Now, time sharing is just another way of describing the common-control operations that we introduced into the telephone plant with the dial system many years ago. With common control, one expensive piece of equipment performs in sequence the same function for a number of different customers. We are limited in time-sharing electromechanical devices because of their limited speed. When we go to electronics, however, we can design complex equipment which completes a function in a few millionths of a second and is then ready to do something else. To appreciate the full power of such electronic speeds, consider a machine that can complete an operation every millionth of a second. Assume also that a man may take a minute to perform the same operation. At

ory” on the gun stock and run his finger down it. This may seem like a rather trivial example, but it illustrates some of the fundamental principles of mechanized memory systems. A modern counterpart of the notched gun stock is the punched card used in modern accounting machines. This card has holes punched in it, and the positions of these holes represent information. A punched card can, for example, remember a man’s social security number or it can remember his rate of pay.

To understand the ideas behind electronic memory it is well to keep in mind the idea of a notch, or a hole, or some other physical modification as the basis for mechanized memory. Other key ideas will be explained with reference to Table I in which are listed some of the words and phrases used in describing electronic memory systems.

A very basic word is BIT—a contraction of BINARY DIGIT. A BIT is the elementary unit of information. It is the yes or no answer to a question. The power of such answers is indicated by the familiar game of 20 questions. As you know, by asking no

TABLE I — WORDS TO REMEMBER

Binary Digit	Bit
Access	Address
Read	Write
Destructive Reading	Regeneration
Volatile	Barrier-Grid Memory Tube
Magnetic-Core Memory	

more than 20 questions it is generally possible to find out which object out of all the objects in the world a person has in mind. The following example shows how yes-no answers can be used to represent numbers. Suppose someone has a number between zero and 31 in mind and we ask this person in succession the following questions and get the answers indicated.

“Is the number greater than 15?” “Yes.” “Is the number greater than 23?” “Yes.” “Is the number greater than 27?” “No.” “Is the number greater than 25?” “No.” “Is the number greater than 24?” “Yes.” Now from this pattern of answers — Yes, Yes, No, No, Yes — we know that the decimal number is 25. We can write the number twenty-five in binary notation by saying that “yes” corresponds to the digit *one* and a “no” corresponds to the digit *zero*. Thus the binary number twenty-five is written 11001. By asking five questions we have determined the magnitude of a number between zero and thirty-one. By asking ten questions we could have identified any

number between zero and a thousand. By asking 20 questions we could have identified any number between zero and a million. Thus any number between zero and a million could be written as a 20-digit binary number.

Why bother with binary representation of numbers? The reason is that a binary digit is something like a notch on a gun or a hole in a paper card. It is very definite. There is either a hole in a card or there isn’t. Similarly a binary digit is either a *one* or it isn’t. Binary digits can be conveniently represented by a variety of components. For example, a relay is either operated or not operated. We can say that the operate condition represents a *one* and the unoperated condition represents a *zero*. Similarly, a transistor can be allowed to represent a *one* when it conducts or a *zero* when it is not conducting. A capacitor can represent a *one* when it contains stored electrical energy, whereas an uncharged capacitor can be used to represent a *zero*. A magnet can be magnetized in such a way that the north pole is at the top or it can be magnetized so that the north pole is at the bottom. Thus the number twenty-five might be represented as a row of magnets that are magnetized North-North-South-South-North.

In addition to the problem of providing the individual memory cells, the designer of a mechanized memory system must provide many other features indicated by some of the words in Table I. These functions will be explained with reference to Figure 2, which shows a pigeonhole memory system. Assume each pigeonhole has a card in it, Figure 2 (a), and that information is stored or remembered on each card. Going to the memory and selecting a particular card is the ACCESS operation. The READ operation is simply the operation of looking at the card. Clearly, the ACCESS operation must precede the READ operation. Similarly, to WRITE into the memory involves an ACCESS operation, because we

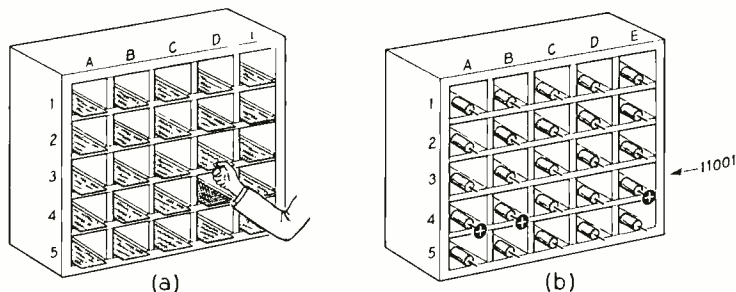
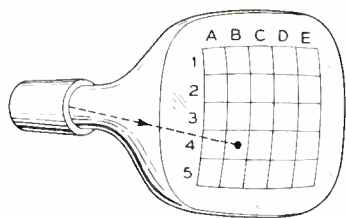

Fig. 2 — A “pigeonhole” memory system: (a) with cards in holes and access to address D3; (b) with capacitors in holes and binary digits 11001 registered in Row 4.

must first find the card we are interested in. To gain access to information systematically, it is customary to provide addresses which give instructions on how to get to each pigeonhole. ADDRESS D3, for example, says go out to the D column and then pro-



*Fig. 3 — Pigeon-hole system on face of a television tube.*

ceed down to the third row to information cell D3. With the aid of such a pigeonhole memory system, we have developed the fundamental ideas of mechanized memory — the idea of ADDRESS, the problem of ACCESS, the concept of BINARY DIGITS and BIT OF INFORMATION, the WRITE operation and, finally, the READ operation.

An electronic system, however, could not be based on a man running around writing on cards, so a more suitable record is needed to put in the pigeonholes. Earlier, when developing the idea of bits of information, it was pointed out that a capacitor could be used to store information. To develop a memory system, we can obtain lots of capacitors and put one in each pigeonhole, Figure 2(b). Suppose you want to write the binary number 11001 into the memory. First of all, at what address will the information be written? Assume that it is to be written in Row 4. Proceed down to Row 4. The first digit is a *one*, so charge the first CAPACITOR. Since the second digit is also a *one*, charge the second CAPACITOR. Since the third and fourth digits are zeros, leave the third and fourth CAPACITORS uncharged. The fifth digit is *one*, so charge the fifth CAPACITOR. Other numbers might be stored in other rows. To read the number at Address 4 at a later time we would short circuit the CAPACITORS in Row 4; whenever we got a spark we would know that a *one* had been stored.

This leads to another basic idea. After the information has been read, where has the information gone? It has been destroyed because short circuiting capacitors was a DESTRUCTIVE READING process. Memory designers must design REGENERATION into memory systems in which reading is destructive. If you want to read information from the capacitor-memory and still leave the information ready to be read again at a later time, you must put energy back into the capacitor if it was storing a *one*. This

combination of a read and write operation is known as REGENERATION. If a capacitor memory sits idle for several days, eventually the charge leaks off the capacitor and the memory is said to be VOLATILE. In such VOLATILE memories the designer insures against amnesia by requiring the memory system to read periodically its contents and also to regenerate them.

An electronic system with capacitors in the pigeonholes is not complete because someone has to walk around charging and discharging the capacitors. To see how the access problem can be solved with electronics, consider the ordinary television set. As you know, the picture is drawn by a spot of light that chases back and forth across the face of the picture tube. This spot of light is a kind of electronic pencil that is time-shared to draw the TV picture. Imagine the face of the picture tube divided into pigeonholes as in Figure 3. The spot of light on the picture tube can be deflected by voltages to any desired address in a millionth of a second. This rapid deflection of an electron beam provides almost instantaneous access to any one of a group of pigeonholes.

How can information be stored on the screen of a cathode ray tube? Physicists have developed a new kind of tube called a BARRIER-GRID MEMORY TUBE. This tube is like a TV picture tube except that it has literally thousands of tiny capacitors deposited on the screen. The electron beam in this tube can charge or discharge capacitors. Thus, in the memory tube, Figure 4, we have a means of gaining access not to just 25 but to over 16,000



*Fig. 4 — W. W. Baldwin welding leads to contacts on glass envelope of barrier-grid memory tube.*

pigeonholes. The memory tube then has a memory capacity of 16,000 bits. To get an equivalent memory capacity with relays would require 16,000 relays. A memory tube is a splendid example of the compactness that can be achieved through electronics. It has, in addition, the tremendous advantage that reading and writing into the tube requires only a few millionths of a second.

A while back we discussed the possibility of a

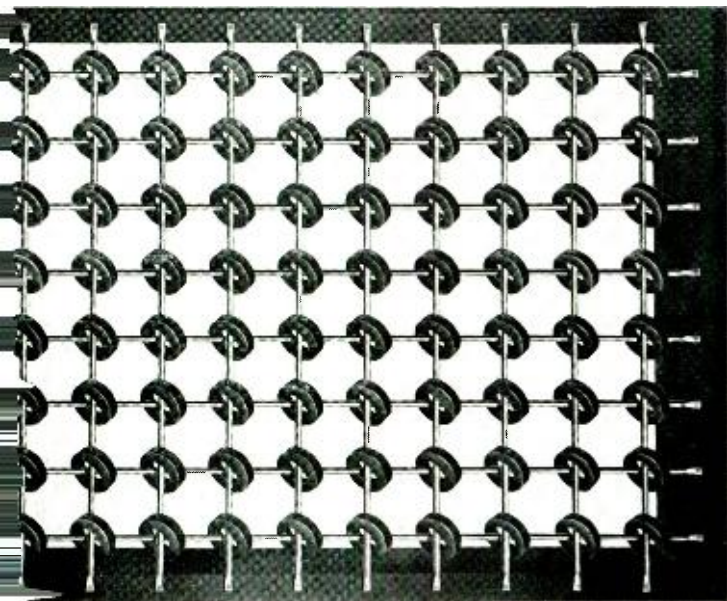

*Fig. 5 — Magnetic-core memory: direction of magnetism of selected cores is reversed by currents in wires.*

magnetic memory. This is another important method of storing large amounts of information in a small space. It would be cumbersome if conventional magnets were used, but physicists have discovered ways of making up a ceramic-like magnetic material (ferrite) into little doughnuts called "cores". In a magnetic-core memory, Figure 5, electrical conductors run through the holes of numbers of these doughnuts mounted in an array. Currents passing through certain of the wires will magnetize or demagnetize selected cores.

The chief advantages of magnetic-core memories are that the ferrite cores can be mass produced very cheaply, and that we can easily gain access to the stored information through transistorized circuits. At present, there is a competition between magnetic-core memories and memory tubes. Many of our telephone engineers believe that the memory tube is a little faster and a little cheaper than the core memory, but they recognize that as further improvements are made in the art the situation may be likely to change.

Having seen how electronic memory systems will store thousands and even millions of bits of information, it is appropriate to consider mechanized logic. We have had logic circuits in the telephone plant for years — they are the circuits that deduce the logical results of the inputs to the circuits. As an example of logic, consider the plight of a fellow named Joe who belongs to a riding group. Every third day it's Joe's turn to drive to work. But things don't often work out that way because somebody is always having to take someone else's turn for one reason or another. Suppose that Joe comes home from work some evening and his wife says: "Honey, did you ask the fellows if one of them could drive for you tomorrow?"

Joe says, "Sure I asked them. When I asked Pete if he'd take my turn, he was just leaving for Philadelphia but he said he'd be glad to drive tomorrow if he didn't have to stay over in Philadelphia and his wife didn't need their car. Anyway, Oscar will probably be able to drive, because his wife has been staying home lately and he will drive her car, if she doesn't go to work. He also said that since his own car is due back from the garage tomorrow, he can drive it even if his wife does use hers provided the garage gets the car back to him. But if this cold of mine gets any worse I'm going to stay home even if those guys have to walk to work and you'd certainly have the car if I am going to be home."

To simplify all this, Joe might draw a logical block diagram like Figure 6 for his wife. The block diagram has an output, a signal present, whenever Joe will drive. It has signal inputs on the left. We have a signal present on the first lead, for example, if Peter's wife needs their car. The "or" circuit is called an "or" circuit because it will have an output whenever there is a signal on the top or bottom lead. The "and" circuit will have an output if there is a signal on its top AND its bottom lead. The third type of circuit, called an INHIBITOR circuit, will have an output if there is a signal on the top lead, unless there is a signal on the bottom lead. Note that if Joe's cold is worse, the INHIBITOR functions and regardless of the signal on the top lead there will be no output because Joe just isn't going to drive if his cold is worse.

Joe could mechanize the circuit with either relays or transistors. With the use of transistors, the circuit could determine its output in a millionth of a second. In our telephone plant of the future, there will be an extensive use of transistors for the kind of logic functions that have in the past been

performed with relays. Since the transistor can be made to operate in a millionth of a second, we can time-share these circuits and, like the chessmaster, reach very fast decisions.

So far we have explored the characteristics that put the magic in electronics. You have seen how we can mechanize functions which lead people to refer to electronic machines as electronic brains. By analogy with the chessmaster you saw how we might, through time sharing, build a new type of electronic switching plant. It is appropriate now to be more specific about the use of mechanized memory and logic in building this plant.

In new electronic switching systems which Bell Telephone Laboratories engineers are now planning, mechanized memory and logic circuits are time-shared to control a high-speed switching network. Extensive memory will be used in such switching systems. Information is stored in both temporary and permanent memories. The kind of information which might be stored in the temporary memory can be determined by going back to the chessmaster or telephone-master analogy. The telephone-master would store in the memory tube certain information regarding the lines coming into the office. Suppose the office is a 10,000 line office. The machine would look at each line and observe whether or not the receiver was off the hook and would then store in the memory a binary digit which answers the question, "Does the line corresponding to this memory cell want service or doesn't it?" The machine would also store for each line the answer to the question, "Is the line getting service?" If the answer is "yes" the machine would not worry about the line. If the answer is "no" the machine would then prepare to give the line service. If dial pulses are coming in over the line the machine will store in its memory the number of dial pulses received. Note that relay registers might

have been provided to store the dial pulses. Instead, the memory is provided wholesale in a big economical memory system where the dial pulse information is stored along with the other information.

Because of these new system concepts and new apparatus such as the transistor and electronic memories, we can expect to see electronics as the basis of telephone switching as well as transmission. Because all functions are achieved by sequences of logic and memory operations, we expect our equipment to become more flexible. In the future the same equipment used to set up telephone calls may

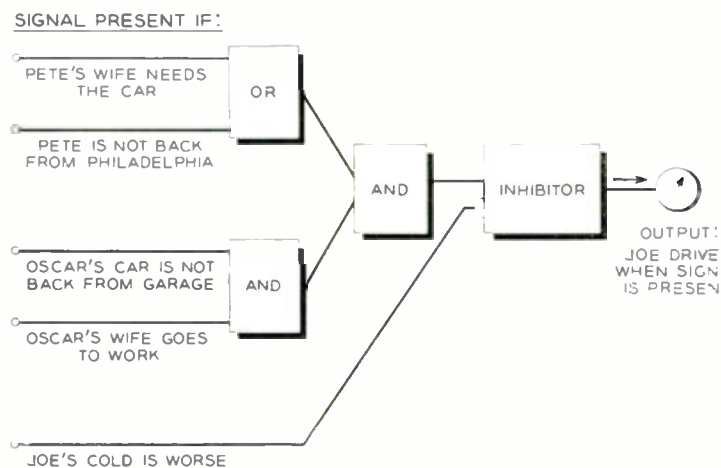

Fig. 6 — Block diagram illustrating logic behind answer to question, "Will Joe drive?"

also be used to perform billing and accounting functions, to prepare service orders, and to do circuit layout engineering. At some stage in the future, we may have a telephone plant in which the boundaries between separate functions are not very distinct because the same machinery is carrying out all of our operations. Many engineers are confident that this is the way to simplify and to make cheaper the cost of doing the telephone job.



#### THE AUTHOR

J. H. FELKER attended Washington University in St. Louis, Missouri, and received the B.S. degree in Electrical Engineering in 1941. Mr. Felker served in the U. S. Army from 1942 to 1945, first as a radar maintenance officer and later as an Army publications officer. He joined the Laboratories in 1945, where, in the Military Systems Engineering Department, he was in charge of the development of the Tradic transistor digital computer. In 1955, Mr. Felker was appointed Director of the Special Systems Engineering II Department, where he is responsible for long range planning in data processing and transmission. He is a member of the Institute of Radio Engineers, and is past Chairman of that organization's Professional Group on Electronic Computers.



# Use of Transistor in New Military Telephone System

A point-contact transistor plays a unique role in the new military telephone system recently designed for the Signal Corps.\* With this system, twelve speech channels are transmitted simultaneously over four conductors twisted into what is termed "spiral-four" cable. To amplify the signals along the cable run, electronic repeaters are spaced at intervals of about 5¼ miles; many of these repeaters do not require attendance by operating personnel.

At these unattended repeaters, however, installation and maintenance tests are sometimes required, which means that occasionally someone must visit the site of the repeater and talk to attendants at other points along the system. A portable test set in combination with a field telephone is used for this purpose. The test set includes a transistor which is used in an oscillator circuit that permits the lineman performing the tests to signal attended repeaters or terminals along the line.

To establish a talking circuit to these points, the lineman connects the portable field telephone to the test set. This telephone includes a hand generator which, when rotated, produces an alternating vol-

tage of low frequency (about 20 cycles per second). Such a signal normally suffices for signaling over the field wire used for other types of military telephone connections. However, the circuit arrangements of the new system do not permit the transmission of these low frequencies, and the receiving-signaling circuits will not respond to them.

The test set is therefore provided with circuits (Figure 1) that rectify the 20 cps signal and apply the resulting dc potential to a point-contact transistor, arranged to oscillate at 1,600 cps. This tone is transmitted by the cable and is of the correct frequency to cause a response by the receiving-signaling circuits at the attended points. The reception of the signal is indicated by a lamp and buzzer.

The special characteristics of transistors are used to great advantage in this circuit. In contrast with a circuit using electron tubes, the oscillator requires no warm-up time. Rotating the hand generator crank less than two turns is sufficient to produce lamp and buzzer indications at the attended points. Also, since the small amount of power necessary to initiate the signal is easily obtained from the hand generator, no battery power is required. Further, because of the size advantage of transistors, the signaling circuit adds little to the volume and weight of the complete test set. Without the transistor, signaling could have been accomplished only with much bulkier and more complex circuits.

H. C. FLEMING

*Military Communication Systems Engineering*

\* RECORD, August, 1955, page 290.

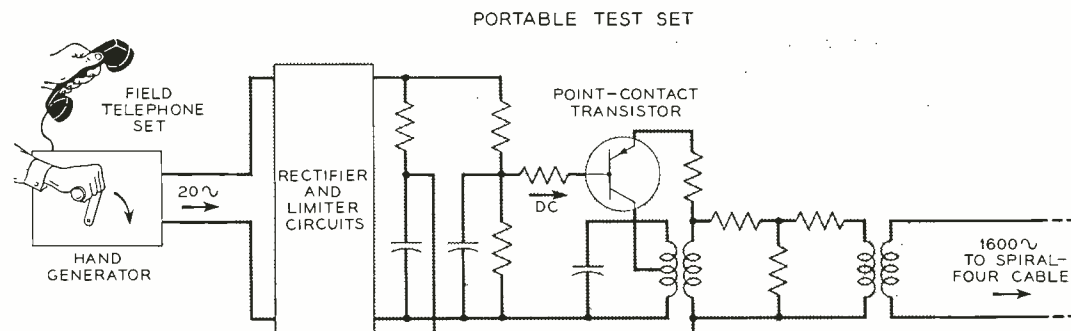

Fig. 1 — Portable telephone and test set signaling arrangement. Transistor circuit supplies 1,600 cps tone to cable.

# The Speakerphone

W. F. CLEMENCY

*Station Apparatus Development*

**As the telephone has become a more and more valuable part of normal American life, the need for many new services has increased. Part of the Laboratories' responsibility, acting on the advice of the A.T.&T. Co., is to anticipate these needs and design the instruments and systems to fulfill them. One good example of this work is the Speakerphone designed to provide "hands-free" telephone service under most conditions.**

Ever since the invention of the telephone, the trend of design has been to increase the ease with which a customer can carry on his telephone conversation. Following this trend a new telephone set, the Speakerphone, that provides hands-free telephony has recently been introduced for Bell System use. The customer, using the Speakerphone, talks into a transmitter about eighteen inches from his mouth, and listens to a loudspeaker about the same distance away. The customer can now readily write notes or refer to charts, reference books, and correspondence during a telephone call. He converses with the distant caller as if the latter were seated across the desk from him; this gives the user considerable freedom of movement. The Speakerphone also provides for group participation. During a call, a number of people seated closely around a desk can talk freely—the transmitter picks up the conversation and the replies are heard from the loudspeaker. This hands-free set is also of considerable value to the physically handicapped.

The location of the acoustic instruments at a greater distance away from the user as required for a hands-free telephone set makes the performance of the Speakerphone more dependent on room acoustics and room noise than that of a handset telephone. The handset is used at such close distances, about one inch for the transmitter and directly on the ear for the receiver, that the ordinary environmental acoustic conditions have little influence. As the distance between the user and the telephone instruments is increased, how-



ever, room reverberation and room noise become important. Hence the quieter and less reverberant the room, the better the Speakerphone performance.

A typical desk arrangement for the components of the Speakerphone is shown in the headpiece of this article. The housing, similar in appearance to the 500-type telephone set, contains the transmitter, on and off buttons, and the loudspeaker volume control, in addition to the handset and other usual components of the 500-type set. The loudspeaker is located in the small plastic housing shown in the upper center of the headpiece. The circuit of the Speakerphone permits independent use of either the handset or the Speakerphone.

The Speakerphone is easy to use. To place a call, it is only necessary to momentarily press the on button which lights up when the set is connected to the line. Then, when dial tone is heard from the loudspeaker, the number is dialed in the normal manner. When answering a call, the on button is momentarily pressed, again causing it to light up, and the conversation can start. The transmitter picks up the voice of the user, and the other person is heard on the loudspeaker. The volume of the incoming speech is adjusted by turning the small knob of the volume control. At the end of the call, the off button is pressed, disconnecting the set from the line.

If privacy is desired during a call with the Speakerphone, or if some transmission difficulty is encountered, lifting the handset automatically transfers the call to the handset, and turns off the Speaker-



phone. If the handset is being used, and it is desired to transfer to the Speakerphone, the on button is depressed while the handset is being returned to the cradle. The Speakerphone is designed for a talking distance of ten to thirty inches. The loudspeaker is placed about three feet from the transmitter and so located that the normal seated position of the user is midway between the two instruments.

In addition to the two desk instruments shown in the headpiece, an apparatus box containing amplifiers, power supply, and associated circuitry is part of the Speakerphone. The interior of this apparatus box is shown in Figure 1. This box is mounted following usual Bell System practices.

Two amplifiers, each having approximately 50-db maximum gain, are required, one for the transmitter and one for the loudspeaker. These two amplifiers are assembled on a printed circuit card which plugs into a socket in the apparatus box as shown in Figure 1. When these amplifiers require servicing, the printed circuit amplifier card can be quickly replaced. The power supply of the Speakerphone is energized from a 115-volt, 60-cps power outlet and consumes 8 watts when the Speakerphone is in use and 0.6 watt when it is in standby condition. The handset of the Speakerphone operates independently of the power supply and will perform in its normal manner in case of power line failure. The other components in the apparatus box are a relay, a hybrid coil, and input and output transformers. The instruments shown in the headpiece and the apparatus box shown in Figure 1, which together constitute the Speakerphone, are coded as the 595-type telephone set.

The basic circuit of the Speakerphone is shown in Figure 2. The hybrid coil, which is a form of Wheatstone bridge, couples the two-way telephone line to the output of the one-way transmitting amplifier and to the input of the one-way receiving amplifier, and introduces a loss between them (the output of the transmitting amplifier and the input of the receiving amplifier). As indicated in Figure 2, the unavoidable acoustical coupling through the air path between the loudspeaker and the transmitter forms a closed loop with the rest of the circuit. This closed loop, when there is power gain in it, acts as an oscillator causing the loudspeaker to produce a sustained tone called "singing". Because of this, there is an upper limit on the total permissible gain which can be used in the transmitting and receiving amplifiers.

The degree of balance between the telephone line

impedance and the balancing network impedance determines the loss introduced by the hybrid coil between the output of the transmitting amplifier and the input of the receiving amplifier. If a perfect balance could be obtained at all frequencies, this loss would be infinite, and singing could not occur. The impedance of telephone lines varies considerably, however. It may be resistive, capacitive, or inductive depending on the length of loop to the central office, the length and type of trunk between central offices, and in the case of short connections,



*Fig. 1—W. J. Zinsmeister replaces an amplifier card in a Speakerphone box.*

also somewhat on the length of loop to the distant party. This is especially true for a line on a PBX which, on internal calls, may have a short loop, but on calls to an external telephone may have a long loop to a central office. There is, fortunately, a rough correlation between loop impedance and loop direct current. The balancing network is designed to be adjusted by this loop direct current, which produces a voltage across the terminals of the network. A varistor in the network varies its resistance in response to this voltage and regulates the impedance of the network. The network is designed to produce a better balance on long loop connections where more loudspeaker gain is required and singing becomes a limiting factor. Because both the transmitting and receiving amplifiers are in the singing loop, it is important that the gains in these amplifiers be properly apportioned.

The gain of the transmitting amplifier is adjusted at the factory so that the Speakerphone transmitting level at a talking distance of eighteen inches is

# *Ultrasonic Delay Lines*

J. E. MAY, JR. *Military Apparatus Development*

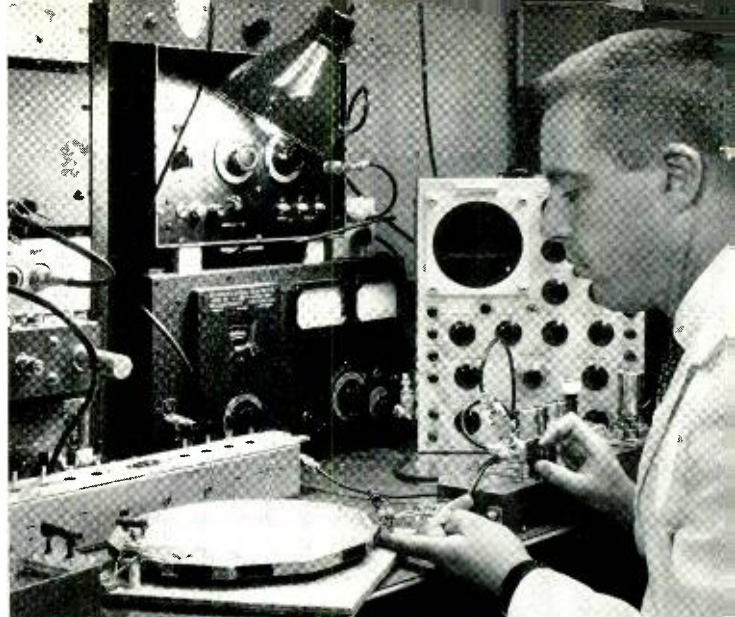

As modern electronic equipment is called upon to perform increasingly intricate operations, electrical signals must frequently be delayed within a circuit. Since electromagnetic waves travel at a speed of more than 186,000 miles per second, most methods of providing such delay require considerable space or equipment. Recently, however, Bell Laboratories has been developing ultrasonic delay lines which occupy a relatively small space, and can provide time intervals ranging from a fraction of a microsecond to several thousand microseconds.

Time delay of electrical signals is useful in many Bell System communication circuits. Such delay is needed, for example, to produce series of pulses accurately spaced in time for various coding systems. Another general field of application is in storage devices wherein an electrical signal is stored for use at a later time, as in electronic computers.

It has been found that ultrasonic delay lines provide a convenient method of providing these delays in a relatively small space. In such a device, time delay is achieved by converting an electrical signal into an acoustical wave, which is propagated along a suitable path and then reconverted to an electrical signal. These delays can range from a fraction of a microsecond to several thousand microseconds, and for these, bandwidths of from three to six megacycles are easily obtainable. Since frequencies in the megacycle range are usually employed, the name "ultrasonic" is applied to these devices.

Ultrasonic delay lines were developed during World War II for use in radar systems, and H. J. McSkimin of the Laboratories' Mathematical Research Department has made valuable contributions to their theory and design. Because of their inherent accuracy and wide-band characteristics, these ultra-

sonic delay lines provided a convenient means of producing series of accurately spaced pulses for radar range calibrations. Long delay lines of this type were also essential to the development of moving target indicators for radar systems, and short lines are now being used in various coding systems for assuring communication privacy.

Other methods of delaying an electrical signal involve transmitting an electromagnetic wave in a coaxial cable or an electrical network and hence require much more space. A video delay of 10 microseconds, for example, would require 6,480 feet of ordinary coaxial cable, 16 feet of specially constructed "delay cable," or an electrical network occupying 56 cubic inches. The same delay with equivalent bandwidth can be provided by an ultrasonic delay line only 1.48 inches long. Acoustic waves travel some 100,000 times slower than electromagnetic waves, and therein lies the space advantage over electrical delay lines.

A simple delay line consisting of two transducers and a delay medium is illustrated in Figure 1(a). The transducers in this device convert electrical signals into mechanical stresses, or vice versa, by the piezoelectric effect. The mechanical stress applied to the delay medium travels through a pre-

scribed path as an acoustic wave which in turn applies a mechanical stress on the output transducer to reproduce the electrical signal.

A single-ended delay line is a simple rod with a transducer on one end. The signal travels the length of the rod, is reflected, and travels back to the transducer where it produces a delayed pulse. Some of the energy is reflected at the transducer, however, and again travels twice the length of the rod before producing a second output pulse. Thus, in response to a single input pulse, a series of equally spaced pulses are produced which can be used for time calibration purposes. In a double-ended delay line with two transducers, as in Figure 1(a), the signal travels the length of the rod only once and produces only one output pulse delayed in time with respect to the input pulse. Any signals arising from reflections at the transducers are, in this case, unwanted responses, and efforts are made to suppress them. To conserve space for longer delays, the transmission path can be folded so that the ultrasonic wave hits one or more reflecting faces before arriving at the output transducer. Delay lines of this kind are called multiple reflection types.

The transducers are most efficient over a frequency band near their resonant frequency, and bandwidths of about 30 percent of the center frequency can be realized. To provide sufficient bandwidth for delaying video signals, this center frequency must be 10 mc or higher. A carrier frequency, equal to the transducer resonant frequency, is modulated by the video signal to be delayed. This modulated carrier signal is applied to the input trans-

ducer of the delay line, and the signal appearing at the delay line output can be demodulated to recover the original video information.

The transducers can be either crystalline materials having intrinsic piezoelectric properties such as quartz crystals, or non-crystalline materials made to have these properties by a polarization process, as in the case of barium titanate ceramic. For delay line applications, a solid medium is preferred to a liquid because of its mechanical stability and simplicity. The solid used almost exclusively because of its low attenuation, is vitreous silica, an optical grade of fused quartz. Vitreous silica has a temperature coefficient of delay amounting to about 100 parts per million per degree centigrade, and hence for some applications the delay line must be temperature controlled.

Ultrasonic delay lines can use either longitudinal waves or transverse waves. In longitudinal waves the particle motion is along the direction of propagation. This is the type of wave transmitted by



*Fig. 2—Ultrasonic delay lines. The three units at the left correspond to the type illustrated in Fig. 1(a), the unit being held corresponds to the type shown in Fig. 1(b), and the unit at the right corresponds to that shown in Fig. 1(c).*

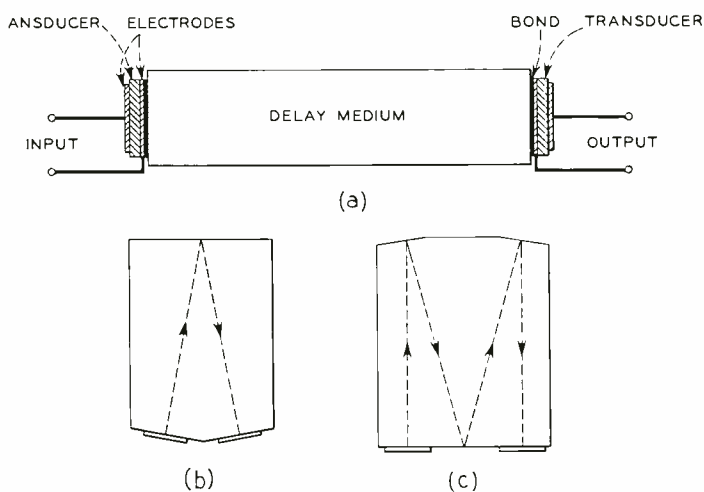

*Fig. 1—Typical simple delay line configurations: (a) rod type; (b) single reflection type; (c) triple reflection type.*

gases and liquids which gives rise to the sensation of sound. Solid materials, however, can transmit not only longitudinal waves but also transverse waves—waves in which the particle motion is perpendicular to the direction of propagation. Transverse waves are similar to light waves in that they can be polarized; that is, they can be arranged so that all particle displacements lie in the same plane. In general, when either a longitudinal or transverse wave is reflected at a solid-air interface, the reflected wave has two components, one longitudinal and the other transverse, each with a different angle of reflection. For the special case of transverse waves polarized perpendicular to the plane of in-

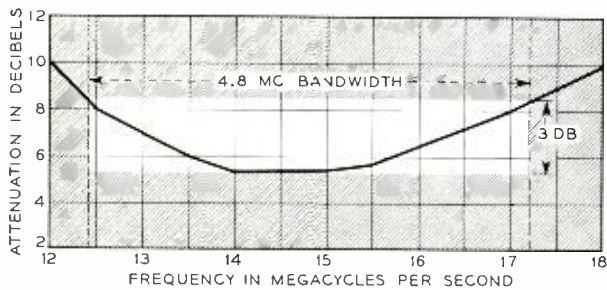

Fig. 3 — Frequency response of a 25-microsecond delay line using barium titanate transducers terminated in a 62 ohm load. The spurious response in this unit is 20 db below the main response.

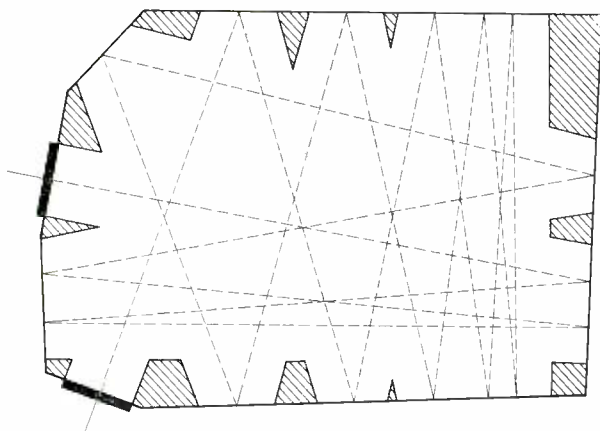

Fig. 4 — Configuration of a double wedge, 500-microsecond delay line.

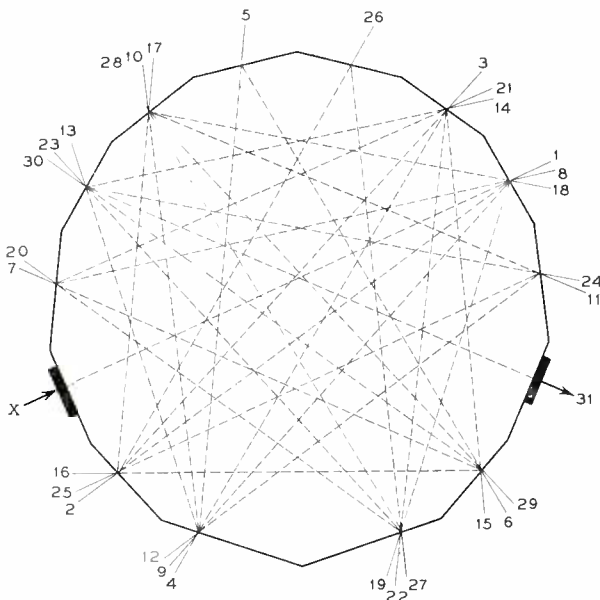

Fig. 5 — Configuration of a 990-microsecond delay line containing 30 reflection paths.

idence, the incident wave is totally reflected as a transverse wave with the angle of reflection equal to the angle of incidence. Hence, this type wave is used for delay lines that require many reflections.

Quartz crystals, used for transducers almost exclusively up to the present time, can be so oriented as to produce either longitudinal or transverse waves. Delay lines constructed with quartz crystal transducers are characterized by a relatively low capacitance and a high characteristic impedance, hundreds to thousands of ohms. Because of the low coupling of quartz crystals, such a delay line must be terminated in a low impedance in order to obtain a 30 per cent bandwidth. This results in a delay line of high loss, some 30 to 50 db. The recently developed barium titanate ceramic transducer, however, has a much higher coupling, which enables the construction of delay lines of 30 per cent bandwidth with much lower loss. The loss ranges from 6 to 20 db when the line is terminated near its characteristic impedance, which is a low value of 30 to 100 ohms. The transducer capacitance is high, 400 to 800 micromicrofarads. For practical reasons, the barium titanate ceramic transducers cannot be polarized readily for generation of transverse waves, and their use is therefore limited to designs based on the use of longitudinal waves.

From the preceding discussion, it might appear that it would be desirable to use polarized transverse waves in all designs because of their simple reflecting properties. However, for low-loss applications it is of great advantage to use barium titanate ceramic transducers because of their high coupling, and for this reason longitudinal wave types are used wherever possible. The performance of designs using longitudinal waves is good, provided the angle of reflection and the number of reflections are kept small. Hence, the designs illustrated in Figures 1(b) and 1(c), while feasible for transverse waves, are also good designs for longitudinal waves, and the low-loss barium titanate transducers can be used in this application.

Some typical short delay lines are shown in Figure 2. At the left are three variations of the single rod type with transducers on both ends as diagrammed in Figure 1(a). One of the transducers can be seen as a light disk soldered to the end-face on each of these units. The solder is allowed to flow over the entire end-face to act as an absorber for end-to-end reflections. The other transducers are mounted on the opposite end-faces not visible in Figure 2. The light areas on the other faces of the second, third, and fourth units from the left are

fired silver electrodes for the electrical ground connections. They are insulated from each other by the uncoated area appearing as a dark grey band passing around the rod, as in the second unit. The other electrical connection is made to the electrode on the exposed face of the transducer.

Single-rod type designs are useful for delays in the 1 to 5 microsecond range. For the 5 to 25 microsecond range the single reflection pattern of Figure 1(b) is used. In these units, the transducers are mounted on faces making equal angles with the far end so that an input at one transducer is reflected at the far end and arrives at the output end on a path perpendicular to the output transducer. An example of this type is shown in Figure 2. Here both transducers are visible on adjacent faces. The grey strips in the light silver coated areas are again uncoated areas to isolate the grounding electrodes. For still longer delays, up to about 100 microseconds, the three reflection pattern of Figure 1(c) is used. Here both transducers are located on the same face, and the beam is reflected from a tilted face at the opposite end back to the center of the transducer face. From there the path is symmetrical, going to another tilted face and then to the output transducer. A delay line of this type is shown at the right in Figure 2. On this unit, solder has been added to the silvered electrode areas to act as an absorber for energy striking the major faces.

Typical delay-line performance is shown by the bandwidth curve in Figure 3 for units with delays up to about 25 microseconds. This design has a 4.8-mc bandwidth centered at 14.8 mc with a mid-band loss of 5.5 db. Spurious responses, due to end-to-end



*Fig. 6—H. D. Cook prepares to fire the silver electrodes on an ultrasonic delay line.*



*Fig. 7—Mrs. M. S. Libby engaged in bonding a transducer to an ultrasonic delay line.*

reflections or reflections from the sidewalls, are kept at least 20 db below the main response. For units of this design using longitudinal waves, the path length is 0.235 inches per microsecond of delay, and for the rod type the cross section can be as small as  $\frac{1}{4}$  inch in diameter.

For delays greater than 100 microseconds, patterns containing many reflections are necessary to save space. Properly polarized transverse waves are used in these applications because of their aforementioned reflecting properties, and because of their lower velocity. The path length is 0.148 inches per microsecond of delay. The "double-wedge" reflection pattern of a 500 microsecond delay line is shown in Figure 4. In this design, a beam is reflected back and forth between the two faces that form a wedge until it is finally reflected back on itself and returns to the input end. There, it strikes a turning face that sends it into another wedge at right angles to the first. Part of the ultrasonic beam actually spreads beyond the geometric path outlined by the shaded areas in Figure 4. This part of the beam follows undesired paths through the delay line, some of which terminate at the output transducer. These give rise to unwanted signals occurring at times other than the designed delay value. However, with 20-mc transducers, the geometry of the double wedge, having a relatively open pattern near

the transducers, produces good unwanted response performance of 40 db below the main response for the 500 microsecond size.

A more compact design used for a 990-microsecond delay line is shown in Figure 5, where 30 reflections are used to fold twelve feet of path into a polygon 5½ inches in diameter. Starting at trans-

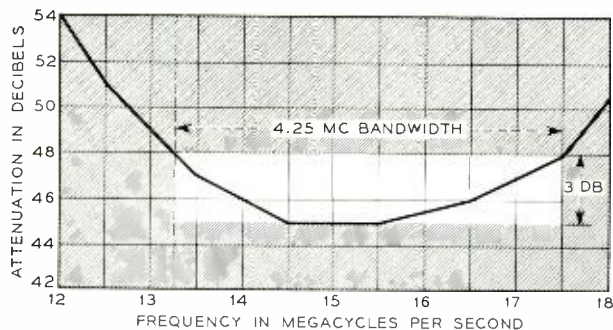

**Fig. 8 — Frequency response of a 990-microsecond line using quartz crystal transducers terminated in a 500 ohm load. The unwanted spurious response in this unit is 34 db below the main response.**

ducer X, the beam follows the reflection pattern in numerical order and finally arrives at the output transducer on path 31. This is one of the most compact designs consistent with good unwanted response, about 34 db in this case. A typical bandwidth curve for this design using quartz crystal transducers is shown in Figure 8. Such a delay line would be packaged in a hermetically sealed container, which would result in a total weight of 5 pounds, 10 ounces.

By suitably scaling up the dimensions of the polygon, longer delays can be attained — up to 3,300 microseconds. This limit is established by the largest available disk of vitreous silica, which is 17 inches in diameter. Recently, some experimental 2,000-microsecond units have been built.<sup>o</sup> Although the loss and bandwidth are similar to those in the 990-microsecond design, the unwanted response is improved to 38 db, due in part to the larger reflecting surfaces.

<sup>o</sup> The photograph at the head of this article shows the author testing an experimental 2,000 microsecond unit.

#### THE AUTHOR

JOHN E. MAY, JR., received the B.A. degree in physics from Wesleyan University in 1943. He then spent three years in the Navy, where he was engaged in the development of radio-controlled aircraft and airborne radar, followed by two years at the Naval Research Laboratory, Boston Field Station, in the development of ultrasonic delay lines. He received the M.A. degree in physics from Tufts College in 1949 and in 1952 received his Ph.D. degree in physics from Yale University, publishing a thesis on nuclear physics research with the Yale cyclotron. Mr. May became a member of Bell Telephone Laboratories in October, 1952, where he has been concerned with fundamental studies of ultrasonic delay lines. He is a member of Sigma Xi, Sigma Pi Sigma, the Institute of Radio Engineers, and the American Physical Society.



### *Claude E. Shannon Elected to National Academy of Sciences*

Dr. Claude E. Shannon, research mathematician in charge of Communication Theory, Discrete Systems and Special Research at the Laboratories, was elected a member of the National Academy of Sciences at its 93rd annual meeting held in Washington, D. C., on April 24. Dr. Shannon, serving now as a visiting professor of electrical communications at Massachusetts Institute of Technology, has been

widely honored for his work on modern communication theory.

The National Academy of Sciences is a private, non-profit organization that is restricted to 600 members. Other members from Bell Laboratories include President M. J. Kelly, Executive Vice President J. B. Fisk, and J. R. Pierce, Director of Research, Electrical Communications.

# Improved Key Handle for PBX Switchboards



Some years ago, the 555 PBX switchboard\* was developed to fill the particular requirements of a number of telephone customers. The design was pointed toward flexibility of equipment, ease of maintenance, adequate range for trunk and station facilities, and low power consumption. One feature of the switchboard was the replacement of lever-action keys by push buttons for ringing and less conventional "push or turn" keys for the usual PBX functions. All cords, lamps, and ringing push buttons are mounted on a sloping shelf, leaving the operator's desk free for writing or other work. The "push or turn" answering keys are mounted on the vertical face of the board, below the sloping shelf.

To answer a call, the operator turns the key handle to the right where a detent holds it in position until it is restored to the normal vertical position. For a "through-dial" or night connection, the key is pushed in toward the face of the board where it is also held by a detent. Locks are provided so that when the handle is turned, it cannot be pushed in, and when pushed in, it cannot be turned.

Experience indicated that some modifications of the key handle would add to the operator's comfort and to her efficiency. Suggestions were made to (1) remove the slight projection at the end of the handle since this projection partially masks the white reference line, making it difficult to see, and also offers some discomfort to the fingers when operating the key; (2) enlarge the "pushing" area and increase the radius around the edge; and (3) provide a suitable indicator for the "in" and "out" positions, since the black handle against the black key-shelf makes the position difficult to determine.

These comments were taken into consideration when the new handle was designed. Figure 1 shows the original handle along with the new version.

\* RECORD, April, 1949, page 125.

The projection, indicated on the original handle by the pencil, has been removed and all edges are rounded. The lever part of the handle is longer, offering a better grip, and blends into the pushing area so as to provide a large smooth surface. The white reference line is longer and wider for increased visibility, and is no longer masked by the projection. The pushing area is larger, tapering toward the back to provide a grip for pulling when the pushed-in key is restored to normal.

Alternate black-and-white stripes at the back of the handle serve as a "flag" to indicate the position of the key. When the lines are visible in front of the key-shelf, the handle is free to turn. When it is pushed in for "through-dial" service, the lines disappear, indicating that it cannot be turned. These handles are being regularly supplied on new switchboards and are available separately for replacement in existing switchboards.

H. J. SMITH, *Component Development*



Fig. 1 — The original handle (left) alongside the new version.

# *Arcing at Telephone Relay Contacts*

P. P. KISLIUK *Physical Research*

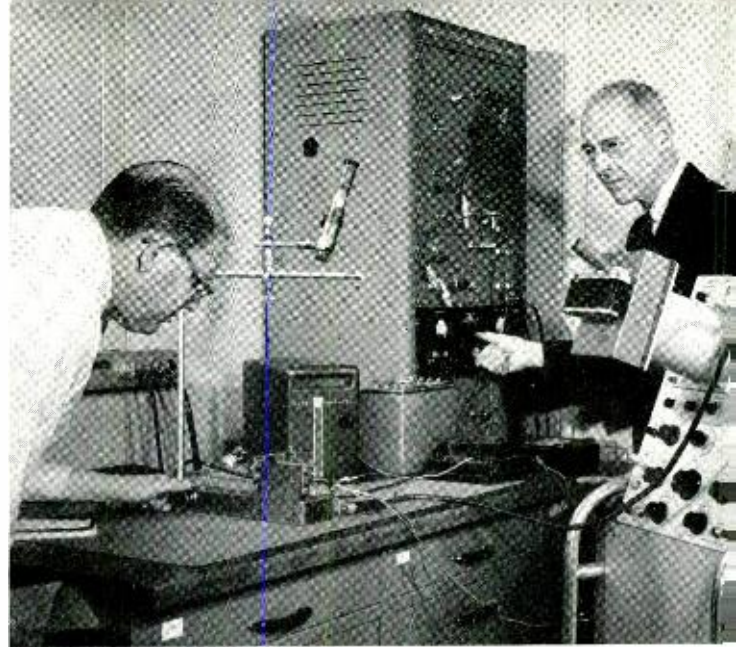

**Not only is Bell Telephone Laboratories concerned with developing new systems and devices for improving telephone service, but it is also constantly endeavoring to improve components in the existing equipment. One important aspect of this work deals with fundamental research aimed at extending the useful lifetimes of relay contacts. The many millions of such contacts used in telephone central offices throughout the country make them a significant item in the maintenance costs of the Bell System.**

Telephone switching systems depend upon the reliable operation of a large number of relay contacts. Many of these carry relatively large currents — about one-half ampere — and operate relatively frequently. They are subject to an erosion of the contact metal, which severely limits their useful lifetimes. This erosion is primarily due to electrical arcing, and hence satisfactory contact lifetimes cannot be achieved unless the energy dissipated in arcs on make and break is limited to a small fraction (about one ten-thousandth) of the energy stored in the inductance of the usual relay loads.

From work on electrical breakdown in gases it was believed about ten years ago that there can be no electrical breakdown, and therefore no arc, unless the potential difference between electrodes is above a certain “minimum sparking potential” which is roughly 300 volts for air. Very early work performed about 1901 gave evidence to the contrary, but this had apparently not been incorporated into recent literature. Thus, until a few years ago, one expected that there might be arcs at the breaking of contacts in an inductive circuit, but that there could be no discharge at all on closure with potential differences less than 300 volts. Nevertheless, experimenters in the field of contact erosion were aware that arcing occasionally takes place on

the closure of contacts when the potential difference between them is only 48 volts. This was explained by assuming that small projections on the surface touch first and that the resulting current evaporates the points of contact with explosive violence, initiating an arc in the hot vapor.

Oscilloscopic studies at Bell Telephone Laboratories revealed no evidence to indicate that contacts touch preceding arcs on closure, and one is led to conclude, in agreement with the very early work, that arcs occur before there is any metallic contact. Furthermore, consideration of the processes expected to take place when contacts close at voltages considerably above the ionization potential of the atoms of contact metal (around 10 volts), but below the minimum sparking potential for air, indicates that a new type of breakdown process will take place. Even for a very low potential difference, the electric field between approaching contacts necessarily becomes extremely high. When the field at the negative electrode, or cathode, becomes great enough, in the neighborhood of ten million volts per centimeter, both theory and experiment show that appreciable current must flow from the cathode. This “field emission” current is not in itself a “breakdown,” but is the first step in the breakdown process.



Field emission current is extremely sensitive to small changes in the field, so that small regions of the cathode surface, where the field is somewhat above average, will deliver nearly all the current. Because no metal surface can be perfectly smooth, projections on the cathode provide such regions of increased field. The flow of the field emission current, through the resistance offered by the small points, heats the projections from which the current is drawn. A slightly larger region of the positive electrode, or anode, is heated also, in this case by electron bombardment.\* When the heated region — either of the anode or of the cathode — reaches the boiling point of the contact metal, the density of atoms and molecules in the gap is increased, so that each electron now experiences a greater number of collisions in crossing the gap. If the electron energy is above the minimum ionization energy of the atoms in the gap, ionization will take place, creating ions and new electrons. These electrons are quickly drawn out of the gap, leaving behind the relatively massive and slow-moving positive ions. The presence of these ions increases the electric field at the cathode surface, which results in greater field emission current. The increase in electron current increases the amount of ionization, and the process rapidly builds up to a “breakdown”; that is, the current increases until it is limited only by external circuit elements. From an analysis of this process it has been shown that a number of ions equal to

\* The electrons do not spread a great deal in crossing the contact gap, because in the range of voltage under consideration the distance at which appreciable field emission appears is less than  $10^{-4}$  cm. Each electron experiences only one or two collisions with gas molecules in this distance.

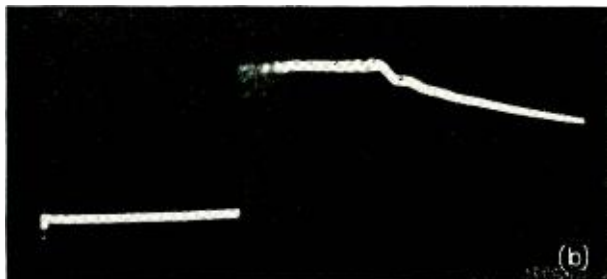
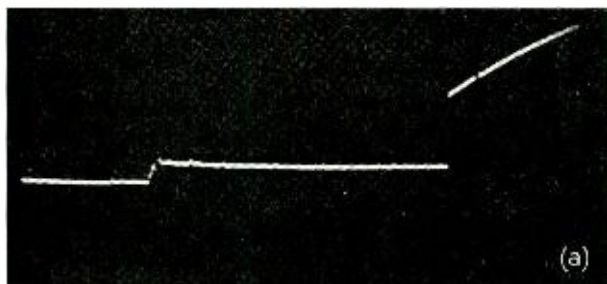

TABLE I  
CHARACTERISTICS OF ANODE AND CATHODE ARCS

	(1)	(2)
	Anode Arcs	Cathode Arcs
1. Anode Appearance	Hole (Fig. 2, left)	Nothing (or shallow hole)
2. Cathode Appearance	Roughened (Fig. 2, right)	Scratches (Figs. 3 and 4)
3. Occurrence: voltage above 400 voltage below 300	Never Sometimes	Always Sometimes
4. Weld	Frequently	Never
5. Arc voltage	about 11 volts	about 16 volts
6. Striking field	High, about $9 \times 10^6$ v/cm	Low, about $4 \times 10^6$ v/cm
7. Metal transfer by weighing	Anode to Cathode	Cathode to Anode
8. Metal transfer by radioactive tracers	Both directions, net from Anode to Cathode	Cathode to Anode

only a few percent of the number of field emission electrons is more than sufficient to cause breakdown, and that the elapsed time from the first measurable currents to the completion of the breakdown is too short to be detected by oscilloscopic observations.

Detailed experimental confirmation of the breakdown process just outlined is difficult in air, because one does not expect this process to be effective above the minimum sparking potential (approximately 300 volts), and at lower voltages the times,

Fig. 1 — (a) Oscillogram of a sustained arc on break followed by an open circuit. Starting from the left, the contacts are closed at first and the trace is a horizontal line at zero voltage. The contacts then open into an arc at 15 volts which lasts for about 300 microseconds. When the arc goes out, the voltage jumps to a new value, then charges up more slowly because of the current from the external source. (b) “Showering” on break followed by a glow discharge. After the portion of the trace at zero voltage, there is a region of rapid charge-ups and breakdowns lasting for about 30 microseconds. This is followed by a steady glow discharge at 300 volts lasting for about 70 microseconds. When the glow discharge goes out, the voltage begins to fall as the capacitance discharges through the power source, which supplies only 50 volts.

spacings, and pre-breakdown currents are extremely small. Furthermore, the effects of dirt and oxide films are difficult to estimate. Each step in the proposed process, however, is also operative in a vacuum. Experiments have been carried out in high vacuum, and the evidence gathered confirms the theory of breakdown caused by field emission enhanced by ionic space charge.

Breakdowns of this type may take place either on closure or break of telephone contacts. Depending upon the circuit and the condition of the metal surfaces the arcs which follow breakdown may last for many microseconds and be easily observable on an oscilloscope, or they may be so brief as to be unresolvable, leading to many rapid cycles of charging up and breaking down of local capacitance. This latter condition is called "showering." It is during these periods of either continuous arcing or showering that most of the damage to relay contacts takes place. Typical oscilloscope traces of the voltage across electrical contacts in these two forms of discharge are reproduced in Figure 1.

Knowing the conditions which lead to arcs on make and break is a promising start in the prediction of the useful life of relay contacts. However, attempts to understand quantitatively the amount of metal transferred by arcing at contacts have frequently been frustrated in the past by inconsistent and contradictory experimental results. A considerable step toward understanding erosion was made by discovering, in experiments performed on palla-

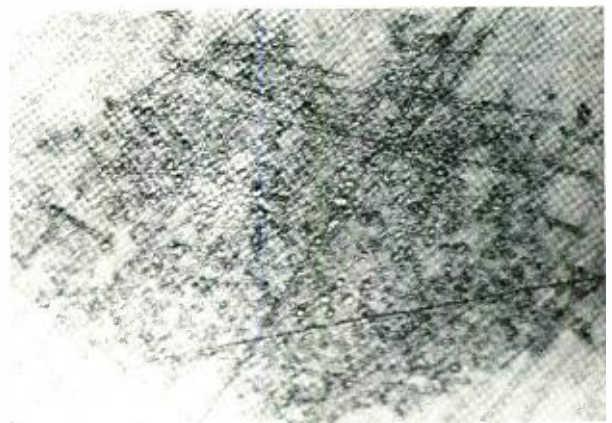

*Fig. 3—Typical cathode mark due to a single "cathode" arc. There is frequently no mark at all to be found on the corresponding anode. Magnification, 1500 diameters.*

dium contacts, that there are two distinct types of arcs. One type, called the "anode" arc, leaves a melted crater on the anode surface and a roughened cathode spot. The other, called a "cathode" arc, leaves many tiny melted spots on the cathode, usually along scratch lines when the cathode is a polished surface, and little or no mark on the anode. Photomicrographs of the damage done to anode and cathode surfaces in single typical arcs of the two types are shown in Figures 2-4. One might expect, from examination of these photographs, that an anode arc transfers metal from anode to cathode, and a cathode arc from cathode to anode. These

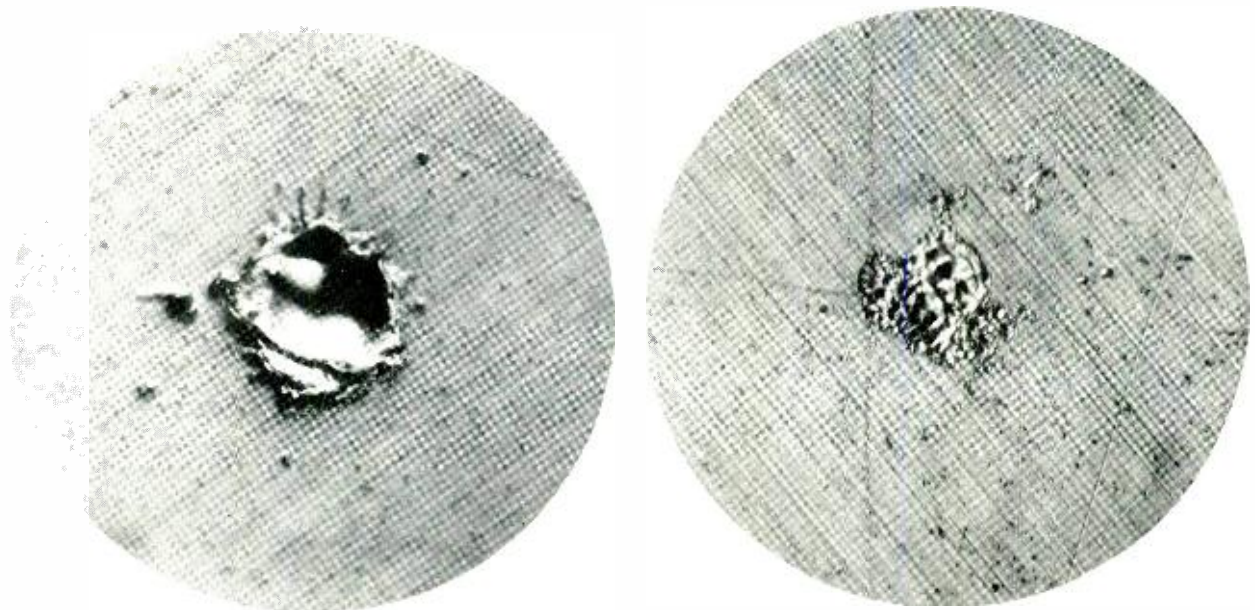

*Fig. 2—(Left) Photomicrograph of a typical anode pit due to a single "anode" arc. Magnification 2000 diameters. (Right) typical cathode mark due to a single "anode" arc. Magnification 2000 diameters.*

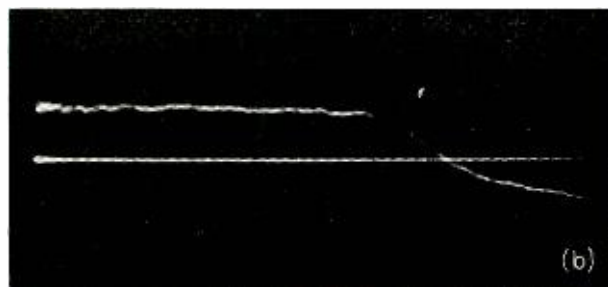
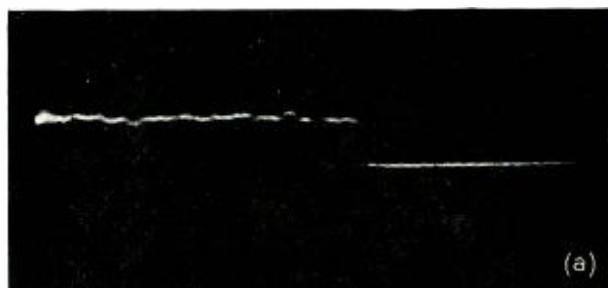

Fig. 4—Electron micrograph of a portion of the cathode mark due to a single “cathode” arc. Magnification 47,000 diameters.

expectations have been confirmed both by determining the transfer occurring in single arcs of each type by radioactive tracer methods, and by weighing on a microbalance after many closures under circumstances known to produce predominantly one or the other type of arc.

To understand contact erosion and to predict contact lifetimes, it is thus necessary to understand the factors affecting the occurrence of the two types of arc. In general, for striking voltages above 400 volts, only cathode arcs occur, and the probability of occurrence of anode arcs increases as the voltage is lowered. Cleanliness of the cathode surface favors

Fig. 5—Oscillograms of arcs on closure discharging 200 feet of 50 ohm cable charged to 200 volts. Trace length is 0.8 microseconds. (a) Arc followed by a “weld”. (b) Arc followed by an open circuit. There is also a trace at zero voltage.



anode arcs, and under reasonably clean circumstances anode arcs greatly predominate at 48 volts. Yet, for a slightly carbonized cathode surface, which readily results from the decomposition of certain organic vapors often present in the air of telephone central offices, arcs generally are of the cathode type even at the lowest striking potentials. The extremely important deleterious effects of such organic vapors has been described in a previous RECORD article.\*

It is now believed that, on clean surfaces, a cathode arc follows a breakdown initiated by the evaporation of a small projection on the cathode by resistive heating. An anode arc occurs when the cathode projection is so large that the anode reaches the boiling point before the cathode projection. In the cathode arc, metal vapor necessary for the arc



Fig. 6—Photomicrograph of an anode pit due to discharging a cable where the arc has gone out and has been re-ignited. This is to be compared with the left part of Figure 2, where the arc did not strike a second time.

is supplied by the cathode, but in the anode arc it is supplied by both electrodes with the larger fraction coming from the anode. Some of the distinguishing characteristics of the two types of arcs are shown in Table 1.

A further complication in the prediction of contact erosion is due to the occurrence of “welds.” Anode arcs are frequently terminated before the circuit is discharged, by short-circuiting the contacts by molten metal from the anode spot. Oscilloscope traces of arcs which do and do not termi-

\* RECORD, June, 1954, page 226.

nate in welds are shown in Figure 5. When welding occurs, the erosion depends upon the time of welding as well as upon the relative numbers of the two types of arc.

The problem of time of welding should properly be considered together with other phenomena that occur at the termination of the arc. In general, neither type of arc can persist when the current falls to indefinitely small values. Observed "minimum arc currents" are of the order of 0.3 to 1.0 ampere for both types of arc on clean metals. The reasons for this minimum are poorly understood for cathode arcs, but for anode arcs it appears that the anode spot grows with time, and thus the power necessary to maintain the surface at the boiling point also increases. When the current is no longer sufficient to supply this power, the arc goes out. Since the size of the anode spot depends on the course of the current up to the time of extinction, the minimum arc current is a function of the history of the arc up to that point. When an arc is extinguished, the electric field at the anode, which was very small during the arc, is suddenly increased and the pool of molten metal is pulled toward the cathode. Thus, welds occur most frequently at the

end of the growth of one of the anode spots when the arc is extinguished. If the circuit is still capable of delivering considerable current, however, the weld may be blown up and the arc reignited. The nature of an anode pit when a second arc strikes in discharging a cable is shown in Figure 6. If the pool of metal in the anode spot is either too small or cools too quickly, the anode metal may not be sufficient to bridge the gap, and the anode arc may end in an open circuit, just as do all cathode arcs.

Although the results of many tests are understood as described, it is not possible to predict contact life with great reliability. In view of the observed dependence of the erosion upon atmospheric conditions, upon the previous history of the contacts, and upon small changes in circuitry, it is difficult to believe that operating conditions can ever be sufficiently well specified in a reasonably concise manner to make such predictions possible. Nevertheless, certain conditions favorable to long lifetimes are understood. They involve, among other things, avoidance, where possible, of the injurious organic vapors, prevention of the discharge of any considerable capacitance on closure, and keeping the energy stored in the load inductance to a minimum.

---

#### THE AUTHOR

---



PAUL KISLIUK received a B.S. degree in chemistry from Queens College, New York City, in 1943. After three years in the armed forces, during which he was engaged in maintenance of repeater and carrier telephone equipment for the Signal Corps overseas, he resumed his education at Columbia University. He received an M.A. degree in physics in 1947 and a Ph.D. degree, also in physics, in 1952. Mr. Kisliuk joined the staff of Bell Telephone Laboratories in 1952, and is a member of the Physical Research Department, where he has been engaged in research in contact physics. He is a member of the American Physical Society and of Sigma Xi.

---

#### *A. G. Jensen Elected Fellow of British Television Society*

A. G. Jensen, Laboratories Director of Television Research, was recently elected a Fellow of the British Television Society in recognition of his outstanding contributions to the development of television. The Television Society, founded in 1927, is "the first society in the world for the furtherance of research in television and allied problems."

Mr. Jensen has received a number of other honors for his work in television research including the David Sarnoff Gold Medal from the Society of Motion Picture and Television Engineers, and the G. A. Hagemann Gold Medal for Industrial Research from the Royal Technical College in Copenhagen, Denmark.



# *CAMA — Automatic Trunk - Test Circuit*

**R. F. DUSENBERRY**

*Switching Systems Development II*

**The Centralized Automatic Message Accounting system serves many local telephone offices by recording information on calls outside the customer's local dialing area. In a CAMA installation, trunks from the local offices are periodically tested by a circuit which helps insure service that is free of interruption or other difficulty. Operation is automatic and does not require assistance from maintenance personnel in the local offices.**

The Centralized Automatic Message Accounting system has required the development of several new circuits and the adaptation of many earlier units.\* This equipment is installed in a centralized location (a crossbar tandem office), so that it can serve a large number of surrounding local offices. With the CAMA feature, customers can dial many extended-area and long-distance calls even though the cost of installing separate Automatic Message Accounting equipment in each local office is prohibitive. The service is much like the previously developed AMA operation, except that after the customer has dialed his number, a special CAMA operator asks for the originating telephone number. Otherwise, the recording of information relative to the telephone call is entirely automatic.

Between the crossbar tandem office and the surrounding local offices there are a large number of pairs of wires which are used for the transmission of telephone conversations, and which are usually referred to as "trunks." More exactly, however, a

"trunk" consists of the pair of wires plus the relay circuits at each end. At the tandem office, such a trunk relay circuit must perform many functions: it must work with other parts of the crossbar switching system to set up the connection to the called telephone office, and it must later take charge of the connection and maintain it until appropriate disconnect indications are received. In the CAMA system it must also perform several tasks in association with the AMA recording equipment.

Described here is an automatic test circuit that tests all the operations of the trunk relay equipment connected to a cable pair on a call coming in from a local office. The wide variety of tests performed, and the rapidity of operation, make this test circuit a very valuable part of the complete CAMA installation. As will be seen later, much of this value derives from the fact that, in the tandem office, maintenance personnel do not need to ask for assistance of the various local offices in arranging for or conducting the tests.

In Figure 1, the automatic test circuit is represented in the shaded portion of the block diagram, and the other units are those parts of the CAMA

\* RECORD, July, 1954, page 241; October, 1954, page 371; May, 1955, page 193; June, 1955, page 223; July, 1955, page 267; August, 1955, page 313.

system and the crossbar tandem office with which the test circuit is concerned. The trunk relay equipment to be tested is represented in the upper left corner of the diagram. What happens on a regular service call is briefly this: the originating customer at the left is connected through the crossbar tandem office via the incoming trunk relay equipment, and during the progress of the call this trunk circuit performs the tasks that have been mentioned. The function of the test circuit is simply to simulate, in as exact a manner as possible, an actual service call as dialed by a customer, and to observe whether the trunk circuit is performing properly. Conditions applied to the trunk circuit during the simulated call are more severe than those usually encountered in service. The test circuit, however, does not automatically test transmission (that is, the transmission characteristics of the voice path), nor does it request the services of the CAMA special operator.

Local offices send called-number pulses in several different ways, termed Panel Call Indicator (PCI), Dial (DP), and Multifrequency (MF)

pulsing. At the present time, the test circuit simulates the panel call indicator and dial pulse types of calls, and the multifrequency type is to be added later. The test circuit recognizes the type of trunk circuit it is to test, and alters the test procedure accordingly. It contains generators for producing both the panel call indicator and dial pulses.

In terms of the called-number pulses and other types of signals, the test circuit is thus a simulated originating office. It is also a simulated terminating office because the outgoing or destination trunk used is actually a "return test line," which has as its destination the test circuit. Signals that the terminating office sends back to the tandem office are by this means also simulated, and the effects on the incoming trunk circuit observed.

Certain tests are made as the trunk circuit responds to the normal sequence of events of a simulated telephone call. The test circuit tests the effects of "answer" and "disconnect" signals as they are normally received from the terminating office. The effects of "seizure" and "disconnect" signals from the originating office are also tested. In addi-

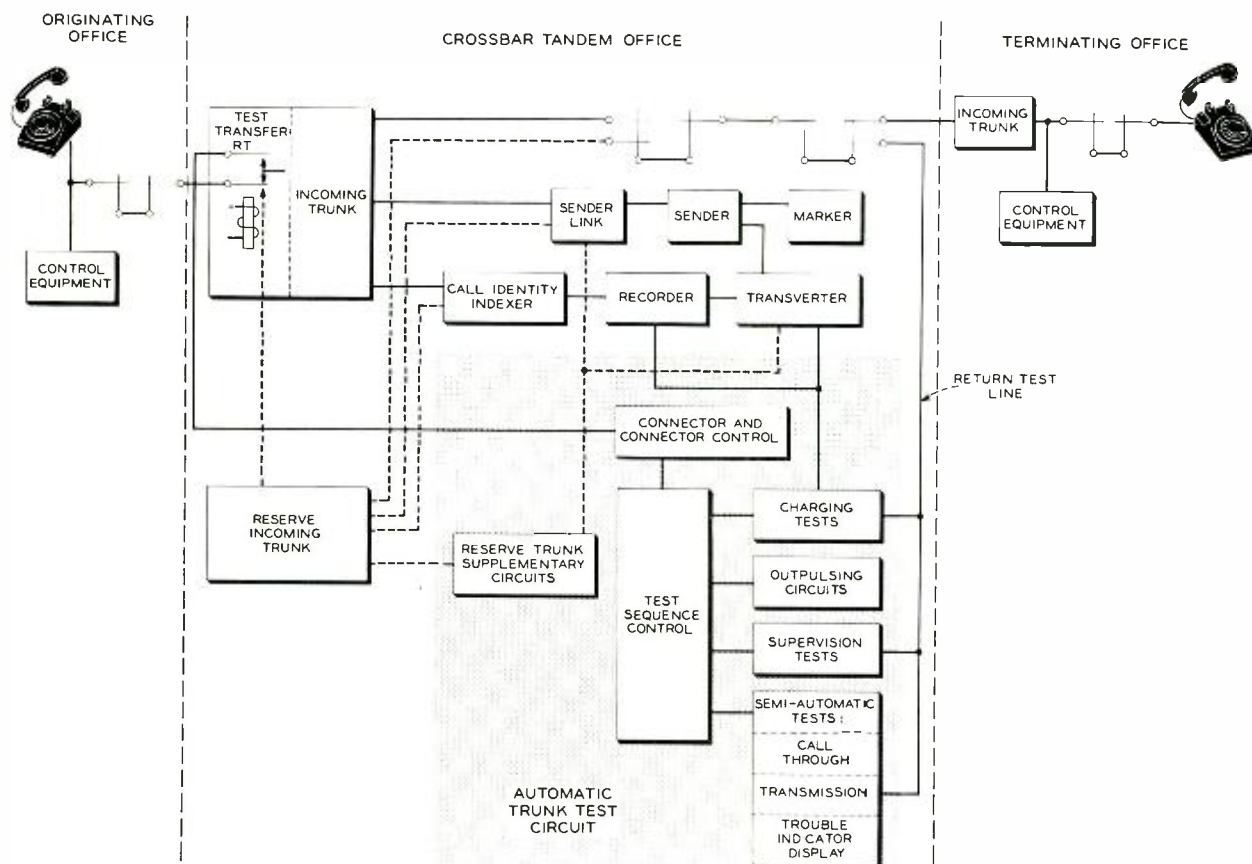

Fig. 1. — Block diagram showing the automatic trunk-test circuit and its association with CAMA crossbar tandem equipment; test circuit acts as a simulated originating and terminating office.

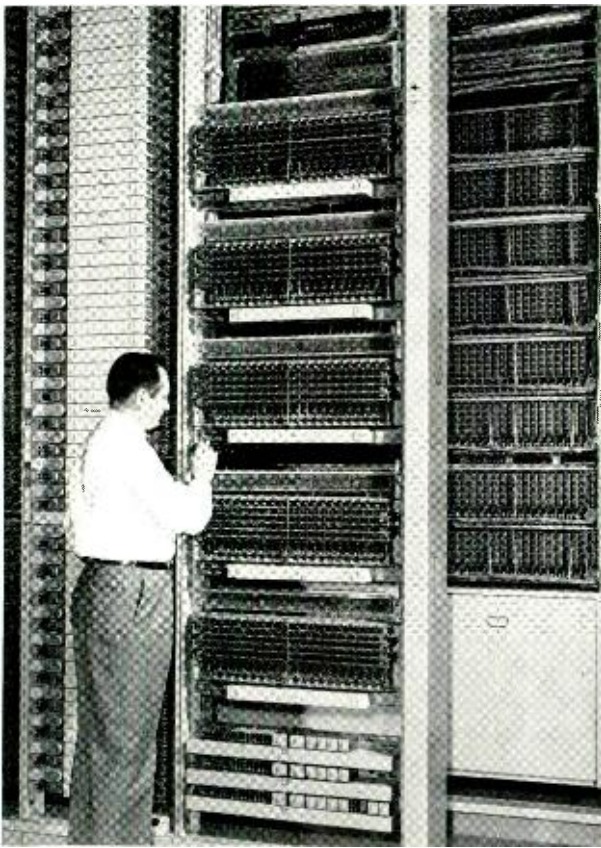

Fig. 2 — Wendell Bushong of the Chesapeake and Potomac Telephone Company at trunk-test circuit connector frame in Washington, D. C., installation.

tion, extra tests are inserted between these normal events. For example, the way the trunk responds to a busy signal is tested while the trunk is waiting for the simulated call to be "answered."

Several additional tests performed by this circuit should also be mentioned. Under certain circumstances, when a first attempt to establish a telephone connection is unsuccessful, a second trial is automatically made by the switching equipment. The test circuit determines whether the trunk circuit properly handles such requests for a second trial. It also checks that there are no trouble conditions on the outgoing leads of the trunk circuit, and connects other leads into the trunk circuit to observe the performance of individual relays. Certain relays must operate and release within specified time intervals, and the test circuit checks such timing characteristics. Also, the test circuit determines whether the incoming trunk circuit is able to cause the proper recording of entries on the paper tape of the Automatic Message Accounting equipment. This is done by a test connection to the re-

order circuit at the time the entries are made. The test call places a special non-billable entry on the AMA paper tape.

All these operations are performed in testing a single incoming trunk circuit. If no trouble is found, another trunk will be selected automatically, and the test circuit will proceed in this manner through all the incoming trunk circuits in the office. Trunk circuits that are busy with actual telephone calls may be passed by and tested later when they are idle. If trouble is encountered, testing will stop and an alarm will sound. An array of lighted lamps indicates the point at which the test was blocked, which is evidence of the nature of the trouble.

The testing described so far is entirely automatic, but several semi-automatic tests may also be performed. Instead of using the simulated terminating office feature of the test circuit, personnel in the crossbar tandem office may perform a "call-through" test on any trunk circuit to any actual terminating office. Also, transmission test equipment may be plugged into the test circuit for a manually performed test of transmission characteristics. In addition, an artificial "trouble" can be introduced to cause a trouble indicator lamp display. This is use-

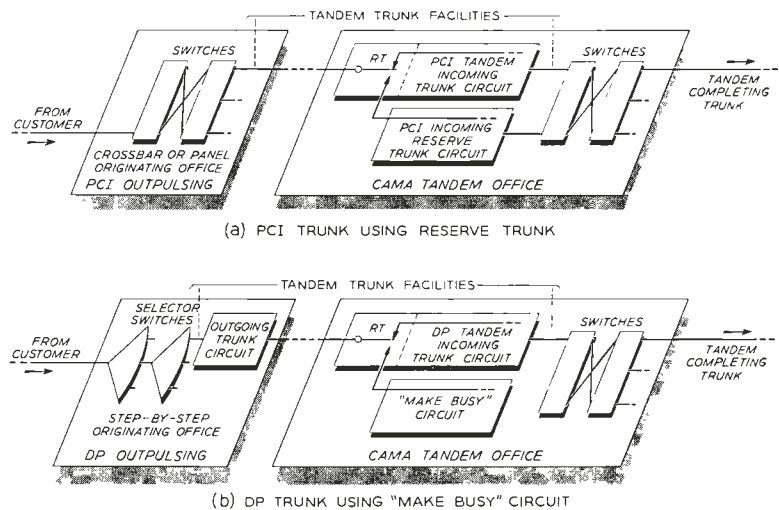

Fig. 3 — Two types of trunk connections between local and tandem offices; both are transferred without assistance from the local telephone office.

ful in checking some of the office wiring which provides information necessary for routing the call and determining the charges.

Some of the interesting aspects of the new circuit are the features associated with the transfer of trunk connections to the test circuit. When a trunk circuit is taken out of service for test, provision

must be made that customers will not be denied service by having their calls run into a "dead end." This is commonly done by making the trunk appear busy; that is, personnel at the originating local office arrange the originating trunk circuit on that end of the cable pair to appear busy to all calls. In this way, calls are diverted to other trunks during the test procedure. Such manual "make-busy" arrangements at the originating end are not practical when an automatic test circuit is located at the tandem office.

This problem is solved in two different ways, as illustrated in Figure 3. The first method has to do with originating offices (crossbar or panel) that use the PCI type of out-pulsing. As seen in Figure 3(a), the incoming telephone call is in this case diverted to a "spare" or reserve trunk circuit, the transfer being accomplished automatically at the crossbar tandem end of the connection. The reserve trunk circuit is a duplicate of the incoming trunk circuit; it is associated with test circuit identification circuits which provide the same rate-class (charging) and class-of-service (routing) information as with a regular trunk circuit normally serving a particular cable pair. Arrangements are also made that if the testing of the regular trunk circuit ends before the end of the customer's call, the transfer condition is maintained as long as the reserve trunk is busy. Under this management the customer's call will not be interrupted if the test being conducted ends before he is finished.

A second method of diverting customer calls is applied when the originating local office (step-by-step switching equipment) uses the DP type of outpulsing. This is illustrated in Figure 3(b). Here, outgoing trunk circuits in the originating step-by-step offices are arranged so that the test cir-

cuit in the crossbar tandem office can make them appear busy. Calls are therefore diverted to other trunk circuits in the originating office, and no reserve trunk circuits in the crossbar tandem office are needed in this case. As with the previous method of transfer, the arrangement here permits automatic control by the test circuit in the crossbar tandem office, and thus eliminates the need for manual assistance in the originating office.

As mentioned earlier, the test circuit proceeds methodically through the incoming trunk circuits in the crossbar tandem office. Now, if a faulty trunk circuit is detected, a feature is provided to hold it out of service for subsequent maintenance action. On the key and lamp panel of the test circuit, there are a number of trunk-hold-busy (THB) keys. With these keys faulty trunks detected by the test circuit can be held out of service pending maintenance action, meanwhile permitting the test circuit to test other trunks. A THB key is associated with the trunks of one AMA recorder. Operation of the key after one of the trunks has been seized by the test circuit will lock that trunk to the key. The test circuit busy test insures that only idle trunks can be thus taken out of service. If further testing of the transferred trunk is required, the test circuit can automatically scan all trunks associated with a particular THB key and locate the transferred trunk. The trunk may be released from its locked-in condition at any time merely by restoring the associated THB key.

The test circuit can automatically test 2,000 incoming trunk circuits, a capacity that is an important factor in the economical maintenance of continuous service to customers. A significant part of the economy is derived from the elimination of the need for manual make-busy arrangements.

#### THE AUTHOR

---

ROBERT F. DUSENBERRY received his B.S. in E.E. degree at Lafayette College in 1948, and he joined the Laboratories in the same year as a student in the Communications Development Training Program. Rotational work assignments performed as part of that program included duties in the Switching Apparatus Development Department and in the Transmission Development Department. Since 1949 he has been in the Switching Development Department where he has worked on switching circuit design, first for the Automatic Message Accounting Center and then for the Tandem Office CAMA project. Later he worked on the design of a portable traffic usage recording circuit and recently has joined the group assigned to the toll office CAMA project. Mr. Dusenberry is an Associate Member of the American Institute of Electrical Engineers and is a member of Tau Beta Pi and Phi Beta Kappa.







# *Repeaters for Twelve-Channel Military Telephone*

**J. M. BARSTOW, JR.**

*Military Communication Systems Engineering*

**Tactical military communication has recently been much improved by the Laboratories' development of a light-weight system for transmitting twelve telephone conversations over a single four-conductor cable. Two types of repeaters have been developed to restore signal strength and permit the terminals to be placed as much as 200 miles apart.**

As a part of the development of a twelve-channel cable carrier telephone system for the military,<sup>o</sup> two types of repeaters were designed. The first of these is officially designated Telephone Repeater AN/TCC-11; it operates without attendance by personnel. The other is an attended repeater, officially designated Telephone Repeater AN/TCC-8. Both units, like all the equipment used in the complete system, were designed to achieve a minimum in weight and a maximum in performance. The equipment thus represents a great improvement over previous tactical military carrier telephone communication systems. The unattended repeater in particular contains some interesting and unique features, and a description of these will comprise most of this article. The attended repeater is more conventional in design and will be described in somewhat less detail.

A photograph of the unattended repeater is shown in Figure 1. These repeaters are normally spaced at 5 $\frac{1}{4}$ -mile intervals along the cable to amplify signals in the frequency range from 12 kc to 99 kc. The gain or amplification of the repeater is equalized to compensate for the attenuation of a 5 $\frac{1}{4}$ -mile cable span at all frequencies in the 12 to 68 kc (message and pilot) range. In addition, the repeater gain is automatically regulated to compensate for changes in

cable loss resulting from temperature variations. The 12- to 99-kc band includes twelve telephone message channels occupying the 12-kc to 60-kc range, a pilot or controlling frequency of 68 kc, and tones used for test purposes at 83, 91, and 99 kc. When a field telephone set (EE-8) and a portable test set (TS-712) are connected to the repeater, personnel may ring the attended points of the system and converse over a voice-frequency order-wire circuit. Voice frequencies are not amplified in the unattended repeater, however.

A block diagram of the repeater is shown in Figure 2. Power from a constant-current 0.1 ampere dc supply is sent along the cable from an attended point, and is delivered to the two amplifiers used for the two directions of transmission. As indicated in the diagram, the tube heater elements are wired in series. Current from the power supply flows through the heaters, and the resulting voltage drop is used as plate voltage for the tubes. One power supply can power as many as three repeaters. The POWER LOOPING SWITCH in the center of the diagram permits connecting the dc power path so that the current either flows through the tube heaters and along the next length of cable to the succeeding repeater, or, if the repeater is the last of a series of three, "loops back" and returns to the low side of the power supply. This arrangement requires good electrical in-

<sup>o</sup> RECORD, August, 1955, page 290.



Fig. 1 — Mounting AN/TCC-11 unattended repeater on a pole. This repeater unit can also be placed on the ground along the cable run.

sulation between the circuit “grounds” and the outside case, since the potential of the circuit “grounds” relative to earth ground may be as high as 450 volts.

Of course, prime requisites for tactical military equipment are that it be portable, rugged, and reliable. This repeater is designed especially for an exposed environment so that it may lie on the ground or be strapped to a pole (see Figure 1) without shelter, in either arctic or tropic climates. The electrical apparatus is shock-mounted inside a waterproof cylindrical aluminum case 28½” long and 10” in diameter. The complete assembly weighs only

83 lbs. Removable covers over ports at each end provide access to cable connectors and test points. The power looping switch and a three-position REPEATER SWITCH (discussed later) are also reached through covered ports on the end sections. The ease of installing and removing the repeater merely by connecting the ends of the cable sections to the mating conductors on the case simplifies the maintenance of the system.

It is beyond the scope of this article to describe the component parts of the repeater in detail, but a few facts and figures deserve mention. The gain of the amplifiers at the pilot frequency (68 kc) is approximately 22.4 db at a temperature of 45°F, the assumed average temperature. Equalization is built into the amplifiers so that at average temperature, the shape of the loss vs frequency characteristic of 5¾ miles of cable is compensated within  $\pm 0.06$  db at all frequencies in the message band. Regulation of the gain characteristic of each amplifier is accomplished by means of an ambient temperature-sensitive thermistor, which controls the loss characteristic of a network associated with the amplifier. If the thermistor temperature follows the cable temperature, compensation for the cable loss variations will be obtained. This compensation is only approximate, of course, since the temperature of the cable and the temperature of the thermistor will seldom be identical. However, errors in the transmission characteristic will accumulate to only a moderate amount between attended points (2.4 db at 68 kc at the end of a 6-repeater span for a 20°F difference in cable and thermistor temperature at each repeater). More-

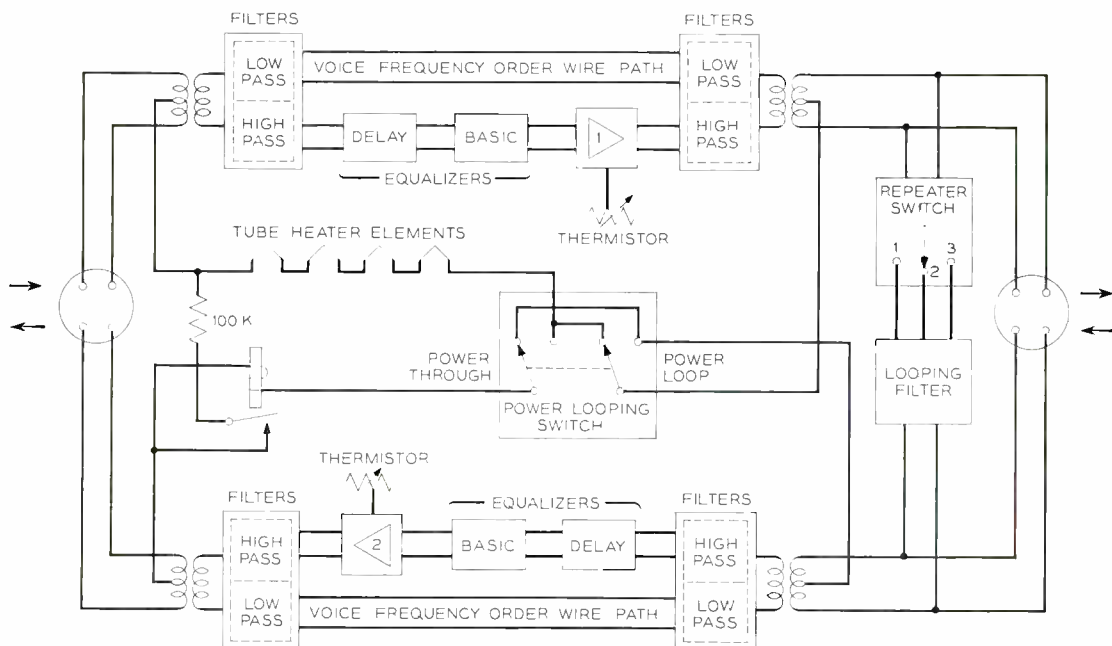

Fig. 2 — Block diagram of AN/TCC-11 unattended repeater

over, at the attended points additional equalization, both manual and automatic, is supplied to compensate for the accumulated error.

Figure 4(a) shows the predicted transmission characteristics of a 200-mile system under the condition that the repeater and cable temperatures are equal at 45°F, and under the further conditions that the repeater temperature is 20° above or below the cable temperature. The closeness of the three curves is an indication of the regulator performance, and the rather modest departure from uniform gain over the frequency band shows the extent to which the system transmission is equalized. Figure 4(b) shows the variation of the same 200-mile system characteristic when the ambient temperature varies  $\pm 30^\circ\text{F}$

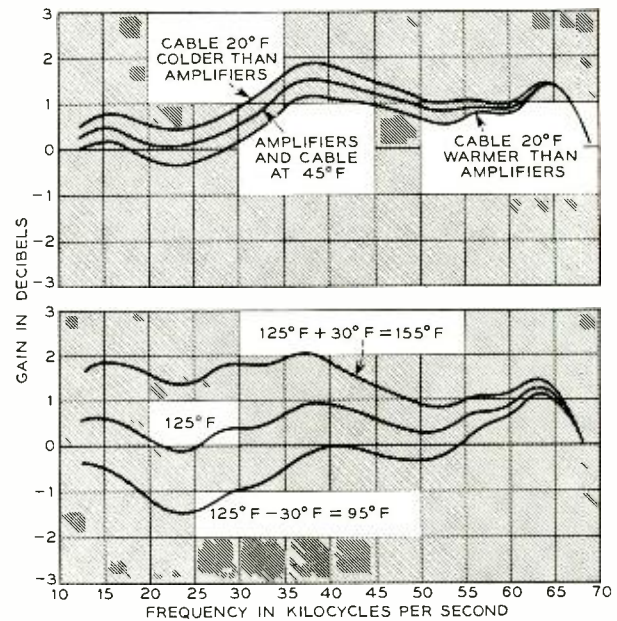

Fig. 4 — (a) Gain-frequency characteristics of 200-mile system, showing changes when cable is colder or warmer than amplifiers; (b) characteristics for hot-weather operation on the same system.

99-kc test tones to the line and measure the signal returned in the opposite direction of transmission. The faulty repeater will not return the applied tone.

Cable breaks in general produce power alarm indications at attended points and can be located by resistance measurements of the line. If power fails, relays in the repeaters release and connect 100,000-ohm resistors across the line. If, then, a break has occurred between the first and second repeater, a resistance measurement will indicate a resistance of about 100,000 ohms. If the break is between the second and third repeater, the resistance will be about 50,000 ohms, and so on.

At intervals up to 40 miles along the cable, the attended AN/TCC-8 repeater is inserted in the transmission path. This repeater is shown in Figure 3. Like the AN/TCC-11, it amplifies, equalizes, and regulates signals in the 12- to 68-kc range (a blocking filter stops incoming high-frequency test signals before amplification). In addition, this repeater includes voice-frequency order-wire amplification, equalization, and signaling circuits; a test set is also provided which enables measurements to be made at various test points in the power and transmission circuits. A 200-volt power supply delivers dc power to the attended equipment, and two 600-volt, 0.1-ampere constant-current supplies deliver power over the cable to as many as three unattended repeaters in each direction of transmission.

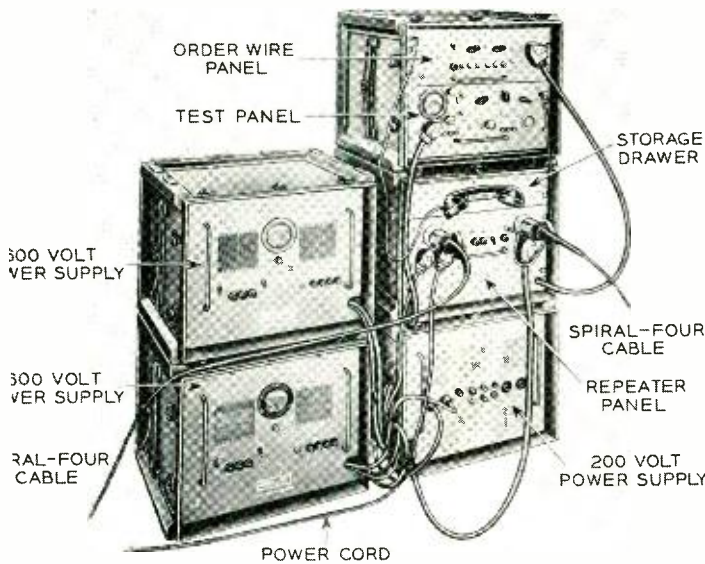

Fig. 3 — The AN/TCC-8 attended repeater.

from an initial temperature of 125°. Equally good performance is obtained when the initial temperature is  $-30^\circ\text{F}$ .

An interesting and important feature of the AN/TCC-11 repeaters is the built-in fault-locating apparatus. Each repeater contains a tunable band-pass filter (called a "looping filter" in the right hand part of Figure 2) bridged across the two directions of transmission. This filter provides a tuned coupling path between the two directions of transmission at 83 kc, 91 kc, or 99 kc. A three-position REPEATER SWITCH selects the proper pass band, which depends upon whether the repeater is the first, second, or third from the attended point at which power is supplied. If a repeater fails, the attendants at the nearest attended point can apply the 83-, 91-, and

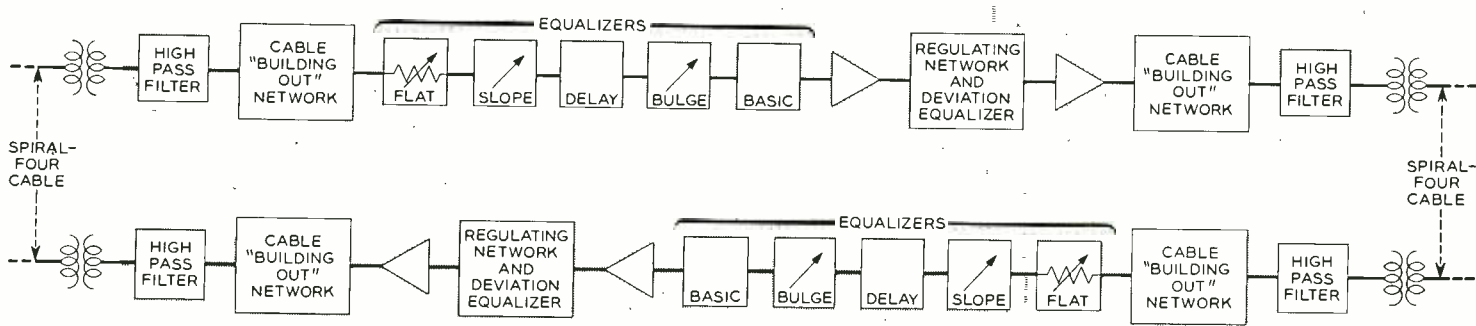

Fig. 5 — Block diagram of the carrier frequency transmission paths of the AN/TCC-8 telephone repeater.

Figure 5 is a simplified diagram of the components in the carrier frequency transmission path. Manually adjustable equalizers permit accurate compensation for manufacturing or other variations in the cable and repeater characteristics. Equalizers with the same loss characteristics as various lengths of cable are provided so that short lengths of cable, which may precede or follow the attended point in a given direction of transmission, can be "built out" to the nominal 5½-mile length. The regulating system at the attended point operates under the control of the 68-kc pilot transmitted from the terminal. The 68-kc pilot is picked off at the output of the attended station amplifier through a narrow-band filter, then amplified and rectified. The rectified voltage is used to control the loss of the regulating network by varying a thermistor element. The regulator network, like that in the unattended repeater, has a loss-frequency characteristic that compensates for the cable attenuation variations. This shape also matches the transmission deviations not compensated for by the unattended repeater. These deviations are "mopped up" at the attended points. Regulators operate over a  $\pm 5$ -db input variation to produce less than a  $\pm 0.5$ -db output variation.

Again, the military requirements of portability, reliability, and ruggedness were important considerations from the standpoint of equipment design. The attended stations will always be provided with some sort of shelter, so waterproof containers are not essential. However, with the covers latched in place, these containers are rainproof and are suitable without added protection for storage and transportation over long distances in all climates. As shown in the photograph (Figure 3), the complete repeater consists of five boxes. The heaviest (the one containing the repeater panel) weighs 118 lbs., and the total weight of the complete repeater is 511 lbs. The boxes have specially notched edges so that the individual units can be stacked as shown in the figure. Inter-unit cables and cable connectors are used to interconnect the various circuits quickly and easily.

The Signal Corps has conducted trials of both repeaters. They were subjected to severe vibration, shock, "bounce," heat, and humidity tests, and electrical tests were made on the units in an experimental cable system. These trials furnished data for final adjustments in design so that, as produced, the repeaters give excellent performance in all respects.

#### THE AUTHOR



JOHN M. BARSTOW, JR. received his degree of B.S. in Electrical Engineering from the University of Kentucky in 1949. He joined the technical staff of Bell Telephone Laboratories in February of that year and enrolled in the Laboratories Communications Development Training Program. In 1950 he joined the Transmissions Systems Development Department where he was engaged in the development of military carrier systems and in the development of the transatlantic submarine cable system. Prior to his resignation from the Laboratories in January 1956, he was associated with military communication systems studies.

## *Outstanding C. D. T. Students to Work Toward Doctorates*

The Laboratories will institute a program of fellowship awards to allow a few outstanding students in the Communications Development Training Program to acquire their Ph.D. degrees while continuing as regular Laboratories employees. Awards will normally be made at the end of the students' first year in C. D. T. A small number will be made each year, depending upon the size of the C. D. T. class and the merit of the candidates. This year one or two additional awards will be made to candidates who completed their first year in C. D. T. prior to this year. First selections will be made later this year.

Nominations for fellowships will be made by the Department of Education and Training, and awards will be made by the C. D. T. Policy Committee, consisting of E. I. Green, Chairman, H. W. Bode, R. R. Hough, A. D. Knowlton, F. D. Leamer, M. B. McDavitt, and S. B. Ingram, Secretary.

Fellows will be selected from the upper scholastic level of C. D. T. with consideration being given to performance on rotational assignments, potential as Laboratories employees, and promise of benefit from advanced academic training. The fellowship program is expected to strengthen the Laboratories staff by the further academic development of outstanding Communications Development Training students.

Choice of institution will be made jointly by the fellow and the C. D. T. Policy Committee, with proximity to the Laboratories being one consideration. Fellows will continue as Laboratories employees, drawing full salary and receiving regular employee benefits. Allowances will be made for tuition, books, and certain other expenses. During academic vacations, Fellows will return to the Laboratories where they will work on projects in various technical departments.

## *Wind-Tunnel Hurricanes Used to Test Telephone Equipment*

A wind tunnel, normally employed in aerodynamic studies, was recently used by the Laboratories to simulate the effect of hurricane conditions on some telephone apparatus. Acting on a request by the A.T.&T. Co., members of the Outside Plant Development and General Staff Departments at the Point Breeze Laboratory conducted a series of tests to determine what effect hurricane winds would have on a "Ready-Access" cable terminal. This terminal is a device used to provide entrance from

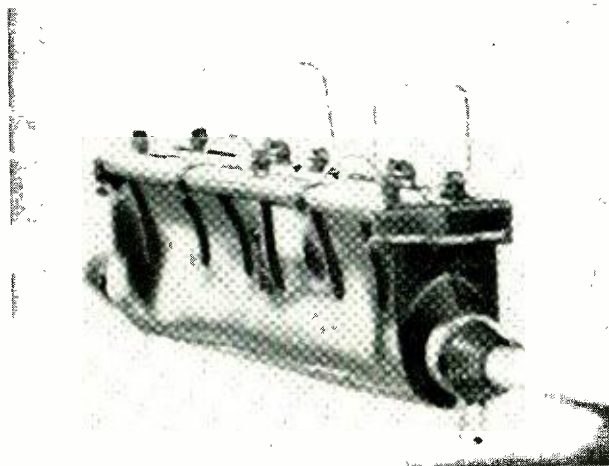

*"Ready-Access" cable terminal after it was subjected to 200-mile-per-hour winds.*



*D. Gross, Director of the Univ. of Maryland wind tunnel, center, with P. P. Kaliss, left, and W. J. Fullerton of BTL in the test room of the Univ. of Maryland wind tunnel.*

polyethylene insulated cable to a telephone customer's premises.

To perform these tests, arrangements were made with the University of Maryland to use the wind tunnel on their campus at College Park, Maryland. Cable terminals were set up in this wind tunnel and subjected to various wind velocities up to and including 200 miles per hour. The terminals survived the tests without damage.



*Cleo F. Craig, President of the A.T.&T. Company, greeted share owners at the 1956 Annual Meeting.*

Bell Companies will spend more than \$2 billion for new construction this year, Cleo F. Craig, president of the American Telephone and Telegraph Company, told share owners at the company's 71st annual meeting in New York City. Such an amount for growth and improvement in any one year is the largest on record for the System. It is also the largest ever planned for a single year's expenditure by any American business.

"So far this year new orders are considerably ahead of 1955," Mr. Craig reported to the share owners. Barring unforeseen developments, the Bell System should be celebrating 50 million telephones in service when the share owners meet in 1957. This compares with about 47 million today.

"Long distance business also continues to show a good healthy growth," Mr. Craig said. This is only partly due to the increase in telephones, although that is an important factor. We increase long distance usage by going out and selling it, Mr. Craig pointed out, and we also promote service by making it more attractive and convenient to use. Mr. Craig cited direct distance dialing as a powerful incentive for our customers to use long distance. All this growth and improvement is the reason for the slightly more than \$2 billion in new construction by the Bell System companies in 1956.

"For most of their new equipment," Mr. Craig said, "the companies rely on Western Electric, the manufacturing and supply organization of the Sys-

## *The 1956 A.T.&T. Stockholders Meeting*

tem." "Last year," as the Annual Report pointed out, "Western Electric did a remarkable job of increasing production. This year they are turning out even more cable, dial equipment and various types of telephone instruments."

The share owners met in a new location—the sixth floor at 50 Varick Street in downtown New York. A.T.&T. purchased the building in 1953 to provide more room for sections of the Treasury and the Comptroller's departments. Earlier this year the Company completed a three-floor addition, and space on the sixth floor can be used from time to time for meetings of this kind.

In answer to questions from the floor concerning the 1955 Annual Report, Mr. Craig replied that last year's advertising expense was less than one per cent of operating expenses; that the recent anti-trust suit consent decree would not disturb the relationship among Bell Telephone Laboratories, Western Electric and the Associated Bell Companies; and that profits from work done for the Department of Defense average about four per cent.

Share owners re-elected each of the 19 incumbent A.T.&T. directors, with votes in excess of 41,000,000. They also re-elected the firm of Lybrand,

*Fred R. Kappel, President of the Western Electric Company, introduced a motion picture about Western Electric at the stockholders meeting.*



Ross Brothers & Montgomery, auditors. During the discussion following nominations for directors, Mr. Craig announced that last year the directors themselves had decided to establish a retirement age of 72, to be fully effective by 1960. While ballots for directors and auditors were being counted, Fred R. Kappel, president of the Western Electric Company, introduced a color film which dramatically told of the important role played by Western Electric in serving both the Bell System and national defense.

During the meeting, more than a score of the share owners present used the microphones provided to ask questions or make comments. In the general discussion period at the end of the meeting, attention centered on earnings and dividends, and of whether the stock should be split.

Mr. Craig stated the present position of the Board. He said in part: "We have made very careful studies to find out what happens to companies when they split their stock. Where there is an announcement of a stock split, the price of stock goes up. There is a flurry in the stock market and a rise in the price of the stock.

"But if there is no substantial dividend increase at the time of the stock split, or shortly thereafter, that stock goes down in the market. In almost every case it goes down below where it was before. There is a spurt, and then a feeling of quite acute disappointment. The stock winds up in a poorer place, financially, after the split than before the split, if the trend of the market is taken into account."

"If the telephone company were to split without a dividend increase," Mr. Craig continued, "the price of the stock would go up on the market temporarily. That would benefit some people who bought the stock on a short-term basis. It would not benefit the people who want to keep the stock as a permanent investment," Mr. Craig stated. "A stock split without any increase in dividends to share owners would be a very short-sighted and damaging step for the company to take. Unless there is a dividend increase at the same time there is a stock split, the speculators may be able to make a profit on the rise and fall in the market. The Board of Directors is not going to take action with respect to the stock merely to push the price up and down on the market."

In discussing the question of a dividend increase, Mr. Craig pointed out that American Telephone and Telegraph stock bought on the market today brings a 4.9 per cent return on the money invested. The company, however, has been able to put only a lim-



*Some of the A.T.&T. stockholders at the 1956 Annual Meeting, held in New York City.*

ited amount per share into undistributed earnings.

Six years ago there were 25 million shares outstanding and today there are 55 million shares outstanding. On the average, about five million shares have been added each year. In 1949 there was \$14.23 in undistributed earnings per share — about a year and a half's dividend protection. There has to be a certain amount of undistributed earnings to protect the whole financial situation.

The company has expanded by nearly 30 million shares. In that period undistributed earnings per share have risen from \$14.23 to \$19.99. This means not only that nearly \$6 per share has been added to undistributed earnings, it means the business has earned enough to put into surplus for each new share an amount equivalent to the surplus per share that existed before those new shares were issued.

Mr. Craig pointed out that in 1955 the company started with \$18.19 in undistributed earnings per share. Roughly, six million shares were added. So for each of the six million shares, the company had to earn, in addition to the dividend payable on those shares, \$18.19 for surplus in order to protect all the previous shares outstanding. What was left after that could be added to the surplus per share, and \$1.80 per share was added last year.

Last year the company, for the first time in a long time, paid out only 69 per cent of earnings in dividends. The Board of Directors is trying to take whatever is left over and put it back into the business, and make that earn for the share owners.

# *American Society for Engineering Education Section Meets at Murray Hill Laboratory*

Dr. Mervin J. Kelly declared to engineering educators last month that our nation is engaged in a technological race for strength, and urged that we move ahead as fast as we can.

Speaking at a conference of more than 300 members of the American Society for Engineering Education, Dr. Kelly described the nation's expanding need for scientists and engineers and emphasized the need for more and better training of both research and development people. He also suggested that educators consider establishing a fifth year for the basic engineering course and then recommend it to all planning a career in research and development so that these students would receive more engineering fundamentals. He also urged that many more students continue their training to the doctorate level. The conference was the Spring Meeting of the A.S.E.E. Middle Atlantic Section, held May 12 at Bell Telephone Laboratories, Murray Hill, N. J.

Concerned with the critical shortage of engineering graduates, the all-day conference had as its theme the "Preparation of Engineering Students



*Dr. M. J. Kelly addresses the spring meeting of Middle-Atlantic Section of the American Society for Engineering Education at Murray Hill.*

for a Career in Industry." Dr. Kelly's keynote address was entitled "Preparation for a Career in Development and Research."

In stressing the need for more and better engineering training, Dr. Kelly pointed out that the four-year engineering graduate generally lacks sufficient training. He showed how Bell Laboratories' belief in more education is exemplified in the Communications Development Training program, established in 1948 as a three-year course for newly employed engineers with bachelor's and master's degrees.

In suggesting a five-year engineering course, Dr. Kelly explained that it could be arranged so that students could stop at the end of four years or continue for the fifth year. This fifth year would be advisable, he said, regardless of whether the student went on for a doctor's degree. Dr. Kelly also urged industry to place greater emphasis on basic research and recommended that research activities be separated from development and design activities.

Dr. Kelly described the successful experiment of Bell Laboratories which 20 years ago separated research from the development and design functions within the company. He explained that the Laboratories worked to create an environment of freedom comparable to that found on university campuses — freedom in research, freedom to publish, and freedom to intermingle with scientific people throughout the world. "The results of the work done in this



*Members of the American Society for Engineering Education attended morning meeting in the Arnold Auditorium at the Murray Hill laboratory.*





*Members of the Society gather following afternoon group meetings.*

area of basic research have created a reservoir of knowledge which, for a long time, will contribute to improvements in communications," he said. Dr. Kelly also insisted in his address that the research scientists must have "the freedom to wander into the area of tomorrow."

In urging that the nation move ahead technologically as fast as it can, Dr. Kelly told of experiences related to him by a professor of a German *Technische Hochschule*. The professor had been forced to work in Russia, and his evidence indicated that top Russian engineering students are more advanced than their counterparts in America.

Dr. Kelly was introduced by R. Karl Honaman, Director of Publication. In welcoming members of the society to Murray Hill, Mr. Honaman expressed the belief that "the community of interest between industry and education is stronger in the field of engineering than in any other area of professionals and their educators. Through common memberships in professional societies and as individuals in contact with each other in both groups, this community of interest is strengthened."

Important problems in the field of engineering education were discussed at three afternoon meetings, as follows: "Preparation of Engineering Graduates for Industry" – Chairman: Sydney B. Ingram, Director of Education and Training at Bell Laboratories. Speakers: Morris D. Hooven, Public Service Electric & Gas Company and President of the A.I.E.E.; Henry N. Meixner, General Assistant Di-

rector, Mechanical Development Laboratory, E. I. du Pont de Nemours & Company, Inc.; and Frank W. Miller, Vice President – Manufacturing, Yarnall-Waring Company, Philadelphia.

"Preparation of Secondary School Graduates for Engineering" – Chairman: Elmer C. Easton, Dean of Engineering, Rutgers University. Speakers: Lynn L. Merrill, Dean of the Faculty, Stevens Institute of Technology; Harold K. Work, Director of the Research Division, College of Engineering, New York University; and Ablett H. Flury, Assistant Commissioner of Education for the State of New Jersey, who delivered a paper by Frederick Raubinger, Commissioner of Education.

"Current Engineering Manpower Needs in Industry and the Colleges" – Chairman: Donald S. Bridgman, Director of College Relations, American Telephone and Telegraph Company. Speakers: William T. Cavanaugh, Executive Secretary, Engineering Manpower Commission of the Engineers Joint Council; and Robert W. van Houten, President, Newark College of Engineering.

Following dinner at the Hotel Suburban in Summit, William E. Burke, Vice President – Defense Projects, Western Electric Company, gave a recently declassified account of construction of the Distant Early Warning Line which guards our Arctic continental approaches.

Arrangements for the conference were made by a Laboratories committee headed by Frank D. Leamer, Personnel Director.



*Tours of various Murray Hill Laboratories were arranged for visiting educators.*

## **Dr. Kelly Accepts New Posts In New York City**

Dr. M. J. Kelly was elected a director of The Economic Club of New York at a meeting in New York City April 16. His term of office is for three years beginning June 1, 1956.

The Economic Club is an association whose objectives are: "to contribute toward building a stronger business leadership in America; to provide a platform for discussing those problems that affect the business community, and to develop an informed opinion among all citizens as to the aims and achievements of our economic system."

Dr. Kelly also recently accepted a post on the New York City Board of Education's Advisory Committee on Science Manpower. In this capacity, he is chairman of a subcommittee on the Role of Industry and Colleges.

## **Field Trial of Rural Telephone System Concluded in Georgia**

The first field trial of a rural telephone system making use of transistors and the Bell Solar Battery, held in Americus, Georgia, has been concluded with satisfactory results. The Bell Solar Battery was installed on a part of this trial system in October, 1955, as an experimental substitute for ordinary batteries, the conventional source of electrical power for such a system where power lines are not readily available. Power engineers report that the Bell Solar Battery, first device to change sunlight directly and efficiently into useful amounts of electricity, has lived up to expectations.

Bell System engineers have ascertained from the Georgia tests that, from the standpoint of reliability and effective operation, the Bell Solar Battery mounted on a pole can be used to furnish electricity for rural telephone equipment. The favorable operation report on the Solar Battery, however, does not mean that regular commercial use of the device is as yet practical. Until the ultra-pure silicon used in the device becomes less expensive, it will be more economical to use conventional power sources for telephone systems. Hence, no further trials of the Bell Solar Battery are planned immediately.

Of more significance for telephone customers and electronics engineers is the future indicated for the transistor. The Georgia tests have justified the confidence placed in the transistor as a key to the planning of future telephone systems.

About 275 transistors were used in the Americus trial. The short-haul, rural telephone system that

was tried out derives its economy largely from the use of transistors instead of electron tubes which should help make it possible to provide improved telephone service in thinly populated rural areas.

Another device, used for the first time in the experimental system, made transistor use practical. This is a lightning protector which affords the low-power transistor special protection against electrical surges. This new device — called a "silicon aluminum junction diode" — in conjunction with standard protectors will protect transistors from ordinary lightning damage. This lightning protector evolved from the same basic research as the transistor itself and belongs to the same general family of semiconductor devices.

## **San Diego First Large City Added to Nationwide Customer Dialing Network**

The recent cutover of the University Crossbar Tandem Office in San Diego, California, marked another major step along the road toward nationwide direct distance dialing. This was the first occasion in which an entire large multi-office city, served by the Bell System, was arranged for direct distance dialing. (In 1950, San Diego had a population of about 435,000, and in 1953, it had about 130,000 telephone customers.)

The San Diego cutover also marked the first occasion in which a city served by step-by-step central offices was included in the nationwide dialing

### **B.S.T.J. CONTENTS**

The May, 1956, issue of *The Bell System Technical Journal* contains the following:

*Chemical Interactions Among Defects in Germanium and Silicon* by H. Reiss, C. S. Fuller and F. J. Morin.

*Single Crystals of Exceptional Perfection and Uniformity by Zone Leveling* by D. C. Bennett and B. Sawyer.

*Diffused p-n Junction Silicon Rectifier* by M. B. Prince.

*The Forward Characteristic of the PIN Diode* by D. A. Kleinman.

*A Laboratory Model Magnetic Drum Translator for Toll Switching Offices* by F. J. Buhrendorf, H. A. Henning and O. J. Murphy.

*Tables of Phase of a Semi-Infinite Unit Attenuation Slope* by D. E. Thomas.

plan. This was made possible by new centralized automatic message accounting and toll features in the crossbar tandem switching system which will ultimately provide service for 10,000,000 customers in about 100 step-by-step cities.

The University Tandem office serves 31 local central offices in the San Diego area. It is a primary outlet in the nationwide dialing plan.

### ***Ferroelectric Devices Demonstrated at National Academy of Sciences***

The Laboratories, at the request of the National Academy of Sciences, presented a number of demonstrations at the annual meeting of the Academy held in Washington, D. C., recently. Among these were demonstrations that showed the applications of new ferroelectric memory devices.

One of these was a ferroelectric shift register—a device in which stored binary digits can be simultaneously moved from one cell to another without interfering with each other. This apparatus can perform a number of basic operations that make it useful for data processing applications, such as digital computing and automatic switching. These include: data storage; pulse counting; the ability to transfer information between devices with widely different pulse rates; and the ability to accept pulses one-at-a-time, store them until the sequence is completed, and then transfer them all-at-once.

### ***Laboratories Plan New Building at Holmdel, New Jersey***

To permit definite planning to meet the Laboratories' needs for more working space, the Board of Directors has authorized the preparation of plans and specifications for major building facilities to be constructed on the Laboratories' property at Holmdel, New Jersey.

Presently authorized construction, including the proposed office building and the single-story warehouse-type building at Murray Hill and additional space at Western Electric locations, are expected to provide for space needs through 1958. The Laboratories is now authorized to prepare detailed plans and specifications for a building unit at Holmdel to be started within the next year to provide for Laboratories space needs for a reasonable period beyond 1958. It is expected that this first unit would provide space for about 1,500 people. Also authorized is the preparation of an over-all building layout for Holmdel so that if future Laboratories space needs justify it Holmdel could be built up

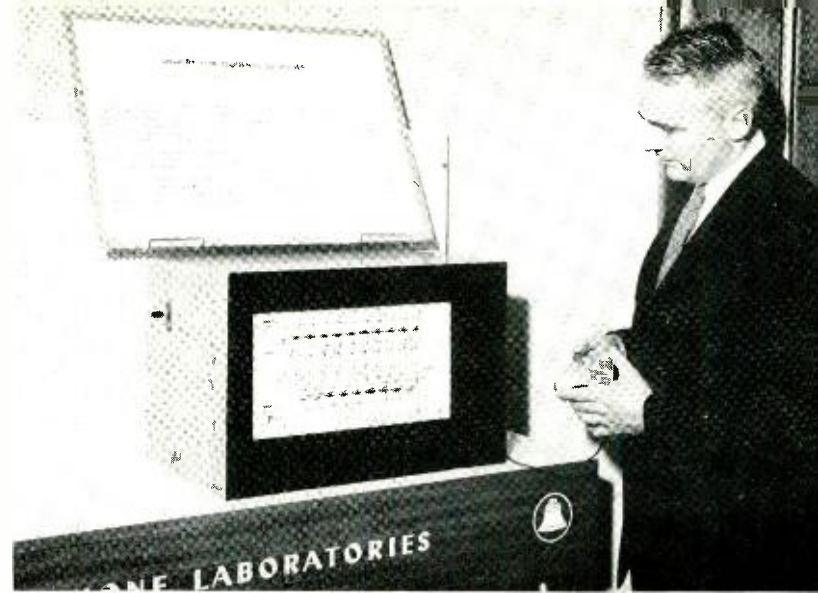

*J. Reid Anderson, of the Laboratories Switching Research Department, demonstrates a ferroelectric shift register at the annual meeting of the National Academy of Sciences.*

under an orderly and efficient plan to become a major location about the size of Murray Hill.

Preliminary studies indicate that Holmdel is a highly desirable location for Laboratories purposes. This location is near enough New York, Murray Hill and Whippany for necessary inter-location travel, yet sufficiently separated to avoid overconcentration in any one area. It is believed undesirable to expand sizably beyond present plans at either Murray Hill or Whippany. Similarly, there appears to be good reason for not enlarging the New York location. Transportation, concentration, availability of suitable manpower, recruiting of professional people, accessibility of residential areas, and many other factors have been weighed in the decision to enlarge at Holmdel.

Holmdel, where there are now about 130 Laboratories employees, is about 25 miles from Murray Hill and about 45 minutes in time by automobile on the Garden State Parkway. It is only a little farther from Whippany and about an hour from New York. There is also rail and bus transportation from New York. The Laboratories now owns about 450 acres at this site.

The authorization given by the Board of Directors includes funds for: surveying, engineering and architectural services necessary to plan the long-term, over-all program; engineering and architectural services to produce complete drawings and specifications for the first building unit; and drilling of wells at Holmdel required to prove the adequacy of the water supply to meet the needs of the program. It is expected that the planning can be completed in time to start construction of the first step in the project late in 1957 or early 1958.

## *Patents Issued to Members of Bell Telephone Laboratories During March*

- Bonomi, F. A. — *Pulse Divider* — 2,737,614.  
Brooks, C. E., McGuigan, J. H., and Murphy, O. J. — *Magnetic Drum Dial Pulse Recording and Storage Registers* — 2,738,382.  
Drugan, W. T. — *Rotary Switch With Centrifugal Contactor* — 2,740,006.  
Fox, A. G. — *Wave-guide Impedance Elements* — 2,740,094.  
Grisdale, R. O., and Sauer, H. A. — *Method for Producing Conducting Coils* — 2,739,371.  
Holden, W. H. T. — *Station Number Identifier* — 2,739,187.  
Houtz, C. C., and McLean, D. A. — *Stabilization of Electrolytic Capacitors* — 2,739,275.  
Hunt, L. E., and Schafer, J. P. — *Method and Apparatus for Detecting and Correcting Amplitude Distortion* — 2,738,417.  
Lewis, B. F., and Muller, K. H. — *Photoelectric Relay Device* — 2,737,598.  
Lovell, C. A. — *Multifrequency High Speed Calling Signal Generator* — 2,739,298.  
McGuigan, J. H., see Brooks, C. E.  
McLean, D. A., see Houtz, C. C.  
Muller, K. H., see Lewis, B. F.  
Murphy, O. J., see Brooks, C. E.  
Newby, N. D. — *Magnetic Scanning Arrangement Providing Compensation for Battery Variation and Variation of Other Components* — 2,739,183.  
Newby, N. D. — *Rotational Use of Register Circuits in Telephone Switching Systems* — 2,740,003.  
Pfann, W. G. — *Segregation Process* — 2,739,045.  
Pfann, W. G., — *Continuous Process for Separating Fusible Materials* — 2,739,046.  
Pfann, W. G. — *Process for Controlling Solute Segregation by Zone-Melting* — 2,739,088.  
Robertson, G. H., and Walsh, E. J. — *Traveling Wave Electron Discharge Device* — 2,740,068.  
Sauer, H. A., see Grisdale, R. O.  
Schafer, J. P., see Hunt, L. E.  
Schramm, E. A. — *Equalizer* — 2,738,465.  
Wallace, R. L., Jr. — *Transistor Amplifiers and Circuit Arrangements Therefor* — 2,739,190.  
Walsh, E. J., see Robertson, G. H.

---

## *Papers Published by Members of the Laboratories*

Following is a list of the authors, titles, and place of publication of recent papers published by members of the Laboratories.

- Ahearn, A. J., and Law, J. T., *Russell Effect in Silicon and Germanium*, J. Chem. Phys., Letter to the Editor, **24**, pp. 633-634, Mar., 1956.  
Anderson, P. W., see Clogston, A. M.  
Arlt, H. G., *Standardization of Materials*, Standards Engineering, **8**, pp. 6-7, Mar., 1956.  
Bashkow, T. R., *DC Graphical Analysis of Junction Transistor Flip-Flops*, Comm. and Elec., **23**, pp. 1-6, Mar., 1956.  
Bennett, W. R., *Synthesis of Active Networks*, Proc. Symp. Modern Network Synthesis, MRI Symposia Series, **5**, pp. 45-61, 1956.  
Bennett, W. R., *Electrical Noise. II—Noise Generating Equipment*, Electronics, **29**, pp. 134-137, Apr., 1956.  
Bommel, H. E., Mason, W. P., and Wainer, A. W., *Dislocations, Relaxations and Anelasticity of Crystal Quartz*, Phys. Rev., **102**, pp. 64-71, Apr. 1, 1956.  
Bozorth, R. M., *Quelques Propriétés Magnétiques, Electroiques Et Optiques Des Films Obtenus Par Electrolyse Et Par Evaporation Thermique*, Le J. De Physique Et Le Radium, **17**, pp. 256-262, Mar., 1956.  
Boyet, H., see Weisbaum, S.  
Clogston, A. M., Suhl, H., Walker, L. R., and Anderson, P. W., *Possible Source of Line Width in Ferromagnetic Resonance*, Phys. Rev., Letter to the Editor, **101**, pp. 903-905, Jan. 15, 1956.  
De Leeuw, K., Moore, E. F., Shannon, C. E., and Shapiro, N., *Computability by Probabilistic Machines*, Automata Studies, Princeton Univ. Press, pp. 183-212, Apr. 1956.  
Eigler, J. H., see Sullivan, M. V.  
Francois, E. E., see Law, J. T.  
Gardner, M. B., *Speech We May See*, Volta Review, **58**, pp. 149-153, Apr., 1956.  
Haynes, J. R., and Westphal, W. C., *Radiation Resulting from Recombination of Holes and Electrons in Silicon*, Phys. Rev., **101**, pp. 1676-1678, Mar. 15, 1956.  
Kleinack, J. J., see Wahl, A. J.  
Law, J. T., and Francois, E. E., *Adsorption of Gases on Silicon Surface*, J. Chem. Phys., **60**, pp. 353-358, Mar., 1956.  
Law, J. T., see Ahearn, A. J.  
Lloyd, S. P., and McMillan, B., *Linear Least Squares Filtering and Prediction of Sampled Signals*, Proc. Symp., P.I.B., **5**, pp. 221-247, Apr. 1955.  
Mason, W. P., see Bommel, H. E.  
McMillan, B., see Lloyd, S. P.  
Mendel, J. T., *Microwave Detector*, Proc. I.R.E., **44**, pp. 503-508, Apr., 1956.  
Merz, W. J., see Remeika, J. P.  
Moore, E. F., *Gedanken-Experiments on Sequential Machines*, Automata Studies, Princeton Univ. Press, pp. 129-153, Apr., 1956.  
Moore, E. F., see de Leeuw, K.  
Remeika, J. P., and Merz, W. J., *Guanidine Vanadium Sulfate Hexahydrate: A New Ferroelectric Material*, Phys. Rev., Letter to the Editor, **102**, p. 295, Apr. 1, 1956.  
Shannon, C. E., see de Leeuw, K.  
Shapiro, N., see de Leeuw, K.  
Suhl, H., see Clogston, A. M.  
Sullivan, M. V., and Eigler, J. H., *Five Metal Hydrides as Alloying Agents on Silicon*, J. Electrochem. Soc., **103**, pp. 218-220, Apr., 1956.  
Turner, D. R., *The Anode Behavior of Germanium in Aqueous Solutions*, J. Electrochem. Soc., **103**, pp. 252-256, Apr., 1956.

Uhlir, A., Jr., *High-Frequency Shot Noise in PN Junctions*, Proc. I.R.E., Correspondence, **44**, pp. 557-558, Apr., 1956.  
 Van Haste, W., *Statistical Techniques for a Transmission System*, Comm. and Elec., **23**, pp. 50-54, Mar., 1956.  
 Van Haste, W., *Component Reliability in a Transmission System*, Elec. Engg., **75**, p. 413, May, 1956.  
 Van Roosbroeck, W., *Theory of the Photomagnetolectric Effect in Semiconductors*, Phys. Rev., **101**, pp. 1713-1724, Mar. 15, 1956.

Wahl, A. J., and Kleinack, J. J., *Factors Affecting Reliability of Alloy Junction Transistors*, Proc. I.R.E., **44**, pp. 494-502, Apr., 1956.  
 Wainer, A. W., see Bommel, H. E.  
 Walker, L. R., see Clogston, A. M.  
 Weisbaum, C., and Boyet, H., *A Double-Slab Ferrite Field Displacement Isolator at 11 KMC*, Proc. I.R.E., **44**, pp. 554-555, Apr., 1956.  
 Westphal, W. C., see Haynes, J. R.

## Talks by Members of the Laboratories

During April, a number of Laboratories people gave talks before professional and educational groups. Following is a list of speakers, titles, and places of presentation.

### AMERICAN ELECTROCHEMICAL SOCIETY, SAN FRANCISCO, CALIFORNIA.

Beach, A. L., see Thurmond, C. D.  
 Biondi, F. J., *Status of Semiconductor Technology*.  
 Guldner, W. G., see Thurmond, C. D.  
 Haring, H. E., see Taylor, R. L.  
 Haynes, J. R., *Radiation Resulting from the Recombination of Holes and Electrons in Silicon*.  
 Law, J. T., *The High Temperature Oxidation of Germanium*.  
 Smith, K. D., see Veloric, H. S.

Taylor, R. L., and Haring, H. E., *A Metal-Semiconductor Capacitor*.  
 Thurmond, C. D., *The Distribution of Copper Between Germanium and Ternary Melts Saturated with Germanium*.  
 Thurmond, C. D., Guldner, W. G., and Beach, A. L., *Hydrogen and Oxygen in Single Crystal Germanium as Determined by Vacuum-Fusion Gas Analysis*.  
 Veloric, H. S., and Smith, K. D., *Design of Diffused Junction Avalanche Diodes*.

### OTHER TALKS

Anderson, J. R., *Ferroelectric Devices and Some Circuit Applications*, R.C.A. Research Laboratories, Princeton, N. J.  
 Anderson, O. L., *The Structure of Inorganic Glass in View of Recent Measurements on Volume Flow*, Brooklyn Polytechnic Institute, Chemistry Symposium, New York City.  
 Anderson, P. W., and Suhl, H., *Nonlinearities in Ferromagnetic Resonance at High Power*, Armour Research Foundation, Relaxation Phenomena in Ferromagnetic Materials Symposium, Chicago, Ill.  
 Baker, W. O., *Materials for Future Electronics*, New England Radio-Electronics Meeting, Boston, Mass.  
 Bangert, J. T., *The Transistor as a Network Element*, A.I.E.E. - I.R.E., Lehigh University, Bethlehem, Pa.  
 Biggs, B. S., *Effect of Air Pollution on Elastomeric Products in the Telephone Plant*, Detroit Rubber and Plastics Group, Detroit, Mich.  
 Budlong, A. H., *Mechanized Intelligence*, Montclair Society of Engineers, Upper Montclair, N. J.  
 Ciccollella, D. F., *The Bell Solar Battery*, A.I.E.E., Salisbury Division, Md.  
 Cioffi, P. P., *Rectilinearity of Electron Beam Focusing Fields from Transverse Component Determinations*, A.I.E.E., Great Lakes District Meeting, Fort Wayne, Ind.  
 Clogston, A. M., *Disorder Scattering of Spin Waves*, Armour Research Foundation, Relaxation Phenomena in Ferromagnetic Materials Symposium, Chicago, Ill.  
 Dillon, J. F., Jr., *Motion of Single Domain Walls in Manganese Ferrite*, American Physical Society, Washington.  
 Fay, C. E., *Ferrite-Tuned Resonant Cavities*, Microwave Properties and Applications of Ferrites Symposium, Harvard University, Cambridge, Mass.  
 Ferrell, E. B., *The Control Chart - Modifications and Extensions*, American Society for Quality Control, Montreal Section, Canada.

Finch, T. R., *Science and Tomorrow's Communications*, Iowa State Science Fair, Cedar Falls, Iowa.  
 Foster, F. G., *Preparation Methods for Materials Microscopy*, Metropolitan Microchemical Society, American Museum of Natural History, New York City.  
 Frost, G. R., *Logic of Switching Circuits*, Queens College, Physics Club, Flushing, N. Y.; and Columbia University, New York City.  
 Ethenakis, E., *A Voltage Regulator Using High Speed of Response Magnetic Amplifiers with Transistor Driver*, A.I.E.E. - I.R.E. - I.S.A., Special Technical Conference on Magnetic Amplifiers, Syracuse, N. Y.  
 Galt, J. K., *Ferromagnetic Domain Wall Motion*, Physics Colloquium, New York University, New York City.  
 Geballe, T. H., *Thermomagnetic Effects in Germanium*, University of Pennsylvania, Philadelphia.  
 Gillo, M. A., *Magnetism in the Perovskite Structure System*, Solid State Physics Seminar, Physics Department, University of Pennsylvania, Philadelphia.  
 Goldstein, H. L., and Lowell, R. J., *Magnetic Amplifier Controlled Regulated Rectifiers*, A.I.E.E. - I.R.E. - I.S.A., Special Technical Conference on Magnetic Amplifiers, Syracuse, N. Y.  
 Gordon, J. P., *The Maser*, I.R.E. Long Island Section, Garden City, L. I.; and Union of Radio Scientific Internationale Convention, Washington, D. C.  
 Hagelbarger, D. W., *SEER - A Sequence Extrapolating Robot*, Seminar on Digital Computers, Joint Student Branch, A.I.E.E. - I.R.E., Polytechnic Institute of Brooklyn, New York City; and A.I.E.E. - I.R.E., Joint Student Branch, Rensselaer Polytechnic Institute, Troy, N. Y.  
 Hamming, R. W., and Rhodes, Mrs. Ida, *General Use of Digital Computers*, General Services Administration Auditorium, Washington, D. C.

## Talks by Members of the Laboratories, Continued

- Hardy, F., *Lubricants and How to Use Them*, A.I.E.E. New York Section, New Jersey Division, Newark.
- Harvey, F. K., *Hearing, Speech and Music*, College Men's Club, Westfield, N. J.
- Haynes, J. R., *Radiation Resulting from the Recombination of Holes and Electrons in Silicon*, Massachusetts Institute of Technology, Physics Department Colloquium, Cambridge, Mass.
- Huyett, Miss M. J., and Sobel, M., *Representativeness of a Sample; Picking the Best of K Binomial Processes; and Comparison of Two Univariate Distributions*, Army Chemical Center, Edgewood, Md.
- Kock, W. E., *Undergraduate Honors – Precursors to Success*, 50th Anniversary Celebration of Cooperative Engineering, Honorary Fraternities, University of Cincinnati, Ohio; and *Polarized Sound Waves*, Physics Colloquium, Brown University, Providence, R. I.
- Kudlich, R. A., *TRADIC – A Transistor Digital Computer*, I.R.E., Akron Chapter, Ohio.
- Landgren, C. R., *Transistors – Their Development and Applications*, John Ericsson Society, Engineer's Club, New York City.
- Lewis, H. W., *Superconductivity*, I.B.M. Watson Laboratory, New York City.
- Lewis, W. D., and Vaughan, H. E., *Electronic Switching and Data Transmission*, American Management Association, Integrated Data Processing Seminar, New York City.
- Loar, H. H., *Semiconductor Developments*, New York Telephone Company, New York City.
- Logie, J. R., Jr., *NIKE I – A Guided Missile System for AA Defense*, A.I.E.E. – I.R.E., Student Activities Day, Eastern District Papers Competition, Rutgers University, New Brunswick, N.J.
- Long, T. R., *The Elastic Constants of Magnesium and Magnesium Alloys*, National Bureau of Standards, American Physical Society Meeting, Washington, D.C.
- Lowell, R. J., see Goldstein, H. L.
- Mauley, J. M., see Rowe, H. E.
- Mattson, R. H., *Properties of Junction Transistors*, I.R.E., Boston Section, Mass.
- McDonald, H. S., *Signal Theory Applied to Speech Processing*, Johns Hopkins University, Electrical Engineering Seminar, Baltimore, Md.
- McKay, K. G., *The Interaction Between Research and Development at Bell Telephone Laboratories*, A.I.E.E. Pittsburgh Section, Pa.
- Mealy, G. H., *Deterministic and Probabilistic Prediction – Their Relation to the Theory of Automata*, Columbia University, Discrete Sequence Transducers Seminar, New York City.
- Millman, S., *How Do Science and Industry View the Secondary School Science Curriculum?*, Ridgewood High School, N. J.
- Monro, S., *Design of Experiments*, Lehigh University, Graduate Seminar, Bethlehem, Pa.
- Morgan, S. P., *Control of Spurious Modes in Multimode Waveguides by Use of Foam Dielectric Inserts*, Union of Radio Scientific Internationale Meeting, Washington, D.C.
- Morgan, S. P., see Young, J. A.
- Paul, C. E., *NIKE I – A Guided Missile for AA Defense*, Sea Explorer Scouts, Ship 20, Livingston, N. J.
- Read, W. T., Jr., *Dislocation Theory*, Maryland Institute of Metals, Baltimore; and *Solid State*, Conference on New Developments in Engineering, University of Pennsylvania, Philadelphia.
- Reiss, H., *Chemical Interactions Among Defects in Germanium and Silicon*, General Electric Company, Knolls Laboratory, Schenectady, N.Y.
- Riesz, R. P., *Mr. Meticulous*, A.I.E.E. New York Section, Communications Divisions, New York City.
- Rowe, H. E., and Mauley, J. M., *General Energy Relations in Non-Linear Inductors and Capacitors*, Non-Linear Circuit Analysis Symposium, Brooklyn Polytechnic Institute, New York City.
- Schroeder, M. R., *Information Theory and Speech*, Siemens und Halske Zentrallaboratorium, Munich, Germany.
- Seidel, H., *Anomalous Propagation in Ferrite-Loaded Waveguide*, Ferrite Symposium, Harvard University, Cambridge, Mass.
- Sharp, W. O., *Submarine Cable Tube*, Royal Arch Masons, Corinthian Chapter, Westfield, N. J.
- Shive, J. N., *The Bell Solar Battery*, Council of Agricultural and Chemurgic Research, Chicago, Ill.; and *Transistors and Solar Batteries*, New York Telephone Company, New York City.
- Sobel, M., see Huyett, Miss M. J.
- Sparks, M., *Chemistry in Modern Communications*, Waynesboro, Sweet Briar, Va; Greensboro, Wake Forest, Kinston, Charlotte, N. C.; Asheville, Columbia, S. C.; and Tallahassee, Lakeland, Gainesville, Fla.
- Suhl, H., *Non-Linear Behavior of Ferrites Under High Peak Powers*, Microwave Properties and Applications of Ferrites Symposium, Harvard University, Cambridge, Mass.; and *Spin-Wave Effects in Ferromagnetic Resonance*, Physics Colloquium, Columbia University, New York City.
- Suhl, H., see Anderson, P. W.
- Tukey, J. W., *Mathematics, Statistics and Computers*, American Statistical Society, Pennsylvania State Chapter, Pennsylvania State University; and *Society for Industrial and Applied Mathematics*, Central Pennsylvania Section.
- Tuthill, W. W., *Some Aspects of Guided Missiles*, Explorer Scouts, Madison, N. J.
- Van Uitert, L. G., *The Dielectric Properties of and Conductivity in Ferrites*, Microwave Properties and Applications of Ferrites Symposium, Harvard University, Cambridge, Mass.
- Vaughan, H. E., see Lewis, W. D.
- Waltz, M. C., *The Time Behavior of Transistors in Useful Circuits*, A.I.E.E., Winston-Salem, N. C.
- Warner, R. M., Jr., *Survey of Transistors for High Frequency Use*, I.R.E. Pittsburgh Section, Mellon Institute, Pa.
- Wilkinson, R. I., *Some Queueing Theory for Engineers*, American Society for Quality Control, Metropolitan Section, N. Y. C.
- Winslow, F. H., *Electrons in Organic Insulators*, American Chemical Society, Philadelphia Section, University of Pennsylvania.
- Young, J. A., and Morgan, S. P., *Helix Waveguide*, Union of Radio Scientific Internationale Meeting, Washington, D. C.