

A network to represent the inner ear

B. P. BOGERT
*Transmission
Research*

As is well known, the ear—acting as a transducer—changes the air pressure variations of sound waves into electrical impulses in the nerves leading into the brain. Not so well known is the exact mechanism by which this conversion is accomplished. The external ear picks up the sound which is then converted into mechanical vibration at the eardrum. These mechanical vibrations are

transmitted by the ossicle bones in the middle ear to the cochlea in the inner ear. The actual conversion of pressure variations into nerve impulses occurs in the cochlea. There are about fifteen thousand nerve fibers connecting the cochlea to the brain, and the pressure variations transmitted to the cochlea by the ossicles produce electrical pulses in some or all of them. It has been

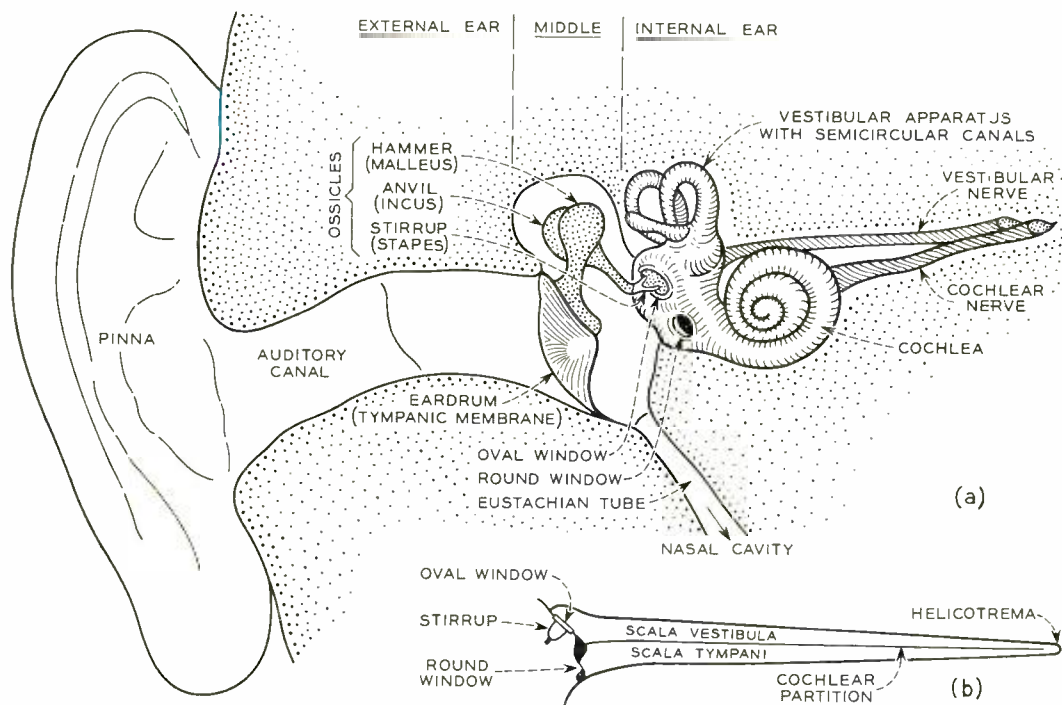

Fig. 1—Cross-section of the human ear.

found that a given fiber reacts more strongly to a certain band of audio frequency sounds than to other frequencies, and that nerves from different regions of the cochlea respond most strongly to different regions of the audio spectrum. These facts support a theory that the cochlea acts as a frequency analyzer — incoming sounds being split into their component frequencies, and the presence (or absence) of the various frequencies being sent on to the brain by different groups of nerves.

The cochlea consists of two tubes, called the scala vestibula and scala tympani, lying alongside each other and separated by the cochlear duct. The tubes are coiled up like a snail-shell, as indicated in Figure 1, and at the tip of the snail-shell, the helicotrema, they are joined together. At the base of the cochlea the scala vestibula is closed by the stapes, the innermost ossicle, while the scala tympani is terminated by the round window — a thin membrane separating the fluid in the cochlea from the air space in the middle

Fig. 3—Front view of the basilar membrane network.

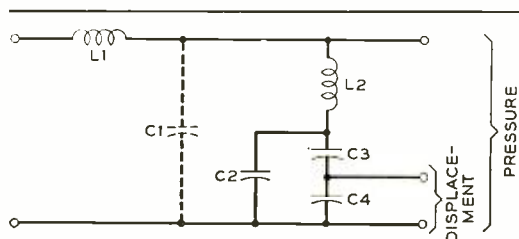
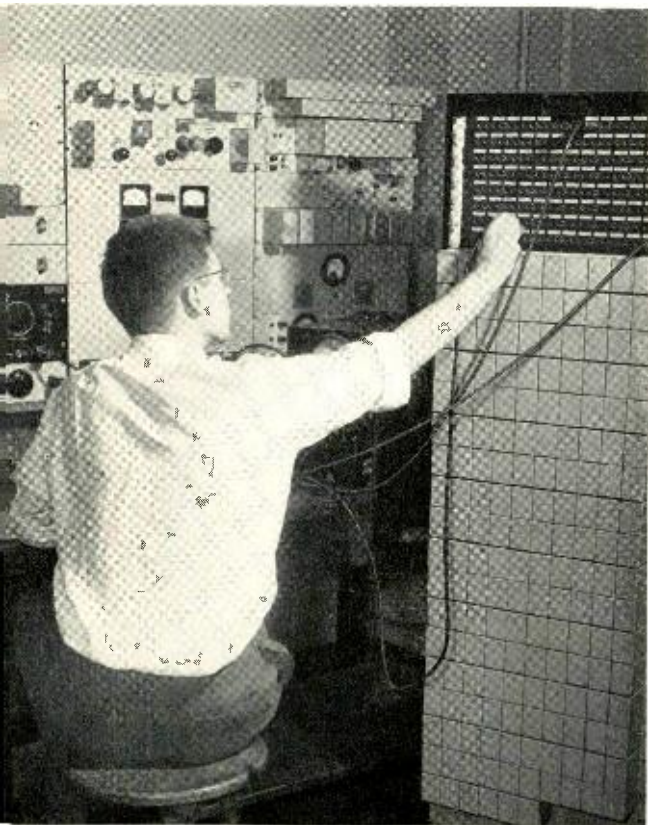

Fig. 2—One of the 175 sections that represent the basilar membrane of the inner ear.

ear. The cochlear duct is filled with a liquid more viscous than that surrounding it, and has, as its most important part, a long narrow basilar membrane comprising one side of it. Imbedded in the basilar membrane are thousands of tiny hair cells from which the nerves emanate. It is believed that motion of the basilar membrane or the pressure difference across the cochlear duct excite the hair cells which send their impulses to the brain. Very delicate experiments have been carried out by G. v. Békésy of Harvard University who showed that in response to audio frequency vibrations of the stapes, the basilar membrane vibrated most strongly in one place along its length—nearer the stapes for higher frequencies and nearer the helicotrema for low tones. This ties in with the observations on nerve fibers referred to previously, since the hair cells near the maximum motion of the basilar membrane would send out the most pulses. Thus the pitch of a tone may be determined by which nerve has the greatest excitation. One unsolved difficulty with such an explanation is that the ear can detect much smaller changes in pitch than can be expected using this explanation and the experimental evidence.

As a method of studying the behavior of the ear, L. C. Peterson of the Laboratories suggested several years ago that the cochlea be represented as two channels filled with water and separated by a series of transverse strings each stretched to a different resonant frequency*. Each string vibrates independently of the others, except for the coupling due to the fluid in the channels on either side. On this theory, several equations were set up which told what the pressures were

*L. C. Peterson and B. P. Bogert, "A Dynamical Theory of the Cochlea," J. Acous. Soc. Am., Vol. 22, No. 3, (May 1950).

in the two channels at different frequencies and gave the amplitude of motion of the various strings.

To simplify the equations, the effects of viscosity in the fluids and other dissipative effects were ignored, and under these conditions, the equations were solved. It was found that the equation which gave the difference in pressure across the basilar membrane could only be solved numerically, and since it involved both the frequency of excitation and the distance along the channels, it would involve great labor to find the solutions for every frequency desired. Because solutions for the pressure difference across and the displacement of the membrane were desired for any frequency, it was decided to construct an electrical network that would, in effect, solve the troublesome equation. In addition, such a network might be useful as a part of a device to give a picture of what happens in the brain when we hear.

The network was designed to make the voltage at each section correspond to the pressure difference that would be found at

the corresponding point of the Peterson model. Although the network is thus not a direct equivalent of the cochlea regarded as a mechanical system, it turned out, as might be expected, that the elements in it were equivalent to physical elements in the cochlea. By suitable choice of some elements, it was also possible to obtain the equivalent displacement of the strings of the model directly from the network. It turns out that the configuration of the network, as constructed, is essentially that given by Wegel and Lane in 1923 as a proposed equivalent circuit of the cochlea*.

The network has 175 sections, each with the configuration shown in Figure 2. Since the cochlea uncoiled is about 35 millimeters long, each section represents a length of one-fifth millimeter. It was felt that 175 sections would be enough to give a reasonable approximation to the smoothly varying properties of the cochlear model. Figure 3 shows

*R. L. Wegel and C. E. Lane, "Auditory Masking of One Pure Tone by Another," *Phys. Rev.*, 1st ser., Vol. 23, Pages 266-285 (Feb. 1924).

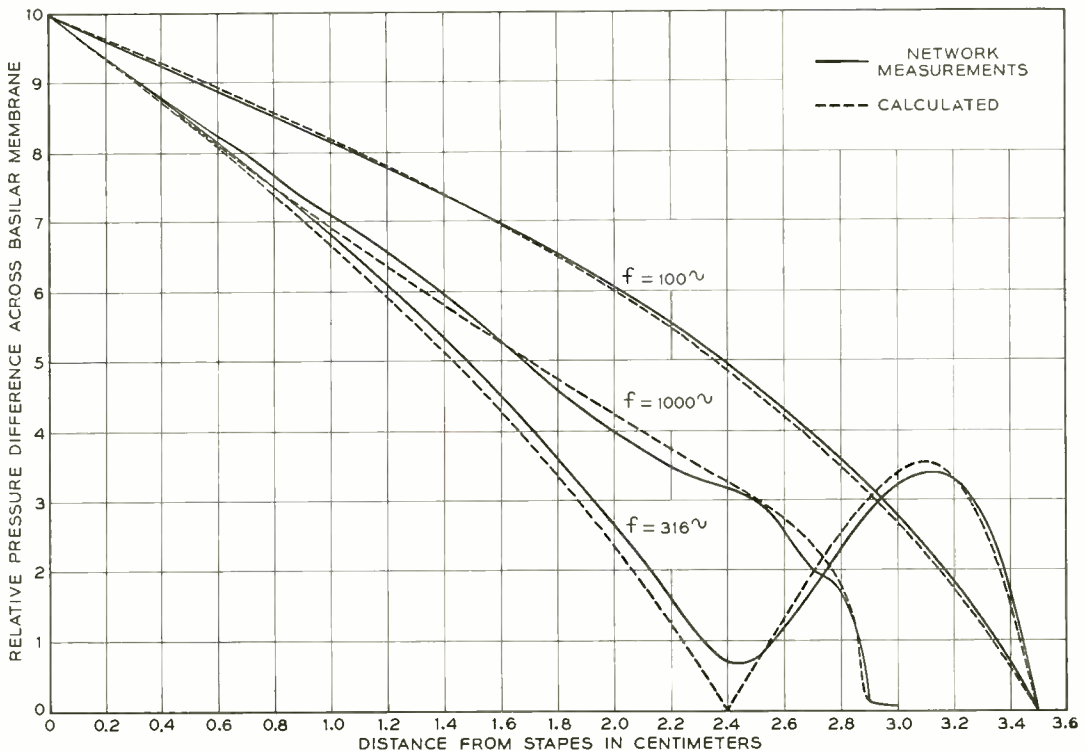

Fig. 4—Response of network in terms of pressure difference across cochlear duct for three frequencies.

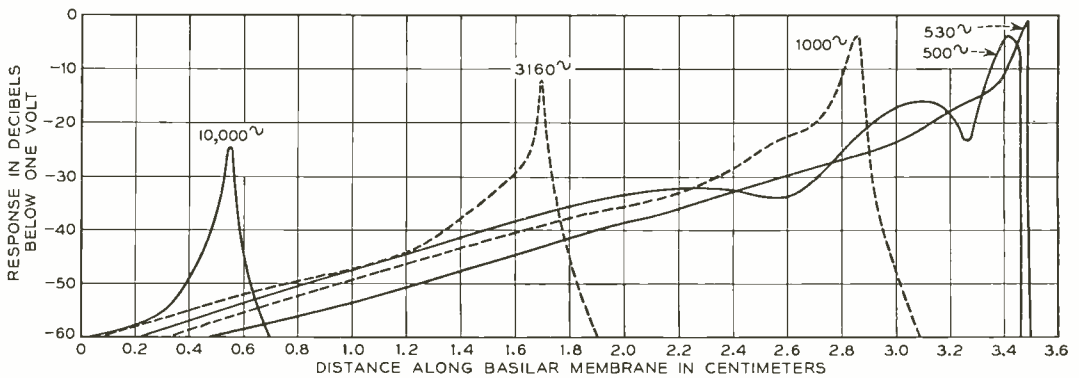

Fig. 5—Response of network in terms of the displacement of the cochlear duct.

front view of the electrical network. The two coils used in each section are in the cans mounted on the front, and the condensers are mounted on strips on the back of the panels. Above the panels supporting the network proper, is a jack field to enable one to measure the voltages corresponding to the displacement of the cochlear duct.

As can be seen from the schematic, the configuration consists of a series inductor L_1 , representing the mass of the fluid in the channels, followed by a series resonant circuit as a shunt element. The inductor L_2 of the series resonant circuit corresponds to the mass of a slice of the cochlear duct, and the capacitors C_1 , C_3 , and C_4 represent the stiffness of the duct. There are three capacitors shown in the resonant shunt to permit the voltage corresponding to the displacement of the cochlear duct to be obtained at the terminals indicated. The level of the voltage corresponding to the displacement is adjusted by C_3 and C_4 , while C_2 brings the total effective capacitance to the proper value. This total capacitance increases from section to section exponentially, and the 175th section has over 1000 times the capacitance of the first. Since L_2 varies slowly (and linearly), the resonant frequencies decrease from 17,400 cycles to 540 cycles at the helicotrema end. The capacitor C_1 , shown dotted, represents the compressibility of the fluid in the channels, but its computed value is a little less than the estimated capacitance of the coils to ground. For this reason it was omitted in the construction. The termination of the network is a short circuit, corresponding to the opening between the two scalas

evident at the rear end of the helicotrema.

How the network behaves can best be seen by a comparison of its response section by section with numerical computations from the original equations. Figure 4 shows the response of the network in terms of the pressure difference across the cochlear duct for frequencies of 100, 316, and 1000 cycles, respectively. The dashed line gives the computations. The comparison between network and equations is good for the lower frequencies. For 316 cycles, the standing wave null is not perfect, but this is not surprising considering the unavoidable losses. For frequencies below 500 cycles, the shunt elements are not resonant, and they behave like capacitors, the closer to resonance, the larger the capacitance. The network offers little attenuation to the exciting wave, which is reflected from the short circuit termination to form standing waves. The curve for 316 cycles also brings out the fact that the wave traveling along the network is progressively slowed down, since the wavelength is progressively longer toward the left. Actually, the velocity drops by a factor of 80 to 1 because of the increasing value of the square root of L/C . At frequencies above 500 cycles, the situation is quite different. Then one of the shunt elements resonates; the wave travels toward the resonant section and is absorbed there.

Figure 4 shows the voltage along the network at a frequency where one of the shunt arms resonates. At a frequency of 1000 cycles, the 144th shunt arm resonates corresponding to a distance of 2.86 cm from the stapes in the cochlear model. To the right

of this point the shunt arms act like inductances, and these sections behave like a ladder attenuator composed of inductances. To the left of the resonant point, the shunt arms act like capacitances, and the sections transmit toward the resonant section. In the cochlear model, this means that there is transmission of the pressure difference wave toward the point where the membrane resonates, and the wave decays rapidly beyond. The cochlear model described supposes that the resonant elements have an infinite Q , while the Q 's of the resonant elements in the network averaged about 50. Even so, comparison between equations and measurements show good agreement. The reason for the ripples in the measured response is unknown, but it is interesting to notice that the ripples have the wavelength that standing waves would have if they existed in the theoretical model at these frequencies. This means that because of the finite size of sections, there is a reflection at their junctions, especially near the resonant one. The reflections set up a standing wave resulting in the ripples.

The response of the network in terms of the displacement of the cochlear duct can be seen in Figure 5, which shows the results for several frequencies. The amplitude of displacement is given in decibels versus the distance from the stapes along the membrane. The theoretical response at the resonant point is infinite, since there is no dissi-

pation in the equation used to represent the cochlear model. Of course, the losses in the network elements round off the peak, but other than this the comparison is good. The ripples present in the measured response of the pressure difference are not so evident as in Figure 5, because of the decibel scale.

It can be seen that as the frequency goes up, the maximum response moves toward the stapes end. The response to the right of the maximum point falls off very rapidly—much more than it falls off to the left. This would mean that at a given point on the membrane the response falls off with increasing frequencies faster than with decreasing frequencies. Qualitatively, this agrees with the results of auditory masking experiments, which show that a tone of higher frequency than a given one interferes less than does a tone of lower frequency. Comparison of these deflection curves with ones measured on the actual cochlea show that the cochlea has a great deal of damping and the resonances are quite broad. To solve the equations of the theoretical model involving damping would require much more effort than adding 175 resistances in the shunt arms of the network sections, and then making measurements. The measured response probably would agree more closely with the calculated response with dissipation added than it does at present, and also it would probably correspond more closely to the measurements on the actual cochlea.

THE AUTHOR: B. P. BOGERT received a B.S. degree in Physics from the Massachusetts Institute of Technology in 1944 and was a staff member at the M.I.T. Radiation Laboratory until V-J day. He then entered the graduate school of the Institute from which he received his doctorate in Mathematics in 1948. Since then he has been in the Transmission Research Department to engage in acoustic research.



Walter S. Gifford

Named Ambassador

Walter S. Gifford, retired head of the Bell System, was appointed Ambassador to Great Britain on September 27 by President Truman. He succeeds Lewis W. Douglas, who served at the Court of St. James's for three and one-half years. Mr. Gifford has been honorary chairman of the board of directors of the AT & T since January 1 of this year, when he retired from active telephone service.

Mr. Gifford's appointment to what is considered the most important ambassadorial post in the diplomatic service marks the beginning of another chapter in his long career of public service. Shortly before the U. S. entered World War I, he was named Supervising Director of the Commission on Industrial Preparedness, an agency of the Naval Consulting Board. Under his direction a census was made of the resources and potential war production effectiveness of 27,000 industrial establishments. Appointed executive director of the Council of National Defense in 1917, he held that post throughout the war and in July, 1918, went to Paris to assist in the establishment of the Inter-Allied Munitions Council.

Continuing his interest in the public welfare, Mr. Gifford was especially active during the decade preceding World War II. During the winter of 1931-32, he served as Director of the President's Organization on Unemployment Relief and in 1933 was appointed a member of the Business Advisory Council for the Department of Commerce. In 1939, when the shadow of war was already falling on the U. S., he was named to the War Resources Board. During and after World War II, he was Chairman of the Industry Advisory Commission of the Board of War Communications. For his achievements in this capacity, President Truman awarded him the Medal for Merit. The citation accompanying the award stated that his leadership was "an inspiring force that helped immeasurably in the guiding of his organization as a part of the Army of Democracy."



Mr. and Mrs. Walter S. Gifford at home.

In addition to his government service, Mr. Gifford has long been active in welfare work. He has served since 1939 as chairman of the board of trustees of the Community Service Society, largest voluntary non-sectarian family and health agency in New York City, and in 1948 was presented a scroll by the Society in recognition of his "leadership in the crusade for human welfare." In 1943 he was national chairman of the American Red Cross War Fund campaign. He is also a director of the Greater New York Fund and in 1949 was cited for his work with that organization.

Mr. Gifford rose from payroll clerk with Western Electric to the top position in the Bell System in 21 years. Entering the organization in 1904, after his graduation from Harvard, he became assistant secretary and treasurer of Western in two years. He joined AT & T in 1908 and was appointed chief statistician three years later. Returning from war service late in 1918, he was appointed comptroller and became a vice president the following year. In 1925, Mr. Gifford was elected president of the AT & T, a position he held until 1948, when he was appointed chairman of the board.

Mr. Gifford's appointment as ambassador, which is subject to Senate confirmation, is effective on an interim basis until Congress reconvenes in November.

A precise decade oscillator

C. H. YOUNG
*Transmission
Apparatus
Development*

Development and manufacture of vibrating reed selectors* presented a problem in generating the desired frequencies with the required precision and stability. Since the operating frequencies for this system are odd multiples of $7\frac{1}{2}$ cycles in the range from about 350 to 850 cycles (later extended to about 2200 cycles for special studies), it is difficult to compare them accurately with the regularly supplied standard frequencies, by means of the oscilloscope. Furthermore, direct reading oscillators such as the film scale heterodyne or the commercial resistance-capacitance tuned types do not possess the stability or precise adjustment characteristics required for reed testing over the narrow

tor using a modified Wien bridge control circuit, provides a relatively simple, yet precise and stable oscillator that overcomes the disadvantages of the heterodyne method. The frequency is determined by the constants of the bridge and these can be made adjustable by using the familiar decade principle employed in resistance and capacitance standards.

In the Wien bridge control circuit shown in Figure 1, the balance relation is

$$f = 1/2\pi RC$$

If the resistance R and capacitance C are expressed in terms of their reciprocals, conductance c and elastance s , then the equation becomes

$$f = (1/2\pi)(cs)$$

From the standpoint of maintaining the impedance presented to the generator E at a constant value over the frequency range, adjustment of the elastance s is preferable. Due to switching complications and bulkiness of the required capacitors, however, it is much simpler to vary the conductance c . Satisfactory switches for "ganging" conductances are readily available and conductance elements of the required precision may be obtained without great difficulty. The effect of the variable impedance of the bridge as well as its phase angle, may be

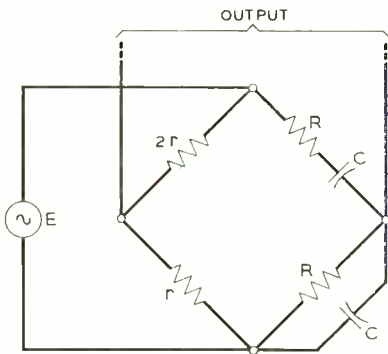

Fig. 1—The Wien bridge control circuit.

frequency bands in the region of resonance.

Low-frequency oscillations are usually obtained by heterodyning two high-frequency oscillators. There are some disadvantages in this method, however, because small percentage changes in the frequency of one oscillator will produce a relatively large percentage change in the heterodyne frequency; besides, the calibration is not constant and must be checked frequently.

The resistance-capacitance tuned oscilla-

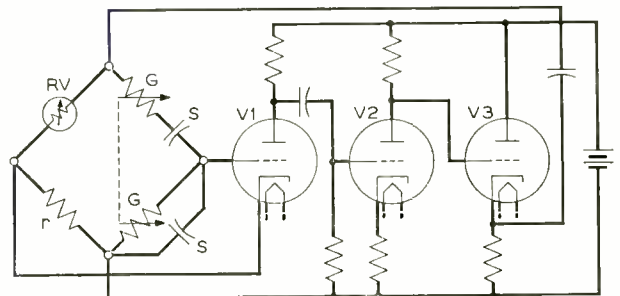

Fig. 2—The modified Wien bridge control circuit and two-stage amplifier.

*RECORD, January, 1950, page 2.

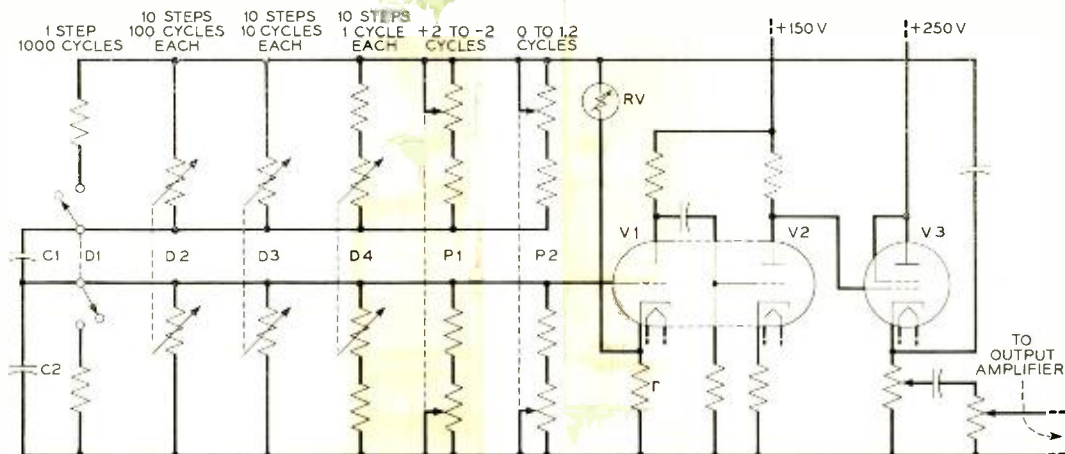

Fig. 3—Schematic diagram of the bridge controlled oscillator circuit.

overcome to a large degree by making the impedance of the source E small as compared to the minimum bridge impedance.

In a bridge controlled oscillator, the amplifier should have a phase shift of some multiple of 360 degrees and the maximum gain consistent with noise and phase transient disturbances. In the circuit of Figure 2, these requirements are met by a two-stage amplifier, which is succeeded by a cathode follower serving as the impedance transformer coupling the amplifier output to the frequency controlling bridge. The oscillation level is controlled by the thermistor rv in one of the bridge arms, this thermistor having a characteristic that automatically maintains the bridge *nearly* but *not exactly* in balance. It is apparent that the greater the amplification provided by the amplifier, the smaller the output required from the bridge and hence the nearer the bridge will oper-

ate at exact balance. Thus, the higher the degree of amplification, the more effective the bridge will be in controlling the oscillation frequency. There are some practical considerations, however, tending to limit the degree of amplification that can be utilized; one of these is response to transients arising from switching disturbances. The intrinsic stability of capacitors and conductance elements do not appear to justify a voltage gain much greater than 65 db.

In the oscillator circuit of Figure 3, the bridge capacitance elements are 0.0398 microfarad silvered mica capacitors having very high "Q" factors and low temperature coefficients. The frequency adjusting elements comprise three dual decade conductances D_2 , D_3 , and D_4 , and two continuously adjustable dual controls overlapping the lowest decade. The decade controls adjust the conductances in each bridge arm in steps



THE AUTHOR: C. H. Young received the degree of B.S. in Electrical Engineering from the University of Michigan in 1927. He at once joined the Technical staff of the Laboratories, where, with the electrical measurements group of the Transmission Apparatus Development Department, he has engaged in the development of precise impedance measuring equipment. Since 1941 Mr. Young has been associated with the electronic measurements group with which he has been concerned with the development of signal generators and detectors.

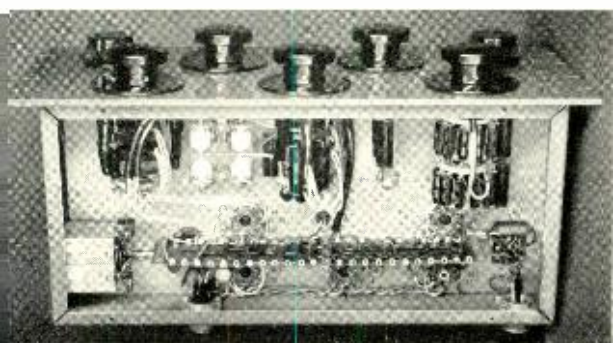

Fig. 4—Top, front view of decade oscillator; center, rear view; and bottom, decade switch assemblies and control capacitors on the underside of the chassis.

of 25, 2.5, and 0.25 micromhos, giving frequency steps of 100, 10, and 1 cycle respectively. The continuous controls have ranges of 1 and 0.3 micromhos, giving frequency ranges of ± 2 cycles and 0-1.2 cycles respectively. In addition to the adjustable controls, a single step dual control of 250 mi-

crohmhos, 01, may be used to add 1000 cycles to the frequency indicated on the dials.

To obtain the 10-decade steps on the 100-cycle and 10-cycle dials, each of two switch wafers combines four conductance elements. The 1-cycle dial uses two simple 11-point wafers, each successively cutting out 10 resistors that are in series with much larger resistors. Dual rheostats of 10,000 ohms each operating in series with larger resistors provide the continuously adjustable ranges. The combined residual conductance under control of the two continuously variable dials plus the 1-cycle dial, is made 25 micromhos to establish the minimum frequency of 100 cycles; hence the "zero" step of the 100-cycle dial is indicated as 1. The over-all range is from 100 to 2212 cycles. Precision wire wound resistors are used throughout the bridge to provide minimum temperature and aging characteristics.

A phase inverter and push-pull feedback amplifier follows the oscillator section, with transformer coupled output for a 500-ohm load. Maximum power output is approximately 1 watt, and the total distortion is less than 0.5 per cent, mainly second and third harmonic components.

After an initial warmup period of about one hour, the oscillator will have a frequency accuracy of $\pm (0.02 \text{ per cent} \pm 0.02 \text{ cycle})$. If one of the continuously adjustable dials is used to adjust the frequency to the exact value indicated by the remaining dials, by comparison with a frequency standard, the accuracy then approaches the actual values shown on the dials—as close as 0.01 cycle over a range as close as ± 5 cycles. This feature is especially useful for accurately interpolating between calibrated frequencies which may be separated by several cycles.

Although developed especially for use with the vibrating reed selectors, this oscillator has found other useful applications. In the fundamental material studies of the reeds themselves, the oscillator has proved to be a valuable tool. It has also found application in determining frequency drift in low-frequency oscillations obtained by heterodyning two high-frequency oscillators.

Register and sender testing in No. 5 crossbar

W. H. SCHEER
*Switching
Systems
Development*

A number of features are included in a No. 5 crossbar office to insure that the occasional faults arising from the continual operation of electromechanical apparatus over long periods of time will not cause repeated failures in establishing connections. These include self-checking features in the marker that test for open and crossed circuits on each call it handles, the automatic monitor¹, and a trouble recorder² that makes a punched card record of the nature and location of troubles reported to it. They are located at a maintenance center³, with a number of other test circuits and facilities

¹RECORD, August, 1950, page 343; ²May, 1950, page 214; and ³July, 1950, page 313.

that are used as required. In addition to these various facilities, provisions have been made for testing registers and senders. The test facilities are combined with the monitor circuit and much of the equipment is used in common. The control of the test circuit is at the maintenance center.

Since the marker's checking features and the automatic monitor keep a continual watch on the behavior of registers and senders, the register and sender test circuit is not made automatic in its initiation of tests, but is under control of the maintenance force at the maintenance center. They use it as varying conditions require. A trouble record on a register or sender, for example,

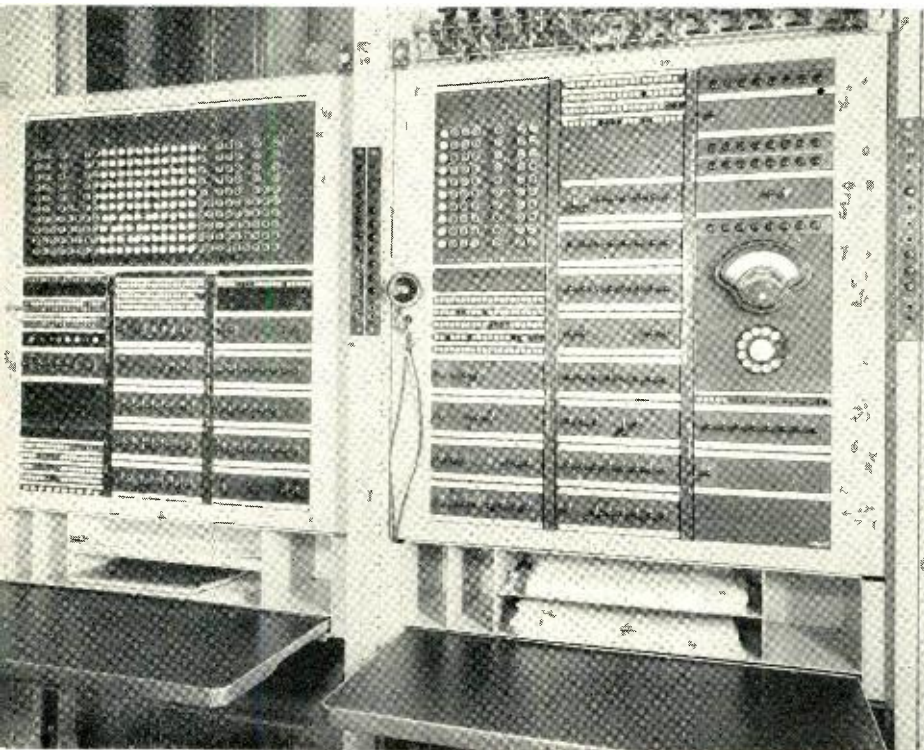

Fig. 1 — Positions at the maintenance center used for controlling the register and sender test circuit.

might indicate that certain registers or senders should be tested.

When a test is to be made, the test conditions are set up on keys on the panels shown in Figure 1. This would indicate to the circuit the number to be called, the particular register or sender to be tested, the method of pulsing, and the type of line or trunk calling. Once these conditions have been set up, the operation of a start key sets the circuit in operation. The tests are run through automatically by the test circuit, and the progress of the test is indicated by lamps. If the call goes through successfully, an OK lamp is lighted, while if trouble is encountered, lighted progress lamps will indicate the stage of operation at which it occurred. Under certain conditions, the trouble recorder is called in to make a record of the conditions found.

In running through its tests, the test circuit calls in a marker to establish connections through the line link and trunk link frames, and to select registers, senders, or trunks in the same general manner as for service calls. The major difference is that the marker may be required to select a particular register or sender rather than any idle one, and that the marker is informed it is handling a test call and will act accordingly. In addition to its other tests, the register and sender test circuit checks the recording of pulses by the register and the outpulsing by senders, and where the work is similar, it uses corresponding elements of the automatic monitor. To provide a margin of safety, all pulsing tests are more severe than encountered on service calls.

The various circuits called into action in testing an originating register are indicated in Figure 2. In each office there is a line link vertical to which the register and sender test circuit has access, and after the test conditions have been set up and the start key operated, a marker is seized and this line location and the particular originating register desired is transmitted to it. The marker then establishes a connection through the line link and trunk link frames to the desired register, operates relay *M* in the register, and then disconnects. Relay *M* connects the register to a set of test leads from the test circuit that is multiplied to all the registers in the office. In this way there is established

a circuit through a line link and trunk link frame to the register and back to the test circuit as indicated by the solid lines in the diagram. Over this circuit the various test conditions are applied. Following this, the register seizes a marker to transmit to it the number pulsed into the register from the test circuit. The marker, recognizing that this is a test call, establishes a connection to the test circuit, over the master test frame connector, so that the digits and other in-

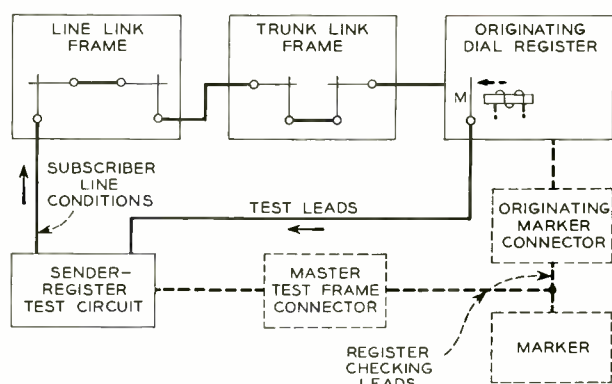

Fig. 2—Block schematic of circuits brought into action in testing originating registers.

formation transmitted to the marker can be recorded in the test circuit and checked against the information transmitted to the register. If the information were not properly recorded by the register and transmitted to the marker, the trouble recorder would be called in to make a record. Other troubles will be indicated by lamps. If all tests are satisfactorily completed, the OK lamp will light and the connection will be broken down.

For testing senders, the circuits employed are those indicated in Figure 3. Following an initial procedure similar to that described above, a marker is seized and establishes a connection to the desired trunk and selects the desired sender, and the trunk connects to the sender through the sender link. Relay *TR* is operated in the trunk to transfer the *T* and *R* leads of the trunk from the circuit to the distant office to the test circuit. Relay *M* in the sender is also operated to connect the sender to the test circuit over a special set of leads as was done for the originating

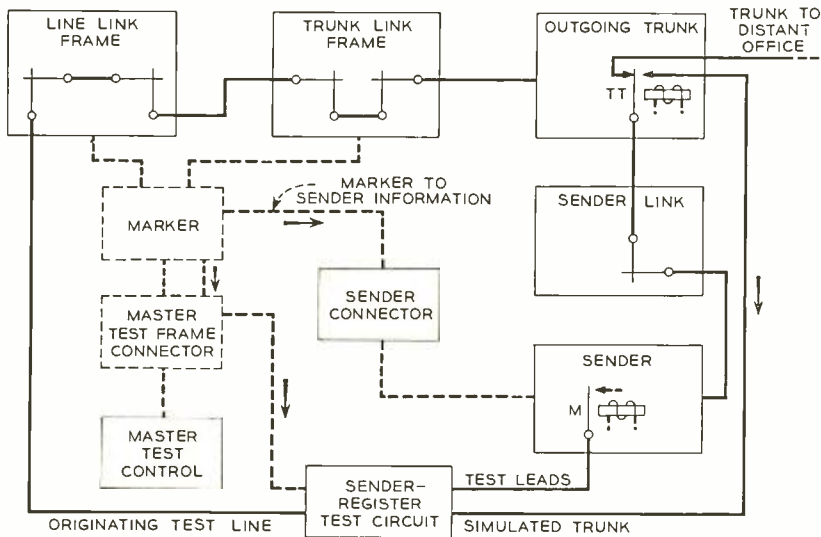

Fig. 3 — Block schematic of circuits used in testing senders.

register. Outgoing pulsing information is then transmitted to the sender by the marker and is received by the test circuit through the master test frame connector. After this, the control circuit shown by the dotted lines is released. The sender test circuit then applies various tests to the sender, records the pulses sent out by the sender, and checks the results against the known information. Pulsing troubles result in a trouble record card. Other types of troubles will be indicated on lamps.

Figure 4 illustrates in a similar way the connections established for checking incoming registers. The marker is not used for establishing the connection, but a preference circuit within the test circuit secures access to the desired register through the incoming

register link circuit. The test circuit applies the desired test, and the register then calls for a marker. Recognizing this as a test call, the marker stops progress, calls in the master test frame connector, and permits the test circuit to record all the information the register is transmitting to it. This connection, shown by the dotted lines, is established only momentarily. The test circuit then matches the register results against the known information, and gives an OK lamp if everything is satisfactory, a trouble card on pulsing failure, or a trouble lamp on other types of trouble.

The relays, amplifiers, resistances, and other circuit elements are mounted on standard frames. One frame is used for the monitoring apparatus, and a double frame

THE AUTHOR: W. H. SHEER majored in mathematics and physics at Doane College, and after graduating with an A.B. degree in 1929, at once joined the Technical Staff of the Laboratories with the Systems Development Department. He has worked on panel tandem, step-by-step switching, dial pulse repeaters, and relay problems. During the war he engaged in military developments, but returned to Systems Development to work on the circuit design of senders, registers, and associated test equipment for the No. 5 crossbar system.



for the test equipment used for all registers and senders employing dial or multifrequency pulsing. An additional frame is required when revertive pulsing or call indicator pulsing is required. The keys for controlling the tests and lamps for indicating the progress and results of the tests are mounted adjacent to the master test control circuit keys and lamps as shown in Figure 1. The monitor register and sender test apparatus is shown on the middle panel of the right-hand frame. The progress lamps are located at the top of the panel with the control keys grouped according to their general functions.

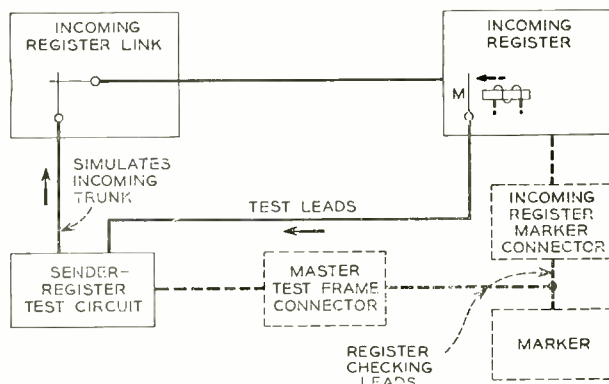

Fig. 4—Block schematic of circuits used in testing incoming registers.

Stock Expansion Voted

The Board of Directors of the American Telephone and Telegraph Company have voted to recommend to stockholders an increase in the authorized capital stock of the Company from 35 million to 45 million shares; authorization of a new issue of convertible debentures in an amount not to exceed \$435,000,000 and approval of a new Employees' Stock Plan, under which up to 3,000,000 shares of stock may be sold to employees of the Company and its subsidiaries. A special meeting of the stockholders to vote on the recommendations will be held November 15.

The Company pointed out that while the quantity and over-all quality of telephone service are now at an all time high, much remains to be done to meet the heavy demand. Expenditures for new construction are running at a rate of nearly a billion dollars a year. There are still 800,000 people waiting for telephones, and 1,700,000 customers now on party lines have asked for higher classes of service. The Company also pointed out that it must continue to be fully prepared to meet demands arising out of the present national defense emergency.

Depending on continuance of the demand for service and the amount of new money received from the conversion of presently outstanding convertible debentures, it is expected that further financing will be

necessary some time during the first six months of 1951. The Company said that as new capital becomes needed it should come for the most part from the further issuance of stock, either through debenture conversions or otherwise. Authorization of the convertible debenture issue is being recommended at this time in order that the Company may be in a position to proceed with such an issue if the Board of Directors should determine that this type of financing is best suited to meet conditions at the time when new money is needed. The issue would be offered to stockholders.

The convertible debentures, if issued, would be offered to stockholders in proportion to their holdings of stock.

The new Employees' Stock Plan would make it possible for the Company to make additional offerings of stock to employees at such time or times as the Board of Directors determines. Employees have purchased or elected to purchase all of the 2,800,000 shares authorized in 1946. Terms of the new plan would be substantially the same as those of the 1946 plan under which stock was offered to employees on an installment basis at a price \$20 below market but not more than \$150 per share nor less than \$100 per share. As was the case under the 1946 plan, officers of AT & T would not be eligible to participate.

Recent improvements in the telephone clock

R. S. MELSHEIMER
*Transmission
Apparatus
Development*

For nearly ten years, the precision display clock in one of the Broadway-windows of the A T & T building at 195 Broadway has furnished accurate time service to the hundreds of thousands of people who pass the window daily. Affectionately known as "Mac,"* it does not deviate by as much as a twentieth of a second from Naval Observatory time. Its accuracy is maintained by operating the clock motor from sixty-cycle constant-frequency current supplied by the Laboratories through the Long Lines Department of A T & T, and by checking the clock every fifteen seconds with the New York Tele-

*"Mac" is a name coined by newspaper writers, and means "Most Accurate Public Clock."

phone Company's Time Bureau, as previously described.†

In the past few years a number of suggestions for improving the general window display have been offered, and last fall the clock was taken out of service to permit some of the suggested improvements to be made. The major suggestion adopted was to install an audible device to indicate the moment when the second hand of the clock passes over the 15-, 30-, 45-, and 60-second marks on the clock face. This enables a person to set his watch easily and accurately without the necessity of trying to look at the clock face and his watch at the same time.

†RECORD, March, 1940, page 209.

Fig. 1—"Mac" in the A T and T window at 195 Broadway.

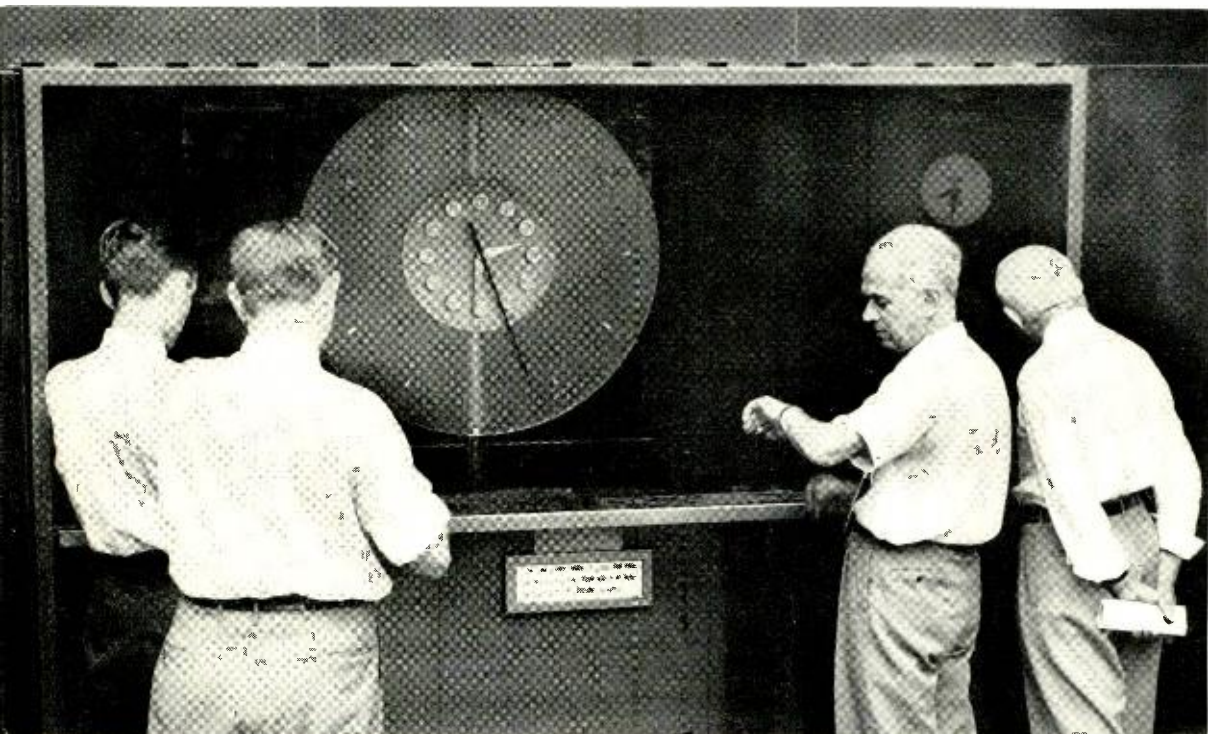

The source of the tone is a simple 800-cycle push-pull oscillator that delivers about one-half watt of power. The output is approximately a square wave which produces a tone in the loudspeaker rich in odd harmonics. Experiment indicated that this type of tone, not unlike that of a clarinet or other wood-wind instrument, serves to call the attention of the mind to the presence of the tone more rapidly than that of a pure sine wave. The oscillator receives both its heater and plate power directly from the 48-volt battery of the local PBX so that the necessity for a separate power supply is eliminated.

The start of the tone at the 15-second intervals is synchronized with the second hand of the clock through the system of relays which compares the time indicated by the clock with the pulses received from the Time Bureau. This circuit in simplified form is shown in Figure 2.

At each quarter-minute interval a pulse is received from the Time Bureau which energizes a relay to close a pair of contacts for approximately one-half second. At the same time the action of a cam rigidly mounted on the same shaft with the second hand of the clock energizes a second relay which closes another pair of contacts for approximately

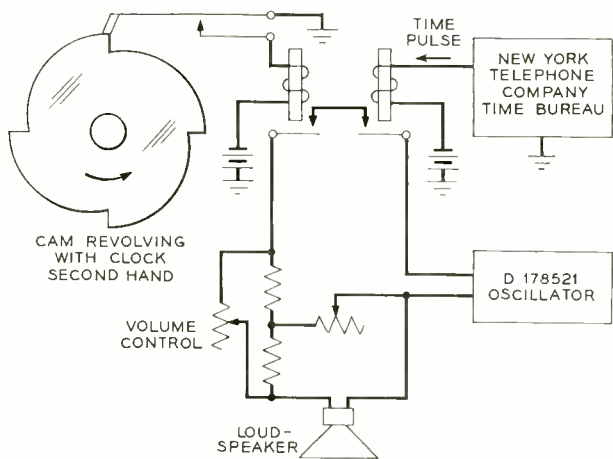

Fig. 2—Circuit through which the half-second tone is applied to the loudspeaker.

seven and one-half seconds. By arranging the two pairs of contacts in series, the tone circuit is completed and the tone is initiated at the proper moment if the clock is in synchro-

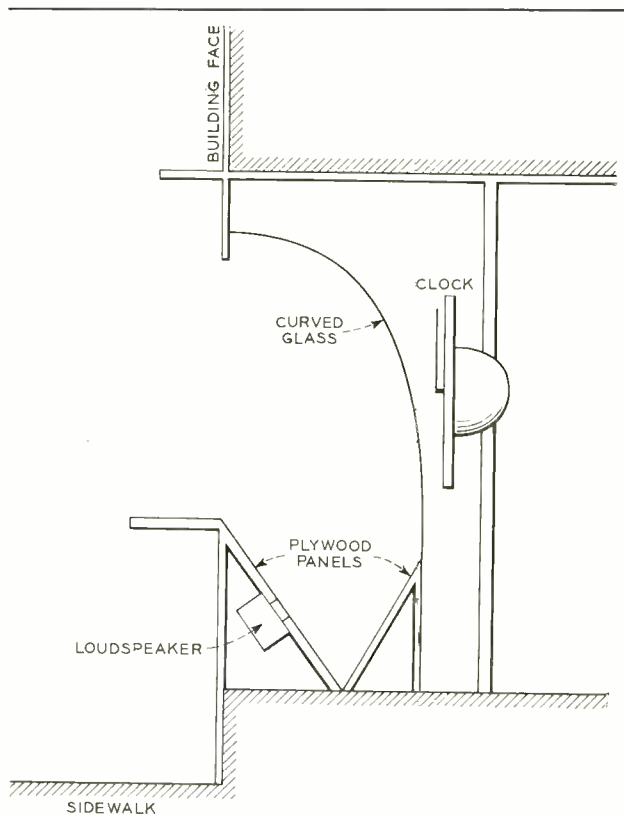

Fig. 3—Cross-section of window showing relative positions of clock, loudspeaker and curved glass.

nism, and continues until the Time Bureau relay releases at the end of one-half second. If the clock is out of synchronism by more than one-twenty-fifth of a second, an auxiliary motor in the clock is energized by additional relay circuits to correct the position of the second hand. Tone is removed from the system should the clock stop for one reason or another, or should the pulses fail to arrive from the Time Bureau.

The loudspeaker is a completely sealed and moisture-proof unit developed during the war, and intended especially for outdoor installations. It is concealed behind a panel on the street side of the window glass in such a position that the curved glass of the window directs the sound toward persons standing in the immediate vicinity of the window opening. The arrangement is illustrated in Figure 3.

An attenuator pad is located at the window to permit regulating the volume of the tone to override the noise level of passing

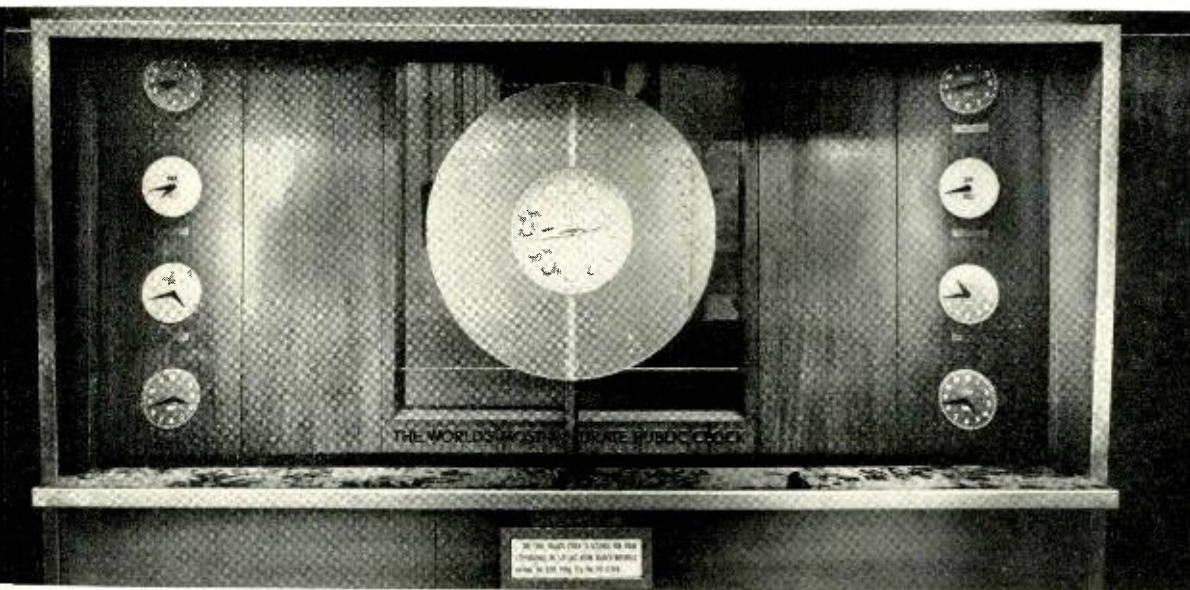

Fig. 4—The face of the Clock was sand blasted to produce a frosted effect.

traffic. From 0 to 18 db of attenuation is provided in 2-db steps with an additional step of infinite attenuation. It was found that the maximum output of the oscillator of one-half watt provides more than ample volume at the speaker under all conditions. The normal setting of the attenuator for average street noise level is about 10 db down from maximum output level.

Another improvement made in the window display is the installation of the curved glass window, mentioned above, to minimize the reflections which heretofore had caused difficulty in reading the clock at times. Also, the back of the clock face was sand blasted

to produce a frosted effect, as shown in Figure 4, and the plywood paneling at the bottom of the window was covered with heavy black velvet, again to minimize reflections. Fluorescent lamps were installed adjacent to the "world-wide" clocks.

These "world-wide" clocks are a group of eight arranged four on either side of the precision display clock. They are adjusted to indicate the local time in eight different cities within reach of long distance telephone throughout the world. Their accuracy is checked once each minute, but since they do not have second hands, they cannot be read to better than half a minute.

THE AUTHOR: R. S. MELSHEIMER attended Ohio State University from 1941 to 1943. He then entered the Armed Forces. After basic training at Fort Benning, he spent a year in the Army Specialized Training Program at the University of Pittsburgh and at Penn State. He was then assigned to the Army Ordnance Department at the National Bureau of Standards where he assisted in the development of testing equipment for laboratory and production testing of the proximity fuse. Following the war he returned to Ohio State from which he received the B.E.E. degree in 1947. He immediately joined the Laboratories and since then has been with the transmission measuring apparatus group working on the development of oscillators and detectors.



Bell Laboratories Record

Portable public address system for lecturers

Because Bell System lecturers must speak in rooms of a wide range in size, and in many cases, having no amplifier already available for the speaker, a small portable public address system has been developed by C. D. Hanscom of Publication, Serving as consultants in this work were the Audio Facilities and the Station Instrumentalities Groups. The new system has been given the title of Lecture Aid No. 14.

This equipment is completely housed in a suitcase 32-in. long, 20-in. deep, and 10-in. thick, and weighs only 49 pounds. Two Western Electric 755A (8-in.) loudspeakers are mounted in the case, the case itself acting as the speaker enclosure. Carried in the case until the system is ready for use, are a 16 watt amplifier, connection and control box (mixer panel), phonograph record player, and the necessary cables. Since speakers' tastes differ, no microphone is supplied, but a crystal lapel type is ordinarily used.

A number of contradictory problems were met and solved in the development of this equipment. It must be inexpensive; because it is portable, the weight must not exceed 50 pounds; quality of reproduction must be at least equal to that of any reasonably portable public address system commercially available, even though having high maximum volume—actually up to the full power rating of the two loudspeakers. High gain is necessary because of the relatively weak inputs from some lecture aids; it must handle several inputs at once, and be capable of matching any required input impedance. Individual and master volume controls are also necessary to facilitate switching between demonstrations. Within limitations imposed by these requirements, the equipment must be rugged and reliable.

The record player provides satisfactory quality with the ordinary 78 r.p.m. commercial records. For the mixer, four input jacks are provided in a box 7-in. long, 4-in. wide and 2-in. deep. There are separate volume controls for each input, and a master control for all four. In addition, the box has

a socket in each input circuit into which a small impedance matching transformer can be plugged, so that any input impedance can be matched by each of the four inputs. The amplifier circuit is similar to that of the Western Electric 124-D amplifier, but is modified to increase gain and to limit the weight to 10 pounds. It is equipped with a second master volume control that may be set to bring the mixer control to a convenient middle position. Treble and bass tone controls are also furnished. Power output is 16 watts and the frequency response rises slightly from 50 cycles to frequencies at the limit of the audible range.

To bring the story of telephone developments and service to the public, Bell System lecturers give about 10,000 talks per year. It was principally for these lectures that the portable public address system was developed. These systems are supplied to Bell System Associated Companies on order in the same manner as other lecture aids.



Optimum Coaxial Lines

PHILLIP H. SMITH
*Military
Electronics*

Developments in communication facilities during the past decade have extended the upper frequency limit and bandwidth requirements of the associated transmission and distribution systems to the point where conventional multi-conductor cable and open-wire line is completely inadequate. The coaxial type of transmission line^{*} and associated equipment, in the development of which Bell Telephone Laboratories has played an important part, provides a means whereby the transmission characteristics needed for these higher frequencies are secured.

In a broad sense, the coaxial transmission line is a type of electromagnetic waveguide—other types being represented by the ordinary two-wire line commonly used for audio frequencies and the tubular metallic waveguide† for ultra-high frequencies. The coaxial transmission line is, however, a very important type of waveguide because it has application over an extremely wide frequency range and because it possesses a number of very desirable properties. Among these are its relative freedom from radiation and crosstalk, and the independence of its circuit constants of weather conditions.

Upon closer analysis of the behavior of a coaxial transmission line, one discovers that the ratio of the inside diameter, D , of the outer conductor to the outside diameter, d , of the inner conductor, which may briefly be referred to as the diameter ratio, is an important factor in the attainment of optimum results. It has long been known, however, that there is no single ratio that is best for all applications in the communication field but, on the contrary, there are perhaps a dozen or more different ratios that are

optimum for specific applications. The characteristics of a coaxial line, and the relationships between its various characteristics and the diameter ratio, will, of course, vary with the dielectric used between the conductors. For air and other gases at atmospheric pressure, the dielectric constant is approximately unity, and for the following discussion a dielectric constant of unity is assumed. A different set of relationships would apply to coaxial lines employing continuous solid inter-conductor insulation whose dielectric constant differs appreciably from unity.

One of the most important and fundamental parameters of the coaxial line is its "characteristic impedance," and this is directly related to the diameter ratio. The relationship is shown at (a) of Figure 1. This is the impedance that one would measure at the input terminals of a line if it were of infinite length. Maximum characteristic impedance of a coaxial line is obtained when the conductor diameter ratio (D/d) is infinity, and minimum impedance when the ratio is unity.

Which diameter ratio will be best for any particular application, however, is commonly determined by some other characteristic that also varies with the diameter ratio. How these other characteristics vary with the diameter ratio are shown by the curves of Figure 1.

If one wishes to transmit a small amount of energy over long distances with minimum attenuation, such as when transmitting a television program over coaxial cable from one city to another, the best conductor diameter ratio is 3.592. This can be seen from the dashed curve of (b). The diameter ratio 3.592 also coincides, as shown at (c), with maximum Q for a resonant section of coaxial transmission line, which might be used, for example, to stabilize the frequency

^{*}RECORD, November, 1946, page 393.

†RECORD, March, 1943, page 194; and May, 1936, page 283.

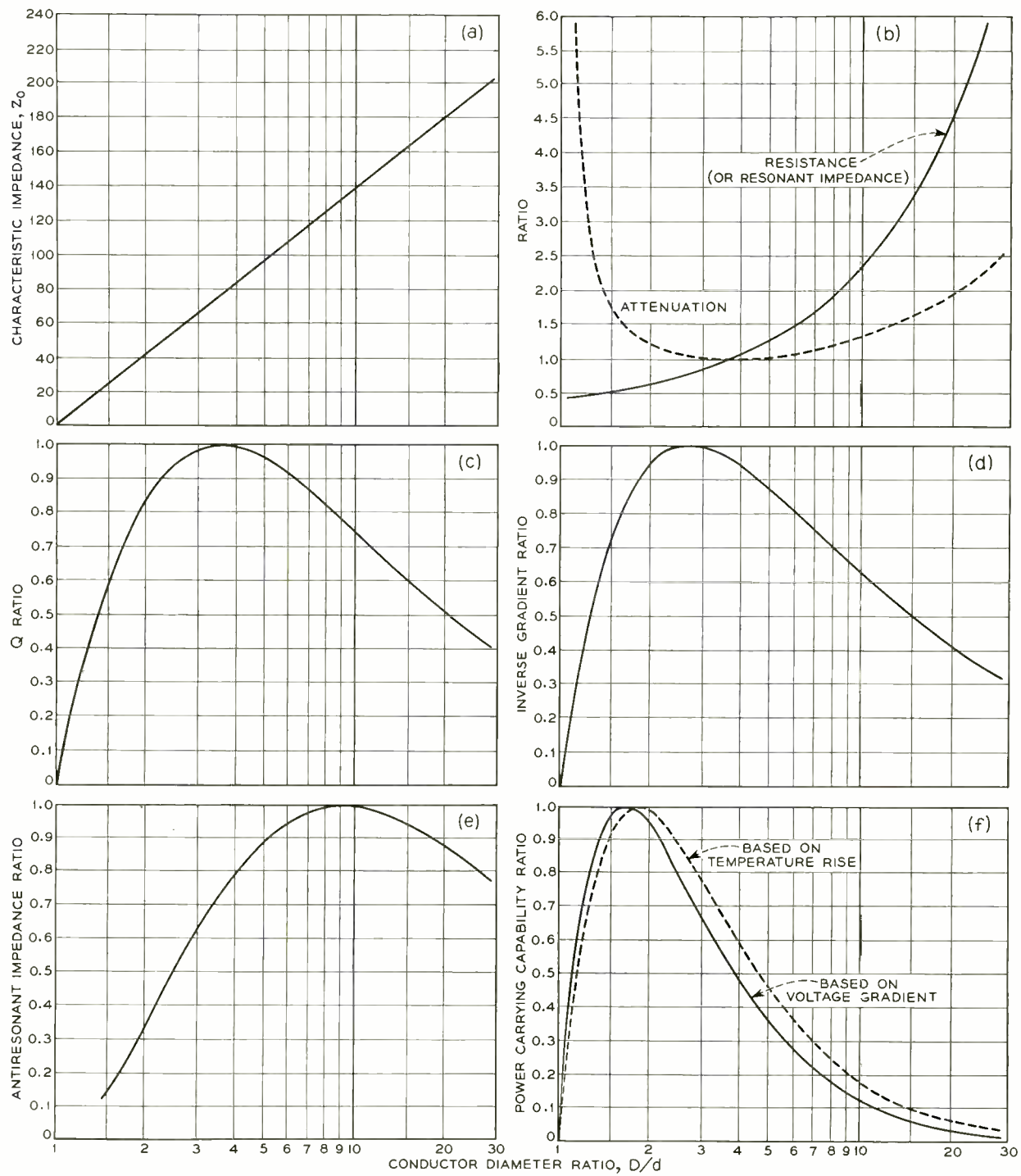

Fig. 1—Curves showing the relationships between various characteristics of a coaxial line and the diameter ratios, or the ratio of the inside diameter, D , of the outer conductor to the outside diameter, d , of the inner conductor. The curves apply to air or gas dielectric lines.

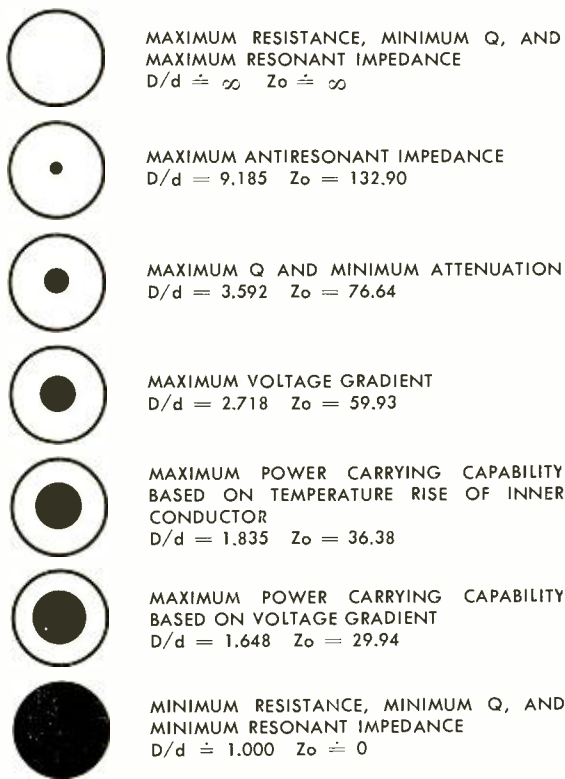

Fig. 2—Scale drawings of the cross section of a coaxial conductor having diameter ratios corresponding to the maximum and minimum values of the various characteristics shown in Figure 1.

of a radio transmitter or signal generator.

When transmitting a large amount of energy over a relatively short coaxial line such as from a television transmitter to its antenna, the maximum power handling capability based on temperature rise of the inner conductor may be of primary concern. The best ratio is then 1.835, as shown by the dashed curve of (f). This assumes that all of the heat dissipated by the inner conductor is transmitted to, and in turn dissipated by, the outer conductor. In other high-power applications, particularly at frequencies below about 50 mc or for pulsed power, where inner conductor heating is not excessive, the maximum power handling capability based on voltage gradient, as shown by the solid curve of (f), may be the most important consideration since this provides the greatest factor of safety against the possibility of flashover between conduc-

tors. In this case the best ratio will be 1.648.

As a calculable broadband high-frequency resistance termination, a section of coaxial transmission line having high resistance per unit length may be desired. One method for obtaining a high resistance line is to make the conductor diameter ratio as high as possible. Maximum resistance is approached when the conductor diameter ratio approaches infinity, as shown by the solid curve of (b).

If so-called "stub" lines or "building-out sections" are used as harmonic suppressors in shunt with the line to a radio antenna, it may be important that the stub line conductor diameter ratio be chosen so that it will have minimum resonant impedance, also shown by the solid curve of (b), in order to effect maximum suppression of harmonic energy radiated by the antenna. In this case, the optimum conductor diameter ratio is unity, and the ratio selected should be made as near unity as practicable. If, on the other hand, the stub line is used for an inner conductor support, it might be important that it have maximum anti-resonant impedance at the operating frequency, in which case the best ratio would be 9.185, as shown at (e).

When selecting a "best ratio" for a given coaxial transmission line application, one must consider the penalty which may be incurred in the performance of the line from other points of view. A ratio near unity may be best for harmonic suppression, for example, but the voltage breakdown point of the line is thereby impaired so that consideration of the voltage breakdown capacity of the line must also be given. The maximum resistance to voltage breakdown is obtained with the ratio 2.718, as shown at (d). A compromise ratio is, therefore, indicated.

The curves* of Figure 1 provide the engineer with a ready means for selecting an over-all optimum diameter ratio for a given coaxial transmission line application and for evaluating the penalty which is incurred by departing from the best ratio with respect to other parameters. To give a more graphic representation of the diameter ratios associated with the maximum or minimum

*Their derivation was described by the author in the February, 1950, issue of *Electronics*.

values of various characteristics, Figure 2 has been prepared. This represents to scale, for a fixed outside diameter, the cross-sections of a coaxial conductor of the various diameter ratios indicated. For a ratio of infinity, the inner central conductor would disappear completely and thus the coaxial

conductor would become a single hollow conductor. For a ratio of 1, on the other hand, the inner diameter would be the same as the outer diameter, and thus the coaxial conductor would become a single solid wire. Between these two extremes are the ratios that are optimum for the characteristics.

THE AUTHOR: P. H. SMITH was graduated from Tufts in 1928 with the degree of B.S. in Electrical Engineering. He immediately joined the Laboratories as a Member of the Technical Staff. His work since then has involved research and development of antennas; radio frequency transmission lines and associated circuits for application in transatlantic radiotelephone; commercial radio broadcasting; and special very-high-frequency and ultra-high-frequency radio systems for the Armed Forces. Before the war he was also actively engaged in field engineering for directional broadcast antenna installations. Mr. Smith invented the commonly used transmission-line matching stub; the optimum-impedance coaxial line for high-frequency power transmission, and the cloverleaf antenna. He is the originator of the circular transmission line reflection chart commonly identified with his name.



Traveling Wave Tubes

A new addition to the Bell Laboratories Series of technical books published by D. Van Nostrand Company, Inc., is *Traveling Wave Tubes*^{*}, by J. R. Pierce. This is the first comprehensive treatise on the theory and use of traveling wave tubes.

One of the disadvantages of present microwave amplifiers, including the klystron and certain triodes, is that gain is reduced as the frequency band width is broadened. The traveling wave tube overcomes this disadvantage, with the result that band widths of more than 1000 megacycles are possible. These tubes have been operated as amplifiers and oscillators at frequencies as high as 48,000 megacycles.

^{*}Price, \$4.50

Starting with an introductory chapter on the theory, advantages and disadvantages, and the place of the traveling wave tube in present-day communication, the book continues with a description of the tube itself and analysis of its operation. This is followed by discussions of the various types of circuits and equations pertaining to the behavior of the tube, including over-all gain, insertion loss, space charge effects, noise figure, and power output. Two final chapters consider briefly the traveling wave magnetron amplifier and the double stream amplifier. Appendices contain material for calculating gain of a traveling-wave tube, discussions of several detailed subjects, and a bibliography.

No. 5 crossbar marker

A. O. ADAM
*Switching
 Systems
 Development*

In the No. 5 crossbar system* only two types of switching frames are employed for completing talking connections. These are the line link and trunk link frames. All connections through them are established by markers, of which there may be from three to twelve in an office depending upon the calling rate and the number of subscribers. A talking connection through these frames has three components: a line link, a junctor, and a trunk link. The line links connect the

line switches to the junctor switches of the line link frame; the junctors connect the junctor switches of the line frames to those of the trunk frames; while the trunk links connect the junctor switches to the trunk switches of the trunk link frame. For any connection, there are ten line links, ten or more junctors, and ten or twenty trunk links that might be used. The marker must first determine which of the suitable components are idle, and then select one of each type to form a continuous path.

This work of the marker is required for

*RECORD, March, 1949, page 85.

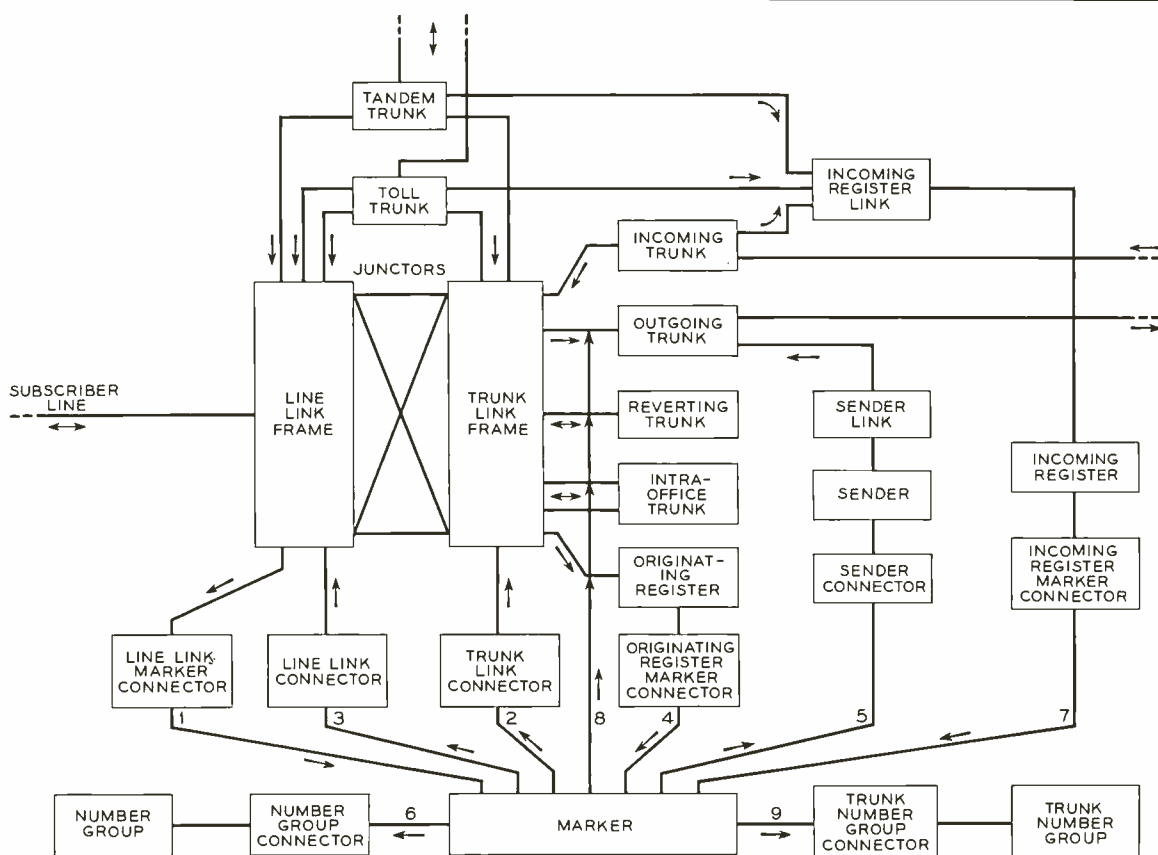

Fig. 1—Block diagram indicating the circuits that are associated with the marker at one time or another.

all types of connections, but before it can be carried out, the marker must have certain other information regarding the call, perform certain other functions, and determine the locations on the line link and trunk link frames between which a connection is to be established. Its actual procedures differ, therefore, with the kind of call, which may be any of nine types: dial tone, intra-office, reverting, outgoing, incoming, through tandem, through toll, pulse conversion, or inter-marker group.

The various circuits with which the marker is associated at one time or another in handling the various types of calls are shown in Figure 1. Since the marker performs its functions in a very short period of time—usually only a fraction of a second—there are only a few markers in any one office, and connections between a marker and the other circuits are established through connectors*. Some of these establish connections when another circuit seizes a marker, and others establish the connections when the marker seizes another circuit. Arrows on the connecting lines of the block diagram, Figure 1, indicate the direction of seizure in all cases.

Since the originating registers and the various types of trunks are all connected to the trunk link bay, the marker gains access to them through the trunk link connector and the trunk link frame. The various paths to and from the marker have been assigned arbitrary numbers in Figure 1, and these numbers will be referred to in discussing the work of the marker in handling the various types of calls.

When a subscriber lifts his handset to place a call, the operation of his line relay causes the marker to be seized over path No. 1. Such a seizure tells the marker that an originating register must be connected to the calling line so that the number about to be dialed may be recorded. Since dial tone will be returned to the subscriber by the register as soon as it is connected to the calling line, these connections of originating registers to calling lines are referred to as dial tone connections. For such a connection, the circuits employed are indicated in Figure 2.

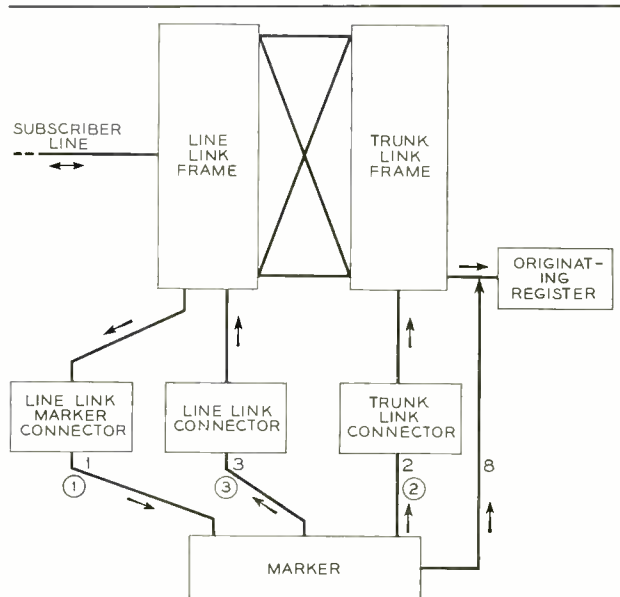

Fig. 2—Circuits associated with the marker for a dial-tone connection.

As soon as the line link frame has seized a marker over path 1, it immediately identifies itself to the marker by its frame number. Over testing path 8, the marker at once proceeds to find a trunk link frame not in use by another marker and having an idle originating register connected to it. Its method of doing this has already been described.* Having found such a combination, it at once seizes the trunk link frame through a trunk link connector, path 2, and selects one of the idle registers. During this time it has also started to find the location of the calling line on the line link frame over paths 1 and 3.

Subscriber lines are connected to the verticals of the crossbar line switches on the line link frame, and are identified by a particular vertical group, a horizontal group and a vertical file. The vertical group includes the fifty lines on the corresponding five adjacent verticals of the ten crossbar switches mounted one above the other on a line link bay. There may be from six to twelve vertical groups depending on the number of bays in the line link frame. The horizontal group includes all the lines on one horizontal row of crossbar switches, and there are 29 to 59 lines in each horizontal

*RECORD, February, 1950, page 56.

*RECORD, August, 1950, page 356.

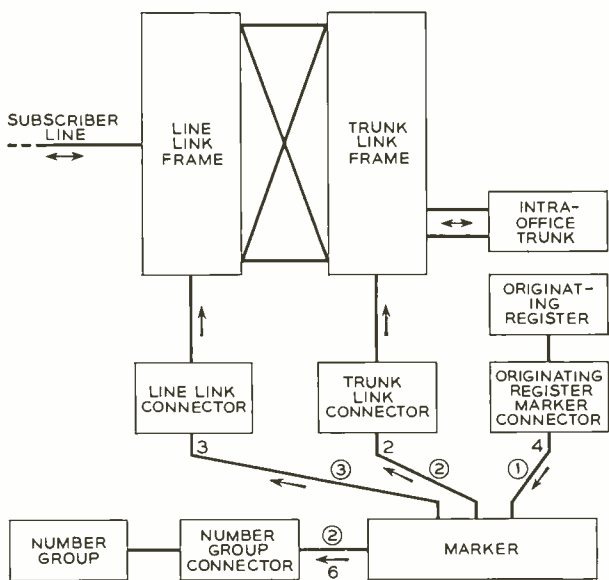

Fig. 3—Circuits associated with marker in completing a call to another subscriber in the same office.

group. A vertical file consists of the ten lines vertically above one another on a line link bay. The vertical and horizontal group identifications indicate the line as one of five on a particular crossbar switch, and the vertical file identification specifies the par-

ticular one of the five lines that are involved. Over leads through the line link marker connector, the marker identifies a preferred vertical group and horizontal group having lines awaiting service. It also connects to the line link frame via a line link connector, path 3, and tests the five lines that are common to the particular horizontal and vertical groups it has already determined, and if more than one is calling selects only one in a prescribed order of preference.

It now has the location of a calling line on the line link frame and that of an idle originating register on a trunk link frame, and thus proceeds to find and close an idle set of links and junctors between them. Once this has been done, and the calling line location stored in the register, the marker releases, and the register sends dial tone to this subscriber.

The number the subscriber dials into the register so connected may be for a subscriber in another office, and thus require a connection to a sender and an outgoing trunk for its completion, or it may be for another subscriber in the same office or even for another subscriber on the same calling line. The latter two types of call are known as intraoffice and reverting calls, respectively, and neither requires a sender.

Whatever the type of call, the register will

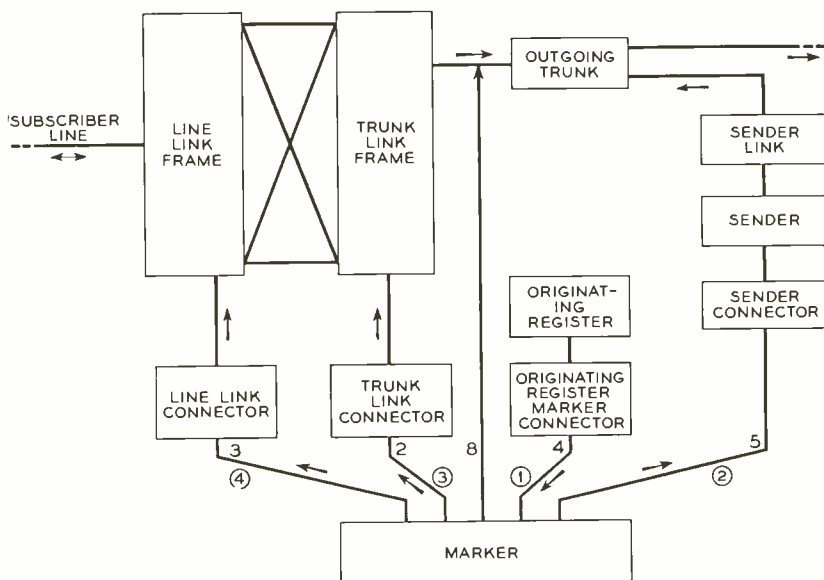

Fig. 4—Circuits associated with marker in completing a call to a subscriber in another office.

seize a marker over path 4 and request that a connection be set up. If the call is for another subscriber in the same office, the work of the marker will be as indicated in the block diagram of Figure 3, where, as in the other diagrams, the order in which the various paths are used is indicated by the numbers in circles. As soon as the marker has been seized, the register transmits to it the number dialed by the subscriber and the location of the calling subscriber's line. The marker, recognizing the office code as requiring an intraoffice trunk, at once proceeds to find and seize a trunk link frame not in use by another marker and having an idle intraoffice trunk. At the same time it seizes the number group frame over path 6 to determine the location of the called line on a line link frame. It secures this information as already recounted,⁹ and then seizes the indicated line link frame, and tests to see if the line is idle over path 3. If it finds the line idle, the marker tests for idle links and junctors and connects the line to the intraoffice trunk. It then seizes the line link frame of the calling line, again, tests for idle links and junctors, and connects the line to the other end of the intraoffice trunk. Having passed ringing information to the trunk, over path 2, the marker releases.

For a reverting call, the marker proceeds as for an intraoffice call, but after finding from the number group that the called line location is the same as the calling line, it releases the intraoffice trunk it had seized, seizes a reverting trunk, and connects the line to it. After giving the trunk the ringing information it obtained from the number group, the marker releases.

Had the marker, on decoding the office digits transmitted to it from the originating register, found that the call was for a subscriber in another office, the work of the marker would be as indicated in the block diagram of Figure 4. As soon as the marker has been seized, the register transmits to it the number dialed by the subscriber. The marker, recognizing the office code as requiring an outgoing trunk, at once proceeds to find an idle sender of the proper type and a trunk link frame not in use by a marker and having an idle trunk to the desired

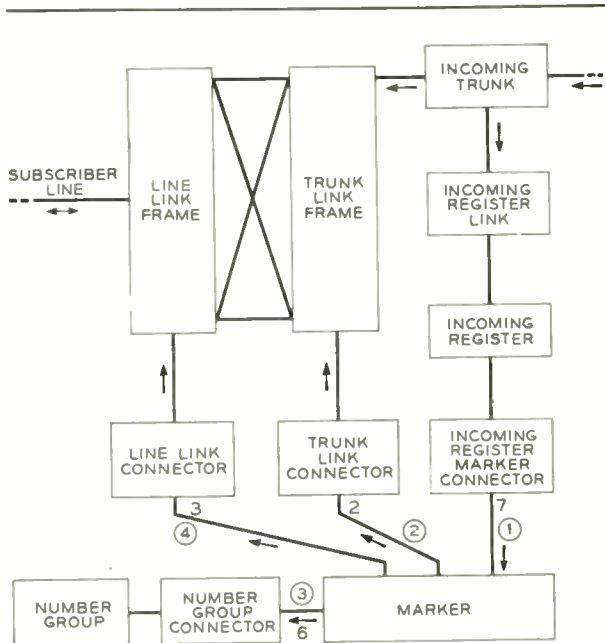

Fig. 5—Circuits associated with the marker in completing an incoming call.

office. It first seizes this sender over path 5. Then, while transmitting to it the number wanted in the distant office, the marker seizes the trunk link frame over path 2 and connects the sender to the trunk. It then seizes the line link frame of the calling line over path 3, the number of the frame and the location of the line on the frame having been given to it by the originating register. It now finds and connects an idle path through the line link and trunk link frames, tells the sender to proceed, and then releases.

All incoming calls, whether on an inter-office, a tandem, or a toll trunk, and whether for termination in the office or for extension through it, seize an incoming register on arriving. The register records the digits pulsed into the office, and then seizes a marker over path 7 and transmits the digits to it. If the call is to terminate in the office, the circuits involved are as indicated in Figure 5. As soon as a marker is seized and has decoded the office digits, it at once seizes the trunk link frame to which the calling trunk is connected. It has already received the frame number over path 7. The marker then goes to the number group to

⁹ RECORD, December, 1948, page 426.

determine the location of the line being called. With this latter information, it seizes the line link frame indicated, and completes the connection through the frames as before.

Through calls, either tandem or toll, are handled as indicated in Figure 6. Tandem and toll trunks have appearances on both trunk link and line link frames; tandem trunks have one line link and one trunk link appearance, while toll trunks have two line link and one trunk link appearance. The trunk link appearance is used for calls terminating in the office, while the line link appearance is used for calls passing through the office. The added line link appearance of the toll trunks is provided to give double assurance of finding an idle path through the office for through toll calls.

For both types of through calls, an incoming register is at once seized to record the digits pulsed in. The register then seizes a marker and transmits the digits to it. Thus far the call has proceeded as described for terminating calls. On decoding the office digits, however, the marker finds the call must pass to another office, and it therefore selects a suitable sender and seizes a trunk link frame and trunk as it did in handling an outgoing call. To determine the line link location of the calling trunk, it then seizes a trunk number group frame. Having this information, it proceeds to find an idle path between this line link location of the calling trunk and the outgoing trunk already selected. It then establishes the connection, and releases.

The major difference in the method of handling a through toll call is that there are

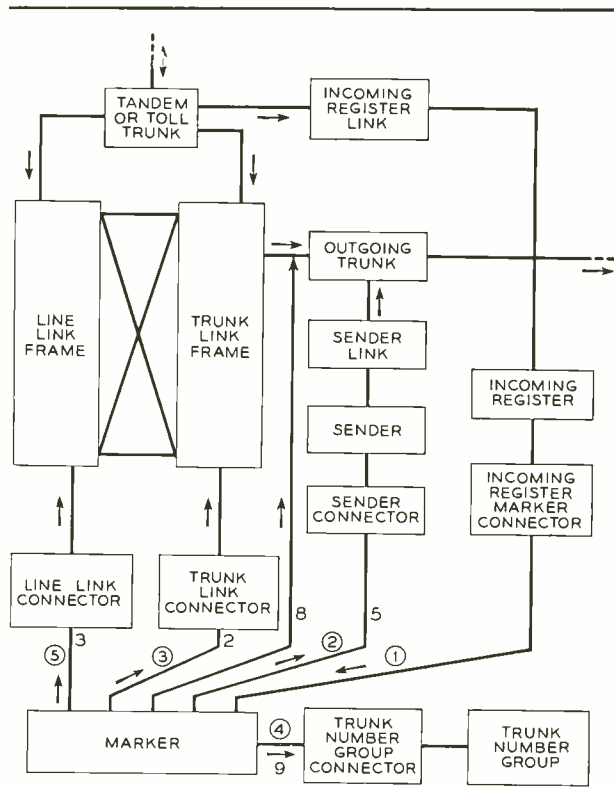

Fig. 6—Circuits associated with marker in handling tandem and toll calls.

two line link frame locations. If the marker is unable to find a path to the outgoing trunk from the location it seizes first, it will return to the other trunk number group, find the second line link frame location of the trunk, and attempt to complete from that point. Provision is also made to handle a small number of tandem or toll trunks in the

THE AUTHOR: After three years with the New York Telephone Company, A. O. ADAM transferred to the Systems Development Department at West Street where he was in laboratory work until 1937. From then until 1942 he designed senders, connectors and routine test circuits for local and toll crossbar systems. From 1942 to 1945, Mr. Adam was on the staff of the School for War Training. During this period his experience included training members of the Army ground forces on maintenance of multi-channelled command sets, training Signal Corps employees on some of the more complicated radar equipments, and training Navy personnel in the use of fire-control radar equipments. Since 1945 Mr. Adam has been associated with the development and design of the marker circuit of the No. 5 crossbar system.



regular number groups at the sacrifice of line numbers.

Besides these more usual types of calls that the marker must handle, there are also intermarker group and pulse conversion calls. The former is a call between two No. 5 offices associated with different marker groups in the same building. For such a call the conventional outgoing trunk and sender are not used. Instead a combined outgoing-incoming trunk is used, and an intermarker-group sender performs the functions of both outgoing sender and incoming register,

this being done without the usual pulsing.

Pulse conversion, which will be described in a subsequent article, permits an operator at a DSA board equipped with a multifrequency keyset to complete calls over trunks direct to an office requiring revertive or dial pulses. For such a call the No. 5 office connects the pulse conversion trunk to an incoming MF register which in turn passes the number through the marker to an outgoing sender associated with the same trunk. This sender provides the proper pulses to the office selected by the DSA position.

Business Is a Good Neighbor, Too

Excerpts from an article by K. P. Wood, Assistant Vice President, American Telephone and Telegraph Company, in Public Utilities Fortnightly, September 28, 1950.

The purchases of the Bell system companies mean a lot of business for communities in every state in the Union.

The Western Electric Company, supply organization of the Bell system, alone bought from 23,000 different concerns in 2,500 cities and towns last year and its purchases totaled more than \$300,000,000.

Last year in Pawtucket, Rhode Island, the Western Electric Company made purchases totaling over \$593,000 from 14 suppliers. These included such diverse products as webbing, wire, bolts, plastics, venetian-blind ladder tape, and cotton waste.

In addition to this sum, major expenses of the New England Telephone & Telegraph Company for payroll, taxes on property, and garage rental amounted to about \$1,014,000. And there was an additional amount of roughly \$120,000 in the form of dividends paid to Pawtucket owners of AT & T stock.

For these purposes, then, Bell system companies disbursed a total of more than \$1,727,-

000 during 1949 in the city of Pawtucket, or an average of about \$4.42 a month for each telephone in service there—a significant amount of money added to the economy of this one community.

Western's purchases during 1949 in Belleville, New Jersey—to take just one typical community—amounting to about \$375,000 included such items as paper, bags, files, rasps, felt, fabricated wood parts, fire extinguishers, chemicals, and precision instruments.

All these things add up to an outstanding example of how business operates in America. They show how the success of one business contributes to the success of others.

Money taken in in return for telephone service goes back into the community in the form of telephone wages, expenditures for supplies, taxes, dividends, and service improvements. It is a continuing process, stimulating other businesses and making an important contribution to the over-all prosperity of communities.



Captain Whitley describes hose layouts, water pressures, and stretching operations.



Responding to the order "Stretch in," the Brigade pulls hose off the Murray Hill fire apparatus.



Operating a fog nozzle, they learn its use on volatile flammable liquids on which a solid stream would spread the fire.

FIRE BRIGADE REFRESHER COURSE AT MURRAY HILL



A. B. WHITLEY



Laying the hose on the apparatus at the completion of an operation assures that on the next stretch the hose will pay off freely. The fire truck is available in case of

fires in outlying buildings, and for brush, forest or automobile fires. Two permanently installed water pumps protect the main buildings.

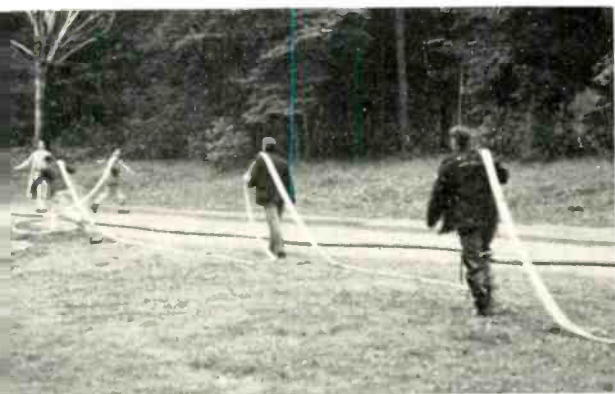

Carrying hose on their shoulders, the men move it rapidly into position.



Having started the water, the Fire Brigade gets actual practice in advancing a charged line.

Under the direction of Plant Fire Prevention Inspector A. B. Whitley, a former New York City Fire Department Captain, members of the Fire Brigade at Murray Hill are being given a refresher course, consisting of seven one-hour sessions, during working hours. Members of the Fire Brigade are so trained in various extinguishment operations that, in the event of fire, they will be able to respond rapidly and operate effectively.



Using two lines of lighter hose, the Brigade wets down a wooded terrain as they would in the path of an advancing brush fire.



Captain Whitley begins instruction on operations that may be performed with fire-fighting facilities within the buildings.



Holding a fire in check with a house line, the men in the foreground are stretching in a "city" hose connected to a stand pipe on the floor below.

Detecting Diabetes

BY DR. M. H. MANSON

Medical Director, A. T. & T. Company

One of the great physicians of all time once remarked that the way to live a long life is to contract a chronic disease and take care of it. If such a condition is decreed for you, your choice, if you had a choice, could well be diabetes, for the diabetic today can, by following doctor's orders, live a happy, useful and practically normal life.

Diabetes develops when the body is unable to use up or store all the sugar which is supplied by the food one eats. This irregularity is brought about by the failure of the pancreas to supply sufficient insulin which is a secretion needed for the normal burning up and utilization of sugar. This unused sugar goes into the



bloodstream until the blood becomes so overloaded that sugar overflows into the urine.

There are approximately 2,000,000 diabetics in the United States, of which number about 1,000,000 are undetected or not diagnosed. This amounts to living with a dangerous enemy. The diabetic, ignorant of his condition, deprives himself of a doctor's guidance which would enable him to avoid or control some of the possible complications, such as early degenerative changes in his arteries, heart and kidneys, and cataracts and other eye ailments. He lives on, unaware of some of the simple requirements of daily hygiene which help to prevent diabetic gangrene or other complications which may result from ordinary infections and otherwise minor bruises and injuries. More important still he cheats himself out of a healthy active life.

These are some of the reasons why everyone is being asked to "watch out for diabetes." The best way to detect diabetes is to have a urine and blood test as a part of a general health examination. Symptoms of well-established diabetes are often absent in early or mild cases. Nevertheless, it is well to be alert, particularly if you are middle-aged and on the

plump side and are: *Always hungry and thirsty; plump but losing weight in spite of big meals, and tired, irritable and weak most of the time.*

If there is diabetes in your family, these complaints become even more significant since it is an established fact that diabetes runs in families, especially if it is present on both the mother's and father's side.

A very useful weapon against the spread of uncontrolled diabetes is now available to every person. This consists of a simple home testing detection kit which may be bought at most drugstores for fifty cents or less. Testing is an absolutely painless procedure, as simple as using a thermometer. The test reveals the presence or absence of sugar in the urine and gives you assurance regardless of which way the test turns out. If free of sugar, you may be reasonably confident that you do not have diabetes. If sugar is present, you also may be confident that your next move of going to your doctor will be the beginning of good teamwork between him and yourself.

The main purpose of this detection program is the introduction of early and adequate treatment, especially in borderline cases. For many such individuals, especially those with a family history of diabetes, the reduction and control of weight is the only treatment needed. In fact, the treatment of well-established diabetes is based on diet and exercise along with insulin.

A.I.E.E. Committee Roster

Members of the Laboratories serving on general committees of the A.I.E.E. are: *Board of Examiners*, F. J. Scudder and H. M. Trueblood (both retired); *Membership*, Charles Clos, District Vice Chairman; *Publication and Public Relations*, R. K. Honaman; *Research*, M. J. Kelly, chairman, and M. B. Long, secretary; *Safety*, A. H. Schirmer; *Standards*, R. D. de Kay; and *Technical Advisory*, E. I. Green and J. D. Tebo.

D. A. Quarles represents the Institute on *United Engineering Trustees, Inc.* and H. M. Trueblood on the *Advisory Board, National Bureau of Engineering Registration*. J. D. Tebo is chairman of the *New York Section*.

Members of professional group committees are: *Charles LeGeyt Fortescue Fellowship and Edison Medal*, R. I. Wilkinson; *Management*, D. A. Quarles; and *Award of Institute Prizes*, M. J. Kelly and H. A. Affel.

Those on technical committees are: *Communication Division*, L. G. Abraham and R. C. Davis; *Communication Switching Systems*, R. C. Davis, chairman, and John Meszar, vice chairman;



U. S. Army Photo

A meeting in Tokyo between R. A. Shetzline, Albert Tradup, Major-General Akin, and Brigadier General Back, Signal Officer of the Far Eastern Command.

Radio Communications Systems, A. C. Dickieson, secretary; Special Communication Applications, Newton Monk; Telegraph Systems, E. F. Watson and R. B. Shanck; Wire Communications Systems, L. G. Abraham, chairman, P. G. Edwards, secretary, and H. A. Affel; Carrier Current, J. M. Dunham; Protective Devices, P. A. Jeame; Transmission and Distribution, P. W. Blye; Science and Electronics Division, E. I. Green, chairman, and J. D. Tebo; Basic Sciences, J. A. Becker, R. M. Bozorth and W. H. MacWilliams; Computing Devices, W. H. MacWilliams; Electronic Power Converters, Electronics, and Metallic Rectifiers, D. E. Trucksess; and Instruments and Measurements, John G. Ferguson.

John Johnston Dies; Former Laboratories Consultant

The many friends of Dr. John Johnston, who was a consultant of the Laboratories on chemical matters during the decade of the Nineteen-Twenties, were saddened by the news of his death at Bar Harbor, Maine, on September 12.

A graduate of St. Andrews University at Dundee, Scotland in 1903, Dr. Johnston continued his studies abroad and became a research associate at M.I.T. in 1908. He was later a member of the staff of the Carnegie Institution, and from 1919 to 1927 was director of the chemistry department at Yale. It was during that period that he was associated with the Laboratories, where his advice helped to give direction to our chemical research program. In 1927 he became director of research of United States Steel, a position which he held until retirement in 1946.

November, 1950

Dr. Tradup Visits Korea

Combat is the ultimate test of military communications, so Albert Tradup, military communications engineer, was invited to visit the Korean theatre and learn at first hand how communication facilities were standing up. His invitation came from the Chief Signal Officer, General S. B. Akin. He left Washington on August 29, the only civilian in a group headed by General Akin. Three days later they were in Tokyo. While they were there, Dr. Tradup saw R. A. Shetzline, a retired member of the Laboratories who is in the Civil Communications Section of SCAP. Mr. Shetzline, according to Dr. Tradup, is doing a fine job in training Signal Corps personnel in telephony, and has written a voluminous text on the subject.

Flying to Pusan in General MacArthur's personal plane, the "SCAP", the party went up to Taegu and Miryang for a day each. Fighting was going on there and Dr. Tradup heard a few hostile bullets whistle overhead. After four days in Pusan he returned to Tokyo for three days and then flew to Anchorage and Fairbanks, and so back to New York.

"The trip was well worth while for the first-hand contacts I made with people who are actually using wire and radio equipment," said Dr. Tradup. "Many of them I already knew, and they gave me a lot of good ideas for development programs. I was really too busy to pay much attention to the military situation, but—this was before the recent west coast offensive—I noted a general feeling of optimism among the military."

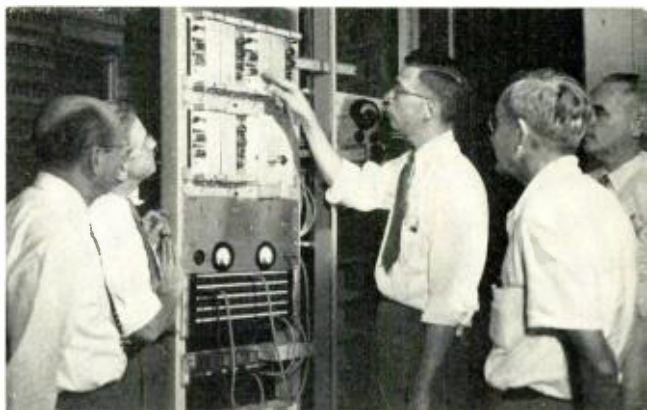

Now undergoing field tests between Shreveport and Alexandria, Louisiana, is a 43A1 carrier telegraph system. Pictured at the Alexandria terminal are L. A. Gardner, Telegraph Development; E. D. Morgan, Southern Bell; J. R. Davey, Telegraph Development; H. E. Beagle and W. M. Shortley, Southern Bell.

511

NEWS OF THE TELEPHONE PIONEERS

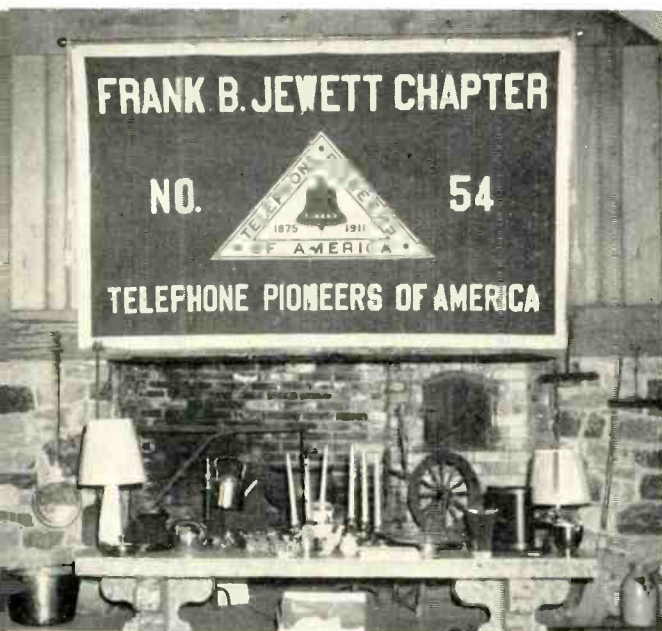

The theater party held on October 4 at the Paper Mill Playhouse in Millburn under the auspices of the New Jersey Council, Frank B. Jewett Chapter, Telephone Pioneers of America, was an outstanding success. The sold-out house of 966, made up of about 450 Pioneers and their guests, enjoyed "Maytime" based on the book by Rita Johnson Young with music by Sigmund Romberg.

During the first intermission the Pioneers

← *The Pioneer theatre party at the Paper Mill Playhouse in Millburn was photographed by Frank Fossetta.* ↓



were greeted by Frank Carrington, Director of the Playhouse, who introduced Ray Brooks, general chairman of the affair. Mr. Brooks called on H. J. Delchamps, chairman of the New Jersey Council, who responded for the Pioneers.

Door prizes were drawn during the second intermission by Dolores Baacke, daughter of E. C. Baacke of Murray Hill, from a transparent rectangular "wheel" divided into fourteen compartments. This ingenious wheel was designed and constructed by K. P. Hansen who operated it. For the three grand prizes the partitions were removed. A. J. Akehurst was Master of Ceremonies during this program.

The Entertainment Committee assisting Mr. Brooks consisted of: Ella Munk and J. G. Walker; *Tickets*, A. J. Akehurst, W. J. Abbenseth, H. L. Downing, B. Leuvelink, Mary Ressler and E. VanHorn; *Arrangements*, A. C. Walker and J. G. Walker; *Prizes*, Agnes Connors, Ada Corcoran and K. P. Hansen; and *General Committee*, H. G. Geetlein, F. J. Hallenbeck, T. C. Henneberger, F. S. Wolpert and Marie Wright. The Ticket Committee was assisted by W. C. Pitman and Thelma Gradwell; and Ella Munk and Lydia Covalence handled all of the transcription requirements.



A section of a luncheon group at the general assembly meeting of the Telephone Pioneers in Montreal includes the Laboratories representatives to the meeting, J. J. Kuhn seated, rear center, and Hattie Bodenstein seated rear right. Mrs. Kuhn is on the extreme right.

B. W. Kendall, retired, at the recent tournament held at the Essex County Golf Club.



The 1950 General Pioneer Meeting

J. J. Kuhn, chairman of the New York Council, Frank B. Jewett Chapter of the Telephone Pioneers, and Hattie Bodenstein, secretary of the chapter, attended the annual meeting of the Pioneers in Montreal. Mr. Kuhn was designated alternate for M. J. Kelly, president of the chapter. There were 125 delegates or alternates in attendance, representing 61 chapters in the organization from every state in the Union and every province in Canada.

Mr. Kuhn, in his report of the meeting, noted that it was a "working" convention with panels of serious discussion in attendance daily from

9 to 5. Highlighting the meeting were discussions on *Hobbies*, and on the need of assisting members of the Bell System reaching sixty years of age to realize that their imminent retirement in most instances will require a new approach to living.

Fletcher R. Sibley, Jr., of San Antonio, Texas, the 150,000th member of the Pioneers, receives his membership certificate from Regional Vice President C. G. Wassall (right) of the Pioneer Association.



November, 1950

513

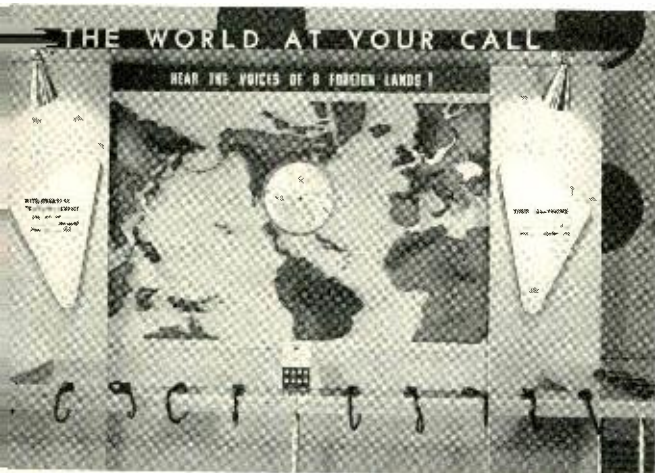

Overseas display for the Chicago Fair. Iris opens when one of eight buttons is pressed and color transparency of a person in a foreign country appears.

The Chicago Fair of 1950

The Publication Department of the Laboratories cooperated with Illinois Bell Telephone Company, and the A T & T in providing displays for the Chicago Fair of 1950 telephone exhibit held during the summer. The telephone exhibit drew 1,307,000 visitors, which was 77 per cent of the total gate.

The overseas display and two hearing test units, originally designed and built under the direction of Henry Kostkos for the New York Telephone Company, were adapted for the Fair. Also shown at the Fair were the automatic message accounting equipment and the radio relay demonstration.

Microwave Notes

September saw the completion of four new TD-2 microwave radio relay systems for transmitting television. Two 380-mile channels between Los Angeles and San Francisco went into service on September 15; one is a northbound channel and the other, although normally southbound, is reversible. Because of the height of some of the repeater sites along this route, two of the hops are 65 miles long — unusually long for a microwave system. On September 18, commercial television was established over a 315-mile route between New York and Washington. It uses stations of the system between New York and Chicago as far as Clark's Knob, some 40 miles west of Harrisburg. From here a branch runs to Garden City, Virginia, where a temporary radio link extends the system to Washington.

One northbound and one southbound channel are provided. The other two systems consist of a 110-mile two-channel system between Dayton and Indianapolis and a 455-mile section of the transcontinental system between Chicago and Omaha. The latter system has two channels, westbound only, with spur circuits to join Davenport and Ames, Iowa. Both of these systems went into service on September 30.

TE-2 television equipment is being used by the Long Lines Department at New Haven and Hamden, Connecticut, to carry football games from the Yale Bowl to New York over the radio relay system between New York and Boston.

On September 22, temporary authorization was granted to the Michigan and the Illinois Bell Companies to transmit television for theatre presentation of football games. This is the first authorization for such an application. The first showings were on September 30: in Illinois, for a University of Illinois game at Urbana, and in Michigan, for a University of Michigan game at Ann Arbor.

Oklahomans Visit Murray Hill

Forty bankers from the state of Oklahoma, attending the New York City 75th anniversary meeting of the American Bankers Association, took time from the association proceedings to visit Murray Hill Laboratory on September 25. Hosts for the occasion were Vice President Douglas Williams of the Southwestern Bell

Collegiate Degrees

Degrees conferred on members of the Laboratories during 1950 include the following:

Name	Degree	College
E. W. Adams, Jr.	I.L.B.	N.Y.U.
J. H. Anderson	M.B.A.	N.Y.U.
M. K. Asdal	B.S. in E.E.	Newark Coll. of Eng.
J. A. Baird	M.S.	Stevens
F. P. Balacek	E.E.	Cooper Union
H. B. Barling	M.E.E.	N.Y.U.
A. L. Blaha	B.E.E.	Brooklyn Poly.
R. A. Buckles, Jr.	I.L.B.	Fordham
Mary E. Campbell	M.S.	Brooklyn Poly.
J. E. Galbraith	B.E.E.	N.Y.U.
F. G. Galter	B.M.E.	Brooklyn Poly.
A. E. Gerbore	B.E.E.	N.Y.U.
J. J. Kernahan	B.S.	Newark Coll. of Eng.
D. C. Koehler	M.S.	Stevens
R. G. McCoy	M.S.	Columbia
J. Stelljes	B.E.E.	N.Y.U.
S. N. Turner	I.L.B.	N.Y.U.
D. H. Wilson, Jr.	I.L.B.	N.Y.U.

Telephone Company and Roy C. Echols, Oklahoma General Manager of Southwestern.

Following opening remarks by R. K. Honaman in the Arnold Auditorium, A. F. Bennett described features of the 500-type station set and W. E. Kock, assisted by F. K. Harvey, told the story of microwave lenses. Then, as arranged by H. B. Ely, groups were conducted by A. R. Brooks, J. Campbell, Hazel S. Reoch and A. J. Akehurst to locations where A. C. Walker, J. N. Shive, M. W. Bowker, A. G. Jensen and M. W. Baldwin gave concise talks about particular fields of Bell Telephone Laboratories' endeavor.

Voluminous Patent

D. E. Branson, G. A. Locke and T. A. Marshall have devised a code translator and printer for which the United States Patent Office has issued what *Science News Letter* calls



Pictured with one of the largest U. S. patents ever issued are T. A. Marshall, J. A. Hall, the attorney who handled it, D. E. Branson and G. A. Locke.

one of the longest patents on record. It covers that part of an automatic accounting machine which can tabulate and print data for telephone bills. J. A. Hall of the Patent Department spent two and a half months preparing the document, equivalent to a 366 page book containing 136 sheets of drawings and 188 columns of printing specifications. C. F. Campagna was the draftsman for the document, Frances Novick, the stenographer.

Murray Hill Interludes

For the 1950-51 season, the Murray Hill Noon Hour program got off to an excellent start September 28 by presenting Frank E. Gunnell in person with his prize winning movie *Bryce Canyon Trails* in Kodachrome. Projection was by J. J. Harley.

November, 1950

The Murray Hill Noon Hour Committee is composed of the chairmen of the various entertainment groups at that location and the membership consists of W. Vierling, Murray Hill Chorus; A. R. Rienstra, Men's Glee Club; F. L. Crutchfield, Popular Orchestra; H. F. Dienel, Symphony Orchestra; Betty-Estelle Prescott, Photographic Club; J. J. Harley, Bell Laboratories Club; and A. J. Akehurst, Noon Hour Program Co-ordinator.

The committee arranges and presents a varied series of half-hour monthly entertainments, each one different in style and appeal, ranging from popular swing music through amateur movies to serious instrumental and vocal recitals. The noon hour programs are so popular at Murray Hill that for each performance several hundred people are unable to obtain tickets drawn by lot from the applications received for each event.

Calling All Square Dancers

Many Laboratories people are taking quite an interest in square dancing, and one of them, Karl Goldschmidt of Circuit Development, has considerable reputation as a "caller." Among the "calls" he has written is the one below, which has had its field trials among the hillbillies in the remoter glens of the Orange Mountains.

(Tune: Little Brown Jug)

Make your squares, sets of eights
In Cartesian coordinates.

Circle to the left in tandem,
Circulate like a memorandum.
Swing your grid if you have the notion,
Gents and gals in harmonic motion.
Counterclockwise pair rotation
Brings you back to your old station.

Twirl that dial,
Ring that bell;
Rotate little Decibel!

Swing that crosstalk engineer;
With his curves you interfere;
Now gyrate the one who's dear.

Activate that left-hand mister,
Don't forget his pet thermistor;
To your own—you can't resistor.

Circle left and don't stand still,
We haven't yet reached Murray Hill.
Swing the one who's full of smiles,
Sweetest girl in Central Files.
Commutate and serenade her;
Promenade around the hall.
Get back home, again you swing her,
Terminate this local call.

515

RETIREMENTS



R. M. PEASE



A. L. RICHEY



W. G. KNOX

Among those retiring from the Laboratories are W. G. Knox with 41 years of service; A. L. Richey, 39 years; G. B. Baker and C. F. Boeck, 31 years; R. M. Pease and W. G. Sawyer, 30 years; and H. D. Kelso, 29 years.

ARCHIE L. RICHEY

During the summer of 1910—between his junior and senior years at Cornell (M.E. 1911) Mr. Richey worked as a station installer in Steubenville, Ohio, for the Central District and Printing Telegraph Company, a predecessor of the Bell Telephone Company of Pennsylvania. There he developed a liking for telephone work, and, upon graduation a year later, came to New York to work in the Engineering Department of the New York Telephone Company. After ten years of outside plant engineering in that company, he was transferred to the A T & T in charge of a group working on cable development.

Among the projects with which he was associated were staggered twist in small gauge cables, gas pressure testing of the integrity of the sheath of cables, four-wire circuits in cables, the elimination of resistance unbalances resulting when cable wires are joined without soldering and fatigue of lead alloy sheath. When his department was consolidated with the Laboratories in 1934, Mr. Richey was Assistant Outside Plant Development Engineer. In the Laboratories he became Cable Apparatus Engineer, in direct charge of such work as the development of cable terminals, protectors against lightning and electric power potentials, outside plant testing apparatus, and cable splicing and maintenance methods and apparatus. About this time, the first coaxial cable was installed from New York to Philadelphia. This was the forerunner of the network of coaxial cables now reaching almost all parts of the United States.

Since 1948, Mr. Richey has been Cable

Systems Engineer in the Outside Plant Development Department. With his wife and daughter, he lives in Basking Ridge where ten acres of ground await his attention.

R. M. PEASE

During his career, Ray Pease has practiced many forms of the communications art. In the Navy during World War I he became so proficient as a radio operator that he was assigned to one of the important overseas circuits and later went to sea on merchant ships for a year. His education at Brown had been interrupted, so he returned and received his Sc.B. in Electrical Engineering in 1921. He then entered Systems Development to work on the standardization of toll equipment. Later he transferred to Apparatus Development to assist in the development of powerline carrier systems. He subsequently became a "charter member" of the Sound Picture Laboratory, where he worked on sound recording.

At that time the late S. P. Grace was lecturing in various cities before large audiences, and illustrating his talks with demonstrations of Laboratories apparatus. Mr. Pease was assigned to set up the special apparatus on the stage, to demonstrate it during the lecture and afterward to pack it up and ship it. As an outgrowth of this work he was called upon to set up apparatus at the Chicago Fair of 1933 and train demonstrators.

Returning to West Street, Mr. Pease joined the group which was developing the Western Electric five-kilowatt transmitter for broadcasting. In 1940 he transferred to the television transmission group, where he worked on wide-band amplifiers and the early pickups of television programs over pairs in regular telephone cables. When World War II began, Mr. Pease continued for a time with this group to work on radar and proximity fuses. For a

year he was on loan to Kearny's physical test laboratory, then returned to write instruction books on radar sets. At the end of the war he worked with a group of engineers in the Patent Department, who prepared technical reports on various government projects. Since 1947 Mr. Pease has been working on a detector for flammable gases; he has also been testing fire extinguishers and formulating requirements for them.

Believing in the universal brotherhood of man, Ray Pease has been active in spreading the use of Esperanto as the International Language to promote universal understanding. In this connection and because of his natural love of travel, which early had led him into shipboard radio, he now plans to travel more extensively than has heretofore been possible.

WILLIAM G. KNOX

With four years in Western Electric's chemical control laboratory in New York (he joined in 1909), W. G. Knox transferred to the chemical research group of the then Engineering Department. He helped in the design and operation of the pilot plant which produced the first electrolytic iron for loading coil cores. Soon he began his lifelong specialization on finishes and their applications. One of his early contributions was a method of applying a spot of gold on thin aluminum diaphragms. Later came methods of applying baked aluminum varnish to central office apparatus. He participated also in early work on colored finishes for telephone handsets.

In 1928 Mr. Knox was placed in charge of the Finishing Shops at West Street, where he had charge of preparing, plating and spraying of all kinds of experimental apparatus. Eleven years later he became engineer of finishes in the Plant and Shops Department. In the following years he prepared the original plans for the finish shop at Murray Hill. His most recent contribution was to design and supervise the installation of modern paint spray and baking facilities at West Street.

During the war, Mr. Knox had a good deal to do with our development of a method for anodizing and plating of aluminum to improve operating facilities and as a protection against corrosive conditions. He also developed a method for plating industrial diamonds so they could be attached to the rim of a wheel and used to saw quartz plates.

Mr. Knox is a graduate of North Carolina State College (1906) and had a year's graduate work in chemistry at Lafayette. He and his wife live in Manhasset, L. I., where they expect to

remain for the present. Their son is a surgeon in New York City; their daughter is married and lives in nearby Roslyn, so Bill expects his leisure will give him more time for his two grandchildren. Also he expects, as opportunity offers, to do consulting work in the field of finishes.

CHRISTIAN F. BOECK

When Mr. Boeck left the Navy after World War I, he thought of completing the work for his Master's degree but instead joined the



C. F. BOECK

W. G. SAWYER

Laboratories. That was in 1919; carrier telephony was a new and growing field, and he entered the Research group which was at work on the Type-B system. Three years later he went into carrier telephony for high tension power lines. In 1925 he joined the commercial products group, working on antenna systems for apartments, on the pioneer sound pickup truck and other problems. Between 1936 and 1941 he worked on voice operated circuits for radio terminals, and on line amplifiers for coaxial systems. For a year he was loaned to Kearny, and then returned to work on radar. Since the war he has been working on coaxial systems, most recently on amplifiers and test equipment.

The three Boecks—father, mother and a grown daughter—expect to remain in Madison. Mr. Boeck sees enough possibilities in photography, gardening, fishing and community service to give him plenty to do. He is a graduate of Carroll College, in his hometown of Waukesha, and had three years' graduate work in electrical engineering at Wisconsin and Columbia.

WILLIAM G. SAWYER

On "Duke" Sawyer's retirement from the Laboratories at the end of last month, he was going up to his farm near Berlin, Mass., to see how his breeding herd of Guernseys

was doing. Then he would come back to New York to look for a publisher for his refresher textbook on French. And as time went on he would look around for worthy additions to his collection of small oriental rugs.

Mr. Sawyer joined the Laboratories in 1920 as a statistician. He transferred in 1923 to Methods and Standards, where he was put in charge of office standards. He has since been studying our business methods, particularly with reference to the application of office machines, equipment, forms, and reproduction



G. B. BAKER

H. D. KELSO

processes. One of his early contributions was in connection with the contract method of purchasing printed forms which permits economies through volume ordering. He also helped to design the forms, with an eye to simplification of routines, and an article by him on forms appeared in the RECORD for March 1927. As new office equipment and technical advances in processes became available, Mr. Sawyer studied their usefulness to us and the changes in routines that might be needed to use them effectively. He had a part in standardizing equipment for many of our accounting, payroll and stock control operations and contributed largely to our correspondence and reproduction manuals. Because of his particular knowledge and experience he was actively consulted by his associates.

A bachelor, Mr. Sawyer lives near our West Street building. He attended University of Massachusetts for three years, was in the Air Corps during World War I, and had brief experience in selling and advertising before joining the Laboratories.

GEORGE B. BAKER

When George Baker entered the Laboratories in 1919, relays for step-by-step equipments were being made by Automatic Electric. Some time later it was decided that the Western Electric Company produce these equipments, and this

presented numerous problems with respect to relays. Mr. Baker was assigned to this work. It was necessary to prepare design information for Western manufacture and as time went on hundreds of new relays had to be designed.

Before joining us, Mr. Baker had received his degree from Union College (B.E. 1911), had worked for General Electric for three years, and had been a Public Service Commission inspector during the third-tracking of New York City's elevated railroads. During World War I he was in France as an electrician of the U. S. Engineers; in World War II he prepared manufacturing specifications for relays as applied to military projects.

As to future activities, Mr. Baker hopes to do a bit of traveling. He is married, lives in Teaneck, has two married children and one grandchild, so he is not likely to lack activity.

HUGH D. KELSO

While one central office looks pretty much like others of the same general type, there are differences to meet the special needs. Western Electric has long had a group of engineers who analyze the information from the Telephone Companies and make up specifications as a basis for Shop and Installation to go to work. Don Kelso joined this group in 1920 after several years in public utilities. In 1929 he transferred to equipment development in New York. Among the projects to which he contributed were the 14C amplifier for program transmission; an arrangement for single cord patching; a locking device for program switching keys; an aisle pilot system for toll terminal rooms; and an "economy" cabinet for a repeater for railroad use.

He devised the 45A shield to prevent magnetic coupling between relays, and a space-saving mounting for 206-type selectors in relay rack units. His final job was the equipment phase of new transmission and noise measuring devices for the No. 17 and No. 18 toll testboards.

Mr. Kelso will continue to live in Mountain Lakes, N. J. With a wife, three daughters, and two grandchildren, he expects no lack of interests in life.

News Notes

TALKS BY S. B. COUSINS, recently elected Vice-President and General Manager, and Dr. Kelly were features of an executive conference held in the West Street auditorium on October 16 at which Dr. Buckley presided.

Mr. Cousins told the conference how the Laboratories looked to Telephone Company

people, and reviewed the various channels available to tell them our story. Dr. Kelly then discussed in some detail the rearmament program and its probable effect in increasing the Laboratories' development load. At his request, Mr. Leamer reviewed the impact of military service on our personnel.

O. E. BUCKLEY visited Battelle Memorial Institute, Columbus, Ohio, September 20, at the invitation of the Director, Dr. Clyde E. Williams. On September 30, Dr. Buckley attended a joint meeting in Washington, of the Council of the National Academy of Sciences and the Chairmen of Divisions of the National Research Council.

A. LEE M. WIGGINS of Hartsville, South Carolina, a Director of the A T & T, was Dr. Buckley's guest at the Murray Hill laboratories on September 19. Mr. Wiggins is Chairman of the Board of the Atlantic Coast Line and of the Louisville & Nashville Railroad Companies, and is a Past-President of the American Bankers Association. He served as Under Secretary of the U. S. Treasury in 1947-48.

AMONG THE recent articles published in technical magazines are the following by Laboratories members: *The Magnetostriction of Permanent Magnet Alloys*, by E. A. NESBITT in the September *Journal of Applied Physics*; *Response Peaks in Finite Horns* by C. T. MOLLOY; *On the Acoustics of Coupled Rooms* by C. M. HARRIS; *American Standard Method for the Coupler Calibration of Earphones Z24.9*, by F. F. ROMANOW; *American Standard Specification for Laboratory Standard*



Talking over the West Street Doll and Toy Campaign are Treasurer Mollie Radtke and Chairman Mary Cross Frank. With forty-three institutions asking for Christmas gifts for their children this year, the smaller staff at West Street still hopes to meet the demand for dolls and toys.

Pressure Microphones Z24.8, by F. M. WIENER and F. F. ROMANOW who also wrote *American Standard Method for the Pressure Calibration of Laboratory Standard Microphones Z24.4* in the *Journal of the Acoustical Society of America*, September, 1950; and in the *Proceedings of the I.R.E.* for September, articles by J. R. WEEKS on *Metallized Paper Capacitors* and D. A. MCLEAN on *Metallized Paper for Capacitors. II*. J. WILLIAMS has written an article on *Ferromagnetic Domains* in the September issue of *Electrical Engineering*.

H. A. MILOCHE visited Hawthorne in connection with relay cost studies.



Swimming Club News

Thirty members of the Laboratories were trained, under the direction of J. J. Pauer, in boat and canoe water safety skills at the Schiff Scout Reservation, Mendham, N. J., during an eight-week outdoor summer pro-

gram. This was a part of the year-around Red Cross Water Safety swimming program. A varied and active fall and winter swimming program is now being conducted Thursday evenings at the Plainfield Y.W.C.A.

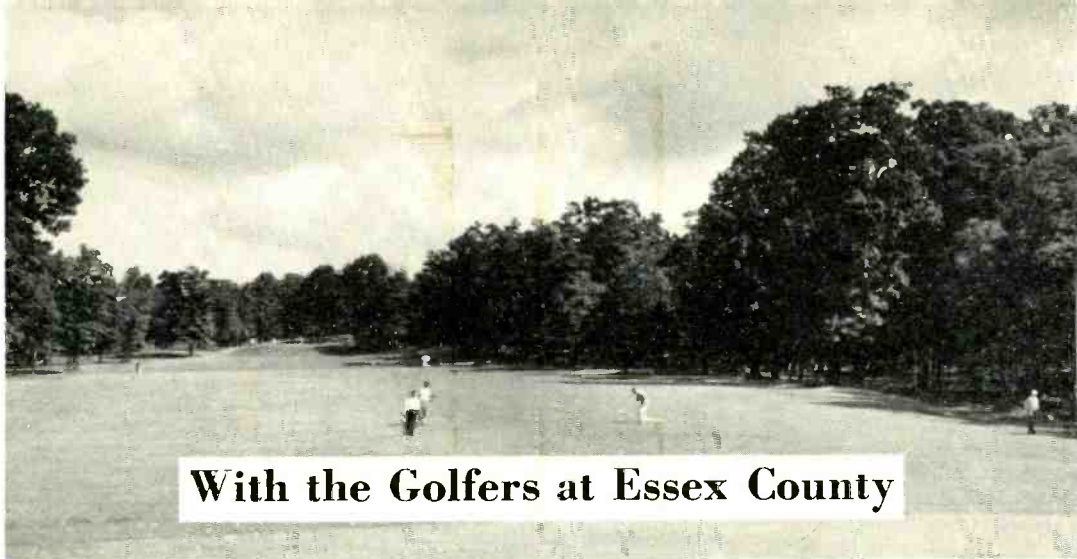

With the Golfers at Essex County

Nearly sixty members of the Laboratories participated in the golf tournament, held on September 16 at Essex County. Low net in Class "A" were T. R. Hoffman, first; H. M. Yates, second; D. Viemeister, third; H. G. Petzinger, fourth; and C. W. Robinson, fifth.

Kickers' prizes went to J. Bardeen, E. L. Fisher and I. W. Whiteside. In Class "B" low nets were H. T. Reeve, first; J. A. Word, second; G. Palladine, third; and R. P. Muhlsteff and H. C. Fleming, tied for fourth. Kickers, W. L. Clarke and R. V. Rice.

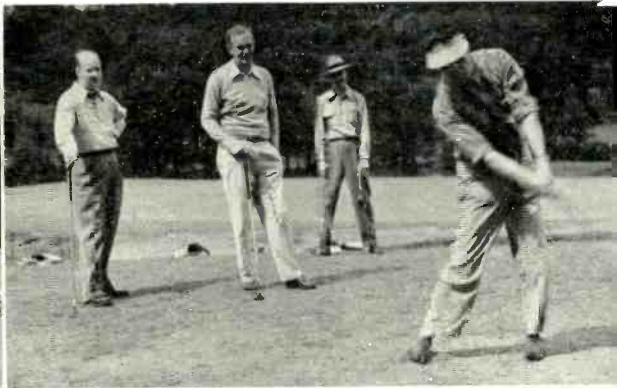
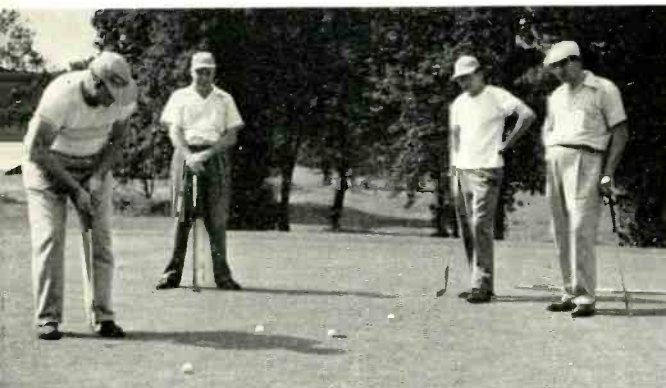



As is the custom in the Switching Drafting Department, members of the group reaching their thirtieth and thirty-fifth service anniversaries are honored at a joint dinner by the co-workers. Left to right, in the first row are Charles DuBois (30), J. Filmore (30), M. H. Cook, R. G. Koontz, C. R. McIver, and J. Hennessey (30). In the second row, T. E. Battaglia (30), R. P. Yeaton (30), R. A. Clarke (35), F. F. Frampton (30), A. Shepherd (30) and William Schroeder (30). In the third row are E. Rahn, A. Loog and W. Frey, all of them 30-year men.

News Notes

R. K. HONAMAN spoke before the Michigan Independent Telephone Association on September 14. His subject was *Frontiers of Telephony*. The Association met in Annual Convention at Lansing, September 14 and 15, and its meetings were attended by a number of Michigan Bell Telephone Company people in addition to representatives of the 150 independent companies in the state. Among other speakers on the program were S. L. Marshall, Michigan Public Service Commissioner; Clyde

S. Bailey, Executive Vice President of the U.S.I.T.A.; and W. C. Patterson, Vice President of Michigan Bell Telephone Company.

WHEN NEW CENTRAL OFFICES are being installed, there is necessarily much more dirt and dust around than would be allowed in an operating office. As a result, the preliminary tests generally disclose an abnormally large number of open relay contacts. In an effort to devise methods of improving this situation, H. J. KEEFER and T. F. EGAN were recently in Norristown, Pennsylvania, where a No. 5 crossbar office is being installed.

Accounting Department Clambake

At Martinsville Inn, Martinsville, N. J., 100 members of the Laboratories enjoyed the First Annual Clambake of the Accounting Department on Saturday, September 24. T. J. Murtha was chairman of the event, assisted by a large committee.



RECENT DEATHS



JOHN GOETZ
1866-1950



L. A. MORTIMER
1878 - 1950



L. W. KELSAY
1883 - 1950

JOHN GOETZ, September 24

For the past nineteen years, Mr. Goetz had been retired from the Laboratories after he had completed thirty-one years of service. He was first employed in the manufacturing department of Western Electric as a packer. In 1905 he was made an inspector on transmitters and receivers, a position he held for seventeen years. Mr. Goetz was assigned to work on vacuum tubes in 1922 and from then until his retirement in 1931 he was engaged in putting together and welding the units comprising the plate assembly for vacuum tubes used in radio transmitters.

LOUIS A. MORTIMER, September 23

Shortly after having completed thirty-six years of service, Mr. Mortimer retired in 1933. He first became associated with the Bell System in 1894 as a pay-station operator for the New York Telephone Company. Having served in the Spanish American war, he then returned to the Equipment Engineering Department of the New York Company where he became a supervisor of the group handling switchboard modifications. Among his tasks as equipment engineer was that of equipping the switchboards throughout the New York area for coin collection. He transferred to the Laboratories doing development work with the toll systems groups.

Mr. Mortimer was also concerned with the engineering of the toll tandem installation at Chicago, Detroit and New York, and toured the country demonstrating the call announcer for the late S. P. Grace.

LEROY W. KELSAY, October 7

Just after the turn of the century, Leroy Wilson Kelsay entered the Bell System as a draftsman for Western Electric. Four years later he accepted an assignment with the City of New York on the fundamental design of

municipal drainage systems, but passage of time could not dim his first love for telephone work and he re-entered the Bell System in 1918. His unique ability as a designer soon became apparent and he transferred to the apparatus design group as a design engineer, where he took up work on cable terminal and protective apparatus. From 1927 until his retirement in December 1948, Mr. Kelsay was in charge of the Outside Plant Department Group having to do with this kind of apparatus.

Among his many contributions in this field were the present 98-type station protector, the compact unit types of building and cross-connecting terminals, a water-tight terminal for underground distribution, terminals for J-carrier and coaxial cables. His final work at the Laboratories resulted in the design of a unit type combined cable terminal and protector as well as the design of a more compact and moisture resistant station protector.

During World War II, he was actively engaged in the design of torpedo controls, apparatus for underwater sound, and pressure-tight seals for airborne apparatus.

Mr. Kelsay died suddenly at the home he constructed at West Point Pleasant on the Metedeconk River before his retirement.

News Notes

THE HAWTHORNE PLANT of the Western Electric Company is now manufacturing the first few frames of a new unattended dial central office for small communities. Coded the 356A, it employs circuits in general similar to those of the No. 355 office that has been in use for some years. The new office, however, will be used mostly in communities requiring only from 60 to 200 station lines, and has been designed in "packaged" form to simplify ordering and installing, both for the original office and for additions to it. F. W. TREP-

tow, in charge of the step-by-step and PBX systems equipment group, has recently been in Hawthorne to inspect the equipment of the first of the new offices produced, and to discuss with Western Electric engineers any questions that have arisen.

A. MENDIZZA conferred on porosity of electrodeposits with other members of the Research Project of Porosity of the American Electroplaters Society at the National Bureau of Standards at Washington.

F. HARDY, at Esso, Standard and Texas Oil Company laboratories, reviewed methods and apparatus for testing greases.

A. W. TREPTOW conferred with the Thomas C. Thompson Company, Chicago, about porcelain enamel frits for the telephone dial number plate.

W. F. JANSSEN went to Haverhill on matters of production of transformer coils.

N. B. HANNAY attended the Gordon Research Conference of the A.A.A.S., on *Instrumentation*, at New London, New Hampshire, where he gave a talk on *The Use of the Mass Spectrometer in the Electronic Industry*.

C. J. CALBICK attended a meeting of the American Society of Photogrammetry at Harvard University at which he presented a paper entitled *Study of Size and Shape by Stereoscopic Electron Micrography*. He also attended the annual meeting of the Electron Microscope Society of America, held at Detroit.

J. R. BOETTLER and A. H. LINCE studied waveguide strain during a visit to Washington.

A COMMITTEE of A T & T, Western Electric and Laboratories engineers was formed some time ago to devise methods of reducing the test period following an installation of a No. 5 crossbar office. Methods were worked out and are to be tried first in the No. 5 crossbar office now being installed in Norristown, Pennsylvania. WILEY WHITNEY and W. I. McCULLAGH of the No. 5 crossbar group, recently went to Norristown to help in getting the new testing method under way.

I. L. HOPKINS spoke at the annual fall meeting of the A.S.M.E. at Worcester, Massachusetts, on *Dynamic Shear Properties of Rubberlike Polymers*.

F. H. WINSLOW presented a paper at the inaugural meeting of the Division of Polymer Chemistry at the Chicago meeting of the American Chemical Society, entitled *Regulation of Polymer Particle Size in Suspension Polymerization*.

R. O. L. CURRY visited Syracuse, N. Y., recently to review the initial trial installation of the machine intercept system. Another trial of the system is scheduled for a step-by-step office in Hartford, Conn., and W. B. SAGE discussed plans for this with the Southern New England Telephone Company engineers last month.

W. BABINGTON discussed sheet metal thickness standardization at Winston-Salem.

H. W. HERMANCE visited central offices in Pittsburgh, Cincinnati and Chicago in connection with sequence switch trials. He was joined in Chicago by C. W. MATTSON.

G. R. GOHN attended the fall meeting of A.S.T.M. Committee B-5 in New York. He was reappointed chairman of Subcommittee G-1 of B-5 on Methods of Test.

E. A. KUENZLER spent some time in Hawthorne this month discussing with Western Electric engineers manufacturing problems of a new system of centralized fusing for No. 5 crossbar.

THREE STATIONS of the TD-2 radio relay system are in locations so remote that commercial power is not available. Hence diesel engine-generator sets are installed in duplicate and devices are provided to start the spare set either automatically or by remote control and switch the load from one to the other. V. T.



Members of the Godmothers' Club at Graybar are busy at noonhour knitting Christmas socks and sweaters for their "godchildren" in a Staten Island orphanage. The Club visits children who are parentless or who have no visitors, befriends them, and at this time of year prepares to give the one Christmas present that each child is allowed to request. Mary Getchius, Bernadette Fullhardt and Muriel Motto are the godmothers.

CALLAHAN recently discussed these sets with the makers, the Hercules Motor Corporation at Canton, Ohio. Mr. Callahan also visited Hartford and New Haven, conferring with Southern New England engineers on a lighter and less costly 150 kw diesel set designed to run at a higher speed than the present standard model.

SOME OF THE RELAY stations on stub lines of the TD-2 system will receive their emergency power from storage batteries. F. W. ANDERSON met with engineers of the Cornell-Dubilier Company in Indianapolis to talk about designs of an inverter for transforming direct current into 60 cycle a-c to supply the various power circuits.

November Service Anniversaries of Members of the Laboratories

<i>40 years</i>	
R. Calame	H. R. Moore
P. Curran	J. A. Ribic
	D. C. Tyrrell
<i>35 years</i>	
L. B. Eames	A. Schmitz
<i>30 years</i>	
May Brown	V. F. Blefary
A. D. Knowlton	W. A. Blikken
J. W. McCaw	G. Forshce
G. O. Pedersen	J. E. Hall, Jr.
I. S. Rafuse	A. Hanzl
H. J. Wiencke	
W. Wynn	
<i>25 years</i>	
Adele Hoffman	R. Angle
A. N. Holden	W. N. Butler
E. J. McCarthy	R. G. Conway
	R. J. Kirkpatrick
	D. W. Mack
	S. D. Robertson
	W. N. Wittnebert

J. R. PIERCE addressed a joint meeting of the A.I.E.E. and I.R.E. in San Francisco.

D. A. MCLEAN attended the American Chemical Society National Meeting and also discussed capacitor problems with Western Electric engineers in Chicago.

G. H. WANNIER presented a talk at the Gordon Research Conference on the Chemistry and Physics of Metals, New Hampton, New Hampshire, entitled *Solid State Theory and Metallic Binding*.

B. E. STEVENS and T. H. CHEGWIDDEN visited Winston-Salem on magnetic amplifiers. Amount

and polarity of a dc input to such an amplifier will control the amount and phase of an alternating current so as to rotate a motor at the proper direction and speed.

R. J. WILLIAMSON was in Haverhill regarding ferrite coils for type XO carrier.

E. P. FELCH attended the National Electronics Conference at Chicago during September. While there he inspected measuring apparatus in use on television transmission facilities.

W. C. MEYER of the Switching Systems Development Department has recently been in Syracuse to study the operation of a magnetic tape recorder that has been installed there as an adjunct to one of the step-by-step offices. Extensive changing of subscriber's numbers has been necessary in preparation for nationwide dialing, and although new directories with the correct numbers have been issued, it was known from past experience that many subscribers would dial the old numbers. When this is done, the line is automatically connected to the announcer, which asks the subscriber to consult the new directory to obtain the correct number. Such a device would reduce the load on the intercept operators, who without it would have to carry a greatly increased burden.

A. B. CLARK, E. I. GREEN and P. S. DARNELL, accompanied by H. Rossbacher of Kearny, visited Haverhill to discuss the manufacture of inductors, transformers and resistors.

C. D. OWENS has been named chairman of a new I.R.E. Subcommittee on magnetic measurements.

HIGHLIGHTED by discussions of the latest steps in the progress of television, the sixty-eighth semi-annual convention of the Society of Motion Picture and Television Engineers was held at Lake Placid during October. Among the papers presented was *Wire Transmission in Telephone Areas* by L. W. MORRISON.

L. G. ABRAHAM, J. M. BARSTOW and H. A. LEWIS visited Atlanta and Birmingham in connection with the southward extension of the coaxial television network. They observed the quality of transmission and determined the effectiveness of recently introduced improvements. The longest television circuit observed was from St. Louis to Birmingham, an equivalent coaxial length of 3100 miles.

R. C. PFARRER visited Baltimore and Washington for their A4A cutover. He also made an investigation of the outgoing senders at the Towson, Maryland, No. 5 crossbar office.



Girls' Bowling League

Above—Watching the scorekeeper, Lillian Pawlowski, Caryl Schrumpf, standing and Clair Halpine seated. Scorekeeper is Agnes Hirsch. Next Winifred Meszaros seated and Amy Cuervo standing.

Above, right—A snack before the game. Left to right, Evelyn Wentsch, Virginia Keyser, Stella Vassilopoulos, Eleanor Ebeling and Caryl Schrumpf, chairman of the Women's League.

Right—Sal Lem chalking up.

Below—Mae Cascy aiming for that spare. Betty Wilson is at the right.

Below, right—Selecting their balls are Betsy Bates, Elena Tighe and Margaret Rimmelman.

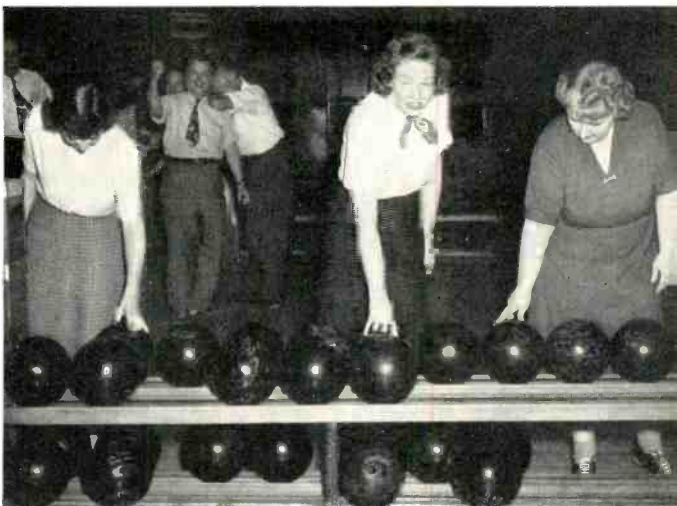

L. R. SNOKE, with engineers of the Bell Telephone Company of Pennsylvania, participated in studies at Lansdale aimed at determining the best practical methods for chemical control of brush on rights-of-way.

G. Q. LUMSDEN visited Detroit and Toronto in connection with extension of the use of greensalt-treated poles by the Michigan Bell Telephone Company and the Bell Telephone Company of Canada.

R. H. ROSS discussed new designs of small 60 cycle motors for Navy projects with the B. A. Wesche Electric Company in Cincinnati, Ohio. He also conferred with engineers of the Lamb Electric Company in Kent, Ohio, regarding 400-cycle motors for a government project.

R. R. GAY inspected power plants of the Ford Motor Company and General Motors Corporation in Detroit for their 81C1 teletype systems.



W. B. SAGE, at Corapolis, Pennsylvania, discussed details of the trial of simplified register and sender test equipment to be installed in the No. 5 crossbar office there. Representatives of the Bell Telephone Company of Pennsylvania and the Western Electric Company Installation Department were present.

W. R. BENNETT spoke on *Current Planning in PCM* at the first 1950-51 meeting of the Deal-Holmdel Colloquium, which was held at Deal on October 6. He stated that present emphasis is on putting PCM into use as a supplement to the K-carrier system, using pairs present in the same cables in many cases.

F. A. JOHNSON supervised the installation of

baffles for the dust study in the No. 5 crossbar office in Williamsville, New York, and arranged for the trial of wire spring relay trunk units with solderless connections in the No. 5 crossbar office at Tonawanda, New York.

F. A. NEWHALL, in Princeton, arranged for the removal from the Long Lines repeater station of testing apparatus used in connection with experimental installations of coaxial cable. A five-mile stretch of "U.S. Route 1" east of the repeater station has been the scene of a number of such installations, to learn the effect of daily temperature changes and other factors on various types of coaxial insulation.

G. E. FESSLER and A. A. HANSEN visited the Lancaster, New York, No. 5 crossbar office in connection with trials of an electronic pulse generator. The Buffalo South Park office also was visited for similar tests of panel office subscribers senders. Performance studies were made of two-wire single frequency signaling associated with CX signaling at Warren and Youngstown, Ohio.

H. H. ABBOTT and A. BURKETT visited North Electric Manufacturing Company at Galion, Ohio, and Kellogg Switchboard and Supply Company at Chicago. Mr. Burkett also visited the Automatic Electric Company at Chicago and the Northwestern Bell Company at Des Moines.

M. B. McDAVITT, F. J. SINGER, H. H. ABBOTT, R. E. COLLIS, A. A. HANSEN, H. D. MACPHERSON and R. H. MILLER attended the cutover of the A4A toll crossbar office in Washington on September 24.

THE LABORATORIES were represented in interference proceedings at the Patent Office by W. M. Hill before the Primary Examiner and H. S. Wertz before the Examiner of Interferences.

W. O. FULLERTON and J. A. WORD visited the Garden City, Virginia, terminal of the New York-Washington TD-2 radio relay system to inspect this new type of "ranch house" repeater station.

THE RECORD gets around. For instance, in the June 1950 issue the Murray Hill Rhythm Trio had a pair of pictures, both of which included John A. DeFeo and his guitar. In September comes a letter from J. Arendsen of The Hague, Netherlands, asking Mr. DeFeo for information about the electrical hookup shown in the pictures. The instrumentalist complied with details about the guitar contact microphone pickup.

News Notes

FRANK B. JEWETT CHAPTER of the Telephone Pioneers of America announces a competition for an original design of a folder-type greeting card featuring the twenty-first anniversary of telephone service, the Frank B. Jewett Chapter No. 54 of the Telephone Pioneers of America and a cordial invitation to join the Chapter. Designs in any convenient size and color combinations, with name and location of contestant on the reverse side, should be submitted to any member of the Contest Committee, comprising D. R. BROBST, A. J. DALY, and C. H. G. GRAY, not later than December 15. As soon as practicable thereafter, the Chapter will announce the name or names of the contestants whose design or designs have been selected by the Executive Committee of the Chapter, will exhibit all designs submitted in a convenient location at both West Street and Murray Hill and will award the winner or winners a purchase order for merchandise.

ANNOUNCEMENT of the development by the Laboratories of the borocarbon resistor*, which is a markedly superior type of deposited carbon resistor expected to find widespread use in the communication and electronic fields, was made to representatives of the Research and Development Board at Murray Hill on September 25. This Board is composed of representatives of the Departments of the Army, Navy and Air Force and acts as a central programming, coordinating and advisory agency in research and development activities of interest to the military departments. Information on the borocarbon development and on possible applications for the new resistor was presented in talks by R. O.

* RECORD, October, 1950, page 447.

"Telephone Hour"

NBC, Monday Nights, 9:00 p.m.

November 6	Ezio Pinza, <i>basso</i>
November 13	Leonard Pennario, <i>pianist</i>
November 20	Marian Anderson, <i>contralto</i>
November 27	Barbara Gibson, <i>coloratura-soprano</i>
December 4	Ferruccio Tagliavini, <i>tenor</i> and Pia Tassinari, <i>soprano</i>
December 11	To be announced
December 18	Robert Casadesus, <i>pianist</i>
December 25	John Charles Thomas, <i>baritone</i>

GRISDALE and P. S. DARNELL. The meeting was attended by members of the Western Electric Company and by twenty representatives of the R. & D. B., and R. D. PARKER, a retired member of the Laboratories representing the National Security Resources Board.

E. G. ANDREWS attended the Association for Computing Machinery in Washington. He also visited the Langley Field Laboratories.

IN LONG LINES' overseas radio stations, the transmitters are shifted from one frequency to another by remotely controlled switches, many of them motor driven. Lubrication of these moving parts, which must operate with unflinching accuracy over long periods, requires specialized lubrication. To discuss these problems with Long Lines people, F. HARDY recently visited the overseas radio station at Lawrenceville, New Jersey.

R. B. HEARN and A. BURKETT visited Des Moines to discuss with the Northwestern Bell Telephone engineers arrangements for a trial installation of a new multi-party full selective ringing system.

LIKE AERIAL CABLE, the waveguides leading up to antennas atop microwave stations are subject to wind vibration which must be taken into account in practical waveguide design. Wind strains have been measured by J. R. BOETTLER, A. H. LINCE and W. W. TUTTILL at the TD-2 radio relay terminal at Garden City, Virginia.

DOODLERS AND CARVERS are going to find their job much harder with the new lining now going into production for telephone booths. The steel sheet will be finished with porcelain which is glass-hard and much more scratch-resistant than the baked finish in current use. Beige color won't be changed. D. H. KING and M. D. RICHTERINK observed initial production at the Baltimore Porcelain Steel Corporation, Baltimore.

J. B. DIXON and W. J. FARMER attended Quality Surveys on steel lashing wire at suppliers' plants in Prospect Park and Monessen, Pennsylvania, and Muncie, Indiana.

J. LEUTRITZ, JR., attended the meeting of the Preservatives Committee of the American Wood-Preservers' Association in Cleveland.

K. G. COMPTON went to Hawthorne and Shadeland in connection with finishing and materials problems. Mr. Compton was elected chairman of the management Committee of the Gordon Research Conferences which are sponsored by the A.A.A.S.

BELL LABORATORIES CLUB ACTIVITIES

<i>Activity</i>	<i>Chairman</i>	<i>Meeting Place</i>	<i>Time</i>	<i>Activity</i>	<i>Chairman</i>	<i>Meeting Place</i>	<i>Time</i>
Archery	W. J. Cernik	Washington Irving High School, N. Y.	Wednesdays 7:00	Horseshoe Pitching	—————	Murray Hill	Noontimes Daily
	W. D. Goodale	Murray Hill	Noontime		—————	Whippany	Noontimes Daily
Basketball	J. J. Darold	Summit YMCA	Wednesdays 6:00	International Relations Group	W. H. Edwards	Murray Hill	Wednesdays 12:15
Bowling	Patricia Munther (Whippany Girls)	Herrman's Bowling Alleys, Morristown	Wednesdays 6:30	Model Railroading	H. H. Hagens (West Street)	Conference Dining Room	Fourth Wednesdays
	Caryl Schrupf (West Street Girls)	National Bowling Recreation Area	Fridays 5:45		J. A. Pasternak (Murray Hill)	Lounge	Meetings as announced
	W. J. Seeger (West Street Men)	National Bowling Recreation Area	Wednesdays and Fridays 5:45	Murray Hill Chorus	W. Vierling	Summit YMCA	Tuesdays 8:00
	J. R. Schweitzer (Murray Hill)	Highway Bowling Alleys, South Orange and Plainfield Bowling Alleys	Mondays and Thursdays 6:30 Fridays 6:15	Murray Hill Popular Orchestra	F. L. Crutchfield	Arnold Auditorium	Tuesdays 12:15
	C. Glazar (Whippany)	O'Dowd Bowling Alleys, Pinelbrook	Fridays 6:15	Murray Hill Symphony Orchestra	H. F. Diemel	Arnold Auditorium	Wednesdays 5:45
Bridge	G. C. Lord (West Street)	Lounge Area	Alternate Mondays 5:15	Painting	Alice Loc	West Street Room 1009	Mondays 6:00
	W. T. Jervey (Murray Hill)	Restaurant	Mondays 5:45	Rifle Club	A. C. Peterson	St. Theresa's Church, Summit	Thursdays 8:00
Camera Clubs	J. J. Harley (Murray Hill)	Arnold Auditorium	Mondays 12:15	Softball	M. J. Doody (West Street)	Stevens Field Hoboken	Schedule to be announced
Ceramics	Elizabeth Bates	Fred Farr Studios, 628 Hudson Street New York	Tuesdays 6:00		W. J. Carroll	Murray Hill	Schedule to be announced
Chess	H. G. W. Brown (New York)	Lounge Area	Wednesdays 5:45		W. H. Thatcher	Whippany	Schedule to be announced
Golf	W. F. Malone	Essex County Country Club	To be announced	Stamp Club	M. E. Esternaux (West Street)	Conference Dining Room	Mondays 12:15
Horseshoe Pitching	—————	Bethune Street	Noontimes Daily		L. G. Kersta	Murray Hill	Meetings as announced
				Swimming	Henry Peters	Plainfield YMCA	Thursdays 6:00
				Table Tennis	J. V. Elliott	Murray Hill	Matinees Daily
				West Street Chorus	R. P. Yeaton	Auditorium	Wednesdays 5:30
				Whippany Glee Club	W. E. Ingerson	Whippany	Wednesdays and Fridays 12:30