

The 81-C-1 teletypewriter switching system

W. M. BACON

*Telegraph
Development*

With the installation of 81-C-1 teletypewriter switching systems for the Pan American Airways, the Eastern Air Lines and the General Motors Corporation, another large step is taken in the rapid advance of teletypewriter communication. Just prior to the war, a system with many features of the 81-C-1 but of somewhat smaller scope and flexibility was installed for the Republic Steel Company. This latter system, known as the 81-B-1, has already been described in the Record.* Both of these systems permit

*RECORD, January 1948, page 20.

teletypewriter messages to be sent from any station on the various private telegraph lines of a large company to any other station on their system. All messages are transmitted to a switching office where they are automatically routed and subsequently transmitted to the proper outgoing line and station. The 81-B-1 system, however, provided for only a single switching center, and some of its facilities—such as those for directing messages to groups of subscribers—were limited to the requirements at the time it was developed. Experience with the

Fig. 1—General view of the operating room of the Pan American Airways installation. Reperforator transmitter cabinets at the right and one line of relay cabinets in the background.



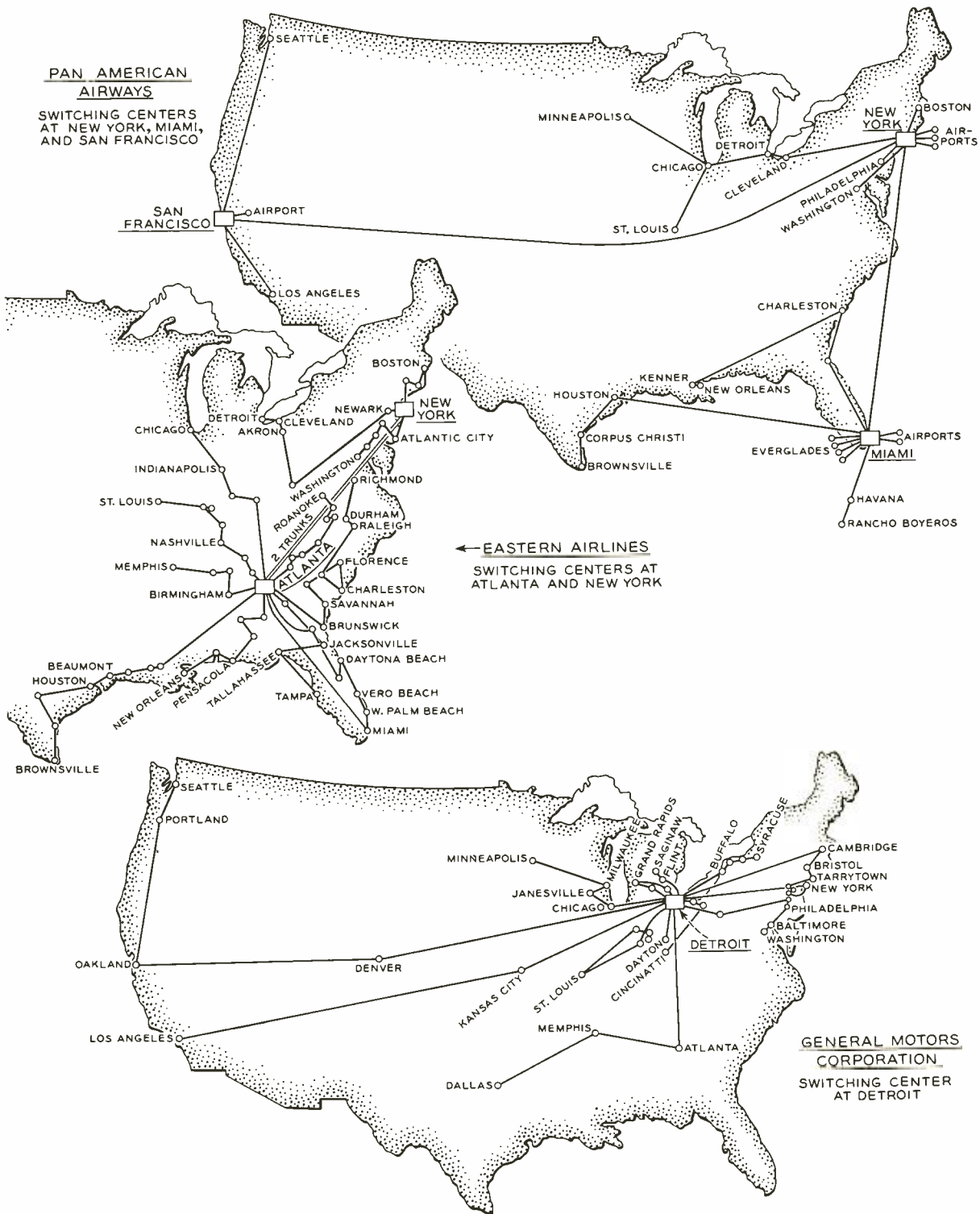

Fig. 2—Circuit maps of the 81-C-1 teletypewriter switching system installed for the Pan American Airways, the Eastern Air Lines, and the General Motors Corporation.

81-B-1 system during the war proved not only its many advantages but the soundness of its basic features. Wide interest in teletypewriter switching systems of this general type resulted in further studies that showed the need of even greater scope and versatility and of employing units so wired and mounted that systems of various sizes and degrees of flexibility can be economically provided by a suitable assembly of standard units. The 81-C-1 system is the outgrowth of these investigations.

Why there is need for certain features not provided by the B-1 system becomes evident on a cursory study of the communication requirements of an organization such as the Pan American Airways. This company is concerned primarily with overseas flights

falling into three major groups: a transatlantic group using airports in the vicinity of New York and Boston; a South and Central American group using airports around Miami; and a Pacific group using airports on the West Coast. Different groups are under the general supervision of offices in New York, Miami, and San Francisco, respectively. Each of these centers is in continual communication with other cities and airports in its territory, and requires less extensive communication with the more distant centers. Three switching centers are thus indicated as desirable. Each handles the large volume of its own local traffic, but each must have access to the other centers, and thus trunk lines between centers are required. Although not needed by the Pan American

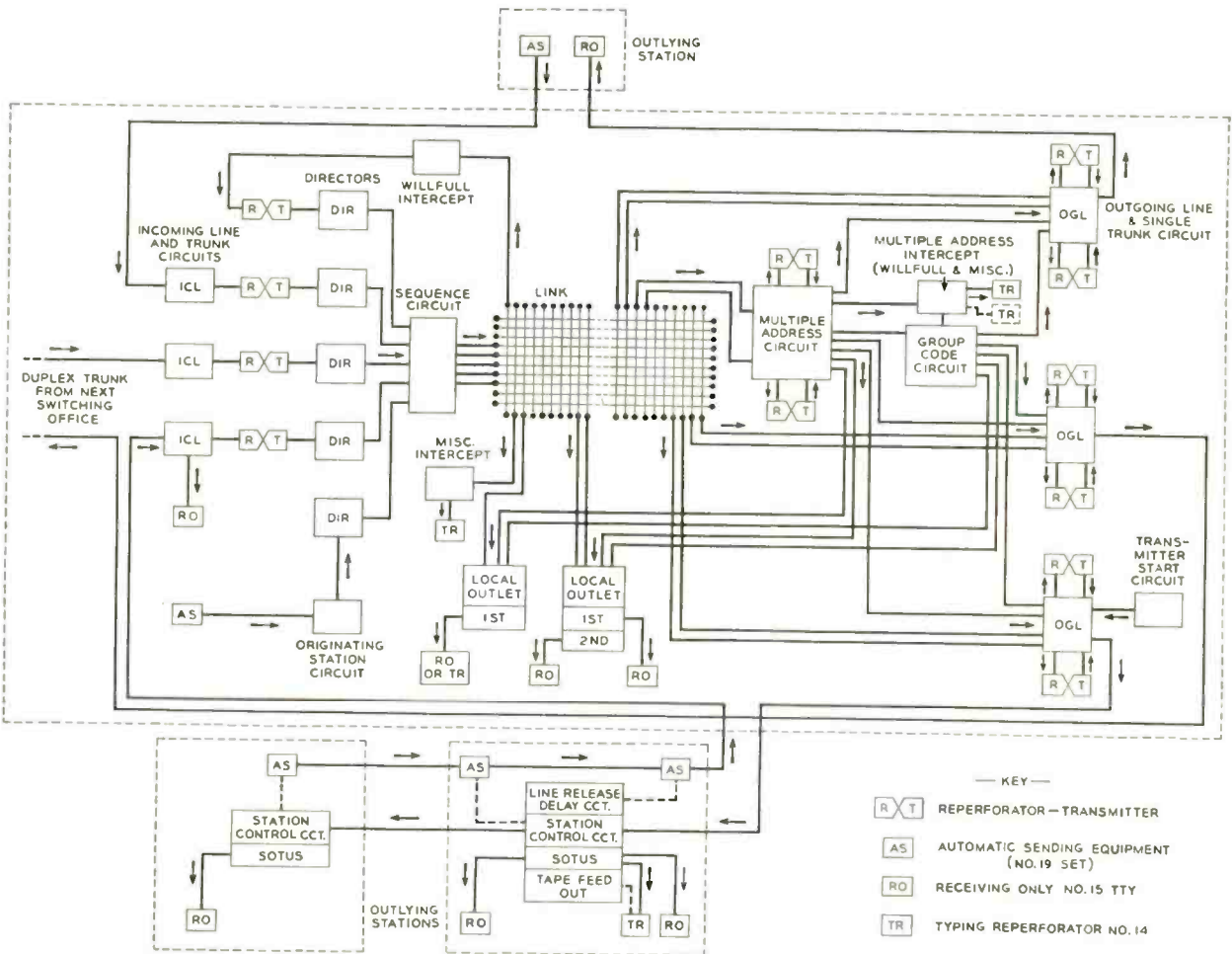

Fig. 3—Block schematic for the 81-C-1 system.

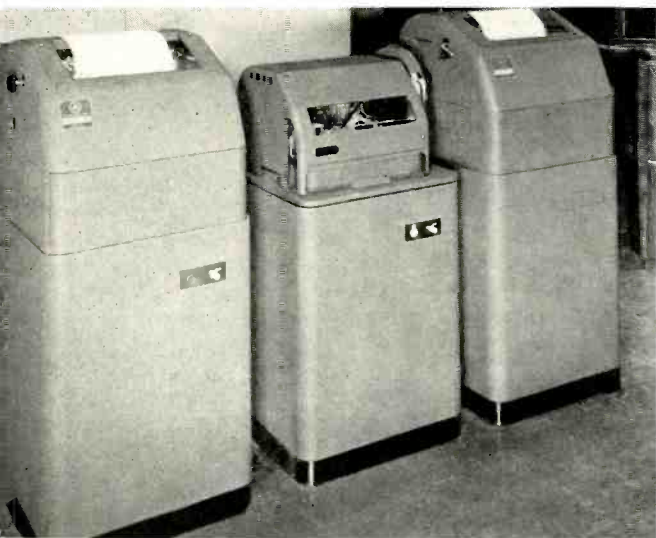

Fig. 4—Local outlet machines: two teletypewriters and one typing reperforator for receiving messages at the switching office. As will be noted, considerable attention was paid to appearance.

system, some systems—such as one recently installed for the Western Electric Company—require multiple trunk groups between switching centers to handle the very large volume of intercenter traffic. The ability to have several switching centers, connected by multiple trunk groups, has thus been made one of the features of the 81-C-1 system.

Probably the most important new feature of the C-1 system, however, is the ability to have a single message sent from a transmitting station received by a group of stations, and only by this group. With the B-1 system, if a message were to be sent to a number of stations on different lines out of the switching center, the message would have to be sent at least as many times as there were outgoing lines to be reached. The message with a code indicating a line or station would be followed by the same message with a code indicating another line, and so on. With the C-1 system, however, the same message on a single transmission



Fig. 5—Two originating station automatic sending equipments in the Pan American installation.

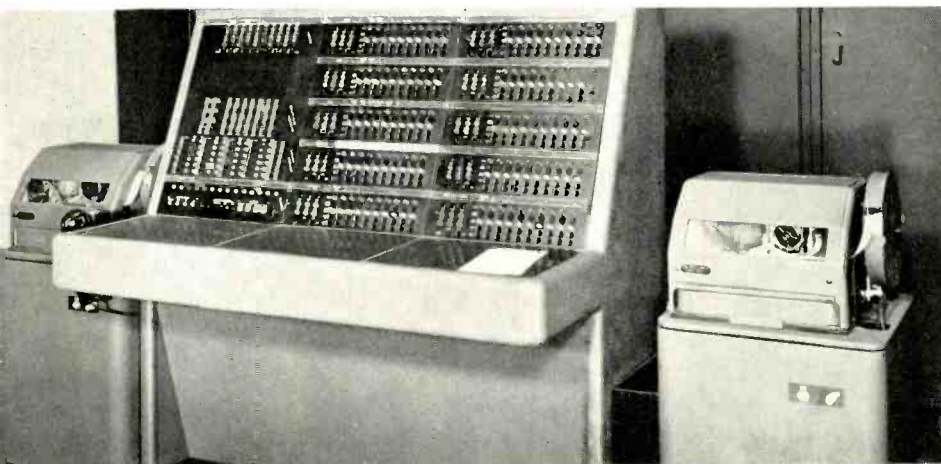

Fig. 6—Control board and intercept typing reperforators.

from the originator may be sent over any number of lines, and be received only by a selected group of stations reached by these lines. To accomplish this two new circuits have been added to the switching center: the multiple-address circuit and the group-code circuit.

The system installed for the Pan American Airways is shown in Figures 1 and 2. There are three switching centers — New York, Miami, and San Francisco. Three types of lines are associated with each switching center: trunks to another switching center, which have no stations bridged on them; multiple station lines, such as that to Chicago from New York, which have other stations bridged on them; and single-station lines. There are also local outlets at the switching center to provide for reception of messages at stations near this center, each of which may have as many as ten receiving-only machines. Stations for traffic originating at switching offices are also provided. All of these stations and lines are reached through link circuits consisting of crossbar switches and their controlling elements. The multiple-address circuit is also reached through the crossbar links, and in turn may reach the group-code circuit.

These various circuits and lines are interconnected as indicated in Figure 3. All incoming circuits pass through an incoming line and trunk circuit to a reperforator transmitter,* where the message is punched on tape and stored to allow time for switching and, if necessary, for waiting until the required outgoing circuit is available. For each circuit, switching within the office is under the control of a director, and up to thirty directors operate through a common sequence circuit to control the crossbar link circuits. All incoming lines, incoming trunks, and originating stations connect, through the directors, to the horizontals of the crossbar switches, while to the verticals are connected the outgoing lines, the outgoing trunks, the multiple-address circuit, the local outlets, and intercept circuits.

Where several stations are bridged on a single line, a switching unit called a "Sotus" —standing for Sequentially Operated Teletypewriter Universal Selector—is installed

*RECORD, March, 1948, page 106.

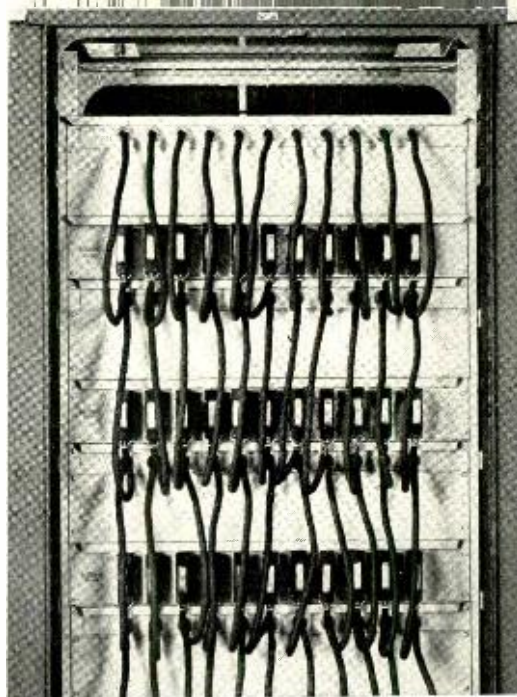

Fig. 7—A section of a typical patching cabinet.

at each station. The Sotus continuously monitors the line, and when the code for that particular station is encountered, will connect in the station, which at other times remains disconnected from the line. The Sotus unit also serves to control the sequence of transmission from the stations to the switching office.

For multiple-address transmission, a multiple-address directing code is placed on the tape first to indicate that a multiple-address message is following. After this directing code follow the directing codes indicating all the stations that are to receive the message, and the last of these will be followed by the message itself. When such a message is received at the switching center, the director recognizes the multiple-address code and selects one of two links through the crossbar switches that routes the following codes and the message to either of two reperforator transmitters which cooperate with the multiple-address circuit. This latter circuit selects the lines called for by the various addresses one after the other — temporarily blocking each circuit, after it has been seized and its codes repeated to it, until all the other circuits have been selected. It then releases all the selected circuits and sends the message to all of them simultaneously. As with the B-1 system, reperforator transmitters are also included in the outgoing line circuits. These store the

messages transmitted across the office until the outgoing line is available, just as those in the incoming circuit store them until a switching path is available.

A number of addresses may be for stations reached through another switching center. The multiple-address circuit recognizes this situation and before giving the outgoing trunk the required codes, prefixes a multiple-address code so that when the message is received at the distant switching center, it will be routed to the multiple-address circuit there, where a similar selection will be carried out.

It often happens that the nature of the business requires that many messages be sent to the same groups of stations. With airlines, for example, all messages pertaining to a particular flight might be sent to all stations along the route of that flight. There may be many of such flight groups, and other groups might comprise all ticket offices or other groups of stations falling under some

For each such group of stations, a two-character group code is assigned, and this is placed on the tape immediately following the multiple-address code — no individual station codes being used to reach the group. When such a message is received at the switching center, the director—as before—recognizes the multiple-address code and routes the message to the multiple-address circuit. This latter circuit recognizing the group code that follows, passes the code to the group-code circuit. For each code group, this latter circuit has information available that tells it what lines the code includes. From this information it sets up circuits to these outlets much as the multiple-address circuit did in the previous example. When some of the addresses are to be reached through a distant switching center, both a multiple-address and the group code will be prefixed to the message so that the multiple-address and group code circuits will be called in to route the message from there on. The multiple-address code also indicates the switching center from which the message is being transmitted so that the group-code circuit at the distant center can eliminate from the list of stations called for by that group code those that have already been selected by the originating switching center.

Besides having these additional multiple-address and group-code features and permitting multiple switching centers connected by one or more trunks, the 81-C-1 system is considerably larger than the 81-B-1 in its load-handling ability. It has a possible maximum of thirty paths through each switching center—fifty per cent more than one B-1 had—and can give service to as many as 200 codes in any one switching center. Four hundred codes are available to the system as a whole—each code consisting of two characters. Multiple point lines will each handle as many as ten receiver and ten transmitter stations, and as many as three stations may be connected by a single Sotus unit. Transmission may be at speeds of either 60 or 75 words per minute, since the reperforator transmitters will absorb the difference in the time of transmission that may exist between an incoming and an outgoing line. Seventy-five word transmission apparatus is always used for transmitting across the office.

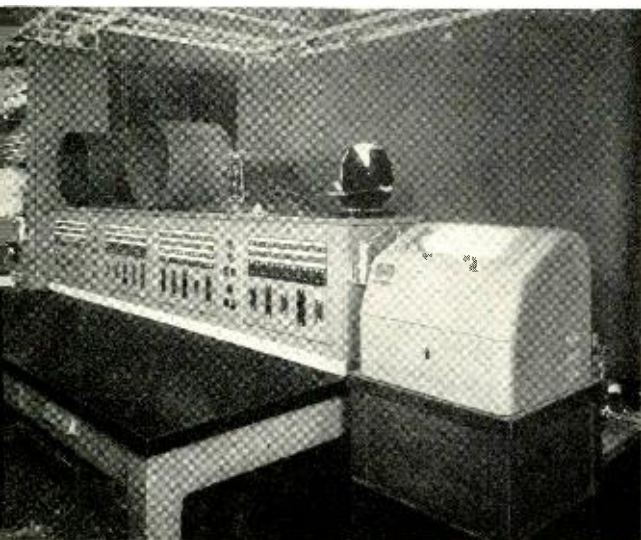
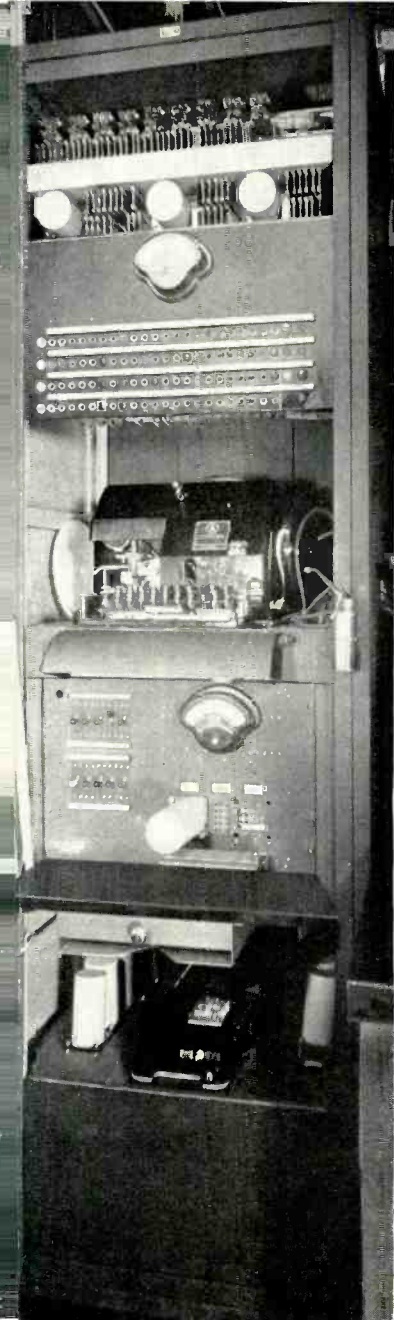

Fig. 8—Test bench and turret with monitoring teletypewriter at right, as installed at Pan American Airways.

single classification. All of such groups could be handled by the multiple-address method, but to do so would not only require the placing of a long list of codes at the head of each message, but would incur the not unlikely possibility of inadvertently omitting one or more of the codes. To simplify the sending of such group messages, the group-code circuit is provided.

Each 81-C-1 installation is divided into an operating room and a switching room. In the operating room are only the teletype-writer machines, the reperforator transmitters, and the control board. All cables in this room are run in fully enclosed ducts, while in the switching room they are supported

on overhead cable racks. A view of the operating room of the Pan American installation is shown in Figure 1. The enclosures for the various units were designed by the Teletype Corporation to meet requirements established by the Laboratories, and considerable attention was paid to appearance.



*Fig. 9
Test cabinet.
April 1950*

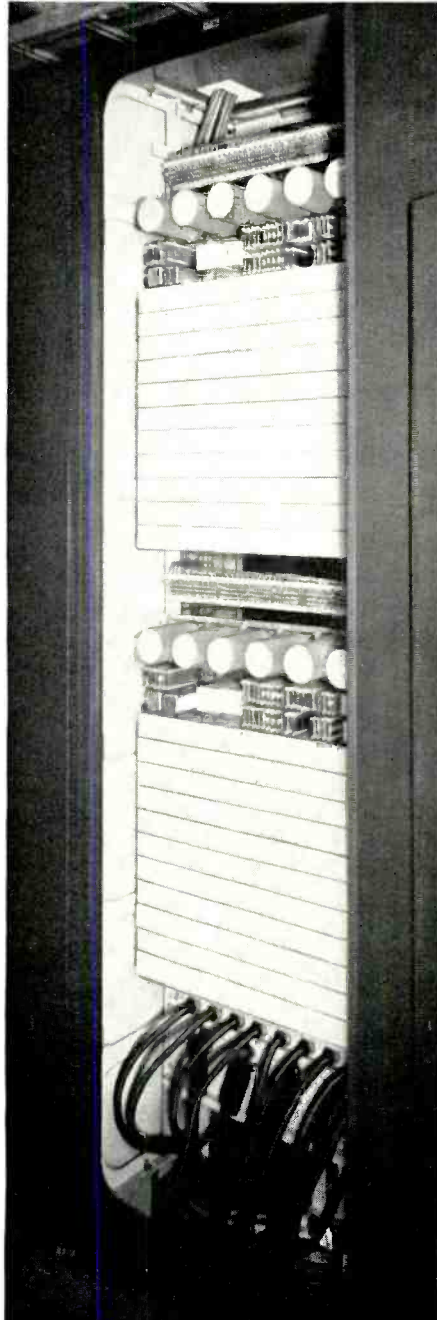

*Fig. 10
First multiple-address cabinet.*

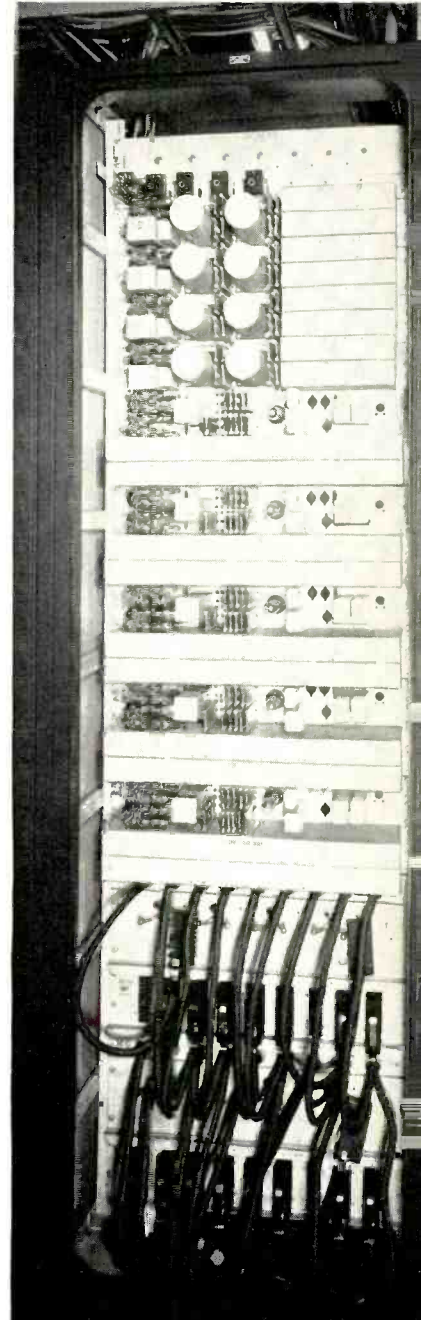

*Fig. 11
Local outlet cabinet.*

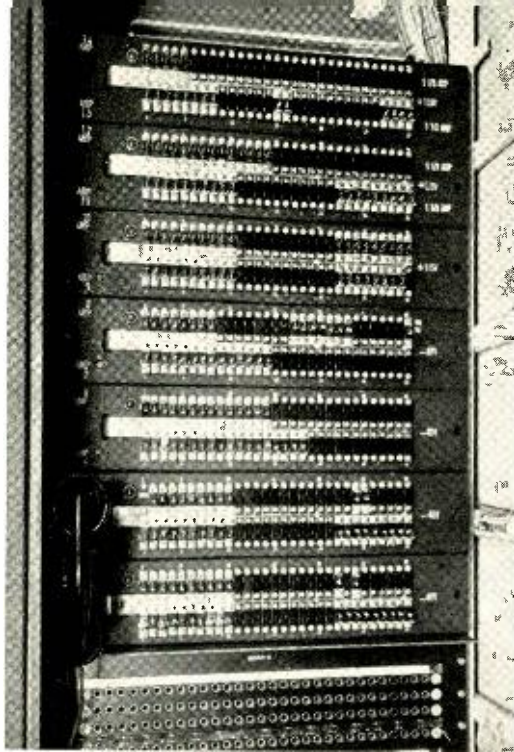

Fig. 12—Upper part of loop cabinet showing fuse panels.

Figure 4 shows the local outlet machines; Figure 5 shows two originating station automatic sending equipments; and Figure 6 shows the control board and the intercept typing reperforators of the switching system.

All the switching, power supply, and maintenance equipment is installed in the switching room. Most of the circuits are arranged as relay rack units, and uniform steel cabinets were designed to enclose them. To permit these cabinets to be carried in elevators and through the usual office building doors, they were restricted to seven feet in height. In some cases, the cabinets are lined up to form the partition between the operating and switching rooms—the space above the cabinets being closed with suit-

able panels. Two colors—gray-green and light brown—are available for all units.

Adequate maintenance facilities are essential to insure continuity of service. These are provided in part by spare relay units and teletypewriter machines for all circuits, with patching cabinets where spare units may be patched into the circuits in place of any unit in trouble. These patching cabinets, shown in Figure 7, are in the switching room where is also a large test bench and test turret, shown in Figure 8, together with storage facilities for spare machines. The test turret, which occupies the rear third of the test bench, encloses suitable test circuits and power supplies for adjusting and testing the machines. Trunks from the patching cabinets also terminate here, and thus the connection from any relay unit may be extended to this point. A number of typical cabinets are shown in Figures 9 to 12, inclusive.

The first installation was for the Pan American Airways system in New York, which was cut into service in October of 1948. Since then, 81-C-1 systems have been installed for the General Motors Corporation with a single switching center in Detroit, and for the Eastern Air Lines with switching centers in New York and Atlanta. A system was installed last year for the Western Electric Company with switching centers at New York and Chicago; and one will shortly be completed for the Ford Motor Company with a single switching center in Detroit. The great versatility of this new system, its high speed of service, and its relative economy of operation make it likely, however, that many additional systems will be installed in the future.

THE AUTHOR: W. M. BACON, after graduating with the E.E. degree from Cornell in 1930, joined the D & R and was concerned with teletypewriter development problems. This work was continued with the Laboratories telegraph facilities group after the 1934 consolidation, and has involved maintenance, repair, and installation methods and procedures as applied to teletypewriters. From 1938 to the present time, he has been engaged in the development of private-wire teletypewriter systems, including full automatic and manual switching systems. During World War II he was engaged in developing teletypewriter cipher arrangements for the Armed Forces.



Multiple close-spaced channels for mobile radio

A. C. PETERSON

Transmission Engineering

Bell System radiotelephone service for trucks and cars was inaugurated in St. Louis by the Southwestern Bell Telephone Company in June, 1946. Since then it has been rapidly expanded until on January 1, 1950 about 140 locations in this country were being served by stations of the Associated Companies. The operating methods and the apparatus employed have already been described in the RECORD.* As originally engineered, the system employed a single transmitting channel and a single receiving channel separated by about 5 megacycles. The single base station transmitter with its antenna was centrally located. Several base station receivers were employed and placed at carefully selected sites through the area served.

Besides the extension of this service to a large number of locations throughout the country, there has been so great a growth in the volume of traffic within many of the cities that additional channels were badly needed. Channels are scarce, however. In the frequency band from 152 to 162 megacycles, which is used to provide this class of service in the larger cities, there are only six channels available. Each of these channels is 60-kc wide, but adjacent channels originally were not assigned to the same city, because of the difficulty of avoiding adjacent channel interference. Two or three channels 120-kc apart had been the best that could be secured. In planning ahead for still further growth, it is hoped to obtain very wide bands at higher frequencies so that multiple channel operation will be possible using a single transmitter and antenna that radiates a large group of channels in much the same way as twelve chan-

nel groups or the much wider supergroups are handled by our broad-band carrier systems. In the meantime some immediate increase in the number of channels has been necessary, and as a result, methods have been devised for using the 60-kc space be-

Fig. 1—Transmitting antenna structure for the six closely-spaced mobile radio channels that are used in Chicago.

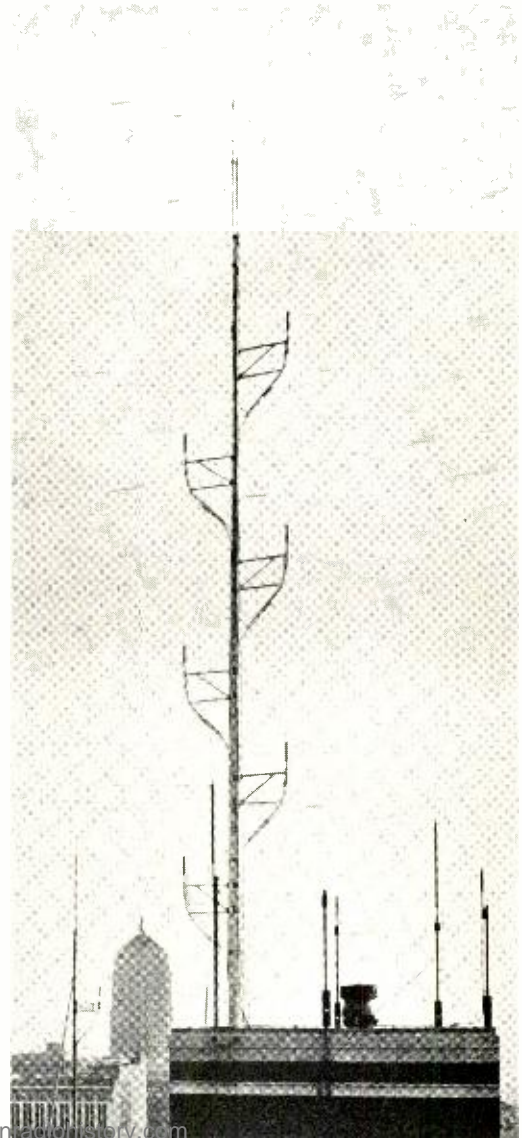

*RECORD, July, 1946, page 267; April, 1947, page 137; June, 1947, page 244; September, 1947, page 330; and October, 1947, page 376.

April 1950

tween the normally assigned 120-kc spaced channels.

A six-channel system of this type requires six antennas and transmitters for the base transmitting stations, and it is necessary to have all the antennas at the same location. If they were at different locations, a mobile unit designed to receive from one transmitter but much closer at the moment to the transmitter for another channel would receive intolerable crosstalk because of the

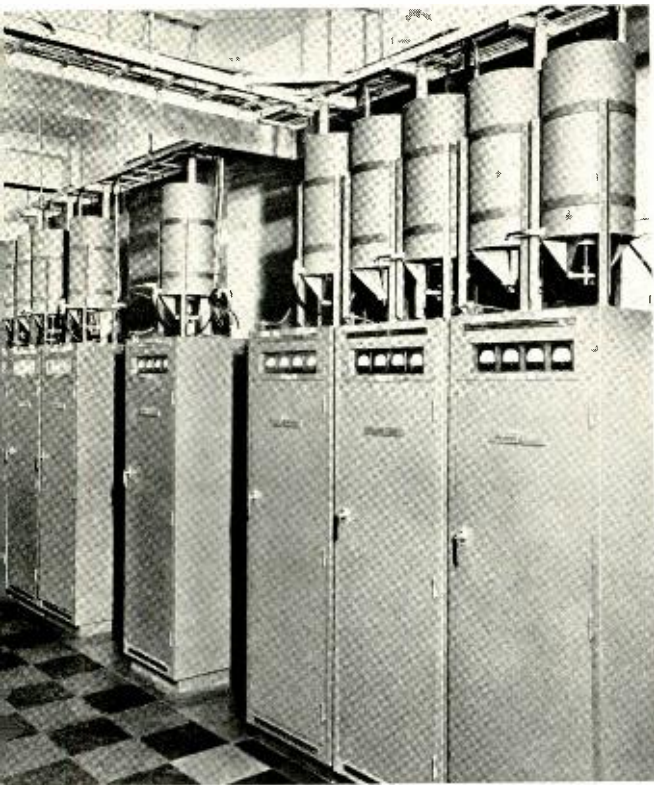

Fig. 2—Tuned cavities mounted above the transmitters in Chicago to attenuate intermodulation products resulting from carrier picked up from adjacent antennas.

much greater strength of the unwanted channel. As long as the signals from two or more stations are received at about equal strength, the wanted channel will take control, and no objectionable crosstalk will be present. One of the first requirements, therefore, is that all the transmitting antennas be at the same location.

For somewhat similar reasons it is desirable to have the carrier for all six channels turned on as long as that of any one is on. If only some of the carriers were on and a mobile subscriber on one of the other chan-

nels should attempt to place a call, the distorted modulation and noise resulting from the presence of the other carriers might be so great that the subscriber would assume that his channel was busy, and abandon the call. A second requirement is, therefore, the coordinated operation of the channels; that is, whenever one channel is turned on, all the others are turned on also, and all are adjusted to radiate about equal power.

With all the transmitting antennas at the same location, one of the first problems to be solved was how to arrange the six antennas to have the least effect on each other. Extensive studies and tests of antenna arrangements were carried out by W. C. Babcock and H. W. Nylund at Murray Hill.* For these tests, the antennas were all mounted on a single pole. For some, they were all mounted on the same side of the pole, while for others they were staggered on diametrically opposite sides. The latter was found somewhat the more satisfactory arrangement, and was adopted. The antenna structure installed for Chicago is shown in Fig. 1.

With antennas mounted in this manner, there is a minimum of coupling between antennas because very little radiation leaves the antenna vertically. With the antennas mounted so close together, however, there will be still an appreciable amount of radiation from any one antenna that reaches the other antennas nearest to it. The resulting voltages induced in the other antennas will be transmitted to the output stage of their associated transmitters where, because of the nonlinear impedance encountered, intermodulation will take place. The intermodulation products then proceed back to the antennas and will be radiated.

It can be shown that if p and q are the carrier frequencies radiated by two such antennas, the most intense and therefore the most important intermodulation products will be at frequencies $2p - q$ and $2q - p$. Depending on the spacing of the two carriers involved, these modulation products may fall from one to five channels above the higher and below the lower of the two channels involved. Many of these products will thus be outside the six channels used, and to avoid causing harmful interference to other

*RECORD, November, 1948, page 456.

services something had to be done to reduce these products to negligible values. This was accomplished by installing tuned cavity filters in the output transmission lines between the antennas and the transmitters. These produce a loss both in the unwanted carrier entering the transmitter from one of the other antennas and in the resulting modulation products passing back to the antenna for radiation. As a result of this added attenuation, all unwanted modulation products are at least 70 db below the carrier level, and thus the requirements of the Federal Communications Commission are met. These tuned cavities in the Chicago installation may be seen above the transmitters in Figure 2.

In a relatively small area around each Bell System base transmitting station, mobile receivers operating in other services which are assigned channels just outside the six channels used by the Bell System, are subject to a limited amount of intermodulation interference caused by receiver overloading. That is, products similar to those described above in connection with transmitter intermodulation may be generated in the mobile receiver. If a receiver operating on one of these foreign channels were very close to a Bell System fixed transmitting station, these products might override the desired signal. A study has shown, however, that these conditions would exist only in about 0.01 per cent of the Bell System coverage area. It has been found, moreover, that if trouble is encountered in these small areas, it may be reduced to harmless proportions by the installation of automatic or manual

radio frequency gain control circuits in the mobile receivers.

There is still one other step that had to be taken to insure satisfactory operation of these close-spaced channels. It was necessary because of insufficient selectivity of the base-station receivers. The traffic operator in a mobile telephone system is notified of a call from a vehicle by a signaling circuit actuated by a reduction in noise output of the detector of a base receiver. This operation takes place when the desired carrier is received in sufficient strength to give acceptable service. It is possible, however, in unmodified receivers, for a strong carrier on an adjacent channel, in the absence of a carrier on the desired channel, to reduce the noise sufficiently to cause a false signal to be sent to the traffic operator. To overcome this fault, a relatively simple "off-channel" squelch was developed. This squelch circuit is so arranged that a signal which is outside the receiver pass band, no matter how intense, is unable to operate the signaling circuit.

With these various steps taken to insure satisfactory service, a close-spaced six-channel system has been in commercial service in Chicago since November, 1948. A similar installation, but employing only three close-spaced channels, has been in service in New York City for about the same period, and a third system is in service in Los Angeles. In these cities, the service provided has been highly satisfactory. Systems of this type will permit doubling the number of available channels in most of the larger cities without any major equipment changes.



April 1950

THE AUTHOR: A. C. PETERSON, JR., received the B.S. degree in Electrical Engineering from the University of Washington in 1928, and in December of that year joined the D & R. With the later consolidation of this department with the Bell Laboratories, he became a member of the Transmission Development Department and in 1940 a member of the Research Department. With these organizations, Mr. Peterson has been concerned with problems dealing with radio transmission and development. During the war he worked on microwave transmission measurements and was a technical consultant to the N.D.R.C. in connection with the development of Loran systems. Since 1945 he has been actively engaged in the development of mobile radio-telephone systems. In 1937 he received the E.E. degree from the University of Washington. He is a senior member of the I.R.E.

155

the seventh digit to give time for an eighth digit to be dialed, while a z indication, which is given when the office code is one not assigned, tells the register to seize a marker after three digits have been received.

Although translation is now commonplace in telephone systems, the method for translating the 576 codes to one of three indications employed by the No. 5 crossbar pre-translator is novel. It permits the translation to be made with much less equipment than would have been required with the more usual method of translation.

Had the usual method of translation been followed, the circuit would have been of the general type indicated in Figure 1. Each of the three digits of the code are transmitted to the pretranslator by the register as ground on two out of five leads. For trans-

multiplied terminals—for the three possible indications to be returned to the register. Jumpers would be run between the bank of 576 and the bank of three terminals to associate each of the 576 codes with its proper x, y or z indication.

With this arrangement there are in all 640 relay contacts and 579 cross-connecting terminals. With the circuit actually used, however, only 288 relay contacts and 219 cross-connecting terminals are required. This great reduction in the amount of equipment was brought about by using the translator circuit indicated in Figure 2.

With this circuit, three codes are translated as a group with one jumper, and thus only one-third as many jumpers need be run as for the arrangement in Figure 1. In spite of this, there is complete flexibility since the translation of one code of a group of three may be changed without affecting the other two codes of the group. Since there are 576 codes in all, there are 192 groups of three codes, and each of the terminals in the column marked c in Figure 2 represents a group of three consecutive codes. The translating jumper wires from these c terminals are not run to the x, y, and z terminals but rather to a bank of twenty-seven p terminals, each of which represents one of the twenty-seven patterns in which three codes may be translated into any of three indications.

The three consecutive codes in any one group may be represented by u, v, and w, where u represents the lowest numbered code of the group and w the highest. The three columns to the right of column p in Table I represent the twenty-seven possible translation patterns for three codes into three indications. In pattern No. 0, for example, all three codes of the group are translated to an x indication. In pattern No. 5, the u code is translated to x, the v code to y, and the w code to z. The column labeled p in Table I represents the number of the p terminal that corresponds to each pattern. If for a particular group of codes the u code requires translation to x, the v code to y, and the w code to z, the c terminal for that group would be jumpered to p5. If it were desired to change the v code of this group to a z translation without affecting the u and w codes, the jumper would be moved from p5 to p8, which represents pattern x, z, z as

TABLE I—THE TWENTY-SEVEN POSSIBLE COMBINATIONS OF THREE THINGS—X, Y, AND Z—TAKEN THREE AT A TIME.

P	U	V	W	P	U	V	W	P	U	V	W
0	X	X	X	9	Y	X	X	18	Z	X	X
1	X	X	Y	10	Y	X	Y	19	Z	X	Y
2	X	X	Z	11	Y	X	Z	20	Z	X	Z
3	X	Y	X	12	Y	Y	X	21	Z	Y	X
4	X	Y	Y	13	Y	Y	Y	22	Z	Y	Y
5	X	Y	Z	14	Y	Y	Z	23	Z	Y	Z
6	X	Z	X	15	Y	Z	X	24	Z	Z	X
7	X	Z	Y	16	Y	Z	Y	25	Z	Z	Y
8	X	Z	Z	17	Y	Z	Z	26	Z	Z	Z

lation by the method of Figure 1, these indications are converted to ground on one lead of each of three sets—one set for the first, or A digit, one for the second, or B digit, and one for the third, or C digit. At the left of Figure 1 are eight B-digit relays, which are operated by the eight B-digit leads. The eight A-digit leads are multiplied to the armature springs of these B-digit relays. There are thus 64 leads leaving the front contacts of the B-digit relays, and each of these is connected to the winding of a relay closing nine contacts. The nine C-digit leads are multiplied to the nine armature springs of each of these latter relays. There are thus 576 (9 x 64) front contacts on the C-digit relays, and they are connected to a bank of 576 cross-connecting terminals—one for each code. Adjacent to these terminals would be three others as shown—or three banks of

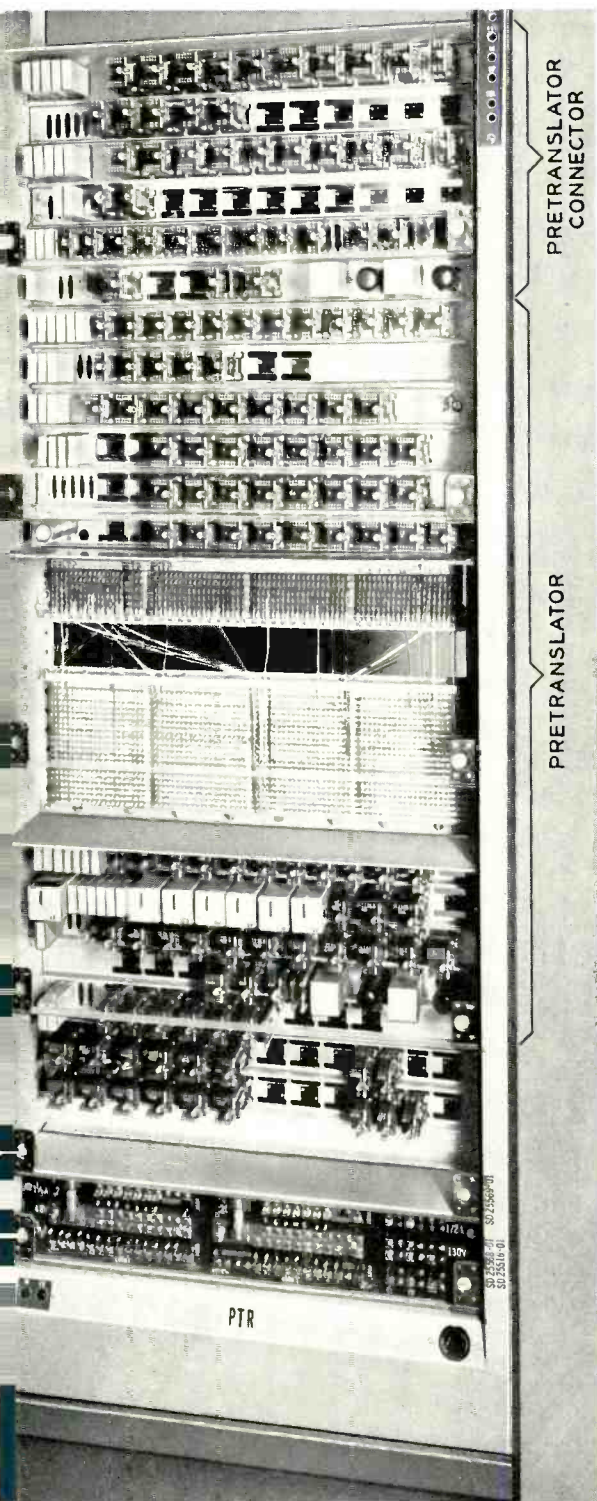

Fig. 3—Lower part of a pretranslator frame. The whole frame is arranged for two pretranslators and two pretranslator connectors.

may be seen in the table. These translating jumpers between the *c* and *P* terminals are the only variables between the input to the pretranslator and the *x*, *y*, and *z* leads, by which the translated information is returned to the register.

To convert the code recorded in the pretranslator to ground on only one of the *c* terminals, eight *B*-digit relays are used as in the circuit of Figure 1, but the *A*-digit leads, instead of being connected directly to their armature springs as in that circuit, are multiplied to the armature springs of a *CR*, a *CS*, and a *CT* relay. The twenty-four leads from the front contacts of these three relays are multiplied to the armature springs of the eight *B*-digit relays. Since a single *U*-type relay will not operate twenty-four contacts, two *B* relays are operated in series by each *B*-digit lead.

Relays *CR*, *CS*, and *CT* are operated from the circuit that records the *c* digit of the code. If the *c* digit is a 1, 2, or 3, relay *CR* is operated; if it is 4, 5, or 6, *CS* is operated; while if it is 7, 8, or 9, *CT* is operated. For each possible combination of the *A* and *B* digits in a code, there are thus three code groups: an *R* group when the *c* digit is 1, 2, or 3; an *S* group when it is 4, 5, or 6; and a *T* group when it is 7, 8, or 9. This group letter is included in the designations of the *c* terminals, which run from 22*R* to 99*T*. The *c* terminals to which the contacts of the *B*₂ relays are connected, for example, will be the twenty-four numbered from 22*R* to 92*R*, 22*S* to 92*S*, and 22*T* to 92*T*—all those, in other words, that have a 2 as the *B* digit.

To distribute the twenty-seven *P* terminals to one or another of the *x*, *y*, and *z* leads, the three relays, marked *CU*, *CV*, and *CW*, are employed. Here also two relays operated in series are used for each designation, since one would not handle the number of springs that are required.

Whether a *P* terminal should be connected to *x*, *y*, or *z* depends on whether the particular code being translated is the first, second, or third of the code group. Since this fact is determined by the *c* digit, the operation of relays *CU*, *CV*, and *CW* is made to depend on whether the code is the first, second, or third of its group. Thus *CU* is operated whenever the *c* digit is 1, 4, or 7, *CV* when it is 2, 5, or 8, and *CW* when it is 3,

6, or 9. It will be noticed in Table I that for P0 all three codes of the group are translated as x; that for P13 they are all translated as y; and for P26, they are all translated as z. These three terminals thus do not need to be carried through the cv, cy, and cw relays since the code is given the same translation whether it is the first, second, or third of the group. These three terminals are thus connected directly to the x, y, and z leads. Each of the remaining twenty-four P terminals is connected to one armature spring on each of the cv, cy, and cw relays, and the front contacts of these relays are connected to the x, y, and z leads as indicated in Table I.

Terminals P1 to P8, inclusive, are connected to the first eight armature springs of each of the three relays; P9 to P17, inclusive, but excluding P13, are connected to the next eight armature springs of each relay; and P18 to P25, inclusive, are connected to the last eight armature springs of each relay. The front contacts of the cv relay are then connected to the x, y, and z leads in accordance with the v column of Table I. Similarly the front contacts of cy are connected according to the y column of Table I, and the front contacts of cw according to the w column.

Suppose, for example, that in code group 325 the first code, 324, requires translation as an x, the second code, 325, requires translation as a y, and the third code, 326, as a z. The c terminal 325 would thus be jumpered to P5, which gives this distribution as may

been seen in Table I. If code 326 were now transmitted to the pretranslator, ground would appear on the No. 3 A-digit lead and the No. 2 B-digit lead. The No. 2 B relay would operate because of the ground on the No. 2 B-digit lead, and the cs and cw relays would operate because the c digit was 6. The ground on the No. 3 A-digit lead would thus be extended through contacts of cs and B2 to c terminal 325, thence over the jumper to P5, and thence through a contact on cw to the z lead.

Two of these pretranslator circuits and two pretranslator connectors are mounted on a single frame. The lower part of such a frame, with one pretranslator and one connector, is shown in Figure 3. Both circuits are protected by time alarms as are other common control circuits, and are arranged for the second trial feature. The pretranslator has access to the trouble recorder so that records of failures may be made. A number of additional safeguards have been provided in the design of these circuits to minimize the likelihood of trouble.

The pretranslator circuit operates in about 0.160 second, and is rated at 15,000 calls per hour—probably the highest usage of any telephone circuit. One pretranslator can carry the traffic in most offices, and two are sufficient for a marker group in any case. One additional circuit is provided for maintenance, however, and thus there will always be at least two pretranslators in an office. There are always as many connectors as there are pretranslators.



THE AUTHOR: R. C. AVERY was associated with the Installation Department of the Western Electric Company from 1922 to 1927, and with the Plant and Engineering Departments of the New York Telephone Company from 1927 to 1945, when he was transferred to the Laboratories. While with the Laboratories, he has worked on No. 5 crossbar system circuits, having developed the marker translator, the master test frame connector, and the pretranslator and pretranslator connector circuits. At present he is designing test circuits for the No. 5 system.

Ten years' service justifies designers' confidence

All broadband carrier systems employ the same system unit of twelve channel modulators and filters, known as a channel bank.^o These carrier systems are all designed to transmit only the high frequencies essential to the message. The carrier frequencies of the individual channels need not be transmitted, and indeed it is important that the amount of carrier frequency that leaks onto the line be kept below a specified amount.

Any economical arrangement for reducing the carrier frequencies to a suitably low value at the transmitting end of a system requires that the channel modulators themselves supply part of the suppression. In most circuits, this means that some elements must be and continue to be sufficiently like other elements electrically so that a cancellation or balance at the carrier frequency will be maintained. Experience with earlier carrier telephone systems

employing electronic tubes as modulating elements had indicated that considerable maintenance was necessary to provide this carrier balance. With the number of channels per system increasing rapidly in each new design, it was important to reduce this maintenance.

During the middle thirties, intensive laboratory investigations were made of the suitability of copper oxide as modulating elements. Early prospects were encouraging, and a number of improvements in the copper oxide unit and in the circuits employing them resulted in a laboratory modulator that appeared to be ready for commercial use. Accelerated life tests and other rough laboratory treatment convinced the design engineers that they had a promising model.

The best information available indicated that with these new modulators provision for balance adjustment would not be needed, although incomplete life data did not permit this to be definitely established. In

continued on page 171

^oRECORD, April, 1937, page 242; April, 1938, page 260; May, 1938, page 315.

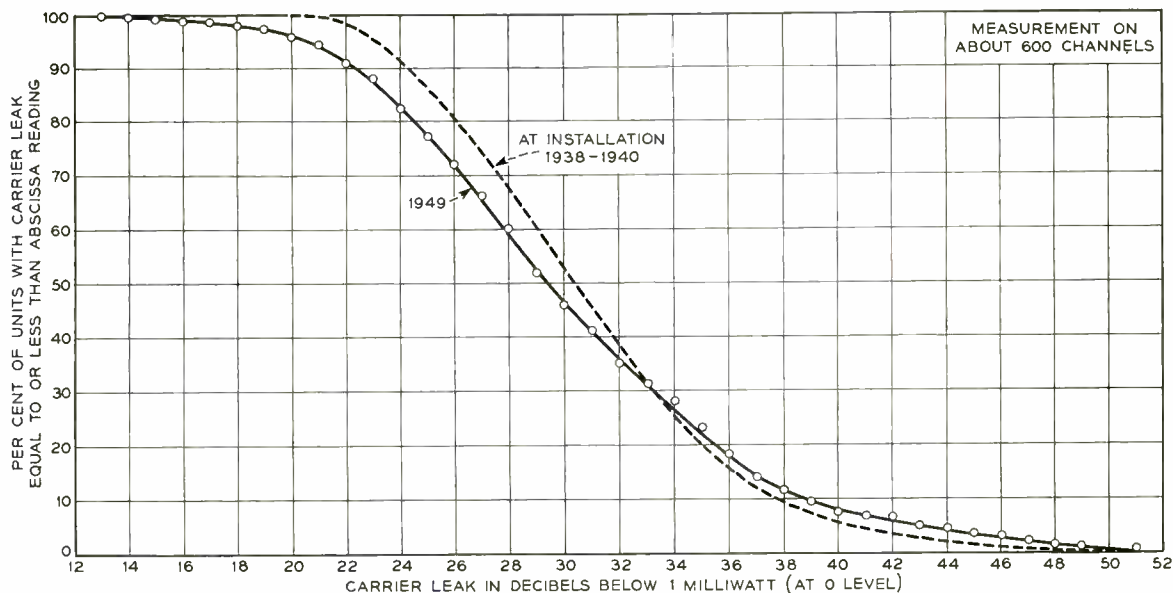

Line-of-sight relay systems — Old and new

L. ESPENSCHIED

Research
Consultant

What is the first of the three pictures you see on these pages? A modern television receiver with a doublet antenna such as decorates many homes today with the observer searching for the illusive picture through a telescope?

Far from being such a flight of the imagination, this is a factual image of the beginning of our modern age of telecommunications. Figure 1 is from a little English book of 1795 containing an article entitled *Observations on the Telegraphe* which was then

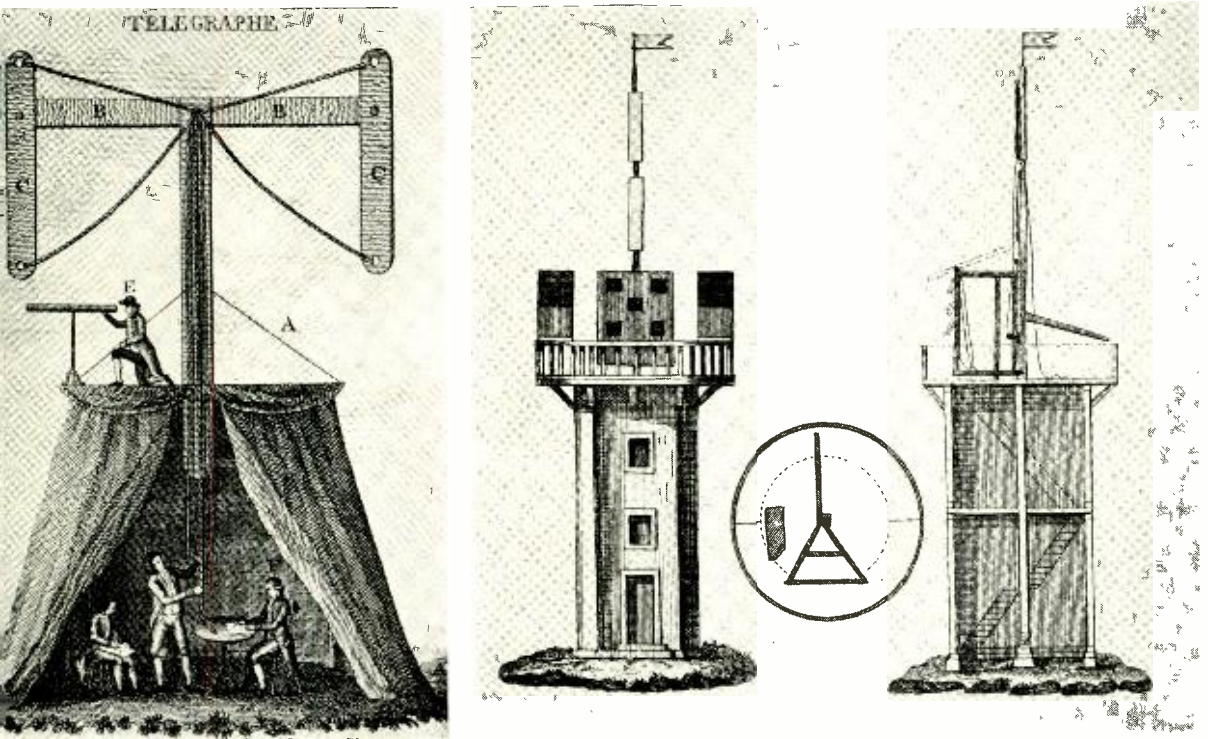

Fig. 1 (left)—The term “telegraph” originally applied to this semaphore kind of relay system. Fig. 2 (right) —Another kind of visual telegraph station, from a rare German book of 1795.

The man at the telescope (left) reads the signal arm position of the preceding station. The man at the ropes then repeats this setting to be read at the succeeding station. The scribes record the successive settings, but they cannot understand the message, for the key to the code is confined to the correspondents at the terminals! From an English book of 1795, entitled *Entertaining Extracts*.

In the view at the right, the flag is flown when communication is desired and during its progress. The signaling is done by either the arms, here lying vertical on the pole, or the rectangular window shutter arrangement. This system is based upon the telescope, as radio systems are upon the vacuum tube. In appearance a striking reminder of our modern radio relay station.

being developed in France, the visual form of telegraph which preceded, and gave name to, the electric telegraph. A succession of such stations formed great relay chains across parts of Europe early in the 19th century, used largely for strategic purposes.

The diligent "technical assistant" is peering through the telescope reading the signal of the station preceding him in the chain, perhaps five miles distant. Upon identifying the signal, he calls it out to those below. The scribes record it. The man at the rope immediately resets it on his transmitting arms and the signal goes out afresh.

Experts in modern "communication theory" will recognize the signals to be discrete ones, "quantized" now called, and the relay station to be of the "regenerative" type. The signal is not passed along just as it comes in, with such uncertainty as may exist due to poor visibility; instead it is called by the observer as a particular one of a series of signals and sent out as such.

The second of the pictures, Figure 2, presents another form of visual relay station, taken from a rare German book of 1795. The masthead flag is flown when communication is desired and while in progress. This station has two facilities for transmitting. One comprises the two arms which here lie vertically above each other on the pole. The other is the rectangular window shutter arrangement, shown to have five signal units.

The appearance of these old stations on high ground is strikingly reminiscent of a modern radio relay station with its projectors, as illustrated in Figure 3. This is one of the microwave stations on the New York-Boston radio relay system.

How was it that Man should leave the line-of-sight relay system a century ago and now find his way back to it? The answer encompasses the entire history of electric communications.

In the first place, while the visual relay system was being extensively developed in Europe in the early 1800's, already in pure science there was being laid the basis of its successor, in the discovery of the new electric medium of the galvanic current and electromagnetism. Then came the electric telegraph. True, the new system had to have provided for it a man-made path, the maintenance of which was difficult in the days

preceding ready overland travel. But it was a path free of weather uncertainties, and one over which the signal traveled likewise with the speed of light. The instruments were fleet in dispatching signals. The direct current, a carrier of zero frequency, was keyed or modulated at the hand frequency of about ten per second. In time came the control of the current at the vibrational rates of sound, and the telephone was born. Unknowingly there had begun a march from zero frequency back up the scale toward the original light frequencies.

Great was the jump up the frequency spectrum given by Hertz in the discovery of the all-electric oscillator, free of mechanical inertia and capable of frequencies of hundreds of megacycles. A long line of scientific inquiry in what proved to be a collateral



Fig. 3—Modern microwave radio station on the New York-Boston relay system.

One pair of projectors represent go and return in one direction, the other pair go and return in the other direction, with the relay path here turning a corner. Microwaves are turned around corners as are light waves: namely, by being re-emitted, here with needed amplification.

stream of advance yielded the vacuum tube and started the age of electronics. There ensued a great new era in electric communications, that of high-frequency systems, radio and wire. The new electronic technique, born first at moderate frequencies, has gone on to the thousands of megacycles, so-called "microwaves." Too short to bend around ordinary obstacles, these waves require line-of-sight paths and optical methods in projection and reception.

Thus has technical history repeated itself, in a measure, as we have gone from light frequencies down to zero frequency and back up to light-like radio waves. The turnaround has been more like a spiral than a circle since we have reached far ahead in attaining freedom from weather interference and enormously increased intelligence-carrying capacity. Line-of-sight relaying today conveys not only telegraphy but telephony and even sight itself.

THE AUTHOR: LLOYD ESPENSCHIED, after experience with amateur experimentation and as a wireless telegraph operator at sea, entered Pratt Institute and graduated in 1909. Following a brief period with the Telefunken Company providing radio equipment for the Army and Navy, he joined



the A T & T, working first on loading coils. He then began an active and prolific career in radio and all phases of high-frequency transmission. He played a prominent part in the early radio telephone tests between Washington, Paris, and Hawaii, in the development of ship-to-shore radio telephony, in the company's early participation in broadcasting, and in carrier telephone developments. He was one of the inventors of the coaxial transmission system and was largely responsible for pushing its early development. The quartz crystal band filter was one of his many inventions. He was one of the first to suggest the use of reflected waves to determine distance, which took practical form in the airplane altimeter and—in radically different form—became the basis of radar. Transferring to the Laboratories with the D & R in 1934, he was Director of High-Frequency Transmission until 1939. Since then, he has served as Staff Research Consultant. He is a Fellow of the A.I.E.E. and the I.R.E. One of the founders of the I.R.E., he is a recipient of its Medal of Honor.

Fine-wire type vacuum tube grids

Since its first use in the De Forest Audion, the control grid of vacuum tubes has gone through innumerable changes. Its function is to provide a control voltage in a plane parallel and close to the cathode. In doing this, however, it should not block the passage of electrons emitted from the cathode. These two major requirements are partially contradictory. To provide a perfectly uniform voltage in a plane parallel to the cathode would require a solid sheet of metal, but since such a structure would defeat its purpose by blocking all electrons emitted from the cathode, a grid of wires is necessarily used instead of the solid sheet. This gives space between the wires for the electrons to pass through, and by placing the wires close together, uniformity in voltage is approached. An additional complication enters here because as the wires are spaced closer together to secure a more uniform voltage, they must become smaller; otherwise the ratio of open to blocked space would become too small. There are limits, however, to the size of wire that can be obtained and handled.

Still other difficulties arise in attempting to keep the grid at uniform distance from and close to the cathode. Vibration or sagging of the wires destroys their uniform distance from the cathode, and the closer the spacing, the more stringent must be the restrictions. As the grid-cathode spacing becomes smaller, moreover, the effect of the hot cathode on the grid introduces still further difficulties.

With the development of the 6AK5 tube* during the war, the limit seemed to have been reached in the smallness of the wire and of the grid-cathode spacing with conventional grid construction. The wire was only 1 mil in diameter and wound 200 turns to the inch, while the spacing between grid

and cathode was only 3.5 mils. Wire of this size corresponds to about No. 49 B & S gauge—finer than the smallest magnet wire—and with only 3.5 mils between grid and cathode, a vibration or sag of only the diameter of the wire is a large percentage of the total grid-cathode spacing.

The construction of the 6AK5 grid is indicated in Figure 1. One mil tungsten wire is wound around nickel side rods 15 mils in diameter and 85 mils apart. Notches in the side rods into which the wire is swaged as it is wound hold the wires in place. So fine

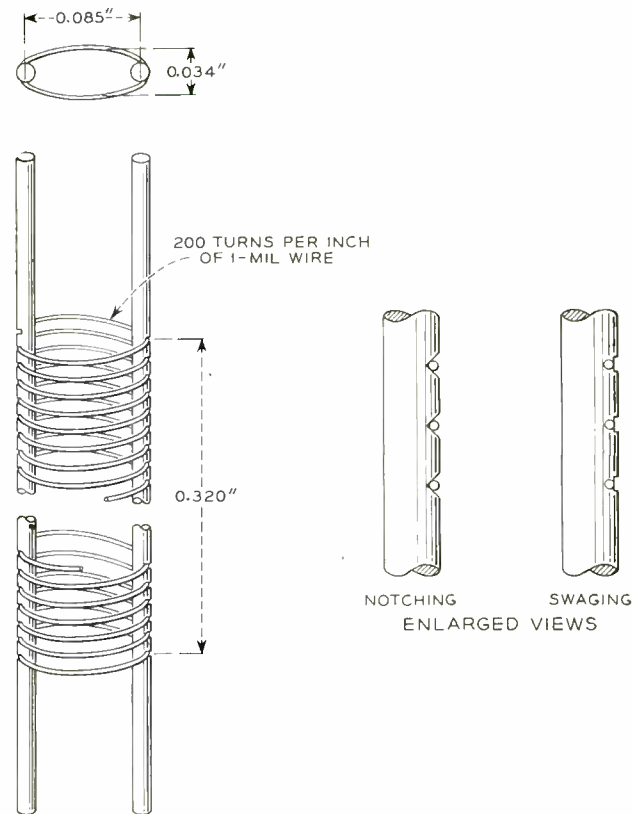

Fig. 1—Grid construction used with the 6AK5 tube. The wires are held in place by notches in the nickel side rods.

*RECORD, November, 1944, page 605.

is the grid wire and so small is the grid-cathode spacing that watch-making precision is required in constructing the tubes. In spite of the difficulties in manufacture, however, it has been possible to produce grids of this type commercially and in large quantities, and they have now become conventional in many types of tubes.

Although the limit seemed to have been reached with the 6AK5 grid, the need for broadband high-frequency tubes with high gain called for still finer wires and closer spacing. To attain these finer wires and closer spacings, however, entirely new techniques were required. In the structure of Figure 1, the grid wires are only 5 mils apart, and if much closer spacing were to be used, the wires could not be held by notching and swaging since the cutting of one notch would affect those adjacent to it. With closer spac-

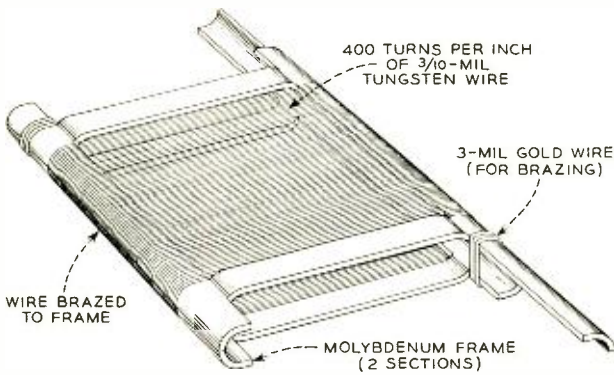

Fig. 2—Grid construction used with the 404A tube. The wires are wound under tension and then gold brazed to the supporting structure.

ing, moreover, the wires would be finer, and the handling, winding, and fastening of wires below a mil in diameter presented innumerable difficulties. At these microscopic diameters the wires are invisible under ordinary shop conditions. Only when a bright light is directly reflected from them to the eye can they be seen at all. To keep such very fine wires from sagging or vibrating into contact with adjacent wires or the cathode, they would have to be wound under high tension. This brings in still other difficulties, such as maintaining a high and well-controlled tension during winding, and obtaining sufficient stiffness in the frame to prevent its bending under the combined pull

of the many wires under high tension.

In spite of these serious difficulties, developments looking towards the finer grid structures were undertaken, and considerable success has been achieved. The first outcome of this project was the 404A vacuum tube.* For the grid of this tube, the wire used is only 0.3 mil in diameter—less than 10 per cent of the size of the 6AK5 wire in cross-section area. It is wound with about 400 turns per inch and has a grid-cathode spacing of only 2.5 mils—an increase of 100 per cent in the number of turns and a reduction of nearly 30 per cent in the grid-cathode spacing.

To maintain this close grid-cathode spacing within satisfactory limits while the wire is subjected to electrical and mechanical vibrating forces and to the intense heat of the cathode, only very strong and stiff wire could be used, and it would be necessary to wind it under nearly its maximum safe tension. With a tensile strength of approximately 530,000 pounds per square inch, tungsten is the only metal available in wire of this size with sufficient strength, and calculations indicated that it would have to be wound under a tension over 300,000 pounds per square inch. For the wire size used, the tension is about one-third ounce.

With tungsten grid wires as close to the cathode as they are in the 404A tube, primary emission from the grid would occur because of heating by the cathode if preventive steps were not taken. Such emission cannot be tolerated because it would seriously increase the noise of the tube and might even result in the loss of the grid control action. It has been known for some time that a thin coating of gold will suppress this emission, and it was thus decided to form a gold surface on the grid wires.

Since grid wires of this size and spacing cannot be swaged to the side rod as were the wires of the 6AK5 grid, and since it had been decided to use a gold coating on the wires, it was decided to fasten them to the supporting frame by gold brazing. This decision somewhat affected the choice of the type of the supporting frame to be used, but the major factor was that it had to be stiff enough to support 400 turns of wire per

*RECORD, February, 1949, page 59.

inch with each wire stretched to a tension of 300,000 pounds per square inch. As a result, the frame structure shown in Figure 2 was developed.

Tungsten would have been the ideal material for the frame both because of its high strength and because with both wire and supporting frame of the same material, there would be no differential expansion of the frame and wires during the brazing process. Unfortunately, however, tungsten sheet now available cannot be blanked and formed economically. It is too hard and brittle. Molybdenum was thus chosen as the next best material. The two halves of the frame are clamped together during winding, and the tension in the wire holds them together until the brazing operation is completed. Prior to brazing, a short piece of gold wire is wound around diametrically opposite legs of the structure as indicated in Figure 2. The entire grid is then put in an oven at a carefully controlled temperature high enough to melt the gold. On melting, the gold brazes the two halves of the grid frame together, and also flows out on the grid wires—evenly coating them to a thickness of only 0.02 mil.

Practically all of the steps in developing the 404A grid have been taken in largely unexplored territory. Only comparatively

recently has it been commercially practicable to obtain tungsten wire as small as 0.3 mil. The smallest wire drawn is 0.45 mil, and smaller sizes have to be obtained from 0.45 mil by etching. To secure uniform diameter and tensile strength by this process is difficult. Both the brazing and plating processes, and the tensioning arrangement for the wires, were successful only after a long and painstaking development as was the technique of handling the very small wire.

One of the major difficulties was the design of the supporting frame. In many ways it would have been preferable to use cylindrical side rods as in the 6AK5 tube, since the diameter of the side rods fixes the distance between the two sides of the grid and the diameter of the rods can be ground to very high precision. Because of the high tension in the wires, however, the rods would have had to be held apart by cross bars, and to secure adequate strength, both rods and cross bars would have to be of molybdenum. At that time, however, no satisfactory method had been developed for welding molybdenum to molybdenum. This difficulty was later overcome, and in the 418A tube the frame consists of molybdenum side rods and cross bars. This grid is larger than that of the 404A, but the wire size and spacings are approximately the same.



April 1950

THE AUTHOR: E. J. WALSH joined the Laboratories as a Technical Assistant in 1928 and became a Member of the Technical Staff in 1939, studying mechanical engineering at the Cooper Union Night School of Engineering during the intervening years. His first years at the Laboratories were devoted to the construction of various types of glass envelopes for vacuum tubes. Following that he worked on the mechanical design of small vacuum tubes. During the war, his efforts included structural design work on magnetrons, proximity fuse tubes, and reflex oscillators. Since the war, his design work has been on small close-spaced vacuum tubes all of which use the fine wire grids. Tubes of this type have been under development for the radio relay systems and the projected L3 carrier systems.

167

Ringling selection in No. 5 crossbar

M. C. GODDARD

Switching
Development

In supplying telephone service under the wide range of conditions encountered, it is often necessary to connect more than one subscriber to a single line. From the point of view of the number of subscribers per line, five types of lines are available at present for No. 5 crossbar: single party, two party, four party, eight party, and ten party. Four party lines may be either of two types: one having full and the other semi-selective ringing. With full selective ringing, each subscriber hears ringing only when his station is being called, while with semi-selective ringing, each subscriber hears the ringing for his own and one other station. On individual, two party, and four party full selective lines, therefore, each subscriber hears only his own ringing, while on four party and eight party semi-selective lines he hears also the ringing for one other party, and on ten party lines he hears the ringing for four others. Coded ringing is used to identify the party called, and the five codes indicated in Figure 1 are employed in the No. 5 crossbar system.

This group of codes has been arranged so that it may be used for all these types of lines. Individual, two party, and four party full selective lines use only code one. Eight

party and four party semi-selective lines use codes one and two; only ten party lines use all five codes.

On party lines, half of the subscriber stations are arranged to be rung over the "ring" conductor, and half over the "tip" conductor. On eight party lines and four party full selective lines, a further limitation in the ringing a subscriber hears is made possible by superimposing the interrupted 20-cycle ringing on either negative or positive d-c. All ringing is superimposed on a d-c component to permit the tripping relay to operate when the subscriber answers, and the normal d-c component is negative; only for eight party and four party full selective is the positive superimposed ringing employed. To specify a ringing code completely, therefore, it is necessary to state the side of the line to which the ringing is applied, whether it is negative or positive superimposed, and the particular one of five codes of Figure 1 that is employed. There are thus in all fourteen types of ringing used at present in No. 5 crossbar, and they are indicated in Table I.

Although very few central offices serve lines of all these types, they frequently have more than one type of line, and the proper type of ringing must be selected for each call. Means must be provided at a central office for selecting and applying ringing to any line, but since this equipment is used only for a brief period in each call, it would in general be uneconomical to associate these circuits with each line. In the step-by-step system they are associated with the connectors, while in the panel and No. 1 crossbar systems, they are associated with the incoming trunk circuits. These latter systems rarely have eight or ten party lines, and thus the equipment for selecting ringing consists of only a few relays. In the rare cases when eight or ten party lines are required, the additional ringing selecting equipment is associated with only the few lines that require it.

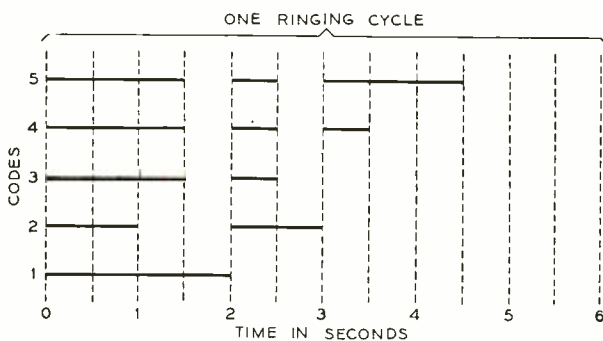

Fig. 1—The five basic ringing codes used by the No. 5 crossbar system.

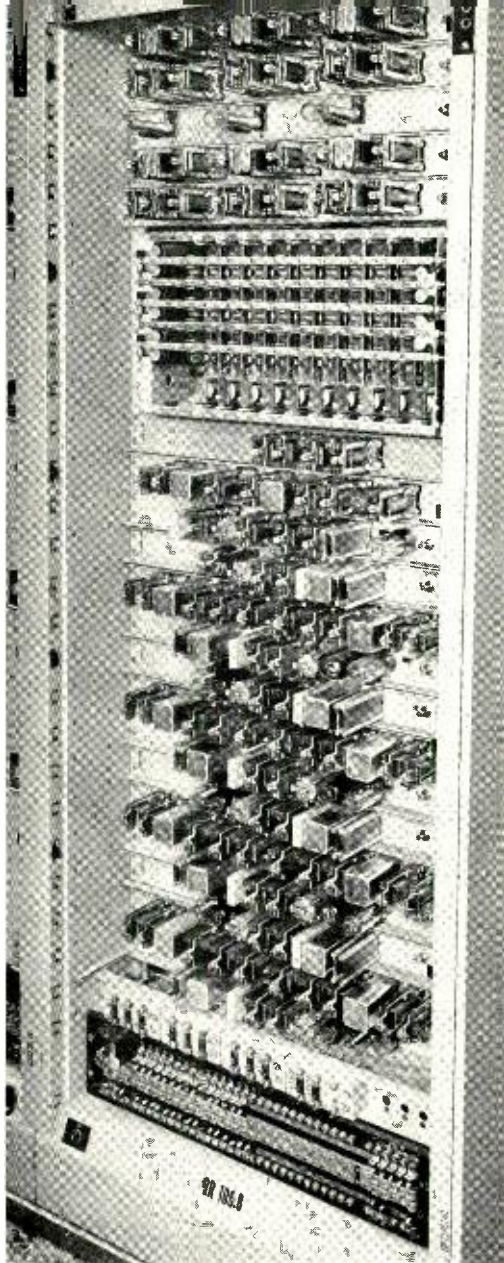

Fig. 2—Lower part of trunk bay showing one ringing switch.

The field of use for No. 5 crossbar offices, however, includes the suburbs of metropolitan centers, and these offices may commonly serve eight or ten-party lines in addition to one, two, and four-party lines. The selecting equipment is associated with the trunk as in the No. 1 system, but all fourteen types of ringing are made available to each trunk. Instead of using a relay circuit, however, a crossbar switch is used to apply the ringing. The trunk circuits are installed on twenty-three inch relay racks. A ten-vertical crossbar switch is used for each ten trunks requir-

ing ringing. Each trunk circuit is associated with a switch vertical to select any one of the required types of ringing. A complete bay of this type will carry twenty or thirty trunks maximum, depending upon the amount of equipment in the trunk circuits, and will thus use either two or three crossbar switches. The lower part of such a bay is shown in Figure 2. The crossbar switch shown serves the ten trunks mounted beneath it—two trunks being mounted on each set of three mounting plates.

A simplified schematic of the circuit employed is shown in Figure 3. Levels 0 and 1 are used to apply ringing to either the tip or ring conductors of the line and ground to the other. When crosspoint 0 is closed, ground is applied to the tip conductor and ringing to the ring conductor, while when

TABLE I—THE FOURTEEN TYPES OF RINGING OF THE NO. 5 CROSSBAR SYSTEM

Code	Polarity	Side of Line	Ind. Line	Two Party	Four Party Semi	Four Party Full	Eight Party	Ten Party
1	—	R	X	X	X	X	X	X
1	—	T		X	X	X	X	X
1	+	R				X	X	
1	+	T				X	X	
2	—	R			X		X	X
2	—	T			X		X	X
2	+	R					X	
2	+	T					X	
3	—	R						X
3	—	T						X
4	—	R						X
4	—	T						X
5	—	R						X
5	—	T						X

the No. 1 crosspoint is closed, ground is applied to the ring conductor and ringing is applied to the tip. Levels 2 to 8, inclusive, select the seven types of ringing supplied by the ringing power plant: negative superimposed code 1, positive superimposed code 1, negative superimposed code 2, positive superimposed code 2, and negative superimposed codes 3, 4, and 5.

Under direction of the marker, the crosspoint for either the No. 0 or No. 1 level is operated and also the crosspoint for one of the levels from 2 to 8 depending upon the type of ringing required by the party being called. Closure of the crosspoints of any of

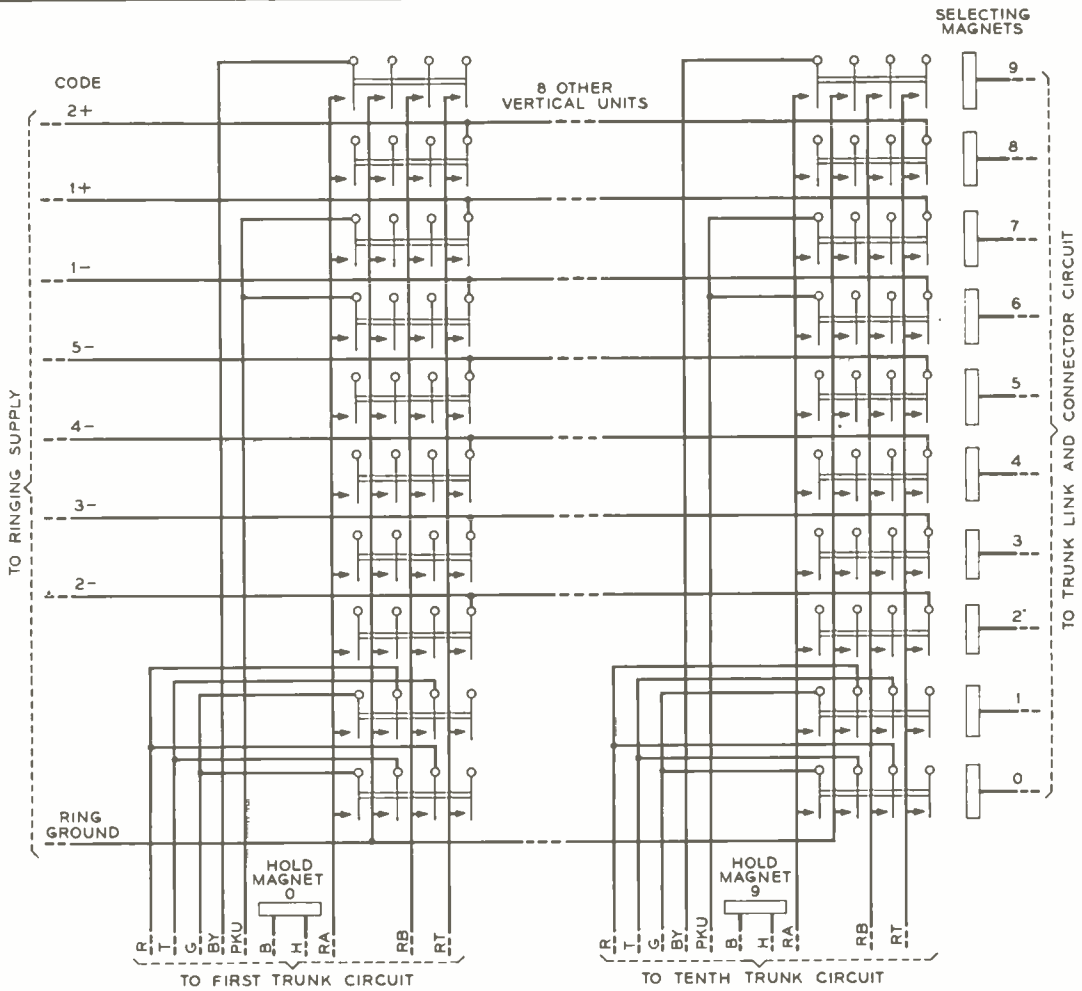

Fig. 3—Simplified schematic of ring circuit in a No. 5 crossbar office.

the levels from 2 to 8 connects the selected code ringing supply to the RT lead to the trunk. Here it passes through the ringing trip relay and back to the crossbar switch over lead RB. Through the crosspoints of the No. 0 or No. 1 level, the RB lead is connected to either the ring or tip conductor of the subscriber's line, and ground is connected to the other lead of the line. Also through the contacts of the No. 0 or No. 1 crosspoint, ground from the trunk circuit over the C lead is connected to the RA lead, whence it returns to hold the trunk in the ringing condition until ringing is tripped or the call is abandoned.

When a line requires code 2, 3, 4 or 5, ringing is connected to a line only at the start of a complete ringing cycle so as to

avoid a partial code from being sent over the line, which might be misinterpreted by the subscriber. This means that there may be a delay of a few seconds before ringing is started. With code 1 ringing, however, there is no possibility of the code's being misinterpreted since it consists of only one ring, and if the first ring were shorter than the others, no confusion would result. For either 1- or 1+, therefore, the code ringing supply is connected at once without waiting for the end of the ringing cycle. This is brought about by using other contacts of the No. 6 and No. 7 crosspoints, which apply codes 1- and 1+, to connect the ground on the RA lead to the PKU lead. Lead RA is grounded by the closure of the crosspoints on levels 0 or 1, and this ground on the

THE AUTHOR: M. C. GODDARD received a B.S. degree in electrical engineering from Worcester Polytechnic Institute in 1921, and then joined the Engineering Department of the Western Electric Company, which later became the Bell Telephone Laboratories. With the Systems Development Department, he engaged in circuit design and development on a wide variety of projects. During World War II he was associated with the School for War Training—in both teaching and supervisory capacities. Since the end of his war work assignment in 1944, he has been on circuit design problems for the crossbar system now designated “No. 5.”



PKU lead tells the trunk to start ringing without waiting for the end of the cycle.

Level 9 on the crossbar switch is not required for applying ringing, and is therefore employed—in conjunction with No. 0 or No. 1 crosspoints—to indicate busy and overflow conditions. If the line called is found busy, the marker, instead of operating one of the ringing code crosspoints, will operate the No. 9 crosspoint and also the No. 1 crosspoint. Closing the No. 1 crosspoint connects ground from the trunk over lead G to the RA lead, and closing the No. 9 crosspoint connects this RA lead to the BY lead. Ground on the BY lead will operate the BY (busy) relay in the trunk circuit.

If the line had not been busy, but the marker had not been able to find a path to it from the trunk link frame, it would have operated the No. 0 and the No. 9 crosspoints.

Closure of the No. 9 crosspoints operates the BY relay in the trunk as before, but closure of the No. 0 crosspoint has connected ringing ground to the tip lead of the trunk. Under these conditions the TC relay is operated in the trunk as well as the BY, giving an overflow instead of busy signal.

Since the ringing selection switch is wired for all types of lines up to and including eight and ten party, there are no ringing options to be selected in furnishing trunk circuits and associated ringing selection switches, and the engineering and installation is simplified. The only variation in an office is in the types of ringing supply. Systems with eight party lines or four party full selective lines require superimposed positive ringing codes and superimposed negative, but where there are none of these lines, superimposed positive codes are not required.

continued from page 161

view of the undesirability of encumbering thousands of modulators with unnecessary adjustment provisions, and of the possibility that the adjustable elements might differ in aging characteristics from the modulators themselves—and thus while satisfactory when installed might be unsatisfactory some years later—it was decided to produce the circuits without balancing adjustments.

Since that decision was made, there have been approximately 60,000 modulators installed. Recently measurements were made on 600 modulators that had been in service for approximately ten years. The results of these measurements compared to the initial measurements are shown in the distribution

curves on page 161. The abscissa scale indicates the amount of carrier leak measured at a reference point in the system, while the ordinate scale indicates the percentage of units that had leaks greater than the value on the abscissa scale at the corresponding point. The curves indicate that the modulators have not changed a significant amount, statistically, in the ten-year period.

This record of outstandingly good performance in service is gratifying to those who recommended introducing into the Bell System plant a simple modulator without balancing adjustments although the successful operation of the circuit depended upon the maintenance of a balance over a period of years.



G. T. Selby Appointed Comptroller

At a meeting of the Board of Directors held on February 27, G. T. Selby was appointed Comptroller, succeeding A. O. Jehle who died on February 10.

Mr. Selby was graduated from the University of Pittsburgh in 1920 with the degree of B.S. in Economics—his college work having been interrupted by two years of service in the Army during World War I. After two and a half years with the Guaranty Trust Company, he joined the Accounting Department of what is now the Laboratories. From 1922 to 1940 he was chief statistician in charge of budgets and statistics. Then, for a little over a year, he was assigned to personnel planning in the Personnel Department. Late in 1941 he returned to the Accounting Department as Assistant General Auditor in charge of corporate, cost and plant accounting, budgets and statistics.

In 1945 he became Equipment Investment Manager and a year later, Staff Manager in the General Staff Department. Here, in addition to his work on equipment investment and general methods, Mr. Selby carried broad responsibilities for budget and personnel studies for the department and served as chairman of the Committee on Non-Technical Staff Activities, the Space and Facilities Committee and the Car Committee. He was also a member of the Clerical Salary Committee.

Mr. Selby's principal outside activity is as a member of the National Board of YMCA's. He has also been active as a member of the World Service and Finance Committee of the Newark Conference of the Methodist Church and has served in several civic enterprises in his home community of Madison, N. J.

Dr. Buckley Concludes School Board Service

In February, Dr. Buckley completed twelve years of service as a member of the Board of Education of South Orange and Maplewood. During the last two years he had served as President of the Board.

In recognition of his service to the school district, the Board passed a resolution of appreciation "with confidence that it also expresses the appreciation of each resident of Maplewood and South Orange for the many years of service which Dr. Oliver E. Buckley has given to this Board." The resolution cited "the intelligent leadership he has exerted during all of this period . . ." and "the high ideals which have always been his own goal and which he helped the Board to maintain."

Laboratories Men Visit Europe

M. J. Kelly, A. C. Keller and H. H. Schneckloth sailed for Europe on March 3 aboard the *Queen Mary*. Dr. Kelly has been visiting universities and telephone administrations' research organizations in western Europe. He spoke before the Royal Society meeting in London on March 23 on the subject, *The Bell Telephone Laboratories—An example of an Institute of Creative Technology*.

Mr. Keller visited telephone administrations' research and manufacturing organizations in France, Switzerland, England, Sweden and Belgium. Mr. Schneckloth discussed switching system developments with representatives of telephone administrations and manufacturers in Sweden, England, France, Belgium, Holland and Switzerland. The itinerary was so arranged that the three also met at key cities on the continent during their visit.

The Murray Hill Chorus

The Murray Hill Chorus has been working steadily on its spring programs since early January. On April 30, the Chorus will present a program at Lyons Veterans' Hospital for the third successive year. The fifth annual Spring Concert has been scheduled tentatively for May 17 at the Summit High School.

Bell Laboratories Record

Employees' Benefit Committee Annual Report—1949

Each year at this time the Employees' Benefit Committee submits its report on operations under the "Plan for Employees' Pensions, Disability Benefits and Death Benefits."

The most significant change in the Plan during 1949 was the increase in the minimum pension provisions whereby a full-time employee having twenty or more years of service at time of retirement receives a minimum payment which, when added to the amount receivable from Federal Social Security, will be \$100 a month after age 65 and \$75 a month prior to that age. As a result of this liberalization, 81 retired employees, or 24 per cent of those on pension as of November 16, 1949, received increased pensions.

During 1949, the Laboratories averaged 6,082 employees. The extent of benefit coverage is indicated by the fact that 5,548 employees, 91 per cent, had two or more years of service and were eligible to sickness and death benefits under the Plan, in addition to the accident benefits to which all employees are eligible.

As compared with the previous year, the rate of accidents at the Laboratories in 1949 increased 14 per cent and the working days lost increased 10 per cent. During the same period, the rate of sickness cases under the Plan decreased 15 per cent; however, benefit sickness absence was one per cent higher than in 1948.

In the course of the year, 60 employees were retired with service pensions and 7 with disability pensions. Altogether, at the year's end, there were 322 retired employees on the service pension roll, 24 receiving disability pension payments and two special pension payments.

The Committee records with regret the death of 14 active employees, 14 retired and one on leave of absence.

At the beginning of the year there were 84 leaves of absence in effect and during the year 109 leaves were granted and 112 were terminated, leaving a total of 81 outstanding as of December 31, 1949.

The members of the Employees' Benefit Committee are: R. Bown, A. B. Clark, F. D. Leamer,

Statement of Payments Under the "Plan for Employees' Pensions, Disability Benefits and Death Benefits" and Status of Pension Trust Fund*

BENEFIT PAYMENTS FOR THE YEAR 1949

Pension Trust Fund

Disbursements by Trustee for Service Pensions During 1949.....	\$ 610,284.93
Payments by the Company	
Disability Pensions	16,723.08
Accident Benefits and Related Expenses.....	22,471.70
Sickness Disability Benefits.....	305,758.29
Sickness and Accident Death Benefits.....	101,352.04
Payments After Death of Retired Employees.....	48,336.71
Total Benefit Payments.....	\$ 1,104,926.75

STATUS OF PENSION TRUST FUND AS REPORTED BY BANKERS TRUST COMPANY, TRUSTEE

Balance in Fund—December 31, 1948.....		\$26,158,130.00
Additions to Fund During 1949:		
Payments Into Fund by Company.....	\$3,159,785.00	
Interest Revenue, Including Gain or Loss on Investments Disposed of	749,725.00	
Total Additions	\$3,909,510.00	
Disbursements for Pensions During 1949.....	610,285.00	
Net Increase in Fund.....		3,299,225.00
Balance in Fund—December 31, 1949.....		\$29,457,355.00

*The Pension Trust Fund is irrevocably dedicated to the payment of Laboratories service pensions and can be used for no other purpose.

W. H. Martin and D. A. Quarles, Chairman, and as alternate members, J. W. McRae, W. Fondiller, M. R. McKenney and M. H. Cook. J. W. Farrell is the counselor of the Committee, J. S. Edwards is Secretary and K. M. Weeks is Assistant Secretary.

J. S. EDWARDS, *Secretary,
Employees' Benefit Committee*

The 430A Electron Tube

Western Electric is now manufacturing the 430A vacuum tube. This is a three-electrode, inert-gas filled cold cathode tube for use in relay, voltage regulator or rectifier circuits. This tube is similar to the 313C tube except that the ionization time is much shorter. The fast ionization time capabilities of this tube make it especially suitable for use in control circuits requiring this feature. The initial use for this tube is in the translator circuit of automatic message accounting equipment in conjunction with crossbar systems. The average characteristics of the 430A are listed below:

Starter Breakdown Voltage.....	.70 volts
Starter Voltage Drop at 20 milliamperes..	.60 volts
Anode Voltage Drop at 20 milliamperes...	.75 volts
Ionization Time, Starter Gap.....	.07 milliseconds

V. E. Legg Discusses Ferrites

Explorations in the field of "magnetic ceramics", ferrites for communication application, were described by V. E. Legg in lectures at West Street on February 20 and Murray Hill on March 2.

These materials, combining the original magnetite, the iron oxide Fe_3O_4 , with ordinary paint pigments of zinc and manganese oxides, pro-

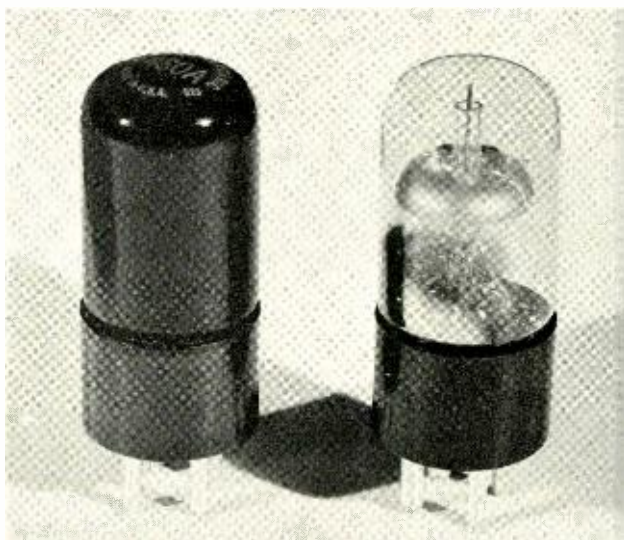

The new Western Electric 430A tube with and without opaque coating.

duce compositions having good magnetic properties as well as an electrical resistivity about a million times larger than that of iron. The combination of high resistivity with high permeability makes it possible to obtain cores for carrier and radio frequency coils of outstanding quality.

Holmdel-Deal Colloquium

At the March meeting of the Holmdel-Deal Colloquium, Dr. C. H. Townes presented a talk on "Microwave Spectroscopy". Dr. Townes is Associate Professor of Physics at Columbia University. From 1939 through 1947 he was with the Laboratories in Physical Research.

In his talk Dr. Townes presented a discus-

NATIONAL SECURITY

Safeguarding information affecting the national security is a matter of grave concern to all loyal citizens of the United States. Accordingly, it is extremely important that the greatest care be exercised by Laboratories employees to insure against unauthorized release of information pertaining to the military projects that are currently under development.

It is as vital to maintain secrecy during peacetime as during war, particularly since time would be heavily on the side of any agents piecing together scattered bits of in-

formation. For this reason, our Government is actively enforcing its security regulations and imposing severe penalties for the release of classified information to unauthorized persons.

All employees are expected to maintain the fine record established during the war and in recent postwar years by continuing to avoid "loose talk" about classified projects, and by strict adherence to security regulations as prescribed in Laboratories General Executive Instructions.

O. E. Buckley

sion of absorption due to molecular resonances. He showed how the techniques of microwave spectroscopy could be used to determine some of the physical constants of isotopes. Because of the extreme sensitivity of the methods very high accuracy is obtained.

Museum Displays

In the photograph at the right, Henry Kostkos of the Publication Department is listening to a synchronized recording that explains overseas telephone service as depicted in a display at New York Museum of Natural History. Two other displays—microwave radio relay and Bell System network broadcasting, below—were part of a recent exhibit at that Museum under the sponsorship of the New York Company.

These three displays, along with seven others, were developed and constructed under the direction of Mr. Kostkos for the New York Telephone Company for use in museums, at fairs and open houses. The display development project undertaken by the Publication Department for Bell System companies has resulted in providing numerous electronic and mechanical units for the new exhibits now nearing completion in the Philadelphia and Chicago Science Museums.

The overseas telephone service display simulates telephone messages coming from eight foreign countries. A particular country is selected by pushing a button. A special picture-changing mechanism in the back moves into viewing position a large Kodachrome picture of a person dressed in native costume. Then the iris diaphragm in front opens, revealing the picture. At the same time the listener hears a recording of the distant person's voice speaking in a for-

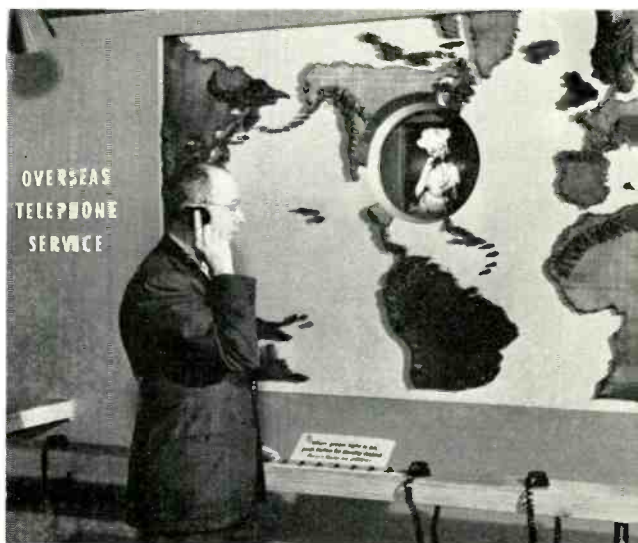

eign language, which is then translated into the English language.

In the microwave radio relay system display a stylized map of the New York-Boston circuit is depicted. Flashes of light from station to station show transmission over the system. A simulated transmission by television of a football game is first shown, followed by multi-channel telephone conversations between the two cities. A recording, synchronized with the action, tells what is happening.

The importance of Bell System lines for broadcasting networks is brought out in another display. Here simulated radio broadcasts are shown coming from various cities and going out over regional networks, with the final action showing a nation-wide hook up. Sound recording is integrated with the action.

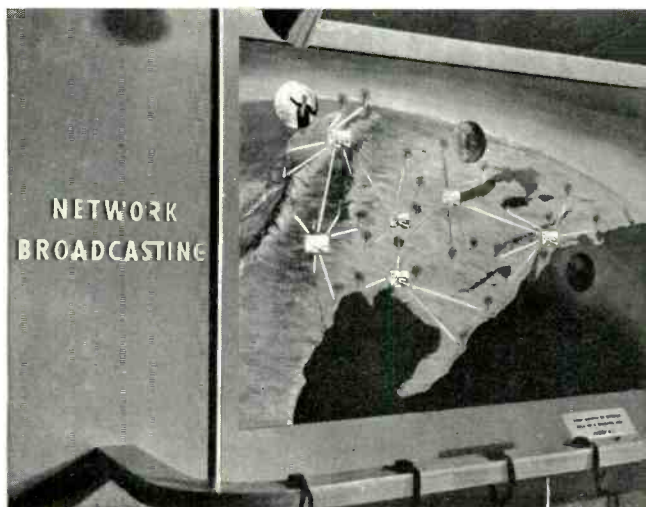



The view above, and the one at the top of the opposite page, show the Medical Department reception room at the Murray Hill Laboratory. Receptionist Muriel Smart and Nurse Helen Cusack are interviewing patients.



Dr. W. W. Widlowson confers on a health problem with a patient.

Nurse Helen Cusack treats a sore throat in the eye, ear and throat unit.

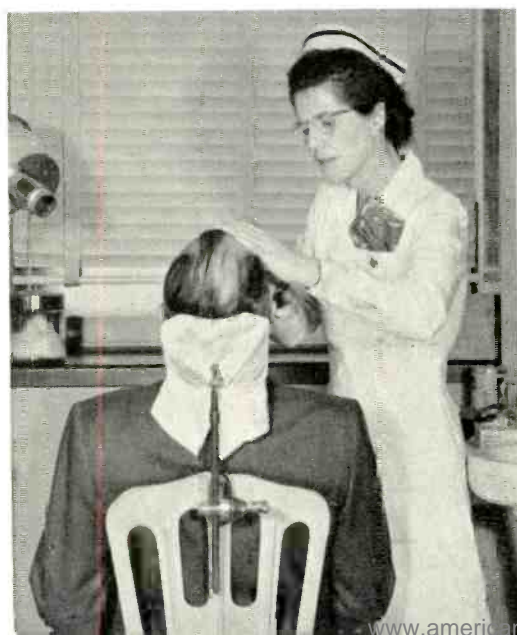

A view from a corridor shows the wall eye-chart and a part of a rest room.



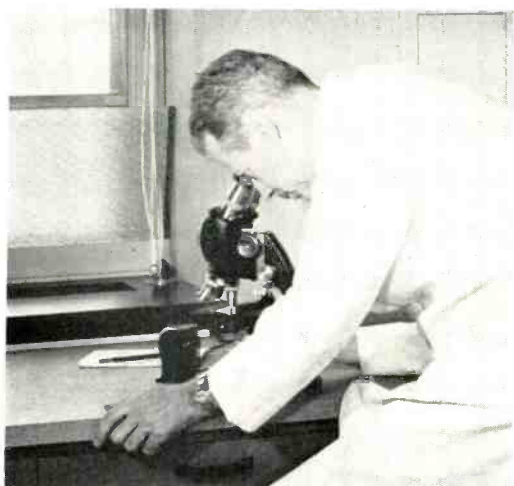

In the laboratory, Dr. Widdowson makes a diagnostic examination of a specimen.

Nurse Gertrude Thomas takes a dental X-ray, one of the many X-ray services rendered.



In one of the several treatment rooms, two patients are receiving hydrotherapy.

As part of periodic check-up, a member of the Laboratories is about to be given a chest X-ray.

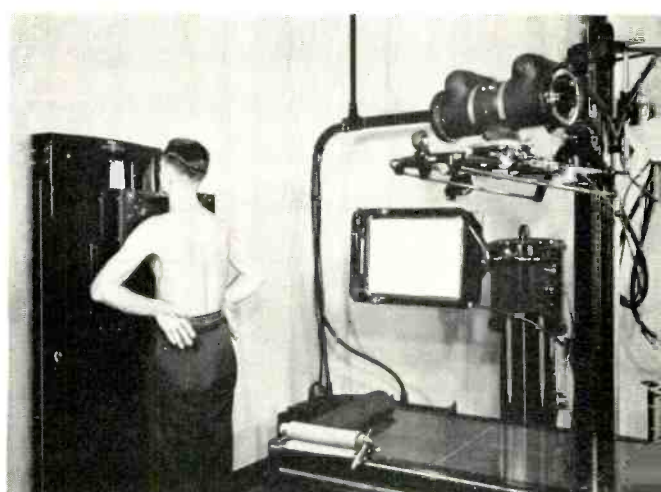
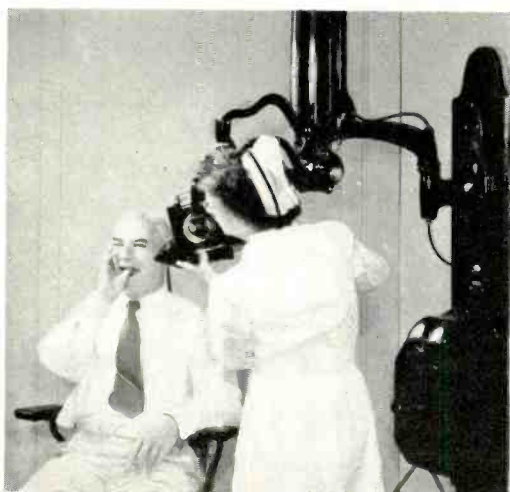

Frank R. McBerty, 1868-1950

Frank R. McBerty, prominent engineer, inventor and executive in the telephone field over a period of 63 years, died at his home in Mansfield, Ohio, on February 19, following several months' illness. He was 82 years of age.

Mr. McBerty was born in Warren, Ohio, on February 14, 1868. He entered the employ of the Western Electric Company in Chicago in 1887, where he soon exhibited unusual qualities in apparatus and circuit design and in research and experimental work. He was a close observer of electrical actions and novel phenomena in his experimental work, and was gifted with great originality and imagination. During his thirty year career with the Western Electric Company, which ended in 1917, he was successively in charge of switchboard engineering work, of patent work, of a special development laboratory in New York, and of the development of the Western Electric Company's dial telephone systems for use in European countries.

Shortly after leaving the Western Electric Company in 1917, Mr. McBerty became associated with the North Electric Manufacturing Company, of Galion, Ohio. He was president of that company from 1921 to 1949, and chairman of the Board after that date. He was the inventor of the McBerty relay system of dial switching placed on the market in 1939.

During his career with the Western Electric Company, Mr. McBerty was granted about 170 United States telephone patents. These inventions covered a wide range of subjects, and a considerable number of them, particularly in

the fields of manual and automatic switchboard circuits and apparatus, were of outstanding significance. Several of the important features of the panel dial system, which has been extensively employed in large Bell System exchanges, were either contributed or first reduced to practical form by Mr. McBerty.

It has been stated that at the time of his death he had been granted more than 400 patents on telephone and telegraph systems and equipment.

Overlook Hospital to Expand Its Facilities

A \$2,000,000 building and expansion program has recently been announced by Overlook Hospital, Summit, which serves that city and surrounding territory. Due to the steadily increasing population in this area and the new opportunities for treatment afforded by modern hospitals, admissions to Overlook have increased markedly in recent years and have made expansion imperative.

As a responsible member of the Summit area community, the Laboratories have joined other companies in this vicinity, whose personnel rely upon Overlook for themselves and their families, in contributing to the building fund. This month those who live and work in the area served by the hospital are being asked to make individual subscriptions.

Campaign volunteers will call upon their neighbors at their homes during the drive and ask for building fund pledges. No solicitation will be made through the Laboratories.

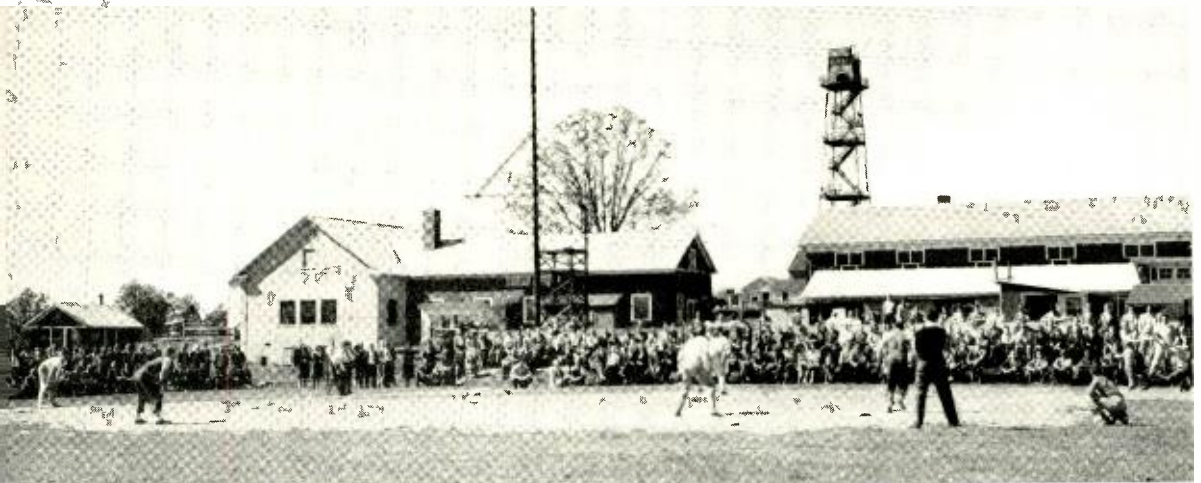

Signs of spring at Whippany where noon-hour baseball fans come out to root for their favorite teams.

Patents Issued to Members of the Laboratories by the United States Patent Office from November to January, Inclusive

W. M. Bacon (3)	O. Cesareo	R. V. L. Hartley	C. Maggs	V. L. Ronci (2)
G. H. Baker	E. E. Crump	G. Hecht	W. P. Mason	S. Rosen
H. L. Barney	C. C. Cutler	R. E. Hersey	R. F. Massonneau	R. L. Rulison
H. M. Bascom	S. Darlington (2)	W. H. T. Holden	R. G. McCoy	R. W. Sears
A. C. Beck	A. W. Daschke	E. W. Houghton	L. A. Meacham	C. F. Seibel
E. A. Bescherer	T. L. Dimond	P. A. Jeanne	F. G. Merrill	O. A. Shann
M. C. Biskeborn	W. Earl	A. E. Joel (2)	S. E. Miller	L. J. Sivian
H. W. Bode	S. O. Ekstrand	W. M. Kellogg	D. Mitchell	T. Slonczewski (2)
W. H. Boghosian	E. P. Felch	R. J. Kircher	E. R. Morton	G. R. Stibitz
J. H. Bollman	F. T. Forster	H. M. Knapp	H. G. Och	C. H. Townes
A. L. Bonner	E. W. Gent	C. D. Koechling	B. Ostendorf	D. E. Trucksess (2)
A. E. Bowen	C. E. Germanton	J. G. Kreer	F. M. Pearsall	W. A. Tyrrell
L. J. Bowne	C. B. Green	L. J. LaBrie	R. L. Peck	E. A. Veazie
F. A. Brooks	O. D. M. Guthe	L. Y. Lacy	R. K. Potter	J. N. Walter
F. G. Buhrendorf	H. H. Hagens	E. Lakatos	W. T. Rea (2)	E. F. Watson
E. T. Burton	H. C. Harrison	C. W. Lucek	L. C. Roberts	W. W. Werring
C. P. Carlson	W. R. Harry	J. J. Lukacs (2)	S. D. Robertson	H. T. Wilhelm
W. W. Carpenter				D. E. Wooldridge

Institute of Radio Engineers' National Convention

The annual national meeting of the Institute of Radio Engineers was held in New York on March 6-8. R. Bown was the guest speaker at the opening meeting of the convention. His talk entitled *A Look Backward and a Glance Forward in Electrical Communication* was carried by newspapers all over the country. In part Dr. Bown said he hoped the engineers were impressed by the thought that television "has a wider destiny and a deeper obligation to man than merely to serve as mass amusement."

"Certainly the idea of bringing television into the full service of man as an individual is a challenging thought," he declared, and added that by this he did not mean improvements in broadcasting or of theater television.

In these services, he went on, the individual has only a right of selection among offered scenic programs. "I am thinking of television as a private servant to each individual in the way his automobile and his telephone serve him to do what he wants just when he wants to do it," he explained.

Although Dr. Bown made no specific predictions about such personal uses for television, he pointed out that many persons failed to see the broad uses that the telephone would have when it was first invented. Radio and communications engineers, he said, must lead in finding out what the future holds for television.

Three members of the Laboratories were recipients of the 1950 I.R.E. Fellow Awards: G. W. Gilman, P. Mertz and C. E. Shannon.

Mr. Gilman's award was for his contribution to the communication art and for his direction of important developments in the field of radio transmission systems. Mr. Mertz's award was in recognition of his important contributions to the fundamental concepts of television transmission and reception. Dr. Shannon received his award for contributions to the philosophy of new pulse methods and to the basic theory of communications.

Papers presented by Laboratories men included: *Statistics: A New Tool for the Planning and Analysis of Laboratories Experiments*, by E. B. Ferrell; *Performance and Measurement of Capacitors*, by H. T. Wilhelm; *Behavior of Resistors at High Frequencies*, by S. E. Church, coauthor; *Quality Rating of Television Images*, by P. Mertz, A. D. Fowler and H. N. Christopher; and *Seven League Oscillator*, by F. B. Anderson. The following Laboratories engineers presided over sessions of the meeting: R. L. Dietzold, chairman, *Passive Circuits—Filter Circuits and Variable Networks*; A. G. Jensen, chairman, *Symposium—Television*; L. W. Morrison, chairman, *Television II—UHF and Color TV*; and R. A. Miller, chairman, *Transducer Design*.

Murray Hill Symphony Orchestra

The Murray Hill Symphony Orchestra presented its second recital at a noon hour concert in the Arnold Auditorium on February 23. Paul Oncley, the conductor, chose *Oberon Overture* by Von Weber; selections from *Naughty Marietta* by Herbert; and *Pastorale* and *Fandole* from *L'Arlesienne Suite* by Bizet.

RETIREMENTS

Among those retiring from the Laboratories are A. G. Hall with 40 years of service; W. P. Albert, 36 years; Patrick Healy, 32 years; A. B. Kvaal, 31 years; Martha Bonifield, 23 years; and A. K. Smith, 19 years.

ARTHUR G. HALL

A. G. Hall joined the Western Electric Company in 1909 after spending two years at the Lewis Institute and graduating two years later

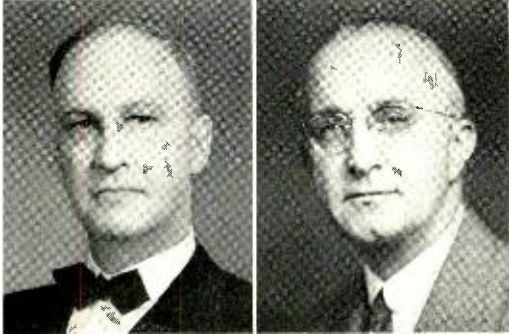

A. G. HALL

A. B. S. KVAAL

from the University of Michigan. After five months in the Student Course at Hawthorne, he transferred to West Street where he entered the Physical Laboratory. About this time work on the development of cables with phantom circuits suitable for loading was started at Hawthorne and, early in 1910, Mr. Hall transferred there to aid in this work. With the exception of a short absence in 1912, he continued this work until late in 1913 when he was placed in charge of a group engaged on cable development work at Hawthorne. In 1921 he was loaned to International Western Electric Company and for a little over two years spent his time in cable factories in Switzerland, Holland and Italy and returned to Hawthorne in 1923. Since then he has been engaged on cable development problems. In 1928 he was detailed to Kearny.

During the next twenty years he and his associates collaborated with Western Electric engineers on many important developments in exchange area cables. Earliest was the technique of insulating wires with paper-pulp; this enabled the use of wires as fine as 26 gauge (16 mils) and as many as 2121 pairs inside a 2½ in. sheath. In recent years Mr. Hall has been concerned with making up sample cables with various kinds of sheath instead of lead; the widely used Alpth sheath and the newly developed Stalpth sheath are the outcome. His varied experience in both toll and exchange

area cable circuits has made him an outstanding authority on capacitance unbalances and the effect of manufacturing processes on these.

For twenty years residents of Westfield, the Halls plan to remain there for the immediate present. Their son, a physician, lives nearby. Mr. Hall is looking forward to his added leisure for fishing, stamp collecting, furniture-making, and just being a grandfather.

ANDREW B. S. KVAAL

When "Andy" Kvaal came to this country in 1916, he wanted to work for Western Electric because he had been in a telephone factory in Norway. Because "Western Electric" was a name to be treated with great respect, he thought it prudent to learn English before applying for a job. Two years in another company taught him the language and a good deal about American drafting practice, so when he applied to Western Electric he was hired. After five years on equipment and cabling he became supervisor of 25 men, and from then on his responsibilities have grown. In 1939 he took over the whole of Systems drafting, and during World War II his force grew to nearly 300, all of whom he had personally selected and welded into a smoothly-running group which turned out an amazing number of drawings.

Spanning 31 years, Mr. Kvaal's career has seen and influenced deep changes in method. The lettering guide, the whole setup for reproducing tracings, and the "highway" scheme for wiring diagrams are some of the innovations to which he contributed. Another is the engineering lettering machine, an oversize flat bed typewriter which quickly puts lettering on drawings.

Because he was a draftsman once, Mr. Kvaal is known for his appreciation of the draftsman's attitude. "Your real draftsman," says Andy, "is a great painstaker. He wants to make every drawing a 'clean' one and no matter what the pressure for time he should never be asked for quality less than his best. 'Rush' work which condones sloppiness will soon bring carelessness and errors which really compromise the job."

Frequently vacationing in Great Barrington, Mr. and Mrs. Kvaal came to love the place. They have just completed a house there to which they are now moving. Furniture-making, a Kvaal family tradition, will be his hobby.

WALTER P. ALBERT

Before Mr. Albert joined us in 1914, he had graduated from Purdue (B.S. 1910; E.E. 1913), and had been a telephone maintenance man and circuit designer in the independent field. His first job here was on the testing of the famous semi-mechanical offices in Newark; he



MARTHA BONIFIELD

A. K. SMITH

also took part in development of the call-distributing systems for Newark and Wilmington. For many years after that he specialized on testing equipment for panel and later for cross-bar. During the war he helped to develop systems for pre-flight training of the crews of military airplanes.* In recent years he has been working on central office circuits for automatic message accounting. Twenty-three patents record his contributions.

In retirement Mr. Albert and his wife expect to live in the country near Richmond, Indiana.

MARTHA BONIFIELD

Martha Bonifield of the West Street PBX retired at her own request on March 2. She began her Bell System service as an operator for the New York Telephone Company where she worked for three years before her marriage to H. M. Bonifield of ERPI. After his death she became an operator at ERPI and in 1938 transferred to the Laboratories exchange. Mrs. Bonifield became a supervisor at West Street in 1943 and held that position during the war. In retirement she will keep house for her sister and niece, and will devote her leisure to reading.

ALBERT K. SMITH

After graduation from Cooper Union in mechanical engineering and some fifteen years of experience as a designer, Mr. Smith joined the Laboratories in 1930 as a member of Telephone Apparatus Development. He was responsible for engineering of apparatus to clean central office equipment, consisting of a blower and portable equipment to filter the dislodged dust out of the air.

About 1935, Mr. Smith transferred to the development of station apparatus, and first was concerned with coin collectors, particularly with the form for use with the handset which requires a separate transmitter to pick up the

coin-identifying tones. Later he worked on telephone booth design; a machine to make wear tests on floor coverings was one of his contributions. In retirement, for reasons of health, Mr. and Mrs. Smith will live near St. Petersburg, Florida.

PATRICK HEALY

Looking back from the serene eminence of his sixty-five years, Pat Healy thinks the world is all right, except that the lads aren't the men they were back in County Kerry. Our guess is that even there and then, not many could stand up to Pat Healy's brawn.

Some years after he crossed the ocean—in 1917 to be exact—Pat came to work here. There was a war on and he carried a photo pass, which he still cherishes. Because he had had experience as a pipefitter, he was soon doing conduit work and that led to wireman's helper, and later to "electrician". Most of the conduit work incidental to the changeover from an isolated plant generating d.c. to central station power using a.c. was Pat's doing. When Building En-



PATRICK HEALY

W. P. ALBERT

gineering decides which conduits are to be run and where, it is up to Pat and his boys to measure up the location, cut the pipe and bend it to fit. Then comes the tough part—getting the pipe into place and securing it.

Mr. and Mrs. Healy have long lived in Yorkville and there they expect to stay. With their friends and their church, and Central Park nearby for a walk, and the beaches only a subway ride, what more could one ask?

News Notes

THIRTY YEARS of issues of *Electrical Engineering* were recently presented to the Technische Hochschule of Munich University by H. O. SIEGMUND through his daughter, Alice Siegmund, formerly in the Research Department of the Laboratories. Miss Siegmund is now special service manual arts supervisor for the American Military Post at Munich.

*RECORD, February, 1945, page 46

A LECTURE BY
LEE DE FOREST, PH. D.

of the American De Forest Wireless Telegraph Company

SUBJECT:

"Wireless Transmission of Intelligence"

ILLUSTRATED BY APPARATUS

ART GALLERY, 174 MONTAGUE STREET

THURSDAY, MARCH 14, AT 8.15 P. M.

ADMIT TWO

Original announcement card of the lecture at which Lee De Forest gave his first public showing of his Audion, the grid-controlled vacuum tube. This card, taken by De Forest himself from an old scrapbook, was sent with a letter of February 15, 1950, to Lloyd Espenschied, as a memento. Espenschied with his amateur pal, Austen M. Curtis, attended this lecture and there first made the acquaintance of De Forest, together with his young assistant, John V. L. Hogan.

The Single-Wire Wave Guide

Following the presentation of a paper at the recent I.R.E. Convention, the Associated Press asked the Laboratories for a statement regarding the single-wire wave guide for the transmission of high frequencies. The Laboratories' statement follows:

"We regard Dr. Goubau's work on the so-called G-string or single-wire wave guide as a brilliant study that has brought out transmission features of considerable technical interest in the field of guided very short waves. This constitutes a definite contribution to the art.

"Some practical applications of this type of

wave guide seem to be indicated, particularly in the military field. These would include simple forms of transmission, for example, from the ground to the top of an antenna structure and trunking of microwaves over very short distances. These have been indicated in the Army announcements.

"If this type of wave guide is considered for longer distances, as for example between cities, many practical problems in transmission arise, the solutions of which are not now apparent. These problems have been recognized in Dr. Goubau's technical reports.

"Considering the difficulties and limitations inherent in the single-wire method of transmission, we do not foresee the likelihood of its finding practical application in the inter-city telephone or television program network."

News Notes

O. E. BUCKLEY attended a meeting of the National Inventors Council at Miami, Florida, on February 20 and 21. At the invitation of Mr. Gillen, President of the Bell of Pennsylvania, Dr. Buckley gave a talk at a dinner in Pittsburgh on February 2, in connection with the Bell System exhibit illustrating telephone advances and developments.

M. J. KELLY attended the Operating Vice Presidents Conference at the Waldorf-Astoria from January 31 through February 2.

D. A. QUARLES addressed the officers of Aberdeen Proving Ground, Maryland, on February 2. His subject was *Electronic Mechanization*.

MR. QUARLES has been elected a Director of the Sandia Corporation.

W. SHOCKLEY and J. BARDEEN have written on *Energy Bands and Mobilities in Monatomic Semiconductors* in *The Physical Review*, February 1, Letters to the Editor section.

April Service Anniversaries of Members of the Laboratories

45 years	W. S. Hane	C. V. Obst	U. A. Matson	F. J. Reilly
H. A. Larlee	J. F. Hart		W. A. Mehmel	
	E. F. Kingsbury	20 years	Karl Morlock	10 years
40 years	C. W. Lucek	Albert Burkett	Ruby Murphy	J. R. Anderson
O. B. Jacobs	Donald MacKenzie	James Campbell, Jr.	George Nielsen	Eric Classen
	C. E. Mitchell	M. J. Challan	L. A. Oberle	L. G. Fitzsimmons, Jr.
35 years	R. P. Yeaton	Owen Clark	W. C. Pitman, Jr.	Violet Gorton
H. B. Coxhead		A. L. Durkee	Catherine Reilly	P. L. Hammann
	25 years	W. V. S. Evans	Evelyn Sabbagh	Genevieve Harrington
30 years	Thoralf Aamodt	Marion Gray	G. N. Thayer	R. R. Hough
H. I. Beardsley	Hilton Anderson	T. J. Grieser		F. J. Howe
N. C. Brower	L. A. Dorff	B. L. Jamison	15 years	C. J. Kuhn
R. W. Chesnut	F. S. Goucher	F. A. Johnson	H. W. Cosgrove	Jane Luckey
G. M. Classen	E. L. LeBright	H. T. King	Katherine Halloran	Jeannette Renz
R. D. Gibson	J. J. Martens	John Kovac	Henry Karaban	T. J. Slattery

THE DIVISION OF ELECTRON PHYSICS of the American Physical Society and the R.D.B. Panel on Electron Tubes jointly sponsored a symposium on thermionics at New York University, January 31 and February 1. During these sessions, papers were presented by H. W. ALLISON and G. E. MOORE on *The Use of Radioactive Strontium in Some Thermionic Experiments on Thin Films*; C. HERRING, *Review of Some Facts on Temperature Variation of Activation Energies*.

DR. LYMAN SPITZER, JR., Professor of Astronomy, Chairman of the Department of Astronomy, and Director of the Observatory at Princeton University was a visitor at Murray Hill in February.

N. B. HANNAY, J. A. BURTON and J. P. MOLNAR visited the National Bureau of Standards to discuss mass spectrometer problems.

E. K. JAYCOX attended the Pittsburgh conference on Analytical Chemistry and Applied Spectroscopy where he presented a paper entitled *The Quantitative Spectrochemical Analysis of Ashes, Deposits, Liquids and Other Miscellaneous Samples*.

J. H. SCAFF has been reappointed chairman of the membership committee of the Institute of Metals Division, A.I.M.E.

G. T. KOHMAN, at a meeting of the Research and Development Board Subpanel on Frequency Control in Cleveland, was invited to report on the Laboratories' synthetic quartz project.

W. O. BAKER's talk before the Deal-Holmdel Colloquium was on *Polymer Research and Development*. The Colloquium was held at Holmdel on February 10.

C. S. FULLER addressed a group of delegates of the Department of the Navy in Washington on activities of the Research and Development Board Subpanel on Elastomer Research of which he is chairman.

A. C. WALKER spoke on *Growing Piezoelectric Crystals* at Syracuse University. He also gave a Sigma Xi lecture at Cornell University on the same subject.

F. J. BIONDI, R. L. VANCE and R. W. SEARS visited the Nela Park Laboratories of the General Electric Company, Cleveland, to discuss tungsten.

W. G. GULDNER and L. A. WOOTEN attended the Pittsburgh symposium on analytical chemistry at which they presented a paper *Low Pressure Techniques: The Determination of Carbon and Oxygen in Metals*.

U. B. THOMAS made tests in Pittsburgh on the newly installed lead-calcium storage battery in the Plantation central office. He also visited the Gould Storage Battery Corporation in Depew, New York, on storage battery problems.

R. M. BURNS has been appointed chairman of the Advisory Committee of The Prevention of Deterioration Center. The center operates in the Division of Chemistry and Chemical Technology of the National Research Council, and provides extensive information, publication, research advisory, and research coordinating services particularly to the Army, Navy and Air Force.



Ethel Ott, left, discussing the monthly reports of the Patent Service Department with her supervisor, Ruth Hoff. Mrs. Ott is in charge of the group handling patent controls and reports.

E. E. SCHUMACHER presented the 29th Institute of Metals lecture before the annual meeting of the American Institute of Mining and Metallurgical Engineers February 12-16 in New York. His title was *Metallurgy Behind the Decimal Point*. Mr. Schumacher has been reelected a Director of the American Institute of Mining and Metallurgical Engineers.

H. A. BIRDSALL attended a meeting of A.S.T.M. Committee D-6 on Paper and Paper Products in New York.

J. R. TOWNSEND attended a meeting of A.S.T.M. Committee B-6 on Die Castings in Pittsburgh. Mr. Townsend is chairman of this committee.

R. M. C. GREENIDGE, B. SLADE and E. C. HAGEMANN participated in conferences at Allentown on deposited carbon resistor problems for L3 carrier applications.



Women Pioneers Celebrate St. Valentine's Day

A "white elephant" party and a demonstration of ribbon tying techniques were highlights of the successful St. Valentine's Day party of the women Pioneers at West Street. The top photograph shows Paul Edwards distributing "Lacelon" for them to try their hand at tying trick bows. To the left is a section of the "white elephant" table with gifts wrapped and ready for sale. Each member donated a "white elephant" and in turn bought another during the party. A buffet supper was served in the cafeteria. The pictures below show a Patent Department group enjoying supper, and a group waiting their turn on the buffet line. Helen Grant of the Development Shop gave a demonstration of the novelty uses of pipe cleaners as party favors and dolls.



News Notes

H. E. KERN and R. T. LYNCH presented a paper entitled *Diode Studies of Oxide Cathodes* at the symposium on thermionics, a joint meeting of the Division of Electron Physics of the American Physical Society and the Panel on Electron Tubes of the Research and Development Board. The symposium was held at New York University on February 1. Their paper was also presented at the Western Electric Company Electronics Plant at Allentown at a joint meeting of the Bell Laboratories and the Western Electric engineering staffs.

C. M. HARRIS is coauthor with V. O. Knudsen of a new book *Acoustical Designing in Architecture*, published by John Wiley and Sons. The book covers the principles and procedures of design in the field of architectural acoustics. It

includes photographs of the Murray Hill Arnold Auditorium and describes the acoustical design of the ventilation systems for the Laboratories' free space room.

W. E. KOCK spoke on *Microwave and Acoustic Lenses* before the Rotary Club at noon and before the Winston-Salem Engineers Club in the evening of February 14 at Winston-Salem. Dr. Kock was guest speaker at the American Institute of Electrical Engineers meeting on February 16 at the University of South Carolina in Columbia, South Carolina. On February 19 he spoke at Dallas before the Fort Worth-Dallas section of the Institute of Radio Engineers.

A. A. HANSEN visited the Boston toll office in connection with field studies of the maintenance of mercury relays and single frequency signaling performance.



Elizabeth Logan, Village artist, attends the Women Pioneers' "White Elephant" sale.

M. W. BALDWIN participated in a one-day television symposium staged in New York on February 11 by the Institute of Radio Engineers. Mr. Baldwin spoke on *Television Picture Fidelity*.

W. D. LEWIS has been elected to serve on the Board of Education in the Boro of Little Silver, New Jersey.

K. K. DARROW lectured on *Nuclear Energy* on February 16 at the University of Connecticut in Storrs, Connecticut. He has been appointed to the Richtmyer Memorial Lecture Committee of the American Association of Physics Teachers.

W. J. KING visited the Western Electric Company, Point Breeze, in connection with polyethylene insulated high frequency cables.

A. BURKETT and M. P. Woodard of Western Electric visited the Automatic Electric Com-

F. LOHMEYER and J. G. NORDAHL joined Western Electric personnel in visiting the General Electric Company at Electronic Park, Syracuse, on February 9 and 10. They discussed technical characteristics of mobile radio equipment. Mr. Lohmeyer, J. B. HARLEY, A. E. RUPPEL and Mr. Nordahl with Western Electric personnel visited the Motorola Corporation in Chicago on February 28 and March 1 to confer on technical and procurement problems on mobile equipment.

U. S. BERGER assisted the Long Lines in connection with color television tests over microwave circuits in Washington.

W. SHOCKLEY gave a talk on *The Statistics of Electron Conduction* at the Massachusetts Institute of Technology Physics Colloquium.

V. F. BOHMAN visited Hawthorne in connection with step-by-step apparatus.

M. SALZER and H. L. BOWMAN visited the Teletype Corporation in Chicago and later the telephone office in Ambridge, Pennsylvania. There they were joined by W. E. DOREMUS and representatives of Teletype and the Western to study the application of Bell System Practices to card perforators.

F. H. MARTIN, at the Newark Accounting Center on February 24, was concerned with problems relating to automatic message accounting equipment.

W. KEISTER gave a talk on *Automatic Control with Relays* for the American Institute of Electrical Engineers on February 21 at a student get-together for the A.I.E.E. branches in the metropolitan colleges.

R. MUELLER and C. SCHNEIDER went to Troy in connection with field installation of relays.

J. G. FERGUSON, K. M. FETZER and O. J. MORZENTI visited Hawthorne in connection with No. 5 crossbar system.

E. HARTMANN, at Archer Avenue, supervised installation of coin collector testing apparatus.

G. S. BISHOP visited Media, W. H. SCHEER and H. J. MICHAEL Chicago, and C. W. HAAS Cleveland, in connection with the No. 5 crossbar.

R. C. MINER visited Indianapolis in connection with production of U1 receiver units.

V. L. JOHNSON visited Cincinnati in connection with No. 5 crossbar.

A. H. INGLIS and A. W. HAYES visited St. Paul, New Orleans, Los Angeles and San Francisco in connection with the progress of the field study of the new telephone set. Mr. Hayes continued on to visit the Associated Companies in Omaha, St. Louis and Chicago.



Preparing for a friendly bout at Summit Y.M.C.A., Charles Ford of the Murray Hill Restaurant and Thornton Read of Mathematics Research shake hands as W. H. Calvert, Y.M.C.A. boxing coach, looks on. Ford fights in the welterweight class, Read as a lightweight; both were in the Golden Gloves last year.

pany in Chicago concerning community dial office matters.

F. A. PARSONS went to the Indiana Bell Telephone Company at Indianapolis with P. E. Bowen, A. F. Wotring and J. W. Larson of O & E and H. C. Harris and D. Younger of Long Lines to discuss the 4A toll switching system proposed for South Bend.

C. H. ERVING's visit to Philadelphia concerned the installation of an experimental 100-pen recorder in the Garfield central office of The Bell Telephone Company of Pennsylvania.

A. HERCKMANS, L. T. HOLDEN, F. A. HOYT, B. O. TEMPLETON and O. A. SHANN visited Hawthorne on coin collector problems.

W. L. TUFFNELL, C. A. WEBBER, F. LINDBERG and H. H. STAEBNER discussed cords for the new telephone set at Point Breeze.

AT THE WESTERN ELECTRIC SPEEDWAY plant, W. L. TUFFNELL, L. VIETH, H. F. HOPKINS, G. A. WAHL and C. L. KRUMREICH discussed the new telephone set; R. E. PRESCOTT and J. H. HAM reviewed the dial; H. A. BREDEHOFT and M. S. RICHARDSON conferred on the ringer of the new set.

R. A. MILLER and H. W. AUGUSTADT were in Cleveland on problems for a new magnetic recording machine for weather announcements. They stopped at Bausch and Lomb Optical Company at Rochester in connection with the same project.

J. A. POTTER and W. V. FLUSHING made tests on the power rectifiers at the No. 5 crossbar office in Media.

J. D. HUBBELL and W. G. BREIVOGEL reviewed ringers and dials at Indianapolis.

A. H. HEARN and C. R. BREARTY investigated the quality of old treated southern pine poles held in storage at Jackson, Tennessee.

D. T. SHARPE and G. M. BOUTON were in Denver on a field study of lead-calcium cable.

A. P. JAHN attended the spring meeting of the A.S.T.M. in Pittsburgh. He also went to Wilimantic, Connecticut, to observe compressor equipment used for pressurizing cable.



H. C. Burke is well known to Laboratories typists, stenographers and secretaries at West Street, Murray Hill and Whippany whose typewriters he keeps in repair. He is shown above making an adjustment on Dolores Iannone's machine in the Stenographic Department at West Street.

J. H. SHUHART visited Trenton with P. E. Tubman of Long Lines regarding methods of minimizing troubles in cable sheath that are caused by bridge vibrations.

W. C. KLEINFELDER and D. C. SMITH instructed splicers at Waterbury, Connecticut, in special cable splicing methods. Mr. Kleinfelder also visited Torrington, Connecticut, and Pittsburgh in connection with this program.

M. W. BOWKER and D. C. SMITH visited the radio relay station in Hallam, Pa., to study methods for locating gas leaks in wave guides.

F. W. ANDERSON conducted tests at the Fort Wayne plant of the General Electric Company on new type alternators for the TD-2 system.

H. J. BERKA conferred with engineers of the Southern New England Telephone Company at New Haven on lighting for information desks. He also conferred with the Crouse Hinds Company at Syracuse on designs for air navigation obstruction lighting for radio stations.

W. B. SAGE went to Cleveland to confer with members of the Ohio Bell Telephone Company and the Western Electric Company on arrangements for a trial installation of simplified register and sender test equipment for No. 5 crossbar offices.



"That wonderful guy in Research makes quadratics seem like fun."

RECENT DEATHS

KARL G. JANSKY, February 14

Mr. Jansky, who became world famous for his discovery of radio waves emanating from interstellar space, joined the Laboratories in 1928. The year before he had been graduated with a B.A. degree by the University of Wisconsin, from which he received an M.A. degree in 1936. His father, Cyril M. Jansky, was Professor of Electrical Engineering at the University from 1908 to 1940 and is now Professor Emeritus.

Mr. Jansky was located at the Holmdel Laboratory and early in his career he specialized in short wave radio telephone trans-



K. G. JANSKY
1905-1950

A. J. ZERBARINI
1899-1950

mission. Later he was responsible for the directional studies of atmospherics at high frequencies. In the 1930's Mr. Jansky came to international attention when he demonstrated the existence of electrical energy in the form of radio waves coming from a point so remote from the earth that it required between 30,000 and 40,000 light years to reach this planet. He was also known for his original studies of noise in amplifiers and receivers, and for the design of several types of wideband amplifiers. He was credited with several basic discoveries in his field, and was awarded an Army-Navy certificate of appreciation for his work in World War II on radio direction finders.

He was a member of many professional societies and was the author of a number of technical papers. Mr. Jansky was a Fellow of the I.R.E. and a member of Phi Beta Kappa.

ANGELO J. ZERBARINI, February 17

Mr. Zerbarini, a Patent Attorney, died in Boston and was buried in Westerly, Rhode Island, his birthplace. He had attended Westerly schools and served in World War I before he entered Rhode Island State College. Following graduation in 1921 with a B.S. degree in Electrical Engineering, he joined the New York

Telephone Company as a student engineer, advanced to engineering assistant and engineer. Meanwhile he studied at Fordham University School of Law and received the LL.B degree in 1928 the same year he transferred to the Laboratories Patent Department. He was admitted to the New York bar in 1929 and the District of Columbia bar in 1930. He became a registered patent attorney in 1930, and was admitted to practice before the U. S. Supreme Court in 1938. He had worked at the Davis Building and lived in Rockville Centre until 1949 when he transferred with a Patent group to the Murray Hill Laboratories and moved his family to Morristown. Mr. Zerbarini's patent work had been in the field of radio and for the past several years he had been responsible for the Laboratories' patent work having to do with antennas and directional radio. During the war this work involved many special types of antennas developed for radar use. His work also included the microwave lenses used in radio relay systems. In the course of Mr. Zerbarini's patent work, he had handled a number of important interferences.

Mr. Zerbarini's outside interests centered around his home and family. He enjoyed his piano accordion, bridge, and golf. Among his societies were the American Legion, the Elks and the Knights of Columbus.

JAMES R. BRADY, February 17

In 1930 Mr. Brady joined the Laboratories as a student assistant and for three years after that studied in the Laboratories training course for Technical Assistants. He completed his technical training evenings at New York University from which he received his bachelor of science degree in Electrical Engineering in 1940. At that time he was promoted to Member of the Technical Staff. With the exception of the war years, Mr. Brady's work was the design and development of coaxial cable terminal equip-



J. R. BRADY
1913-1950

G. F. ANTONETTI
1929-1950

ment. He participated in the testing and trial of the 800 kc, 240-line television coaxial system, predecessor of the present day system; and in engineering tests of early television experiments between Point Stevens, Wisconsin, and Minneapolis. He also participated in the opening of the New York-Philadelphia coaxial television circuit in 1940 when the Republican National Convention was televised. During the war he was engaged in the development of radar, particularly with airborne search and bombing radars. From 1945 until 1950 he was again concerned with coaxial trial installations, particularly with the development of television operating centers.

GEORGE F. ANTONETTI, February 22

Shortly after graduating from Emerson High School, Union City, New Jersey, in 1947, George Antonetti joined the General Service Department as a messenger. The following year he was promoted to photostat assistant in the Photocopy Department. In May, 1949, he went on a military leave of absence, joined the United States Navy, and was honor man in his class when he completed boot training at the Great Lakes Naval Training Station. He was assigned to the U.S.S. *Tidewater* as Storekeeper Apprentice Seaman. He died suddenly while stationed aboard ship in Charleston, S. C.

News Notes

H. J. KOSTKOS went to Montreal at the request of Bell Telephone of Canada for consultations in planning exhibits featuring the telephone art of yesterday, today, and tomorrow.

THE LABORATORIES were represented in interference proceedings at the Patent Office by J. A. HALL before the Examiner of Interferences.

H. H. BAILEY and E. H. SHARKEY attended conferences at Wright Field, Dayton, Ohio, on present and future equipment for the Air Forces.

W. L. MRAZ presented a paper on *Automatic Gain Control and Automatic Frequency Control as Feedback Problems* to the Northern New Jersey subsection of the I.R.E.

J. C. BAIN and S. E. WATTERS visited Vinco Corporation, Detroit, Michigan, to discuss the manufacture of servo mechanisms.

K. G. COMPTON of Murray Hill and W. E. LIGHTBOWNE of Whippany are members of the newly formed Morristown Flying Club. The club owns a 1949 Piper Clipper. Members of the Laboratories, whether they hold pilot's licenses or not, are welcome to join the group.

Mr. Compton or Mr. Lightbowne will be glad to talk to prospective members.

A. J. AIKENS and R. M. HAWEKOTTE, who were conducting tests on rural power line carrier near Celina, Texas, jointly with representatives of a number of other organizations, were forced to discontinue the tests for about a month on account of damage to the power lines from a storm which deposited about three inches of sleet on the wires.

M. T. DOW has been testing certain transmission characteristics of exchange plant cable pairs at several locations in New Jersey.

D. E. BRENNEMAN, W. L. GAINES and T. W. THATCHER visited a trial installation of carrier between Madison and Milwaukee, Wisconsin, to observe acceptance testing and system operation.

D. T. OSGOOD and representatives of the A T & T visited Elk City, Oklahoma, in connection with a trial of a new test set for the M1 carrier telephone system.

PIERRE MERTZ and J. M. BARSTOW of the Transmission Engineering Department, in company with representatives of the A T & T were observers at the demonstration of color television by Color Television, Inc., in Washington, on February 20. Mr. Mertz also was an observer at the demonstration of February 23 in which three systems (R.C.A., C.B.S. and C.T.I.) were compared under auspices of the Federal Communications Commission at Laurel, Maryland.

A CONFERENCE to discuss the work of the Solid State Research Group was held in the Arnold Auditorium at Murray Hill February 15 at which *Microwave Spin Resonance in Paramagnetic Organic Compounds* was discussed by C. KITTEL, A. N. HOLDEN and W. A. YAGER.

C. C. HIPKINS addressed the Industrial Management Council of Rochester on the testing and the selection of organic finishes for industrial products on January 31.

L. J. COBB went to Archer Avenue in connection with coin collector problems.

R. R. STEVENS, in Indianapolis and Chicago, was concerned with production of T1 transmitters and coin collectors.

H. J. KEEFER, A. F. SCHWEIZER, H. W. HERMANCE and T. F. EGAN visited Hawthorne in connection with relay contact studies; and R. D. WILLIAMS, equipment development designs and ordering information on 740E PBX's.

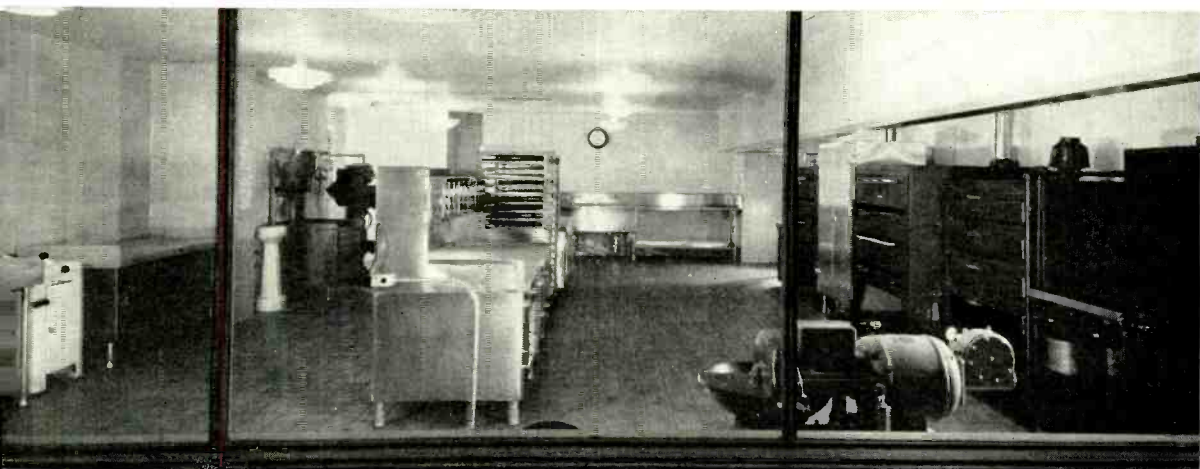

Murray Hill Restaurant

*The bake shop at
Murray Hill.*

*In the preparation
area there is an
eighty-gallon kettle
in which soup stock
is prepared. The area
also contains two
butcher blocks and
band-saws, electric
vegetable peelers,
and thawing sinks.*

*The scullery, show-
ing the electrically
operated roller con-
veyor on which racks
of soiled dishes are
carried into dish
washing machines.*

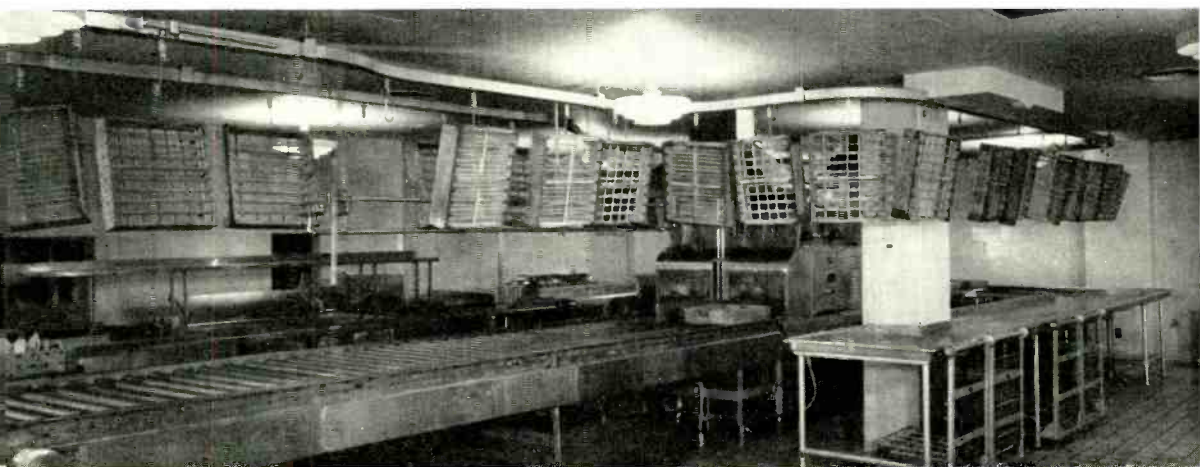

F. A. SCHWENDER, A. E. BACHELET and H. M. PRUDEN were in Philadelphia for a few days on the microwave radio project. Mr. Schwender and Mr. Bachelet visited all stations between New York and Philadelphia on the same project.

L. A. WEBER is spending a few weeks in Milwaukee on the NI carrier system.

W. W. BROWN conferred at Cleveland, Elkhart, Indiana, and Hawthorne on central office framework design and on operators' chairs.

K. M. COLLINS and LOUIS PINTER attended a panel discussion on "how-to-do-it" books held by the American Institute of Graphic Arts on March 8. A. R. THOMPSON, a former president of the Institute, acted as moderator.

F. R. LAMBERTY, at Detroit, discussed selector repeaters for step-by-step offices with local telephone engineers.

R. A. HECHT, W. ORVIS and T. S. HUXHAM went to Point Breeze to confer on the manufacture of nylon plug shells.

E. ST. JOHN consulted the Standard Electric Time Company, Springfield, Massachusetts, on an electric clock used for maintenance work.

M. SALZER observed the application of Bell System Practices at the Vineland, New Jersey, central office.

L. N. HAMPTON, M. SALZER, E. G. D. PATERSON and H. L. BOWMAN visited the Teletype Corporation, Chicago for a discussion of matters related to the perforator.

AT HAWTHORNE, C. A. LOVELL, H. O. SIEGMUND, B. F. RUNYON, H. M. KNAPP, R. F. MALLINA and H. A. MILOCHE were concerned with apparatus developments for the crossbar system; K. L. WARTHMAN, the training course on manufacturing methods; and V. F. BOHMAN, aluminum die-cast frame for switches.

R. M. BOZORTH, H. J. McSKIMIN and W. P. MASON discussed *Elastic and Magnetoelastic Properties of Single Crystals of Nickel* before a conference of the Solid State Research Group on March 1 in the Arnold Auditorium.

A. H. HEARN and B. R. EYTH surveyed residual Douglas fir pole stocks on yards of the New York Telephone Company in the upstate New York area.

C. C. LAWSON discussed drop wire attachments at the Clearing plant of Western in Chicago.

J. B. HAYS visited Philadelphia on cable testing problems.

J. B. KELLY made tests in Washington on the selenium rectifiers used in the L carrier system.

V. T. CALLAHAN conferred with various engine manufacturers at Detroit and Lansing, Michigan, and Canton, Ohio, in connection with new automatic engine design.

H. T. LANGABEER went to Cincinnati in connection with the new No. 5 crossbar office power plant.

W. G. SMITH, A. F. BURNS and H. J. BERKA, with representatives of A T & T, inspected the trial of power room fluorescent lighting in the No. 5 crossbar office at Freeport, Long Island.



Noon hour at Deal finds W. F. Bodtmann playing shuffleboard as C. F. P. Rose awaits his turn.

H. N. WOLF, in Newark, studied the modification of the G2 terminal for use with the trial installation of coin boxes on the mobile radio-telephone system on trains.

A. H. SMALENBACH will be in Key West, Florida, and Havana, Cuba, during the installation of the terminal equipment for the Key West-Havana submarine cable project.

R. B. BAUER visited Pittsburgh to discuss training problems of the crossbar switching system.

C. A. NICKERSON conferred at the Audichron Company in Atlanta on two occasions regarding magnetic recording and reproducing equipment for transcribed message services.

W. L. BLACK went to Cleveland to gather information from the Ohio Bell Telephone Company on new magnetic recording machines for the 3A announcement system.

J. Z. MENARD went to the Brush Development Company at Cleveland to confer with them on magnetic recording components. At a later date during the month he also made another trip to Cleveland in connection with the 3A announcement system installation for the Ohio Bell Telephone Company.

R. A. MILLER, H. W. AUGUSTADT and W. J. BROWN attended a meeting of the Institute of Radio Engineers, Audio Techniques committee. Mr. Miller also attended the Standards Committee meeting at I.R.E. headquarters.

R. MARINO and H. C. HART were at the Patent Office in Washington during January relative to patent matters.



Engagements

- °Suzanne Campbell—Midshipman W. H. Ayres, Jr.
- °Julia Darr—Michael A. Papio
- Anne Dobosz—°F. Raymond Misiewicz
- °Catherine Egan—Alfred J. Hedden
- Elizabeth Rapp—°John W. Tukey
- °Helen Sahn—°Joseph C. Berka

Weddings

- °Margaret Bindewald—Leonard C. Kasper
- °Kathleen Curran—Gerard Powell
- °Margaret O'Shea—Brendan J. Baldwin
- °Evelyn Suozzo—Bernard Young

°Members of the Laboratories. Notices of engagements and weddings should be given to Mrs. Helen McLoughlin, Section 11A, Extension 296.

“The Telephone Hour”

NBC, Monday Nights, 9:00 p.m.

April 3	<i>Ferruccio Tagliavini</i>
April 10	<i>Ezio Pinza*</i>
April 17	<i>Lily Pons</i>
April 24	<i>Clifford Curzon</i>
May 1	<i>Jascha Heifetz†</i>
May 8	<i>Bidu Sayao</i>
May 15	<i>Pia Tassinari and</i> <i>Ferruccio Tagliavini</i>
May 22	<i>Jussi Bjoerling</i>
May 29	<i>Polyna Stoska</i>
°At Carnegie Hall	†From Hollywood

S. N. TURNER appeared before the Board of Appeals at the Patent Office relative to an application for patent.

H. H. BAILEY participated in a two-day conference on Air Force equipment at Wright Field, Dayton.

A. A. CURRIE spoke before the Jockey Hollow Chapter, Reserve Officers' Association, in the National Guard Armory in Morristown. A Lieutenant Colonel in the Organized Reserve Corps, he is executive officer of the 1536th Guided Missile Battalion.

NOSTALGIA NOTE—From time to time the luncheon menu at Murray Hill lists *Chicken Stew á la West Street*.

Change in Organization

Effective March 1, 1950, S. L. Eppel was appointed Laboratories Field Engineer in Detroit, replacing H. M. Craig who transferred to the General Department of the American Telephone and Telegraph Company as assistant to H. S. Sheppard. Mr. Eppel transferred to the Laboratories from the Illinois Bell during the war. Following that he was assigned to a telegraph group and later worked on AMA. On January 1, 1950 he transferred to the Quality Assurance Department. Mr. Craig has been a field engineer since entering the Laboratories in 1929. His territory included Omaha, Chicago, and Detroit.

This Month's Ad →

When Publication asked D. K. Martin, in charge of microwave tests on the salt flats, to furnish a picture for the facing advertisement, he came up with this striking close-up of a parabolic dish. Both this picture and that on the front cover were taken by C. W. Ellefsen of Long Lines Equipment Maintenance, who found in them an excellent opportunity to put his photographic hobby to work. Similar microwave tests were recently completed by R. L. Kaylor over the sage brush country of Nevada; others, under H. C. Franke, are in progress across Nebraska's Platte River Valley.