

A. C. WALKER
 Chemical
 Laboratories

PIEZOELECTRIC CRYSTAL CULTURE

When some solids in the crystalline state are subjected to mechanical pressure, electric charges develop on their surfaces. They are called piezoelectric crystals, and those of quartz, Rochelle salt and ammonium dihydrogen phosphate (ADP) were used extensively in World War II in underwater sound ranging equipment. Quartz is found

in nature, but the other two named must be grown from aqueous solutions of their salts. Demand for these crystals became so urgent during the war that a pilot plant for studying ADP growing methods was set up by the Laboratories to assist the Western Electric Company in establishing the full-scale plant which met requirements for many thousands of ADP bars.

Crystal culture and agriculture are arts with points in common. Like the farmer, the crystal grower must start with seeds, and both speak of planting and harvesting crops. Because ADP possesses two of the most important ingredients of fertilizer—nitrogen and phosphate—the farmer and the ADP crystallographer even use similar materials to stimulate the growth of their crops. While the farmer obtains fine yields of plants from his use of seeds and fertilizer, the product of the ADP artisan is the same fertilizer initially employed, albeit in a more attractive crystalline form.

Both arts are critically dependent on weather and the favor of fortune. Weather for the crystallographer consists in the constancy of temperature which he must maintain in the crystal growing bath; also he

EDITOR'S NOTE: As this issue of the RECORD goes to press, a new synthetic crystal—the EDT—is being announced by the Laboratories as a substitute for widely used quartz. Its characteristics and production, which differ from those outlined in the above article, will be described in a forthcoming issue.

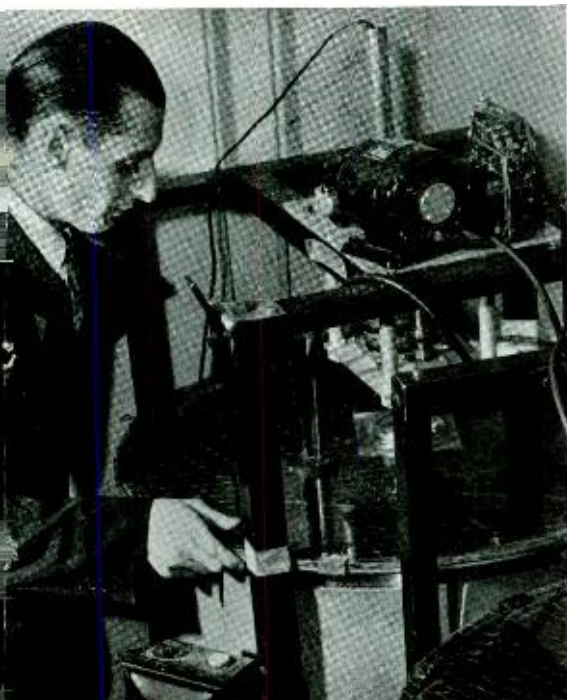

must have patience over periods of several months, meanwhile hoping that no adverse accident will ruin his efforts. For example, an unseasonable snow storm may be disastrous to the farmer—a similar precipitate of small crystals due to loss of temperature control in a supersaturated solution during crystal growth may be equally unfortunate to the crystallographer.

The general principle employed in ADP crystal culture is that of circulating a supersaturated solution of nutrient material past the growing surfaces of a seed crystal and slowly lowering the temperature of the solution a fraction of a degree per day. As the growing seed continuously removes salt from the solution, this loss is balanced by the decrease in salt solubility as the temperature decreases.

The higher the degree of supersaturation the faster the rate of crystal growth, although there is obviously an upper practical limit to this rate. At high supersaturations, multitudes of extraneous small crystals may form spontaneously in the solution and grow into large masses of waste material in the bottom of the tank. Further-

more, some of these seeds settle on perfect prism faces of the desired units, thus causing disorderly growth, as shown in the top crystal of the cover illustration. At high rates of growth, or where circulation of the solution is not uniform, cloudy areas called veils are sometimes formed on the growing surfaces. If the rate is thereupon reduced somewhat, satisfactory growth again may take place on these surfaces, and the crystal will be clear and transparent beyond a veil. This occurrence, also shown in the uppermost crystal of the cover illustration, demonstrates a healing property present in crystal growth, but the scars or veils remain to show the effects of wounds caused by a control failure.

Figure 1 is a view within an air-conditioned room of one of the Western Electric installations.* Crystals are grown here in stainless steel tanks each 48 inches long by 25 inches wide by 12 inches deep. Figure 2 illustrates the mounting of seed crystals on stainless steel pins fastened to suitable frames holding 40 seeds in five rows of eight per row. The crystals may grow to a length of about 10 to 12 inches

Fig. 1—This rocking-tank type of crystal-growing equipment yielded many thousands of large single crystals for the war effort

Fig. 2—Forty ADP crystal seeds are shown mounted in a rocking-tank tray so that the liquor will swirl to and fro against the two capped faces

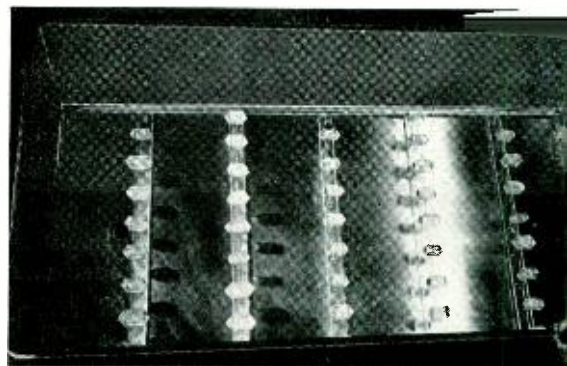
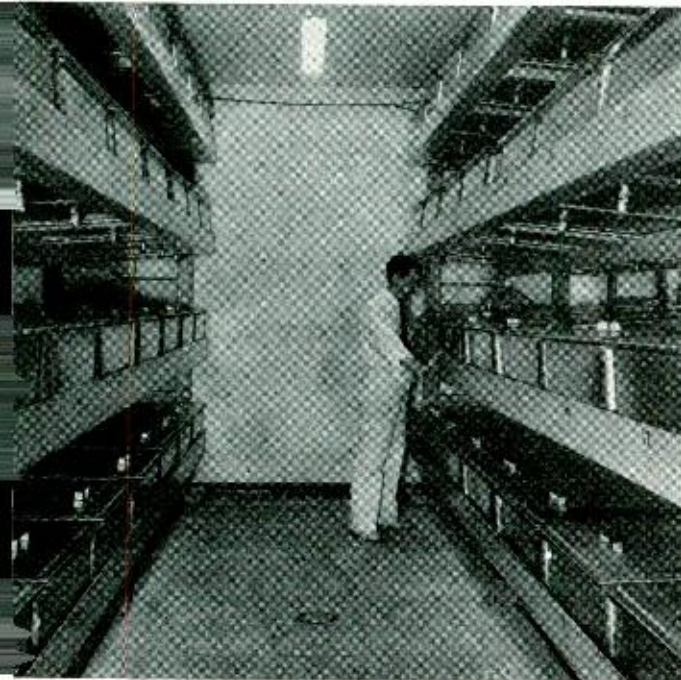

without interference but, as they lengthen, circulation of the liquid is sometimes altered, particularly at the tank ends, and

*The growing equipment and methods used by Western Electric were adaptations of the rocking-tank process of the Brush Development Company. Engineers of the latter company were most helpful in supplying essential information leading to successful application of this process in both the commercial installation and the Laboratories' pilot plant at Murray Hill.

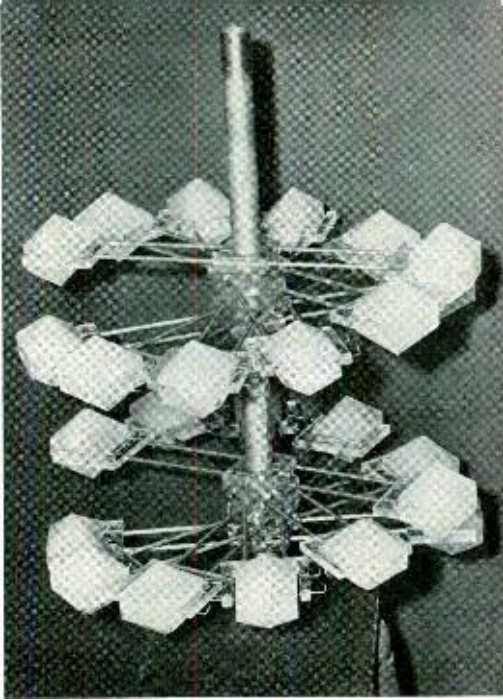

Fig. 3—The radial crystallizer tank developed in the Chemical Laboratories for synthetic piezoelectric crystal culture. The stainless steel gyrator has arms with methacrylate frames that hold the seed plates as shown, until the plates are fully capped. They are then turned 90 degrees in order that the flow of solution will be uniform against actual growing surfaces

The pilot plant modification of this second type is shown in the headpiece photograph. It is described as a reciprocating rotary crystallizer and was developed in first form as a smaller glass laboratory unit by A. N. Holden of these Laboratories. It consists of a stainless steel gyrator tube, $1\frac{1}{2}$ inches in diameter, rotating coaxially within a cylindrical stainless steel tank. The gyrator tube itself is provided with suitable mountings of stainless steel rods with methacrylate resin frames to hold the crystals, as shown in Figure 3. The tube is suspended through the glass lid of the tank from an overhead frame having a motor-driven device which rotates the tube and crystals for a short interval in one direction and then for an equal interval in the opposite direc-

this may cause veiling of a few crystals per tank. The tanks are mounted in series of four superimposed rocking platforms arranged on each side of a central aisle. Each platform holds two rows of seven tanks each, totaling 56 tanks, thus utilizing room space effectively. Most of the tanks are covered with stainless steel lids sealed with rubber gaskets, although some have glass lids to permit viewing the growing operation. The rockers tip the tanks lengthwise through a small angle several times per minute. This equipment must be enclosed in a temperature controlled room with provision for cooling at the desired rate, and the control must be good to about 0.1 degree C. The pilot unit has four of these tanks mounted one above the other on independent rocking members to give a fair likeness of the commercial installation.

This type of apparatus was entirely satisfactory for growing ADP crystals. However, for laboratory research involving the investigation and production of other possible piezoelectric crystals, another type of growing apparatus also was developed.

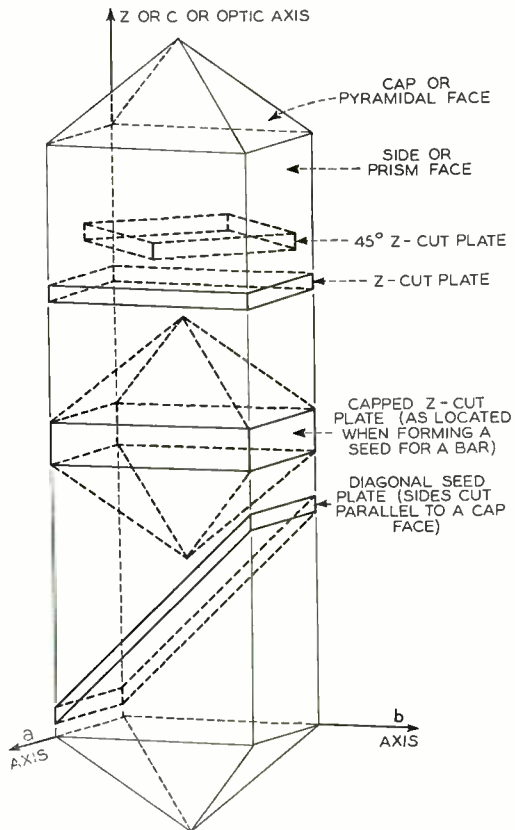

Fig. 4—Sketch of an ADP crystal bar with the various features of the bar and of the cut sections defined

tion. This reversal is essential to prevent veils by providing a uniform circulation of solution on all growing surfaces.

Heat is supplied by electric units mounted beneath the radial crystallizer tank. Suitable controls are provided in the solution to maintain the temperature within ± 0.1 degree C., and with means for daily reducing the temperature of the solution to secure optimum crystal growth. This arrangement is substantially independent of ambient conditions, provided a felt jacket covers the tanks to protect them against the effect of sudden changes in room temperature. In summer it is desirable to place the crystallizer in a temperature-controlled room maintained at a point slightly below the final growing temperature, which is usually about 18 to 20 degrees C. Control of this room is relatively simple compared

Any piece of a single crystal is a possible seed for a new crystal bar, regardless of the character and complexity of its bounding surfaces, but there are some practical limitations to this generalization. Crystals, like people, have habits that are both good and bad. One bad habit of the ADP crystal is that it grows only on the end or pyramid faces in a supersaturated solution of the pure primary salt. Figure 4 is a sketch of an ADP crystal bar with the various features of the bar and the cut sections defined. Thus if distances along the *a* or *b* axes—the prism face—of the ADP seed are very small, a bar grown from it will be long and slender and of no practical value because, for commercial purposes, bars must have cross sections greater than one inch. Cross sectional growth of the ADP crystal may be accomplished by

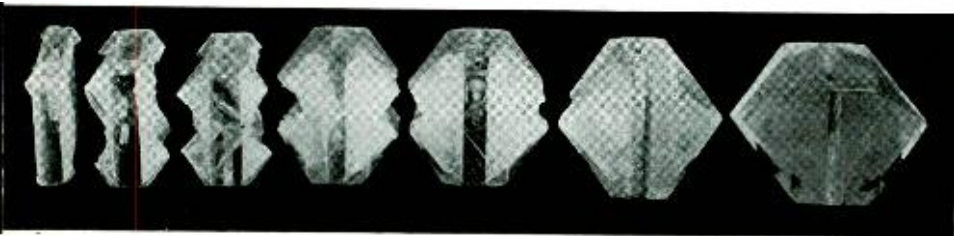

Fig. 5—Successive stages of ADP seed development into the final capped seed. The growing period of this commercial unit for bar growth is twenty-eight hours to this point

with that of the rocking-tank room because the requirement is a single temperature that is continually maintained constant within one to two degrees C.

Although this radial crystallizer does not use space and equipment as effectively as the rocking-tank apparatus, it has several advantages, particularly with much less stable solutions than those of ADP. For example, a thin layer of solution can be maintained on the bottom at a temperature slightly above the saturation point, due to the heat gradient through the tank from the heaters below. Spurious seeds settle into this hot layer and dissolve. Also, water vapor that condenses on the lid of the tank drips back into the surface layer of the solution and dilutes it. Thus any seeds which may float on the surface are readily dissolved. This apparatus makes possible a quite uniform circulation and it has been found that crystals may be grown somewhat faster in the radial crystallizer than in the rocking-tank apparatus.

making the solution more alkaline with ammonia or diammonium monohydrogen phosphate. This more alkaline solution, however, encourages another bad habit, because it is less stable and spurious seeds form in it much more readily. This necessitates frequent harvesting and replanting of seeds with consequent relatively small growth in cross section per planting. Starting with seeds of about $1/3$ inch in cross section, which can be prepared almost overnight, it requires nearly six months of replanting and harvesting to obtain crystal bars free from flaws and with prism faces $1\frac{1}{2}$ inches across. When bars of this dimension are available, growth is made to take place only on the pyramid faces in solutions of pure primary phosphate and thus applied to lengthening bars in which the initial cross section area is adequate.

Other bad habits observed in the growth of ADP crystals are a tendency for spurious seed deposits on the prism faces to

cause some sidewise growth; also, an ADP bar may be tapered appreciably during growth by impurities such as dissolved iron, chromium or tin. This latter occurrence is exhibited in the top crystal of the cover illustration. These two bad habits may be utilized to offset each other to some extent. The presence of iron in the solution seems to have a stabilizing effect against spurious seeds, and this is of advantage particularly in the rocking-tank method. However, with the radial crystallizer, perfectly formed ADP bars, 3 inches in square cross section by 12 inches long, have been grown without the addition of iron and with no evidence of spurious seeds, see bottom crystal of the cover illustration. A cloudy central portion of the ADP bar is of no value for piezoelectric purposes but it provides seed material for the growth of additional bars.

Growth is most successfully performed in two operations. The first consists in forming all of the natural faces on a Z-cut plate obtained from the central portion as indicated in Figure 4. Because growth takes place only on the pyramid faces, these Z-cut seed plates are mounted in the primary phosphate solution so that movement of the liquor is past their major faces, which are not natural surfaces of the complete crystal. Therefore, the initial growth takes the form of developing small tent-like surfaces originating at the corners of the plate where circulation is a maximum. Figure 5, from left to right, shows the stages of growth of these pyramid faces. The unit on the right is the finished capped plate, to be used as a seed in the second, or bar growing operation. Under optimum conditions the initial tent-like corners enlarge until they choke off any circulation within the middle area of the plate faces and finally these tents converge to thin-walled pyramids covering each face. Enclosed within these thin-walled pyramids are appreciable amounts of salt solution. If the capping operation is stopped before the pyramid walls are of sufficient thickness, this trapped liquor will effloresce through cracks and prevent use of the capped plates as seeds for growing bars. In Figure 3, the units mounted on the gyrator (at the left) are 3-inch capped

plates that have just been removed from the capping operation.

For the second operation, that of growing clear bars on these cloudy central capped plates, the seed holders are rotated 90 degrees on their mountings so that the axes of the pyramids on the capped plates

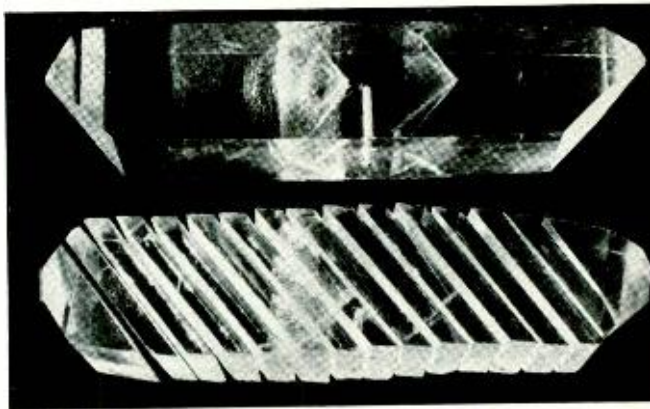
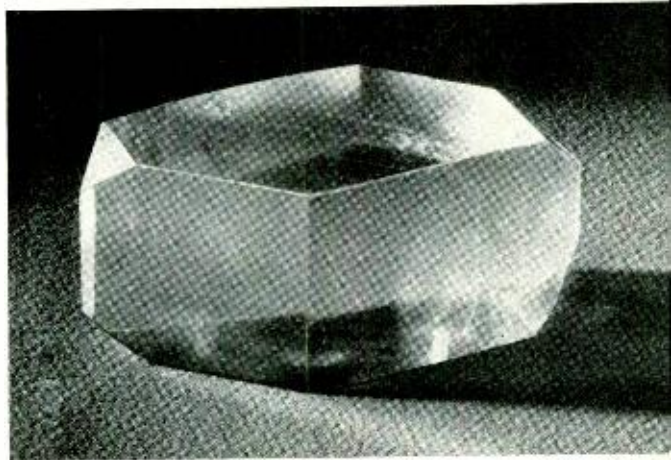

Fig. 6—It was found that if seed stock were diagonally cut as illustrated, with major faces parallel to the pyramidal face, new single crystals could be grown free from veils under proper control

Fig. 7—Early growth of an ADP crystal begun from a diagonal seed cut. Note the absence of veils



are horizontal instead of vertical. This provides maximum uniform circulation of the solution over the pyramid faces, thus insuring clear bar growth. Only seeds having all their natural faces developed can be used to grow clear material, because clear growth takes place only on these faces which, in this case, are the pyramid faces. This important principle led to a means



Fig. 8—Continual vigilance to avoid failures of temperature control in mechanical and electrical apparatus was required by the task force of the piezoelectric crystal pilot plant. The photograph shows John Ryoul, plant watch operator, observing the temperature records on a twelve-point instrument in the crystal growing laboratory

of growing clear, transparent bars with no middle cloudy, double pyramid. If a bar is cut into diagonal seed plates, such as those shown in Figures 4 and 6, each plate may be considered as having all natural faces or faces parallel to natural faces, because the angle of the diagonal conforms to that of the pyramid face with respect

to the Z-axis. Such diagonal plates begin immediately to put on clear growth in the growing solution and in time all the pyramid faces begin to form. Figure 7 shows a bar started from a diagonal plate, with only the outlines of the diagonal seed plate revealed. The bar has clear, useful material from end to end. The faint outlines of the original seed are caused by slight solution of the edges of the seed during the initial hours after planting and while the solution is still above the saturation temperature. This procedure is not attractive commercially in growing ADP as compared with the two-stage operation because of the close requirements in the angle of cut of the diagonal plate and the temperature control during initial stages of growth. The method just described emphasizes, however, an important principle in the growing of clear crystals.

The average dimensions of ADP production bars of useful size were about 1¾ inches in square cross section by 9 inches in length and the war demand so increased their output that the art of crystal culture rapidly achieved the status of an important industry. The pilot plant of Bell Telephone Laboratories made an effective contribution in the successful effort to mass-produce synthetic ADP crystals.

THE AUTHOR: A. C. WALKER graduated from the Massachusetts Institute of Technology in 1918 with an S.B. degree in Chemical Engineering. Previously he had studied two years at the University of Colorado. In 1923 he received the Ph.D. degree in Physical Chemistry from Yale University and came to the Laboratories that year. Dr. Walker had had previous experience in the Chemical Warfare Service and as research chemist for a paper mill and a firearms plant. Problems concerned with textile and paper research first occupied his time here, particularly methods of purifying and inspecting textile insulation. Early in the war he became actively engaged in the growing of synthetic crystals for sonar equipment. Recently his time has been spent in operating a pilot plant growing crystals for telephone pur-

poses. Dr. Walker has been associated in the work of the Textile Research Institute and is at present a member of its Advisory Research Committee.



J. M. BARSTOW
Transmission
Engineering

CARRIER TELEPHONES FOR FARMS

A general extension of telephone service to widely scattered farms has long been an objective of the telephone industry. In ad-



dition to commercial practices facilitating rural expansion, improved technical developments have been introduced over a period of years to reduce the cost of furnishing service in sparsely settled areas. These include long-span open-wire construction, an improved insulated wire which in favorable terrain may be plowed into the ground, and the joint use of poles by telephone wires and power distribution circuits. Supplementing these more usual methods is the relatively new power-line carrier technique which permits the use of power distribution poles and wires for both power and telephone services, and also—

for communities that may not readily be connected with other communities by wire—radio telephone links. Each of these new methods has its particular field of use, and each is competitive in its field with the conventional method of connection to existing cables and open-wire lines.

As long ago as 1936, Bell Telephone Laboratories began studying the possibility of providing rural telephone service over power lines. The work continued more or less concurrently with the rapid expansion of power distribution facilities in rural areas, and in 1940 arrangements were made for the project to proceed on a coöperative basis* with the Rural Electrification Administration. By the time the entry of the United States into World War II postponed further work, enough data had been accumulated to indicate that there was a good chance that a carrier telephone system, operating over rural power distribution wires, was practicable.

Early in 1945, a small group of telephone engineers was assigned to the work, and coöperation with the REA was reëstablished during the summer of 1945 in the form of transmission measurements and preliminary systems trials on an REA line near Hutchinson, Kansas. In these tests earlier data were corroborated, and new data obtained on the effects of power-line equipment on carrier transmission and on means for confining carrier transmission to selected portions of power distribution systems so as to enable more than one carrier system to operate on a single power system. It also became apparent during these tests that atmospheric noise would be the limiting factor in transmission.

Further development was carried on in the fall of 1945, and two single-channel systems were built for purposes of trials

*RECORD, February, 1943, page 145.

with customer participation. One was installed near Jonesboro, Arkansas, on REA lines, and cut into service in December, 1945, and the other was installed on private power company lines near Selma, Alabama, and cut into service in January, 1946.

Experience gained from these installations and from the Kansas tests, as well as from the pre-war tests in La Plata, Maryland, and Martinsville, Indiana, were combined with further improvements conceived during the spring of 1946, and manufacturing information on the various equipments involved was given to the Western Electric Company during the spring and early summer of 1946. By late September, a few models known as pre-pro-

the central office. Only one of these latter two is used in a normal call, the other being used for a reverting call, i.e., when one party wishes to talk to another party on his own channel, or "line" to use voice-frequency terms. Each of these carrier channels is used as a party line and may serve as many subscribers as is customary in a given area. Assuming eight parties per channel, each carrier system has a potential capacity of forty-eight farms.

The principal parts of the M1 system are shown in Figure 2. At the subscriber's location is placed a combined telephone set, a subscriber's carrier terminal, and a connection by a carrier drop wire to a coupling unit at the nearest convenient high-tension power pole. The coupling unit is connected to the high-tension line (maximum 8.7 kv to ground) by a high-voltage capacitor and fuse. When the system is used over telephone pairs, the telephone set, terminal, and drop wire are the same, but the coupling units are somewhat different. The high-voltage capacitor is no longer needed, and since the coupling is in this case to a balanced line, two low-voltage capacitors are used, one for each side of the line.

In the subscriber's carrier terminal are the modulating and demodulating circuits for the outgoing and incoming speech, and also for converting pulse-modulated carrier to current pulses for operating the ringer, and for converting dial pulses from the subscriber's set to carrier-frequency pulses for transmission to the central office. Seven watts are used during idle periods, and twenty-five watts during operating periods.

At the central office end of the power line there is a common-carrier terminal for each carrier channel. The carrier side of the terminals are multiplied together and are connected to the power line through a drop wire, common coupling unit, coupling capacitor, and fuse. The terminals convert voice-frequency and ringing current from the central office to carrier-frequency signals for transmission over the line, and convert received carrier signals to voice frequencies and to d-c pulses for operating the dial equipment. During idle periods, sixteen watts of power is required, while thirty watts is taken during operating periods.

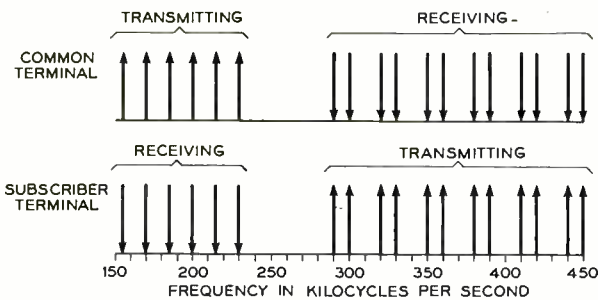

Fig. 1—Frequencies employed by the M1 carrier telephone system

duction models had been built and were shipped to a few trial locations. Some of these were in service by January, 1947, and the Western Electric Company is producing systems in substantial quantity for 1947 installations. The system is known as the "M1 Carrier Telephone System." It may also be used over open-wire voice-frequency lines to supplement existing telephone service.

The M1 system employs double side-band, amplitude modulation, and transmitted carrier. The frequencies used lie between 150 and 455 kilocycles as shown in Figure 1. Within this band six channels are provided, each using three specific frequencies: one for transmitting from the central office to the carrier subscriber, and two for transmitting from the subscriber to

Although six carrier channels are provided by the equipment, in some localities certain channels must be omitted because of the possibility of interference with or from other systems such as airway beacons or broadcast receivers. The subscriber transmitting channel employing the 440 and 450 pair of frequencies is not generally used in power-line applications because these frequencies are close to the intermediate frequency of many commercial broadcast receivers. When such receivers are provided with insufficient radio-frequency tuning in the input stages, conversations that are carried on over power-line carrier systems might be overheard.

Of the three frequencies available for each channel, one—designated F_3 —is always used for receiving at the subscriber's station. The other two— F_1 and F_2 —are available for transmitting from the subscriber's station, and the common terminals have two receivers, one for each of these frequencies. For calls between a rural subscriber on the carrier system and a subscriber not on the carrier system, the F_1 frequency is always used, as indicated in the upper part of Figure 3. For reverting calls, however, that is, calls between two subscribers on the same carrier channel, the F_1 and F_2 frequencies are both used as indicated in the lower part of Figure 3. For such a call, the calling subscriber hangs up after giving the number wanted to the operator, thus taking the F_1 frequency off the wires. The operator then rings, and after the called subscriber answers, using F_1 , the calling subscriber lifts his handset, and his terminal—recognizing that F_1 is already in use—automatically selects F_2 for transmitting.

To prevent reflections or serious loss at taps or other irregularities on the power line, and to restrict carrier transmission to only the section of the power line required, a number of corrective steps must be taken. Reflections from the ends of the carrier section of the power line are avoided by terminating the line in the characteristic impedance for the frequencies involved. Where power-line taps that are not to be equipped are made to the main power line, choke coils are installed to block off the tap. If the taps are to be part of the

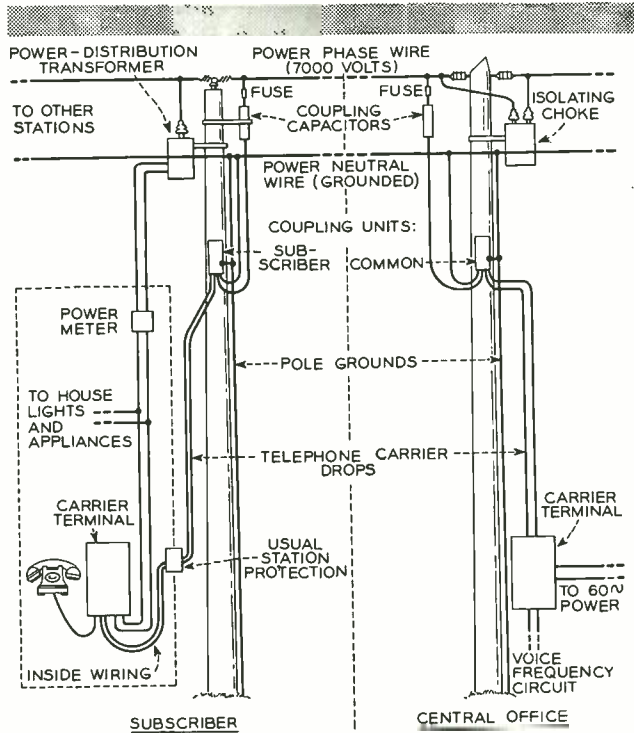

Fig. 2—Major apparatus units at the subscriber and central office ends for the M1 carrier

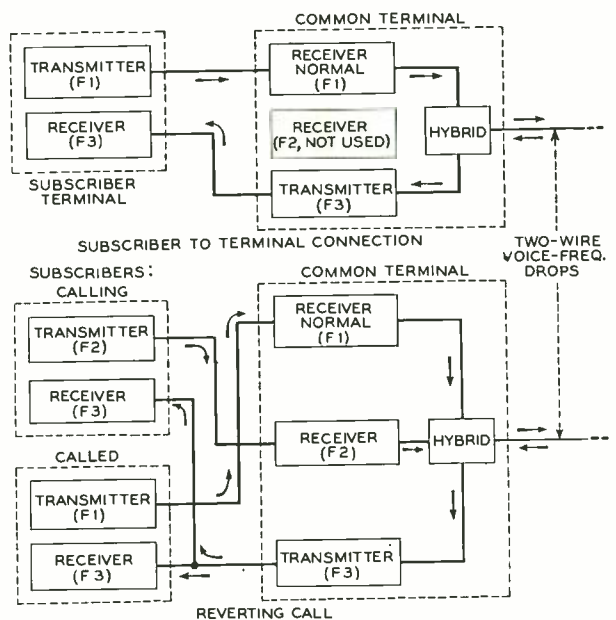

Fig. 3—Block diagram showing frequencies employed in a normal and in a reverting call

carrier system, transmission chokes are employed. These have sufficiently low inductance to allow enough carrier to flow into the tap to give adequate telephone service, but have enough impedance to

make the tap appear to be a reasonably high-impedance bridge on the main line. In addition, all carrier-equipped taps are terminated in the characteristic impedance for the carrier frequencies.

THE AUTHOR: J. M. BARSTOW received the B.S. degree from Washburn College in 1923 and the M.S. degree from the University of Kansas in 1924. After three years as an instructor in Physics at Kansas State Agricultural College, he joined the D & R, where his major work was on noise measurement and evaluation. In connection with this work he served as a member of Project Committee 1B of the Joint Subcommittee on Development and Research, Edison Electric Institute and Bell System, and as Secretary of the Technical Committee on Sound Levels and Sound Level Meters. He transferred to the Laboratories in the merger of 1934, where he continued in the same type of work. During World War II, he directed the electrical design of certain equipments for Army communications systems, and in 1943 was overseas in the European Theater of Operations for several months as technical adviser

to the Signal Corps. Near the close of the war he assumed charge of a small group to continue the development of power-line carrier telephone systems, which had been begun by another group before hostilities began.

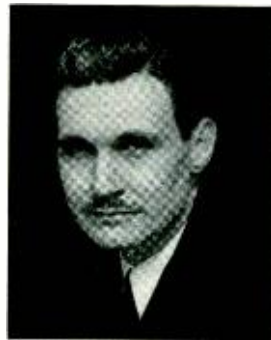

TELEPHOTOGRAPH NETWORK FOR THE ARMY AIR FORCE

To facilitate the more economical distribution of weather maps to all Army air fields in the United States, the Long Lines Department is providing a nation-wide network for the Army Air Force. Some of the stations are now in service, and more than one hundred are planned for service within the next few months. It will be the largest telephotograph network ever attempted.

With the network in service, the Army expects to be able to reduce the technical work required at air fields by centralizing the forecasting service. Both National and International weather maps will be prepared at the main control point at Arlington, Va., and sent from there to all Army air fields in the United States. In addition, regional maps will be distributed from secondary transmitting points at Fairfield-Suisun near Oakland, Calif.; at San Antonio and Oklahoma City; at Warner Robins near

Macon, Ga.; and at Mitchell Field, Long Island. The network will be arranged to operate as a single circuit or as four separate circuits.

Associated with the telephotograph network at each transmitting station and each switching station is a 110A key equipment which has been developed at the Laboratories. Externally this appears to be similar to the 101A key equipment,* but the circuit details are made somewhat different to provide the transmission and signaling conditions particularly needed for telephotograph service. Some of the keys on the face of the equipment permit the circuits to be used for signaling and telephone intercommunication during periods between telephotograph transmission. Other keys control the switching together of the different telephotograph circuits.

*RECORD, August, 1937, page 370.

LLOYD ESPENSCHIED
Research
Consultant

EARLY DREAMS OF ELECTRON RELAYS

These days, as never before, we are conscious of the revolution in physics that was caused by the discovery of X-rays and radio-activity in 1895-6. These discoveries had been preceded by a long series of studies of the so-called cathode-ray discharges in vacuum tubes, but it took the discovery of these brand new rays with their remarkable penetrating qualities to jolt physicists out of the classical frame of mind and into the new era of corpuscular radiations.

In January and mainly in February, 1896, the American newspapers gave widespread publicity to the announcements rising out of Europe of the properties of the new X-rays. Seeing the bones of the hand amazed and excited the public. Many ideas must have

been stimulated in the minds of inventors, many thoughts of how such rays might be harnessed to further usefulness. It is pertinent to the rôle the Bell System has played in the history of the vacuum-tube amplifier that two of the telephone engineers then in the Boston laboratory of the Company were moved to think of these rays in terms of their possible application to the problem of the telephone relay. The relaying of electric communication signals on to greater distances has been a prime objective of telegraphy from its very beginning. Naturally relay action was sought for telephony in the very beginning of that art, since telephone waves died out more rapidly than did telegraph signals.

Reproduced here are some of the records that these young telephone engineers were then moved to make, seeking to use X-ray tubes as telephone relays—what probably is the first entertainment of the idea of the vacuum-tube amplifier. These records were found by the writer in the old Boston files of the Company only in recent years in the course of a search made for other purposes. Notice that the suggestions were made starting in February, 1896, the very month in which the X-ray newspaper publicity reached its zenith in this country.

These records had lain forgotten all these years. They were premature at the time, as so often happens. The electron had not yet been identified. We know now that it was not X-rays that might be used for amplifying purposes, but rather the electrons which create them. Much more had to be known about the vacuum tube in its thermionic form before it could be utilized in electric communications. As it turned out, the then newly budding art of radio had to lead inventors to seek better de-

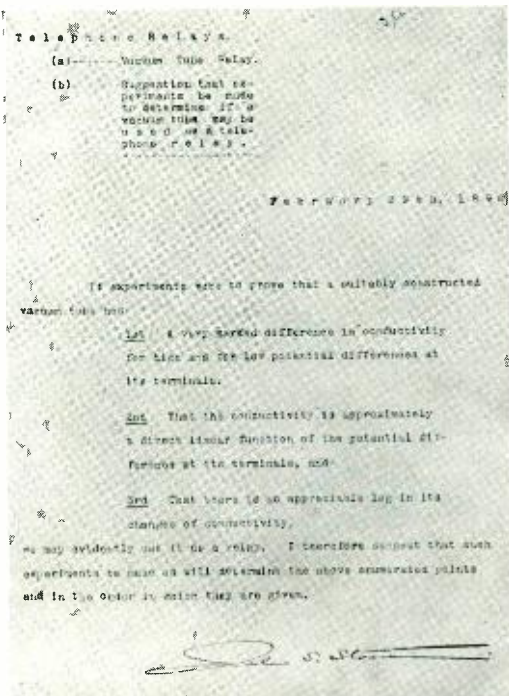

- (1)-----The use of radiations from vacuum tubes for the purpose of telephone relaying.
- (2)-----Suggestion for a Method of Experiment.

March 6th, 1896.

It has long been known that radiations from sparks and from vacuum tubes facilitate the discharge of negative electricity from an insulated body. It is now pretty well settled in my mind that it was through misinterpretation of the experiments that the effect of these radiations in facilitating the discharge of a charged body was confined to negative charges. The real effect of these radiations is, I believe, to temporarily convert dielectrics through which they pass into conductors of electricity, i. e., to enormously enhance the conductivity of the dielectric pro tempore.

I suggest that we make use of this property of these radiations to relay telephone currents and as a sensitive arrangement for this test, I think the arrangement shown below would be found satisfactory.

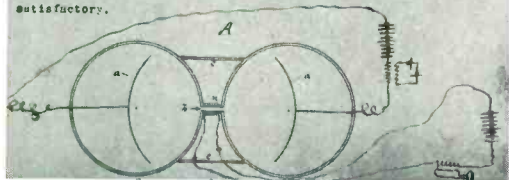

- A---is a vacuum tube.
- a---are electrodes of large surface.
- b---is a very narrow passage with thin walls.
- c---is a thick tube to strengthen an otherwise weak construction.
- d---is a coil of two parallel insulated wires as shown on a large scale at n in Figure 2.

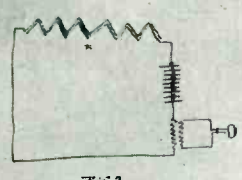

Fig 2

J. S. Stone

tectors, and it took a deForest to wrestle, finally successfully by means of the grid, with the problem of how to enable a weak incoming signal to control the electron flow. It was not until 1912-13 that the accumulated knowledge was great enough to produce the amplifying vacuum tube in the truly serviceable high-vacuum form. It is fitting that this latter great step, which resulted in the first really serviceable electron relay, was taken in the New York Laboratories of the Western Electric Company by H. D. Arnold in 1913.

Both of the telephone engineers who made these early suggestions have now passed on. John Stone Stone, best known as the radio pioneer that he became, made the first two of them. He was then a young telephone engineer who had done some early work in common-battery telephony and in the elimination of the d-c in a manner analogous to carrier elimination today. He early worked on loading, and had taken, prematurely as it proved, an interest in the possibilities of high-frequency carrier transmission over wires. Along in the late 1890's he left the telephone company to pursue the development of radio on his own account, again prematurely as it turned out. Imagination often proves unable to reap its full reward because the stage is not yet set. Here in these old notes is vivid evidence of the brilliance and creativeness of a telephone-radio pioneer.

The second pair of suggestions is by a colleague of Stone's at that time—Frederick L. Rhodes. Many of those still active in telephony remember the genial and industrious Mr. Rhodes. It was he who wrote the "Beginnings of Telephony," published in 1929, and it was he who wrote the biography of John J. Carty, published in 1932. Carty was the chief engineer of the American Telephone and Telegraph Company who led the company in the successful pursuit of the vacuum-tube amplifier, starting with Arnold's work on the mercury-vapor type of tube in 1911-12, and it was during Carty's chief engineership that the company entered actively in developing high-frequency telephony on wires and by radio, starting about 1914. When Rhodes wrote these books, he probably failed to recall that he himself had entertained some

Relays.
Application of Röntgen Rays
to Telephone Relay.
Suggestion.

April 27th, 1896.

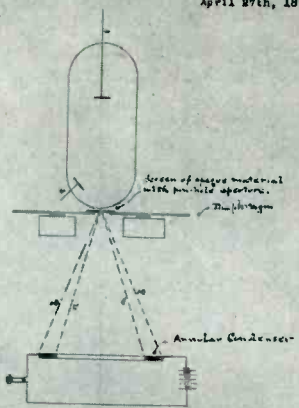

The rays have a normal path B-B. As the dielectric is affected downwards, the rays appear a-a

October 1947

early dreams of the vacuum-tube Aladdin's lamp then shedding its life-giving rays over the whole field of electric communications. From long waves to minute corpuscles is a wide span in physics and in time, and those are fortunate who have lived through the period, and fortunate also is the telephone company that harbored such valiant young engineers, and that has so effectively carried the vacuum tube into public service.

These youthful electronic suggestions prove to have been prophetic of the revolutionary practical results that were to follow decades later from the great scientific discoveries of the gay "90's." Meanwhile, the more fundamental scientific advance has continued and is giving us striking new conceptions of the relation between matter and energy, time and space, waves and corpuscles. Further great consequences are to be expected. Far from diminishing, the opportunity of today's young scientist and inventor seems greater than ever.

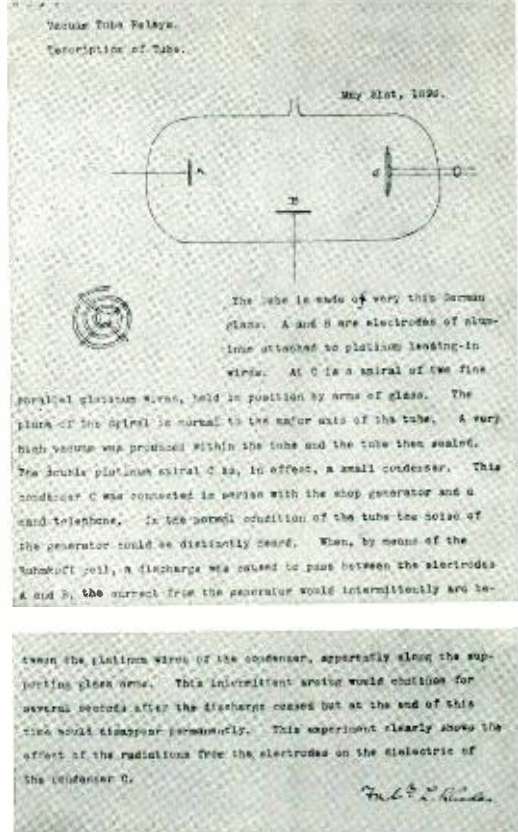

THE AUTHOR: LLOYD ESPENSCHIED, after experience with amateur experimentation and as a wireless telegraph operator at sea, entered Pratt Institute and graduated in 1909. Following a brief period with the Telefunken Company providing radio equipment for the Army and Navy, he joined the A T & T, working first on loading coils. He



then began an active and prolific career in radio and all phases of high-frequency transmission. He played a prominent part in the early radio telephone tests between Washington, Paris, and Hawaii, in the development of ship-to-shore radio telephony, in the company's early participation in broadcasting, and in carrier telephone developments. He was one of the inventors of the coaxial transmission system and was largely responsible for pushing its early development. The quartz crystal band filter was one of his many inventions. He was one of the first to suggest the use of reflected waves to determine distance, which took practical form in the airplane altimeter and—in radically different form—became the basis of radar. Transferring to the Laboratories with the D & R in 1934, he was Director of High-Frequency Transmission until 1939. Since then, he has served as Staff Research Consultant. He is a Fellow of the A.I.E.E. and the I.R.E. One of the founders of the I.R.E., he is a recipient of its Medal of Honor.

IMPROVEMENTS IN D-C TELEGRAPHY

B. P. HAMILTON
Telegraph
Development

Until about the end of World War I, practically all long-distance telegraph circuits were on open-wire lines. About this time, however, cables began to come into extensive use for long telephone circuits, and it became desirable, therefore, to develop a telegraph system that could utilize the rapidly growing cable plant. The open-wire telegraph systems already described in the RECORD* employed high voltages and comparatively large currents which would produce excessive disturbance in the closely packed pairs of the cable. The fact that the circuits were grounded would also have greatly increased the disturbing effects of the large currents. A new telegraph system was therefore developed for metallic circuits. Since a metallic circuit inside a cable is essentially free from external interference, lower currents and voltages are practicable without decreasing the quality of the signals.

In its basic principles the metallic system is very similar to the differential-duplex system described in the article already referred to, and its evolution from it is shown in Figure 1. The subscriber's loop circuit differs, however, in employing polar transmission toward the subscriber, and thus in part takes advantage of its improved transmission. With such a loop, the received signals have no effect on the transmitting relay, and thus no auxiliary holding circuit is required. The "break" feature is incorporated by the addition of a single polar relay. The circuit for one terminal is shown in Figure 2. The operation of the loop circuit is somewhat similar to that of

the polar system already described.* With the subscriber's key closed, as for receiving, incoming signals at the central office operate the receiving relay alternately to mark and space, and thus connect negative or positive battery to the balance point of the loop circuit. Under both conditions, the currents through the windings of both the pole changing and break relays are such as to hold them to the "mark" contacts, but current flows over the loop for the mark pulses, and no current flows for the space pulses.

Should the subscriber open his key to break in on the line, the break and pole-changing relays will both operate at the first incoming marking signal from the line, and the operation of the break relay will connect negative battery to the spacing contact of the receiving relay so that all further incoming signals, either marking or spacing, will maintain negative or marking battery on the loop at the central office. As a result, a continuous space pulse is sent out over the line, which blocks transmission at the distant end.

To meet the lower current requirements of metallic cable circuits, new polar relays were developed that will operate on about one-tenth of the operating current of the previous relays, and the weight of the armature and the contact travel were both reduced, thus greatly reducing the likelihood of signal distortion. The new relays will operate at more than double the speed of the previous ones. They carry an additional pair of balanced windings which is used with a vibrating circuit to increase the

*RECORD, October, 1945, page 373.

*Loc. cit.

speed of operation. This vibrating circuit is shown in Figure 3. With the armature on the marking contact, a current flows through one half of the winding and the resistance to ground which tends to move the armature to space but is not quite large enough to do so. The condenser is charged negatively through the other half of the winding, and as the armature leaves the marking contact in response to a spacing pulse, the condenser discharges through the two vibrating windings in a direction that tends to operate the armature to the spacing contact. As the armature reaches the spacing contact, positive charging current to the condenser gives an additional spurt of current to hold the armature firmly on the spacing contact. With the armature on the spacing contact, a current flows through one half of the winding tending to move the armature to the marking contact, and as the armature leaves the spacing contact in response to a marking pulse, the condenser discharges in the opposite direction, and thus kicks the armature rapidly over to the marking contact. The vibrating circuit, as a result, speeds up the action of the armature, and tends to avoid contact chatter.

Metallic telegraph has remained in operation to the present day, but the relative extent of its use has decreased considerably because voice-frequency carrier telegraph has been found more suitable on the back-bone cable routes. Such systems are capable of providing as many as eighteen telegraph channels for each voice channel. Their introduction so greatly increased the number of available telegraph channels that the relative importance of the factors affecting the choice of a telegraph system changed. While the necessity of securing as many channels as possible was an important factor before this time, a decrease in maintenance now overshadowed it. One of the most exacting operating features of duplex-telegraph circuits is maintaining the balance on long circuits, since the balancing networks at each repeater station and terminal often have to be readjusted to meet the changing line conditions. To avoid this effort, a four-wire metallic circuit was tried in 1927. Several years later, it was decided to extend the use of this

method considerably, and today most of the d-c metallic telegraph service is provided by four-wire circuits.

With a four-wire circuit, no balancing networks are required because, since transmission is always in the same direction

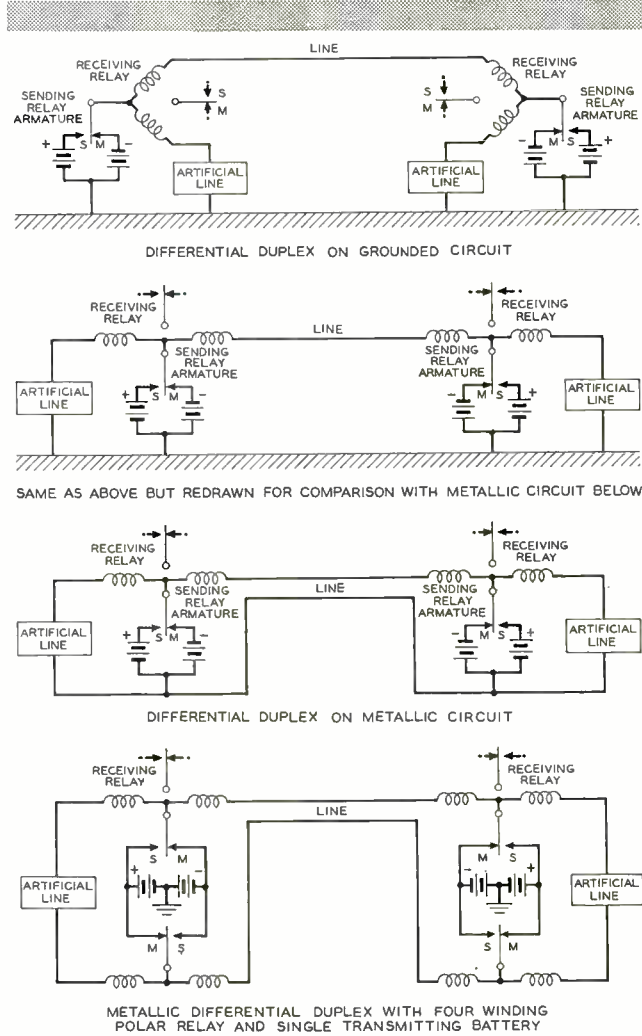

Fig. 1—Evolution of the “metallic” telegraph circuit from the differential-duplex system operating on a grounded circuit

over one pair of wires, no balance is required to keep the receiving relay from being affected by the outgoing signals. The circuit arrangement is as shown in Figure 4. A break relay is required as for the two-way circuit, but it is omitted in Figure 4 for the sake of simplicity. This

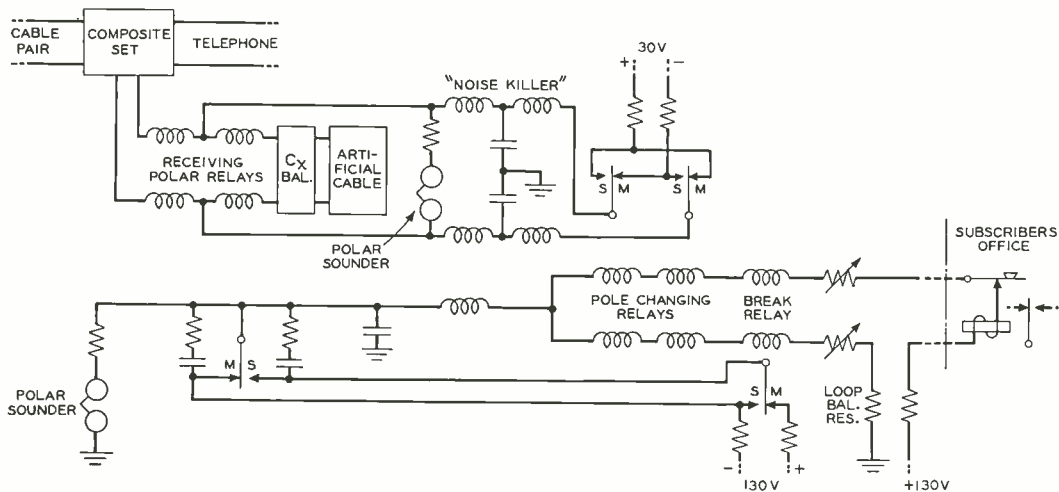

Fig. 2—The “break” feature is incorporated by the addition of a single polar relay

system has the additional advantage of reducing the disturbing effect of changes in the characteristics of the line. The same value of current, but of opposite direction, flows over the line for both the marking and spacing pulses, and thus any tendency to change the length of the marking pulse is offset by an equal tendency to change the length of the spacing pulse.

Prior to the use of metallic circuits, several developments were made to improve the operation and maintenance of grounded

duplex balance restricted the building up of long multi-unit circuits. For some circuits only one-way transmission was necessary, and taking advantage of this fact, a one-way polar system was developed. Such a circuit is similar to the early single-line grounded system except that the sending relay applies positive or negative battery to the line instead of opening it and closing it. The first circuits of this type were put into service in 1919 for distributing news out of New York City.

In some cases, two of these one-way polar systems were used to provide two-way transmission. In 1930, a combination differential-duplex and two-path polar repeater was standardized, which could be used either for the two-path polar systems or for the differential-duplex as desired.

Although the various polar duplex systems in use at this time secured most of the advantages of polar transmission, they were not entirely free from the effects of changing characteristics of the line. These changing characteristics are due principally to variations both in the resistance of the line wire itself and in the leakage resistance which permits some of the current to drain off the line to ground. With cable circuits there is very little change in the leakage current, and thus the major part of the changing characteristics is due to

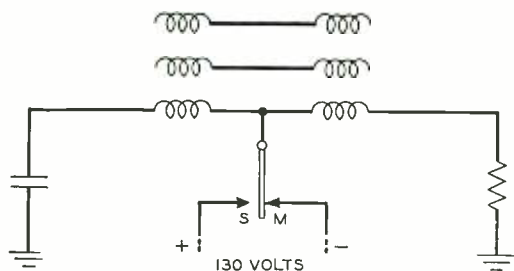

Fig. 3—The vibrating circuit incorporated to improve operation of the faster polar relays

circuits. With the polar relays then in use, the speed of transmission was rather limited, and the difficulty in maintaining the

variations in the line resistance with changes in temperature. With open-wire lines, on the other hand, the leakage changes greatly from dry to wet weather, but since the line conductors are much larger than those used in cable, the changes in resistance due to temperature are relatively less important. With the polar-duplex systems, these changes in line characteristics change the marking and spacing currents unsymmetrically, and therefore cause signal distortion unless they are compensated by an adjustment. This adjustment involves frequent attention, and in the attempt to decrease the amount required, especially for unattended locations, the polarential system* was developed.

Because of the differences in the characteristics of cable and open-wire circuits,

spacing are seldom equal. This is because to meet the condition of equal marking and spacing currents, the limiting line resistance for satisfactory operation would be considerably reduced if the usual values of line current were employed in the polar sending direction. The system as commonly used, therefore, does not completely compensate for changes in line resistance but does so sufficiently well for practical purposes.

The system for open-wire lines is shown in a simplified form in the lower diagram of Figure 5. As before, transmission from west to east is on a true polar basis and is therefore practically immune from the effects of a change in line leakage. For transmission from east to west, the circuit is so arranged that the voltage between

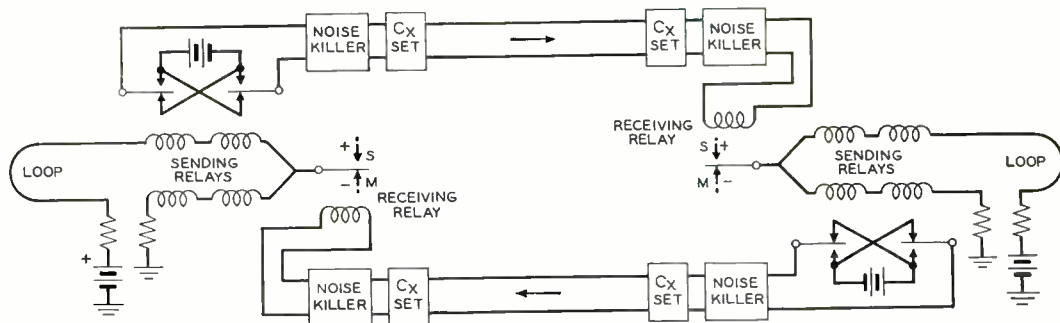

Fig. 4—Arrangement of the four-wire circuit

the polarential system was made available in two forms: a type A system for cable circuits and a type B system for open-wire lines. The system for cables is shown in a simplified elementary form in the upper diagram of Figure 5. Transmission from west to east is on a true polar basis, and is therefore practically immune from the effects of a change in line resistance. For transmission from east to west, the circuit is so arranged that the current also reverses for the marking and spacing conditions and would be equal in the two directions for the circuit of Figure 5. However, with the type A polarential system as used in practice, the currents for marking and

the mid-point of the line and ground is approximately the same value but reversed in sign for the marking and spacing conditions. Thus, the effect of leakage current in the marking and spacing signals is approximately the same. As in the case of cable circuits, the system actually used does not completely compensate for changes in line leakage but does so sufficiently well for practical purposes.

The single-line repeater that had been employed extensively in the Bell System for many years used neutral relays, and as a result its operating speed was rather low. With the increase in the speed of sending following the use of the teletypewriter, a higher-speed repeater was desired to use

*RECORD, March, 1941, page 217.

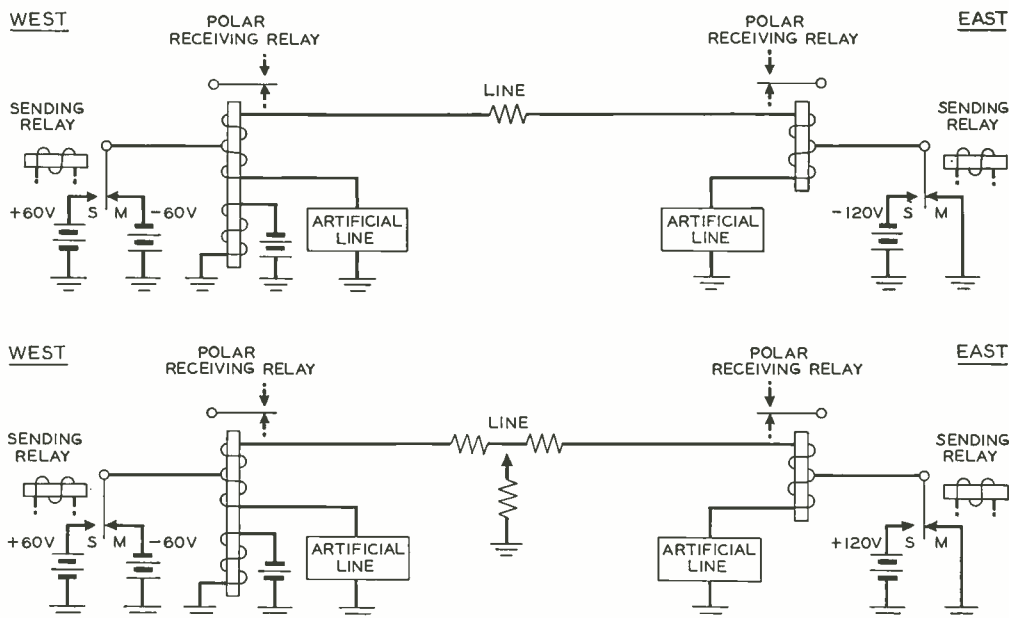

Fig. 5—Polarential system for cables (upper diagram) and for open-wire lines (lower diagram)

for setting up three-way connections on metallic and carrier systems as described in the earlier article. In 1925, development was therefore started on a new single-line repeater using polar relays. The circuit of this repeater is indicated in Figure 6. Although this repeater was designed primarily for providing a three-way connection, it may also be used as an intermediate re-

peater wherever a single-line telegraph repeater is needed.

Of the two pairs of balanced windings of each relay, one carries the incoming and outgoing signals and the other, a biasing current from local battery. With the conditions shown in Figure 6, both relays are on their marking contact—in each case held by the marking current through windings A of both east and west relays against a weaker biasing current tending to operate the relays to space. When a spacing signal comes in, say from the west, current in the A winding of the west line relay drops to zero, and the biasing current in the B winding moves the armature to the spacing contact, thus sending a space signal east. The armature of the west holding relay is also moved to space, and this results in a reverse current through the east biasing windings to hold the east line and biasing relays on mark. A following marking pulse restores the circuit.

As originally designed, this repeater included arrangements for adjusting the bias to compensate for bias introduced elsewhere in the circuit. In a later design, how-

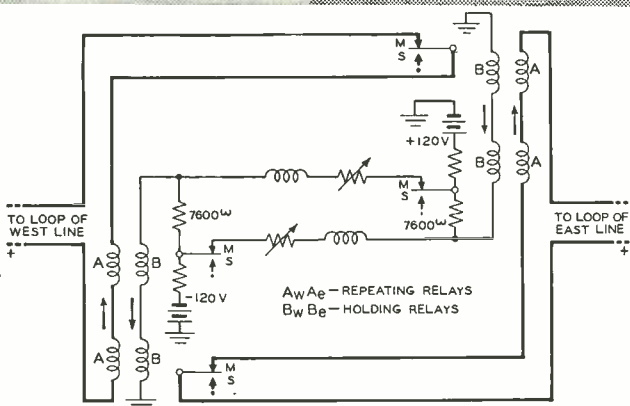

Fig. 6—Single-line repeater using polar relays

ever, this adjustable feature was omitted, since it was preferable to locate any bias appearing, and to correct it at its source rather than to introduce compensating bias at the repeater.

These developments brought the various d-c telegraph systems into line with the most modern standards, and made them

suitable for the high-speed transmission required for the newer teletypewriter equipment. By the late 1920's, however, carrier systems began to assume the leading position in the telegraph field, and all the more recent larger developments have been associated with them. These will be discussed in a forthcoming article.



THE AUTHOR: B. P. HAMILTON was graduated by Columbia University in 1913 with the E.E. degree. He taught there for two years and then joined the Engineering Department of the American Telephone and Telegraph Company in 1915 to work on equipment design and later on field tests of high-frequency and voice-frequency carrier telegraph systems. Mr. Hamilton's work has also involved development problems in connection with the Key West-Havana submarine cable and transcontinental carrier telegraph systems. Since 1930 he has been engaged in developing voice-frequency carrier telegraph systems and applications to carrier telephone channels.

A TELEPHONE ARIADNE

In the maze of cabling of a telephone central office, or even in the smaller groups of wires run through walls of subscriber premises, individual conductors lose their identity to visual inspection. The telephone maintenance man or installer needs an identifying trace to permit him to follow the particular electrical path he is seeking, much as Ariadne's thread guided Theseus through the Cretan Maze on his return from combat with the Minotaur. Such a trace is now supplied by the 81-A test set recently developed by W. L. Betts and now in manufacture by Western Electric.

This set consists of a plastic, oval-shaped case containing two flashlight batteries, a small buzzer, a capacitor, a three-position switch, and two spring-type binding posts. With the switch in the central position, the set is off. With the switch moved to the C position for a continuity test, battery is connected to the binding posts, and wires of a closed circuit connected to them will cause the buzzer to operate. With the switch moved to the T position, tone from the buzzer is applied to the binding posts, and a pair of wires connected to them may be identified at a distant point by tone in a headset. The illustration shows the set housed in a transparent case, but the ac-

tual production cases are of a resilient black plastic. The small hole at the top is for a screw-driver adjustment of the buzzer. Weighing only sixteen ounces with batteries, the set measures approximately $1\frac{3}{4}$ x 3 x $4\frac{1}{2}$ inches. It replaces the 66-A test set formerly used for the same purposes. An identical set, but marked "Western Electric" on its top instead of "Bell System," is coded the 81-AW and is available for users outside of the Bell System.



A RADIO TELEPHONE TRANSMITTER FOR AUTOMOBILES

W. G. HENSEL
Radio
Development

The 38-type radio transmitter has been developed as a part of the recently inaugurated mobile radio telephone program.* This transmitter is used in conjunction with the 38A radio receiver and the 41A control unit to form a vehicular radio telephone installation. The transmitter, with top cover removed, is shown in Figure 1. It is supplied in two forms: the 38B for 6-volt and the 38C for 12-volt operation.

*RECORD, April, 1947, page 137.

Operating at frequencies between 152 and 162 megacycles, the 38-type transmitter has a rated carrier output power of 25 watts. The circuit arrangement is shown in Figure 2. A temperature-controlled crystal oscillator, operating at a thirty-sixth of the carrier frequency, drives a buffer amplifier. The amplifier output is phase-modulated by a reactance-tube modulator, and is then multiplied by four harmonic generator stages to obtain the carrier frequency. The harmonic generator output is amplified by a push-pull stage whose output is fed through a coaxial cable to a whip antenna mounted on the top of the vehicle. Voice-frequency input to the phase modulator is obtained from the microphone of an F3WW3 handset, and a gain adjustment control is provided so that a peak frequency deviation of ± 15 kc may be obtained under speech modulation.

To cut standby current drain from the vehicle's storage battery to a minimum, quick-heating filament-type vacuum tubes are used. Plate and grid bias voltages are obtained from a dynamotor. The transmit-

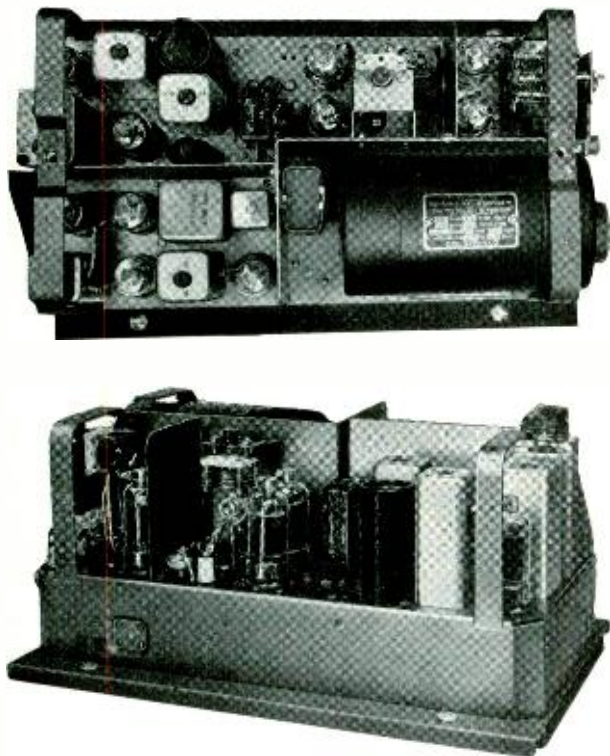

Fig. 1—The Western Electric radio transmitter for mobile service is supplied in two forms—the 38B (shown at left) for 6-volt operation and the 38C for 12-volt operation. The dynamotor for supplying high voltage is shown at the lower right and the oscillator-modulator compartment at the lower left of the upper view. The radio stages of the transmitter are shown in the lower view

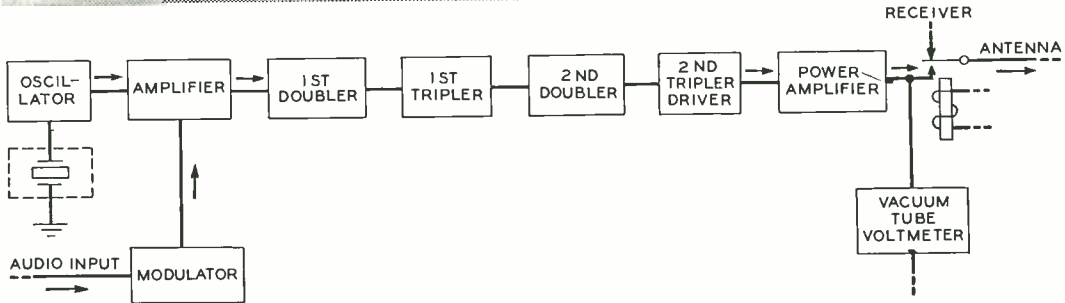

Fig. 2—Block schematic of the 38-type radio transmitter which operates at frequencies between 152 and 162 megacycles and has a rated carrier output of 25 watts

ter is remotely controlled from the 41A control unit. With the power switch of the control unit turned on and the handset in place, the only power used by the transmitter is that required for one relay and the crystal heater. When the handset is removed from the control unit, the filaments are heated and the dynamotor starts, but a disabling bias holds the crystal oscillator in a quiescent condition. Operation of the press-to-talk switch on the handset removes the disabling bias and the transmitter is ready for use. A test-meter jack is provided on the front of the unit for connection to a test-meter for circuit

alignment. A built-in vacuum-tube voltmeter provides a safe and convenient indicator for properly adjusting the final amplifier plate and antenna circuits, and eliminates the need for metering the amplifier plate current, which, with filament-type tubes, would have to be done at a high potential point in the circuit.

The transmitter, identical in size to the 38-type receiver, is $17\frac{5}{8}$ inches long, $10\frac{1}{4}$ inches wide, and $8\frac{1}{4}$ inches high. It has no external controls or adjustments, and the entire assembly is sufficiently rugged to withstand the hard usage that is encountered in a mobile installation.



THE AUTHOR: W. G. HENSEL received the B.S. degree in Electrical Engineering from Ohio Northern University in 1929, and joined the Specialty Products Department of the Laboratories in June of that year. Since then he has been engaged in the development of radio transmitting equipment of various kinds, including equipment for long-range transatlantic telephony and VHF equipment for aircraft. Engaged in the design of aircraft and vehicular communication equipment for the Signal Corps during the war, he is at present concerned with the design of vehicular radio telephone transmitters for Bell System use.

SCR-545-A — A COMPLETELY AUTOMATIC TRACKING RADAR

C. R. TAFT
Radio
Development

By the latter part of 1941, radar had made tremendous advances, and many types were either under development, being manufactured, or had already been delivered to our Armed Forces. Although progress had been great, many improvements in radar systems were still to come. The possibilities could be seen, but the intricate circuits and refined apparatus needed for locating and tracking distant and rapidly moving enemy targets to give more accurate control of gunfire were still largely in an embryonic stage. It was at this time that the Anti-Aircraft Artillery Command formulated its requirements for a truck-mounted radar to pick up enemy aircraft at a distance, to accurately track them as they approached firing range, and to transmit suitable information to fire-control apparatus such as the M-9 director.* To increase precision and give smooth information to this gun director, it was desired to make the tracking completely automatic. With manual tracking, the precision depended largely on the skill of the operators in maintaining the radar beam accurately on the target. With full automatic tracking, this major source of error could be eliminated. The Laboratories were asked to develop such a system, and the SCR-545-A was the result.

For quickly picking up planes at long distances, a comparatively wide angle beam is desirable and lower frequencies may be used, while for accurate tracking at shorter range, the beam must be narrower and the frequencies correspondingly higher. To fulfill both these functions most satisfactorily,

*RECORD, *January, 1944, page 225.*

EDITOR'S NOTE: The story of this outstanding contribution to the radar art has been long delayed for security reasons.

the 545 employs two frequencies: 205 mc for target acquisition and 2800 mc for fire-control tracking. The acquisition system uses 200-kw pulses and has a maximum range of about 46 miles, while the fire-control tracking system uses 350-kw pulses and has a maximum range of about 23 miles.

After a plane has been picked up with the long-range system, it is followed manually until it approaches within the range of the tracking radar. As both systems are in operation at all times, the operators may switch from manual or aided-manual to automatic tracking without disturbing the continuous data information transmitted to the gun director. Under automatic control, the beam will follow the plane without the operators' assistance.

Separate antennas are used for acquisition and tracking, and both are mounted on the same frame as shown in Figure 1. The lower frequency antenna consists of sixteen half-wave dipoles spaced by one-half wavelength horizontally and vertically. The connections to these dipoles are such that the four dipoles of each of the four quadrants form a separate lobe-switching unit which is used in placing the narrow beam track system on the target. Behind the dipoles is a perforated metal sheet that acts as a reflector for the low-frequency waves. Projecting toward the rear from the center of this plate is the 57-inch parabolic reflector of the tracking antenna. The high-frequency waves are directed into this reflector so as to produce conical scanning of the antenna beam.

This is how "conical scanning" keeps the radar on its target. Pulses of microwaves are led from the transmitter by a wave-guide feed to a rotating aperture in the

focal plane of the parabolic reflector. This aperture is offset slightly from the center line of the reflector, about which it is rotated. The beam from the reflector is quite sharp and due to the offset it describes a conical path in space as the scanner ro-

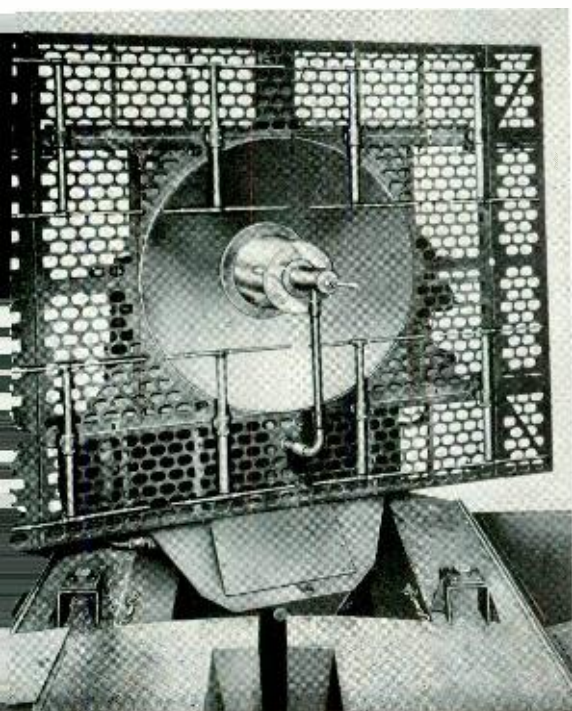

Fig. 1—The acquisition antenna consists of sixteen dipoles, while the tracking antenna is a 57-inch parabolic reflector against which a rotating wave beam is directed

tates. A target which lies along the axis of the reflector will return a constant signal at all directions of the beam. However, a target which lies off center will return a maximum signal in that phase of the conical scan when the beam is pointing most directly toward it. In the echo signal, therefore, there will be an alternating component whose period is that of the scanning beam and whose phase is an indication of the direction of the target. The receiving circuits are arranged to swing the tracking antenna in a direction to bring this voltage to zero, and when that is achieved the beam is directly "on target." As the target moves, the alternating current will be re-established, and the antenna will consequently swing to annul it, thus continuously

tracking to target in azimuth and elevation.

To track the target in range, use is made of the "gating" principle. Since the duration of each individual pulse is about one microsecond while the interval between pulses is two milliseconds, wanted signal information is coming in only 1/20 per cent of the time, and the rest of the time a "gate" may be closed to shut out noise, interference and unwanted echoes. This "gate" is a pulse which removes the cut-off bias on one tube; the pulse is timed by an extremely accurate delay circuit devised by L. A. Meacham.* By suitable adjustment of the delay, the gate will open just before and close just after the signal pulse returns from the target. Adjustment is made by rotation of a shaft geared to two dials, one of which covers 2,000 yards in one revolution; the other covers 50,000 yards. It is thus possible to read range continuously from about 500 yards to 50,000 yards with an inherent accuracy of ± 5 yards at any point of the scale.

Visual indication of correct timing is given for manual tracking by a range oscilloscope. Horizontal motion of the beam comes from a linear-sweep circuit related to target range while the vertical deflecting plates receive a negative pulse each time the gate opens, and a positive pulse each time the signal comes in. The operator then turns a handwheel until the "notch" from the negative pulse is centered around the signal "pip," at which time the range to the target can be read directly on dials.

Automatic tracking in range is accomplished by a second gating circuit, interlocked with the range-timing circuit and arranged to split the signal pulse into two parts. These parts are amplified separately and compared with each other; the gating circuit is shifted automatically in the direction of the larger part of the signal until both are equal, when the range tracking is "on target."

From the indications described above, "present position" coordinates are derived which are transmitted to the gun director and there used to compute the elevation, azimuth and fuse setting for effective fire.

In many tracking radars there is incorporated as a help to the operator in manual

*RECORD, June, 1947, page 231.

tracking the feature of "aided" tracking. This feature causes displacement of the operators' handwheels to impart *rate*, in addition to displacement, to the driving motors. The usefulness of such an arrangement may be illustrated in the simple case of an airplane target flying directly away from the radar at a constant speed. On the oscilloscope the range operator will see the signal pulse go past the range gate and by turning the handwheel he will attempt to make the range gate follow the pulse. In so doing he will impart to the gate a rate of motion. As the gate approaches the pulse he will synchronize the gate speed to the target speed by adjusting the handwheel until the pulse remains in the gate. Within the precision of this adjustment the range unit will then follow the echo pulse

tion tracking, and one for range tracking for both the high and low-frequency systems. Indicators and control units for these three operators are mounted in the rear of the cab as shown in Figure 3. Facing these control units—on the front wall of the cab—are the power control panel and various testing units—used in maintaining the system.

The rear section of the trailer contains the operating units for both frequencies: the high-voltage rectifiers, servo amplifiers, range unit, and automatic controlling apparatus. Doors along each side open up as shown in Figure 3 to give access to this apparatus, and each unit is arranged to slide out for convenience when making repairs or replacements, or maintaining the 375 vacuum tubes. A pedestal mounted on



Fig. 2—Power truck and trailer of the SCR-545-A radar folded for travel

without further manipulation on the part of the operator, as long as the target continues at the same speed.

Antennas and all the radar control apparatus of the 545 system are housed in a trailer which is drawn by a power truck carrying a gas-engine-driven 60-cycle alternator to supply all the power required. These two units, with the antenna folded down for traveling, are shown in Figure 2. A work truck, of about the size and appearance of the power truck, is the third unit. Once the 545 has arrived at the place where it is to be used, a trained crew of ten men can place the equipment in operating condition in less than thirty minutes.

The front end of the trailer, which is higher than the rest, is the control cab, with room for three operators—one responsible for azimuth tracking, one for eleva-

tion tracking, and one for range tracking for both the high and low-frequency systems. Indicators and control units for these three operators are mounted in the rear of the cab as shown in Figure 3. Facing these control units—on the front wall of the cab—are the power control panel and various testing units—used in maintaining the system.

The rear section of the trailer contains the operating units for both frequencies: the high-voltage rectifiers, servo amplifiers, range unit, and automatic controlling apparatus. Doors along each side open up as shown in Figure 3 to give access to this apparatus, and each unit is arranged to slide out for convenience when making repairs or replacements, or maintaining the 375 vacuum tubes. A pedestal mounted on

Fig. 3—The trailer includes a control cab in the front, radar apparatus accessible from each side of the rear section, and the antenna mounted on top

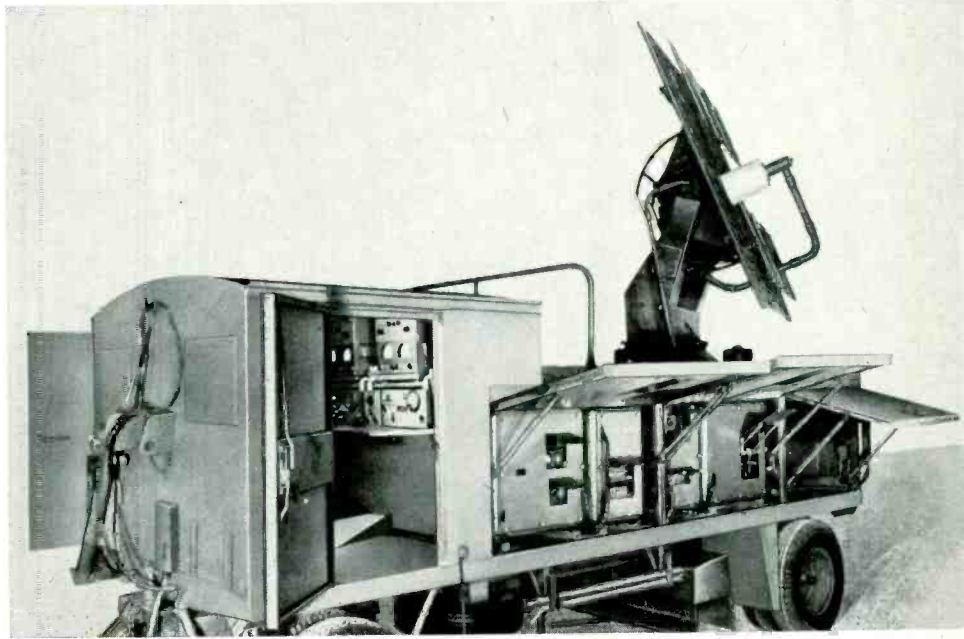

development. Nearly three hundred systems were shipped to the Signal Corps in the succeeding ten months. Performance tests made by the Anti-Aircraft Artillery Board showed that, when tracking high-

speed aircraft, the average error in angle was about 9 minutes of arc, and the average slant range error 18.1 yards. Since the range error is constant for all distances, the percentage error is very much less than with optical range finders.

Fig. 4—In the control cab three operators control horizontal, vertical, and range tracking, each with his control units and pair of scopes for the two frequencies

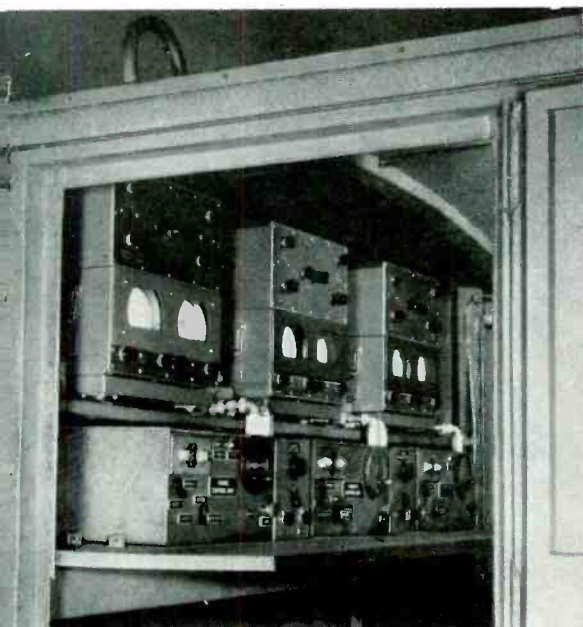

During the performance tests the following demonstration was made of the dependability of the equipment. A test plane was sent aloft with instructions to fly arbitrary courses within 20,000 yards of the radar, but not including direct overhead passes. The radar was then made to track automatically, after which all operators left the cab. When they returned some two hours later the radar was still tracking the same plane satisfactorily.

The first units produced were shipped to Camp Edwards in Massachusetts for the use of the 108th A.A.A., and in this camp the equipment was put through various tests to give the operators basic training. Shortly thereafter, these units were loaded aboard ship and sent to the Mediterranean area, landing at Oran, North Africa, and thence going to the defense of Algiers. From this location they were sent to Naples and the Anzio Beachhead, where they made a noteworthy record. Once the crews had become proficient under battle conditions, the use of SCR-545-A radar and

THE AUTHOR: C. R. TAFT came with the Western Electric Engineering Department in 1919, and shortly thereafter became a member of the apparatus drafting and specifications group at West Street. During the following years, he studied Electrical Engineering at Newark Technical School. In 1934 he transferred to the Radio Development Department at Varick Street, where he worked on the mechanical design of police, aircraft, and government radio transmitters and receivers. In 1939 he transferred to Whippany and was assigned to the mechanical design of the first fire-control radars and later supervised their installation aboard naval vessels. During the war years Mr. Taft spent thirteen months in charge of the Laboratories' liaison design group at the Western Electric plant at Point Breeze, and later set up the manufacturing relations engineering

group at Kearny. In 1944 he returned to the Radio Development Department at Whippany, and has since been engaged in the development of search and fire-control radar for the Navy.



director-controlled gun battery reduced the number of shells required per plane destroyed to one-fiftieth of what it had been with earlier methods. Reports from other areas such as Antwerp, Breda, and Brest in the ETO, and from Saipan, Iwo Jima, and Okinawa in the Southwest Pacific indicated the effectiveness of this equip-

ment. Just before V-E Day, encouraging progress in the use of this equipment for tracking the V-2 rocket was reported from Belgium.

Radio set SCR-545-A was the first completely automatic tracking radar and, so far as is known, the only such radar actually used in the past war by any nation.

A T & T STOCKHOLDERS TO VOTE ON NEW DEBENTURES

The Board of Directors of the American Telephone and Telegraph Company have recommended that the stockholders authorize a new issue of convertible debentures, which would be offered to stockholders in the ratio of \$100 of convertible debentures for each six shares of stock held. A special stockholders' meeting will be held on October 15 for the purpose of acting on this proposal. Proceeds from the sale of the debentures and from conversions thereof into stock would be used to provide funds for extensions, additions and improvements to the plant of A T & T and its subsidiary and associated companies, and for general corporate purposes.

If the new issue is authorized, the Company will thereupon file a registration statement with

the Securities and Exchange Commission and expects that warrants representing subscription rights will be mailed to stockholders about November 10. On the basis of the number of shares outstanding at August 15, 1947, the amount of the issue would be approximately \$354,000,000.

The debentures will be dated December 15, 1947. It is contemplated that they will bear interest at a rate of not less than 2½ per cent nor more than 3 per cent, will mature not earlier than December 15, 1957, and not later than December 15, 1967, and will be convertible into A T & T stock during a period beginning not later than six months from the date of issue at a conversion price not exceeding \$150 per share.



CLARENCE G. STOLL



STANLEY BRACKEN

Stoll Retires, Bracken Becomes Western Electric President

Stanley Bracken, executive vice-president of the Western Electric Company, has succeeded Clarence G. Stoll as president upon Mr. Stoll's retirement on September 30.

Mr. Stoll has served as president of Western Electric since 1940 and his retirement brings to a close a distinguished career of more than forty-four years in that company. Under his leadership during the recent war years, Western Electric produced more than \$2 billion worth of electronic and communications equipment for the Armed Forces. In the post-war period, he has guided a most intensive program of production in meeting the Bell System's urgent demand for telephone equipment.

Mr. Bracken brings to his new assignment more than thirty-five years of experience in the company's manufacturing organization. He was born at Blair, Nebraska, in 1890, and was graduated from the University of Nebraska in 1912. He joined the Western Electric Company immediately after his graduation. Assigned to development engineering, he continued in various branches of this activity until 1922. He then represented the company abroad for three years and returned to Western Electric's Hawthorne Works in 1925. Four years later he became as-

sistant engineer of manufacture and in 1930 was named executive vice-president and a director of Teletype Corporation, a subsidiary of Western Electric. In 1937, he was elected president of Teletype. Mr. Bracken resigned as president of Teletype in 1941 to become general manager of manufacture of the Western Electric Company and was elected a director of that company. In May, 1947, he was elected a director of the Laboratories.

G. D. Edwards Honored by War Department

"For loyal and outstanding assistance to the Ordnance Department during World War II in the application of Quality Control to quantity production of ordnance matériel" is the citation on G. D. Edwards' Certificate of Appreciation presented to him by the War Department on September 5. The certificate, signed by the Secretary of War and by the Chief of Ordnance, was presented to Mr. Edwards by Lt. Col. Edward Gluck, Chief of the New York Ordnance District.

At the same ceremony, J. H. Bacon of the Western Electric Company received a similar certificate for "operational training of Army personnel in the use of Director M-9 and SCR-545 Radar while assigned to Hawaiian Antiaircraft Command."



Henry C. Beal

vice-president of Western Electric, has been elected a director of the Laboratories. Entering Western Electric from Purdue University in 1914, Mr. Beal rose through successive grades in manufacturing planning and industrial relations to become works manager at Kearny in 1939. Three years later he became engineer of manufacture, and recently vice-president—manufacturing

Changes in Organization

Effective September 1, W. A. MacNair was transferred to the Systems Development Department as Assistant Director of Switching Research, reporting to T. C. Fry, Director of Switching Research and Engineering. In addition to his new duties, Mr. MacNair, as Military Research Consultant, carries out certain military research activities, reporting in this latter capacity to D. A. Quarles. W. C. Tinus, as Radio Development Engineer reporting to M. H. Cook, Director of Specialty Products Development, assumed the military project responsibilities formerly handled by Mr. MacNair in the Research Department. The group formerly reporting to Mr. MacNair on these projects report to Mr. Tinus. A. Tradup was transferred to the Specialty Products Development Department as Military Communications Engineer, reporting to Mr. Cook. As part of his new assignment, Mr. Tradup continues his military communications activities.

E. J. Thielen, formerly Systems Staff Engineer, now reports to Morton Sultzter, Personnel Planning Director. Mr. Thielen is now concerned with planning training programs and with analysis of employee classifications.

R. S. Plotz, who has been Assistant to Vice-President A. B. Clark, has become Systems Staff Engineer.

Work Started on New York-Albany Coaxial Cable

Construction has begun on the first coaxial cable to connect New York and Albany. The cable, jointly owned by Long Lines and the New York and New Jersey Companies, will supplement facilities between New York, Albany, Buffalo, Cleveland, and Chicago. The cost of the initial line and terminal equipment is estimated to be about \$4,000,000.

The cable contains eight coaxial conductors which will be capable, when fully equipped, of handling about 1,500 simultaneous telephone conversations. The distance involved is 154 miles and the route passes through the northeast corner of New Jersey and then near Southfields, Monroe, Kingston and Catskill in New York. The cable will be placed in existing underground conduit between Catskill and Albany. A cable-laying plow will bury the cable between Monroe and Catskill.

A T & T Stockholder Total Hits All-Time High

The number of stockholders of the American Telephone and Telegraph Company reached an all-time high of 712,300 on August 25, surpassing the previous high of 712,187 shareholders established in August, 1932.

The average number of A T & T shares held is 30 and no stockholder holds as much as one-half of one per cent of the total stock outstanding. More than half of the stockholders are women. Holders of 1 to 5 shares number 208,000 while 671,000 stockholders, or 94 per cent of the total, hold less than 100 shares each. Holders of 100 shares or more, including insurance companies and other institutions representing additional thousands of investors, total 41,000 and hold 46 per cent of the stock.

Two New Models of Hearing Aids Offered to Employees at Discount

Two new models of Western Electric hearing aids, available to members of the Bell System at a 25 per cent discount, have been introduced on the market. Both have self-contained batteries. Model 65, measuring 4½ inches in

length and weighing six ounces, was created to meet the needs of the majority of persons having a hearing loss. Its retail price is \$155. Model 66, which is slightly larger, was designed for those having severe hearing loss and for those wishing maximum power, fidelity and amplification in a hearing aid. This model, which sells for \$185, can also be used with separate batteries where additional power is required.

Any employee or retired employee of the Bell System may purchase these models at a discount of 25 per cent for himself or for a member of his immediate family or a dependent. Those interested may contact the nearest hearing aid dealer as listed in the Classified Telephone Directory and present their Bell System identification card. If no dealer is readily available, employees may write directly to Dept. 380, Western Electric Company, 195 Broadway, New York 7, N. Y.

An article on the technical features of these Laboratories' developed hearing aids will be described in a forthcoming issue of the RECORD.



Western Electric

Two new models of Western Electric hearing aids are available to Bell System employees at a 25 per cent discount. The Model 66 (her left hand) is designed for persons having severe hearing loss. The Model 65 (right hand) is for the majority of persons having some hearing loss

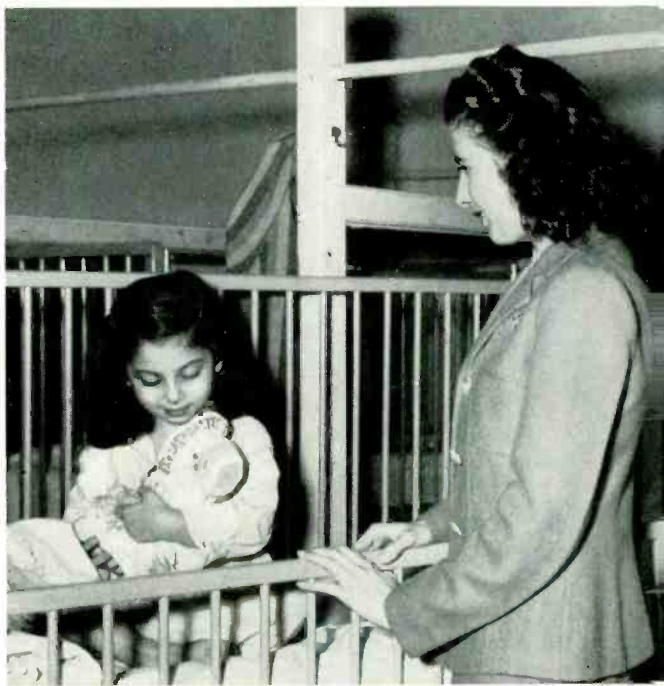

"WHAT A LOVELY DOLL"

This little patient at St. Vincent's Hospital was made happy while convalescing by the baby doll which Mary Reiners of the Doll and Toy Committee gave her on Christmas Eve last year. The doll was one of 4,500 toys delivered to sixty institutions as gifts of the men and women of the Laboratories

The Doll and Toy Committee Asks Your Support

Playing Santa Claus this coming Christmas for children in sixty hospitals and institutions is the task of the Laboratories members through their Doll and Toy Committees in three locations, Murray Hill, New York and Whippany. Members of the Committees are already hard at work to make this year's contributions equal to the splendid showing of last year's \$3,000, which bought 4,500 toys, dolls and books. In addition, many people donated dolls, stuffed animals, and toys, which they themselves brought in from their homes or bought in stores.

A desk-to-desk notice will be circulated, giving the names of girls on the Committee in each department who will accept contributions and distribute dolls to be dressed. The Committee in New York is under the chairmanship of Florence McGuire; in Whippany, Harriet Filmer; and in Murray Hill, Genevieve Beveridge. Helen Conklin is accepting contributions at the Holmdel laboratory and Laura Fenimore those at the Deal laboratory.



Repeat performance, with something new added: J. A. Pecca accepts from the City of Summit Recreational Director, H. S. Kennedy, the winner's trophy for the 1947 season in the B Softball League, duplicating last year's championship of this Murray Hill team and, because the post season play-off among the top four teams resulted in a clinched title, the second trophy, held by T. J. Crowe, president of the B League, is also being presented for formal acceptance by Manager Pecca. From left to right, J. J. Oestreicher, W. L. Hawkins, J. Z. Takacs, F. J. Ochs, Mr. Crowe, H. D. Bone, M. C. Neilson, Mr. Pecca, N. R. Pape, R. S. Boughram, Mr. Kennedy, A. H. Jankowski and A. W. Koenig. Other members of the team are G. W. Galbavy, J. Leutritz, Jr., and W. A. Notte

The Summit Softball League

Since 1936, the Laboratories have been represented in the eight-club B Softball League in Summit. T. J. Crowe, Murray Hill Plant Department, who is a resident of Summit, has been president of this division for ten years. Representation remains in this community sport because in the beginning the team was

composed of members of the chemical group then located in Summit. Thus the Board of Recreation considered that the large group of Summit residents from the Laboratories and the team's record of interest and good sportsmanship merited continuance when the Laboratories moved just outside the city limits. There are eight clubs in the B League.

October Service Anniversaries of Members of the Laboratories

40 years
E. J. White

35 years
W. C. Oakes
G. R. Martin
B. B. Webb

30 years
William Buhler

E. C. Edwards
S. F. Hayes
J. C. Kennelty
Elizabeth Klarmann
J. J. Shabet
H. S. Smith

25 years
A. J. Akehurst
J. H. Bollman

W. A. Bunzel
Elsie Burger
Elsie Dittmar
H. A. Doll
H. W. Ericsson
K. E. Fitch
Erhard Hartmann
A. T. Jensen
E. B. Mechling
J. W. Moeller
A. H. Muller

C. G. Pangburn
L. J. Purgett
G. T. Selby
Jack Stark
R. I. Wilkinson

20 years
Emil Alisch
J. C. Irwin
C. S. Knowlton
Margaret Mare

Estelle Potter
E. A. Veazie

10 years
S. T. Brewer
H. W. Dohlmar
Michael Konash
Helen Quick
Anne Roeder
Ruth Vieweger

Last year, under management of N. R. Pape, the team won its division title and again this year, with J. A. Pecca in the same post, the trophy was re-won.

The Orchestra Opens Its Twentieth Season

The Bell Laboratories Club Orchestra, under the baton of L. E. Melhuish, will open its twentieth season on Tuesday, October 7, at six o'clock, in the West Street Auditorium. Rehearsals will be held every Tuesday thereafter at the same time. Men and women musicians at locations other than West Street are especially invited to play. W. A. Krueger, of Section K-32, extension 798, will be glad to answer any questions about the orchestra.

Institute of Radio Engineers

Members of the Laboratories serving as officers or members on general committees of the Institute of Radio Engineers for the year 1947-1948 include: R. A. Heising and F. B. Llewellyn, *Board of Directors*; A. E. Bowen, Ralph Bown, G. W. Gilman, F. B. Llewellyn, J. W. McRae, L. A. Meacham, E. L. Nelson, W. C. Tinus, E. K. Van Tassel, E. C. Wentz, G. W.

chairman, and Lloyd Espenschied, *Admissions*; R. A. Heising, *Sections*; and F. B. Llewellyn, *Nominations*.

Memberships on Technical Committees include: H. W. Bode, E. Dietze and S. A. Schelkunoff, *Annual Review*; W. E. Kock, S. A. Schelkunoff, J. C. Schelleng and P. H. Smith, *Antennas*; H. W. Bode, chairman, *Circuits*; E. Dietze, chairman, *Electroacoustics*; S. B. Ingram and J. A. Morton, *Electron Tubes*; Pierre Mertz and E. F. Watson, *Facsimile*; R. L. Dietzold, *Handbook*; H. S. Black, *Modulation Systems*; W. L. Bond, W. P. Mason and R. A. Sykes, *Piezoelectric Crystals*; H. T. Friis, *Research*; A. E. Kerwien and J. C. Schelleng, *Radio Transmitters*; S. A. Schelkunoff, chairman, and A. G. Fox, *Radio Wave Propagation and Utilization*; H. W. Bode, E. Dietze and S. A. Schelkunoff, *Standards*; A. E. Anderson and A. F. Pomeroy, *Symbols*; and A. G. Jensen, *Television*.

On special committees are: F. B. Llewellyn, *Editorial Administration and Fiscal*; Ralph Bown, chairman, and F. B. Llewellyn, *International Liaison*; R. A. Heising, chairman, and F. B. Llewellyn, *Office Quarters*; and R. A. Heising, chairman, *Planning*.



Noontime sports at Holmdel. Left to right, W. A. Tyrrell



A. P. King, H. W. Anderson, J. P. Noll and

Willard and William Wilson (retired), *Board of Editors*; F. B. Llewellyn, chairman, *Awards*; F. R. Stansel, *Education*; E. Dietze, W. P. Mason, Pierre Mertz and W. E. Reichle, *Papers Procurement*; H. A. Affel, H. S. Black, F. W. Cunningham, I. E. Fair, W. M. Goodall, J. G. Kreer, Jr., W. P. Mason, G. G. Muller, A. F. Pomeroy, S. O. Rice and L. Vieth, *Papers Review*; R. A. Heising and F. B. Llewellyn, *Constitution and Laws*; F. A. Polkinghorn, vice-

FM Radio Between Block Island and Narragansett

A point-to-point radio telephone system was recently placed in service between Block Island and the town of Narragansett by the New England Telephone and Telegraph Company. Two FM transmitting and receiving antennas used at each of the two terminals are of the three-element directional type. This installation, simi-



Representing the Laboratories at the Radio Shops at Burlington, N. C., is this volley ball team which won the championship in the Shops League. K. O. Thorp makes the presentation to J. S. Whitaker; others on the team are J. V. Sineath, C. R. Turner, D. V. Whitaker, R. V. Lohmiller and E. L. Meyers

lar to those already in service at Death Valley, Calif., and at Mount Hood, Ore., provides two direct radio circuits, supplementing five existing circuits, three of which are carrier, in a two-pair Coast Guard submarine cable between Point Judith and the island.

News Notes

W. H. MARTIN testified on August 27 about the Laboratories work for the Bell System Operating Companies and the Western Electric Company before the Rhode Island Public Utility Administrator in an application of the New England Telephone and Telegraph Company for an increase in Rhode Island intrastate rates.

HARVEY FLETCHER has been appointed chairman of the acoustic meeting of the S.M.P.E. Theater Engineering Conference to be held on October 23 in New York City.

C. H. TOWNES participated in a conference on *Moments of Radioactive Nuclei* at the Brookhaven National Laboratory on Long Island. K. G. MCKAY and A. J. AHEARN attended the *Symposium on High Speed Counters and Short Pulse Techniques* at which Mr. Ahearn spoke on *Conductivity Pulses Induced in Diamond by Alpha Particles*.

J. R. TOWNSEND, in the August issue of the *Proceedings of the I.R.E.*, reviewed the book *An Introduction to Engineering Plastics* by D. Warburton Brown and Wilbur T. Harris.

ARTICLES by Laboratories members in the May, 1947, *Journal of the Acoustical Society of America* include F. M. WIENER'S *Sound Diffraction by Rigid Spheres and Circular Cylinders*; W. P. MASON and H. J. MCSKIMIN'S *Attenuation and Scattering of High Frequency*

Sound Waves in Metals and Gases; and L. J. SIVIAN'S *Hearing in Water vs. Hearing in Air*. The July issue contains HARVEY FLETCHER'S *An Institute of Musical Science—A Suggestion*; M. B. GARDNER'S *A Pulse-Tone Technique for Clinical Audiometric Threshold Measurements*; W. A. MUNSON'S *The Growth of Auditory Sensation*; and H. B. BRIGGS, J. B. JOHNSON and W. P. MASON'S *Properties of Liquids at High Sound Pressure*.

At Kure Beach, North Carolina, Laboratories' test specimens are guests of International Nickel Company at its testing station. From time to time K. G. Compton and his associates change the samples and survey the effect of a marine atmosphere on various materials and finishes



T. C. FRY spoke on *Switching* at Holmdel on September 12 during the meeting of the Deal-Holmdel Colloquium.

C. R. STEINER visited the Cardwell Manufacturing Company, Plainville, Connecticut, to discuss air capacitors.

AT HAVERHILL, A. B. HAINES discussed transformer problems; L. W. STAMMERJOHN witnessed the pre-production manufacture of new current supply sets for the K2 carrier system; and H. S. FEDER discussed the manufacture of transformers for the 1A key telephone systems.

U. A. MATSON, at Winston-Salem, discussed video transformers for Government use; G. D. JOHNSON, E. F. KROMMER, J. H. HERSHEY, C. H. WILLIAMS and J. B. D'ALBORA, radar equipment; F. W. STEELE, mobile radio; H. A. WHITE, special equipment for the Navy; R. C. NEWHOUSE and E. A. BESCHERER, radio and radar equipment; and J. W. GEILS and F. A. MINKS, M1 carrier equipment.

D. R. BROBST conferred on enameled wire and switchboard cable at the Tonawanda Plant of the Western Electric Company.

R. T. STAPLES, H. H. STAEBNER and F. W. LINDBERG conferred with engineers at Point Breeze on cord development problems.

F. P. BALACEK visited Allentown regarding the initiation into manufacture of mercury relays.

P. B. DRAKE went to the Taft-Peirce Company in Rhode Island in connection with special switching apparatus.

W. A. REENSTRA of the Systems Development Department has received a degree of B.E.E. from Rensselaer Polytechnic Institute. Mr. Reenstra was in military service from December, 1942, to June, 1946. The following September, he left on a personal leave of absence to attend college.

AT BURLINGTON, F. A. HUBBARD, E. J. JOHNSON and F. KEELING discussed radio equipment; J. R. POWER, hearing aids; G. F. SWANSON, A. C. PEYMAN and A. D. LIGUORI, the design of transmitters; R. E. CORAM, A. K. BOHREN, J. B. BISHOP and N. C. OLMSTEAD, the production testing of the 10-kw FM transmitter; and A. A. SKENE, the 3-kw FM transmitter. B. O. BROWNE supervised the construction of a model of the 3-kw FM transmitter and E. D. PRESCOTT inspected the first production of the 10-kw FM transmitter.

H. M. SPICER and R. R. GAY witnessed the testing of a power plant at the Mount Asenubskit Station of the New York-Boston radio relay system.

W. H. BENDERNAGEL visited the Philadelphia and Harrisburg toll offices in connection with a trial installation of signaling equipment.

R. H. ROSS discussed rheostat drive motors at the Lamb Electric Company in Kent, Ohio.

H. J. BERKA, with Long Lines engineers, studied fluorescent lighting for teletypewriter switchboards at Philadelphia. He also supervised the installation of fluorescent lighting in the new crossbar office at Media.

R. D. DE KAY, L. A. LEATHERMAN and G. B. THOMAS, JR., attended a conference at the Exide Plant in Philadelphia.

V. T. CALLAHAN was at the General Motors Corporation in Detroit in regard to 20-kw diesel-engine alternator sets. He also went to the Duplex Truck Company, Lansing, regarding 10-kw diesel-engine alternator sets.



Gloria Morris, taking dictation from A. E. Bowen, is a member of West Street Transcription assigned to Holmdel. Miss Morris lives on a neighboring farm. Before she joined the Laboratories, she and her sisters, now married, comprised a name band that played in many large city theaters, including New York

AT HAWTHORNE, A. A. BURGESS, R. L. LUNSFORD, D. H. WETHERELL, J. MESZAR and C. F. SEIBEL discussed new crossbar developments; O. MOHR, die-cast frames for polarized relays and preliminary designs of a new line relay for the No. 5 crossbar system; W. McMAHON, metallized capacitors; J. R. TOWNSEND, I. V. WILLIAMS, and F. S. MALM, cable and materials problems; L. J. PURGETT, G. E. STOWE and M. C. GODDARD, No. 5 crossbar equipment; and R. P. ASHBAUGH, the initial production of Alpeth sheath and general cable problems.

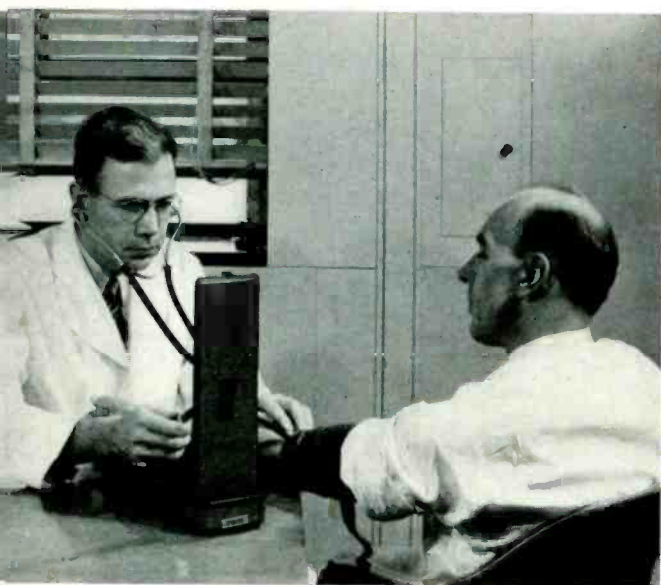

Dr. Widdowson, in his Murray Hill office, checking G. H. Ruble's blood pressure

E. G. Andrews discusses a problem in process of solution on the Bell Laboratories relay computer which was turned over on August 22, 1947, to the Ballistics Research Laboratory, U. S. Army, at Aberdeen, Md. With him are J. O. Harrison, mathematician in charge, and Miss Betty Boyd of the Aberdeen staff



Dr. W. W. Widdowson Heads Medical Department at Murray Hill

W. W. Widdowson, M.D., joined the Laboratories staff in May as medical officer responsible for Murray Hill and Whippany. A veteran, Dr. Widdowson was graduated from the University of Pittsburgh and Hahnemann Medical College, and interned at St. Luke's and Children's Medical Center, Philadelphia. He had a private practice in his home town, Indiana, Pennsylvania, in 1941, when he was called to active duty as a reserve officer. After serving for three years in the Philadelphia General Dispensary and Induction Board, he was assigned to study and was graduated from the Command General Staff School at Fort Leavenworth. Then followed fourteen months of duty in the ETO with the 104th General Hospital in England. His final military assignment was medical director of the Philadelphia Quartermaster Depot.

WHAT'S

Dr. Widdowson's headquarters now are Murray Hill, with scheduled visits during the week to Whippany. With his family—his wife, son, ten and daughter, thirteen—he is now living in Summit. By spring they hope to have a home of their own, where the doctor will resume his favorite hobby, gardening.

W. H. Doherty Represents the Laboratories at Rome Radio Congress

W. H. Doherty, of Specialty Products Development, is now in Rome attending the Radio Congress sponsored by the Italian National Council of Research in commemoration of the fiftieth anniversary of Marconi's pioneering experiments in radio. Mr. Doherty will present a paper on *Linear Power Amplifiers in American Broadcasting*. In addition to his stay in Rome from September 28 to October 5 for the Congress, he will also visit a number of radio stations and scientific laboratories in Europe to discuss recent advances in radio communication. His itinerary includes England, France, Switzerland, Sweden, Belgium, Luxembourg, and Eire. Some of the scientists whom he will call upon were visitors to Murray Hill recently with the International Telecommunications Conference delegation.

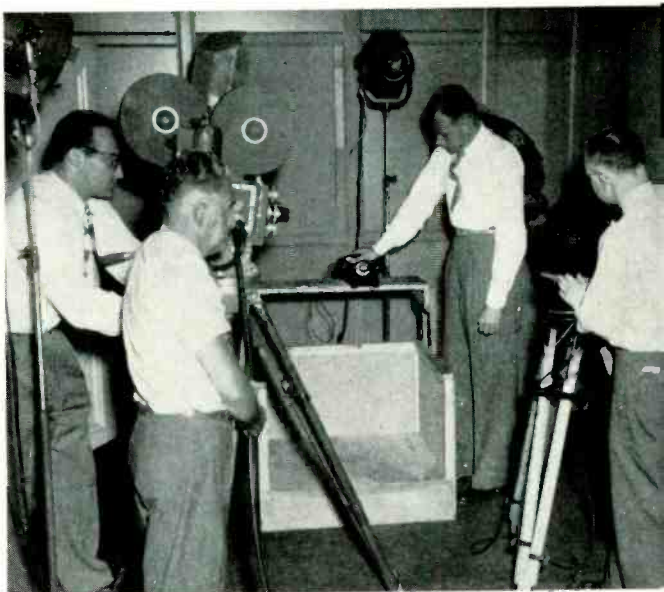
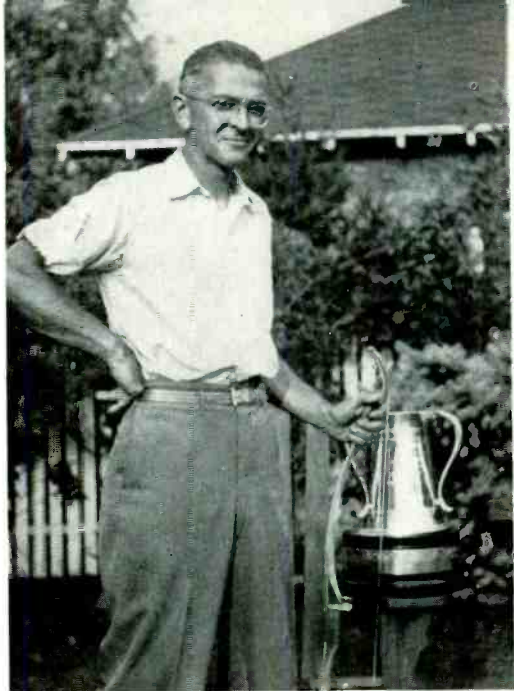

Above, left: I. H. Baker, of Murray Hill, became the National Flight Champion during the August tournament of the National Archery Association. He exceeded the standing flight record of 521 yards by 54 yards

Above: A Pathé News feature which will soon appear in theaters throughout the country shows the Fastax camera and how it is used to study the telephone. Left to right, Andrew Gold, Pathé staff cameraman; Ben Alexander, assistant cameraman; G. A. Wahl, of Station Apparatus Development; and F. M. Tylee, high-speed cameraman of the Laboratories

Below: Cabinetmaker H. H. Carlisch completes a synthetic traffic study machine for the No. 5 crossbar

NEW

Vice-President Quarles presents a ten-year service emblem to W. G. Shepherd of Electronic Apparatus Development. The occasion was a luncheon tendered to Dr. Shepherd on the eve of his departure, on leave of absence, to the University of Minnesota to become head of its Communication Division





Some 26,000 sheets of mimeograph and hectograph reproductions are turned out daily at West Street, where peaks as high as 185,000 sheets a week have been reached. Here, Alice Bugler, one of ten girls engaged in this work, puts a stencil on the cylinder of her mimeograph machine preparatory to running her assignment

News Notes

G. A. PULLIS, with G. J. Seldon of Western Electric, spent two weeks at Fort Bliss, Texas, attending conferences and giving engineering assistance on operational problems and maintenance procedures concerned with four data recorders and a dynamic tape tester. The recorders have been in use about eight hours a day for the last three years.

H. A. WHITE investigated problems arising from production of naval equipment at the Radio Condenser Corporation, Camden, and the Struther Dunn Company, Philadelphia.

A. H. HEARN, with engineers of The Bell Telephone Company of Pennsylvania, inspected poles in test lines near Sunbury, Pennsylvania. He also conducted experimental treatments at Nashua, New Hampshire, to improve the surface condition of Douglas fir poles that are pressure treated.

H. A. AFFEL presided over a *Symposium on Sonar* at the Pacific General Meeting of the A.I.E.E. at San Diego. En route he visited the coaxial system experimental work being conducted at Dallas, as well as a new program transmission system being tested at Los Angeles. He discussed transmission problems with Pacific Company personnel at Los Angeles, San Francisco, Portland, and Seattle.

T. H. CRABTREE discussed vacuum-tube problems concerning hearing aids with the Raytheon Manufacturing Company in Newton, Massachusetts.

W. L. TUFFNELL, F. L. CRUTCHFIELD and R. R. KREISEL went to Archer Avenue to witness the beginning of production of the new operator's receiver.

J. T. MULLER and G. G. SMITH visited the Belgian Block Road for testing wheeled vehicles at the Aberdeen Proving Ground.

C. FLANNAGAN discussed radio telegraph equipment with the Bureau of Ships in Washington, and H. A. BALLER, a military project with the Bureau of Ordnance.

I. M. MILLER, with New York Telephone Company representatives, examined test plots at Monticello, New York, that had been previously established to study control of brush growth under pole lines.

C. H. AMADON, who is now stationed at Denver, was at Murray Hill for two weeks recently to discuss timber problems.

C. S. GORDON and C. C. LAWSON conferred on wire development problems at Point Breeze.

J. G. BREARLEY, D. T. SHARPE, E. D. SUNDE and D. G. NEUMAN made dielectric strength tests on the newly designed "Lepeth" sheath coaxial cables now being installed between Chicago and Terre Haute.

R. J. NOSSAMAN visited several New England locations set up for field trials of the NC cable terminal.

J. H. GRAY and D. C. SMITH, at Hazleton, Pennsylvania, witnessed the installation of a portion of the Allentown-Hazleton toll cable.

F. V. HASKELL, R. A. SIETZLINE and R. M. HAVEKOTTE went to Erie, Pennsylvania, for transmission measurements on coaxial cable.

THE LABORATORIES were represented in interference proceedings at the Patent Office in Washington by J. W. SCHMIED before the Examiner of Interferences.

G. H. HEYDT and W. M. HILL were in Princeton, N. J., relative to interference matters.

HENRY KOSTKOS conferred with public relations people of the Illinois Bell Telephone Company in Chicago and The Bell Telephone Company of Pennsylvania in Philadelphia on exhibits for the science and industry museums in those two cities.

C. SHAFER, JR., and T. C. HENNEBERGER were in St. Louis for discussions of outside plant problems with the Southwestern Bell Telephone Company.

G. T. KOHMAN, E. BUEHLER and A. C. WALKER visited the Naval Research Laboratory and the Geological Survey Department in Washington in regard to studies on synthetic quartz.

W. BUHLER visited Baltimore in connection with No. 1 crossbar.

J. H. COOK and L. H. KELLOGG conferred on military projects at the Evans Signal Laboratory, Belmar, N. J.

Engagements

*Lillian Bernard—Peter Freytag
Margaret Bodie—*Robert F. Logan
*Janet Brown—*Guy F. Boyle
*Louise Fausross—Edward B. Gannon
*Margaret Kort—Steven Sulek
*Anita Patti—Dominick Galdieri
Doris Reincke—*William M. Ehler
Marie Zazula—*Joseph A. Fairbrother
*Lorraine Zimmerman—Richard Carey

Weddings

*Anna Catizone—Thomas Hearn
*Irene Nemic—Charles Popadines
Eileen Smith—*M. Jean Thiel
*Mary Studney—Michael Entrabartolo
*Frances Truzzolino—John Kaufmann

*Members of the Laboratories. Notices of engagements and weddings should be given to Mrs. Helen McLoughlin, Room 803C, 14th St., Extension 296.

"The Telephone Hour"

NBC, Monday Nights, 9:00 p.m.

October 6	<i>Jascha Heifetz</i>
October 13	<i>Marian Anderson</i>
October 20	<i>Gladys Swarthout</i>
October 27	<i>Polyna Stoska</i>
November 3	<i>Tagliavini and Tassinari</i>

O. H. KOPP is working in Philadelphia on changes in panel tandem which are concerned with new No. 5 installation of The Bell Telephone Company of Pennsylvania at Media.

Forming hot spirals from a Remalloy strip for the experimental production of ring magnets in the Metallurgical Laboratory, D. Wallace rotates the mandrel and M. Tompa guides the strip

A. C. KELLER presented a paper on *Submarine Detection by Sonar* before the *Sonar Symposium* of the A.I.E.E. Pacific general meeting held from August 26 to 29 at San Diego. En route he spoke on new switching apparatus to members of The Mountain States Telephone and Telegraph Company at Denver and of The Pacific Telephone and Telegraph Company in Los Angeles and San Francisco. Mr. Keller also made a tour of inspection of the Naval Electronics Laboratory at Point Loma, California, at the request of the Navy.

O. CESAREO accompanied E. G. ANDREWS on a trip to Aberdeen, Maryland, in connection with the installation of a new computer at the Proving Ground.

W. W. FRITSCHI, C. W. LUCEK and W. E. REGAN visited Harrisburg and Philadelphia in connection with a trial installation of voice frequency signaling.

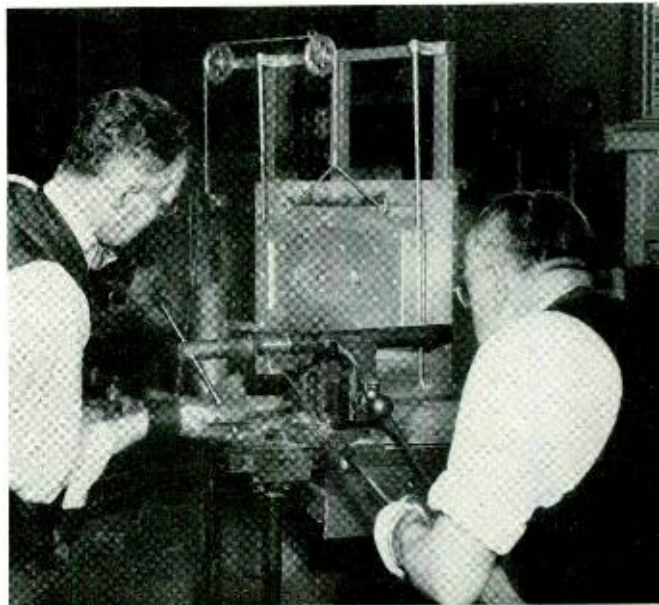

RETIREMENTS



A. W. LAWRENCE



J. P. MAXFIELD



E. W. GENT



PAUL NEILL



ALFRED QUARANTA



A. S. PAGE

Members of the Laboratories who retired on September 30 were A. W. LAWRENCE and A. S. PAGE, with 41 years of service; E. W. GENT, 34 years; J. P. MAXFIELD and PAUL NEILL, 31 years; KATHRYN JOYCE, 29 years; and ALFRED QUARANTA, 28 years.

JOSEPH P. MAXFIELD

Receiving an S.B. degree from M.I.T. in 1910, Mr. Maxfield remained there for four years as an instructor and for graduate work. He then joined the Engineering Department

of the Western Electric Company and engaged in research work on the physical and electrical properties of microphone contacts. During World War I he aided in the development of methods for the acoustic detection of aircraft and sound ranging of artillery. From 1919 to 1926 he made many contributions to the Western Electric activities in the transmitting, recording and reproducing of high-quality sound, out of which came public address systems, the design of broadcasting studios, the development of microphone technique, the orthophonic phonograph and the adaptation of sound recording and reproducing apparatus to motion pictures.

In 1926 Mr. Maxfield, on a leave of absence from the Western, joined the Victor Talking Machine Company, where he directed engineering and research on the orthophonic phonograph.

Returning to the Bell System three years later, he joined Electrical Research Products, Incorporated. The rapid advance in the quality of sound pictures during the next few years was largely due to two main lines of work with which he was closely associated—coöperation with motion picture engineers to develop acoustic techniques and the development of methods of acoustic design for stages, studios and theaters in view of the special requirements of recording and of sound reproducing from loud-speakers behind the screen.

From 1936 to 1942, as Director of Commercial Engineering of Electrical Research Products, Incorporated, Mr. Maxfield was responsible for the development of equipment for the measurement, analysis and recording of sound and vibration and for furnishing consulting service to industry on the measurement of noise and vibration and methods for their control. Typical of this work were a study of the noise conditions and the specification of means for quieting the exhaust towers of the Hudson Tunnels; a study for the CAA of airplane vibration and "flutter"; and the acoustic design of several buildings at the New York World's Fair, including the Bell System building, and of the Kleinhaus Music Hall in Buffalo.

In May, 1942, Mr. Maxfield returned to the Laboratories as a physicist, but six months later was granted a leave to become Director of the N.D.R.C. Division of Physical Research at Duke University. Since his return to the Laboratories in January, 1944, he has been with the acoustic products development group of the Apparatus Development Department, during which time he has authored a number of papers on "Liveness" as related to sound pick-up techniques.

ANDREW W. LAWRENCE

Andrew W. Lawrence, Assistant Specifications Engineer, retired on September 30 following forty-one years of service. Coming to West Street in 1906, Mr. Lawrence first engaged in engineering inspection work. Three years later he became a member of the Apparatus Design Department where the activities of the special order group were placed in his charge in 1914. He joined the Army in 1917 and sailed for France as a Second Lieutenant with the 69th New York Regiment. While there, he was transferred to the research and inspection division of the Signal Corps and was promoted to First Lieutenant.

Returning to the Apparatus Design Department after being mustered out of service in 1919, Mr. Lawrence was placed in charge of a group designing subscriber station and protective apparatus. He became Assistant Specifications Engineer in 1922 and in recent years has been responsible for four specifications groups covering relays and coils, transformers and manual apparatus, switching apparatus, and networks and condensers. These groups have been responsible under his supervision for analysis of the information which is to be furnished to the Western Electric Company or other suppliers from the standpoint of the manufacturer. They assure that the information finally sent out in specification form is complete, consistent and, above all, that it is susceptible of but one interpretation, thereby avoiding the correspondence, revision of drawings, reissuance of specifications and of course the possibility of time-consuming and costly errors in manufacture which result from ambiguity. In addition, specification problems involving standardization of materials and finishes and the elimination of duplicate or near duplicate parts or items of apparatus have come under his supervision.

During World War II he was first a Captain and then a Major in the reorganized 69th Regiment of the New York State Guard set up for emergency service in this country.

EDGAR W. GENT

Edgar W. Gent of the Switching Apparatus Development Department retired on September 30 following thirty-four years of Bell System service. Mr. Gent began his telephone work in 1902 with the Southwestern Company at Dallas. After two years as telegraph-repeater and toll-line test operator, he joined the Cincinnati and Suburban Telephone Company and in 1905 left to attend Purdue where he received his B.S. in E.E. degree in 1908. He then came to the old New York and New Jer-

sey Telephone Company where he engaged in power-line interference studies and system layouts at the Brooklyn office.

Leaving the company in 1910, Mr. Gent joined the Electrical Alloy Company of Morristown and then the Esterline-Angus Company of Indianapolis. He came to West Street in 1918 and, except for a short military leave that same year, has been continuously with the Apparatus Development Department where he has been engaged in the development of Army and Navy radio equipment, public address equipment, sound pictures, radio broadcast equipment, special central-office apparatus and tools for servicing such equipment.

During World War II Mr. Gent was concerned with the design and development of various electromechanical components used in gun directors, range finders and other electrical computing devices and during the last year of the war was at Murray Hill on the development of special procedures required in the construction of sea-water batteries. Since the war, he has been working on selectors for mobile radio, automatic trouble recorders and card translators.

PAUL NEILL

Paul Neill of the Switching Apparatus Development Department retired on September 30, following thirty-one years of service. Before Mr. Neill joined the Bell System in 1916, he had spent twelve years with the Westinghouse Electric and Manufacturing Company where he was concerned with the development, testing and manufacturing of electrical instruments and watt-hour meters. In this connection he was among the first, if not the first, to apply the stroboscope to meter testing. He was also associated with the early electrification of the New York, New Haven and Hartford Railroad, particularly on the design, application and use of indicating and recording instruments on the electric locomotives.

Mr. Neill's first work with the Laboratories was on the design and development of keys. During World War I he worked on the design of airplane detectors, air-damped transmitters for submarine detection and gun ranging as well as telephone sets for location of enemy underground mining operations. Since then, in the Switching Apparatus Development Department, he has been engaged in the design and development of central-office apparatus, specializing in plugs and jacks, and gauges for their maintenance. During the recent war, he was concerned with the development of matched-impedance coaxial connectors and special multiple-type connectors.

ALFRED QUARANTA

Alfred Quaranta of the Development Shops Department retired on September 30, following twenty-eight years of service. Mr. Quaranta entered the Engineering Department of the Western Electric Company in 1918. Since then, he has been continuously associated with the Development Shop at West Street as a cabinet maker, woodworking operator, shop mechanic and carpenter.

ARTHUR S. PAGE

Arthur S. Page of the Switching Development Department retired on September 30, following forty-one years of Bell System service. After receiving the B.S. degree in electrical engineering from Tufts College in 1906, Mr. Page immediately joined the New England Telephone and Telegraph Company. After preliminary installation experience, he was placed in charge of central office and PBX installations in Pittsfield. In 1911 he transferred to Springfield, where he assisted the Supervisor of Equipment and Buildings of the Western Division of the company.

Mr. Page transferred to the Laboratories in 1919 as a member of the methods-of-operation group of what is now the Switching Development Department where he was engaged in the preparation of circuit descriptions and then on the analysis and testing of panel systems. Since

1925 he has been concerned with the maintenance, records and demonstrations of the panel laboratory. He has also done considerable work more recently in connection with special power services for the crossbar and toll-crossbar laboratories.

KATHRYN JOYCE

Kathryn Joyce of the Switching Development Department retired on September 30, following twenty-nine years of service. Miss Joyce came to the Engineering Department of the Western Electric Company in 1918. Since then she has been an office clerk, first in one of the testing groups of the Telephone Systems Development Department and then in what is now the Switching Development Department.

News Notes

Dictation via Telephone in the September issue of *Office Management and Equipment* is the story with pictures of Transcription facilities at West Street.

F. F. ROMANOW and M. S. HAWLEY are authors of *Proposed Method of Rating Microphones and Loud-Speakers for System Use* in the September, 1947, issue of *Waves and Electrons*. Also featured in the same issue is L. E. HUNT's *A Method for Calibrating Microwave Wavemeters*.

Four tables of girls make a party noon hour at Murray Hill. Beginning with Marie Wright, extreme left, and going clockwise, the girls are: Alice Heithmar, Anna Mae Koehn, Marion Pope, Agnes Connor, Alice Todd, Janet Brown, Jane Melroy, Jeannette Renz, Elsie Melroy, Mae Kane, Reine Levesque, Ruby Murphy, Marie Vitelli and Muriel Brown

