

**L. G. ABRAHAM**  
Transmission  
Development

## THE COAXIAL CONDUCTOR EXPANDS IN SIZE

Since its invention\* over fifteen years ago, and its first demonstration in 1937, the coaxial system has steadily increased in importance as a carrier of communication. The coaxial conductor is inherently suited to high-frequency transmission, and with the rapid increase in the use of high frequencies during the war, and the growing interest in and prospects for extensive television transmission, it is only natural that the coaxial system should come to the front. As announced by the American Telephone and Telegraph Company, some seven thousand miles or more of coaxial cable will have been installed by the end of 1949—over 1,500 miles were installed by the first of this year. Even this figure does not adequately indicate the volume of com-

\*RECORD, April, 1946, page 148.

munication that will be possible over coaxial channels because each channel contains a number of coaxial units, each unit transmitting a very wide band of frequencies.

The first long cable to be installed—that between New York and Philadelphia—had two coaxial units, and at first transmitted a one-million-cycle band, while the first commercial installations—between Stevens Point and Minneapolis and later between Atlanta and Jacksonville—each had four coaxial units, and transmitted a three-million-cycle band. On the Philadelphia-Baltimore route installed in 1942, and on later routes, cable with six coaxial units was employed, while eight-unit cable is being employed for some of the latest installations. A still more recent change in the coaxial cable is the use of larger coaxial units—0.375-inch inside diam-

eter instead of the 0.27 inch of all the earlier cables. This larger coaxial, with eight per cable, is already in place between Fort Worth and Dallas on the southern transcontinental circuit, and will be used on all sections from there west and for most of the other sections that will be installed in the future.

In the early stages of the development of the coaxial, it was established that to obtain minimum attenuation, the ratio of the inner diameter of the outer conductor to the outer diameter of the inner conductor should be about 3.6, regardless of the actual size selected. The size chosen for the inside diameter of the outer conductor,

new wider-band systems will be at least correspondingly increased. This larger coaxial facilitates the transmission of wider frequency bands which may be needed to provide even better picture detail than that now obtained, or to handle color television, now widely talked about.

With the present coaxial system, a single coaxial unit handles either telephone channels or television. With a need for television channels a nearby prospect, and with an ever-increasing demand for additional telephone channels, it is very desirable to have a coaxial system in which each unit can carry an increased number of circuits or a television program in addition to its voice



*The two-unit 0.27-inch coaxial cable for the first installation that was made between New York and Philadelphia transmitted a band that was initially one million cycles wide*



*Four-unit 0.27-inch coaxial used between Minneapolis and Stevens Point*

which also establishes the size of the inner conductor because of the fixed ratio of 3.6, was 0.27 inch, and all cables have been of this size until recently.

Cable development work based on experience in manufacturing 0.27-inch coaxials, and operating experience with the coaxial system, however, have made it possible and desirable to increase the size of the coaxial unit. By using 0.375-inch coaxial, repeater spacing for the present system can be increased from about 5.4 miles to about 7.8 miles because of the lower attenuation, and the closer repeater spacings for the

channels. This requires a frequency band that is much wider.

With greater attenuation due to this wider band, and thus closer spacing of the repeaters, more repeater power supply will be needed per mile of cable. This is greatly facilitated by the use of a larger conductor, since power for the intermediate repeater stations is transmitted at low frequency over the inner conductors of the coaxials.

During the early years of the coaxial, a number of methods of construction were tried,\* but since the first commercial instal-

\*RECORD, July, 1935, page 322.

lation between Stevens Point and Minneapolis,\* no radical change has been made except the use of polyethylene disks† instead of the hard rubber disks that had been used previously. For the Stevens Point cable, the four coaxial units were placed together in the center with ordinary voice pairs in the center space between them and in the layers around them, and special pairs in the outer interstices between adjacent coaxials. With the six and eight-tube cables, the coaxials are distributed annularly in the cable with voice pairs in the center and sometimes around the periphery of the cable

\*RECORD, *January, 1941, page 138.* †RECORD, *September, 1945, page 321.*

outside of the coaxials. For the 0.375-inch coaxial units, the same type of cable construction is employed, but because of the larger size of the conductors, the over-all diameter of the cable is greater. In some cases, single insulated wires are placed in the outer interstices, and pairs of these are used for voice or signal circuits.

With transcontinental coaxial systems employing the new eight-tube cable with 0.375-inch coaxials, the Bell System will be in a better position to provide television transmission wherever it is required, and at the same time will have greatly augmented its ability to take care of the steadily increasing telephone traffic.



*Six-unit 0.27-inch coaxial used between Atlanta, Ga., and Meridian, Miss.*

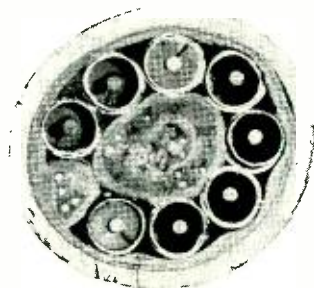

*Eight-unit 0.27-inch coaxial used in several recent installations. The absence of voice pairs outside of the coaxial units makes this cable relatively small in outside diameter*



**THE AUTHOR:** L. G. ABRAHAM received the degrees of B.S. and M.S. in Electrical Engineering from the University of Illinois in 1922 and 1923, respectively. In July of the latter year he joined the Department of Development and Research of the American Telephone and Telegraph Company as a member of the Transmission Development Department and was transferred to the Laboratories in 1934. His work has been chiefly in connection with toll circuits, and he has devoted most of his time to securing optimum over-all performance of message circuits.



## HIGH-FLYING TELETYPE

R. A. VANDERLIPPE

Telegraph  
Development

Another milestone in the history of radio communications has been reached, for it is now practicable to send teletype messages to and from airplanes in flight. The equipment which makes this possible is the new lightweight Model 31 teletype printer, developed by the Teletype Corporation, and an associated converter-control unit, developed by the Laboratories.

Smaller and lighter than a standard typewriter, this printer uses the regular teletype

keyboard and signaling code. The converter-control unit at a station which is sending changes this code into frequency-shift signals in the audio-frequency range for transmission over existing radio-telephone equipment. At a station which is receiving, the converter-control unit changes these frequency shift signals into electrical impulses for operating the receiving-typing part of the printer.

An interesting feature in connection with

*Teletypewriter and converter-control unit for use with radio-telephone system*

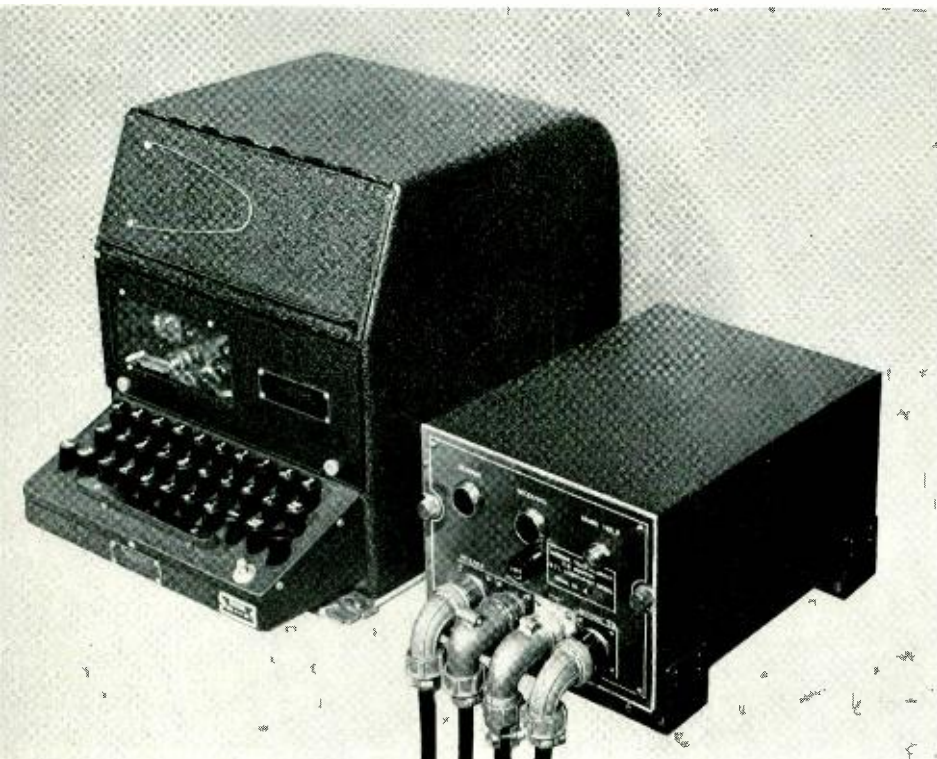

the use of this new instrument is that it will work with any existing radio-telephone installation capable of carrying on satisfactory two-way voice communication. This, of course, means that by the simple addition of the radio teletype equipment, weighing less than thirty-five pounds, and without any modification of the radio-telephone equipment, two-way, typed communication, with all its advantages, may be achieved. The normal use of the radio-telephone equipment is in no way affected by the installation of the radio teletype.

A radio teletype network installed in aircraft and ground stations operates very much like a press-to-talk radio-telephone network, except that instead of spoken words it handles typed messages. No manual operation of a "press-to-talk" control is required since the radio transmitter is turned on automatically when the first teletype character is sent. As in standard land wire teletype equipment, two signaling conditions, commonly referred to as "marking" and "spacing," are used for transmission of teletype signals. The unit of time during which a character is transmitted is broken into seven intervals. Each character begins with a spacing "start" interval and ends with a marking "stop" interval. During these intervals all printers which are receiving are synchronized with the printer which is sending. During each of the five time intervals between the start and stop intervals, the signaling condition may be either marking or spacing, depending on the teletype character being transmitted, so that thirty-two different signaling combinations are possible. By assigning one combination for "upper case" and one for "lower case," any or all of the remaining thirty combinations may be used for the transmission of either of two characters or symbols so that there are enough combinations for all characters and symbols on the keyboard of the teletypewriter.

Circuits in the converter unit provide an automatic closure to condition the radio-telephone equipment for transmission when the first teletype character is sent. This function is disabled when a message is being received. Other control circuits provide for holding the selector magnet circuit of the teletype printer in a marking condition

during idle periods of the circuit, so that radio noise will not cause false characters to be printed, and to light lamps to indicate whether the terminal is in a transmitting or a receiving condition.

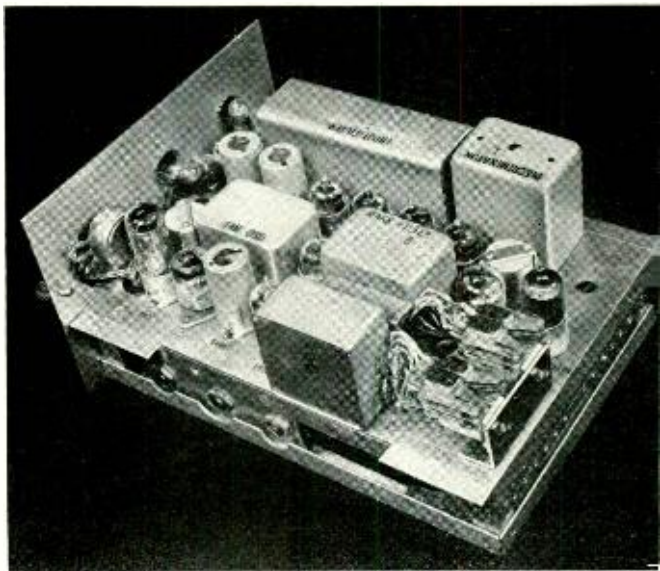

*Interior view of the converter-control unit*

Openings and closures of the printer transmitting contacts which occur as the keyboard is operated are applied to the sending circuit and shift the frequency of an oscillator between 1,615 and 1,275 cycles as required by the marking and spacing elements of the character to be transmitted. The output of the sending circuit modulates the radio transmitter in the same manner as a voice signal. A small amount of energy from the sending circuit is applied to the receiving circuit in which it functions in the same manner as a signal received from a distant station. In this way, a local copy of the teletype characters being transmitted is obtained. During transmission, the auxiliary contacts of the teletypewriter close during each character and, operating through the control circuit, cause the press-to-talk control circuit of the radio transmitter to close at the beginning of transmission and remain closed as long as at least one character is sent every five seconds.

Release of the mark-hold circuit during a



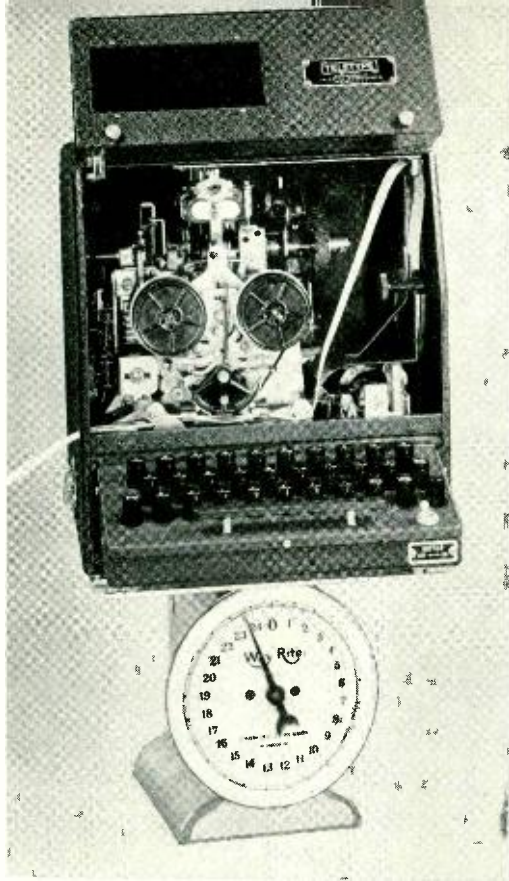

*Interior view of the Model 31 teletypewriter. It weighs less than 24 lbs.*

receiving condition causes a green-capped REC lamp to light. At the same time that the marking hold is released, the sending control circuit is disabled to prevent accidental operation of the keyboard from interfering with the incoming signals. During the transmitting condition, a red-capped SEND lamp is lighted and the circuit for lighting the REC lamp is disabled.

When signals are being received, the 1,615-cycle marking and 1,275-cycle spacing tones, together with the important side band components resulting from signaling, are passed by the input band pass filter to a fast-acting amplitude-limiting circuit and applied to frequency-discrimination circuit. The output of the discriminator circuit is a positive voltage for marking and a negative voltage for spacing signals which result in a current of 20 milliamperes in the selector magnet for a marking condition and zero current for a spacing condition. The output of the amplitude limiter is also applied to the "mark-hold" circuit. The marking ele-

ments of the first teletype character to be received cause the marking hold on the output circuit to be released so that subsequent signals may pass through the output circuit to the printer selector magnet.

The primary source of power for the converter-control unit and the Model 31 teletype is the 26.5-volt battery commonly used in airplanes. Plate voltage supply of +250 volts for the converter-control unit is normally obtained from a generator winding on the teletype driving motor. This high-voltage supply is also used for an electronic speed regulating circuit that is incorporated in the printer.

Tubes having 6.3-volt heaters are used in the converter-control so that this unit could be adapted for vehicles having a 6-volt battery by reconnecting the filament circuits. A vibrator type high-voltage supply circuit operating from 6-volt battery has been constructed for supplying plate voltage to the converter-control unit.

The Model 31 teletype printer is only 10½ inches high, 10 inches wide and 13½ inches deep, and weighs only 24 pounds. The converter-control unit is 5 inches high, 7 inches wide and 9 inches deep, and weighs 8 pounds. This makes it possible to provide teletype service over existing press-to-talk radio-telephone circuits by adding less than 35 pounds to the weight of the communications equipment. No modification of the radio-telephone equipment is necessary. An additional feature of importance to aircraft operation is the fact that this equipment will operate in any position, even upside down.

With teletype operation, a printed record of all communications is available at all stations in the network. Messages may be handled easily and accurately by inexperienced personnel, and are received without attention from the operator. Since a standard teletype code is used, messages may be sent from any other teletype station such as a land-wire "weather" network. In international service code groups of teletype characters could be standardized to cover all routine phases of weather reporting, take-off, landing and other instructions to be given to the plane.

The new lightweight terminal equipment has special application to other fields in

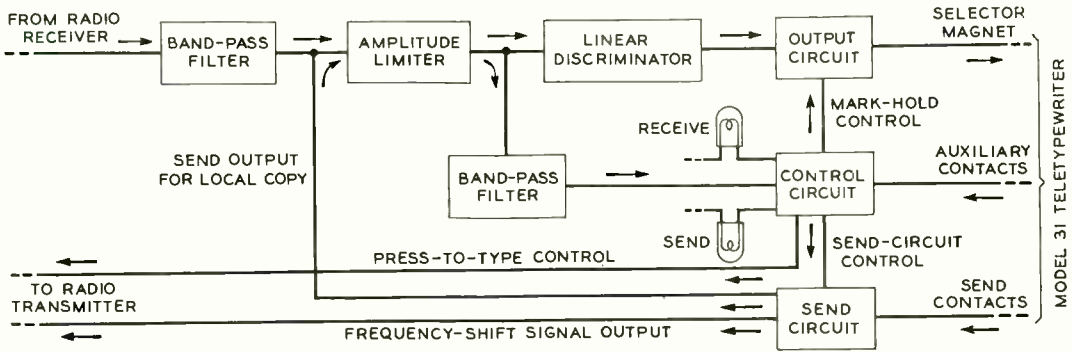

Block schematic of a telegraph terminal

which the large size and weight of standard equipment has prevented the use of teletype methods of operation. These fields include mobile service to trucks, cars and harbor craft and military applications to landing operations and forward command posts of advanced echelons of a battle

force. Of particular importance in these uses is the advantage of making a record of instructions or other data without continuous attention from an operator. Also of importance is the fact that messages may be handled easily and accurately by inexperienced operators.



**THE AUTHOR:** R. A. VANDERLIPPE attended the University of Omaha and the University of Nebraska from 1925 to 1930, receiving the degree of B.Sc. in E.E. from the latter. While attending Nebraska he also worked as toll-test boardman and equipment engineer. He joined the Laboratories in 1930, and worked on voice-frequency carrier telegraph and d-c telegraph circuit design problems. Later he supervised laboratory testing of telegraph transmission circuits and laboratory and field testing of private line telegraph switching systems. During World War II he was concerned with the development of voice-frequency carrier telegraph systems used by the Army and of long-haul radio teletype apparatus and systems used by the Army and Navy. At present Mr. Vanderlippe is a supervisor responsible for the development of radio teletype systems and of special electronic circuits that are used in these and other telegraph systems.

## AUTOMATIC GLAZING MACHINE

R. RULISON

Electronic  
Development

Small rod-shaped thermistor elements are sometimes protected by a glazed covering made by depositing powdered glass on them and melting it down to a smooth layer in a furnace. The equipment used was formerly manually controlled and demanded the full time of one person to attend it. An automatic glazing machine has been developed by the Laboratories to carry out this process. It eliminates operational variables and only requires the attention of an operator to load and unload it.

The rods that are to be glazed are mounted longitudinally in four slotted disks on an extension of the shaft of a slow-speed

motor. A magnetic clutch connects the motor to a pinion gear which engages a rack fastened to a rail platform to advance the thermistor units into an electrically heated furnace. The units are withdrawn after a definite time by reversing the motor. Limit switches at each end of the rail control the distance the carriage travels. The time the units remain in the furnace is determined by an interval timer on the control panel that can be seen at the left of the photograph that is shown below. There is also a variac to adjust the temperature of the furnace, a temperature indicating meter, an on-off switch and a starting button.

*Thermistor elements being protected by glazed covering*

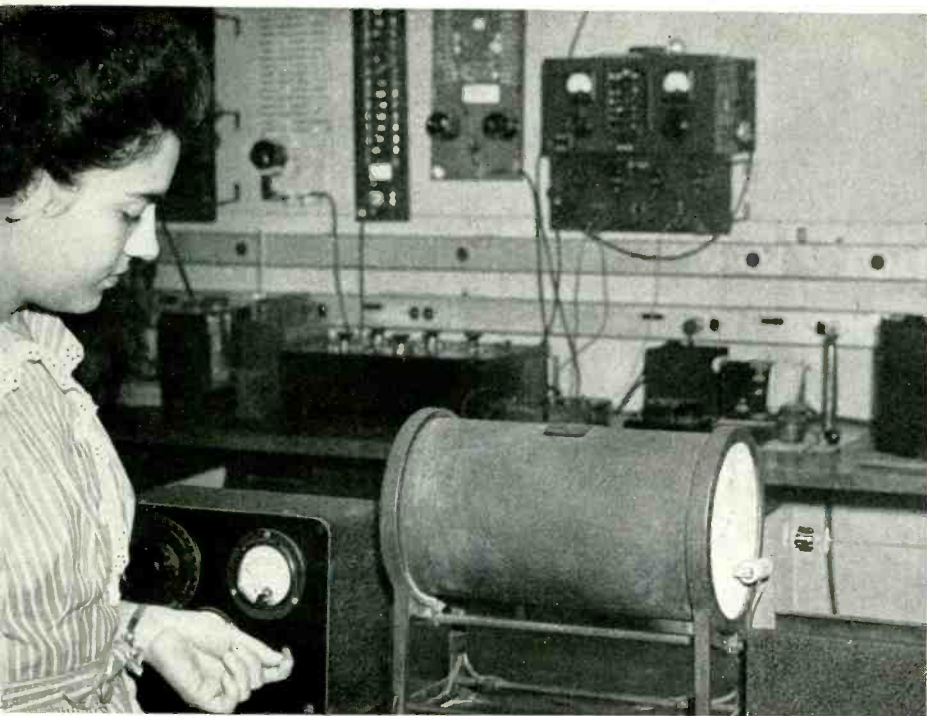



Thermal shock to the glass is avoided by inserting and withdrawing the rods slowly from the furnace. They are continuously revolved on the motor shaft to obtain a uniform distribution of glass over the surface. The temperature within the furnace is maintained at 900 degrees C.

The glazing cycle is carried out by throwing the central panel switch T to ON, setting the interval timer I and then pushing the start button S. This starts the motor and simultaneously energizes the magnetic clutch C, thereby moving the carriage until it strikes the forward limit switch L, which disengages the magnetic clutch. At the expiration of the time interval chosen, contacts close on the timer I to operate a relay R, which, in turn, energizes

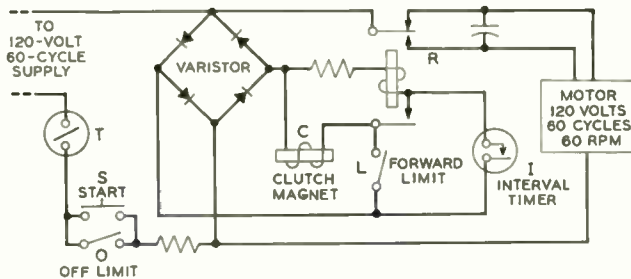

*Circuit diagram of the automatic glazing machine. Pushing the button S energizes the magnetic clutch C and moves the thermistor units into the furnace until stopped by the limit switch L. At the end of the time interval chosen the timer I re-energizes the clutch and reverses the motor*

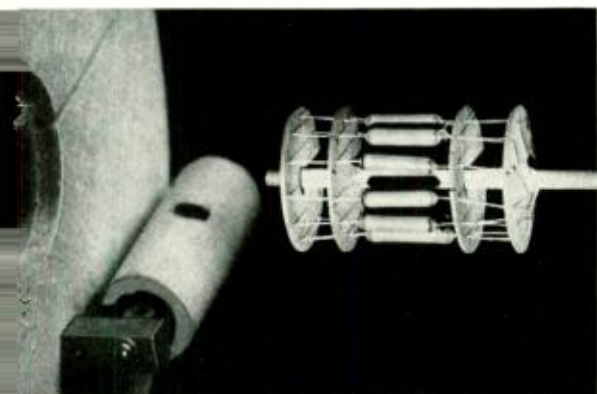

*The rods to be glazed are mounted in four slotted disks on an extension of the shaft of a motor that rotates at a slow speed*

the magnetic clutch C and at the same instant reverses the motor. The direction of motion of the carriage likewise reverses and withdraws the rods from the furnace. When the carriage strikes the off limit switch O, current is cut off from the motor and control circuit. This completes the glazing cycle. The operation takes from 20 to 25 minutes, one minute of which is required to insert and withdraw the units.

Experience with this equipment indicates greatly increased uniformity of coatings as compared with non-automatic methods besides the advantages of requiring much less attention by the operator.

**THE AUTHOR:** R. RULISON joined the Laboratories in 1921 and became a member of the Technical Staff in 1930. Until 1941 he worked in the electro optical research group on photo-electric problems connected with telephoto and television developments. When the war came, he transferred to Physical Research and was concerned with thermistor development and a special project for the Signal Corps. In 1944 he joined Electronics Apparatus Development to engage again in thermistor development. Mr. Rulison attended the Newark Technical School soon after he had joined Bell Laboratories.



## SJ RADAR FOR SUBMARINES

C. L. VAN INWAGEN  
Radio  
Development

Early in 1941 our Navy decided that it needed search radar on its submarines to provide a warning system while the ship was surfaced for battery charging at night, and also to provide accurate torpedo fire-control data for offensive action against enemy naval and merchant ships. The Whippany and Holmdel Radio Laboratories were already at work at that time on other radar developments, and they were requested to add the submarine radar project to their list of jobs.

Some of the stories of the Navy's exploits with the SJ which have filtered back to Whippany have been very gratifying, especially to those who worked many long overtime hours during the early days of the war to put this job across. Little has been pub-

lished on the subject, but it is true that a major part of the sinkings of the Japanese vessels by our submarines was accomplished by radar, sometimes supplemented by optical means.

Enthusiasm for the SJ radar by ships' personnel was lacking during the first few months of its use, as evidenced by a report from a Western Electric field engineer stationed on a mid-Pacific island who met a newly equipped submarine returning from its first patrol with no successful attacks. This engineer then spent several days at sea with the submarine, training operators and demonstrating the performance of the SJ to the captain while making practice attacks. When this ship returned to the island from its next patrol, the engineer was

*Installation of SJ radar in submarine*

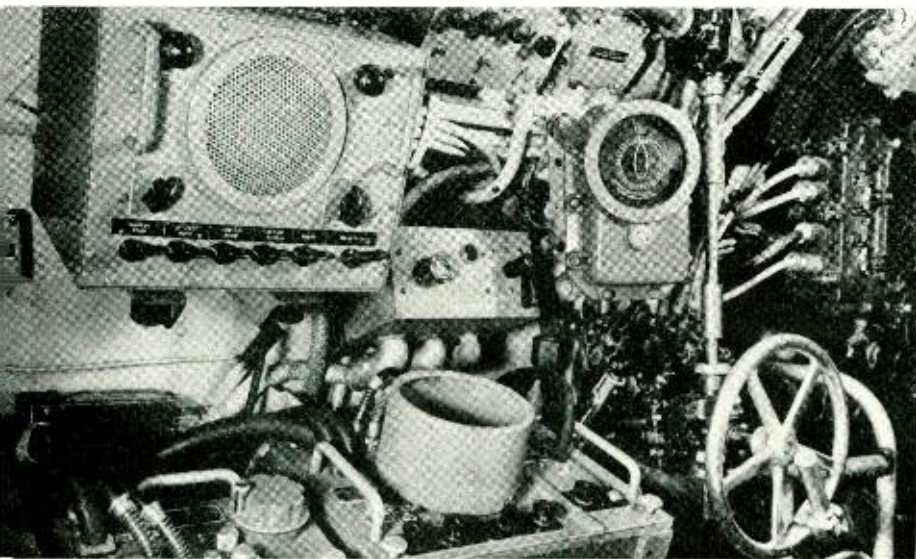

greeted heartily by the captain as he came down the gangplank, who then and there made the engineer an honorary member of the submarine crew. On this patrol they had sunk three Japanese ships, all by using SJ radar.

Another interesting case involved the sinking of a Japanese submarine. The enemy submarine had sighted one of our submarines on the surface, and was following it for the "kill." Our ship detected the enemy's presence but did not reveal this knowledge to the Japs so as not to scare them into a retreat. The captain had decided upon deception, and radioed another American submarine, giving his position, saying that he would lead the Japs within range of the other submarine. This was done and radar was used by the second American submarine to sink the stalking Jap. This not only shows the value of radar, but also attests the courage and daring of a submarine captain who chose to risk his and his crew's lives by leading the Jap into a trap rather than to submerge his submarine and take the easy way out.

One of the most remarkable achievements of submarine radar occurred when one of our submersibles surfaced at night in the Pacific to find itself practically surrounded by twelve enemy ships clearly defined on the radar plan-position indicator. Having only fourteen torpedoes left, the captain quickly took radar bearings on the seven largest targets, and sent two torpedoes toward each. He remained surfaced long enough to see the radar signals representing these seven Jap ships disappear from his indicator as the torpedoes found their marks.

Another remarkable incident occurred on the second night after landing on Leyte when the Japs were doing their utmost to bring reinforcements to repel the invasion. On this night, a wolf pack of five American submarines operating off the west coast of Luzon detected a twenty-six-ship convoy heading toward Leyte. Using SJ radar for torpedo data, the five submarines sank twenty-four of the enemy ships and left one other burning. All of their torpedoes had been expended.

The American submarine is a compact and efficient vessel with no space of any

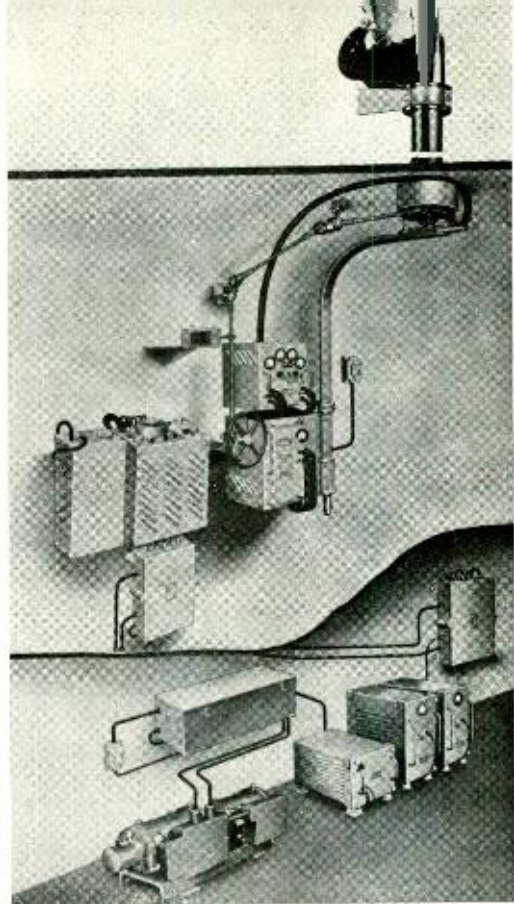

*Typical arrangement of SJ radar apparatus in a submarine*

consequence left in the submarine designer's plan for relatively complex electronic equipment. It immediately became apparent, therefore, that the radar equipment would have to be broken up into small compact units that would go through twenty-five-inch hatches, and these units would have to be stowed in whatever small spaces were found available. Numerous visits were made by Laboratories' engineers to the U. S. Navy Yard at Portsmouth, N. H., which is devoted entirely to the planning and building of submarines, and then plans for submarine radar were laid in collaboration with the Navy's Radar and Submarine Design Sections at the Bureau of Ships and the Portsmouth Navy Yard.

The main components of the SJ radar equipment are the antenna projector, the transmitter-receiver, an indicator for "A" presentation, a range unit, a bearing indicator, a plan-position indicator—added later to present a map of targets surrounding the



ship—and auxiliary power apparatus. The main operating position is in the conning tower, where the transmitter-receiver, indicators, range-measuring device, and the means for training the antenna equipment are mounted. In the early systems, the training device was manually operated, but this was later modified to add a variable speed and reversible motor drive which can be used at the option of the operator. All

came necessary, therefore, to design a whole new set of radio-frequency components for this set, and this required a large amount of original work by engineers of the Laboratories.

The Navy asked that target indications should be within  $\pm$  fifteen minutes of arc in azimuth. The sharpest radio beam that can be projected at this frequency with the antenna dimensions permitted is about eight degrees wide, and to obtain the required accuracy, lobe switching is employed. To allow for the pitch and roll of the ship, this beam is fanned out in a vertical plane to an angle of about eighteen degrees. The reflector meeting these requirements is the central zone, ten inches high, of a thirty-inch-diameter parabolic reflector, as illustrated on page 403.

One major design problem was this antenna, which of necessity is mounted atop the ship, and which must be sturdy enough to withstand deep submersion, and not leak with water pressure ranging up to 300 pounds per square inch. Crash dives and collision with floating debris also had to be considered. The antenna illustrated is made from heavy castings, gasketed and pressure-tested at 300 pounds per square inch. Radio-frequency power is fed through a thick polystyrene window, which is also designed and gasketed to withstand the water pressures encountered. A later modification of the antenna provides for the substitution of a grated reflector for the one illustrated to reduce underwater drag, and to improve its electrical performance. The antenna is continuously rotatable in either direction, and thus requires a rotary joint between the vertical rotating wave guide and the stationary wave guide leading to the transmitter. This rotary joint not only conducts radio-frequency, but also low-frequency power and indicator circuits through five slip-rings to the lobe switch.

The mast or torque tube, enclosing the wave guide and supporting the antenna projector, is a four-inch brass tube supported in plain bearings on the "shear" structure of the ship. This mast passes into the top of the conning tower through a stuffing box bearing of similar design to those used for periscopes. The antenna does not move vertically as do the periscopes,

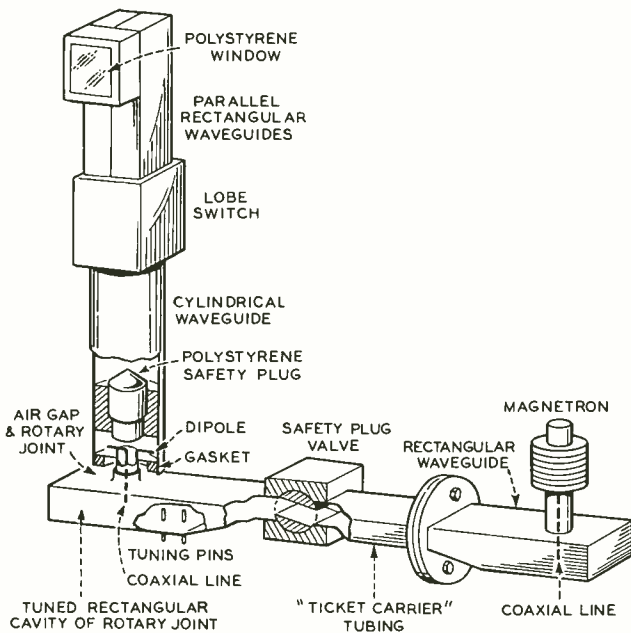

*Wave-guide feed to antenna for the SJ radar*

other components of the radar are mounted below the conning tower in the control room or pump room of the vessel. These latter components require only occasional inspection and servicing, and can be stowed in relatively inaccessible locations.

Heretofore, most radar had been designed to operate in the P and L bands of frequencies, ranging up to approximately 700 megacycles. The plan for the submarine radar called for operation in the S band, that is, around 3,000 megacycles, or a wave length of 10 centimeters. It be-

however, but is fixed in elevation. Training the antenna on a target is accomplished by a worm and gear reduction attached to the lower end of the torque tube.

The wave guide leading into the ship is sealed from inside the conning tower against an inrush of sea water in the event of antenna breakage. Outside in the water at the antenna is the polystyrene window previously mentioned, and near the bottom of the wave guide, inside the conning tower, is a polystyrene plug with a conical seat something like a poppet valve, which is inserted in a constricted portion of the wave guide. The rotary joint is provided with a gasket, which can be secured by tightening four nuts on the supporting studs, and the wave-guide cavities comprising each side of the rotary joint are strong, heavy manganese bronze castings designed to withstand full water pressure. The inward end of the joint terminates in a taper plug valve having a rectangular opening to match the rectangular wave guide leading from the transmitter-receiver. This plug valve is the final seal against sea pressure.

As indicated in the schematic drawing, rectangular tubing, like that used for pneumatic-tube toll-ticket distributing systems in toll offices, is used for a wave guide to connect the radio-frequency components in the conning tower. A cylindrical wave guide in the mast connects the conning tower components to the antenna projector above. At the lobe switch, a transformation is made from one cylindrical to two parallel rectangular wave guides that feed the reflector through the window of the wave guide.

The later SJ equipment provides two types of target presentation: a plan-position indicator (PPI) and an "A" presentation. PPI presentation is used for general search to locate possible targets or to warn of the approach of hostile craft. When a particular target on the PPI screen has been chosen for closer scrutiny, its approximate location in azimuth is noted from its position on the PPI screen. The antenna can then be stopped and manually trained directly on the target selected. It is here that the "A" presentation is normally used. The range unit measures the distance, and the bearing in azimuth is read directly from an

indicator geared to the antenna training mechanism. By continuously tracking the target, complete and accurate data on the movements of an enemy vessel can be fed into the torpedo data computer, which ultimately furnishes complete firing information for the torpedoes.

The first SJ radar equipment to be installed was shipped from Whippany to the Portsmouth Navy Yard on March 31, 1942. Except for the antenna components, which were produced at Hawthorne, this radar

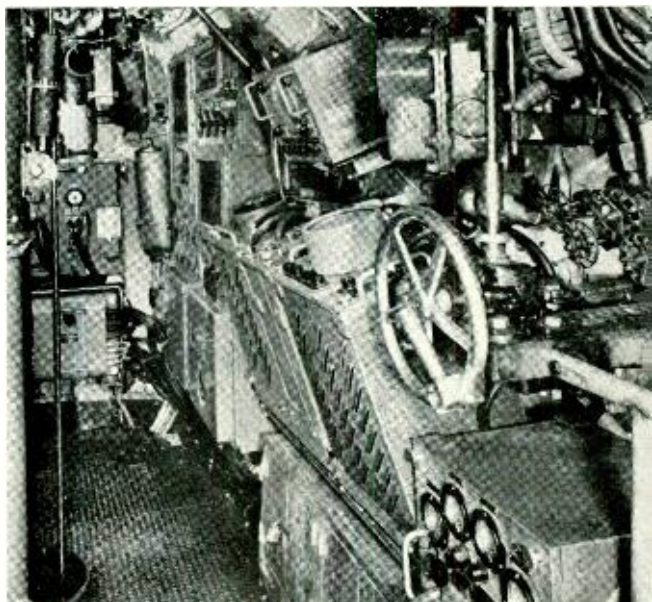

*Interior of conning tower looking aft: main control unit at the lower right; transmitter receiver center left; hand wheel for training antenna, center right*

was built at Whippany, and engineers from Whippany assisted the Navy with the installation. Other Laboratories engineers were stationed at Hawthorne during the greater part of 1942 to assist in solving the many manufacturing problems that arose, and to help establish the electrical system tests which were required to insure satisfactory performance.

This radar is also regarded as an invaluable aid to navigation. While the Japs held Kiska and Attu in the Aleutians, one of our submarines entered Kiska harbor at

night, sank three Jap war vessels, using its SJ radar entirely for navigation and torpedo data. Newspapers reported that the captain used "all devices at his command."

Another submarine entered a certain Maine harbor through a very difficult channel in foul weather and in darkness to

spend the night. The captain used his SJ radar to locate buoys and headlands, and safely proceeded to his anchorage. In the morning local fishermen were amazed to see that a 300-foot submarine had safely navigated the channel under conditions that would be discouraging to a 30-foot boat.

**THE AUTHOR:** C. L. VAN INWAGEN first studied at the University of Cincinnati and then at the Rochester Institute of Technology, where he specialized in electrical engineering. Graduating in 1915, he spent two years with the Selden



Motor Vehicle Company and then joined the Laboratories. Here he was associated with the design of telephone apparatus and of radio-telephone apparatus for World War I. Following the Armistice, he continued the development and mechanical design of central office apparatus until 1929, when he joined the Outside Plant Department to develop cable laying and splicing tools. He then transferred to the Commercial Products Department for the mechanical design of ultra-high-frequency radio equipment, and later of audiometers and audiphones. From 1939 to the middle of 1941, with the electro-magnetic switching group, he designed high-speed panel switching apparatus and carried on contact studies of step-by-step switches. Returning then to the Commercial Products Department, he was concerned during the war with the mechanical design of radio equipment for the Army and Navy.

### C. N. HICKMAN COMMENDED FOR ROCKET RESEARCH WORK

During the war, C. N. Hickman was loaned by Bell Telephone Laboratories to National Defense Research Committee, where, as chief of Section H, he directed the committee's work on military rockets. Recently he has received a certificate of appreciation from the War Department "for outstanding services rendered in time of war to the Rocket Development Program of the Ordnance Department."

Dr. Hickman has also received the following letter from Vannevar Bush, Director of the Office of Scientific Research and Development:

"You are one of the rare human beings who has lived to see his vision of the future completely justified. At the very out-

set of hostilities abroad, and before the United States was involved in the war, you foresaw with remarkable accuracy the rôle of the rocket in modern warfare.

"That the rocket weapons of the United States turned out to be one of the most vital and successful types of ordnance is the result in no small part of your vision and planning.

"It is a great pleasure to me to congratulate you on the successful accomplishments of Section H. I desire to thank you also for your long and unflagging devotion to the N.D.R.C. program. You must feel a great sense of personal satisfaction that your efforts may have been a direct contribution toward shortening the war."



**A. F. LEYDEN**

**Plant  
Operation  
Manager**

## **ALARM SYSTEM AT MURRAY HILL**

The old adage, "An ounce of prevention is worth a pound of cure," is axiomatic with people who operate buildings such as Bell Telephone Laboratories, but in spite of all efforts, troubles develop, fires start, equipment and services fail, and the building operator is forced to provide ways and means to make these emergency situations reveal themselves quickly and accurately.

At West Street and at Murray Hill, considerable thought has been given not only to the quick detection of fire but also to insuring continuity of services such as electricity, water, compressed air, etc., that are essential to the Laboratories' work. Continuity of the various utility services has been partially assured in the design of the distribution systems and in the provision

of spare equipment where it was justified, but over and above this, some method was wanted of giving an immediate indication of any circumstances that, if not at once corrected, would lead to an appreciable curtailment of output. This need was met by an automatic alarm system broad enough in scope to cover practically every field of hazard. At Murray Hill this unified system includes the following:

1—A manual fire alarm station from which the occurrence of fire can be immediately and succinctly reported.

2—An automatic fire alarm system that reports an abnormal rate of rise of temperature anywhere in the group of buildings.

3—A sprinkler water flow detection system to signal the flow of water in the sprinkler piping in specially protected areas.

4—A watchman's tour system to insure that watchmen complete their established patrols according to a prearranged plan and report to headquarters periodically.

5—A group of alarms that indicates when any of the utilities—electricity, water, steam, etc.—reaches a condition that threatens its continued availability.

The automatic alarm system selected is of the closed-circuit type, with all electrical circuits continuously supervised. This system is classified as "positive non-interfering and successive," and these characteristics will be amplified further in the text. The principal feature of the system is the code transmitter shown on page 408. In general, each of the various detecting devices at a protected or supervised location has its associated transmitter whose signal is as individualistic as a person's signature. This transmitter carries a metal disk with ratchet teeth around its periphery. One face is machined to receive an insulating plate carrying a pattern of contacts arranged in concentric circular paths. Brushes ride



along these paths as the disk is rotated by a magnet-operated pawl, and contacts are made at various positions for each complete revolution. The arrangements of the

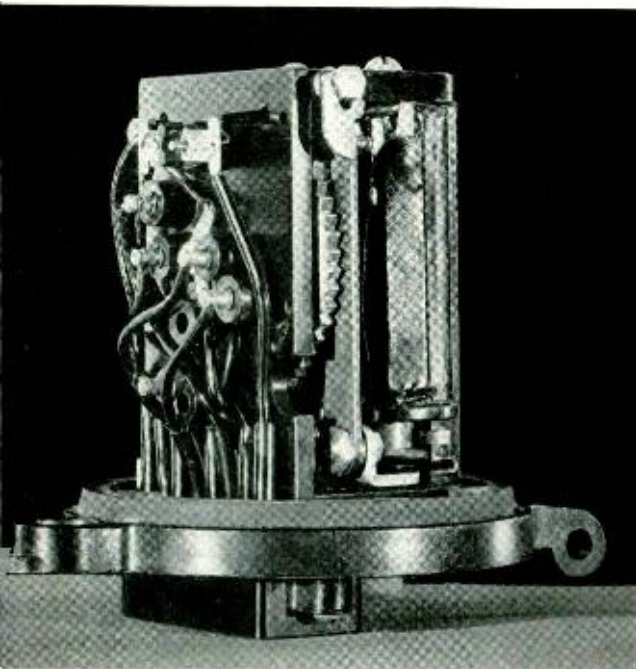

*The transmitter with cover removed to show the operating magnets and the ratchet wheel provided for carrying the contacts*

contacts of four of the rings are the same for all transmitters, and control the operation of the circuit. Those of the fifth are different for each transmitter and are arranged to send a coded signal to indicate the location and use of the transmitter. For additional control needed to give the traditional six round fire signal, the manual and automatic fire alarm and sprinkler water flow transmitters require a sixth ring.

Supervision of all these alarms is concentrated in an alarm desk located in a room just off the main lobby in Section 1B. An attendant is on duty here continuously, ready to receive and acknowledge alarms, transmit information, and request any assistance that may become necessary. A separate intercommunicating system is provided that permits the attendant to call or be called by the watchman or other building operation employees

wherever they might happen to be located.

Besides sounding audible signals, all alarms are recorded on continuous charts. This chart indicates the what, where and when, the nature of the trouble being indicated by a word or words, the point of origin by a numerical code, and the time of occurrence by a time stamp of the year, date, and time of day. Two recorders are located on the alarm desk shown in the headpiece and each recorder has its own alarm circuit and records a certain group of alarms. On one of these alarm circuits are connected all alarm devices associated with fire detection, sprinkler water flow, and a watchman's tour system; on the other are those that supervise the various building services. The two systems may be combined, however, and may both record on one of the recorders should anything go wrong with the other.

A section of the chart, made on one of the recorders when part of the system was being cut into service, is shown on the next page. As mentioned above, the first of the four digits sent by the transmitters sets a type wheel to print the class of alarm. **MANUAL** represents a fire alarm turned in at a manual fire station; **AUTO** an alarm originated by the automatic fire detection device; **SYSTEM** an alarm caused by failure of the d-c power supply to the alarm system. The following three digits indicate the location of the transmitter sending the alarm. The notation "Bell Lab. 1" indicates that this record was made on the No. 1 recorder, which is the one used for the fire alarm system. Printed lengthwise on the recording tape in red ink at six-inch intervals is a series of numbers: No. 2416006 and No. 2416007 appear on the section shown. This permits any removal of a section of tape to be discovered readily, and insures the validity of the record which is kept on file for the information of our insurance inspectors.

Each of the two alarm circuits is arranged as indicated in the simplified schematic. The fundamental circuit consists of a three-conductor loop which leaves the alarm desk, passes through the transmitters one after another, and returns to the alarm desk. Of the three wires of the loop, one is positive battery, one negative bat-

tery, and the other, the signaling lead over which the code is transmitted. Each conductor is "supervised," that is, it carries current all the time; if one of the wires of the loop should become open-circuited, the supervisory relay would sound an alarm.

Relays ps, ns, and ss are the positive, negative, and signal supervisory relays, respectively. Relay REA operates the recorder, controlling other relays that move the type wheels and print the code as it is transmitted. REA is normally operated by current from positive battery, which flows through its winding, around the signaling loop, and to negative battery through the resistance R. It is released by a connection of positive battery to the signaling lead at any transmitter. Should the signaling loop become open-circuited, the current through the winding of REA would pass through the winding of ss, and an alarm would be sounded by the operation of this relay. An open circuit in either the positive or negative loops, by releasing its su-

perisory relay, sounds an alarm and also closes a circuit to an oscillator, which then opens and closes the negative circuit about three times a second.

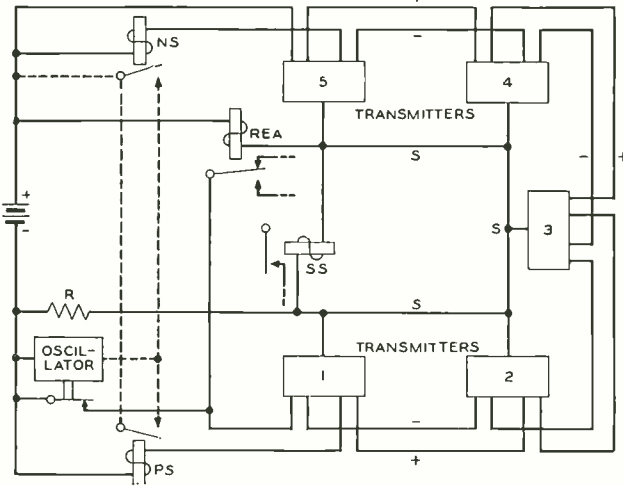

Simplified schematic of alarm circuit

*Test alarm chart made when part of the system was cut into service*

MANUAL	2	4	-	BELL LAMP	1502 APR 7 AM 11:40
MANUAL	2	3	-	BELL LAMP	1502 APR 7 AM 11:40
MANUAL	2	2	-	BELL LAMP	1502 APR 7 AM 11:40
MANUAL	2	4	-	BELL LAMP	1502 APR 7 AM 11:40
MANUAL	2	3	-	BELL LAMP	1502 APR 7 AM 11:40
MANUAL	2	2	-	BELL LAMP	1502 APR 7 AM 11:40
MANUAL	2	4	-	BELL LAMP	1502 APR 7 AM 11:40
MANUAL	2	3	-	BELL LAMP	1502 APR 7 AM 11:40
MANUAL	2	2	-	BELL LAMP	1502 APR 7 AM 11:40
MANUAL	2	4	-	BELL LAMP	1502 APR 7 AM 11:40
MANUAL	2	3	-	BELL LAMP	1502 APR 7 AM 11:40
MANUAL	2	2	-	BELL LAMP	1502 APR 7 AM 11:40
MANUAL	2	4	-	BELL LAMP	1502 APR 7 AM 11:40
MANUAL	2	3	-	BELL LAMP	1502 APR 7 AM 11:40
MANUAL	2	2	-	BELL LAMP	1502 APR 7 AM 11:40
SYSTEM	-	1	-	BELL LAMP	1502 APR 7 AM 11:40
MANUAL	2	4	-	BELL LAMP	1502 APR 7 AM 11:40
MANUAL	2	3	-	BELL LAMP	1502 APR 7 AM 11:40
MANUAL	2	2	-	BELL LAMP	1502 APR 7 AM 11:40
SYSTEM	-	1	-	BELL LAMP	1502 APR 7 AM 11:40
AUTO	2	2	-	BELL LAMP	1502 APR 7 AM 11:50
MANUAL	2	2	-	BELL LAMP	1502 APR 7 AM 11:50
MANUAL	2	2	-	BELL LAMP	1502 APR 7 AM 11:50
MANUAL	2	2	-	BELL LAMP	1502 APR 7 AM 11:50
MANUAL	2	2	-	BELL LAMP	1502 APR 7 AM 11:50

An alarm is sent by closure of the alarm contact at one of the transmitter locations. This, as may be seen in the upper sketch on page 410, operates the transmitter magnet, which opens an associated contact in the outgoing positive lead. The opening of the positive lead releases relay ps at the control center and starts the oscillator. The first time the oscillator opens the negative circuit, the transmitter magnet releases, moves the contact disk one step, and leaves the circuit at the transmitter arranged as shown in the lower sketch on page 410, with the operating magnet connected across the loop through contact No. 4. The "negative-out" lead is now open at disk contact No. 1, and the "positive-out" lead is opened each time the magnet is energized by the oscillator at the alarm desk and kept open as long as battery is connected to the "negative-in" lead. Since the "negative-out" and "positive-out" leads run in opposite directions through the chain of transmitters, no transmitter on either side can now operate. Those on the "negative-out" side



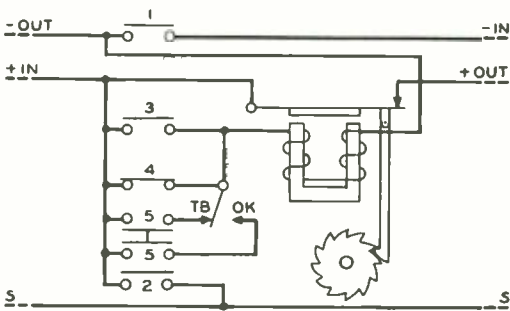
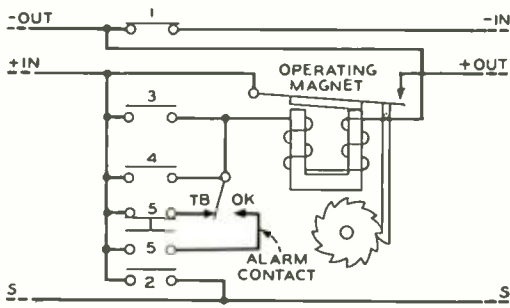

*Simplified schematic of transmitter circuits before an alarm has been turned in, above, and after operating magnet has released following the first operation*

will have no negative battery at any time during the transmission of the code, and those on the "positive-out" side will have positive battery only when the operating magnet is released, during which period the negative battery is open at the oscillator at the alarm desk. This is the "positive non-interfering" feature of the system. The operating magnet of the active transmitter, however, will operate and release following the closures and openings of the oscillator contacts. At the third release of the transmitter magnet, transmission of the code will begin by periodic openings and closings of contact No. 2, which represents one ring of contacts on the disk, and these pulses of current will set up the code wheels within the recorder located on the alarm desk and cause the proper record to be made.

The transmitter disk requires fifty-two steps to make one complete revolution, and during this period the code is sent twice, each transmission requiring about eight seconds. Between the first and second transmissions, however, the "negative-out" and "positive-out" circuits are momentarily

closed to allow any other transmitter to "seize" the circuit if it has an alarm waiting. This is the "successive" feature of the system. At the end of one complete revolution of the disk, the transmitter circuit returns to its normal position in readiness for another alarm.

While the transmitter is the keystone of the entire system, it must receive the initial impulse from some detecting device, and these devices differ with the condition to be detected. The automatic fire detection system, for instance, operates on the change of pressure of air within a small copper tube of which there are approximately 70,000 feet installed throughout the buildings. Where wet pipe sprinkler systems are installed, flow devices sensitive enough to detect the flow of water equivalent to the opening of a single sprinkler head are installed. Abnormal conditions on the various systems listed in the table below are detected by devices sensitive to pressure, temperature, or change in level, arranged to set off an associated transmitter whenever conditions reach the point where an alarm should be given. Manual fire alarm stations are provided for use of the building occupants, and are located in stair-wells, on all floors, and in the cellars and attics. A typical installation of the manual fire alarm station,

#### *Service Alarms—Second Alarm Circuit*

- 1—High and low water on house supply
- 2—High and low water on fire supply
- 3—High and low water on cooling water supply
- 4—High and low temperature on house supply
- 5—High and low temperature on fire supply
- 6—Low pressure on street water main
- 7—High and low level of drinking water make up
- 8—High and low level in sump pits
- 9—High and low pressure of 60-pound air
- 10—High and low pressure of compressors for various refrigerators
- 11—High and low steam pressure, 125-pound supply
- 12—High and low gas pressure
- 13—Emergency lighting system on or off
- 14—High water in waste neutralization plant
- 15—Power on three electrical distribution loops in cellars
- 16—Operator's delinquency alarm
- 17—Alarm system (d-c power)
- 18—Position of sprinkler valves (open or closed) (future)

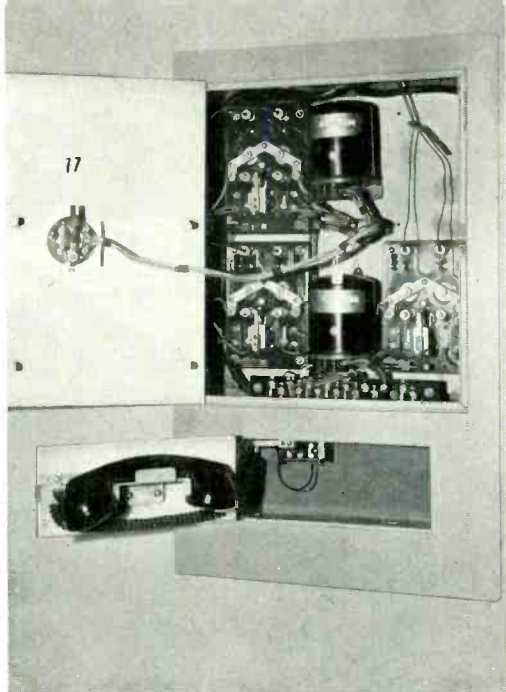

A fire alarm installation in one of the stairwells of the Murray Hill Building

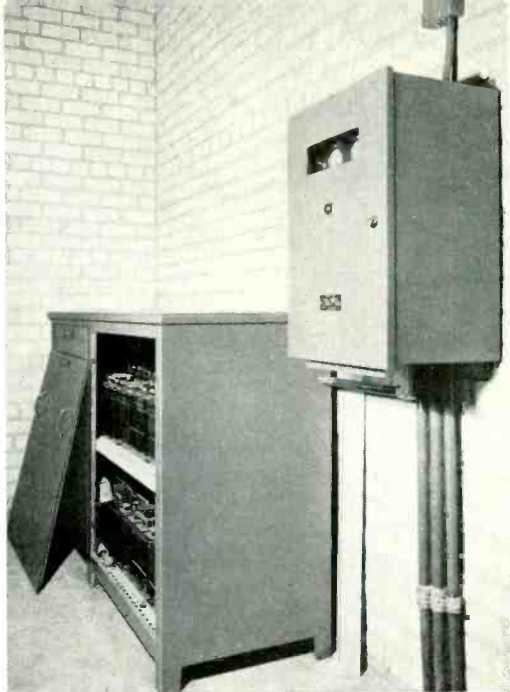

The alarm battery and automatic charger are in a room adjacent to the control center

with the telephone set used in conjunction with fire prevention and watchman's service, is shown above. The manual alarm is associated with one of the transmitters, and the three rate-of-rise fire-detector devices with the other.

Three types of alarms, automatic, manual and sprinkler water flow, are considered as fire alarms and consequently sound their codes over a series of fire gongs located through the building. These fire gongs are installed adjacent to the stair-wells and are grouped on eight circuits or zones as indicated in the table below. When a fire alarm reaches the alarm desk, gongs in the zone of the fire are rung, but all zones may be grouped and a general alarm sounded if desired. Automatic closing fire doors, isolating all stair-wells, are electrically released

over zone circuits similar to the gong circuits, and the fire doors of the affected zones are released on receipt of a fire alarm. These release circuits may also be grouped and operated automatically or manually altogether if desired. As a matter of fact, these doors are released by operation of the manual switch shortly after office hours each night. Zoning is also applied to the watchman's call lamps which are operated from the alarm desk.

Power for the alarm system is provided by a 60-cell, 120-volt storage battery continuously floated across the output of a copper oxide rectifier. This battery, which is in itself sufficiently large to meet the signaling needs for approximately seventy-two hours, should the a-c supply to the charger fail, makes the entire alarm system independent of the power supply of the building during emergencies.

The general philosophy of supervising all parts of the alarm system has been carried out to the extent that the attendant himself is required to report periodically or the system will record him delinquent and notify others in the building. This type of supervision is provided by an electric clock-driven device within the control desk that runs continuously and is arranged to sound

#### Fire Zones at the Murray Hill Laboratory

Zone No.	Area Covered
1	Sections 1D, 1E, 1F
2	Section 1C
3	Section 1B
4	Section 1A
5	Acoustic Building
6	Garage
7	Gate House
8	Boiler House



*On a board behind the desk in the control center is the supervisory equipment for heating, ventilating and power supply*

an alarm at the end of a selected interval if it is not reset within that time by the attendant. At Murray Hill the attendant must thus reset the device at least every fifteen minutes or be recorded delinquent. Ample warning is given by a buzzer which sounds at the end of the ninth minute and

continues to sound until the reset switch is pressed. This insures that the control center is never unattended for more than fifteen minutes at most at any time.

In setting up the control center, established telephone-exchange cabling practice, which permits repairs and changes in circuits to be made without interference with operation, was followed and all wiring for the alarm and control circuits carried to terminal strips in a terminal room across the corridor from the control room. In this room are also located the 120-volt storage battery and the automatic charger for the alarm system.

In the same room with the alarm desk, but entirely independent of it, is the supervisory and control board for the building heating and ventilating systems, the road lighting system and the electrical system.

The centralization of alarms and controls within one room, which by usage has come to be known as the "Control Room," makes it practicable to maintain a trained alarm and control board operator in constant attendance to acknowledge promptly alarms arising out of all sorts of irregular conditions, to inform the responsible operating personnel concerning the alarms and, in general, to act as a clearing center for building operation information.

**THE AUTHOR:** A. F. LEYDEN, after receiving the degree of B.S. in E.E. from New York University in 1922, entered the electrical engineering group of the Plant Department. In 1924 he became head of that group, and two years later took charge of the design and installation of the power room facilities necessary for the new Section H. After a period devoted to revision of shop order handling and office scheduling procedures, he assumed charge of the plant construction group in 1929. In 1931 he acted as Laboratories representative in connection with the New York Central Railroad alteration project through the West Street building, and performed special engineering assignments for the consolidation move of the Department of Development and Research of the A T & T in 1934. He then took charge of the plant operation engineering work, and in 1939 was transferred to the Murray Hill Project as Assistant Construction Engineer—Mechanical, later being

one of two engineers handling occupancy engineering for the entire group of Murray Hill buildings. Upon completion of the occupancy, he transferred back to the Plant Department as Superintendent of Plant Operation at Murray Hill and last April became Plant Operation Manager.



November 1946



W. J. KING  
Transmission  
Apparatus  
Development

## DETECTING CORONA IN CABLES

Most of the radar systems and many of the communications systems developed by the Laboratories during the war required shielded high-voltage cables for d-c and high-frequency transmission. Space and weight limitations for the systems dictated that the cables be small, light and flexible. This meant that between the conductor and the shield surrounding it, flexible insulation of high dielectric strength was required. Suitable materials were available, but the difficulty was in making sure that the insulation completely filled the space between the conductor and shield. Air has a much lower dielectric strength

than the insulations employed, and if there were air pockets or layers between the conductor and shield, corona would form as a result of the electrical breakdown of the air.

Corona forms wherever the voltage gradient exceeds the dielectric strength of the air. Its formation ionizes the air, and ionized oxygen reacts with most organic substances and rapidly deteriorates them. It can cut through rubber-insulated cable as cleanly as a sharp knife can cut through a piece of soft cheese and almost as quickly. If a rubber-insulated cable is operated at a voltage producing considerable corona in the cable structure, its service life may be measured in minutes. Many other materials used for insulating cables are affected by corona, and although they may not be deteriorated so quickly as rubber, the life of the cable may be shortened considerably. To obtain certain other electrical and mechanical properties required for the cables, it was necessary to use insulating materials which were affected by ionized air, and thus these cables had to be designed and manufactured to be corona-free at their operating voltages.

The susceptibility of a cable-insulating material to attack by corona has no relation to its dielectric strength. A cable operated at a voltage gradient considerably below the dielectric strength of its insulation may be destroyed in a short time by corona. If corona is to be avoided, there must be no interstices at places where the voltage gra-

*Apparatus for corona detection*



dient exceeds the dielectric strength of air. If the conductor is stranded, one of the likely places for corona formation is between the strands and the insulation where the gradient is the highest. Another likely place is at the terminals where the edges of the conductor may cause voltage gradients higher than normal. In designing the cable and connectors, all of these factors were, of course, carefully considered. Since the most likely places of corona formation are within the cable structure, the presence of corona cannot be detected visually. Special testing

band of frequency for detection by the receiver. To prevent outside disturbances from affecting the receiver, the entire circuit is enclosed in a shielded cabinet so that only the corona discharges will be picked up. As shown in the photograph at the head of this article, a control panel at the upper right includes a dial by which the applied voltage is varied and an indicating voltmeter to show the voltage. The loud-speaker with which the disturbance is heard is behind the grating below the control panel.

Difficulties in obtaining corona-free cables and connectors for airplanes are greater because of the lower density of air encountered at high altitudes. The dielectric strength of air decreases rapidly with altitude, as indicated below, and thus while corona might not appear at sea level, it might very well appear at an altitude of forty thousand feet, where the dielectric strength of air is only one-quarter that at sea level. It is necessary, therefore, to carry on the tests at greatly reduced pressures. This is accomplished by including a vacuum pump within the test set and a large bell

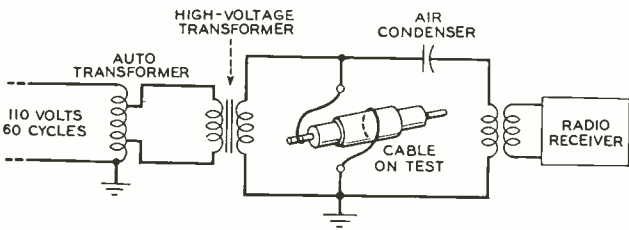

*Simplified diagram of the circuit employed for detecting corona in cables*

apparatus was required not only to guide the development of the cables and connectors, but to test the product after it had been manufactured.

Previous investigations of corona on other apparatus, such as high-voltage transformers, had resulted in a method of testing which, with slight modifications, was found suitable for testing cables. When corona forms, it produces an electrical disturbance similar to the static heard on radio receivers during a lightning storm, and the test equipment was designed to detect and amplify these disturbances. A simplified schematic of the circuit employed is shown above. When the voltage is increased to a value causing corona in the cable, the electrical disturbance is detected by a tuned circuit inductively coupled to a radio receiver. A noise similar to the usual radio static is heard in the loud-speaker of the receiver. The tuned circuit, consisting of an air condenser and an inductance, selects a

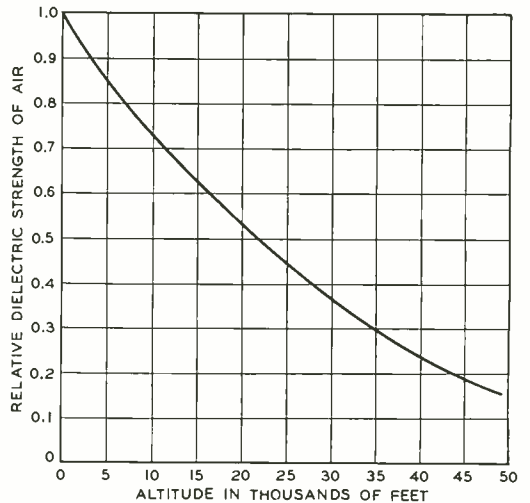

*The relative dielectric strength of air decreases rapidly as the altitude increases*

jar under which the connector or sections of cable for test may be placed. This jar with a connector inside ready for test is shown in the photograph reproduced at the right. The air condenser is evident above and to the rear of the jar, while the inductive coupling that connects to the radio receiver is out of sight at the right.

The detection circuit does not, of course, distinguish between corona formed in the cable under test and corona formed in parts of the test equipment. Precautions are necessary, therefore, to insure that the equipment itself is corona-free to a voltage higher than that at which the cable is tested. The equipment that has been designed for this purpose is corona-free up to 30,000 volts rms.

Similar test equipments were constructed for testing high-voltage cables and terminal assemblies during their manufacture. Hundreds of thousands of these assemblies made by and for the Western Electric Company for radar and communications systems of the Armed Forces were tested to insure that they would not be destroyed by corona in service.

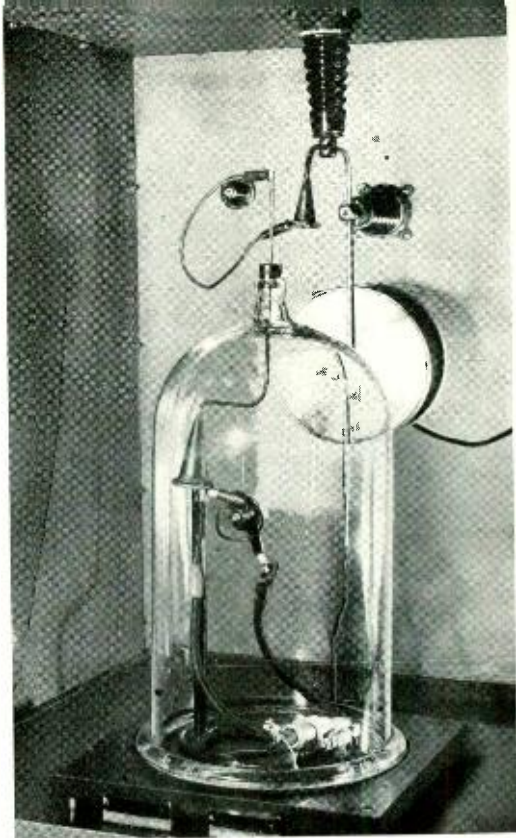

*Interior of test cabinet showing bell jar used for tests at reduced air pressures*



November 1946

**THE AUTHOR:** W. J. KING joined the Laboratories after graduating from Flushing High School in 1934. Beginning as a messenger, he later became a technical assistant and worked on the design and testing of telephone cords. Prior to the war he had begun studying electrical engineering at New York University, and in 1943 he received the degree of B.E.E. The same year he became a member of the Technical Staff. During the war years he worked chiefly on high-voltage cables and connectors for radar apparatus. Some of this work is being continued and carried along with developments of wire and cable for Bell System use.



## NEW FIELD-WIRE LOADING COIL

J. R. BARDSLEY

Transmission  
Apparatus  
Development

To extend the transmission range of Army field wire, loading is often resorted to, and a loading coil enclosed in a plastic case—known as the C-114-A—had been used by the Army in the decade before World War II for maneuvers based on World War I experience. For the fast-moving mobile fighting units of the recent war, long lines of communication had to be rapidly installed, and loading coils have thus been required in far greater quantities and under a wider range of conditions than anticipated. This extensive use soon revealed deficiencies in the existing units, and the Signal Corps Engineering Laboratory asked Bell Telephone Laboratories to develop an improved loading unit.

Two types of field wire are in common use: the W-110B and the newer W-143. The former is twisted pair, while the latter is parallel pair with the rubber insulation bonded where the two wires touch. The over-all diameter of the individual wires of the latter is about five mils less than that of the twisted pair, and where the two wires are torn apart to lead them into the loading unit there is a slightly flattened band along one side where contact has been made with the other wire. It was found with this wire particularly, which is now being more extensively used, that the seal around the wires at the entrance to the loading coil was not very tight, and moisture would enter to give trouble. With this

*The C-426 loading unit consists of an outer aluminum case, an inner molded unit, and two cap assemblies for the entering wires*

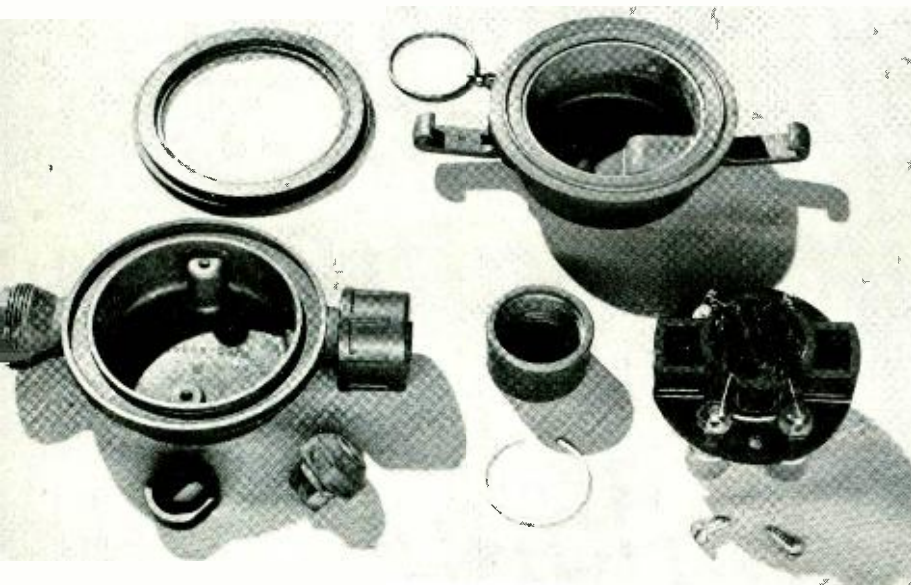

earlier loading coil, sealing was provided by a molded gasket with orifices for the four wire entrances, and pressure, developed when the cover was forced shut by the single trunk-type latch, was relied upon to make the unit tight. Also, the wires tended to pull out when the coils were suspended on the lines between poles, which is commonly done to locate them at the proper loading point.

Designated the C-426, the new loading unit comprises three major assemblies: an outer casing of die-cast aluminum, an inner molded phenolic unit comprising the loading coil and the binding posts, and two cap assemblies to seal the wires at their entering points. These assemblies are shown on the opposite page. The caps are of die cast aluminum, and screw over threads on the

On its under side, the inner phenolic assembly includes a cylindrical cavity into which the loading coil is sealed, and a thin sheet of molded insulation, not shown in the illustration, is placed between the sealed end of this opening and the bottom of the housing. Leads from the coil are fastened to four binding posts which project through the top of the inner assembly. On the two sides where the wires enter, this inner unit is provided with stiffening webs and a bearing surface through which the pull of the wires is transmitted to the outer housing. The upper surface with this bracing flange slopes down from the binding posts to the entrance holes to give easy access to the wires as shown below. This assembly is fastened to the bottom of the outer case by two screws, and is not removed



*A loading unit with cover removed showing method of fastening wires*

main housing. The wires pass through a rubber bushing coned at one end to fit a similar cone on the end of the housing. On the end of the bushing opposite the cone fits a molded phenolic ferrule through which pressure from the cap is applied to the bushing. Besides distributing the pressure over a wide area of the bushing, this ferrule prevents the bushing from extruding along the wires, and helps apply pressure around the wires at the inner ends. After the caps have been screwed tight, a lock-ring is snapped in place to prevent the cap from being inadvertently backed off and lost in the field.

in disconnecting or connecting the unit.

Around the top of the rim of the bottom half of the casing is a rectangular slot in which is placed a rubber gasket in the form of a flat T that fits into the slot and overlaps it on both sides. The upper half of the case has a small V-shaped annular ridge that bears on the gasket just above the middle of the T. When the cover is locked on with the two latches, this V-ring compresses the gasket and makes a tight seal. Cases have been tested, employing various types of field wire, by submerging them in water for several weeks with no indication of water seeping into the case.

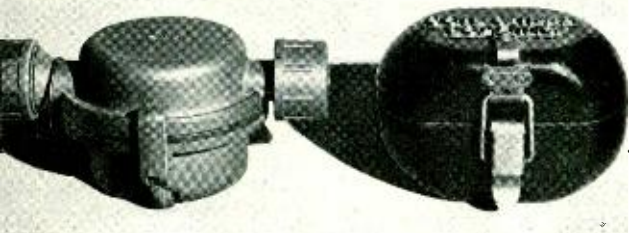
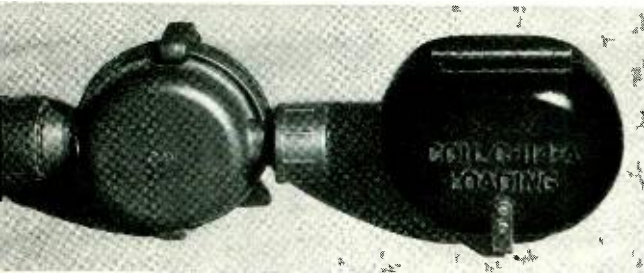

*The new C-426 loading unit, at the left, and the C-114-A that it replaces*

To install one of these coils, the wires from each side are pushed through the cap and then threaded through the ferrule and bushing and the two holes in the bottom half of the casing, and the cap is screwed on just far enough to hold it in place. The ends of the wires are then inserted in side slots of the binding posts, and when the

heads of the posts are screwed down, a pin pierces the insulation and makes contact with the wire itself. The wire is snubbed around the post and tightened by pulling from the outside. After this, the two caps are screwed firmly in place. With the cover now clamped in place, the entire unit is tightly sealed and the wires firmly held. They will not pull out with tension, almost to the breaking point.

The original C-114-A unit included an 88-millihenry loading coil, but the Army asked that a 44-mh coil be employed with the new unit. This permits a standard Western Electric coil to be used, and makes the location of the coils in the line less critical. When C-426 coils are installed at one-mile intervals in W-110B wire, they will boost the voice-frequency transmission range under wet weather conditions from about 12 miles to approximately 20 miles and to about 27 miles under dry conditions. When they are installed at  $\frac{1}{2}$ -mile intervals in W-143 wire, the voice range is increased from about 23 miles to approximately 70 miles under wet weather conditions and approximately 75 miles under dry weather. The appearance of the old and new coils is shown at the left. A slight decrease is obtained with the new coil in both size and weight, but the chief advantage is the tighter seal and more firmly held wires.

**THE AUTHOR:** J. R. BARDSLEY joined the Apparatus Drafting Department in 1919 where he later served as a group supervisor. In 1924 he graduated from the Technical Assistants' course, and the following year transferred to the Apparatus Specification Department, where he engaged chiefly in the preparation of loading coil case specifications. After two years with this department, he became associated with the group developing retardation and loading coils, and in 1928 transferred to the group developing loading coil cases—at this time actively engaged in the development of welded cases. In the years prior to the war he was associated with the development of welded steel cases for submarine applications, and continued similar work for war applications, one development being the loading described in this issue.





## MEDAL FOR MERIT TO DR. BUCKLEY



Highest civilian award, the Medal for Merit, has been conferred by President Truman on Oliver E. Buckley, president of the Laboratories, and on Clarence G. Stoll, President of Western Electric. Presentation to Dr. Buckley was made at West Street on September 26 by Major General Harry C. Ingles, Chief Signal Officer of the Army; the citation was read by Colonel Grant Williams, Signal Officer, First Army. Guests of honor were Major General William H. Harrison and Brigadier General Carroll O. Bickelhaupt, Vice Presidents of A T & T.

Responding, Dr. Buckley said:

It is with a deep sense of humility that I accept this award, for no one knows better than I that it comes, not because of the little I was able to do, but because of the accomplishments of the others who make up this great organization. No medals nor any system of awards that could be devised could ever serve to give appropriate individual credits to those in our group who most deserve them—men and women throughout the Laboratories, in all departments. There was self-sacrificing devotion to duty in the laboratory as well as in the field. All of us here, whose assignments required us to remain at home and in safety, were well aware of the sacrifice others were making in our behalf, and we were spurred by this knowledge to do our utmost in providing tools for them to use.

The secret communication system cited in the award was certainly one of the outstanding technical achievements which it was the privilege of the Laboratories to contribute to the war, but like all our other contributions it was the product not of any individual but of a team supported by the efforts of all who worked here.

So it is with great pride in the group which it is my privilege to represent that I accept

this medal. There is an added pleasure in receiving it from your hands, General Ingles, not only because you are Chief Signal Officer of the United States Army, but also because of my personal esteem for you. I am honored, too, by the presence of General Harrison and General Bickelhaupt who, by their distinguished service in the Signal Corps, brought credit to the whole Bell System. Bell Telephone Laboratories, by the very nature of its activities, has a bond of common interest with the Signal Corps, a bond which has been strengthened by close personal association, not limited to the period of the war. I have, too, a special pride in the Signal Corps because of my service in it during World War I.

I am deeply indebted to you, General Ingles, for coming here to present this medal which is esteemed so highly, and wish to assure you that we will ever continue in our endeavor to serve the Nation and to contribute our best to the service which you represent.

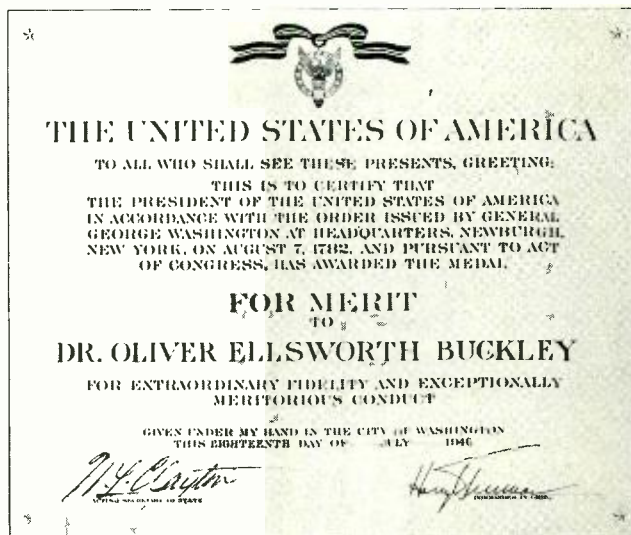

## "Picao" at Indianapolis

Western Electric airborne teletypewriter equipment and the Bell System radio-telephone system were demonstrated at Indianapolis during the fortnight from October 9 to 23 for the benefit of 120 delegates from some thirty-eight countries belonging to the Provisional International Civil Aviation Organization. This international group is undertaking to determine the most satisfactory instrumentalities for facilitating world-wide aviation. Once decisions are reached, it is planned to have standardized facilities adopted by all the participating countries so as not to seriously handicap commercial planes flying transnational routes by requiring them to be equipped with different navigational aids for each country to which they fly.

Sponsored by the Civil Aeronautics Administration with the coöperation of the State Department, the Army, the Navy, the Coast Guard, and the American Aeronautical Radio Industry, the Indianapolis program was held at the headquarters of the C.A.A.'s Technical Development Service at the Municipal Airport. The Western Electric aircraft teletypewriter system includes a lightweight teletype machine developed by the Teletype Corporation and a small

*Harvey Fletcher as he spoke on "The Science of Hearing" during the New York Philharmonic Symphony Program, sponsored by the United States Rubber Company, on the CBS network, October 6*



*Al Wilson in plane equipped for teletypewriter and telephone service*

size lightweight converter-control unit developed by the Laboratories. This system, described on page 396, was demonstrated by Al Wilson and the mobile radio-telephone system by Walter Hunter, both of the Laboratories. In the capacity of official observers at the demonstration were D. K. Martin of these Laboratories and F. C. McMullen, Radio Division, Western Electric.

Guests of the exhibit had arrived a few days earlier from a similar demonstration of British apparatus held in England from September 9 to 30. The delegates convened in Montreal on October 30 to determine which of the air navigational systems they have seen in operation will be specified for international adoption.

According to the program that was laid out, all the delegates spent twenty-four hours in the air besides attending ground demonstrations and lectures. During this period they had an opportunity to use the teletypewriter and radio-telephone system as well as to study the operation of the other navigational aids demonstrated.

## Drafting and Shop Training Program

The General Employment Department has resumed classroom instruction for young veterans whose training in the Drafting Assistant and Junior Mechanic Courses was interrupted when they entered the Armed Services. All such former students

November 1946

were invited to take advantage of this opportunity to complete their training and forty-seven have enrolled. This number includes thirty-one from Research, Apparatus Development, Commercial Products Development, Systems Development, and Patent drafting rooms, and sixteen from the Development Shops Department.

The courses cover topics in drafting, materials and processes, mathematics, and mechanical and electrical theory and practice which would serve as directly applicable or useful background knowledge in the drafting rooms and development shops. Classroom instruction is supervised by R. C. Fremon, who is assisted by J. A. Seifert and W. G. Stephens.

In addition to the classroom instruction, which began on September 3, the Development Shops Department resumed the formal shop training of each former Junior Mechanic upon his reinstatement. Under close guidance of supervision, the men acquire experience in the various development shop operations. Shop training is under the general supervision of G. Scott, who is assisted by A. S. Lawrence.

*Award presented to Colonel Engelberg with the citation "as Air Communications Officer, Oklahoma City Air Technical Service Command, your performance of duty was marked by thorough professional skill, unhesitating willingness to assume heavy responsibilities and unquestionable loyalty to the war effort, reflecting highest credit upon yourself and the Army Air Forces"*

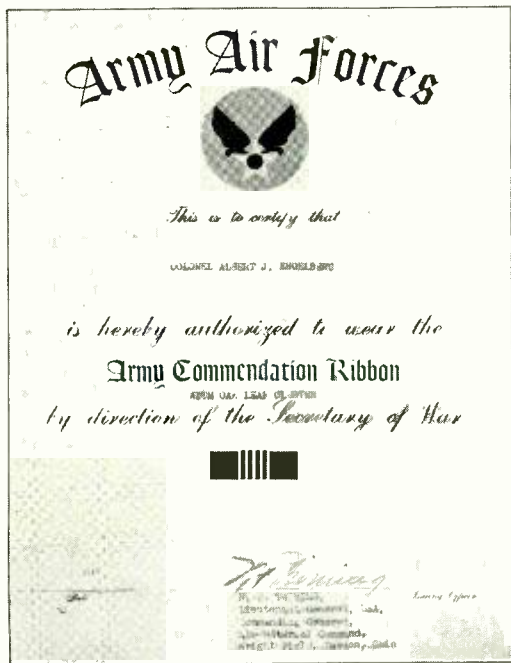

## Engagements

L. Bruce Boutillette—\*Betty Buser  
 Jerome P. Bugger, U. S. Army—\*Marion Leary  
 James Callas—\*Penelope Zografos  
 Gilbert J. Carr—\*Jean Kackenmester  
 Carmine M. Chisano—\*Rose Sena  
 William E. Flood—\*Margaret Frost  
 Alfred Force—\*Jean Nally  
 John J. Freeman—\*Helen Powers  
 John M. Gibson—\*Ann Teoli  
 H. Stanley Hansen—\*Josephine Capozzoli  
 \*John W. Kittner, Jr.—Evelyn Boise  
 \*Francis L. Kossuth—\*Muriel Cadmus  
 Daniel Lawlor—\*Mechalina De Meo  
 Richard D. Lewis, U. S. Navy—\*Barbara Losey  
 \*Edward J. Moskal—\*Eve Prodomides  
 William Ricciardella—\*Rosella Reibel  
 Herbert Taylor, U. S. Army—\*Verna Nichols  
 James Williams—\*Helen Callaghan

## Weddings

John H. Eick—\*Marie Teschner  
 William R. Grace—\*Marie Fletcher  
 Rudolph F. Mathias—\*Charlotte Schandolph  
 Harold J. McKay—\*Rose Mary Curran  
 Robert L. Powell—\*Catherine Ridner  
 Louis F. Tremallo—\*Ann Schindo

\*Members of the Laboratories. Notices of engagements and weddings should be given to Mrs. Helen McLoughlin, Room 803C, 14th St., Extension 296.

## Manfred Brotherton Author of New Book

Manfred Brotherton of Publication is the author of a new book on *Capacitors* which was recently published by D. Van Nostrand as part of the Laboratories series of scientific and engineering texts. The book presents, in streamlined form, the essential knowledge necessary to a circuit designer on the use of capacitors in electronic circuits, and provides him with an understanding of capacitor problems. Dr. Brotherton wrote the book while he was a member of Apparatus Development.

## News Notes

D. A. QUARLES and R. J. HEFFNER attended the general assembly of Telephone Pioneers in Cleveland from September 18 to 20.

G. D. EDWARDS spoke on *Possible American Society Contributions to the Advancement of Quality Control* before the Society of Quality Control Engineers in Buffalo and Iowa Society for Quality Control in Waterloo.



A. G. GANZ was guest speaker at the opening meeting of the Berkshire Society of Metals at Pittsfield, Mass. The subject of his discussion was *Thin Nickel-Iron Alloy Tapes, Their Properties and Uses*.



*This microwave radio station at Barnstable on Cape Cod provides eight channels between there and Nantucket*

R. G. McCURDY and A. J. CHRISTOPHER investigated the Bosch machinery at Hawthorne for lacquering and metallizing condenser paper and also discussed other transmission apparatus problems.

P. S. DARNELL attended an RMA committee meeting on power-type resistors and rheostats. Mr. Darnell and A. H. SCHAEFER visited the International Resistor Company in Philadelphia to discuss resistors.

S. G. HALE was at Winston-Salem, N. C., in connection with the manufacturing of choke coils employed with the M-1 carrier system.

R. J. WILLIAMS and H. A. STONE visited Haverhill, Mass., for conferences on the development of 274-type retardation coils.

D. E. CAVENAUGH conferred with the Power Equipment Company on the manufacture of power coils for the radio relay system.

R. A. HECHT visited the Eby Manufacturing Company in Philadelphia in connection with multi-contact connectors.

D. G. BLATTNER and J. F. BALDWIN, at Hawthorne, discussed the manufacture of terminal strips.

B. B. MANN visited the Buffalo central offices in connection with the treatment of panel banks to eliminate noise.

W. H. MARTIN, W. B. SNOW and C. F. WIEBUSCH attended a symposium of the Navy Department in Washington.

H. I. BEARDSLEY, C. A. JOHNSON and A. F. BENNETT were at the Archer Avenue plant of the Western Electric Company in Chicago during September.

D. W. MATHISON witnessed field trials of coin collector apparatus in Norfolk and Baltimore, and L. T. HOLDEN discussed coin chutes at Archer Avenue in Chicago.

H. ECKHARDT was chosen sub-chairman for Murray Hill at the Camera Club's first post-war meeting. He will be assisted by L. E. CHEESMAN, M. B. GARDNER, R. L. HANSON, S. K. HARVEY, A. N. HEARN, R. S. KENNEDY and N. R. PAPE.

R. M. BURNS has been appointed a member of Princeton's Advisory Council of the Department of Chemistry and of the Plastics Program.

K. G. COMPTON spoke on *The Selection of Protective Coatings* on September 11 at the Engineers' Club in Dayton.

LABORATORIES members who attended the American Chemical Society meetings in Chicago included D. A. McLEAN, C. S. FULLER and F. H. WINSLOW.

W. H. DOHERTY selected *Some Recent Developments in FM* as the topic for his talk at the Deal-Holmdel Colloquium of October 4 which was held at Holmdel.

A REVIEW OF *Quartz Crystals for Electrical Circuits*, R. A. Heising's new book, was published in the September, 1946, *Proceedings of the I.R.E.*

S. A. SCHELKUNOFF is giving a graduate course, *Electromagnetic Waves*, on Monday evenings at the College of Engineering Electrical Engineering Department, New York University.

J. E. KARLIN attended the annual meeting of the American Psychological Association on September 4 and 5 in Philadelphia.

## November Service Anniversaries of Members of the Laboratories

	40 years	R. C. Kamphausen	C. R. Meissner	J. M. Dunham	10 years
H. H. Hall		J. P. Maxfield	T. D. Robb	J. J. Halligan	Ruth Ammons
E. F. Ketcham		P. C. Seeger	J. W. Van De Water	Frederick Keeling	N. H. Anderson
W. V. Thompson		Il. B. Smith	John Whytock	Burton McKim	D. F. Cuneo
			W. H. S. Youry	William McMahan	M. J. Doody
	35 years			G. P. Spindler	A. F. Hofmann
William Bodenstedt				William Wissel	D. F. Hoth
G. H. Stevenson	25 years		20 years	E. E. Wright	H. E. Vaiden
		Joseph Bell	E. W. Anderson		J. M. Weitovich
		A. F. Grenell	W. S. Bishop	15 years	
	30 years	Fay Iloffman	Frank Cowan	R. J. Philipps	
J. J. Collins		E. W. Kane			

O. E. BUCKLEY was in Minneapolis on September 20, where he visited the Northwestern Bell Telephone Company. Glenn L. Allen, Vice President and General Manager of the Minnesota Area, gave a luncheon in honor of Dr. Buckley at which were present a group of telephone officials and representatives of Western Electric, General Mills, and the University of Minnesota. Dr. Buckley addressed the luncheon group, and in the afternoon visited the research laboratories of General Mills, Inc.

O. E. BUCKLEY and RALPH BOWN visited Cornell University on September 13. Through the courtesy of Dean S. C. Hollister and Professor Charles R. Burrows, formerly a member of the technical staff of the Laboratories and now head of the Electrical Engineering Department at Cornell, they inspected new equipment and discussed recent progress.

DR. BUCKLEY attended the Bell System President's Conference at Absecon, N. J.

R. M. BURNS gave a lecture demonstration before 100 members of the American Ceramics Society in Trenton, New Jersey, on *Ceramics in Communications Engineering*.

R. K. HONAMAN addressed 800 members and guests of the Western Electric Company Hawthorne Science Club in the Albright Gymnasium at Hawthorne, October 3, on *What's Happening in the Bell Telephone Laboratories*. His talk was illustrated by demonstrations of microwave phenomena, the bolometer and other equipments.

HENRY KOSTKOS assisted Mr. Burns and Mr. Honaman, arranging and operating the demonstration equipment.

M. S. RICHARDSON has been appointed a member and secretary of the A.S.A. Committee on Acoustical Terminology.

J. B. DIXON discussed wire and wiring accessory problems with suppliers at Cleveland and Portsmouth, Ohio.

C. C. LAWSON and W. S. BISHOP conferred on wire development at Point Breeze.

G. R. YENZER went to Burlington, N. C., in connection with testing recorders.

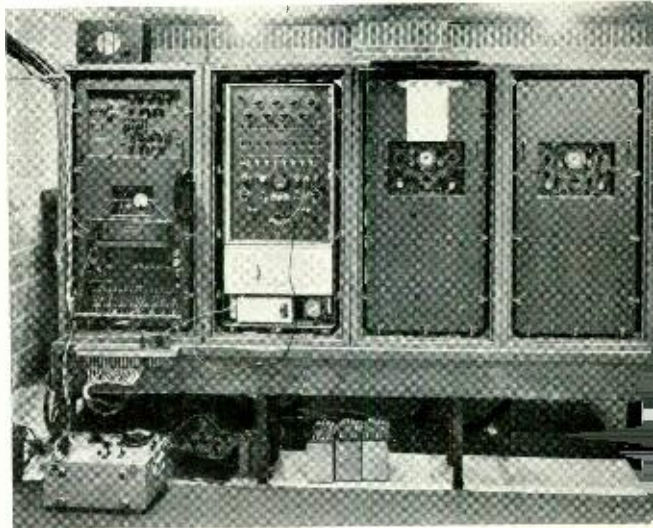

*Equipment panels at the Barnstable terminal of the Barnstable-Nantucket microwave radio link*

MARY CASEY, MARGARET SWEENEY, MARGARET MOORE and GLEN WHITFIELD assisted in training local personnel at the Western Electric Radio Shops in Winston-Salem and Burlington, N. C., in the operation of the joint Laboratories and Radio Shops Files.



A. F. SCHWEIZER



F. A. KUNTZ

### Golf Tournament

The Long Island Golf Tournament, sponsored by Bell Laboratories Club, was held at Bethpage State Park "Red Course" on September 28. Players were divided into three classes. In Class A low gross were H. M. Yates and A. E. Hague; kicker, S. Brand; in Class B low gross were H. L. Downing and S. E. Miller, and kickers, C. Slausson, R. D. Fracassi and W. F. Malone; in Class C low gross were L. G. Willbigg and W. D. Stratton; kickers, C. Maggs, H. W. Everett and L. W. Drenkard.

### News Notes

J. R. ERICKSON and D. R. POPE in Chicago supervised the erection of a demountable soundproof room which was moved from Murray Hill to the Archer Avenue Plant.

R. R. STEVENS and G. F. SCHMIDT conferred on coin collector problems at Hawthorne. F. L. CRUTCHFIELD, at Hawthorne, discussed receiver production problems.

F. F. ROMANOW and H. F. HOPKINS attended a meeting of the Executive Committee of the Sound Equipment Section, Radio Manufacturers' Association, at Chicago.

G. J. V. FALEY conferred on hearing aid problems in Burlington, N. C., and on magnetic problems in Charlotte, N. C.

J. M. ROGIE and T. H. CRABTREE visited the International Resistance Company in Philadelphia to confer on volume controls and switches for use in hearing aid sets.

T. H. CRABTREE went to the Sprague Electric Company, North Adams, Mass., to discuss matters regarding paper condensers.

H. F. HOPKINS visited the Hawley Products Company in St. Charles, Ill., to confer on diaphragm problems.

V. T. BOHMAN, at Hawthorne, discussed step-by-step apparatus; C. C. BARBER and F. J. REDMOND, crossbar switches; H. H. GLENN and N. INSLEY, wire, switchboard lamps and lamp caps.

R. A. SYKES discussed with manufacturers at Carlisle, Pa., plans for specifications for crystal designs in connection with the R.M.A. Standardization of Components.

J. H. BOWER called on R. P. Mallory, Inc., North Tarrytown, N. Y., in connection with mercury type dry batteries.

J. O. McNALLY presented a paper *Reflex Oscillators for Radar Systems* before the Connecticut Valley Section of the I.R.E. at a meeting held in New Haven on September 28. W. G. SHEPHERD was co-author.

C. H. ACHENBACH, D. E. TRUCKSESS and I. V. WILLIAMS participated in a foreign aeronautical equipment symposium held September 9 to 13 at Wright Field.

W. H. BENDERNAGEL discussed trial equipment at the Albany 3 step-by-step office with F. Jones of the New York Company.

G. E. AKIN visited the Hugh H. Eby Company in Philadelphia in regard to trial equipment for the No. 5 crossbar system.

### "The Telephone Hour"

NBC, Monday Nights, 9:00 p.m.

November 4	<i>Maggie Teyte</i>
November 11	<i>Jascha Heifetz</i>
November 18	<i>Ezio Pinza</i>
November 25	<i>Nelson Eddy*</i>
December 2	<i>Marian Anderson</i>

\*From Hollywood.



J. K. MILLS' trip to the Superior Electric Company at Bristol, Conn., concerned voltage regulators.

P. W. SHEATSLEY went to Washington for conferences on the trial installation equipment in the Georgia Office.

M. F. FITZPATRICK visited Baltimore and Philadelphia in connection with a multi-frequency signaling system for toll offices.

R. R. GAY discussed rectifiers for radio relay systems on his recent visit to the Power Equipment Company in Detroit, Michigan.

A PAPER entitled *A Multi-Channel Microwave Radio Relay System*, by H. S. BLACK, J. W. BEYER, T. J. GRIESER and F. A. POLKINGHORN, was presented on October 10 at the Great Lakes District meeting of the A.I.E.E. in Indianapolis by Mr. Black.

J. O. McNALLY and W. G. SHEPHERD; *Generalized Boundary Conditions in Electromagnetic Problems*, by S. A. SCHELKUNOFF; and *Cathode-Ray Oscilloscope as a Research Tool*, by W. L. GAINES.

R. E. CRANE visited the Long Lines office in Philadelphia to participate in an inspection of the coaxial terminal equipment.

G. R. FRANTZ and G. W. ATKINS, on September 15, supervised the last of a series of experimental transmission of television pictures with the new type TE radio system in Hollywood.

R. P. ASHBAUGH at the Plastic Wire and Cable Company, Jewett City, Conn., witnessed the extrusion of plastic jackets on experimental cables, in connection with the development of a composite sheath.

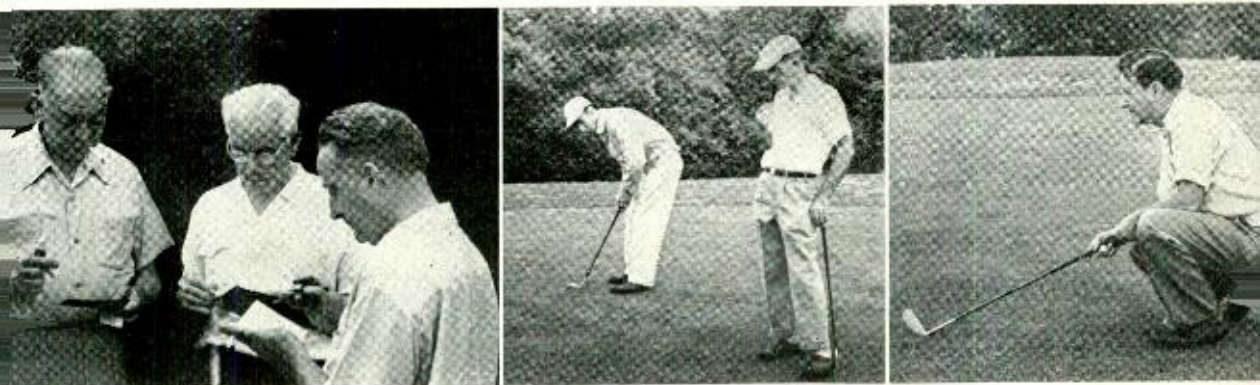

CRAWFORD, L. N. HAMPTON, R. S. NEWSHAM R. D. FRACASSI, D. K. GANNETT

W. A. MALONE

H. M. SPICER's and G. W. MESZAROS' trips to Jacksonville, Florida, and to Waycross and Chauncey, Georgia, concerned equipment for type-L carrier-power supply.

J. M. EGLIN, J. L. LINDNER, L. W. MORRISON and R. S. TUCKER visited the Columbia Broadcasting Corporation in connection with problems of wire transmission encountered with color television.

PAPERS PRESENTED by Laboratories men at the National Electronics Conference held from October 3 to 5 in Chicago were: *Radio Propagation at Frequencies Above 30 Megacycles*, by K. BULLINGTON; *Interference Between Very-High Frequency Radio Communication Circuits*, by W. R. YOUNG, Jr.; *Reflex Oscillators for Radar Systems*, by

G. Q. LUMSDEN, J. LEUTRITZ, JR., and representatives of Western Electric Supplies Inspection Department, at suppliers' plants in the South, inaugurated new methods developed at the Laboratories for the control of copper naphthenate-petroleum-cresote solutions for pressure treatment of pine pole.

R. H. COLLEY conferred with representatives of the Bureau of Plant Industry, U. S. Department of Agriculture, and with those of the American Wood-Preservers' Association in Washington on treatment specifications and methods of evaluating various wood preservatives.

A. H. HEARN cooperated with a supplier at Nashua, New Hampshire, on the treatment of Douglas fir poles.

THE LABORATORIES were represented in interference proceedings at the Patent Office by R. T. HOLCOMB.

MARTHA G. PUGH appeared before the Board of Appeals at the Patent Office, relative to an application for patent.

H. A. FLAMMER was at the Patent Office in Washington during September.

WILLIAM WILSON, who retired from the Laboratories in 1942, is now a professor in the Physics Department of North Carolina State College, Raleigh, N. C.

C. J. DAVISSON and K. K. DARROW attended the Bicentennial Conference on the *Future of Nuclear Science* held September 23 to 25 at Princeton University.

HARVEY FLETCHER and W. S. GORTON attended the American Physical Society meetings on September 19 and 20 in New York.

IN ATTENDANCE at the closing dinner and public session of a Conference on Engineering and Human Affairs sponsored by Princeton University were P. B. FINDLEY and R. M. BURNS.

G. T. KOHMAN and D. A. McLEAN conferred on capacitors at Hawthorne. Mr. Kohman also discussed contact noise studies in progress in the Superior exchange.

## A.S.A. War Committees Honored

Thirty-five members of the Laboratories are among the engineers who have been honored by the American Standards Association for their service on the Association's War Committees. In the words of the certificate, their effort toward "simplification of products, interchangeability of repair parts, better procedures for subcontracting, higher standards of manufacture . . . resulted in the saving of time, money and material, and contributed to the victory."

Those who received the certificate of award were:

C. H. Amadon	H. H. Glenn
W. A. Bischoff	R. M. C. Greenidge
J. H. Bower	W. L. Heard
D. R. Brobst	C. D. Hocker
C. J. Christensen	W. H. Lichtenberger
A. J. Christopher	D. K. Martin
R. H. Colley	C. R. McIver
K. G. Coutlee	F. T. Meyer
A. I. Crawford	B. H. Nordstrom
P. S. Darnell	W. Orvis
A. W. Dashke	C. Schneider
H. F. Dodge	G. M. Thurston
E. C. Erickson	D. E. Trucksess
W. A. Evans	R. S. Tucker
I. E. Fair	C. W. Van Duyne
H. B. Fischer	A. H. Volz
F. J. Given	W. A. Yager
W. H. S. Youry	

## YOU — and Santa Claus

Last year YOU made Christmas brighter for 3,000 sick and underprivileged boys and girls in 55 hospitals and social organizations.

"I am sure that you all realize how much happiness you have brought into the lives of these children, and in some cases provided the only genuine toys that they have ever had. They send their heartiest thanks and appreciation."—City Hospital.

"Each year we open your box we are impressed with the lovely things that you give us for our children. The dolls are always so beautifully dressed; the toys have all made our children very happy, and continues their belief that there is a Santa Claus."—Hopewell Society.

Representatives of the Doll and Toy Committee are asking you to participate again this year by contributing a doll, a toy, or your talent in dressing one of the dolls or a gift of money so the committee can buy additional toys and games.

If no one contacts you, a telephone call will bring someone to take your contribution:

West Street, Ida Wiberg, Extension 644; Murray Hill, Marie Wright, Extension 527; Whippany, Harriet Filmer, Extension 103.

A. R. KEMP discussed rubber development and manufacturing problems with rubber chemists at the B. F. Goodrich Company, Akron. He also attended a convention of the Rubber Division of the American Chemical Society in Chicago.

C. S. FULLER while in Chicago discussed plastics problems with Western Electric engineers. Mr. Fuller was also in Baltimore, where he addressed the Maryland Section of the A.C.S. on *Interpretation of the Properties of Thermoplastics*.

A. C. BECK and D. H. RING spoke on *Testing Repeaters With Recirculated Pulses* at the meeting, held in Red Bank on September 18, of the Monmouth County Subsection of the I.R.E. New York Section.

W. F. JANSSEN, at Stupakoff Ceramic and Manufacturing Company in Latrobe, Pa., discussed metal ceramic seals.

F. D. LEAMER attended the 21st Annual Rutgers Industrial Conference on September 12 in New Brunswick.

### Obituaries

Mrs. Elizabeth M. Ablett of the Plant Operation Department died on September 16. From 1919 to 1922 Mrs. Ablett was with the New York Telephone Company as a telephone operator. Late in 1942 she joined the Laboratories as a matron, working successively at West Street, Chambers Street, Graybar-Varick and Davis buildings. She had been ill since last July.

James E. Kelly of the General Service Department died on September 23. Mr. Kelly joined the Western Electric Company



J. E. KELLY  
1889-1946

W. H. WILLIAMS  
1880-1946

as an inspector in the Raw Material Inspection Department in 1911. When the Manufacturing Department moved to Hawthorne in 1913, he became a group inspector and two years later was made a section head in charge of all sheet metals, insulating materials, rod and tube stock and similar materials. Wartime activity was responsible for his return to West Street in 1918, when he was placed in charge of the Raw Material Department. In 1925 the Receiving Department was placed under his charge. The responsibility of this department remained with him until about three years ago when he was absent for a year due to sickness. When Mr. Kelly returned to work, he became associated with the Traffic Office, where, along with special assignments of general traffic problems, he was responsible for securing the proper authorization for all shipments.

William H. Williams, who retired in 1944 because of disability after eighteen years of service, died on August 31. Mr. Williams joined the Building Shop of the Laboratories in 1926. In 1932 he transferred to the Development Shops, where he repaired electric soldering irons until 1934, when he became a delivery man for the Receiving Department. From 1936 to the time of his retirement, he was a cleaner and freight elevator operator in the Plant Operation Department.

Nicholas Flynn of the Plant Operation Department died on October 3. Mr. Flynn retired on January 1 of this year and a biography of him appeared on page 79 of the February RECORD.



NICHOLAS FLYNN  
1880-1946

MRS. E. M. ABLETT  
1896-1946





C. J. DAVISSON

J. W. FOLEY

T. C. CRUGER

R. J. PODEYN

H. C. DIEFFENBACH

## Retirements

Recent retirements from the Laboratories include A. L. FOX, with 40 years of service; GEORGE RUPP, 40 years; T. C. CRUGER, 38 years; H. C. DIEFFENBACH, 38 years; H. H. GLENN, 37 years; MARTIN WHITE, 37 years; J. W. FOLEY, 35 years; JOHN BANE, 34 years; R. J. PODEYN, 31 years; and C. J. DAVISSON, 29 years.

### CLINTON J. DAVISSON

Dr. Davisson, in 1937 Nobel Laureate in Physics for his investigations which gave the first direct proof of the undulatory properties of matter, entered the Research Department of the Western Electric Company in 1917. Shortly thereafter he began his research work on thermionics, thermal radiation and electron scattering. The investigations on scattering, in which he was ably assisted by L. H. Germer, led eventually to the discovery and demonstration of the fact that under certain conditions electrons behave as beams of waves might be expected to behave. In recognition of this discovery, Dr. Davisson was awarded the Comstock Prize of the National Academy of Sciences in 1928, the Elliott Cresson Medal of The Franklin Institute in 1931, the Hughes Medal of the Royal Society (London) in 1935, the Nobel Prize in Physics in 1937, and the Alumni Medal of the University of Chicago in 1941. He also has received honorary degrees from Purdue, Princeton, the University of Lyon (France) and Colby.

From 1930 to 1937 Dr. Davisson devoted his studies to the theory of electron optics and to applications of this theory to engineering problems. He then investigated the scattering and reflection of very slow electrons by metals and, during the war, worked on the theory of electron devices for the Armed Forces.

Dr. Davisson received a B.S. degree from the University of Chicago in 1908. In 1910 he was awarded a Fellowship in Physics at Princeton, where he was an instructor, and during that school year completed requirements for the degree of Ph.D., which he received in

1911. For the next six years he was an instructor at the Carnegie Institute of Technology.

### ARTHUR L. FOX

On receiving his M.E. degree from Ohio State in 1906, Mr. Fox, Plant Systems Engineer, immediately entered the Plant Engineering Department of the New York Telephone Company. When the Company took over the upstate territory in 1909, Mr. Fox became Division Plant Engineer of the Central Division at Syracuse and then of the Western Division at Buffalo. In 1920 he went to Albany as Division Engineer in charge of both outside plant and equipment. He then returned to New York in 1925 as Engineer of Outside Plant.

In 1927 Mr. Fox joined the D & R as Assistant Outside Plant Development Engineer; and when this department was consolidated with the Laboratories in 1934, he became Plant Systems Engineer. He has been responsible for developing new outside plant systems involving open-wire lines for broadband transmission and systems of construction of aerial and underground cable lines, making many valuable contributions in these fields.

### HOWARD H. GLENN

After receiving the degree of B.S. in E.E. from Penn State in 1909, Mr. Glenn of Transmission Apparatus Development immediately joined the Western Electric Company at Hawthorne, where he took the student training course. The following year he transferred to the Physical Laboratory in New York, where he worked on the development of cords, wire and switchboard cables. He was placed in charge of this work in 1920. Air-conditioning development work was added to his responsibilities in 1924, and lamps, lamp caps, batteries and sealed terminals in 1940. During this time Mr. Glenn actively participated in many outstanding developments, including purified textile insulation, cellulose acetate treatment of wires, solderless cord tips, greatly improved cord designs, and lightweight high-voltage connectors and interconnecting cables for aircraft radar equipments.



H. H. GLENN

A. L. FOX

GEORGE RUPP

MARTIN WHITE

JOHN BANE

**JOHN W. FOLEY**

Upon receiving the degree of B.S. in E.E. from the University of Illinois in 1911, Mr. Foley of Transmission Engineering immediately joined the Western Electric Company at Hawthorne. Upon the completion of the student training course, he entered the Transmission Laboratory at New York. His work soon became centered upon telephone sets and their associated circuits. He has been intimately connected with the development of the anti-sidetone telephone sets now standard for both subscribers and operators as well as many sets for special purposes such as train dispatching, amplifier sets for the hard of hearing, and loud-speaker systems for both intercommunicating and regular telephones. More recently he has participated in the development of closed-core induction coils for operator and subscriber sets, and of acoustic shock prevention devices.

**GEORGE RUPP**

Mr. Rupp joined the Western Electric Company in 1906 as a pipefitter. In 1919 he was made supervisor in charge of the pipefitter group. Later other groups of mechanics were added to his responsibilities, and in 1936 he was placed in complete charge of the Building Shop of the Plant Operations Department as General Foreman.

**JOHN BANE**

Mr. Bane joined the Plant Department of the Western Electric Company in 1912 as a fireman. At this time all steam for power and heating purposes for the West Street building was generated in its own power plant, and "Jack" had the reputation of always being able to keep the steam pressure up. In 1923, when the generation of power was discontinued, he became engaged in maintaining all of the boiler room equipment.

**MARTIN WHITE**

Mr. White joined the Plant Department of the Western Electric Company in 1909. "Martin's" first assignment was as a watchman at the "annex" building occupied by the Western

Electric Company and located on the south side of Bank Street. During the period the Shops were being moved to Chicago, Martin was in charge of the porter group. Later he was assigned as usher at the main entrance of the West Street building.

**HARRY C. DIEFFENBACH**

Mr. Dieffenbach joined the Western Electric Company in 1906 as a draftsman. He left the Company in 1910, returning the next year. In 1919 he transferred to the panel apparatus group where he was concerned with the design and development of relays until 1929, when he joined the system's drafting group of Equipment Development. Since then he had been responsible for proving the final drawings covering all types of circuits.

**THOMAS C. CRUGER**

Mr. Cruger joined the Western Electric Company in 1904 as an assistant storekeeper. He later went to the New York Telephone Company as head storekeeper in the Repair Shops, returning to the Western Electric in 1914. In 1917 he transferred to the Model Shop and was placed in charge of raw material stores in 1920. He left the Company in 1921, returning to General Service in 1925 with the group handling general storage, plant stock and patterns. In 1944 he transferred to Plant Operation and since then had been a building service supervisor at the Graybar-Varick, Chambers Street and Davis buildings.

**RUDOLPH J. PODEYN**

Mr. Podeyn joined the Engineering Department and engaged in drafting work on special products. During World War I he was with the group designing apparatus for Government uses. Following the war, Mr. Podeyn was assigned as a design draftsman in the Apparatus Development Department. In 1928 he became a supervisor responsible for the drafting work in connection with subscriber sets, telephone booths, coils, resistances, ringers, relays and similar equipment. Since 1938 Mr. Podeyn had been engaged in special checking work in the Apparatus Development Department.





N. A. POPP

CAPT. HOFFMAN

J. A. PECON

LIEUT. LIGHT

LIEUT. ORAM

LT. COL. LOVE

## RECENTLY RETURNED VETERANS

**NELSON A. POPP**, operating with a torpedo bomber squadron as an aviation radioman and aerial gunner, trained off the coast of Florida. He is now in Research Drafting at Murray Hill.

**CAPT. HAROLD H. HOFFMAN** held a reserve commission in Ordnance when he was ordered to duty in July, 1941. For the following three years he was assigned to Frankford Arsenal, where he was responsible for the design and production engineering of fire control instruments. His next and final assignment was Staff Plans and Training Officer of the V. T. Detachment at Johns Hopkins University, training personnel on the use of the proximity fuze.

**JOSEPH A. PECON** served nineteen months in the Navy. He received Electronic Technician's Mate training, and was sent to San Francisco.

**LIEUT. ROBERT H. LIGHT** studied at Princeton, M.I.T., the B.T.L. School for War Training and at Pearl Harbor before receiving his first assignment—radio and radar matériel officer aboard the aircraft carrier *Intrepid*. He was at Wake and at Eniwetok on her before she joined the 3rd Fleet off Tokyo.

**LIEUT. GEORGE E. ORAM** spent eight months on convoy duty in the North Atlantic as communications officer on various tankers before being sent to the Pacific. He was land based in New Guinea at the 7th Fleet Headquarters and served with a mobile communications outfit during the invasion of Borneo. Subsequently, he was assigned to a Navy mobile communications liaison unit attached to MacArthur's headquarters in Manila and then in Tokyo.

**LT. COL. STANLEY H. LOVERING** was called to active duty in World War II with the Signal Corps at Fort Monmouth in 1942, having previously served in World War I. At Fort Monmouth

he was primarily concerned with problems associated with the installation, suppression of radio noise interference, and test and maintenance of vehicular radio equipment. He became Chief of the Branches involved in this work and conceived and organized the Signal Corps Test and Maintenance Equipment Branch under the Engineer Laboratories of the Signal Corps Ground Signal Agency. On May 3, 1943, Col. Lovering was called to Washington to assist in setting up and organizing the Maintenance Division, Army Service Forces. He was appointed Chief of the Communications Equipment Section, which subsequently became the Electrical Equipment Section of the Division under the Maintenance Engineering Branch. After V-J Day the group was also engaged in the declaration of surpluses.

**JOSEPH KOCAN** maintained aircraft electronics equipment on Guam for the nine months of his overseas duty. Prior to that he had trained in Illinois, Mississippi and Texas.

**THOMAS J. O'CONNOR** has returned to the Commercial Products Drafting Department after receiving an ETM 3/c rating from the Navy.

**LIEUT. PETER M. WARGO** flew B-24's, doing radar countermeasure work during the war, jamming enemy radar during reconnaissance missions in the Philippines and Okinawa. His final assignments were in Japan.

**EDWARD F. DOWNES** served in the Navy for over two years, first with an amphibious outfit participating in the invasions of New Guinea, Leyte and Mindora and later on the *Houston* in the Atlantic.

**JOSEPH A. FAIRBROTHER** was in the Marine Corps for two years, during which he served at

430

JOSEPH KOCAN

T. J. O'CONNOR

LIEUT. WARGO

E. F. DOWNES

J. A. FAIRBROTHER

E. R. PONTECCO







COL. MINKS    LT. COL. KOBYLARZ    LIEUT. WATROUS    GLORIA CARSTENSEN    C. F. MOORE, JR.    COMDR. SHOWER

Hawaii and Guam with a 115-mm Gun Battalion. Returning to the States, he was assigned to Camp Pendleton.

**EUGENE R. PONTECORVO** served in the 251st Alsace General Hospital with the Medical Corps after receiving medical technician training. Later he was assigned in Europe to the Regional Transportation Office.

**LT. COL. FLOYD A. MINKS**, who was called to active duty with the National Guard early in 1941, spent a year with the 101st Signal Battalion and in various signal offices before he was transferred to the Signal Corps Laboratories at Fort Monmouth, where he was responsible for the design of all wire communications equipment for the Army.

Eight months later Col. Minks went to the Command and Staff School. Upon his return he was advanced to Executive Officer of the Eatontown Signal Laboratory and then to Director of the same laboratory. He continued there until early in 1945, when the Eatontown facilities were transferred to the Air Force. At that time he was transferred to the Specialized Training Section of the Signal Corps Laboratory. He left Fort Monmouth in July, 1945, for the Pacific Theater, where he was Director of the Technical Liaison and Investigation Division, GHQ, Tokyo, which was charged with the complete investigation of all Japanese signal equipment.

**LT. COL. ALBERT G. KOBYLARZ** was called to active duty from the Officers Reserve Corps in 1941 as a Captain and was assigned to the Maintenance Division, Office of the Chief Signal

Officer, Washington. There he was engaged in staff supervision of the maintenance of Aircraft Warning and Anti-Aircraft Systems. He later became Executive Officer to the Chief of that Division. In October, 1942, Col. Kobylarz

was transferred to Wright Field to organize and become Chief of the Ground Radar Unit in the Signal Section, Headquarters, Air Service Command. In July, 1944, he became Chief of the Radar Branch at Wright Field. He held this position till July, 1946, and was released from Percy Jones General Hospital, Battle Creek, Mich., in August, 1946, where he had gone for processing prior to separation on account of service-connected injury to his

leg. He became a Lieutenant Colonel in June, 1944, and will be promoted to the grade of Colonel while on terminal leave.

**LIEUT. ALBERT B. WATROUS** holds the distinction of having been commissioned in the field. First an infantryman, he transferred to the Signal Corps in Italy and later to the Ordnance. Returning to this country after two major engagements, he attended schools at Aberdeen Proving Ground and then became chief of the Instrumentation Laboratory at that post.

**GLORIA I. CARSTENSEN** spent a year and a half in the Coast Guard. She trained at Palm Beach and was stationed at Long Beach, Cal., where she worked with the Personnel Office.

**CHARLES F. MOORE, JR.**, was a Hospital Corpsman 1/c during his naval service. His assignments were in the operating rooms at Navy hospitals in Jacksonville, Fla., and Vera Beach, S. C.



The Laboratories has employed 1,178 veterans of World War II

J. MADDEN    G. E. SCHOENER    J. E. O'KEEFE    J. J. FEENEY    ENS. ROSEN    LIEUT. ELT





MILDRED BECKNER CATHERINE RIDNER L. F. ALBRECHT J. J. COZINE V. J. PIANO G. F. BROWN

**COMMANDER E. G. SHOWER** reported for active duty in 1943 at the Navy Department Bureau of Ships, Electronics Division, with the rank of Lieutenant Commander. His duties were coordination of development of electron tubes for the naval establishment within the Navy and with other branches of the Armed Forces; liaison with laboratories and manufacturers carrying on tube development; and research contracts for electron tubes. Early in 1945 Commander Shower reported aboard the *St. Paul* for duty involving tests of various electron tube types under combat conditions in the Atlantic and Pacific. He returned to his former billet in the Navy Department at completion of tests and was promoted to Commander.

**JAMES J. MADDEN** trained at Aberdeen Proving Ground and at Frankford Arsenal, where he remained to design testing equipment for optical instruments.

**GEORGE E. SCHOENER** trained at Sampson, after which he attended Signalman's School, and V-5 at Union College, finally becoming an aerographer at Floyd Bennett Field.

**JOSEPH E. O'KEEFE** saw service in the Pacific from Australia to Korea. As radioman on the LST 721, he was engaged in four invasions and in the occupational landing on Japan.

**JAMES J. FEENEY**, an Air Corps radio operator, was land based for ten months at the ground station in Labrador. Then he was assigned to C-54's, flying on check runs with stopovers in Paris, London, the Azores and Newfoundland.

**ENSIGN ELLSWORTH R. ROSEN** spent a year and a half at the Naval Research Laboratory in Washington as a radio engineer.

**LIEUT. GEORGE N. ELTZ** spent eighteen months in the ETO with the 366th Fighter Group. Pilot of a Thunderbolt, he completed twenty missions. After that he was stationed at Fretzlar, Germany, as Squadron Communications Officer and Flight Commander.

**MILDRED D. BECKNER** served with the Marines at Camp Pendleton, Cal., in the office of Personnel, where she handled correspondence and assisted in assigning officers for duty.

**CATHERINE RIDNER** served a year in the Waves and was stationed in Washington.

**LAWRENCE F. ALBRECHT** was a Quartermaster 3/c attached to the Motor Torpedo Boat Base at San Pedro Bay on Leyte during his overseas service. In addition to having trained at various quartermaster corps schools, Mr. Albrecht had also studied in the V-12 program.

**JOHN J. COZINE** trained at Camp Crowder and served as wire chief in a radio control center responsible for overseas teletype circuits in General Headquarters in Manila.

**V. J. PIANO**, following V-J Day, was assigned to MP duty and had charge of the processing section for receiving and discharging Japanese war criminals in Tokyo.

**GEORGE F. BROWN** took part in the invasions of Iwo Jima and Okinawa, and in the occupational landing in Japan. An AETM 2/c on the seaplane *Hamlin*, he maintained radar equipment on a squadron of PBM's.

**LEAVES OF ABSENCE** to study under the GI Bill of Rights have been granted to DONALD E. BLESSE, DANIEL T. HAYES, MARGARET S. MCILVAINE, MAXWELL C. ANDREWS, THEODORE T. O'SHAUGNESSY, RICHARD C. URBANEK, JAMES L. WEST, WILLARD A. REENSTRA, EDWARD J. BYBEL, RAYMOND W. ECKERSON, WILLIAM H. GRAY, KENNETH F. MCKENNA, HAROLD B. GUERCI, and ROBERT H. MEUSER.

### Leaves of Absence

As of September 30, there had been 1,054 military leaves of absence granted to members of the Laboratories. Of these, 896 have been completed. The 158 active leaves were divided as follows:

Army 78 Navy 53 Marines 6  
Women's Services 21

There were also 10 members on merchant marine leaves and 1 on personal leave for war work.

### Recent Leaves

#### United States Army

Edward R. Jurek Michael Konash