

U.S. Navy Radio & Sound Laboratory
San Diego 52, California

BELL LABORATORIES RECORD

PROPERTY OF THE LIBRARY
U.S. NAVY ELECTRONICS LABORATORY
SAN DIEGO 52, CALIFORNIA

VOL. XXIV NO. 1

JANUARY 1946



A monthly magazine for members of Bell Telephone Laboratories, for their associates in the Bell System and for others interested in the progress of the communication art. During the war some 90 per cent of the Laboratories' activities were devoted to producing communication and electronic apparatus for the Armed Forces. In peace, the Laboratories' work is the development of apparatus and systems for manufacture by the Western Electric Company and use by the Bell System.

CONTENTS OF THIS ISSUE

PAGE

New Year's Greetings, *O. E. Buckley* 1

Measuring Coaxials at Ultra-High Frequencies, *C. C. Fleming* 2

Glass-Sealed Resistors 6

Visible Speech, *R. K. Potter* 7

Trouble Indicator for the Sender-Link Frame, *A. E. Hague* 12

Relative Strength of Crossarms, *R. C. Eggleston* 18

Rolling Magnetic Tape 21

Football Via Coaxial 24

Telephone Pioneers of America 27

The Cover—An L-band magnetron, one of the many types designed by the Laboratories and manufactured by the Western Electric Company to generate high-frequency power for radar.



Published monthly by BELL TELEPHONE LABORATORIES, INCORPORATED, 463 West St., New York 14, N. Y. Paul B. Findley, *Editor*; Philip C. Jones, *Science Editor*; R. Linsley Shepherd, *Associate Editor*; Helen McLoughlin and Phyllis Foss, *Assistant Editors*; Leah E. Smith, *Circulation Manager*.
 Subscriptions, \$2.00 per year. *Printed in U. S. A.*

BELL LABORATORIES RECORD

JANUARY 1946

VOLUME XXIV

NUMBER I

To the Members of the Laboratories:

WE ARE ending a year that will be marked in history books of the future as one of the most significant in man's long record of adventure and achievement. In our own sphere, this year has special significance for the members of Bell Telephone Laboratories. We have finished a great task in which we accomplished more than we would have believed possible. These wartime accomplishments have reflected great credit on every member of this organization.

But the completion of the task created by the war has not given us much opportunity to relax our efforts. It has, on the contrary, thrown us into a problem of reconversion to peacetime activities that taxes all of us. The demand for the products of our work cannot wait for orderly rearrangement of people and facilities. We must get under way effectively while we are still in a period of transition. New assignments of work must be made; work must go on where best it can while rearrangements are in progress. It is our earnest intention that these changes shall be made with the sole objective of the most efficient use of our forces and facilities, to the end of better results more rapidly achieved.

As we start the New Year and again take stock of ourselves, we can all



have well-justified pride in being members of Bell Telephone Laboratories. The Laboratories family is a great team. Let us together resolve to do our best in the coming year to add to the accomplishments and fame of that team.

I give you my best wishes for the New Year. I want also to thank each one of you for your contributions to the hard work and fine performance of 1945.

Oliver E. Buckley
President

December 31, 1945

January 1946

1

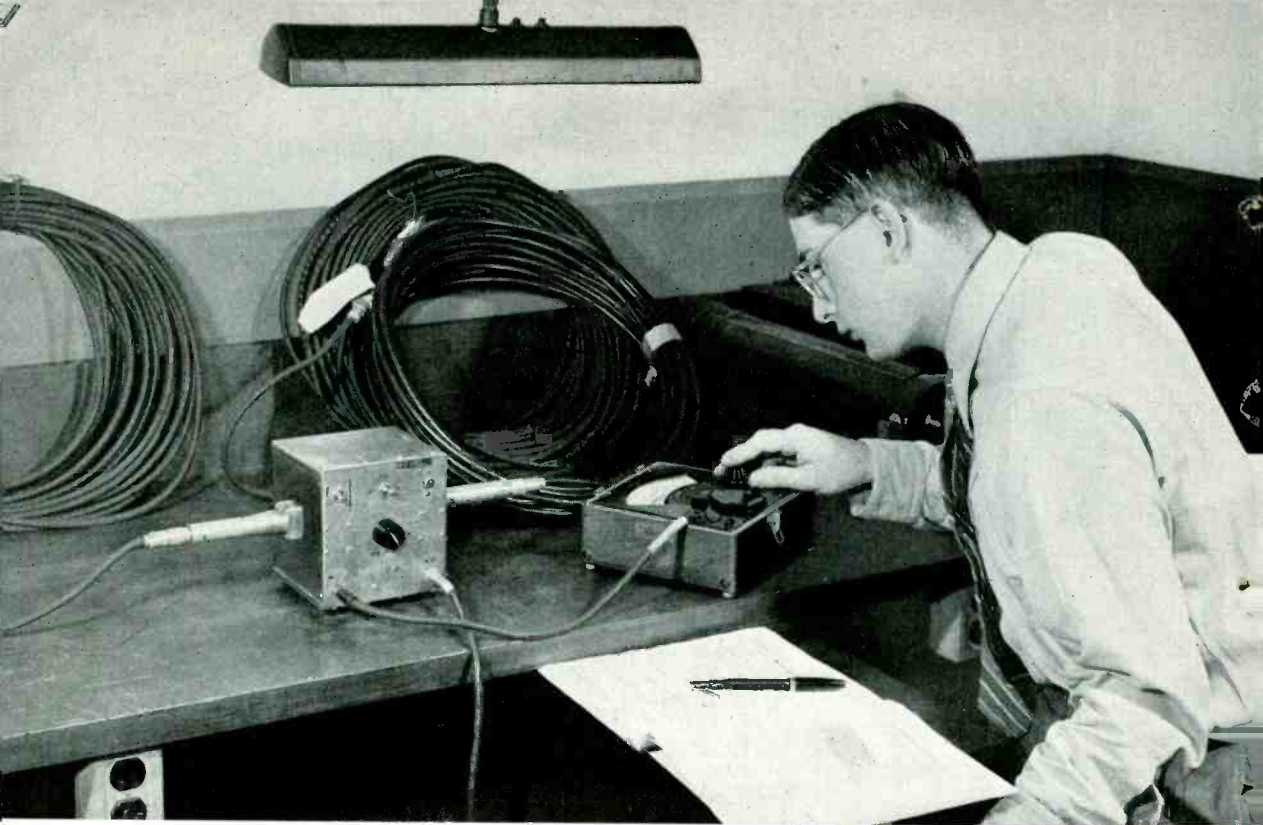

Measuring Coaxials at Ultra-High Frequencies

By C. C. FLEMING

High Frequency Transmission Engineering

QUITE early in the Laboratories' program of war development, it became evident that higher frequencies than had been generally used before would be employed. Coaxial conductors would be required to carry these high frequencies, but war conditions made a solid dielectric preferable to the more usual construction employing air as a dielectric with separating disks to maintain the spacing between inner and outer conductors. Fortunately, a suitable low-loss dielectric called polyethylene had been developed in England shortly before this time. To design cables using polyethylene as the dielectric, however, it was necessary to make extensive tests of possible arrangements over a range of frequencies for which no suitable measuring apparatus was available. The Laboratories played an important rôle both in designing measuring apparatus and in making measurements, and it is now possible to describe some of the methods used.

Attenuation is the characteristic of chief

concern, and although this could have been measured by observing standing-wave phenomena with traveling detectors and other apparatus, it was found that the greatest practical precision was obtained by measuring the insertion loss of a simple section of cable long enough to have considerable attenuation at the frequency of test.

The insertion loss of a section of line may be defined as the loss of energy caused by inserting the line into the original circuit. A generalized set-up for measuring the insertion loss of cable is shown in Figure 1. In a circuit terminated by an oscillator at one end and an indicating device calibrated in db at the other, the cable under test is inserted between two isolating loss pads, which take the form of lengths of coaxial cable. "Measure" and "reference" readings are taken respectively with and without the cable under test in the circuit, and the attenuation is determined by subtraction. If the loss cables closely match the characteristic impedance of the cable under test, and

if the cable connectors introduce no impedance irregularity, it is possible to eliminate one of the isolating pads and still read true attenuation differences on the indicating meter. Since one cannot be very certain of these factors at high frequencies, however, it is general practice to provide as good a



Fig. 1—Block form of typical circuit for measuring insertion loss

termination as possible on each side of the cable under test. It is also possible to place the indicating meter ahead of the second loss pad which reduces its sensitivity.

This principle is utilized in the shielded voltmeter set, a block diagram of which is shown in Figure 2. The name of this set may appear to be generic rather than specific, but it is the result of an attempt to distinguish the equipment from a set with unshielded coupling loops designed by the Naval Research Laboratory for a similar frequency range. The shielded voltmeter is usually operated in the range from 140 to 420 mc, and thus includes the frequency of 400 mc now specified for attenuation measurement of production samples of polyethylene cables. The device consists of a diode vacuum tube mounted on a short section of air-dielectric coaxial line of impedance about equal to that of the cable under test. Both the tube and the short section of line are enclosed in a small copper box. The indicating instrument is a multi-scale microammeter that reads rectified current, and is calibrated in relative db of R.F. signal. Since the air-dielectric coaxial in the set is not of the same diameter as the polyethylene cables tested, connections to the test cable and to the terminating cable are made through tapered coaxial lines about five inches long, shown in the center foreground of Figure 3.

Most of the standard polyethylene cables have a characteristic impedance of either 50 or 75 ohms. Since it is necessary to avoid increases in impedance irregularities with frequency, interchangeable in-

ner conductors for the voltmeter coaxial line and tapers, and also sets of padding and terminating cables, have been provided at each of these impedance levels. At 50 ohms, "Type N" Army-Navy connectors are used; and at 75 ohms, "Holmdel" connectors. In the 140-420-mc range, the signal source is a General Radio 757A or 857A oscillator utilizing a Western Electric 316A vacuum tube. It has also been found possible to make measurements with the shielded voltmeter in the 20 to 60-mc region by using a suitable oscillator. A test with the shielded voltmeter is shown in progress in the photograph at the head of this article.

At frequencies much above 400 mc, it has been found desirable to read attenuation differences on a variable attenuator operating at a frequency considerably lower than that of test. This has been accomplished by using the double-detection or heterodyne system of Figure 4. This method has been used in the regions of 1,100 and 3,000 mc, but may be extended to any part of the frequency spectrum for which oscillators are available. In general, it is necessary to change the design of the crystal converter to secure tuning at the frequency that is desired.

Two oscillators with frequencies 60 mc apart are introduced into an International type of crystal converter; the beat oscillator directly, and the signal oscillator through isolating loss cables and the cable under test. The difference-frequency product is fed into an intermediate-frequency (IF) system consisting of a variable attenuator, a high-gain amplifier, a rectifier, and an indicating meter. The insertion loss is the difference in db between readings on the attenuator with and without the test cable in the circuit, but with the same indicating meter reading at both readings. To achieve linearity of conversion of voltage ratios in the signal circuit to voltage ratios in the

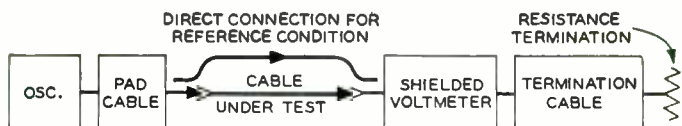

Fig. 2—Block schematic of the shielded voltmeter method of measuring insertion loss

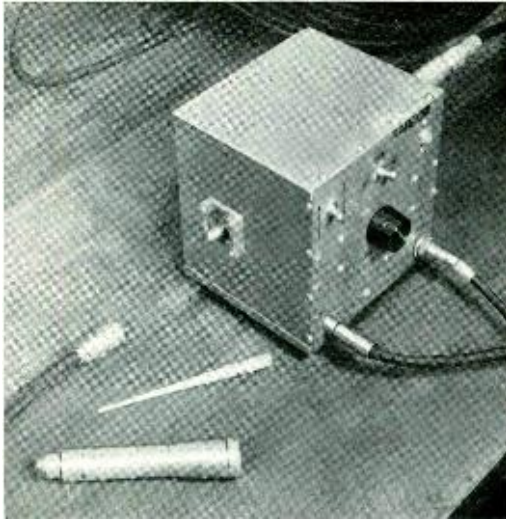

Fig. 3—The shielded voltmeter includes a short section of air-dielectric coaxial. This is larger in diameter than the cable under test, and five-inch tapered coaxial lines are used for the inter-connection

60-mc circuit, that is, to insure “db for db” conversion, it is necessary that the crystal operate at essentially the same point of its characteristic at both “reference” and “measure” conditions. This is done by maintaining sufficiently high and constant beat-oscillator power at the crystal converter.

Oscillators at 1,100 and 3,000 mc are of special design. In the case of 1,100 mc, Type GL-446 “Lighthouse” tubes are used in resonant cavities. These are specialized triodes with elements of cylindrical structure. At 3,000 mc, a velocity-modulated* type of oscillator is used. As in the case of the shielded voltmeter, separate sets of pad cables and connectors are used for 50 and 75-ohm cables respectively.

Still another test method, which does not fall in the insertion-loss category, has been commonly employed. This is the use of a Q-meter to measure cable samples of relatively short physical length that resonate electrically at about 100

*RECORD, August, 1945, page 287.

mc. The cable characteristics determined by this method are velocity ratio, characteristic impedance, and attenuation at 100 mc. Theoretical considerations and comparison measurements indicate that, if the structure of a polyethylene cable does not vary with length, the velocity and impedance are effectively constant between 100 and 3,000 mc. The 100-mc results are therefore effective over that range. The quantities that must be measured on a test sample are: physical length, electrical length, resonant frequency, effective resistance at resonance, and capacitance at any frequency below 1 mc.

A Boonton 170A Q-meter is shown schematically in Figure 5. The junction between the test cable and the Q-meter occurs at a high impedance point on the resonant cable. The resonant frequency is determined by finding the frequency at which the resonance setting of the variable condenser is the same with and without the test cable in circuit. From the physical and electrical lengths and the resonant frequency, the velocity ratio is calculated. From these data and a measurement of capacitance at a frequency under 1 mc, the characteristic impedance is calculated.

The equivalent resonance resistance of the cable is determined by comparing the Q of the cable with that of a number of

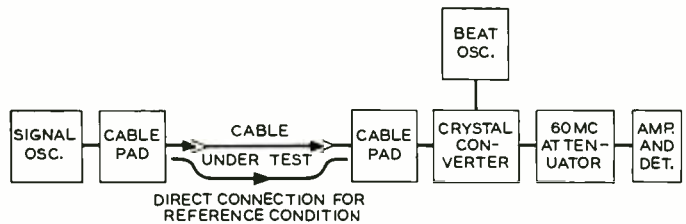

Fig. 4—Block schematic of a heterodyne method of insertion loss measurement

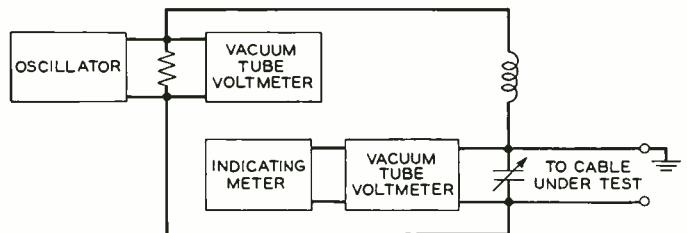

Fig. 5—Schematic circuit of Boonton 170A Q-meter

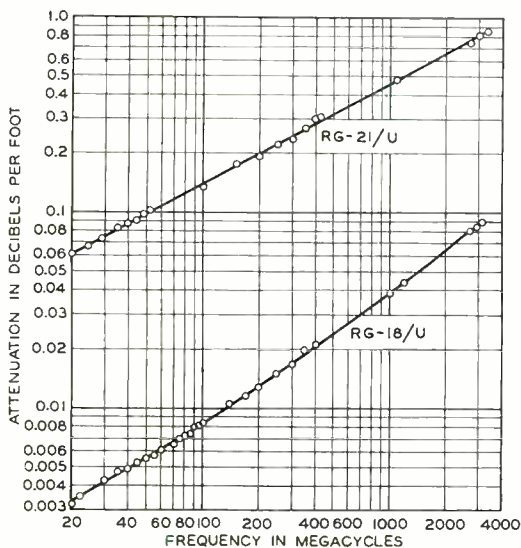

Fig. 6—Relationship between attenuation and frequency for polyethylene cable

IRC Type F resistors which, like the coaxial cables, have their effective conducting material in a very thin tubular film. It has been determined that the resistance of such resistors under 10,000 ohms remains nearly constant from direct current to 100 mc. It is found convenient, therefore, to measure the resistors on a standard Wheatstone bridge with direct current, and then to connect them into the Q-meter and plot a curve of meter deflection against d-c resistance. To increase the precision, the values of relative Q are read on an external meter of 10 or 30 microamperes full scale sensitivity. On the curve so obtained, the value of resistance of the cable may be spotted. From the measured resistance and the previously measured quantities, the cable attenuation is calculated.

It should be emphasized that, using the foregoing procedure, no dependence is placed on absolute values read on the Q-indicating meter or on the variable-capacity dial of the Q-meter. On the other hand, assumption of the constancy of resistance of IRC Type F resistors appears to be well justified by tests at the Naval Research Laboratory, Bell Telephone Laboratories, and elsewhere. Moreover, the attenuation results obtained by the resistance comparison method lie very nicely on curves of attenuation plotted against frequency.

All methods described here have been used to determine the measured attenuation values plotted in Figure 6. The curves of attenuation against frequency drawn through the measured points are in close agreement with the results of theoretical analyses. Some degree of engineering judgment is required in making such comparisons, but it is possible to calculate closely enough to enable a test engineer to maintain a critical attitude toward test results. In Figure 6, the curve for RG-21/U cable is very nearly a straight line with slope of 0.5. This result is in accord with the concentration of attenuation in the high resistance inner conductor, the attenuation component of which varies as the square root of frequency. Considering the curve for RG-18/U cable, it may be noticed that the slope of the curve increases with frequency. This is caused by the dominance at lower frequencies of conductor losses which vary about as the square root of frequency, and by the increasing percentage contribution at higher frequencies of dielectric loss, which varies about as the first power of frequency. As to absolute magnitude of attenuation, the RG-18/U cable, by virtue of its comparatively large size and solid copper inner conductor, has much lower attenuation than RG-21/U. These methods, widely used, provided very useful results in our work with the Army-Navy RF Cable Coördinating Committee.

THE AUTHOR: C. C. FLEMING entered the Laboratories in 1927 and enrolled in the Student Assistants' Course. By attendance at evening courses he received the E.E. degree at Polytechnic Institute of Brooklyn in 1935, and the M.S. degree in Physics at New York University in 1939. His early work was on high fidelity recording of sound on vertical-cut disks.



In more recent years he engaged in development of coaxial cable carrier systems. During the war he developed electrical test methods for transmission lines at high radio frequencies.

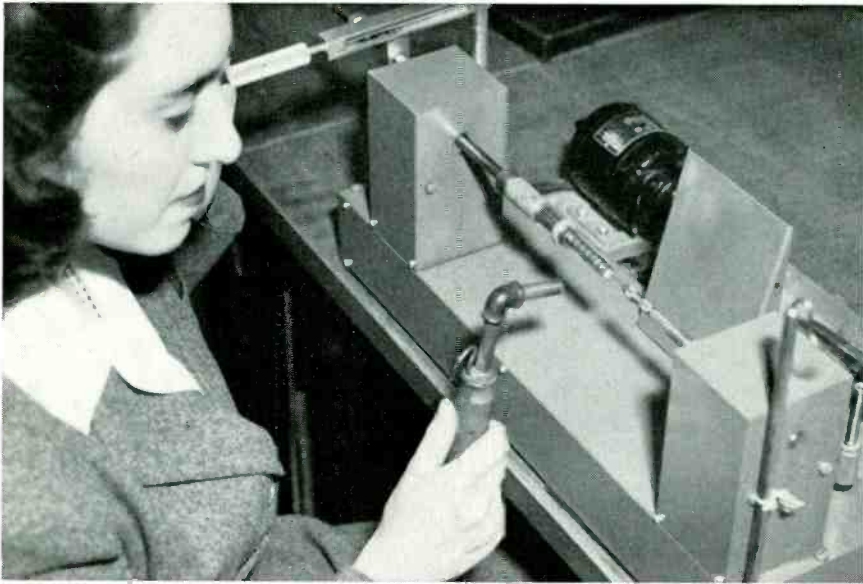

GLASS-SEALED RESISTORS

Small resistor units, which find frequent application in radio equipment, are sometimes sealed in a glass envelope with an inert gas to protect them from the atmosphere. Mildred S. Spencer demonstrates how this is done at Murray Hill in the accompanying illustrations. The resistor units have a wire terminal at both ends and on one of these a glass bead is fused. Each unit is inserted into a glass tube which is then mounted in a chuck and rotated in a

gas flame, as shown above, until the bead is sealed to the envelope. At its opposite end the resistor wire protrudes into a glass tube through which the air is pumped from the envelope prior to filling it with an inert gas. The glass tube is then sealed off beyond the end of the wire after which the unit is rotated in the machine to seal the wire to the tube. The excess length of glass tubing is then cut off and the sharp edge of the tube is smoothed by a small flame.

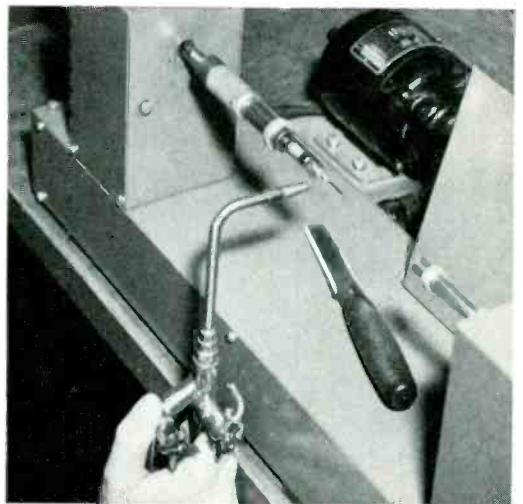



Visible Speech

By RALPH K. POTTER

Director of Transmission Research

A PERSON totally deaf, particularly if he has been so since birth, can be taught to speak only with the greatest patience, and at best his speech is unpleasant sounding and difficult to understand. Being unable to hear his own or any other voice, he has no criterion to guide his efforts, and the sounds he produces depart widely from those of normal speech. Though he may be able to read lips well enough to understand others, his manner of response tends to discourage normal conversation. Through the use of a new translation of speech sounds into a form called "Visible Speech," however, the problem of teaching the deaf to talk properly seems to show promise of solution. Although speech training for those without hearing is of most immediate concern, it is likely that visible speech may ultimately enable the deaf to read the speech of others, and particularly to use the telephone.

There are many other uses for these patterns of sound than those of special interest to the deaf. Since in telephony our problem is mainly one of speech transmission,

this new way of picturing speech sounds and the effects of noise and distortion upon such sounds should be of considerable value. Also, to the scientist working in the fields of phonetics and language development, it should bring far better means for analysis and illustration than any now in use. Where at present books on speech and sound in general are noticeably lacking in illustrations, it is to be expected that when translation apparatus is widely available, these new patterns of sound will be used abundantly. In addition to these direct applications, visible speech, through offering a better understanding of speech characteristics, seems likely to show the way to the solution of many problems to which it is only remotely related. One, for example, is control of operations by the voice so that mechanisms might respond as directed by speech over a telephone circuit.

Consideration of ways to picture meaningfully various effects of distortion and noise upon speech led to the original concept of these patterns of sound. This was before the war, and subsequently military

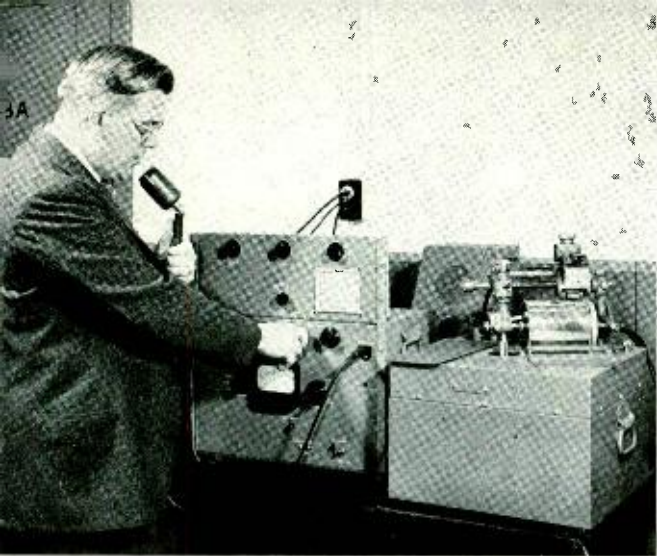

Fig. 1—George A. Kopp with a sound spectrograph developed during the war

interests resulted in a considerable improvement of the first experimental models by the Laboratories.

Making speech visible is not, of course, a novelty. The wiggly trace of speech on the familiar oscilloscope is visible but not in a comprehensive form. In oscillograms, and sound tracks of other similar kinds, two of the basic dimensions of sound, those of frequency and intensity, are indiscernible much as letters would be in a printed word if they were piled one upon the other instead of being arranged side by side in a row. Although an oscillogram has many uses, it does not serve to make speech ac-

tually visible in the sense of the word as used here. A true visual counterpart of speech should show the intensities of the various component frequencies in continuous succession as the sounds are produced.

Visible speech is formed in both permanent and transient patterns: the former in shades of gray upon white paper, and the latter in traces of light upon a moving belt of phosphorescent material. The pattern shapes are the same in both cases, frequency being represented by height above the base line, so that the upper part of the pattern represents the high frequencies and the lower part the low frequencies. Intensity is indicated by the darkness of recording in the permanent patterns and by the brightness of the light traces in the transient type. The words "Visible Speech," spelled in these new automatically recorded symbols, are shown in Figure 3.

An instrument called the sound spectrograph is used in making these patterns. The principle is indicated by the schematic diagram of Figure 2. Here the speech is first recorded on a magnetic tape, then passed through a variable filter, and recorded as a line of varying density on sensitized paper wrapped around a rotating drum. For each revolution of the magnetic tape, the filter is set for a different band, and the position of the line on the drum shifts according to the frequency band selected.

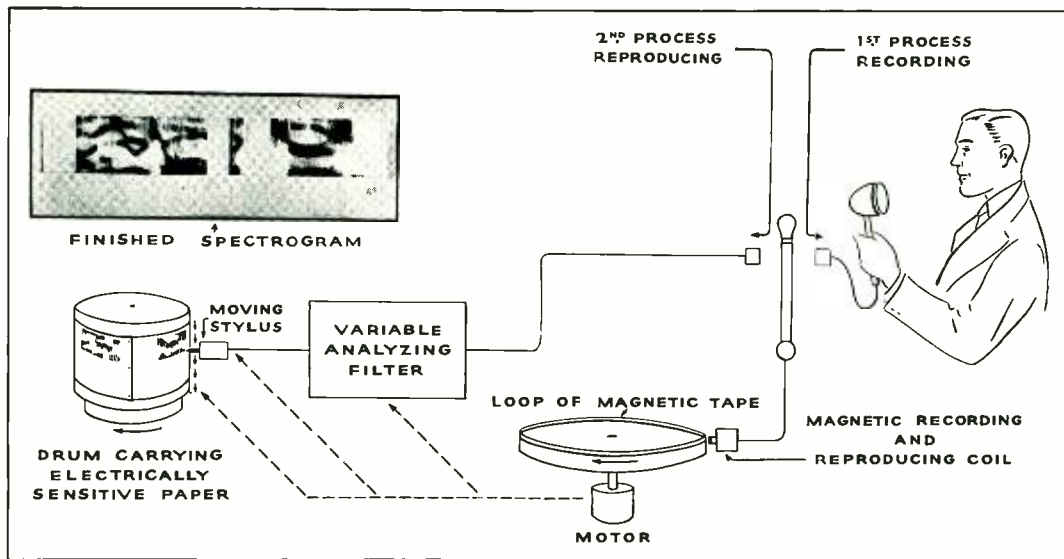

Fig. 2—One of the several methods devised for displaying visible speech

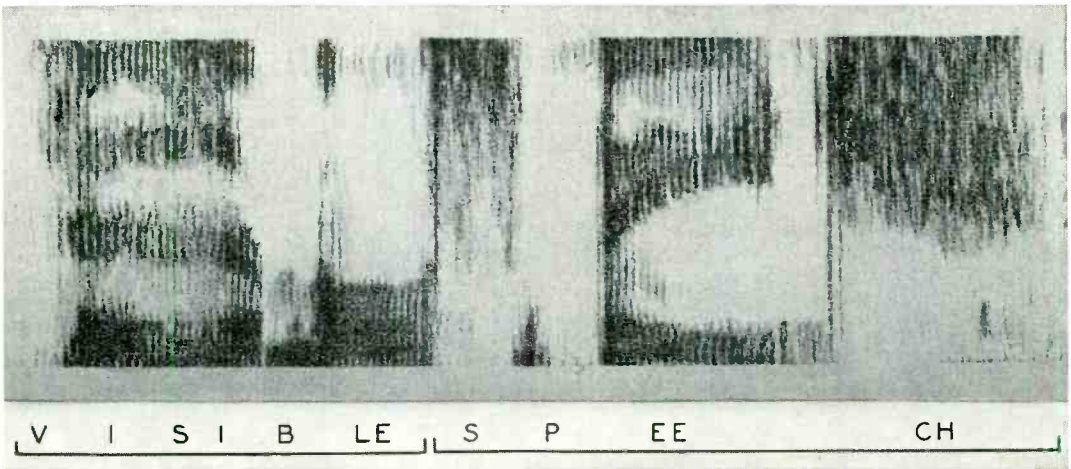

Fig. 3—The words "Visible Speech" as they would appear in visible speech

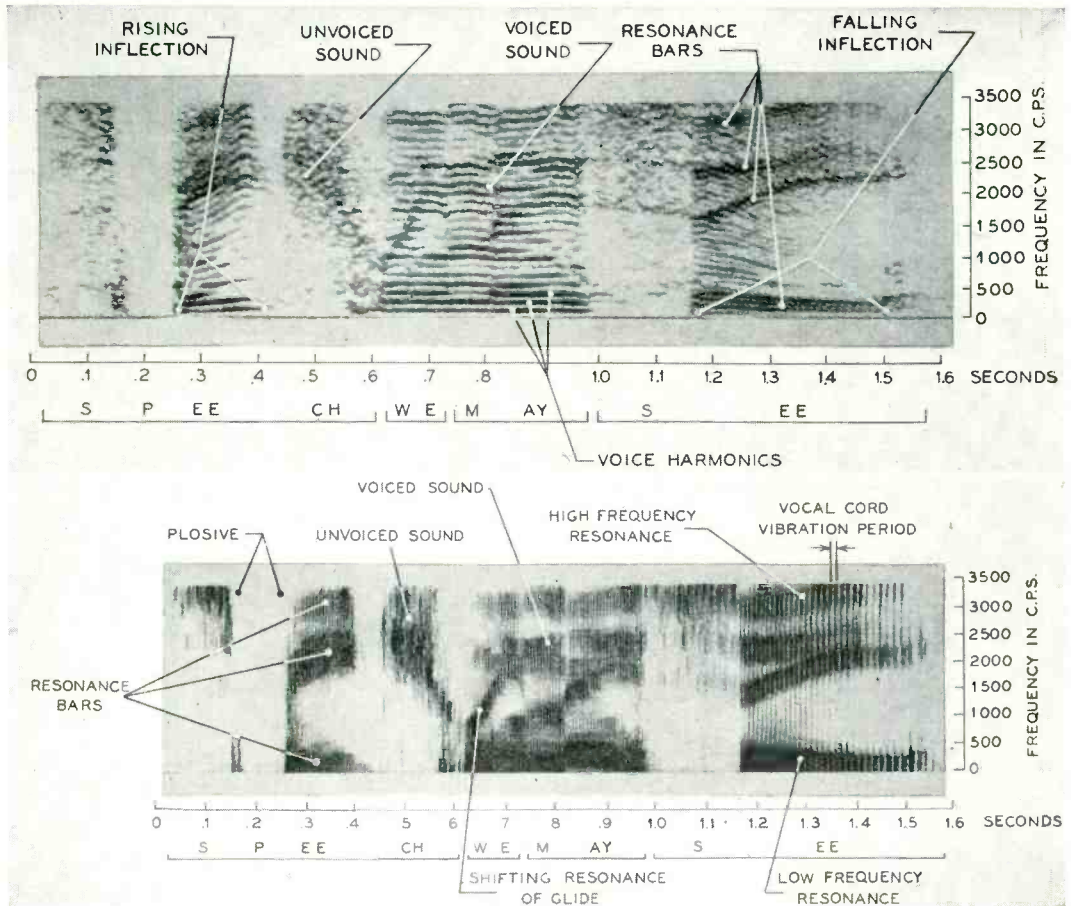

Fig. 4—The phrase "Speech we may see" as it appears using 45-cycle bands, above, and 300-cycle bands, below. In the lower illustration, a wider filter eliminates the harmonic detail and leaves only the sound regions reinforced by mouth cavity resonances

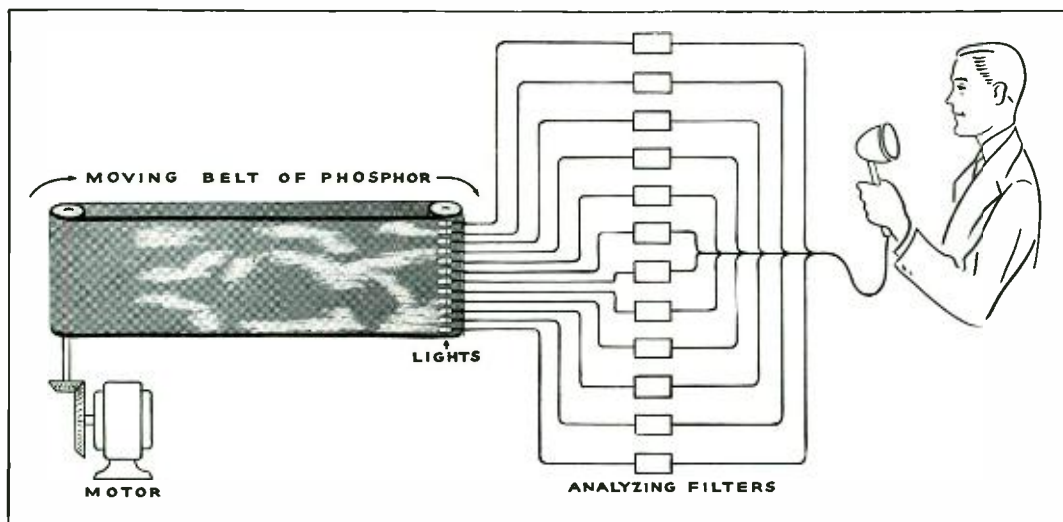

Fig. 5—An instantaneous form of translator used for visible speech

One type of sound spectrograph developed during the war is shown in Figure 1. The loop of magnetic tape is in the box at the right and the drum on which the sensitized paper is wrapped appears at the top of this box with the recording stylus above. By altering the band width of the analyzing filter, sounds may be pictured in detail or in broad outline. The upper part of Figure 4 shows the words "Speech we may see" in enough detail to reveal by the horizontal line structure the harmonics of the voice and even minute variations in pitch. In the lower part of Figure 4, a wider filter eliminates the harmonic detail and leaves only the regions in which the sounds are reinforced by mouth cavity resonances. These less detailed patterns contain practically all the intelligence without the finer variations that represent individuality or quality in the voice. The patterns in the upper part of Figure 4 are of scientific and engineering interest, while those in the lower part are of particular interest for visual hearing and phonetic studies. Patterns made by the sound spectrograph are, of course, produced too slowly for visual hearing purposes; for such use it is necessary to carry on the translation to visible speech without an appreciable lapse of time between the spoken sound and its visible representation.

A schematic of an instrument that makes patterns of speech at the talking rate is

shown in Figure 5. The speech is passed through a set of twelve band-pass filters, each of which selects a band of frequency about 300 cycles wide in the range from

THE AUTHOR: R.K. POTTER, Director of Transmission Research, graduated from Whitman



College in 1917 with a B.S. degree and after nearly two years in the U. S. Army attended Columbia University, receiving the E.E. degree in 1923. He then joined the D & R and took part in the first studies of broadcast distortion caused by fading. Subsequently he extended these

studies to transoceanic radio circuits, using observation and recording methods that provided a basis for the later development of sound portrayal methods. Following the transfer to the Laboratories in 1934, he joined the Transmission Engineering Department and extended his interests to telephone and program transmission over wire circuits and to the problem of "scrambling" speech as protection against eavesdropping on radio circuits. During the war he had a responsible position in connection with the Laboratories work with N.D.R.C., and supervised the sound pattern development that was started before the war and continued thereafter with official rating as a war project.

150 to 3,500 cycles. The outputs of these filters light 12 lamps near the right end of a moving phosphorescent belt, and the intensity of illumination of each lamp is proportional to the intensity of the speech components within the corresponding filter band. The traces upon the belt surface glow with an intensity proportional to the lamp brilliance, and the glowing persists long enough for the belt to travel the full length of its exposed section. The patterns are then "erased" at the rear by an infrared light source not shown. In another form of direct translator a special new type of cathode ray tube is employed to display the visible speech. In the present design, cathode ray tube circuits are more complicated than are necessary for the phosphorescent belt type. Although the display area is much smaller, the images are very sharp and have been especially satisfactory for small group experimental training purposes. This latter translator is shown in the photograph at the head of this article.

Although interest in speech patterns at the present time is in connection with the needs of the deaf and studies relating to telephone problems, these patterns will, as mentioned earlier, find other important uses. They will permit a study of numerous non-speech sounds within the range of normal hearing and many outside the hearing limits of the human ear. Patterns of some familiar non-speech sounds are shown in Figure 6.

Beyond the present developments, one of the more immediate interests is in pictures that represent a form of analysis approaching closely that carried on by the ear, that is, an "aural type" spectrograph. Another is in instruments that will store comparatively slow variations such as heart beats or mechanical vibrations and translate these into sound spectrograms at high speed. There are many potential applications for these different kinds of patterns, both in our telephone research and engineering and in outside specialized fields.

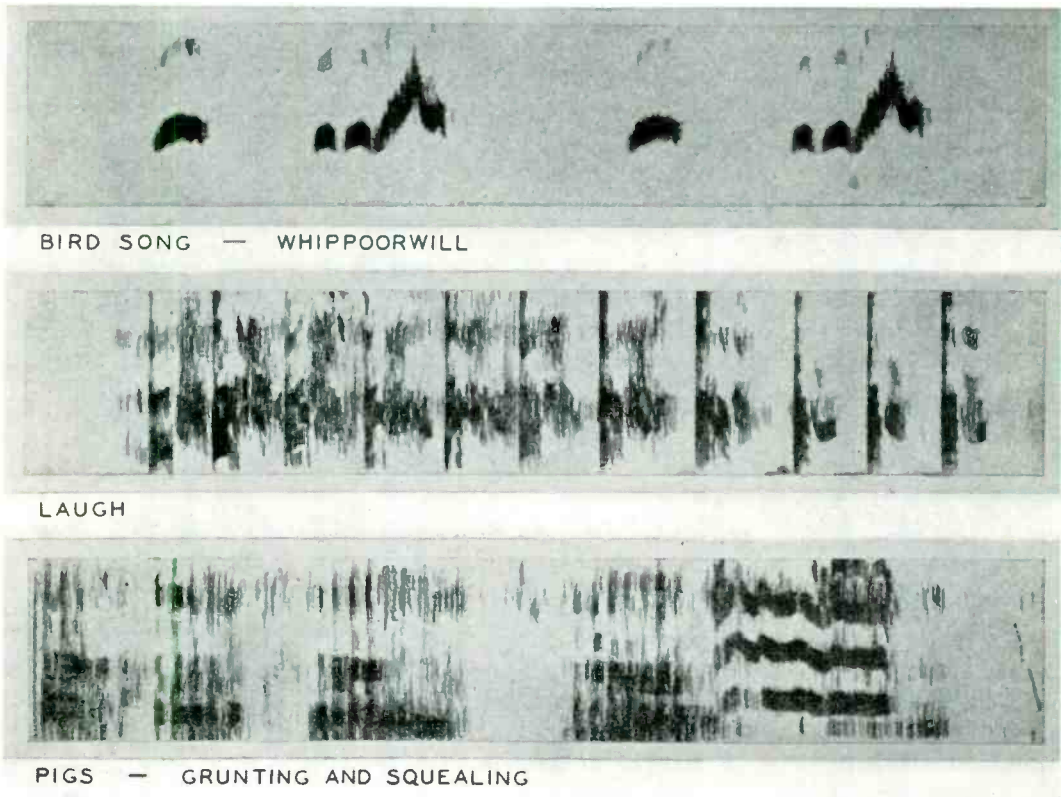

Fig. 6—Various sounds as recorded in visible speech



Trouble Indicator for the Sender-Link Frame

By A. E. HAGUE

Switching Development Department

A CROSSBAR office completes its tens of thousands of calls a day with a surprisingly small percentage of trouble. Certain components of the system, however, such as markers and senders, are associated with each call for only a very short interval, and thus any undetected irregularity in their operation would affect many calls in a very short time. To avoid such a condition, trouble indicators have always been used with some of these units. At the originating end, for example, a trouble indicator is associated with the sender, marker, and the district and office-link frames to indicate the circuits involved and the stage reached for any trouble occurring during the operation of the originating marker. No trouble indicator was originally used, however, in conjunction with the sender-link frame, since it was thought that the gen-

eral alarms provided, together with means for "holding" the circuits pending the location of trouble, would provide all the maintenance aid required. Subsequent experience under heavy load conditions, however, indicated that additional help would be desirable, and a trouble indicator has now been developed for the link frames that are associated with the subscriber senders.

When a subscriber places a call, the controller circuit of the line-link frame cooperates with the controller of some one of the five or fewer associated sender-link frames to establish a channel from the subscriber line to a sender so that the number wanted may be recorded and the call extended to the desired office. This channel, consisting of a line link, a district junctor, and a sender link, may be traced in Figure 1.

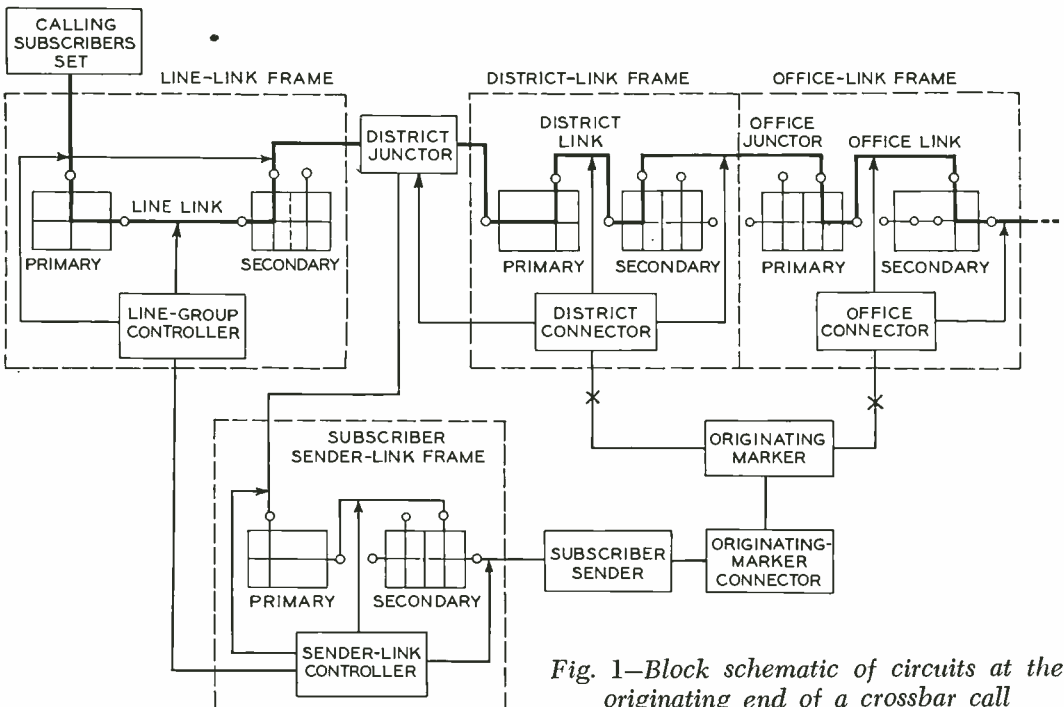

Fig. 1—Block schematic of circuits at the originating end of a crossbar call

Each sender-link frame is arranged for access to 100 district junctors and 100 senders, but the senders may also be reached by other sender-link frames, and each sender-link frame may also be reached by other line-link frames. In addition, each district junctor may be connected to several line-link frames and used by any of a thousand or more lines. The possible combinations of line, district junctor, sender-link frame, and sender is thus large, and the location of trouble may be difficult once the particular combination has been released. The function of the trouble indicator, which is called in when a trouble occurs while establishing a connection to a sender, is to make a record of the line-link frame, district junctor, sender-link frame, and sender involved, and the particular stage reached in setting up the connection when the trouble occurred. With this information available, the maintenance force can more readily analyze and locate the source of the trouble.

The information recorded by the trouble indicator is indicated by lamps. One set of

progress lamps serves for all the sender-link frames, since the indicator is connected to the sender-link frame involved after the trouble occurs. Besides various lamps and the relays that control them, the trouble indicator has a group of relays associated with each sender-link controller, and a connection to these relays is made in the sender-link controller when trouble occurs. The trouble indicator also has a small group of common relays that work in conjunction with any of the sets of relays associated with the various sender-link controllers. This general arrangement is indicated schematically in Figure 2, where the heavy line indicates the main dialing path.

When trouble occurs in establishing a connection to a sender, the sender-link controller signals the trouble indicator, which returns a signal to the sender-link controller. This latter signal results in the operation of a relay that establishes connections to a group of leads over which the district junctor group, the individual junctor, and the stage reached will be indicated, and

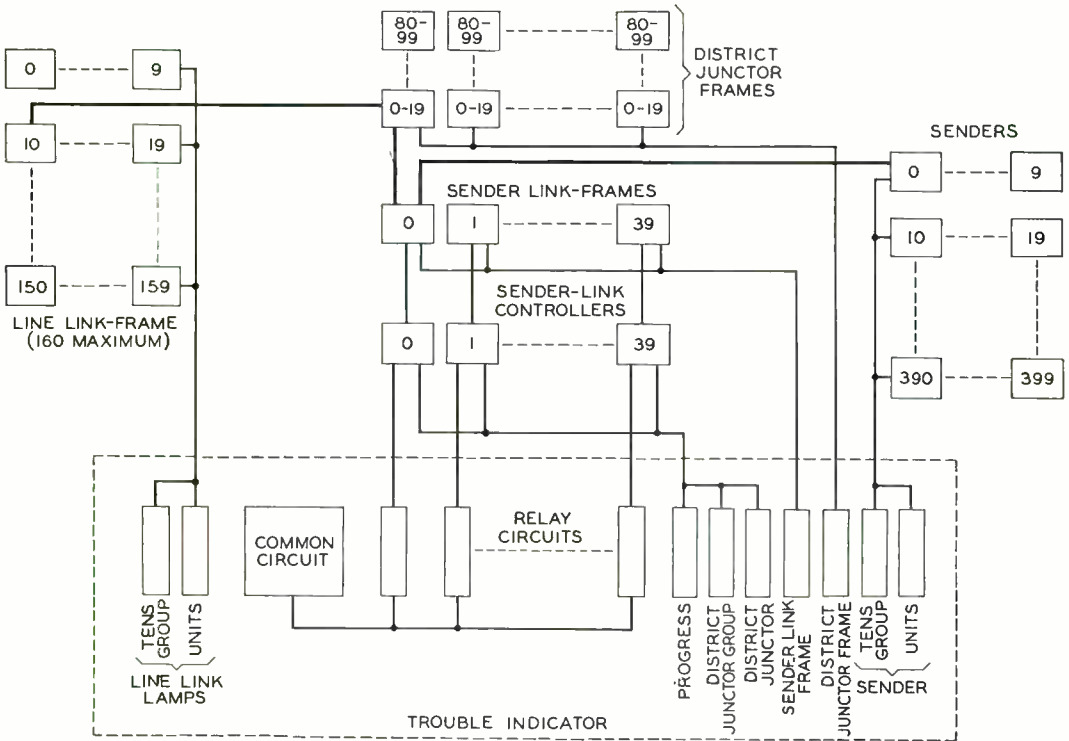

Fig. 2—Block schematic showing major connecting paths between the trouble indicator and the other office circuits

also in the operation of relays which establish paths to indicate the particular sender-link frame, line-link frame, the sender group, and the individual sender. The trouble indicator first sets up a circuit to hold these relays operated and then sounds an alarm and disconnects itself from the sender-link controller, and makes itself unavailable to other sender-link controllers. This disconnection of the trouble indicator from the sender-link controller after the necessary information has been recorded on the relays is accomplished by a timing circuit that allows about a fifth of a second for the various relays to be operated and the alarm to be sounded. When a maintenance man responds to the alarm, he makes a record of the lighted lamps corresponding to all relays operated so that the trouble

may be located and cleared. By operation of another key, the trouble indicator is then restored to normal to be ready for the next appearance of trouble.

The type of circuits performing these functions may be seen from Figure 3, which is a very much simplified diagram of the various circuits. Only a few of the indicating lamps are shown, and only three of the sets of relays associated with the various sender-link controllers. Each sender-link controller has a timing circuit that allows a certain interval of time for a connection to be set up from a subscriber to a sender. If no connection has been made within this period, the timing circuit operates the TI relay, which, in turn, makes contact with the trouble indicator.

In each sender-link controller, the TI re-

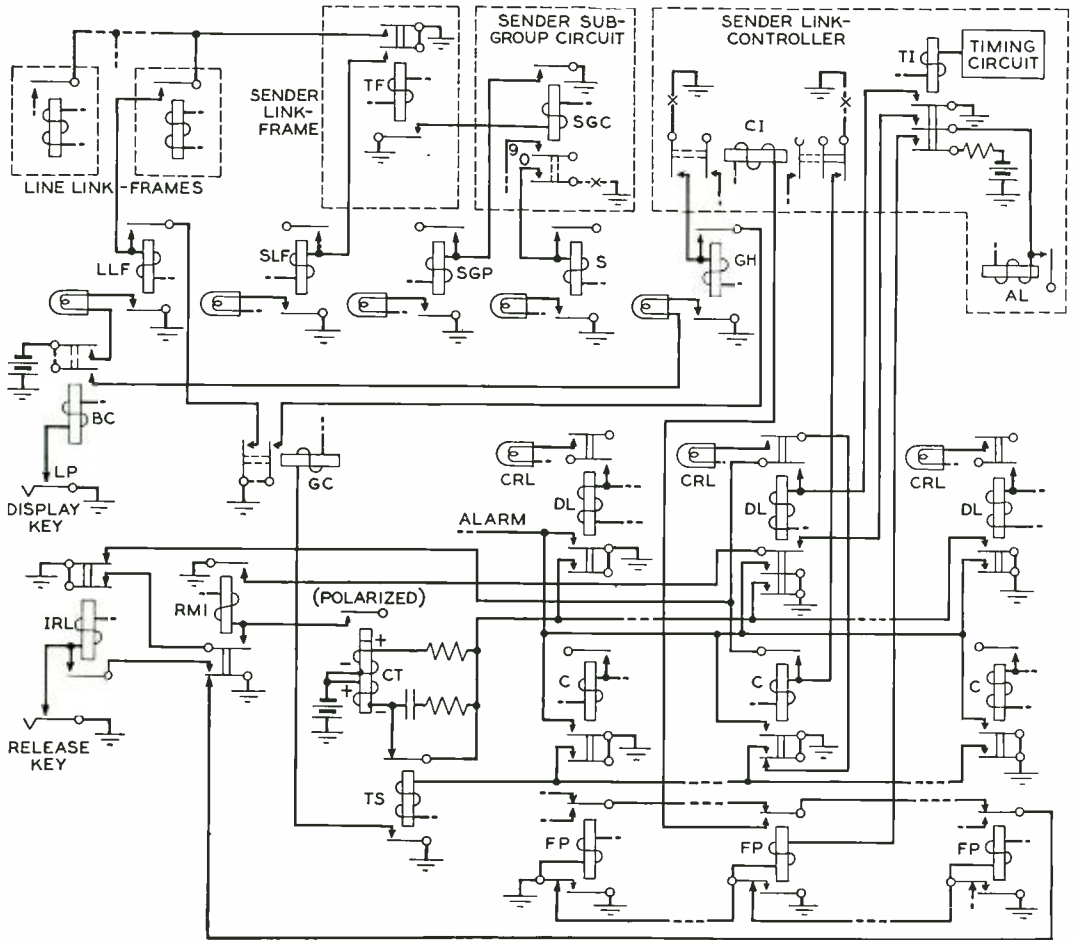

Fig. 3—Simplified schematic of some of the principal circuits of the trouble indicator

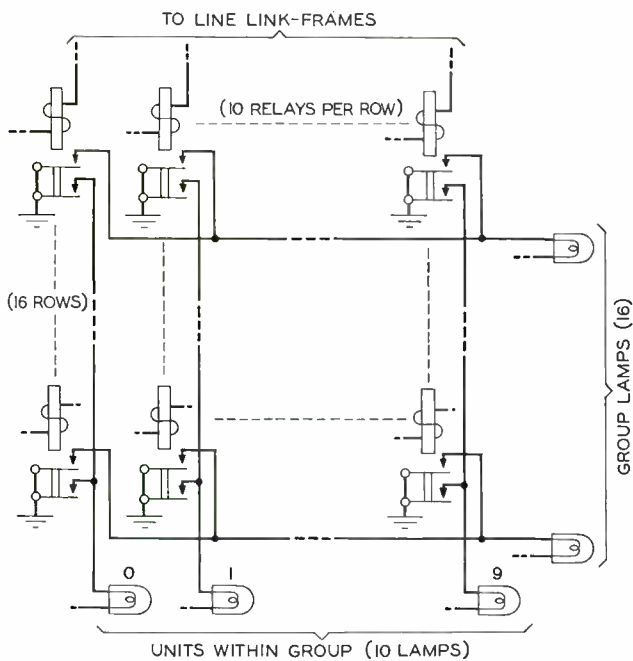

Fig. 4—Method of lighting group and unit lamps for the line-link frames

lay is connected with a set of three relays in the trouble indicator, and one of these, the FP relay, is operated by the closure of TI if the trouble indicator is not in use at the time. Relay FP, in turn, operates relay CL in the controller, and this latter relay makes connections over which the district junctor being used and the operating stage reached by the controller will be indicated, and also operates relay C in the trouble indicator. At the same time, the controller operates relays associated with the sender-link frame, the line-link frame, and the senders, and these transmit signals to the trouble indicator to indicate the various elements associated with the call at that time. Each of these signals operates a relay that establishes a path to a display lamp that will light through a display key that is usually kept operated.

The FP relays for all the sender-link controllers are connected together into a lock-out circuit. When one has operated, no other sender-link controller can be connected to the trouble indicator; either the FP relay will not operate, or the path over which it operates the CI relay will be open.

The timing circuit of the trouble indica-

tor, based on accepted principles, consists of the double-winding polarized CI relay with a condenser—short-circuited when relay TS is not operated—in the connection to one of the windings. When a DL relay operates, current flows in both windings of CI, but since these oppose each other, the relay does not operate. When relay C operates, the TS relay operates and opens the short circuit around the timing condenser. Current still continues to flow in the lower winding of CI for a short time while the condenser is charging. As the charging current decreases, however, a point is reached where the opposition of the lower winding to the upper is so small that the relay operates, and in turn operates RMI. This relay operates AL in the sender-link controller, and causes the timing circuit of the controller to restore relays TI and CI to normal and thus disconnect

THE AUTHOR: A. E. HAGUE received the B.S. degree in E.E. from Purdue University in 1912,



and then joined the North Electric Company at Cleveland, manufacturers of automatic telephone equipment. Late in 1913 he came to New York where, in the Engineering Department of the Western Electric Company, he was engaged in laboratory work on panel

equipment and in the application of various types of automatic switches developed for telephone purposes. During World War I he spent a year and a half with the field artillery as first lieutenant and then returned to West Street where, with the Central Office Switching Development Department, he was first associated with the development of some of the early types of step-by-step PBX equipments, and then with circuit design work for the panel and crossbar systems. During the recent war he engaged primarily in projects for the Armed Forces and more recently with the development of the automatic message accounting system.

the trouble indicator. It also releases the line-link frame so that a second attempt may be made to reach a sender.

When relay TS operates, it also operates GC, which supplies a holding connection for the relays associated with the indicating lamps so that these will remain operated after the trouble indicator is disconnected. Relays DL, C, TS, CT, and RMI are also held operated after disconnection. Relays DL, C, CT, and RMI hold themselves operated, while TS is held by C. With the trouble indicator in this condition, the display lamps will be lighted whenever the display key is operated, and the entire circuit may be released by the operation of the release key. Before release, the ground connection for the upper springs of the FP relays is open at relay RMI, and if any sender-link controller should attempt to establish connection to the trouble indicator, no ground would be returned to operate the CI relay. This would operate the DL relay and would light the CRL lamp to indicate that such an attempt was made.

The method of making connection to and operating the relays associated with the display lamps varies with the different groups.

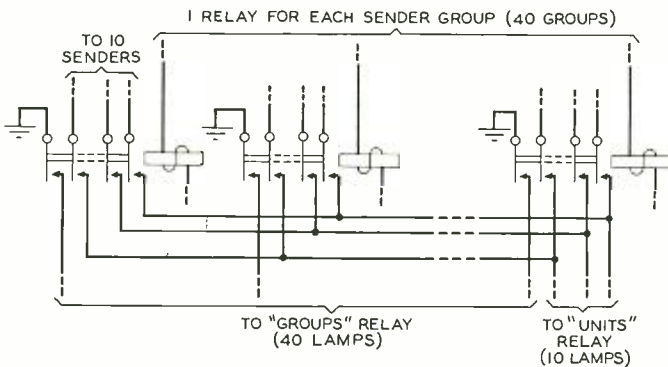

Fig. 5—Method of lighting group and unit lamps in the trouble indicator for the senders

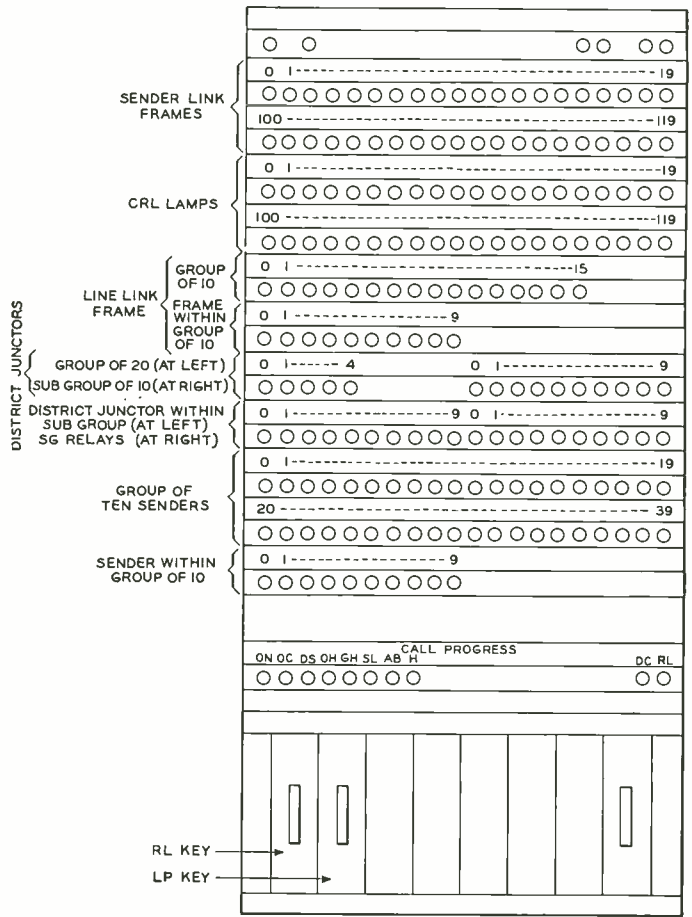

Fig. 6—Lamp arrangements in trouble indicator

Connection to the progress relays and certain others is made directly from the sender-link controller through the CI relay, which really consists of several relays operated as a unit to provide a large number of contacts. Senders, district junctions, and line-link frames are indicated by groups and units within the group. One method of doing this, used for the line-link frames, is indicated in Figure 4. Each line-link frame is connected to one of a bank of relays in the trouble indicator, and ground from the sender-link frame is passed to the line-link frame with which it is associated at the moment, and through a closed contact

there operates the associated relay in the trouble indicator. The operation of this relay will light two lamps: one, in the horizontal multiplying, indicates the group of line-link frames; and one in the vertical multiplying indicates the particular frame in that group. The same set of individual lamps is thus used for all the groups and the combination of a group and individual lamp completely identifies the frame involved in the trouble.

Another method, used for indicating the senders, is shown in Figure 5. With this method there is one relay mounted on the miscellaneous frames for each group of ten senders. The ten senders of each group are connected to ten springs of its group relay, and the front contacts of these springs are multiplied, so that only ten leads are carried to the trouble indicator. Each group relay also makes another contact that is carried directly to the trouble indicator. Each of

these latter leads operates a group relay and lamp in the trouble indicator, and the ten multiplied leads operate unit relays and lamps. Here also a group and a unit lamp definitely designate the particular sender.

The arrangement of the lamps on the sender-link trouble indicator is shown in Figure 6. Arrangement is made for two groups of sender-link frames, CRL lamps, and sender tens and these groups are differentiated by two series of numbers: 0-19 and 100-119. Frequently two central offices, and thus two groups of sender-link frames, senders, and markers are located in the same building and maintained from the same point, and this method of numbering provides a ready means of distinguishing between the two groups.

The sender-link trouble indicator is applicable to old as well as new installations, and conforms to the relatively inexpensive display-lamp arrangement.

CF-6-A CARRIER TELEGRAPH

FOR MANY APPLICATIONS of carrier telegraph to Army wire networks in combat areas four two-way telegraph circuits are adequate. These are provided by using a CF-2-B terminal* at each end of the circuit. Under such conditions, eight carrier bands are used, four in each direction, and if the facility is "two-wire" it must be capable of transmitting frequencies from approximately 400 to 2,100 cycles. Where traffic conditions require additional telegraph circuits, and the wire facility is capable of passing frequencies from approximately 300 to 2,400 cycles, two additional two-way telegraph circuits may be provided over a two-wire circuit by utilizing the CF-6-A carrier telegraph terminal together with the CF-2-B terminal at each end of the circuit. Where the facility is four-wire, twelve two-way telegraph circuits may be obtained by using two CF-2-B and two CF-6-A terminals at each end of the circuit, and operating each on a four rather than two-wire basis. The CF-6-A terminal shown is both smaller and lighter than the CF-2-B. Like the CF-2-B, it contains its own power supply.

*RECORD, May, 1944, page 404.

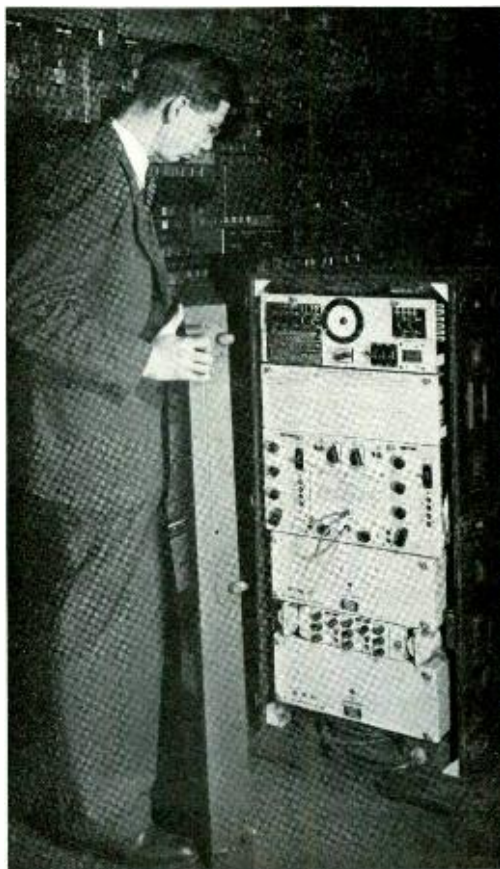



Relative Strength of Crossarms

By RICHARD C. EGGLESTON
Outside Plant Development

shape of the section. Thus, the value of the resisting moment in the graphs of Figure 1 are lower at the pinholes than elsewhere, and highest at the unroofed central portion of the arms.

For convenience in constructing the diagrams, it was assumed that the maximum load the arms would support was located at the end pin position. The graph of the bending moments produced by a load concentrated at one position on an arm is a straight line, because each moment is proportional to the distance between that load and the section under consideration. For any arm section the value of the bending moment is equal to the load multiplied by the distance between that section and the load point. When the magnitude of the bending moment for a given section exceeds its resisting moment, the arm will break. This is true whether the load be concentrated at a single point as in the moment diagrams, Figure 1, or distributed at several pin positions. Hence the maximum load an arm will support is the load that results in a bending moment just equal to the resisting moment of the critical section. Thus, by drawing a straight line from the end pinhole to a point as high as possible on the moment scale without intersecting the resisting moment graphs, a maximum bending moment graph is constructed and the load of such a bending moment graph will be the maximum that an arm that has the given resisting moment will sustain.

The value of these maximum loads was calculated by dividing the moment at the point of coincidence between the bending and resisting moment graph for each type by the distance from the corresponding critical section to the end pinhole. This point of coincidence is located at the pole pinholes, which emphasizes the need for keeping the pole pinhole sections reasonably free from strength-reducing defects. The moment reading at the point of coinci-

SEVERAL new types of crossarms have been approved for service. They are intended primarily for carrier toll lines where the circuits are point transposed.* The pinholes are located to provide various standard spacings between the wires of a pair and also between pairs, and at the same time to eliminate the need for several old type arms.

An estimate of the relative strengths of one of the new arms, known as Type W6, and of the old standard JW arm, which it replaces, was made by use of the moment diagrams of Figure 1. In this figure are shown graphs of the resisting moments of clear JW and W6 arms, together with graphs of the bending moments due to the maximum loads these arms can withstand when the loads are concentrated at the end pinholes of the crossarm.

The resisting moment of a crossarm is a measure of the internal stresses in any cross-section that balance the exterior forces acting on that section. The comparable measure of the external forces is called the bending moment for the section. The resisting moment depends on the size and

*RECORD, January, 1945, page 8.

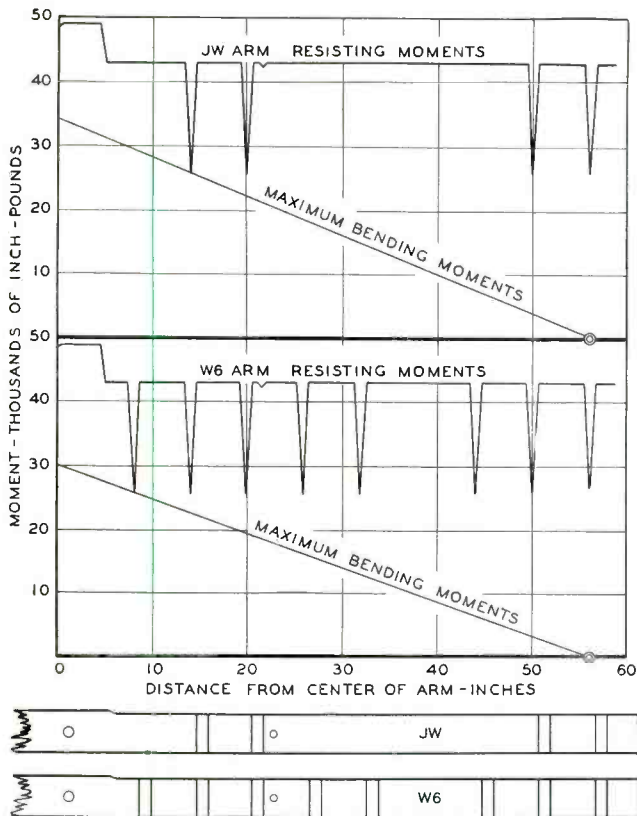

Fig. 1—Resisting moments of JW and W6 crossarms and corresponding maximum bending moments

dence was 25,550 inch-pounds, which divided by the distance to the end pinhole, 42 inches for the JW arm and 48 inches for the W6 arm, results in loads of 608 pounds for the JW and 532 pounds for the W6 arm—a difference of about 12 per cent.

The actual strengths of the two arms were also determined by tests carried out on ten matched specimens of each type. The arms were made of air-seasoned, clear Douglas fir from blanks $3\frac{3}{4}$ inches by $4\frac{1}{4}$ inches by 20 feet. Only straight-grained pieces free from manufacturing or other defects were chosen. Each blank was cut into two ten-foot lengths, one of which was made into a W6 and the other into a JW arm, thus providing matched, full-length specimens. Figure 2 shows one of the arms in an Amsler machine ready for test, and Figure 3 the same arm after failure. The average breaking load at the end pinholes was 1,159 pounds for the JW and 1,002 pounds for W6 arms. These loads are high compared with the

Fig. 2 (below, left)—A W6 crossarm mounted in an Amsler machine for a strength test

Fig. 3 (below, right)—The break occurs at one of the inner pinholes of the crossarm where the fiber stress set up is greatest

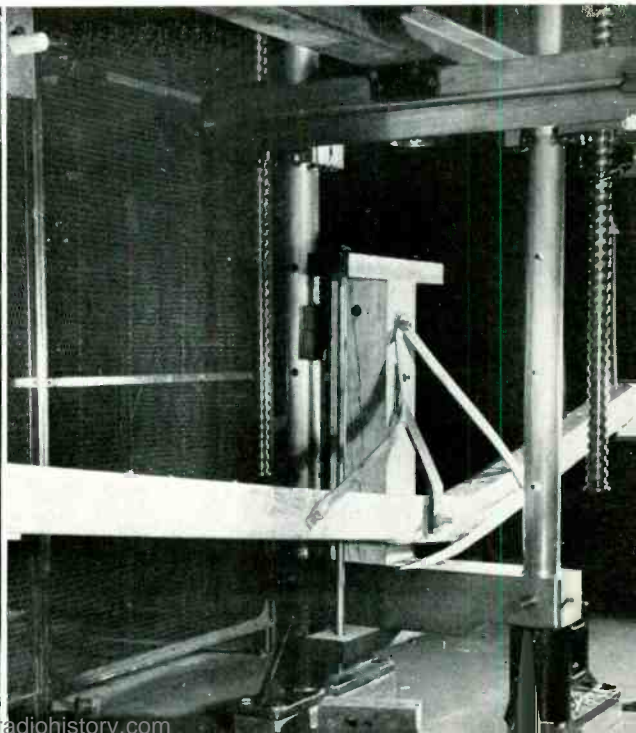
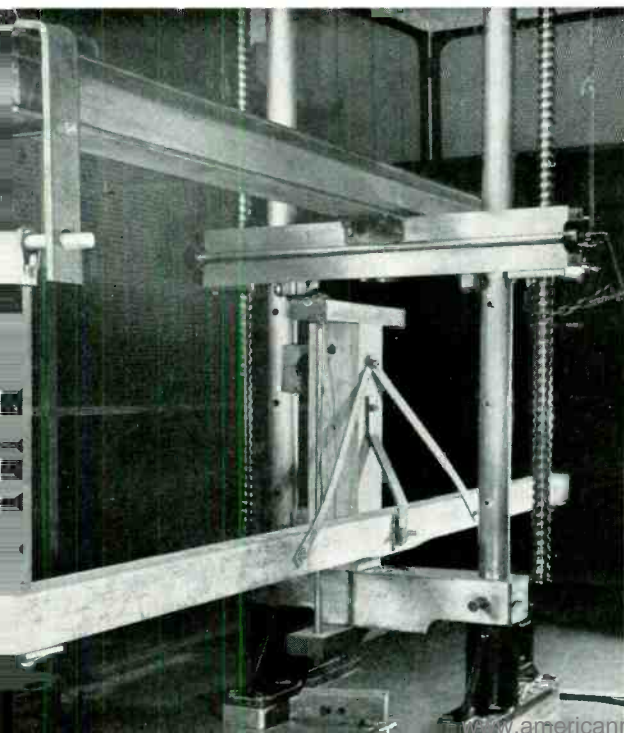

estimated breaking loads because the average ultimate fiber stress developed by the arms selected was considerably greater than that used in drawing the resisting moment graphs. This is not surprising in view of the exceptionally high quality of the test arms. Moreover, so far as the information sought is concerned—namely, to determine not the actual strength, but the strength relationship between the two types—the results would be the same regardless of the fiber stress factor used in computing the resisting moments.

The ratio of the strength of the W6 to that of the JW arm obtained by the actual strength tests was $1002 \div 1159 = 0.865$. By the moment diagrams it was $532 \div 608 = 0.875$. These ratios justify the belief that the moment diagram gives reasonably accurate estimates of the relative bending strengths of crossarms and the results obtained show a remarkably close agreement between theory and actuality.

THE AUTHOR: RICHARD C. EGGLESTON attended the Yale School of Forestry the year following his graduation in 1909 from Sheffield Scientific School. On receiving the degree of Master in Forestry he entered the United States Forest Service, where he was engaged in silvicultural problems until 1917. The following year he was employed in forest work



with the Pennsylvania Railroad. After serving a year as first lieutenant in the Army, on forest products projects, he returned to timber surveying with the Pennsylvania Railroad. In 1920 Mr. Eggleston joined D & R. He transferred to the Laboratories in 1927, where he has since been engaged in problems relating to the strength of timber and statistical investigation in this field.

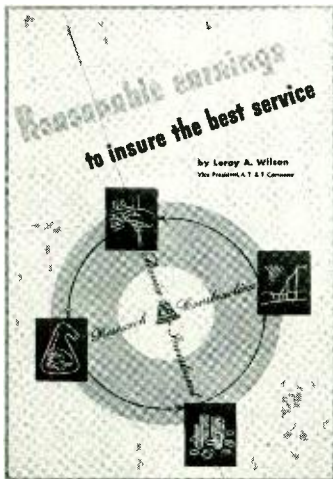

“There has never been a time in the history of this business when there have been more new developments capable of being translated into better and more valuable service for telephone customers,” says Leroy A. Wilson, vice-president of A T & T. “But let there be no mistake about it: in order to do the job that the System has the skill to do, it is going to need very large amounts of new capital and it urgently needs earnings adequate to enable it to obtain the necessary billions.”

Mr. Wilson backs up his statement in the pamphlet at the left, which is being distributed to supervisors in the Laboratories. Additional copies are available in the Library.

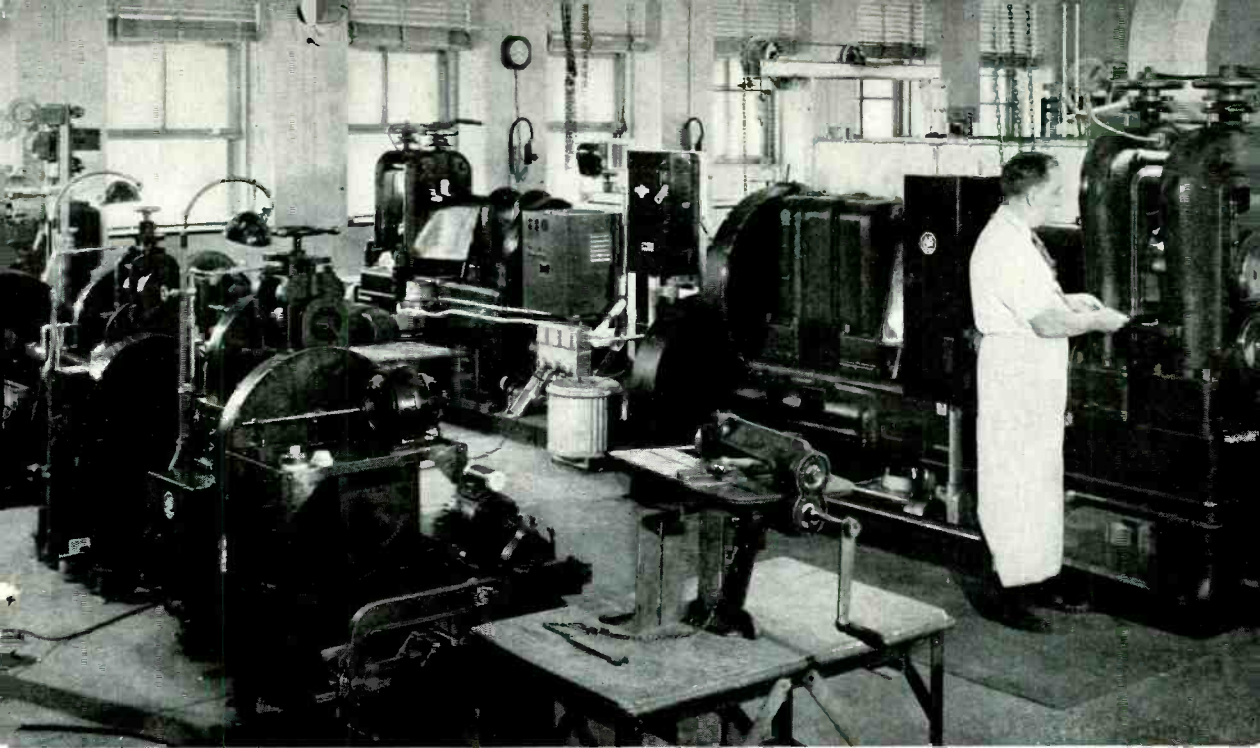

ROLLING MAGNETIC TAPE

Magnetic tape about one-tenth of the thickness of a human hair is rolled in the Metallurgical Laboratory at Murray Hill from a thirty-pound ingot five inches wide and an inch and one-half thick. More than two hundred thousand feet of tape, three-thirty-seconds of an inch wide, are produced from each ingot as shown in the photographs on this and the next two pages.

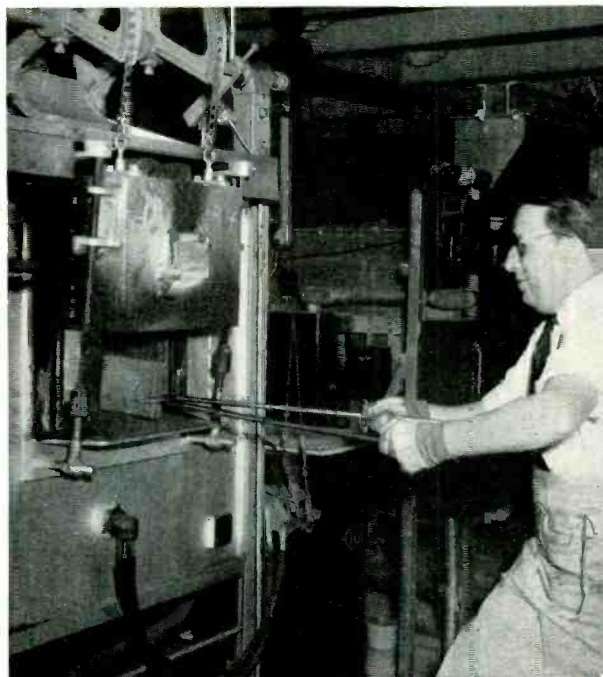
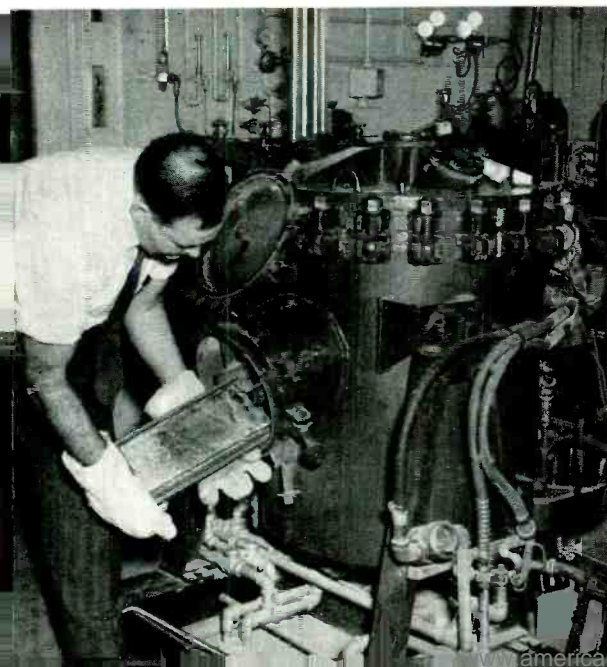

At the left, an ingot of a magnetic alloy is removed by P. H. Schmitt, Jr., from the controlled-atmosphere furnace where it was melted in a hydrogen atmosphere. Above, half of an ingot is placed in a furnace by R. J. Riley for heating to 1,200 degrees C. in preparation for hot rolling

Football Via Coaxial

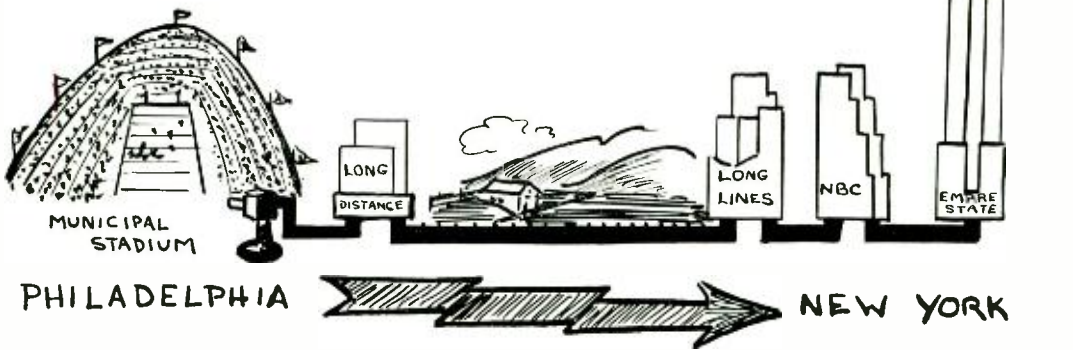

A BRIGHT new era in big-time spectator sports was forecast December 1 when a telecast of the Army-Navy football game in Philadelphia was flashed via the Bell System's intercity coaxial cable to New York for a broadcast by NBC. It was the first time in television history that a major sports event had been piped this distance from one city to another for broadcast.

The national passion for sports spectacles after the last war brought the 100,000-seat stadium and the million-dollar gate. With the projected extension of coaxial cable throughout the country, audiences would no longer be limited by the number of seats in a stadium or its distance from their homes. Spectators numbering in the millions may some day gather around their television screens to watch a single major contest, and television rights could become as important as sale of seats within the arena itself.

Although coaxial cable is particularly suitable for transmission of television pictures, it was originally designed in the Bell Laboratories as a channel which would carry hundreds of telephone messages simultaneously, each one riding on a different carrier frequency. It is essentially a conductor through which a broad band of frequencies will flow. High frequencies, passing through it, do not fade so readily with distance as they do in ordinary insulated telephone wire. In addition, since the cable by its design shields itself from outside electrical interference, the transmitted signals have a larger margin above noises which would mar the program.

Faithful transmission of television signals requires a band of frequencies several times wider than the band in which all normal commercial radio broadcasts are grouped. Thus the peculiar characteristics built into the coaxial cable for telephone purposes are precisely the qualities useful in television transmission. It will carry the whole broad band of television frequencies; the fading of high frequencies as they travel may be restored successfully by amplification.

The game at Philadelphia was televised at Municipal Stadium by three NBC television cameras and delivered through mobile control equipment and one thousand feet of flexible coaxial cable to a telephone terminal operated by The Bell Telephone Company of Pennsylvania. The signals were led along ordinary telephone cables, equipped with repeater amplifiers to restore fading, to the Long Distance Building at 9th and Race Streets in Philadelphia.

At the Long Distance Building the sig-

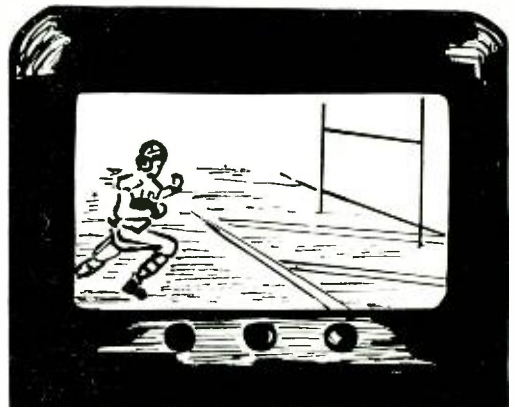

nals were modulated to slightly higher frequencies and funneled into the pencil-thick copper tubing of the coaxial cable to New York. The cable runs across the Delaware River and underground through the New Jersey countryside, past Newark, and under the Hudson River to Manhattan Island, where it emerges in the Long Distance Building at 32 Avenue of the Americas. Every five miles along the route, repeater-amplifiers boost the signals and kick them along to the next station. Since high frequencies are subject to more fading than low frequencies, they must be amplified a proportionately greater amount to retain the original balance over the broad frequency band.

At the New York Long Distance Building the signals were demodulated to the original frequencies and sent along a special shielded pair of wires to the NBC's television control equipment in Radio City. They needed amplification, even in this short distance. At Radio City they entered another coaxial cable, installed especially for television purposes, which leads to the broadcast transmitter on top of the Empire State Building. Here they left the wires and cables that had sheltered them over the long miles from Municipal Stadium and jumped the relatively short distance through the air to the television receivers in the metropolitan and surrounding areas.

Special equipment was necessary to carry signals to and from the terminals of the coaxial cable and to modulate them for transmission over the cable. This equipment was designed and fashioned in Bell Laboratories by groups working under J. F. Wentz, high-frequency transmission engineer, and L. G. Abraham, coaxial engineer. During the 4½-hour broadcast, members of the Laboratories, Long Lines and Associated Companies concerned manned the lines at strategic points to insure satisfactory transmission during this first post-war trial.

Please put your **RECORD** in the "Correspondence-Out" box when you are through with it so that it can be sent to a Serviceman's family.

The last previous event televised over the New York-Philadelphia coaxial cable was in 1940 when the Republican Convention was brought to New York viewing screens. Although the cable when fully equipped at its terminal will carry 480 telephone messages simultaneously, it will carry only one television program at a time, and for the present no other messages can go on the cable during the period of the broadcast.

Income and Expense Record Books



Income and Expense Record Books are again available for members of the Laboratories who are interested in them to keep personal financial accounts. You may obtain a copy of the booklet for 1946 by

contacting the Employee Service Department on Extension 435, Room 565, at the West Street building.

Employees' Benefit Committee Announces Changes in Plan

Revisions that have been made in the Plan for Employees' Pensions, Disability Benefits and Death Benefits that became effective on January 1, 1946, were outlined in a letter by R. L. Jones, as Chairman of the Employees' Benefit Committee, which was distributed to all members of the Laboratories. The booklet covering the Plan is being reprinted to incorporate these changes and will be given out shortly.

The principal changes in the Plan are: The minimum service pension increased from \$30.00 to \$50.00; elimination of need as a factor in granting disability pensions; death benefits to certain surviving beneficiaries of pensioners to be the final annual salary rate if death occurs during year following retirement, or, if death occurs later, this amount reduced by 10 per cent thereof for each year elapsed since retirement, but to not less than the annual pension; and half-pay benefits continued during the period of total disability on account of accidental injuries arising out of or in the course of employment in the Laboratories.

The Board of Directors also authorized

January Service Anniversaries of Members of the Laboratories

<p style="text-align: center;">40 years</p> <p>A. D. Hargan F. S. Malm</p>	<p style="text-align: center;">30 years</p> <p>J. M. Maxey W. B. Mosher H. A. Richardson</p>	<p style="text-align: center;">20 years</p> <p>J. H. Gray P. C. Ryder</p> <p style="text-align: center;">20 years</p> <p>H. P. Cummings Harry Ericson John Landers John Leonard James Marshall P. J. Nolan Anna Palmer</p>	<p style="text-align: center;">15 years</p> <p>L. C. Peterson W. C. Plumb John Rerecich L. A. Rich J. M. Rogie R. E. Wirsching</p> <p style="text-align: center;">15 years</p> <p>Martin Clohessy W. T. Cunningham J. R. Hendl</p>	<p style="text-align: center;">10 years</p> <p>J. N. McTighe Hermann Schwarz</p> <p style="text-align: center;">10 years</p> <p>Evelyn Apolant H. L. Bond H. L. Brunjes James Fagan R. J. Latsch Anna Surman Grace Torgesen</p>
<p style="text-align: center;">35 years</p> <p>R. P. Ashbaugh J. J. Catogge R. L. Young</p>	<p style="text-align: center;">25 years</p> <p>Carmel Campagna W. A. Evans</p>			

the Employees' Benefit Committee to decrease from ten to five years the period of employment required following a break in Bell System service in order that service prior to the break may be credited.

Radio Relay System Planned Between Chicago and Milwaukee

A series of the newest type of microwave radio relay stations, designed to handle television, sound radio programs, or long-distance telephone calls, is to be constructed between Chicago and Milwaukee, according to a recent announcement made by the American Telephone and Telegraph Company. The Long Lines Department has filed applications with the Federal Communications Commission for authority to build and operate this system on an experimental basis.

The radio relay system between Chicago and Milwaukee, which will cost about \$500,000, is expected to be ready for tests in the spring of 1947. It is planned initially to employ this system for television transmission in coöperation with television station WMJT in Milwaukee or with any other broadcaster who might be able to use the facilities during the experimental period. The early experiments will be on frequencies in the 4,000-megacycle range.

The terminals for the system will be at the Illinois Bell Telephone Company long-distance center in Chicago and at the Wisconsin Telephone Company's toll building in Milwaukee. There will be three radio repeater stations along the way, one near Barrington, Ill., another also in Illinois but near Wilmot, Wis., and the third in the vicinity of Prospect, Wis. Along the Chicago-Milwaukee route, the terrain is fairly level, so that station antenna towers about 120 feet in height will insure sufficient clearance for the straight-travelling microwaves. A building will be erected at the foot of each tower to house the power and other equipment that is needed.

Telephone Hour Rated First

Laboratories' families who listen to the Telephone Hour every Monday night will be interested to know how their own radio program stacks up in public esteem alongside other offerings. A national organization is retained by the Bell System to report on its continuing investigation as to what proportion of radio listeners are tuned in to a particular program. In November our program was first among nine comparable programs, and was rated equal to the average of all evening programs.

A separate index to Volume 23 of the RECORD will be mailed with the February issue to those who received it last year. Others may obtain it upon request. Bound copies of Volume 23 (January, 1944 to December, 1944) will be available in the near future—\$2.75, foreign postage 25 cents additional. Remittances should be addressed to Bell Laboratories Record, 463 West St., New York 14, N. Y.

O.E. BUCKLEY
R. L. JONES

DR. & MRS. F.B. JEWETT
WILLIAM FONDILLER



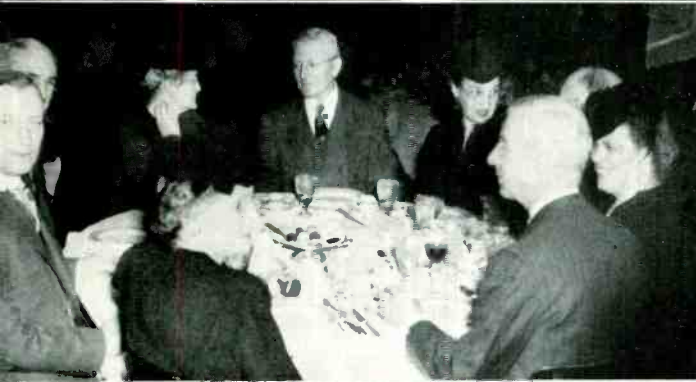

Telephone Pioneers Meet

Over eight hundred members and guests of the Frank B. Jewett Chapter of the Telephone Pioneers of America gathered at the Hotel Commodore on November 29 for the annual winter party. Following an informal reception and the dinner, M. B. Long, president of the Chapter, welcomed those attending and introduced the officers and the chairmen of the several committees. A program of entertainment and dancing, featuring Bob Cronin and his NBC orchestra, concluded the evening's festivities.

Radio Communication Courses for Associated Company Engineers

Last November the Laboratories completed the first of a series of three courses for training Associated Company engineers in radio-telephone communication. The purpose is to acquaint these men with the Bell System program for extending telephone service by the use of radio and to impart to them the radio systems engineering knowledge developed in recent years.

All categories of the current radio development program are being covered, but the emphasis is on radio systems for urban and highway vehicular service, and related applications such as rural, police and railroad services.

The physical and administrative facilities of the former School for War Training, now the Bell Telephone Laboratories Training School, are being utilized. In addition, all departments are participating by furnishing lecturers best versed in various specialties. In all, three courses are being given, each of six weeks' duration and each for about thirty-five Associated Company engineers. The second course will start on January 7.

At the completion of the first course, a dinner was given at the Downtown Athletic Club. Albert Tradup, Director of the Training School, acted as toastmaster and introduced speakers from the Laboratories, the A T & T and the Associated Companies. About eighty men attended, including the thirty-four who completed the course.

Dr. Isaiah Bowman Addresses Executive Conference

Dr. Isaiah Bowman, president of Johns Hopkins University and a director of A T & T, was the guest speaker at an executive conference in the West Street Auditorium on November 21. Introducing him, Dr. Buckley said that he felt Dr. Bowman's long experience as a geographer and his work on State Department Committees had given him a viewpoint in world affairs which would be of interest to leaders of the Laboratories at this time.

Dr. Bowman was an Advisor to the American Delegation at the San Francisco International Conference. Speaking of his impressions of the Conference, Dr. Bowman



Guest speaker at the Executive Conference on November 21 was Dr. Isaiah Bowman (center). Surrounding him are W. Fondiller, M. J. Kelly, W. H. Martin, R. L. Jones, and O. E. Buckley, who presided

said that at no time can Americans ever afford to ignore international affairs. His audience was accustomed to physical problems for which a solution can be found that will remain valid. However, in the field of international relations, the larger problems can never be solved, in the engineering sense; today's constants are really variables, which at some future time will yield a new solution. By the same reasoning, a failure to get the right answer is a failure for today only; we must pick up the problem at once and tackle it again.

Every citizen, said Dr. Bowman, must feel that he too is responsible for international affairs; he must concern himself with them in thought and speech, and exert himself to do what seems to him right.

Plans for Move to Murray Hill

The construction of additions to the present Murray Hill buildings is now under way, and they are scheduled for completion early in 1947. It is planned to occupy the new Murray Hill laboratories by transferring work from other locations of the Laboratories.

The plans call for the transfer of practically all of the Research Department from New York to Murray Hill. A large group of the Apparatus Development Department, including Transmission Apparatus Development, Station Apparatus Development and Electronics Apparatus Development, together with a portion of the Apparatus drafting and file groups, will be transferred from New York to Murray Hill. In addition,



Excavating in preparation for the addition to the Murray Hill buildings which is now under construction and which will more than double their present size

there will be a group selected from the various Staff Departments.

As yet it is not possible to specify the order of the moves or the exact date on which they will take place, but it is expected that the first moves will be during the early part of 1947, and that other moves will follow at intervals throughout the year. Management earnestly desires that every individual involved in this transfer have the longest possible time to appraise the situation which confronts him personally, and accordingly, as soon as it can be determined that the transfer of any individual to Murray Hill is definitely indicated, he or she will receive a personal notification to that effect. On receipt of a notification, anyone who is confronted with personal problems by virtue of the change of work location may consult D. D. Haggerty, who has been designated to act as Personnel Counselor in connection with the move.

Long Distance, TWX and Private Line Rates Reduced \$20 Million

Reductions in interstate rates estimated to save users more than \$20,000,000 a year will become effective February 1, 1946, according to an announcement made recently by the A T & T and the Federal Communications Commission. Approximately \$17,500,000 of this reduction is in long-distance telephone rates, principally for distances be-

tween 340 and 2,140 miles. Rates for teletypewriter exchange service for distances of more than 350 miles will also be reduced \$1,000,000. Also, rates for private-line telephone, teletypewriter and telephotograph for the longer hauls are being reduced.

The FCC in making its announcement said, "In its consideration of these reductions, the Commission was mindful of the tremendous post-war program ahead of the Bell System, including the restoration of plant, the expansion of rural service, and the overall improvement and extension of service, in line with developments in the art. This overall program, calling for some \$2,000,000,000 in new money, is expected to provide thousands of jobs and to aid in the Nation's reconversion program."

President Walter S. Gifford of A T & T said that the reductions had been occasioned by discontinuance of accruals to the company's employment stabilization fund. These have been made since the latter part of 1943 to take care of maintenance expenses which would have been incurred during the war years had it not been for lack of manpower and materials. Viewing Bell System earnings as a whole, he said there is nothing in the present or near future outlook that would justify any rate decreases whatever; in fact, the level of the System's earnings in recent years has been the lowest in its history, except for the

worst years of the depression. However, the reductions were made on the showing of the interstate traffic by itself, which is under the exclusive jurisdiction of the FCC. Earnings on the interstate portion of the business have been abnormally affected by the extraordinary volume of long-distance calls and by the temporary overloading of the long-distance plant.

Mr. Gifford also stated that looking to the future he was pleased with the Commission's appreciation of the tremendous post-war program which lies ahead of the Bell System Companies.

Television Transmission of the Army-Navy Game

During the Army-Navy television transmission, described on page 24, the Laboratories supervised the operation of the line facilities from the Municipal Stadium in Philadelphia to the Empire State building with assistance from Long Lines personnel. C. N. Nebel, stationed at the National Broadcasting Company control room in New York City, was in direct charge during the entire program. Connection to the Na-

tional Broadcasting Company mobile television equipment at the Stadium was in charge of H. C. Hey, who was assisted by R. W. Gutshall and by B. J. Thomas of Western Electric. The television terminal equipment at Race Street in Philadelphia was supervised by J. R. Brady with the assistance of J. H. Bacon of Western Electric. The operation of the coaxial circuit was in charge of B. Dysart, who was stationed at the Long Lines building in New York. Working with him along the line were O. M. Akey at Princeton and W. R. Greer at the Philadelphia coaxial terminal. To assist in clearing possible troubles, of which there were none, C. L. Cahill and O. D. Grismore were stationed along the coaxial line out of Princeton with Long Lines personnel standing by with them. A. R. Kolding and H. E. Powell, stationed at the terminal in the Long Lines building at 32 Avenue of the Americas, were in charge of the demodulating equipment where the signal was received from the coaxial cable. A. F. Mott, stationed at the National Broadcasting Company Studio, took care of the video circuits from the Long Lines building.

The softball league championship at Whippany was won by the "South Wing Slobs." Here we see W. A. Jakob (left), Bell Laboratories Club representative at Whippany, presenting the trophy to A. K. Kulaszewski, captain of the team. The others, left to right, are J. D'Agostino, H. Miller, R. A. Fritts, C. Cannon, H. R. Saunders, E. I. Bulman, W. S. Ballantyne and J. L. Sherry. J. Hendl and U. S. Fowle were also members of the team



News Notes

THE A T & T has announced the availability of its Frank B. Jewett Fellowships for a second year. These post-doctorate fellowships in the physical sciences, including chemistry, mathematics and physics, carry an award of \$3,000 to the fellow and an honorarium of \$1,500 to the academic institution where his or her research is pursued. Announcement of the awards will be made on February 1, 1946.

W. H. HARRISON, vice-president of the A T & T and a Director of the Laboratories, has been elected the eighth recipient of the Hoover Medal. This Medal is awarded by representatives of the national societies of Civil, Mining, Mechanical and Electrical Engineers "to a fellow engineer for distinguished public service."

O. E. BUCKLEY visited the Western Electric Company Point Breeze plant in Baltimore on November 14. On November 16 and 17, Dr. Buckley was in Philadelphia for the joint meeting of the American Philosophical Society and the National Academy of Sciences.

M. J. KELLY addressed the Management Group of The Bell Telephone Company of Pennsylvania on November 5 at Franklin Institute on the subject *Bell Laboratories Contribution to the War Effort*. Dr. Kelly also attended the joint meeting of the American Philosophical Society and the National Academy of Sciences that was held in Philadelphia on November 16 and 17.

THE HONORARY DEGREE of Doctor of Science was conferred on R. M. BURNS, Chemical Director, by his alma mater, the University of Colorado, at commencement exercises there on October 20, 1945. Dr. Burns also holds B.A. and M.A. degrees from Colorado University. He received his Ph.D. at Princeton University in 1921 and has been associated with the Laboratories since 1922.

H. D. HAGSTRUM's talk on *Generation* delivered December 6 was one of six lectures in a course on the fundamentals of *Radar* given at Vail Hall in Newark, N. J. This

series was sponsored by the New Jersey Activities Committee of the A.I.E.E., for the convenience of those living in New Jersey who found it inconvenient to attend the lectures in New York.

AT THE MEETING of the Deal-Holmdel Colloquium held at Holmdel on December 7, E. B. FERRELL delivered a paper on *Glass-Sealed Relays*.

C. A. WEBBER, H. H. STAEBNER and W. V. THOMPSON visited the Point Breeze plant of the Western Electric Company to discuss cord development problems.

E. B. WOOD and N. INSLEY were at Hawthorne on matters pertaining to lamp caps and switchboard lamps. While there, Mr. Wood took up the subject of enamelled wire.

R. A. SYKES in Philadelphia conferred with RCA and Philco engineers on crystal requirements for FM receivers.

Fire Control Radar was the topic of a paper which W. H. DOHERTY presented on December 8 to the Radar Symposium sponsored by the New York Section of the Institute of Radio Engineers.

G. H. HUBER was in California for several months to cooperate in radio relay tests being conducted under the auspices of the Signal Corps and Army Air Forces.

W. D. MISCHLER visited the Atlanta, Jacksonville and Washington toll offices to make observations and special installation tests on coaxial telephone terminal equipment. L. R. Cox also visited the Washington toll office in the same connection.

LABORATORIES men who participated in recent tests of a new type sonar equipment on the U.S.S. *Semmes* were D. ROBERTSON, J. B. GARDNER, H. W. HEIMBACK, JR., J. J. McGEENEY and A. C. KELLER.

Tests were made at New London; in Casco Bay; off Port Everglades, Florida; and off Nassau in the Bahama Islands.

O. M. AKEY, C. L. CAHILL, M. E. CAMPBELL, B. DYSART, G. B. ENGLEHARDT, G. R. FRANTZ, O. D. GRISMORE and F. A. JANISZEWSKI, JR., have visited Philadelphia, Washington and points between in connection with tests of the new coaxial system.

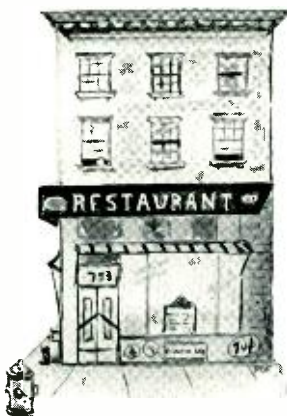



Visiting With Our Servicemen

Col. A. M. Elliott

"I came to Korea with the initial occupation forces early in September. The people here are proud and very conscious of the historical background of Korea and look down on the Japanese as upstarts. The extent of Japanese investments here is amazing—complete industrial cities with warehouses full of supplies and factories full of excellent machinery. The country has a hydro-electric power generating and high-voltage transmission system superior to any I have seen. Every native hut is served. My assignment is Signal Officer, Army Service Command in Korea. Existing communications facilities are fairly good in quality but short in quantity by our standards."

Lieut. Robert S. Williams

"Am assigned here in Trinidad as Signal Construction Officer. When it stops raining, Trinidad is a wonderful place—January and February are supposed to be dry—I'll be here then, and many months thereafter, too."

Capt. Oscar Y. Otero

"Last Sunday we took a trip to Cooch Behar to visit the palace of the Maharaja, Bhup Bahadar, of Cooch Behar. This is an independent state south of Tibet. The Maharaja has his own militia, and the only

thing that I can say is that everything you hear about them is true. They live in luxury while the people die of diseases and starvation. The palace is a big affair with all the trimmings. We had lunch at the bungalow for guests. What a bungalow! The hostess is a French lady who was married to the uncle of the Maharaja. We had an elephant ride through a trail in the jungles. On my job, I had to go to Myitkyina, Burma, Kunming, China, and Chahua and Calcutta in India."

William R. Spenninger

From Guam, Bill Spenninger writes that: "We brought a little monkey back from Okinawa with us. He goes wild in the plane, and it takes two men to hold him. Our bombardier started to call him 'Pajories' after a live volcano north of Saipan, so that's his name now."

Carl W. Bachmann

Carl W. Bachmann covered most of the southern portion of the American zone in Austria while serving with the Counter Intelligence Corps and made many friends there. He claims that he speaks English with a German accent now. Currently, he is located in Darmstadt, Germany, with the Political Intelligence unit of the Military Government, dealing with the selection of



Alfred T. Stiller sent this photograph of himself from Austria

new German government people. Carl is an investigator and interrogator for facts concerning these people, and in the course of his work says he has access to the full secret report of the Potsdam meetings.

John A. Zweig

"Receiving the B. T. L. RECORD really is a morale booster, and makes a fellow feel that the people at home haven't forgotten them even though the war is over.

"Am being kept pretty busy, what with occupational duties plus working at P. W. cages remodeling and constructing new barracks for S.S. troops this winter."

William L. Willdigg

"I am now in Tokyo, as we landed on the first of the month. I have worked in the Tokyo Central Office, which is all dial, and I am now repairing all Japanese switchboards the Army wants to use. Very interesting over here. I hope to see you all next spring."

Capt. Lester H. Hofmann

Capt. Lester H. Hofmann is now able to disclose that he has been working on the radio proximity fuse for the past 18 months as Plans and Training Officer for the

teams of officers and men that introduced this ammunition into all theaters of operation. This also included field trials, writing manuals and indoctrinating trainees at the National Bureau of Standards where this principle of fusing was applied to non-rotated projectiles such as bombs, rockets, and mortar ammunition.

* * * * *

JULIAN M. WEST has returned to the Laboratories following a personal leave of absence to work as a consultant to the Army Air Forces.

DONALD A. LOUGHLIN, a veteran of Okinawa, where he discharged cargo during forty-nine air raids, is aboard the U.S.S. *Arcturus* in the Pacific.

WARREN J. BOO is now stationed at Camp Hood, Texas.

MARSHALL L. GLAAB, stationed at the naval base, "Johnston Island" in the Pacific, is a radio technician with the Air Transport Command.

ALEXANDER E. LAWSON reports that he is with with the occupation forces in Korea, having come from Okinawa.



Major Harold B. Guerci writes: "Since the end of hostilities, I have had the good fortune to visit Czechoslovakia, Austria, and Italy. The photograph shows me at a Siemens-Halske electron-microscope in a war research laboratory in Heidelberg"

CECIL G. STEWART completed aviation radioman's school, aviation radar operation, naval air gunner's school, and is looking forward to getting his aircrewman's wings at Ft. Lauderdale, Fla.

GEORGE H. REINHARDT was one of the lucky GI's to receive a furlough to the Riviera.

LIEUT. WILLIAM E. ARCHBOLD has been transferred to Stewart Field at West Point, where he is instructing flying cadets half the day and has classes in gunnery and armament the other half.

JOSEPH KOCAN, located on Guam, says he is doing clean-up work rather than radio and repair work, now the war is over. He is, however, taking a review course in calculus "to keep his hand in."

DOUGLAS W. GRAHAM is working on Usingen repeater station of Berlin-Frankfurt circuit, a modern underground system built in 1939.

WILLIAM N. LEUFER is a few miles from Keijo, the capital of Korea, with the occupation forces.

MORGAN F. HICKEY "had a wonderful time" in Ireland while on furlough from France. He sends regards to all the boys in the Plant Department.

FRED C. RUPPENSTEIN visited his uncle, B. A. NELSEN, at West Street before going overseas as an aviation mechanic on a B-29. MAJOR FRED B. MONELL met C. E. NELSON and T. L. McCANN recently. FRANK L. PETRY has finished boot training and is awaiting radio school.

VICTOR SILZER completed a course in math and physics at the Shrivenham American University in England. He is now in Nuremberg working in the Palace of Justice in connection with the international military tribunal.

JOSEPH H. HILL at Haiku, T. H., works with the radio which transmits direct to San Francisco and Washington, D. C.

THE FOLLOWING MEMBERS of the Laboratories on military leaves of absence have recently been promoted: E. L. Fieldhammer, RM 1/c; M/Sgt. A. Haas; M/Sgt. Ralph Nelsen; S/Sgt. John Scharf; Clifford Underhill, PhM 3/c; Sgt. R. B. Burns; D. A. Loughlin, FC 3/c; J. W. Hoell, ART 1/c; W. P. Weiler, CSF; Corp. C. W. Bachmann; Capt. O. Y. Otero; Corp. Stanley Wojtaszek;

T/4 Clarence Anderson; T/Sgt. A. O. Christiansen, Sgt. Elizabeth McIlravey; Pfc. Joseph Stordeur; T/5 E. M. Kennaugh; Margaret Kenny, AerM 2/c; 1st Lt. J. A. Lasco; C. G. Stewart, ARM 3/c; T/4 J. M. Sullivan; R. M. Gambon, S 2/c; Pfc. J. E. Cronin; and H. B. Compton, RT 1/c.

Lieut. Robert F. Healy Officially Declared Dead



Lieut. Robert F. Healy, 1924-1945

Lt. Robert F. Healy was the pilot of a P-47 (Thunderbolt) fighter plane which departed from England on a combat mission to Frankfurt, Germany, on November 5, 1944. During his return flight at 2:10 p.m., east of Orfordness, England, and over the English Channel, a radio message was received from Lieut. Healy that he was going to bail out, as his plane was having difficulty. No further word was received, and searching parties failed to locate him. Accordingly, after the elapse of one year, the War Department has officially listed Lieut. Robert F. Healy as presumptively dead as of November 6, 1945. He is survived by parents and a brother. His father, MALACHI F. HEALY, is with the Advertising Department of the New York Telephone Company at 140 West St., New York City, and his brother is a member of Pan American Airlines in the maintenance division.



We Welcome Back



Major Irving C. Osten-Sacken

Major Irving C. Osten-Sacken had many interesting experiences during his military service. The accompanying illustration shows him with Haile Selassie during a 45-minute interview. The Emperor's favorite mastiff was camera shy, but afterwards Major Osten-Sacken managed to take a head-on view of the dog which prompted Selassie's effusive gratitude.



Major Irving C. Osten-Sacken with Emperor Haile Selassie

In 1942 he received a direct commission and proceeded to Bolling Field, D. C., where he was pilot and flight operations officer before reporting to MacDill Field, Fla., as flight commander of the 16th Photo Squadron. He spent four months photographing Haiti, Puerto Rico, Brazil and British Guiana and then went overseas on November 15, 1944.

Their first task was to rapidly photograph along twenty-mile-wide strips the air routes our planes would fly to the Middle and Far East. Thereafter, they more leisurely photographed Africa, Arabia, Persia, India, Italy and France with thirty geodetic ground officers, three airplanes, and nine officers in the 7th AAF Geodetic Control Squadron, over which Major Osten-Sacken had charge. Three times African tribes attacked their camp site. They flew over the treacherous Belgian Congo usually forbidden to air travel, and Major Osten-Sacken took an eight-day hunting trip during which he bagged the ferociously wild buffalo and returned home with his plane filled with Frank Buck-looking trophies.

Lieut. Col. Richard A. Devereux

The National Guard brought Lieut. Col. Richard A. Devereux into active duty in February, 1941, when he was assigned with the 207th C.A. at Camp Stewart, Ga. In 1942 he instructed anti-aircraft artillery tactics at Ft. Monroe, Va. In 1943 he joined the 8th Bomber Command in England as Flak Officer and returned to the States early in 1944 to run a Flak Analysis School for training Army and Navy Flak Officers at Camp Davis, N. C. His next assignments were to the AAF Headquarters as Flak Officer and in Europe to the U. S. Strategic Air Forces until after V-E Day. For his service in the development and establishment of principles and procedures of Flak Analysis, he was awarded the Legion of Merit.

Major M. Maxwell Bower

Major M. Maxwell Bower has resumed work after serving three years and a half with the Signal Corps. For his first two months, he was Officer-in-Charge of Military and Civilian Personnel, General Development Branch of the OCSO. He was next assigned as Officer-in-Charge of the carrier telephone and telegraph and the wire and cable sub-sections of the Ground Signal Equipment Branch. During this time he went to Africa with 6,000 tons of this material and assisted in the introduction of carrier telephone and telegraph cable and rapid pole line. In November, 1943, he transferred to the Signal Corps Engineering Laboratory, Brad-



Maj. Gen. Elwood R. Quesada presenting Legion of Merit to Lt. Col. Richard Devereux for his work on Flak Analysis



MAJ. M. M. BOWER LT. A. R. PARKER



MICHAEL SHEEHAN CAPT. S. T. BREWER

ley Beach, N. J., and was Control Officer of the Eatontown Signal Laboratory for one month. He organized the Systems Engineering Branch at the Evans Signal Laboratory, endeavoring to compile information on communications systems engineering to coordinate developments within the Signal Corps. From May until his release he was Chief of the Radio Direction Finding Branch of the Evans Signal Laboratory.

Lieut. Arthur R. Parker

Lieut. Arthur R. Parker, U.S.M.C.R., was indoctrinated at the Aviation Ground Officers' School in Quantico, Va., and transferred to Corpus Christi, Texas, to study airborne radar while serving as a company commander at the N.A.T.T.C. From there he transferred to St. Simon's Island, Ga., and studied more navigation and shipborne radar gear, together with flight director officer and air defense command center work. At Congaree Field, Columbia, S. C., he acted as operations and training officer, air operations officer and chief day fighter controller for two months before his final transfer to Eagle Mountain Lake, Texas, where as executive officer and night fighter controller of the Air Warning Detachment with a command of one hundred and fifty men, he controlled approximately four hundred night flight interceptions.

Michael Sheehan

Michael Sheehan, in 1942, was assigned to the 25th Engineers, 6th Armored Division, and trained in Camp Chaffee, Ark., the Louisiana maneuvers, Mojave Desert and Camp Cook, Calif., before arriving in England in February, 1944. From there he went through five battles in Luxembourg, Belgium and Germany, building bridges, doing mine sweeping, infantry and demolition work.

Capt. Sherman T. Brewer

As a reserve officer, Capt. Sherman T. Brewer was placed on active duty March 13, 1942. He attended the Signal Corps School at Fort Monmouth for five months and was sent to Camp Murphy, Fla., assigned to the 560th Sig. A. W. Bn. and on the staff and faculty of the radar school there. From there he transferred to Orlando, Fla., where he took a radar staff officers' course and became radar officer of his battalion with which he went overseas on December 12, 1942. They went to Africa and in January, 1944, went to Corsica, where Capt. Brewer planned the radar operations for the northern half of the island in conjunction with British and American officers. In September, 1944, they moved to Leghorn, Italy, where he planned radar dispositions and operations during the stalemate in the Apennines and later the Po Valley offensive in which he personally participated and was awarded the Bronze Star Medal. At the conclusion of the war, he instructed a radar officers' school in Fano, Italy.

Lieut. Comdr. Charles A. Hebert

Lieut. Comdr. Charles A. Hebert has returned to his former department from active naval duty which began in July, 1941, at which time he spent over a year as Communications Officer for the Ambrose Section of the Inshore Patrol based in Staten Island. He studied underwater sound and matériel for three months at the Fleet Sound School, Key West, Fla., and



The Laboratories has employed 429 veterans of World War II



LT. COMDR. HEBERT



LT. COL. SHEPPARD



LT. R. J. KOECHLIN

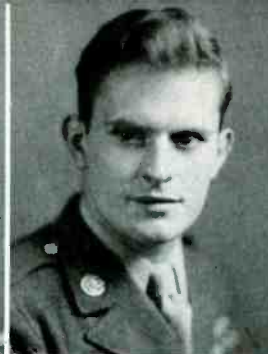

G. F. HALL



J. M. MARKO

was thereafter assigned to the destroyer tender U.S.S. *Denebola* as Communications Officer during one year of Atlantic duty. From November, 1943, to June, 1945, he was Communications Officer for the task group operating PT Squadrons and participated in the New Guinea campaign, the occupation of Morotai and the Philippine liberation.

Lieut. Col. Hubert A. Sheppard

Lieut. Col. Hubert A. Sheppard, who had been a reserve officer, was ordered to active duty in February, 1942. He worked one month at the Office of the Chief Signal Officer before his transfer to the AAF, where he was attached to the Office of the Director of Air Defense. This later became the Air Communications Office and, as Officer-in-Charge of the Radar Branch, he supervised the specification, development, procurement and allocation of ground radar. A portion of his time was spent in traveling around the States to manufacturing concerns, to training places such as Drew Field to check up on training personnel and Orlando, Fla., to observe tactical and operational tests.

Lieut. Robert J. Koechlin

Robert J. Koechlin started military service in July, 1941, and trained at Camp Croft, S. C. After five months as a machine gunner at Fort Simonds, Jamaica, B. W. I., he transferred to OCS at Fort Benning, Ga., and was commissioned in July, 1942. Lieut. Koechlin served eighteen months overseas in Hawaii, New Caledonia, Guadalcanal, the Russell Islands and saw action at Rendova in the New Georgia campaign. He was wounded and evacuated to the States, where he remained at Camp Wolters, Texas, until his discharge.

John M. Marko

Cpl. John M. Marko has been reinstated following military service which took him to the Fort Monmouth Signal Corps School in April, 1943, for seven weeks, through the ASTP program at Randolph-Macon College, Va., and overseas with the 95th Division. As a telephone switchboard operator he served with the Third Army through France, Belgium, Luxembourg, Holland and Germany and returned to the United States in July.

Gerald F. Hall

S/Sgt. Gerald F. Hall was an infantry squad leader with the 104th Division of the First Army through the campaigns in France, Germany, Belgium and Holland. He was awarded the Combat Infantryman Badge, three battle stars for Northern France, the Rhineland, and Central Germany, and the Purple Heart. He was evacuated on the *George Washington*, the same ship he went over on, and was transferred to Camp Upton Convalescent Hospital, from which he received his C. D. D.

Lieut. Col. Malcolm A. Specht

Lieut. Col. Malcolm A. Specht was called to active duty on January 23, 1941, with the National Guard in the 186th Field Artillery Regiment. He was stationed in New York and then attended Field Artillery School in Fort Sill, Okla. He spent some time at Fort Ethan Allen in Vermont and then returned to Fort Sill to instruct in gunnery until at Camp Maxey, Texas, he activated a field artillery battalion which he commanded. In March, 1944, he was sent to England as a liaison officer at the British School of Artillery at Larkhill, from which he returned to Camp Hood, Texas, as Execu-

W. J. DOUGLAS

M. P. ROSATO

LT. P. W. FOY

H. V. BERLIN

D. SPICCIATI





W. N. BUTLER

C. E. SMEDBERG

LT. COL. M. A. SPECHT

LT. E. J. MOSKAL

J. F. GULBIN

tive Officer of the 220th Field Artillery Group. Upon completion of training, he and his group returned to England and participated in the battle of the Rhineland with the Third Army until they stopped at the Inn River. After V-E Day, Col. Specht handled displaced persons at Regensburg and Munich. He was awarded the Bronze Star Medal for his meritorious achievement in making a reconnaissance under fire.

Lieut. William N. Butler

Lieut. W. N. Butler has returned from military leave of absence after spending approximately three years in the Army Air Forces. He received his wings at Stuttgart Air Field, Arkansas. Most of his piloting was done in a B-24 while flying gunners who were making training films. In connection with piloting research, he flew ships in gunnery training at Laredo Army Air Field, Texas. On two or three occasions Lieut. Butler piloted L. J. SIVIAN.

Carl E. Smedberg

Carl E. Smedberg, MM 2/c, was assigned to naval base duty in Oran, Arzew and Bizerte in Africa before the invasion of Sicily. During the invasion, he landed ammunition and supplies with a beach battalion at Gela, Sicily. He stayed in Palermo, Sicily, for two years in charge of the machine shop which repaired bombed ships and landing craft. Upon returning to the States, he attended Gunner's Mate Electric Hydraulic School, Washington, D. C., until discharged.

Lieut. Edward J. Moskal

Lieut. Edward J. Moskal has been reinstated following his release from the Army Air Forces. He enlisted in September, 1943, and pursued

a navigation course culminating in his commissioning at Selman Field, Monroe, La., on December 23, 1944. Thereafter he was assigned to crew phase training in B-24's and B-29's at Mountainhome, Idaho, until he was assigned to the navigation of B-32's.

Mario P. Rosato

Mario P. Rosato has been reinstated in the Laboratories after serving approximately four months as a rifleman in the infantry at Camp Blanding, Fla. He reports that the camp is situated on a monotonously level, sandy plain and that he is delighted to be back in hilly country again.

William J. Douglas

Coast Guardsman William J. Douglas, S 1/c, underwent boot training at Manhattan Beach before assignment to the U.S.S. *Bibb*, a cutter converted into a communications ship. As a quartermaster striker, he stood wheel watches during their travels to Africa and Sicily on convoy duty and later to Okinawa, where his ship acted as flagship for mine craft.

James J. Viggers

James J. Viggers started military service in May, 1942, and chauffeured a colonel so efficiently for a year and a half at Camp Kilmer, N. J., that the colonel took him to the Brooklyn Army Base as a general clerk. He then transferred to the corps training center at Camp Plauchie, La., and subsequently went overseas. Sergeant Viggers operated traffic control posts during three of the Seventh Army's battles in France and Germany. At the end of the war he was stationed in France before returning home on the *Queen Mary*.

J. HAUSLER

J. J. VIGGERS

J. M. JACKSON

ENS. J. H. RILEY

H. E. EARL





PATRICK CONNOLLY

W. C. HEATON

John F. Gulbin

John F. Gulbin, glider pilot, began active duty in 1940 when he was assigned through the National Guard mobilization to the 245th C. A. A. at Fort Hancock, N. J. In 1942 he transferred to the AAF and underwent glider training at Lubbock, Texas, until January, 1944, at which time he was rated a Flight Officer. Overseas, he served sixteen months as a glider pilot in France, Holland and England for which he was awarded the Air Medal, Presidential Unit Citation, Bronze Arrowhead (signifying invasion) and battle star. On a flight over Holland he was shot down and was also awarded the Purple Heart.

Robert J. Hausler

Robert J. Hausler enlisted in the Navy in November, 1942. After a short assignment at Tompkinsville, S. I., he attended radio school at Corpus Christi, Texas. He was assigned to the Naval Air Training Station, Miami, Fla., where he maintained and installed radio gear on PBM flying boats. Perhaps the proximity to airplanes gave him the desire to be a flyer. At least he applied for flight training and took pre-flight at St. Mary's College, San Francisco, Calif., and primary training at Ottumwa, Iowa. Shortly after he soloed on his birthday, the war was over and he was discharged.

Ensign James H. Riley

Ensign James H. Riley has returned from the Merchant Marine to his former drafting job in the Research Drafting Department. He attended radio school at Hoffman Island in April, 1943, and went on sea duty as a radio operator from October until his release. While serving on two freighters, he saw England, France, Italy, Egypt, Arabia, India, South Africa and South America. They were twice attacked by submarines, but his closest call was with a V-2 bomb in England.

Lieut. Philip W. Foy

Philip W. Foy, who attained the rank of first lieutenant in the Army Air Corps, has returned to work at Murray Hill. Following his training, he was assigned as a B-17 pilot in the Eighth Air Force and for eight months was stationed in England. On his thirty-fourth combat mission, the bomber which he was piloting was badly hit over an air field in Germany. The crippled plane was maneuvered back to the coast of England and crashed. Lieut. Foy was thrown clear of the wreck and spent six and one-half months in the hospital.

Harold V. Berlin

T/4 Harold V. Berlin entered the Army on September 17, 1943. Immediately after basic training at Fort McClellan, Ala., he shipped overseas from Fort Ord, Calif., to New Caledonia for permanent assignment to the Island Command Headquarters, where he handled secret and confidential correspondence.

Lieut. Robert Angle

Robert Angle received aviation training at Chapel Hill, N. C.; Fort Eustis, Va.; State College, Pa.; and Selman Field, La., and was commissioned on September 4, 1944. He was sent overseas in January, 1945, and assigned to the 448th Bombardment Group, 8th Air Force. Lieut. Angle completed twenty-five combat missions, bombing Berlin, Magdeburg, Munich, Brunswick and Munster, during which he survived several crash landings.

Ward C. Heaton

Ward C. Heaton, formerly of the Commercial Relations Department at Murray Hill, has been reinstated there after approximately thirty-one months of Army service, twenty-four



R. C. EISELE

ENS. D. W. MACK

Leaves of Absence

As of November 31, there had been 1,018 military leaves of absence granted to members of the Laboratories. Of these, 184 have been completed. The 834 active leaves were divided as follows:

Army 447 Navy 285 Marines 29

Women's Services 73

There were also 19 members on merchant marine leaves and 6 members on personal leaves for war work.

Recent Leaves

United States Army

Frank Bresk Andrew F. Hackett
John J. Downes John F. Nicholas
Gustave H. Tillwitz

of which were spent overseas at air bases in England and France, attached to the ground forces of the 27th Photo Reconnaissance Squadron. He wears a European theater ribbon with six battle stars for his group's support of offensive operations in Normandy, Northern France, Ardennes, Rhineland, Central Europe and the air offense over Europe, and also the Presidential Unit Citation.

Daniel Spicciati

Daniel Spicciati was attached to the Seabees in the 15th Naval District maintaining naval bases in Ecuador and Panama. Although classified as a Chief Storekeeper, he spent most of his time doing yeoman work in connection with personnel records. One of his unit's recent jobs was putting two floating drydocks through the canal sideways because of their bulk.

Jesse M. Jackson

Jesse M. Jackson was assigned to sea duty almost immediately after leaving the Laboratories in June, 1942, and engaged in navigation and signal work as Assistant to the Officer of the Deck. It was his responsibility to maintain all equipment on the bridge. His assignments took him mine sweeping off the Atlantic Coast and through Mediterranean waters off the coast of Africa. His ship also did escort work during the African invasion.

Herbert E. Earl

Herbert E. Earl was overseas with the 8th Air Force approximately one year, and served

as Flight Officer-Navigator on a B-17. A total of 408 hours' flying time accrue to his credit, of which 113 hours was combat flying, during which he navigated over France, Holland, Belgium, Germany, England. He returned to the United States by way of Iceland and Greenland. He navigated aircraft over land and water under varying flying conditions such as adverse weather, anti-aircraft, enemy action, low altitude and small arms fire.

Patrick Connolly

Patrick Connolly, on military leave of absence since August, 1943, attended several Navy schools for training in fire fighting and in boiler room work. He served for eight months on the U.S.S. *Eichenberger*, a destroyer escort, in the invasion of New Guinea. For nine months he was on the U.S.S. *Topeka*, a light cruiser, in the final stages of the Pacific operations. The *Topeka* played a substantial part in the destructive shelling of the radar installations around Tokyo Bay.

Howard J. Reed

Howard J. Reed was first stationed in Williamsburg, Va., with the Seabees and thereafter was transferred to the Naval Landing Port Equipment Depot, Albany, Calif. He studied the landing of amphibious tractors for eleven months at the Naval Air Technical Training School, Norman, Oklahoma, and was sent overseas in January attached to Headquarters and Supply, 5th Amphibious Tractor Battalion, USMC. He was in Eniwetok, Guam, Saipan and Iwo Jima where his unit received a Presidential Citation for its maintenance work.

Robert C. Eisele

R. C. Eisele, Air Cadet, spent eight months at Dartmouth in the Navy V-12 program and three months in Flight Preparatory School at Rensselaer Polytechnic Institute; also five months in the Pre-Flight School at the University of North Carolina. His primary and most of his intermediate flight training were completed prior to his discharge from the Navy.

Ensign Donald W. Mack

Ensign Donald W. Mack has returned to work at the Plant Department at Murray Hill. Most of his time while in service he piloted single and multi-engined planes to tow targets for other planes and ships to shoot at. During one tour of duty, the plane he was piloting was hit by flak fired from a carrier. At various times Ensign Mack also piloted planes for photographic and mapping work and for radar calibration measurements.



ELLEN MEYER, a refugee from Germany, was only twelve when she arrived in New York without any knowledge of English. Six years later, in 1943, when she came to the Laboratories, she had not only mastered English via a short period of kindergarten training and then four years at Hunter College High, but she had completed a war training course, gained business experience in other concerns and lost completely any trace of a foreign accent. Miss Meyer is in the filter group of Transmission Apparatus

Development, where her work as a technical assistant has included such jobs as the wiring and testing of filters and the measuring of all components for networks. She has also tried her hand at simple network designs and has carried them through to completion.

When asked what more accomplishments a child raised in Germany had than an American youngster, Miss Meyer could think only of juggling, a feat which is stressed abroad because it trains a child in eye and body control and in balance. Other than that she engaged in the same sports in New York—skating, swimming, hiking and tennis—as she did in Worms and Lautern, where she spent her childhood. She is interested in weaving, an art she learned from her father, who designs and weaves by hand gold, silver and jewelled threads into exquisite cloth from which evening gowns, evening bags and other luxury accessories are made.

* * * * *

IDA WIBERG's round-robin letters to some forty servicemen of the Apparatus Staff Drafting Department have become a byword among servicemen everywhere. The round-robin is ten or twelve pages of single-spaced type in which the serviceman reads the answer to his own letter and answers to twenty or thirty other letters as well. Current addresses of all servicemen



ELLEN MEYER

from the drafting group are appended to the round-robin so that the men may keep in touch with all their friends in service.

Miss Wiberg has answered the men's letters at home in her free time and has had the round-robin mimeographed at the Laboratories. During the war that left her little time for anything except Red Cross surgical work and Red Cross knitting—she did a great number of sweaters, mufflers, sox and gloves. Now, however, she plays bridge, goes to the theater and motion pictures, and reads all her favorite magazines: *Readers' Digest*, *Cosmopolitan* and *Good Housekeeping*, which she prefers to books.

With the exception of one year at I T & T, Miss Wiberg's Bell System service has been at the Laboratories, which she joined after graduation from Eastern District High School. She has been a member of the Systems Department stenographic group, a special typist in Apparatus Staff and secretary to R. R. IRELAND (retired); she is now secretary to W. A. BISCHOFF.

* * * * *

SHOWN below, framed by voluminous folders of correspondence concerning sub-

stitute materials used during the war, is DOLORES ABBAMONTE. Miss Abbamonte is a member of the Central Files, where she is responsible for the preparation of en-

gineering correspondence for the files and for filing it in the case folders. Upon graduation from John Adams High School in the June, 1944, class, she entered the Laboratories as a mail clerk and was soon promoted to her present position. One of her after hours interests is dancing; another is bowling with the Bell Laboratories Club; swimming at the Hotel St. George is a third interest. However, most of her spare moments are spent corresponding with a chap who is now in the Navy. For some weeks past, she and

friends in the Files have been planning a week-end in the Poconos, where they hope to participate in winter sports, especially skiing, a newly acquired hobby.

* * * * *

FOUR YEARS of substituting as a relief typist in the Financial Department had prepared ANNE COOPER, formerly of Transcription, for the opportunity of transferring to the financial group when the occasion presented itself two years ago. Miss Cooper,



IDA WIBERG



in addition to general typing, handles monthly schedule checks and monthly vacation pay. She is also responsible for the daily summation of the Imprest Fund account representing the balances of the four cashiers of the Laboratories, two at West Street, one at Murray Hill and one at Whippany, and for the issuance of checks from this account. During vacation periods she acts as cashier and bookkeeper.

Miss Cooper is an all-round sportswoman who enjoys bowling, ice skating, and hiking with a group of friends in her home community, Ridgefield. She is interested in the theater, too, and is a subscriber to the Theater Guild. Her sister, ELSIE COOPER, is a member of the Laboratories in the Apparatus Staff Department.

* * * * *

SYLVIA COHEN brought to Bell Laboratories exceptional training in radio when she joined the Systems Development Department last February. During the previous two and a half years she had worked at Fort Monmouth Signal Corps Ground Signal Agency and the Monmouth Procurement District at Bradley Beach and had traveled for the Signal Corps under whom she had received intensive radio training. She had done fundamental radio research as well as work on the procurement of the



SYLVIA COHEN

proximity fuse, a radar-directed fuse for bombing. Here at the Laboratories in the Switching Engineering group, Miss Cohen is engaged in the preparation of parts catalogs for naval and airborne radar equipment, work which requires the ability to read and to interpret circuit and equipment drawings and their associated stock lists, as well as the ability to visualize for descriptive purposes apparatus from drawings.

Miss Cohen is attending New York University evenings, taking advanced work in Economics, particularly in mathematical statistics, in which she majored at Brooklyn College, having been graduated in 1942. Her home is in Passaic, and her interests are the theater and ballet, good books, and the piano.

* * * * *

WHILE STUDYING at St. Joseph's College, Brooklyn, JEAN WILSON had unknowingly prepared for her present position in the General Service Department by serving as a teacher-in-training at Jamaica High School and as a truant officer. Miss Wilson now assists in the supervision of mail girls at West Street and in the Chambers, Fourteenth, and Eighteenth Street buildings, as well as in the Davis building. To supplement her training she is studying Psychology, History and French at New



ANNE COOPER

York University, the French being on her agenda to keep her primed for the realization of her biggest ambition, to visit France, particularly Paris, as soon as travel restrictions and her time allow.

At college, Miss Wilson joined in many activities, among them fencing, debating—she was president of the debating club—and dramatics; she was also treasurer of the class of '44 and advertising manager of the school paper. Now her interests are studying evenings for her master's degree; teaching a Sunday school class at Bellrose, where she lives; and corresponding with a young naval radar specialist due home soon from France.

* * * * *

LUCILLE MENGES' first opportunity to utilize her training in chemistry and physics, which she studied at Hunter College, came three years ago when she joined the Metals Engineering and Specifications group of the Chemical Laboratories. Miss Menges' work has included the testing of metals to determine their physical properties, and the x-ray inspection of assembled apparatus and castings. The development of some secret devices, such as rockets and of wave guide for radar, was aided in a small degree by this work. In the accompanying photograph she was preparing to x-ray magnesium castings to determine general soundness and presence of possible defects. With G. R. GOHN she is co-author of a paper shortly to be submitted to the ASTM on *Atmospheric and Indoor Aging Studies on Some Aluminum and Zinc-Base Die Casting Alloys*; she has also had a byline in an earlier ASTM technical paper dealing with



the corrosion properties of various metals.

Miss Menges lives on Staten Island with her mother and three sisters. In the winter-time she spends considerable time on her hobby, photography, developing and printing pictures which she takes. The rest of the year she is kept busy with her garden and her duties as a nurses' aide at St. Vincent's Hospital on Staten Island. Her interest in contemporary fiction and non-fiction is allied to her interest in English, in which she has taken several post-graduate courses. She also reads a great deal of technical material pertinent to her work in the Chemical Laboratories. For the first time in several years Miss Menges has time to enjoy ice skating and tobogganing, two sports in which she is proficient.



JEAN WILSON WITH ELLEN MENZINGER AND IRIS MCLEAN



GLIMPSES OF CHRISTMAS GIFTS FROM THE LABS TO THE NEEDY

Above are members of the Doll and Toy Committee at West Street; to the left its Chairman, Tene Sullivan, flanked by Wille Harris and Florence Dvorsky; and just below, Mary Mahairs, of the Graybar-Varics committee. In the lower left are Josephine Kowaleck, Joan Thomas and Bette Swayze of Whippany's committee, and directly below are Gladys Sanderson and Ruth Bowerman, of the Murray Hill committee.



Engagements

John E. Cavallero—*Margaret Talbot
Albert L. Martiny—*Elizabeth Belleri
Anthony R. Petrillo, U.S.A.—*Elaine Arlotta
Harry W. Petry—*Ellen Flad
William W. Reid, Jr.—*Margaret Latsha
Frederick J. Thompsen—*Mildred Avoglia

Weddings

Ens. James Doherty, U.S.N.R.—*Margaret Kilroy
Ens. Frank W. Lindberg, U.S.N.R.—*Effie Ross
Stephen McDonald—*Betty Laureys
Alfred E. Ruppel—*Martha Keller
E. Loyd Skinner—*Claire Gibson
Charles A. Stodgell, U.S.M.C.—*Ann Anderson
Lieut. Robert C. Torgesen, U.S.N.R.—*Grace Haas

*Members of Laboratories. Notices of engagements and weddings should be given to Helen McLoughlin, Room 803C, 14th Street, Extension 296.

News Notes

THE FOLLOWING MEMBERS of Bell Laboratories are serving on Technical Committees of the Institute of Radio Engineers for the term ending May 1, 1946: A. C. Keller, J. F. Morrison, *Annual Review*; J. F. Morrison, S. A. Schelkunoff and J. C. Schelleng, *Antennas*; H. W. Bode and A. F. Pomeroy, *Circuits*; A. C. Keller, *Chairman*, and R. A. Miller, *Electroacoustics*; R. L. Dietzold and J. C. Schelleng, *Handbook*; W. L. Bond, R. A. Sykes, and W. P. Mason, *Piezoelectric Crystals*; J. F. Morrison, *Chairman*, and J. C. Schelleng, *Radio Transmitters*; S. A. Schelkunoff, *Radio Wave Propagation and Utilization*; A. C. Keller and J. F. Morrison, *Standards*; A. F. Pomeroy, *Symbols*; A. G. Jensen, *Television*; S. B. Ingram, J. A. Morton, and A. L. Samuel, *Vacuum Tubes*. Mr. Samuel is also chairman of the I.R.E. subcommittee on *Advanced Developments*.

A. R. KEMP and F. S. MALM have been appointed to serve on the Rubber Technical Committee of the Civilian Production Administration which will replace the War Production Board in the duty of furthering an orderly transition from wartime to peacetime production of rubber products.

ANNA K. MARSHALL gave an illustrated talk before the New York State Historical

Association on November 18 at their Headquarters House in Ticonderoga, N. Y.

E. B. FERRELL is the author of a paper *The Servo Problem as a Transmission Problem* in the *November Proceedings of the Institute of Radio Engineers*.

C. D. HOCKER attended a regional outside plant engineering conference held at San Francisco.

T. C. HENNEBERGER visited Chicago, Omaha, Denver, and St. Louis to discuss outside plant testing requirements with associated company engineers.

C. H. AMADON was in Hawthorne recently to review lumber supply problems involved in the manufacture of central-office rolling ladders.

The Morristown Little Theater

An interesting after-hours activity of Laboratories members was brought to light on November 30 and December 1 when eleven thespians from various Laboratories



locations assisted in *But Not Good-Bye*, a comedy in three acts presented by the Morristown Little Theater group at Morristown High School. The cast included CLEMENT LAWSON of Murray Hill; MURIEL LAZEAR, ALBERT KALL and H. M. WATTS, all of Whippany, and MANFRED BROTHERTON of Fourteenth Street. As Production Manager, T. A. WILLIAMS, on loan to Whippany from the Illinois Bell, was assisted by H. A. STONE of West Street; by E. A. KRAUTH, Whippany, in charge of lighting; by ELIZABETH JENTZEN, Whippany, in charge of publicity and programs; and by MARIE LUHR and HELEN BENZ, both of Whippany, who were ushers.

"The Telephone Hour"

NBC, Monday Nights, 9:00 p.m.

January 7	Lily Pons
January 14	Josef Hofmann
January 21	Nelson Eddy
January 28	Helen Traubel
February 4	Jascha Heifetz

John J. Lohrey, 1882-1945

JOHN J. LOHREY, a member of the Development Shops who retired in 1941 after



forty years of service, died on December 2. Mr. Lohrey joined the manufacturing organization of the Western Electric Company as a milling machine operator and later became a foreman. In 1913, when the group moved from

New York to Hawthorne, he went to Chicago but returned to the Development Shop of the Engineering Department at West Street in the middle of the following year. During World War I he was placed in charge of the night shift of a newly formed milling machine group working on special Government work. Since that time and until his retirement he had been concerned with milling machine work.

News Notes

C. J. CALBICK, R. D. HEIDENREICH, J. J. LANDER and H. H. STORKS attended a meeting of the Electron Microscope Society of America at Princeton. Mr. Heidenreich, who is a director in the society, gave a paper entitled *Investigation of Etched Metallic Surfaces by Electron Diffraction and Electron Microscope*. This work was done at the Dow Chemical Company before Mr. Heidenreich's recent transfer to the Laboratories.

W. E. CAMPBELL presented a paper on *Carbon-Brush Wear* at the lubrication session of the annual meeting of the American Society of Mechanical Engineers. Mr. Campbell also attended the regional conference on *Statistical Quality Control* held at Princeton University.

Thermal Neutron Scattering Studies in Metals, an article by F. C. Nix and GEORGE F. CLEMENT, appeared in the October 1 and 15, 1945, issues of *Physical Review*.

M. D. RIGTERINK has accepted an invitation to serve on a ceramics research advisory committee which will assist in directing the

ceramics research program at Rutgers.

R. G. KOONTZ, R. E. OTTMAN and T. T. ROBERTSON conferred with representatives of the Navy Bureau of Ships in Washington on November 1 in regard to microfilming of manufacturing drawings.

J. W. WOODARD and E. J. QUINN visited the Illinois Bell Telephone Co., the Michigan Bell, the Ohio Bell, also the Western Electric Co. at Hawthorne, to discuss analytical work on current orders.

E. T. BALL and H. C. BROWN visited the Dahlstrom Metallic Door Co. at Jamestown, N. Y., on November 7, to discuss new types of sheet metal frames.

J. G. FERGUSON was at Hawthorne during November on problems relating to the No. 5 crossbar system.

DURING the month of October the United States Patent Office issued patents on applications previously filed by the following members of the Laboratories:

B. S. Biggs	A. A. Lundstrom
H. S. Black	K. Lutomirski
W. L. Bond	R. F. Mallina
A. R. Bonorden	L. A. Meacham
S. T. Curran	C. G. Miller
A. C. Dickieson	E. W. Niles
C. J. Frosch (2)	H. Nyquist
L. A. Gardner	K. W. Richards
H. C. Harrison	M. D. Rigterink
W. R. Harry	H. H. Spencer
R. V. L. Hartley	L. K. Swart
R. H. Hose	E. P. Williams
K. S. Johnson	S. B. Williams

L. W. MORRISON is now back at the Graybar-Varick building after two and a half months in Guam where he acted as Radar Officer for the 20th Bomber Command while the results of the action against Japan were being studied.

P. T. SPROUL and C. N. NEBEL were in Philadelphia and Washington, D. C., on November 15, in connection with provision of television terminal and video amplifier facilities for the Army-Navy game and for television on coaxial service to be inaugurated between Washington and New York on the first of January.

J. W. GEILS visited the General Electric Co. in Schenectady on November 16 in reference to thymotrol drives.

