



Properties of Paracon

By B. S. BIGGS
Chemical Laboratories

WHEN the development of paracon, a new synthetic rubber, was announced by the Laboratories,* its resistance to oil and heat and its low brittle point, lack of odor and fast curing cycle were emphasized. Not all of these characteristics can be held at maximum values in every composition, but various combinations of them can be obtained by selecting the intermediate compounds used in manufacture. This follows because the paracons, in contrast with most elastomers, comprise a group of compounds rather than a single one.

Chemically, the paracons are chain esters

*RECORD, *May*, 1943, p. 300.

of high molecular weight which are made by combining organic acids and alcohols. Among the substances that may be used are sebacic and succinic acids and ethylene and propylene glycols. These chemicals are obtainable from agricultural, coal and petroleum products. Some of them are manufactured in reasonably large quantities but they are inadequate to produce the huge tonnage of rubber used in this country. For this reason and also because of its characteristics, paracon will probably remain a specialty product.

Paracon gums are light colored, translucent or transparent resins which resemble milled natural rubber. They can be com-

pounded on rubber mills with many of the common rubber ingredients. Some samples may be handled on rolls by the usual rubber technique, but others are so sticky that special equipment is required.

Like natural rubber, the paracons can be vulcanized with sulphur and sulphur accelerators when they are sufficiently unsaturated, that is, have carbon atoms capable of combining with other groups. For many applications, however, it is desirable to have products that are free from sulphur and anti-oxidants. These can be obtained by vulcanizing paracon with about one per cent of benzoyl peroxide. Much less unsaturation is required for the peroxide than for the sulphur vulcanization, usually from three to four per cent. If the amount of peroxide is increased to four or five per cent, very satisfactory cures can be obtained on a gum which contains no unsaturated carbon atoms. Peroxide-cured paracon is practically odorless and thus is suitable for many

applications where odor is objectionable. Furthermore, the vulcanization is controlled entirely by the amount of peroxide used and the degree of unsaturation built into the molecule. Therefore the product does not over-cure with prolonged heating, although the cure is very fast.

When long chain dibasic acids are used in preparing paracon, products with very low brittle points can be obtained. If high resistance to oil is desired, a short chain acid is chosen in which the ratio of oxygen to carbon atoms is high. Paracons derived from short chain compounds are completely inert to oil and gasoline and are swollen only about twelve per cent by immersion in toluene. Furthermore, these paracons are particularly stable against dry heat. Samples have still been found serviceable after being kept at 150 degrees C. for forty-five days, a condition which no other rubber will withstand.

The tensile strength of properly compounded paracon stock averages about 1,700

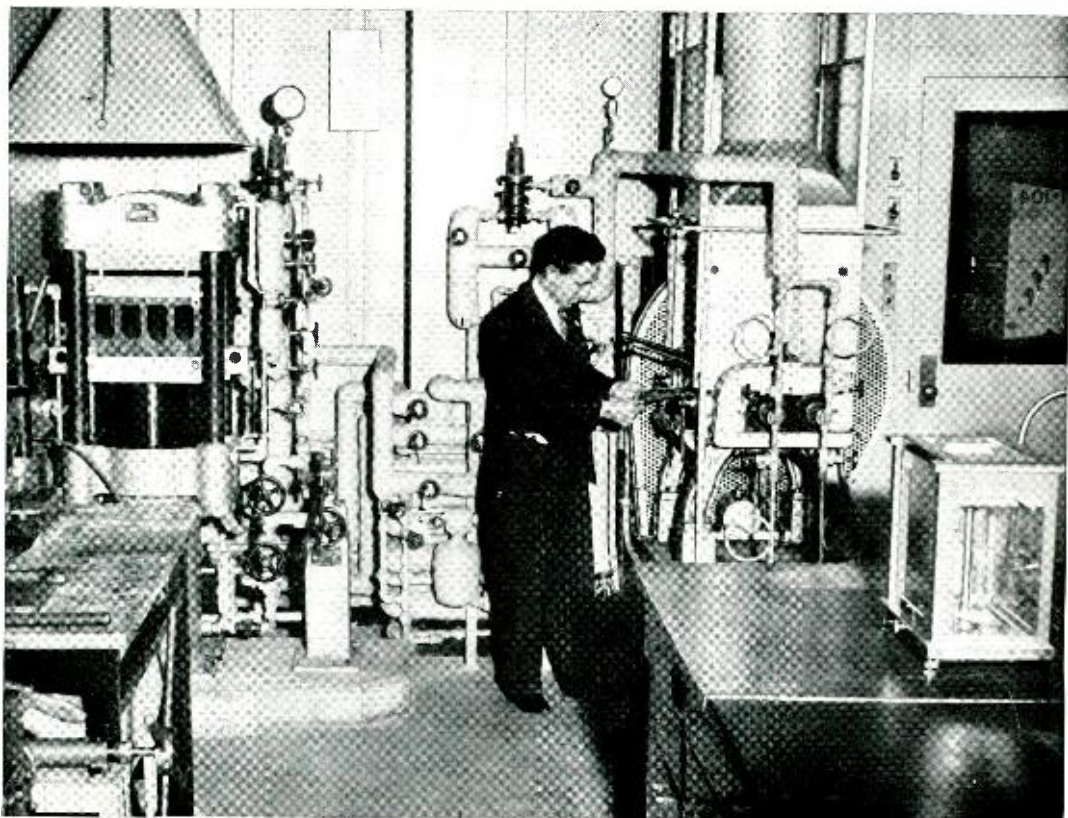

Some of the paracons are compounded on rolling mills like natural rubber; others require special mixing equipment. C. J. Frosch is taking a sample of paracon from the rolls

pounds per square inch but samples have reached 3,000 pounds. Elongation at break in some paracon compounds is as high as 600 per cent, although the average is approximately 400 per cent.

The relatively low resistance of the paracons to alkaline and acid solutions and to steam is due to their tendency to react with water but resistance to this tendency is quite good at room temperature in products derived from long chain paraffin-like acids. Their electrical properties are also inferior to those of natural rubber for insulation and they are not suitable for tire construction, because carbon black interferes with the vulcanization reaction. Suggested applications include special tubing, gaskets, extruded articles of many varieties, coated fabrics, adhesives, binders and ignition-cable coverings in automobile and airplane engines and other similar uses.

One of the important results of this development is the light that it throws on rubber structure. Many of the paracons exhibit crystal formation when examined in the stretched state by X-rays. Since the reaction of organic acids with alcohols, which is used in making the paracons, is highly controllable as compared with the processes commonly required to produce synthetic rubbers, they have more uniform and better defined structures than most of the synthetic elastomers. The size and structure of the molecular chains can be controlled independently with considerable precision. In



B. S. Biggs (left) measures a sample of paracon which has been soaked in gasoline to show its resistance to swelling as C. S. Fuller looks on

this way much can be learned about the influence of these various structural features on elastic qualities.

Paracon is one of the incidental results of a peacetime study of plastic materials carried on under the supervision of C. S. Fuller. Others associated with the development and contributing to its success include W. O. Baker, W. S. Bishop, R. H. Erickson, C. J. Frosch and J. B. Howard.

THE AUTHOR: B. S. BIGGS graduated from South West Texas Teachers' College with the degree of A.B. in chemistry in 1927. He taught science two years at the Texas City High School before starting graduate work at the University of Texas where he received an A.M. degree in 1931 and the Ph.D. in 1933. The following three years Dr. Biggs spent at the Coal Research Laboratory of the Carnegie Institute of Technology at

Pittsburgh. He came to the Laboratories in 1936 to work on organic chemical problems connected with dielectric materials and insulation. Since 1940 most of his time has been spent on plastics and it was in connection with this work that the rubber-like properties of some of the polyesters were discovered. With the war and the shortage of rubber it became worthwhile to develop, as rubber substitutes, these materials.



Inspecting and Determining the Axis Orientation of Quartz Crystals

By G. W. WILLARD
Crystal Research

IN PASSING from the mountains and streams of Brazil to the intricate interior of a radio transmitter, quartz crystals undergo a long and complicated processing. In their finished form, these thin plates of quartz must vibrate accurately at one preselected frequency regardless of temperature and other surrounding conditions, and to attain this ability, they must be accurately cut and ground along planes making definite angles with the basic crystal structure. In addition, the finished plates must be free from defects of many kinds so that no irregularities in their behavior will occur, and so that their rapid expansions and contractions will not cause them to break, and thus render inoperative a complex and expensive piece of fighting apparatus, and interrupt communications at a vital moment.

Although in one form or another quartz is widely distributed throughout the earth's crust, forms most suited for electrical work

are found chiefly in certain sections of Brazil. Here it is encountered either embedded in rock formations near the surface or in river beds. Presumably, the water flowing over quartz deposits has washed the crystals free and carried them downstream. In river quartz the natural faces have been eroded away, leaving rounded stones. Crystals broken from their original formation may be entirely defaced, and look like a piece of glass, but often retain at least some of their natural faces. In size, they range up to 800 pounds, but crystals of the latter size are extremely rare. For the most part they are 20 pounds or under, with the most common sizes being from one-half to one pound. In color, they vary from clear to smoky and even to black. For the most part, only the clear or lighter shades are used in electrical work, and any color existing is not evident in the finished plates.

In the original crystallization of quartz, foreign substances, either other minerals or

bubbles of gas or liquid, may be included, and part of the inspection procedure is undertaken to locate such inclusions so that that may be cut away. One of the dangers of using plates with inclusions is that the resulting discontinuities in their elastic and thermal properties may cause them to crack under the influence of temperature changes. Another common defect is the presence of cracks, due either to the effect of inclusions or to the rough treatment the quartz receives in river beds or in being broken from its natural formation. These cracks may be completely internal and very fine, and thus not apparent on casual inspection. Another common defect arises from small interior bubbles. These may be isolated or grouped irregularly, or in very fine form may exist in lines or in plane or curved sheets, when they are called needles, phantom planes, or veils. So common are defects in quartz that only one in a hundred of the mined stones is saved for piezoelectric use.

Besides these various physical defects, crystals as found may have two other types of defects that result from structural misgrowth of otherwise perfect crystals, and give no evidence of their presence to inspection in ordinary light. Two types of quartz crystals are found that are similar, yet opposite in external form, like the left and right hands, and their internal structure differs correspondingly. They are called right-hand and left-hand crystals. Either may be used in electrical work, but a single plate should not include material of both types. Presence of both types in the same crystal is called optical twinning. Although such twinning is common, usually any one crystal is predominantly of one type. A region containing twinning usually consists of thin layers of opposite hand. Inspection for optical twinning consists primarily in locating these small regions of unusable material so that they may be discarded in cutting.

The other form of twinning that may be present is electrical twinning. With such

twinning, adjacent regions of quartz have their electrical axes oppositely poled. This form of twinning is also common, but it differs from the optical in that each type may occupy large regions of the same crystal. Either type is usable, but not both in the same plate; and during inspection the dividing line between regions of different types is marked on the crystal, so that the regions may be subsequently separated and each section cut properly with respect to its own electrical axis.

Because of their wide variety in basic nature, these defects may not all be economically removed at the first stage of processing. Different inspecting devices are required at different stages of processing. The sort of procedure that is carried out may be illustrated, however, by describing one of the procedures that has been used at the Hawthorne plant of the Western Electric Company.

To locate the various mechanical defects and regions of optical twinning in the raw crystals, a device known as the inspectoscope is used. This apparatus, as designed by the author, is shown diagrammatically in Figure 1 and in actual use at the head of this article. Two light sources are provided: one, a projection lamp, which gives concentrated white light, is used for locating the various mechanical faults; the other, a mercury lamp, where light is passed through

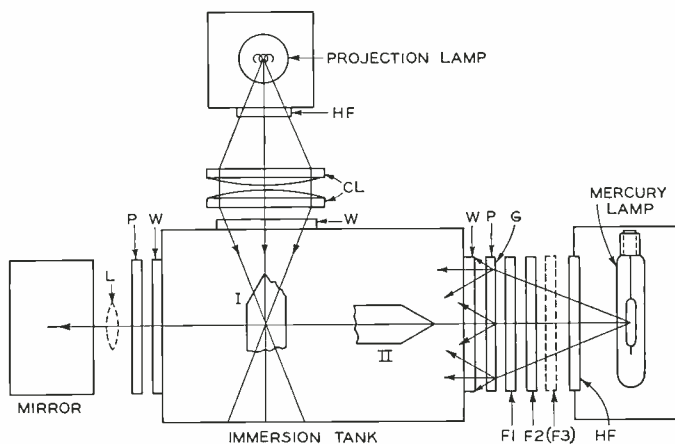

Fig. 1—With the inspectoscope the quartz is placed in the tank and viewed from the top through the fluid surface when using white light, or in the mirror at the left when using polarized light from the mercury lamp



Fig. 2—Bubble phantoms seen on edge in a crystal that has no natural faces



Fig. 3—The phantoms of Figure 2, but with the crystal rotated from the on-edge position

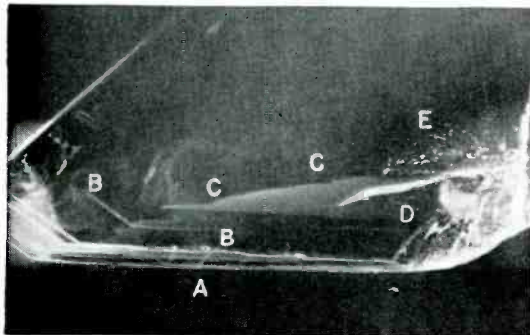

Fig. 4—Besides many layers of phantom planes at the left, this crystal contains a blue veil at CC, two fractures at D and a bubble veil at E—a curved surface of bubbles

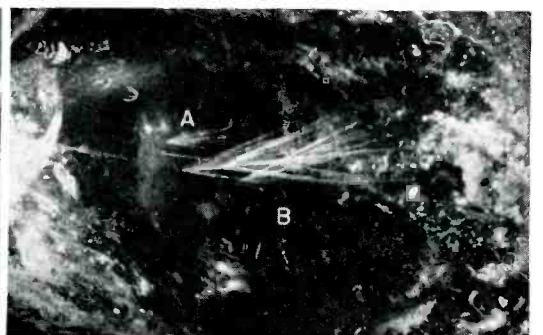

Fig. 5—This piece of quartz is full of blue needles, but due to their fineness they are visible only where the most concentrated part of the light strikes them

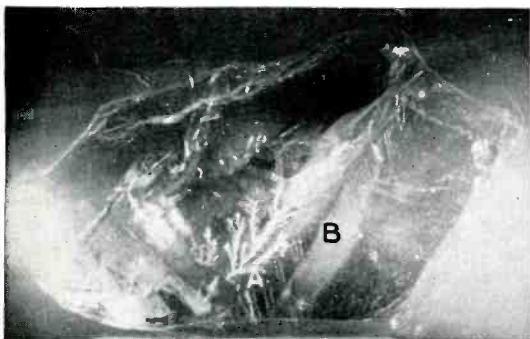

Fig. 6—A fern-like, or Dendrite, inclusion, very uncommon in quartz, is evident in the interior of this crystal at A. While uncommon in quartz it is quite common in some other crystals. A blue veil is shown at B

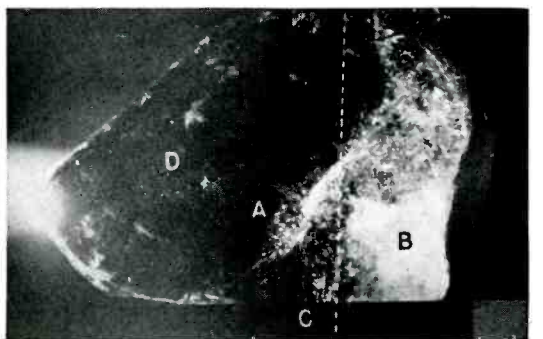

Fig. 7—This crystal shows concentrated cracks and bubbles, chiefly at one end. Sectioning along the dotted line would remove this region and leave the rest of the crystal usable with little loss in further processing

filters and a polarizer to give red and green polarized light, is used to determine the approximate direction of the optical axis, and to reveal regions of optical twinning. The tank in which the crystal is held is filled with a fluid that has a refractive index approximately the same as that of quartz. With this provision, the light rays are not bent when passing from the bath to the crystal and its interior may be viewed as easily as a polished plate of glass. When the white light is used, the crystal, in position I of Figure 1, is viewed by looking into the top of the tank, while for polarized light, with crystal in position II, it is viewed by the mirror at the left. Various defects, as they appear on inspection, are shown in Figures 2 to 7, inclusive, which were made at Hawthorne.

In the various cutting and grinding procedures leading to the final crystal plates, the first step is to cut sections perpendicular to the optical axis. The preliminary location of the axis is made in the inspectoscope using the mercury lamp. A spectrum of the light from this lamp shows three prominent lines: one blue, one green and one yellow; and two bands: one blue-green and one red. By using two color filters, one to cut out all light of shorter wave length than the green, and the other to cut out the yellow light, the green and red lights are selected for transmission

through the crystal. This light is polarized by a polarizing slide between the color filters and the inspection tank, and is seen through another polarizing slide between the tank and the mirror. When the light passes through the crystal in a direction approximately parallel to the optical axis, a contour pattern of alternate green and red bands will appear. The farther the light path is from the optical axis, the narrower will the bands be. The optical axis is located, therefore, by turning the crystal in the tank until such a pattern appears, and then turning it back and forth until the position is found in which the bands have their greatest width and farthest separation.

The appearance of such patterns is shown in Figures 8 and 9. In such a test, regions of optical twinning show up as a toothed pattern interrupting the contours. A fairly large region of optical twinning is evident in both Figures 8 and 9.

After the position of the optical axis has been marked as a result of this inspection, and the large defective areas indicated, the crystal is sawed into sections perpendicular to the optical axis and of a thickness depending on the size of the plates later to be cut from them. For smaller plates, the sections are generally thick enough to give several plates across a slab cut angularly to

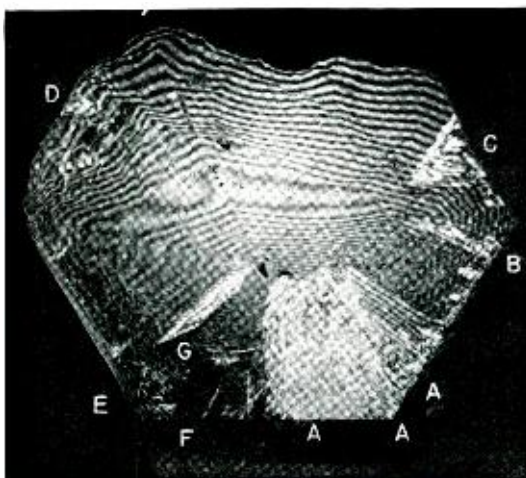

Fig. 8—A crystal viewed with polarized light slightly off the optical axis. Note the closeness of the bands of the contour pattern. Lettered regions show optical twinning



Fig. 9—The same crystal as Figure 8, but turned to bring the optical axis parallel to the line of sight. Note greater width and separation of contour bands

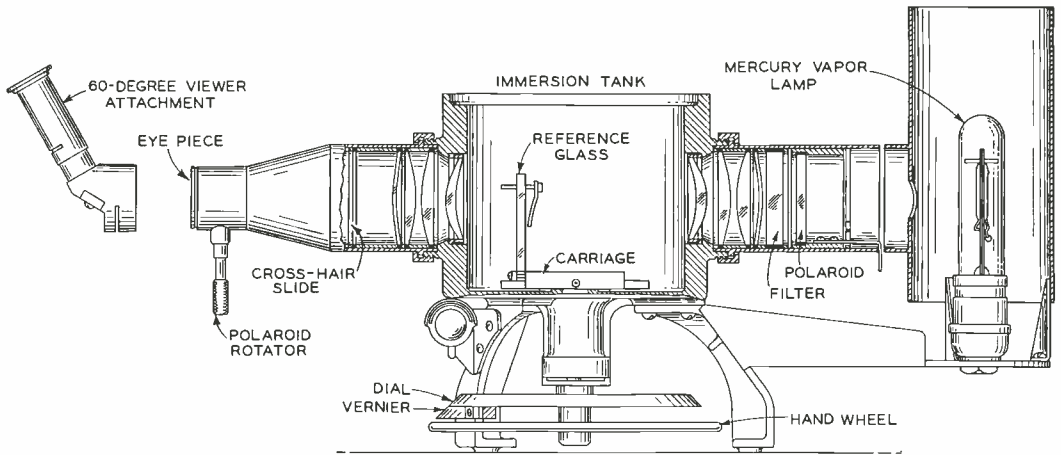

Fig. 10—Cross-section of a conoscope used by the Western Electric Company

the section, but for larger plates they may be thick enough only for one. The exact direction of the optical axis is then determined for each section by use of a conoscope, Figure 10, which was designed by W. L. Bond of these Laboratories.

In the conoscope, mono-chromatic polarized green light, secured from a mercury lamp by suitable light filters and polarizing slide, is passed through the crystal, much as the red and green light is passed through it in the inspectoscope. The conoscope has lenses at both sides of the crystal to give conical illumination and viewing, and as a result what is seen is a series of concentric circles. When the optical axis of the section is parallel to the lens system, the circles are centered on cross-hairs marked on a slide. When the optical axis is not aligned with the lens axis, the circles move away from the cross-hair intersection. By rotating the crystal in the holder until these circles are centered on the cross-hairs, the optical axis is accurately determined. Whether the crystal is left-handed or right-handed is also determined in the conoscope by rotating the polarizing slide on the eyepiece side, which causes the circles to contract or expand, depending on their hand. After the optical axis is accurately located, the surfaces of the section are re-

ground to make them truly perpendicular to the optical axis.

The next cutting step is to saw the sections into slabs of thickness greater than that of the final plates, which plates will later be obtained by dicing the slabs. Since the slabs must be parallel to an electrical axis, and at definite angles and proper angular sense from the optical axis of the crystal, it is necessary to locate the electrical axes and to determine their sense before the slab is cut. This is done in an orioscope. For this purpose, the surface of the section is etched with hydrofluoric acid. The rate at which this reagent dissolves quartz varies with the direction, being a similar but reverse process of growth. As a result, the surface of the section is pitted mainly with very small tetrahedral indentations. Light falling vertically down on such a surface is reflected mainly in three directions, which have defi-

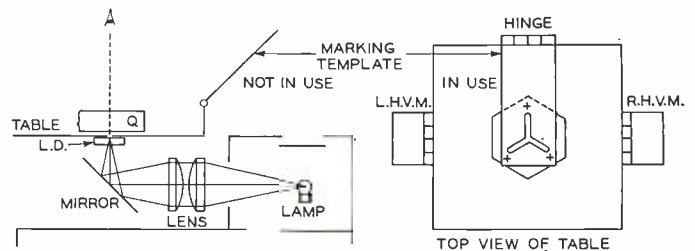

Fig. 11—The pin-hole orioscope uses concentrated white light, which is passed through the crystal and refracted from the upper etched surface

nite relationships to the internal structure of the crystal. If instead of throwing light down on the etched surface it is passed through the crystal from beneath, it will be refracted from the three triangular surfaces of each etched pit, and will thus come out from the etched surface in three directions.

Orioscopes using both reflected and transmitted light are available, but the results obtained are similar for both types. A diagram of a pin-hole orioscope is shown in Figure 11 and a photograph of the instrument as used by the Western Electric Company is shown in Figure 12. The refracted light from the etched surface forms a three-arm pattern of light with each arm approximately along one of the electrical axes. The section is then rotated to bring the figure in line with three radial lines on the window of a hinged viewing arm, which is lowered to the surface of the section.

After the crystal has been properly aligned, the viewing arm is replaced by a marking template, so that the three axes may be marked. This gives the sense and

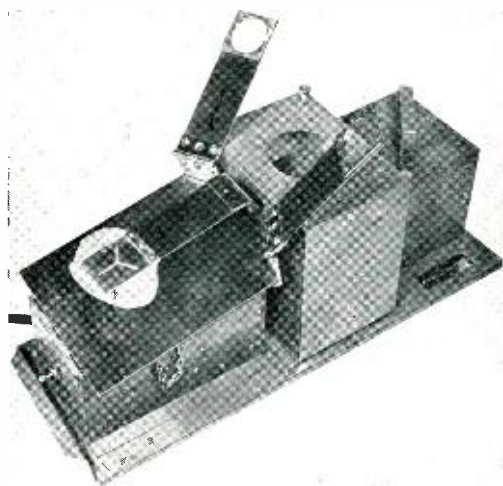

Fig. 12—A pin-hole orioscope with marking template lowered for marking electrical axes

direction of the electrical axes within five degrees. Accurate determination of electrical axis is made with an X-ray goniometer, but to use the goniometer, the direction of the axis must be approximately known. It is for this reason and to determine twinning and the sense of the electrical axis that the pin-hole orioscope is used. The X-rays are reflected from the atomic planes and permit a precise location of electrical axis, which is necessary for cutting the sections into slabs.

At the termination of the X-ray test, crystal sections will be available which have been ground accurately perpendicular to the optical axis on the upper and lower surfaces, and on one of the surfaces will be marked the direction of an electrical axis, and the regions of electrical and optical twinning and of various other defects, particularly if they cover extensive regions. From the electrical axis markings, the proper direction for cutting the slabs is determined. Since the sense of angle will differ for electrical twins, regions of different electrical sense—if of fairly large extent—are usually separated by an additional cut before the slabbing is done. In this way, each region may be slabbed to obtain usable crystals, while if this were not done, some of the slabs would contain areas of opposite sense of angular orientation, and would thus not be usable. In the final cutting process, the slabs are diced by cutting longitudinally and transversely to form the individual crystal

THE AUTHOR: Since his entrance into the Laboratories in 1930, G. W. WILLARD has



been engaged in theoretical studies of piezoelectric circuit elements. From his study of the effects introduced by changes in orientation he has been able to propose a number of new types of crystal circuit elements. As a result there have been produced the high-frequency AT and BT quartz circuit elements which are now finding such wide application in radio communication. These types are unique in that they are cut from the natural crystal with special orientation, and it is due to these orientations that they possess unusual properties. Mr. Willard holds the Bachelor's Degree (1924) and Master's Degree (1928) from the University of Minnesota, and for two years was a graduate student at the University of Chicago.

plates of approximately the desired size, and are then ground to the exact dimensions.

Other instruments than those described are used in preparing the plates, some of which are variations of the various principles already outlined. Several of the instruments are capable of determining the same faults or angles, but are designed specifically for

use at a particular stage of the processing. Regions of optical twinning, for example, may be located in the inspectoscope or by the various forms of orioscopes, and are generally marked after each test. Such variations in procedure, however, do not affect the general nature of the processing that is required for this work.

WOOD HOUSING FOR OUTDOOR TELEPHONE SETS



Urgent demand for telephone sets for out-of-door locations and the quantity of critical materials required for the standard sets, necessitated the development of a new set which employs a wood housing and existing stock station apparatus. The wood housing encloses a hangup or side-switch set, high volume output bells, induction coil, condensers and a terminal strip which, when interconnected, comprise a complete telephone for dial or non-dial service. Openings are provided in the side and bottom of the box, adjacent to the gongs, for the emission of sound and also for drainage. These openings are screened to prevent the entrance of insects. The housing has a protective paint finish inside and out

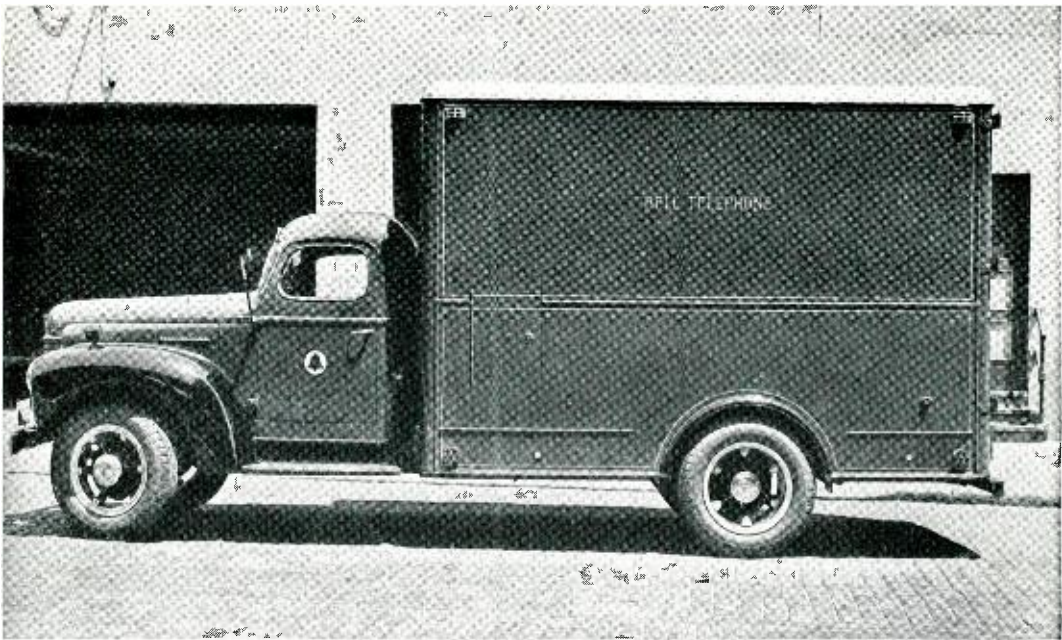

Mobile Field Testing Units

By J. E. CONWELL
Systems Development

WITH telephone lines and apparatus covering all parts of the country, and encountering conditions as varied as the geography, the testing of new systems and apparatus cannot always be confined to Laboratories buildings in the New York area. Engineers and apparatus must frequently be sent into the field to make studies and measurements under local conditions. Transportation, the setting up and dismantling of the testing equipment, and the possible erection of test shacks for short periods are likely to be slow and expensive. To improve this situation, the Systems Department, beginning some years ago, has designed a number of mobile field testing units that may be driven to the point of test—transporting both the personnel and the required test apparatus already set up for use. When these units are not all in use by the Systems Department, they are available to other groups that may have need for them.

A survey of the needs of the various groups which might use these units indicated that an available floor space of about seventy-five square feet and a load capacity of about twenty-five-hundred pounds would meet most requirements. To permit test personnel to work within these units without discomfort, a minimum ceiling height of six feet two inches was adopted. Over a period of years, a number of mobile units have been secured, which, meeting these general requirements, differ in arrangement and in the permanent equipment provided.

An exterior view of unit No. 1 is shown in the photograph at the head of this article, while an interior view is shown in Figure 1. For some work, a local source of power is required, so in this unit a cabinet is provided in the forward wall to house a 3-kw gas-engine generator shown in Figure 2. A 12-volt battery used for starting the motor is charged by a generator coupled to the power unit. Six- and twelve-volt taps



Fig. 1—Interior of No. 1 mobile unit

from this battery are run to outlets on the partition above the cabinet, where is also an output panel for the main generator, a starting switch for the engine, a fuse box, safety flares, fire extinguisher, and a first-aid kit. Two cabinets, one used as a work bench, and a stool-high box were furnished to store ground rods, wire, and other testing equipment. There are four compartments around the skirt of this unit for the storage of tools.

Two types of interior lighting are provided—one to operate from a 6-volt storage battery, and the other from a 110-volt supply from the gasoline generator. The latter type consists of a number of 40-watt tubular bulbs along the wall just below the ceiling; outlet receptacles are also provided along the same line. The 6-volt system is ordinarily used only for short intervals when the generator is not running. This

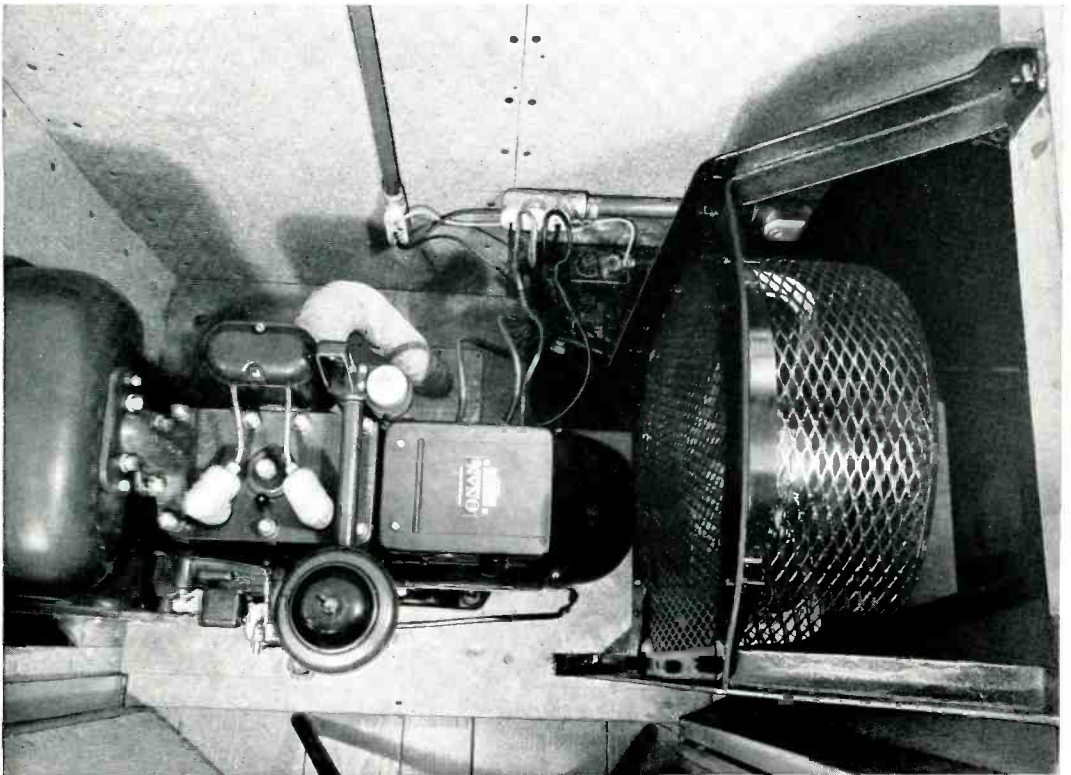

Fig. 2—A gasoline generator set supplies power for testing

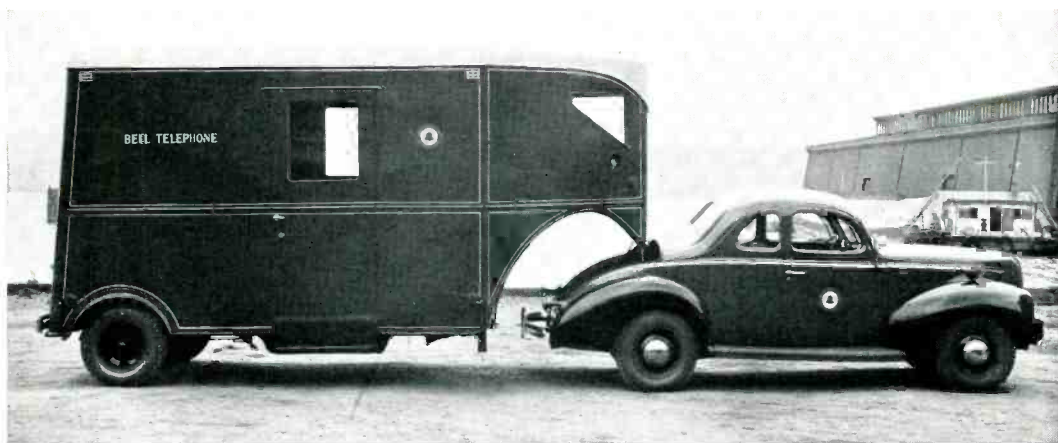

Fig. 3—A trailer and power car comprise the No. 2 unit

lighting arrangement is evident in Figure 1.

Unit No. 2 consists of a trailer and power car. An advantage of such a combination is that the power car may be disconnected from the trailer and used separately. It is convenient, for instance, in transporting part of a test crew to different locations along the test line while testing is in progress. Figures 3 and 4 are general views of the exterior and interior of this unit. A 1500-watt gas-engine generator is installed in the front

of the unit. Lighting is similar to that of the No. 1 unit, but is not needed so often because of the large windows in the sides and front of the unit.

No. 3, shown in Figure 5, is a power-supply unit used principally in cooperative tests of induction from ac electrified railroads. Included in this unit is a 220-volt dc generator, driven by the truck engine through a V belt, which supplies power to a motor generator set, the alternator end of

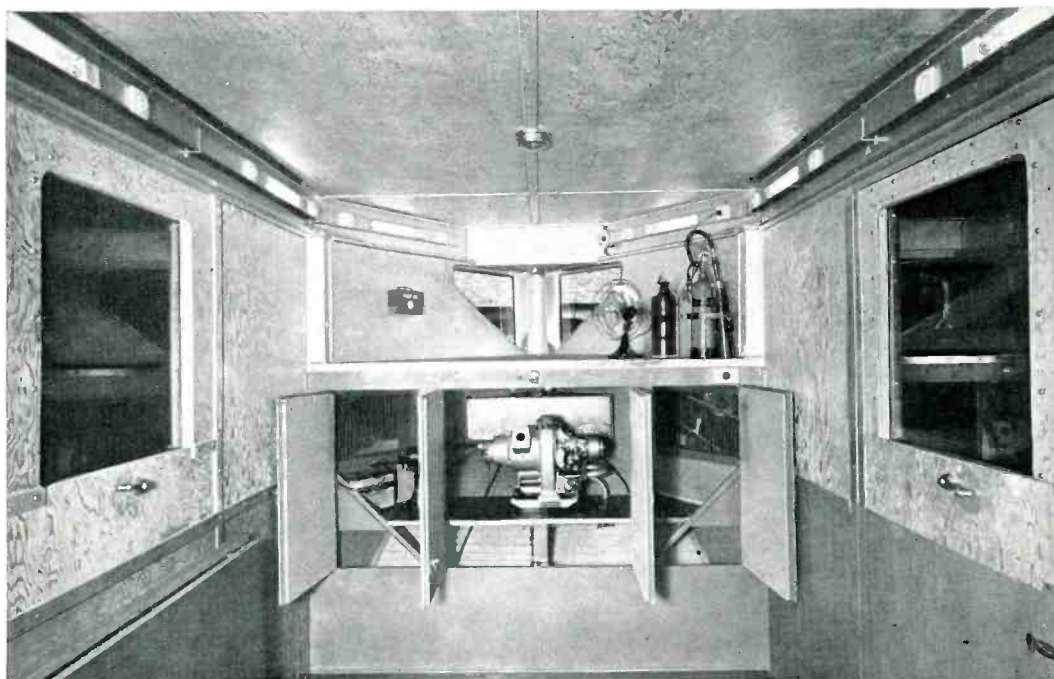

Fig. 4—Interior of the trailer showing gas-driven generator set in front cabinet

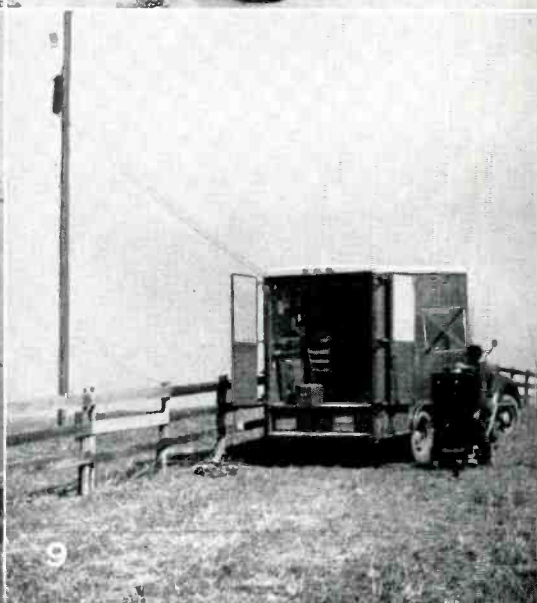
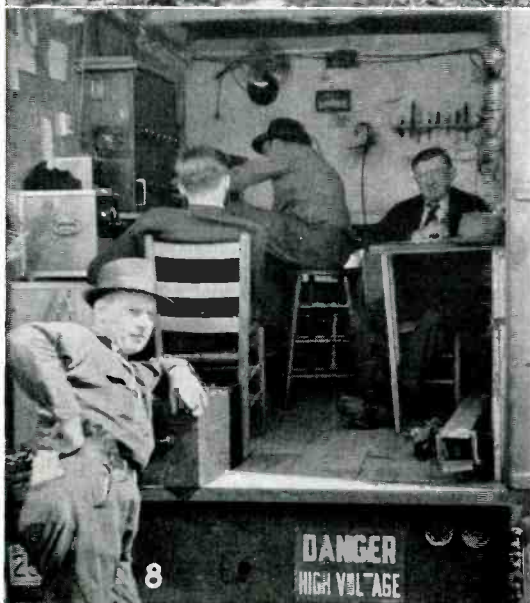
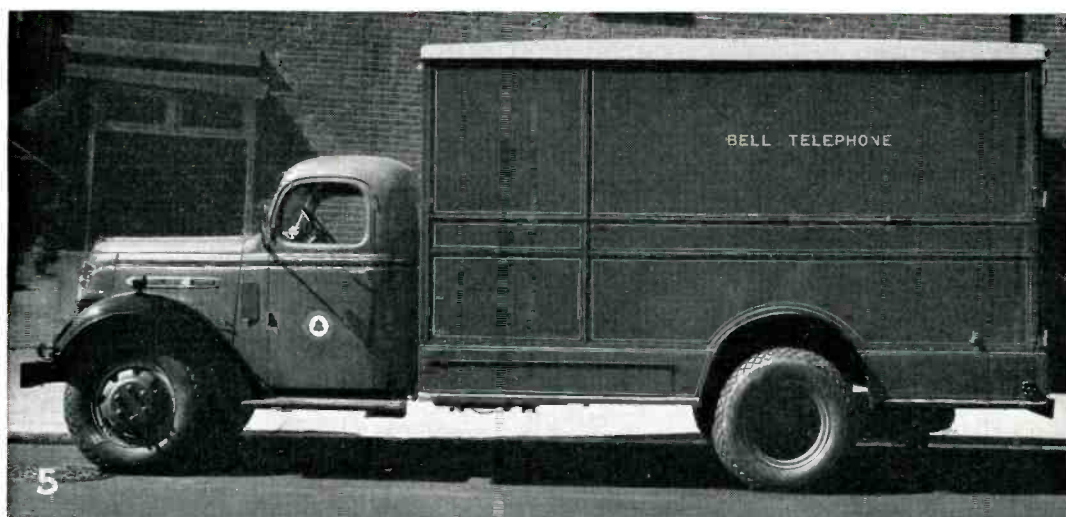

Fig. 5—Unit No. 3 is designed to furnish power for such work as inductive coordination tests.
 Fig. 6—One of the station wagons in field. Fig. 7—One of the station wagons in bad going.
 Fig. 8—Interior of No. 2 unit on job. Fig. 9—The No. 2 unit on a southern job

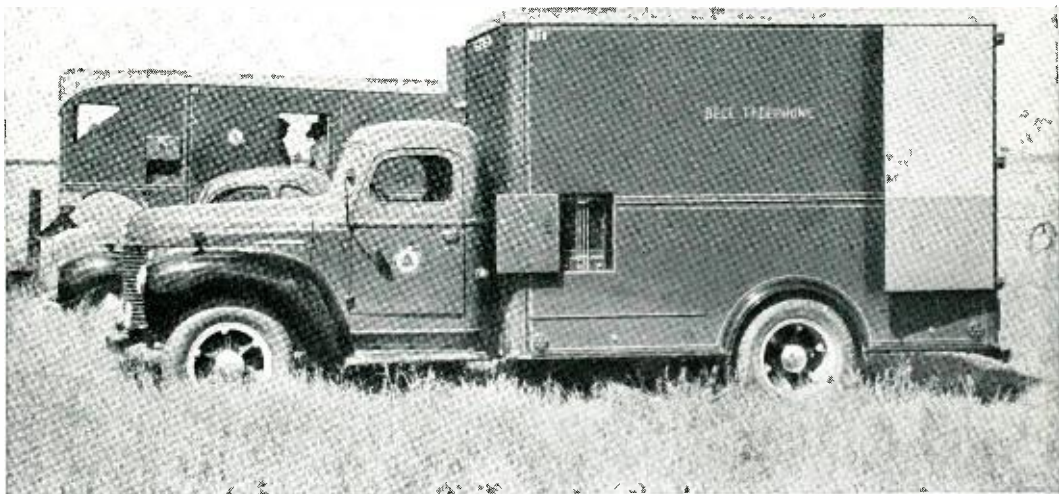

Fig. 10—For this test both No. 2 and No. 3 were required

which has a 15-kva capacity, single-phase. The frequency of this alternator is variable between fifteen and seventy-five cycles, and voltages up to about a thousand volts can be obtained. A power control panel contains the necessary apparatus and instruments needed for regulating the output.

A considerable amount of the field development work of the Systems Develop-

ment Department requires the transportation of personnel and testing equipment to isolated locations in the field where public conveyance is impractical or is not available. Several station wagons are available for such work. One of them is shown in Figure 6, and another in Figure 7.

Other of these units in use in the field are shown in Figures 9 and 10.

THE AUTHOR: J. F. CONWELL began his telephone career in 1927 with the General Service Bureau of the Department of Development and Research of the American Telephone and Telegraph Company. With the transfer of this Department to the Laboratories in 1934, he became a member of the Transmission Department of the Laboratories. When the Systems Administrative Department was formed, he was made responsible for the design, development and construction



of laboratories and mobile test equipment in addition to the supervision of other service functions. In 1942, when the Bell Telephone Laboratories School for War Training was established, he developed the layout and directed the modification of the plant. Currently he is liaison man in the School's relations with the Armed Forces, and is responsible for the procurement and maintenance of all Government equipment associated with the operation of the school.

Excerpts from A. T. & T. Annual Report

WORKING at full war tempo, the American Telephone and Telegraph Company and its Associated Companies continued to face unprecedented demands for telephone communication throughout 1943. Use of long distance was well above even the record levels established in 1942.

* * *

The Western Electric Company expanded its facilities still further during 1943. It is the largest producer of electronic and other war communications equipment in the United States and is now engaged almost exclusively in the manufacture of this equipment which is playing such a vital part in the war. Bell Telephone Laboratories is the largest industrial laboratory in the world. As in the preceding year, substantially all its resources and the special talents of its scientists and engineers were devoted in 1943 to war research and development activities.

* * *

In meeting military needs, the Laboratories is especially competent because of its leadership in electronic research and its ability and long experience in carrying projects through all the successive stages of fundamental research, development of apparatus, and the production and test of models designed for quantity manufacture. For this reason, it has been entrusted by various Government departments and agencies with wide responsibilities for development work. That this trust has been well placed is amply proved by many confidential reports on the successful military use of its products and by letters of commendation from high authorities.

* * *

Two years of war have tested the Bell System's character and its capacity to serve the Nation. Good telephone service is vital to victory and events have demanded the utmost efforts to insure that every war telephone need be met. The results have contributed to the extraordinary accomplishments of American industry and the progress of our fighting forces all over the world.

Ships, planes, tanks and guns have been produced in vast quantities, and men trained and equipped to win victories, with a speed which would hardly have been possible without swift and plentiful telephone communication.

The war achievement of America is based on the heritage of freedom that America is waging war to preserve. The things we are fighting for are the things that will enable us to win. Our system of freedom of private enterprise has outmatched the productive accomplishments of every other country in the world, and our telephone service meets the requirements of American industry, and heightens its pace, because the telephone industry itself has had the stimulus of freedom.

Imagination and initiative, thus encouraged, have created the incomparable communications plant of the Bell System and have brought about steady progress in the telephone art. Telephone men and women have learned to work skillfully together as a team; abilities of individuals have been recognized and supervisory and management positions have been filled from the ranks. This policy has built up the collective experience necessary to meet the emergency of war and to train the great numbers of younger people now serving in the Bell Telephone Army on the home front. The System has been able to expand its service because over the years it has been permitted, under regulation, to earn enough money to pay good wages and also to pay a reasonable return on the savings invested in the business, sufficient to attract the new capital needed to meet growing demands.

Above all, the complement of freedom is the sense of responsibility which telephone people call the spirit of service. In this war the spirit of service is the spirit of victory, and the men and women of the Bell System, in whom this spirit lives, may be relied on to do their utmost.

For the Board of Directors,

WALTER S. GIFFORD, *President.*

R. R. CORDELL



E. A. FERN

E. B. GEMPLER

F. J. SCHWETJE



In the Nation's Service

Lieut. Nils Anderson

LIEUT. NILS ANDERSON, who was seriously wounded in Italy on December 5, has received the Purple Heart. A former draftsman in the Systems Development Department, Lieut. Anderson received four leg wounds which he writes are nearly healed and a chest wound for which he will soon undergo an operation. He is at present at a station hospital in Africa. "Although I'm not really in the pink," his letter reads, "I am still smiling." After a period of recuperation following the operation, it is expected that he will be returned to a hospital in this country.

"In the Nation's Service"

Members of the Laboratories whose pictures are shown above are EDWARD B. GEMPLER, ROBERT R. CORDELL, EDWARD A. FERN and FRED J. SCHWETJE.

EDWARD B. GEMPLER, who was formerly in the 4B Development Shop, is now aboard a DE. He had been on active duty in the Pacific and his last shore leave was New Orleans.

ROBERT R. CORDELL's post in Guatemala seemed like a paradise. "It is a land of eternal spring with flowers all year round and the most beautiful girls in the world," he explained when on a recent furlough.

EDWARD A. FERN, who was reported as being wounded in action in last month's RECORD, has since been listed by the War Department as Missing in Action. Formerly a draftsman in the Systems Development Department, Edward fought at Bougainville.

FRED J. SCHWETJE is shown wearing a naval aviation cadet's uniform, but he hopes that he will be changing it for that of a Marine lieutenant. When he receives his commission down in Corpus Christi, he will become a bomber pilot in the Marine Corps.

Major Ward K. St. Clair

"Christmas here in India was half a holiday with the temperature in the seventies. Even though we were miles from home, the Christmas spirit prevailed. The Indians did their best to make it a day to be remembered. Their efforts in a great many ways resemble those of children.

"They have a great time maintaining telephone lines and keeping our 'C' carrier system in operation. There are several of our C-5's installed. It seemed rather strange after having been so intimately involved in the design of it to walk into a toll office here and see it installed next to German, English and other foreign systems. However, it works in spite of native maintenance."

Lt. Frank L. Krzyston

"If I were to do things 'according to Hoyle,' this would be just another note acknowledging the receipt of your package. But I like to feel that it's a personal matter between all of you—and all of us—in the Armed Forces.

[Groups in many departments sent Christmas packages to their men in service.]

"As you probably know, just about everything that flies, floats or rides on land con-

tains equipment upon which you have worked. Without you, there wouldn't be us. Together we spell Victory. What you do affects us directly. We are doing this together, that's the way it should be—that's the way it is—if I know you.

"Now perhaps you know why I like to feel it is a personal thing between us—the packages you sent to all of us. They speak words which are not often said openly, 'We're thinking of you—pulling for you—praying for you.'"

Andrew F. Martinelli

"Because of my feet and ankle I was sent to the General Hospital in Naples and then to Africa for treatment. After that I was reclassified to 1-B and am now driving a jeep.

"The American soldier gets what he goes after, but we pay dearly in lives, believe me.



This picture of Lieut. Robert J. Koechlin shows how well he has progressed at McCloskey's General Hospital in Texas. Bob was seriously wounded last July during the fighting at Munda, and suffered severe leg wounds. He has recently been home on sick leave



James P. Larimer's two sons, Edward and Patrick, are proud of their sailor Daddy who is training at the Armed Guards School in Norfolk, Virginia

People back home don't realize what the boys are going through in Italy. They read about our victories but never our casualties. The soldiers who come over as replacements are too green."

Sebastian Gutierrez

"I wish to thank DR. BUCKLEY for the kind thoughts and wishes expressed in his letter.

"I cannot describe the pleasure I derive when I receive the RECORD. It is really a pleasure to read this and to look back to all the pleasant moments I spent with the Laboratories.

"At the present time I am stationed at Missouri and quite contented with the Army life. As you may already know, I am in the Airborne Engineer Corps. Our duties in this outfit are concerned with construction work."

William R. O'Neill

"I just received the Christmas card from the General Service Department. I thought it was one of the nicest things a fellow could receive and I will keep it always. It was sure nice to open up an envelope, see the picture of the old gang I used to work with and know that they are thinking of me."

David W. Webster

"I have just completed a 65-day 'fur-



JOSEPH SCIORTINO

HAROLD PHARES

"I am in Italy and if I am not careful I'll probably wind up in Berlin. Adolf and myself have a little matter to talk over anyway. There is the small item of a year or more that he has taken out of my social life." From JOHN J. LORDAN's latest letter.

WARREN J. BOO has been assigned to study engineering at Princeton.

FRANK J. MAJOROSSEY, who worked with JOHN P. MAHONEY in the Photocopy Department, writes: "I was on the lookout for John Mahoney and when I saw him it was really funny. Waiting to get a shot in my arm, I saw him coming in my direction in civvies and I called out 'Hi, soldier.' He spoke and kept on walking. He didn't recognize me in uniform."

ALOIS H. LOBISSER of the Signal Corps is studying at the University of Pittsburgh under the A.S.T.P.

"RECEIVED the December RECORD," says GEORGE A. SEIBEL, "and the nice Christmas card sent out by J. S. EDWARDS. It sure puts spirits into a fellow to be remembered by the Labs."

ENSIGN JOHN R. BOYLE of Apparatus



W. J. BOO

A. H. LOBISSER

Drafting visited the Laboratories shortly after he received his pilot's wings. He is in Louisiana for operational training.

MARGARET E. STONEBRIDGE of the Wacs visited her friends at West Street when on furlough from Pueblo Air Base, Colorado, where she is a chaplain's assistant.

MAJOR ROBERT W. HARPER, who is serving with the Signal Corps in the South Pacific, is the father of RUTH HARPER whose picture appears on page 332O.

ROBERT H. MEUSER, formerly of the Library, is now with the Signal Corps at Fort McClellan, Alabama.

"AT PRESENT my destination and location are confidential, but if the destroyer I'm on doesn't spring any leaks, I will be back soon to see my friends at the Labs." From ROBERT H. FUNCK.

"I THINK man was not made to live down here on the South Pacific Islands. We do



MAJOR R. W. HARPER

R. H. MEUSER

manage to exist. As long as the mail comes through nobody minds the sun and the dehydrated food." LIEUT. HERMAN E. MANKE.

"I AM CORPORAL of the Guard at the Anti-aircraft Command here at Richmond, Virginia. When I was at Camp Davis, part of my job was to meet incoming trains and I used to drive quite a few engineers who were coming from the Labs to work on various experiments. You can imagine their surprise when they'd find that I was also from the Labs." FRANK J. HOWE.

"JUST RETURNED from Vandalia, Illinois, my wife's home," writes LIEUT. BERTRAM M. FROEHLI, who is now at Florence, S. C.

LT. ROBERT T. ROONEY's card to the RECORD reads: "Hello gang—spending a wonderful vacation in the South Pacific."

WHEN HELEN I. OLIN was on furlough from the Walter Reed Hospital in Washington she said: "Up at 5:00 a.m., training films from 5:30 a.m. to 6:30 a.m., before breakfast, is not unusual in a Wac's program."

EDITH K. RUCHE had completed her training in the Naval Training School at Cedar Falls, Iowa, before she visited her friends at West Street and at Graybar.

"I GUESS you wonder why I transferred to the Marines," writes LIEUT. CHARLES R. LEUTZ from Cherry Point, N. C. "During my training as a naval aviator many of my instructors were Marines. Some were new and some were back from the Pacific. After talking to them I decided it was the Marine Corps for me."

ROBERT J. DROUT is somewhere in India.

RICHARD J. COMER, at Lafayette, La.: "Glad to hear that FRANK R. HULLEY is doing okay in his flying. We entered the Army on the same day but were separated in Atlantic City. Give him my best wishes and ask him to write to me."

"FINISHED MY basic at Miami and am now at Fort Monmouth. Regards to 1420." From HANS W. MENZEL.

"HAVEN'T SEEN much of this down under country yet, but it's dry land. After all the



J. C. BERKA

C. S. GRAHAM

water I've seen that's enough for me." HERBERT J. BRAUN.

ANDREW M. KURUTZ is a soundman on board a destroyer somewhere in the Pacific.

LEON P. NEWBY of the Navy is at Camp Hollyday at Gulfport, Miss.

JOHN W. McCONNELL is one of three Warrant Officers in the radio laboratory in Charleston. "Our duties consist of testing and adjusting all radio and sound gear installed on the destroyers and DE's."

"DANIEL F. O'SULLIVAN, now with the Marine Corps at New River, N. C., has two small sons, Daniel and James." From a military news item in the *Nassau Star Review*.

JOSEPH SCIORTINO of the Navy CB's, while on leave, called to see MARGARET McNALLY and his friends in the Mail Room.

LIEUT. ELWOOD N. RIKER, who received his silver wings in December, visited West Street before taking up his present assignment for training at a B-24 School.

"NUMBER 463 West Street is only as far away as my nearest BELL LAB RECORD," says CARMEN D'AMICO of the Navy, who is stationed at Treasure Island, California.

CHARLES S. GRAHAM visited West Street while on his January furlough from the A.S.T.P. course at Ball State College, Indiana.

JOSEPH C. BERKA, a frequent visitor to West Street, has been assigned to Frankford



Major and Mrs. Harold B. Guerci were snapped in the Apparatus Development Files where Mrs. Guerci works. Shortly after the picture was taken Major Guerci received his promotion and he is now the executive officer of a Searchlight Battalion in North Carolina

March 1944

332E

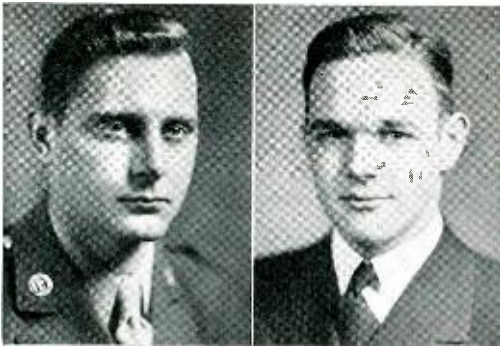

GEORGE E. TIRONE CEDRIC W. SHEPPARD

Arsenal where he is in an optical and electrical instrument maintenance detachment under COL. H. B. ELY.

"PENSACOLA is a wonderful place . . . for flying," according to CADET JOHN P. MANNING, who is now with his final squadron, carrier-based fighters.

AFTER HIS January visit to the Laboratories, HENRY A. LAMPERTY was assigned to the A.S.T.P. at Haverford College.

GEORGE E. TIRONE, formerly an expeditor at Whippany, called at West Street when on mid-semester furlough from the A.S.T.P. at the University of Connecticut.

GEORGE A. SCHIESER, home on leave from Georgia Tech in January, hopes to be commissioned in April when he will have completed his engineering training.

DONALD R. SCHEIDERMAN of Murray Hill Laboratories has been assigned to basic training as an Aviation Cadet at Amarillo, Texas.

TWO CADETS at the U. S. Navy Pre-Flight School at Athens, Georgia, sat opposite each other at mess, each wondering where he had seen the other before. Suddenly L. MARVIN BRACKEN and W. D. KUNTZ, both formerly of Whippany, recognized each other.

"AM NOW in Australia and have two telephone men and a Western Electric man working with me, and it certainly helps to be with friends when one is

so far from home." FREDERICK W. HOLD.

WILLIAM V. HOSHOWSKY visited Systems Drafting Department group before reporting for primary flight training.

"THIS is the Naval Radio Technician's School at Corpus Christi and BTL is well known down here," says GEORGE F. BROWN.

"SAY HELLO to the boys in 4B and 4C for me," is the request of WILLIAM WIEGMANN, who is getting ready to go to advanced navigation school in Texas.

"I ENJOY receiving the RECORD, and many of my associates here in the Army War College are interested in the technical articles." MAJOR WILLIAM W. STURDY.

CEDRIC W. SHEPPARD, naval aviation cadet, visited West Street recently. He is at Corpus Christi taking advanced flight training and hopes to receive his commission some time in April. At that time he may become a Marine Pilot.

"WAS SURPRISED and delighted to find articles on the M9 in December and January's RECORDS. It is of special interest because it is used in part of my instructional work here at Camp Murphy," writes GUSTAV A. BACKMANN. "I'd welcome any mail which would fall my way, so tell the boys in 1420 not to be slackers."



Clifford J. Lundquist of the Merchant Marines talks over old times with G. P. Lenormand and H. C. Baarens in the Apparatus Development Drafting Department

FROM FORT EUSTIS, Virginia, WALTER F. LICHTÉ sent a card saying: "The boys here were very much interested in the December and January RECORDS which contained much news on equipment on which we have been training."

MAXWELL C. ANDREWS has been helping to maintain the Navy's weather or meteorological equipment at the Navy Pier of the U. S. N. Air Technical Training Center, Chicago, Illinois.

LEONARD M. NIELSEN's greetings from north of the Arctic Circle gave a clue to the location of the Signal Service Company with which he serves.

"MY PRESENT location is England. I am feeling fine but I hope the war will be over this year. The RECORD comes through to me quite late, but it's appreciated very much."

JOHN J. O'SHEA.

Others from whom cards or letters have been received include:

Thomas Musca, Elena Tighe, L. C. Munch, Lieut. Comdr. J. B. Newsom, Lieut. R. F. McLaughlin, Major J. W. McRae, Ensign W. L. French, A. A. Luciano, W. T. Reck, Marcae Bitowf, E. L. Fischer, E. H. Jockel, W. B. Sage, R. J. Seymour, W. R. Spenninger, M. V. Sullivan, J. A. Zweig, H. C. Meier, M. I. Hampton, Lieut. R. D. Horne, G. H. Reinhardt, A. J. Nolan, R. E. Filler, W. J. Rapp, W. E. Archbold, P. W. Foy;

M. F. Hickey, J. H. Isleib, Major S. H. Lovering, R. C. Benkert, F. J. Hurt, J. R. Merchant, A. O. Schwarz, A. O. Schmitz, R. M. Scheller, J. M. Mills, J. U. Meats, P. V. Lodato,

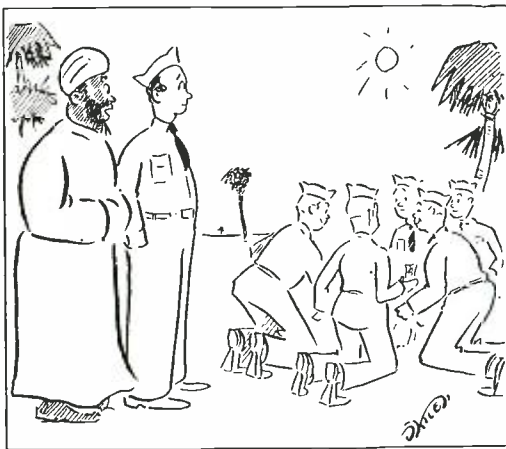

Courtesy Public Utilities Fortnightly

"Do all Signal Corps warriors worship a pair of little dotted idols like that, effendi?"

March 1944

"I suppose they have you stepping at the Lab, but just remember that every hour you put in is shortening the war by days. If the people back home could see the equipment that is needed for each push, they wouldn't stop to think before buying a war bond. Many fellows will never return but they believe that they were backed by the folks at home."

—Letter to a member of the Laboratories from a soldier in Italy.

L. A. Hopper, Walter Burkart, Lieut. C. R. Schramm, Lieut. C. J. McDonald, W. J. Conner, Henry Widmann, W. T. Reck, Walter Sokolsky, J. G. Phillips, R. G. Dolbear, Arthur Wright, G. A. McArdle, H. H. Hoffman;

William R. Frees, R. S. Williams, Marcelle Lesire, R. J. Seymour, Peter Wargo, J. P. Mahoney, R. A. Yerden, Laura Chamberlin, R. R. Stephens, J. E. O'Keefe, C. G. Peterson, C. W. Muccio, R. F. Healy, S. W. Erickson, W. C. Brossok, E. J. Filipovits, C. N. Greene, J. E. Sienko, Richard Fiala, J. F. Daly, P. E. Watts, E. L. Fieldhammer, E. J. Flannery, H. E. Earl, Robert Klem.

News Notes

FRANK B. JEWETT participated as one of the speakers at the meeting of the Army Ordnance Association, held at the Waldorf-Astoria Hotel on January 19. His subject was *National Defense Research Committee*. Dr. Jewett also gave the address on the career of Dr. Vannevar Bush in connection with the presentation of the Edison Medal to Dr. Bush on January 26 at the general session of the A.I.E.F.

HARVEY FLETCHER has been elected vice-president of the American Physical Society.

The Genesis of a Vitamin was the topic of R. R. WILLIAMS' talk to the Women's Engineering Societies. Dr. Williams was introduced by HARVEY FLETCHER.

B. L. CLARKE, on January 22, attended a meeting of Advisory Editorial Board of *Industrial and Engineering Chemistry* in Washington.

C. J. Forsyth, 1916-1944

CHESTER J. FORSYTH, who joined the Laboratories last August, died on February 2. Mr. Forsyth was a bench-machine operator and assembler in the Development Shop at Whippany.

Urgent Need for Housing Accommodations

A number of men have transferred recently to the Laboratories and a few more will come in soon. Those bringing their families will need assistance in finding suitable housing.

Last year two appeals for leads to housing accommodations were circulated in the Laboratories and the results were very helpful. The housing situation is even more critical today and consequently if you know of any houses or apartments, now or soon to be

vacant, accessible to Laboratories locations in New York, Murray Hill, Whippany or Kearny, you will render a real service by getting in touch at once with D. D. HAGGERTY, Extension 542. Past experience indicates that the most frequent requests are for five or six-room houses with rental rates varying over a range up to \$80 or \$85. It is desirable, however, to have a few listings as high as \$90 or \$100 per month.

* * * * *

B. S. BIGGS and G. G. WINSPEAR have been at Hawthorne on problems connected with the conversion from natural to synthetic rubber.

W. O. BAKER visited the Rubber Reserve Company, Washington, the Synthetic Rubber Division of the United States Rubber Company, Naugatuck, Conn., and Cornell University on the development of synthetic rubber.

"THE TELEPHONE HOUR"

(NBC, Monday Nights, 9:00 P.M., Eastern War Time)

MARCH 6, 1944

Overture to La Cenerentola *Rossini*
Orchestra
Scotch Fantasy— *Bruch*
2nd and 3rd Movements
Jascha Heifetz and Orchestra
In Deep Woods *MacDowell*
from "New England Idyls"
Orchestra
Prophetic Bird *Schumann-Heifetz*
Zapateado *Sarasate*
Jascha Heifetz and Orchestra

MARCH 13, 1944

Chopsticks *Traditional*
Orchestra
Lullaby *arr. Cantaloube*
Gladys Swarthout
Riviera Girl Waltzes *Kalman*
Orchestra
Dancing in the Dark *Schwartz*
from "The Bandwagon"
Gladys Swarthout
Saltarello from Symphony No. 4, *Mendelssohn*
in A Major
Orchestra
Katushka's Air *Alfano*
from "The Resurrection"
Gladys Swarthout

MARCH 20, 1944

Who's Gonna Mourn for Me *Wolfe*
The Low-Backed Car *Lover*
James Melton

Can't You Do a Friend a Favor?
from "A Connecticut Yankee" *Rodgers*
Orchestra

The Farmer's Son *Howard*
James Melton

On Hearing the First Cuckoo in Spring *Delius*
Orchestra

Fantasie, aux Divines Mensonges *Delibes*
from "Lakmé"
James Melton

MARCH 27, 1944

Overture to Orpheus in the *Offenbach*
Underworld
Orchestra

Rondo Capriccioso *Mendelssohn*
Josef Hofmann

Concerto No. 4, in D Minor— *Rubinstein*
First Movement
Josef Hofmann and Orchestra

APRIL 3, 1944

Blow, Blow, Thou Winter Wind *Ilgenfritz*
Nobody Knews De Trouble *Trad. Spiritual*
I've Seen

Helen Traubel
La Calinda from "Koanga" *Delius*
Orchestra

The Rosary *Nevin*
Vespers *Fraser-Simpson*
Helen Traubel and Chorus

Good Friday Spell from "Parsifal" *Wagner*
Orchestra

Alleluia *Trad.-Arr. O'Connor-Morris*
Helen Traubel and Chorus



BLOOD DONORS

V. J. Albano
 Jean G. Asbury
 Helen M. Asher
 Ruth Bayajian
 Marie G. Beck
 W. C. Bengraf
 C. F. Benner
 G. Bittrich
 F. J. Black
 Lois E. Burford
 Gloria Carstensen
 A. Clark, Jr.
 M. Corry
 L. Dorrance
 R. H. Erickson
 J. R. Fisher
 A. P. Flagstead
 L. O. Frey
 Jean E. Fuhs
 Frances V. Galavy
 Mary E. Gargiulo
 C. Jean Gauthier
 W. D. Goodale
 J. B. Hays
 Mildred M. Hoogstraat
 C. C. Houtz
 J. B. Howard
 Elizabeth J. Hyde
 H. Jackson
 F. C. Koch
 L. T. Kruskamp
 C. Lansidle
 G. W. Lees

A. F. Leyden
 V. E. Lowden
 C. V. Lundberg
 E. P. Mack
 J. Madden
 Jean Mater
 G. T. McGugart
 Carlos Miller, Jr.
 F. J. Morin
 Phyllis E. Nimmo
 J. J. Oestreicher
 Lillian C. Ortolan
 Jane A. Otto
 Ruth Palley
 Mary B. Parsons
 W. Pearce
 R. P. L. Piltan
 Dorothy Schilling
 Dorothy Y. Shaw
 Eleanore D. Soneson
 M. M. Sparks
 L. Spiwack
 O. E. Stelter
 B. Stiratelli
 Marion R. Stites
 A. C. Teyman
 H. Thomas
 R. G. Treuting
 G. N. Vacca
 C. Van Benschoten
 P. Venneman
 L. Vieth
 Ellen M. Vreeland

F. S. MALM and V. T. WALLDER were in Washington for conferences in the office of the Rubber Director. With A. R. KEMP and G. N. VACCA, they also went to the Point Breeze plant of the Western Electric Company to discuss the use of synthetic rubber for wires and cables. Mr. Wallder also attended a Signal Corps cordage meeting in Chicago.

D. A. McLEAN and G. T. KOHMAN conferred with engineers of the Western Electric Company at Hawthorne on matters relating to condensers and crystals. Later, with J. P. Greiner of the Hawthorne Plant, they visited the Institute of Paper Chemistry to review the results of recent paper studies.

W. R. BENNETT is the author of an article,

March 1944

Response of a Linear Rectifier to Signal and Noise, published in the January issue of the *Journal of the Acoustical Society of America*.

W. P. MASON, in the January issue of the *Journal of the Acoustical Society of America*, reviewed the book, "Dynamical Analogies," by Harry F. Olson (D. Van Nostrand).

IN A PAPER entitled *Wave Guides in Electrical Communication*, presented before the Institution of Electrical Engineers (England) last November, a comprehensive review of the work done by G. C. SOUTH-WORTH, S. A. SCHELKUNOFF and their co-workers is included.

S. A. SCHELKUNOFF's article on *Antenna Theory and Experiment* appears in the January *Journal of Applied Physics*. A supplement to this paper, *A Modification of Hallén's Solution of the Antenna Problem*, by MARION C. GRAY, also appears in the same magazine.



Winter at Murray Hill

UNDER THE AUSPICES of the War Production Board, A. B. HAINES made an extensive tour of various manufacturers in the Middle West and Eastern states from December 12 to 30 to study the production of sealed transformers.

R. G. McCURDY, A. B. HAINES and C. J. FROSCH visited the Westinghouse Research Laboratory at East Pittsburgh on January 24 to confer on power transformer problems. Mr. Haines and Mr. Frosch were also at the Westinghouse plant at Sharon, Pa., on

January 14 and 25 on the same problems.

ON TRIPS to Boston and to the Point Breeze plant, R. T. STAPLES attended conferences on cables.

C. A. WEBBER was in Baltimore and at Hawthorne to study cable problems. While in Chicago he also attended a conference of the Signal Corps on cordages.

H. H. STAEBNER went to Baltimore on cord problems.

H. H. GLENN discussed wire with engineers at Hawthorne on a recent visit.

M. WHITEHEAD visited the AeroVox Corporation at New Bedford, Mass., on matters pertaining to electrolytic condensers.

R. H. COLLEY attended the January 19 meeting of the executive committee of the American Wood-Preservers' Association which was held in Chicago.

DURING A VISIT to the Eatontown Signal Laboratory, Fort Monmouth, on January 14, J. H. GRAY attended trials of recovery equipment for buried cable.

O. S. MARKUSON, who is located at Point Breeze, visited the A. T. & T. to discuss an improved design of armor protection for the 275-mile Atlanta-Meridan coaxial cable and other coaxial cables to be placed in 1944.

AT THE U. S. Rubber Company plant in Providence, W. H. S. YOURY was concerned with DR tape problems.

Automatic Ticketing of Telephone Calls, a paper by O. A. FRIEND, was presented at the winter technical meeting of the A.I.E.E. held in New York City.

H. F. MARTING was in Hawthorne on moisture and fungus proofing problems for equipment for the Armed Forces.

A. J. WIER discussed K2 carrier equipment with engineers at Hawthorne.

SPECIAL EQUIPMENT development problems were taken up by W. G. SCHAEER when he visited the Signal Corps Plant Agency in Philadelphia recently.

T. J. ARKINSON visited the Point Breeze plant of the Western Electric Company, the Pioneer Gen-E-Motor Company in Chicago, and the Universal Electric Company in Owosso, Michigan, in connection with lubricating problems.

H. M. SPICER discussed control problems for war projects at Hawthorne and at the Roller Smith Company in Bethlehem, Pa.

AT THE WINTER technical meeting of the A.I.E.E. and the I.R.E. held in New York from January 24 to 28, L. G. ABRAHAM, A. J. BUSCH and F. F. SHIPLEY presented a paper, *Crossbar Toll Switching System*.

JOHN MILLS addressed the Electric Club of Toronto on February 9 and the Engineering Institute of Canada at Montreal on February 10 on *Every-Day Electronics*.

February Service Anniversaries of Members of the Laboratories

10 Years
M. J. Kelly

15 Years
H. C. Bonacker
P. V. Brunck
Margaret Connors
J. J. Darold
E. P. Dinsdorf
F. W. Doering
Eleanor Dunn
J. O. Edson
N. J. Glock
W. T. Gustafson
J. G. Havens
L. B. Hochgraf
F. L. Hunt
L. W. Kirkwood
W. J. Kopp
E. V. Koski

H. K. Krantz
L. C. Krazinski
Sheldon Kroeter
Sylvester Longo
W. A. MacNair
John Mallet
Henry Misan
James Morrison
A. J. Nelson
E. J. Noon
F. M. Pearsall
Hedwig Post
J. L. Prendergast
W. R. Prinz
G. F. Richards
F. J. Rinciari
Pauline Skowfoe
C. W. Vadersen
H. A. White

20 Years
K. S. Cadmus
H. I. Emery
J. J. Gillich
H. L. Holley
Mary La Mantia
E. C. Laughlin
William Patterson
Hazel Reoch
Harold Schmitt
Martin Sorensen, Jr.
R. E. Turner

25 Years
H. B. Brown
F. H. Chase
C. A. Conrad
J. C. Crowley

L. L. Eagon
Helen Fitzgerald
Raymond Guenther
R. V. L. Hartley
Joseph Kelly
Mary Midtgardt

30 Years
Nicholas Flynn
C. J. Hendrickson
A. F. Price
Everett St. John
R. M. Sample

35 Years
J. F. C. Dahl
H. W. Everitt
J. H. Pflanz
Martin White

Your Magazine and the Paper Shortage

As a result of the shortage in paper, the RECORD has been drastically limited in the amount which it can use during 1944. All the possible reductions in paper have been considered, and those which seem to have the least reaction on the usefulness of the magazine have been adopted. A lighter weight paper cannot be used until the present supply is exhausted. The February issue was of 48 pages, and that is proposed for the future size of the magazine. All servicemen, at home and abroad, will receive a special edition printed on thin paper. That part of the "News and Pictures" which appears in the 16 center pages will not be circulated outside the Laboratories personnel. Servicemen's families will be supplied from the copies returned, after reading, by members of the Laboratories. A Bulletin Board notice to that effect was posted at West Street early in February and the response was gratifying.

You can make your copy of the RECORD available to a serviceman's family after you have read it by dropping it into an "Outgoing" correspondence box.

R. BURNS spoke on *Corrosion Problems of Modern War* before the Cleveland Section of the Electrochemical Society.

LLOYD ESPENSCHIED was chairman of one of the technical sessions of the 1944 I.R.F. mid-winter technical meeting held in New York on January 28 and 29.

R. M. BURNS presented a paper, *Testing and Comparison of Molding Materials*, at the Chemical Industries panel meeting of the War Production Conference on January 14 in New York City.

C. R. BURROWS and C. B. FELDMAN received Fellowship Awards at the I.R.F. 1944 winter technical meeting.

W. A. EDSON presented a paper, *Intermittent Behavior in Oscillators*, at the winter technical meeting of the I.R.F.

R. A. HEISING has been reappointed Treasurer of the I.R.F. for 1944.

G. DEEG visited the Andover Kent plant in New Brunswick, N. J., to discuss plastics.

C. J. FROSCH, at the Hawthorne plant of the Western Electric Company, conferred on various plastic problems. He also visited the Virginia Lincoln plant, Marion, Va., on plastic forming procedures.

THE WESTERN ELECTRIC COMPANY has leased a section of the Eau Claire Ordnance Plant in Wisconsin which was formerly engaged in arms production.

ON SATURDAY evening, January 29, a chess team of ten men led by F. B. FERRANDIZ challenged the West Side YMCA Team, which finished second in the 1943 Metropolitan Chess League Tournaments. Only three of the Laboratories men had ever participated in match games. The Labs team lost as was expected, but the score, 7 to 3, was a surprise and gave the team added confidence in itself.

STANDARD and ADVANCED First Aid Courses of the American National Red Cross are being conducted at West Street after regular working hours for men and women of the Laboratories. E. D. JONES is in charge of the standard course, given Thursday evenings from 6:00 to 8:00 p.m.; L. C. COON conducts the Advanced Course at the same hour on Friday evenings.

Engagements

Louis E. Filipovits, U. S. Army—*Alice Williams
*Raymond W. Kosley—*Julia Lynch
*Wilbert H. Kossman—Marie Lewis
James Shea, U. S. M. S.—*Claire Amrhein
Ens. Robert C. Torgesen, U. S. Navy—*Grace Haas
*George J. Wolters, U. S. Army—Catherine Clancy
Wilbur A. Wood, U. S. Navy—*Shirley Smith

Weddings

Santi J. Arena—Aurora Mignani
H. A. Gruendel, U. S. Army—*Grace Williams
*Edward A. Hake—*Marjorie McLinden
*James M. Sullivan, U. S. Army—*Mary Zuckerman
Joseph Trezza, U. S. Army—*Helen Scott

*Members of the Laboratories. Notices of engagements and weddings should be sent to Mrs. Helen McLoughlin, Women's Editor, Room 1103.

March 1944

332K

Women of the Laboratories

CAROLE OTTMER stepped out of the glamour of the show world to take her place during wartimes in one of the non-glamorous jobs which are so essential to winning the war. As a member of the Stock Control Group, Carole maintains three thousand items in eighteen storerooms by keeping perpetual inventories, and replenishing when the stock reaches an ordering point. These items include batteries, condensers, resistors, metals, chemicals, wire and small fabricated parts. She transfers stock from one location to another where items have reached a low point and it is up to her to decide what quantity should go into each stockroom.

Carole is a Richmond Hill girl and a graduate of Newtown High School where she specialized in music. For thirteen years she studied under a protege of Paderewski to become a concert pianist. However, her voice also showed promise and eventually she decided upon a career as a vocalist. She swung from the classics to popular music, be-

came a member of a trio known as the Beverly Sisters, and for two and a half years toured the country. She appeared in such New York night spots as Leon and Eddie's and the Famous Door.

Because her family was unhappy over her long absences from home, Carole decided to come to the Laboratories where she knew the urgency of the work from friends. Now she is investing nearly half of her salary in war bonds to hasten the return of her fiancé who is with a * * * unit in Italy. Then she'll willingly give up her stock control ledgers for a housewife's order pad on a kitchen wall.

* * * * *

WHEN SHE WAS BARELY three months old "AMY" CUERVO arrived in Florida from her native Spain. Her given name, AMERICA, was chosen for the New World where she was to grow up. After graduating from Jacksonville High School, she came north with her family and attended Kells Business College in New York City. Then she joined the Patent Department where she is responsible for the filing of patent papers relating to studies of applications for United States Letters Patent resulting from work done under Government contracts on war developments. For recreation Amy bowls with the Laboratories League on Friday nights. She enjoys Spanish music and dancing, particularly folk dances like the "Jota" which she and her husband enjoy and do quite well.

* * *

IN THE Engineering Complaint Bureau of the Quality Assurance Department CATHERINE COONEY has replaced a man who has gone off to war. In her present capacity she receives all incoming complaints on telephone apparatus and



CAROLE A. OTTMER

equipment sent from all parts of the Bell Telephone System.

She appraises each complaint and determines its proper classification to the end that it is directed to the engineer concerned. Each of these complaints is recorded by her by Operating Company areas as well as serially for the numerical record. When the complaint is answered, Catherine assures correct mailing of the final correspondence, and types for the record a summary of the final disposition of the complaint.

Kay, as she is known to her many friends, graduated from St. Cecilia's High School in Englewood and did hospital work for a year before coming to the Laboratories. One of nine children, she finds plenty of friends and hobbies right in her family circle. Ice skating, swimming and bowling are among the sports she enjoys near her home in Bogota, New Jersey. Her favorite sailor is her brother; her favorite pastime, dancing at the U.S.O. Club.



CATHERINE M. COONEY

Till They Come Home

The following article by Evelyn Clark Emmett in *Vogue*, February, 1944, contains practical advice, as well as psychological weapons, for the wives or sweethearts of soldiers and sailors overseas.

March 1944

This is for all wives, brides and brides-to-be of men at war. This is for all of you whose hearts were scooped out when you said "goodbye" to the man the war has taken from you.

You want the war to end fast . . . and it doesn't. You want a swift, thorough, violent victory; you want him home. Isn't there something you can do to make that happen?

What will bring him home in time to miss the bullet, the torpedo marked for him? I didn't—I don't—know. But the day after he sailed away I tried to find out how the war could move faster, be shortened. I asked innumerable men in the Armed Forces how the war could be short-



AMERICA CUERVO

ened. One serviceman said gravely: "If people all worked and stuck at their work, it would shorten the war. It would be over now, if we all fought." Because men and women everywhere slow down or strike—the war is prolonged, and your man stays away. For women there are only a few big jobs; for most of us, it is a huge volume of little jobs to be done. We've heard that, of course, all along. But this year is the big fight—the year of the big pull.

There are four psychological weapons that all of us need to use with efficiency, with vitality, to help win the war.

FIRST: Be aware of the whole war picture. It is an aware woman who does a job that is not just a salving job, but a war winning one; who sees the connection between saving fat and a battle won; who knows that buying—and KEEPING—war bonds stops inflation, as well as pays war expenses; who sees all the little irritating savings and chores add up to huge victories

332M



Verve can do it, as well as weight, says Mary Galvin of Rubber Research. She needs all of her 120 pounds, sometimes, to bring the handle of the hydraulic press down to the end of its final stroke. When a sample of a new rubber compound is ready to be vulcanized in the hot press, she starts in like an old-fashioned organ pumper and then runs the gauge up to its mark by a quick leap onto the handle. It's good exercise, she says, and it's her job

—or defeats. It is an aware woman who recognizes the insidious criticism of those war-weary people who like to say it is nearly finished. It is an aware woman who looks at the ugly story on the maps and sees that our men are on but the fringe of enemy territory.

SECOND: Don't underestimate the importance of your job. Many vital industries are unable to get workers because the workers want more "glamorous" jobs. Other plants lose workers every week, because the work seems dull. But any woman, aching for the safe return of her man, need not be told by a paid personnel woman how important each job is.

THIRD: Have the fixed determination to do ALL, not just some of what you can. Keep constantly in your mind the thought, "He must come home," and you will see a hundred opportunities to make that nearer to coming true. Do not only the known things, such as enlarging your Victory Garden, reporting Black Markets, taking your proper war job; but expand your influence as well. Know that by saving bulbs you save tungsten needed for the * * * that may save your husband's ship; that a ten per cent saving in electricity would save four million tons of coal and seventy-five million bulbs; that ten per cent saving of household gas would save a million and a half barrels of fuel oil.

FOURTH: Pray. Say a prayer each night. Say, "I will work at my job hard and long. I will do it better than ever before. And I will try to encourage others to increase their efforts, too—for if all of us are thinking, doing, and working he will be coming home that much sooner."



M. VIRGINIA O'HARRA

VIRGINIA O'HARRA was the first woman to join the drafting room at Whippany. There she prepares drawings on electronic devices for the Armed Forces. Although she is only nineteen, she prepares her own layouts as well as the associated assemblies, wiring and cabling drawings. She is a graduate of Morristown High School where she took the academic and commercial courses simultaneously. She received her initial drafting



RUTH HARPER

training as part of the Rutgers Extension Engineering day course. Before coming to the Laboratories she worked at the A. T. & T. test station at Morristown.

Miss O'Harra's father is a pure Montauk American Indian and her mother also boasts of Indian blood. She has two younger sisters and an only brother, now an Army lieutenant; the family live in Morris Plains. Her hobbies are skating; singing with the Whippany Glee Club; and designing and sewing her own clothes—she designed the powder blue dress she wears in this picture. The young officer whose picture is on her desk is her fiancé, a Marine lieutenant who is about to go overseas.

* * *

RUTH HARPER'S career at the Laboratories is a reversal of the usual rôle in wartimes when a parent goes into an essential industry to assure the safe return of

To hasten the return of their husbands these three Army wives learned to do essential work in the Development Shops. They were members of a six-weeks course of shop and classroom instruction given by the Development Shops and the Personnel Department. The members of the class shown in this picture are Agnes Jordan, Dorothy Fraser, and Carter Delafield with A. G. Martensen, one of the instructors. Other members of the class are: Betty Baird, Virginia Ballantyne, Leona Chambers, Katherine Lott, Elizabeth Patton, Ann Post, Edythe Shaw, Marian Smith, Pussie Smith, Gloria Weiman and Eileen White



a soldier or sailor son. Ruth came to West Street to work on the development of war devices which will help to bring back her soldier father. Equipped with a degree in mathematics from Mount Holyoke College, she decided to replace, in a measure, MAJOR ROBERT W. HARPER, formerly of the Switching Development Department, who is serving with the Signal Corps in the South Pacific. In the Television Research Department where she is a Technical Assistant she designs oscillographic circuits for war developments. She is studying *Advanced Circuit Theory* and *Electromagnetic Theory* at Brooklyn Polytechnic Institute two evenings a week toward her master's degree.

When she was at college she participated in all kinds of sports. Now she enjoys reading when she has time, as well as the theater and an occasional game of bridge. She is interested in art and as a hobby is making a collection of prints. Ruth lives with her mother in West Orange.

* * * * *

DOROTHEA ALBANESE, who operates the electric lettering machine shown on this

page, is a graduate of Walton High School in the Bronx. Before coming to the Laboratories she had been a supervisor of the Listing Department with the Red Cross in the Bronx, and she had worked on the listing campaign for the United China Relief campaign. She had also done bookkeeping for the Associated Press; and she had handled letters of appreciation and questions sent to *Woman's Day*, a national magazine. Dorothea's diversions are dancing, reading and making her own clothes.

The Automatic Lettering Machine

SYSTEMS Development Drafting Department has an automatic lettering machine which has relieved that group of some of its most tedious work of lettering on drawings. This electrical lettering machine, which is operated by DOROTHEA ALBANESE, a special typist, has an electromagnetically controlled keyboard adjustable to produce letters of any density. It is being used for lettering with pin-point accuracy at any location on a drawing; it allows 396 square inches of drawing to be in full view and in

lettering position at all times and it permits erasure of typing without destroying the surface of the tracing cloth because of a special ribbon designed for this purpose. Small or large sheets can be handled with equal facility, the sheets being placed on a large flat writing surface as they would be on a drafting board. By changing the position of the tracing or paper, typing can be done at any angle or following a curve, and a single letter can be placed accurately in any desired position. The automatic lettering machine is also being used to type lists and tables and to make notes on curves.



DOROTHEA G. ALBANESE

Tinsel for Navy Telephones

By H. H. STAEBNER
Cord Development

FOR many of its telephones, the Navy requires cords with tough rubber jackets, waterproof, resistant to salt spray, and with conductors able to stand repeated bending. Navy standard cordage, having conductors of stranded wire much like electric lamp cord, is admirably suited for this use in many respects. In the case of transmitter and receiver cords, the ability to withstand repeated flexing is of especial importance. The service life of these cords, where the telephones are in constant use, has been comparatively short because the stranded wire conductors become broken just outside the instrument.

The Navy's engineers brought this problem to Western Electric, which makes many of their tele-



U. S. Navy Photo

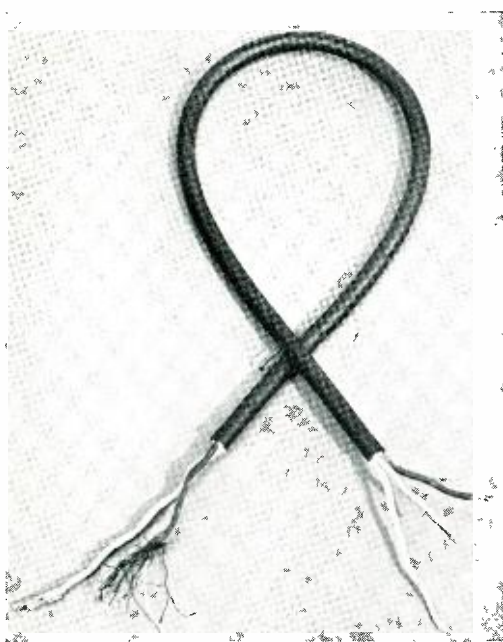

phones. When it was referred to the cord development group, some samples of stranded cords were secured and the Laboratories cord-testing machine was equipped with holders to simulate the Navy's instruments. Life tests were run on these cords and for comparison on Bell System standard tinsel cords. Tinsel proved to have a life many times longer than that of strand.

In a sound-power telephone system, widely used in the Navy, because it is independent of batteries, the only energy is that of the speaker's voice, and losses must

A cord to connect the transmitter of a Navy telephone. At the extreme left, a conductor terminated by a solderless metallic tip; the other conductor has been unravelled out to show the tinsel strands. On the right are seen the cotton stay-cord, to take mechanical strains, and the two conductors with ends served by copper wire and soldered

be held to a minimum. That means conductors of low resistance, a property in which strand is superior to tinsel. Strand will therefore be retained for the longer cords—some of them 20 feet long—and tinsel will be used for the short transmitter and receiver cords.

Tinsel, for those who think of it only in terms of Christmas trees, is basically a bronze ribbon about 1/1000th inch thick and approximately twenty times as wide. Two of these ribbons are wound in a double layer around a cotton thread, and six of these assemblies are twisted together around a cotton thread to form one conductor. Over the six-thread tinsel conductor a rubber insulation is applied with a knitted cotton "barrier" beneath it to keep the copper and rubber apart. Two such insulated conductors with filler threads are twisted with a dummy conductor, of seine twine, to round out the structure and provide a tie cord at each end; the whole is then covered with a tough rubber jacket.

One of the cord engineers' problems was

THE AUTHOR: H. H. STAEBNER received the B.S. degree in Electro-Chemical Engineering from Massachusetts Institute of Technology in 1927 and joined the Technical Staff of the Laboratories in August of the same year. His work has been concerned with the development of central-office wire insulation, switchboard and telephone cords and enamel-insulated wire for winding coils and for use in cable.

to cut down the outside diameter from 0.265 in., the Bell System standard, to about 0.245 in., and yet to avoid weakening the cord. This was accomplished by using smaller threads, of mercerized instead of plain cotton, and by reducing the thickness of the knitted barrier.

As a result of performance tests of sample tinsel cords, the Navy has placed a large order on the Western Electric Company for such cords, cut to length and with ends finished for the terminals of the sound-power telephone instruments.

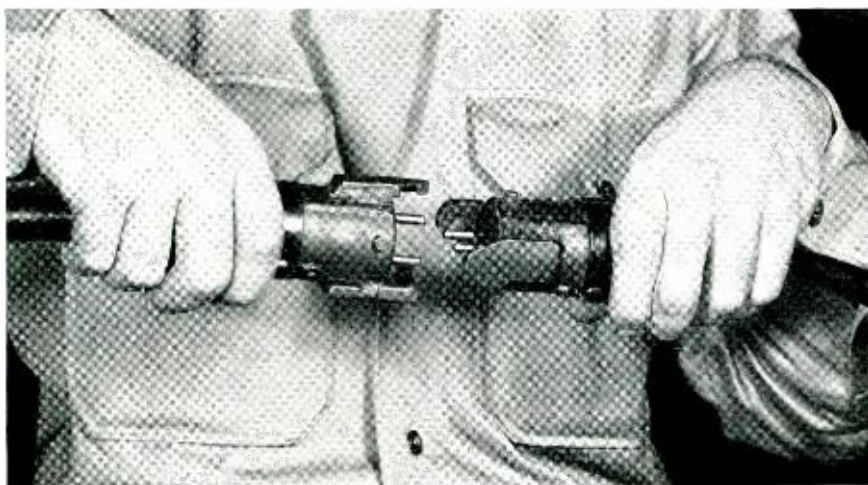

The spiral-4 cable for the four-channel carrier system is made in quarter-mile lengths with water-excluding couplings at each end to permit rapid connection

Historic Firsts: The Crystal Clock

FREQUENCY is of the essence of time, and is generally used as its measure. One cycle of the axial rotation of the earth establishes our basic temporal unit, the day. Smaller units of sidereal time—the hour, the minute, and the second—are derived by dividing the day into 24, 1,440, or 86,400 equal parts. A device making only one cycle per day, however, is not convenient for timing ordinary affairs, and for nearly three centuries the most accurate secondary marker of time has been the pendulum. Through an escapement mechanism, the pendulum controls the motion of hands on a dial to indicate time. Besides measuring time, such a clock also measures frequency—the frequency of the oscillation of the pendulum.

While frequency is thus important to the measurement of time, it is important in its own right to electrical communication. The quality of speech, the transmission characteristics of electrical circuits, and the behavior of telephone transmitters and receivers all depend on the frequencies involved. The measurement of frequency is thus basic to telephone research, but just as the terrestrial cycle is too slow for ordinary measurements of time, so the pendulum is too slow for ordinary measurements of frequency. For many years Bell Laboratories employed a 100-cycle tuning fork as a standard. The oscillations of the fork also were counted by a clock mechanism, but in this case the hands of the clock were driven by a synchronous motor using an alternating

current whose frequency was governed by the fork.

Because of the ever-present need for greater precision, and of the increasing use of higher frequencies in radio and carrier systems during the 1920's, it was decided to use a quartz crystal as the oscillating standard. After an extensive study of the factors involved, W. A. Marrison devised and built a crystal-controlled clock using the crystal and mounting shown. This clock was put in operation in 1927, and from the start proved a very accurate timepiece—with a daily deviation

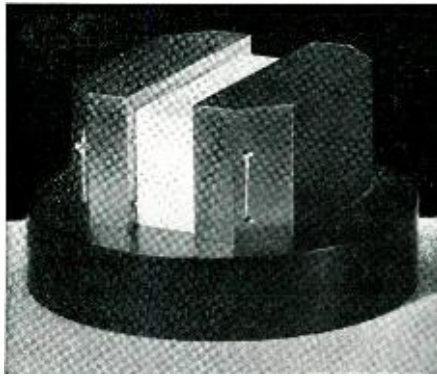

of less than one part in one million. Quickly improved by 1929 to one part in ten million, the crystal clock can now be provided in greatly simplified form with a daily deviation of well under one part in a hundred million.

For astronomical use, crystal clocks have a number of advantages in addition to their great stability. Chief among these is their complete freedom from the effect of gravity, and the facility with which a single crystal can control mechanisms indicating both sidereal and mean solar time, from either of which accurate time determinations can be made at any instant. Because of these advantages, and because the accuracy of a good crystal clock is now greater than that of the most precise pendulum clocks, it has been widely adopted by astronomical observatories and Government laboratories, where it is playing a rôle of steadily increasing importance.

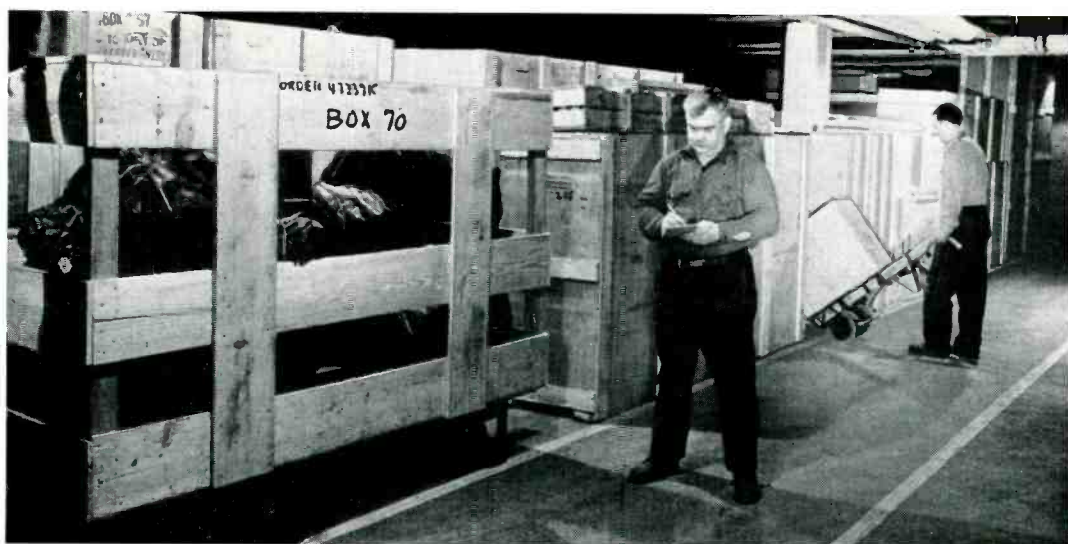

Central Offices in Boxes

LONG before Pearl Harbor, the American Telephone and Telegraph Company, recognizing the importance of promptly restoring communication facilities should they be damaged by bombing or sabotage, made an extensive survey to determine the minimum essential facilities that would be

needed at various locations both in the way of office equipment and transmission circuits. Alternative locations for emergency toll offices were determined in some instances, and specific plans were prepared for connecting emergency offices to existing cable or open wire circuits. The Laboratories were then asked to prepare complete plans and specifications for office units that could be assembled at once and stored ready for immediate shipment in emergencies. So far as possible, standard equipment was specified, but certain arrangements, such as the height of frames, had to be designed to meet non-standard conditions that the emergency quarters might require.

The Western Electric Company assembled and completely tested the apparatus called for, and then packed it in carefully marked boxes. All the boxes for one office unit are kept together and such units are stored in strategic locations to be available for immediate shipment. In preparing the apparatus for packaging, everything possible has been done to reduce the labor that will be required at the time of installation. Cable cut to the correct length in conform-

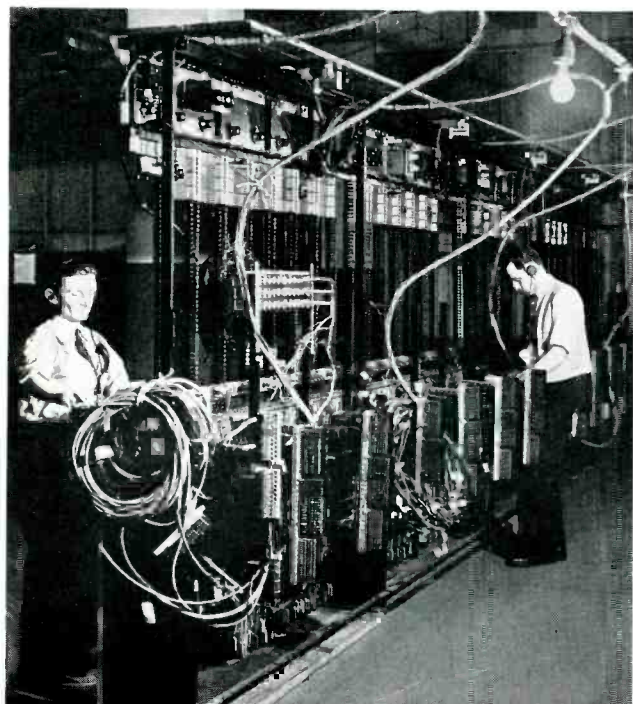

ance with the prepared plans has been soldered to the equipment at one end and to terminal strips at the other end.

With such meticulously completed arrangements, and with equipment ready for immediate use, the time required to restore service in emergencies will be drastically reduced. The photograph at the head of this

article shows some 140 items of boxed equipment that represents a complete central-office unit capable of giving service to 1,200 essential lines in either dial or manual areas. The other photograph on page 336 shows pre-connections being made by the Western Electric Company to a subscriber switchboard before the apparatus is packaged.

GERMAN SPIRAL-4

THE illustration shows O. B. Jacobs with a reel of spiral-4 cable captured from the Germans by the advancing American Armies in North Africa. This cable is apparently usable in the same manner as our own spiral-4 described in the RECORD for April, 1943. The loading for the German cable is in a separate unit, however, which plugs to the cable at junctions between reel lengths, while our loading is smaller and is made integral with the coupling devices. Our assembly procedure is thus simpler, and since our cable sections are 1,320 feet long as against a length of 820 feet for the German, we require fewer couplings. Our conductor size is also less, and thus we require less copper. A steel braid in our cable supplies most of the longitudinal strength, while the German cable is dependent upon the strength of the conductors.

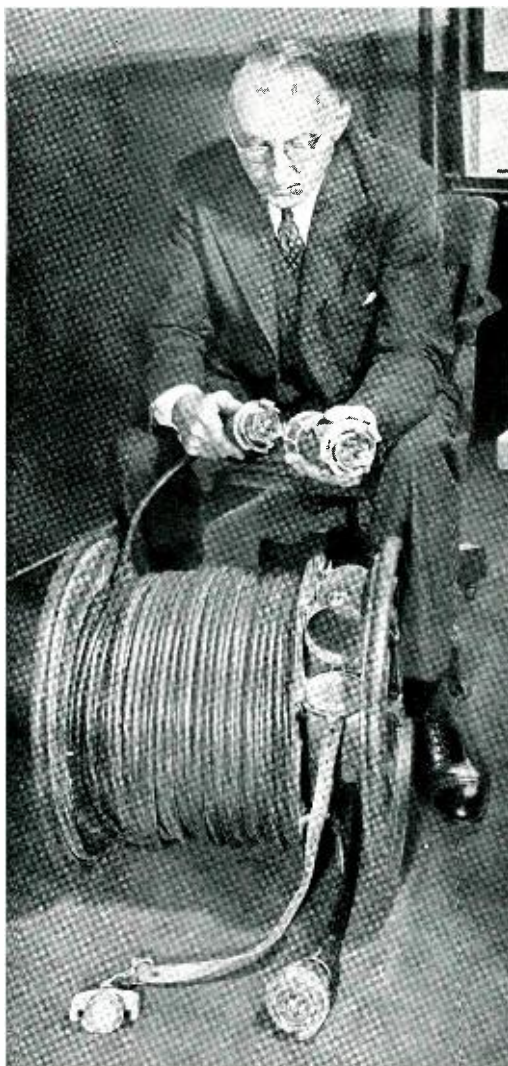

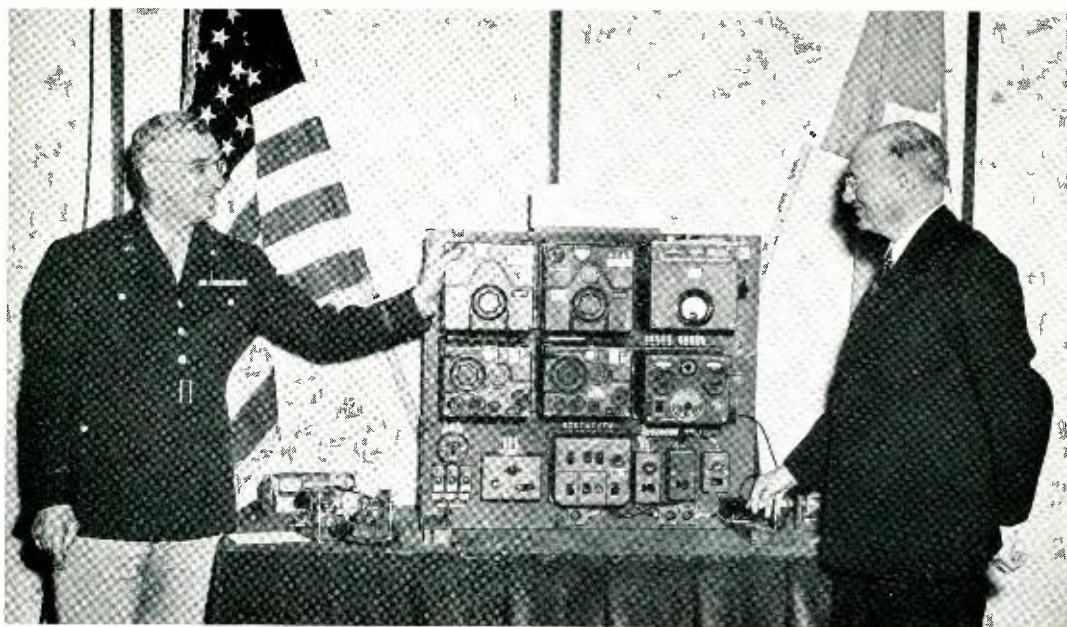

Captured Enemy Equipment Exhibited at the Laboratories

THE first complete display in the New York area of captured German, Italian and Japanese military communications equipment was exhibited from January 22 to 25 in the West Street auditorium. Here the engineer had the chance to see how the enemy were solving the same problems that had faced him, and to judge whether we were victorious on the technical front as well as on the fighting front.

All the apparatus exhibited had been carefully analyzed and tested either at the Aircraft Radio Laboratory at Wright Field or at the Camp Coles Laboratory at Fort Monmouth. It was these two organizations that provided the equipment.

Much of the apparatus, such as command sets and airplane radio transmitting and receiving sets, was similar in general arrangement and operation to our own apparatus, as could be seen by comparison with a considerable amount of Western Electric equipment, which was also exhibited. Certain distinguishing features were obvious, however. The German equipment made extensive use of complicated magnesium die

castings, and on the whole their apparatus seemed more complicated than ours, but without attaining better over-all performance.

Japanese apparatus, on the other hand, seems more nearly like ours in design and construction. Elaborate die castings were conspicuous by their absence. But the Japs use quartz crystals quite generally in their aircraft apparatus while the Germans do not. As might be expected, they are lavish in their use of rubber.

Among the items of particular interest was a radio direction finder captured from the Japs before it had been unpacked on Attu. It consists of a square loop some 8 feet in diameter with a crank for turning, and a 360-degree graduated dial with a vernier for reading angles.

Another interesting device was a German photophone—in appearance a large pair of binoculars set on a tripod. It is used for communication over moderate distances by modulated light waves. A telephone line, for example, might be brought up to this apparatus on one bank of a wide river. The incoming telephone currents would modulate a

light beam which would be picked up by a similar device on the other bank. Infra-red filters are incorporated so that the "light" used will be invisible.

One of the few pieces of Italian equipment was a pedal generator—designed apparently to serve as a power supply for portable electrical apparatus. It looks like a canvas-seated deck chair with two bicycle pedals fastened to it at the foot to drive an electric generator. The operator reclines in relative comfort and cranks the power with his feet.

Among other items of equipment were field telephone sets, a German sea rescue set, tank radio receivers and transmitters and various forms of power units.

Also displayed were the latest model U. S. Army tank sets, "handie-talkie," "walkie-talkie," and guidon radio sets, telephone switchboards, a mine locator, the airborne radio command set and military telephones.

This apparatus was later exhibited at the conventions of the A.I.F.E. and I.R.F., where Major General Roger B. Colton, in charge of Army engineering and technical services, discussed it at a joint meeting.

Arrangements with the Signal Corps were made by R. K. Honaman. Assembly and mounting at all locations were planned and carried out by H. J. Kostkos with the assistance of M. Brotherton, J. R. Erickson, John Pollio and E. J. Riley.

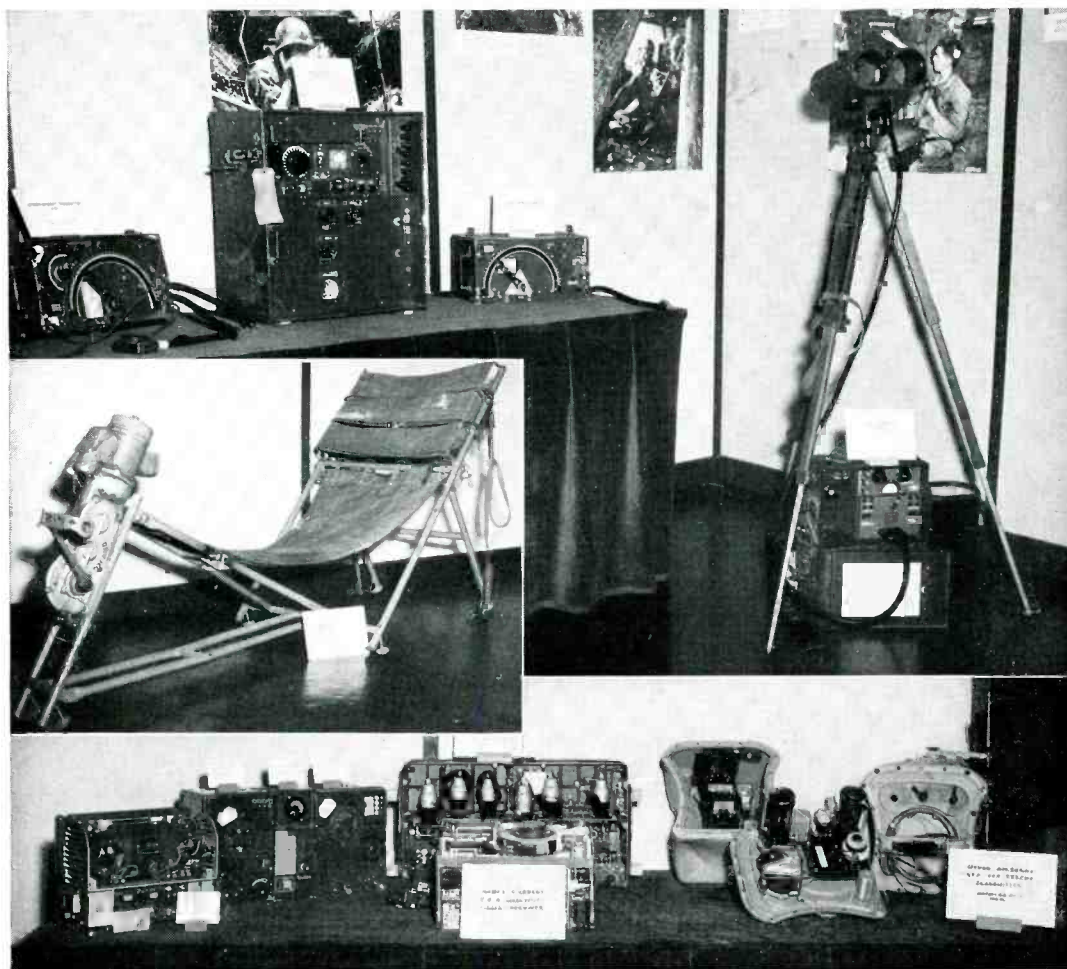

The German equipment shown in the upper photograph includes an aircraft transmitter, a carrier unit, an aircraft receiver and a photophone. The insert shows an Italian pedal generator while the lower photograph shows airborne equipment



Signal Corps Photo

Underwater Telephone Line

(From a War Department Press Release)

UNWILLING to wait for the arrival of regular submarine telephone wire during the desperate fighting for Munda in July of last year, a Signal Corps detachment laid an underwater telephone line from Corps headquarters on Rendova Island to two divisions on the mainland with spiral-4 cable. This cable is made to be used on land. This marked the first time its use for underwater communication purposes had been reported.

Spiral-4 cable ordinarily is used by Signal men to establish semi-permanent wire channels to the front lines. It is utilized with carrier equipment and furnishes a number of voice and telegraph circuits to division and regimental command posts. It was used with great success in the North African and Sicilian campaigns and is playing its part in furnishing vital communications to troops fighting in Italy.

The story of its utilization as submarine wire was brought back to this country by Col. Francis L. Ankenbrandt, Signal Officer of U. S. Army forces in the South Pacific Theater of Operations. Col. Ankenbrandt described the operations as follows:

"The job of getting wire communications to the two divisions on Munda was one of the outstanding feats I witnessed during the year and a half I have been in that theater. The nine-mile route was half jungle and half ocean. Part of the time the working party, led by Major George A. Reeves of Oklahoma City, Oklahoma, was under heavy fire from Jap artillery emplaced in the hills, strafing attacks by Jap aircraft, and snipers along the shore of the mainland.

"When we learned that Corps wanted that line through, we organized a construction section of fifty men from an operations company and a construction

battalion. The route ran through 1.25 miles of muddy plantation; 2.2 miles of ocean, with a depth of 1,700 feet; 2.4 miles of almost impassable jungle; another 2.2 miles of ocean and 1 mile through tangled jungle on the mainland.

"The ocean-laying part of the job was the most interesting from a technical angle. Much care was given the sealing of connectors to assure maximum waterproofing. Rubber tape and friction tape were used, since it was the only material available. The cable was looped at each of the connectors to relieve the strain, and then laid in a landing boat in figure 8 loops.

"Paying out the cable over the first water route was completed in one hour and forty-five minutes. Nothing unusual was en-

countered except that extreme care had to be taken so as not to bruise the cable or shear the connections on the coral. The cable was paid out generously and reached a floating level at an estimated depth of between 25 and 50 feet. Barbed wire stakes were used as anchors and were placed at every one-eighth mile.

"Field wire was used to link the two submarine circuits at Roviana Island, in the middle of the channel of water. Wire had to be carried from boats to shore over sharp coral from 50 to 100 feet. The men wore out new shoes in a single day doing this.

"Out of the four circuits obtained, three were still in operation when I left in November. One circuit had gone out about 30 days after the installation."



Signal Corps Photo

This and the photograph on the opposite page show a cable being laid between Sawto and Tutuba. Spiral-4, which comes from the manufacturers in half-mile lengths, has been jointed into 2½-mile lengths and wound on reels for underwater laying. A splice can be seen on the reel in the foreground of the illustration on the other page

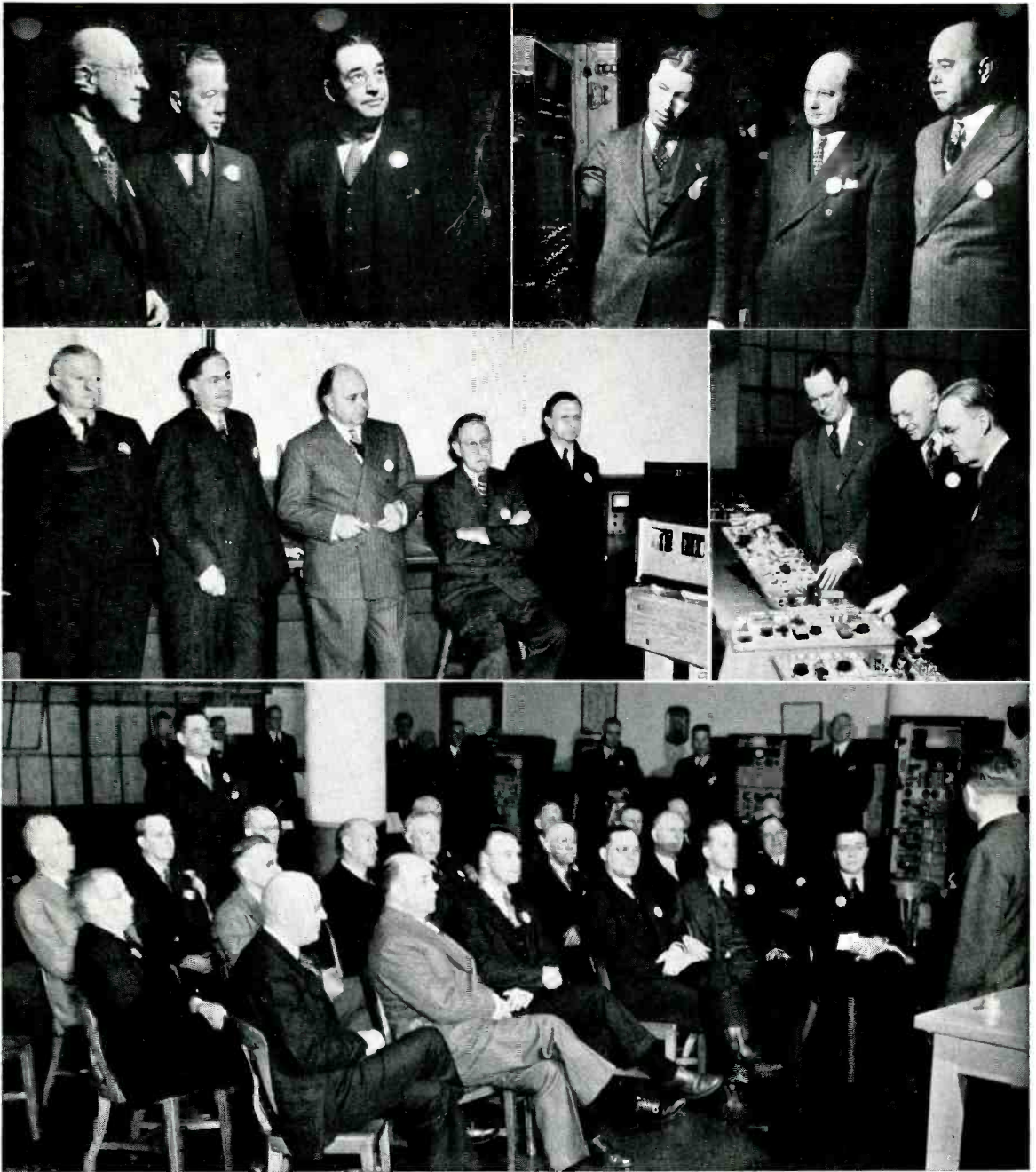

OPERATING VICE-PRESIDENTS OF BELL SYSTEM VISIT SCHOOL FOR WAR TRAINING

Upper left—F. J. Chesterman, Bell of Pa.; A. B. Clark, B. T. L., and B. L. Kilgour, Jr., Cincinnati. Upper right—C. A. Dahlborn, B. T. L.; G. H. Jess, Pacific Tel., and M. R. Sullivan, A. T. & T. Left center—Carl Whitmore, N. Y. Tel.; J. J. Pilliod and M. R. Sullivan, A. T. & T.; J. A. Remon, C. & P., and H. S. Osborne, A. T.

& T. Right center—L. H. Peterson, B. T. L.; T. N. Lacy, Michigan Bell, and W. O. Kurtz, Illinois Bell. Bottom—The whole group hears how the School for War Training instructs military personnel and certain civilians in the operation and maintenance of the instruments developed by the Laboratories for the Armed Forces

The Western Electric mirrophone helps Navy airmen "talk" their way out of tight spots. With their lives often depending on the split-second transmission of messages, Navy fliers cannot afford to talk with "mush" in their mouths, so the mirrophone, which enables them to hear their own voices, thus eliminating speech defects, is proving to be a valuable training tool for student pilots, gunners, radio telephone operators and others who are called upon to transmit important orders without error or delay



Mirrophone on All Aircraft Carriers

The Army and Navy have stepped up their use of the Bell System's Mirrophone for use in language instruction and in speech training for combatants who transmit important orders and messages.

A recent telegram from Rear Admiral D. C. Ramsey, chief of the U. S. Navy Bureau of Aeronautics, called on the Western Electric Company to produce more of the Mirrophones at once, and added: "This recording device is considered so valuable that it has been installed on all our aircraft

carriers. Split-second communications are vital to the success of combat operations, and your Mirrophone helps to attain such precision by developing the best voice technique for transmitting messages."

The recording machine, which will "play back" a sixty-second conversation spoken into a transmitter, also is being used extensively in the Army Specialized Training Program at Yale University, to help the trainees capture elusive pronunciations in their study of Japanese, Burmese, Russian and other foreign languages.

Do You Know?

A—If you overheard a Long Distance operator say "NC" you would say

1. No, operator, Quiggsville is not in North Carolina
2. Will you call me back when you can get a line?
3. Of course I'm nice!

B—A jack is

1. Something to plug into
2. A toy for little girls
3. What takes a ten-spot
4. Tire-changing tool
5. At the end of a switchboard cord

C—A decibel is a

1. Girl's name
2. Musical instrument
3. Spring flower

4. Lineman's whistle

5. Unit in acoustics

D—A crystal is

1. Used by war-forecasters and stock tipsters
2. Tableware for company only
3. What breaks first on your watch
4. Frequency-control device
5. Switchboard lamp cap

E—Crossbar is a term meaning

1. Menace to navigation
2. Dial system
3. Part of a distributing frame
4. Wrestling hold
5. Cattle brand

Answers on page 347

The Fourth War Loan Campaign

During the Fourth War Loan Campaign for the purchase of United States War Savings Bonds, 5,568 members of the Laboratories bought bonds amounting to \$342,084.75. Of this amount, \$201,225.50 worth were purchased in cash or over-the-counter sales by 2,369 members, while 3,205 others subscribed \$140,859.25 in bonds through a special payroll allotment plan. The figures given were as of February 17.

Advanced Course in Mathematics at Brown University

A bulletin of Brown University accords recognition to the part played by Laboratories men in setting up and operating the University's program of advanced instruction and research in mathematics.

As far back as 1939 there was a conviction at Brown that the impending conflict demanded a strengthening of the program in mathematics. That conviction was implemented in a report by T. C. FRY to the National Resources Planning Board. He pointed out the expansion of mathematical analysis into new fields, the growing need for professional mathematicians in industry, and the lack of university courses to train them.

Accordingly, a twelve weeks' session on applied mathematics was offered in the summer of 1941; to evaluate it, a committee

of scholars and administrators was appointed which included M. J. KELLY, Director of Research. On the basis of its report, a program was arranged of courses of varying difficulty but all on the graduate level. S. A. SCHELKUNOFF presented a series of lectures which later appeared in book form under the title "Electro-Magnetic Waves." Dr. Fry was appointed a member of the Advisory Committee and one of the editors of *Quarterly of Applied Mathematics*, a publication which is sponsored by Brown University.

Course in Supervision Being Given at Murray Hill

An out-of-hours course in *Human Problems in Production Supervision* is being given at Murray Hill on Thursday evenings in cooperation with Rutgers University as one of the Engineering, Science and Management War Training Courses authorized by the United States Office of Education. C. G. MAISE of Rutgers is the instructor. The course consists of twelve two-hour meetings and has an enrollment of twenty-eight members of the Laboratories, five of them being women. Its purpose is to give supervisors a practical understanding of supervisory duties and responsibilities with emphasis on a free discussion of current practices in dealing with problems of leadership in industrial groups.



The operation of an improved resuscitator, which has been added to the equipment of the Medical Departments at Murray Hill and Whippany, was recently explained by a representative of the supplier to the First Aid leaders at these locations. From left to right are shown C. D. Hartman, G. A. Smith and E. B. Stallman with the representative inspecting the apparatus at the Murray Hill laboratory

The deep mud can't stop this American Red Cross hospital worker who is attached to an advanced evacuation hospital somewhere in Italy. Besides the box of American Red Cross supplies, she is also carrying what was a German ammunition box. Now it is serving a good cause and is labeled with the cross of mercy.

Many of the Laboratories men fighting in Italy and in the South Pacific, and especially those in England and Northern Ireland, have written to the RECORD praising the medical supplies, food, clean sheets, showers, and recreational facilities which the Red Cross organization is giving them



Red Cross Photo by Atkins

1944 Red Cross War Fund

WHEN bombs fall there is no time to send help halfway around the world. When a wounded fighting man needs a transfusion, it is too late to begin looking for a blood donor or find a nurse to care for him. When a lonely soldier learns of trouble at home, he needs help—immediately.

The American Red Cross provides that help wherever and whenever the need arises. A continuous procession of blood donors must be maintained, nurses must be recruited for the Army and Navy, trained Red Cross Workers and supplies must be sent to camps, hospitals and foreign theaters of operation the world over. When a train crash leaves scores injured, when flood engulfs a town, when epidemic strikes, delay may cost lives.

To fulfill its many obligations to the Armed Forces and our people, the American Red Cross needs your help. During 1944 it must supply some 5,000,000 blood donations. Each month 2,500 nurses must be recruited for the Army and Navy. Red Cross field directors and other trained personnel must be stationed at military and naval posts and hospitals to help our fighting men and their families when personal trouble brews, a task in which the Red Cross chapter on the home

front ably does its share. At home nurses' aides and others must be trained, food parcels packed for prisoners of war, surgical dressings made and the thousand and one details of administering a far-flung, busy organization must be attended to.

All activities of the American Red Cross are financed by voluntary gifts and contributions. During March, designated by President Roosevelt as Red Cross Month, the American Red Cross must raise its 1944 War Fund of \$200,000,000 to meet unprecedented needs. Your contribution will assure maintenance of all Red Cross services and thus indirectly help save many a life. Let's give!

Give to the Red Cross

When you fill your pledge card you may designate the chapter or branch to receive your donation. The Bell Laboratories Club Campaign Committee will forward your contribution. If you wish you may have it deducted by Payroll from your salary.



One group of an exhibit of seventy war photographs of communications equipment in the restaurant lobby at Murray Hill. The camera angle allows identification of (left to right) R. A. Haislip, E. W. Baxter and J. F. Morgan of the Western Electric Co., C. J. Christensen and Jean Lafitte, but does not disclose clearly F. S. Goucher, Mildred Hoogstraat and Edwina Hazen

Pioneer Chapter Continues to Grow

The interest of the Laboratories in its own chapter—Bell Laboratories Chapter No. 54, Telephone Pioneers of America—was demonstrated during the month of January when sixty-three new active members joined its ranks. Starting with an active membership of 885 last September when the new chapter was organized, the membership roll grew to 995 at the end of the year and increased further to 1,059 at the end of January. Life memberships increased from 117 to 119 during the month, bringing

the total membership of the Chapter to 1,178. In January alone the membership increased from 64.8 per cent to 68.2 per cent of those eligible.

Automatic Ticketer Now in Service

Commenting on the Culver City cutover, R. R. Davidheiser, installation foreman for Western Electric, said in a letter to F. J. SCUDDER:

“Automatic ticketing in Culver City has now been in service for four days and I am glad to report that its performance is highly

Telephone Pioneers Enrolled During the Month of January

H. A. Abbott	O. H. Danielson	M. O. Kastner	A. R. Reinstra
S. W. Allison	J. F. DeZavala	A. C. Keller	T. D. Robb
M. L. Almquist	Mary E. Donnelly	H. Keppicus	H. A. Rosenbohm
E. G. Andrews	A. S. Dubuar	H. T. Langabeer	G. N. Saul
E. T. Ball	J. M. Duguid	J. Lee Larew	D. F. Seacord
S. J. Bernard	G. H. Duhnkrack	L. A. Leatherman	J. B. Shiel
B. R. Blair	Loretta P. Farrell	B. L. Leger	C. A. Smith
J. H. Bollman	A. S. Fritz	G. T. Lewis	C. J. Smith
W. W. Brown	R. Haard	V. L. Lundahl	W. C. Somers
H. T. Budenbom	R. W. Halliday	T. A. Marshall	L. J. Stacy
W. C. Burger	W. S. Hane	R. A. Martiny	C. L. Van Inwagen, Jr.
A. J. Busch	D. M. Hannum	Margaret McEntee	Annie M. White
Emily Callagy	A. W. Hayes	C. R. Meissner	P. L. Wright
C. F. Campagna	R. E. Hersey	R. J. Miller	A. J. Zerbarini
M. L. Clarke	Frank Huebsch	R. A. Ogg	Catherine D. Zinnel
J. Almon Coy	D. F. Johnston	L. J. Purgett	

D. H. Pennoyer, of Bell Telephone Laboratories, at left, with O. B. Sipe, wire chief, and W. A. Edwards, local manager of Southern California Telephone Company, shown with automatic ticketing equipment recently placed in service in Culver City, a Los Angeles suburb. This new system permits Culver City subscribers to reach nearly all of the telephones in the Los Angeles area by means of direct dialing, whereas, previously, they had been able to reach only about twenty per cent



satisfactory. I never thought the day would come when I would gaze with such admiration upon an inanimate object, but I confess that when I see that identifier-sender and ticketer work in unison, I bow in reverence to the ingenuity of man. Never have I seen such complicated equipment subjected to so

many exacting tests with so few initial changes as automatic ticketing. This can be attributed solely to the Bell Lab—you fellows certainly have done a good job.”

Mr. Davidheiser concluded with an expression of appreciation for D. H. PENNOYER, Laboratories representative on the job.

Army Homing Pigeons

Add to the list of such famed feathered messengers of the United States Army Signal Corps as “Yank” and “Lady Esther”—both of which won battle honors during much of the heaviest fighting in North Africa—the name of “GI Joe,” a blue, check-splashed cock credited with making what is believed the most outstanding flight yet made by a homing pigeon in World War II.

The bird came through from British Headquarters with a message that probably saved the lives of at least 100 Allied soldiers. An American Infantry division had made a request for air support to aid in breaking the heavily fortified German position at Colvi Vecchia, Italy, the morning of October 18, 1943. The message contained information that a British Infantry brigade had taken the same village just a short time before a unit of Allied Air Support Command was



Signal Corps Photo

After making a landing, this paratrooper releases a pigeon to report

March 1944

Answers to Quiz on Page 343
A-2; B-1; C-5; D-4; E-2

due to bomb the town. "GI Joe" made the trip, some 20-odd miles, from British Headquarters, in the same number of minutes, arriving just as the bombers were preparing to take off. Had the message arrived five minutes later, the friendly forces occupying the town might have suffered heavy casualties.

Pigeons have been taken across the enemy lines by patrols in pursuit of valuable information and have returned with news concerning strength and location of enemy troops, gun positions, a pending attack, traffic conditions on certain roads, and other vital data concerning enemy activity.

Homing pigeons had not been used to any appreciable extent on the Italian front until fairly recently. However, in a little more than a month, records show that at least 200 messages of importance were brought through, in one case by a bird that had been severely wounded. During a seven-day period in the battle for, and crossing of, the Volturno River, north of the city of Naples, 81 very vital messages were carried.

Use of the pigeon has kept step with the use of the airplane. One or two pigeons are standard equipment of R.A.F. planes raiding Europe. When planes crash at sea, pigeons carrying notice of the exact location are released. When radios are destroyed in flight and messages still must be sent, pigeons are used as supplementary means of communication. Experimental tests conducted by the Signal Corps and the Army Air Forces reveal that pigeons can be released from planes flying at 25,000 feet and at 350 miles an hour with no protection of any kind. The temperature at such altitudes is often as low as 59 degrees below zero.

It is now possible to drop basket containers of pigeons from the air. A six-foot parachute is used for four-bird baskets, and an eight-foot 'chute gently lets an eight-bird cage down to the ground. To date in Italy, there has been no necessity to use the parachute baskets. The birds can take considerable punishment, and suffer little, if any, damage from the impact.

The Army-Navy "E" flag with second star flies under Old Glory at Whippany. Following the Army-Navy request, no ceremonies were held at the initial raising. Below: E. I. Bulman is holding flag and W. C. Prendergast is at the pole

