

# BELL LABORATORIES RECORD

JUNE  
1939

VOLUME XVII

NUMBER X



*Entrance to Bell System  
Building, New York  
World's Fair 1939*

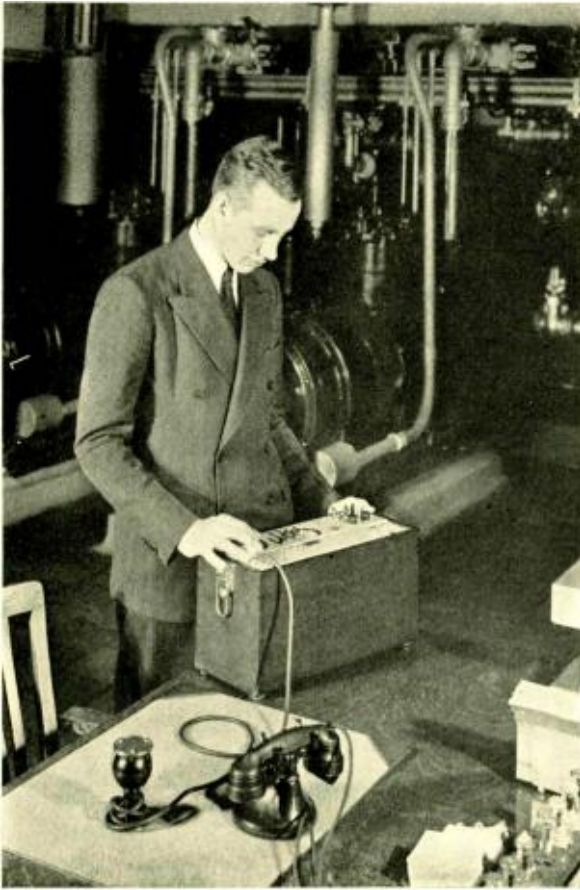

## Noise at Telephone Locations

By D. F. SEACORD  
*Transmission Development*

taken at relatively few locations and were based on listening tests in which sound from an auxiliary source was balanced against the room noise. A more extensive survey, carried out in 1929, included some two hundred and fifty locations largely in and around New York City; these measurements were made with noise meters as well as by listening tests. More recently, during 1936 and the early part of 1937, noise measurements were made at over six hundred locations in four cities.

THE ease with which speech can be heard over a telephone depends on noise conditions at the point of reception as well as on the characteristics of the telephone circuit. A knowledge of noise conditions at typical telephone locations is, therefore, of interest to telephone engineers; and measurements of room noise have been made from time to time by the Bell System. The results disclose wide variations in noise level. Recent data, obtained by the Laboratories, show that the average level in typical areas varies from forty db for residences to eighty db at factories, although in individual instances the levels may be more than ten db greater or less than these values.

The earliest measurements were

Late in 1937, a still broader survey was undertaken in conjunction with several of the associated telephone companies which covered a wide range of locations in various areas including rural and congested city districts in and around several major cities. Measurements were made under winter conditions at about nine hundred places in and around Chicago and Philadelphia; and these data were supplemented by summer measurements at about five hundred of the same locations. Further results were obtained under summer conditions at about eight hundred places in the territory in and around Cleveland and New York including, in the latter group, nearby points in New Jersey. It is impractical to obtain enough data

for each type of location in each area to define rigorously the room noise but suitable methods of combining these data should provide noise values sufficiently accurate for engineering purposes. At each location fifty noise meter readings were made at approximately five-second intervals—twenty-five by each member of a two-man crew. The average of the fifty readings was taken as the average noise and the concentration of the individual values near the average was computed as a measure of the variability of the data.

The noise meters used in both the 1936 survey and the one described here had 40-db loudness weighting networks and conformed to the specifications of the American Standards Association. The microphones were of the moving-coil type, and the meters read sound level in db above the reference sound level of  $10^{-16}$  watt per square centimeter at 1000 cycles in a free progressive wave. The noise level in the average residence for ex-

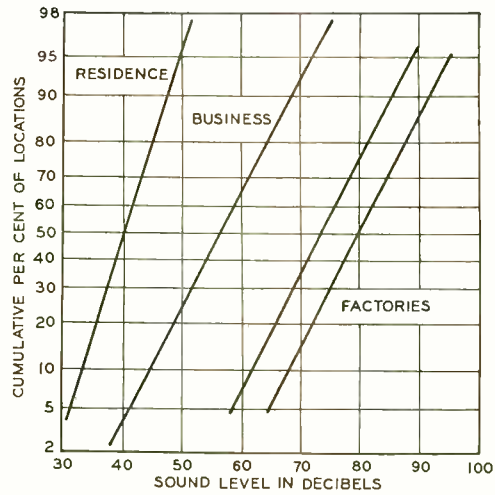

Fig. 2—Noise level at different locations of the same general type may vary over a range of from 20 to 30 db

ample is about 40 db above this standard reference point.

Some of the results of the measurements made during the winter in Chicago and Philadelphia are shown in Figure 1, which presents a general picture of the variation in room noise with respect to type of location. The length of each bar represents the average value of the noise for the number of locations indicated. These numbers represent merely the number of locations visited and are not to be taken as representative of the relative distribution of such types of locations in the plant. The single-line extension at the end of the bar represents twice the standard deviation and corresponds to the range covered by 68 per cent of the measurements. The noise level in summer at the same locations averaged about 3 db higher. Allowing for the difference between summer and

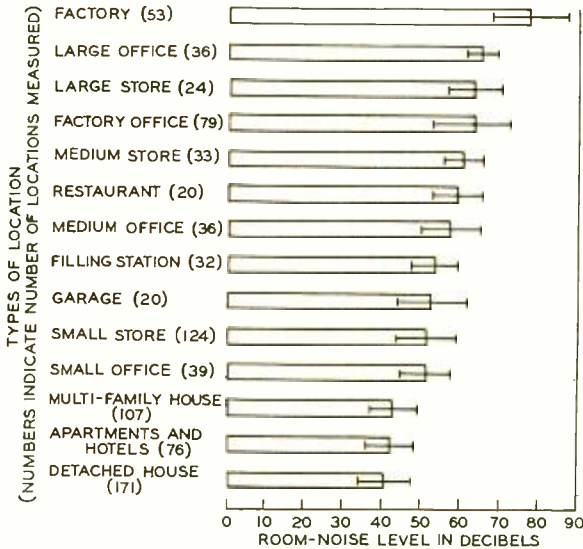

Fig. 1—Average noise level at different types of locations varies over a range of nearly 40 db

winter conditions, the results of this survey and the 1936 survey are in close agreement.

The distributions of room noise obtained from the winter data by grouping the locations in three general classes, i.e. residence, business (including factory offices), and factories are illustrated in Figure 2. For the business and residence classifications the data obtained in the Pennsylvania and Chicago surveys are in such close agreement that a single curve fits the two areas. This appears significant even though the proportions of the locations of each type measured in the two surveys are not identical. The Pennsylvania factory noise data gave higher values than the corresponding Illinois data, possibly because the types of manufacturing establishments chosen in the random

selection of locations were different.

The results of this survey of noise conditions where telephones are installed emphasize again the wide range of variation of room noise from one location to another. For example, in the case of residences as shown in Figure 2, five per cent had average noise levels of about fifty db and another five per cent were lower than about thirty db, thus indicating a total range of over twenty db. The noise in some residences approaches in magnitude the average noise in business buildings and the noise at some business locations approaches the average noise in factories. The data presented here together with those of the summer survey are being used as a basis for working out methods of allowing effectively for room noise in the design of the telephone plant.

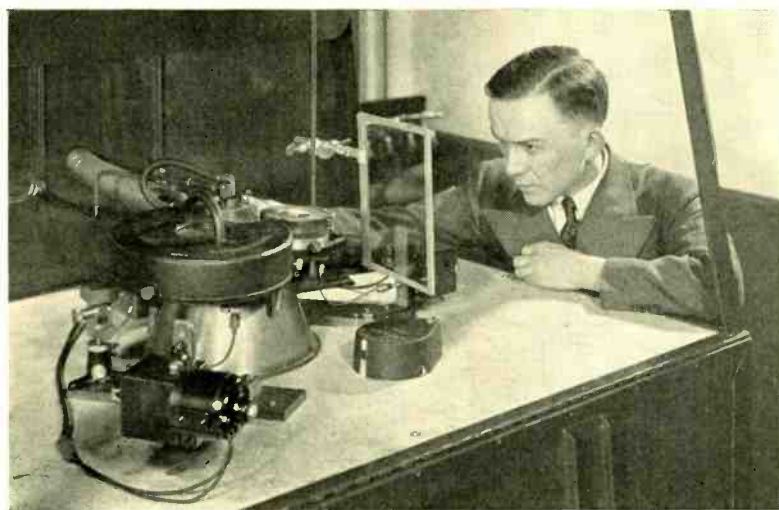

*X-Ray diffraction apparatus used for studying the structure of metals. The X-Ray tube, shown at the center of the cabinet, has two disc-shaped diffraction cameras, one on either side; the large one on the left for structure identification, the small one on the right for precision measurement of lattice spacing. Mr. E. S. Greiner is shown adjusting the position of the precision camera*



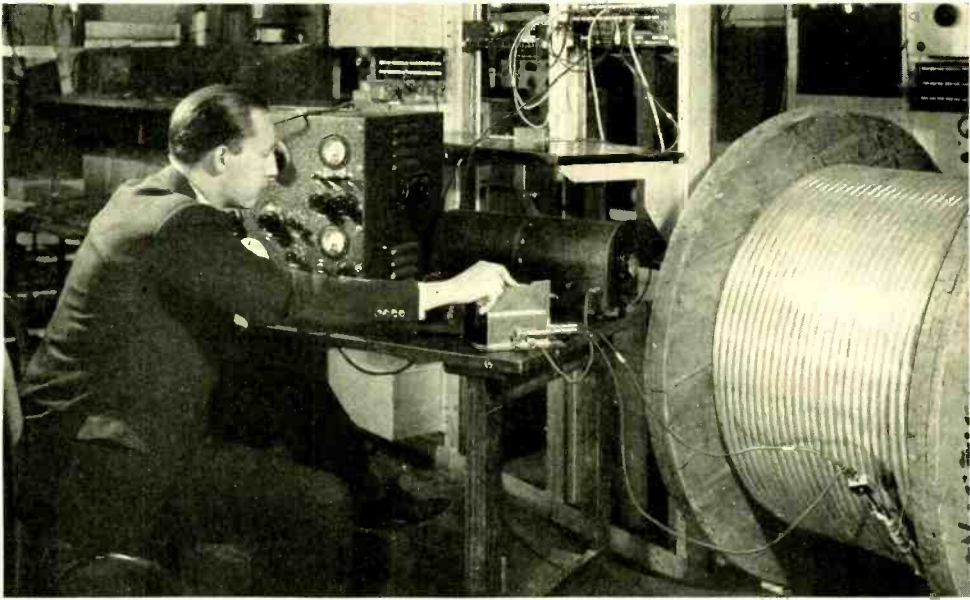

## Measuring Transmission Speed of the Coaxial Cable

By J. F. WENTZ

*High-Frequency Transmission Development*

**W**HEN we pick up the telephone to answer a call we never realize that our "hello" takes any time to reach the caller's ear. It is a fact that on any call we can make, even to distant countries, this time is so short that it seems only an instant before the answer returns. The lines and apparatus which transmit our speech have been so designed that delays due to them are always a small fraction of a second. If it took even half a second to traverse the connection from talker to listener, its effect on transmission would become noticeable. The total transmission time including instruments, terminals, and miles of line should be short enough not to react appreciably on ease of conversation.

We cannot always control the transmission time of all the various components that make up the complete circuit, and for some very long circuits only the highest speed lines can be used. One of the advantages of the coaxial cable with which we are now experimenting between New York and Philadelphia is its high transmission speed. The waves of carrier current that bear the voice over the line travel with a velocity of around 170,000 miles per second. Over even the longest circuit we might have in the United States, perhaps 4,000 miles, current traveling at this speed would require less than one-fortieth of a second to pass through the coaxial cable itself. Delays of this magnitude are not objectionable for tele-

phone purposes, and are even less important for television. Variations in the delay for different frequencies, however, are more important, and they are much more important for

gether. Similarly, if the cable is one-half mile long, the carrier will require the time of only one-half cycle to traverse it, and the currents at the two ends will be "out of phase,"

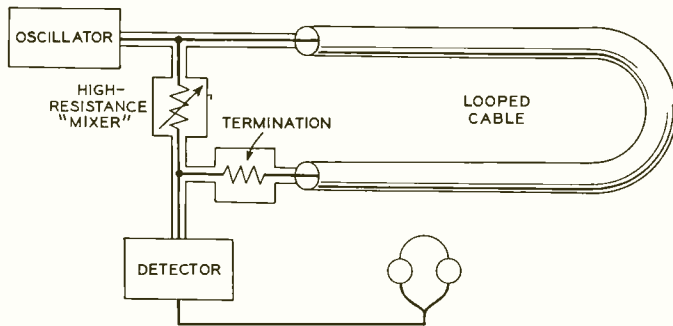

Fig. 1—Method of measuring phase delay when cable can be looped to bring the two ends together

one rising while the other is falling. If a half-mile length of cable is looped so that both ends are at the same place, the sent and received currents can be made to "buck" each other, resulting in zero current in a receiver. This is the simplest method of measuring the delay, and Figure 1 shows the

essential apparatus that is involved.

The accuracy of the measurement on any length of cable depends mostly on how closely the frequencies for which the particular length of line represents odd multiples of half a wavelength can be determined. These are the frequencies at which sent and received currents are exactly out of phase. If there are no variations in

television than for telephone signals.

A 170-kilocycle carrier requires  $1/170,000$  of a second for one complete cycle. On a cable with a speed of 170,000 miles per second, therefore, such a wave will travel one mile in the time taken by one cycle; the current received at a distance of one mile and the current sent out are "in phase" because they rise and fall to-

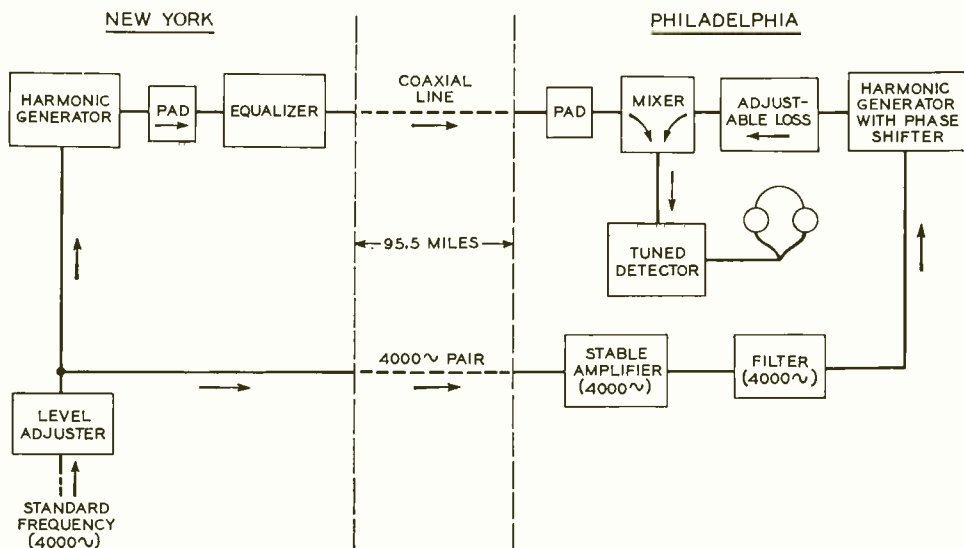

Fig. 2—Method of measuring phase delay on a "straightaway" test

the properties of the cable from one frequency to the next, these frequencies will occur at regularly spaced intervals, and the speed will be constant at all frequencies. Our cables can never reach this phase perfection and still be efficient, and so for sending television pictures it is necessary to correct them with a "phase equalizer."

The measuring method described above is very satisfactory where two long identical lines that can be looped are available. For a "straightaway" measurement, where the two ends of the cable are many miles apart, some means had to be devised to supply

a reference current at the receiving end which had some fixed-phase relation to the sending current. To do this, the method shown in Figure 2 has been employed. Here the sending wave is generated by a harmonic generator. This device takes a low frequency of a few kilocycles and turns it into a much-distorted signal which is very rich in harmonics. The wave shapes of the input and the output with their relative position in time are shown in Figure 3. Such a wave when analyzed is found to contain harmonics to a very high order—the narrower the peak the larger the high-order harmonics.

The generators built for the tests between New York and Philadelphia delivered at least 250 harmonics of 4 kc, all at about the same level of one milliwatt. A useful property of this generator is that the various harmonics have a fixed-phase relation to the fundamental if the shape of the peak is always the same. In this way

a generator is provided that has many high frequencies all fixed with respect to time by the 4-kc input to the circuit. Any number of degrees phase shift of the 4 kc can be translated into phase shift of a particular harmonic simply by multiplying by the order of the harmonic. A phase shifter with a

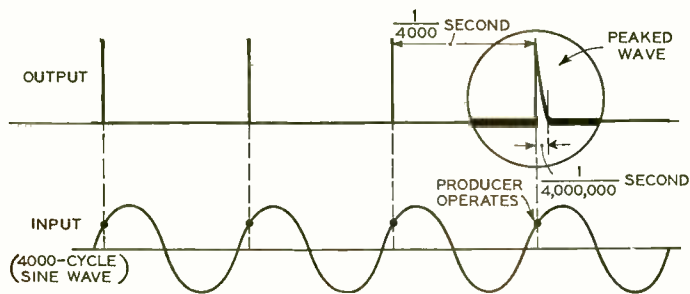

Fig. 3—The harmonic generator produces a peaked wave that provides for a large number of equal-value harmonics from a 4-kc fundamental frequency

calibrated dial was installed in the amplifier that is a part of the harmonic-generator circuit so that any length of line could be matched at any harmonic of 4,000 cycles up to 1,000 kilocycles.

In actual measurements, identical harmonic producers, driven by the same low-frequency source, are used at each end of the cable. The Laboratories' 4-kc standard is used as a reference. It operates one harmonic producer at New York which sends into the coaxial line all multiples of 4 kc, reduced to a level that will not overload the repeaters at the tops of the peaks. The standard frequency is also transmitted to Philadelphia on a pair of wires without repeaters, where, after filtering out any noise which the pair has picked up, the same 4 kc is used to operate harmonic producer No. 2. Its output is sent into a mixer together with the signal received from the coaxial circuit. After the detector has been tuned to any one har-

monic, the amplitude and phase can be adjusted to give no response in the phones. This is the condition that means the harmonic from the line is just 180 degrees out of phase with the same harmonic coming from producer No. 2. In general, tuning to the next harmonic results in some reading

The cable was first measured without amplifiers and equalizers. This was done by determining the absolute time of transmission for each of the nine 10.5-mile sections, and then adding the results. The carrier current which bears the voice of a subscriber using channel 59, which is the

one assigned to 300 kc, can be seen to take 555 microseconds to traverse the cable. Since it travels 95.5 miles it is going at the rate of 172,000 miles per second. The effect of the line amplifiers and attenuation equalizers is to increase the delay at all frequencies, but to a much greater extent for the high than for the low frequencies. As a result the curve for delay of the line with amplifiers and attenuation equalizers is above that for the line alone, but is much flatter.

As already noted it is the difference in delay for the various frequencies that is ordinarily of greatest importance, and this difference in delay with respect to some reference frequency is known as the delay distortion. A distortion

curve for the line with amplifiers and attenuation equalizers is plotted in the upper part of Figure 4 for a reference frequency of 144 kc. Over the entire band used for 240 telephone channels (60-1020 kc) the distortion is less than ten microseconds. For telephone purposes no better phase equalization is needed. Over a band of 4,000 cycles, which is used for one telephone channel, the distortion is negligible for speech. When a phase equalizer is added, the result is "practically a dead-heat finish for all the frequencies" in the television range which covers the band above 100 kc.

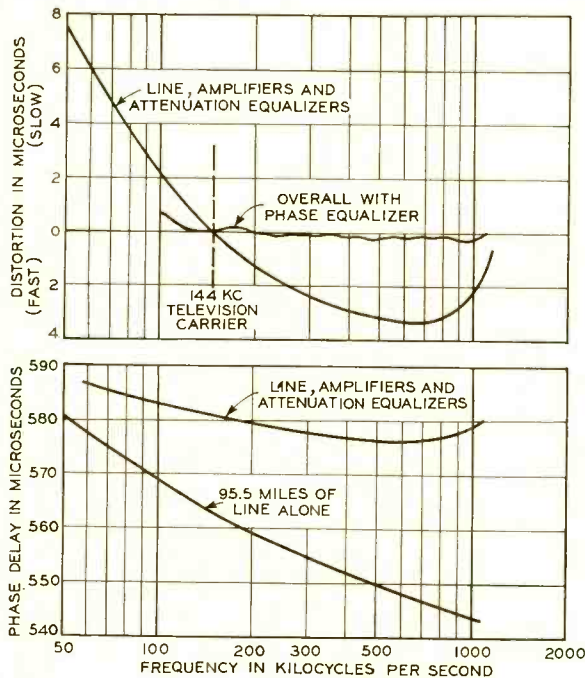

Fig. 4—Phase delay, below, and distortion, above, for various conditions of the coaxial circuit

on the detector, and the amount the phase dial has to be changed to re-establish the correct balance represents the difference in phase delay for a 4-kc interval.

During the time taken for two such readings we must assume that the lines themselves do not vary, and that the voltage delivered to the harmonic generators does not change its amplitude. By frequent checks it was proved that the variations encountered in either the line or the harmonic generator were negligible.

Some of the results obtained by this method are shown in Figure 4.



A curve for the distortion with the phase equalizers included is also plotted in Figure 4.

Further refinements in delay-measuring equipment are being called for as frequency range is extended. For the 1,000-kc television trial,\* an

\*RECORD, February, 1938, p. 188.

accuracy of about five or ten degrees at the upper frequencies was sufficient for the 240-line picture used for tests. For the 441-line television, which has been adopted as standard, future cables will have to be measured to better accuracy and for frequencies up to 3,000 or 4,000 kilocycles.

---

## TELEVISION PICK-UP OVER TELEPHONE CABLE PAIRS

On the evening of May 20 events at the 6-day bicycle race in progress at Madison Square Garden were "telecast" by the National Broadcasting Company in a half-hour program of sight and sound. The facilities for carrying the television signals from Madison Square Garden to the National Broadcasting Company were furnished by the New York Telephone Company and the Laboratories as an experiment in television transmission.

The television signals were picked up by the N.B.C. "telemobile" unit from the edge of the track at the Garden, and were transmitted over existing telephone cables to the Circle central office on West 50th Street and thence over a similar circuit to the N.B.C. studio at Radio City. Special amplifiers, attenuation equalizers, and phase equalizers were provided at the Circle office and at both terminals. The adjustment of the overall circuit was such that the signal was delivered at Radio City without noticeable impairment. Although the illumination available was far less than is used for studio pick-up, and thus made the undertaking a difficult one, the results were felt to be distinctly satisfactory.

This accomplishment has created considerable interest because of the use of pairs in ordinary telephone cable rather

than the coaxial conductor, which has been generally associated with the transmission of television signals. The use of ordinary telephone cable, under certain conditions and properly arranged and equipped, for the transmission of such a wide range of frequencies as television requires, was discussed in a paper by A. B. Clark of Bell Laboratories before the American Institute of Electrical Engineers in January, 1935. The recent experimental accomplishment is a practical demonstration of the possibility which he then described. The energy loss of television currents, however, in passage over a mile of ordinary telephone cable is about a million times greater than over a mile of coaxial cable. A series of measurements on the cable must precede its use, there must be some alterations in it, and the provision of amplifiers and of special apparatus for equalization of attenuation and phase. The recent experiment, therefore, does not imply that ordinary cable pairs can be economically used for television except over comparatively short distances. What the experiment does show, however, is the possibility of using telephone cable to pick up television news and carry it over short distances to main lines of coaxial cable or to nearby transmitting stations.



# An Automatic Power Plant for Toll Systems

By J. L. LAREW  
*Power Development*

**P**OWER for telegraph circuits and for the plates of repeater tubes at the smaller terminal and repeater stations has until recently been supplied either by tungar rectifiers or by motor generators floated across a battery. To maintain properly balanced voltages on the telegraph circuits and the proper charging conditions for the batteries, extensive regulating equipment is required. The development of grid-controlled recti-

fication in recent years, however, has provided inherently such greatly improved regulation for charging voltages that the additional regulating equipment can be greatly reduced. A still more important advantage of grid-controlled rectification is the much longer life secured from the batteries because of the closer voltage limits within which they are held. To bring these advantages to the large number of smaller installations, the

410A power plant has been developed. It provides from 1 to 25 amperes at 130 volts with three sizes of plant.

This new power supply is completely automatic in operation, and may thus be used for either attended or unattended offices. Other than an occasional tube replacement or the addition of water to the batteries, little maintenance is required. The plant consists of from one to three bays of charging equipment, each bay being two feet wide and eight feet high. Up to ten amperes, one bay is required; from ten to twenty amperes, two bays; and above twenty amperes, up to the maximum capacity

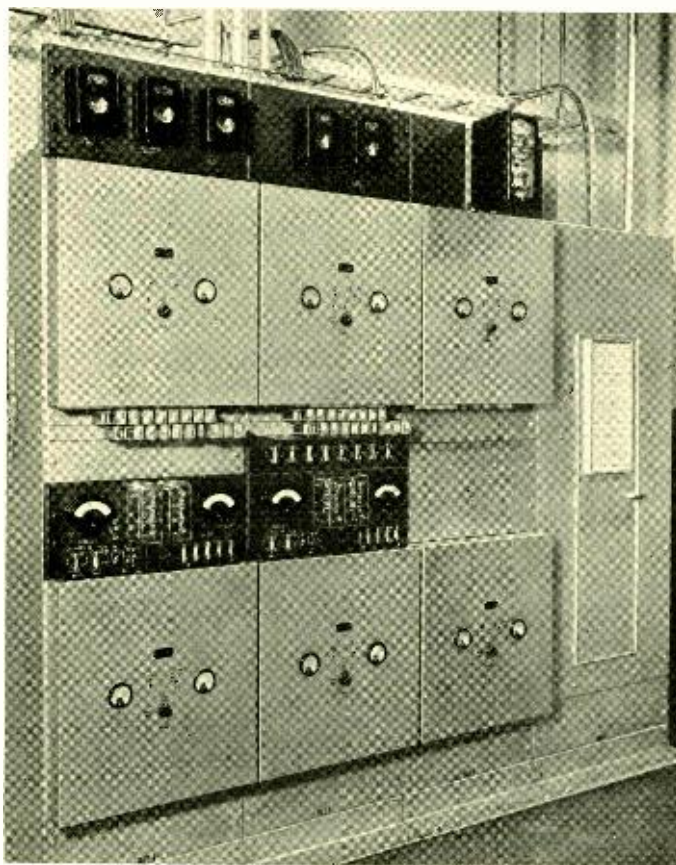

of twenty-five amperes, three bays. Where positive and negative batteries are employed for telegraph transmission, a power plant of from one to three bays will be used for each. When repeater plate supply is taken from one of the batteries through additional filters, the plant for this battery may be larger than that for the other.

A front view of a recent three-bay installation supplying both telegraph circuits and plates is shown in the figure. Here two of the bays are for the positive battery, and the third is for the negative, the second positive bay supplying the additional power required for the plate supply. Each bay includes two grid-controlled rectifiers, one in the upper and the other in the lower rectangular panel. These rectifiers are of the type already described in the RECORD.\* Each is rated at eight amperes; in general one is required for each five amperes of load—a certain amount of capacity being reserved for bringing the batteries up to full charge after a period of heavy drain, such as might be caused by a power failure.

The batteries associated with the rectifiers have sixty-six cells, and are floated at 142 volts. Counter-EMF

cells are provided in the discharge circuit to maintain the voltage at the fuse panel between 125 and 135 volts under all conditions. Under normal conditions the rectifiers supply the load and maintain just sufficient trickle charge into the batteries to hold them fully charged. A sufficient number of counter-EMF cells will be connected in the discharge circuit to maintain the desired voltage at the fuse panel.

During a power failure, these counter-EMF cells will be switched out, as required, to maintain the supply voltage. On the return of the primary power, the rectifiers charge at a constant current near their maximum capacity until the battery voltage is between 2.2 and 2.3 volts per cell. During this period the counter-EMF cells are cut in to reduce the supply voltage. This cutting-in is accomplished by relays on the middle panels of the two left-hand bays illustrated. The transfer of the charging from constant potential to constant current, or vice versa, is handled by relays mounted in the rectifier cabinets. Alarms are provided to indicate various troubles, such as rectifier or fuse failure, high or low voltage, and failure of the main power supply.

\*RECORD, July, 1937, p. 350.

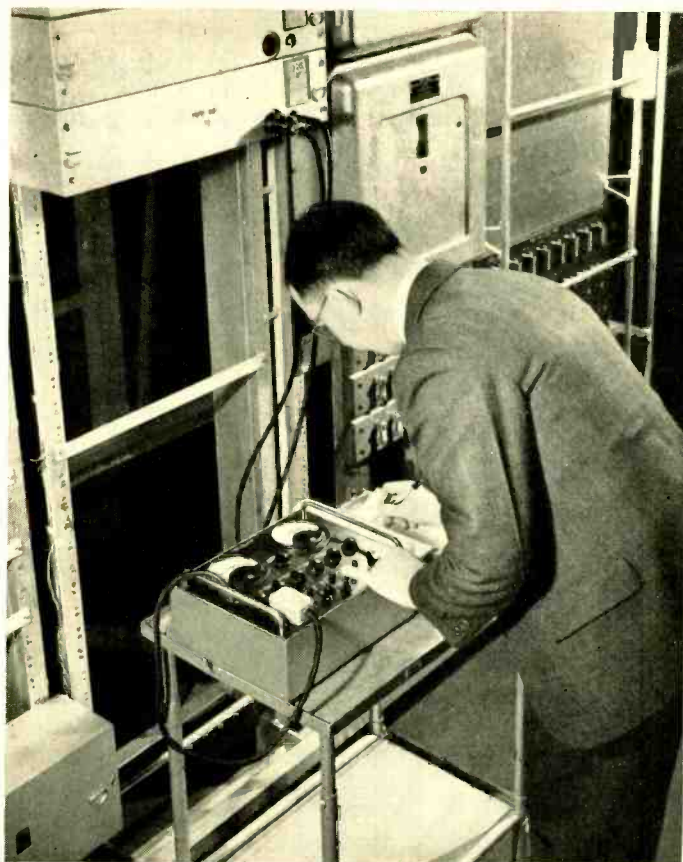

## A Vacuum-Tube Testing Set for Carrier Systems

By K. LUTOMIRSKI  
*Carrier Telephone Development*

**I**T has been common practice to make periodic tests of the vacuum tubes used in transmission circuits, so that the maintenance force will have warning of approaching failure and be able to replace tubes before the service is affected. For this purpose suitable testing equipment has commonly been mounted on some convenient bay in each office, and from it leads are run to the various

bays, where they may be connected into the vacuum-tube test circuit by cords or plugs when tests are to be made. In planning such testing equipment for broad-band carrier systems, however, it was felt that these comparatively long leads between the tubes under test and the testing equipment were undesirable because of the greater likelihood of crosstalk and noise pickup. It was decided to



avoid this condition by making the testing equipment portable. Such an arrangement would also be more economical, because it would avoid the necessity of having a permanent installation in each repeater station. Since broad-band systems require many more repeater stations than the voice-frequency systems, this would represent an appreciable saving.

The 1R tube test set, shown in the photograph at the head of this article, was the result. Careful consideration was given not only to making it as compact as possible so as to increase its portability, but to incorporating in it equipment that would permit testing the tubes of all the types of amplifiers used with the J and K broad-band systems as well as the type C-5 system without removing the amplifiers from service. The size was restricted so that the unit could be placed on a step of the usual rolling ladders and thus bring the test set close to the amplifier under test. Provisions had to be made for measuring filament, space, and grid currents for a varying number of tubes depending on the type of amplifier, and also for changing the value of the filament current to check the change in tube performance. To provide the needed connections, the set is furnished with a plug-ended three-conductor cord used for measuring filament current, and a fifteen conductor jack to provide for the other measurements. Each repeater is equipped with jacks for the three-conductor plug, and also for three, twelve, or fifteen-conductor plugs depending on the type of amplifier. Several cords with plugs on both ends are provided for the purpose of connecting the test set to the various types of amplifiers.

On the front of the test set are two meters, one for filament, and one for

grid and space current, together with a number of adjusting dials and keys. The meter at the left is for filament current, and is used in connection with one of the cords shown, the two left-hand keys, and the adjusting dial between the meters. The meter has two scales to give greater accuracy in reading filament current of two types of tubes. The key at the extreme left selects the scale to be used. The second key from the left, and the adjusting dial—which con-



*Fig. 1—Portable set being used to test vacuum tubes of type-K amplifiers in the Long Lines building in New York City*

trols a rheostat—are used in a filament activity test to determine the change in space current for a known change in filament current.

The second meter is used for measuring plate and grid currents. It is a three-scale millivolt meter, and is bridged across resistances in the cathode and grid leads to measure the space and grid current. Depending on the type of amplifier, grid current measurements may be required on three tubes, and space current measurements on six. A nine-point switch in the lower right-hand corner permits the meter to be switched to either of the three grids or the six plates. Since the grid currents may be flowing in either direction, a reversing switch is supplied to reverse the meter as required. Moreover, since the approximate reading cannot always be foretold, particularly when the amplifier is in trouble, a shunt is connected across the meter and may be removed by the operation of a key. This provides protection, and avoids possible damages to the pointer. Both meters have a mirror scale to in-

crease the accuracy in reading them.

In making activity tests, the change in space current is measured for a change in filament current. This test may be made on as many as six tubes in an amplifier, and to simplify the circuit, the six space-current leads are brought to six rheostats controlled by the knobs along the center of the test set. The filament rheostat is first set for normal filament current and then readjusted for its minimum value. For the normal filament current, the space-current reading is adjusted with its corresponding plate rheostat to the maximum deflection, or the zero per cent reading. After readjustment for minimum filament current, the space current will gradually decrease, and can then be directly read on the per-cent scale of the space current meter.

The set is convenient to use, and facilitates the maintenance of carrier amplifiers. A typical method of using the vacuum-tube test set is illustrated in Figure 1 which shows a test being made on type-K amplifiers in the Long Lines building in New York City.

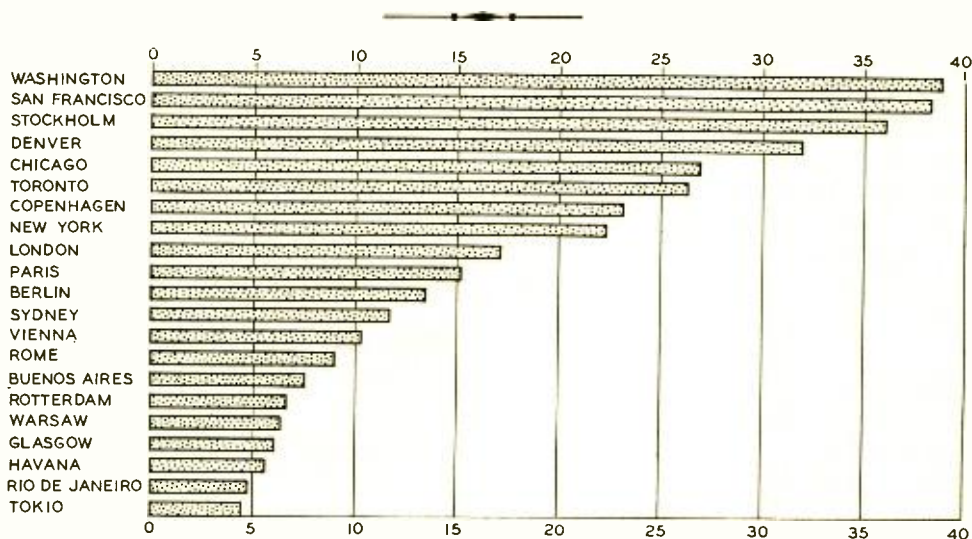

*Telephones per 100 population of some typical large cities, January 1, 1938*

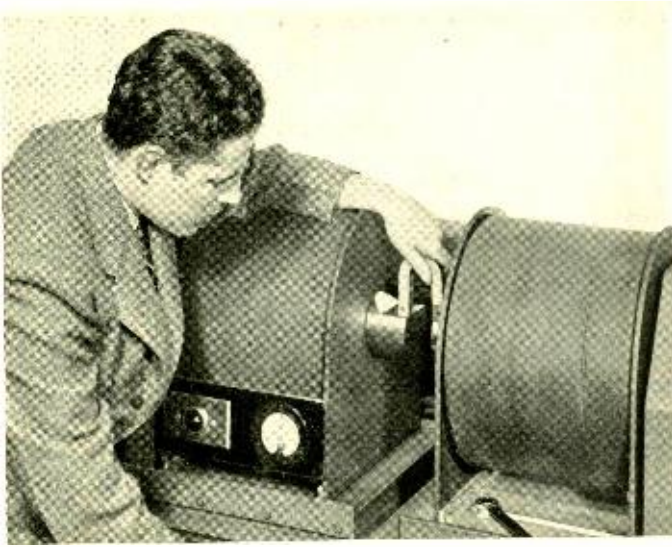

## A General-Purpose Electromagnet

By R. A. CHEGWIDDEN  
*Electromechanical Development*

THE introduction of new materials for more powerful permanent magnets has greatly increased the difficulty of magnetizing magnets made from them. Electromagnets have been used as magnetizers for many years, but some of the recent alloys resist magnetization so stubbornly that a more powerful general purpose electromagnet than was available was needed in the Laboratories to magnetize them.

To fill this need a very efficient electromagnet has been built. It has two coils, each fifteen inches in diameter, which are mounted facing one another close together on large horizontal cores. Heavy soft iron end plates resting on an even heavier iron base plate are bolted to the ends of the cores to complete the magnetic circuit. The entire magnet weighs about one ton. To permit varying the air gap between the pole faces, one core with

its coil and pole-piece assembly can be adjusted by a jack-screw which maintains the air gap within close limits although the force of attraction between the poles of the magnetizer may be thousands of pounds for short gaps. In addition, the coils may be slid independently on skid plates to entirely cover the air gap. Cap screws which extend through slots in the base of the coils are used to anchor them securely in any desired position.

The coils, which have 4500 turns each, are designed for a 120-volt circuit. They consume about 700 watts when connected in series and 2800 watts in parallel. The series connection provides 50,000 ampere turns for continuous operation without requiring forced cooling and as much as 100,000 ampere turns can be obtained with the coils in parallel. By utilizing the full capabilities of the magnetizer it is possible to thoroughly



magnetize bars of the hardest commercial magnet-steel ten inches long and  $3\frac{1}{2}$  inches in diameter.

The cores are made of Permendur which is the best magnetic material known for high flux densities. They are tipped with pole-pieces held in place by large soft iron bolts which extend through the end plates and the centers of the cores. This makes it easy to change pole tips. Normally two sets are used; one has 45-degree conical tips for producing highly concentrated magnetic fields; the other has the upper surface planed off flat for magnetizing horseshoe magnets and similar devices.

Since the total magnetic flux produced is about 1,500,000 maxwells, it was necessary to protect the magnetizer coils from insulation breakdown which might result from the high voltages induced when a rapid change

in this flux occurs. Threefold protection is provided to cover all possible contingencies. Lightning protectors, which operate if the voltage exceeds about 500 volts, are connected permanently across each coil. Surge voltages are smoothed by connecting across the input to the magnetizer coils a large varistor whose resistance decreases rapidly as the voltage increases. Finally the current through the magnetizer is controlled by a variable series-resistance which permits changing the current only in small amounts at a time. A dash-pot arrangement has been provided to limit the speed at which the resistance-control handle may be moved.

The new magnetizer has been in daily use since its installation. Its high power and flexibility combine to make it a valuable addition to the working tools of the Laboratories.

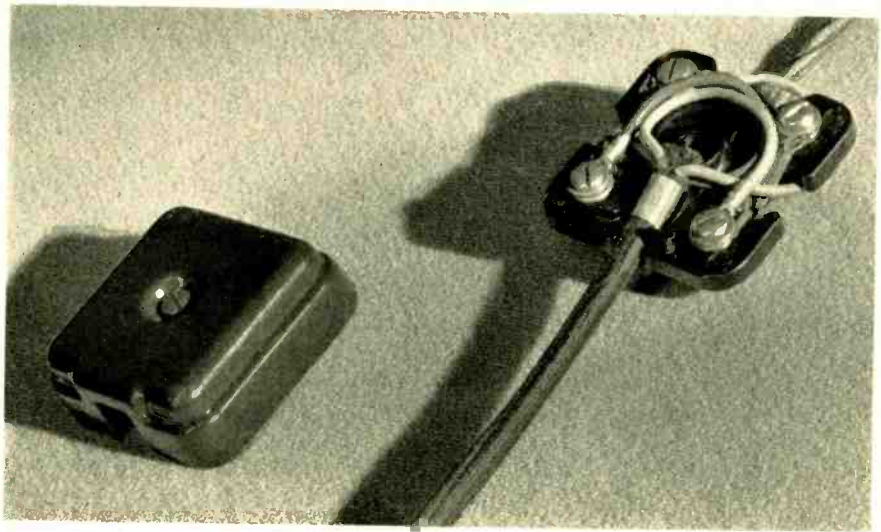

*A new connecting block which can be used interchangeably on desk stand, hand telephone, or combined sets with cords having two, three or four conductors has been developed for station installation. It has four instead of two connecting posts. The conductors are looped around the center post and connected to the terminal screws which are lettered to correspond to the color of the insulation on the wires. The new blocks are furnished with either an ivory or brown cover*





THE BELL SYSTEM  
AT THE  
NEW YORK WORLD'S FAIR  
1939



The demonstration long-distance telephone call. At one end of the room is a huge map of the United States, with switchboard lamps marking the location of some 3500 important cities and towns. On either side of the map are booths from which, one at a time, the participants place their calls. In front of the map are tables with head receivers, where visitors can listen in and hear both sides of the conversation. Receivers are provided for a couple of hundred visitors. The route of the call is indicated by brightening the lamps of the towns through which it passes. Participants are chosen by lot, at the desk shown at the right.

All photographs are by JOHN MILLS, JR.



A LARGE and successful World's Fair offers to such an institution as the Bell System a unique opportunity to create public good will. Visitors are eager to be amused, and ready to be interested and impressed. In the lives of most of them a world's fair is a distinct event, which they will remember for many years; and a favorable impression once made has a permanence which does not usually accompany other forms of advertising.

But the organization of a successful exhibit for a fair is also a unique problem. No matter what the exhibitor himself may wish, the crowd always has a tendency to treat the fair as an amusement park, to look upon the entire thing as a show, and to judge each exhibitor by the novelty, drama, and attraction of the acts which he puts on. A world's fair crowd is one of great mobility, easily diverted but of short-lived interest. The whole atmosphere of flags, music, brightly colored buildings and transient crowds works against an exhibit which demands more than short-timed attention.

Furthermore, by its very size and variety an exposition calls for a quick "once over" rather than for the leisurely study which exhibits get in a museum or gallery. The New York fair covers 1216 acres—of which the Bell System occupies slightly more than three acres. If a conscientious visitor should devote his time to the various exhibits, restaurants, and amusements upon the basis of the acreage they occupy and, in doing so, should spend a whole week, twelve hours a day, his proportionate time on the Bell System grounds would be only about thirteen minutes.

The Bell System hopes, of course, to win a larger share than this of the visitors' attention,

and the hope seems to be justified by early spring attendance at the fair. For the first few weeks the visitors at the Bell System Exhibit have averaged 30 to 35 per cent of the total paid admissions to the fair.

Hundreds of possible exhibits for the Bell System were imagined and critically analyzed. Those that were chosen met one or both of the two criteria which previous experience had established: participation by visitors in doing something of personal interest to themselves, using equipment and techniques of the Bell System; and scientific novelty, comprehensible to the public and based on Bell System researches. Visitors participate in all but one of the feature exhibits; the non-participating exhibit, the Voder, is a striking novelty that interests everyone. The exhibits are shown, and briefly described, on the accompanying pages.

All of the exhibits are essentially acoustic and each requires a room acoustically treated and sheltered from adjacent rooms. Functionally, therefore, the exhibit building takes the general form of a series of small theaters, with their foyers contiguous and, following the line of the foyers, a continuous balcony. With this balcony arrangement, those who are taking part in an exhibit become a show for an even larger number of visitors. This principle of a "show within a show" follows the well-recognized psychology of the amusement park, where the crowd watching participants sliding down chutes or tumbling around on turning tables gets its amusement vicariously rather than by participation. By using the balcony, a visitor may pass through the building as quickly as he pleases, and at the same time gather a vivid and fairly complete impression of what is going on.





*In the "Audition for Visitors," five persons chosen at random from the audience, seated on the terrace, carry on a short, informal conversation with an interlocutor. They are then escorted to seats at the lower end of the garden, while a second and exactly similar stage is moved into the place of the first. On this are seated five mannequins, in the same relative positions as the visitors. The visitors' conversation, recorded by a high-quality two-microphone system, is then stereophonically reproduced.*



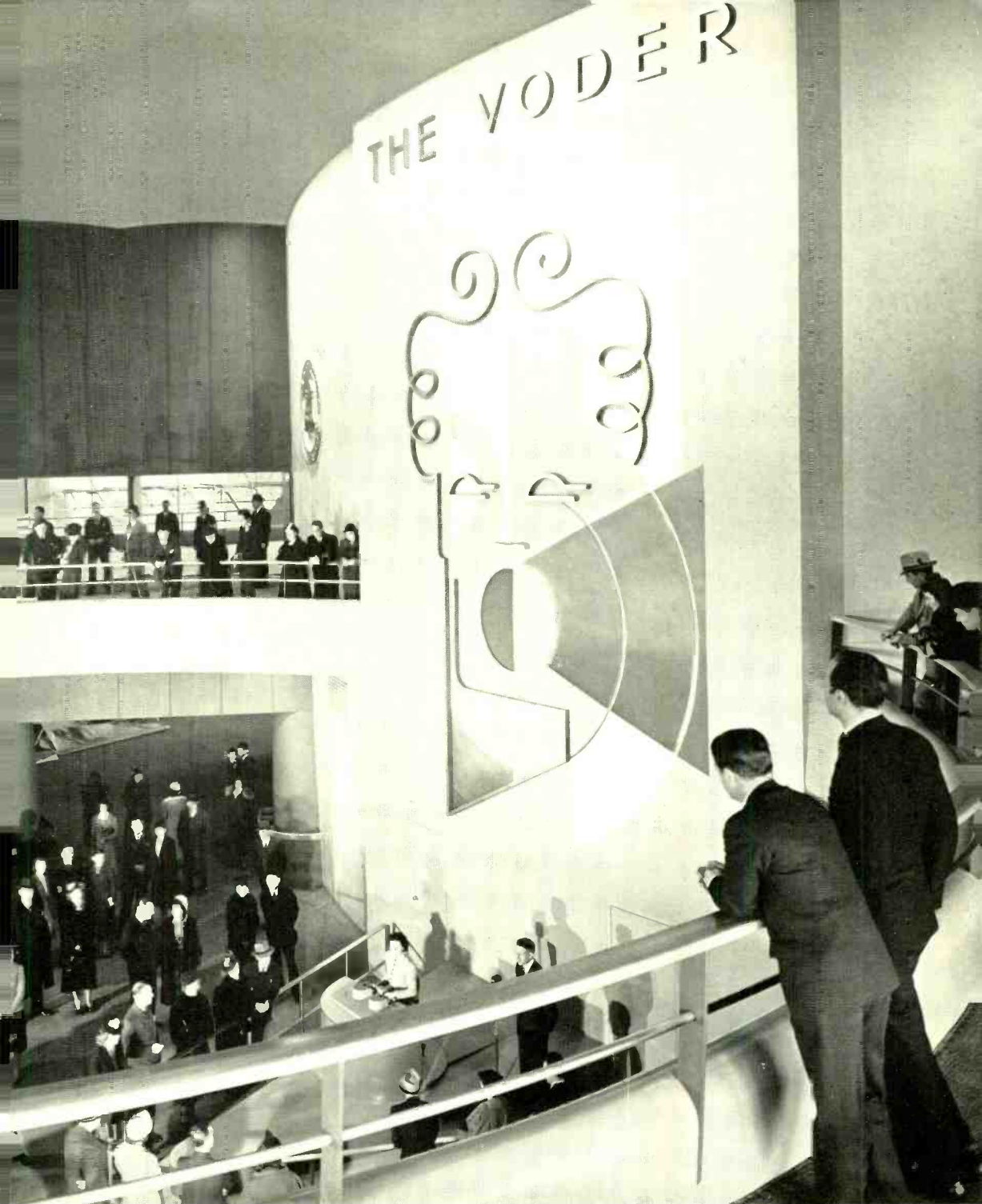

*The Voder—"the machine that talks"—is the only one of the main exhibits in which fair visitors do not participate. A lecturer explains the operation of the machine with the assistance of the keyboard operator, who demonstrates some of its possibilities. The technical features of the Voder were described in BELL LABORATORIES RECORD for February, 1939.*



The photographs on this and the following page were taken while there were no Fair visitors in the Bell System building, in order to show the architectural treatment of the structure as clearly as possible. The color scheme is French gray and Venetian red. All floors are heavily carpeted—a precaution necessary because of the acoustic nature of the exhibits.

The room above houses one of the two "Voice Mirror" demonstrations; the other is in the "Hall of Pioneers," a corner of which is shown at the right. The most striking feature of the Hall is a pair of large and handsome photographic murals. One of the murals shows a lineman and the other, a group of operators at a telephone switchboard.

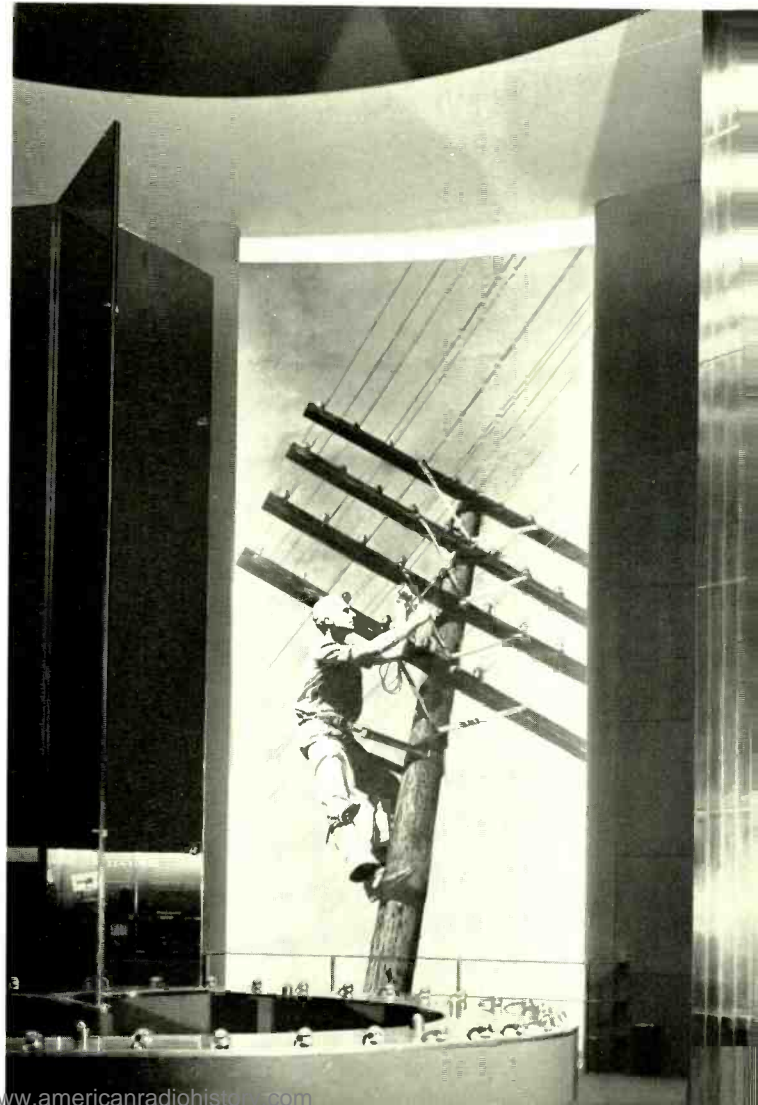



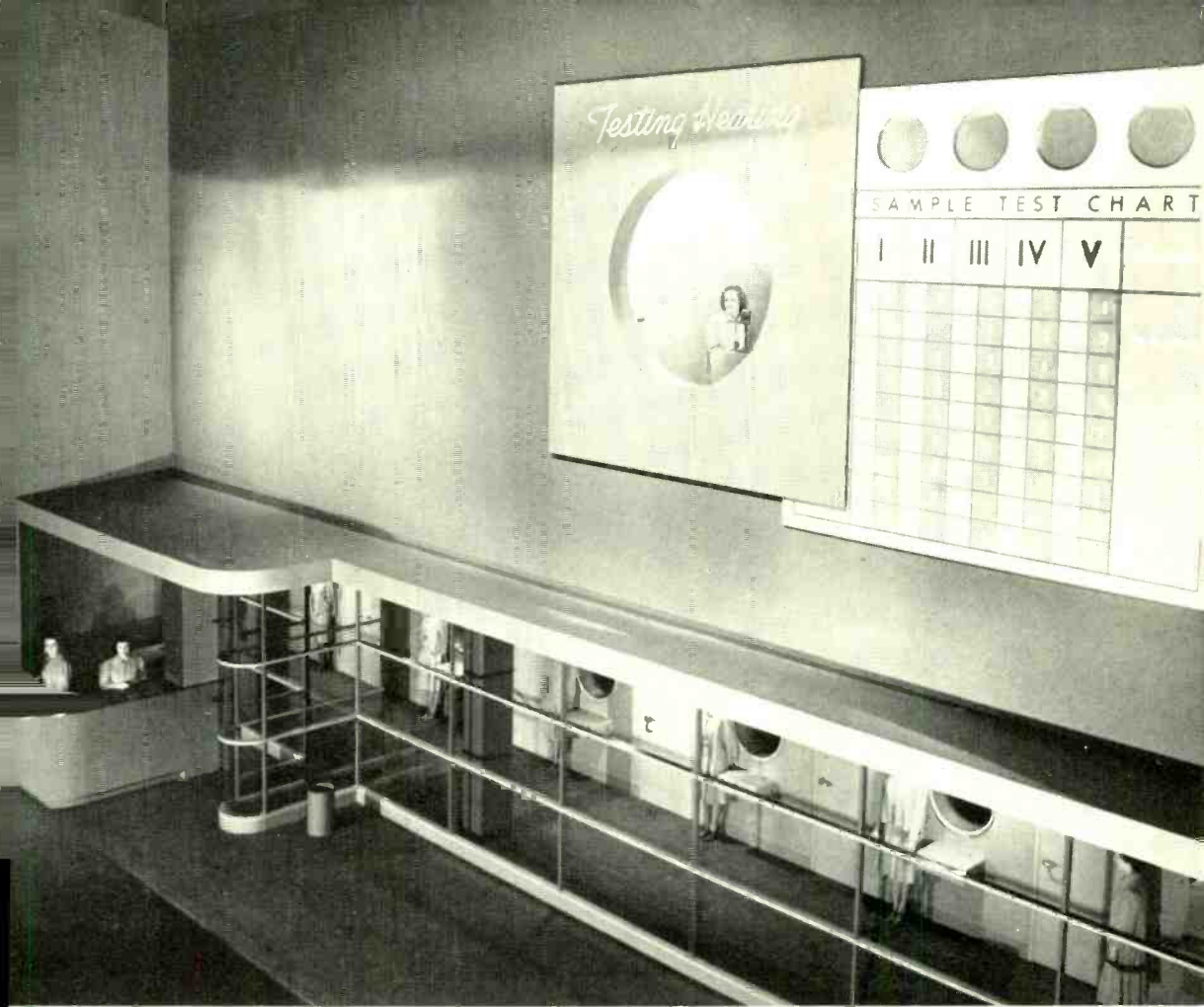

*Above is the Hearing Test demonstration. Behind the glass partition is a large number of booths where visitors may test their own hearing. An operator, behind the round window, explains the test and at intervals takes a demonstration test, showing her results on the illuminated test card at the right.*

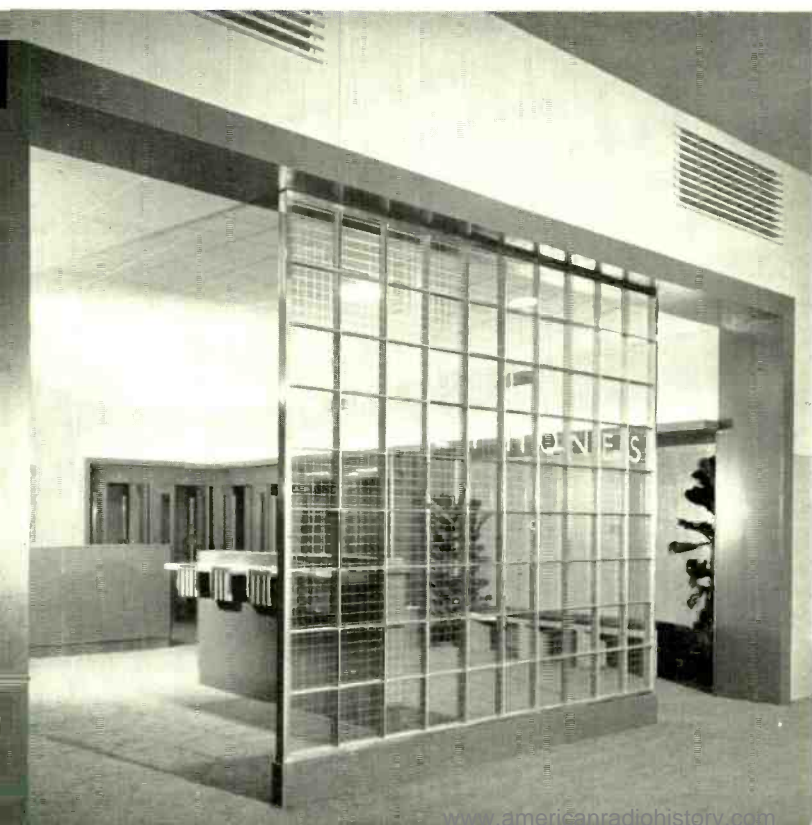

*Not one of the exhibits, but still an important part of the building, is the public telephone station shown at the left. It is separated from the neighboring exhibit room by a handsome glass and chromium screen.*



*A comfortable lounging room is included in the building, for the enjoyment of Telephone Pioneers and other members of the Bell System.*



*In the Hall of Pioneers are a number of small but interesting supplementary exhibits. One of them is a demonstration of how a dial telephone operates.*





# Sender-Link and Controller Circuits

By A. J. BUSCH

*Central-Office Switching Development*

TO establish a connection in the crossbar system, two senders\* are used: an originating, or subscriber, sender at the office of the calling subscriber and a terminating sender at the office of the subscriber called. The sender-link frames are the assemblages of crossbar switches used to connect the senders to the calling line or the incoming trunk, as the case may be. Although the senders and their link frames of the two types differ considerably from each other, many of their functions are similar. The originating sender-link frame must first select an idle district from the group of ten districts that the line-link controller circuit has selected, and then connect an idle sender to it. The terminating sender-link frame must first find the incoming trunk being used, which is in a group that has been indicated to it, and then likewise find and connect to this incoming trunk an idle sender.

Simplified block diagrams for the two sender-link frames are shown in Figure 1. The subscriber sender-link frame is like most of the other major frames of the system in employing ten 20-unit primary crossbar switches, but differs in employing only five 20-unit secondaries. Functionally, however, the difference is greater than this, because two units are multiplied throughout to provide an additional number of leads. Each two primary switches act as a single switch, so that the primary bay has, functionally, only five 20-unit switches; and on the five secondary switches each two vertical units act as one, so that functionally there are only five 10-unit switches on the secondary bay. Subsequent diagrams and discussion refer only to functional switches.

The district junctors, coming from the secondary switches of the line-link frame, are arranged in groups of ten, and two of such groups are connected to the vertical units of each

\*RECORD, April, 1939, p. 234.

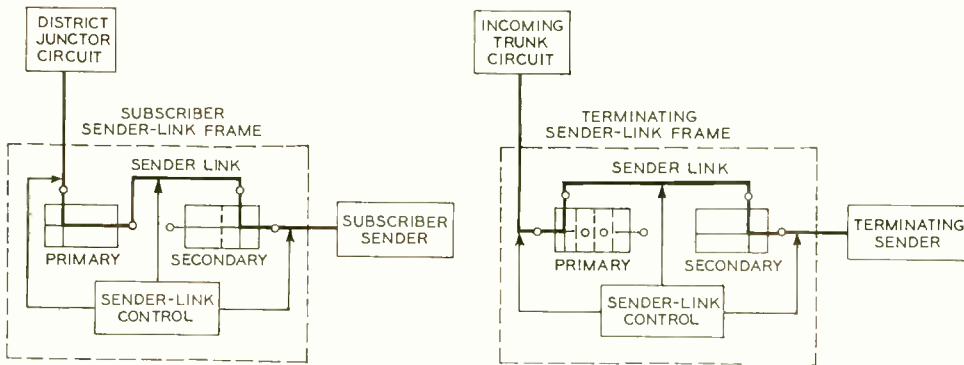
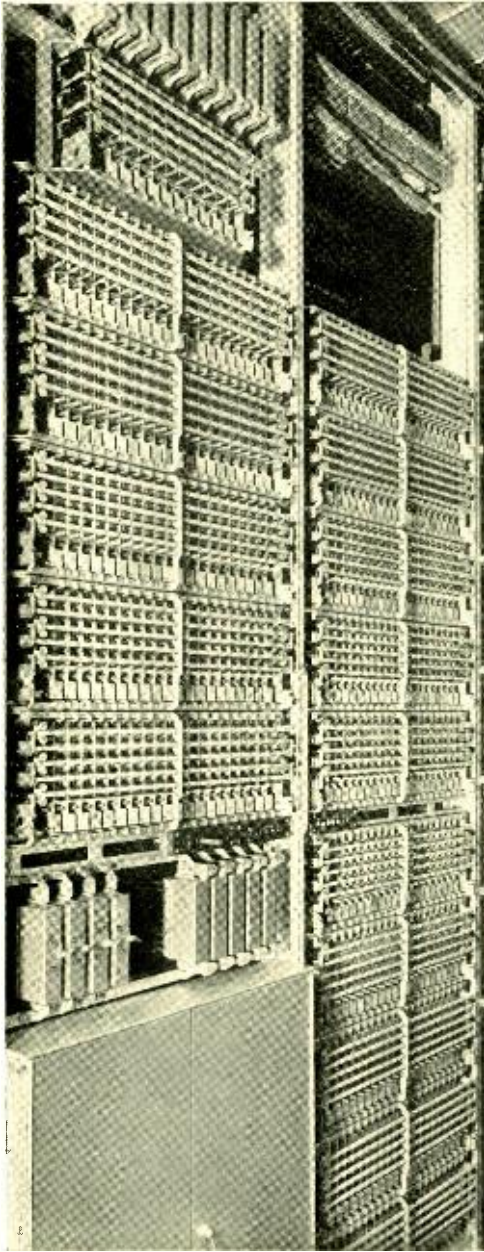

Fig. 1—Block diagrams of subscriber and terminating sender-link frames



*Fig. 2—Originating sender link*

primary switch of the originating sender-link frames, as indicated in Figure 3. Each sender-link frame thus serves one hundred district junctors.

The sender links are connected to the horizontal multiple of the primary

switches, and since there are functionally five switches, there are fifty sender links. These run to the vertical multiple of the secondary switches. These latter switches are divided in two by a cut in the horizontal multiple, and as a result the secondary switches consist essentially of ten 5-unit switches instead of five 10-unit switches. One link from each primary switch runs to a vertical unit on one of the five secondary switches. Since the horizontal multiple of the secondaries is split, one hundred senders can be connected to the secondary switches, twenty to each switch. This makes one hundred senders available to each one hundred district junctors. The senders, however, are multiplied to a number of sender-link frames, so that although one hundred senders serve a group of one hundred district junctors, the same senders are also serving many other groups of junctors. In ordinary offices there are about ten district junctors for each originating sender.

Since, for any particular call, a group of ten district junctors has been selected by the line-link controller circuit, and since any junctor of this group has access of the same group of one hundred senders, the selection by the sender-link controller of a particular junctor in the group is guided primarily by the necessity of using a junctor not already in use. One of the idle junctors is selected as indicated in Figure 5. Although the provisions are not shown in the diagram, the junctors are used in rotation as far as possible, so that over a period of time all will be used to about the same extent. A D relay is connected to each of the junctors of the particular group, but only those relays connected to idle junctors will operate. Of these idle junctors one is chosen and the

others are released for the next call.

While this selection is being made, the controller circuit also selects one of the sender groups that has at least one idle sender in it; where there is more than one such group, one of them is chosen. This sender-group selection is made by the SG relays, of which there is one on each sender-link frame for each group of senders. The windings of these relays are connected, by a group relay not shown in Figure 5, to back contacts on the secondary hold magnets of the ten sender links coming from the primary switch that will be used. If the hold magnet of a link is not operated, thus indicating that the link is idle, the back contact will be closed. From this back contact, the circuit passes to ground through other contacts that will be closed only if there is an idle sender in the group. Only the SG relays for those groups having both an idle link and an idle sender will operate; one of them is chosen and the others are

released. The operation of an SG relay operates the select magnet on the primary switch that governs the particular link selected. At this point, therefore, a particular district junctor,

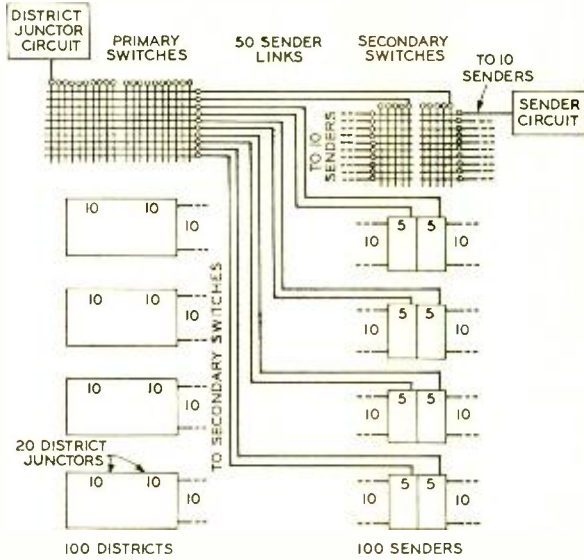

Fig. 3—Simplified schematic showing arrangement of links on subscriber sender-link frame

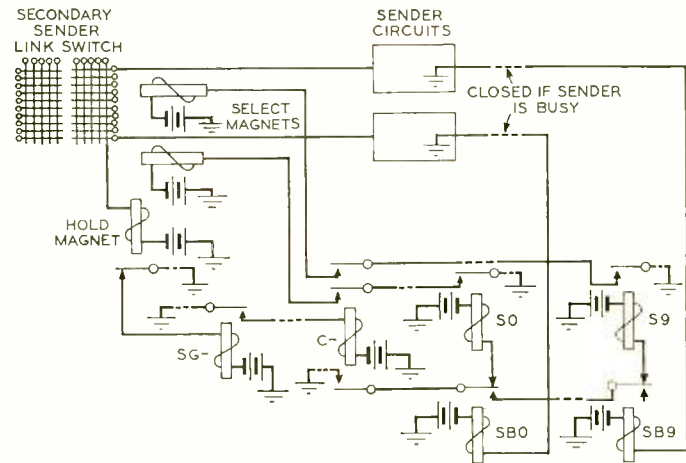

Fig. 4—Simplified schematic of the chain circuit that is used for making sender selection

and a particular sender link have been chosen, and the select magnet of the link at the primary switch has been operated. It is necessary now to select a particular sender from the group of ten to which that link has access at the secondary switch location.

How this selection is made is indicated by Figure 4, which shows a simplified schematic of the principal part of the selecting circuit. When one of the SG relays is operated, it causes a C relay serving that particular group of ten senders to

operate, and—in turn—c through a front contact, extends a ground connection to the armature of the first of a set of ten SB relays. The winding of each SB relay is connected to one of the senders of the group in such a way that the SB relay is operated if the sender is busy. If the first SB relay is operated, the grounded lead from the c relay is continued through a front contact of that SB relay to the armature of the next. In this way the grounded lead from the c relay is carried successively

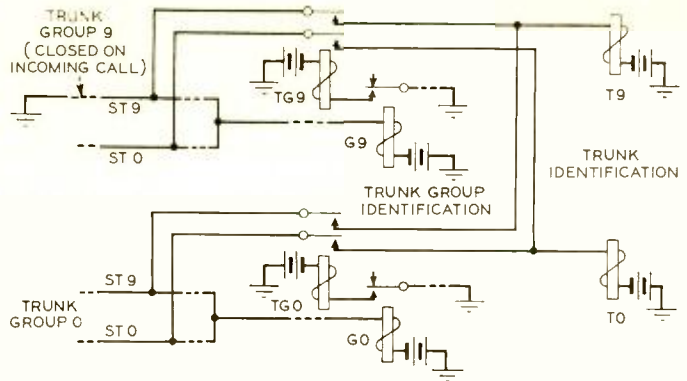

Fig. 6—Simplified schematic of trunk identification circuit at the terminating sender-link frame

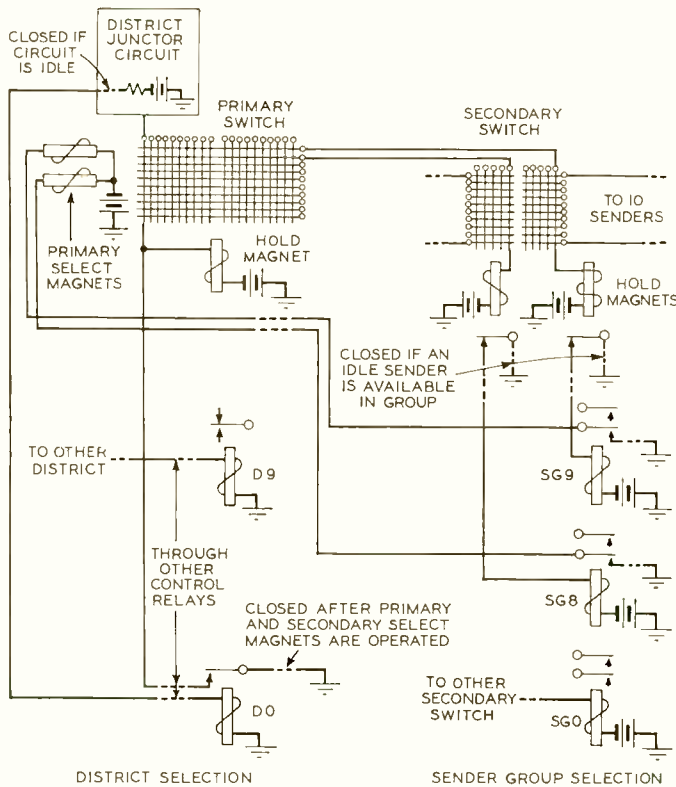

Fig. 5—Simplified schematic of circuit making district-juncator and sender-group selection

through the SB relays until it meets one that is not operated, indicating that that sender is idle. Through a back contact of this relay the grounded lead from the

c relay will be connected to the winding of an s relay, of which there is also one for each sender. This relay will be operated from the ground at the c relay, and in operating will operate the select magnet for that sender at the secondary switch. Immediately after this, the hold magnets corresponding to the selected district juncator at the primary switch and sender link at the secondary switch of the sender-link frame will be operated, and the sender will be connected through to the calling line. The select magnets are then released and the controller circuit restores to normal. Only about a half a second is re-



quired to serve a call by either the originating or terminating sender-link controller.

The selection of a terminating sender follows essentially the same procedure as that for the originating sender so far as the choosing of an idle link and sender is involved. At the originating sender-link frame, however, a district junctor must be selected in addition, while at the terminating sender, the incoming trunk—which corresponds to the district junctor at the originating link frame—has already been selected, and it is necessary only to identify it. This is done as indicated by Figure 6. A G relay corresponding to the group of trunks operates, and closes a corresponding TG relay which completes a connection from all the trunks in the group to a group of ten T relays. The T relay corresponding to the calling trunk will then operate. With this determined, the selection proceeds in the same way as with the originating sender-link frame.

Although the selecting procedure is essentially the same for terminating as for originating senders, the arrangement of the sender-link frame itself differs considerably. Where the originating sender-link frame, shown in the photograph at the head of this article, employs ten 20-unit primary and five

20-unit secondary switches, a total of fifteen 20-unit switches, the terminating frame consists of only six 10-unit switches, three primary and three secondary switches, as shown in Figure 8. Each secondary has ten senders connected to the horizontal multiple as does that of the originating sender-link frame, and thus there are only thirty senders in a terminating group instead of one hundred as in an originating group. This smaller number is made possible largely by the shorter holding-time that is required for the terminating senders.

The greatest difference, however, is in the arrangement of the primary switches, since it was desired to make a single sender-link frame serve ten trunk groups, each comprising ten incoming trunks. Since there are ten groups of incoming trunks at the primary switches and thirty vertical units on the three secondary switches, there can be just three links serving each group of ten trunks. How this is accomplished is shown in Figure 8. The primary switches are divided horizontally so as to give a total of ten groups of three vertical units, each connected to a sender link. To secure a convenient wiring scheme, the upper and lower primary switches were divided into

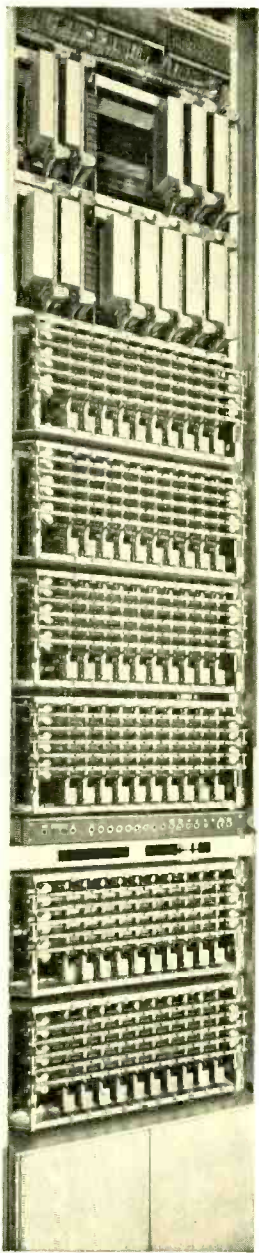

*Fig. 7—A terminating sender link has six crossbar switches*





# Originating Markers

By OSCAR MYERS

*Central-Office Switching Development*

AFTER a sender has been connected to a calling line on a crossbar-to-crossbar call, and has recorded the number wanted, a talking path must be established through four crossbar frames—two in the office of the calling subscriber and two in the office of the subscriber called. The selection of an idle path through each of these pairs of frames is under the control of a “marker”—an originating marker in the calling office, and a terminating marker in the office called. The two types of markers are similar in their general function. They both must find a suitable idle path through two crossbar frames between the circuit incoming to the frames and an outgoing circuit, which the marker itself must find. The major differences in the two types of markers spring largely from the differences in the outgoing circuits to which they must establish a connection. For the originating marker, these outgoing circuits are trunks to other offices or to the incoming frames in the same office; while for the terminating marker, they are subscriber lines.

Besides these functions of finding a suitable outgoing line or trunk and selecting an idle channel through the crossbar switches, the markers gather certain information regarding the outgoing circuit selected, and this information will be used in setting up the call. Another function of the marker is to provide cross-connecting facilities which permit the location of the lines and trunks on the frames to be

independent of the office code and line number dialed. The cross-connecting bays for an originating marker appear at the lower right of Figure 1. Two of these cross-connecting bays are shown in greater detail in Figure 2. In general each group of cross-connecting terminals includes a strip of individual terminals immediately above or below a bank of multiple terminals, appearing somewhat like the bank of a panel selector.\* Each strip in the multiple bank may, for example, represent the cut-in relay for a pair of office frames, and the office frames picked for any particular code would depend on the cross-connection made at this point.

The originating marker is seized by the subscriber sender as soon as the latter has recorded the office code dialed. The marker has three sets of four register relays on which this office code is recorded. The relays of these sets are designated A1, A2, A4, and A5; B1, B2, B4, and B5; and C1, C2, C4, and C5, and the sender transfers the code digits to the marker by grounding or not grounding certain combinations of leads running to the windings of these twelve relays. The A relays register the first digit, the B relays, the second, and the C relays, the third. The sum of the numerical designations of the operated relays of each group indicates the values of the corresponding digits. Thus if the office code were 686, the relays operated would be A1 and A5; B1, B2 and

\*RECORD, October, 1931, p. 521.



85; and c1 and c5. Actually the sender first operates all the relays to make sure there are no open circuits in the leads, and then if there are no false grounds, releases those not needed to give the correct registration.

Zero and one are never used for the first or second digit of the office code, since no letters correspond to these digits on the dial, and thus there is a possible total of  $8 \times 8 \times 10$ , or 640,

office codes. Some of the codes are not used, of course, but for each code used a group of route relays is provided. In general a route relay is provided for each group of forty trunks or less going over the same route and serving the same class of calls. Each route relay has fifteen contacts, and its operation thus closes fifteen paths which are used for various purposes such as for establishing connections

to the group of trunks for busy test, for returning information to other circuits in the marker or to the sender regarding the handling of the call, for enabling the marker to find an idle path through the district and office frames to the idle trunk selected, and ultimately for operating the necessary select and hold magnets to connect the talking circuit through. Where there is more than one route relay in the group — because of their being more than forty trunks — one of the leads from the first route relay runs, through a cross-connection, to the next route relay of the group. If the first forty trunks are busy, the second route relay will be brought in, and the next set of trunks are then tested.

The desired route relay is selected by operating one relay of each of two groups.

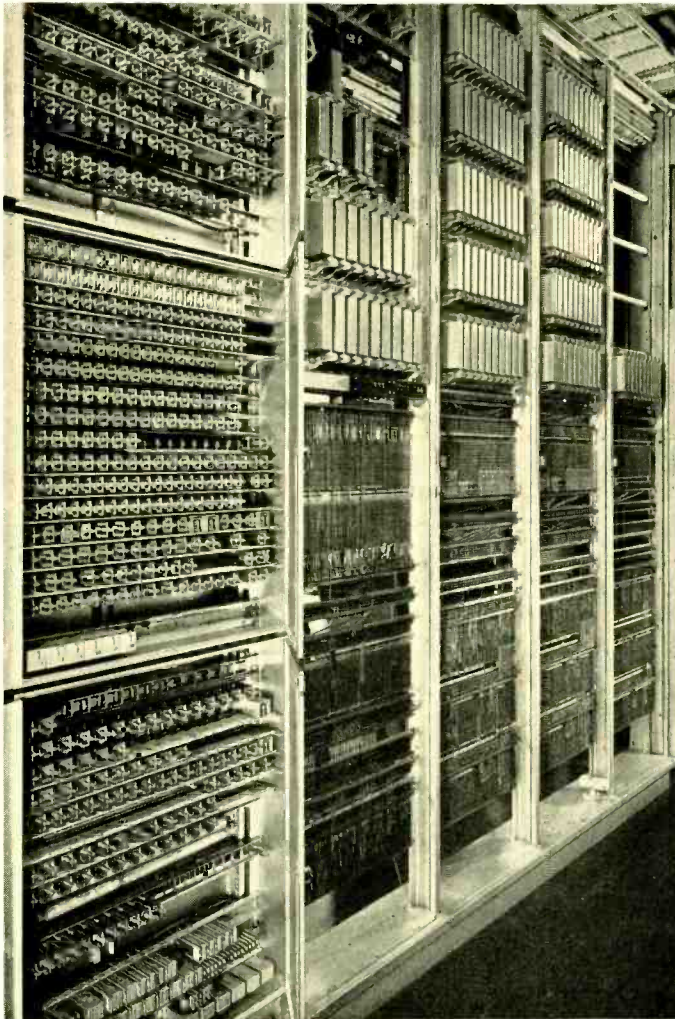

*Fig. 1—An originating marker, with relay cabinet at the left, route relays at the upper right, and cross-connecting terminals at the lower right*

These are the TN and the H relays, the former closing ten contacts and the latter, fifty, as indicated in Figure 3. The winding of one route relay of each group is connected—through cross-connecting terminals—to one contact of one of the H relays. Thus each H relay, when operated, will close a circuit to fifty route relays of consecutive codes, and the H relays have numerical designations corresponding to the group of route relays with which they are associated. Thus the H2 relay connects to route relays corresponding to codes 200 to 249 inclusive, and H2' connects to route relays for codes 250 to 299 inclusive. The numbers of the H relays are 2, 2', 3, 3', and so on up to 9 and 9'—there being sixteen of them all

told. The particular H relay to be operated for any one code is thus indicated by the first digit of the code plus an indication as to whether the second digit is above or below five. If the first digit is 6, either H6 or H6' must be operated; H6 if the second digit is less than 5, and H6' if it is five or above.

Eight circuits running from ground through front and back contacts of the A group of register relays are so arranged that ground will appear on one and only one of the circuits for each possible first digit from 2 to 9

June 1939

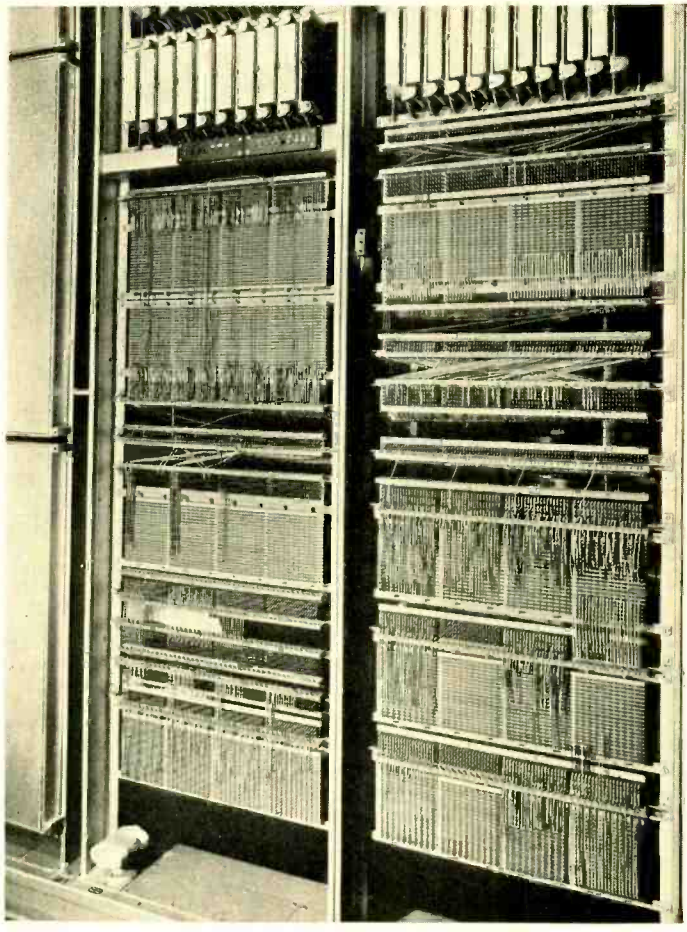

Fig. 2—A close-up view of some of the cross-connecting arrangements of the originating marker

inclusive. These leads pass to spring contacts on the B5 relay, and depending on whether or not the B5 relay is operated, will be extended to a front or back contact. Sixteen leads are thus provided, each running to the winding of one H relay. The possible office codes, the corresponding combinations of the four A relays and B5, and the H relay operated are indicated in Figure 4.

The five TN relays are operated by five circuits carried through contacts of relays B1, B2, and B4. As shown in Figure 3, the ten contacts of each TN relay are multiplied to a consecutive



set of ten contacts on each of the H relays. Thus the ten leads from TN0 will run to the lowest ten contacts on

each H relay, those of TN1 to the next set of ten contacts and so on. If the code called were 686, for example, the operation of H6' indicates that the first digit is 6 and that the second digit is 5 or above. Of the fifty leads to H6', however, only the ten to TN3 will be connected through. The combinations of B relays that operate the various TN relays are shown in Figure 5. TN4 will be operated when the second digit is 4 or 9, relay TN3, when it is 3 or 8, and so on. Zero and 1 are not used for the first or second digits of an office code, but they are employed for such special codes as 211, for long distance, or 411, for information, and for a number of operators' codes. For code 686, TN3 will be operated.

The ten leads from the spring contacts of the TN relays are carried to circuits running through contacts of the C register relays, and depending on the final digit of the code, one of these leads will be grounded. The combinations are shown in Figure 6. The ground on this one lead will be carried through the TN relay operated and the operated H relay to the particular route relay corresponding to 686. These operations are not carried through sequentially as described, but almost coincidentally, so that a route relay is operated almost as soon as the number-recording relays are operated.

The code 686 resulted from dialing MUrray Hill-6, and the operation of the corresponding route relay, or one of them when several are required, gives all the necessary electrical information pertaining to the group of trunks running to the MUrray Hill-6 office. Each group of forty trunks is distributed over two office frames to avoid all the trunks of a group being out of service should there be trouble on one frame. Each pair of office

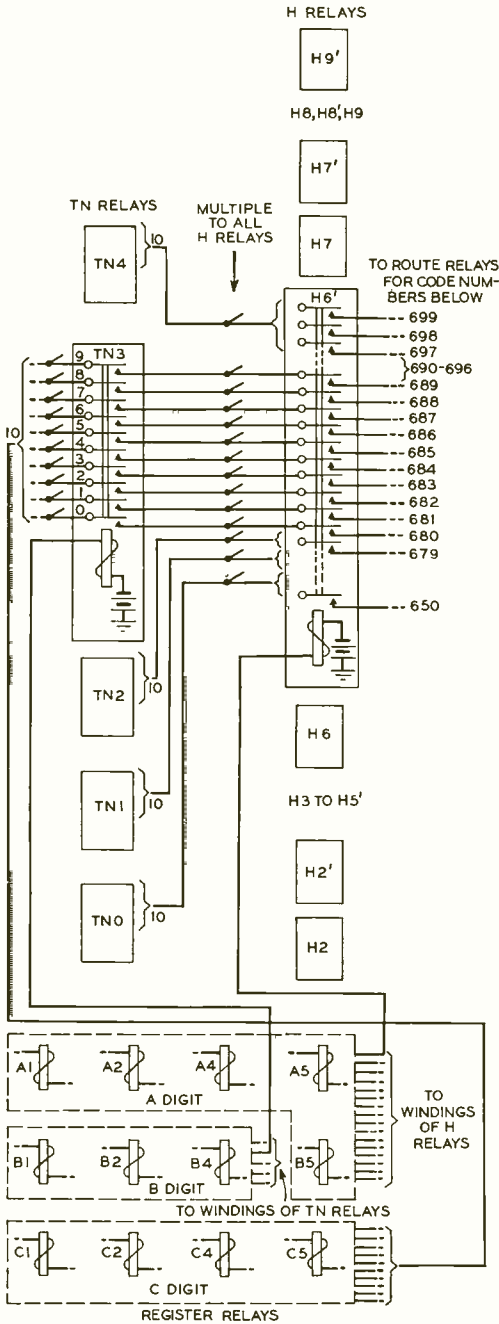

Fig. 3—Simplified schematic of the circuit for selecting and operating a route relay



frames has an office connector through which the circuits of that pair of frames are brought to the markers. One of the leads from the route relay runs—through cross-connecting terminals and other relays—to the “cut-in” relay of the two frames having the 686 group of trunks. Each of the office connectors has a group of multi-contact trunk cut-in relays through which the sleeve of the trunks may be connected to the marker, forty circuits at a time, for busy test. Certain of the leads from the route relays, again through cross-connections, operate the particular trunk cut-in relays for trunk group 686. The beginning and end of the desired group will be indicated by cross-connected leads from the route relays, and the marker will test only those of the desired group.

Busy testing is done by a group of trunk-test relays. The windings of these relays are connected to the sleeve leads of the trunks through the trunk cut-in relays of the office frame. The test relays connected to busy trunks will operate, and a chain circuit through their contacts will cause the operation of the select magnet of the first idle trunk. This selects and “marks” the chosen trunk. While these operations are being carried out, the district circuit has also been connected to the marker through a district connector, and the district junctor being used for the call is also “marked.” Having thus marked the

trunk and the district, the marker then tests for an idle channel between these two points through the district and office frames. There are ordinarily not less than ten of such channels and each consists of a district link, an office junctor, and an office link. The method employed tests all channels and all three links of a channel at the same time, and selects one for connecting through. Having operated the proper select and hold magnets, the marker makes a continuity test to insure that the call has been properly set up.

In the meantime grounds have been carried through the route relay and cross-connections over leads to the sender, where they operate relays that will guide the sender in controlling the call. Information conveyed in this manner indicates to the sender whether the trunks are to a panel or crossbar office, or to a tandem office or an operator; whether the trunks have proper resistance to permit the

OFFICE CODES INDICATED BY H RELAYS	REGISTER RELAYS OPERATED					H RELAY NUMBER
	A1	A2	A4	A5	B5	
200-249	—	x	—	—	—	2
250-299	—	x	—	—	x	2'
300-349	x	x	—	—	—	3
350-399	x	x	—	—	x	3'
400-449	—	—	x	—	—	4
450-499	—	—	x	—	x	4'
500-549	—	—	—	x	—	5
550-599	—	—	—	x	x	5'
600-649	x	—	—	x	—	6
650-699	x	—	—	x	x	6'
700-749	—	x	—	x	—	7
750-799	—	x	—	x	x	7'
800-849	x	x	—	x	—	8
850-899	x	x	—	x	x	8'
900-949	—	—	x	x	—	9
950-999	—	—	x	x	x	9'

Fig. 4—Operated register relays for various codes, and the corresponding H relays operated

TWO LAST DIGITS OF OFFICE CODE INDICATED BY TN RELAYS		REGISTER RELAYS OPERATED			TN RELAY NUMBER
		B1	B2	B4	
00-09	50-59	—	—	—	0
10-19	60-69	x	—	—	1
20-29	70-79	—	x	—	2
30-39	80-89	x	x	—	3
40-49	90-99	—	—	x	4

Fig. 5—Combinations of register relays required to operate the various TN relays

sender pulsing relays to operate properly over them, and a variety of other facts. The final signal transmitted to the sender indicates that the trunk has been found and a path completed through the district and office frames, and on receipt of this signal, the sender releases the marker, which is then available for another call.

To enable the marker to handle calls at as high a rate as possible, an overlap feature is provided that permits each marker to be handling two calls at a time. After an idle trunk has been found, the marker is disconnected from the sender, since it can proceed to test for an idle channel through the district and office frames without further reference to the sender. While this is being done, therefore, this same marker may be seized by another sender, a new code registered, and the desired TN and H relays operated. Ordinarily the first call will have been completed by this time, so that the marker may proceed with the second. If the first call has not been handled, the second call will wait the very short interval until it has been.

One of the interesting features of the crossbar system is its ability to make a second trial under certain conditions should it fail to establish a connection. When the originating

marker fails to set up a connection to an outgoing trunk, either because of a trouble condition or of its inability to find an idle channel to the trunk selected, it signals the sender to release it and to call in another marker for a second trial. When the marker fails to find an idle channel through

the crossbar switches to the trunk selected, however, it tests first the trunks on the other frame of the pair. If it finds an idle trunk on this second frame, it tests for an idle channel to it through the crossbar switches, establishing the connection if it finds one. If it does not find one, it gives the second-trial release to the sender. Under these conditions the sender will call in another marker to set up the call to an overflow trunk on the office frame.

To prevent any of such troubles from seriously affecting the service, all markers are provided with a timing arrangement that, should the marker be unable to complete a call within a

C1	REGISTER RELAYS OPERATED			C5	FINAL DIGITS
	C2	C4			
—	—	—	—	—	0
x	—	—	—	—	1
—	x	—	—	—	2
x	x	—	—	—	3
—	—	x	—	—	4
—	—	—	x	—	5
x	—	—	x	—	6
—	x	—	x	—	7
x	x	—	x	—	8
—	—	x	x	—	9

Fig. 6—Combinations of the C relays for the various final digits

short interval, would notify the sender to release it and try again. The timing circuit starts to measure time as soon as the marker is seized, but the period after which it will "time out" the marker depends on what stage of the selecting progress the trouble appears. Not only, therefore, does the marker make second trials at completing calls, or—with certain types of difficulty— notifies the sender

to make a second trial with a different marker, but by the process of "timing out" prevents a call from being delayed more than a very short interval for any type of failure of the marker whatever. The originating marker is engineered to handle 4,460 calls per hour and, during a normal busy hour, will complete all its usual functions in 0.65 second, including the average delays at the district and office frames.

*This micro-chemical apparatus, developed in the Research Department, is used to study impurities in lead cable sheath. It operates by taking advantage of the large difference in solubility of lead chloride in hot and in cold hydrochloric acid solution. The sample of sheath which is to be analyzed is dissolved in hydrochloric acid in the flask by applying heat. The lead chloride solution obtained is flowed over into the cooling chamber below at the left, where the lead chloride precipitates in very pure crystalline form. The filtrate is returned to the solution chamber by an air-lift pump. This process continues until the sample has been completely dissolved and the lead precipitated as chloride in the cooling chamber. The filtrate contains the impurities that form soluble chlorides, which include all of the principal impurities except silver. By this procedure as little as one thousandth of a gram of tin can be separated from 50 grams of lead with an error of less than one part in a million*

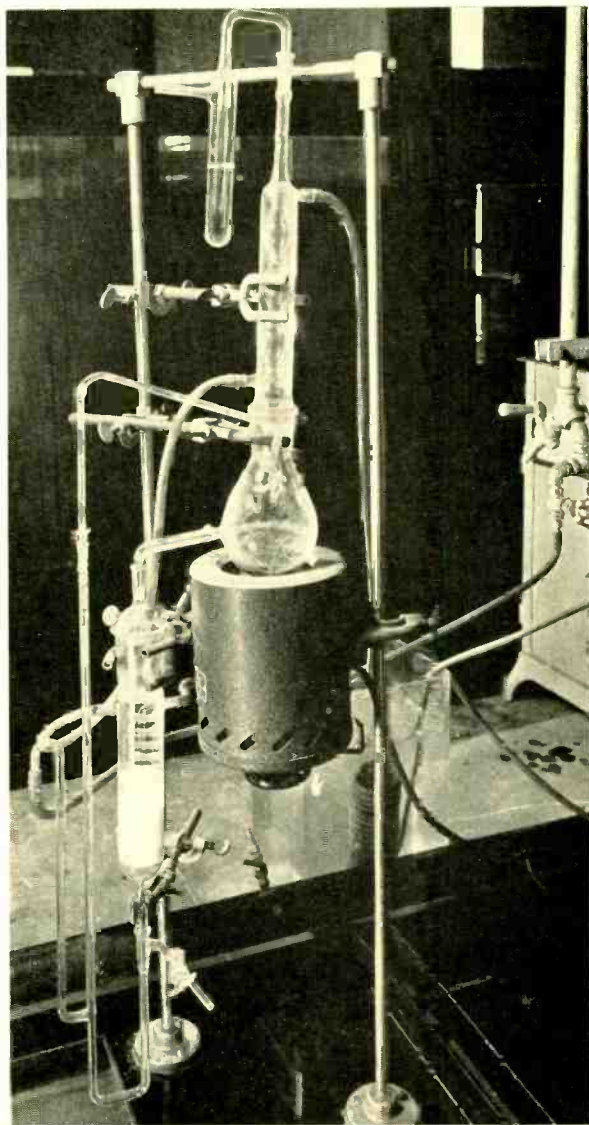



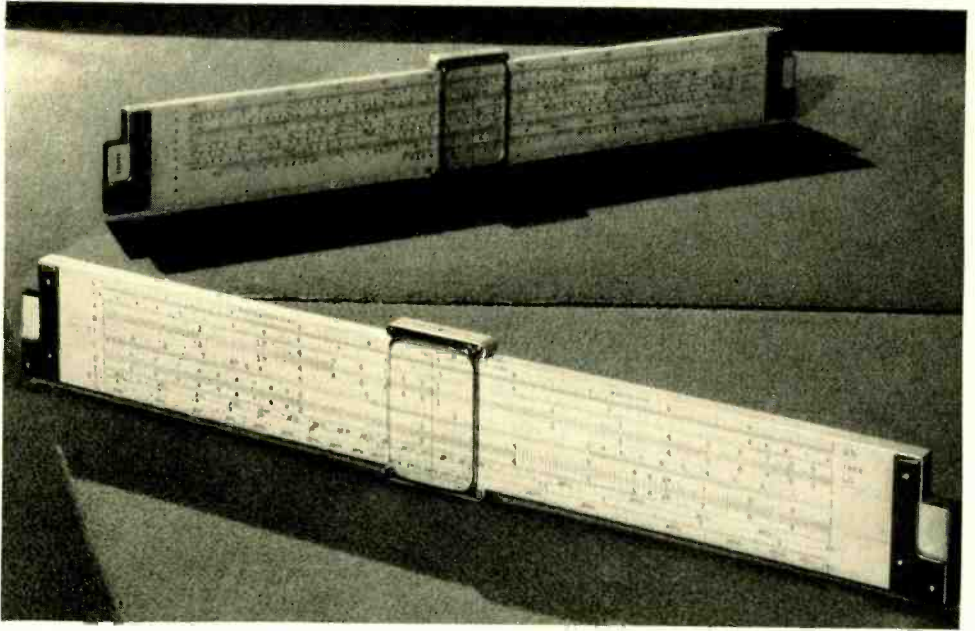

## A Radio Slide Rule

**A** NEW slide rule has recently been designed by J. F. Morrison of the Broadcast Development Department to facilitate the work of the radio engineer. This slide rule, manufactured by the Keuffel and Esser Company, is similar in appearance to the duplex rule and has on one side the usual A, B, C, CI, D and trigonometric scales. The conventional L scale has an added designation "db" and is used for the conversion of ratios of power, voltage, and current in reference to the D scale. The LC product for a given frequency, the value of inductance or

capacity to resonate a reactive circuit, and the transformation of vectors from rectangular to polar form or vice versa, are among the operations which can be performed on the F or frequency scale, also on this side of the rule. The reverse side of the rule carries a number of special scales arranged for solving problems relating to propagation of radio waves over a plane earth. The rule is thus capable of solving a wide range of special radio problems in addition to the usual type of problem solved with the slide rule, and makes a very convenient tool for the radio engineer.

## Contributors to this Issue

---

J. F. WENTZ was graduated from Lehigh University in 1917 with an E.E. degree. He then served as first lieutenant in the 35th Infantry before coming to the Western Electric engineering department in 1919. Here he worked for two years on high tension fuses and protectors, and then transferred to the Research Department. During 1921-1922 he did part-time graduate work at Columbia, receiving an A.M. degree in Physics in 1923. During the development of loaded submarine cables Mr. Wentz worked on cable design and permalloy loading technique. From 1931 to the present time he has had charge of development of coaxial structures, and transmission tests on the New York-Philadelphia coaxial installation.

A. J. BUSCH joined the Laboratories in 1922 immediately upon receiving the E.E. degree (cum laude) from the Polytechnic Institute of Brooklyn.

After completing the student course, he was engaged in laboratory testing and analysis of both manual and panel telephone circuits for two years. An equal period was spent in designing manual circuits and from 1926 to 1933 he engaged in the design of panel selector circuits. Since 1933, he has designed circuits for the crossbar system.

J. L. LAREW received a B.Sc. degree in mechanical engineering from Rutgers University in 1917, and during the following five years he held positions with several engineering and construction companies and gained a varied engineering experience. In 1922 he joined the Laboratories and was assigned to the power division of the Systems Development Department. For the past twelve years he has supervised a group engaged in the development of power plants for the toll system. Among these have been



*J. F. Wentz*



*A. J. Busch*



*J. L. Larew*



*Oscar Myers*



*D. F. Seacord*



*R. A. Chegwidden*



*K. Lutomirski*

those for telephone and telegraph repeaters, transatlantic radio, picture transmission and the more recent coaxial and types-J and K carrier systems.

AFTER receiving a degree of Bachelor of Chemistry from Cornell University in 1921, Oscar Myers joined the Installation Department of the Western Electric Company where he installed and tested panel central offices until 1924, when he joined the Technical Staff of the Laboratories. At first he was with the circuit laboratory, where he tested various circuits, including the decoder sender, and the toll key-pulsing system. In 1929 he transferred to the sender design group where he worked on senders, decoders, and test circuits. In 1932 he took part in the fundamental design work of the crossbar system. Since that time he has been engaged in crossbar development and design, mostly in connection with marker circuits for both local and toll systems.

D. F. SEACORD entered the Engineering Department of the New York Telephone Company in 1916 after graduation from the Sheffield Scientific School at Yale University, with a Ph.B. degree. He worked on transmission and economic studies in connection with the toll plant until 1924. From 1924 to 1927 he conducted a fundamental rate plan study in the General Commercial Engineering Department. In 1927 he transferred to the Development and Research Depart-

ment of the A. T. & T. and came to the Laboratories with that organization in 1934. He has been principally engaged recently in field studies of local transmission, including a field study of room noise conditions at telephone locations.

R. A. CHEGWIDDEN joined the Laboratories in 1919. For nearly ten years he worked on the development of new magnetic alloys as a member of the Magnetic Research Group. In 1930 he transferred to the Apparatus Development Department where he has since been engaged in general studies of magnetic materials and their commercial applications. After completing the three-year student assistant course Mr. Chegwidden continued studies at the Brooklyn Polytechnic Institute where he received an E.E. degree in 1937.

K. LUTOMIRSKI studied from 1911-1914 and 1918-1921 at the Technical University of Delft (Holland), graduating in 1921 with a degree of e. i. (electrotechnisch ingenieur). During the war he was in charge of military signaling systems in Holland. In 1922 he worked for the telephone company of The Hague (Holland). In 1923 he came to the United States where he joined the laboratories of the Western Union Telegraph Company, and later the Local Systems Development Department of these Laboratories. Some two years later he transferred to the Toll Systems Department. Since 1930 he has been engaged in carrier-systems development.