

LIBRARY
JUN 13 1932
U. S. PATENT OFFICE

BELL LABORATORIES RECORD



THE NEW
AUDIPHONE
J. B. Kelly, W. C. Jones, W. L. Betts

MOTION PICTURES
IN RELIEF

CARRIER TELEPHONE
FOR POWER SYSTEMS
K. O. Thorp

JUNE 1932 VOL. 10 No. 10

BELL LABORATORIES RECORD

Edited by the Bureau of Publications:

PAUL B. FINDLEY

Managing Editor

PHILIP C. JONES

Associate Editor

Board of Editorial Advisors:

O. E. BUCKLEY

W. FONDILLER

H. A. FREDERICK

O. M. GLUNT

H. H. LOWRY

W. H. MATTHIES

JOHN MILLS

D. A. QUARLES

J. G. ROBERTS

W. B. SANFORD

G. B. THOMAS

R. R. WILLIAMS

BELL TELEPHONE LABORATORIES, INCORPORATED

463 West Street, New York, N. Y.

In this Issue

| | |
|---|-----|
| Frontispiece | 341 |
| An electrometric analysis of a salt solution used for the preservation of telephone poles. | |
| What is a Satisfactory Hearing Aid? | 342 |
| <i>J. B. Kelly</i> | |
| Transmission Instruments for the New Audiphone | 346 |
| <i>W. C. Jones</i> | |
| Pacific Gas and Electric Extends its Carrier System | 350 |
| <i>K. O. Thorp</i> | |
| Transformer Equipment for Large Experimental Radio-Telephone Transmitter | 357 |
| <i>W. R. Lyon</i> | |
| Audiphones | 362 |
| <i>W. L. Betts</i> | |
| Motion Pictures in Relief | 367 |

BELL LABORATORIES RECORD



VOLUME TEN—NUMBER TEN

for

JUNE

1932



What Is a Satisfactory Hearing Aid?

By J. B. KELLY

Auditory Apparatus Engineer

THE normal human ear has a tremendous range of auditory response. Over the band of frequencies from 500 to 2000 cycles it will respond to the almost unbelievable energy range of one hundred million million to one—equivalent to 140 decibels in telephone terms. This range is bounded at the lower level by the intensity of sound that is just audible, and at the upper, by the intensity that becomes painful. The sensitivity is not alike at all frequencies, however. If the upper and lower limits of hearing were plotted on an absolute pressure scale both would

curve: the upper convex upward, and the lower convex downward. For the purpose of studying hearing loss, however, it is convenient to employ a straight base line and to indicate the range of pressure to which the ear will respond at the various frequencies as the curved line shown on Figure 1.

When a person is hard of hearing, the range of pressure that he can hear is decreased, and the amount it is decreased at the various frequencies can readily be indicated on a chart like that shown. The same base line may be retained but a new line, representing the person's range of hearing,

is plotted from data secured with an audiometer. Such a curve is known as an audiogram, and Figure 2 gives such an audiogram for the two ears of a person we may refer to as Mr. A. As shown by this curve a sound of 1024-cycle frequency, which could just be heard by a person of normal hearing, would have to be increased 60 decibels, or sensation units, to be audible to Mr. A. Lower frequencies require less amplification and higher frequencies, more. The audiogram of a person totally deaf would be on or below the broken line representing total loss of serviceable hearing.

Because of the great range in both pitch and intensity that the ear possesses, a person may lose part of the area and not notice it. Our ears may not respond to some pitch ranges or to some intensity levels that are easily heard by others, and yet we may not be conscious of the fact. When the hearing loss is about 35 sensation units, it becomes noticeable in conversation, especially with a group, and difficulty is experienced in hearing at a theatre or in some similar

situation. When the loss is appreciably more than this amount, we become definitely conscious of lessened hearing acuity. In noisy places we may still fare very well, however, since all voices are being raised.

Because of the various agencies which may cause a loss of hearing acuity, it could not be expected that the type of loss would be the same in all cases, or that it would consist of an equally diminished acuity at all pitches. The shape of the audiogram, in other words, differs radically for various people. To obtain perfect correction for deafness would require a specially designed audiphone for each person, which is obviously not very practicable. It is preferable, therefore, to design an audiphone that will give the best results in the average case, as indicated by an extensive study of various types of deafness.

The design of a satisfactory audiphone thus requires extensive knowledge of the nature of speech and hearing, and a wide experience in solving communication problems. Bell Telephone Laboratories has for years

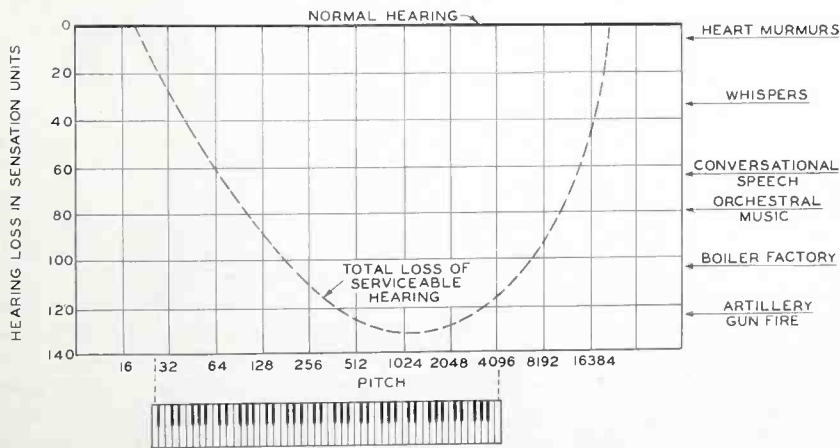

Fig. 1—The auditory area. The curved line represents the hearing loss necessary at various frequencies to produce total deafness

carried on broad studies in speech and hearing, on account of their practical bearing on telephony, and from its intimate knowledge of communication circuits and apparatus is well equipped for the development of audiphones. It has, therefore, made designs available to the Western

The number understood correctly both with and without the audiphone is recorded and is a measure of the usefulness of the audiphone. Many factors affect even this method as may be illustrated by the case of Mr. A whose audiogram was given in Figure 2. Ten sentences of this sort are addressed to Mr. A who

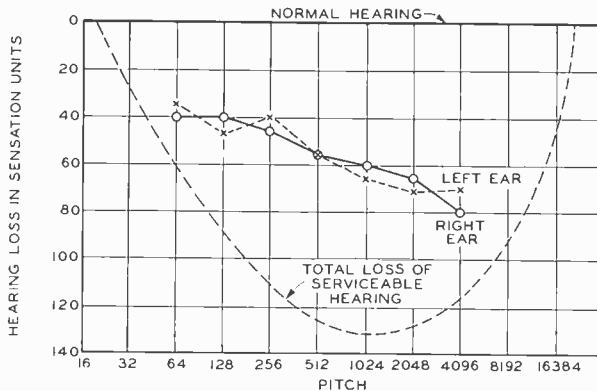

Fig. 2—An audiogram for Mr. A whose hearing loss runs from about 40 db at 64 cycles to 70 db at 5000

Electric Company, which has manufactured audiphones for a number of years. In the design of the new audiphone, advantage has been taken of all the latest developments.

Because of the large number of factors that comprise one's ability to understand speech, the value of a hearing aid is difficult to determine. Many years of study have proved quite conclusively that the only satisfactory way is by an intelligibility test. In applying such a test to determine the effectiveness of an audiphone, the user is seated at some fixed distance, usually about three feet, from a speaker who pronounces in an even, conversational voice, a number of sentences such as "Fire insurance is desirable; Washington was called the father of his country; It is dangerous to throw away a lighted match."

addressed to Mr. A who is hard of hearing. He understands only two complete sentences although he hears snatches of others. He is then requested not to watch the speaker, and of the next ten questions he fails to understand any although again he hears parts of several. These results indicate that, although perhaps unconscious of it, Mr. A has some lip-reading ability, which enables him to obtain some information by observing the positions of the speaker's lips. With Mr. A again watching the speaker, the test is continued with the new Western Electric audiphone and Mr. A quickly and correctly repeats every sentence.

The ability of Mr. A to hear so well with the new audiphone was, of course, due in part to the care taken in its design, and to its many convenient features, but there is another consideration that helped the audiphone to perform so well in his case. He has been using a hearing aid for years, and has thus kept his ears in an environment of speech—always interpreting through hearing irrespective of the distortion. He does not have to go through the process of learning to interpret through his ears. Someone else may have a hearing loss

identical with that of Mr. A, but if he has withdrawn wherever possible from contacts where he has to depend on hearing, he may not be able to obtain so much aid from the audiphone at first. If he uses it constantly, however, he will become more and more proficient in interpreting what he hears, and the audiphone will thus increase its effectiveness.

As has been mentioned, lip reading plays an important part in the interpretation of speech, even though a hearing aid is used. Studies of speech and hearing show that speech sounds which are in the same class are often confused. *P*, *k*, and *t*, for example, are often misunderstood and interchanged. They are all stop consonants and are unvoiced. There is thus no sounding of the vocal cords for any of them, but the manner in which the stop is formed for the three sounds is quite different. The stop for *p* is formed by lip against lip, for *t* by the tongue against the teeth, and for *k* with the tongue pressed against the soft palate.

A person might be confused in hearing these three sounds, but if he had any fundamental lip-reading knowledge, he would be able to identify them by what he read from the lips. Thus speech sounds which may seem similar to the ear do not look alike, and similarly some sounds which look alike do not sound the same. *B* and

p, for example, are both formed by lip against lip, and would thus look alike to a lip reader. When *b* is pronounced, however, the vocal cords are vibrating and when this fundamental vibration is heard, *b* is readily identified. Because of these facts lip reading may supplement a hearing aid with very good results. Neither alone might be satisfactory, yet the combination might give perfect understanding.

Mr. A's test is not hypothetical but merely one of the many that have been made with the new audiphone. Some of the people tested have had very moderate hearing losses, and others—at the other extreme—have had very little useful hearing range. The results obtained have varied accordingly. Detailed comment on individual cases would be out of place, but two very encouraging conclusions may be drawn. The first is that the new audiphones are better aids to hearing than any portable equipment heretofore available. The second is that very few people were encountered whose hearing loss was so great that they were not able to carry on conversation with the help of the new audiphone. The careful study of the needs of the hard of hearing being carried on in the Bell System, and the practical accomplishments that have been attained, have already made deafness far less of a handicap than it has been in the past.

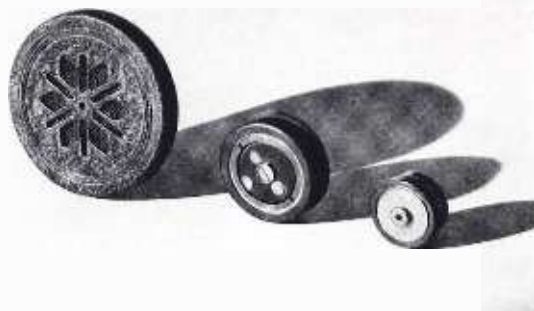

Transmission Instruments for the New Audiphone

By W. C. JONES

Transmission Instruments Engineering

SINCE the primary object of an audiphone is to amplify the sound reaching the ear of a deafened person by an amount that will offset his loss of hearing, some part of any hearing aid must have this amplifying ability. The simplest and least expensive device suitable for this purpose is a variable-resistance transmitter—fundamentally the same as the carbon transmitter universally adopted for telephone use. In such a transmitter a small amount of power in the form of sound releases to an associated receiver a much larger amount of power from a local source of electrical energy. If the transmitter is sensitive and the receiver efficient, the sound delivered to the ear will not only be a fairly faithful copy of that reaching the transmitter, but will also be materially amplified in intensity. The simplest form of audiphone, therefore, requires only two transmission instruments: a sensi-

tive transmitter and an efficient receiver.

The amplification that can be obtained with this simple form of audiphone, however, is limited, and is often inadequate to compensate for a serious loss of hearing. Furthermore it does not provide means for adjusting the volume, which is often important when the sound reaching the transmitter varies over a wide range. The additional amplification needed to meet these requirements could be secured with a vacuum-tube amplifier, but such a device is large and heavy, and hence not well suited to the portable type of audiphone. It has proved feasible, however, to utilize again the amplifying ability of the carbon transmitter to provide a mechanical amplifier which increases the output of the transmitter by approximately 20 db, an amount equivalent to one stage of vacuum-tube amplification, without adding materially to the size or weight

of the audiphone. The amplification obtained is substantially uniform throughout the range of frequencies important in speech.

In addition to a new transmitter and receiver designed for the present audiphones, an amplifier of the type just described has been provided. The appearance of these three elements is shown in the photograph at the head of this article. The transmitter, at the left, is less than $2\frac{1}{2}$ inches in diameter, and the receiver on the right, which weighs less than $\frac{3}{4}$ of an ounce, is only $\frac{7}{8}$ inch in diameter.

Because of the use to which it is put, the transmitter for an audiphone should differ in certain features from those employed for other purposes. In the design of the transmitter for the new Western Electric audiphone, the construction of all parts has been carefully selected to attain the best overall results. Steps have been taken, for instance, to insure substantially uniform values of contact pressure on the carbon granules so that erratic transmission or undesirably high carbon noise may be eliminated. Precautions have also been taken to reduce aging of carbon, and to compensate for the effects of temperature changes which occur when a transmitter is connected in a circuit for any appreciable time. Another feature contributing to improved response and better quality is a cavity between the back of the diaphragm and the mounting plate. The volume of air in this cavity is comparatively small and adds sufficient stiffness to the diaphragm to make its displacement substantially uniform over most of the important frequency range.

As has already been pointed out, the amplifier makes use of an element similar to that of the carbon transmitter coupled to a receiver element.

The electrical output from the audiphone transmitter passes through the winding of the receiver element of the amplifier, thus setting up a field in the air gap of the magnetic circuit, that causes the permalloy diaphragm to move correspondingly. The permalloy diaphragm drives a carbon diaphragm of similar dimensions through an air coupling formed by the narrow air space between them. This carbon diaphragm acts on the granular carbon as does the diaphragm of a transmitter, and produces the desired amplification. The same battery supplies current for both amplifier and transmitter as shown by the circuit diagram of Figure 1.

Many of the features of the granular-carbon element of the amplifier are the same as those of the transmitter. A reserve carbon chamber is provided, and the impressed voltage is distrib-

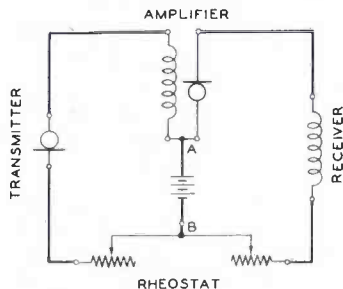

Fig. 1—Circuit diagram of audiphone with mechanical amplifier

uted between a number of contacts, but the diaphragm is of carbon instead of aluminum.

No permanent magnet is employed in the receiver element of the amplifier. The polarizing flux required to obtain proper receiver action is set up by the direct current supplied by the battery. The magnetizing current for maximum efficiency of the amplifier depends on the length of the air gap

between the permalloy diaphragm and the central pole piece. Provision has been made for adjusting the length of this gap so that the maximum efficiency of each amplifier will occur at the same value of direct current. After the adjustment has been made, the pole piece is sealed in place to prevent subsequent change. Permalloy is em-



Fig. 2—The universal type earpiece, on the right, may be adjusted to conform to the ear, while the individual type, on the left, is specially moulded for each user

ployed in all the parts forming the magnetic circuit.

One of the difficulties encountered in using this type of amplifier in the circuit in Figure 1 is that sustained oscillations or "howling" will result if the resistance of the common section of amplifier and transmitter circuits between A and B exceeds a certain value. So long as the resistance of this portion of the circuit, which includes the battery and its connecting cords, is below this value, however, howling will not occur. It is possible to place requirements on the cords which will insure uniformly low values of resistance, but the resistance of dry cells, particularly of the small cells which because of their light weight are well suited for audiphone use, in-

creases with use. As the set is used, and the dry cells increase in resistance, a point is ultimately reached where howling occurs. If no special precautions were taken, this might occur before the battery had aged sufficiently to render it unsuitable as a source of current. To obviate this, a small hole is made in the carbon dia-

phragm to connect the space between the two diaphragms to that adjacent to the carbon chamber. This hole reduces the coupling between the two diaphragms at low frequencies sufficiently to allow the battery to age almost the entire permissible amount before the set will oscillate. Under these conditions oscillation occurs at a higher frequency and is an unmistakable indication to the user that the battery should be replaced. This reduction in coupling between the two parts of the amplifier also prevents the changes in current due to the tempera-

ture rise in the transmitter from reacting on the carbon element and changing its sensitivity. Possible sustained or transient oscillation caused by mechanical coupling between the transmitter and amplifier, when—as in the 38-A audiphone—they are mounted in the same housing, is avoided by a rubber shield for the amplifier.

The receiver for the new audiphone, although similar to those used with earlier Western Electric sets, has several new features. The receivers have all been of the electromagnetic type, but the core of the older type was fixed while that of the new is adjustable, as is that of the receiver part of the amplifier, which allows the air gap to be adjusted so that the

maximum efficiency of all receivers occurs at the same value of magnetizing current. After adjustment the core is sealed in place, and the design insures that stresses developed when the ear piece is attached or removed do not affect this adjustment.

These ear pieces may be either of the two types shown in Figure 2. One is of the individual type, moulded to fit the ear of a single user, and the other of a universal type which can be adjusted to fit the important dimensions of the ear of any user. The individual type is preferable because the pressure on the ear is uniformly distributed, while with the universal type a certain amount of concentration of pressure is required to prevent

acoustic leakage around the ear piece.

The higher amplification provided by the instruments developed for the new audiphone has made it possible to furnish a hearing aid that is not only invaluable in case of serious loss of hearing but is also particularly helpful with moderate hearing loss because of the adjustable amplification. The design of the instruments attains not only an outstanding improvement in quality but a markedly decreased aging rate. Interfering noise is also reduced, and greater uniformity of performance secured throughout the life of the instrument. All of these features have been obtained without making any sacrifice in weight, size, or appearance.



A first-prize winner in the Clubs' photograph contest: landscape, senior class, by S. G. Lutz

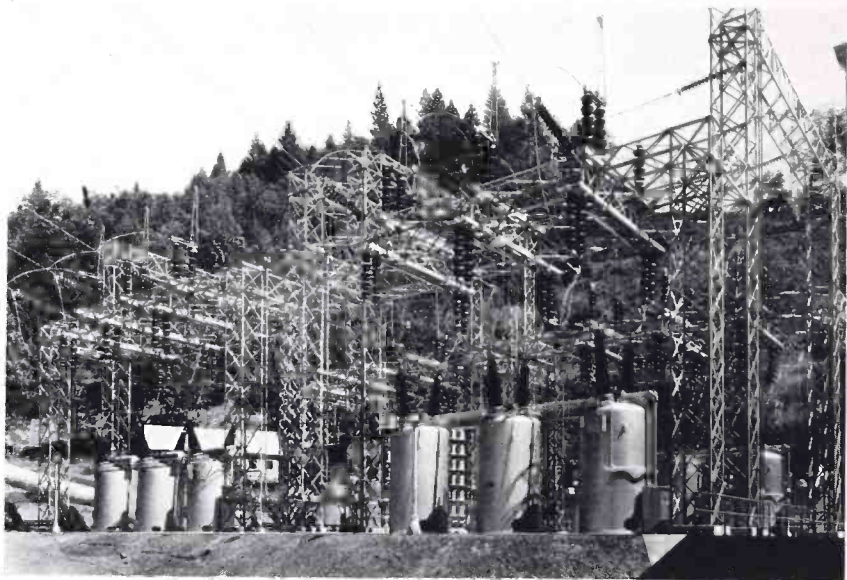

Pacific Gas and Electric Extends Its Carrier System

By K. O. THORP

Radio Development

POWER-line-carrier telephony has, for a number of years, served the Pacific Gas and Electric Company as a means of private communication between their Pit No. 1 Hydroelectric Generating Station and their Claremont and Vaca-Dixon Substations. The first application of power-line carrier to the lines of this utility company was made in 1925. Communication between Claremont and Vaca-Dixon was to be carried on over approximately fifty miles of 110,000-volt transmission line. A repeater or a by-pass was to be provided at Vaca-Dixon for the purpose of continuing the circuit around the

110,000- to 220,000-volt autotransformers at this station, and thence over approximately 200 miles of 220,000-volt transmission line to the Pit No. 1 generating station. The Western Electric Company submitted for this service trial their then standard two-frequency, carrier-transmitted equipment. Because of the relatively long distance over which the equipment was required to operate, and of the high noise level on the 220,000-volt lines, this installation was not entirely satisfactory commercially.

As a result the Bell Laboratories engineers who conducted the trial, with the cooperation of the Pacific

Telephone and Telegraph Company, constructed in the field two terminals of a carrier-suppressed, single side-band type of equipment. These terminals were operated between Vaca-Dixon and Pit No. 1 with a marked degree of success. As a result of this experiment the Type "E" power-line-carrier telephone equipment* was developed. The first commercial installation of this equipment was completed in the summer of 1928 at the three stations between which the original trial had been conducted. This circuit was extended over a voice frequency telephone circuit from the Claremont Substation to the Load Dispatcher's Office in Oakland. This equipment provided a communication circuit which, for the past three and one-half years has served the Pacific Gas and Electric Company in a most satisfactory manner. It has particularly distinguished itself from the standpoint of low maintenance expense and continuity of service.

As a result of the satisfactory performance of the Type "E" equipment on the Pit lines, it was natural that, when considering communication requirements for the Mokelumne River Development, the engineers of the Pacific Gas and Electric Company should decide upon this type of equipment to provide the major communication channel between this project and the distribution center at Newark and the Load Dispatcher in Oakland. The recent consolidation of the San Joaquin Light and Power Company with the Pacific Company,

making necessary frequent and reliable communication between the Oakland and Fresno Load Dispatchers, permitted the application of a second link in the carrier communication channel which was to be installed at this time.

Part of the high voltage transmission system of the Pacific Gas and Electric Company and its subsidiaries is shown in Figure 1. The heavy lines shown between Oakland, Newark, Tiger Creek, and the San Joaquin Steam plant provide the channel for carrier communication between these stations. The 220,000 volt lines between Tiger Creek, Newark, and the San Joaquin Steam plant are particu-

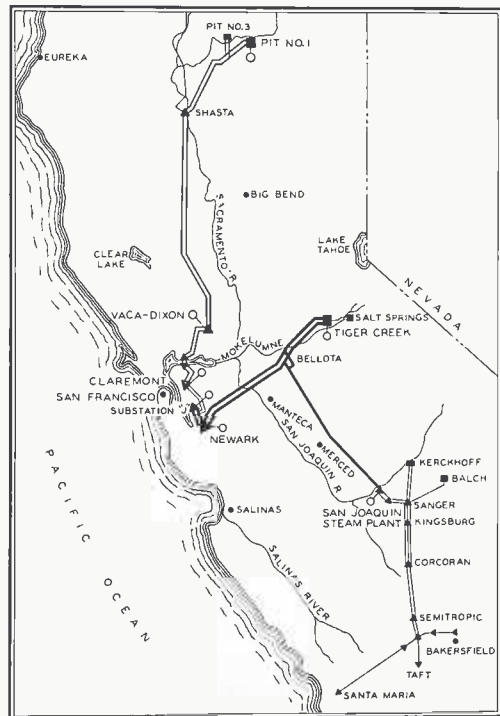

Fig. 1—Map showing a part of the 110- and 220-thousand volt lines of the Pacific Gas and Electric Company. Carrier terminals are indicated by circles

*RECORD, July, 1929, p. 451.



Fig. 2—110,000 volt coupling equipment at Station "J"

larly adapted to carrier communication, since the type of construction employed results in a relatively low high-frequency line noise and a low transmission loss. The lighter lines shown on the map between Pit No. 1 power house, Vaca-Dixon, and Claremont represent the transmission medium for the original installation of power line carrier on the lines of this utility.

The characteristics of a power system as a transmission medium for carrier communication are a function of the complexity of the system and of the connected power apparatus. For this reason no two power systems will have identical characteristics. It is therefore necessary, when undertaking an installation of this sort, to make a thorough study of the charac-

teristics of the particular power network over which the equipment is to operate. To do this the equipment is installed at all stations and test circuits are added which will permit the use of the terminal equipment as a means of measuring the power-line attenuation. Switches are provided for connecting the output of the transmitting circuits either directly to the coupling equipment or to a fixed non-inductive resistance in series with a thermocouple. Switches are also provided to connect the coupling equipment to a second fixed non-inductive resistance of the same value as that to which the transmitting circuits may be connected. A thermocouple is also connected in series with this resistance. Thus, to measure the power-line plus coupling attenuation at any given frequency, a fixed voice frequency input level is introduced into the transmitter and the output level measured into the fixed resistance. The transmitter is then connected to the coupling equipment and the received level at the distant station measured into the second fixed resistance which is of the same value as that at the transmitting station. The difference between these two levels is taken as a measure of the line plus coupling loss. The above process is repeated as a check with the distant station transmitting and the other receiving.

This method of attenuation measurement does not result in an accurate measure of the absolute attenuation since it does not take into account the impedance into which the equipment is operating. It is sufficiently accurate, however, to enable the selection of the best transmitting frequency, since, for this purpose it is only necessary to know the relative attenuations at all frequencies through-

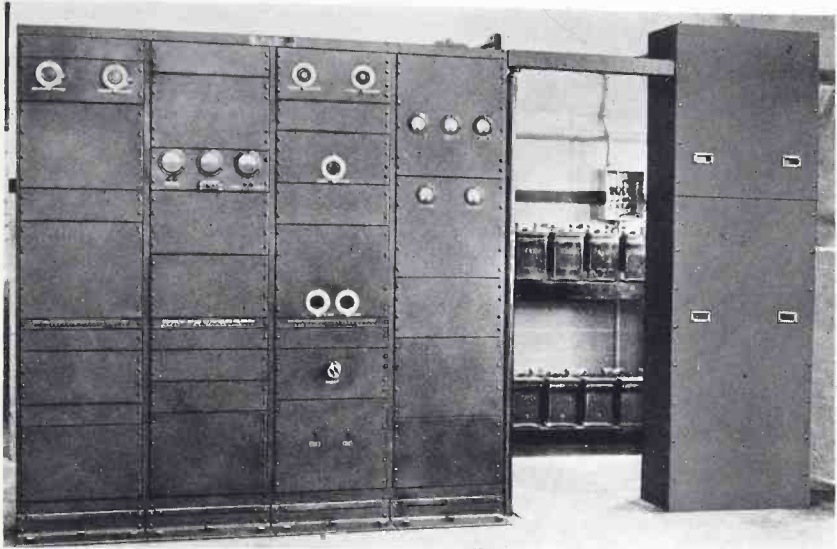

Fig. 3—Carrier terminal equipment at Station "J"

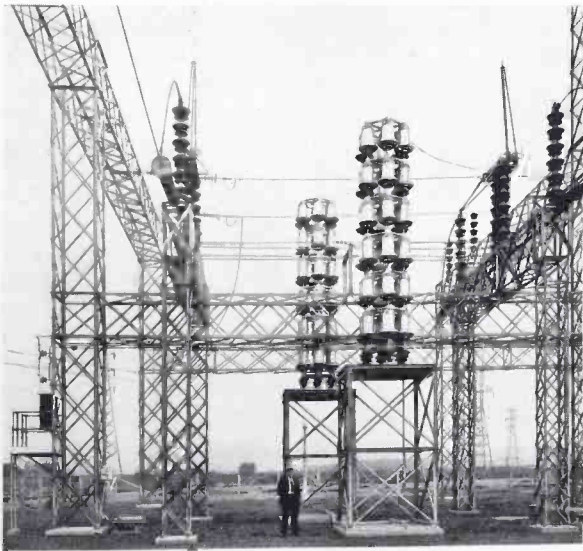

Fig. 4—220,000 volt coupling equipment at Newark Substation



Fig. 5—Carrier terminal equipment in the control room of the Newark Substation

out the operating range of from 50 to 150 kilocycles.

Attenuation measurements are made between all stations at which the equipment is required to operate. The frequency at which the lowest average attenuation is obtained between all stations is then selected as the operating carrier frequency for the system. A more detailed study is then made to determine the variation of attenuation within a 2000-cycle band on either side of the transmitting frequency selected. This is for the purpose of determining more accurately the best placement for the voice frequency band which will be transmitted. Adjustments are made on the coupling circuits at all stations to compensate for the irregularities of line attenuation within this band, in an attempt to obtain as wide and as smooth a voice frequency band as possible. A 2000-cycle band width with not more than six db variation between the two most distant stations on the system is considered satisfactory quality for the purpose for which the equipment is

intended. Sufficient equalization is obtained in the voice frequency circuits of the terminal equipment to compensate to a certain extent for the variation in attenuation over the relatively narrow band width.

At the Newark substation and at the San Joaquin steam plant the installations were further complicated by the necessity of using long underground cable lead-in wires between the coupling equipments and the carrier terminals. At Newark the terminal is connected approximately midway between the 110,000 and the 220,000 volt couplings which are about one thousand feet apart. Single-conductor lead-covered cables in an iron conduit connect these two couplings. At the San Joaquin steam plant the underground cable lead-in is also approximately one thousand feet long. The input impedance of these long lead-in wires was found to be very low due to the shunt capacity between each conductor and ground. This resulted in excessive coupling losses at these stations. A study was

made of these couplings and certain modifications in the power amplifier output circuits and in the coupling filters were made for the purpose of compensating for the high shunt capacities. These modifications resulted in a satisfactory coupling loss at each station. The lead-in wires at Oakland and Tiger Creek are also in underground cable but are much shorter than those at the other two stations, so that no modifications in the coupling and output circuits were necessary at these stations.

The location of the carrier panel and coupling equipment at each station was determined, to a great extent, by the space available and the general lay-out of the power station apparatus. At Tiger Creek and Newark the terminal equipment was mounted in the operating room near the switchboard and the instrument and relay panels. At Station "J" in Oakland and at the San Joaquin steam plant, however, no space was available in the operating rooms, and the equipment was installed elsewhere.

The coupling equipment is installed in the switching yard as near as possible to the point where connection is made to the high tension bus. As a safety measure, this equipment is mounted either above reach from the ground or made inaccessible to unauthorized approach by fencing.

The telephone channel provided by this equipment terminates at each station in the private telephone switchboard and in a telephone set, both of which are located on the station operator's desk. Voice frequency extension circuits, with remote control of the terminals, are installed between Station "J" and the Load Dispatcher's office in Oakland, and between the San Joaquin steam plant and the Load Dispatcher's office in Fresno.

It is possible at either the terminal points or at the Load Dispatcher's offices to extend the carrier circuit over the privately owned telephone lines of the Power Company, provided, of course, that these lines meet the transmission requirements specified for voice frequency extensions on this equipment.

Due to the fact that there are very few occasions on which communication is required between stations on the Pit and Mokelumne systems, the new carrier channel was adjusted to operate on a transmitting frequency which is approximately sixteen kilocycles removed from that of the Pit channel. The selectivity obtained in the coupling circuits, and in the band-pass filters which are connected ahead of the receiving circuits, is sufficient



Fig. 6 — 110,000 volt coupling equipment at Newark Substation

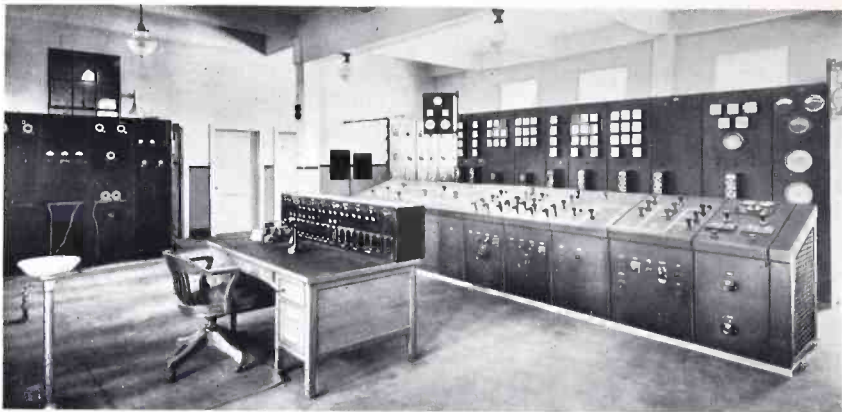

Fig. 7— Interior of operating room at Tiger Creek power house, with carrier terminal at the left

to eliminate all interference between the two channels. This permits the simultaneous use of both channels. When necessary the two systems may be connected together by patching the voice frequency circuits at the Load Dispatcher's office in Oakland.

The circuit as it was finally adjusted gave approximately a 10 db overall voice frequency equivalent between the Load Dispatchers' offices in Oakland and Fresno which are the most widely separated stations on the system. The equivalents between the other stations are slightly lower. At Newark, since it is centrally located on the system, the transmitter and the receiver were padded to compensate for the greater line attenuations between the remaining stations.

An interesting feature of this particular installation is that the equipment was installed simultaneously with the later phases of construction work on the Tiger Creek, Newark,

and San Joaquin projects. The carrier circuit was available for use in connection with some of the tests involved in placing these stations in operation as well as for passing operating instructions as soon as the stations were in service. A single-band carrier circuit is particularly valuable in connection with power system tests because it permits party line communication between all stations at which the equipment is installed. Thus it is possible for the man conducting the tests to be in simultaneous communication with all stations involved, providing the tests do not involve opening of the transmission line over which the carrier is operating. The primary use of the carrier is, of course, for the operation of the power system in receiving reports of load and water conditions at the various stations for the use of the Load Dispatcher in operating the system in the most economical manner.

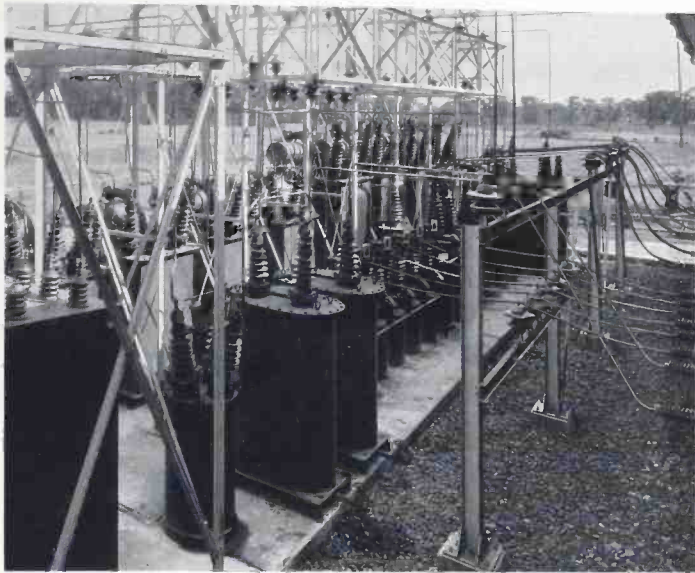

Transformer Equipment for Large Experimental Radio-Telephone Transmitter

By W. R. LYON

Telephone Apparatus Development

WITHIN the next few years it is planned to improve the facilities for long-wave transoceanic radio telephony. To determine the actual amount of power required, and to carry on other experimental work for the new transmitter, it was decided to erect an experimental model at Whippany which would be as large as any likely commercial installation. Designed for experimental studies, the power equipment was made flexible in the way of voltage adjustment and load capacity, and every precaution was taken to prevent breakdown due to the high transient voltages that might arise from the variety of tests projected.

In general the power equipment consists of transformers for two rectifiers—the larger for supplying the final power stage of the amplifier and the smaller for supplying the two preceding stages; filament transformers for the final stage of the amplifier of the transmitter, and the necessary accessory apparatus. The diagram of Figure 1 shows a general scheme of connections and indicates the principal pieces of apparatus. With the exception of the filament transformers for the amplifier, not shown in the sketch, and the two smaller regulators, all the transformer equipment is mounted out of doors as shown in the photograph at the head of this

article. The rectifier tubes themselves are inside the building adjacent to the transformer platform as is the control equipment for the oil switches.

The larger of the two rectifiers is capable of developing nearly 900 kw of direct current at any potential from

12,000 to 26,000 volts. To secure this wide voltage range, the transformers supplying plate potential are provided with two primary windings which may be connected in either series or parallel. Taps also are provided for smaller adjustments. An induction regulator

is provided in addition which can vary the voltage applied to the primary windings from 11,220 to 15,180 volts.

The secondary windings of the plate transformers are also in two sections and are connected in double three-phase Y to provide a six-phase supply for the rectifier which has six banks of tubes. The neutral points of the two Y's are connected together through an interphase reactor tapped at its mid-point for the supply to the final power stage of the amplifier, which is passed through a filter retardation coil.

Requirements placed on the plate transformer are rather severe, partly because they are used with rectifiers and partly because of the nature of the experimental work for which they are intended. The current from the secondary windings consists of a series of uni-directional pulses lasting for only a third of a cycle, but at the highest part of the voltage wave.

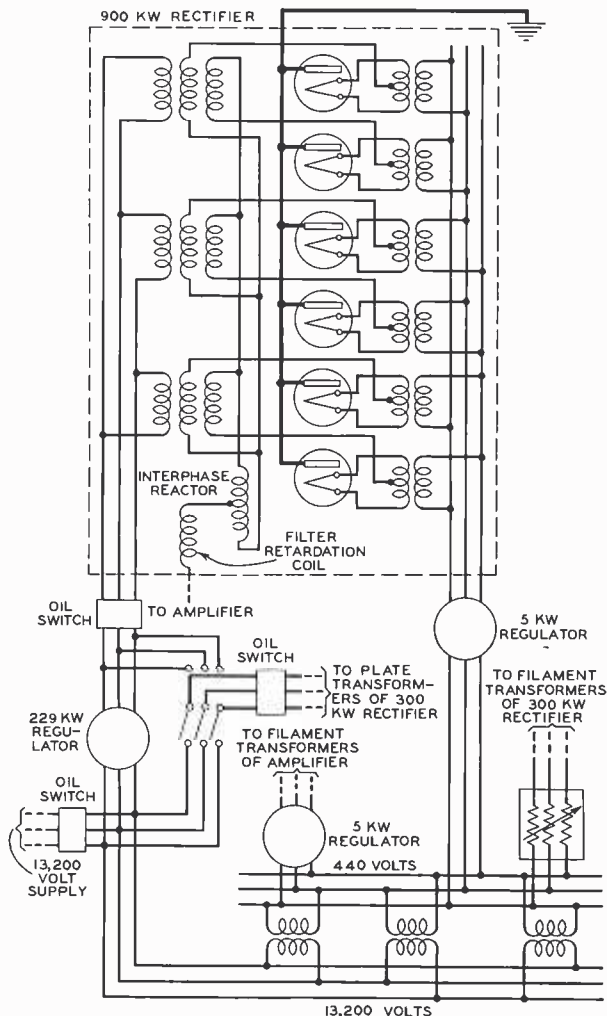

Fig. 1—Two rectifiers with their associated apparatus form the major part of the power equipment. As many as six tubes in each phase of the rectifier circuit are represented on the diagram by a single symbol

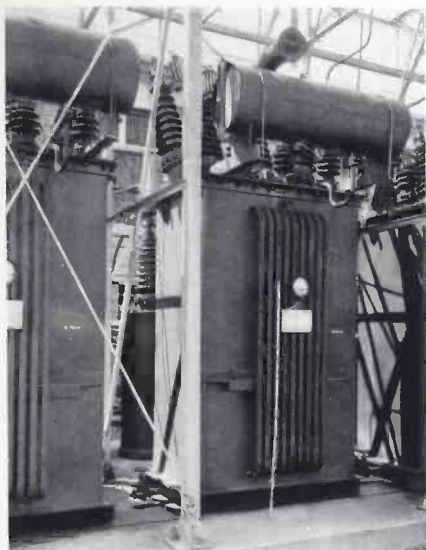

Fig. 2—One of the plate transformers showing oil reservoir, pressure relief pipe, high voltage bushing, and the resistors for the ball gap protectors. The balls themselves are hidden behind the structural framework

For the rated power, therefore, the current is greater than it would be if it lasted during the whole cycle, and the heating, which varies as the square of the current, is approximately 50 per cent greater than in transformers used for ordinary power supply. Because of this the secondary windings of each transformer are rated at 450 kv-a while the primary windings, to which this effect is only partially passed, are rated at only 325 kv-a.

Voltage requirements are also severe. Because of the double Y connection, the potentials above ground at the secondary winding terminals, which are connected to the rectifier tubes, rise, when the tubes block, to about twice the normal plate voltage. In addition it was felt necessary to insure against possible high voltage surges during the experimental work

so that the secondary windings were designed to withstand 144,000 volts both to the primary winding and to ground. This high voltage insulation was extended to all apparatus connected directly to the secondary windings of the plate transformers.

One of these transformers is shown in Figure 2 with a six-foot rule beside it for comparison. An oil reservoir is mounted above the transformer to keep the case completely full at all

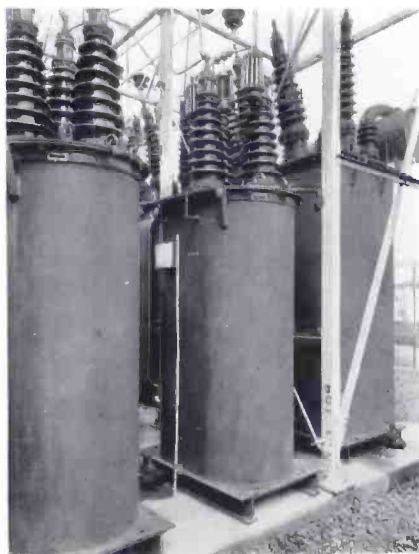

Fig. 3—The interphase reactor, like the other equipment connected to the plate voltage transformers, is insulated for 144,000 volts to ground

times. A pressure release is provided to prevent possible explosion of the transformer in case of internal short circuits. This is the large curved pipe projecting over the top of the oil reservoir in the photograph. It has a glass plate over its end which will break under excess pressure. The 72,000 volt bushings are provided with ball-gap protectors with series

resistance units as a further safeguard against high transient voltages.

The interphase reactor, Figure 3, and the filter retardation coil, in the center of Figure 4, are both oil insulated and supplied with high voltage bushings. The filament supply transformers for the large rectifier, at the left of Figure 4, are similarly equipped. Spares are provided for all major units to reduce lost time due to possible damage to working units.

Rated at 229 kw, the induction regulator, shown in Figure 5, is approximately twelve feet high and weighs over eleven tons. Within the enclosed casing on the top is the motor, brake, relay, and contact mechanism used for rotating the armature to secure the required regulation. What appear to be corrugations on the sides are really flattened cooling tubes that take the heated oil

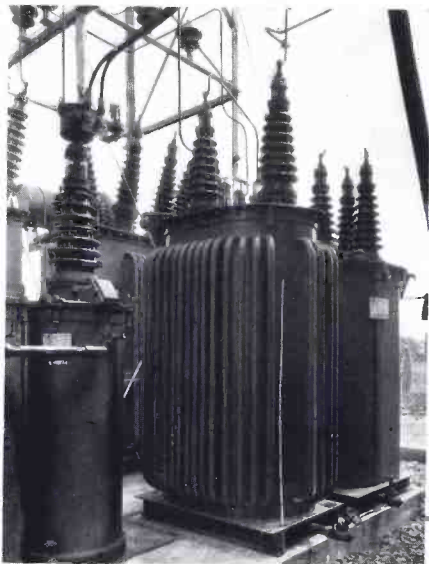

Fig. 4—One end of the transformer platform showing a filter retardation coil, in the center, and one of the filament supply transformers for the larger rectifier, at the left

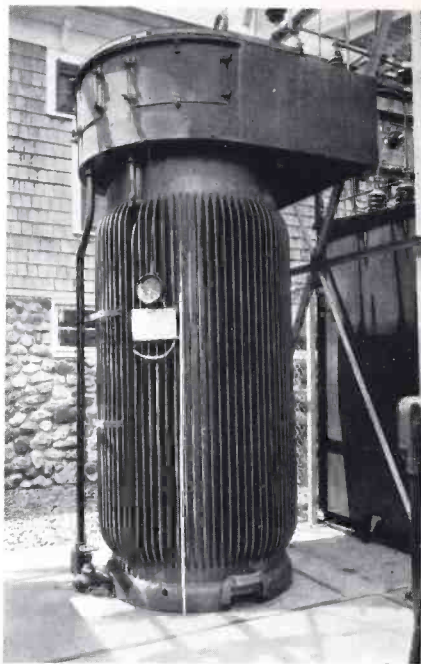

Fig. 5—The 229 kw induction regulator is also oil cooled, and its five-foot diameter tank requires 500 gallons of oil

from the top of the tank, cool it, and pass it back to the regulator at the bottom.

Equipment for the 300 kw rectifier is similar except in size, to that just described, but it includes two filter retardation coils because two amplifier stages are supplied. Both the plate and filament transformers appear in the photograph at the head of this article but they are rather difficult to pick out because of the wiring and steel work.

The general arrangement of the power supply is evident in Figure 1. Sixty-cycle three-phase power is taken from the lines of a public utility company at 13,200 volts. After passing through an oil switch the circuit divides into three branches. One goes

to the 229 kw induction regulator supplying the large plate transformers, one to a bank of three standard 13,200 to 440 volt transformers feeding the three filament supplies, and the third to one set of terminals of a double throw switch feeding the plate transformers for the smaller rectifier. The second set of terminals of this switch are connected to the leads from the large induction regulator so that the smaller rectifier may be operated from a regulated or unregulated supply.

Each of the filament supplies fed by the 440 volt transformers is regulated. Those for the large rectifier and for the amplifier tubes have induction regulators which are inside the building. That for the smaller rectifier

employs a regulator of the resistance type. The transformers for the amplifier filaments, which are not shown in any of the illustrations, are small self-cooled transformers rated at sixty amperes and twenty volts on the secondary side.

Including spares, there are in all sixty-three pieces of transformer equipment of twelve more or less distinct types. All were made by an outside supplier to meet operating requirements specified by the Laboratories. The total capacity is about 2,700 kv-a. Experimental results obtained by the use of this equipment will be used as the basis of design for the final commercial installation to be made near Bangor, Maine.



First-prize portrait, senior class, by C. G. Scofield



Audiphones

By W. L. BETTS
Special Products Development

ALEXANDER GRAHAM BELL was a teacher of the deaf, and it was to his studies of sound—an outgrowth of his interest in speech and hearing—that the telephone owes its existence. It is eminently fitting, therefore, that from telephone research there should spring apparatus for aiding the deafened to hear. Hearing aids and the telephone, however, are associated not only because both were major interests of Bell's life, but because the apparatus and circuits of both are essentially alike. Those most

familiar with the development of telephone systems are—other things being equal—best able to produce satisfactory hearing aids, and it is natural, therefore, that Bell Telephone Laboratories should play an important part in aiding the deafened.

For nearly forty years after the invention of the telephone, the research and development activities of the Bell System were occupied with the creation of a nation-wide telephone service of high quality. Shortly after the war, work being carried on



Fig. 1—Although the 10-A audiphone was very satisfactory as a hearing aid, it was far too large for general use

in the study of speech and hearing by Dr. Fletcher led to the construction of a number of experimental sets to aid the hard of hearing. The success obtained was such that, early in 1922, a program for the development of these types of hearing aids was embarked upon. Two of these were to be binaural—employing two receivers and two transmitters so as to secure a sense of the direction from which sound comes—and one, monaural.

The first to be developed was a large binaural set known as the 10-A audiphone. A receiver for each ear was associated with a separate transmitter and a three-stage amplifier. The two amplifiers with their battery supply were assembled in a bookcase unit, nearly three feet wide and four feet high, shown in Figure 1. The weight of the complete set was over two hundred pounds. The second set, the 20-A, was also a binaural but was considerably smaller, using two-stage amplifiers and weighing but 35 pounds. The first monaural set, the 30-A, was essentially the same as the smaller binaural set but required only a single receiver, transmitter, and amplifier, and its weight was reduced to 11 pounds.

Because of their size and weight these sets were never widely used, so that the development of a smaller monaural set was undertaken. The set produced, known as the 6032 type, is shown in Figure 2. All the elements are considerably reduced in size. A very small transmitter and a midget receiver were specially developed for it. This type of receiver has been used in all subsequent audiphones. A two-stage amplifier with both filament and plate batteries was enclosed in a small carrying case, and the entire set weighed only seven pounds.



Fig. 2.—In the 6032 audiphone a great reduction in size was obtained but even with it the most desirable size did not seem to be reached

Even this audiphone, however, was too large for general use, and in 1924 work was started on a transmitter which would have good quality and at the same time sufficient power to make an amplifier unnecessary. The results were the 6033 and 6034 audiphones, but it was soon found that the power was not great enough to make them of maximum usefulness to many of the deafened. A still smaller and better transmitter seemed needed, and some form of amplifier which would be smaller than the ordinary vacuum-tube type. The development which was initiated as a result yielded the 616-A transmitter and the 65-A mechanical amplifier, both of which are described in an accompanying article.

In 1928 a number of the 6033 and 6034 type audiphones were equipped with these new amplifiers and sent out for trial. So satisfactory were the results that work was at once started on



Fig. 3—The 36-A audiphone employs no amplifier but has a wide field of use with those whose hearing is only moderately impaired

the commercial design. Consideration was given to the various ways in which the elements of the set might be grouped together for convenience, and two arrangements selected as the most satisfactory. In one the transmitter is separate, and the rheostat and amplifier are combined. With such a set the transmitter may be worn inconspicuously by the user and the combined rheostat and amplifier

placed in a pocket. In the other, transmitter, amplifier, and rheostat are combined in a single unit, thus attaining compactness. For both of these sets it was decided to keep the battery separate so that either a battery box with standard flash-light cells, or a special audiphone battery could be used. For use with the set having transmitter, rheostat, and amplifier in a single unit, a carrying case



Fig. 4—The 37-A audiphone has an amplifier, but mounted with the rheostat in a box of cigarette-case size, it makes little more demand on space than does the 36-A

was designed which would accommodate the battery.

Various models of these sets have been made to determine which would have the best appearance, and an intensive study of designs was made to insure economical manufacture on a quantity basis.

In addition to these two sets employing amplifiers, a third set using the same transmitter but without an amplifier has also been provided. Besides the receiver and transmitter it has only the small rheostat. These three sets cover the immediate requirements for such devices. The set without amplifier, called the 36-A and shown in Figure 3, will be of value to many whose hearing is not greatly impaired but who do require some aid. The sets with amplifiers, the 37-A which has the transmitter separate as shown in Figure 4, and the 38-A combined unit, Figure 5, are for those either with moderate hearing loss who require greater flexibility of volume range, or with a greater degree of deafness who need the greater power that the amplifier makes available.

The transmitter, which is alike for all three sets, has an attractive geometric design on the face and is finished in a blue-grey crinkle lacquer which blends well with almost any color and fabric, and thus makes it inconspicuous. A clip on the back of the transmitter, similar to those used on fountain pens, makes it easy to attach to the clothing of the wearer.

With the 36-A set, which has no amplifier, the only parts to conceal are the small cylindrical rheostat, which is easily placed in a pocket or inside a woman's clothing, and the battery. A special audiphone battery is available which incorporates contacts to fit the plug on the audiphone. This battery is small and light and



Fig. 5—Although differing from the 37-A audiphone in appearance, the 38-A is exactly like it in equipment, and like it offers a choice of arrangements to the user

thus is readily disposed of on one's person. As an alternative, a battery box, similar in finish to the transmitter, is available which carries three standard flashlight cells. Although slightly larger than the special battery, this battery box is still small enough to fit readily in a pocket.

The case containing amplifier and rheostat that forms part of the 37-A



Fig. 6—Still another alternative arrangement is provided by the 12-A carrying case which assembles the complete 38-A audiphone and battery in a single unit

audiphone has a black bakelite frame with metal sides finished in the same blue-grey crinkle lacquer and is smaller than the usual cigarette case. The smallness of the parts of all these sets is not adequately brought out in the photographs because of the lack of a comparison standard of easily recognized size. Since the diameter of the transmitter is only $2\frac{1}{2}$ inches, however, the small proportions of the other parts may be judged from comparison with it. The case of the 38-A audiphone, which encloses not only the amplifier and rheostat, but the transmitter as well, is only three inches wide and is less than three-

quarters of an inch in thickness.

The carrying case designed for the 38-A audiphone provides a convenient method of carrying it as shown in Figure 6. There is also space in this case for the battery and for the receiver and cord of the set when it is not in use. The audiphone may be used in the case, or, if preferred, it may be removed and placed where desired and the case used only for the battery.

A great deal of thought has been given to the design of even the minor elements of these sets. Whereas twisted cord was used for the earlier models, all the new sets use a very small concentric cord which is easily handled and does not readily kink. The plug for connection to the battery combines the maximum of serviceability with simplicity of design and smallness of size. The rheostat, also, is greatly improved structurally over the earlier forms. The great reduction in size obtained in the new audiphone is brought out by comparing either the 37-A or 38-A with the 6032 type, all of which have about the same amplification and power. The 6032 weighed seven pounds and had a total bulk of about 200 cubic inches. The 38-A audiphone on the other hand, including its dry cells which weigh about a pound, weighs less than a pound and three quarters, and it may be so disposed upon the person of the user that practically nothing is noticeable but the receiver and part of its connecting cord.

Motion Pictures In Relief

THE projection of motion pictures in relief, visible to a group of observers occupying a wide range of positions with respect to the screen, but demanding no special spectacles or other apparatus at the eyes, has been experimentally realized in the Laboratories according to disclosures made before the National Academy of Sciences on April 26, by H. E. Ives. This extension of Dr. Ives' three-dimensional work from still pictures to motion does not employ the conventional celluloid film, but harks back to a toy which the older generation will remember in which a series of pictures are mounted on a revolving wheel. Although the action lasts only a couple of seconds

before it repeats, the spectator sees a true motion picture which has all the depth and roundness of a stereoscope view. The cumbersome wheel is thus far essential because of the high degree of accuracy of position needed to project the pictures on a special screen, and serves to emphasize Dr. Ives' caution that commercial application seems remote.

To understand his latest development, one must first recall that seeing anything stereoscopically means that one sees it with each eye from a different viewpoint. The brain then interprets the slight differences in the two retinal images as meaning that the scene has depth. In the familiar parlor stereoscope, each eye sees a

different photograph, the pair having been taken initially through cameras about three inches apart. If motion pictures are taken in a similar manner, and viewed in such a way that each eye sees only the picture meant for it, there will be an illusion of depth in the picture. So far, the successful methods of doing this have involved the projection of the pictures alternately or in two complementary colors for the two eyes, and either a rotating shutter in front of each

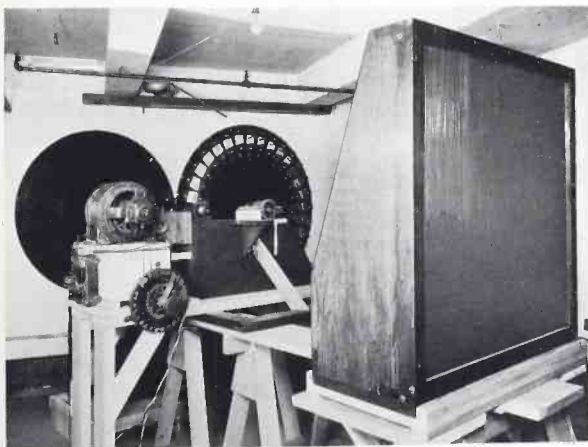

The projector and screen developed by Dr. Ives for showing motion pictures in relief. The wheel carries 32 successive pictures which make up Dr. Ives' brief "movie." Behind it, in the other wheel may be seen the aperture which admits a flash of light as each picture reaches the projection point



The projected relief-picture as viewed from three directions

person or a pair of spectacles, colored red and green, to prevent the eyes seeing any but the appropriate picture. Dr. Ives' developments break away from using anything on or near the beholder; apparatus ends at the screen.

This screen is one of the basic elements of the system. It is made up of vertical celluloid rods, about a quarter-inch wide, and ground to accurate cylindrical curvature at front and rear. The curvature of the front face of each rod is such that rays of light starting from an elemental segment of the rear face are refracted in a narrow parallel beam toward the observer. By impressing successive elements of the picture, in the form of vertical lines, on the back of successive rods, the whole picture is built up for the observer. The picture on each successive element of a rod is refracted in a slightly different direction, so that the two eyes of each observer will see different pictures as built up by two different series of picture elements. Since these two pictures are appropriate for left and right eyes respectively, a stereoscopic image is seen.

To place the picture elements on the rear surfaces of the rods, the latter are given a frosted finish, and a lantern slide is projected on them. Making this slide is, however, a diffi-

cult proposition. Since the ultimate spectators, if there be any considerable number of them, will probably be spread over an angle of thirty degrees on each side of the auditorium, or a total angle of sixty degrees, the original picture has to be made from a series of viewpoints extending over an arc of sixty degrees around the object. One way to do this would be to take a series of pictures, either successively by a single camera, or simultaneously by a group of cameras arranged along the arc of a circle and pointing toward the object at that circle's center. These schemes are, however, cumbersome and expensive. It is desirable to make the pictures with apparatus employing a single photographic exposure. In order to accomplish this, Dr. Ives had recourse to a concave mirror four feet in diameter. Light rays from the object placed at the focus of the mirror would be reflected back to a focus at their origin, were it not for a semi-transparent plane mirror which reflects them off at right angles. At the new focus of the mirror which has been thus established, a group of images of the object are formed, one for every possible viewpoint around the concave mirror. These images are superposed, but it is possible to dis-

entangle them, since the rays which form each one differ in the direction from which they approach the focal plane. The discrimination between images is effected by interposing a glass screen of fine concave grooves. This breaks up each image into a series of lines spaced regularly across a photographic plate. In the space between adjacent strips of one view appears, in order, a strip from each other view, so that if one eye of the observer could see but one family of strips, it would perceive the picture as viewed from one point on the concave mirror as though seen through a grille of this vertical wires. Precisely this effect is achieved by making a lantern slide from the plate and projecting it upon the back of the rod screen described in an earlier paragraph. It will now be understood why each eye of the ultimate beholder sees a different picture, the difference being that of beholding the original scene from two viewpoints a few inches apart. Stereoscope vision is thus attained,

and those who have seen Dr. Ives' laboratory set-up have reported that the effect of depth is well marked.

To make a motion picture, it is necessary to project successively varying pictures on the screen. It will be appreciated that the minute accuracy necessary to register a fine structure of lines exactly upon a series of rods can only be secured by glass plates firmly but adjustably mounted on a rigid moving support. Dr. Ives therefore affixed his series of 32 transparencies to a rotating disc so that each plate could be separately orientated in the optical system. Since the pictures do not halt in the projection gate, it was necessary to flash a light through each as it reached the projection point. All in all, the size and delicacy of the apparatus emphasize Dr. Ives' caution as to the remoteness of commercial application while the lifelike quality of the moving image is convincing evidence that another milestone has been passed in the development of motion pictures in relief.



Acoustical Society Hears New Vertical Recordings

MEMBERS AND GUESTS of the Acoustical Society of America, in number completely filling our Auditorium, heard on May 2 a demonstration of experimental phonograph records made by the vertical-cut method. A paper on the acoustic pick-up

results are hoped for in the very near future. He also mentioned the possibility of the composer creating his music directly in tone rather than writing it in the conventional form on paper. Mr. Stokowski brought out also that the

range in intensities was capable of being greatly extended by electrical amplification, permitting a greater emotional content in music by a more pronounced contrast.

The demonstration of the marked increase in frequency and volume range made possible with the new records was preceded by a brief talk by H. A. Frederick in which he explained the essential features of the new process. Orchestral records which he demonstrated consisted of symphonic music by the Philadelphia Orchestra which was recorded experimentally by Laboratories engineers during recent concerts con-

ducted by Mr. Stokowski in the Academy of Music at Philadelphia. The records were played by courteous permission of the RCA-Victor Corporation which issues the commercial recordings of the Philadelphia Orchestra.

For the benefit of Laboratories members, Mr. Frederick on May 5 repeated his portion of the program given at the Acoustical Society meeting and included additional records which he had made by the vertical-cut process.



Mr. Frederick and Mr. Stokowski with one of the new cellulose acetate records. Behind them is the group of loud speakers

for the Philadelphia Orchestra broadcast was read by J. P. Maxfield of E.R.P.I. and an address, *New Horizons in Music*, was given by Leopold Stokowski, conductor of the Philadelphia Orchestra.

Mr. Stokowski outlined new horizons which the electronic arts opened for music. Among these was the synchronization of voice, reproduced from new records, with the dramatic action on the operatic stage. Experiments of this nature are now under way, he said, and concrete

1921 he has been supervisor of various development groups. Carrier apparatus, rheostats, potentiometers, vacuum tubes, and special products such as hearing aids have successively engaged his attention. He also supervises the development of apparatus for sound picture systems, public address systems, audiometers, and other special equipment such as the artificial larynx.

K. O. THORP graduated from Purdue University in 1924 with the degree of B.S. in Electrical Engineering, and immediately joined the Technical Staff of the Laboratories. Since that time he has been with the Special Products Department. During this period the development and installation of power-line carrier systems has received the greater part of his attention.

W. R. LYON received a B.S. degree from Worcester Polytechnic Institute in 1917 and an E.E. degree in 1928. Except for six months in the Signal Corps and two summer vacations with the Western Union Telegraph Company on inductive

interference problems, he spent the next three years as research graduate assistant in electrical engineering at the University of Illinois—received an M.S. degree in 1920. During this period he carried on experimental work on the magnetic properties of electrolytically refined iron alloys. The four-year period following this he spent as instructor of electrical engineering at the University of Wisconsin. During the next two years he was with the Pennsylvania Power and Light Company in charge of voltage control and power factor correction for the 66 kv. network of the 225,000 kw. power system. During the next two years he was with the Products Protection Corporation, engaged in the development of X-ray sterilizing equipment commercially. This work included the development of methods for hermetically sealing high voltage bakelite terminal insulators to transformers containing nitrogen at 225 pounds per square inch. After a year of power sales engineering, he joined the Laboratories in 1929. Part of his time here has been spent in the design of plate and filament transformers, and part in special transformer studies.



K. O. Thorp



W. R. Lyon

IF THERE WERE ONLY TWO TELEPHONES IN YOUR TOWN



IF THERE were only two telephones in your town the fortunate possessors would probably put them on pedestals in the most prominent places in their homes. Neighbors would flock to see them. Children would clamor to touch them. Bolder ones would lift the receiver to hear the magic voice—then hang up suddenly in bewilderment.

Because the telephone is in millions of homes and offices and is so much a part of our daily lives, it is not regarded with this strange awe. Yet the miracle of it is no less real. The magic of it no less powerful. At any hour of

the day or night you can talk to almost anybody, anywhere—to far countries and to ships at sea.

The first wonder is that you can talk to folks around the corner. The second wonder is that the service is so organized that you can talk to people in far away lands. The third wonder—perhaps the greatest of all—is that telephone service is so inexpensive.

Of all things purchased, there is none that costs so little and brings you so much convenience, security and achievement as the telephone.



AMERICAN TELEPHONE AND TELEGRAPH COMPANY