Bell Laboratories Record

Volume Seven

JUNE, 1929

Number Ten

Picture Transmission in England

By L. A. O'BRIEN

Systems Development Department

GLASGOW, Start!" A second's pause,— "Manchester, Start!" When the operator at the picture transmission station of the *Daily Express* in London hears these signals from his monitoring loud-speaker, he presses the "start" key on the transmitting machine. Instantly, the film cylinders of picture machines in the publishing houses of the London Express Newspaper, Ltd., in London and Manchester, England, and in Glasgow, Scotland, start rotating in synchronism, and a picture passes over a telephone line from London to the other two cities.

Over lines of the British Post Office in England and Scotland there now operates* a Western Electric Type A Picture Transmission System for the London Express Newspaper, Ltd., publishers of the *Daily Express*. The main editorial staff and publishing house of this company are in London; branch publishing houses

are at Manchester and Glasgow. Theirs is a high-class morning newspaper, with a daily circulation of over one and a half millions. Competition in the race for increased circulation is strong. The larger newspapers are national publications, distributing their issues throughout the British Isles. One would suppose that there was little need for electrical transmission of pictures in an area as closely knit as England and Scotland. But such systems are, in fact, of great value to these newspapers.

This value is largely accountable to special British news-geography. London is the news center for the Isles. Throughout the provinces widespread interest in London and international news prompts a demand for London newspapers, and the larger papers are edited with a view toward reaching all parts of the British Isles. Distance makes difficult the problem of distributing papers from London: to ship to some of the more distant points requires from eight to twelve hours.

To avoid this delay, the leading

* F. G. Gardner and M. A. Byers of the Long Lines Department were associated with the writer in installing and testing this system and in training operators for it.

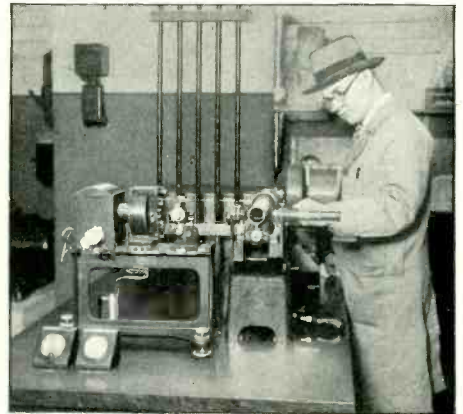
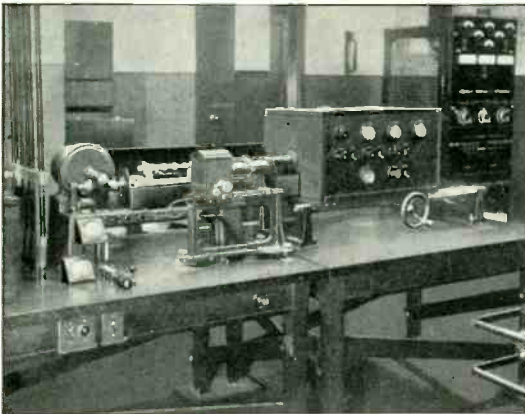

Above, left, apparatus associated with the picture machines at Manchester; right, power switchboard and motor-generator of English manufacture, at the Manchester Station. Below, left, picture-transmitting machine and associated apparatus at Manchester; the posts supporting the tables on the floated cement block appear at the floor level. Right, operating the picture-receiving machine at Manchester

newspapers are establishing branch publishing houses in distributing centers throughout the country. The first-opened branch of the *Daily Express*, at Manchester, serves northern England and Ireland; quite recently a branch to serve Scotland opened in Glasgow. Most of the editorial work, preparation of advertising layouts, and the like, is done in London, and the copy is transmitted to the branch houses over printing telegraph systems. Papers are printed at the branches as nearly like the corresponding London editions as possible, except for local advertising and news.

Most of the leading papers feature a page of photographs and include a great many more in the news columns. The rapid transfer of these photographs between offices is difficult. Before the advent of picture transmission by wire, pictures lagged behind text, and news offices were unable to distribute "late" news photos to their branches in time for corresponding editions.

Wire transmission not only gives photos the speed of news but eliminates the duplication of "morgues": the files of portraits of persons in the public eye. Pictures filed in London can be transmitted to the branch publishing houses whenever their subjects come to the front in the news. The system also expedites the distribution of editorial cartoons based on current news and of layout information for display advertisements received shortly before the time for publication.

The Type A picture-transmission sets furnished the *Daily Express* are of the most recent design, resembling those used by the Bell System in this country. The engineering of the equipment for England was done at

the Laboratories, and the machines and optical apparatus were made in its Engineering Shop. The remainder of the sets, except the power plants, was manufactured at the Philadelphia Instrument Shop of the Western Electric Company; and the sets were assembled and tested there before shipment to England. Storage batteries, power switchboards, motor-generators and the like were manufactured by English companies to meet the Laboratories' specifications, in order that the component parts would conform to the requirements

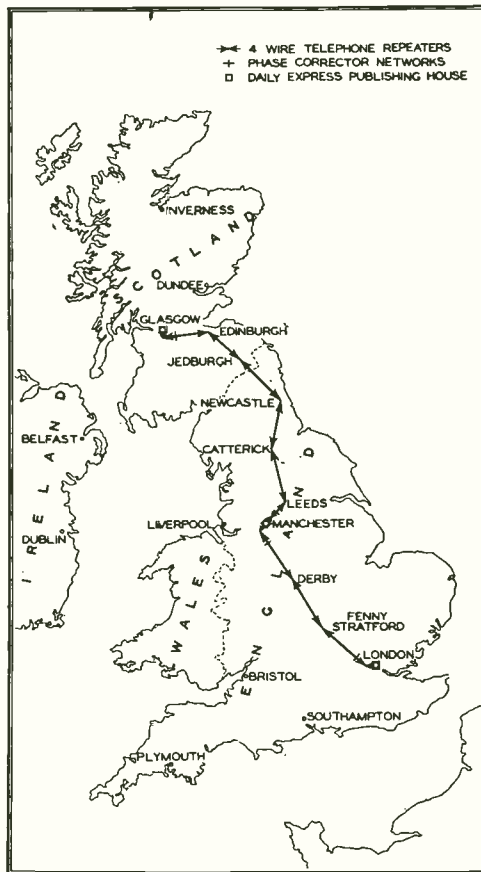

Route, over British Post Office lines, of pictures transmitted electrically by the *Daily Express*

of the English electrical code. To interconnect this terminal apparatus, transmitting facilities were adapted in cooperation with British Post Office engineers.

The picture-transmission stations at the London and Manchester of-



A picture, taken at the investiture of the Archbishop of Canterbury, after being transmitted from London to Manchester

ices are located in the basements of buildings which house large printing presses. It was necessary to take special precautions in installing the sets to prevent the vibration of the buildings by the operation of the presses from disturbing the picture machines and optical systems. Due to the nature of the soil, these buildings do not have foundations of the type in which the walls and column bases support the building; instead, the basement floor is made of concrete six or eight feet thick, and the entire building rests on this large concrete slab. In these buildings vibrations which are caused by the printing

presses in one part of the building are transmitted quite effectively through the basement floor.

To insulate the table-mounted equipment from vibration, it was installed with the table legs resting on short posts, supported on a large concrete block which was "floated" on steel springs. The block, about eighteen feet long, five feet wide and three feet high, rests in a pit in the basement floor, with clearance of about a foot and a half at the sides and ends. Along each side of it, four sets of leaf springs engage the ends of steel beams cast into the block and support its weight. The pit was covered by a false floor with holes for the posts supporting the table legs. Building vibrations are absorbed by the springs supporting the block, and the picture machines are undisturbed.

The Type A system transmits five-by-seven inch pictures at a maximum rate of about eight per hour. At present the *Daily Express* leases the picture line circuit from the British Post Office for the period from 6.00 P.M. to 10.00 P.M. each day, and transmits an average of about fifteen and sometimes as many as twenty-four, pictures daily. When two or three small pictures can be copied photographically on one five-by-seven inch film, they are transmitted together. For economy and uniformity the pictures are retouched before transmission; retouching of received pictures is confined to those which are enlarged photographically for publication at greater size than that transmitted. Identification is secured by serial numbers marked on the original pictures before the transmitting films are prepared; the titles of the pictures are telegraphed. A letter prefixed to each serial number designates the publish-

ing house from which the picture was transmitted.

It is obvious that, if the photographic operations required in preparing the films for the transmitting machines, developing the films from the receiving machines, and enlarging the received pictures are not done correctly, the received pictures will not be of the best quality. Since a considerable volume of photographic work is involved, the processes must be systematized and a routine for handling the pictures efficiently must be established. At the *Daily Express* stations, a large sink with suitable tanks for the developing solutions and washing baths was provided in the operating rooms. While pictures are being received, the rooms are illuminated with "safe light" lamps, as photographic darkrooms are. The received pictures are developed by the station operators, following a standardized process. The operators can thus watch the pictures received and note any markings indicating faults in transmission, so that operating troubles can be detected before they become serious.

The remaining photographic operations were done for a while in the art departments. These groups had photographic facilities as necessities to their

work before the picture transmission system was contemplated. But the increase in photographic work occasioned by the electrical transmission of pictures, and the importance of doing this work according to processes best suited to the Type A system, warranted the use of separate photographic equipment with the system. A camera room and developing room with carefully selected apparatus were recently provided at the London station for preparing the transmitting films and developing the



Another transmitted picture of the investiture of the Archbishop of Canterbury (crop markings appear at top and left)

received pictures. One photographer will devote himself entirely to this work. This specialized equipment and personnel will make the average picture as good in quality as only the best formerly were.

The initial installations of Type A equipment for the *Daily Express* comprised a two-way station at Manchester, a transmitting set at London, and a receiving set at Glasgow. Re-

sults with this equipment have been so gratifying that the *Daily Express* has ordered additional apparatus sufficient to provide for two-way operation at the London and Glasgow stations. The utility of picture transmission in Great Britain, the enthusiasm of newspaper organizations for its speed and quality, and the interest of the British Post Office in its growth, augur still wider future use.



Radio and Commercial Aviation

The rapid development of civil aviation has brought sharply to the forefront the vital importance of adequate means of communication between ground and air. Such communication is not only indispensable in directing the commercial operation of aircraft, but is particularly important as a means to the safety of the craft and its passengers, particularly during heavy weather.

The Bell System fully recognizes these needs and the obligation thereby imposed upon it for the development of proper methods and apparatus for these purposes; and it has been conducting for some time in the Bell Telephone Laboratories extensive and intensive research along these lines. It expects within a comparatively short time to be able to make available to the aviation industry through the Western Electric Company apparatus of a superior type to meet these needs.

Radio is obviously the means of communicating with aircraft in flight, and it has been found that radio telephony is the most effective way of carrying on such communication. The establishment of a connecting link by radio telephony between the aircraft in flight and the ground, and the use of wire facilities which the Bell System is in position to supply, make available the proper combination of radio and wires to meet the varied communication requirements of the aviation industry.

Toll-Line Signalling

By R. S. WILBUR

Systems Development Department

SIGNALLING between switchboards at each end of toll lines is necessary so that the attention of the distant operator can be attracted when a call is to be set up and so that a signal to take down the connection may be received when the call is completed. As toll circuits in the Bell System were used at first for transmitting nothing but telephone conversations and their supervisory signals, there were no strict limitations as to the type of signalling that could be used. Twenty-cycle current is used for ringing the bells of local subscribers and it was convenient, therefore, to use the same source of power for toll-line signalling because the toll-line operators had not only to signal the distant operator, but to call the local subscriber after the call had been established.

Conditions soon changed, however. Since long toll lines are expensive, it is desirable to make the maximum possible use of each pair of wires. Toll circuits were rapidly equipped, therefore, so that simultaneous telephone and telegraph messages could be sent over the same circuit. In addition the usefulness of each pair of wires has recently been increased by the use of carrier currents for transmitting many telephone and telegraph messages over a single pair of wires at the same time. The length of circuit over which messages are successfully transmitted has also been greatly increased by the use of telephone repeaters. As the equipment that has been associated with the line to obtain these additional facilities and the increased range, however, will not transmit twenty-cycle current,

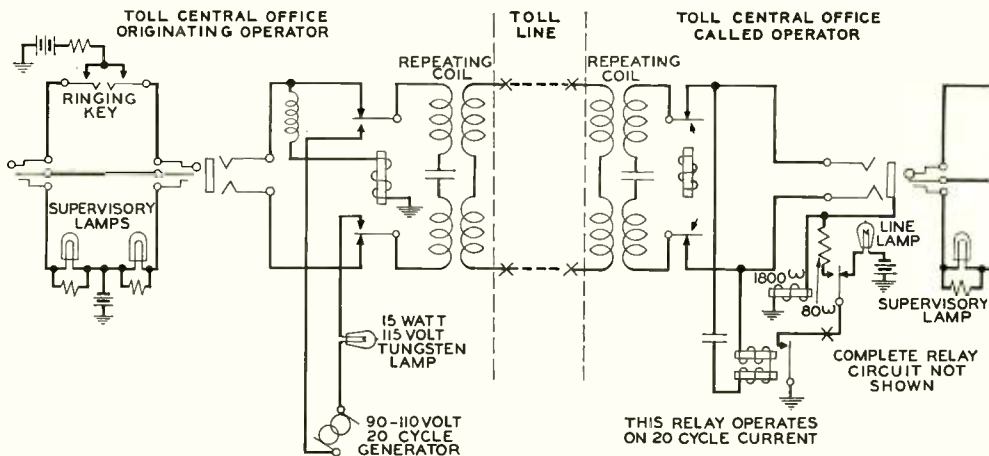

Fig. 1—Toll lines without composite sets or repeaters use twenty cycles for signalling

changes had to be made in the methods of toll-line signalling.

To send a twenty-cycle signal over a toll line used for transmitting only telephone conversations, the operator inserts one plug of a cord circuit

by the composite set, which makes it impossible to signal over even a very short line with current of this frequency.

Telegraph receiving equipment is adjusted to operate on currents with

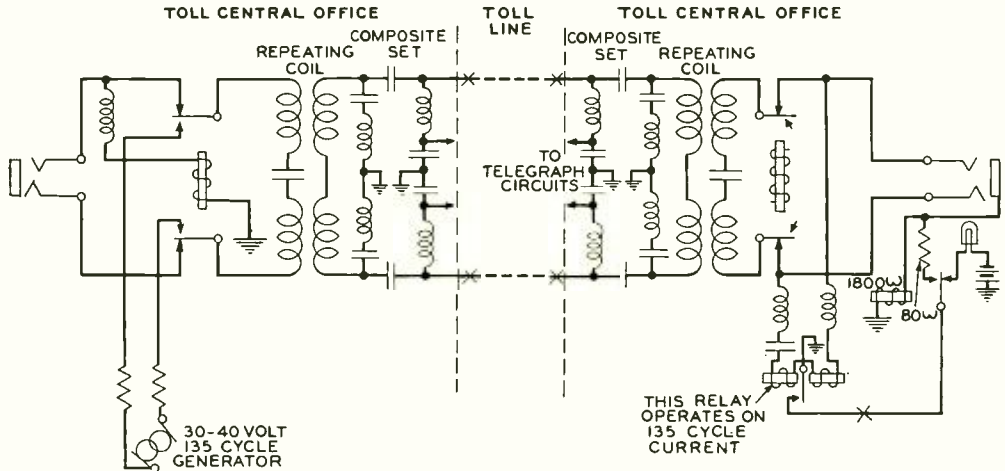

Fig. 2—The use of a composite set makes it desirable to select a frequency for signalling that belongs neither to the telegraph nor the voice range

into the jack of the line and operates the ringing key. This connects twenty-cycle current to the toll line and causes a relay in the distant office to operate, lighting a "line" lamp in front of the operator. The line lamp is extinguished when the called operator inserts the plug of a cord circuit into the line jack. After a connection is completed between the toll line and a subscriber, signals from either office are received at the other on a supervisory lamp associated with the cord circuit.

Means for sending and receiving telephone and telegraph messages simultaneously are provided by the composite set, which separates the voice and telegraph currents at the terminals of the line. A high series impedance and a low shunt impedance, for currents with a frequency of the order of twenty cycles, is introduced

frequencies of about fifteen cycles while the lower frequencies transmitted by the voice are of the order of two hundred cycles. A frequency of 135 cycles, about half way between telegraph and voice, was chosen for signalling in order to avoid interference with the telegraph equipment by the signalling current, or with the signalling circuit by the voice current.

Although twenty cycles is suitable for signalling over toll lines not containing composite sets, and 135 cycles for composited toll lines, neither is entirely satisfactory for use on lines using a number of repeaters. Repeaters will not transmit twenty-cycle current, and the gain through the repeater at 135 cycles is approximately six db less than that obtained for the voice currents. In spite of this fact these frequencies were used for signalling when telephone repeaters first

came into use, by relaying the signalling current at each repeater station when necessary. This is accomplished by receiving the signal current in a circuit similar to the terminal equipment in the central office and sending out new twenty- or 135-cycle current at each relay station. As the length of circuits increased, however, and more telephone repeaters were connected into the circuit, the time intervals required to relay the signalling current at each repeater point became prohibitive, and new methods of signalling had to be developed.

Telephone repeatered circuits are generally arranged to transmit satisfactorily voice currents which have frequencies between 200 and 3000 cycles. To signal from terminal to terminal of lines which have several

a high impedance to avoid excessive transmission losses to voice currents having frequencies in the neighborhood of the signalling frequency. The receiving equipment must be designed also so that it will not falsely operate on voice currents having the same frequency as the signalling current.

One thousand cycles, about the middle of the voice range, has been selected as suitable for signalling, and Figure 3 shows a simplified circuit of the sending and receiving equipment that is used.

The signalling current for this system is obtained from a generator which is designed to furnish 1000 cycles modulated at a twenty-cycle rate. The receiving circuit amplifies the modulated current received from the line and demodulates it to operate

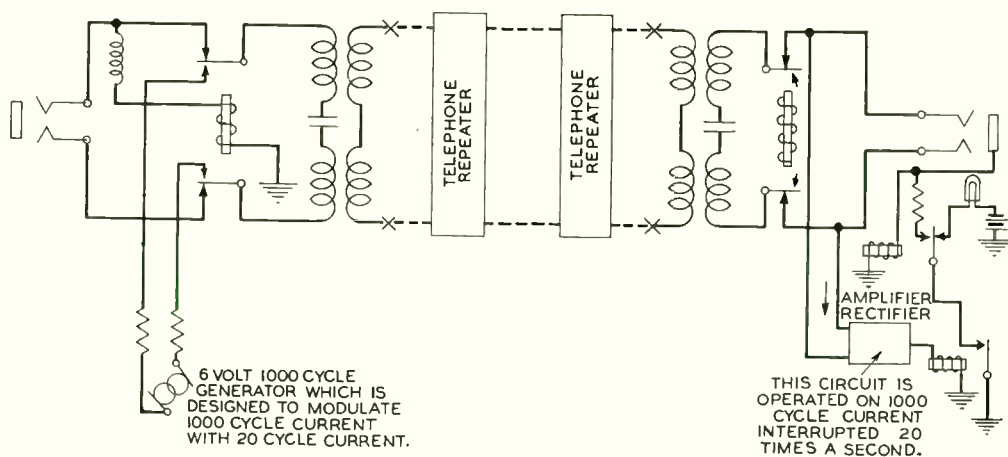

Fig. 3—Telephone repeaters pass only the frequencies of the voice range so that on repeatered lines one thousand cycles is desirable for signalling

telephone repeaters operating in tandem, the frequency of the signalling current must be within this band of frequencies if the use of relaying equipment at intermediate points is to be avoided. In order to use any of these frequencies, however, the equipment in the receiving circuit, which is connected across the line, must be of

a twenty-cycle relay in the plate circuit of a rectifier tube. The transmission loss to voice currents is negligible as the impedance of the input circuit connected across the line is about 20,000 ohms.

False operations of the ringer on voice currents, line noises, or the tones used in the plant for transmit-

ting various traffic indications are practically eliminated by a scheme of double tuning. The input circuit is sharply tuned to 1000 cycles so that only frequencies closely approximating this enter, and after the demodulation there is a second circuit sharply tuned to twenty cycles. As a result only approximately one thousand cycles, modulated at about a twenty-cycle rate, will operate the signalling relays. A further precaution is taken by introducing a time element, so that the current flow must last for a defi-

nite time to actuate the signal relays.

The signalling range of this circuit is satisfactory over any toll line which has a transmission equivalent of 20 db or less. Sending current is limited to .001 ampere to prevent objectionable noise in adjacent circuits.

This method is being used extensively in the Bell System for signalling over cable and open-wire circuits of length greater than about 100 or 150 miles. Among such circuits are the New York-Chicago, Chicago-San Francisco, and New York-Havana.



Rights to Subscribe for Debentures

Stockholders of the American Telephone and Telegraph Company have received warrants entitling them to subscribe at par for one \$100 bond of that company for each six shares of stock held by them on May 10, 1929. These bonds pay 4½ per cent interest. They may be converted after January 1, 1930, into common stock of the company. Between that date and January 1, 1931, each \$100 of bonds entitles the holder to receive one share of stock on surrender of the bond and payment of \$80 in cash. During 1931 and 1932, the cash payment is \$90; in the years from 1933 to 1937, inclusive, it is \$100. The bonds will be paid at their face value on July 1, 1939.

Rights must be exercised on or before July 1 next, otherwise they become valueless. The Financial Department of Bell Telephone Laboratories will be glad to give information, and to assist in the purchase and sale of rights.

Panel Fundamental Circuit

By R. E. COLLIS
Systems Development Department

AMONG the many suggestive words and phrases which have been adopted into the language of the telephone engineer, none, perhaps is more significant than the phrase "fundamental circuit" as used in the panel type of the dial system. As may be inferred from the phrase itself, the circuit thus designated is vitally related to the mechanical and electrical design of the system; it is the signalling circuit by which the sender controls the movement of the selectors which make the various connections required to obtain the number called. The "fundamental circuit" is thus a pulsing circuit, but its method of pulsing, known as the revertive, is decidedly different from the better known direct method.

Both direct and revertive methods of pulsing have their field of practical application governed primarily by the means employed for moving the registers or selectors. The direct method is used in connection with magnetically driven apparatus; apparatus which moves one step and then stops for each pulse received. A subscriber's dialing circuit, illustrated in Figure 1, is of this type. Here the pulses are originated by the opening and closing of the dial contacts at a subscriber's station. The pulses release and reoperate the "L" relay in the sender at the central office, which in turn closes and opens the back contact of the relay and causes a series

of register relays to operate. The end of a train of pulses is indicated by a closure of the circuit longer than that between pulses. This long closure allows slow-operating apparatus to function, which transfers the back contact of the "L" relay to another series of register relays.

In contrast with the direct, the revertive method of pulsing is used with power-driven selectors; selectors which, when set in motion at the beginning of a selection, continue in motion until the selection has been completed. With the revertive method, each selector while in motion sends pulses to the sending end where they are registered and acted upon to stop the selector at the required position, while with the direct method the selector receives pulses from the sending end, each pulse moving it one step.

In the panel system the power drive consists of a continuously rotating roll with a cork covering to which the selector elevators are connected by friction clutches operated magnetically during the process of selection. Figure 2 shows the elements of the panel fundamental circuit in conjunction with a power driven elevator of the selector. It will be assumed that the number called requires that the elevator of the incoming selector circuit be raised to occupy position No. 2 of the several possible positions shown in the figure.

When the sender, located in the

calling subscriber's central office, has recorded the number dialed, it prepares the circuit to the counting relays and closes the STP relay to the trunk or fundamental circuit. Relays L and STP then operate in series, the former operating the clutch magnet which forces the rack against the cork roll by means of the bronze roller on the armature of the magnet. This causes the selector elevator to move upward. Meanwhile, since the STP relay has operated, counting relay No. 2 operates.

The elevator, moving upward, brings the commutator brush into contact with segment No. 0 of the commutator, thus closing ground to the tip side of the trunk. Since the ring side of the trunk is already grounded, the tip and ring are short-circuited, and STP releases. This is a signal

to the sender, informing it that the elevator has reached segment No. 0. The sender records this signal by the operation of counting relay 2' from ground on the front contact of relay 2. This transfers the lead from the front contact of STP to the winding of the No. 1 counting relay through the back contact on 1'. The L relay in the selector circuit is held operated during this time from ground on the No. 0 commutator segment.

The advance of the elevator now causes the commutator brush to break contact with the No. 0 segment, re-establishing current in the fundamental circuit and operating STP which, in turn, operates counting relay 1.

The elevator next makes and breaks contact with No. 1 commutator segment. This releases and re-operates the STP relay, which is a signal to the sender that the commutator has reached position No. 1. The sender records this fact by the operation of relays 1' and 0.

When the commutator brush makes contact with segment No. 2 of the commutator, relay STP releases again, this time allowing relay BO to operate, which opens the fundamental circuit. Relay L is, as before, held operated by the ground on the commutator segment so that the elevator continues to advance until the brush breaks contact with segment No. 2. When this occurs relay L releases, disengaging the clutch, and stopping the upward movement of the elevator which is prevented from dropping back by a pawl dropping into a slot in the rack.

One important requirement of the fundamental circuit is fast operation. Time required to set up a connection not only delays the subscriber but limits the traffic which a given amount

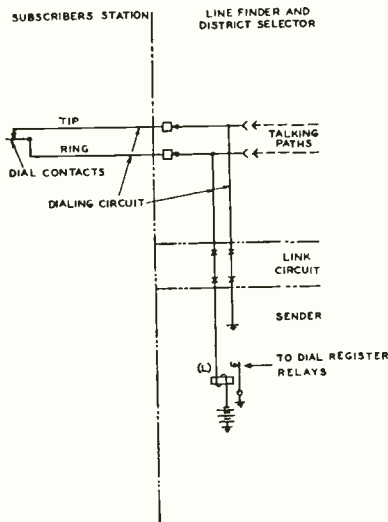

Fig. 1—With the direct method, pulses are originated at the sending end and operate some form of register at the receiving end of the circuit

of equipment can handle. It is therefore essential that the speed of all the apparatus be as fast as is possible, consistent with reliable operation. The maximum speed of pulsing of the revertive circuit is approximately thirty-two pulses per second. To follow this speed properly the STP relay and the counting relays are designed for fast operation. The latter, of the No. 208 type, are especially fast; in fact they are among the fastest in the telephone system.*

The STP relay must function over trunk circuits of various lengths and resistances, which means that its operating and releasing times are subject to considerable variation due to the varying capacity and resistance of the loop. The relay which has been found to meet best the exacting requirements of these conditions is one of the No. 207 type.

The design of the L relay at the receiving end of the fundamental circuit is also of great importance because its inductance and resistance affect decidedly the operation of the STP relay, and also because its releasing time affects the stopping of the selector at the required position. When the commutator brush breaks contact with a segment, the current flowing in the winding of L is suddenly reduced from that determined by the resistance of the relay alone,

to that determined by the resistance of the trunk circuit including the STP relay. This energy, stored in the winding of the L relay, discharges through the trunk circuit, and is very effective in securing fast operation of the STP relay.

At the end of the selection—when the fundamental circuit has been opened at the BO relay and the com-

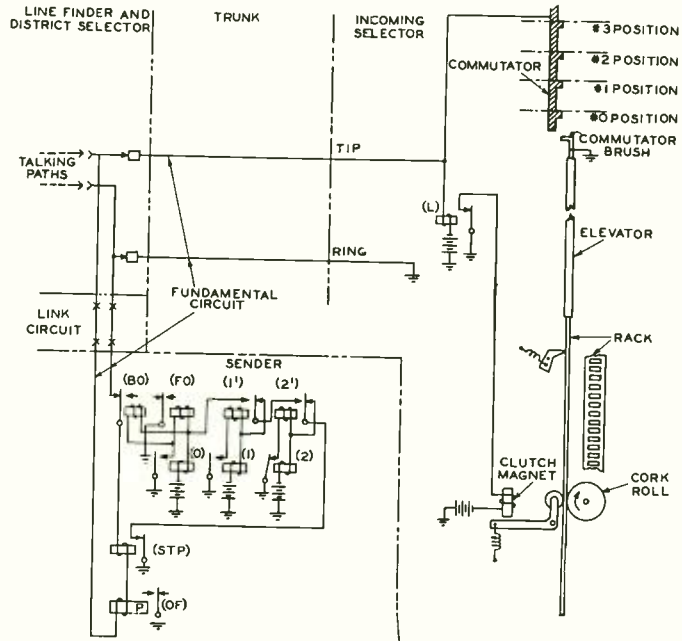

Fig. 2—With the revertive method, pulses are originated at the receiving end and actuate registers or relays at the sending end of the circuit

mutator brush breaks contact with the segment—the L relay must release quickly to prevent overstepping of the elevator. When selections are being made over short trunk loops, L releases practically on open circuit, which insures a quick release. As the length of the trunk loop is increased, however, the mutual and grounded capacity of the cable act to cause the L relay to be slow in releasing. A length of cable is finally reached which causes the L relay to

* *Critical Relays of the Telephone System.* BELL LABORATORIES RECORD, October, 1928, p. 51.

release so slowly that, with the simple circuit arrangement shown in Figure 2, there is danger of the elevator overstepping.

One of the methods employed to overcome this condition is shown in Figure 3. Here the L relay controls directly, not the clutch magnet, but one winding of an auxiliary relay T which in turn controls the clutch. A secondary winding on the T relay is connected to an auxiliary "centering" commutator whose segments also are grounded by a brush as the elevator advances. Due to the position of the segments of the pulsing commutator

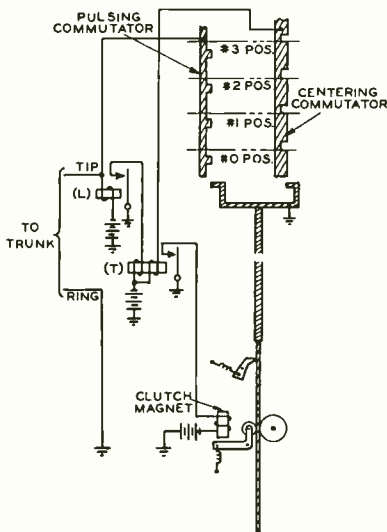

Fig. 3—To avoid the effect of long loops on the action of the L relay, a second relay has recently been employed to control the action of the clutch

relative to those of the centering commutator the ground pulses are transmitted earlier relative to the stopping positions, than when only a single commutator is used. When relay L releases after the last pulse, relay T is still held operated over its secondary winding to commutator C,

until the proper position is reached. The releasing time of the T relay can be made very small regardless of the length of the cable loop, and relay L may be allowed to release as slowly as necessary, the only requirement being that it be released by the time the brush of the centering commutator leaves the segment.

Although the auxiliary relay arrangement just described is used in the latest type of panel selector circuits, full advantage can not always be taken of the centering commutator arrangement because of limited space on the commutator bar. For this reason a fast-releasing L relay is still essential. The type which best meets this condition and at the same time furnishes a high inductive "kick" for the STP relay is the N type relay. Since this relay is rather expensive a method has been devised to use the L relay of one circuit to control the positioning of two selectors, such as the incoming and the final.

This arrangement is shown in Figure 4, which represents the fundamental circuit of the latest type of panel incoming and final selectors when in position for final selections. With this arrangement the relay designated C in the final circuit performs the same function for the final selector that is performed by the T relay for the incoming circuit shown in Figure 3. The L relay acts as a line relay for both incoming and final selectors.

Besides those for controlling selections, the panel fundamental circuit must also transmit signals for other purposes. After the elevator of the incoming selector has been raised to the proper position in the selector bank, it finds itself at the lowest terminal of a group, any of which except

the last may be used to complete the connection. Some of these terminals, however, may already be in use by other selectors. It is therefore necessary for the incoming selector to pick out for itself an idle terminal from among those available in this particular group. This process, called "trunk hunting," has already been described in BELL LABORATORIES RECORD.*

If all of the trunks in the group are already busy the elevator of the incoming selector will come to rest on the last terminal of the group, called the "overflow" terminal. In such an event the incoming selector signals the sender that the "overflow" condition exists by returning "reverse battery," that is, the condition of battery on the tip, and ground on the ring is reversed. The OF relay in the sender, Figure 2, which is in the fundamental circuit during all selections, is a polarized relay and is so poled in the circuit that it operates only when a reverse battery condition exists. When the OF relay operates, the sender, if selections have not been completed, recognizes that overflow condition exists

* September, 1928, p. 5.

and immediately causes the district selector circuit to return the distinctive "overflow" tone to the calling subscriber, which is equivalent to "all

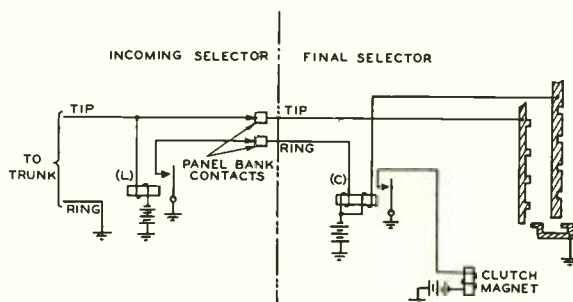

Fig. 4—A recent development uses only one L relay for both the incoming and final selectors

trunks busy" of the manual operator.

After the sender has completed final selections, it awaits the signal from the incoming circuit that both it and the final circuit are ready for the talking connection to be established. The incoming selector produces this signal also by returning reverse battery to the sender. The sender, since final selections have been completed, does not interpret this signal as an "overflow" but proceeds to cause the district selector to cut through the talking circuit. Having finished its task, the sender frees itself from this call and awaits another call.

All-Relay Register Circuit

By R. RAYMOND

Systems Development Department

IN dial systems connection with a subscriber is obtained by a series of selections, and the manner in which this selection is controlled is one of the features that distinguish the panel from the step-by-step method. With the latter the selection directly follows the dialing; the first digit dialed causes the first selection;

the second, the second selection; and so on. In the panel system, on the other hand, the complete number is recorded in the sender which subsequently controls the selection according to the number registered in it. As an inherent part of the sender there is thus a register circuit.

Formerly rotating switches, known as 200-type selectors, were used for this purpose. One of them responded to each dialing operation—moving around in step with the dial to a terminal corresponding to the digit selected. When the decoder* sender was developed, however, a new register circuit consisting entirely of relays was incorporated in it. By this change less space is required, and certain operating improvements are made. Maintenance is simplified and greater variation in the action of the subscriber's dial is possible without causing trouble.

The "all-relay register circuit," as the new development is called, consists of two sets of relays; one set counts the impulses of each dialing operation, and the other records each of the seven or eight digits of the number dialed. The position of these relays in the sender cabinet is shown in Figure 2. In the lower right hand corner are six pairs of counting relays which are explained later; and at the left are eight rows of registering relays. When a digit is dialed the

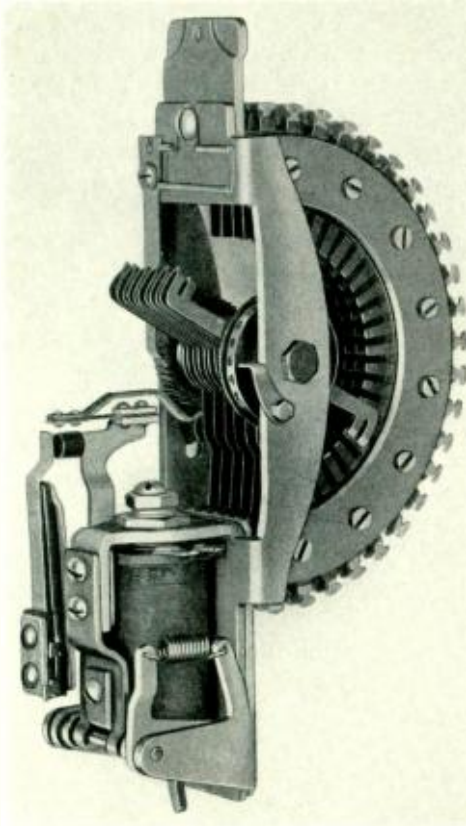

Fig. 1—The 200-type selector was used for recording the digits dialed with the early senders

* BELL LABORATORIES RECORD, Vol. VI, No. 3, pp. 273-277, May, 1928.

relays of the first set count the number of impulses, and when the dial has returned to the normal position, the number counted is registered by the relays of the second set. The first group of relays is then returned to normal position, where it is ready to count the impulses of the second dialing operation.

The set of counting relays consists of twelve relays arranged in two rows of six each; and working with them is a group of six auxiliary relays. These are all shown in Figure 3. In the extreme upper right hand corner is indicated the dial contact of the subscriber's set which is closed at all times except for the duration of the indi-

vidual pulses as the dial returns to normal after having been pulled around. Thus, the line relay (L) is held operated by the dial contact all the time the receiver is off the hook and the sender is connected to the line, except when the contact is momentarily opened to transmit a pulse.

Operation of the line relay operates relay L₁; operation of L₁ operates SR; and operation of SR operates SR₁—the front or make contact of each relay closing a circuit to energize the next one. When the line relay releases on a dial break, L₁ releases also. Relay SR, however, has a heavy block of copper on its core which makes it very sluggish in action, so that it does not release on the momentary dial breaks but remains continuously operated, and consequently SR₁ remains operated also.

The function of these last two relays is to recognize that the sender is attached to the line and that the receiver is still off the hook. The springs and wiring of the six relays in the top row are not all shown in the diagram as they have special functions and details of operation which do not

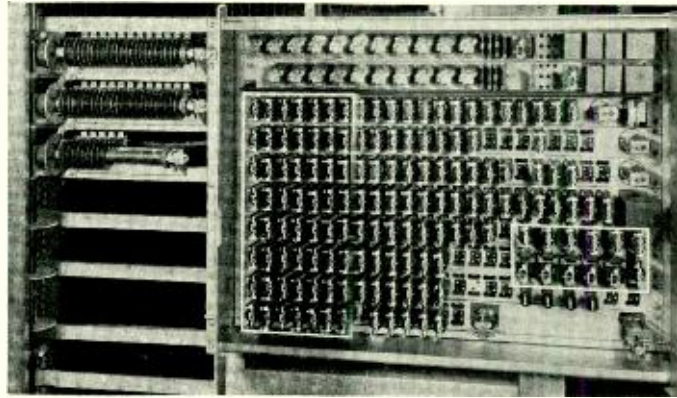

Fig. 2—Eight groups of register relays and the twelve counting relays are indicated on this panel sender

require any discussion at this time.

When relays L and L₁ release on the first dial break, the register advance relay RA is energized by a circuit through the back or break contact of relay L₁. It is a slow release relay like SR, and after being operated by the first dial break, remains operated throughout the subsequent momentary closures and breaks of the dial and is released when the dial contact closes at the end of the set of pulses. Relay RA₁ operates in reverse order, releasing while the dial is returning from a pull and remaining operated between dialing operations.

The counting relays proper, occupying the two lower rows of Figure 3, are arranged in pairs numbered P₁ and P₁' to P₆ and P₆' inclusive. Leading from these relays to the

group of register relays are six leads marked RA, 1, 2, 4, 5, and Z. How these act on the register relays will be described a little later; for the present it is sufficient to know that a ground on any of the numbered leads — 1, 2, 4, and 5 — indicates that that number has been dialed. A ground on two of them such as 1 and 2 indicates that 3 has been dialed, or a ground on 1, 2, and 5 indicates that 8 has been dialed. A ground on Z indicates that 0, the last digit, has been dialed. At the end of each dialing operation a ground is placed on lead RA which locks up the number dialed with the preceding operation, and brings into action another set of register relays to record the next digit dialed.

Relay RA1 releases at the first open of the dial contact and, due to slow release feature of RA, remains released during the subsequent makes and breaks of the dial switch until a short interval after the last make al-

lows RA to release and RA1 to operate. During transmission of the dialing pulses, therefore, a ground is placed on the lead running from the back contact of RA1 to the counting relays. At each opening of the dial contact a ground is momentarily placed, through the back contact of L, to another lead running to counting relays. It is the action of these two grounds, one retained and the other pulsing with the dial, that causes the counting relays to act.

The first momentary ground from L brings in P1 and on the removal of this ground, P1' is brought in through the ground from RA1. This action continues with successive pulses, bringing in next P2, and P2', followed by P3 and P3', P4 and P4', P5 and P5', and then starting over again with P1 and P1' which had remained operated only till P2' had been closed. Just which relays are operated and which released, at each make or break of the dial contact, is

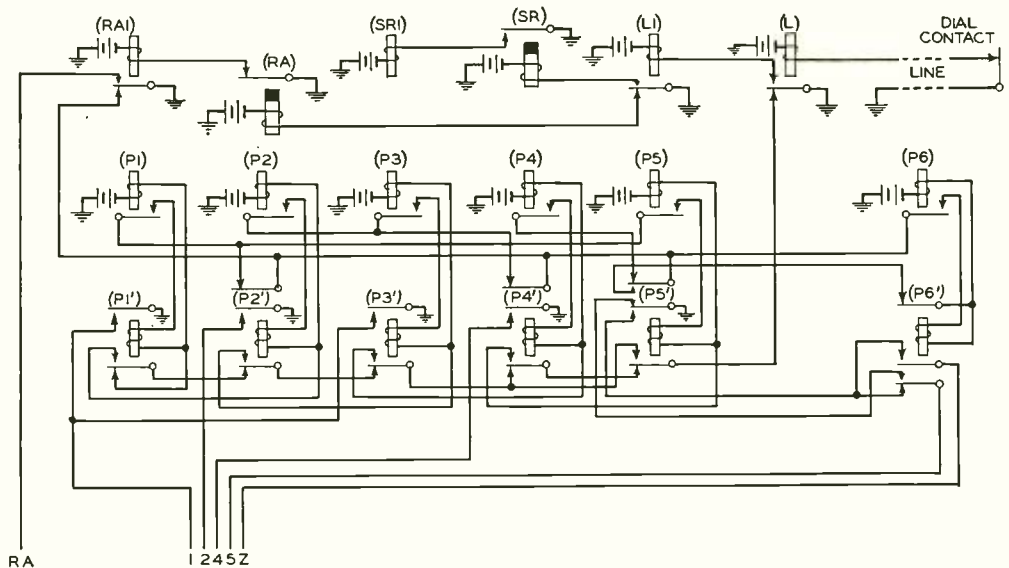

Fig. 3—Counting Relays. Instead of using ten relays to count the number of pulses sent out by the subscriber's dial, only six are used; the five used to count the first five digits also count the last five—the sixth relay being operated to distinguish between 1 and 6, 2 and 7, and so forth

shown on Figure 4. Here, near the top, is represented the line current interrupted the full ten times by the dial contact. Just above, for each make and break, is marked the relays that are operated, and just below, those that are released. It will be

held operated a ground exists on lead 2 also, so that both 1 and 2 are grounded which records the number 3 on the register relays. The duration of the grounds on the five leads to the registering relays is shown at the bottom of Figure 4.

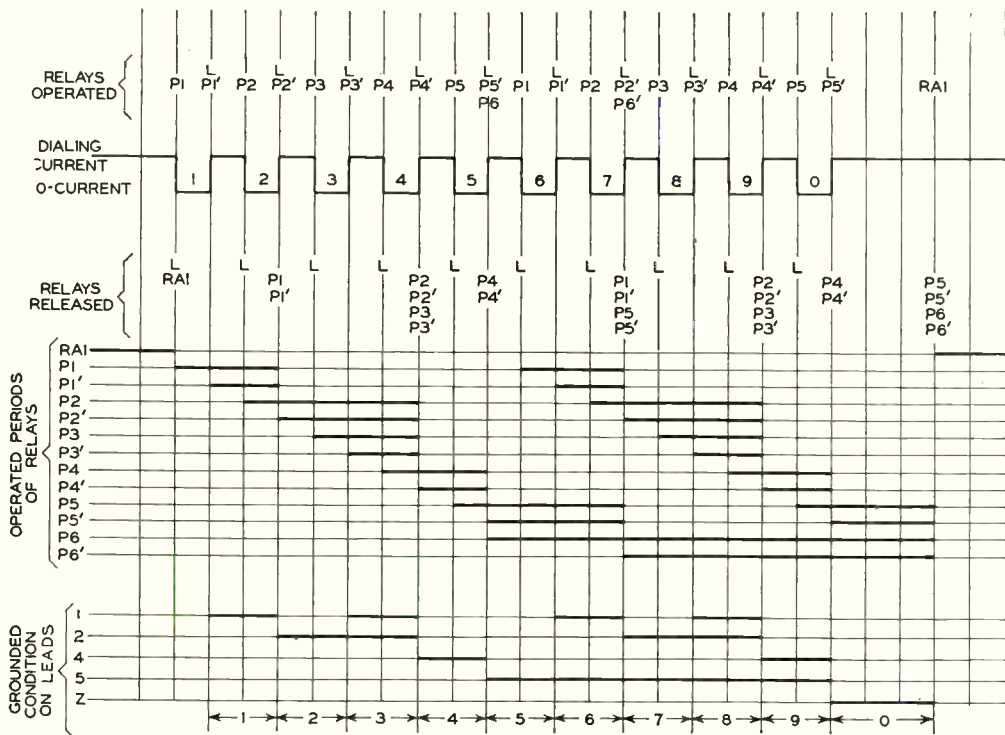

Fig. 4—Operation of the various relays and the length of time they remain operated in relation to the dial pulses are indicated above

noted for example that at each dial opening L is released and at each closing it is operated. Below this is a group of lines—one for each relay—indicating the duration of operation of each.

The completion of the first pulse brings in P1' and through it places ground on lead 1. The second pulse releases P1' but brings in P2' which puts ground on lead 2. The third pulse brings in P3', placing a ground on lead 1 again, and as P2' is still

Completion of the fourth pulse operates P4', placing a ground on lead 4 and releasing relays P2' and P3'. Completion of the fifth pulse brings in P5' and through its contacts, and through a contact of P6' after P5' has released, ground is left on lead 5 until the end of the tenth pulse. The sixth pulse brings in P1' again and the counting proceeds as for the first five pulses except that lead 5 is grounded in addition. Completion of the tenth pulse places a ground on

lead Z and removes the ground from all the others. Shortly after the dial has returned to its normal position RA1 is operated which releases all the counting relays that are operated, locks up the number dialed on one of the groups of register relays, and prepares the next group to receive the following digit.

Two of the eight groups of register relays are shown in Figure 5, the other six groups are arranged in the same manner and to form a complete diagram would be drawn in below the groups shown.

After the receiver has been lifted from the hook and the sender has been selected, the C relay of the first

are placed on one or more of the five connecting leads to operate corresponding relays in the register group. The relays remain operated as long as ground remains on their leads so that the ones operated for any digit dialed are indicated by the heavy lines on the bottom section of Figure 4.

When the dial has returned to normal, and after the short time required for the slow-release relay RA to release, a ground is placed on the lead RA through the front contact of relay RA1. Lead RA passes through a series of back contacts on the C relays of all register groups but the first, through the winding of the AL relay, to battery through whatever

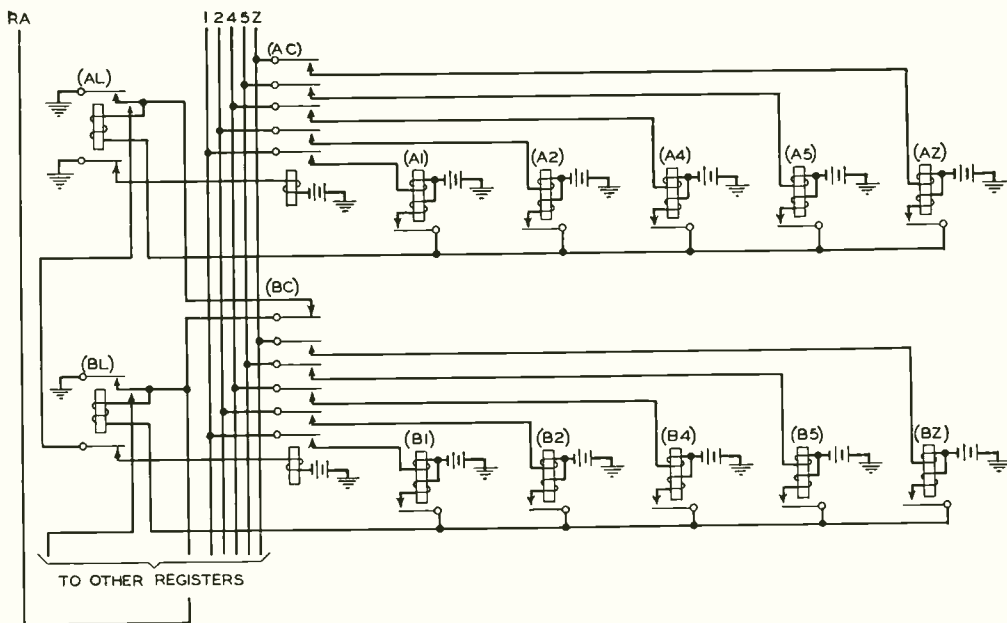

Fig. 5—The register relays are arranged in eight groups—one for each digit dialed

or "A" group (Relay AC) operates and connects the five leads—1, 2, 4, 5, and Z—from the counting relays to the windings of five corresponding relays of the first group of register relays. As the pulses from the first dialing operation come in, grounds

relays in the first group are operated. This holds these relays operated and at the same time operates AL. The operation of AL releases AC, thereby disconnecting the first group of register relays from the five counting leads, and, through the back con-

tact of BL, operates BC—connecting relays of the second group to the counting leads. The operation of BC also disconnects lead RA from relay AL which is now held in from a ground through one of its own front contacts.

In a similar manner the second digit dialed is recorded on the second group of register relays, the third digit on the third group, and so on for the complete eight digits. When dialing is completed the number is recorded by the eight groups of register relays, one digit by each group. The additional contacts on these reg-

ister relays, required to control the selection of the number called, have been omitted for the sake of simplicity.

Silently and with machine-like precision the counting relays count the pulses from each dial operation, and when the dial returns to normal position the register relays, with equal silence and precision, record consecutively the digits dialed. The mechanical movements of the 200-type selectors, formerly used for registering, have been done away with, and smaller, quieter, more easily maintained equipment has been substituted.

A Slide Rule for Vector Calculations

By M. K. KRUGER

Apparatus Development Department

ELECTRICAL networks such as filters, attenuation equalizers, transformers, balancing networks and speech delay circuits are used in large numbers in many parts of the telephone plant. For example, filters separate the voice and carrier frequency currents at the ends of each toll circuit on which carrier currents are superposed, and attenuation equalizers are used on broadcasting circuits to give sufficiently uniform transmission over the wide range of frequencies necessary for high grade radio programs. Transformers are extensively used at junction points in circuits where the impedances are unequal.

These networks are made up of resistances, inductances and capacities and in some cases the number of elements reaches a hundred or more. In order to ascertain their performance accurately, a large amount of mathematical computation is involved. Any

considerations simplifying the work of computation are therefore deserving of serious thought, particularly when a considerable saving in time is thereby effected.

In most cases the solution of electrical networks involving alternating voltages can be simplified by expressing the voltages and currents as vectors, to show their magnitudes and the phase relationships between them. The voltages and currents are represented in polar form, with magnitude and direction given, or in rectangular form, by complex numbers giving the real and imaginary components. Partly offsetting the advantages of this notation, however, is the work frequently involved in solving the equations, particularly the routine operations in transferring them between the polar and rectangular forms.

If a complex quantity is expressed in polar form, its length r and the angle θ which it makes with the hori-

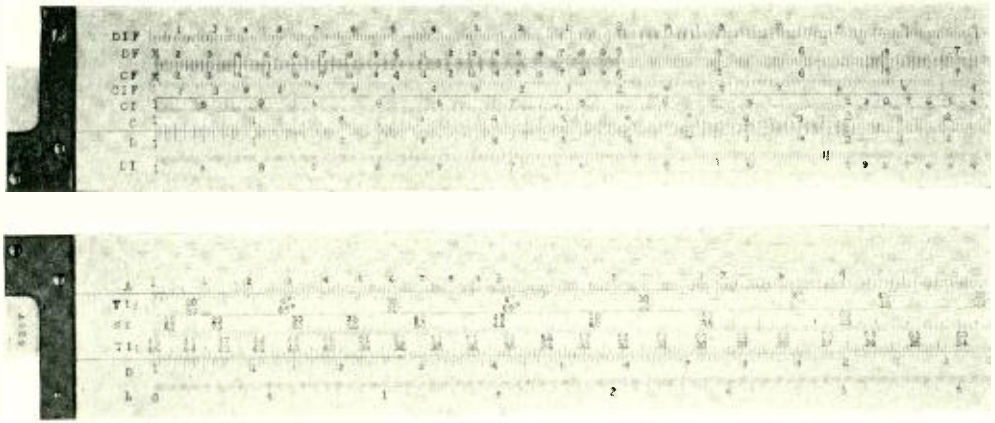

Fig. 1—Above, the front of the new rule, with the added scales, DIF and DI, on the upper and lower stationary sections; below, reverse side, showing the inverted trigonometric scales on the slide

zontal axis are given, usually in the notation $r \angle \theta$. In the rectangular form the number is expressed as $a + jb$. The relationship between these notations, shown in Figure 2, is such that either can be changed to the other by the simplest trigonometric equations. Simple as it is, however, the change involves a number of separate computations, and when there is an extensive series of equations to be solved the work of computation is long and tedious.

Various mechanical devices, some of them specially designed for the purpose, have been used for reducing the time taken by this operation. An ordinary duplex slide rule is used most commonly, but it was designed for general use rather than for this particular operation, and numerous settings of the rule are required. An instance is that the tangent scale between the values 0.1 and 1.0 runs the full length of the slide, while in the same linear distance the sine scale extends between the values 0.01 and 1.0. Since both sine and tangent of the angle are used in each transformation, the time lost in resetting the

rule on account of this discrepancy between the two scales is considerable. Other similar situations require more settings of the rule than are inherently necessary for these transformations.

Accordingly in 1916 F. A. Hubbard* designed a special slide rule for vector transformations, with scales provided on it which reduced to three the number of settings of slide and hair line for a complete transformation. Such a rule was later made, and it proved a valuable time saver. It had however two disadvantages. Although its length was twenty inches, the scales were so arranged that the accuracy was only that of a ten-inch rule. Also it was necessary to set up the numerical factors on an inverted scale, reading from right to left; that increased the chance of error from carelessness on the part of users, since the reverse side of the rule was also used for ordinary operations of multiplication and division.

* Now Vice-President and General Manager of the Mexican Telephone and Telegraph Company.

Another special slide rule, intended particularly for solving equations involving hyperbolic functions, was designed by Professor M. P. Weinbach of the University of Missouri, and was described in the Journal of the A. I. E. E. for May, 1928. Problems involving ordinary complex numbers may be solved as well, but four settings are required for a change from rectangular to polar form, and six settings are needed for the reverse transformation.

To expedite our filter computations, a twenty-inch rule was designed with the scales arranged especially for vector transformations. Preliminary arrangements for its manufacture were made with the Keuffel and Esser Company early in 1928, and in the summer six of the rules were made for the Research Department and the Apparatus Development Department. In this rule only one setting of the slide and two settings of the hair line are needed in changing a complex number from either form to the other. The numbers are set on an ordinary logarithmic or D scale, and the operations are performed in the same manner as are multiplication or division on an ordinary slide rule. The results are obtained on the D scale—the full-length logarithmic scale on the stationary part of the rule—and since the rule is of duplex type, additional operations such as multiplication or division may when desired be carried on without a resetting of the complex number.

The front of the rule, shown in Figure 1, has the scales usual for polyphase duplex rules, and has in addition the reciprocal or inverted scales DIF and DI on the stationary part of the rule. These scales, giving the reciprocal of a result directly, end

the need for a separate operation to secure a reciprocal. They are specially useful in such operations as finding capacitive reactance and admittance. For obtaining the reactances in a network containing both inductance and capacity only a single setting of the slide is made, and then all the reactances are obtained by moving the hair line.

It is on the reverse side of the slide that the principal changes have been made. Trigonometric scales for sine and tangent have both been inverted, and are both referred to the DI scale—the inverted D scale—rather than to the A and D scales, respectively, as before. Referring both to the same scale does away with the

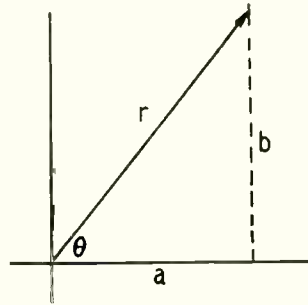

Fig. 2—In a complex number, r is the vector and θ the angle it makes with the axis of real numbers; a is the real component and jb the imaginary component. With either a and b or r and θ known, conversion between polar and rectangular form consists in finding the other pair of values

need for resetting the rule to use one function when the other has just been ascertained. The principal tangent scale TI_1 , runs from $5^\circ 43'$, the angle whose tangent is 0.1, to 45° , just as in all polyphase rules, and in addition an auxiliary tangent scale TI_2 running from approximately $34'$ to $5^\circ 43'$ is given, to cover the angles whose tangents are between 0.01 and 0.1.



Fig. 3—Beginning of a conversion from rectangular to polar coordinates. When the slide is set on 1195 and the hair line on 1530 on scale D, angle θ is given as 52° on scale TI_1 . The later example is also illustrated here. With the slide set on 119.5 and the hair line on 1530, the angle is read on scale TI_2 — $85^\circ 32'$

The sine scale extends between the limits 0.1 and 1.0 only—that is, between angles $5^\circ 45'$ and 90° . For angles less than $5^\circ 45'$ however sine and tangent are so close together that scale TI_2 may be used in place of an auxiliary sine scale without serious error.

Convenience of this rule in changing a complex number from rectangular to polar form can best be shown by a numerical example, such as $1195 + j1530$. First the angle θ is obtained through its tangent. The index of the slide is set on the smaller number, 1195, on the D scale, and the hair line is moved to the larger number, 1530, on the same scale. Then the point on the slide beneath the hair line marks the ratio of the two sides, which is the tangent or cotangent of the angle, depending on which side

was larger; in this case the ratio is the tangent. Then the point on the tangent scale beneath the hair line is read directly as the angle wanted—in this case, 52° . With the angle known, the length of the vector is next obtained by dividing the length of the vertical component by the sine of the angle, or the horizontal component by the cosine of the angle. In this case the horizontal side, 1195, is already set on the rule; accordingly the hair line is moved to 52° on the divisions of the sine scale SI corresponding to cosine values, and the length of the vector, 1942, is then found under the hair line on scale D.

In the example given, the ratio of the larger to the smaller component was less than 10, and the tangent scale TI_1 was therefore used. When the ratio is between 10 and 100 the

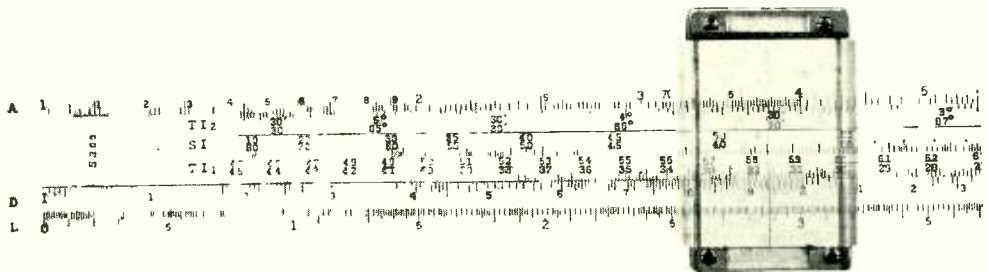

Fig. 4—With θ learned, the slide is left at 1195 and the hair line moved to 52° on scale SI. Then the vector r is given on scale D; its value is 1942

procedure is the same except that the other tangent scale on the slide, TI_2 , is used. It gives the tangents of angles between $85^\circ 43'$ and $89^\circ 26'$, and of course the cotangents of the complementary angles. A case in which this scale would be used is the complex number $119.5 + j1530$. The index of the slide is set on stationary scale D at the smaller number, 119.5, just as before and the hair line moved on the same scale to the larger number, 1530. Then the ratio of the two sides appears on the slide, and on scale TI_2 it represents the tangent of angle θ — in this case, $85^\circ 32'$.

The length of the vector cannot be obtained directly on the rule, since the sine scale has not been continued between 0.01 and 0.1 on a scale comparable to TI_1 . Should the vector be wanted closely it can be obtained readily by auxiliary computation, but ordinarily it is sufficiently accurate to take the larger component as the value of the vector. At most the error is one-half of one per cent, when the ratio of the components is just ten, and as the ratio increases the error drops rapidly, so that when the larger side is about twenty-two times the smaller, the error is only a tenth of one per cent. The factor by which the larger component is to be increased is shown in Figure 5; when the desired accuracy justifies the extra computation, the larger component is increased by the fractional

per cent through additional settings of the rule or by mental calculation. In the example shown, the increase is 0.3%, and length of the vector 1535.

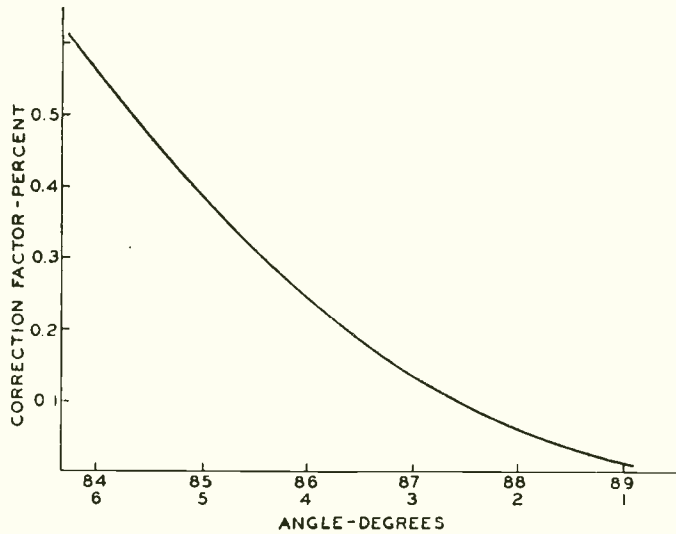

Fig. 5—For values of θ not given on scale SI , the larger component is increased in accordance with this curve to get the vector

When a complex number in polar form, as $1942 \angle 52^\circ$, is to be changed to rectangular form, the operations are the reverse of those already described. The hair line is set on the length of the vector, 1942, on scale D; the angle 52° , on sine scale SI is drawn beneath the hair line; then the hair line is moved to 52° on tangent scale TI_1 . Thereupon the two components are read directly on scale D — one of them beneath the index of the slide, and the other at the hair line. That at the index, 1195, is the vector multiplied by the cosine of angle θ and is accordingly the real component; the number at the hair line, 1530, is the imaginary component — the vector multiplied by the cosine of the angle and then multiplied by the tangent.

Although the rule was originally

intended primarily for filter computations, its usefulness is not restricted to those engaged in designing filters. In ten-inch size it would be in many ways advantageous for general engineering and student use. For such a field however, certain modifications would be desirable. On the tangent and sine scales the angles should be divided decimally rather than in minutes and seconds, to facilitate interpolation and to simplify addition and subtraction of angles. The scale of equal divisions, or L scale, might well be placed on the front of the rule, and the space on the reverse side vacated by this change used for exponential, or log-log, scales. With that arrangement there would be no need for a cube or K scale, and little if any need for a square—A—scale. Another change, though one whose general advisability is somewhat open to question, is a further modification of the sine scale. That part of the scale between 0.707 and 1.0 , or between 45°

and 90° , is never used in transforming complex numbers, and its only value is to give directly the numerical values of sines and cosines within its range. Since these could easily be found from other parts of the sine scale by additional operations, this part of the SI scale could be replaced by an SI_2 scale extending from $5^\circ 45'$ down to $4^\circ 8'$. If that were done, the angle whose vector could be obtained directly on the rule would be increased from that with the tangent 10 to that with the tangent 14, and the greatest error which would be present if the vector were not corrected in accordance with the curve of Figure 5 would be 0.3% rather than 0.5% .

Since complex numbers enter into computations in many other fields than those of telephone filters, a rule so made would speed up computations of many sorts, and at the same time fit the general types of computation for which a slide rule is commonly used.



The Inquiring Investor

Question—American Telephone stock is selling at its highest price in history. Is this the time to accept a very substantial profit?

Answer—You have in your American Telephone stock an interest in a huge company which has reported a steady expansion of earning power. While the common dividend yields slightly less than 4% at the current price of 220, the periodical rights materially increase the return. As a permanent investment the stock has few if any peers.

—Barron's, May 13, 1929.

Condensers for Many Uses

By C. R. YOUNG
Apparatus Development Department

STRIPPED to its essentials a condenser consists of two plates or sheets of conducting material separated by a dielectric or non-conducting medium. The Leyden jar, a glass container coated inside and out with tinfoil, was one of the earliest types used. With the growth of the electrical industry, and particularly with the use of radio broadcasting, condensers have come to be commonplace pieces of equipment. Modern communication circuits, in particular, would be impossible without them. Ranging in capacitance (in the non-adjustable types) from twelve hundred-thousandths to twelve hundred microfarads, a range of over ten million to one, they are used in almost every telephone circuit.

When an electromotive force is connected across the inner and outer conducting surfaces of a condenser, a certain amount of electricity is stored which is discharged when the two surfaces are later connected together. As there is no electrical connection between its two metallic surfaces, a condenser constitutes an "open circuit" in any steady current network in which it is placed. Due to its ability to store a charge directly proportional

to the voltage across it, however, the condenser acts as though it were conducting whenever alternating or varying potentials are applied to it. With an alternating potential, for example, as the voltage increases the condenser charges and as the voltage decreases it discharges so that there is a continuous flow of current to and from the condenser which follows the variations in the potential.

This ability of the condenser to transmit alternating or varying currents and to block direct currents makes it very useful in telephone circuits. A condenser is used in every subscriber's set primarily to pass the alternating ringing current to the bell and to keep from it the direct current from the central office battery. This use of the condenser is plainly evident in Figure 1 which shows the new sub-

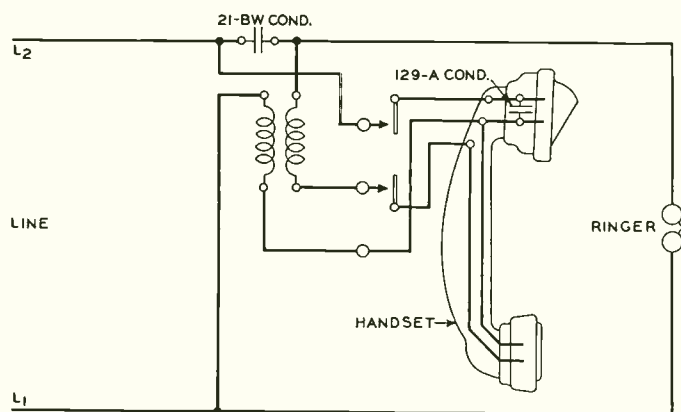

Fig. 1—Diagram of subscriber's set showing a condenser across the transmitter of a hand set as well as in the ringing circuit

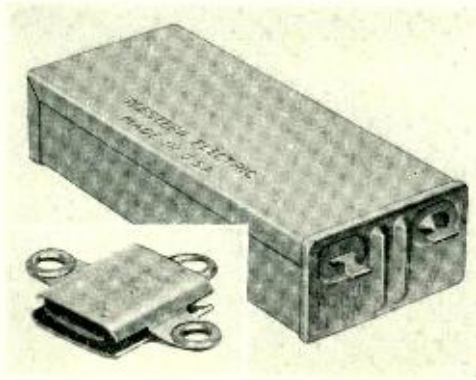

Fig. 2—21-BW condensers are used in the ringing circuit of all common battery subscribers' sets. Fig. 3—(Inset) The 129-A condenser used with the new handset sets is one of the smallest used in the telephone system

scriber's handset. A second condenser, the 129-A, is bridged across the terminals of the transmitter to prevent the granular carbon from cohering.

Condensers for most of these common uses in the telephone plant have tinfoil, only a few ten-thousandths of an inch thick, for the conducting surfaces, and paper for the dielectric. Two long strips of tinfoil separated by two or more sheets of very thin paper are rolled up, compressed to a roughly rectangular shape, impregnated with wax and then, surrounded by a sealing compound, are placed in a suitable metal casing. When five mil treated paper with a width of four inches is used, about eighteen feet is required for each microfarad of capacity. At present condensers of this type are being manufactured by the Western Electric Company for the Bell System at the rate of about

seven million microfarads per year. They range in capacitance from twelve hundred-thousandths to two microfarads.

Of last year's production some 1,200,000 microfarads were made into the 21-BW condensers, shown in Figure 2, which are used in the common battery subscribers stations. Some three thousand microfarads, assembled in units of about one hundredth of a microfarad capacity and known as the 129-A condenser, shown in Figure 3, were used with handset transmitters. A large part of the remaining production appeared as the numbers 57, 89 and 90 condensers, shown as Figure 4, which are arranged to mount on relay racks in central offices where they serve various purposes.

In contrast with the small No. 129-A, and two hundred thousand times larger, is the 20,000 volt condenser used in the filter power circuit at the 3XN radio transmitting

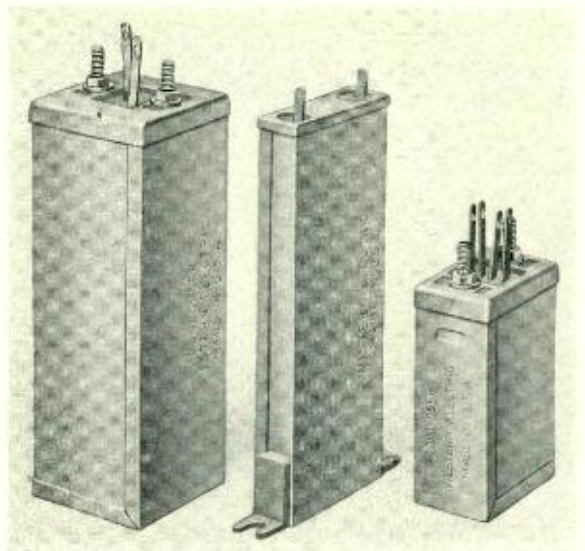

Fig. 4—Condensers for mounting on relay racks are made in many shapes and sizes

station at Whippany. These, shown as Figure 5, are also built up of tin-foil and paper with five layers of thin paper between the strips of foil and the whole carefully treated and potted to prevent the entrance of moisture. By connecting all the units in parallel a total capacitance of three microfarads is obtained.

Paper condensers have the advantage of being inexpensive, but there are certain limits to the accuracy with which they can be commercially produced. Ordinarily a tolerance of plus twenty-five percent is allowed and in the places where they are used this amount of divergence from their nominal capacitance is permissible. By selection after manufacture, smaller divergences from the nominal capacitances may be obtained. There are situations, however, where very high accuracy is required. Filters used with carrier systems are among them. For many such uses the allowable variation, even including aging over a period of fifteen years, and temperature changes that occur in a central office, is about one percent.

To obtain this high accuracy a different type of construction is employed. Mica is used for the dielectric and, instead of being rolled, alternate layers of conductor and dielectric are laid one on top of the other. Alternate sheets of foil extend beyond the dielectric on opposite sides and when the stack is completed the sheets on each side are connected together. This method, in addition to giving greater uniformity in capacitance, gives very low resistance for the conducting path. With the paper condensers used with subscribers' sets a single conducting lead is laid across the strip before it is rolled up so that the average

path for the current is much longer.

Although the layer method of construction gives a fairly high degree of accuracy in itself, even a greater degree is made possible when necessary by making some of the conducting foils of brass, to obtain greater

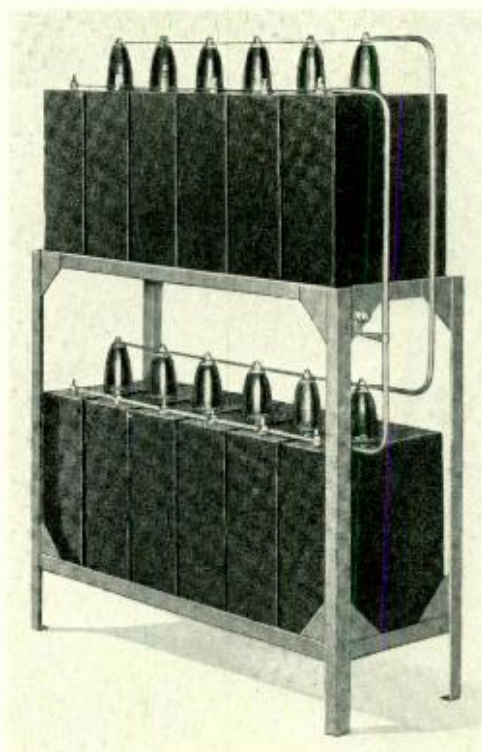

Fig. 5—Twenty-thousand-volt condensers used at the Whippany station

strength, and then after the condenser is tested, the exact capacitance required is obtained by pulling a few of these foils partly out from the pack. Two of such dry stacked mica condensers are shown as Figure 6.

Besides paper or mica as the dielectric material, air is sometimes used—particular for the lower voltages and smaller capacities. One of the principal uses of air condensers is for radio receivers but they are also

used in the impedance bridge described in BELL LABORATORIES RECORD* for December, 1928. One of the advantages of the air condenser is that it is readily made adjustable.

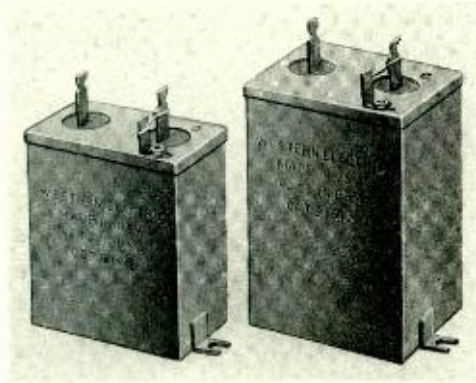

Fig. 6—Typical mica condensers of high accuracy and constancy. The containers are now finished with aluminum lacquer

The plates comprising it are so mounted that one set of alternate plates is fixed and the other set can be rotated about a perpendicular axis. This arrangement allows the effective area

* *Development of the Impedance Bridge*, S. J. Zammataro, pp. 150-154.

and hence the capacitance, to be easily changed. At the other extreme, where very large capacitances are required, and where phase angle and high voltage are not important, the electrolytic* condenser is used. Capacitances obtained for a given volume are enormously greater than could be obtained with mica, paper, or air condensers.

The uses to which condensers are put in the Bell System have increased at a rapid rate during the last ten years, due to advances in wire and cable systems, picture transmission, carrier current, radio, television, and varied requirements of central office equipment. Six thousand or more conditions must be met as to values of capacitance, precision adjustment, dielectric strength, and other factors. By increasing attention to the design, this large variety of conditions is being met with a constantly reduced number of types of condensers.

* *The Electrolytic Condenser*, by H. O. Siegmund, BELL LABORATORIES RECORD, Vol. 4, No. 2, pp. 276-279, April, 1927.

NEWS

and Pictures of the Month

including

Activities of the Club



The Laboratories plane, with D. K. Martin, Thomas Durfee, and W. C. Tinus in the foreground. This picture was taken at Hadley Field, in connection with the first public demonstration of two-way radio telephone conversation between a plane and the lines of the Bell System



News Notes

H. P. CHARLESWORTH attended the Bell System Operating Conference held at White Sulphur Springs.

Mr. Charlesworth has been elected Chairman of the New York Section of the A. I. E. E., which has a membership of about four thousand in the metropolitan district. In this capacity he will also serve as a member of the New York Reception Committee of the American Committee of the World Engineering Congress. A number of European delegates will pass through the United States next fall on their way to the World Engineering Congress in Japan, and the New York Reception Committee will see that they are properly welcomed.

* * *

ON MAY 7 the Laboratories played host to the Society of Motion Picture Engineers, in four-day session at its New York City meeting. Papers were read in the Auditorium — among them *A Machine for Cutting Master Disc Records* by D. G. Blattner and L. A. Elmer, and *A Reproducing Machine for Picture and Sound*, by H. Pfannenstiehl — luncheon was served in the restaurant, and a demonstration of television was conducted by H. E. Ives.

* * *

AS A FEATURE of its annual meeting, fifty-seven members of the New York Section of the Student Branch of the American Institute of Electrical Engineers paid a visit to the Laboratories on April 26. Assembling

in the Auditorium, they were welcomed by G. B. Thomas, then escorted through the Laboratories by A. F. Noe, H. C. Essig, E. T. Stammer, C. N. Stephan and P. M. Neave.

* * *

DURING the first week of May, our airplane radio equipment and personnel participated in two demonstrations of telephone transmission between the plane and distant points, employing wire and radio links. The first on May 1, was under the auspices of the Western Electric Company, for whom the equipment was developed. A group of newspaper men made flights from Hadley Field, during which they talked with their papers and dictated stories about what they saw and about the equipment used. These stories appeared prominently in the metropolitan dailies. The procedure was that after communication had been established between the plane and the ground station at Whippany, a connection was made with the Whippany central office of the New Jersey Bell Telephone Company and the telephone call was put through in the usual manner. In all cases the transmission and reception were reported as excellent.

On Saturday May 4, the plane was connected with Mr. Charlesworth, who was at White Sulphur Springs, at a conference of Bell System executives. While those present at the conference listened through loud speakers, Capt. A. R. Brooks, our chief air pilot, carried on a short two

way conversation with Mr. Charlesworth and gave a brief description of the radio equipment and the day's flying conditions.

In general charge of the demonstrations were F. L. Nelson and F. M. Ryan. At Whippany were D. K. Martin, L. G. Young, W. K. Caughey and E. S. Dobson; at Hadley Field and in the plane were F. S. Bernhard, W. C. Tinus, W. E. Reichle, A. R. Brooks, and Thomas Durfee.

* * *

THE MEETINGS of the Acoustical Society of America were held in the Auditorium on May 10 and 11. Of the twenty-five papers presented, seven were by members of the Laboratories: *Tube Method of Measuring Sound Absorption*, by E. C. Wentz; *Description and Demonstration of Artificial Larynx*, by R. R. Riesz; *Articulation Testing Methods*, by H. Fletcher and J. S. Steinberg; *The Dynamics of Vibration of the Vocal Cords*, by R. L. Wegel; *Speech Power and Its Measurement*, by L. J. Sivian; *The Effect of Distortion on the Recognition of Speech Sounds*, by J. C. Steinberg, and *Methods and Apparatus for Measuring the Noise Audiogram*, by R. H. Galt. Members of the society were guests of the Laboratories at lunches during the convention.

* * *

AT A JOINT MEETING of the acoustical and motion picture societies in the Auditorium on May 9, H. D. Arnold delivered a demonstration lecture on *Acoustic Facsimile*.

SYSTEMS DEVELOPMENT

S. F. BUTLER, C. E. BOMAN and H. E. MARTING visited Atlantic City

and Wilmington to view the installation of a new type of superstructure in step-by-step offices.

L. M. ALLEN and S. B. WILLIAMS visited Atlantic City and Somers Point in connection with step-by-step equipment.

W. J. LACERTE and J. R. KIDD visited Olean, where new equipment for eight-party rural line service is being installed for trial.

J. W. GOODERHAM was called to Philadelphia and Harrisburg in connection with interference studies.

F. S. ENTZ spent several days in Detroit where an installation of repeaters in straightforward trunks is under way.

J. B. SHIEL was in Denver last month in connection with the installation of a new No. 3 toll board.

H. M. PRUDEN and C. C. MUNRO visited the Transatlantic Radio Station at Lawrenceville.

W. A. PHELPS and R. B. STEELE spent some time in Key West and Havana in connection with the carrier telegraph circuits on the Key West-Havana cables.

A. D. DOWD and L. A. O'BRIEN were in Philadelphia to test the picture transmission equipment being prepared for Manchester, England.

J. R. STONE was in West Lynn, Massachusetts, attending a Survey Conference with the General Electric and Western Electric Companies.

J. C. GREENE went to Atlanta to discuss with representatives of the Telephone Company the new No. 3 toll board to be installed there.

A. E. PETRIE and V. T. CALLAHAN inspected an ATT-4 gasoline engine installation at Buffalo.

EUGENE L. RUYMEN died in Long Island College Hospital on April 16. From 1904 to 1907 Mr. Ruymen was

in the shops as an assembler. Returning after a year elsewhere, he was associated with the Laboratory for local central office development as a laboratory assistant until his retirement in 1927.

F. E. MASEK visited Harrisburg and Pittsburg, in connection with the trial of high insulation test equipment.

F. L. MORGAN and R. P. JUTSON visited Netcong, where power equipment for the short-wave receiver is being installed.

W. J. BOHRMAN visited Somers Point, to inspect the power equipment used with the unattended step-by-step central office there.

L. P. BARTHELD was in Chicago to discuss test splices with members of the staff at Hawthorne.

F. T. FORSTER was in Philadelphia in connection with the tests to reduce evaporation in batteries of the open tank type.

T. PAUL observed a trial of harmonic ringing on eight-party semi-selective lines in Albany.

RESEARCH

DURING the week of April 13, H. D. Arnold, R. M. Bozorth, O. E. Buckley, K. K. Darrow, C. J. Davisson, H. Fletcher, F. S. Goucher, H. E. Ives, W. A. Marrison and W. Wilson attended a conference on "Certain Aspects of Atomic Physics" at the Loomis Laboratory, Tuxedo, New York. Dr. Davisson presented a paper on *Electron Waves*.

IN ADDITION TO THOSE who delivered papers, listed in the May RECORD, there attended the meeting of the American Physical Society in Washington A. L. Johnsrud, G. R. Stilwell, C. J. Davisson, L. H. Germer, A. L. Samuel, H. E. Mendenhall, H. H. Lowry, S. O. Morgan,

E. J. Murphy, G. T. Kohman, P. P. Cioffi, F. S. Goucher, J. B. Johnson, and C. A. Kotterman. While in Washington Mr. Kotterman made an inspection of the telephone exhibit maintained by the Laboratories in the museum of the National Academy of Sciences and the National Research Council Building.

AT VARIOUS TIMES during April W. C. Jones, N. Blount, H. A. Larlee, E. W. Conger, and J. T. L. Brown were in Hawthorne in connection with the development of transmitters and receivers.

C. H. G. GRAY was in Hawthorne during the week of April 14 to confer on the application of machine testing methods.

H. H. LOWRY and W. B. WARREN revisited the Jeddo-Highland Coal Co., and W. E. Orvis inspected properties of the Lehigh Valley Coal Co. at Hazelton and Drifton, Pennsylvania, in an investigation of new sources of coal for transmitter carbon.

AT THE MEETING of the Colloquium on April 22, W. P. Mason spoke on *Acoustic Lines, Filters and Networks*. At the May 6 meeting, W. A. Marrison spoke on *A High Precision Standard of Frequency*, and F. R. Lack on *Observations on the Vibration of Quartz Plates*.

J. M. FINCH visited the Central Office at Wilmington, Delaware, for a study of insulating materials.

A. R. KEMP was in Hawthorne in connection with the study of cable development.

E. O. SPERR visited Philadelphia April 1 to 5 observing the accuracy of tolerance tests on creosoting oils.

A. R. OLPIN spoke before the faculty and graduates of New York University on "The Most Recent Developments in Improving the Sensitivity of Photoelectric Cells."

HARVEY FLETCHER attended a luncheon and meeting at Yale University which was called to formulate a program of research on speech and hearing. In the evening he gave a demonstration-talk on the mechanism of hearing and the use of 4-A audiometer before the New Haven League for the Hard of Hearing.

H. A. LARLEE has been elected a member of the Edward J. Hall Chapter of the Telephone Pioneers of America.

INSPECTION ENGINEERING

G. D. EDWARDS and A. G. DALTON visited the New England Telephone and Telegraph Company in Boston early in May in connection with Inspection Engineering work.

A. F. GILSON and S. H. ANDERSON visited the General Electric Company at West Lynn during the latter part of April and the early part of May to conduct a study of inspection and quality control methods as applied to telephone power machines.

T. L. OLIVER, Atlanta Field Engineer, visited New Orleans and several Mississippi cities during the last week of April in connection with field inspections of telephone equipment.

R. C. KAMPHAUSEN, Detroit Field Engineer, was in New York during the first week of May to confer with members of the Inspection Engineering Department concerning Field Engineering work.

E. G. D. PATERSON and O. S. MARKUSON attended the New York Electrical Society inspection of the John A. Roebling's Sons Company wire and wire-rope factories at Trenton and Roebling on May 2.

O. S. MARKUSON and D. S. BENDER visited Springfield, Massachusetts during the first week of May to ob-

serve installation processes used in connection with the new 1800-pair lead-covered cable.

APPARATUS DEVELOPMENT

The Outside Plant Development Department moved from the second and third floors of sections J and K at West Street to the 10th floor of the Maltz Building at 480 Canal Street on April 27.

This space contains both offices and laboratories in about equal proportions. The work which is being done in the various laboratories can be briefly indicated by their names: Cable and Hardware, Wire Finishing and Tools, Timber Products, Concrete and Conduit, Electrical Measurements, Artificial Weathering and General. The General Laboratory contains such apparatus as a wire tensile machine, a rubber compression machine, and an Amsler machine for testing a variety of materials in tension, compression and transverse bending.

Members of the Department may be reached by telephone from West Street through tie lines to the Canal Street P B X by calling "Canal Street," or from outside by calling Walker 0380.

D. D. MILLER visited Hawthorne during the week of April 22 for conferences on new relay developments and work of the American Engineering Standards Committee on gauges for wire and sheet metal.

F. J. REDMOND was at Hawthorne recently in connection with new developments in dial number plates.

J. D. TEBO visited Hawthorne during the week of April 29 on an inspection trip arranged to familiarize members of the Laboratories with manufacturing conditions.



S. P. Grace, and R. M. Pease of the Apparatus Development Department, demonstrate some recent developments of the Laboratories

J. ABBOTT visited Hawthorne during the week of April 22 with J. M. Labaugh of A. T. & T. in connection with new equipment for adjusting and inspecting dials.

C. D. HOCKER made trips to Pittsburgh and Altoona during the latter part of April with members of the American Society for Testing Materials to inspect outdoor exposure tests on galvanized metal.

C. R. MOORE visited Kearny on April 27 to investigate methods of loading and blocking cable reels in railway cars.

G. Q. LUMSDEN, accompanied by Mr. Lindsay of the Mountain States Telephone and Telegraph Company, made an inspection of lodge-pole-pine and cedar poles in the Lordsburg-Duncan line of that Company in connection with timber preservation studies during the latter part

of March and the first part of April.

R. P. ASHPAUGH, of the Outside Plant Development organization in Hawthorne, visited New York from April 15 to April 24 to witness experimental field tests on cables.

W. E. MOUGEY, of the Outside Plant Development organization in Kearny, made a trip to Fort Worth, Texas, during the latter part of April to observe the handling of the new tape-armored toll cable which is being installed there.

A. B. BAILEY directed the installation of the new speech-input equipment at Station WABC of the Columbia Broadcasting System.

N. BISHOP inspected the one-kilowatt broadcasting equipment of the Oregon State Agricultural College, and the five-kilowatt broadcasting equipment of the Western Broadcasting Company at Hollywood.

B. R. COLE supervised the installation of the one-kilowatt broadcasting equipment for the Outlet Company at Providence.

J. C. HERBER made a survey for one-kilowatt broadcasting equipment for the Toledo Broadcasting Company. He also inspected the five hundred watt broadcasting equipment of Strawbridge and Clothier, Inc., of Philadelphia.

O. W. TOWNER made a survey for one-kilowatt broadcasting equipment for the Reynolds Radio Company at Denver. He inspected the one-kilowatt broadcasting equipment for the Gurney Seed and Nursery Company, Yankton, South Dakota, and the Kansas City Star.

C. E. LANE attended the Dallas regional meeting of the A. I. E. E. and presented a paper prepared jointly with T. E. Shea on *Transmission Networks—Types and Problems of Design*. He also assisted in Mr. Grace's lecture there by demonstrating the operation of the artificial larynx.

SEVERAL MEMBERS of the General Apparatus Development Department, including W. Fondiller, W. J. Shackelton, H. N. Van Deusen and F. F. Lucas, took a trip arranged by the New York Electrical Society to the John A. Roebling Sons Company plant at Trenton on May 3. The visitors saw the manufacture of telephone cable and various wire products, including the suspension wire for the new Hudson River Bridge.

C. R. YOUNG and H. A. ANDERSON, with C. B. Evans of Hawthorne, visited the General Electric Company at Schenectady on May 6 to discuss improvements in methods of welding loading coil cases.

J. R. TOWNSEND delivered a talk

on non-ferrous alloys at one of the technical sessions of the Chemical Exposition at Grand Central Palace.

ON MAY 10 F. F. Lucas, H. A. Anderson, R. M. Sample, C. H. Greenall and I. V. Williams attended the sectional meeting and inspection trip of the American Society for Steel Treating at the Bethlehem Steel Company.

GENERAL STAFF

EDWARD BUTTNER, a shop mechanic with forty-three years of Bell System service, died at his home on May 2. His was an unusual record — of thirty-nine years of shop service without accident, injury or sickness. Coming to West Street in 1886, he operated a milling machine in the Engineering Shop until 1925, save during two years spent at Hawthorne and a short time in the Tool Room. The Laboratories regrets the termi-



Edward Buttner

nation of nearly a half-century of devoted and valued assistance.

AUGUSTINE W. CARAS died at the Methodist Episcopal Hospital in Brooklyn on April 22. From 1922 to 1925 Mr. Caras was a member of the Payroll Department of the Western Electric Installation Department. On June 14, 1925, he joined the Expense Accounting Department of the Laboratories.

G. F. FOWLER addressed the annual convention of the Boston Alumni of Worcester Polytechnic Institute at the City Club of Boston on "Side Lights on Communication."

L. S. O'ROARK talked on April 25 before 200 members of the Mountain Lakes Men's Club on "Why Men Cannot Understand Women." During May he spoke on "The Photoelectric Cell and Its Application to Communication" to two hundred electrical and mechanical engineering students of the senior class of Cornell University, and to the Engineers' Club of Dayton, Ohio. Mr. Fowler accompanied him to Cornell and demonstrated sound pictures.

DEMONSTRATION lectures on sound pictures were given by W. C. F. Farnell before 150 telephone employees at the conference of the General Board of the Southern New England Company's Employees' Association at Norfolk, Connecticut, and by P. B. Findley, assisted by Mr. Fowler, before the Boston Post, American Signal Corps Association, on May 22.

S. P. GRACE gave a talk to the department heads of the Southern Bell Telephone and Telegraph Company

in New Orleans on May 4. On May 7 Mr. Grace addressed the Regional Convention of the Seventh District of the A. I. E. E. in the ballroom of the Adolphus Hotel, Dallas, Texas. About six hundred Dallas people and four hundred engineers and students from all parts of the Southwest were present.

JOHN MILLS addressed the Western Universities Club of New York City on April 23. At the Washington Convention of the Institute of Radio Engineers he gave a description of sound pictures, accompanied by a demonstration by Mr. Farnell.

DURING APRIL M. B. LONG visited the University of Pennsylvania to interview 1929 engineering graduates interested in Bell System employment, and R. A. Deller visited the University of Michigan, Case School of Applied Science, Ohio State, and Penn State to follow up employment offers previously made.

G. B. THOMAS was in Boston in connection with the cooperative plan for students carried forward by the Laboratories and Massachusetts Institute of Technology.

HELEN M. CRAIG attended the annual conference of the Special Libraries Association in Washington during the week of May 13.

PATENT

BETWEEN April 10 and May 7 G. C. Lord, J. F. McEneaney, M. R. McKenney, T. P. Neville, C. A. Sprague, and W. B. Wells visited Washington for the prosecution of patents.



Vail Medal Awards for 1929

FOUR silver medals have been awarded by the National Vail Medal Committee to men and women selected from the fifty-two to whom bronze medals were awarded during 1928 by Associated Companies of the Bell System. ¶ To be selected for National Vail Medal recognition an act must have for its objective the accomplishment of something of real value in the public interest through the medium of Bell System facilities, organization, training or experience, and must reveal to a high degree many, if not all, of the positive qualities of intelligence, initiative and resourcefulness, and usually courage, endurance and fortitude.

AWARDS AND CITATIONS

MRS. MABEL HITE, *Agent, Northwestern Bell Telephone Company, Potter, Nebraska.*

For alertness and responsiveness in sensing an emergency under unusual circumstances and for initiative and resourcefulness resulting in the saving of life and the accomplishment of an important communication service.

On the evening of February 17, 1928, while on duty alone at the telephone central office, Potter, Nebraska, she heard overhead the sound of an airplane and noted

that it continued for some time as though the plane were circling over the town. A blizzard was raging at the time, and she deduced from the unusual behavior of the plane that the pilot must be lost or in other difficulty. She therefore immediately called the Air Mail field about twenty miles east of Potter and received advice that the most helpful action under the circumstances would be to mark out the boundaries of a possible landing field with red flares which might be obtained from the railroad company. She called a local garage and explained the emergency and the action which

should be taken. The garage man secured help and marked out a landing place, thus enabling the pilot, who was carrying United States mail, to land safely, refuel the plane and continue on his way.

* * *

OLIN ETHERIDGE PERDUE, *Line Measurer, Long Lines Department, American Telephone & Telegraph Company, Atlanta, Georgia.*

For courage, resourcefulness and persistence in the rescue and resuscitation of a fellow employee.

On September 14, 1928, when a fellow employee, encumbered with a heavy tool box and climbers, had fallen into the flood swollen Altamaha River, near Jesup, Georgia, he dived from a twenty foot trestle, risking his life to save his comrade. He reached the man, brought him to the surface and fought his way fifty yards through floating debris to the river bank but, with his helpless burden, he was unable to reach firm ground at this point. Standing on the submerged branch of a tree, he hauled the now unconscious man up into the branches and unstrapped and cast off the heavy tool box and climbers, after which he again fought his way twenty-five yards further through the flood to some logs that had lodged against a tree. Here he pulled his comrade out of the water onto the logs and applied artificial respiration, restoring him to breathing and consciousness.

* * *

MRS. ALTHEA P. MARKS, *Agent, The Pacific Telephone and Telegraph Company, Saticoy, California.*

For courage and devotion to the public service during an emergency.

On March 13, 1928, at about 12:40 A.M., on answering a call at the central office switchboard in her home in Saticoy,

she learned that the St. Francis dam had broken and that the entire Santa Clara River Valley was in danger of being flooded. Although aware that the enormous amount of water impounded by the dam might inundate the town, she remained at the switchboard, warned the residents of the community of the impending danger, calling those she could by telephone, and directing messengers to others. She kept everyone informed as to the progress of the flood and after it subsided she continued without respite for three nights and two days to render essential public service in connection with relief work.

* * *

ANNA C. YURECKO, *Night Operator, New Jersey Bell Telephone Company, Rockaway, N. J.*

For resourcefulness and intelligent action in an emergency.

Late in the night of June 24, 1928, while on duty alone in the telephone central office, Rockaway, New Jersey, she learned from a subscriber of an automobile accident in which the car had crashed over a railroad bridge and fallen onto the tracks, blocking the passage of oncoming trains.

Realizing the seriousness of the hazard that the wrecked car created on the railroad tracks and that a train was soon due to reach that point, she undertook to stop this train in time to prevent a second accident. She was unable to communicate directly with the only signal tower from which the train could be stopped, but telephoned the warning to the train dispatcher's office some fifteen miles away, and through that office got word to the signal tower over the railroad's private telephone line. After being assured of the safety of the train, she summoned police aid for the injured who had been rescued from the wrecked automobile.

Contributors to this Issue

L. A. O'BRIEN received the B.S. degree in electrical engineering from Kansas State Agricultural College in 1914, and returned there to receive the E.E. degree in 1919, after four years with the Equipment Engineering Department of the Western Electric Company. After two years as Employment Manager for the Dain Manufacturing Company, and two years as Production Engineer of the National Carbon Company's Jersey City works, he came to the Systems Development Department of these Laboratories. During his first three years here Mr. O'Brien was concerned with toll equipment development, including that of picture transmission. He has since been working with the development of local systems.

* * *

R. E. COLLIS received the M.S. degree from Iowa State College in 1917 and came to the Laboratories the same year. From 1917 to 1922 he was engaged with the development of

the printing telegraph. In 1922 he was transferred to the Systems Development Department, where he is now concerned with special problems relating to the panel type of dial telephone system.

* * *

M. K. KRUGER graduated from St. Lawrence University in 1920, and entered these Laboratories that fall. After a brief period in the Transmission Department and about a year and a half in the Physical Laboratory, he was transferred to the Educational Department, and in 1926 to the group in the Apparatus Development Department engaged in the design of filter networks.

* * *

C. R. YOUNG received the B.S. degree in electrical engineering from the University of Vermont in 1900, and came in that year to West Street to join the Western Electric Company's Inspection Department. He was later transferred to the design



R. E. Collis



L. A. O'Brien



M. K. Kruger



C. R. Young



R. S. Wilbur



R. Raymond

section of the Engineering Department, and is now concerned with the design of loading coil assemblies and cases.

* * *

ON GRADUATION by Cornell University in 1900, R. Raymond entered the engineering department of the Western Electric Company where he had an important part in development of early common-battery circuits. He was identified with panel switching developments from the outset. One of his major contributions during the early panel stages was the preparation of a key sheet for each job to specify the circuits necessary to meet individual traffic requirements.

In the laboratory study of the coordinate system, Mr. Raymond was responsible for development of operative circuits. His most recent activity has been the development of the decoder, which he described in the RECORD for May, 1928.

* * *

R. S. WILBUR began his telephone experience in the independent field in 1899. After eleven years in telephone operating and manufacturing companies, he joined the Circuit Laboratory at West Street. In the Systems Development organization he has participated in manual and toll development and is now Toll Circuit Engineer.

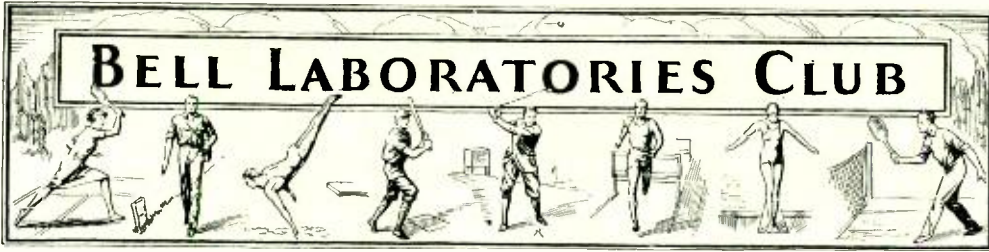

IT had been rumored that there were Talleys and Tibbetts in our Glee Club, and it was not without a certain conviction to that effect that an audience of seven hundred heard and applauded an excellent program given at the Hotel Pennsylvania, April 26. The singers gave pleasing evidence of the time and diligence which had gone into preparation for the evening's entertainment. The large ballroom was well filled and most of the boxes occupied when Mr. Richards mounted the rostrum to direct the first number, "Allah's Holiday." Other numbers by the Glee Club which were well received were "Dreaming" and "Swing Along." Solos by Russell P. Yeaton, tenor, and Francis M. Costello's baritone rendition of "Captain Mac," were especially liked. Dorothy M. Allyn, soprano, sang "Dawn" with Friml's "L'Amour, Toujours l'Amour" for encore and was presented with a bouquet of American Beauty roses which genuinely expressed the appreciation of the audience. Other numbers by the Women's Chorus and the Men's Chorus evinced Mr. Vere S. Richards' very capable direction of the Glee Club. Ada I. Van Riper and P. H. Betts were the managing committee for the Club.

After the concert, Hood's Orchestra, augmented to fourteen pieces, provided music for dancing and by smart playing of popular numbers

found little competition with the punch bowl and lounging foyer in attracting the dancers for the remainder of the evening.

THE GLEE CLUB CELEBRATES

The Glee Club sang its finale at a party at Keen's Chop House Wednesday evening, May 1. Forty-four of our amateur songsters exhibited a familiarity with the dining fork equal to that with the tuning variety. At the dinner, appreciation was expressed to Ada Van Riper and P. H. Betts of their enthusiastic efforts in helping to make the Glee Club season a success. By dint of an excellent dinner, the party grew expansive and adjourned to a private hall, there better to celebrate the festival to Orpheus.

Vere S. and Mrs. Richards again contributed some of their cleverly executed games which were thoroughly enjoyed. The games were interspersed with songs, a harmonious duet and an amusing ad lib of the Miserere Chorus.

Finally the evening ended with hearty cheers for Director and Mrs. Richards as an expression of thanks for their part in the season's success and au revoirs were said until next fall.

WOMEN'S BOWLING

"Bowling Them Over," the play presented by the Women Bowlers of the Bell Laboratories Bowling

League on Monday, May 6th, was an eminent success.

The prologue opened at the County Fair restaurant, where the play was given, to a scene of unusual gaiety. Besides the bowlerettes who had gathered for this final reunion, there were present as guests sev-



eral members of the Men's Bowling League, whose valuable assistance had contributed toward the success of the women's bowling season. Prominent among them were O. M. Glunt and H. F. Dodge, President and Vice-President, respectively, of the Bell Laboratories Club.

As an aid to appetites H. F. Dodge and Miss Melita staged an impromptu derby just before dinner on the outer "racetrack" of the dance floor with two grotesque wooden steeds provided by the management of the County Fair. Bulletin: weather fair, track slippery. Contrary to ground rules, the fair jockey did *not* win the race.

At the close of a speech, replete with stories for which he is famous, Mr. Gilson as Chairman of the Bowling League awarded prizes.

A pocketbook was awarded to each of the following members of the winning team (Rulers):

Antoinette Kelly
Leona Feil
Lee Melita
Dorothea Jacobs
Lillian Cunningham

Each of these members of the second highest team (Erasers) received a string of crystal beads:

Elsie Baran
Martha Kapusinsky
Martha Niebob
Margaret Tully
Helen Bortfeldt

The prizes for the season's high averages were as follows:

Antoinette Kelly—Silk umbrella
Natalie Skinner—Crystal beads
Leona Feil—Compact

The prizes for the season's high scores were awarded to the following:

Lee Melita—Parker fountain pen
Dorothea Jacobs—Parker pencil
Natalie Skinner—Bridge set

The grand surprise of the evening was a special prize donated by D. D. Haggerty for the greatest improvement in average for the entire season. In awarding this prize, a fine aquamarine brooch, Mr. Haggerty commended the winner, Dorothea Jacobs, on the remarkable improvement she had made.

Speeches were also made by H. F. Dodge, O. M. Glunt and D. R. McCormack.

After the dinner the girls attended the performance of "Lady Fingers" and the men dejectedly went home.

THE MALE BOWLERS DINE

The pilgrimage from West Street to Two Park Ave. . . . The smoke-filled billiard room where losers at bowls triumphed at Kelly pool. . . . The statue of Nathan Hale which Bob Nossaman mistook for a guest. . . . The wild search for the placecard. . . . The well-aimed grapefruit-juice. . . . The hardworking "black-in-the-face" orchestra. . . . The rainbow 'round the shoulder. . . . The chairman—Al Gilson—who swung a wicked gavel as toastmaster. . . . The

Prize Winners of the Bowling Season

LEADING TEAMS

A	B	C	D
<i>*Buzzers</i>	<i>Signals</i>	<i>Coils</i>	<i>Plugs</i>
<i>Won 49, Lost 35</i>	<i>Won 50, Lost 34</i>	<i>Won 52, Lost 32</i>	<i>Won 52, Lost 32</i>
R. J. Miller	C. White	F. G. Buhrendorf	W. R. Steeneck
J. R. Kidd	R. S. Wilbur	H. A. Lewis	H. O. Wood
C. L. Deelwater	J. Babcock	E. A. Wieland	E. F. Ketcham
E. J. Johnson	A. G. Jeffery	H. W. Schaeffer	L. C. Dikeman
W. P. Trottere	T. V. Curley	A. G. Eckerson	L. H. Bachmann

SECOND TEAMS

<i>*Plugs</i>	<i>Buzzers</i>	<i>Lamps</i>	<i>Relays</i>
<i>Won 49, Lost 35</i>	<i>Won 49, Lost 35</i>	<i>Won 51, Lost 33</i>	<i>Won 47, Lost 37</i>
C. E. Flaig	F. S. Entz	A. G. Lang	J. Meszar
J. Umschied	A. W. Hawley	F. W. Treptow	C. G. Gerth
F. A. Korn	C. W. Green	H. W. Hodgkins	F. F. Stoner
H. Rosenbohm	V. J. Hawks	E. K. Eberhart	O. H. Danielson
A. W. Dring	H. W. MacDougall	C. G. VonZastrow	H. LaFrenz

*Tied.

HIGH TEAM SCORES

<i>Ringers</i>	<i>Signals</i>	<i>Coils</i>	<i>Lamps</i>
<i>Score 1005</i>	<i>Score 931</i>	<i>Score 909</i>	<i>Score 905</i>
J. Dusheck	C. White	F. G. Buhrendorf	C. C. Kingsley
A. M. Elliott	R. S. Wilbur	H. W. Schaeffer	T. V. Borlund
R. J. Nossaman	J. Babcock	H. A. Lewis	J. M. Peabody
C. J. Hay	A. G. Jeffery	E. A. Wieland	C. R. Taft
T. C. Rice	T. V. Curley	A. G. Eckerson	A. D. Ligouri

HIGH INDIVIDUAL AVERAGES

Dieffenbach ...183.27	Lohmeyer168.75	Kobylarz160.33	Steenek149.96
Rice181.10	Boyles166.93	Lewis155.26	Taft148.28
Muller179.64	Entz166.92	Pullis154.44	Bendernagel ..146.59
Flaig176.99	Held165.81	Bollinger153.88	Paulssen146.19
Miller176.73	Wilbur164.97	Buhrendorf ...151.81	Meszar145.98

HIGH INDIVIDUAL SCORES

Fairlamb256	Greene249	Scribner238	Ligouri223
Bodenstedt254	Wilbur247	Reybert236	Paulssen221
Rice251	Boyles235	Lewis230	Parker221

results of the season's rolling, as told by L. E. Parsons. . . The presidential remarks by O. M. Glunt. . . The doubling of Mr. Dixon for Mr. Charlesworth. . . The ditto by Phil Norton for Dr. Jewett. . . The little



group of serious bowlers selected by James A. Wilson for individual honors. . . The disintegration. . . The long wait for overcoats. . . The choice of subway or taxi. . . The search for the theatre-ticket. . . The show-girls and comedians who made pleasure abound. . . The commuters in inside seats who must catch the 11:15 to Mud Lake. . . The grand exit. . .

Splits and Slices

As between after-dinner speeches, profound or humorous, the stags at the bowling dinner showed a distinct preference for a song which purported that the scarcity of women was ruinous to the party.

After which many were seen to leave the table ostensibly to make phone calls, never to return—in spite of A. F. Gilson's magnetism as a story teller.

The mezzanine at the Majestic Theatre acquired a telephone complex when 225 satisfied banquet bowlers perched there like sparrows on a bank of phone wires, the actors catching the mood and wise-cracking for the betterment of telephone service.

In the midst of victory comes defeat. Equal in dramatic effect to the football player who ran 60 yards to the wrong goal, Tom Rice carefully split his last bowl in the Bell System League play-off and went down to a glorious defeat.

BATTER UP

With the cry of "play ball" heard in opposite ends of Brooklyn on Saturday, May 4, the Club Departmental Baseball League opened the



1929 season. At Farmers Oval an exciting and close game was played by the Systems Development Department and the Ringers, a team composed of ball players from the Apparatus Development, Research, and Commercial Departments. The Systems team won the game. At Erasmus Field on the same day the Tube Shop team defeated the team representing the Plant and Shop Department of West Street. Games are scheduled at both ball parks on the Saturdays in May, after which all games will be played at Erasmus Field.

On Wednesday evening, May 8, the Laboratories' team in the Bell System League played its first game and was defeated, 4 to 2. Its op-

ponent for the evening was the Western Electric Company, Brooklyn team. The Laboratories' team in the Bell System League will play games on June 11, June 19 and June 25.

SWIM AND SAVE

The swimming season is here with its bright panoply of blue skies, white sands, brilliant-hued beach wear and —unguentine. The wise ones are running down to Brighton Beach evenings, Saturdays and Sundays, taking advantage of the conveniences offered by our arrangement with the Beach management and avoiding crowds, long queues and extra expense.

Tickets may be purchased from the Club Secretary at one-half the regular price, entitling the holder to full privileges. Tickets for Sundays and holidays are one dollar each. Club membership cards are necessary with the admission tickets.

For those who would avoid the devastating effects of the sun there is the Shelton Hotel pool available to our members for the summer season. This arrangement offers a reduction in regular price, the seventy-five cents charged being one-half the regular rate. The Shelton is convenient, is open to both men and women, has splendid facilities, including restaurant, lounge and library, in addition to the excellent pool.

THE CLASS IN RHYTHM GRADUATES

The Rhythm classes at the Noyes School of Rhythm were concluded on May 14 with a short program of Lyric-Drama Dances by Miss Catherine Rapp of the school.

The exhibition illustrating rhythm, as formed in the dance, was highly

interesting to the class. The classes in rhythm undertaken somewhat as an experiment have definitely proved to be beneficial and instructive. It is expected to resume the classes in the fall when more who are interested will have an opportunity to take part.

NEW COURSE FOR WOMEN GOLFERS

Golf promises to be one of the most popular outdoor sports for women if we are to judge by the excellent course which has been tentatively selected as the locale for this sport. The Tyson Manor Golf Club course on Staten Island is particularly suitable and offers many advantages.

Interested golfers should learn more about it from Marion Kane.

BRIDGE SEASON ENDS

May Lynch and G. T. Lewis arranged an enjoyable bridge party on April 22 to close the men's and women's bridge season. The winners were:

<i>First Men's Prize</i>	
E. H. Leonard	1584
O. L. Michal	
<i>First Women's Prize</i>	
Misses Lynch and Munn	1457
<i>Second Men's Prize</i>	
J. C. Field	1141
J. E. Clark	
<i>Second Women's Prize</i>	
Misses Haunfelder and Wilson	795

It is planned in the Fall to have a bridge for the girls at the Happiness Restaurant, Fifth Avenue and 44th Street. This party is being arranged to stimulate interest in the weekly bridge games during the winter.

Telephoning to Trains

On May 6, the newspapers carried an account of successful experiments in telephoning from a moving train of the Canadian National Railways. Duplex transmission was employed, using separate frequencies for sending and receiving. Separate antennas were on the roof of one car, and the ground station was connected to the open-wire line along the route, half the wires being grouped for the receiving channel and the other half for the transmitting channel. Technical phases of the tests were directed by J. C. Burkholder, formerly of these Laboratories, who went to the Canadian National Telegraphs early in 1928 in connection with its purchase of carrier telegraph systems from Northern Electric.

On account of the Bell System's prominence in the communications field, some of the newspapers enquired of the American Telephone and Telegraph Company as to similar facilities in this country. President Gifford made the following statement:

"For some years the American Telephone and Telegraph Company has been ready to install telephone service on moving trains, and about two years ago had the matter up actively with two of the leading railroad systems in the country. Both railroads decided against it as it was not considered commercially practical. If any railroad wishes to give such service on its trains and bear the necessary cost of it we shall be very happy to install it and connect it with the lines of the Bell System."