

CLASSIFIED AD
DEADLINE JUNE 10TH

A.R.C., P.O. Box 2, CARLISLE, MA 01741
RETURN POSTAGE GUARANTEED



SECOND CLASS



VOLUME 7 JUNE 1990 NUMBER 6

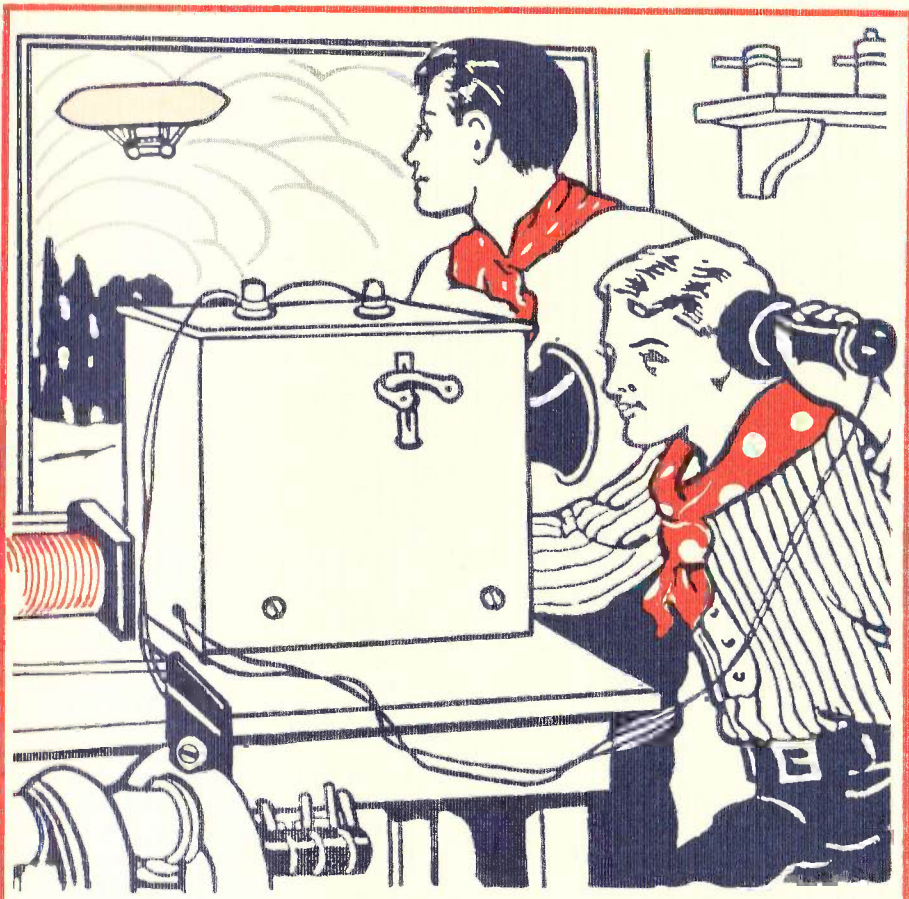

THE RADIO BOYS

THE NATIONAL PUBLICATION FOR BUYERS AND SELLERS
OF OLD RADIOS AND RELATED ITEMS - PUBLISHED MONTHLY

ANTIQUE RADIO CLASSIFIED

Antique Radio Classified (ISSN:8750-7471) is published monthly, 12 times per year, by John V. Terrey, 498 Cross Street, P.O. Box 2, Carlisle, MA 01741. Second-class postage paid at Carlisle, MA, and additional mailing offices. Telephone: (508) 371-0512, 9:00 AM to 5:00 PM ET weekdays; machine answers phone at other times.

Annual subscription rates within the U.S. are \$20.00 by Second Class mail and \$30.00 by First Class mail.

Annual foreign rates. By air: Canada - \$32.00; Mexico - \$30.00; Other foreign countries - \$60.00. Surface mail: Canada - \$27.00; Other foreign countries - \$30.00 (Surface delivery to countries other than Canada may take two or more months and cannot be guaranteed.)

Two-year subscriptions are twice these rates and receive an extra month. Sample issues are available free on request.

© Copyright 1990 by John V. Terrey.

POSTMASTER: Send address changes to Antique Radio Classified, P.O. Box 2, Carlisle, MA 01741.

STAFF

Publisher and Editor: John V. Terrey
 Production Manager: Scott J. Young
 Publishing Staff: Dave Crocker
 Betsy Dumka Chris Frederickson
 Bobby Lyman Shirley Sauer
 Founding Publisher/Editor: Gary B. Schneider
 Contributing Writers: Richard L. Arnold
 Paul J. Bourbin Norman S. Braithwaite
 Dave Crocker Alan S. Douglas
 Richard C. Foster Frank Heathcote
 David W. Krauter Jim Kreuzer
 Ron Ramirez Henry Rogers
 Gil Schiehlman Gary B. Schneider
 Howard Stone Frank R. White
 Ralph Williams John P. Wolkonowicz

PURPOSE. Antique Radio Classified is published for people involved in the radio collecting hobby. Its purpose is to stimulate growth of the hobby through the buying, selling and trading of radios and related items, and to provide a monthly forum for the interchange of ideas and information.

WRITING TO ANTIQUE RADIO CLASSIFIED.

All correspondence should be sent to:
 Antique Radio Classified
 P.O. Box 2, Carlisle, MA 01741.

Your ads, renewals, letters, etc. can be handled faster and more efficiently if (1) each is on a separate piece of paper, and (2) your name, address and SUB# is written on each.

Unfortunately, A.R.C. is not staffed to answer letters with questions about antique radios or requests for advice. However, A.R.C. does solicit letters of interest to its readers

DISPLAY AND BUSINESS CARD ADS - DETAILS AND RATES

Advertising is accepted only for items related to antique radios, communication, electricity, etc. All items must be described fairly; reproductions, reprints and not-original items must be so identified. Advertisers agree to respond promptly to inquiries and orders, and to resolve problems promptly if the buyer is not satisfied.

The deadline for display and business card ad artwork, payment and repeat requests is the first of the month. All advertising must be prepaid; see "Payment" paragraph above. Late ads will be run only if space and time permits. As artwork is reduced to 63% in the printing process, originals should be the artwork size listed below. Do not send in artwork on art board or send negatives. Ads should be typeset or typed neatly with a carbon ribbon. If you want us to prepare your ad, include the one-time cost listed below for A.R.C. to make up the ad.

"Tear sheets" will be sent only for 1/2 and full page ads, if requested when ad is submitted.

Business card ads are limited to one per advertiser. Photos should be at an 85 line screen; otherwise, add

Page	Artwork Size (send in this size)		As Printed (size in magazine)		Cost for 1-month	Cost for 3-months	Cost for 6-months	One-time Cost for A.R.C. to make up Ad (if requested)
	H x W (inches)	H x W (inches)	H x W (inches)	H x W (inches)				
Full	12 3/16 (or 10 1/2)	x 7 1/2	7 3/4 (or 6 5/8)	x 4 3/4	\$110.00	\$295.00	\$530.00	\$40.00
1/2 H	5 1/4	x 7 1/2	3 5/16	x 4 3/4	55.00	148.00	265.00	20.00
1/2 V	11 13/16	x 3 9/16	7 7/16	x 2 1/4	55.00	148.00	265.00	20.00
1/4	5 1/4	x 3 9/16	3 5/16	x 2 1/4	28.00	75.00	135.00	10.00
1/8	2 5/8	x 3 9/16	1 5/8	x 2 1/4	15.00	40.00	72.00	4.00
Business Card	2	x 3 3/4	1 1/4	x 2 3/8	not avail.	22.00	39.00	4.00

and will publish them as space permits. A.R.C. assumes that permission is given to edit and to publish all correspondence received unless otherwise indicated.

GUARANTEE. You may cancel your subscription at any time and receive a pro rata refund for issues not yet mailed. If errors to ads are made by A.R.C., upon request a free correction will be run in the next available issue.

PAYMENT. Please send in full payment with your order or ad. A.R.C. does not carry accounts; all subscriptions, ads, etc. must be prepaid. Pay in U.S. funds; checks drawn on a U.S. bank or money orders are preferred. Make check out to "A.R.C." U.S. stamps or cash are OK for small amounts. Canadian payers may send a Canadian check in U.S. funds, but please add \$1.00 (U.S.) for conversion costs. On request, subscriptions will be prorated to amount sent, minimum term is one year.

CHANGE OF ADDRESS. Please notify us 4 weeks in advance of a change of address. Send both your new and old address, and include your SUB# and effective date of your new address. Temporary address changes can be made also.

SUBMISSION OF MATERIAL. Antique Radio Classified welcomes and solicits information that pertains or relates to radio history or collecting. This may include articles, book reviews, photos, information on upcoming radio events, meetings, antique radio organizations, radio auctions and price reports, sources of old radio and restoration supplies, and other related and interesting material. All material submitted should be neat and verified for accuracy. Unless prior arrangements are made, all submitted materials may be edited, become the property of Antique Radio Classified and will not be returned.

MAILING OF ISSUES. A.R.C. is available by subscription in the U.S. either by First or Second Class mail (Second Class is the way most magazines are mailed). First Class copies usually are received by the fifth of the month; copies by Second Class mail, by the tenth. The mailing of First Class copies is staggered, with those living farthest away mailed on the first day, and local copies mailed the last day. All non-U.S. copies are mailed on the first day. All Second Class copies are mailed on the last day. Mailing is usually completed by the 25th of the month.

ETHICS. No person involved in the production of A.R.C. is to act on any information in the magazine until they receive their copy through the mail.

DISCLAIMER. The publisher is not responsible for any buying and selling transactions incurred, or for any other use of the contents of this publication.

Antique Radio Classified subscription rates, frequency of publication, content, policies, size and ad details, and rates are subject to change at any time by A.R.C.



ANTIQUE RADIO CLASSIFIED

EDITOR'S COMMENTS

This issue marks our sixth anniversary as well as another year of success and growth. In the past year, subscriptions have increased by over 1,300 - a 29% increase! Classified ads have increased 28%, and the total number of pages has gone up 12%! Thanks to all of you for your support, for advertising and for writing articles; all these make A.R.C. the leading monthly publication for antique radio.

This month's lead article is on television in the 1940s, and the article features the General Electric Model 901 projection television set. Mike Adams describes how General Electric produced this do-it-all model.

Alan Douglas has contributed an article on the unusual Nyacco Model R2 reflex crystal/two-tube receiver. Thanks to Dave Crocker and Scott MacWilliam for providing the photographs and drawings for this article.

In his second article, Ron Ramirez offers more hints on rebuilding Philco condensers. After you read this and the first part (in October 1989 A.R.C.), the mysterious cans in the Philco AC sets should no longer addle your brain.

The illustration on the cover is from an early "Radio Boys" book and introduces the new story "The Antique Radio Boys and the Garrulous Grebe," the first chapter of which appears in this issue. This story is written by Stan Dryer in the style of the 1920's Radio Boys series, and Dave Crocker is the illustrator. The reclusive Stan Dryer can be reached through A.R.C.

The new book on Catalin radios - *Classic Plastic Radios of the 1930s and 1940s* by John Sideli - is reviewed by Catalin expert Ed Lyon. Ed predicts that this book will become the new standard for identifying Catalin radios.

The March auction in Marshalltown, Iowa, reported by Craig Huseboe, included over 350 lots of radio-related items. In addition, this issue contains the *Photo Review* and the latest *Radio-Book Bestsellers* list of the top ten books among collectors.

OOPS!

The price listed in an ad in the last issue for John Sideli's *Classic Plastic Radios for the 1930s and 1940s* was incorrect. The correct softcover price is \$19.95, not \$14.95.

The April issue of A.R.C. had an article on filament rejuvenation which implied that electrons were "used up" at the surface of a filament as it ages. As one would expect among nearly 6,000 critical readers, there are a couple of engineers in the crowd. We are publishing two letters in this issue to set the record straight.

New Rates. As announced last month, subscription rates are going up. Since the new rates go into effect July 1, you can extend your subscription at the current rates until then. Use the card in the center of the magazine and save now!

Visa, MasterCard. A.R.C. now accepts Visa and MasterCard for all orders, subscriptions, books, advertising, etc. The minimum charge is \$10.00. When charging to your credit card, please include the name on the card, the card number, the expiration date, your phone number, and your signature.

Fax. Our Fax number is (508) 371-7129. Fax has been a frequently requested service. When combined with Visa and MasterCard for payment, we can now accept Fax orders for books, subscriptions, ads, etc. Free classified ads can also be faxed. If you have an ad over the free 20 words, but under the \$10.00 minimum charge, we would prefer receiving it by mail with payment. Near the deadline we will accept these ads with follow-up payment by mail. It will be interesting to see how this new technology contributes to the activity of collecting old technology.

Club Events. The summer season begins with the Antique Radio Club of America's convention in Cincinnati, Ohio, June 14-16. This event held in Crosley territory will highlight Crosley products from radios to cars, and a tour of the Crosley radio station WLW is planned.

July brings the big Michigan Extravaganza '90, and with August comes Illinois' Radiofest 1990 in Elgin, IL. In September, the annual Antique Wireless Association Conference (which previously was held in Canandaigua, N. Y.) attracts over 1,000 collectors and will be held at a new location, Rochester, N. Y. This event has been sold out in the past, but will be at a larger hotel this year; it is not too early to make reservations - call the Thruway Marriott, (716) 359-1800.

A.R.C. plans to be at the meetings in Ohio, Illinois and New York. See you there.

Happy collecting!

John V. Terrey

ON THE COVER

The cover illustration this month is from Richard Bonner's *The Boy Inventor's Radio Telephone*, published in 1915 by Hurst & Company. This introduces the new serial story in A.R.C. about the Antique Radio Boys.

The Bonner book is one of many radio stories in addition to the more familiar twenty-nine Radio Boys titles. A.R.C. plans to publish a checklist in a future issue of over 100 "Radio Boys" books, those which have the word radio in their titles or have a radio-based theme.



VINTAGE TELEVISION

The General Electric 901 Projection TV The Device That Defined a Decade

BY MIKE ADAMS

Question: What 1940's electronic device both predicted the future and proclaimed the past? What 45-year-old device introduced a technology that has just come into its own during the past decade? And what manufacturer was so concerned and careful so as not to introduce an out-of-date device such that half of it was obsolete before it was ever made? Had enough? The answer to all these questions is the 1948 General Electric Super Distance 901 projection television, radio and phono combination (Figure 1). More than technical, the real story behind the G.E. 901 is one of powerful interests, postwar confusion and preposterous claims by soon-to-be competing interests in a new telecommunications environment. More than just a television, the G.E. 901 provides a history lesson on the postwar frequency allocation process and government regulation of spectrum space. Look closely at the dial of the 901 shown in Figure 2; it reflects some of the results of the political process in action between 1945 and 1948.

THE VIEW IN THE FORTIES

From a mid-40's perspective, the future would be one in which every home would have a plethora of communications media. World War II and its restriction on the manufacture of consumer goods had just ended, and those companies involved in radio prior to the war were certain that television was about to enjoy a boom not unlike that of radio in the 1920's. The major radio broadcasters realized that the postwar communications expansion would be in television and FM, and they wanted the frequency bands assigned exclusively for TV and FM broadcasting. Manu-



Figure 1. The General Electric Model 901 Super Distance console television receiver.

facturers like G.E. knew in 1945 that if the newly-empowered consumer was to embrace television, channel standards would have to be set, and the resulting new sets would have to have a screen size larger than those few experimental prewar models.

So the original maker of Radiolas, along with Westinghouse under the RCA agreements and

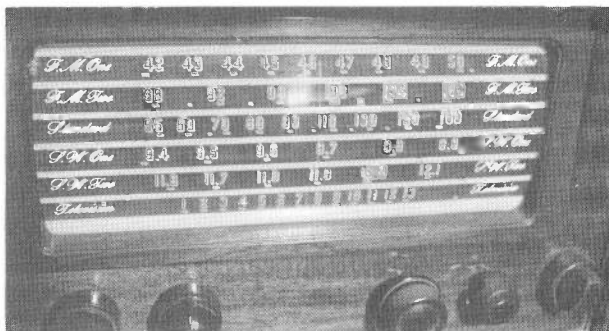

Figure 2. The complex multiband dial of the General Electric Model 901 Television receiver.

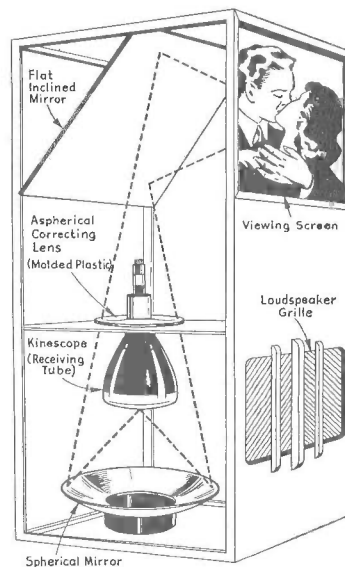

Figure 3. The projection television system for the General Electric Model 901, developed by the RCA Laboratories. ("Television: The Eyes of Tomorrow", 1945.)

the sole maker and supplier of the famous Alexanderson Alternator, would truly have to come on strong with a serious television. The year 1948 would be the first full year of television manufacturing, and the G.E. 901 was positioned to be the home entertainment center of tomorrow. Imagine having a big screen projection television and an AM/FM/shortwave radio and a phonograph all in one very large cabinet. You would, without doubt, be the envy of the neighborhood.

TV & FM FREQUENCY ASSIGNMENTS

Perhaps the designers of the G.E. 901 said: "No matter what the government does in the area of channel assignments, we want this one to have every consumer radio and television service possible." Look at Figure 2. AM: Naturally the 540-1600 kilocycle (now kilohertz) broadcast band was still, after the war, the most popular broadcasting service anywhere. Didn't we depend on the big networks to bring us both the news of the war and provide escapist entertainment in the form of music, comedy and drama? There were also two international shortwave bands, 9.4-9.9 and 11.6-12.1 megacycles (now megahertz or MHz), for still another window on world events during the war. Shortwave bands began appearing on radios in the middle 30's and would continue to be an obligatory feature of big radios throughout the 1940s. AM radio, broadcast and shortwave, was still the pre-eminent broadcasting service.

Television was another story. From 1928-1937, both mechanical and experimental electronic television operated in the 2.0-2.2 and 2.7-2.9 MHz band, just above the AM broadcast band. In 1937, the government gave television

nineteen channels of 6 MHz each in the 44-294 MHz band. Electronic television gradually grew from a low definition 60 line picture to the final 525 line standard in spring of 1941. The National Television Systems Committee (NTSC) finally accepted what was then called "electronic, high-definition" TV, just a few months before the attack on Pearl Harbor. The NTSC standard notwithstanding, television broadcasting would have to wait until later.

This probably meant that frequency allocations for both TV and FM could not be resolved either. Indeed, for broadcasters and the Federal Communications Commission (FCC), the early 1940's were filled with enough important issues. The major networks were fighting the music licensing group, ASCAP (American Society of Composers, Authors and Publishers), and the FCC was attempting to curtail the influence of the networks and return more control to the local station. The fact that Major Edwin Armstrong and the TV people were arguing over where FM and television would reside on the dials of tomorrow was an ongoing issue that would have to wait until after the war. Little noticed in 1940, the FCC, angry at RCA pressure for permanent TV channels, threw out the then channel 1 (42-50 MHz) and gave it to FM. Channel 1 would return.

At the conclusion of 1944, those few television stations that had remained on the air during the war had been using channels 1-5 in the 50-90 MHz band. In 1945, the FCC gave TV its current thirteen VHF channels in the 44-88 MHz (channels 1-6) and 174-216 MHz (channels 7-13) bands and moved FM to 88-106 MHz (later to 108). Obviously, FM interests, led by Armstrong, were angry about the move, arguing that many thousands of prewar FM transmitters and receivers would instantly become obsolete. To resolve this problem, FM stations were allowed to broadcast on both bands from 1945-1948. This move effectively kept television's future use of their new channel 1 in government regulatory limbo and did nothing to resolve the long fight between RCA and Armstrong for the channel.

Postwar frequency allocation pressure was not just limited to broadcasting. Sure, television wanted at least 30-40 channels, 6 MHz wide. Some more enlightened types even wanted to move TV up around 400-1000 MHz and establish thirteen MHz wide channels, just like the new high definition people are saying today, 40 years later. The fact was that in 1945, the railroads asked for 124 channels between 100-200 MHz, bus and trucking wanted 50 channels, facsimile interests wanted 180 channels between 52-56 MHz, aviation wanted the entire 50-200 MHz band, and the forestry service also pressured for channels, all on FM. There was so much intense lobbying for FM spectrum space and so much uncertainty surrounding frequency allocations that it was going to be very difficult to manufacture any device with TV or FM.

While the allocation controversy was mostly resolved by 1948, there must have been a few unanswered questions as the G.E. 901 was rolling off the assembly line. The dial on the G.E.

(Continued on following page)

WITH THE COLLECTORS

Nyaccoflex and the Model R2

BY ALAN DOUGLAS

The New York Album & Card Co. Inc., which claimed to date from 1907, originally made record albums for upright phonographs. In the early twenties, the company advertised a small portable phonograph, and in 1924 combined this with a two-tube crystal-reflex radio. Figure 1 shows an ad appearing in 1925 for the portable radio/phonograph combination.

Nyacco also offered this same radio in a separate cabinet as the Model R2, shown in Figures 2 and 3.

The reflex circuit used in these sets was a popular method of economizing on tubes and battery power. One tube was used for both radio- and audio-frequency amplification. The detector in the Nyacco sets was a crystal de-



Figure 2. The Nyaccoflex Model R2 crystal-reflex receiver.

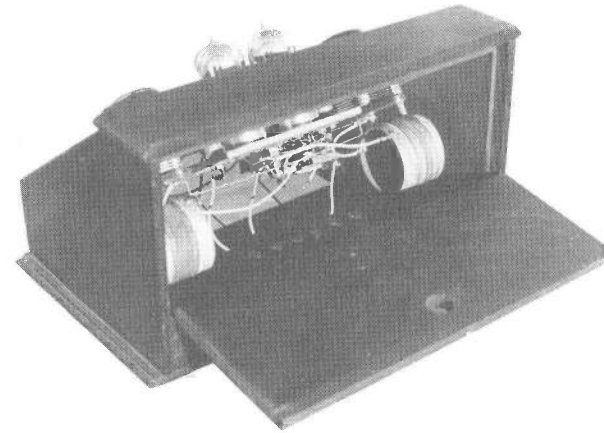

Figure 3. The Nyaccoflex Model R2 with the rear access panel pulled down to expose the two-tube chassis.

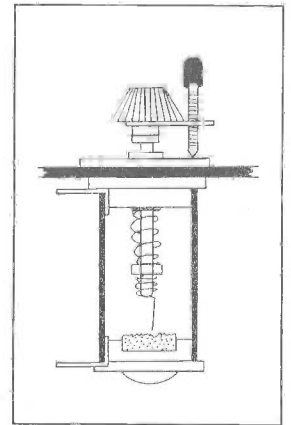

Figure 4. Cross section of the Nyaccoflex crystal detector. (Drawn by Scott MacWilliam).

tor mounted inside a Bakelite tube as shown in Figure 4. This assembly was mounted on the panel, and the crystal could be adjusted with a knob. The schematic for the R2 is shown in Figure 5.

A panel version of this set for installation in upright phonographs was also offered. In 1925, both a three-tube model and a five-tube model (presumably not reflexed) were added. In April 1926, came a portable six-tube model, followed by a two-dial, slant-panel, home model in Sep-

tember. However, Nyacco never did list a price for this "Lyric" home model and soon stopped using illustrations of specific models in its ads. A listing of Nyacco's offerings appears in Table 1. Nyacco's last ad in any publication appeared in September 1928.

Alan Douglas is the author of the three-volume "Radio Manufacturers of the 1920's." Editor. (Alan Douglas, Box 225, Pocasset, MA 02559) (Photos from the collection of Dave Crocker).



NOW IS THE TIME FOR
Portable Radio Phonograph Combination
R. P. 1

WE MAKE IT YOU PREPARE FOR BIG DEMAND

LIST \$55.00 WITHOUT ACCESSORIES 10% LESS USUAL DISCOUNTS



Dealers, write your jobber for details, or address

Radio Panels for Console Phonographs

R. P. 3	R. P. 5
3-tube reflex loudspeaker volume, distance selectivity panel: 10x14	5-tube tuned radio frequency receiver. Two sizes: 14½x17 3/16 or 15 3/16x16½
List \$45.00	List \$65.00

New York Album & Card Co., Inc.
23-25 Lispenard Street, New York

Figure 1. Ad for the Nyaccoflex Model RP1 from "Talking Machine World" for June 15, 1925.

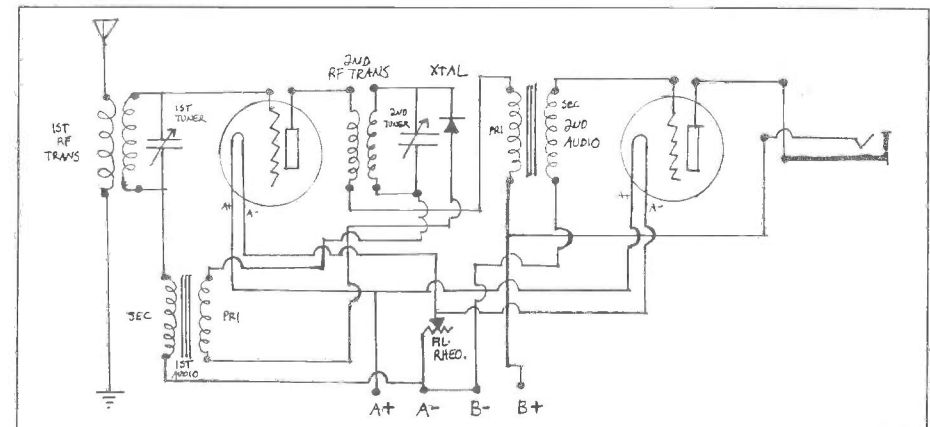

Figure 5. Schematic diagram of the Nyaccoflex Model R2. (Courtesy of Scott MacWilliam).

Model	Date	Price	Tubes	Type
RP1	1924	\$55.00	2	radio-phonograph
R2	1924	32.50	2	table radio
RP2	1925, June	-	2	portable
RP3	1925, Jan.	45.00	3	phono panel
R5	-	40.00	5	-
RP5	1925, May	65.00	5	phono panel (2 sizes)
Nyacco Port	1926, April	65.00	6 ('99s)	portable
Nyacco Lyric	1926, Sept.	-	5 or 3 (listed both ways)	-

Table 1. Listing of the radio models produced by the New York Album & Card Company (Nyacco).



PHOTO REVIEW



This column presents in pictorial form many of the more unusual radios, speakers, tubes, advertising, and other radio-related items (covering the years 1900-1950's) from our readers' collections. The photos are meant to help increase awareness of what's available in the radio collecting hobby. Send in any size photos from your collection. Photos must be sharp in detail, contain a single item, and preferably have a light-colored background. A short description must be included with each submitted item. Please note that receipt of photos is not acknowledged, publishing is not guaranteed, and photos are not returned.

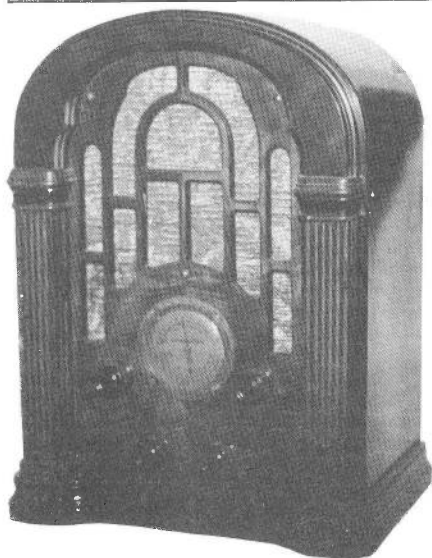

MINT AK - This Atwater Kent Model 735 cathedral looks brand new! It is a five-tube superheterodyne receiver with shortwave bands. (Ron Boucher - Goffstown, NH)

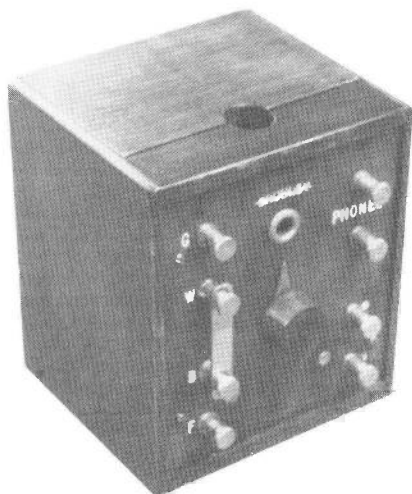

CROSLLEY AUDION DETECTOR - This is the later, better designed, of two audion detector units offered by Crosley in 1922. It is often connected between the Crosley Model 1 crystal set and the Crosley RFTA tuner. (Dave Crocker - Duxbury, MA)

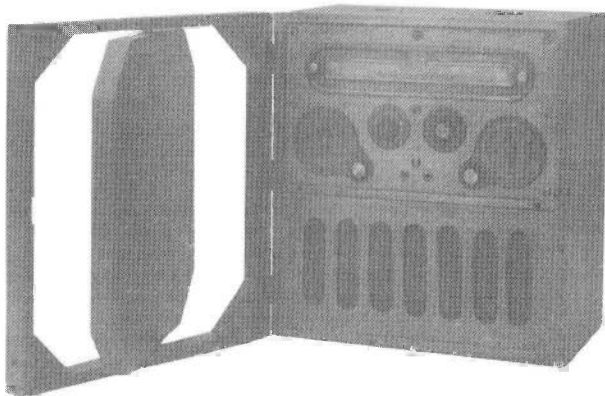

RADIOLA 26 - The Radio Corporation of America offered this two-dial Superhet portable in 1925. It used six UV199 tubes. Note the radio direction finding antenna in the door to the left. This "portable" was a hefty 35 pounds with batteries. (Larry Cannon - Fresno, CA)

PHOTO REVIEW

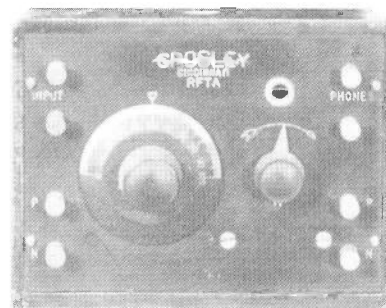

CROSLLEY RFTA - The "RFTA" meant "Radio Frequency Tuned Amplifier". It was used to increase the tuning range of the Crosley Harko receivers. Both pieces were sold in late 1922. (Dave Crocker - Duxbury, MA)

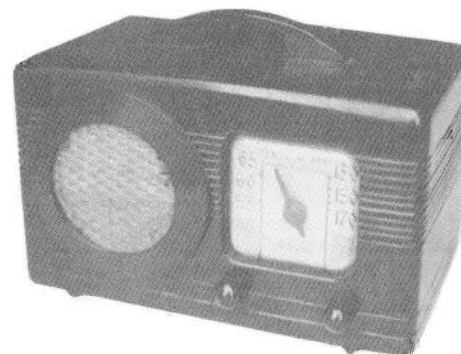

1940 MOTOROLA - The Model 50XC4 was an amber Catalin cabinet radio with a porthole-type speaker grille. The knobs are translucent. The five-tube set received the broadcast band only. (Ron Boucher - Goffstown, NH)

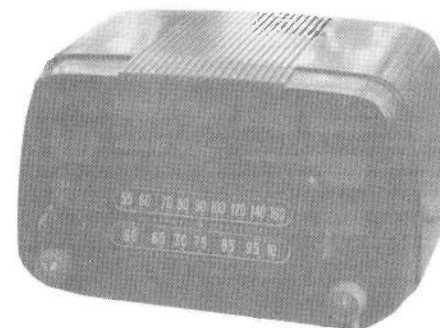

GENERAL ELECTRIC MODEL 220 - The GE radio shown here is an AC/DC model with BC/SW bands built in the late 1940s. This interesting design reminds me of a robot or a bulldog. (John S. Neuman - San Carlos, CA)

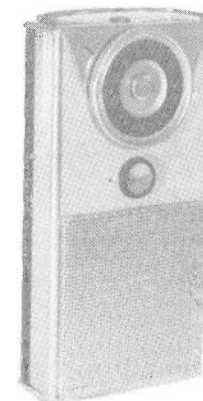

GE MODEL (?) - This General Electric transistor radio has a beautifully machined case. The antenna is beneath the black strip to the left. It has an earphone and RCA pin plug output jacks on the bottom of the case. The late 1950s would be my best guess as to its age. (Bob Moore - Lakewood, Co)

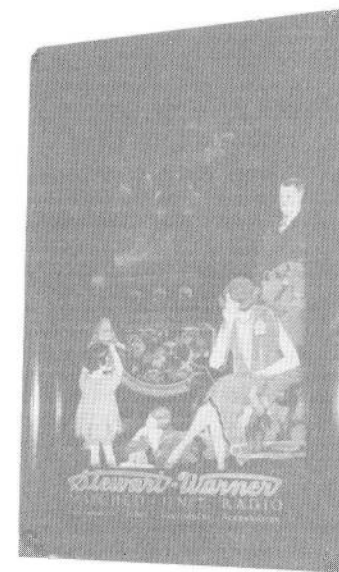

COLORFUL DISPLAY - This 1925 dealer display sign is truly magnificent! It measures about 18"x29". It is very colorful and bright when turned on as it features all the colors of the rainbow. Inside a revolving cylinder is powered by the heat of the bulb, casting a series of shadows up from the orchestra to the top of the blue and grey toned picture above. This gives the effect of sound waves. It still operates with its original GE Mazda light bulbs. (Don Howard - Spokane, WA)

RESTORATION TOPICS

Rebuilding Philco Condensers – Part II

BY RON RAMIREZ

Last time, (in A.R.C., Oct. 1989, page 8, "Rebuilding Philco Condensers"), we dealt with rebuilding Philco Bakelite block condensers. Part II will enable you to repair your Philco set while keeping it looking as original as possible.

Now, let us turn our attention to other condensers in Philco sets. We will begin with the rectangular metal can condensers found on the underside of many Philco sets. Like the Bakelite blocks, these are paper-wound condensers sealed in a black waxy or tar-like substance, wrapped with one layer of thick insulating paper, and put into a metal can. Some cans have only one condenser, and others may have up to five (see Figure 1).

REBUILDING THE CANS

As you can see from Figure 1, it is also easy to rebuild these cans. There are four metal tabs folded over the side of the can where the leads come out. Unfold these tabs carefully (you don't want to break them), and then you can slide the contents out. There is a tiny bare wire that is soldered to one side of the metal case; it is *not* necessary to unsolder this wire from the case if you do your work carefully.

Now that you have the old innards out, the next step is to remove the piece of cardboard-like insulation which the wires pass through. Also remove the insulating paper which is wrapped around the condenser(s). Save these materials for later use.

There are four more examples of metal can condenser hookups in Figure 2. You will note that in many cans with more than one condenser, the lead wires are color-coded. Keep this in mind when rebuilding your cans. If the can you are rebuilding is not shown here, study the schematic of the set to see how the capacitors should be hooked up inside the can before proceeding.

We are assuming that you carefully unsoldered each lead from where it hooked up in the set before you removed the can. Do not cut these wires nor discard them as we will reuse them. At this point, disconnect these lead wires from the original condenser body, as close to the unit as possible. If you use your long nose pliers, you can usually pull the wires free from the old

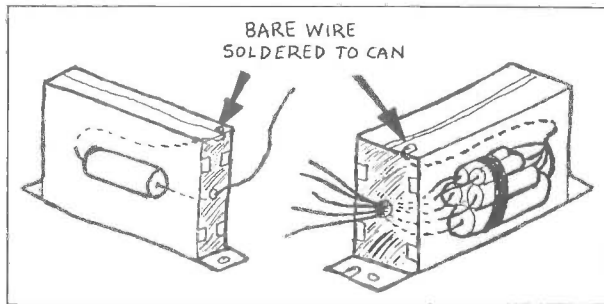

Figure 1. Philco condenser cans. (Left), Part No. 3583, 0.5 mfd, used in Models 20, 70 and 112. (Right), Part No. 06624, 0.05, 0.05, 0.09, 0.09, 0.25 mfd, used in Model 89.

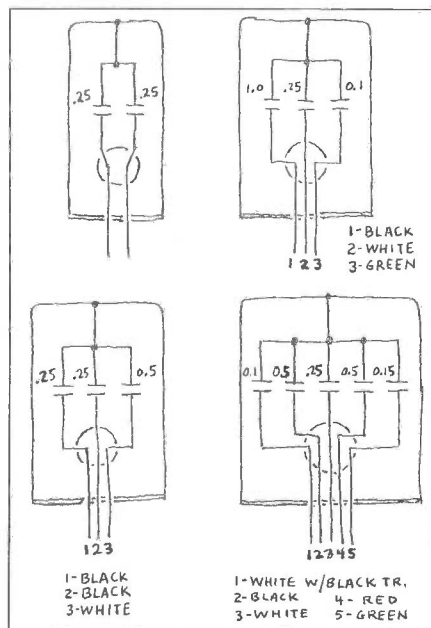

Figure 2. Examples of Philco condenser can hookups. (Top left), Part No. 3557, used in Model 20 and the early Model 112. (Top right), Part No. 03327, used in Model 90 with one Type 47. (Bottom left), Part No. 03029, used in Model 90 with two Type 45s. (Bottom right), Part No. 03915, used in Model 38.

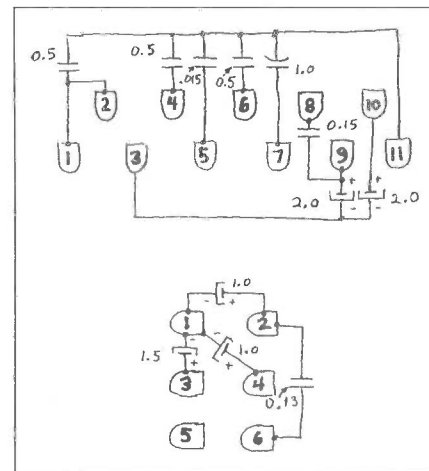

Figure 3. Capacitor replacement layouts for Philco condenser cans. (Top), Part No. 4235, used in Model 20. (Bottom), Part No. 3754, used in Models 111, 112, 211 and 212.

condenser(s). Also disconnect the bare wire from the old condenser body, leaving the other end soldered to the metal can.

Now take your replacement capacitor(s) and prepare them for inserting into the metal can. I recommend the small metalized film (yellow) capacitors such as we used in the Philco Bakelite blocks in my previous article, because of their small size.

One note of warning here: I recommend 600-volt capacitors for all *except* Philco Part No. 3583 (which is shown in Figure 1 and uses only one 0.5 uf capacitor). The metalized film 0.47 uf, 600-volt capacitor is just slightly too large to fit easily into that particular can; therefore, I recommend a 400-volt capacitor for that condenser, which should not cause any problems.

Place the insulating paper which was wrapped around the original condenser back into the can. If the can uses two or more capacitors with one side of each grounded, twist the common leads together with the bare wire soldered to the metal can, and solder these wires together as shown in

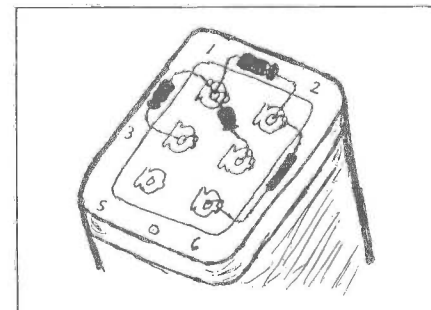

Figure 4. Internal wiring of Philco filter condenser, Part No. 4235, used in Model 20.

Figure 1. If the can uses one condenser, solder one lead to the bare lead if one side of the capacitor is grounded.

Using your original lead wires, stick these through the thick piece of insulation they ran through, and connect each wire to the proper capacitor, as they were hooked up originally. Tape your solder joints (it is not necessary to tape the joint where the capacitor(s) are soldered to the bare wire), and if your can uses two or more capacitors, tape them together as shown in Figure 1.

Now put your new capacitor assembly back into the can. You will have space to fill in the can; you can use bathroom tissue, newspaper, etc. as filler. Once this is done, put the insulating piece which the lead wires pass through into place on the can and fold the tabs back over. You now have a rebuilt metal can condenser which cannot be distinguished from the original, if you did your work carefully.

THE PHILCO FILTER CONDENSERS

Many early Philco sets such as the Model 20 and the early Model 112 had their filter condensers sealed in a large can which sits on top of the chassis. We will now describe how to rebuild the filter condenser can of a Model 20, but you can adapt this method to other models.

Disconnect the can, noting where the leads connect to its solder lugs; unbolt it and remove it from the chassis. The solder lug assembly is riveted to a metal piece which is a press fit onto the can and can be pulled off once the can is removed from the chassis. Once removed, you will see that the wires from the condenser assembly inside the can pass through rivet holes in each solder lug and are soldered to their respective lug (much like a Bakelite block). Disconnect these wires from the solder lugs, and set the bottom piece of the can (the solder lug assembly) aside for now.

Next, you must remove the condenser assembly from the can. The only way to do this is with a small torch. Heat the can until the old assembly falls out. This is very messy, but necessary as you will need some of the space in the old can.

After you have done this, take the bottom piece of the can and mount your replacement capacitors on the side that will go into the can; run the wires through the proper rivets in each solder lug and then solder the leads to each lug (see Figures 3 and 4.) Once this is done, press this assembly back onto the can, bolt the can back onto the chassis, and hook the disconnected leads back to the proper solder lugs. Did you also notice that your rebuilt can now weighs much less than it did before?

Figure 3 also shows that the internal wiring for the filter condenser can be used in the early Models 112 and 212 as well as the 111 and 211. The solder lug assembly of this can is mounted in much the same manner as the 20.

That is all for now. We hope this series on Philco condensers will be of help to you as you restore the Philco sets.

(Ron Ramirez, 811 Maple St., Providence, KY 42450)

THE ANTIQUE RADIO BOYS AND THE GARRULOUS GREBE



"Thick black smoke pouring from a first floor window of the house gave every indication of a serious fire in progress."



RADIO ADVENTURES

The Antique Radio Boys and the Garrulous Grebe – Chapter 1

BY STAN DRYER

"Fire!" cried Terry Johnson. He set down the bag of old radio components he was carrying and broke into a run towards the Beaucart Mansion. His two chums Jimmy Carver and Gary Staunton were close behind him.

Thick black smoke pouring from a first floor window of the house gave every indication of a serious fire in progress. It was fortunate that the Antique Radio Boys had spotted the fire, for the mansion, owned by the millionaire Frank Beaucart, was set in an isolated part of Carlisle, New York. The three young men had taken a short cut home from the town dump where they had been searching for old radios and components for their collections when they spotted the mysterious smoke.

As the boys rush towards the fire, this might be a good time to introduce them. Those of you who have read the previous stories in this series (*The Antique Radio Boys First Sale* and *The Antique Radio Boys at Canandaigua*) will know the kind of exciting adventure this trio of red-blooded American boys might likely encounter. For the poor unfortunates who have missed these thrill-packed episodes, some biographical facts are in order.

Terry, the leader of the crew, was a tall lad with an open manner. A junior at Carlisle High and treasurer of the Antique Radio Club, he was known as an honest youth who could be trusted to face up to a bully or give a fair appraisal of the price of a radio set.

Jim was a boy of a darker temperament. Not as outgoing a fellow as Terry, he was as honest at heart as his companions and could be counted on to hold up his end in any crisis.

Gary, the youngest of the three, was a plump and easy-going lad with the priceless gift of being able to see the humor in a dark situation. While his jokes sometimes missed the mark, his affectionate nature won for him the friendship of all but the hardest of heart.

But enough of introductions and back to our story. The three boys had reached the mansion. From within could be seen the orange flicker of flames. "Try the door!" cried Terry.

Jim tried the knob of the front door and found it locked. "Give it a go, Gary!" he cried, and the stout lad threw his weight against the door. It burst inward, and the young men rushed into a foyer larger than most living rooms.

"Holy Heterodyne!" cried Gary. "Look at all those radios!" They were in a room surrounded by shelves full of vintage radios. Even through the smoke they could see that there were many

unique and valuable models. They had heard rumors that the reclusive Frank Beaucart was a collector, but they had had no idea of the magnitude or importance of his collection.

"We better start saving what we can," cried Gary, "or all of these sets are going to be wireless!"

"Wait," said Terry. "We'd better check to make sure that no one is in here." He dashed forward to a door at the rear of the foyer and burst through it. His quick thinking was fortunate, for behind the door was a lovely young lady of no more than sixteen years, bound and gagged. The terror in her eyes revealed her knowledge of the impending danger.

"Have you out of here in a minute," said Terry. He pulled out the pair of diagonal cutters he kept in his pocket for just such emergencies and cut the ropes in a flash. Lifting the girl in his arms, he dashed out into the open air. Placing her on the grass, he quickly removed the gag.

The young girl took a deep breath of fresh air and then smiled up at Terry. "Thank you for saving my life," she said.

Terry, modest lad that he was, blushed to the roots of his hair. "It was a good thing we happened to be passing by," he said.

The other boys had not been idle. Jim had found a phone and called the fire department. Then he and Gary had busied themselves dashing into the smoke and flames to save what they could of the radios. Fortunately, their years of experience in the antique radio market and their keen eye for value made it possible for them to remove the most valuable sets first. By the time the progress of the fire made it impossible for them to re-enter the room, they had saved all of the vintage plastic radios and the best of the wooden models.

The girl had risen now. She smiled up at Terry. "I'm afraid in all the excitement I haven't introduced myself," she said. "I'm Lucinda Beaucart. My father is the owner of this mansion, Frank Beaucart."

"And I'm Terry Johnson," said Terry. "But can you tell me just what happened?"

But before she could reply, the wail of sirens announced the arrival of the Carlisle Fire Department. As the trucks pulled up to the mansion and the firemen rushed to their duty, a black Mercedes skidded to a stop behind them. A man wearing a Harris Tweed jacket jumped out. "My gosh," he cried, "my collection! Has it been saved?" He rushed about the lawn examining

(Continued on following page)

(Radio Boys, continued)

one after another of the sets that had been pulled from the fire.

"I think all of the important items were saved," Terry called to him. "And also your daughter."

The man, noticing his daughter on the lawn, turned and confronted our young hero. "Just who are you?" he demanded. "And what have you to do with this business?"

Lucinda stepped forward. "This young man is Terry Johnson," she said. "He saved my life. His friends risked their lives to rescue most of your old radios."

"Well, all of you have my eternal gratitude," said Beaucart. He warmly shook hands with each of the young men. "Now tell me, exactly what has happened?"

"After you left, about an hour ago," said Lucinda, "I was sitting at the piano practicing my singing."

"My daughter is entering the Old Tyme Radio Performance Competition," interrupted Beaucart. "But please go on."

"The door of the music room suddenly opened," Lucinda continued, "and a man in a ski mask entered. Before I could give the alarm, he seized me, tied me to a chair and gagged me. Then he disappeared into the foyer. A few minutes later I smelled smoke and saw the flames. Terry came just in time."

"Do you have any idea who this man might be?" asked Beaucart.

"He did not speak," said Lucinda, "but I noticed a scar on the back of his hand very similar to that on the hand of your old assistant, Verton Gridleak."

At the mention of this name, the three boys gave a gasp of recognition. "Verton Gridleak worked for you?" Jim said in disbelief to Beaucart.

"For a while," said the millionaire, "I employed him in restoring some of my sets. Then one day I caught him replacing a cat's whisker with a silicon diode in a crystal set."

"Not the right way to rectify that problem," interjected Gary, not one to pass up the opportunity for a jest.

"Just ignore him," said Jim. "We all try to."

Beaucart smiled faintly and continued, "Needless to say, I was forced to dismiss Gridleak. We had a most unpleasant parting. I can see now that his threats were not idle."

"We know this Gridleak," said Terry. "It is rumored that he got that scar in a soldering iron fight with a fellow ne'er-do-well over the possession of a stolen Silvertone console."

A thought seemed to strike Beaucart. "Do you suppose that he made off with one of my sets?" he cried. He glanced quickly at the sets lined up on the lawn. "It looks like you boys saved all the valuable ones, but I see that my Grebe CR-4 is missing. Do you think you might have left it inside?"

Both Jim and Gary shook their heads. "Looks like Gridleak's grabbed a Grebe," said Gary.

"That's good news," said Terry.

"Good news?" demanded the millionaire. "One of my most valuable sets missing is good news?"

"Certainly," said Terry. "We need to prove that it was Gridleak who set fire to your house. If we can find the Grebe in his possession and prove that it is yours, we'll 'have the goods' on him. Now was there anything special to indicate that the set was yours?"

"Well, each of my sets has a small brass tag with my name and inventory number on it carefully concealed within its case," answered Beaucart.

"We might have difficulty in getting Gridleak to open up the case," said Terry. "Is there any characteristic of the set that would identify it?"

"Certainly, certainly," said Beaucart. "As you must know, the Grebe CR-4 is a regenerative set. This particular one is so unstable that it frequently breaks into regenerative oscillations and must be readjusted."

"That may be just the fact we need to solve this case," said Terry with a grim smile. He nodded to the other boys. "We'd better get right on this."

"Don't you think I should call the police?" said the millionaire.

"I think that until we have some proof, the police would only interfere with what we have to do," said Terry.

"Well, good-bye, and please be careful," said Lucinda to Terry as he left.

The boys headed back to town. Terry had to take a lot of good-natured ribbing from the other two about the obvious impression he had made on the millionaire's lovely daughter.

"Where do you suppose we can find this Gridleak?" said Terry to the other boys. They were seated in Terry's family kitchen, and Gary, as was his custom, was polishing off his second piece of Mrs. Johnson's apple pie.

Jim thought a moment. "I think we should try Barton Sneer's barn first," he said. Sneer was a local bully who was often involved in activities on the shady side of the law.

"Good thinking," said Terry, "Now that you mention it, I've seen Gridleak skulking around Sneer's place a couple of times."

"Well, what are we waiting for?" demanded Jim. "Let's get a moving."

"Hey," said Gary, "give a fellow a break. After a hard morning's work, a guy needs to refuel." But he stuffed the last portion of pie into his mouth and followed them out the door.

They approached the barn on the Sneer property from the rear. The building seemed deserted.

"That door leads to a stairway," whispered Terry. "I think our best bet on finding the Grebe would be the second floor."

They moved silently forward. Jim eased open the door, and they found themselves at the foot of a narrow stairway. Terry motioned the others to follow. Quietly, they made their way up the stairs.

Then, when they were about a third of the way up, they heard an ominous rumbling from above. Looking up, the three Antique Radio Boys saw hurtling down toward them the three-hundred-pound chassis from a vintage disk scanning television set.

To be continued....

AUCTION REPORT

Radio Auction

Marshalltown, Iowa - March 31, 1990

CONTRIBUTED BY CRAIG HUSEBOE

A large collection of battery and AC radios - over 350 lots of radios, tubes and miscellaneous items - were auctioned on March 31, 1990, at the Gene Harris Antique Auction Center, 203 South 18th Avenue, Marshalltown, Iowa. Tom Harris, phone (515) 752-0600, was auctioneer. 126 bid numbers represented attendees from seventeen states and Canada. Most of the items were in good to excellent condition and contained tubes. A few surprises were in store for the bidders as a number of radios and speakers were consigned too late to get on the advertised list.

Freshman Masterpiece	\$60
Stromberg-Carlson Model 636A	45
American Bosch Model 48	60
Atwater Kent Model 145	30
RCA Model 32	25
E.H. Scott Phantom, cabinet not original	100
Federal Type 61	1,000
Arborphone Model 27	50
Western Coil & Electric Type WC-10	240
Federal Type A10	30
Tri-City Model W2, (2)	80
RCA Radiola RS	175
Priess Straight Eight	80
Philco Model 610	60
Magnavox R2 speaker, base only	90
Crosley Model 51	80
RCA Radiola III	95
Zenith Model 5S135	40
RCA Radiola Model 18	85
Pilot Super Wasp, DC version	230
Freshman Masterpiece	80
Atwater Kent Model 20, Big Box	55
Hallcrafters Model S-40B	50
Neutrowound Model 1927, blue, w/tube caps	475
Atwater Kent Model 12 breadboard	1,200
Saal horn speaker	70
RCA Radiola Model AR814	110
Bosch Cruiser Model 116	40
Grebe Synchrophase Type MU1	120
E.H. Scott Phantom chassis & power supply	180
Crosley Trirdyn, (2)	50, 75
Atwater Kent Model 627	325
RCA Radiola IIIA, with 3 WD-11 tubes	150
Fada Model 9312-H	50
Atwater Kent Type E speaker	40
Philco Model 95-45	70
Zenith Trans-Oceanic Model V600	55
Atwater Kent Model 10 (4560) breadboard	800
Master Parmak 1-tube set	205
Atwater Kent Model L horn speaker	40
Atwater Kent Model 49	65
Atwater Kent Model 20C, (3)	60 to 80
Atwater Kent Model 48	50

RCA Radiola Model 16	60
National Model 46 comm. receiver	35
Fada Neutrodyne kit radio	50
RCA Model 16T2	20
Atwater Kent Model 46 with speaker	80
E.H. Scott Model 16, no cabinet	125
E.H. Scott Allwave 12 Deluxe, no cabinet	195
Fada Model 192A	80
Atwater Kent Model 10 breadboard	500
Rider's Volumes 1 through 14	150
Edison Model E phonograph w/oak horn	1,600
Edison Amberola 30	325
Box of 40-50 cylinder records	90
Atwater Kent Model 100 speaker	70
Atwater Kent Type E2 speakers, (4)	35 to 50
Operadio speaker	35
RCA Radiola Model UZ1325 speaker	80
Atwater Kent Model H speaker	70
Hallcrafters Sky Buddy	45
Stewart-Warner Model 325	90
McMurdo-Silver Masterpiece II	250
Day-Fan OEM7	50
Fada Model 175A	120
Atwater Kent Model 465	200
Clarion Model 80	150
Metrodyne with fancy silk screen panel	205
Fada Model R60	210
Atwater Kent Model 30 in Pooley desk	130
Atwater Kent Model 35, (4)	25 to 60
RCA Model K-80	50
Airline Model 62-403	60
E.H. Scott Model 800B	65
Knight kit Model R100A comm. receiver	40
Freed-Eisemann Model FE15	90
Steinite Model 80	37.50
Hallcrafters Model SX-96	70
Miraco 2 tube	70
Workrite Neutrodyne	45
Philco Model 511	45
Howard Neutrodyne	70
RCA Radiola Balanced Amp	200
Philmore crystal set	80
Clapp-Eastham Type HZ amplifier	245
Master Parmak 1-tube radio	200
Atwater Kent Model 3925 breadboard	750
Westinghouse Aeriola Senior	105
Philco Model 37-60	65
Philco Model 267	70
Zenith Trans-Oceanic Model H500	60
Arborphone Model 27	110
Kennedy Model 281 and 521	850
Kennedy Model 220	600
Music Master horn, spruce bell, cracked	125

(Craig Huseboe, 2706 Nelson Rd., Marshalltown, IA 50158)

BOOK REVIEW

Classic Plastic Radios of the 1930s and 1940s

A Collector's Guide to Catalin Models

By John Sideli

REVIEWED BY ED LYON

Radio collectors have always needed books with pictures of collectible radios. How else to convey meaning when corresponding with another collector, and how else to punctuate a description in a classified ad, than to say, "See F.O.S., p. 67..." for example? For us in the collecting craft, the meaning is clear: it refers the reader to page 67 of Morgan McMahon's book *A Flick of the Switch*.

However, more recently, in the ads for Catalin and Bakelite radios, the reference is not to *A Flick of the Switch*, but to Collins' *Radios: The Golden Age* (often abbreviated R.G.A.) Phil Collins'

book of striking pictures of plastic radios has become a catalog for interested collectors. Phil may now have to move over as a new standard will soon be available for the Catalin collector.

That catalog is John Sideli's new book, *Classic Plastic Radios of the 1930s and 1940s*. Graced with vivid photographs of over 200 different cast phenolic radios, the book is bound to be the bible for collectors and dealers. In all, the book has about 230 color photos, superb examples of the craft of photographer Michael Fredericks.

John Sideli has done more than simply give us a packet of beautiful photographs. His book contains some very useful information for both veteran and novice Catalin collectors. One thing often difficult to explain is Catalin color restoration. Sideli presents a clear display of the basic differences one can expect between a Catalin radio as-found and the same radio after restoration to the original colors. He also correctly points out that tastes have changed in fifty years since the radios were made, and some of the colors intended then are not deemed that attractive today; indeed, some of the color fading that has occurred over the years has improved certain color combinations, in the eyes of many collectors.



Other color schemes are markedly improved when restored to the original colors. He presents both sides of the controversy (to restore to the original colors or not) based on the artistic value of the result.

With all the color photos in the book, and a total of only 127 pages, is there any room for text? The answer is yes – some, but not enough to let this book become the final reference for Catalin radio enthusiasts. The book will do nicely in identifying most of the available Catalin cabinets, most of the proper dial faces, grille cloths, and knobs, but the chassis information, model number vari-

ations and other technical data are missing. In the data given for each model illustrated, Sideli very consistently differentiates between the usual colors found and those colors made by the various Catalin manufacturers.

Insofar as accuracy of the data is concerned, the author does a reasonably good job. He has included a number of reproductions of magazine articles and ads, mostly from *Modern Plastics*. These ads and articles presumably became sources of background data for Sideli, giving dates, plastics' manufacturers, and the like, and he must have had other sources as well. Most of these dates and manufacturer and model data are correct. However, a few minor snags did crop up which would normally bother only the purist. With the high likelihood that collectors will adopt this book as their Catalin bible, any errors of substance should be caught early.

Sideli opens with an introduction which details his personal history in collecting these radios, along with other art. Then he launches into "What is Catalin?", and, in answering this question, raises others. After stating that Catalin and Bakelite quickly became generic terms, he fails to maintain the concept that Catalin was only one

type of plastic cast from liquid phenolics and that Bakelite was only one type of plastic compression molded from pulverized phenolic resin. In fact, his illustrations of workmen pouring "Catalin" into lead molds, etc., are, ironically enough, Bakelite Corporation factory scenes. (Bakelite called its "Catalin" "Bakelite Cast Resinoid." The Catalin Corporation also made a "Bakelite" and called it "Catavar," among other names.) It might have been better for the author to have avoided comparing two trade names, and to have contrasted compression molding from casting, as key process differences.

The sections which follow this are more to the theme of the book – the beauty, art, and value of these radios as rare representatives of a classic period in American personal and household furnishings.

Sideli devotes the bulk of the work to a "Gallery of Catalin Radios," and in this chapter he shows, alphabetically by manufacturer, the vivid color photos and data on each model. In the entry on the beautiful Emerson AU190/BT245 "Cathedral" (which most collectors call the "tombstone"), Sideli notes the cabinet to be of Fiberlon (Monsanto Co.) whereas in fact it was made of Marblette (Marblette Corp.); furthermore it is one of only two radio cabinet models made of that material. The other Marblette model also is identified incorrectly; the Emerson BM-258, is mislabeled the BN-258.

In the sizable section on Fada Catalins, Sideli must have realized there were more early model numbers cropping up than early cabinet styles, so he showed an "Evolution of Early Fada Cabinet Style" page to finalize the section. Some of

the model numbers given are in error there, too, but these errors are minor and somewhat understandable. Fada was notorious for model number variants, including the addition of letter suffixes to indicate radio cabinet color. Sideli's Fada Model 53X refers to the Model 53 in an onyx-colored Catalin cabinet, for example.

And, alas, some models of Catalins are missing from the book, like the Detrola 274/281, the Gillette and Maguire Catalins, the Sentinel 195 (although he shows a Lafayette Radio mail-order version of this radio, but fails to identify Lafayette's model numbers, E62 and E63), the Federal and RCA "Big Boxes," and several color combinations known to exist in some of the models shown.

However, to Sideli's credit, here at last is a photo of an Espey 851, one of the rarest of all Catalins and one whose existence is even denied by some.

Sideli can be proud of this book as a work of art, and he should see it referred to aplenty in the future. This book will become the standard for Catalin ads and descriptions for the next several years. But what shorthand initials will be used for *Classic Plastic Radios of the 1930s and 1940s*? How about "C.P.R."?

The publisher, E. P. Dutton, expects a mid-June delivery to its suppliers. At \$19.95 the paperback version of this book is a bargain, and the \$29.95 hardback is also reasonable.

[Note: Only page proofs were available for this review, and possibly some of the errors mentioned here will be corrected in the final printing.]

(Ed Lyon, 11301 Woodland Ln., Myersville, MD 21773)

Radio-Book Bestsellers

CONTRIBUTED BY GEORGE A. FATHAUER AND JOHN V. TERREY

AES	ARC	
1	1	<i>Guide to Old Radios: Pointers, Pictures and Prices</i> , by David and Betty Johnson: Wallace-Homestead Book Co., 1989, \$16.95.
2	2	<i>A Flick of the Switch, 1930-1950</i> , by Morgan E. McMahon: Antique Electronic Supply, 1975, \$11.95.
3	-	<i>How to Repair Old-Time Radios</i> , by Clayton L. Hallmark: Tab Books, 1979, \$9.95
4	-	<i>1990 Price Guide to Vintage TV's and Collectible Radios</i> , by Harry Poster and John Sakas: Sight Sound Style, 1989, \$10.00.
5	3	<i>Vintage Radio, 1887-1929</i> , by Morgan E. McMahon: Antique Electronic Supply, 1981, \$11.95.
6	4	<i>Communications Receivers, the Vacuum Tube Era: 50 Glorious Years 1932-1981</i> , by Raymond S. Moore: RSM Communications, 1987, \$14.95.
7	8	<i>Radio, A Blast From the Past</i> , by H.G. Wolff and I. Jacobson: Sound of Music, 1987, \$25.00.
8	9	<i>Antique Radios, Restoration and Price Guide</i> , by David and Betty Johnson: Wallace-Homestead Book Co., 1982, \$14.95.
9	5	<i>Radio Manufacturers of the 1920's, Vol. 2</i> , by Alan Douglas: The Vestal Press, 1989, \$24.95.
10	7	<i>Radio Manufacturers of the 1920's, Vol. 1</i> , by Alan Douglas: The Vestal Press, 1988, \$19.95.
-	6	<i>Radios - The Golden Age</i> , by Phillip Collins: Chronicle Books, 1987, \$14.95.
-	10	<i>Most Often Needed 1926-1938 Diagrams</i> (reprint): Supreme Publications, \$11.95.

"Radio-Book Bestsellers" is a ranking of the top-ten selling books of interest to radio collectors according to the sales in early 1990 at Antique Electronic Supply (AES) and *Antique Radio Classified* (A.R.C.). The data is supplied by George A. Fathauer of Antique Electronic Supply, 688 W. First St., Tempe, Arizona 85281, and John V. Terrey of *Antique Radio Classified*, P.O. Box 2, Carlisle, MA 01741. Prices shown are the publisher's suggested retail prices.

CLASSIFIED ADVERTISEMENTS

FOR SALE: Westinghouse Model H648T4 small white plastic radio, works - \$20. GE Bakelite radio - \$25. Jeff H. Gentry, 708 Locust Ave., Charlottesville, VA 22901. (804) 295-5619

WANTED: Old electrical and radio books, switch-board meters, knife switches, dynamotors, open-frame motors, etc. H. Andreoni, 250-D, So. Lyon Ave., Hemet, CA 92343

WANTED: Philmore one- or two-tube battery receiver. Please describe condition. Robert Stapleford, 1800 Randolph, Topeka, KS 66604

FOR SALE: Power supply for Radiola 47 - Offer. J. Stueber, 8920 Lexington Ave. NE, Albuquerque, NM 87112

WANTED: Antique vacuum pumps, equipment and catalogues from Radio Tube Mfg. and Science, pre-1940. Ed Graper, 5960 Mandarin Ave., Goleta, CA 93117. (805) 964-7117

WANTED: Telegraph equipment made before 1900, foreign and domestic, especially early camelbacks and registers. Gil Schlehman, K9WDY, 335 Indianapolis Ave., Downers Grove, IL 60515. (312) 968-2320

FOR SALE: Hickock 533 tube tester, good condition, with manuals, checks antique tubes - \$58 includes shipping. Kirk Ellis, KK4YP, 18 Foxfire, Selma, NC 27576. (919) 965-9577

WANTED: Midwest, Royale, Regal radios. Televisions; projection sets, kit TVs, prewar, etc. Bernard Sampson, 2905 Rusk, Houston, TX 77003. (713) 228-6741

WANTED: Power pack and speaker complement Scott Super Deluxe AVC Super 1933. George Demeroukas, 1417 N. 36th, Melrose Park, IL 60160

FOR SALE: Balloon-type tubes, tested, boxed, guaranteed. LSASE for list and other electronic items. John Snow, 4539 Bartlett, Shorewood, WI 53211. (414) 964-0194

WANTED: Kennedy 521 amp. Paragon DA 2 detector/amp. Excellent to mint Radiola (RCA) 103 speaker. E. E. Hite, 2625 Colecreek Ln., Rock Hill, SC 29730. (803) 366-9998

WANTED: For Collins 75A3, 8R-1 100 Kc calibrator, CW/AM filters, F455-08, F445-60. Parting B&W 5100B/51SBB. Robert G. Schafer, WA7IHN, PO Box 442, Aumsville, OR 97325. (503) 749-1149

FOR SALE: B&K Model 700 tube tester, excellent to mint w/manuals - \$65, I ship. John Snow, 4539 Bartlett, Shorewood, WI 53211. (414) 964-0194

FOR SALE: Stock Certificates: Collins Radio Warrants - \$5, Sentinel Radio - \$10., Jefferson Travis Radio - \$10. J. J. Papovich, 53 Magnolia Ave., Pitman, NJ 08071. (609) 582-8279

WANTED: RCA Model 816K, any condition including parts. Chuck Dachis, The Hallicrafter Collector, 4500 Russell Dr., Austin, TX 78745

FOR SALE: Sams Photofacts, most from 27 to 750 - \$1.25 ea. plus postage. SASE for list. Bob Zimmer, 205 Brigham Hill Rd., Milton, VT 05468

**SELLERS ... PLEASE NOTE
A.R.C. ADVERTISING POLICY...**

ALL ITEMS MUST BE DESCRIBED FAIRLY. REPRODUCTIONS, REPRINTS AND NOT-ORIGINAL ITEMS MUST BE SO IDENTIFIED. ADVERTISERS AGREE TO RESPOND PROMPTLY TO INQUIRIES AND ORDERS. AND TO RESOLVE PROBLEMS PROMPTLY IF THE BUYER IS NOT SATISFIED.

FOR SALE: Weather warning radio Bearcat Model BCWA with alert, new in box - \$35, plus shipping. J. J. Papovich, 53 Magnolia Ave., Pitman, NJ 08071. (609) 582-8279

WANTED: Indicatorscope I-152-A for SCR-718 radio altimeter. Also APS-10 radar system or components. William Van Lennep, PO Box 211, Pepperell, MA 01463. (508) 433-6031

FOR SALE: Atwater Kent Big 20, cabinet only - \$24. Webster wire recorder - \$60. Rider's Manuals 7, 8, 9, 10, 12, 13, 14, 16 - \$15 ea. Precision tube checker Model 612 - \$15. Plus UPS. Leon Gann, 1134 E. 50th Pl. No., Tulsa, OK 74126. (918) 425-3590

FOR SALE: Home brew 5-band receiver, 15 tubes, 15 hand-wound plug-in coils, with speaker, all very well built - \$65, I ship. John Snow, 4539 Bartlett, Shorewood, WI 53211. (414) 964-0194

WANTED: Crystal sets collection now at 163 pieces, looking for more sets. Erwin Macho, Ambrosweg 17/A/8, A-1230 Vienna, Austria

WANTED: Speedx bugs and keys by Johnson and Logan. Herb Spivey, POB 27, Baldwyn, MS 38824. (601) 365-5594

CLASSIFIED ADVERTISEMENTS

FOR SALE: Antique Voltammeter by Y.E.W. of Tokyo. DC voltages of 45mv; 3v; 30v; 150v; 300v - \$30. I ship. John Snow, 4539 Bartlett, Shorewood, WI 53211

FOR SALE: Jukebox service manuals: 1960's-1970's Wurlitzer, Seeburg, A.M.I., Rock-Ola. Seeburg transistorized stereo amplifier TSA 1 - \$85. Heathkit transistor tester IT 121 - \$75. Write for details. Jack Naimann, 365 Bronx River Rd., Yonkers, NY 10704. (914) 237-4650

WANTED: Knobs for Admiral 19A11 TV. One knob for Crosley 9425 TV or junk set with knobs. 7- & 10-in. TV's from late 40's. **FOR SALE:** Rider's #4 & #5 - \$25 ea.; #6, #7, #8, #11, #12, #13, & #15 - \$10 ea. Rider's Automatic Record Changers & Recorders - \$25. RCA Red Book Vol. #2, 1938-1942 - \$25. Drakes Radio Cyclopedic - \$40. Tony DeMara, 40231 Day, Mt. Clements, MI 48044-2535. (313) 263-0325

FOR SALE: WWII radio stuff; aircraft and field sets, but mostly parts, accessories, etc.; lots of dynamotors, some ARC-5. New list, send SASE. Henry Engstrom, PO Box 5846, Santa Rosa, CA 95402

WANTED: Cabinets for Zenith T405P, green/ivory; RCA 9-X-571, brown/gold; Zenith H725Z1, brown. Philip Brunais, 14185 Pleasanton Hwy., Bear Lake, MI 49614

MESSAGE: Anyone from or going thru Ohio to Bloomington, Minn., please contact me. L. Luke, LB415, Coshocton, OH 43812

CLASSIFIED ADVERTISEMENTS

FOR SALE: Sola 500 V.A. constant voltage xfmr. - \$50. Hewlett-Packard Model 500B freq. meter - \$25. General Radio Lab. Type 716C capacitance bridge - \$50. Westinghouse P-50 computer plug-in cards, Teletype Models ASR35 and RO33, SASE for information. **WANTED:** Reproduction AK double crystal detector, please name price or have AK variocoupler or Edison cylinder phono to trade. D. W. McDonald, 1813 Main Ave., Clear Lake, IA 50428. (515) 357-2446

WANTED: Crosley Pup, in any condition, with or without tube. Will pay any reasonable price. Tony Piccoro, 3261 Park Forest Dr., West Bloomfield, MI 48033. (313) 363-1017

FOR SALE: German WWII cipher machine enigma. 3-rotor model with all five rotors. (Only three of the five uniquely wired rotors are used at one time.) Machine is complete, in wooden case with all jumper cables and light filter. Includes Xerox copy of operator's manual and coding instructions, both in German - \$2,400 firm plus shipping. Steve Schreiner, Rte. 1, Box 342A, Maricopa, AZ 85239. (602) 424-3247

FOR SALE: New Stancor P-6415 isolation testing transformer. Input 117vac; Sec: 105/115/125vac @350va 3 receptables. \$50, I ship. John Snow, 4539 Bartlett, Shorewood, WI 53211

WANTED: Zenith radios Models 4B313, 5D610, 5G617 and 6D620. Dennis Choinski, 1435 Oakes Rd., #5, Racine, WI 53406. (414) 886-3968, call after 3 CST

WIRELESS COMMUNICATION IN THE UNITED STATES

The Early Development of American Radio
Operating Companies

BY THORN L. MAYES, W6AX
240 Pages - 160 Illustrations

The glory days of high powered wireless, 300,000 watt spark transmitters, 1,000,000 watt arc transmitters and mighty Alexanderson alternators with antennas as long as nine miles.

Factual accounts of alternators, arcs and sparks, and of coherers, barretters and tikkers!

Unscrupulous stock promotions that by chance yielded technical breakthroughs.

Excerpts from unpublished letters of pioneers and early drawings of quenched gap spark transmitters.

Prepared for publication by Westinghouse engineer, Arthur C. Goodnow, W1DM.

Softcover - Expected shipping date: Dec. 31, 1989

Send \$29.95 plus \$3.00 for shipping & handling to:
The New England Wireless and Steam Museum, Inc.
697 Tillinghast Road, East Greenwich, RI 02818

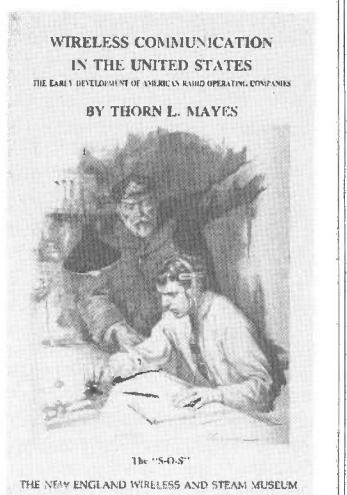

CLASSIFIED ADVERTISEMENTS

WANTED: Cabinet or dimension details for Crosley Model 7, shortwave converter, utilizing plug-in coils. Jim DiRuzza, 2607 Old Troy Pike, Dayton, OH 45404. (513) 233-5004

FOR SALE: ARC-5 racks, FT-226A black wrinkle - \$12; FT-227A nat. alum. - \$15; FT-220A triple black wrinkle - \$20. I ship. John Snow, 4539 Bartlett, Shorewood, WI 53211. (414) 964-0194

FOR SALE: VCM 2001 (video control module) 1989 Westinghouse, new never-opened w/manual, original cost \$300 - \$165. I ship. John Snow, 4539 Bartlett, Shorewood, WI 53211

WANTED: Manual for Jackson 103 tube tester. Manual and tube chart for Seco 107B tube tester. Also mystery control for 39-116 Philco. Thanks. Robert Varney, Rt. 1, Box 192-A, Dakota, MN 55925. (507) 643-6388

FOR SALE: Balloon-type tubes, tested, boxed, guaranteed. LSASE for list and other electronic items. John Snow, 4539 Bartlett, Shorewood, WI 53211

FOR SALE: Hickock 6000, 6000A, and 6005 tube tester owners. Obsolete tube types and supplementary test data, 23 pages - \$8 pp. John Snow, 4539 Bartlett, Shorewood, WI 53211. (414) 964-0194

WANTED: RCA Models 816K and ACR-11, any condition including parts. Chuck Dachis, The Hallicrafter Collector, 4500 Russell Dr., Austin, TX 78745

rainy day books

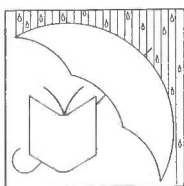

PO Box 775
Fitzwilliam, NH 03447
(603) 585-3448
frank bequaert
lucia bequaert

**Radio and Other Technical
Books, Catalogs and
Magazines Bought and Sold**

Come visit our shop!
Rt. 119, Fitzwilliam Center, NH

Open May 1 to November 15
11 a.m. to 5 p.m.
(Closed Tuesdays and Wednesdays)

Or write for our list of lists

CLASSIFIED ADVERTISEMENTS

WANTED: Kardonstrip 3-dial, Kardon Carnival 3-dial, complete sets or parts and info. Mike Parker, 945 S.E. Linn, Portland, OR 97202

WANTED: Summer 1959 Popular Science with Philco Safari on cover. Also need one Safari side knob and battery. Michael Arken, 1427 Diamond St., San Francisco, CA 94131. (415) 648-6817

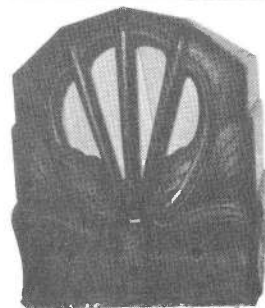

HELP: Need chassis, speaker, knobs for Crosley, Chassis #59 Snow Boy. (5) tubes: 1-80, 1-47, 2-35, 1-24. I'll pay cash, and renew your A.R.C. for year. Thanks. Peter Burton, 39 E. Walnut St., Belcher-town, MA 01007. (413) 323-5019

WANTED: Dial face for Philco Model 38-12 table radio. Gordon Phillips, 610 N.E. Royal Ct., Portland, OR 97232

WANTED: E. H. Scott and McMurdo-Silver sets, chassis, literature, parts. Anything Scott/McMurdo! Mike Greene, 19113 Alpenglow Ln., Brookeville, MD 20833. (301) 774-3203

FOR SALE: National PW-4 precision four section condenser, excellent to like new - \$40. I ship. John Snow, 4539 Bartlett, Shorewood, WI 53211. (414) 964-0194

SEND ALL A.R.C. MAIL TO
Antique Radio Classified
P.O. Box 2, Carlisle, MA 01741

WANTED: Late 50's battery-operated transistor clock radios. Write for illustrated list. Michael Arken, 1427 Diamond St., San Francisco, CA 94131. (415) 648-6817

FOR SALE: Arvin to Zenith service bulletins, copy. Ex: Philco Model 90/A, (8 pp.), LSASE - \$1.50. James J. McGrath, W2IOJ, 2 Centerview Ln., West Seneca, NY 14224. (716) 675-0160

FOR SALE: Marantz 7, JBL Metregon, WE 15B horns, tube amps, WE tubes, audio books. Vernon Vogt, 330 S.W. 43rd St., #247, Renton, WA 98055. (206) 251-5420, ext. 247

WANTED: Tuning dial assembly for 1927 Edison R-1 radio. Don Bolton, 4875 E. Maychelle Dr., Anaheim, CA 92807. (714) 974-4054

WANTED: Harmon-Kardon AM tuner, narrow band, tube type. Kenneth Miller, 10027 Calvin St., Pittsburgh, PA 15235. (412) 242-4701

CLASSIFIED ADVERTISEMENTS

WANTED: Need PC boards form Harris Corp. RF-716 xmtr. Also Collins TD-1, CP-1. Hallicrafters S-36. Gary Cain, 1775 Grand, #302, St. Paul, MN 555105

WANTED: Transistor radios, need R2-D2 robot, Dick Tracy or any odd-shaped transistor TV's. Al Kertesz, 3439 W. Brainard, #260, Cleveland, OH 44122. (216) 831-4199, (216) 831-9110, office

WANTED: Black handle for top of Fada 1000. Also small knobs for Crosley dashboard radios, all colors. Stephen Fabrico, Box 27, Church St., Bloomington, NY 12411. (914) 331-4760

FOR SALE: New Stancor P-6415 isolation testing transformer. Sec: 105/115/125vac @350va. - \$50, I ship. John Snow, 4539 Bartlett, Shorewood, WI 53211

HELP: Does anyone have a Peerless 65 working chassis? Both units. Pay cash. Don Smith, 1323 North B St., Hamilton, OH 45013. (513) 894-5489, call collect

WANTED: Hallicrafters DD1 Skyrider Diversity. CBs: Lincoln, General, International (CB10 & 1500); information on Relyodyne. Harry Blesy, 2409 Northgate, North Riverside, IL 60546. (708) 442-8855

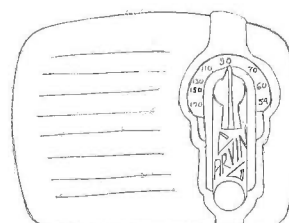

FOR TRADE: Rare 1940 Arvin 2-tube Model 40, pictured. **WANTED:** Hopalong Cassidy for my wife's birthday present. Help make someone happy! Lee Alder, 848 Appleberry Dr., San Rafael, CA 94903. Work # (415) 981-2882, days

HELP: Need Fada 711 butterscotch case with red handle and knobs. Other IF available. Joe Patrick, Box 760, West Elizabeth, PA 15088. (412) 384-5211

WANTED: Needed badly, Auto Dyne oscillator coil for a Philco Model 89 cathedral. Randy Smith, 822 W. 7th Ave., Lancaster, OH 43130

FOR SALE: Antique, Simpson Model 479 FM-TV signal generator, mint condition w/manuals - \$65, I ship. John Snow, 4539 Bartlett, Shorewood, WI 53211

WANTED: Speedx bugs and hand keys. Herb Spivey, POB 27, Baldwin, MS 38824. (601) 365-5594

CLASSIFIED ADVERTISEMENTS

WANTED: Old transistor radios, small portables. Send photo or model number with price. John Hoffnagle, 10 Sunset Ave., New Oxford, PA 17350. (717) 624-8894

FOR SALE: Reel-to-reel player/recorder; VM Model 722 stereo & Model 1688 speaker amplifier - \$75. Wilcox Gay Recordio, mono - \$35, plus shipping. J. J. Papovich, 53 Magnolia Ave., Pitman, NJ 08071. (609) 582-8279

HAS YOUR SUBSCRIPTION

EXPIRED?

It has if your mailing label reads
"EXP= JUN90" or earlier.
Renew now!

BONUS: Renew before
your "EXP" month and receive
13 issues per year instead of 12!

Renewal rates are:
\$20.00 for Second-Class Mailing
\$30.00 for First-Class Mailing
(Two-year renewals are twice above rates.)

WANTED: Loop antenna preferably DeForest. Ham transmitter Thordarson. What do you need? Money? WD-11's? Mercury Super 10? ? ? H. K. Fredrickson, 218 Skeena Cres., Saskatoon, Saskatchewan, Canada S7K 4G8

FOR TRADE: Emerson Patriot (red, white, blue) for RCA Model 40X57 (Golden Gate Exposition). No cracks, all parts authentic. Kris Gimmy, 1441 Nottingham Dr., Aiken, SC 29801. (803) 649-9795

FOR SALE: Hewlett-Packard oscilloscope Model 130C w/manuals, excellent condition - \$125, I ship. John Snow, 4539 Bartlett, Shorewood, WI 53211. (414) 964-0194

WANTED: 1921-23 regenerative receivers. AK, RCA cathedrals. Scarcer Radiola. Aeriola Jr., Winchester, Eveready, Ozarka. Single items or a collection. Edward K. Bell, 5311 Woodsdale Rd., Raleigh, NC 27606. (919) 851-1517

• LOUDSPEAKER REBUILDING •

Custom rebuilding, with special attention to original appearance and quality.

Field coils: We rewind them.

Obsolete cones: If we don't have a replacement, we will try to fabricate one for you.

In business for 18 years, we are authorized service for most major speaker manufacturers. Call toll free for information: 1-800-367-SPKR

Lakes Loudspeaker Service

4400 W. Hillsboro Blvd.
Coconut Creek, FL 33073

We ship UPS and Greyhound



CLASSIFIED ADVERTISEMENTS

FOR SALE: For experimenters only: Power transformers, open-frame with soldertabs removed from equipment, primary 115 volts secondary 50 volts and 6 volts, also 30 volts and 6 volts, also other voltages, 1 pc. Thordarson #23V104 rectifier transformer PRI 115v sec. 24/27/30/33/36/volt at 3 amps., never used, list - \$36, only \$15. Relays: plastic-encased with octal plug 24v DC coil 5-amp contacts d.p.d.t. Type Sigma 50R02 and others, color TV, theory and service techniques books by Philco, RCA, GE, Rider (b&w) Buchsbaum (b&w) - \$15 ea. ppd. Please write for details. Jack Naimann, 365 Bronx River Rd., Yonkers, NY 10704. (914) 237-4650

WANTED: Junker AC-DC battery peanut tube portable chassis for parts. Must have good variable cap. and 1R5 oscillator coil. Open IFs OK. Jim Zacher, 39W345 Central, Elgin, IL 60123

WANTED: Radiola 30 power unit Model AP947. Polleroyal Gem of the Air radio parts from the front panel back and schematic. Good, Bakelite base, no tip WD-11. Browning-Drake Model 5R schematic. Back for a FM promotional radio that is shaped like a microphone, white. Also, what chassis type is used in a Stewart-Warner "our world today" radio that looks like a set of books? Leonard Arzooonian, 61 Columbus Ave., North Providence, RI 02911. (401) 232-0869

FOR SALE: AK 50 - \$110. AK 70 - \$95. Majestic 71 - \$75. Zenith 34-P, rough - \$40. Table models: Telefunken Allegro - \$75. Day-Fan 5 - \$55. OEM 7 - \$70. Graybar 310 - \$40. Frank Williams, 201 Luther St., Rising Sun, OH 43457. (491) 457-7594

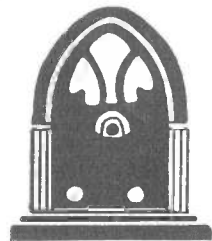

**Craig L. Graybar
Furniture Works Ltd.**
(414) 258-2390

SPECIALISTS IN RESTORING, REPAIRING AND REPRODUCING CLASSIC STYLED ANTIQUE TV, RADIO & PHONOGRAPH CABINETS

Send us your plans or your project via UPS for immediate price quotes

1535 S. 84th St.
West Allis, WI 53214

"We Turn Ideas Into Heirlooms"

CLASSIFIED ADVERTISEMENTS

FOR TRADE: Patriot Emerson Catalin red, white & blue for Bendix Model 115 - yellow with swirl, red front. Jim Martes, 1022 E. Hayward, Independence, MO 64050. 836-0688

FOR SALE: Kennedy 20 - \$165. Thermidyne TF-6 - \$125. Tri-City, one-tuber - \$125. Klitzgen (Michigan) one-tuber - \$95. Reg. one-tuber - \$75. Crosley 51 - \$95. Hallicrafters Sky Buddy - \$45. Radiola UZ-1325 horn - \$85. Atwater Kent 55 chassis - \$25. Atwater Kent 37 chassis - \$25. Others. Books. SASE for enquiry. Arthur Harrison, 501 Arbor Dr., Columbia, MO 65201. (314) 474-8729

**HAVE YOU MOVED? ARE YOU MOVING?
PLEASE NOTIFY US A.S.A.P.
SEND US YOUR...
OLD ADDRESS
NEW ADDRESS and
SUB #
MANY THANKS!!!!**

WANTED: E. H. Scott 30- or 33-tube Philharmonic chassis in rough, rusty condition. Tuner can be rusty, bashed-up and/or missing parts. Amplifier can be rusty and/or banged-up just as long as it's complete. The speaker can be rusty and/or torn-up just as long as the field and voice coils are good. Please sell me your scrap-heap! P.S. I'll also settle for one in good condition! Craig Korpak, 9130 Silver Lk. Rd., Linden, MI 48451. (313) 735-7264

HELP: Information on a Seymour Century lowboy from Ashton Ltd. 5-tube set including a UU6, VP41, TH41, NL41/DD, and a PEN45. Request tube/radio data, schematic diagrams or any help you can give me. Dan Robidoux, 2394 Rosemary Dr., Sparks, NV 89434. (702) 459-8858

WANTED: Model 90 Philco, 1950's Coke cooler radio, and Bing Crosby Junior jukebox phonograph. Carlton Ward, 120 Vassar Dr., Lake Worth, FL 33460-6357. (407) 588-2272

FOR SALE: Schematics manuals, commercial, industrial, some copies, some industrial receivers, transmitters, test equipment. SASE. Walt Belsito, 409 Willow, Waterbury, CT 06710

**WANTED
TRANSMITTING TUBES FOR MUSEUM**

Do you have any old amateur or commercial transmitting tubes worthy of saving for posterity? If yes, help us do same. Contact:

**The Olde Transmitting
Tube Museum**
P.O. Box 97, Crescent City, CA 95531
(707) 464-6470

CLASSIFIED ADVERTISEMENTS

WANTED: SW3 coils, power supply and plugs. Scott Phantom, RCA 30/40's short tombstones. Hallicrafters SX-28, S38, S-53. **FOR TRADE:** Mills hightop 10¢ slot machine, Philco 16 cathedral case, Tektronics 544 scope with L20 spect. analyzer, 2 CA dual trace and 1 Type E plug-ins. Hewlett-Packard 608 signal gen. Frank Maggioro, 600 Westtown Rd., West Chester, PA 18382. (215) 436-6051

WANTED: National HFS manuals, etc., copy OK. Top & back of wraparound. Sayre Winkie, 1836 Washington Ave. SE, Cedar Rapids, IA 52403. (319) 364-1414

**NOTICE TO ALL
CLASSIFIED ADVERTISERS!
OUR CLASSIFIED AD DEADLINE IS
12:00 NOON
ON THE 10th OF EACH MONTH**

FOR SALE: 630-type RCA-licensed TV manufactured by Sheraton, 20-inch pix - \$25. Al Smith, 25 Stonehedge, Lincoln, MA 01773. (617) 259-9351

HELP: Please help: I have a Hickock cardmatic tube tester. I need tube cards for radio tubes. Riggs Smith, 7477 W. Nichols Pl., Littleton, CO 80123. (303) 973-8792

FOR TRADE: My 1937 Zenith console 6S152 or 1940 console 10S464 for your Zenith console 1936 Model 5S52. My sets in good condition. Can deliver to Cincinnati meet June 14. Carl Bryant, 269 Melbourne Way, Lexington, KY 40503. (606) 278-7355

CLASSIFIED ADVERTISEMENTS

FOR SALE: Sencore Model VA48 color TV and video analyzer, like new, in box with manual - \$275 or trade for cathedrals I need. J. A. Jenkins, 4970 Dunkeith Wds. NW, Canton, OH 44708. (216) 477-9501

FOR SALE: Webster wire recorder 80-1, wire spools - BO. RCA Model 66X11, nice cabinet - \$25. Bob Puttre, 637 Stratford Rd., Baldwin, NY 11510. (516) 223-9667

WANTED: Any type or length of 16mm films. Educational, institutional, etc. Alan Brooks, 623 South Pine St., Seneca, SC 29678. (803) 885-0364

WANTED: Calibrator 8R-1 for Collins 75A3. Manual or schematic for Breting 12. Copies OK. Rider's radio manuals full set or Start #1 thru ? Parting B&W 5100B-51SBB. Robert Schafer, WA7IHN, POB 442, Aumsville, OR 97325. (503) 749-1149

FOR SALE: N.O.S. and used tubes of 20's, 30's, 40's. Send SASE with your needs. John W. Richardt, Jr., W2WIY, 94 Bald Eagle, Hackensack, NJ 07840. (201) 852-7278

FOR SALE: Mint RCA Stratoworld 3-BX-671 - \$150. Nice Silvertone Deco - \$50. Superior 1240 tube tester - \$25. Nice temple metal G-418 - \$50. Nice Emerson 510 - \$60. Emerson 235AX green swirl Catalin, cracked - Offers. Prices include UPS. LSASE for list of 2000+ N.O.S. tubes. Carl R. Shirley, 824 Fairwood Rd., Columbia, SC 29209. (803) 776-6850

**Your Tubes, Parts and
Supplies Headquarters**

TUBES:

3000 audio, receiving and industrial types in stock, including early and foreign types. Discount Prices!

CAPACITORS:

High voltage electrolytic and mylar capacitors for tube circuits.

TRANSFORMERS:

Hard-to-find power transformers, audio transformers, and filter chokes for tube equipment.

SUPPLIES:

Chemicals, test equipment, wire, batteries, tools, etc.

LITERATURE:

Extensive offering of literature and books on antique radios, hi-fi, communications equipment, tube data, and circuit diagrams.

KITS:

Radio, transmitter, stereo amplifier and power supply kits for learning and experimentation with vacuum tube circuits.

PARTS:

Resistors, lamps, tube sockets, potentiometers, grill cloth, knobs, vibrators and more.



"Write or call for our 26 page wholesale catalog"

ANTIQUE ELECTRONIC SUPPLY

688 W. First Street, Tempe, AZ 85281, Phone (602) 894-9503, FAX (602) 894-0124

CLASSIFIED ADVERTISEMENTS

FOR SALE: Majestic 8FM783 console. Lincoln & Rolls Royce transmitter. Want old Coke bottle radio. Norman M. Landis, 1315 Marbendale Ct., Kirkwood, MO 63122. (314) 821-7933

FOR SALE: Old radios, magazines, parts for radio TV's, radio TV diagrams. Sams Photofacts. Car radios. Florian A. Rogowski, 25103 Cunningham, Warren, MI 48091

WANTED: Harold Peary interviews, recordings and biographical information. Also radio, TV and film appearances. Kayleen Sybrandt, 3333 Morningside Rd., Wilmington, DE 19810

FOR SALE: Buckingham 6-tube 1-dial TRF chassis - \$30. Hallicrafters S-38E - \$38. Knight Kit Star Roamer - \$35. Philco 46-420, works - \$40. Majestic floor models, 90B and 91 - \$100 ea. Sylvania 161 service scope - \$10. Tektronix 502 dual-beam oscilloscope, uncheeked - \$25. Hickock 610A universal TV-FM alignment generator with manual - \$25. Philco 030 signal tracer - \$15. Globe Electronics CB - \$15. Lafayette tube CB - \$15. Polytronics tube CB - \$10. Heathkit IT-11 capacitor checker - \$20. Emerson 543 white Bakelite, works - \$40. Emerson service literature, 500 series radios - \$10. Raymond Filozof, 339 Howertown Rd., Catasauqua, PA 18032. (215) 264-4733

FOR SALE: N.I.B. Cunningham C-324 and RCA 227, boxes are mint - \$20 ea., or trade for Marconi stock certificates. Steve Zingmond, 6241 Radford, North Hollywood, CA 91606. (818) 769-9283

CLASSIFIED ADVERTISEMENTS

FOR TRADE: Zenith Royal 500, black case with round gold speaker for Philco T-7. James Treharne, 11909 Chapel Rd., Clifton, VA 22024. (703) 830-6272

WANTED: Na-Ald WD-11 tube socket, brown Bakelite. Need several. Gary B. Schneider, 9511 Sunrise Blvd., #J-23, North Royalton, OH 44133

WANTED: General Electric progress line commercial 2-way equipment. Call Speed Gray, NS8V, 1260 Troon Ct. SE, Grand Rapids, MI 49506, at The Prog-Line Orphanage. (616) 676-2153, after 6 pm

FOR TRADE: Harvey Wells TBS50 bandmaster for your Zenith console or chairside. A. Bruno, 24 Butternut Dr., New City, NY 10956. (914) 354-8899

WANTED: Black dial for Zenith 10S155 Cha. 1004 8-inch shadow meter with 5 knobs, one each corner, one large tuning knob bottom center. Wm. Stayduhar, 394 Hoffman Rd., Pittsburgh, PA 15212

WANTED: By a wheelchair-bound young man: A Zenith Model Royal 2000-1 all transistor FM-AM radio. John Glaze, 199 Possum Hollow Rd., Greenwood, IN 46143. (317) 862-2334

FOR TRADE: I need Zenith Trans-Oceanics #A600, L600, 3000. Will trade for the following: Grunow Teledial, Hammarlund HQ-170, Hallicrafters S38E and S94. Gil Paquette, 42 Strohmaier Ln., Rising Sun, MD 21911. (301) 658-2260

CLASSIFIED ADVERTISEMENTS

FOR SALE: Harvey-Wells Bandmaster Senior, Model TBS-50C, with P/S. Some circuit mods but restorable, case looks like new - \$40 plus UPS. Sam Sullivan, 20565 Fifth E., Sonoma, CA 95476

FOR SALE: Emerson 520 Catalin. Radiola balanced amp. transistor On The Air microphone radio. Zenith, Philharmonic and Philco radio/phono, wood tabletop, Arvin 451 LT, Coronado 800 - \$15 ea. Chassis: Crosley 53, Coronado. Doug Koehn, 2200 Elmers Ln., Norfolk, NE 68701. (402) 379-0548

WANTED: Plastic frame, require for B/C opening in wooden console, for 1937 Silvertone Model 4686, I.D. #101.483. C. Bier, 4021 Via Picapagos, Palos Verdes Est., CA 90274

WANTED: Driver for in-cabinet speaker on a Freshman Masterpiece, 1924 radio. H. W. Johnson, 36 Sunset Dr., Bristol, VA 24201. (703) 669-2239

FOR SALE: Rola horn speaker F - \$125. Philco cathedral, Model 31-34 battery - \$90. Radiola horn speaker, Model UZ-1325 - \$75. Philco Model 48-182 SW, looks and plays fine - \$85. Pack. & UPS extra. Owen Orndorff, RR2, Box 237, Danville, IL 61832. (217) 442-6812

WANTED: Silver-Marshall RF choke coil Type 277. Pilot 75-ohm center-tapped resistor. Electrad 10,000-ohm 25-watt resistor Type B-100. No substitutes. Will pay your price. Gale J. Roberts, 912 Church St., Clyman, WI 53016. (414) 696-3491

CLASSIFIED ADVERTISEMENTS

WANTED: Small cone-type speaker for Philco Model 70 or 90. Dave Froehlich, PO Box 16, Yorkville, NY 13495. (315) 768-6163

SERVICES: Transfer services available, tape, video, film, wire recordings, etc. Also record cutting. Buy and sell. Allan H. Weiner, 14 Prospect Dr., Yonkers, NY 10705. (914) 423-6638

Classified Ad Deadline Noon
Jun. 10 for Jul. 1990 Issue
Jul. 10 for Aug. 1990 Issue
 Box & Photo Ads - 5th, Display Ads - 1st

WANTED: Will pay top dollar \$ for a Sony TC-110 cassette tape recorder. Ask for Rob Kirschner, 900 Pleasure Dr., Riverhead, NY 11901. (516) 369-1367, (516) 369-1368

WANTED: Model SX-122 or SX-133 Hallicrafters receiver in good condition. Please state price. David Lyons, 623 Carlson St., Sycamore, IL 60178. (815) 895-6862

WANTED: Premium paid for original back for Emerson AU-190. Leads & instructions for Supreme 582. Antenna assy. for Predicta AC949U. Additional socket assy. for 1-177B. **FOR SALE/TRADE:** Roberts 2 pc. recorder Model 90 Serial #05017, mint. General Radio Wavemaster 224S or 204. MTY-Gloritone cathedral cab. Seeburg Master amp MA 1L6 #9368. Sams TV Photofacts #1-20. AK 55F chassis. John Myers, Box 98, Wilson, NY 14172-0098. (716) 751-6053, evenings

**WANT MORE BANG FOR YOUR COLLECTING BUCKS?
 JOIN THE MID-ATLANTIC ANTIQUE RADIO CLUB (MAARC)**

Over 600 collectors from most every state and three continents have done so. Why? Because the \$12 annual dues is a bargain! It gives you...

- **Monthly Newsletters**, up to 20 pages each, packed with radio history, restoration guidelines, and service tips, *plus* a free classified section for members! Some mailings also include supplemental radio booklet reprints.
- **Monthly Meetings**, in Laurel, Maryland, (except August and December) that include a mart and auction every time, *plus* educational programs!
- **Special Annual Picnic Meeting** as large or larger than most meets!
- **Knob Exchange & Schematic Service** (only \$3.00 for any schematic supplied!).
- **Publication, and Club Paraphernalia Sales!** • **Extensive Library for Members' Use!**
- **Membership Card** good for the whole immediate family! • **Fellowship and Friendship!**
- **NEW: Widow Assistance Program** involving sale of radio collection for surviving widow(er) at no profit to MAARC.

FREE: Copy of "The Zenith Story: A History From 1918 to 1954," a professionally done 28-page booklet, for new members.

Don't be left out! Join MAARC.
Send your \$12 payable to "MAARC" to:
 Nevell Greenough (ARC) - MAARC Membership Chair
 62 Nancy Drive, Hamilton Square, NJ 08619

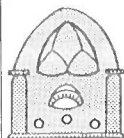

Mid-Atlantic
 Antique Radio Club

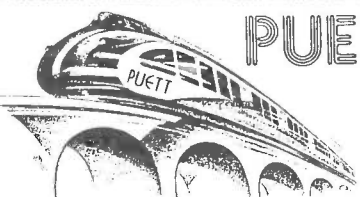

PUETT ELECTRONICS

P.O. BOX 28572 DALLAS TX 75228



OUR PAST CATALOGS AND PRICE LISTS ARE NOW OBSOLETE.

CATALOG 77 (20-PAGES) OUR BASIC CATALOG \$2.00 POSTPAID. YOU RECEIVE A \$3.00 DISCOUNT COUPON WITH CATALOG 77.

CATALOG 77/PLL-2 (56 PAGES) -- \$5.00 POSTPAID. YOU RECEIVE A \$6.00 DISCOUNT COUPON WITH CATALOG 77/PLL-2.

WE NOW HAVE MORE THAN 1,500 DIFFERENT ANTIQUE RADIO PUBLICATIONS AVAILABLE! CATALOG 77/PLL-2 LISTS EVERYTHING WE HAVE TO OFFER!

WE OFFER BOOKS, INSTRUMENT MANUALS, SERVICE DATA, SALES BROCHURES, ATWATER KENT, RCA, CROSLY, ZENITH, ETC. FACTORY SERVICE MANUALS, STROMBERG CARLSON, CAPEHART, SCOTT, MCMURDO SILVER, FISHER CLASSIC RADIO LITERATURE, DIRECTORY OF ANTIQUE RADIO SERVICES, SCHEMATIC DIAGRAMS ON NEARLY ANY RADIO, OLD-TIME RADIO PROGRAMS ON CASSETTES, TUBES, TUBE MANUALS, BOOKS ON WIRELESS AS OLD AS 1902, TUNING DRIVE BELTS, TUNING DIALS, TUNING-DIAL GLASS COVERS, KNOBS, OUR OWN PERIODICAL "ANTIQUERADIO TOPICS" WITH THE ANTIQUE RADIO NEW ACQUISITIONS LIST, AND MUCH MUCH MORE!! ORDER OUR CATALOG TODAY!!!!!!

CLASSIFIED ADVERTISEMENTS

WANTED: Zenith tombstone radios like 6S128, 7S28, 5S29, 7D127. Good, working condition. Riggs Smith, 7477 W. Nichols Pl., Littleton, CO 80123. (303) 973-8792

HELP: Majestic treasure chest Model 381. Need data on the wood pieces that hold down leather straps. Pictures, drawings, anything please. Repro costs assured. R. F. Haworth, 112 Tilford Rd., Somerdale, NJ 08083. (609) 783-4175

WANTED: Portable reel-to-reel tape recorders made by Nagra Kudelski. Mike Baird, 10802 Keller St., Silver Spring, MD 20902

HELP: Need coin mechanism for Dahlberg pillow radio. Ancman, 2462 Brown Bark Dr., Beaver-creek, OH 45431. (513) 429-1534

FOR SALE: Communications (Hammarlund, National, Hallicrafters, etc.) battery sets, books, speakers, large SASE. Jim Sargent, 1010 Chepstow Ln., Sherwood, AR 72116. (501) 835-5610

FOR SALE: WWII radio BC-728 with AN75C antenna - \$80. Navy RBM receiver low frequency with AC-supply - \$150. TBY transceiver with antenna AC-supply military - \$350. TBY-6 radio only - \$100. Test set Weston Type OE-8 - \$125. Scope 3" OS8-EIU, with manual - \$75. Simpson V.O.M. 269-2 - \$125. Steve Bartkowski, 4923 W. 28 St., Cicero, IL 60650. (708) 863-3090

WANTED: Chassis, knobs and speaker for Majestic Model 97. Jerry Gilchrist, 2145 Sugar Valley Rd., Ohatchee, AL 36271



WAVES
ANTIQUES
EARLY RADIOS
&
PHONOGRAPHS
78 RECORDS
BOUGHT • SOLD
OPEN 12 - 6
CLOSED SUN. & MON.

32 EAST 13TH ST., NEW YORK, N. Y. 10003 212 989-9284
PROPRIETORS Bruce and Charlotte Mager

THIS MONTH'S SPECIALS:

1. AK breadboard, Model 4340 \$925
2. AK breadboard, Model 12 825
3. Amplion horn, model AR-19 265
4. Hopalong Cassidy Radio 265
5. Sonora radio lamp 165
6. Crosley 11-100U, white 150
7. Framed Radiola 20 advertising blotter... 35
8. Mr. Radio Man sheet music 15

SEE NEXT MONTH'S LIST FOR MORE !



CLASSIFIED ADVERTISEMENTS

FOR SALE: BO: Motorola 17T6-C TV, audio, no video. Motorola 56-CD-3 clock radio, OK. RCA V-205 1941 anniversary AM/shortwave/78 rpm, bad 78. Philco K-162BX-123 AM/FM/45/33 console, OK. Silvertone 3621 AM/shortwave, warped grille. Crosley F25-BK clock radio, OK. **WANTED:** 1957 Chevrolet radio, 12-volt, with tubes, and separate power supply, speaker not mounted to chassis. 3 types: no tuning buttons, with buttons, or "wonderbar" tuning. Also want other 1957 parts and literature. Michael Kowalchuk, 3124 Shirlene Rd., East Norriton, PA 19403. (215) 272-7973

One Month Free!

BONUS FOR EARLY RENEWALS

If you renew **before** the month shown on your mailing label (your expiration month), you will receive an extra month on your subscription: 13 months instead of 12! 26 months for an early 2-year renewal!

WANTED: Push buttons for Silvertone 1561. Set or singles, Radiola 60, 18, or 17. Bob Drapeau, KT1K, 39 Steven Rd., Bellingham, MA 02019. (508) 883-1132

FOR TRADE: E. H. Scott Leamington cabinet (uses Sixteen chassis) or Braemer cabinet (uses Masterpiece chassis), both in excellent original condition. Will trade either cabinet for a Scott Louis XV highboy cabinet, uses Sixteen or Masterpiece chassis. I can also include some cash and/or Scott item(s). Craig Korpak, 9130 Silver Lk. Rd., Linden, MI 48451. (313) 735-7264

FOR SALE: Illustrovox Jr. show and tell phonoviewer. Bob Shivers, 1233 W. Vine St., Taylorville, IL 62568. (217) 824-9546



WANTED: Chassis and speaker for this radio (see drawing) or at least info. on it. Cabinet is marked J. C. Olsen Cabinet Co. Inc., Cohoes, N. Y. 938. I have nice large U.S. Apex cathedral cabinet to trade also 1931 Sonotone hearing aid, tortoiseshell plastic in ob with booklets. Philip Brunais, 14185 Pleasanton Hwy., Bear Lake, MI 49614

FOR TRADE: For trade only: Fada 1000 yellow/red for: 1961 A.M.I. Continental jukebox or 2 large Seeburg teardrop wall speakers. Jim Downes, 607 E. 12th Ave., Covington, LA 70433. (504) 893-7057

FOR SALE: Collins 51J4 good condition manual - Offer. Grundig Majestic 1060 manual - Offer. Levy, 8 Waterloo, Morris Plains, NJ 07950. (201) 285-0233

CLASSIFIED ADVERTISEMENTS

FOR SALE: Vintage and modern electronics items. Lots of tubes! N.I.B. Mallory, Radiart, and Delco vibrators. N.O.S. dials and glasses. N.I.B. Zenith, Philco, and RCA parts. Reconditioned test equipment, tools, scopes, variable capacitors, lots of knobs, 300+ crystals. Commodore computer items. N.I.B. Motorola (Galvin) automobile control heads ca. 1940 and later. Radios: Kadette, AK, Emud 713, Radiola, Silver-Marshall 710, Ozarka 90, etc. Speakers: Crosley, RCA 100A, Symington, etc. Columbia 160 windup portable phono. (1000) 78 and 45 rpm records. Edison disks. Send \$2, \$5 outside U.S.A., in American cash or stamps (no checks) with long SASE for twelve plus lists. Refundable with order. Richard and Rose's Radio Mart, PO Box 691443, Tulsa, OK 74169

FOR SALE/TRADE: BC-603 - \$40. Philco 37-84 - \$80. Zenith 5-S-319 - \$40. Zenith 6-S-632 - \$55. Paul Ernst, 3465 Eddy Rd., Marion, NY 14505. (315) 589-9471

FOR SALE: Radios tabletop and floor models from 1920 to 1960. Tubes 4-pin. For list send long SASE to: David Lyons, 623 Carlson St., Sycamore, IL 60178. (815) 895-6862

WANTED: 1 1/2 volt battery radios, cathedral, tombstone, tall square, wood or plastic. John Porter, 701 N. Main, Osceola, IA 50213

FOR SALE: Various unrestored wood and Bakelite radios including cathedrals, tombstones and 1920's battery and early AC sets, some work, fair prices. Kevin Eftink, 16 Edgewood Dr., Quincy, IL 62301. (217) 228-2221

CLASSIFIED ADVERTISEMENTS

FOR SALE: Philco 620 tombstone - \$95. Philco 84 beehive - \$90. Zenith tombstone - \$145. Stewart-Warner #206-FA brown Bakelite tombstone, mint, works - \$125. RCA #128 cathedral amateur cabinet restoration, works - \$125. Detrola treasure chest radio - \$150. Midwest Miraco Unitune battery op - \$95. AK 49 battery op - \$55. DeForest F-5 battery op needs restored - \$150. SASE. UPS extra. Joe Szabat, 1019 Hiland Ave., Coraopolis, PA 15108. (412) 264-7498

FOR SALE: Catalins, cathedrals, battery, crystal, telegraph sets, Westinghouse RC's with Baldwin phones/Crosley Musicaire speaker. Call or write. Rain Buttignol, 214 State St., #7, Portsmouth, NH 03801. (603) 427-1384

NEW FAX NUMBER FOR
ANTIQUE RADIO CLASSIFIED
(508) 371-7129 - 24 Hours per day
Ads - Subscriptions - Book Orders
Charge to Visa/MasterCard
Minimum Charge: \$10.00

FOR SALE/TRADE: Radios 20's-40's: Freed-Eisemann, Crosley, Philco, Freshman, Kennedy, others. Generous trades for Zenith, AK, Scott. New inquiries send SASE for list. Anthony Matt, 425 Waltham St., W. Newton, MA 02165. (617) 527-4794, eves.

WANTED: N.O.S. tuner drive motors for 1957, 1958, 1959 Ford radios, Motorola Part Numbers 59C535466, 59C540838, 59C561887. Also complete radios, Models 76MF, 78MF, 86MF, 95MF. Dennis Smith, KN8H, Box 113, Trenton, MI 48183

Active Antenna

Model AA10

Only \$34.95

Allows antique radios which were designed for a long wire outdoor antenna to operate on a 42" indoor whip antenna. Operates from 9 volt battery.

Order from PTI, Box 9769, Little Rock, AR 72219, (501)568-1995. Orders shipped UPS, prepaid in continental U.S. Please allow 3 weeks for delivery. Arkansas residents add 5% sales tax.

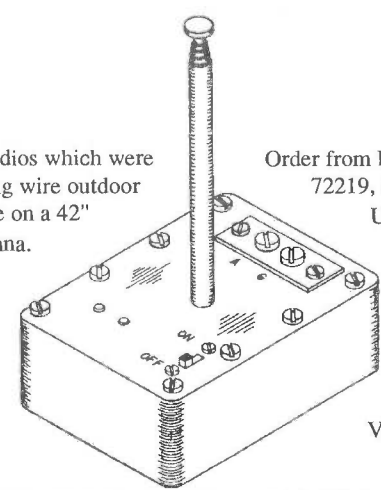

Visa and MasterCard accepted

CLASSIFIED ADVERTISEMENTS

WANTED: Sherwood S-7700 II tube-type stereo receiver. David Matson, 6 Hawthorne St., Acton, MA 01720. (508) 263-0661

FOR SALE: Tubes antique, new, used. Over 800 different types. Send \$2.00 for list: Kad Tek Co., 11 Olympus Dr., Macedon, NY 14502

FOR SALE: Capehart 113-P2 radio-phonograph, 25 tubes, with rare postwar turnover intermix 78-rpm changer, ca. 1947, excellent condition and tone, new capacitors, refinished - \$975. SASE for correspondence, please. Photos - \$2. Robert Gates, Mountainside Rd., RD #3, Mendham, NJ 07945. (201) 543-6208, 6-9 pm EDT

WANTED: Pre-1965 hi-fi equipment, Electro-Voice, McIntosh, Marantz, Scott, Fisher. Also audio magazines, catalogs. John P. Wolkowicz, 11 Hartford Rd., Worcester, MA 01606

WANTED: Dial glass for Philco console #39-6444, 2 3/8 x 8 1/2 inches, or information leading to one. Dan Bauman, 334 Longacre Ln., Palatine, IL 60067. (708) 397-0225

FOR SALE: Edison home phonograph - \$375. Clarion 80 cathedral - \$175. (8) globe type 27 tubes - \$26. Postage extra. Jeff Gentry, 708 Locust Ave., Charlottesville, VA 22901. (804) 295-5619

WANTED: Telegraph keys and sounders, also radio keys. F. W. Nicholas, PO Box 37094, Phoenix, AZ 85069. (602) 864-9987

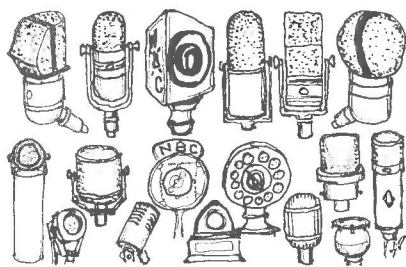

WANTED

FOR MY BROADCASTING MUSEUM

Microphones, stands, call letter plates. Tube amplifiers, mixers, compressors, Hi-Fi equipment. Speakers, on-air lights, equalizers. Disk, wire & tape recorders. Blank recording disks. Catalogs, magazines, manuals. 16" transcriptions, turntables, arms, pickups. Early TV cameras & receivers. Elaborate console, deco, plastic, mirror, novelty & wireless radios. Jukeboxes & pans. Acoustic phonographs.

We are looking for all makes of equipment, and especially *Western Electric*, *Telefunken*, *Neumann* and *RCA*. The museum contains various duplicates and items surplus to our needs, and many of these articles are available for sale or trade. The collection is located in my Victorian seaside inn, The Caffrey House, situated on a bay next to the ocean, in the Southampton resort area of Long Island. A trade of equipment for a stay at the hotel is always encouraged.

Robert Van Dyke, 2 Squires Ave., East Quogue NY 11942
516-728-9835

CLASSIFIED ADVERTISEMENTS

WANTED: Philco Model 38-9 & Model 6C (39-6). Also Westinghouse Model WR-209 & Zenith Model 6-S-128. Cabinet must be in excellent condition. Please include the shipping price. Robert Schrantz, 233 B North Willow Ave., West Covina, CA 91790-1957

FOR SALE: JH Bunnell telegraph memorabilia, etc. Drawings, catalogs, patents, advertising, peg switchboard, flameproof key, sounder, adjustable resonator metal, parts, etc. SASE for list. Joe Jacobs, 60 Seaview Terr., Northport, NY 11768



WANTED: Slant-front Philmore radio or kit un-built. Fred L. King, Rt. #1, Box 280A, Moberly, MO 65270. (816) 263-3778

WANTED: Dial glass for Magnavox CR715BB or junker for glass and parts. Manual or schematic for U.S. Navy RBS/CCT46217 receiver. Supplemental tube data cards (or copies) for Triplett 1183-SC tube tester. 1L6 and 1U4 tubes. Francis Donovan, 19 Winthrop St., Medway, MA 02053. (508) 533-8356

— WANTED —
PICTURES FOR PHOTO REVIEW
PHOTOS MUST BE SHARP IN DETAIL
A SHORT DESCRIPTION IS A MUST!
SEE PHOTO REVIEW PAGES FOR
ADDITIONAL INFORMATION

FOR SALE: Mitchell bed lamp radio, cream, plays - \$25. RCA T-2E transistor, cream leather - \$15. RCA 4RG51 transistor - \$10. Grundig MS65 chassis w/tubes, turntable, pwr. supply, 2 woofers, tweeters - \$25. Radio & TV News, 1958 & 59 - \$10/year. Hallicrafters S-41-G, plays - \$20. **WANTED:** AWA Review Vol. 1. Checks for cost only, items shipped UPS trans. collect. John Martin, 817 Cook Ave., Billings, MT 59101. (406) 252-4287

WANTED: Grundig/Majestic 4085 for parts. Cabinet back and antenna for umbilical-cord type Predicta. Garnier TV, PO Box 971, Warsaw, MO 65355. (816) 438-2320, 547-2764, eves.

WANTED: Literature originals on Scott Shield Grid 9, instruction manual, sales information, etc. John Meredith, 1626 Lake Rd., #188, Haslett, MI 48840. (517) 339-4153

CLASSIFIED ADVERTISEMENTS

WANTED: Gilfillan Model 20 battery set as per illustration, or Model 25 (which is just the receiver section on top). For sentimental reasons I particularly want this set so am prepared to pay above the market value. I will arrange collection and shipping. Alan Brehaut, 22A Cain St., Timaru, New Zealand ISD. Phone 64 56 89501

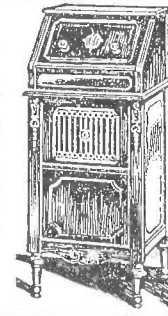

FOR SALE: Westinghouse Little Jewel, green, very good. National NC57B receiver, clean, plays good. Philco 89 cathedral, very nice. Ekco A145 English radio, multiband. Arvin 5440 white Bakelite, nice, dial on left side. Philco Model 42-22CL clock radio, 1942 model, wood case. Philco 38-14 Bakelite. Silvertone 6012 ivory Bakelite w/push buttons. Sanborn 1950's EKG machine. Sylvia 543 VE yellow Bakelite, early '50's. **WANTED:** R520 URR Zenith military version of Trans-Oceanic. Copy of instruction manual for Eico 315 signal generator. Charles Harper, 2081 Harmony Ct., Lexington, KY 40502. (606) 268-8549

WANTED: Scott shield grid 9 power supply, 3 tubes, black appearance, Scott Transformer Co. nameplate. John Meredith, 1626 Lake Rd., #188, Haslett, MI 48840. (517) 339-4153

FREE - 20 WORD AD EACH MONTH
To get your free 20 words,
include your SUB# with your Ad.
Additional words are 10¢ each.
Read inside back cover for details.
MANY THANKS!!!!

WANTED: Any components of an SCR 183 radio to include: Radio Control Box BC-AR-231, antenna switching relay BC-AR-198, control box BC-AR-198, complete Dynamotor BC AR 83 and mounting bases FT-99, FT-100 and FT-141 and any associated cabling. William Howard, 219 Harborview Ln., Largo, FL 34640. (813) 585-7756

FOR SALE: Gonset Communicator III, 6-meter, built in nuvistor pre-amplifier, five crystals, microphone and manual, mint condition - \$60, includes packing and shipping via UPS. W. P. Sides, W4AUP, 750 W. Fleming Rd., Montgomery, AL 26105

WANTED: Auto radios (European) by Blaupunkt, Becker, Telefunken, etc., 1960's and older, 2-piece tube or transistor type, AM-FM, complete or incomplete. Wilford Wilkes, Box 103, Swoope St., Brisbin, PA 16620. (814) 378-8526

WANTED: Any World's Record radio, circa 1925-1930. Phone calls preferred. Jim Clark, 1292 Starboard, Okemos, MI 48864. (517) 349-2249

CLASSIFIED ADVERTISEMENTS

WANTED: For Eico 221 VTVM, assembly instructions and leads for AC ohms, DC, RF probe P-75, and high voltage probe HVP-1. Willing to buy whole unit to get test leads. Also need operator's manual for Hallicrafters S-120. Mike DeVivo, 231 Park Rd., Waterbury, CT 06708. (203) 755-1209

FOR SALE: American made 600v and 450v capacitors. Unused tubes - 25¢ and up. Copies old ads showing radios. Power and output xfmr. Lots of trash and treasures from closed repair shops. List available. Sue Coulter, 4200 Prince St., Bakersfield, CA 93301

WANTED: Old style crank phonographs, horns, parts, junk machines, any condition. **FOR SALE:** Orchestion Deluxe wooden bell horn. Magnavox R-3 D horn. Radiola UZ4325 horn, open. Fada Neutrolite 192-A radio with original instruction manual. Must sell - best offer. Dave Faehrich, 8215 Stone Rd., Independence, OH 44131. (216) 447-0837

FOR SALE: Magnavox horn decal - \$15. Philco tuning eye unit plus Philco 70 knobs - SASE. Floyd A. Paul, 1545 Raymond Ave., Glendale, CA 91201. (818) 242-8961

WANTED: Desk (not secretary) with built-in tube radio as manufactured (not home brew). Gerald Schneider, 3101 Blueford Rd., Kensington, MD 20895. (301) 929-8593

FOR SALE: Tubes, new in box. Please send \$1 for list of 300+ tubes. Refundable. Wilson Hauck, BTB, Inc., 6820 Stout Rd., Memphis, TN 38119

ARBE - III

- * ANTIQUE RADIO BATTERY ELIMINATOR
- * ADJUSTABLE HIGH CURRENT A SUPPLY
- * 8 DIFFERENT B & C VOLTAGES
- * 5 YEAR LIMITED WARRANTY

\$139.95 SHIPPED WITHIN CONTINENTAL U.S.A.
MICHIGAN RESIDENTS ADD 4% SALES TAX

ANTIQUE RADIOS INC.
P.O. BOX 6352
JACKSON, MICHIGAN 49204

PHONE 517-750-4992
AFTER 7:00 P.M. EST.

Stereo Action

The Sound Your Eyes Can Follow

You've heard a lot about it, but what is it? Here's Robert Oakes Jordan to tell you more:

"STEREO ACTION is a conscious and deliberate effort to set music in motion by actually moving the sound of various instruments from one speaker to the other, and, at times, suspending it in the space between. Musical motion is first conceived by the composer or arranger. He must score every note of his music with Stereo Action in mind... An elaborate system of charting each and every instrument for proper stereo placement guides the scoring itself. A companion series of schematic diagrams for the physical placement of instruments and microphones are developed for each section.

"[At a session for Dick Schory's Percussion and Brass Ensemble,] engineer Bob Simpson is seated at the controls of his specially-built twelve position three-channel mixing console. A new passive phantom mixer designed by Joe Wells offers an additional channel providing four more microphone inputs for the new feats of Stereo Action. Two Ampex 300-3 three-channel tape recorders manned by technician Ronnie Steele are set in operation to faithfully preserve the musical scores. In order for Bob Simpson to have full facility of the fine room sound of Orchestra Hall, Telefunken U47m's condenser microphones—and one U49—are placed high out over the tenth row with 360° pattern set. The rhythm section is tightly placed in center stage and covered by three RCA 77DX ribbon mikes."

Want to know more? Subscribe!

- 1 year(4 issues)/\$5.00
- 2 years(8 issues)/\$9.50
- 3 years(12 issues)/\$14.00
- The rest of my natural days(∞)/\$150.00

Please
make checks
payable to:
"Jerry
Nutter"

**AUDIO
CARPÆTORIUM**
111-32 112th St., Dept. A6
SOP, NY 11420-1026

FOR SALE: 1928 Radiola tin-porcelain dealers sign, nice condition. RCA AVR-5 tombstone, similar to 140. 1931 Austin clock radio, mantel set. Radiola 61-10 - \$25. Sears metal set - \$25. Harmon-Kardon & Heath hi-fi eg. Several unusual Stewart-Warner cathedrals. Bill Moore, 1005 Fieldstone Ct., Huntsville, AL 35803. (205) 880-1207

WANTED: Early color TVs, chassis, parts or related items. I am looking for any early color TVs from 1954 or earlier. These sets use the 15GP22 or 15HP22 picture tube. I am also looking for any scanning disk type color TVs or B&W to color converters using a scanning disk, or any type of field sequential type color TV. I would also like to find any chassis or parts (flybacks, yokes, convergence transformers, etc.) for these type sets, as well as any schematics, technical literature or related documentation or advertising. Please call collect or write. John Folsom, 450 Golden Dove Ave., NE, Palm Bay, FL 32907. (407) 725-3462, eves., weekends

FOR TRADE: Hammarlund SP-600-JX-26 w/ metal cabinet. Value estimated \$175-225? For Swan equipment. Jack Buren, KJ6KI, 5952 Meadowbrook Ln., Riverside, CA 92504. (714) 686-5407

— WANTED —
**PICTURES FOR PHOTO REVIEW
PHOTOS MUST BE SHARP IN DETAIL
A SHORT DESCRIPTION IS A MUST!
SEE PHOTO REVIEW PAGES FOR
ADDITIONAL INFORMATION**

WANTED: Back for my Hoppy radio and complete Hoppy radios. Also, novelty tube sets and junker General Television and Radio Corp. sets, Model 5A5 only. Tony D'Agostino, PO Box 6848-143, Big Bear Lake, CA 92315. (714) 585-6953

HELP: Need a junk Zenith chassis desperately. Model Nos. 6S203, 6S222, 6S223, 6S229, 6S239, or 6S241. I need that 3-band oscillator coil assembly, Part No. S-4942. Roger Muir, 2911 Lapsley, Dallas, TX 75212. (214) 905-0822

FOR SALE: Scott 99D amplifier - \$50. Stromberg-Carlson tuner - \$50. Jerry Schaefer, 932 N. 4th St., Grand Forks, ND 58203. (701) 772-2991

FOR SALE: Philco Jr. Model 80 cathedral - \$65 plus UPS. Kenneth Miller, 10027 Calvin St., Pittsburgh, PA 15235. (412) 242-4701

FOR SALE: H. H. Scott Model 350B FM tuner with manual - Best Offer. Zenith 6G801 with manual, excellent - \$45. Hickock Model 850 transistor analyzer, mint, with manual - \$25. Philco 48-472 - \$25. RCA 8R75 - \$20. Gary Pirkkala, 2306 Audley Ave., New Castle, PA 16105. (412) 654-8481

WANTED: Shadow meter for Philco 37-630. Elkay (Langbein-Kaufman Radio Co.) battery or AC radios. Detrola console. Knobs and dial trimplate for Zenith 6S241 radio bar. Knobs for American Bosch 460 console. Ron Trench, Jr., 12 Virginia Rd., East Haven, CT 06512. (203) 469-7340

FOR SALE: Auction. Sat. - June 2 - Grey, Maine. Approx. 50+ lots of radios, (a few wind-up phonographs) to follow general antique auction. Time of auction 1:30. Preview 8-10 am. Exit #11 off Maine Turnpike, left at toll booth 1/4 mi. on left, at Morrill's auction facility. By Bacons Auction Co., auctioneer - Paul Hemen Lic. #870. (207) 985-1401. Jahan Acciavatti, PO Box 231, Southborough, MA 01772

**HAVE YOU MOVED? ARE YOU MOVING?
PLEASE NOTIFY US A.S.A.P.
SEND US YOUR...
OLD ADDRESS
NEW ADDRESS and
SUB #
MANY THANKS!!!!**

FOR SALE: 19" rack mount black table model cabinet. RCA 9K2 chassis, 7K chassis and speaker. Philco 39-25 table model. Two little Devel ohmite resistor cabinets. Zenith 35APX power supply. Bill Coolahan, 1450 Miami Dr. NE, Cedar Rapids, IA 52402. (319) 393-8075

WANTED: Zenith Trans-Oceanic 7G605 sailboat model. Gary Pirkkala, 2306 Audley Ave., New Castle, PA 16105. (412) 654-8481

FOR SALE: Philco 70 grandfather clock - Offers. RCA 811K console - \$125. RCA 6K console - \$70. Pickup only. Philco 37-610 tombstone, excellent condition - \$115. Zenith Trans-Oceanic L600 - \$70. All play. Rider's 6 thru 13 - \$15 ea. Marconi Victor Course in Wireless Telegraphy, records with booklet, 1917 - \$55. Plus shipping. Ron Trench, Jr., 12 Virginia Rd., East Haven, CT 06512. (203) 469-7340

FOR SALE: Information, How to Read Vintage Radio Diagrams, now available - \$6. Charles Ahr, 2291 Sylvet Ln., Cincinnati, OH 45238

Paying \$450 for ZENITH RADIO NURSES!

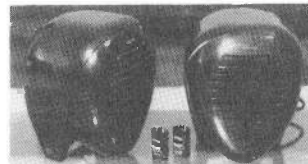

HARRY POSTER
(201) 794-9606
PO Box 1883, So. Hackensack, NJ 07606

HELP: Still need name of someone who can refinish Kennedy 281 dials. Merrill Bancroft, 169 S. Row Rd., Townsend, MA 01469. (508) 597-6623

FOR SALE: Sams Auto Radio Manuals Number 19 thru 307, lot only, perfect condition. Russ Turner, 414 Liberty, San Francisco, CA 94114. (415) 824-8367, eves.

WANTED: Quack medical devices and early scientific instruments. Richard Cane, 8391 NW 21st St., Sunrise, FL 33322. (305) 741-6838

FOR SALE: (5) Scott Chippendale (F.O.S., p. 170). (3) German 1937 A.E.G. (4) Telefunken 1957 Gavotte 8U. (4) Grundig 50's, 4-tube portables. (2) Grundig S012U1. (2) Grundig speakers. (4) Zenith advertising football games (2) Zenith clocks. (4) Zenith Trans-Oceanics and parts. (3) Zenith 7S633 t.m. (5) BC 603-BM and power supply. (4) Navy TCS-13 transmitters. (6) old CB's Vocaline JRC400, Stalker 14. (5) Johnson Messinger 123A; Sears 23. (5) six-, eight-, and ten-inch electrodynamic speakers. (3) Farnsworth BT71 tombstones. (6) novelty kitchen RCA spice chest radios. (5) Precision 14-watt audio amps. (5) 12v regulated power supplies. (4) Bendix Model 523 t.m. Send \$1 & SASE for photo. Bill Coolahan, 1450 Miami Dr., NE, Cedar Rapids, IA 52402. (319)-393-8075

FOR SALE: Tubes - 75¢ each. Heathkit AA-40 tube amp. Hewlett Packard 400E meter. Simpson VOM. Joseph Zambri, RD4, Box 216, Towanda, PA 18848

Antique Radio Club of Illinois

Presents:

RADIOFEST 1990

AUGUST
9th, 10th, & 11th

The Holiday Inn
Holidome
and
Convention
Center



345 River Road, Elgin, IL 60123
Call: (708) 695-5000

- Auction
- Special Exhibit
- Hospitality Suite
- Donation Auction
- Three-Day Flea Market
- Afternoon Presentations
- Friday Evening Awards Banquet
- Old Equipment Contest
- Ralph Muchow's Radio Museum

Info: Dave Johnson, 2336 S. Kenilworth, Berwyn, IL 60402 - (708) 484-2743

WANTED

CATALIN RADIOS



MOTOROLA
Model 51X16

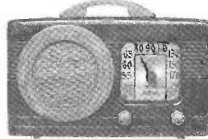

MOTOROLA
Model 50-XC1

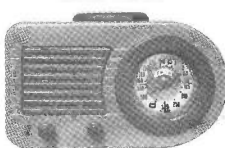

FADA "BULLET"
Model 1000 w/insert grill



FADA
Model L-56

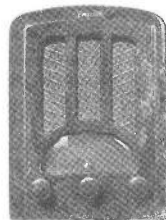

EMERSON TOMBSTONE
Model AU 190 or BT 245



AIR KING
Skyscraper



GAROD or AMC
Model 126



SENTINEL
Model 284-N1 (blue)

Don't sell yourself short!
Get your absolute top price, then call me.
I also trade.

ROD SMITH
(617) 423-3796

© 1990 Rod Smith

FOR SALE: \$1000 crystal mystery set in original excellent condition. Send SASE for Xerox of original instructions with picture. Robert West, WA6MFJ, 12130 Tiara St., No. Hollywood, CA 91607

FOR SALE: RCA 54BI miniature - \$50. GE M-61 cabinet - \$15. Philco 3812 - \$40. John Lyle, 1161 S.W. Mulvane, Topeka, KS 66604. (913) 232-0128

FOR SALE: CPY HP-200AB manual plus 10 pages of service notes - \$6 ppd. Pyramid CRA-2 capacitor analyzer w/manual - \$37.50. RCA WR-49B RF signal generator - \$35. Ward Becht, 625 Tufts Ave., Burbank, CA 91504. (818) 842-3444

FOR SALE/TRADE: Catalin: RCA 66X9 black & yellow swirl, Emerson 520, Garod drop handle 1B56, black Philco Safari TV, Silvertone tombstone/battery, Emerson jewelry box-wood, parts. **FOR TRADE:** Black colonial Globe towards green Fada 652, Catalin parts. **WANTED:** Catalin radios & parts, Catalin clocks, Bakelites, 1970's unusual TV's. Ross Litrenta, 1 Wilton Rd., Eastchester, NY 10709. (914) 337-7176

**NEW PHONE NUMBER FOR
ANTIQUA RADIO CLASSIFIED**
(508) 371-0512

**Best time to call is weekdays:
9 am to 5 pm Eastern Time**

(Please no classified ads by phone. Thanks!)

WANTED: Receivers, Radiola 60, Atwater Kent Model 20C (compact), Crosley Model 51, Speaker Radiola 103. H. Vernon Lee, 6601 Sausalito Ave., West Hills, CA 91307. (818) 346-6984

FOR SALE: Chassis photos, top & bottom: Emerson #U6D (Models 38, 42) & RCA Model 110 cathedral. Restoring butchered sets & need help! Tim Fuss, 573 Grand Ave., Rochester, NY 14609 (716) 482-8963

FOR TRADE: Bendix Model 111, brown with tan Bakelite knobs and tan dial, good condition. John Elkowitz, 34A Main St., Clinton, NJ 08809. (201) 735-0165

WANTED: The New England Antique Radio Club wants you! Join over 400 others and be part of one of the best radio clubs in the country! Make plans now to attend our big Summer Swap & Sell Meet and Auction, Saturday, July 21, 1990, at Resurrection Center, Nashua, N. H. Morning Swap & Sell Meet - 8 am to 11 am - features over 70 tables, hundreds of radios, two old equipment contests and a 50/50 raffle! Afternoon Auction begins at 12 noon (Preview 11 am to 12 noon). Be there for another great day of radio fun and excitement! For more Swap Meet/Auction details or membership info, call or write and be sure to ask for a free sample copy of the club newsletter. NEARC, PO Box 809, Contoocook, NH 03229. (603) 746-6127

WANTED: Scott Philharmonic, 30 or 33 tubes with round airplane dial, chassis and power supply, chrome-plated, chrome should be excellent. Phone calls preferred. Jim Clark, 1292 Starboard, Okemos, MI 48864. (517) 349-2249

WANTED: Chassis AK-84 and 184, AK-93 cabinet. AK-228-702, 735, 825 and others. Bob Nicholson, 3423 S. Long, Topeka, KS 66605. (913) 266-9473

FOR SALE: URM-25F with accessories. **WANTED:** TV-7D tube tester. Hammarlund HQ-120, black. DZ-2 aircraft radio direction finder receiver. Walter M. Chambers, PO Box 17091, Memphis, TN 38187-0091. (901) 725-6995

WANTED: Sparton radios (not limited to Art Deco models), advertising, etc. Needed for world class Sparton display at Extravaganza '90 event in Lansing, Michigan, July 12-14. Call or write Jim Clark, 1292 Starboard, Okemos, MI 48864. (517) 349-2249

Classified Ad Deadline Noon

Jun. 10 for Jul. 1990 Issue

Jul. 10 for Aug. 1990 Issue

Box & Photo Ads - 5th, Display Ads - 1st

FOR TRADE: WD-11 good filament for 2 duds with tips. Oscar L. Smith, Jr., Rt. 9, Box 16, Dublin, GA 31021. (912) 275-3657, call after 6 pm

WANTED: Metal cover for AK 44, 21" X 10 1/2". Sams most needed number 17, 1957, pay - \$15. Sams Transistor 16 through 23, pay - \$10 ea. Two old audio transformers, horizontal mount, 2 holes 2 inches apart through the end laminations, pay - \$20 ea., if usable. Claus, 2305 W. Rice, Sioux Falls, SD 57104. (605) 332-3747

WANTED: Tubes, Type 45's and Type 80's. Please write. David L. Muse, PSC Box 1193, APO Miami, FL 34001

HELP: Need Utah Junior transmitter schematic. Will pay reasonable costs or trade. Send needs. Bob Mattson, KC2LK, 10 Jane Wood Rd., Highland, NY 12528. (914) 691-6247

WANTED: Plug in coils for Unelco Model 1914 shortwave radio. R. Chenez, 47 Lake St., A605, Gardner, MA 01440

WANTED: Information on Sodian receiving set DR-6, Connecticut Telephone manufacturer. Leon C. Duggar, 205 E. 164 Terrace, Belton, MO 64012

FOR SALE: Radios: Day-Fan 7, Grundig transistor 11, Raytheon T2500, Emerson 641, Lafayette 99-3548W, and GTC Porta-Power Model P, Tun-gar A-B charger. R. Chenez, 47 Lake St., A605, Gardner, MA 01440. (508) 632-6826

Wanted

For Exhibition & Publication

- receive a free 144-page
exhibition catalog* -

The New Museum of Contemporary Art, NYC

From Receiver to Remote Control: The TV Set†

(Formerly: The Television
Apparatus Exhibition)

- New and old photographs (b&w preferred) of people watching TV (any type of photo including family snapshots)
- Photos, drawings or diagrams of unusual, unique or imaginative TV set installations in the home (built-in, home theatre, etc.)
- Original or published fictional stories about the TV set or TV set-like apparatus (Xerox copy O.K.)
- Films & Videotapes —
 - Television advertisements for TV sets
 - Documentaries, TV programs, sitcom episodes, Hollywood & home movies about or including the TV set

Any information about the history, origin or contents of the material you send will be helpful.

* A signed exhibition catalog will be sent to all those who provide material that we use. All material can be returned. Appropriate credit will be given. Sending us material constitutes your permission to reproduce, exhibit or publish.

**If you have any questions,
please call (collect) or write:**

Matthew Geller
Exhibition Curator - 4 White Street
New York, NY 10013-2443

Voice: (212) 925-1247
Fax: (212) 925-1293

Thank you to those
who have already sent material.

† See A.R.C. Feb. '90 (p. 15) & March '90 (p. 18) for additional information about the exhibition.

CLASSIFIED ADVERTISEMENTS

FOR SALE: (7) RCA plug sets. (8) 1B3 caps. (22) 6B96 caps. (5) A/C male connectors. (26) assorted controls. (5) assorted slide controls. (24) assorted tube sockets. (8) assorted IF transformers. (1) Romona 30K HV test probe. Telechron electric clock Model 711, working. Make offer plus UPS. Jerry Finkel, 4924 N.W. 54th Ct., Ft. Lauderdale, FL 33319

WANTED: Chassis for Clarion AC-94, Transformer Corp. of America Model 90 or 91, prefer working condition. Post-1940 tube chart or copy for Triplett 1213, 1612 or 1613 tube tester. Repair info for Bendix/Dayrad Series 57 multimeter. Richard Graham, 14041 Newcomb Ave., Orlando, FL 32826. (407) 380-6017

WANTED: One pair of socket adaptors for a Radiola III. Send details including price. Stan Marlin, Box 1035, Assiniboia, Saskatchewan, Canada S0H 0B0

WANTED: Quadraflex Speaker made by Stephens Trusonic, Inc., about 1956-1960. Square speaker set on four-legged aluminum pedestal base. Bob Turner, PO Box 2313, Fair Oaks, CA 95628. (916) 721-9063

FOR SALE: New and used tubes, electrolytic capacitors, cone speakers. Send SASE for lists. C. Elmer Nelson, 11 S. Church St., Princeton, IL 61356

WANTED: Tannoy anything. Books on acoustics, hi-fi. Any Rel Tuner. Barry Nadel, Box #29303, San Francisco, CA 94129. (415) 346-3825

CAPACITORS - All Prepaid

Dual 33/47 µf @160 volts ..\$3 ea., 4 for \$10
 Dual 22/47 µf @250 volts\$3.50 ea.
 Four for\$12

Single 10 µf @450 volts ..\$2.50 ea., 4 for \$8

Single .1 µf @600 volts **or**
 Single .22 µf @600 volts ..\$3.00/2, 8 for \$10

All capacitors are insulated with 7" leads.
 Electrolytics are new.
 600 V. CAPS are Mil. Spec.

GRILLE CLOTH - All Prepaid

"Desert Sand" - Free Samples

14" x 18"\$7.00
 26" x 36"12.50
 36" x 54"20.00

DIAL BELTS

New or N.O.S. \$10.00 ea. Prepaid. Need brand & model number, or chassis number, or old belt, or length & width.

FRONTIER ANTIQUES - Everett Hoard

Box 38, Lehr, ND 58460

(Winter to May 1st) - PO Box 1002
 Apache Junction, AZ 85217

CLASSIFIED ADVERTISEMENTS

FOR SALE/TRADE: Xerox copy of AN/ART-13, BC-224/348, or SCR-284/BC-654; manual: 2-PRC-8A R-T units, unchecked but complete: SCR-610/629/BC-1335: A few plugs for ARC-5/SCR-274N: PE-103 power unit: BC-654 R-T unit: SCR-522 with some plugs, W/A.C. and Dynamotor P.S. **WANTED:** PE-97, PE-117, PE-120, power supply; EE-89-(*), telephone repeater; CS-131-(*), BX-49 spare parts box; BC-684-(*), transmitter; CH-291, battery box; FT-234, FT-237, FT-25-0; FT-317; FT-346, FT-506, FT-508, mounting racks; PE-219, battery charger; BC-745 Pogo-Stick, R-T unit; J-72/GR terminal box; BX-40 spare crystal box; CD-1294 cord. Wm. A. Stokesbury, Rt. #3, Box 200B, Selbyville, DE 19975-9519

WANTED: 12v vibrator transformers. Tube type automobile radios and parts, especially prewar, automobile phonographs. Dan Schulz, PO Box 892, Crystal Beach, FL 34681. (813) 785-8733

CLASSIFIED AD NOTICE
Please check your ads carefully
before sending them in.
It is difficult to make changes to ads
once they are received.

WANTED: Adams-Morgan Paragon RB-2. Cutting-Washington 11, 11A, 11B, 12 or 15. Tuska 222, 224 or 225. Richard Sharisky, PO Box 521, Belmont, MA 02178. (617) 484-5784

FOR SALE: Hallicrafters S-20-R owner's manual reprint with schematic and additional servicing data - \$5. Scott Allwave 12 owner's manual reprint with schematic and repair data - \$5. Fixing Up Nice Old Radios by Romney, 188 pp., illustrated - \$19. Add shipping. See my display ad. Ed Romney, Box 96, Emlenton, PA 16373. Visa/MC. (412) 867-0314

WANTED: Cabinet-mounted power and antenna switches with trim plates for Majestic 91 or 92. Alan Schreier, 12805 Powderhorn St., Austin, TX 78727. (512) 835-2056

WANTED: Manual for Eico Model 324 signal generator, copies OK. Mark Hewitt, 4396 Straw Ln., Roscoe, IL 61073. (815) 623-8729

WANTED

- NEUTROWOUND RADIOS
- UNUSUAL HORN SPEAKERS
- CRYSTAL SETS
- WIRELESS
- OLD TELEPHONES

TIMELESS RADIOS - Jerry Finamore
 87 Stonewood Place
 Catasauqua, PA 18032 (215) 264-8412

CLASSIFIED ADVERTISEMENTS

WANTED: Grille cloth for E. H. Scott console radios, original or repro. Mike Ceklovsky, 3116 Smoky Ct., Sacramento, CA 95826. (916) 363-3211

FOR TRADE: AK 10C, Radiola 25 with loop, meter. **WANTED:** Hammarlund Comet Pro, Aerola Junior, Radiola I. Brian Roberts, 3068 Evergreen Rd., Pittsburgh, PA 15237. (412) 931-4646

WANTED: I Need chassis for Sparton Model 500, Cloisonne. Will trade or pay your price. Lairy Wilcox, 357 Gravatt Dr., Berkeley, CA 94705. (415) 548-7099

FOR SALE/TRADE: For Collins, Drake - rcvr. Grundig 1060, 2066 HQ-215, mint w/manuals. Levy, 8 Waterloo, Morris Plains, NJ 07950. (201) 285-0233

FOR SALE: Zenith Trans-Oceanic plus 16 pre-1960 Bakelite + plastic table + clock radios, half of them working well - \$125 for the lot. Will not separate or ship. Dave Smith, 6 Delaney St., Stow, MA 01775. (508) 897-6148

WANTED: Scott Transformer Company World's Record 8, 9, 10, or AC 9, AC 10. Shield-Grid 9B, 10, 10B or Symphony AC or DC copper sets. Mike Ceklovsky, 3116 Smoky Ct., Sacramento, CA 95826. (916) 363-3211

FOR SALE: Radios and radio-related items, test equipment and electronic toys. List for SASE. Robert Gates, Mountainside Rd., RD #3, Mendham, NJ 07945

CLASSIFIED ADVERTISEMENTS

WANTED: Philco 90 cathedral metal dial plate. Kiel table lid hinge. AK 84 and 206 cabinets. Knobs and station dial for 7J232 Zenith tombstone. Jerry Randolph, 2934 Cameron St., Indianapolis, IN 46203. (317) 787-3937

FOR SALE: Photofacts sets under #1400 - \$5 ea. ppd. Send \$2 for latest listing of parts, tubes, and test equipment; refunded with first order. R & D Associates, 514 West Ave., North Augusta, SC 29841. (803) 278-0744

WANTED: Wind-up phonographs, inside and outside horn types, any condition, parts, related items. Gary Nitkin, 102 Long Highway, Little Compton, RI 02837. (401) 635-2816, eves.

WANTED: Antique Radiotron Type P UV-204 transmitting tube. Pat Stewart, W7GVC, 1404 Ruth Ave., Walla Walla, WA 99362. (509) 525-1699

FOR SALE: AK 33. I will send surprise gift for info on AC Dayton Type X-L-5. Norman M. Landis, 1315 Marbendale Ct., Kirkwood, MO 63122. (314) 821-7933

WANTED: Wooden AC table & console radios, quantities preferred, will pick up. Larry Cooper, 425 Court St., Rockwell City, IA 50579. (712) 297-7232

WANTED: Howard 220-270 wooden cabinet. Chassis has 4 push buttons on top right. Junker OK. Stan Kleen, 200 Castle Dr., Kettering, OH 45429. (513) 293-3194

WANTED
Top Prices Paid

- Radio & Audio Tubes:** 2A3, 45's, 50's, 845, 8005, KT66/88, etc.
Western Electric Tubes: 101, 102, 104, 203, 305, 211, 212, 242, 244, 252, 262, 264, 271, 274, 275, 276, 284, 285, 300, 301, 310, 339, 345, 347, 348, 349, 350, 421, 422, VT25A, VT52, etc.
W.E. Speakers & Tweeters: 555, 594, 595, 596, 597, 713, 728, 754, 755, 756, 757, TA4151, 4153, 4181, 4191, 4194, etc.
W.E. Consoles & Amps: 25B, 41, 42, 46, 86, 91, 92, 94, 95, 105, 106, 117, 118, 120, 121, 124, 129, 130, 131, 142, 143, etc.
W.E. Horns: 22, 24, 25, 26, KS-6368, 12024, 12025, 12027, etc.
W.E. Microphones & Parts, etc.

Also looking for:

Tube-type equipment by McIntosh, Marantz, Westrex, Langevin, Altec, etc.
Vintage speakers, units, by Jensen, Altec, JBL, Tannoy, etc.

Audio City USA, PO Box 802, Northridge, CA 91328-0802
(818) 701-5633

CLASSIFIED ADVERTISEMENTS

FOR SALE: Book on Canadian Mercury receiver, 36-page reprint of 1928 original - U.S. \$4.50 ppd. Bob Murray, 3216 Assiniboine Ave., Winnipeg, Manitoba, Canada R3K 0B1. (204) 885-3045

WANTED: Any microscope made by the McIntosh Battery and Optical Co. Other antique microscopes. Allan Wissner, PO Box 102, Ardsley, NY 10502. (914) 693-4628

FOR SALE: Hickock 6000, 6000A, and 6005 tube tester owners. Obsolete tube types and supplementary test data, 23 pages - \$8 ppd. John Snow, 4539 Bartlett, Shorewood, WI 53211

WANTED: RCA AR-88/CR-91A vernier dial and window or parts set. Also want cabinet for AR-88 and SP-600. Sam Thompson, W6H DU, 1031 San Antonio Ave., Alameda, CA 94501. (415) 521-1429

FOR SALE: Console liquidation sale - all restored! Pick up only. GE AM/SW, 40's - \$175 or BO. RCA Radiola 80 AM Superhet - \$175 or BO. Silvertone #117 AM - \$150 or BO. Philco 1008, AM/SW w/ phono (inoperable) - \$175 or BO. RCA K80, 1939, AM/SW - \$175 or BO. Magnavox sidechair AM/SW/phono, 50's - \$100. Stromberg #1406 - \$175 or BO. Temple lowboy, inoperable - \$50 or BO. All 75+ 78's - \$40. T. Brennon, 215 Common St., Quincy, MA 02169. (617) 773-8356

WANTED: Chassis, speaker & knobs for Majestic Model 15 grandfather clock radio. Andy Czymbor, 3799 East Burt Rd., Burt, MI 48417. (517) 624-5185

CLASSIFIED ADVERTISEMENTS

WANTED: Dial glass for DeWald A-501, knobs for Philco 38-9. Duane Doel, 280 Kohler St., Tonawanda, NY 14150. (716) 692-2017

FOR SALE: BC-1206C Beacon Receiver Model 524 w/manual in original box, looks new - \$30. I ship. John Snow, 4539 Bartlett, Shorewood, WI 53211

FOR SALE: Crystals, many different type holders - \$1 ea. Send LSASE for list and many other electronic items. John Snow, 4539 Bartlett, Shorewood, WI 53211

WANTED: First and second audios for AK 35 or junker for parts. Audios can be open. No cabinet needed. If no junker then just audios. Mickey Deems, 13114 Weddington St., Van Nuys, CA 91401. (818) 763-1055

FOR SALE: Antique, PACO G-30-PC signal generator by Precision, new factory sealed - \$65, I ship. John Snow, 4539 Bartlett, Shorewood, WI 53211. (414) 964-0194

WANTED: RCA Victor Model 9EY3 or similar 45 rpm record player, must be very good working condition. Harold Head, 114 Three Iron Dr., Summerville, SC 29483. (803) 873-6565

FOR SALE: Electric Radio Magazine, "celebrating a bygone era" with stories on vintage ham equipment, military gear, AM operations and the pioneers. Large classified section. Write or phone for a free sample copy. ER, Box 139, Durango, CO 81302. (303) 247-4935

CLASSIFIED ADVERTISEMENTS

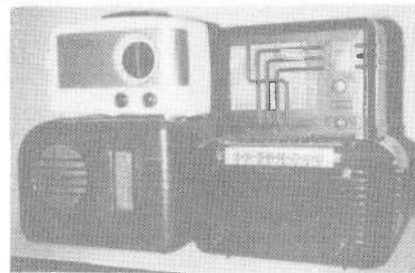

FOR SALE: TL-Emerson, TR-Fada 260V, BL-GE54, BR-Motorola 67X. Ross Litrenta, 1 Wilton Rd., Eastchester, NY 10709. (914) 337-7176

WANTED: W.R.L. Globe King, Pilot Super Wasp, Viking 6N2 Thunderbolt. R. French, KBØBY, 852 Sunrise, Salina, KS 67401. (913) 823-8455

WANTED: (4) fine tuning knobs for Admiral TV Model 24R12 in Bakelite console cabinet. Warren Burdine, 1606 Idylwild Dr., Prescott, AZ 86301. (602) 778-1608

IF YOUR EXPIRATION DATE IS JUNE OR BEFORE, RENEW TODAY! EARLY RENEWALS RECEIVE AN EXTRA ISSUE!

FOR SALE: Moving to Florida June 29th - must sell: All plus UPS. Metal Silvertone 132.818 vista green (R.G.A., p. 100, bot. mid.), super, refinished - \$65. Brass-plated Silvertone 132-878 (R.G.A., p. 100, top rt.) - \$50. Wood-unknown kit radio, unusual shape, plays great - \$35. Airline 84BR-1504D ivory, fluted wraparound grille - \$25. Silvertone 132-881 (G.O.R., p. 124), sm. hairline - \$35. RCA 8X542, bone Bakelite, round dial, golden throat sound - \$25. Stewart-Warner C51TI (G.O.R., p. 115), big Bakelite, chips - \$35. Westinghouse Little Jewel, refinished, doesn't work - \$35. Fada plastic big dial tb. model, works great, heat spot on top - \$20. RCA 25BP leatherette portable, no sound - \$10. RCA 1X592 unusual, waterfall grille, golden throat, chips - \$15. Telechron 8H59 clock radio - \$20. Packard Bell #602 masonite, stationized dial, rare - \$49. Zenith H511, mint, (G.O.R., p. 128, brown) - \$50. Emerson wood #512, needs pointer - \$20. Airline 6-tube, lg. fluted grille - \$45. Philco Transitone 46-200, scratch on top - \$19. Bulova plastic #310, hairline top - \$10. Arvin 552AN, refrigerator style - \$29. Same Silvertone #2015 - \$29. Consoles: RCA 9K2 (G.O.R., p. 74, same as 13K) - \$150. Arvin Phantom Bachelor, rare, works great - \$300. Philco M-14 - \$150. RCA 242 - \$150. Jay Flesher, 100 Cornfield, Rd., Milford, CT 06460. (203) 878-4553

WANTED: Manual/schematic for Hickock 580A tube tester and test settings for older tubes. Ray Bintliff, K1YDG, 2 Powder Horn Ln., Acton, MA 01720

CLASSIFIED ADVERTISEMENTS

FOR SALE: TV's. RCA 630, excellent condition, with original stand, restored working - \$450. RCA 621, excellent condition, restored, working - \$675. Zenith portable table model, white cloth, restored, working - \$350. Hallicrafters push-button table model, wood - \$275. Eric Fogel, 87 Sandra Dr., Parsippany, NJ 07054. (201) 316-8461

WANTED: Zenith Royal 500H, oval speaker pocket transistor. Michael Arken, 1427 Diamond St., San Francisco, CA 94131. (415) 648-6817

FOR SALE: Tube manual, GE 1973, covers 01-A up; base diagrams, specs, interchangeability charts, more; 474 pages, originals (not copies), mint condition - \$8.95 ea. plus \$2. Don Diers, 4276-A15 North 50 St., Milwaukee, WI 53216-1313

FOR TRADE: My good condition Rider #14 for your #17, #18 or #19. Tom Pencak, 26660 W. Catalpa Rd., Antioch, IL 60002. (708) 395-8890

WANTED: Edison records, thick. AK 46 speaker. **FOR SALE:** Emerson 541 (F.O.S., p. 83) - \$35 + UPS. (5) 301A tubes - \$5 ea. Wayne Himel, 5230 August Ave., Marrero, LA 70072

FOR SALE: Arvin red plastic portable radio, mirror in center - \$45. Ware radio, slant-front, 4-199 exposed tubes - \$350. Music Master slant-front 5-tube set - \$350. Lemmone slant-front radio - \$300. Atwater Kent Model 35, metal case - \$50. 199 tubes - \$12 ea. 201A brass base - \$16 ea. Pat Cutini, 2114 Main Rd., Corfu, NY 14036

WANTED

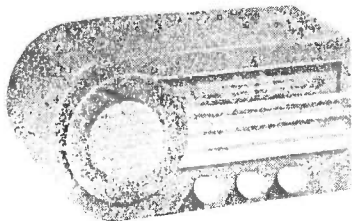

CYART MODEL #B - LUCITE TABLE RADIO

PHILIP COLLINS
El Royale #406 - 450 North Rossmore Avenue
Los Angeles, CA 90004
(213) 466-2546

ALL A.R.C. BACK ISSUES AVAILABLE

Feb. '87 to current issue: Originals available 32 to 80 pages each.

Oct. '86 to Jan. '87: Reprints available Reprinted from original artwork; 28 to 32 pages each. Quality and appearance same as an original copy.

June '84 to Sept. '86: Photocopies available Not original quality, useful for info.; 16 to 28 pages ea.

The above availability is as of April 1990. As stocks of original copies are exhausted, reprints will be substituted for the issues after January 1987. Publication of Antique Radio Classified began in 1984 which had only five issues: June, Sept., Oct., Nov. & Dec. 1984. 1985 through 1989 have had 12 issues each.

\$3.00 each - Postpaid to U.S., Canada and Mexico.

Orders of 12 issues or more may take a 10% discount. Foreign orders other than Canada and Mexico: \$5.00 each by air. Massachusetts residents, please add 5% sales tax.

Send Order with Payment to:
ANTIQUE RADIO CLASSIFIED
P.O. BOX 2, CARLISLE, MA 01741

CLASSIFIED ADVERTISEMENTS

FOR SALE: GE Model 203, no knobs, not working - \$10. GE Blue Max, like new - \$15 plus UPS. **WANTED:** 8-, 9- or 11-pin round female octal power plugs and Sams CB Photofacts. George M. Manter, 5782 N. 4th, Fresno, CA 93710. (209) 432-5176

FOR SALE: Rider's Radio Manuals. Vol. 1-5 - \$10 ea., Vol. 6-15 - \$19 ea. ppd. Cover torn Vol. 14. All fair to good. Index Vol. 1-10, 11, 12, 13, 15. All - \$225 ppd. Dave Gautier, 1420 N. Pace Blvd., Pensacola, FL 32505. (904) 438-3319

WANTED: Spy-related equipment! Military radios in civilian suitcases. M-209 cipher machine. Highest prices paid, or trade! H. Melton, PO Box 5755, Bossier City, LA 71171-5755. (318) 747-9616, days

WANTED: One round aluminum escutcheon plate for rheostat on early Midwest battery sets. Two tuning knobs for Kodak C-13, 2" diameter with 360 numbers. Wally Worth, 2 West Elm Ave., Wollaston, MA 02170. (617) 479-4512

FOR SALE/TRADE: Catalins: GE L573 tortoise/maroon, Fada 1000 yellow/red, Fada 652 yellow, Emerson A-27 green, Halson yellow - Best Offer. Lairy Wilcox, 357 Gravatt Dr., Berkeley, CA 94705. (415) 548-7099

WANTED: E. H. Scott AM Phantom Deluxe (20 tube) or Masterpiece in a Braemar cabinet. Excellent to mint condition. Mike Ceklovsky, 3116 Smoky Ct., Sacramento, CA 95826. (916) 363-3211

Please Save This Want List!

CUTTING & WASHINGTON

8A, 9A, 11, 12, 12A, 15, Teledyne

KENNEDY

311 Portable with built-in Amplifier V, X, XI, VI

ADAMS MORGAN

RA-6 Receiver, RB-2 Receiver, III Receiver

WESTERN ELECTRIC

4-A Receiver, 2-A Tuning Unit, 20-A Filter

TUSKA

220, 221, 222, 223, 224, 226
225 (2-panel version with straps)

As it may be a long time before I find some of the sets listed in these ads, remember to call me when you can part with yours. I am putting together a collection of early broadcast and wireless equipment and adding to it each month. I buy single sets or collections, also - books, catalogs, manuals and other related documentation.

Call and surprise me; make my day!

John V. Terrey, 498 Cross Street
Carlisle, MA 01741 - (508) 369-9770

CLASSIFIED ADVERTISEMENTS

WANTED: Excellent to mint Zenith 7G605, 8G005, & D7000Y Trans-Oceanics. Amplion, Music Master, Burns, Dictograph horns. Mike Ceklovsky, 3116 Smoky Ct., Sacramento, CA 95826. (916) 363-3211

FOR SALE/TRADE: Wood radios: RCA 85T2 tombstone - \$35; Philco 37-38 tombstone - \$50; Sears 101.808 push button - \$38; Truetone D-704069, battery tabletop - \$25; GE 221 - \$48; Philco Tropic 41-788, 8-band large tabletop - \$70. Plastic radios: RCA 56X - \$23; RCA 2-C-521 - \$15; Sonora 102B - \$10; GE 202 - \$18; GE 60 - \$28; GE C-433C - \$20. Rider's Vol. 1-5 abdg. - \$15. T.V. Vol. 1 - \$10. T.V. Vol. 2 - \$15. Radio Vols. 7, 8, 10, 12, 14 - \$10 ea. Mahogany veneer suitable for all wood sets (can be cut with scissors - \$2.20/square foot or odd sizes at 2¢/square inch. All radios with good tubes. **WANTED:** Radios from the 20's or 30's; 01-A, 99, and WD-11 tubes; 99 to 01-A adapters; glass bullet-shaped resistors 2-4 meg. for old battery sets. All prices do not include shipping. Ralph Ripke, Box 430052, South Miami, FL 33243-0052. (305) 667-5047

**NEW FAX NUMBER FOR
ANTIQUA RADIO CLASSIFIED
(508) 371-7129 - 24 Hours per day
Ads - Subscriptions - Book Orders
Charge to Visa/MasterCard
Minimum Charge: \$10.00**

FOR SALE: Crosley 635, TM, AM/SW, wood cabinet, plays - \$95 plus shipping. Harry W. Overholtzer, KA3BDN, 1480 Farmington Ave., Pottstown, PA 19464. (215) 323-7640

WANTED: McIntosh amps 15-W1, 50-W1, tuner MR-65A. Dave Carver, 43 Jewett St., Ansonia, CT 06401. (203) 734-4641, after 6 pm EST

WANTED: Admiral All-World Model 909, reasonable please. Bob Moore, Box 27232, Lakewood, CO 80227

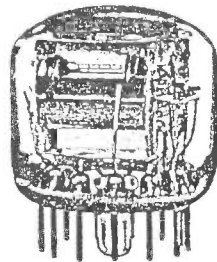

FOR SALE: Stewart-Warner bar radio, glass-ware, inc., not tested - \$110. Zenith Service Notes, 1938 to 1942 - \$10/ea. or \$35/all. UPS extra. **WANTED:** The compactron shown. Also seeking a repro DeForest audion. Richard C. Foster, 12 Shawmut Ave., Cochrutuate, MA 01778. (508) 653-2418

CLASSIFIED ADVERTISEMENTS

WANTED: RCA Red Books Service Data, 1939 and 1941 issues, two books. Gilbert Smith, 248 South 36th St., San Diego, CA 92113. (619) 236-7990

HELP: If you have a Richard Nixon transistor, please call me. I need to mold or cast his left hand to repair my missing one. Will make it worthwhile to arrange this. This ad is not a satire. Stefan Ponek, 2741 Center Rd., Novato, CA 94947. (415) 892-5670

FOR SALE: Or part out: Airline Movie Dial 62-309, Crosley 828M slant-front console. Cliff Berthelsen, PO Box 1096, Merced, CA 95341. (209) 723-7026

Classified Ad Deadline Noon

Jun. 10 for Jul. 1990 Issue

Jul. 10 for Aug. 1990 Issue

Box & Photo Ads - 5th, Display Ads - 1st

FOR SALE: Rider's XV, vg condition - \$18 + shipping or swap for VII. John Kendall, PO Box 436, Fallston, MD 21047. (301) 879-0657

WANTED: An 11Kc or 9Kc quartz xtal or a 1Kc tuning fork of magnetizable metal for time reference. Ray Larson, 12241 1/2 Gorham Ave. W. Los Angeles, CA 90049

WANTED: Dial parts for RPC (Radio Products Corp.) radios with large round dial. Bruce Eddy, 2590 W. Needmore Hwy., Charlotte, MI 48813. (517) 543-3021

FOR SALE: H. H. Scott tuner, Stereo Master 312 transistorized wideband FM MPX stereo - \$75 plus shipping. J. J. Papovich, 53 Magnolia Ave., Pitman, NJ 08071. (609) 582-8279

FOR SALE: Early Saal horn - \$90. Large dial Zeniths - \$50. Art Deco Admiral, wood, 30's - \$60. Plus others. R. Burick, 21B N. Earl, Shippensburg, PA 17257. (717) 530-5040

WANTED: Leutz Leutz Leutz Paragon Grebe CRL old tubes. Marc Gottlieb, Box 1112, South San Francisco, CA 94083-1112



TIMELESS RADIOS
87 Stonewood Place
Catasauqua, PA 18032
(215) 264-8412
Jerry Finamore

- FOR SALE -

QUALITY RADIOS

**LARGE SELECTION OF ALL TYPE
RADIOS AND ACCESSORIES.**

SEND SASE TODAY FOR LIST!

CLASSIFIED ADVERTISEMENTS

FOR SALE: Capehart AM-FM Panamuse, Model 22M2FM, Serial Number 88373, excellent original condition, once owned by Cecil B. DeMille? - Best Offer by July 15, 1990. Send one dollar & SASE for photograph and more information. Richard Gray, 9181 Chesapeake Dr., San Diego, CA 92123

FOR SALE: Sams Tube Substitution Book Vol. #8 - \$2. GE Essential Characteristics, 1961 - \$1. RCA Rec. Tube Manual RC-24 - \$2. H.C. Cisinis(?) Tube Sub. Guide - \$1. Massey Tech. Inst. Course, Books #43 through 50 - \$4. Bureau of Naval Personal Fund. of Elec. Vol. 1A - \$2. TV Ser. Guide Book H/B - \$5. Sams Radio Rec. Ser. RS-1 - \$2. Sams 101 More Ways To Use VOM and VTVM - \$2. Sams Guide to TV Ser. - \$2. Rider's TV Troubleshooting Vol. 1 - \$2. Rider's Test Scope Tracer - \$2. Sams Index 1963-1980 - \$4. Accurate Instrument Co. tube tester Model 257 - \$17.50. Tube tester Eico Model 625 - \$15. All plus UPS. Thomas Burnside, 4838 S. Westhaven Dr., Jackson, MS 39209. (601) 922-2235

SERVICES: Antique TV and radio repairs. **FOR SALE:** BOBP4 CRT. Mitchell Lullaby bed lamp radio, mint in original box. Thrifty TV, 11 E. Marie St., Hicksville, NY 11801. (516) 822-4501, days. (718) 465-6702, eves.

WANTED: Good last stage audio for Crosley 5-38, or any older type Crosley audio except Sheltran, good or bad. Also looking for good Musicone Type D speaker or good sound unit. Maurice Gillette, 1374 David Rd., Cloquet, MN 55720

JOIN

A.W.A.



ONE OF THE WORLD'S LARGEST AND OLDEST
HISTORICAL RADIO COLLECTOR ORGANIZATIONS.

- * International "Meets"
- * Nationwide "Meets"
- * Sponsors world's largest radio Conference and Flea market
- * Maintains unique radio and television museum
- * Publishes quarterly journal featuring columns covering:
 - Battery & AC receiver restoration
 - Loudspeaker operation
 - Commercial receiver column
 - OT amateur transmitter operation
 - Vacuum tube collector's column
 - Early television receiver column
 - Current radio book & magazine reviews
 - Free Want-Sell-Swap column
 - Radio obituaries
 - Reports on public radio museums
 - Information on collector clubs in U.S.A. and foreign countries.

All this for only \$10.00 per year. Mail check to:
Antique Wireless Association, Inc.
Box 2-E, Breesport, New York 14816

CLASSIFIED ADVERTISEMENTS

WANTED: Power box for AK 40. Speaker for 1930 Brunswick Model 15 console. In working condition required on both. Richard Arnold, Box 275, Lone Grove, OK 73443

WANTED: Five tube shields 2"OD (round) for 1930 American Majestic, Model #20. Ernest D. M. Yeaw, RR#3, Tatamagouche, Nova Scotia, Canada B0K 1V0. (902) 657-2554

FOR SALE/TRADE: Catalin Stewart-Warner Model 62T36 (R.T.G.A., p. 72) in perfect condition. Will consider any of the following: Kadette Classic, colored Kadette Jewels, red Kadette Junior, small Addison Plaskons, or partial trade for other Catalins or Air-King tombstone. David Mednick, 1450 Palisade Ave., #5-H, Fort Lee, NJ 07024. (201) 461-3082

FOR SALE: Motorola A22B blue plastic, plays - \$15. Motorola 66X brown Bakelite, slight scratch on plastic dial, plays - \$12. GE Model 410, wood, 6-tube - \$15. Silvertone 101-808 wood, plays - \$22. Plus UPS. Ferdinand Estree, 660 Fineview Ave., Kalamazoo, MI 49007. (616) 344-0231

WANTED: Gernsback Official Service Manual(s). Also magazines & books circa 1934. Richard Gray, 9181 Chesapeake Dr., San Diego, CA 92123. (619) 560-4162

WANTED: Bell and gooseneck for an AK L and H speaker. Radiola 25, 26, AR810 and AR812. BB, TT tubes. Noriyoshi Tezuka, 2-2-6-407 Ebisunishi, Shibuya-ku, Tokyo 150, Japan. Tel. 03-780-7021. Fax 03-780-7029



Antique Radio Service

508-653-2418

A Complete Restoration Shop

Home radio, auto radio, chassis, cabinet, veneer, wood and finish restoration.

Buying auto radios and parts pre-1960.

Service literature, all kinds.

RICHARD C. FOSTER
12 Shawmut Ave.
Cochituate, MA 01778

Call or Write for Quotes

CLASSIFIED ADVERTISEMENTS

WANTED: Schematic and operating manuals for Knight VTVM Model KG-620 and source for dual electrolytic capacitors. Loren H. Dudley, 14 Valley Rd., Bath, ME 04530

FOR SALE: 69 years collection: 10,001 items, antiques, radios, televisions, phonos, sound, military, ham, books, flyers, catalogs - 48 pages, \$1 refundable. F. Yonker, W21BH, 7 Old Farms Rd., Saddle River, NJ 07458. (201) 825-1895

IF YOUR EXPIRATION DATE IS JUNE OR BEFORE, RENEW TODAY! EARLY RENEWALS RECEIVE AN EXTRA ISSUE!

FOR SALE: Johnson Viking Ranger amateur transmitter, untested but appears to be in excellent condition - \$175. Hammarlund HQ-100A amateur receiver with matching speaker, both units working and extremely nice - \$200. 1957 Mike-Radio in mint condition. Early Zenith clock radio, Deco with hairline crack, otherwise excellent - \$24. Zenith Y615-W Deco set in very good condition - \$45. Zenith Deco set similar to H-725 in G.O.R., very good condition - \$37. Westinghouse 382-T5 Bakelite set in excellent condition - \$20. Telechron clock radio 8H57 with thumbwheel tuning, uses metal tubes, excellent condition - \$28.50. Sea Hawk Helmet transistor set - \$12.50. Silvertone 8004 metal set in excellent condition - \$55. RCA X-552 Deco set similar to X-551 in G.O.R. - \$27. Philco 40-155 - \$75. Metrocone frame with partial driver for 17" cone speaker - \$5. Many large type tube portables in very good to excellent condition. Plus more wood, plastic and Bakelite radios. I also have early test equipment, parts and literature. Please send SASE to: Neil O'Donnell, 1809 Sampson Ave., Butte, MT 59701. (406) 494-8162

FOR SALE: Philco Model 48-200 brown Bakelite - \$45. Philco Model 666, has built in flashlight, maroon plastic - \$56. Philco Model 48-206, imitation leather, needs work - \$40. Zenith 1000, almost mint - \$150. Silvertone (G.O.R., p. 124), Model 132.881 - \$50. Westinghouse Model 202 (G.O.R., p. 109) - \$40. Coronado, Belmont Model 636 (G.O.R., p. 88) - \$70. Jim F. Montague, 921 S. Cuba, Spokane, WA 99202

NEEDS MORE 40's, 50's, 60's COLORFUL PLASTICS



LES WAGENHEIM (216) 442-1600
% XONEX 750 Beta Drive Mayfield Village, Ohio 44143

CLASSIFIED ADVERTISEMENTS

WANTED: Box for five Brighton blue, four knobs Airline 62-337. Pete Gamache, Box 35, Leaf Rapids, Manitoba, Canada R0B 1W0

WANTED: Sparton Equisonne 301 chassis. Bruce Fredrick, 6559 Mission Rd., RR#1, Bullhead City, AZ 86430. (602) 768-2461

FOR SALE: Beautiful Motorola miniature AC/portable 5M1U in green metal case with flip lid, 7.25w x 6.625h x 4.125d - \$99. Edison Bell 4-tube TRF, ancient, restorable wood table model - \$85. Stromberg-Carlson brown table radio (Johnson, p. 120) - \$75. RCA 86T1 3-band AM/SW to 22 MHz wood table (similar, p. 84) - \$150. Unusual Emerson 908/974 simulcast AM/FM 2-piece mahogany table stereo radio. Listener's special - Pacific Electronics 610A, 0.5-18 MHz receiver - \$65. Kuhn 26-174 MHz miniature 5-tube super-regenerative receiver. Exotic tubes: 4-65A, RK150, 4E27, ballasts, photomultipliers, German tuning eyes, RK6BM6 other Klystrons, 2A3's, Amperex, many more N.I.B. Collins 465, 500 kHz mechanical filters. Parts for 51J, 51S. Tektronix plug-in's. Vacuum tube hi-fi equipment. Variacs - \$25-75. Cash for Emerson, Collins, Hallicrafters equipment. SASE for newly updated super list. Steve Lipsky, W2VVN, Vintage Technology Associates, 1254 Cox Rd., Rydal, PA 19046-1207. (215) 884-1817

FOR SALE: Radio (on the escutcheon it says) 3-tube AC with plug-in coil. Also glass telephone insulators. Russell or Irma Schoen, E7340 Nietzsche Rd., Clintonville, WI 54929. (715) 823-6744

CLASSIFIED ADVERTISEMENTS

WANTED: Official Radio Service Manuals Volumes 2 and 3 by Gernsback. Marconi stock certificates. Crosley Bandbox Jr. in need of restoration. Small, unique, early battery sets in need of restoration (not home brew). AK 46 in need of restoration. Steve Zingmond, 6241 Radford, North Hollywood, CA 91606. (818) 769-9283

FOR SALE: Philco 37-116 chassis, no tubes, no speaker - \$55. Philco 95 chassis w/tubes & spkr. (bad cone) - \$95. Philco 37-93 chassis, no tubes, w/spkr. (no cone) - \$50. Philco 610 chassis w/5 tubes, & dyn. speaker - \$60. RCA C13-2 complete console - \$115, will sell chassis & spkr. for \$95. RCA 143, 242 chassis w/tubes, no spkr. - \$70. Radiola 18 complete w/tubes & spkr. - \$145. Zenith 10J669 chassis w/tubes, no spkr. - \$65. Plus shipping. J. J. Papovich, 53 Magnolia Ave., Pitman, NJ 08071. (609) 582-8279, 10 am to 9 pm

FOR SALE: Several radios, small quantity WWII items, etc. SASE for list. Sony ICF-2010 for sale or trade. Mark Smith, 1314 Eddy Dowling Hwy., Lincoln, RI 02865. (401) 769-4769

WANTED: Tektronix 570 tube characterizer and AR1 and AR3 argon glow lamps. Bruce Ashcraft, 1300 Burrows Rd., Campbell, CA 95008-6302. (408) 374-5228

WANTED: Fahnstock type binding posts, roll of Slipknot semiconducting rubber tape. **FOR SALE:** Grebe CR 9 - \$225. Hickock Traceometer - \$75. Violet Ray #11 - \$20. Zenith Beta VCR - \$25. Duncan W. Mackiernan, 603 Clay Ct., Brandon, FL 33510. (813) 689-3256

You heard it right.

The newest audio magazine is all about vacuum tubes!

Glass Audio features the best vacuum tube designs for audio reproduction—past and contemporary. The new designs take advantage of improved components and control techniques that make the end results far superior to anything possible during the early days of audio's rebirth after World War II.

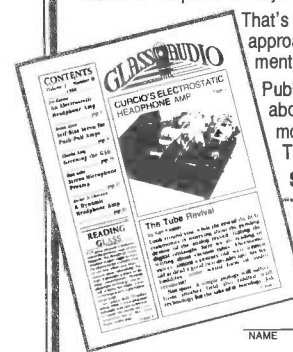

That's why tubes are having such a renaissance of interest as a perfectionist approach to good sound. And that's why tubes are reappearing in original equipment, in high end consumer and professional audio systems.

Published twice a year, in June and December, *Glass Audio* will inform you about new innovations in the field and about parts sources. We'll also include modification projects, reviews of technical basics and regular columns such as Tube Troubles, Tube Tips and much more.

Subscribe today!

GLASS AUDIO, PO Box 176, Dept. ARO, Peterborough, NH 03458

- Two years @ \$18 (SAVE \$2 on 4 issues)
 - One year @ \$10 (2 issues) Canada add \$2 per year postage
- Payment enclosed: Check MO MC VISA

NAME _____

STREET & NO. _____

CITY _____

STATE _____

ZIP _____

MC OR VISA NUMBER _____

EXPIRE _____

CREDIT CARD ORDER LINES: VOICE: (603) 924-9464; M-F, 9-4 EST
ANSWERING MACHINE: (603) 924-9464 p.m.-8 a.m. **FAX:** (603) 924-9467—24 hours

CLASSIFIED ADVERTISEMENTS

FOR SALE: Novelty transistors, (2) old world Globe radios - \$15, \$20. Red Radio Shack lettered radio - \$35. Early Channel Master 6506, red, mint - \$25. Motorola SP32R, red, tube portable - \$20. Harald Herp, 6615 Michele Ct., Hunt-ingtown, MD 20639. (301) 855-7071

FOR SALE: Choice console radios & jukeboxes, trade for microphones & broadcasting equipment for my museum - SASE. Robert Van Dyke, Museum of Broadcasting, Film & Recording, 2 Squires Ave., East Quogue, NY 11942. (516) 728-9835

WANTED: Rider manuals, 1 through 23. **FOR SALE:** Radio News, 1920 through 1960. Pete Anderson, 1209 W. Cochiti, Hobbs, NM 88240. (505) 392-8866

FOR SALE: IP-500 - \$1800 or BO. Steve Raymer, 3515 Raleigh Ave., St. Louis Park, MN 55416

WANTED: Reward: \$40 for original BC348 (J, N, Q) manual in very good condition. Bill Seaby, 9727 Brittain Ln., Baltimore, MD 21234-1863. (301) 661-5734

FOR SALE: Radiotron Designers Handbook, Fourth Edition, 1952, ed. F. Langforth-Smith, clean, as new - \$17 ppd. Radio Physics Course, Second Edition, 1942, by A. A. Ghirardi, 508 illus, clean and tight, fine - \$13 ppd. American Electricians' Handbook, Eighth Edition, 1961, ed. C. C. Carr, clean and tight, appearance as new, fine - \$7 ppd. Henry E. Wenden, K8IKO, 55 West River-lyne Dr., Worthington, OH 43085

CLASSIFIED ADVERTISEMENTS

FOR SALE: Prewar radios - \$20 to \$30. 1950 radios - \$10 to \$15. Harmon Kardon Award #300 stereo tubes - \$80. RF generators - \$15. Jackson oscilloscope with manual - \$50. Heath solid-state triggered scope and manual - \$90. Auto radio power supply, 6v & 12v - \$15. Prewar RCA RF generator - \$30. Johnson CB tester - \$20. SWR meter & coax dummy load - \$15. Rider book Meter at Work - \$15. Oscillator at Work - \$10. Everybody's Radio Manual - \$10. Roper's Stationary & Marine Engineers and Electricians, 1900 - \$20. Multiband transistor radios - \$20. Rubicon Wheatstone bridge - \$20. Earphones - \$10. Wallensack tape recorder tubes - \$20. Triumph oscilloscope - \$30. General Radio signal generator, WWII - \$50. Heath AR-15 stereo & manual - \$50. Assorted Sprague ceramic caps - \$10. Erickson telephone - \$15. Good meters - \$3. 50Ω panel meter, 3 1/2 in. - \$15. Test picture tube - \$15. B&K color generator - \$40. Weston 8-in. meter, old - \$10. RCA TV bias supply - \$10. Pocket transistor radios - \$10. Blaupunkt auto radio stereo - \$20. GE TV service manual - \$15. **WANTED:** How to Troubleshoot and Repair Amateur Radio Equipment, J. Carr, #1194. S. Goldhor, 1014 B St., Hayward, CA 94541. (415) 537-5149

WANTED: Grille or complete cabinet for a Philco 70 cathedral. Karl Stegman, 4 Cresthaven Dr., Belleville, IL 62221. (618) 234-7992

FOR SALE: Vidicon 8507 unused - \$27 ppd. ARRL License Manual 1947 - \$4. Joe Koozman, K2GFH, 87 Lamb-Hope Tpk., Hopewell, NJ 08525. (609) 466-0136

CLASSIFIED ADVERTISEMENTS

FORSALE: RCA V-225 Magic Brain radio-phonograph, plays records on both sides - \$400. Brunswick radio-phonograph with Radiola 28, good 199's - \$450. Fred Rice, 1933 Greymont St., Philadelphia, PA 19116. (215) 673-2854

FOR SALE: Montgomery Wards Airline radio, Model #14BR-734B, very good condition - \$100. Northwest Electronics Surplus, 2509 West 11th Ave., Suite A, Eugene, OR 97402. (503) 485-3016

WANTED: Nice restorable General Motors chassis S-3-A or S-3-B for Models 252 thru 258. Ray Nelson, 3786 S.E. 8th, Portland, OR 97202. (503) 233-5063

CLASSIFIED AD NOTICE
Please check your ads carefully before sending them in. It is difficult to make changes to ads once they are received.

FOR TRADE: My Harvey Wells TBS-50 Bandmaster for your Zenith console. A. Bruno, 24 Buttner Dr., New City, NY 10956. (914) 354-8899

FOR SALE: Radios, manuals, electronic magazines, catalogs. Send SASE for big list. Clifford R. Stout, 2241 E. Broodway, Muskegon, MI 49444

WANTED: TV's! Collector buying 7" TV's by Atlas, Raytheon, Viewtone, National, Automatic, Meck, Temple. Don Hauff, Box 16351, Minneapolis, MN 55416. (612) 425-0089

FOR SALE: Wire resistors, fixed and adjustable. Advise ohms, wattage, sizes. Include SASE for reply. Leon Horsted, 6616 CTHI, Waunakee, WI 53597. (608) 846-3287

FOR SALE: Meissner radio model #8C, good condition with manual - \$100. Northwest Electronics Surplus, 2509 West 11th Ave., Suite A, Eugene, OR 97402. (503) 485-3016

WANTED: Good working & complete chassis for Philco Model 41-290 and Zenith Model 6D630. G. Hastings, 227 Riverbend St., Athol, MA 01331. (508) 249-3735, after 7 pm EST

WANTED - I would like to purchase the following Shortwave Receivers:

- SONY**
 - 1: Sony 330K (with tape recorder)
 - 2: Sony 320K (without tape recorder)
 - 3: Sony CRF-1
 - PANASONIC**
 - 1: Panasonic RF-9000
- Mathew Wolf - 1001 Fannin
Suite 2000, Houston, Texas 77002-6709
(713) 650-3330

CLASSIFIED ADVERTISEMENTS

WANTED: Dial bezel for Philco Model 38-9 (see F.O.S., p. 125). Stanley Caesar, 512 Country Club Cir., Midwest City, OK 73110

WANTED: AK 41 working radio or junker for parts. Also require GE K-80 cabinet. Jim Wilson, 888 Pearce Rd., Schenectady, NY 12309. (518) 372-9625

FOR SALE: Coronado radio Model #43-8437, very good condition - \$100. Northwest Electronics Surplus, 2509 West 11th Ave., Suite A, Eugene, OR 97402. (503) 485-3016

FOR SALE: Orange drop caps: .022-1600v, .033-1600v - 50¢ ea. or \$10/25+ shipping. Harry Pewowaruk, 1535 N. 8th Ave., Saint Cloud, MN 56303

WANTED: Weston 981 tube checker manual. RCA cartridge tapes. David R. Collins, 115 Chestnut St., Medina, NY 14103

FOR SALE: Phillips Ampli. stereo table model radio, nice condition. RCA Model 18. Pete Putra, 1429 Lawndale Ave., Racine, WI 53403. (414) 632-2543

WANTED: AK 82D and 84D. AK 217D and 558D. Price and condition first letter. Johnny Johnson, 2201 Newton St., Denver, CO 80211. (303) 455-3421

WANTED: TV flyback substitution box. They were made by Sencore, B&K, etc. Alvin Abramowitz, 3327 Essex Rd., Baltimore, MD 21207

New Wireless Pioneers

Books, Magazines, Literature Bought and Sold

New Wireless Pioneers buys and sells books, catalogs, magazines and other literature from the 1800's to 1950 that deal with early radio, wireless and electricity. A selection from our list of specialties:

- Pre-1900 Electricity
- Pre-1925 Radio or Wireless
- Pre-1950 Computers
- Pre-1900 Telegraphy
- Pre-1940 Television
- Early X-Ray

Magazines, Catalogs, Autographs or Ephemera related to the above topics. Also: Pre-1920 Wireless and Telegraph Apparatus - Radio-Related Novelties and Advertising - Early Vacuum Tubes and Electrical Devices. *Some items available in other technical subject areas also.*

Several catalogs featuring items for sale are published each year.

New Wireless Pioneers - Jim & Felicia Kreuzer
P.O. Box 398, Elma, NY 14059
(716) 681-3186

VIBROPLEX Collector's Guide

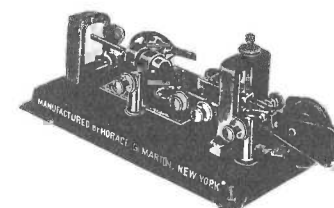

- ✓ HISTORY OF EVERY KEY
- ✓ IDENTIFICATION GUIDE
- ✓ COMPLETE KEY PATENTS

--- and much more ---
Softbound, 87 pages.
ONLY \$14.95 plus \$2.00 S&H
Mass. residents add 75¢ tax
Order now, or send for free brochure

ARTIFAX BOOKS
Box 88-A, Maynard, MA 01754

CLASSIFIED ADVERTISEMENTS

FOR SALE: Heathkit IM-11 VTVM - \$20. McMurdo-Silver Model 903 absorption wavemeter, all elements - \$50. Ron Vanke, 5094 Longridge Rd., Westerville, OH 43081. (614) 890-0609

FOR SALE: LSASE for list of new/used receiving tubes; octal, miniature, some older. Will also trade for old or unusual tubes or related material for my collection. John H. Walker, Jr., 16112 W. 125th St., Olathe, KS 66062. (913) 782-6455

WANTED: I am looking for the following TVs (preferably unrestored) and related items: Philco 48-700 7" TV, Philco TP400 projection picture tube, Scott 6T11 tabletop projection TV, Olympic RU3H TV duplicator. Call collect evenings, weekends, or write. John Folsom, 450 Golden Dove Ave., NE, Palm Bay, FL 32907. (407) 725-3462

FOR SALE: TV collector, tried of looking for those hard-to-find high voltage capacitors? Now selling .0047 and .001 ceramic disk capacitors at 6000 volts, most made by Sprague - \$2 ea. Tony & Lynn DeMara, 40231 Day, Mt. Clemens, MI 48044-2535

FOR SALE: Precision Instruments Co. signal tracer, Model #202, very good condition - \$49. Northwest Electronics Surplus, 2509 West 11th Ave., Suite A, Eugene, OR 97402. (503) 485-3016

WANTED: Information on the Machlett Co., producers of X-ray and transmitting tubes. Also copies of the company magazine, The Cathode Press. John H. Walker, Jr., 16112 W. 125th St., Olathe, KS 66062. (913) 782-6455

LATE 40's AUDIO GOLD MINE

AUDIO ANTHOLOGY:

Volumes 1 and 2 are 124-page (8½ x 11) reprints of major Audio Engineering articles published from 1947-52. All are hands-on projects with complete construction details for everything from preamps to tuner, and power amps to speakers, plus much more in between. Valuable info on early phono reproduction. Vol. 1 has 38 articles, Vol. 2 has 45. A gold mine of authoritative information on tube-based audio.

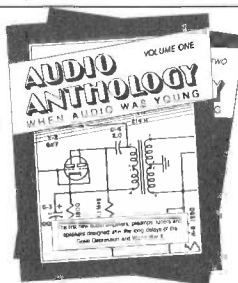

Send me: _____ copies Volume 1 @ \$16.95 each \$ _____
 _____ copies Volume 2 @ \$16.95 each \$ _____

NAME _____ Shipping \$ _____
 TOTAL \$ _____

STREET & NO. _____ MC VISA CK

CITY _____ STATE _____ ZIP _____ Shipping per book: \$1.75/
 USA, \$4.50/Canada, \$7.00/
 elsewhere. \$0c each additional book.

CREDIT CARD _____ EXP. DATE _____

Old Colony Books
 PO Box 243, Dept. ARO
 Peterborough, NH 03458

MC/VISA phone orders:
 (603) 924-6371 - 924-6526
 FAX: (603) 924-9467

CLASSIFIED ADVERTISEMENTS

FOR SALE: Zenith 6G601M, ship grille cloth, clean, plays well - \$75. English Pilot Little Maestro, nice, plays well - \$70. \$1.00 brings list of miscellaneous collectibles for sale. R. C. Moore, 45-716 Anoi Rd., Kaneohe, HI 96744

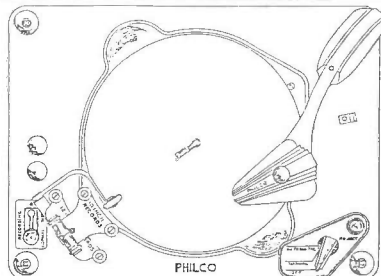

WANTED: Philco record changer #35-1285. Gregg Humanic, 540 Wicklow Ln., Monroe, OH 45050. (513) 539-8926

WANTED: Any parts or complete components of RCA DR-89 diversity receiver. I have the manual and one rcvr. Looking for rack-mount AR-88 with diversity IF gain control, tone keyer TK 43, monitor, speaker panel, etc. Also interested in other diversity receivers. Henry Rogers, PO Box 501, Minden, NV 89423. (702) 267-2725

WANTED: NB-7 noise blanker for Drake TR7 or any other accessories for same. Dwain Ludlow, POB 552, Stigler, OK 74462. (918) 967-8002

NEW PHONE NUMBER FOR ANTIQUE RADIO CLASSIFIED
 (508) 371-0512

Best time to call is weekdays:
 9 am to 5 pm Eastern Time

(Please no classified ads by phone. Thanks!)

FOR SALE: W.U. Tel. Co. DB meter 3-A, wooden case - \$20. Knight RF gen. 160 Kc to 112 Mc, works - \$15. Eico Model 315 sig. gen., glass broken, Model 360 TV-FM sweep sig. gen., Model 221AC VOM, Model 1040 battery eliminator/charger - \$13 ea. Eico Model 425 push-pull oscilloscope - \$20. B&K Model 970 transistor equipment analyst - \$75. Herald 15-ohm earphone, original package, with ear clip - \$1.50. Kolster electric phonograph reproducer (amplifier) Type 500 - \$10. RT-68/GRC transceiver - BO pickup. More, LSASE for list. Mike Crain, RR 1, Box 472, Harveys Lake, PA 18618. (717) 639-2794, after 5:30

WANTED: National AGS-X. Hallicrafters SX-11. Any diversity receivers. Henry Rogers, PO Box 501, Minden, NV 89423. (702) 267-2725

WANTED: Sony TR-63, will buy or will trade Regency TR-1. Also, will trade Sams TSM Vol. 1 for Vol. 19, 20 or 22. Wilson, 2007 Water Edge, Birmingham, AL 35244

CLASSIFIED ADVERTISEMENTS

WANTED: Tube sockets for Eimac 1500TH, Western Electric 212D. Industrial/special purpose tube manuals or pamphlets. Eimac 300T. Also any strange or out-of-the-ordinary tube types. John H. Walker, Jr., 16112 W. 125th St., Olathe, KS 66062. (913) 782-6455

FOR SALE: Reprints of significant early radio articles (E.G., Marconi, Fleming) 1890's to 1930's. Send 25¢ stamp for list. Rainy Day Books, PO Box 775, Fitzwilliam, NH 03447. (603) 585-3448

WANTED: Blue Crosley Coloradios. Alexandria Nelson, 9225 Evangeline NE, Albuquerque, NM 87111. (505) 291-9468

FOR SALE: B&K CRT tester and rejuvenator, Model #465, very good condition - \$55. Northwest Electronics Surplus, 2509 West 11th Ave., Suite A, Eugene, OR 97402. (503) 485-3016

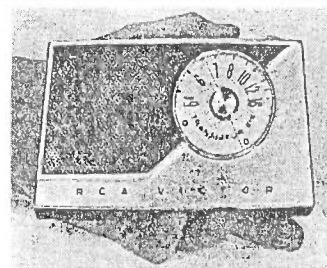

WANTED: RCA 7-BT-9J transistor. Michael Arken, 1427 Diamond St., San Francisco, CA 94131. (415) 648-6817

FOR SALE: Plastic/Bakelite radios, choice - \$30 plus UPS: Emerson 547A, top crack, ivory; GE 3465 clock radio, edge crack, ivory; Silvertone 132.42901 clock radio, ivory; Zenith 598W, plays, ivory; GE AM-FM clock radio 1525A, new filters, ivory; GE C647A clock radio, light brown, edge crack, plays; Mitchell bed lamp radio, paint chips, ivory; Westinghouse clock radio RLA1010, green; Music Air 5171, case crack, brown; Zenith 5D027, good wood cabinet, part of dial gone, plays. Choice \$40: Crosley 66T excellent brown Bakelite, knob gone, plastic face good; Zenith clock radio C520B powder blue, crack left side, plays; Philco 49.601 red plastic/knobs, small crack, real nice; Federal 1030 excellent wood case, 2 knobs gone. Zenith Trans-Oceanic H-500 complete - \$75. **WANTED:** Trade? Globe CB-100 3 channel. Globe Star 5 channel. Johnson Viking white face. What do you have in tube sets? Don Nordboe, 3220 West Broadway, Council Bluffs, IA 51501. (712) 322-2255

WANTED: AK 20C driver and output transformer. Also cabinet for Philco 90. Ed Barbacow, 330 Ceylon Rd., Carmichaels, PA 15320. (412) 966-7934

CLASSIFIED ADVERTISEMENTS

FOR SALE: Zenith 4B231 tombstone, late 30's, AC conversion - \$45. Firestone 4-A-41, white, 40's, plastic, slight hum - \$40. Both excellent. Larry Schiebel, 5834 Balsam Rd., #3, Madison, WI 53711. (608) 276-7768

FOR SALE: Black Philco PT-33 (G.O.R., p. 92), nice, inop - \$30. White RCA 75X12 (F.O.S., p. 158), nice, works - \$39. White Sentinel 3291 (G.O.R., p. 110), nice, inop - \$33. Green Westinghouse H-125 (R.G.A., p. 63), very nice, works - \$90. **WANTED:** Emerson U5A, 109, 199. Hopalong Cassidy. Kadette M43. Fada 254, 652, 845. Belmont 534. Zenith 7S240, 10S669. Console, chairside or upright cabinet for my 1938 chassis such as 9/12 S-232, 245, 265, 267, etc. What do you have? I can pick up in Midwest or possibly Elgin, Lansing or Rochester, N. Y., AWA meet. All letters answered. Bill Timoszyk, 35283 Leon, Livonia, MI 48150. (313) 421-2076

FOR TRADE: Philco UG4242M 21" Predicta, mahogany tabletop, restored and in vgc. I want to arrange some sort of trade for your early color TV (pre-1955) or 1940's black & white TV. Call collect evenings or weekends or write. John Folsom, 450 Golden Dove Ave., NE, Palm Bay, FL 32907. (407) 725-3462

WANTED: Sony ICF-6800W in good working and physical condition. Zenith Trans-Oceanic 7000 in good working and physical condition. Need the 2 doors that go on the front of the Ross Worldmaster radio. Am willing to buy a non-working Worldmaster. Norman Wittschen, III, 3924 Barley Circle, Columbus, OH 43207

FOR SALE

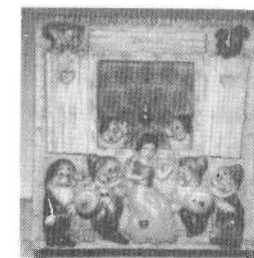

— Emerson —
Snow White and the Seven Dwarfs Radio

Call for info: Gary Schneider
 216-582-3094, Evenings

(Note: This photo is not of the actual radio for sale.)

CLASSIFIED ADVERTISEMENTS

FOR SALE: Victor Radio-Electrola RE-45, superb cosmetics and operation - \$175. Cannot ship. Zenith Royal 2000, beautiful - \$50, 15 lbs. Zenith L600 T/A portable, brown leather, cracked plastic - \$50, 23 lbs. Philco mystery control - \$40, 7 lbs. RCA Victor transistor 8-BT-10-F - \$10, 7 lbs. RCA Victor AC/DC plastic 9-X-10JE, 1959 era - \$20, 7 lbs. Sony SSA-905A early portable reel recorder, not wkg. - \$7, 10 lbs. Philco 1939 yearbook - \$5, 2.5 lbs. Philco 1951 parts catalogue - \$5, 2.5 lbs. RCA 1950 Red Book, complete, well used - \$7, 5 lbs. RCA Victor projection TV 8PCS41 - \$150. Cannot ship. Motorola 59T5 AC table model superb, 1937 era - \$75, 18 lbs. Doug Houston, 3441 South Hadley Ln., Ortonville, MI 48462. (313) 627-4141

FOR SALE: General Electric portable battery radio Model 620, dark green case, leather-like carrying case, untested - \$30 plus 6 lbs. UPS. Also Model 620 dark green case, no carrying case, shows battery acid damage, untested - \$12 plus 5 lbs. UPS. John Uscinowski, RR#1, Box 379, Greenwich, NY 12834-9519

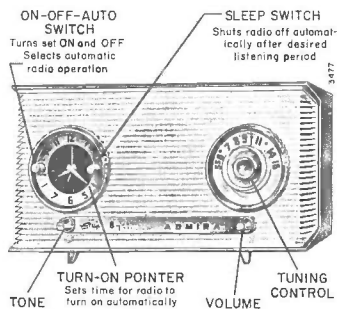

WANTED: Admiral transistor clock radio (811, 816, 810). Michael Arken, 1427 Diamond St., San Francisco, CA 94131. (415) 648-6817

FOR SALE/TRADE: Sentinel 7" TV Model #400-TV, cabinet vg, has sound, screen lights up - \$140. Rola speaker, very interesting style - \$65. Navy Model LM-18, vg cond. - \$40. (2) Edwards Fidelotuner FM sets - \$20/both. Test equipment untested, don't know how to hook them up! Precision sweep generator #E-400, RCA test oscillator #167, Aerovox L-C checker Model #95, Eico oscilloscope Model #425 - \$25 ea. or make me an offer. Joseph Gambaccini, 192 Division Ave., Shelton, CT 06484. (203) 734-0271

WANTED: E.H. Scott radios. Also Flyer phonograph motor, by General Industries Co., mid-30's, painted green or black. Mike Greene, 19113 Alpenglow Ln., Brookeville, MD 20833. (301) 774-3203

WANTED: Catalin radios and parts. Chassis for Fada 652. Ken Short, 3330 East Erie Ave., Lorain, OH 44052. (216) 288-2674

CLASSIFIED ADVERTISEMENTS

WANTED: Plug-in units for Tektronix 561A oscilloscope, especially 3 series types. Carl Ratner, 550 Lamoka Ave., Staten Island, NY 10312. (718) 317-1838

SERVICES: Speaker Reconing, authorized Waldom dealer requesting to recone your antique radio speakers, all brands. Also all new type, and stereo speaker. All parts and labor 100% guaranteed. Discount offered for quantities. Jack Minnaert, 1635 10th St., NW, Cedar Rapids, IA 52405. (319) 364-5491

FOR SALE: Boonton 160-A Q-meter - \$50 plus shipping. High Fidelity magazines Vol. 34, Nos. 3 thru 10 - make offer. Vacuum tubes, antique thru modern, most in original boxes - send SASE for list. Roy Kursberg, 150 Sharon Circle, Athens, GA 30606. (404) 548-1050

WANTED: For Zenith 9S244 Shutter-Dial - manual tuning knob, plated dial pointer. Bill Keifling, 4568 Clayton Rd., Brookville, OH 45309. (513) 833-2258

WANTED: Collins 51S-1/55G-1. Western Electric, Marantz tube-type audio equipment. McIntosh MC-40/75 tube cages, MI-3 'scope; KT-66/88, WE tubes. **FOR TRADE:** E.H. Scott RCH/CZC-46209. Sparton 5-26. Hammarlund HQ-170AC. Hallicrafters S-53B. Ampex 601. N.O.S. 01-A, 401, 403 tubes. Lowell Thomas, Box 15026, Fresno, CA 93702

FOR SALE: Freed-Eisemann NR-6 in original mint condition incl. tubes, works perfectly - BO. Shel Rubin, KT2L, 117 N. Ridge St., Ryebrook, NY 10573. (914) 937-6376

FOR SALE: Atwater Kent 20 with tubes, excellent condition - \$150. **WANTED:** Cylinder record players. Frank Eder, Route 403, Garrison, NY 10524. (914) 424-3470

WANTED: Radiola balanced amplifier. Radiola UZ1325 horn speaker. Radiola III panel with ground link. Douglas D. Fox, 1324 N. Russell Ave., Aurora, IL 60506. (708) 896-5490

HELP: Still looking for dial face for Fada 1000 bullet. Paul Fulton, 711 Jacquelyn Rd., Westwood, NJ 07675. (201) 664-7628

WANTED: Tuning dial for Philco 37-650. Center of dial has Part Number 27-5248 or 27-5212, covers broadcast band plus SW bands 5.7 to 11.6 Mc and 11.5 to 18.2 Mc. Will pay premium price for perfect dial, or will buy entire chassis. Carl Ratner, 550 Lamoka Ave., Staten Island, NY 10312. (718) 317-1838, call collect

FOR SALE: Yankee Prince table phonograph. Fluted metal horn. Complete, excellent. Details SASE. C. R. Powell, Somo Ct., #16, Tomahawk, WI 54487. (715) 453-5230

CLASSIFIED ADVERTISEMENTS

FOR SALE: Radio power transformers, some with tapped primary, all 110v. SASE required. No calls. John Swett, 8116 Olmway, Olmsted Falls, OH 44138

SERVICES: Antique radio repair by collector, reasonable rates, work guaranteed. Steve Pazar, WA4DUT, 4950 Deerwood Dr., Santa Rosa, CA 95403. (707) 544-8142

WANTED: Lafayette Model HC-10 receiver, working condition. Wallace H. Langell, Jr., PO Box 471, Reading, MA 01867

WANTED: Power transformer for Sonora Model A-30, A-32, A-40, 2RP-2S, 3R or 4R. Bottom left brass knob for Northern Electric Model 50. John Swett, 8116 Olmway, Olmsted Falls, OH 44138. (216) 235-1463

FOR SALE: 50's Zenith, neat, dial, maroon - \$35. 20's round Utah wood speaker, does not have speaker but wood is OK - \$30. 1938 GE small radio phono, very Art Deco - \$50. Jim Sprea, 1741 Ellis St., Stevens Point, WI 54481. (715) 341-3251, after 6 pm

HELP: On wrinkle finish technique. Supply sources, etc. Ed Richardson, WI5D, 1040 Cleveland Ave., Stephenville, TX 76401. (817) 968-3365

WANTED: John Firth Vocophone 235B. Will trade NESCO CN240 or DeForest unit panel. Craig Ball, 204 N. 5th St., Marshalltown, IA 50158. (515) 752-0406

CLASSIFIED ADVERTISEMENTS

FOR SALE: Atwater Kent 184 tombstone, works, finish needs a little darkening on top, Old English polish should do it - \$120. Philco 389 Art Deco table model (see F.O.S., p. 125), 1938, works but squeals when a station is tuned in, excellent - \$90. Also many other radios, books & tubes. Send 2 stamps for complete listing to: Ron Boucher, PO Box 541, Goffstown, NH 03045. (603) 497-2988

MESSAGE: To the party residing in South Seattle, Wash., who recently purchased an E. H. Scott radio with a built-in record cutter at an auction, please call me collect at home! I'll make it worthwhile! Craig Korpak, 9130 Silver Lk. Rd., Linden, MI 48451. (313) 735-7264

WANTED: Dictogrand R-3 horn bell. Crosley Super Musicone driver, have good cones for trade. Victor Leader horn base and driver. Kolster speaker with iron paw feet. Chassis for Bosch 5-A. Ken Marten, 12667 Eckard Way, Auburn, CA 95603. (916) 885-0243

FOR SALE: Magnavox Model J cabinet. RADA cabinet. Eveready I, not working, cabinet fair. Dahlberg pillow radio, green, works, cracked but good for parts. **WANTED:** Cabinet or junker with restorable cabinet for Splitdorf Model R-V-695. Tom Wagner, 45 Windsor Rd., Hamden, CT 06517. (203) 248-1659

FOR SALE: Booklist #5, over 300 radio related - SASE. 1847 booklet describing Morse's first Washington to Baltimore telegraph in great detail, 26-page photocopy - \$8. T. Wickstrom, 1664 E. Shore Dr., St. Paul, MN 55106

TUBES WANTED

We need the following tubes to replenish our stock. You may ship your tubes to us by UPS or Parcel Post. We'll mail our check upon receipt and testing of tubes. We pay prices shown plus shipping charges.

USED GLOBE OR BALLOON SHAPE TUBES - ALL MUST TEST GOOD

WD-11*	\$25.00	UV-199*	\$10.00	227	\$2.00
WD-12*	15.00	UX-199*	9.00	245	10.00
112A	6.00	200A	5.00	250	20.00
120	8.00	201A	5.00	280	5.50
171/A	5.50	210	8.50	281	5.50
183/483	6.00	222	3.50	401	12.00
184	6.00	226	4.00	403	15.00

* Tubular

We buy all types of receiving and transmitting tubes. Types not listed above must be new and in original boxes. Send us your list for our bid.

ANTIQUE ELECTRONIC SUPPLY

688 W. First St., Tempe, Arizona 85281, 602/894-9503

CLASSIFIED ADVERTISEMENTS

FOR SALE: Radiocraftsman 800 tuner. (2) Eico HF-87 70-watt tube amps. Send SASE for book & mag. list. **WANTED:** Tubes EL-34 tubes. HiFi magazines 1947-1965. Ernest Naaz, 30 Charlton, Apt. #4C, New York, NY 10014

WANTED: Several 813, 814, and 837 tubes. Please write details to: Bill Downs, 4805 Sullivan, Wichita, KS 67204

WANTED: Old meters/galvos, working or not – your firm price. Cashier's check in advance. Leonard W. Cartwright, 113 Sea Terrace Way, Aptos, CA 95003. (408) 662-2977

FOR SALE: Radios, books, magazines, parts. Send large SASE for 8-page list. P. Majewski, PO Box 92, Tamaqua, PA 18252

MESSAGE: Free: Send 2-stamp LSASE for just released Flyer, No. 190 to: Olde Tyme Radio Co., 2445 Lyttonsville Rd., Silver Spring, MD 20910

FOR SALE: Millen 4-pin, plug-in coils: 43022 (2), 43012 (1), 43082 (1), 43042 (2); 5-pin 43680 (1), 43640 (1) – \$15/all ppd. H. F. Brammell, Box 319, Americus, KS 66835

WANTED: Schematic or manual or Supreme oscilloscope Model 546. **FOR SALE:** 455Kc ceramic resonators – \$1.25. .0047mf 6KV axial lead Sprague – \$3.75. Expanded selection of tubes and caps. If you are not on Frankenstein's mailing list, send LSASE for new summer catalogue. Frankenstein's Radio Lab, 4010 Fairmount Pkwy., Suite 285, Pasadena, TX 77504



The famous Zenith logo is now on two T-Shirts.

Introducing the 1937 Zenith "Around the World" logo.

Plus, Zenith sweatshirts, mugs, and reprod. parts.

Also, books and supplies.

Write for free illustrated catalog.

Alan Jespersion
PO Box 17338
Minneapolis, MN 55417
(612) 727-2489

CLASSIFIED ADVERTISEMENTS

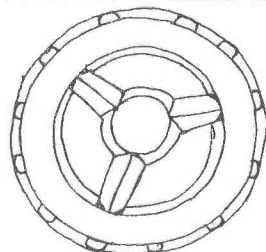

WANTED: Chrome knobs for Crosley E15, white table radio, 1 7/8 in. dia. Jon Edmondson, 2333 Bering Dr., #201, Houston, TX 77057

FOR SALE: Tubes new and used. Send \$1.00 for large list. Dave Pettyjohn, PO Box 131, Grayling, MI 49738

FOR SALE: Radiola 20 with good tubes and homemade power supply, works – \$185. Ed Bell, 5311 Woodsdale Rd., Raleigh, NC 27606. (919) 851-1517

Classified Ad Deadline Noon

Jun. 10 for Jul. 1990 Issue

Jul. 10 for Aug. 1990 Issue

Box & Photo Ads - 5th, Display Ads - 1st

WANTED: Flyback coil winding machine. It is becoming hard to find flyback (and power) transformers for those old TVs, so I wish to learn to wind them so I can offer this service to other collectors. Please help me find a machine and the knowledge to use it. If you know where a machine is, or have any books, technical data, or personal knowledge on the art of winding flyback transformers, please get in touch with me. Call collect evenings, weekends. Thanks. John Folsom, 450 Golden Dove Ave., NE, Palm Bay, FL 32907. (407) 725-3462

FOR SALE: Knight tube tester, mfg. date 1967, just like new – \$65. Northwest Electronics Surplus, 2509 West 11th Ave., Suite A, Eugene, OR 97402. (503) 485-3016

FOR SALE: 500+ N.O.S. tubes, from 1A5GT through 117Z3, lowest prices. Send SASE for list. Bill Sadler, 8225 E. Montebello, Scottsdale, AZ 85250

WANTED: Any type of 16mm film. Educational, institutional, etc. Alan Brooks, 623 South Pine St., Seneca, SC 29678. (803) 885-0364

FOR SALE: Zenith 6G601ML portable junk salvage parts set with tubes – \$15 + UPS. Donald Sochurek, W191, S7500 Richdorf Dr., Muskego, WI 53150. (414) 679-0212

FOR SALE: Rider's radio manuals, Vol. 1-15, 1-5 abridged – \$200, plus postage. Bob Baker, 36148 Spruce St., Newark, CA 94560. (415) 791-6273

CLASSIFIED ADVERTISEMENTS

FOR SALE/TRADE: Tektronix RM503 oscilloscope with manual, excellent condition – \$125, 1 ship. Will trade for cathedral or Freshman Masterpiece in good condition, or what have you? United Motors (Delco) service bulletins, copy, up to 3 pages – \$2.75 ppd., 50¢ per additional page. Herman Gross, W91TT, 1705 Gordon Dr., Kokomo, IN 46902. (317) 459-8308

SEND ALL A.R.C. MAIL TO
Antique Radio Classified
P.O. Box 2, Carlisle, MA 01741

FOR SALE: Zenith like Model 5G41 (F.O.S., p. 196), works excellent. Philco chairside Model 40-170. Russell Schoen, E7340 Nietzsche Rd., Clintonville, WI 54929. (715) 823-6744

WANTED: Morris coil winder, will pay \$50. Rider's Vol. 2 and 18-23. AK 37 power pack cover. RCA V xtal detector and top board. GE F80 brass dial trim (F.O.S., p. 92). RCA 810K dial glass and trim (F.O.S., p. 153). Stromberg-Carlson 68 chassis and speaker. Jim Berg, 2648W Arkansas Ave., Denver, CO 80219. (303) 937-1399

FOR SALE: Federal 200 panel, very good, no tubes – \$225. Ed Bell, 5311 Woodsdale Rd., Raleigh, NC 27606. (919) 851-1517

WANTED: Eico HF-50/60 amps. Radiocraftsman RC-500 amps. Other tube mono amps. Cash or trade. Large list of tube audio gear and lit. SASE for list. C. Kittleson, PO Box 691, Belmont, CA 94002. (415) 595-4164

FOR TRADE: Complete, original, working Radiola 26. Trade for National AGS-X. Henry Rogers, PO Box 501, Minden, NV 89423. (702) 267-2725

FOR SALE: Located three more transistor radios: Sloan AM-FM radio clock Model 2356 in case similar to small ladies purse, a little beauty, clock does not turn on radio; GE P1710C pocket size; Motorola Ranger X31N in cowhide case; all work – \$40 for the three ppd. R. J. Eastwick, N2AWC, 224 Chestnut St., Haddonfield, NJ 08033. (609) 429-2477

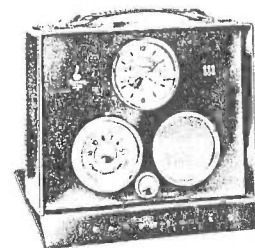

WANTED: Emerson 888 Transtimer II. Michael Arken, 1427 Diamond St., San Francisco, CA 94131. (415) 648-6817

CLASSIFIED ADVERTISEMENTS

FOR SALE: Lincoln Radio Corp. Model 8-40B, 1930, no power supply, not sure of tubes in set, (shown in F.O.S., p. 103 top), good condition – \$300 or BO + \$25 shipping in U.S. money order. Bernard A. Payne, 116 Palisway Dr., SW, Calgary, Alberta, Canada T2V 3V6. (403) 281-4341

FOR SALE: Spark: One KW Thordarson spark transformer, circa 1915, (V.R., p. 49) – \$195. Large heavy duty RF inductance – \$20. 1923 CW power equip. Acme plate & filament transformer "For four UV202s" – \$35. RCA #1627 heavy iron cased filter choke, 300 ma. – \$35. All plus shipping. Paul C. Crum, W9LC, 6272 N. Cicero Ave., Chicago, IL 60646. (312) 282-3033

WANTED: RCA R-37. RCA 143. RCA 140. GE Models K-80, K-60, K-52. Atwater Kent Model 206. CPT Jacques L. Fuqua, CFAY DET, Box 61-196, FPO Seattle, WA 98761

WANTED: Members! Are you interested in old ceiling and desk fans? Join the American Fan Collectors Association. Write for free details to: A.F.C.A., POB 804, South Bend, IN 46624

WANTED: Copy of operator manual for a Hickock tube tester Model # KS-15560-L2. This was made by Hickock for Western Electric. Paul Mattei, 4009 White Swan Dr., Garland, TX 75044. (214) 414-9145, call after 6 CST

FOR SALE: Zenith radio Model #H511, good condition – \$100. Northwest Electronics Surplus, 2509 West 11th Ave., Suite A, Eugene, OR 97402. (503) 485-3016

**— FOR SALE —
RADIO
COLLECTION**

★ Over 140 sets!
S.A.S.E. for list ★

**Scott, McMurdo-Silver,
Leutz, DeForest, Norden
Hauck, Amrad, Tecla, Etc.**

J. E. Cunningham
917 Lunt Avenue
Schaumburg, IL 60193
708-529-0640

CLASSIFIED ADVERTISEMENTS

WANTED: Manuals, Tektronics Type 515A oscilloscope. Hickock 533 tube tester. **FOR SALE:** Philco 15" speakers. Kwanghoe Lee, 150 W. Village Pl., #321, Ithaca, NY 14850. (607) 273-5918

FOR SALE: AK 55C chassis, untested but in very good condition - Best Offer. Mike Keller, 609 Westphal Ave., Columbus, OH 43213. (614) 231-3489

FOR SALE: Admiral 7C64M-UL radio-phonograph console, circa late 40's, you pick up - \$45. Henry A. Schwartzman, 133 W. Fourth St., Corning, NY 14830



WANTED: Zenith Golden Triangle transistor clock radio. Michael Arken, 1427 Diamond St., San Francisco, CA 94131. (415) 648-6817

FOR SALE: Pocket transistors, table transistors, Stewart Lady Bug, Tactdenk. Phono Radio, 3 1/2" wide - plays 33 1/3, Jefferson Travis, F211, Kowa 6, Philgee Mickey Mouse, Truetone DC-3090, Bulova SW, Sony 3F61, Coronet 2 trans., many more. For 9-page Xerox photo list, send large envelope and 2 stamps. Thanks. Robert Rogers, 1407 Riverside Rd., Old Hickory, TN 37138. (615) 847-2475

FOR SALE: Instruction manual for Radiola III, nice reprint - \$3 ppd. in U.S.A. Arthur Obermeyer, KAØPDC, 5254 Fairview Ave., St. Louis, MO 63139. (314) 351-6991

WANTED: Motorola #41A (G.O.R., p. 92). Belmont #636 (G.O.R., p. 88). Zenith #6D414 (G.O.R., p. 88). Stewart-Warner #0751H (G.O.R., p. 90), and other unique Bakelites in original, complete, and very good condition. Claude Poletti, 17940 Harman, Melvindale, MI 48122. (313) 389-2662

FOR SALE: GE megacycles. Kilocycles. Looks good. May need some work. Information. Tom Butler, PO Box 80803, San Diego, CA 92138-7529. (619) 460-8849

FOR SALE: Rider's I-XI, fair - \$195. Rider's I-XX, better - \$350. Plus shipping. Ed Bell, 5311 Woodsdale Rd. Raleigh, NC 27606. (919) 851-1517

WANTED: Dial face & oscillator coil assembly for a Belmont radio Model 878. Dick Hagman, 3429 W. Berry Pl., Littleton, CO 80123. (303) 794-6674

CLASSIFIED ADVERTISEMENTS

WANTED: Hallicrafters SX-27 or SX-28, good condition. Steve Leffel, 1790 Edison St., Green Bay, WI 54302. (414) 465-1855, after 5 pm

WANTED: Chassis for 1933 Philco Model 38 small console. Scott Guthrie, 307-234 Willow Rd., Guelph, Ontario, Canada N1H 7C6. (519) 767-0159

FOR SALE: Vibrators, N.O.S., 6 & 12v, write needs or send SASE for list - \$4 to \$9. Zenith Trans-Oceanic Model R-600 manual, works, has logs & charts, complete, except inside line cord reel, some dings and scuffs, wood shows in some small places - \$60. Watt meter used for calibration, about 6x6 by 7 1/2 inches high, metal case and lid, carrying handle, GE Type 1-B-9, 110-230v, 1-5-25 amp - \$45. Hallicrafters Model S118, works, case repainted gray, 5 band, .19-30μ, STBY, BFO, ANL - \$25. Sencore tube tester Model TC14L, chart included, small, lightweight, like new - \$40. Parts for Zenith Model-230 cathedral radio. Power supply for Zenith Model 28T925 TV - \$40. GE 8-transistor radio, brown plastic case, chrome front, uses 8 D cells, quite heavy for a transistor model, 8x11x4, Model P780B - \$15. Philco farm set table model 40-100, works, very nice cabinet, 90v @ 8MAB (uses 10 9v batteries), 1 1/2 A battery, 6 pushbuttons, wood cabinet - \$35. Boland & Boyce Model 701, like new, pix tube tester, goes between TV & pix tube, no book or cables - \$10. **WANTED:** CW paddle w/ or w/o side tone. Also good serviceable straight key. Chester F. England, 98 Montague Ave., So. Zanesville, OH 43701. (614) 452-1335

WANTED: Sams Photofacts folders or transistor service manuals for pocket-size transistor radios. Bill Burkett, PO Box 1204, Peoria, AZ 85380. (602) 979-0452

FOR SALE: AK #55 chassis radio, 7 tubes inc., used, in Kiel table or console, speaker available - \$75. Bearcat #220 police-fire scanner, 20 channels, SS, aircraft, Marine also, like new, cost \$250 new, now - \$75. Zenith SS Model #2000 BC & FM - \$45. Hallicrafters S40-B, looks & runs well - \$50. **WANTED:** Plug-in coils for National HRO 50T1 or 60, 50Kc-30Mc. Cabinet for RCA IIIA. Basket case Crosley Pup. William Key, W1DWD, 58 Sycamore Dr., Halifax, MA 02338. (617) 294-1813, before 9 pm

FOR TRADE: One N.O.S. WWII military MP-48 antenna base for WWII two-buckle boots, size 10 1/2 D. Sam Hevener, W8KBF, 3583 Everett Rd., Richfield, OH 44286

WANTED: Inside-the-lid identification plate for the Radiola Sr. **FOR SALE:** Crosley 4-29, w/T excellent. AK 35, w/T, excellent. Freshman Masterpiece, slant Bakelite panel version, excellent plus, NT. All sets play. SASE for prices and photos. Leo F. Robinson, 615 Hideaway Ct., Sanibel, FL 33957. (813) 472-9763

CLASSIFIED ADVERTISEMENTS

WANTED: Grebe CR-1, CR-3A, CR-4, and CR-6. Trade CR-2. **FOR SALE:** Scott 23-tube - \$600. Jim Collings, 12005 Victoria Pl., Oklahoma City, OK 73120. (405) 755-4139

FOR SALE: Audio Technica professional dual magnet new stereo cartridges ATP-1 - \$32 ea. ppd. J. J. Papovich, 53 Magnolia Ave., Pitman, NJ 08071. (609) 582-8279

NEW FAX NUMBER FOR ANTIQUE RADIO CLASSIFIED (508) 371-7129 - 24 Hours per day Ads - Subscriptions - Book Orders Charge to Visa/MasterCard Minimum Charge: \$10.00

FOR SALE: Grunow Teledial Twelve as on Vintage Radio calendar Sept. 1989. Also Radiola 24. R. Brewster, 454 Diablo Dr., Pittsburgh, PA 15241. (412) 833-4287

WANTED: Clean Philco 70 chassis, working or not. Magnavox R-3C base & driver. Ware Type T cabinet. Weston Model 566 set analyzer battery cover. Back grille for Graybar 330 highboy. 14" mahogany Music Master horn. H. Brown, 2 Central Ave., Morris Plains, NJ 07950. (201) 538-2014

HELP: Need help: Need parts for following radios: AK 33, bias resistors. AK 165, dial, case (or rear panel). Philco 37-610, dial, dial glass, lower center knob, tube shields, speaker. Arvin Phantom Prince, restorable cabinet. Bruce Fredrick, 5659 Mission Rd., RR#1, Bullhead City, AZ 86430. (602) 768-2461

CLASSIFIED ADVERTISEMENTS

HELP: I need the left door and legs from an E. H. Scott Roslyn Grand cabinet. The cabinet is mahogany, and the doors cover almost all of the front-side including the speaker area and the dial/tuning area. Craig Korpak, 9130 Silver Lk. Rd., Linden, MI 48451. (313) 735-7264

FOR SALE: Westinghouse H125 - \$135. Airline 14WG-625A - \$50. **FOR TRADE:** Belmont 6D 111. Setchell Carlson 458R intercom radio. **WANTED:** Silvertone 7022. Crosley 11-116U, 11-100U. Zenith Royal 790 Super Navigator. Richard Bell, 721-20 Ave. W, Kirkland, WA 98033. (206) 822-5435

WANTED: Leg kit for Eveready Model 1, maple finish. Glen Heath, 108 Gallivan Ln., Uncasville, CT 06382. (203) 848-3318

FOR SALE/TRADE: Zenith 7S363 console. Lark 4-tube cathedral. Crosley 5-tube cathedral. Silvertone 8-tube ornate tombstone. Crosley Oracle grandfather clock radio (Repwood). Blue Crosley Coloradio. Belmonts 6D111, 6D121 & 534. Westinghouse Little Jewel. Silvertone 4502, early Bakelite. Stromberg-Carlson 2-color Bakelite. **WANTED:** Cabinet for Philco 89. Chassis for Echophone 60 or 80, junker set OK. Fireside Wireless, 1507 Ridge Ave., New Castle, PA 16101. (412) 654-9335

FOR SALE: Hickock Model #288X Universal crystal-controlled signal generator, very good condition - \$49. Northwest Electronics Surplus, 2509 West 11th Ave., Suite A, Eugene, OR 97402. (503) 485-3016

**IT IS HERE!
FIXING UP NICE OLD RADIOS**

If you learn radio repair, you can buy Scotts for \$50, Zeniths for \$25 and Hallicrafters for \$15 or less as I have been doing for years. Fix them easily with the know how in this new book. Written by an old radio instructor, it has 185 pages, over 100,000 words and over 300 drawings and photos taken inside your favorite old radios. It is spiral bound-8 1/2 x 11. Simple language. No higher math. It starts right at the beginning with Ohm's law and crystal sets. A challenge for the expert, too, it explains all-wave bandswitches, crystal filter alignment, the Wunderlich tube and it pictures and describes EVERY PART in the Scott AW-12. Price \$19 to go to \$25 in Aug. Order today, Visa/MC OK. Phone orders accepted. Include \$1.50 ship. Satisfaction guaranteed. If you prefer send an SASE and I'll mail you a few sample pages from the book...

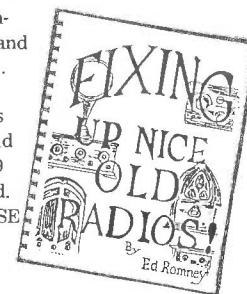

ROMNEY

BOX 96 EMLINTON PA 16373

(412) 867-0314

Fine technical books since 1974

Mail order only—not sold in stores

CLASSIFIED ADVERTISEMENTS

FOR SALE: Browning-Drake Regenaformer 5-tube kit with 3 stages resistance-coupled amplification. Velvet verniers, mahogany cabinet, engraved & embossed panel, working - \$90 plus shipping. Robert Rathbone, Rt. #1, Box 127, Ossipee, NH 03864. (603) 539-2762

FOR SALE: 17-year collection of radios, horns, radio equipment, magazines and advertising. Includes everything from AK breadboards to grandfather clock radios. SASE plus \$1 for list. Kevin Bosomworth, 2225 Bridge, Albert Lea, MN 56007

WANTED: Service manual for Hickock Model 900-C. What is this instrument supposed to be? Thank you very much. Charles D. Prater, Edna, KY 41419.

WANTED: Guthman, JLA McLaughlin, J-T Jefferson Travis 1930's-1940's products. Also simple shortwave receiver or transmitter with 1-2-3-4 tubes or transistors. Hugh Miller, 6400 Maltby, Woodinville, WA 98072-8375, or (206) 487-3047, weekends

WANTED: WW II German, Japanese, Italian military radio equipment and parts, any condition, plus any informational paper. My main interest is studying, completing, and restoring to on-air operation this less-known equipment. Also interested in U.S. Coast Guard and Forest Service gear, 1940's aviation, mechanics, and electronics periodicals. Thank you! Hugh Miller, KA7LXY, 6400 Maltby, Woodinville, WA 98072-8375, or (206) 487-3047, weekends

CLASSIFIED ADVERTISEMENTS

WANTED: External parts for Colonial World Globe radio, Aeriola Jr., Regency TR-1, RCA table for 630TS. Carl Baxter, 1133 So. Clinton Ave., Rochester, NY 14620. (716) 473-5322

FOR SALE: Lots of small wood & Bakelite radios. Also test equipment. SASE list. Chuck Humphreys, PO Box 598, New Haven, WV 25265

WANTED: Dial for Philco 37-670, Part #27-5213 or chassis. Also Pierson KP-81. Dan Mason, 1325 North Lima St., Burbank, CA 91504. (818) 848-9474

FOR SALE: Army tube tester 1-177B - \$30 plus UPS - \$5. Ed Povraznik, 9606 Biddulph Rd., Brooklyn, OH 44144

WANTED: Speedy bugs and keys. FT243 xtals for 80 and 40m CW bands. Herb Spivey, POB 27, Baldwyn, MS 38824. (601) 365-5594

WANTED: Porcelain rheostats, RJ4-type. I have Atwater Kent breadboard components to swap or cash. Phil Weingarten, 67-61 Alderton St., Rego Park, NY 11374. (718) 896-3545

FOR SALE: General Radio precision condenser, Type 722-M, in hardwood box - \$20 plus shipping. Jim Barrows, 15121 41 Ave., SE, Bothell, WA 98012. (206) 337-4880

FOR SALE: Precision signal generator. Also tube tester. Very good condition. Name your price. Rodney Schrock, 402 Lincoln St., Somerset, PA 15501

CLASSIFIED ADVERTISEMENTS

FOR SALE: WWII military reperforator/transmitter teletype, Model #TT/76A/GGC, very good condition - \$49. Northwest Electronics Surplus, 2509 West 11th Ave., Suite A, Eugene, OR 97402. (503) 485-3016

FOR SALE: Over 100 old radios: beehive, tombstone, battery, some consoles. Will sell at cost. Ted Rupinski, 170 Cheshire Rd., Pittsfield, MA 01201. (413) 447-9816

WANTED: Horn speakers, complete or parts. Zenith 8-tube chassis No. 5801 or 5802. Richard Anthony, 2551 Adler Rd., Placerville, CA 95667

WE'RE STILL HERE! Tubes: "Oldest," "Latest." Schematics. SASE for lists to Steinmetz Electronics, 7519 Maplewood Ave., Hammond, IN 46324

WANTED: Early tube hi-fi components and studio equipment by Acrosound, Brook, Brociner, Fairchild, Hadley, Marantz. Also want Western Electric amplifiers, speakers, tubes, microphones. Richard Sharisky, PO Box 521, Belmont, MA 02178. (617) 484-5784

DAN'S SCHEMATIC SERVICE. Radio diagrams, 1921 to 1960 - \$2.50 ppd. T.V. diagrams, 1938 to 1960 - \$3.50 ppd. Send make and model number of set, or chassis layout sketch with tube types, if model number is unknown, to: Dan's Schematic Service, P.O. Box 53061, San Jose, CA 95153.

WANTED: Pre-1926 radios by AMRAD. Also, Amrad radio parts, accessories, and literature. Richard Sharisky, PO Box 521, Belmont, MA 02178. (617) 484-5784

TELEGRAPH INSTRUMENTS WANTED, pre-1900, any type, any condition. Reinke, 5301 Neville Ct., Alexandria, VA 22310-1113

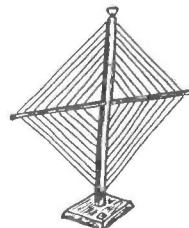

BRASS DIAMOND (TM) Spider Loop. The most beautiful antennas ever made. People love them as pure art. Play your antiques anyplace without inconvenient antenna/ground leadins. Solid brass wire spans shimmering 22-inch diagonal frame finished with Hidyne's mysterious Glotone (TM) varnish. Felt pad base. Hand-crafted, numbered, \$178.50 ppd./MASTER CARD/VISA. Hidyne Research, Box 3342, Williamsport, PA 17701. (717) 326-2148

CLASSIFIED ADVERTISEMENTS

FOR SALE: Attention! Owners of neutrowound sets. Exact replica nickel-plated brass tube covers are now available. Complete your set now. \$18 ea. plus UPS. Quantity limited. Order now from: Peter Yanczer, Tesla Electronics Co, 835 Bricken, St. Louis, MO 63122

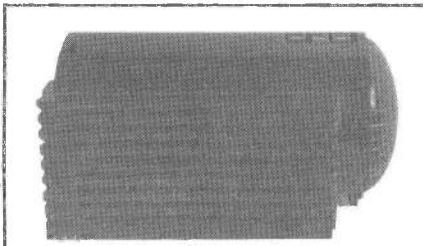

WANTED: SILVERTONE RADIO as pictured above. E. Brill, 405 Wire Mill Road, Stamford, CT 06903. (203) 329-2254

FOR SALE: PHONO NEEDLES & CARTRIDGES (ceramic - magnetic). What do you need? Send SASE. J.J. Papovich, 53 Magnolia Ave., Pitman, NJ 08071. (609) 582-8279

Desperately needed: Skyrider Commercial, S-30, S-33, S-35, EC-4, EC-6, HT-8, HT-12, HT-14, silver panel Skyriders, other old or unusual gear, parts manuals, memorabilia of the Hallicrafters Co., and 1934 "H", "Z", "K", "J", line of Silver-Marshall radios. **The Hallicrafter Collector** - Chuck Dachis, 4500 Russell Drive, Austin, TX 78745

WANTED: QST-S for 1916 and 1917. R. Arrowsmith, W4JNN, 3505 Woodburn Rd., Annandale, VA 22003. (703) 560-7161

TUBES AND MISC. Large stock of **NEW** and **GOOD** used radio tubes, etc. Send \$1 (stamps OK) - REFUNDABLE for latest flyer. Don Diers, 4276 - BC1, North 50 St., Milwaukee, WI, 53216-1313

FOR SALE: 100's of vintage radios, TVs, speakers, radio magazines, etc. Send \$1.50 (stamps OK) for America's best monthly SALES LIST to: Jim Clark Enterprises, Dept. ARC, 1292 Starboard, Okemos, MI 48864

INDIVIDUAL PHOTOFAC FOLDERS. From sets under #1400 - \$4. Over #1400 - \$6. Pre-paid First Class postage included. Also full stock Sams specialized books. Allen J. Loeb, 414 Chestnut Lane, East Meadow, NY 11554. (516) 481-4380

WANTED: Catalin, Bakelite, Plastic and Novelty radios of 30's, 40's, 50's. I am a collector only, and will pay top price for good radios. FADA, Emerson, Motorola, Garod, etc. Sandra Mills, 5782 Florence Terrace, Oakland, CA 94611. (415) 428-0431



**Your Ads to RADIO AGE
24 hours a day**

Subscribers can run a FOR SALE ad (up to 50 words) absolutely FREE in each issue. Now you can have a fresh source of new ads every two weeks since "RADIO AGE" comes out in the middle of each month. If you missed our first 17 years, why not give us a try now and see what you've been missing! Send for your FREE sample today!

We look forward to adding you to the mailing list at our special two-year rate: **First Class** (mailed in an envelope) \$37/2 years or \$20/year (U.S.) \$40/2 years or \$21/year (Canada), or **Second Class** (slower delivery) \$32/2 years or \$17/year. **Foreign subscriptions are \$38/year.**

**RADIO AGE - 636 Cambridge Road - Augusta, GA 30909 - 404/738-7227
FAX 404/724-4200**

CLASSIFIED ADVERTISEMENTS

WANTED: Working or restorable chassis, RCA Victor, Model R6, 1932, with speaker and dial escutcheon. Any similar chassis OK. Sam H. Jansen, 304 Calif. Ave., Arcata, CA 95521. (707) 822-4510

FOR SALE: Crosley Trirdyn, good audios - \$100. Emerson Catalin - \$275 ppd. Many Rider's books - \$15 ea. Drugstore type tube tester - \$35. Mallory Encyclopedia - \$25. Bill Rolif, 30131 Center Ridge, Westlake, OH 44145. (216) 871-4547

WANTED: Chassis for Sonora Model FA-55. Also need 3 tuning knobs for Amperex Ace. Jim Walker, PO Box 1349, Van, TX 75790. (214) 963-7280

FOR SALE: Reproduction dial glasses for Catalins. FADA 652 and Sentinel 284 - \$35 ea. plus \$2 postage. Radioart, Box 102, Centerbrook, CT 06409

SOLID STATE VIBRATORS for most automobile radios 1932-57. Exact duplicates of originals in metal cans. Synchronous, Non-sync, European. One year guarantee. Dealer prices. Free catalog. Antique Automobile Radio, Box 892, Crystal Beach, FL 34681. (813) 785-8733.

EXPERT ANTIQUE RADIO REPAIR. All makes. Ken Keiter, 106 Boulder Rd., Plymouth Meeting, PA 19462. (215) 828-2027.

WANTED: Schematic and parts list for a Dictaphone Model 1680 Calculator. Send price and cost of mailing. Russell Sound Systems, 720 College Dr., San Jose, CA 95128-2812

WANTED: Howard Model W, also known as Explorer, vintage 1933/1934, and Howard Model Grand, vintage 1935/1936. Both sets use multiple chassis and have nineteen tubes, though they utilize different circuitry. Any literature, partial sets, firsthand information would be appreciated. Thomas Peters, PO Box 3925, McAllen, TX 78502

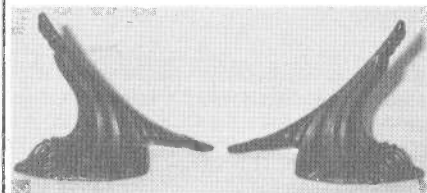

TIRED, DISFIGURED FEET? Now you can replace those unsightly, disintegrating "Pot Metal" feet on your otherwise beautiful "UTAH" speaker. High quality reproduction feet, made of "cast Epoxy" and color tinted now available. **\$39.00 pr. P.P. SUNSHINE TECHNICAL SERVICES, 14407 N.E. FREMONT ST., PORTLAND, OR 97230. (503) 254-9296, eves.**

CLASSIFIED ADVERTISEMENTS

WANTED: Atwater Kent breadboards in working condition. Mike Ceklovsky, 3116 Smoky Ct., Sacramento, CA 95826. (916) 363-3211

CLASSIFIED AD NOTICE

Please check your ads carefully before sending them in. It is difficult to make changes to ads once they are received.

FOR SALE: LSASE brings list of tubes, parts, radios, novelties, Rider's Manuals, ARRL Handbooks, etc. Stan Lopes, KB6LGV, 1201-74 Monument Blvd., Concord, CA 94520. (415) 825-6865

WANTED: 7-in. & 10-in. TVs. RCA, Philco, Motorola, Emerson, etc. **FOR TRADE:** 10-in. RCA TV Anniversary Model #9T-246. Tele-Tone 7-in. TV Model #220. Tony & Lynn DeMara, 40231 Day, Mt. Clemens, MI 48044-2535. (313) 263-0325

FOR SALE: Porto Smokerette, ivory, near mint - \$300. John England, PO Box 1674, Alexandria, VA 22313

FOR SALE: Eight fully restored antique radios in excellent working condition, 1929 to 1939. Jacob Anthes, Lutz Rd., Box 52, Glidden, WI 54527. (715) 264-5004

BOXED CLASSIFIED ADS WORK! This is a boxed classified ad. These ads can be run more than two months. See the inside back cover for details. Boxed ad deadline: the 5th of the month.



WANTED: Scott radio as pictured above. I will pay up to \$1,000 for this set. Jim Clark, 1292 Starboard, Okemos, MI 48864. (517) 349-2249

COLLECTING: National regenerative receivers SW3-4-5, etc. Also parts and accessories for them. Glad to correspond with "Thrill Box" enthusiasts. Dean Showalter, WA6PJR, 36308 Panorama Dr., Yucaipa, CA 92399. (714) 797-1782

WANTED: Edison two-speed cylinder machine with Cygnet horn; Grommes 50PG HiFi amp; Wire spools for Webster Chicago recorder; RCA sound tape cartridges; Driver for AK horn; Freed-Eisemann mono HiFi tuner; Echophone EC1; Radiotron Designer's Handbook. Robert Perlstein, 17 Vine St., Medford, MA 02155. (617) 391-3026

WANTED: LIGHT BULBS, tipped, pre-1900, Edison, Thomson-Houston, Westinghouse, and all others, bases, books, literature, advertising postcards, description, best price. Mel Kirchner, 276 Riverdale Road, Pompton Lakes, NJ 07442. (201) 839-4358. After 7 pm.

CLASSIFIED ADVERTISEMENTS

FOR SALE: Supreme Instruments Corp. Model #576 signal generator, very good condition - \$49. Northwest Electronics Surplus, 2509 West 11th Ave., Suite A, Eugene, OR 97402. (503) 485-3016

FOR SALE: Drake TR-3 - \$75. RV4 VFO - \$35. Heath SB10 - \$25. RME 4350, nice - \$95. Rare RME 4301 ext. sideband selector - \$35. Instruction graph code machine w/tepes - \$20. Eldico TR75V CW xmtr. - \$20. MFJ 3KW diff. t-tuner, like new - \$195. **WANTED:** 1958-62 Walter Ashe, Allied, Radio Shack, WRL, Olson, Lafayette, Burstein-Applebee catalogs. A 1961-62 U.S. Callbook with KN3OMI and 1969-71 DX Callbook with KR6MI. Gary Wagner, K3OMI, 11124 Oak Hollow Rd., Knoxville, TN 37932. (615) 690-4217, days, work

DAN'S SCHEMATIC SERVICE now has NEW and GOOD USED TUBES, parts, RADIOS, test equipment, books, magazines and lots of miscellaneous. Send large SASE for lists to: Dan's Schematic Service, PO Box 53061, San Jose, CA 95153

WANTED: WWII RCA aircraft radios. AVT-112A transmitter, AVT-15 transmitter, AVR-20A receiver, AVA-126A power supply. George Damiano, 4131 Denver, Yorba Linda, CA 92686. (714) 993-1052, after 5 pm

WANTED: LIGHT BULBS, tipped, pre-1900 anything pertaining to. Best price, description. Mel Kirchner, 276 Riverdale Road, Pompton Lakes, NJ 07442. (201) 839-4357

WANTED: SCOTT LITERATURE, original Scott News, instruction manuals, brochures, etc. Pay or trade generously. Jack Sacra, 1720 Solomon Rd., Charlottesville, VA 22901. (804) 293-9985

WANTED: Grebe Synchrophase MU 1, MU 2, battery boxes, parts, signs, owner's manuals, etc. Fred Schultz, 1246 Lincolnway W., Ligonier, IN 46767. (219) 894-3779, days. (219) 894-3092, evenings

WANTED: STROMBERG-CARLSON half-round consoles, chairsides, and mirrored chairsides, any configuration. Must be complete and very good or better condition. Also Stromberg and Zenith advertising. John England, PO Box 1674, Alexandria, VA 22313. (703) 548-2952

WANTED: Radiola AR, Aeriola, Jr., Federal No. 35 RF Transformer. Tod Prowell, W3URG, 1073-15 Lancaster Blvd., Mechanicsburg, PA 17055. (717) 697-5227

COLLECT KEYS? You'll enjoy W11MQ's illustrated references. "Introduction to Key Collecting," 64 pages, \$9.95. "Vibroplex Collector's Guide," 87 pages, \$14.95. Add \$2.00 s/h to total. Artifax Books, Box 88-A, Maynard, MA 01754.

CLASSIFIED ADVERTISEMENTS

FOR SALE/TRADE: QST hardbound volumes, 1925 - \$20, and 1934 - \$15; 35 miscellaneous issues, 1930 thru 1936 - \$35. Niel Wiegand, WA5VLZ, 911 North Bend Dr., Austin, TX 78758. (512) 837-2492

FOR SALE: World War I airplane antenna reel, dated 1918 - \$115 ppd. BC-348R, BC312-D, BC-645 - \$75 ea. AK 20, large one open audio - \$100. VT166/WE371A, N.I.B. - \$15. RME-VHF-152A RF converter with manual - \$60. Hallicrafters SX99 - Best Offer. All plus UPS. **WANTED:** Wire recorders. Grebe CR18. Peter Dieguez, 36-48 34th St., Long Island City, NY 11106. (516) 625-0429

WANTED: Radiola 24 with loop. Early superhets other than RCA. Kit sets OK if in good condition, well made. Tektronix 570 curve tracer, (tube). Finders fee. Mr. & Mrs. Charles W. Rhodes, 3906 Quisenberry Dr., Alexandria, VA 22309. (703) 780-0719

FOR SALE: Stromberg cathedral, mint - \$375. Transistors: Emerson #842 - \$40. Franklin 16" wood cathedral - \$60. Zenith Royal #400 - \$50. All mint. List - SASE. Richard Bednarick, 28 Steeple Ave., Lincoln Park, NJ 07035. (201) 694-6374, eves.

WANTED: Broadcast-type MICROPHONES. Early carbon, condenser, ribbon, dynamic, etc. Cash or trade. James Steele, PO Box 620, Kingsland, GA 31548-0620. (912) 729-2242

Johnson's Old Radios, Pointers and Prices. \$15.00 postpaid. Homebiz Books, 2919 Mistwood Forest Dr., Chester, VA 23831-7043

UNIVERSAL TRANSFORMER SAVER:

The ultimate "bolt on" for TRF receivers. Restores dead interstage coupling transformers instantly. Just solder across bad transformer's terminals. Works with any transformer in any 20's TRF receiver and its appearance is proper. With instructions just \$8.63, \$16.06 per pair, ppd. Hidyne Research, Box 3342, Williamsport, PA 17701. (717) 326-2148

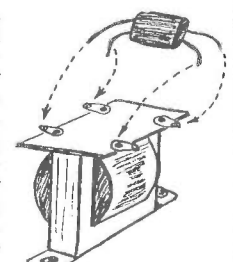

FOR SALE: "Highway Radio. A Guide to Tuning in on America's Highways." William J. Stank, compiler, 1988. 112 pp., 8 1/2" x 11", softcover. 8,500 AM & FM listings, by state, with maps, coded to station format, with frequency and power (KW). New copies, \$2.50 each postpaid, cash or stamps preferred. Jeff Davis, 432 N. Eustis St., Eustis, FL 32726.

CLASSIFIED ADVERTISEMENTS

FOR SALE: Our new picture flyer has 150 radios, many N.O.S. parts, 1 3/8" dia. volume controls 10Ω to 25KΩ, cloth-covered wire, much more. Some audio, amateur, TV items. We have some old auto radios, a few thousand tubes N.I.B., 6v, 12v, series string, compactrons. Substantial discounts from other list prices. Send want lists. For pickup in Conn. only: Brandes E15 console, Big Zenith 8A03. Our new literature list is ready. Hundreds of books and magazines, 30's up. We don't have a lot of expensive merchandise, just good collectible items at reasonable prices. Send large two-stamp SASE for all lists. **WANTED:** Assortments of mixed radio knobs. Dick Mackiewicz, 1549 N. River Rd., Coventry, CT 06238. (203) 742-8552

WANTED: Walnut cabinet for Harmon/Kardon Award Series equipment, circa 1963. Nuvisitors Type 8393. Alan Kriss, 1872 Portsmouth Way, Union, NJ 07083. (201) 688-2092

WANTED: Antenna for Radiola 28, Model AR-920. Knobs for Bendix #526C. George A. Freeman, WIKI, 102 E. Main St., Madison, IN 47250. (812) 265-6878

FOR SALE: RCA Radiolette R5 parts radio - \$25. Philco Lowboy 87 - \$25, pickup only (Milwaukee area). Zenith M505 - \$20. Cream Radiola 61-9 - \$20. Air-King 494 maroon pocket radio - \$15. Maroon Arvin 461T - \$20. Ward's 62-405 airplane dial farm set - \$35. Dumont 168 scope - \$20.

WANTED: Feet for AK42 or parts radio. Stephen Scheel, 21405 West Lawnsdale, New Berlin, WI 53146. (414) 549-1355

WANTED

ELECTRON TUBES - ST SHAPE

50, ST19, large size	\$30	80, ST14	\$4
45, ST14	15	2A3, VT-52, VT-62	6

ANTIQUA GLOBAL SHAPE TUBES

37/237	5	145/245/345	15
250,350,450	30	210/310	10
80/280/380	10	UV202, Tip, Brass Base	25
UV201, Tip, Brass Base	12	UV216, Tip, Brass Base	20

TRANSMITTING TUBES

211/VT-4C/RS237	15	845/845W	30
-----------------------	----	----------------	----

WESTERN ELECTRIC TUBES

101D, F, G/102D, F, G, E/216A/104D/D86326/D86327 Tennis Ball	20	VT2/205B	35
VT1/203B	20	101D, F/102D, F/104D, ST	6
205D, E, Tennis Ball	40	205F, ST	15
244A	6	262A/262B	10
252A	100	274A/274B	30
271A	30	300A/300B	80
275A	30	339A	20
348A	10	349A	6
350B	30	211D/211E	40
242C/261A/276A	25	284D	70
212D/212E	70		

TRIAL ELECTRIC PRODUCTS, INC.

201 Common City Yotsuya, 4-13 Suga-Cho, Shinjuku-Ku, Tokyo 160 Japan

CLASSIFIED ADVERTISEMENTS

WANTED: Sparton 79A console, power supply and amplifier chassis. Also any literature or pictures. **FOR SALE:** RCA 2-XF-91 Bakelite AM/FM with dual-ganged dials - \$35. Rod Galloway, 2220 Woodbury Rd., Melbourne, FL 32935. (407) 254-0280

FOR SALE: Emerson 888 Pioneer transistor radio, red case, with stand, volume control knob missing, untested - \$18 ppd. T23/ARC-5 6126 c.w., with tubes, no cover - \$10 plus 13 lbs. UPS. John Uscinowski, RR #1, Box 379, Greenwich, NY 12834-9519

WANTED: Vacuum tube amplifiers by Valley & Wallman. Manual for H.H. Scott Model LK72 integrated hi-fidelity audio amplifier. Hallicrafters SX122/122A SW receiver, junker OK, but must have BFO assembly & knob intact. Tube type hi-fidelity audio output transformers, especially U.T.C. LS55, LSGL4, etc. and Aerosound TO300, 330, 350, etc. Original Electro-Voice T-35 tweeter w/16 ohm voice coil, or v.c./diaphragm assembly for same. Working Telechron clock for Hammarlund HQ series receivers or junked unit with working clock. Hammarlund HQ 180AC or AX SW receiver. Manuals for Tektronic Type 561 oscilloscope. Also manuals for Tektronic Type 346 dual trace AMP & 3B1 time base plugins. Mullard or Amperex E-55L tubes. David S. Richards, 300 N. Francis St., Lansing, MI 48912. (517) 374-7656

WANTED: Hallicrafters DD-1 dual diversity receiver. Phone calls preferred. Jim Clark, 1292 Starboard, Okemos, MI 48864. Phone (517) 349-2249

CLASSIFIED ADVERTISEMENTS

WANTED: For Grebe 1924 Synchronphase: volume control, filament rheostat with its knob and plate. Robert Larson, 1325 RidgeWay, Medford, OR 97504. (503) 773-5214

WANTED: Philco 42-360 escutcheon and dial. Dial plate GE F-63. Philco 89 chassis, spkr. Jack Hofeld, 61 Trinidad Bend, Coronado, CA 92118. (619) 429-0165

FOR SALE/TRADE: Abbottwares Horse radio Z477 - \$200. Mitchell bed lamp radio 1251 - \$50. Crosley 635C tombstone - \$75. Freshman Masterpiece - \$75. RCA 84BT6 tombstone - \$50. **WANTED:** Zenith 805, 230, 10S130, Zenette AH, and other pre-WWII Zeniths. RF choke and plate choke for 6V27. Skyrover/Belmont 777 tombstone. Martin Blankinship, Box 157, Lecompton, KS 66050. (913) 887-6681, 10 am - 2 pm, CDT or weekends

FOR SALE: Consoles. Brunswick 14. Delco R1131. Majestic 90B. Philco 76. Philco 42-1012. RCA RE57 rough. Zenith 750. Zenith 12H695 early FM, shutter dial. Zenith 6-tube half round chairside. TeleKing 710 TV. Hammarlund Super Pro 200 and HQ129X. Will not ship. SASE for complete list. **WANTED:** Detrola console and round table model. Chassis for AK 84, Philco 81, Zenith 5S29. Dennis Smith, KN8H, Box 113, Trenton, MI 48183

WANTED: E.H. Scott Phantom (19-tube, 7-knob version) chassis and speaker with excellent chrome. Cash or trade. Jack Sacra, 1720 Solomon Rd., Charlottesville, VA 22901. (804) 293-9985

WANTED: Musical instrument amplifiers, including those by Fender, Gibson, National, Supro and Silvertone; microphones, Jensen speakers, and other musical items. Mark van Roojen, 127 Moore St., Princeton, NJ 08540. (609) 921-8171

FOR SALE: Catalin, DeWald A-502, beautiful yellow, works well, original grille & knobs. Robert Rogers, 1407 Riverside Rd., Old Hickory, TN 37138

FOR SALE: Jukebox service manuals: 1960's 1970's Wurlitzer, Seeburg, A.M.I., Rock-Ola. Seeburg transistorized stereo amplifier TSA 1 - \$85. Heathkit transistor tester IT 121 - \$75. Color TV, theory and service techniques books by RCA, GE, Philco, Rider (b&w), Buchsbaum (b&w) - \$15 ea. ppd. Filament and rectifier transformers, different voltages, removed from equipment. Plastic encased relays with octal base, 24-volt DC, 5 amp contacts. Write for details. Jack Naimann, 365 Bronx River Rd., Yonkers, NY 10704. (914) 237-4650

WANTED: Tubes. 01-A BBT rainbows. Need 2. True Blues in box. Ed Bell, 5311 Woodsdale Rd. Raleigh, NC 27606. (919) 851-1517

CLASSIFIED ADVERTISEMENTS

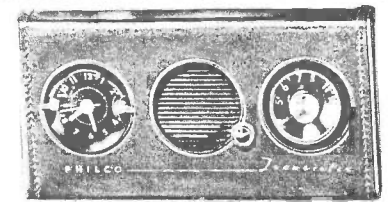

WANTED: Philco TC-47 transistor clock radio. Michael Arken, 1427 Diamond St., San Francisco, CA 94131. (415) 648-6817

FOR SALE: Rider's, complete set 1-21 - \$300 plus shipping; also Volumes 4-13, 15, 18, 19 - \$15 ea. Also send LSASE for list of over 1000 tube types. Jeff Moskow, WA11, Rustic Trail, Groton, MA 01450. (508) 448-5516

WANTED: Original knobs for Wards Airline 93WG-1103C console, set of four. Michael May, 120-A Lincoln St., Marysville, PA 17053-1303. (717) 957-4833

WANTED: Mitchell Mitchell Mitchell Mitchell, Mitchell, Mitchell, Mitchell, Mitchell, Mitchell, brand appliances. Please see Mitchell ad in business card section. Lee Mitchell, 875 N. Michigan, 3412, Chicago, IL 60611. (312) 337-3123, (312) 266-7100

FOR SALE: 1928 Atwater Kent factory reprints: AK Radio Service Manual, 98-page manual covers breadboards to Model 52, horns and speakers - \$12.95; AK Radio Parts List, 64-page companion to above, shows photos of chassis and lists parts for Models 9 to 67, horns and speakers - \$11.95. Prices do not include shipping. Vintage TV & Radio, 3552 West 105 St., Cleveland, OH 44111. (216) 671-6712

WANTED: WWII German military radio tubes. RL 1 P2, RL 2.4 P2, RL 2.4 T1, DDD 25. Arthur Obermeyer, KA0PDC, 5254 Fairview Ave., St. Louis, MO 63139. (314) 351-6991

WANTED: Manual, or photocopy, for B&K 960 transistor radio analyst. Also early Sams TSM's. Bob Davidson, 310 Main St., Concord, MA 01742. (508) 369-2007

MESSAGE: Free: Our new 1990 catalog flyer is now available. We have added more new-old-stock parts, reproduction items, refinishing supplies, Sprague capacitors, etc., etc., to our catalog. Call or write to get our new 20-page catalog. Vintage TV & Radio, 3552 West 105 St., Cleveland, OH 44111. (216) 671-6712

FOR SALE: Capehart radio-phonograph, works well - \$475. 1922 RCA Grand Radiola, gift of RCA to Henry Ford in 1937, documented - \$1,500. Shipping extra. Bart Cox, 11305 Riverview Rd., Fort Washington, MD 20744. (301) 292-1333

CLASSIFIED ADVERTISEMENTS

FOR SALE: Gloritone cathedral cabinet w/spkr. - \$45. GM cathedral cabinet - \$35. 1936 Olds Deco car radio, vgc, no control head - \$150. Grundig Satellit #2600 - \$150. Philco #38-610, parts or restore - \$35. Sony #TR-7 xstr., AM/SW - \$35. Empire AM xstr. - \$15. Realtone AM 8 xstr. - \$10. Heathkit #TR-3 signal tracer - \$30. Unassembled 1946 AM radio kit - \$65. 3" reel-to-reel xstr. tape recorders - \$30/3. Jimmy Downes, 607 E. 12th Ave., Covington, LA 70433. (504) 893-7057, eves.

WANTED: Osc. coil (#C & D) for Grunow Model 750, chassis #7-B. It is the coil closest to the front of the chassis in a row of 4. M. K. Tremper, 965 Newark St., Aurora, CO 80010. (303) 343-4642

FOR SALE: Hallicrafters w/speakers: SX-24 Skyrider Defiant; SX-71 (F.O.S., p. 231) - \$100 ea.; S-40, needs love - \$20. Stewart-Warner: R113 SW converter - \$50; tombstone #A1401A music note grille, plays - \$100; Trav-Ler 5015, cream, plays - \$45, brown - \$20. Reproduction radios: Fada Bullet, Belmont 6D111, both nice - \$60 ea. **WANTED:** Speaker for Philco 70, any SW3 coils, any Murad battery set, Sparton Bluebird chassis, AK 40 power supply lid, Zenith 3-band osc. and RF coils. Bill McCuskey, WATWQV, Box 140, La Conner, WA 98257. (206) 466-4683

WANTED: Western Electric 4B & 4D receiver. Marc Ingenthron, 9748 Outlook, Overland Park, KS 66207. (913) 642-4767

WANTED: Heath HG10B VFO in clean and operating condition. James T. Schliestett, W4IMQ, PO Box 93, Cedartown, GA 30125. (404) 748-5968

FOR SALE: Majestic 15A 5-tube, 1932, (F.O.S., p. 107) - \$65. Crosley Gem Chest metal cabinet, cut out of a swan on front, this is a unique cab. console model, black trim in gold color, no chassis or speaker - \$100. Zenith table model 27, big dial, AC, (F.O.S., p. 192), exc. cond. - \$110. Larkin panel & chassis - \$50. Sparton panel & chassis - \$40. Crosley tombstone model 516A - \$50. Kolster 6F, nice cond. - \$55. RCA Victor Model 3-BX-671, shortwave, time map on inside cover, brown leather case, exc. cond. - \$95. Gloritone cathedral, nice cond., chassis needs minor work, also pencil hole in grille cloth - \$95. Atwater Kent lamp, no shade, exc. cond. - \$225. Freed-Eisemann Model 30, battery, nice cond. - \$80. Crosley #51, needs audio - \$65 or BO. Philco table model 610T (F.O.S., p. 124) - \$60. (2) AK Type F4 speaker - \$30 ea. (2) Majestic AC power supplies, #1 Super B, #2 Standard B - \$20 ea. Crosley Model 10-135, white, nice cond. - \$45. Crosley Model 156 cathedral, nice cond. - \$100. Hallicrafters Model TW2000 Worldwide, 8 bands, brown leather case - \$120. Grundig Majestic Model 1097, W. Germany, 3 bands - \$70. Ralph D. Howard, 1 Church St., Dansville, NY 14437. (716) 335-8746, between 6-10 pm

CLASSIFIED ADVERTISEMENTS

FOR SALE: Hallicrafters. Bandsread. Standby. Band selector. Main tuning. Tom Butler, PO Box 80803, San Diego, CA 92138-7529. (619) 460-8849

WANTED: Chassis for GE K-43 and Detrola 4J. Cabinet for Zenith 15U270. Dan Szablewski, 1204 Andrews Ave., Lakewood, OH 44107. (216) 226-4054

WANTED: Adapters for Hickock tube tester Model 6000. CA-5 (1050-164) or SA-11 (1050-177). Arthur Obermeyer, KAØPDC, 5254 Fairview Ave., St. Louis, MO 63139. (314) 351-6991

FOR SALE: Tuska 224. Kodel P-12 (Douglas Vol. 2, p. 109). Viking 599 (Douglas Vol. 2, p. 220). Federal Variocoupler. Addison 56B. Crosley New Buddy Repwood case. Amplion AR-43 driver/base. Music Master horn minus wooden bell. Holtzer-Cabot and Majestic horn bells. Walt Curry, 10035 Country View Rd., La Mesa, CA 92041. (619) 461-9327

FOR SALE: N.O.S. Universal 78, 45, 33 rpm 3-speed Sapphire phonograph needles for set-screw cartridges. Cushion-Action angled-shaft. Factory-sealed display cards. \$2.95 ea., \$25/10 ppd. Don Diers, 4276-A16 North 50 St. Milwaukee, WI 53216-1313

WANTED: National HRO-60T accessories: HRO-60TS speaker, SOJ-3 Select-O-Ject; coils F, AA, AB, AC. Rider's Radio Vol. 23 to complete my set. Philco 84B tube shield. I will pay top \$ for any or all of the above. Frank DeCoito, Star Rt. #2, Box #242, La Honda, CA 94020. (415) 948-2045

FOR SALE: Crosley American Overseas, may need work. Information. Tom Butler, PO Box 80803, San Diego, CA 92138-7529. (619) 460-8849

FOR SALE/TRADE: Butterscotch swirl Canadian General Electric table radio, Model KM-51. This is the Canadian version of the set on p. 43 of R.G.A. This set is in excellent condition. I also have a Canadian Marconi battery set, Type 4V-SW-6-A. Tuning range is 17 to 125 meters. It uses a 222 and three 201A's, all good; this set is in good condition, complete, and correct but not tested. Please call or write with offers or trades. Greg Bilodeau, Box 716, Redwater, Alberta, Canada T0A 2W0. (403) 942-2737

WANTED: Nordmende Globe Traveler or Grundig Satellit. Any model of either series. Daryl Jorud, R#1, Box 180, Battle Lake, MN 56515. (218) 864-5725

WANTED: Sherwood HiFi amplifier Model S-1000II. Also need dial glass for Silvertone 4563. Vince Schiebel, 221 N. Few St., #3, Madison, WI 53703. (608) 257-6157, eves. & weekends

CLASSIFIED ADVERTISEMENTS

WANTED: Anything vintage Zenith. Advertising, radios, original paper, dealer props - that is, anything! We will consider trades for all items in our ad. **FOR SALE:** Coca Cola cooler radio, original paint touched up, small crack in grille - \$500. Coca Cola cooler radio, no cracks - \$700. Stewart-Warner Porto Baradio, glassware complete and very clean, hairline in top rear of cabinet, rebuilt chassis - \$325. Very clean Philco 90. Very clean Philco 70. Jackson Bell 62 Modern. Zenith 8-tube tombstone Model 288. Crosley maroon Bakelite, looks like a TV, with brass trim, mint - \$145. Zenith backlit sign, 16"x8", some reverse paint flaking, "Zenith radio" - \$150. Zenith 5S218 table model, speaker in end - \$150. RCA wooden Little Nipper, same as Catalin set - \$135. Stromberg-Carlson Model 68 console, Art Deco, original finish. (2) Belmonts, both cracked but not destroyed, Model 519 and C640 - \$150 ea., your choice. RCA double-sided porcelain Radiola sign, 99 & 44/100% - \$225. Tin litho N.O.S radio 1310 K-BUC San Antonio 5000 watts, mint, 2'x3' - \$110. Philco telephone dial remote box - \$55. Zenith chairside 12S245 (F.O.S., p. 187). Zenith Zephyr chairside. Zenith 9S244 chairside, super mint. Zenith 5S29 tombstone, mint. Majestic wooden treasure chest, perfect, working - \$185. Lime green Emerson Aristocrat, crack in lower front - \$300. Setchell-Carlson Frog Eye, maroon with white grille - \$150. Floor lamp radio, brass and paint, speaker below globe, controls at middle of column, chassis in base, in very good condition. Philco radio timer clock designed by Norman Bel Geddes, 1931, cleaned and rewired - \$125. Zenith 6D315 Wavemagnet Bakelite - \$200. Zenith 6J322. Detrola chrome face, AC/DC - \$175. Radio Days new movie poster, black background with a radio dial and Mia Farrow as the dial pointer, from Woody Allen's flick - \$19 ppd. Consoles: RCA C15; Philco 37-116; Zenith 12U158; 9S365 shutter dial; 10S470, sometimes known as the poor man's stratosphere; 12S370; 7S28; 12A57; 12A58; GE 135, motor drive, 13 tubes, big beautiful cabinet; 100 other consoles in inventory. Call for more info. Send for illustrated catalog of new radio-related items, including Zenith T-shirts, logo coffee mug, etc. Satisfaction guaranteed. Shipping extra. Yes, we can and do ship consoles with one day service and with no damage. Alan Jesperson, POB 17338, Minneapolis, MN 55417. (612) 727-2489

FOR SALE: Radio literature - magazines, books, manuals, brochures - TV, radio, ham, military. Send LSASE for 6-page list. D. Ripka, 1367 University Dr., State College, PA 16801

WANTED: Damaged or junker Zenith Royal 1000 or 3000 Trans-Oceanic for parts only. Jack Philpot, 632 E. 160th Ct., South Holland, IL 60473. (708) 596-0580

WANTED: Zenith Trans-Oceanic Royal 7000, last model made in U.S.A. Mark Mathison, 417 Ogden, Medford, WI 54451. (715) 748-5455

CLASSIFIED ADVERTISEMENTS



WANTED: RCA Victor 96E2 chairside radio (shown), Sansui 500A stereo receiver, and Telefunken Opus 7 table model radio. **FOR SALE:** Philco 70 cathedral, plays good but needs cabinet work - \$175 + \$10 UPS. Send SASE for radio and literature list. Robert Wiczkowicz, PO Box 86, Craryville, NY 12521. (518) 325-5307

FOR SALE: Philco K847-124. Philco 48-200. Radiola 61-9. Philco 49-902. Zenith DeLuxe Royal 755. Zenith M723. Automatic Radio Tom Thumb. Sparton 6-26. Truetone, Model D2616. Zenith portable TV, 50's vintage. RCA outdoor sign, 3'x6'. Pilot FM tuner T-601. Stromberg-Carlson 900H cabinets. Sharp UC-228 Allwave portable, early. Sylvania UHF converter, large dark maroon Bakelite case. Regency UHF converter Model R653. SASE for prices, condition, many additional items. Dean R. Kazmierczak, 886 Eggert Dr., N. Tonawanda, NY 14120. (716) 692-3455

WANTED: Early phonograph-radio console, 1929-1932 in restorable condition: Kolster, Brunswick, Atwater Kent, Capehart, Columbia, Electrola, Majestic, etc., in close pickup proximity please. Long, rectangular tube shield for 11-tube Philco Models 211, 212, 111, 112, console chassis 1931. Colonial style, wood stand for Radiola 18, good unrestored condition. Maroon base and speaker for Colonial New World globe radio. 16mm films with optical sound track to fit Italian-made Cinebox or Colorama video jukebox. Changer motor and the record disk motor for any early Mills Novelty Co. jukebox, Ferris wheel style, 1929. **FOR SALE/TRADE:** Guild-Grafanola radio/phonograph, excellent restored condition. Karl Doerflinger, 2082 Victory Hwy., Coventry, RI 02816. (401) 397-5579. (401) 421-9227

WANTED: Victor phonographs or parts. \$500 for wooden horns. \$15,000 for Regina Music Boxes or parts. John Brown, 193 Roselawn, NE, Warren, OH 44483. (216) 394-3201

FOR SALE: Old stock Hytron transmitting tubes in original packaging, have (6) HY1269 and one each 3C50 and 5516 - \$12 ea. or make offer for the lot. Carl Ratner, 550 Lamoka Ave., Staten Island, NY 10312. (718) 317-1838

FOR SALE: Old parts, radios, literature, odds and ends. LSASE for list. Hidyne Research, PO Box 3342, Williamsport, PA 17701. (717) 326-2148

CLASSIFIED ADVERTISEMENTS

WANTED: Auto Dyne oscillator coil for a Philco Model 89 cathedral. Randy Smith, 822 W. 7th Ave., Lancaster, OH 43130

FOR SALE: Early 20's Crosley Ace V receiver with Crosley 50A amplifier, Baldwin headphones in original box, batteries, receiver works, amp has one bad transformer - \$150 plus postage. Jim Fitzgerald II, 81 Faire Harbour Pl., New London, CT 06320. (203) 447-8171

WANTED: The following needed for Federal Models 59, 60, or 61. Amplification selector control. Federal RF transformers #31, #32, #35. Federal #2 vernier knob. James S. Fisher 344 Harrison Ave., Manville, NJ 08835. (201) 715-7476

WANTED: Dial for Philco Model 66. **FOR SALE:** R77/ARC-3 aircraft receiver. BC 733D 190-550kHz receiver. Carl Andersen, RFD 1, Box 663, Hampden, ME 04444. (207) 862-3925

FOR SALE: Zenith T-600 and 8G005TZIY Trans-Oceanics - \$35 ea. Philco 650 console, clean - \$75. AK 89 console, good condition - \$100. Howard 482 FM converter - \$15. Precision E-200-C tube tester for parts - \$10. Precision E-200-C signal generator - \$15. Philco 51-631 and Westinghouse H-559P4 battery/AC portables - \$10 ea. Heathkit OL-1 3" scope, manual - \$25. Emerson 543 plastic, white, black handle and knobs, 1 1/2" crack in front - \$15. Call for details, add UPS. Consoles pickup only. Rick Weibezahl, 305 Belvidere Ave., Washington, NJ 07882. (201) 689-3276

FOR SALE: Celluloid dial covers reproduced from your broken or dirty originals. Write or call: Edward L. Delano, 4923 Ridgeview Ln., Bowie, MD 20715. (301) 464-2303

WANTED: Garod V 6-tube neodyne. (2) Wesco 205-D tubes. Wesco 14A amplifier. Dubilier-Duratron radio frequency transformer 225-550 meters. Tad Drogoski, 507 Coal Valley Rd., Jefferson Boro, PA 15025

WANTED: Copy of manual for Knight R-100A receiver and Conar Model 400 novice transmitter. Al Bernard, PO Box 690098, Orlando, FL 32869-0098. (407) 351-5536

FOR SALE: GE K-50 cathedral (F.O.S., p. 89) - \$150. Freed-Eisemann NR-20, impressive cabinet with corner columns and gold-plated hardware - \$195. Stromberg-Carlson 635-A treasure chest - \$100. Philco 37-60 cathedral, needs restoration - \$65. Splintdorf R-V-695, needs restoration - \$45. Knight KG-600B tube tester, complete with all manuals, like new - \$45. John Hayes, 27 Highland Dr., Henniker, NH 03242. (603) 428-3053

WANTED: Metal cover for AK 40. Earle Drake, Box 1808, Hyannis, MA 02601

CLASSIFIED ADVERTISEMENTS

WANTED: Push-button knobs for 1939-1940 RCA motor-driven dial radio. Also fit the TRK-12. Craig Roberts 35-L Ridge Rd., Greenbelt, MD 20770. (301) 474-3506

WANTED: Crank-up phonographs & parts, horns, reproducers, etc. No motors please. Local 78's. Thanks. J. L. Acciavatti, PO Box 231, Southborough, MA 01772. (508) 476-3229

FOR SALE: Large supply of radios including 1929 Zenith floor model, Philco 77, Bosch 60 in lowboy floor model, table models, etc. Books, tech. manuals, Riders, Sams, test equipment, TV service manuals, Wallaces Telaides, and tubes. Send SASE. Doug McManus, KB2IAY, 20 Deland Pk. A, Fairport, NY 14450

FOR SALE: Consoles: Philco 41-290, Philco 38-4, Zenith 8S563. Table models: Hallicrafters Sky Buddy, Philco 39-7, Crosley Model 56, Zenith 6D0300, Zenith H723Z. GE E-81 tombstone. Small Emerson plastic. General Radio battery cathedral. Vance Rayburn, 2718 Homestead Rd., Madison, WI 53711. (608) 274-3002

HELP: Help RCA people help out an RCA retiree. Need RCA meatball 3/4" dia. (any mount) to restore AR88. Purchase unit or chassis. Robert Haworth, W2PUA, 112 Tilford Rd., Somerdale, NJ 08083. (609) 783-4175

WANTED: Magic Lion visual tuning indicator, escutcheon dial plate for Zenith 5S29, and an audio transformer for a Radiola III. Don Catton, 609 10th St., Silvis, IL 61282

WANTED: One of the ornate feet for Radiola 60 cabinet. Rob Becker, 6 Tibbetts Ave., Danvers, MA 01923. (508) 777-0670

FOR SALE: Toning Lacquer as used by Philco and others to color those cheap veneers. Colors available: Van Dyke brown, cherry brown, brown mahogany, medium walnut, extra dark walnut. \$5.75 per 13 oz. spray can. Does not include shipping; \$2 for 1st can, \$1.00 for each additional can. Vintage TV & Radio, 3552 West 105 St., Cleveland, OH 44111. (216) 671-6712

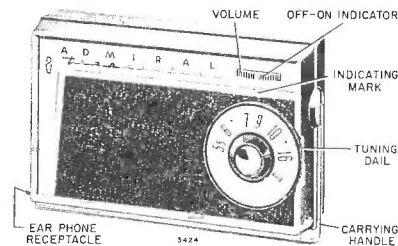

WANTED: Admiral transistor (801, 802, 808). Michael Arken, 1427 Diamond St., San Francisco, CA 94131. (415) 648-6817



ARKANSAS - Jun. 7

ANTIQUÉ RADIO COLLECTORS CLUB OF FT. SMITH - CLUB MEETING
 Ft. Smith, AR - Creekmore Park Magnolia Room, Greenwood and Rogers
 May 3 - 7:30 pm. May 31-June 7 - Show Central Mall Shopping Center, Rogers Ave.
 Info: Wanda Conatser - (501) 646-7147

ARKANSAS - Jun. 14

ARKANSAS ANTIQUE RADIO CLUB CLUB MEETING
 Little Rock, AR - The Auditorium S.W. Bell Bldg., 120 W. 8th St. - 7 pm
 Info: Tom Burgess - (501) 565-1750

WASHINGTON - Jun. 17

PUGET SOUND ANTIQUE RADIO ASSN. SWAP MEET/MEETING
 North Seattle, WA - Ronald School North 175th St., 1 mile W. of I-5, exit 176
 11 am - Swap Meet; 1 pm - Meeting
 Info: Frank Banks, 28232 27th Ave. S Federal Way, WA 98003 - (206) 941-2965

OREGON - Jun. 9

NORTHWEST VINTAGE RADIO SOCIETY MEETING
 Oregon City, OR - Buena Vista Clubhouse 16th and Jackson Streets - 10 am - Meeting
 Info: Dan Howard, 2940 SE 118th Ave. Portland, OR 97266 - (503) 761-7799

CALIFORNIA - Jun. 12

NORTH VALLEY CHAPTER CALIF. HISTORICAL RADIO SOCIETY MEETING
 Anderson, CA - Goodtimes Pizza Parlor 6:30 pm
 Info: NVC-CHRS, PO Box 2443 Redding, CA 96099 - (916) 246-4209

OHIO - Jun. 21

NEW CLUB FORMING ANTIQUE RADIO COLLECTORS OF OHIO MONTHLY MEETING
 Dayton, OH - 2929 Hazelwood Ave. - 7:30 pm
 Info: Karl Koogle, 2929 Hazelwood Ave. Dayton, OH 45419 - (513) 294-8960

OHIO - Jun. 14-16

ANTIQUÉ RADIO CLUB OF AMERICA & Greater Cincinnati Radio Collectors ANNUAL CONVENTION
THEME: THE CROSLY COMPANY
 Cincinnati, OH - Ramada Inn, Off I-75
Flea Market: All days
Old Equipment Contests: Regular & Crosley Anything (Cars judged outdoors)
Thursday: Seminars: WLW, Mel's Corner Tours: Union Terminal Museum, WCET-TV
Friday: Seminars: Restoration Tips, Crosley Tour: Voice of America Banquet & Awards
Saturday: Auction, Tour of Fax Museum
 Info: Lloyd McIntyre - (304) 344-5488
 Ramada Inn, (Group #491), 11029 Dowlin Rd. Cincinnati, OH 45241 - (513) 771-0300

INDIANA - Jun. 22-23

INDIANA HISTORICAL RADIO SOCIETY MID-SUMMER MEET
 Indianapolis, IN - Howard Johnson Motel Post Road and I70 East
Special room rate w/IHRS: (317) 897-2000 (Reserve before June 1 if possible)
Friday - June 22
AM Swap Meet - Luncheon Buffet
 7 pm - Dinner and Business Meeting
 8 pm - AWA Slide Show and Old Movies
Saturday - June 23
AM Swap Meet
 11:30 am - Contest Judging
 (Any item of which you are very proud)
 1 pm - Auction
 Info: Glenn Flitch - (317) 565-6911

PA. - Thru Sept. 30, 1990

ATWATER KENT MUSEUM EXHIBIT
 Philadelphia, PA - 15 So. Seventh Street
 Tues. through Sat.: 9:30 am - 4:45 pm
 "Tune In: Philadelphia Radio 1920-1950"
 Info: (215) 686-3630

Non-members welcomed at all meets!
Admission charged at some meets.
Mention A.R.C. when contacting clubs!
Enclose a SASE when requesting info.

CALIFORNIA - Jun. 23

**CALIF. HISTORICAL RADIO SOCIETY
SAN LUIS OBISPO REGIONAL MEET**
San Luis Obispo, CA - 7 am - 11 am
Sunset Drive-in Theatre, 255 Elk Ln.
Info: Dan Steele - (805) 544-2904

MARYLAND - Jun. 23

**MID-ATLANTIC ANTIQUE RADIO CLUB
CLUB MEETING**
Laurel, MD - Applied Physics Lab.
Johns Hopkins Univ. - 6:30 pm
Info: Joe Koester - (301) 725-4229
Glenn Hartong - (301) 997-8413

ALABAMA - Jun. 25

**ALABAMA HISTORICAL RADIO SOCIETY
MEETING**
Birmingham, AL - Manpower Services
1605 11th Ave. South - 7 pm
Info: ALHRS, 4721 Overwood Circle
Birmingham, AL 35222 - (205) 595-2856

MICHIGAN - Jul. 12-14

**MICHIGAN ANTIQUE RADIO CLUB
ANTIQUE WIRELESS ASSOCIATION
EXTRAVAGANZA '90**
Lansing, MI - 7501 W. Saginaw
Holiday Inn Lansing Conference Center
(517) 627-3211 - Reserve rooms before July 1
3-Day Open-Air Flea Market - 50/50 Raffles
Programs - Equipment Contest
Thursday - Jul. 12
Flea Market - Programs - 50/50 Raffle
Friday - Jul. 13
Flea Market - Contest - 50/50 Raffle
Spartan Display with Nocturne Mirrored Radio
Equipment Auction
Saturday - Jul. 14
Flea Market - 50/50 Raffle
Silent Auction - Donation Auction
Info: Jim Clark - (517) 349-2249

ILLINOIS - Aug. 9-11

**ANTIQUA RADIO CLUB OF ILLINOIS
RADIOFEST 1990**
Elgin, IL - Holiday Inn, 345 River Road
(312) 695-5000 - 30 min. W. of Chicago
Exit Route 31 South on I-90 NW Tollway
3-Day Flea Market - Afternoon Programs
Awards Banquet - Special Exhibit
Old Equipment Contest - Auctions
Ralph Muchow's Radio Museum
Info: Dave Johnson, 2336 S. Kenilworth
Berwyn, IL 60402 - (708) 484-2743

MARK YOUR CALENDAR

Thru Sep. 30 - PA, Philadelphia - Exhibit*
May 28 - AL, Birmingham - ALHRS §
Jun. 7 - AR, Ft. Smith - ARCCFS Meeting §*
Jun. 9 - OR, Oregon City - NWVRS §*
Jun. 12 - CA, Anderson - NVC-CHRS §*
Jun. 14 - AR, Little Rock - AARC Meeting §*
Jun. 14-16 - OH, Cincinnati - ARCA Conf.*
Jun. 16 - PA, Forest Hills - PARS
Jun. 16 - TX, Irving - VRPS Swap Meet
Jun. 17 - WA, Seattle - PSARA Meet §*
Jun. 21 - Australia, Melbourne - HRSA
Jun. 21 - OH, Dayton - ARCO Meeting §*
Jun. 22-23 - IN, Indianapolis - IHRS Meet*
Jun. 23 - CA, San Luis Obispo - CHRS*
Jun. 23 - MD, Laurel - MAARC §*
Jun. 25 - AL, Birmingham - ALHRS §*
Jul. 9 - IL, Belleville - BAARC
Jul. 12-14 - MI, Lansing - Extravaganza*
Jul. 14 - CA, San Francisco - CHRS
Jul. 15 - MN, Fridley - NARC Picnic
Jul. 21 - MD, Laurel - MAARC §
Jul. 21 - NH, Nashua - NEARC Meet/Auction
Aug. 9-11 - IL, Elgin - Radiofest 1990*
Aug. 11 - CA, Los Altos Hills - CHRS Meet
Aug. 18 - IN, Windfall - IHRS
Aug. 25 - Ontario, London - LVRC
Aug. 31 - Australia, Sidney - HRSA
Sep. 8 - PA, Forest Hills - PARS
Sept. 10-15 - NY, Rochester - AWA Conf.
Oct. 6 - IN, Terre Haute - IHRS Meet
Oct. 19-21 - TX - VRPS/AWA Convention '90
Oct. 20 - NH, Nashua - NEARC Meet
Nov. 11 - CA, Los Altos Hills - CHRS
Nov. 17 - TX, Irving - VRPS Fall Swap Meet
*See expanded listing this month. § Monthly Meeting.

WISCONSIN

**NEW CLUB FORMING
WISC. ANTIQUE RADIO & PHONO. SOC.**
Wautoma, WI - Vintage Radio
112 S. Ste. Marie Street
Info: Jerome Schliepp, 831 Berlin Rd.
Ripon, WI 54971 - (414) 748-2471

RADIO CLUB LISTINGS

CLUBS: Send antique radio club and meet information to A.R.C. for free listing here, as space permits. Sorry, we don't have room for hamfests. Always send a SASE when writing to clubs!

NATIONAL CLUBS:
Antique Wireless Association (AWA). P.O. Box "E", Breesport, NY 14816. Pub: *The Old Timer's Bulletin*, quarterly. Dues: \$10.00. National and regional conventions. Museum.
Antique Radio Club of America (ARCA). William Denk, 81 Steeplechase Rd., Devon, PA 19333. Pub: *The Antique Radio Gazette*, quarterly. Dues: \$12.00. National and regional conventions. Regional chapters.

(Continued)

REGIONAL CLUBS:

Alabama Historical Radio Society (ALHRS). 4721 Overwood Circle, Birmingham, AL 35222. Meetings 4th Mon. evening each month but Dec.
Antique Radio Club of Illinois (ARCI). Carl Knipfel, Rt. 3 - Veterans Rd., Morton, IL 61550. Pub: *ARC/News*. Dues: \$12.00. Annual Radio-fest and additional meets each year.
Antique Radio Collectors Club of Ft. Smith, Arkansas. Wanda Conatser, 7917 Hermitage Dr., Ft. Smith, AR 72903. Monthly Meetings.
Antique Radio Collectors of Ohio (ARCO). Karl Koogle, 2929 Hazelwood Ave., Dayton, OH 45419. Quarterly newsletter. Dues: \$10.00. Monthly meetings.
Arkansas Antique Radio Club (AARC). Tom Burgess, P.O. Box 9769, Little Rock, AR 72219. Pub: None. Dues: \$5.00. Monthly meets.
Arizona Antique Radio Club (AARC). Treasurer, 8311 E. Via de Sereno, Scottsdale, AZ 85258. Pub: *Arizona Antique Radio Club News*, quarterly. Dues: \$15.00. Monthly meetings.
Belleville Area Antique Radio Club (BAARC). Karl Stegman, Treasurer, 4 Cresthaven Dr., Belleville, IL 62221, (618) 234-7992. Newsletter. Dues: \$10.00. Bi-monthly meetings.
California Historical Radio Society (CHRS). Paul Bourbin, 25 Greenview Ct., San Francisco, CA 94131. Pub: *CHRS Journal*, quarterly. Dues: \$15. Quarterly swap meets.

North Valley Chapter, CHRS (NVC-CHRS). Norm Braithwaite, PO Box 2443, Redding, CA 96099. Bi-monthly newsletter. Dues: \$5.00 (+ \$15.00 CHRS). Bi-monthly meetings.
Cincinnati Antique Radio Collectors (CARC). Tom Ducro, 6805 Palmetto, Cincinnati, OH 45227. Informal organization. Write to be put on mailing list. Two meets per year.
Colorado Radio Collectors (CRC). New club forming. Johnny Johnson, 2201 Newton St., Denver, CO 80211. Pub: Not yet. Dues: \$10.00. Quarterly meets.
Greater Boston Antique Radio Collectors (GBARC). Richard Foster, 12 Shawmut Ave., Cohituate, MA 01778. Informal organization. Write to be put on mailing list. One winter and one spring meet each year.
Greater New York Vintage Wireless Association (GNVWVA). Bob Scheps, 12 Garrity Ave., Ronkonkoma, NY 11779. Pub: Meeting Notices. Dues: \$4. Six meets/year.
Houston Vintage Radio Association (HVRA). Kathy Botto, 3505 Del Sur Dr., Baytown, TX 77521. Pub: *The Grid Leak*, monthly. Dues: \$10.00 (\$15.00, local). Regional meets.
Indiana Historical Radio Society (IHRS). 245 N. Oakland Ave., Indianapolis, IN 46201-3360. Pub: *IHRS Bulletin*, quarterly. Dues: \$8.00. Quarterly swap meets in various areas of state.
Mention A.R.C. when contacting clubs!

BUSINESS CARD ADS - \$22.00 FOR 3 MONTHS

SPECIAL PURPOSE TUBES SEMI-CONDUCTORS
PICTURE TUBES RECEIVING TUBES

Donna L. O'Connor

(201) 751-2591
(201) 471-8120

824 MAIN ST.
BELLEVILLE, NJ 07109

WANTED - OLD RADIOS BEFORE 1930

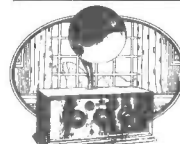

- Early Crystal Sets
- Battery Radios
- Horn Speakers
- Radio Magazines & Books
- Radio Tubes & Parts
- Early Radio Advertising

G.B. Schneider Phone: 216-582-3094
9511-23 Sunrise Blvd. North Royalton, Ohio 44133

WRIGHT ELECTRONIC SERVICE THE RADIO DOCTOR

"You Don't Have To Worry When It's Done Wright"

1920-1960'S RADIOS-PHONOS-CAR RADIOS- TUBE AMPS
COMPLETE CHASSIS REFURBISHMENT
N.O.S. & USED PARTS - SEND FOR PRICE QUOTES
SCHEMATICS \$2.00 PER COPY

WRIGHT ELECTRONIC SERVICE P.O. BOX 8252
(206) 859-3592 FEDERAL WAY, WA. 98003

WANTED!



MITCHELL TV's,
radios, hi-fi's, and all
other appliances (made
by Mitchell Mfg. Co.,
Chicago, in 30's to 50's).

'The Mitchell Collector'

Lee Mitchell, 875 N. Michigan, 3412
Chicago, IL 60611 - (312) 337-3123, 266-7100

ANTIQUE JUKEBOXES, MICROPHONES
Deco & Deluxe Console & Table Radios
Broadcasting, Hi Fi & Recording equipment
16" Transcriptions & Blank recording disks
Buy, Sell & Trade.
Robert Van Dyke 516-728-1327
2 Squires Ave., East Quogue NY 11942

WANTED: Tube Hi-Fi Components & Studio
Equipment of the 1950's and 60's

Marantz, McIntosh, Scott, Fisher, Brook
Acrosound, Brocner, Western Electric
Fairchild, Altec, Tannoy, JBL

Richard Sharisky
P.O. Box 521 Belmont, MA 02178 (617) 484-5784

BUSINESS CARD ADS - \$22.00 FOR 3 MONTHS

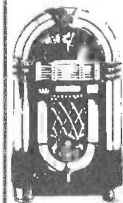
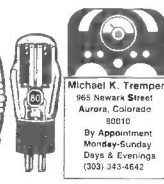
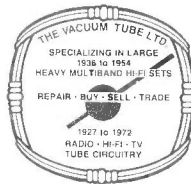

If you buy, sell or like jukeboxes you need ALWAYS JUKIN'—THE MONTHLY JUKEBOX MAGAZINE!! Subscribers in 25 countries, ALWAYS JUKIN' LEADS THE WAY: Articles, photos, show reports, ads, new products, price guides, restoration tips, repairs—everything you need to know about JUKE-BOXES—the fastest appreciating collectible in the world!!! Fun & a great investment. Sample copy, \$3. 12 Issues, \$24. ALWAYS JUKIN, 221 YESLER WAY AR, SEATTLE, WA. 98104. (206) 233-9460. Master/Visa ok.

Blade & Cage

Electric Brass Desk Fans Bought, Sold, Restored



M.L. YOUNG
4200 Sunshine Rd.
Miami, FL 33133

(305) 661-6245



john d. eckland

969 ADDISON AVENUE PALO ALTO, CALIFORNIA 94301
415/323-0101



- Radios
- 78 RPM Jukeboxes
- 78 RPM Turntables
- Radio Tubes
- Shure Needles & Cartridges
- Astatic Needles & Cartridges
- Parts & Accessories

(815) 229-6900

ASTATIC

VINTAGE RADIO And Electronics

SCOTT A. WEBSTER
Owner

1414 - 17th STREET
ROCKFORD, IL 61104

SHURE

RELIABLE - PROMPT - GUARANTEED

SOUND REMEDY
LOUDSPEAKER REPAIR SERVICE

381 Virginia Avenue
Collingswood, New Jersey 08108

Authorized Waldom Dealer

Telephone
(609) 869-0238

RALPHS

Repairs any tube radios
\$25.95 - Guaranteed to work good
UPS and large parts extra
SASE required for answer

Ralph Kilsheimer - 50 years of service!
107 Robins Road, New Rochelle, NY 10801
(914) 632-4371

TUBES & STUFF

EXTENSIVE STOCK OF **NEW AND GOOD USED TUBES ETC.**

Send \$1 (stamps O.K.) - Refundable for latest lists *now...*

DON DIERS — 4276-AB2 N. 50 St.
Milwaukee, WI 53216-1313

"Dead Radios Brought Back to Life"

FRANKENSTEIN'S RADIO LABORATORY

Specializing in Antique Radios.
Old Radio Cadavers and Parts Bought and Sold.
Mail Order Sales of New, N.O.S. and Used Parts.

MAIL ORDER SALES
4010 Fairmount Pkwy., Suite 285
Pasadena, Texas 77504

Gordon R. Rolston
Repairs by Appointment
(713) 998-0130

DAN'S SCHEMATIC SERVICE

RADIO DIAGRAMS
1921 to 1960 - \$2.50 PPD
T.V. DIAGRAMS
1938 to 1960 - \$3.50 PPD
Send make and model number or chassis
layout sketch with make and tube types if model
number is unknown, to: P.O. Box 53061
San Jose, CA 95153

VINTAGE TV and RADIO
REPAIR and RESTORATION
ELECTRONICS and COSMETICS



DAVID B. JOHNSON



2336 S. KENILWORTH AVE.
BERWYN, IL 60402 • (708) 484-2743

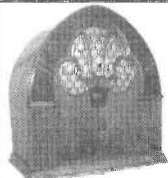

PhotoCard
Computer Imagery
3500 Mowry Avenue, #A
Fremont, CA 94538
(415) 794-7441

Photographic Business & QSL Cards

BUSINESS CARD ADS - \$22.00 FOR 3 MONTHS

WANTED

RADIO — WIRELESS
Pre-1925
ELECTRICITY — TELEGRAPHY
Pre-1900
Books, Magazines, Autographs, Catalogs, Ephemera
One Item or Entire Collection
New Wireless Pioneers
6270 Clinton, Elma, NY 14059 USA
(716) 681-3186



(201) 794-9606

VINTAGE TV'S
& RADIOS

HARRY POSTER

P.O. Box 1883 • South Hackensack, New Jersey 07606

ANTIQUE RADIO REPAIR

Repair - Restore - Buy & Sell
Schematic Diagrams \$2.00
DAMASKE ELECTRONICS
574-W16834 Janesville Road
Muskego, WI 53150
Phone: (414) 679-0838

Victorian Talking Machine, Company
261 Robinson Ave. Newburg, NY 12550



914-561-0132
SHOP HOURS
BY APPT.



Antique Phonographs
Cylinders, Discs,
Buy, Sell, Restore & Repair

100 Needles \$3.00
Book & Parts Catalog - \$3.00
TELEPHONE ORDERS
MC/VISA

50 years **CHUCKS** of service!

Any Tube Radio Repaired and
Guaranteed to work good.
\$26.00 plus large parts & UPS

CHUCKS
167 LYNN DRIVE - PO Box 598
NEW HAVEN, WV 25265 - PH (304) 882-2220

RADIO-TV TUBES

Dick Bergeron
Box 311
Essex Center, Vt. 05451
Tel: 802-879-0611

FREE PRICE CATALOG

Over 1400 types, all new in original boxes

Are You Looking For Antique Radios, Parts,
Tubes, Schematics and Restoration Services?
For Free Flyer, a 2-Stamp LSASE is required to insure a
response to your request. Send to:

Olde Tyme Radio Company
2445 Lyttonsville Road, Suite 317, Silver Spring, Md 20910

Wish to contact us by phone?
Our number is (301) 585-8776.
Please call 10 am to 10 pm (Local Time)

Antique Radios



David & Nancy Snow
P.O. Box 6352
Jackson, MI 49204
(517) 750-4992

We Buy, Sell, Repair
ARBE - III Battery Eliminators

E.H. Scott Radio

Collector Historian Admvr



JIM CLARK
1292 STARBOARD
OKEMOS, MI 48864
(517) 349-2249

ELECTRONS PAST
Vintage Radio

RESTORATION

BUY - SELL - TRADE - REPAIR
Mike Lynch



P.O. Box 23
Midvale, UT 84047



(801) 282-3211

SCHEMATICS 1920-1960
RADIO/TV/HAM/MISC.
FULL DESCRIPTION OF SET IN
FIRST LETTER PLEASE - \$3.50 EA.

ALTON H. BOWMAN
RD2 (CHAPIN VLG.)
CANANDAIGUA, NY 14424

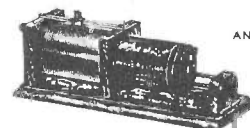

JAMES A. DiRUZZA
MEMBER A.W.A.

WANTED
ANTIQUE WIRELESS
ITEMS
PHONE (513) 233-5004
2607 Old Troy Pike
DAYTON, OHIO 45405

REPRINT BOOKS ON EARLY RADIO - WIRELESS - TELEVISION TELEGRAPH - TELEPHONE

RADIO

Blake, G.C., *History of Radio Telegraphy and Telephony*. Early wireless schemes, developments and patents to 1928. 50-page bibliography. 449 pgs. \$35.50
Codel, M., *Radio and Its Future*. 1930. A 1930's look into the future. A collection of articles including DeForest, Grunow, Kolster, Sarnoff, Maxim, Colpitts, Paley, Durstine and Codel. 375 pgs. \$28.00
Dunlap, O.E., *Radio's 100 Men of Science*. 1944. Biographical narratives of pathfinders in electronics & television including Gilbert, Galvani, Faraday, Loomis, Hughes, Dolbear, Tesla, Hertz, Popoff, Nipkow, Branly, Jenkins, Conrad, Weagant, Kolster, DuMont, Olson. 330 pgs. \$25.00
McNicol, D., *Radio's Conquest of Space*. 1946. A chronological treatment of the early days of radio, the scientists and their inventions. A few of the chapters: Spark Gaps & Oscillators, Wireless Spans the Atlantic, Regenerative Receivers, The Advent of Commercial Radio. 388 pgs. \$29.00
Military Signal Communications. A two-volume anthology of early documents covering the history of military communication, the Civil War to WWII. Includes visual signaling, telegraph, telephone and radio. 2 vols., 750 & 625 pgs. ...\$71.50
Report of the Chief Signal Officer: 1919. A record of the telegraph, telephone and radio in WWI.\$46.50
Signaling and Communicating at Sea. A two-volume anthology of over 50 articles. Semaphores, pigeons, flashing lights, flags, radio, teletype. 2 vols., 480 & 524 pgs. ...\$73.00
Summers, H.B., ed., *Radio Censorship*. 1939. Collection of excerpts from articles & books + brief bibliography.\$23.50

THE FAMOUS M.I.T. RADIATION LAB. SERIES AVAILABLE AGAIN

#13. *Propagation of Short Radio Waves*, 746 pgs. \$29.95
 #15 *Crystal Rectifiers*, 457 pgs.\$19.95
 #17 *Components Handbook*, 640 pgs.\$29.95
 #18 *Vacuum Tube Amplifiers*, 761 pgs.\$29.95
 #19 *Waveforms*, 799 pgs.\$29.95
 #20 *Electronic Time Measurements*, 546 pgs.\$24.95
 #21 *Electronic Instruments*, 735 pgs.\$29.95
 #22 *Cathode Ray Tube Displays*, 764 pgs.\$29.95
 #23 *Threshold Signals*, 400 pgs.\$19.95
 #25 *Theory of Servomechanisms*, 383 pgs.\$19.95
 #27 *Computing Mechanisms & Linkages*, 371 pgs. \$19.95

The above are quality reprints. Send for free list of over 80 reprints of books on early radio, television, broadcasting and telegraph available from A.R.C.

Send payment with order. Mass. residents add 5% tax. Allow 4 to 6 weeks to receive books. Add \$1.50 for shipping in U.S. Outside of U.S., please add 10% for shipping. Send order with payment to: Antique Radio Classified, P.O. Box 2, Carlisle, MA 01741

Jun-90

TELEVISION

Abramson, A., *Electronic Motion Pictures: A History of the Television Camera*. Mechanical TV to Zworykin to 1940's. 228 pgs.\$24.50
Dunlap, O.E., *The Outlook for Television*. 1944. Records the evolution of television from 1925 to 1932. Includes 22-page chronology of Radio/TV from 640 a.c. 310 pages. \$24.50
Hess, G.N., *An Historical Study of the Du Mont Television Network*. 1960. A search for why the fourth television network failed.\$19.00

TELEGRAPH TELEPHONE

Bright, C., *Submarine Telegraphs: Their History, Construction and Working*. 1898. An account by a chief engineer, of early cable attempts, failures & successes, starting with the 1850 cable between England & France. 819 pgs. ...\$57.50
Development of Submarine Cable Communications. A two-volume anthology of over 50 articles. The 1858 and later trans-Atlantic cables, cable-laying ships, cable routes, technology thru 1973. 2 vols., 500 & 480 pgs. ...\$71.50
Electric Telegraph: An Historical Anthology. The rise and progress of the electric telegraph from the late 19th century to recent times. A collection of early writings. 625 pgs. \$4.00
Eyewitness to Early American Telegraphy. Reprints of reports and letters of Alfred Vail from the 1830's and 40's. An invaluable primary resource. 288 pgs.\$25.50
Fahie, J.J., *A History of Electric Telegraphy to the Year 1837*. 1884. A definitive history of the earliest telegraph systems preceding Morse. 566 pgs.\$38.50
Kingsbury, J.E., *The Telephone and Telephone Exchanges: Their Invention and Development*.\$40.00
Prescott, G.B., *Bells' Electric Speaking Telephone*.\$38.50
Smith, Willoughby, *The Rise and Extension of Submarine Telegraphy*. An engineer's and designer's autobiographical account of cable laying in the mid-1900s including the 1856-66 Great Eastern missions. 409 pgs.\$32.00

EXTRAVAGANZA '90

Proudly Announced & Sponsored By



THE MICHIGAN
ANTIQUÉ RADIO
CLUB



&
THE ANTIQUE
WIRELESS ASSOCIATION

3 Days This Year!!

— July 12-14, 1990 —

Featuring a world class Sparton display on Friday,
highlighted by Doug & Judy Heimstead's
Sparton Floor Model Nocturne Mirrored radio!!!

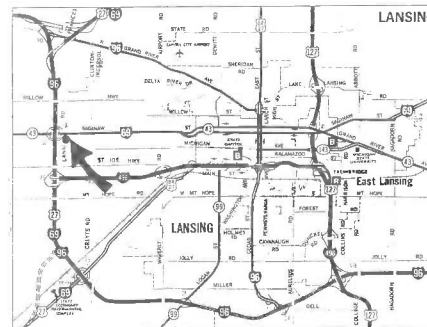

New & larger facilities this year:

Holiday Inn Lansing
Conference Center
7501 W. Saginaw
Lansing, Michigan 48917
(517) 627-3211

For additional meet info, call:

Jim Clark (517) 349-2249

— OTHER EVENTS —

- ★ 3-Day Open-Air Flea Market
- ★ Donation Auction (Saturday)
- ★ "Silent" Auction (Saturday)
- ★ 50/50 Raffle Each Day
- ★ Programs
- ★ Hospitality Room
- ★ Equipment Contest (Categories To Be Announced)
- ★ Equipment Auction, Conducted by Steve Waldron (Friday)

EXTRAVAGANZA '90

SCHEDULE OF EVENTS

Thursday, July 12

All Day	Open-Air Flea Market	N.E. parking lot
All Day	Hospitality Area	Ambassador Room
Noon - 5 pm	Sparton Display Setup	Michigan Room
5 pm	50/50 Raffle	N.E. parking lot
5 pm - 6 pm	Program #1	Delta East
6 pm - 7 pm	Program #2	Delta East

Friday, July 13

All Day	Open-Air Flea Market	N.E. parking lot
All Day	Hospitality Area	Ambassador Room
10 am - 10 pm	Sparton Display Viewing	Michigan Room
8 am - 10 am	Contest Check-in	Regency B
10 am - Noon	Contest Judging	Regency B
Noon - 1 pm	Women's Luncheon	Mulberry's
1 pm - 5 pm	Contest Room Viewing	Regency B
1 pm - 7 pm	Auction Check-in/Preview	Regency A
6 pm - 7 pm	Business Meeting	Regency A & B
7:30 pm	50/50 Raffle	Regency A & B
7:30 pm - 10 pm	Auction with S. Waldron	Regency A & B

Saturday, July 14

All Day	Open-Air Flea Market	N.E. parking lot
8 am - Noon	Hospitality Area	Ambassador Room
8 am - 9 am	Silent Auction Check-in	Delta East
9 am - 11 am	Silent Auction	Delta East
9:30 am - 10:30 am	Program #3	Delta Central
11:30 am	Donation Auction	N.E. parking lot
11:30 am	50/50 Raffle	N.E. parking lot

CONTEST CATEGORIES

- | | |
|-----------------------------------|------------------------------|
| 1. Pre-1921 wireless gear | 7. Floor model radios |
| 2. Passive detectors/crystal sets | 8. Televisions |
| 3. Battery radios, pre-1927 | 9. WWII era military radios |
| 4. AC table models, pre-1945 | 10. Foreign (non-USA) radios |
| 5. Test instruments/equipment | 11. Post-1945 table radios |
| 6. Speakers | 12. Weird/bizarre radios |

Cut apart conference registration and room reservation coupons on dashed lines and mail each to the address indicated on each coupon.

MARC/AWA EXTRAVAGANZA '90 REGISTRATION

Mail before **JUNE 15, 1990** to:
MARC, PO Box 585, Okemos, MI 48864

	Fee	No. Adults	Total
Advance Registration (before 6/15)	\$4.00		
Registration (After 6/15 or at door)	\$6.00		
Flea Market Seller's Card - MARC member	\$10.00	<input checked="" type="checkbox"/>	
Flea Market Seller's Card - non-member	\$15.00	<input checked="" type="checkbox"/>	
1990 MARC Membership (MEMBERSHIP NOT REQUIRED TO ATTEND/MEET)	\$6.00	<input checked="" type="checkbox"/>	
<input type="checkbox"/> New <input type="checkbox"/> Renewal			
Make check out to MARC and mail to address above		TOTAL:	

Name _____
Address _____
City _____ State _____ Zip _____
Phone# (H) _____ Phone# (W) _____
Deposit (check) enclosed _____

ROOM RESERVATION REQUEST

Mail before **JULY 1, 1990** to: **HOLIDAY INN**
7501 W. Saginaw, Lansing, MI 48917 - (517) 627-3211
(Late reservations will be accepted if rooms are available)
Special Discount Rates: \$49 a room

No. of People _____ King-Size Bed _____ Twin/Double Bed _____
Arrival Date _____ Departing _____

Check-in Time: 3:00 pm - Check-out Time: 12:00 noon

Name _____
Address _____
City _____ State _____ Zip _____
Telephone # () _____

ONE NIGHT'S DEPOSIT OR A MAJOR CREDIT CARD NUMBER
WITH EXPIRATION DATE MUST ACCOMPANY THIS COUPON
TO HOLD EACH ROOM REQUESTED. THANK YOU!

Deposit by check enclosed _____
Credit Card Guarantee: AE VISA MC Discovery
Card No. _____ Exp. Date _____
Signed _____

FOR SALE

1. AK 3-tube Breadboard\$ 250
2. Aeriola Senior 125
3. Aeriola Senior Amplifier 175
4. Radiola Special 400
5. Radiola III in the Box 200
6. Radiola II 250
7. Radiola III 75
8. AK Model 10 for Kiel Cabinet 300
9. AK Model 55 in Kiel Table 350
10. AK Model 55 in Cabinet - 53" hg. 36" wd. 300
11. AK Grandfather Clock, Model 82 Chassis 500
12. Crosley Pup 300
13. Crosley 50 250
14. Crosley V 250
15. (3) Crosley 51 75 ea.
16. Crosley Cathedral 150
17. Clapp-Eastham HR 250
18. Colon B. Kennedy 220 Radio with 525 Amp. 1000
19. Federal 61 1000
20. Federal 110 600
21. Spark Transmitter, Conn. Tele. & Elec. BC15A 500
22. General Radio Crystal Set BC14A 500
23. Grebe CR3 Radio & RORD Amp. 1200
24. Paragon RD5 Radio & A2 Amp. 1000
25. Paragon Type 2 300
26. Philco Cathedral 200
27. Tuska 224 350
28. Westinghouse Detector Amp. DA 400
29. Stewart-Warner with Power Pack & Speaker 150
30. National Electric Supply Co. BC131 1200
31. Zenith 1R 400
32. Double Button Carbon Microphone 200
33. (2) Howe Crystal Sets 250 ea.
34. Liberty Crystal Set 300
35. Commerce Radio Phone Crystal Set 600
36. Lincoln Antenna 100
37. Bodine Antenna 150
38. Home Brew Antenna 25
39. Radio Lite Antenna 200
40. (2) Radiola Horns UZ1325 125 ea.
41. Music Master Horn 21" 250
42. (2) Music Master Horns 14" 175 ea.
43. Music Master Horn 14" (no base) 50
44. Magnavox R3 Horn 225
45. (2) Burns Horns (black) 200 ea.
46. (20) Pairs of Earphones & (20) Bugs & Keys bid
47. (20) Telegraph Sounders bid
48. DeForest Everyman Crystal Set 600
49. DeForest D7A (no antenna) 600
50. Grebe Synchrophase 225

Large Library & Many Miscellaneous Items

WILLING TO NEGOTIATE — BEST OFFER ABOVE \$10,000

Owner: Hardin W. McCauley - 8471 Patterson St., St. John, IN 46373
Phone (219) 365-5979

Order Now – Shipping in late-June

John Sideli's

Classic Plastic Radios of the 1930s and 1940s

A COLLECTOR'S GUIDE TO CATALIN MODELS



ADDISON
AIR KING
ARVIN
AUTOMATIC RADIO
BENDIX
CROSLLEY
CYARTS
DEWALD
EMERSON
ESPEY
FADA
GAROD
GENERAL ELECTRIC
GENERAL TELEVISION
HALSON
KADEITE
LAFAYETTE
MOTOROLA
R.C.A.
SENTINEL
SONORA
SPARTON
STEWART-WARNER

127 Pages – Over 200 Illustrations of Radios in Full Color

55 different models from 25 manufacturers are extensively covered. Included for each is a description, the year of manufacturer, dimensions, colors found and photos illustrating the various colors and variations. A 15-page introduction describes the growth of Catalin radio collecting, the Catalin material itself, the "Catalin" style, rarity and value, and colors and restoration. The introduction contains an additional eighteen photos, twelve in full color.

Softcover: \$19.95

Hardcover: \$29.95

U.S. Orders: Enclose \$1.50 per order for packing & book rate shipping if total order is under \$35.00.
If using VISA or Master Card, include name on card, card number and expiration date.
Send payment with order. Mass. residents please add 5% sales tax. Allow 2-4 weeks to receive order.
Foreign orders – write for shipping costs or use Credit Card; allow 2-3 months.
(Expected shipping date is June 25th. If shipping is delayed beyond July 15th, will you be notified.)



Send order to A.R.C., P.O. Box 2, Carlisle, MA 01741



COLLECTOR BOOKS AVAILABLE FROM ANTIQUE RADIO CLASSIFIED

BOOKS MARKED WITH "☞" ARE THE MOST POPULAR AND ARE
ESPECIALLY RECOMMENDED FOR NEW COLLECTORS!

- Antique Radios – Restoration and Price Guide, Johnson. *Beginner's introduction to collecting antique radios, how radios work, radio repair & restoration.* 1982. 99 pgs.\$14.95
- The Auto Radio: A Romantic Genealogy, Matteson. *Information, photos & ads from the early days of the automobile radio through the 1950's.* 316 pgs., hardcover.\$34.95
- ☞ Classic Plastic Radios of the 1930s and 1940s – A Collector's Guide to Catalin Models, Sideli. *Over 200 models from 25 manufacturers are illustrated in full color.* 127 pgs. NEW (hardcover: \$29.95) \$19.95
- ☞ Communications Receivers, Moore. *Information on 700 vacuum tube receivers by 50 manufacturers produced from 1932 to 1981 are included in this 112-page book. 100+ radios are illustrated.*\$14.95
- ☞ Crosley Catalog (reprint). *1923 catalog covering the early Harko through the XX models.* 32 pgs.\$4.50
- ☞ Flick of the Switch, McMahon. *The standard photo reference guide for collectors for radios from the 30's to the 50's. 1000+ photos of radios.* 263 pgs.\$11.95
- ☞ Great Radio Personalities (reprint). *Black & white portraits and info on all the favorites from the golden days of radio – Abbott & Costello, Baby Snooks, and more.* 128 pgs.\$11.95
- ☞ Guide to Old Radios – Pointers, Pictures & Prices, Johnson. *1989. The latest book by the Johnsons describes the history of radio and includes 350+ photos and a price guide to 3300 sets.* 128 pgs.\$16.95
- ☞ Hertz: The Beginning of Microwaves, Bryant. *Photos and descriptions of Hertz's apparatus and experiments. A book prepared for the IEEE Hertz Centennial exhibit.* 50 pgs.\$15.00
- ☞ Los Angeles Radio Manufacturing, Paul. *History of radio manufacturers in the Los Angeles area from 1922 to 1942. Features Echophone, Gilfillan, Jackson Bell & 9 others.* 88 pgs.\$10.50
- ☞ Most Often Needed 1926-38 Diagrams (reprint). *Circuit diagrams for 600 of the most common radios of the period.* 240 pgs.\$11.95
- ☞ Official Radio Service Manual (reprint). *100's of pre-1930 circuits & notes.* 356 pgs.\$19.95
- ☞ Price Guide to Plastic Collectibles, McNulty. *Describes types of plastics, etc. Radio is 8 of 207 pgs.*\$19.95
- ☞ Radio Collector's Guide, McMahon. *Listing of 9,000+ radios made by some 1200 companies from 1921 to 1932. Gives manufacturer, year, model name and other info. No photos.* 264 pgs.\$11.95
- ☞ Radio – A Blast from the Past, Wolf/Jacobson. *Reprints of advertising from 1927 to 1942. Useful for identification of cathedrals, tombstones, consoles and table model radios of the period.* 321 pgs.\$25.00
- ☞ Radio Craft – 50 Years of Radio (reprint). *Reprint of Golden Jubilee issue of 1938.* 144 pgs.\$14.95
- ☞ Radio Enters the Home, RCA (reprint). *1922. The Aeriola Jr. and RC era.* 128 pages.\$12.95
- ☞ Radio Equipment & Supplies, Robertson-Cataract Electric Company (reprint). *1922 catalog of radios, accessories and other equipment. Includes RCA, Clapp-Eastham & others.* 168 pgs.\$13.95
- ☞ Radios-The Golden Age, Collins. *Full-color book on the colorful Catalin and Bakelite radios from the late 1920's to the early 1940's.* 128 pgs.\$14.95
- ☞ Radio Horn Speaker Encyclopedia, Paul. *Listing of horn speakers for over 320 manufacturers for the 1920's. Expanded information on ten manufacturers.* 80 pgs. Over 145 photos.\$12.90
- ☞ Radio Manufacturers of the 1920's, Vol. 1, Douglas. *The first of three comprehensive volumes. Vol. 1 covers A-C Dayton thru Ferguson.* 225 pgs. (hardcover: \$29.95) \$19.95
- ☞ Radio Manufacturers of the 1920's, Vol. 2, Douglas. *Second of three comprehensive volumes. Freed-Eisenmann thru Priess.* 266 pgs. (hardcover: \$39.95) \$24.95
- ☞ Radio & T.V. Collector's Guide Book, Biraud. *The "Vintage Radio" illustrated guide to European sets (very few British sets) from early wireless to the 1930's (a few later). Text is in both French and English.*
- Vol. 1 - Early History & Manufacturers A to P. 256 pgs.\$49.95
- Vol. 2 - P to Z & T.V., Speakers, Tubes, Loops, Parts & Novelties. 256 pgs. NEW \$49.95
- ☞ Radio Trouble Shooting, Haan (reprint). *1928 guide to trouble shooting battery sets.* 317 pgs.\$14.95
- ☞ S. Gernsback Radio Encyclopedia (reprint). *1927 classic encyclopedia on radio.* 175 pgs.\$11.95
- ☞ Saga of the Vacuum Tube, Tyne. *Standard reference to vacuum tubes prior to 1930. Several 100 photos.* 495 pgs.\$15.95
- ☞ 70 Years of Radio Tubes and Valves, Stokes. *The story of the radio tube from the laboratory to the commercial market.* 256 pgs. Over 400 photos and illustrations.\$19.95
- ☞ Vintage Radio, McMahon. *The standard photo reference guide for collectors for radios prior to 1930. Over 1000 pictures.* 263 pgs.\$11.95
- ☞ Westinghouse Catalog (reprint). *Early 20's catalog featuring the RA-DA and other early Westinghouse apparatus.* 8 pgs.\$4.00
- ☞ Wireless Communication in the U.S., Mayes. *Early development of American radio operating companies. Alternators, coherers, stock promotions, unpublisher letters, etc.* 240 pgs, 160 illustrations. NEW \$29.95

All books are softcover except those marked "hardcover." Most books in stock and shipped within 4 days. Send payment with order. Enclose \$1.50 shipping per order for orders under \$35. If using Visa or Master Card, include name on card, card number and expiration date. Allow 2 to 4 weeks to receive books. Mass. residents please add 5% sales tax. Foreign orders – write for shipping costs or use credit card.



Send Order To: A.R.C., P.O. Box 2, Carlisle, MA 01741





I BUY TV'S AND RADIOS !



**Any Condition...
 Any Quantity!**

TV'S – Early or Unusual

**RADIOS – Catalin, Mirror
 Unusual & Novelty
 Early & Novelty Transistors**

Paying Too Much For Your TV's? Try Me!

- RCA: 630 Restored, 641 with Tambour Doors, 721 TS, 9PC41 Projection, 8TS30...More.
- CBS – Columbia 205 - Early 19" Color - Working!
- Philco – 48-700, 48-1000, 48-2500 Projection
 - Emerson 608 with Pop-up Tube
 - DuMont RA-101- Westminster with 20" Pop-up Tube!

**TV REPAIRS — Most vintage TV's
 fixed for about \$100 plus UPS**

Member AWA – ARCA – PARS – MAARC – MARC – VRPS
 NFWA – NZVRS – HRSA – IHRS – NEARC – GNYVWA

CLASSIFIED ADVERTISING POLICY

ONE FREE 20-WORD AD for subscribers in each issue; additional words are 10¢ each. See details below. All classified ads must be received (not just postmarked!) by the ad deadline. Late ads are held for the following issue. Please enclose correct payment with all ads. Stamps or cash are OK for small amounts. (Canadian and other foreign advertisers, please see "Payment" on page two for methods.) "Free words" cannot be accumulated from month to month; free words must be requested when ad is submitted.

Please write each ad on a separate sheet of paper, especially when included with other A.R.C. correspondence. Include SUB# with ad. Ads may be sent in advance; but, write each ad on a separate piece of paper and indicate the month (or successive two months) you want the ad to run.

Please write legibly and use both capital and small letters. Do not use dashes between words. Some numbers and letters can look alike, for example 1, l and I (the number one, the capital i and the small L.) Write the following characters clearly (especially in model numbers): 1, l and I; 0, o, Q and D; r and n; 6, b and G; V, U, u, v and Y; A and R; 5, S and s; 2, Z and z. We try to correct spelling errors, so when using an uncommon word or manufacturer which looks similar to a common word or manufacturer, note it so that we do not "correct" it. Editor's comments are in [brackets].

Advertising is accepted only for items related to antique radios, communication, electricity, etc. All items must be described fairly; reproductions, reprints and not-original items must be identified as such. Advertisers agree to respond promptly to inquiries and orders, and to resolve problems promptly if the buyer is not satisfied.

Publisher reserves the right to edit ads without notification to the advertiser and to reject ads for any reason. Publisher is not responsible for errors due to illegibly written ads or for any other reason. Since club activities receive free advertising on the *Coming Radio Events* page, the free 20 words may not be used for club activity ads. See inside front cover for additional information.

CLASSIFIED AD DETAILS

Deadline: 10th of the month!

Classified ads must have a standard heading such as WANTED, FOR SALE, FOR TRADE, FOR SALE/TRADE, SERVICES, MESSAGE, HELP, etc. This heading is the only bold or all-capitalized words allowed in the ad. Capitalize only manufacturer names, model names, etc. Wanted and For Sale ads are mixed together to encourage the reading of all ads, including the Wanted ads. This standard ad format makes scanning the ads easier.

Before writing your ad, please look over the ads in a recent issue of A.R.C., and try to write your ad in the same style. Full name and address is required in all classified ads; we will add it if you forget.

To encourage varied content of the ads, **multiple insertions of the same classified ad are limited to two successive months.** (To run an ad longer, use a boxed classified or display ad.)

Classified Ad Rates per Month

Subscribers:

First 20 words: **FREE***
 10¢ per word for extra words over 20 **plus**
 10¢ per word for a shaded ad (count all words including free words).

* Subscribers may take 20 free words on only one ad each month.

Non-Subscribers:

20¢ per word **plus**
 10¢ per word for shaded ad.

Please do not forget to send in the extra 10¢ per word when your classified ad runs over the free 20 words; your payment will be appreciated, and it will help to keep A.R.C. healthy.

BOXED CLASSIFIED AD DETAILS

Deadline: 5th of the month!

Boxed classified ads can run unchanged for three months or more. No words are free. Ads may be shaded and may include bold and all-capitalized words freely. The ad need not begin with For Sale, etc.

Minimum run is 3 months, prepaid.

Boxed Classified Ad Rates per Month

Nonshaded ads:

16¢ per word for all words,* none free, **plus**
 10¢ per word for each bold word **plus**
 10¢ per word for each all-caps word.

Shaded Ads:

26¢ per word for all words* **plus**
 10¢ per word for each all-caps word.

Note: All words in shaded ads are bold.

Non-Subscribers:

Add 15¢ per word to above costs.

*Three of the total words can be bold-all-caps at no extra charge.

PHOTO & DRAWING DETAILS

Deadline for classified and boxed classified ads with drawings or photos: 5th of the month.

Drawings and photos are encouraged as the response to your ad is much larger and the reader knows better what you want or are selling. Send in your drawing or photograph, and A.R.C. will reduce it or enlarge it as needed.

Photo and Drawing Rates per Month

\$6.00 per month for each photo or drawing

IMPORTANT — COUNTING WORDS — IMPORTANT

The standard headings: WANTED, FOR SALE, etc., count as **one word** each time used in an ad. Name, address and (one) **telephone number**, count as **6 words**, regardless of length. Ham call letters and business name can be included in the 6 words and do not count extra. Full name and address is **required** in all classified ads – it does not cost extra! Each additional word, abbreviation, model number or number group, extra telephone numbers, etc. count as one word. Hyphenated words count as two words.