



ANTIQUE RADIO CLASSIFIED



VOLUME 16

JULY 1999

NUMBER 7



**Traeger's
Pedal
Radio**

A.R.C. — THE NATIONAL PUBLICATION FOR BUYERS AND SELLERS
OF OLD RADIOS AND RELATED ITEMS — PUBLISHED MONTHLY

ANTIQUE RADIO CLASSIFIED

Antique Radio Classified (ISSN:8750-7471) is published monthly, 12 times per year, by John V. Terrey, One River Road, P.O. Box 2, Carlisle, MA 01741. Periodicals postage paid at Carlisle, MA, and additional mailing offices. Telephone: (978) 371-0512, 8:30 AM to 5:00 PM ET weekdays; machine answers phone at other times.

Annual subscription rates within the U.S. are \$39.49 by Periodicals mail and \$57.95 by First Class mail.

Annual foreign rates. By air: Canada - \$61.00; Mexico - \$67.00; Other foreign countries - \$105.00. Surface mail: Canada - \$51.00; Other foreign countries - \$58.00. (Surface delivery to countries other than Canada may take two or more months and cannot be guaranteed.)

Two-year subscriptions are twice these rates and receive an extra month. Sample issues are available free on request.

© Copyright 1999 by John V. Terrey.

POSTMASTER: Send address changes to Antique Radio Classified, P.O. Box 2, Carlisle, MA 01741.

Printed in U.S.A.

STAFF:

Publisher and Editor: John V. Terrey
Production & Advertising Manager: Cindie Bryan
Office Manager: Tammy DeGray
Managing Editor: Dorothy Schecter
Publishing & Editorial Staff:

Malaika Brodeur, Dave Crocker, Bobby Lyman
Founding Publisher/Editor: Gary B. Schneider
Contributing Writers & Consultants: Mike Adams, Richard L. Arnold, Richard Begbie, Ray Binliff, Ron Boucher, Paul J. Bourbin, Norman S. Braithwaite, Dave Crocker, Dick Desjarlais, Alan S. Douglas, Richard C. Foster, Fred Geer, Jim Kreuzer, Ron Ramirez, Henry Rogers, Ian L. Sanders, Gary B. Schneider, Daniel Schoon, Frank R. White, Ralph Williams, Walter Worth

PURPOSE. Antique Radio Classified is published for people involved in the radio collecting hobby. Its purpose is to stimulate growth of the hobby through the buying, selling and trading of radios and related items, and to provide a monthly forum for the interchange of ideas and information.

CONTACTING ANTIQUE RADIO CLASSIFIED. All correspondence should be sent to:

A.R.C., P.O. Box 2, Carlisle, MA 01741.

Only UPS, Federal, etc. items to street address: One River Road.

Telephone: (978) 371-0512; Fax: (978) 371-7129

E-mail: ARC@antiqueradio.com - Web: www.antiqueradio.com

Please, no classified ads by telephone, thanks.

Your ads, renewals, letters, etc. can be handled faster and more efficiently if your name, address and SUB# are written on each.

Unfortunately, A.R.C. is not staffed to answer all letters with questions about antique radios or requests for advice. However, A.R.C. does solicit letters of interest to its readers and publishes them as space permits. (See "Publishing Rights" paragraph.)

GUARANTEE. You may cancel your subscription at any time and receive a pro rata refund for issues not yet mailed. If errors to ads are made by A.R.C., upon request a free correction will be run in the next available issue.

DISPLAY AND BUSINESS CARD ADS - DETAILS AND RATES

The deadline is the first of the month for display and business card ad artwork, payment and repeat requests.

Advertising is accepted only for early items related to radio, communication, etc. All items must be described fairly; reproductions, reprints and non-original items must be so identified. Advertisers must agree to respond promptly to inquiries and orders, to resolve problems promptly if the buyer is not satisfied, and to comply with a buyer's refund request on unaltered returned items.

Advertising must be prepaid, except as noted below; see "Payment" paragraph above for details. Late ads will be run only if space and time permit. Since artwork is reduced to 63% in the printing process, originals must be the artwork size listed below. Do not send in artwork on art board or send negatives. Ads should be typeset or typed neatly with a carbon ribbon, black ink (not pencil) on white. If used, reverse type must be limited to 25% of the ad. If you want us to prepare your ad, include the one-time cost below for A.R.C. to make up the ad.

Photos should be at an 85-line screen; otherwise, add \$16.00 per photo for screening. Do not cut or trim photos or glue photos to artwork; submit separately.

If you are confused by these requirements and terms, please

Page	ARTWORK SIZE (SEND IN THIS SIZE)		As Printed (size in magazine)		Cost for 1-month	Cost for 3-months	Cost for 6-months	Cost for 12-months	One Time to make up Ad
	H x W (inches)	H x W (inches)	H x W (inches)	H x W (inches)					
Full	12 7/16 x 7 1/2	7 3/4 x 4 3/4	3 5/16 x 4 3/4	146.00	\$289.00	\$769.00	\$1329.00*	\$2325.00**	\$69.00†
1/2 H	5 1/4 x 7 1/2	7 3/4 x 2 1/4	3 5/16 x 2 1/4	146.00	389.00	389.00	675.00*	1175.00**	37.00†
1/2 V	12 7/16 x 3 9/16	7 3/4 x 2 1/4	3 5/16 x 2 1/4	146.00	389.00	389.00	675.00*	1175.00**	37.00†
1/4	5 1/4 x 3 9/16	3 5/16 x 2 1/4	3 5/16 x 2 1/4	74.00	197.00	142.00	342.00	595.00	19.00†
1/8	2 5/8 x 3 9/16	1 5/8 x 2 1/4	1 5/8 x 2 1/4	38.00	101.00	177.00	305.00	9.00†	9.00†
Business Card (1st)	2 x 3 3/4	1 1/4 x 2 3/8	1 1/4 x 2 3/8	not avail.	53.00	90.00	159.00	7.00†	7.00†
Business Card (2nd...)	2 x 3 3/4	1 1/4 x 2 3/8	1 1/4 x 2 3/8	not avail.	68.00	118.00	205.00	7.00†	7.00†

* Full & 1/2 page, 6-mos.: 1/2 due with order; 1/2 due in 3 mos. ** Full & 1/2 page, 12-mos.: 1/2 due with order; 1/2 due at 3, 6 & 9 mos.

† For 6 and 12 month ads, no ad make-up charge if no change is made to ad for entire run.

PAYMENT. Please send in full payment with your order or ad. A.R.C. does not carry accounts, all subscriptions, ads, etc. must be prepaid (except for the 6 and 12 month display ads indicated below). Pay in U.S. funds. Checks drawn on a U.S. bank, money orders, VISA or MasterCard (\$10.00 min.) are preferred. Make check out to "A.R.C." U.S. stamps or cash are OK for small amounts. Canadian payers may send a Canadian check but specify U.S. funds. Subscriptions will be prorated to amount sent if amount is incorrect.

FAX & E-MAIL, PROCEEDURES/PAYMENT. Subscriptions, book orders, classified ads, display ads, etc. are welcome by fax or e-mail. Deadlines are the same for ads received by mail. Please calculate the amount due. Payment by VISA or MasterCard is preferred if your order is over \$10. If under \$10, or if you prefer to send a check or money order, state the amount being sent and that the payment is in the mail. Do not send another copy of your ad with your payment; simply indicate that it is a fax or e-mail payment. If you want confirmation of our receipt of your fax, call immediately after sending your fax.

CHANGE OF ADDRESS. Please notify us 4 weeks in advance of a change of address. Send both your new and old addresses, and include your SUB# and effective date of your new address. Temporary address changes can be made also.

SUBMISSION OF MATERIAL. Antique Radio Classified welcomes and solicits information that pertains or relates to radio history or collecting. This may include articles, book reviews, photos, information on upcoming radio events, meetings, antique radio organizations, radio auctions, sources of old radio and restoration supplies, and other related and interesting material. All material submitted should be carefully researched, typed and accompanied by good photos, if appropriate. Computer disks are appreciated. Writing guidelines are available upon request.

PUBLISHING RIGHTS. Unless other arrangements are made: (1) All received materials (ads, articles, letters, correspondence, e-mail, photos, artwork, etc.) become the property of A.R.C., may be edited, combined with other material, published, and will not be returned. (2) For all received materials, A.R.C. is granted publishing and reprint rights in all forms of media including the monthly printed magazine, internet, etc. (3) Publication is subject to approval by A.R.C. and to time and space constraints.

MAILING OF ISSUES. U.S. subscribers can receive A.R.C. by First Class or Periodicals mail (Periodicals is the way most magazines are mailed). The mailing of First Class copies is staggered with faraway copies mailed before local copies. Non-U.S. copies are mailed on the first day. Periodicals copies are mailed on the last day. Mailing dates change each month, but mailing is usually completed by the 27th of the month. First Class copies usually are received by the 5th of the month; copies by Periodicals mail, by the 10th.

ETHICS. No person involved in the production of A.R.C. is to act on any information in the magazine until the first delivery day after local copies are mailed.

DISCLAIMER. The publisher is not responsible for any buying and selling transactions incurred, or for any other use of the contents of this publication.

Antique Radio Classified subscription rates, frequency of publication, content, policies, size and ad details, and rates are subject to change at any time by A.R.C.



EDITOR'S COMMENTS

Reminding collectors of the significance of radio to life in the 20th century may seem like preaching to the converted. But, in many ways, our Australian correspondent Richard Begbie's article on Alfred Traeger, the "Pedal Radio Man," does just that.

Reading the Traeger article, we are once again struck by the power of radio to spread to remote corners of the world. And, we can't help but think how amazing it is that, in the footsteps of Marconi, someone in far off Australia could also take a concept that had been around for years and apply it to the real and immediate problems of his countrymen.

As collectors, we sometimes romanticize radio, but this article brings home its enormous practical value. Traeger's pedal radio, a clever application of engineering, proved to be the salvation of the Australian outback settlers. Whether on sea or land, we are reminded that, in creative and practical hands, radio has been both a kind of miracle and a tool of progress.

And of course, A.R.C.'s mission is to spread the word about these radio "miracles" to our readers throughout the world. One other way to do that is to be an exchange for information. Robert Enemark fills that bill with his compilation of responses received from fellow collectors across the U. S. and Canada regarding his May 1998 article on Edison's light bulb — surely, another 20th century miracle.

Two interesting conclusions may be drawn from Walter Hall's story about his vintage Western Electric Model 4A phonograph pickup: 1) This electro/mechanical device was built so well that it still works 70 years later; 2) It could still be used to play a modern disk. One wonders if a device made today will be compatible with an equivalent device made 70 years from now. I confess to skepticism.

A fortunate find for Richard Arnold was his rare Philco 44H. We're pleased that he decided to share the experience of his restoration project.

Photo Review includes a Mignon "RW-4" — an extremely rare, early wireless receiver, which has a tubular Audion connected to binding posts on the front panel. It is also rare to have an "Oops!" on this page. We show front and back views of two cathedrals correctly paired. In the May 1999 issue, we had incorrectly shown the front of one of these sets with the back of the other.

Howard Hood's story of restoring an RCA Model T-80 is really the story of a collector's dream come true. How many of us have looked at a junker and dreamed of finding replacement parts to restore it? Well, Walter had the rare opportunity of finding two radios of the same model from which to make one restored set. He also had the foresight to photograph one of the sets before the transformation. His luck is our luck too.

Four auction reports from across the country and the U.K. tell us that our reach to the radio world is widening. We are particularly grateful to those contributors, like Dale Donaldson and the intrepid Ray Chase, who spend long hours compiling these reports for A.R.C.

The Southern California Antique Radio Society auc-

tion was a big one, totalling almost \$20,000. Early battery sets sold well, as indicated by a Grebe Synchrophase's selling price of \$1,100. A damaged Fada Catalin sold for \$540. Two small auctions had limited radio content, but as Ray Chase will attest, there could always be "sleepers" in such sales.

Thanks to Parkman Shaw who passed a Christie's catalog on to us, we are able to report on the May 8 radio auction in London. Christie's graciously provided photos, and thus, a report evolved. Although British and European sets predominated, U.S. sets also sold well. A rare Marconi receiver and a magnetic detector sold for nearly \$17,000 each.

Dick Desjarlais continues his journey through WebTV land. In this installment, he buys it, takes it home, hooks it up, and turns it on. Dick has been launched into cyberspace and promises to continue to report on his adventures.

As always, we're pleased to have a book review by longtime contributor Paul Joseph Bourbin. Paul gives Barry Nadel's book — *The Western Electric Loud Speaker and Horn Compendium* — several thumbs up. And a short piece by Alcey Massini of Brazil about his search for a book on TV attests to our increasing, international outreach. Alcey longs for a book on TV like the Bunis books on radio. We hope someone out there hears his plea.

Radio Miscellanea contains two very positive responses to our 15th anniversary issue, as well as one about the nostalgia evoked by our April cover. April's 1-tube radio article also takes a little ribbing. Special good news on this page is that putting ads on the Web will be of great benefit to people with hearing loss who have trouble using the telephone.

Internet Update. Turn to page 23 for an update on our Web site expansion. You will also see where your log-on ID and your password are located on your mailing label. I urge you to check the A.R.C. Web site regularly for updated Web site information.

Coming Radio Events. The summer event season is revving up. There are 36 meets in July, two of which are multiday meets. I encourage you to pack your car and attend at least one of these in your area for some good radio talk and maybe even a sale or two.

Happy Collecting

John V. Terrey, Editor

ON THE COVER

Our cover photo is one of several originals that the Rev. Dr. Fred McKay graciously consented to loan to us. The photo appears in Rev. McKay's book, *Traeger: The Pedal Radio Man*, where he describes it as "the photograph that is now so historically and universally famous." The photo was taken by the Rev. John Flynn, revered in the Australian outback for his passion to bring medical security to the settlers there and the driving force behind Traeger's invention. At Flynn's insistence upon first seeing the pedal generator, Traeger put on his Sunday suit for this "very important photograph."

The Pedal Radio of the Great Outback

BY RICHARD BEGBIE

The fascinating story of radio's vital role in connecting the vast outback to the rest of Australia is a story of dream turned to reality. The dream belonged to Alfred Traeger, a reclusive engineer and radio buff, whose dogged pursuit of the right equipment, resulted in a momentous change in the quality of life for those isolated settlers of the outback. We're grateful to Australian Richard Begbie for bringing this story to our attention. (Editor)

In 1907 a quiet Australian farm boy astonished his family by building a telephone between the homestead and a machinery barn 50 yards away. He had no commercial equipment — the magnets were made from pitch fork prongs, the diaphragms from tobacco tin lids, and the charcoal for carbon granules came from the kitchen stove. The ubiquitous farm fencing wire was also called into service.

The boy's name was Alfred Traeger, and a shrewd father soon had him enrolled in an electrical engineering course. Before he was 20, Traeger had put together a transmitter, 1914 style, was sending Morse at 20 words a minute, and was working towards his amateur license.

1920s RADIO IN AUSTRALIA

Australia is a fair sized place. Its land area is four-fifths that of the U. S., and the drive from Sydney to Perth is similar to the New York-Los Angeles run, except with fewer people and more desert. Eighty-five percent of the country's population lives in urban areas, mostly on the eastern and southern seaboard.

So when radio took off in the early 1920s, it was hailed as the magic bullet for loneliness in the great outback. Radio magazines and newspapers of the time crowded that wireless, as it was usually called, would help catch crooks, save lives, and educate the masses, but mostly that it would bring isolated people together.

It soon became obvious the talk was all hot air. Benevolence disappeared when serious broadcasting began in 1923. If people in the interior could afford a sophisticated 5- or 6-tube outfit, which would pick up an occasional capital city program when conditions allowed, then good luck to them.

While Aborigines had learned to survive the arid interior, European immigrants found the isolation hard to bear. Giant pastoral ranches of thousands of square miles meant women and children often had no outside human contact for months at a time. Clearly the situation cried out for more than fluke broadcast reception. These people needed a voice as well as ears.

FLYNN OF THE INLAND

Today, among the most revered of Aussie names stands the Rev. John Flynn, head of the Australian Inland Mission and immortalized on our twenty dollar bill. "Flynn of the Inland" (as he became known) was a visionary fired by the huge difference both airplane and radio could make to outback life. From the early 1920s, Flynn became obsessed with what he called "a mantle of safety" for the isolated and the dispossessed. Writing about Flynn in his book on Traeger, which is used

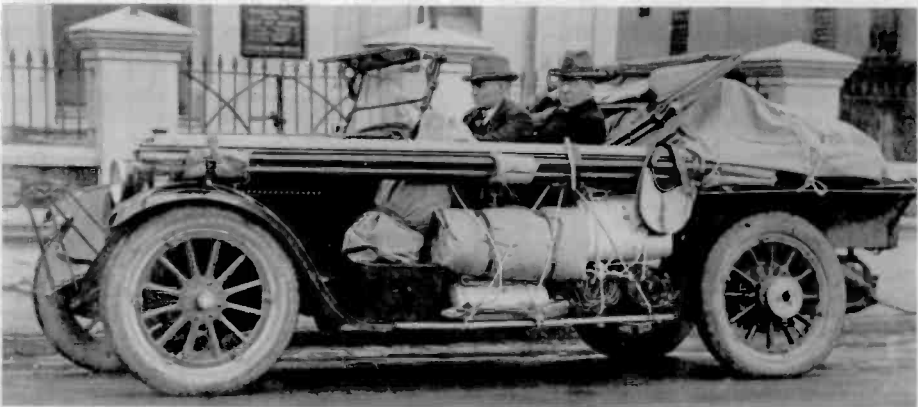

Figure 1. John Flynn (right) and George Towns leave Adelaide in the laden Dodge buckboard, June 1925. Note the pulley built into the rear wheel hub to drive Traeger's generator.

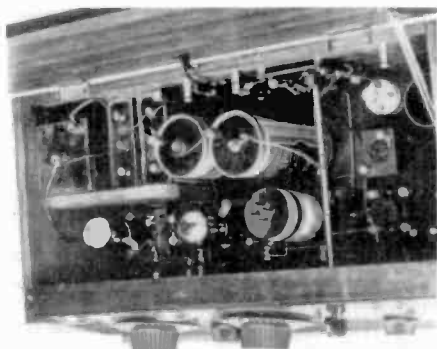

Figure 2. Traeger's remodeled, compact, easy-to-operate "baby set."

as a reference for this article, Fred McKay said, "He had a 'fire in his belly' about the creation of a scheme of flying doctors to bring medical security to the entire Australian frontier country." His name is still associated with the Flying Doctor Service of the bush.

Flynn got right into radio, and soon became a proficient amateur himself. In mid-1925, he stashed his old Dodge buckboard with wireless gear, as shown in Figure 1, and headed north from Adelaide with a retired army officer named George Towns. For their 500-mile exploratory jaunt, they carried a 100-watt transmitter and a demountable tube-section aerial mast. Also aboard the Dodge was a 600-volt generator, driven off a pulley specially mounted on the rear wheel.

ENTER ALFRED TRAEGER

The generator, made by a young Alfred Traeger, brought about his first meeting with Flynn. When George Towns' failing health forced him to pull out of the project, Flynn turned to the younger man. Fired by Flynn's vision, Alf Traeger was soon on the outback trail experimenting, modifying, improving. It was to become a way of life.

Together Flynn and Traeger set up the first base station at Alice Springs — the country's geographical center. A couple of outstations soon followed, and in 1926, 2-way radio became a reality in one of the most remote places on earth. But Alf Traeger quickly saw the major obstacle to a wider network — the awkward, heavy duty, glass, copper oxide Edison batteries — as well as the need for a reliable high-power voltage supply to the lo-

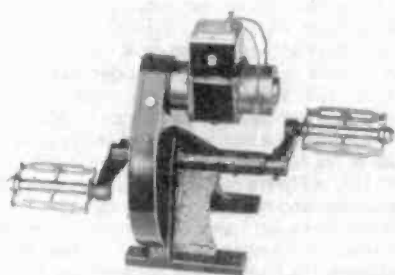

Figure 3. Traeger's solution to the outback's isolation was this prototype of a pedal-operated generator unit for radio sets. Electro-mechanical work was Traeger's specialty.

cal transmitter. A simple, durable alternative was essential for ordinary outstation use.

In 1927, Traeger built a hand-powered generator. It was transported from Longreach to Cloncurry in the vast emptiness of western Queensland. Flynn turned the generator while Alf worked the Morse key. The rig performed beyond expectations. Excitement for a wider bush network mounted, with Cloncurry the proposed site for a

(Continued on following page)



Figure 4. Once telephony had become feasible, the pedal outfit provided complete communication for the isolated homestead. Here, Mrs. Gertrude Rothery of Augustus Downs, operates the first pedal radio on June 19, 1929.

(The Pedal Radio of the Great Outback, continued)

base station. All systems were go, until the fatal flaw in the hand-generated outfit became apparent. A lone operator could not generate power and send Morse simultaneously, and most homestead emergencies involved a lone woman.

Traeger, now a man possessed, worked dawn to dusk in his Adelaide workshop to solve this problem. But, at Flynn's request, he first remodeled the transmitter and receiver into a compact, easy-to-operate "baby set," shown in Figure 2. He then returned his attention to the high voltage supply problems. His brother Jack remembered the moment in August 1928 when Alf, eating lunch in the workshop, suddenly stood up and said, "I'm going to buy bicycle pedals."

Flynn played down the idea. He had seen a bicycle-mounted generator used in a travelling Pathé picture show, and it produced nowhere near the required voltage. But, being a clever practical engineer, Alf turned generator armature winding into an art form. By late 1928, he had his prototype of a pedal generator, shown in Figure 3. Flynn came to see it, was deeply impressed, and told Traeger to put on his Sunday suit. "I want to take an important photograph." The result is the photo shown on our cover.

A BUSH NETWORK

The pedal wireless Alf posed with on that November afternoon



Figure 5. Transceiver Set #1, ca. 1930, reconditioned and encased in a metal cabinet. Note the telegraph key at right.

The 1937 Traeger Portable Model

The Traeger portable set of the mid-1930s, shown here, was built in identical stacked cases with receiver and transmitter mounted up top, and pedal generator and batteries below.

The receiver tunes from the broadcast band to the higher frequencies of the bush network. It uses a Type 32 tube as RF amplifier, a second Type 32 as regenerative detector, a Type 30 for audio driver, and a transformer-coupled Type 49 for output. Receiver power comes from 90v/22.5v dry B batteries, 9v bias for output grid. Two large No. 6 (1.5v) cells in series supply the 2v heaters.

The transmitter uses a Type 33 as Miller-type oscillator, keyed directly for CW signals. For telephony, a Type 30 is used as microphone preamp, and is transformer-coupled through a 19 double triode to the Type 33 oscillator/final. The high-power plate supply for the Type 33 comes from the pedal generator.

Transmitter coils are wound on a plug-in



former, which also carries the open slab crystal in a plated cylinder along with tuning capacitor and tuning lamp. The set uses a random length aerial, plus counterpoise. Power output is around 1.5 watts into the aerial.

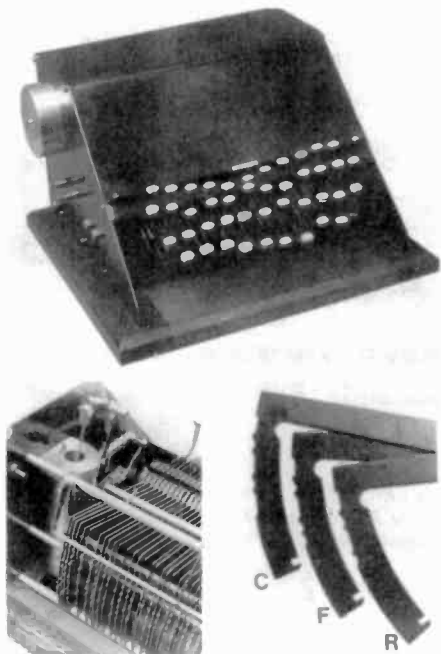

Figure 6. Traeger's ingenious solution for the Morse code illiterate. Not unlike a standard typewriter (top), the keys activated steel arms with a working face cut to required long and short spacings (lower right). The internal view (lower left) shows the oil-filled dash pot necessary to produce smooth movement of the keyed arms.

with notched spacings corresponding to the Morse alphabet. Traeger's Morse keyboard is shown in Figure 6. Figure 7 shows a complete setup with the Morse keyboard.

In 1937, Fred McKay, then a young minister with the Australian Inland Mission (A.I.M.) and pictured in the box at the bottom of the previous page, used the Traeger radio system in his travels in the dry outback. Fred, now an active 93 year old, succeeded John Flynn as director of the mission and is himself the subject of a biography by Maisie Mc-Kenzie entitled *Outback Achiever*.

Meanwhile, Alf was continually improving the pedal radio, and telephony soon became stan-

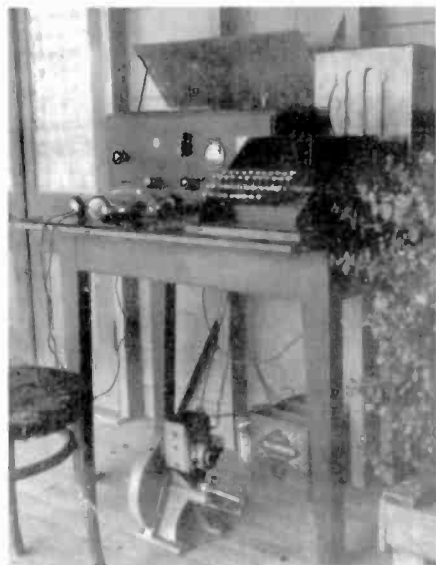

Figure 7. A complete setup with Traeger's Morse keyboard device.

dard. A 1936-1940 model is seen in Figure 8. Its nameplate, shown in Figure 9, reads, "Australian Aerial Medical Services" with "AAMS" set in a wings insignia. Figure 10 shows a 1943 model.

Much of the rest of Traeger's life was spent bringing the latest in radio to the bush. He introduced the new vibrator sets as soon as practicable, and was actively involved up to and including the birth of solid-state technology. By the 1970s, the Adelaide workshop was turning out single sideband sets, such as the typical unit shown in Figure 11. Traeger, shown in his later years in Figure 12, maintained his interest in the work until his death in 1980. By that time, there were 6,000 transceivers throughout Australia.

The 2-way network became the heartbeat of outback life. In conjunction with the Flying Doctor Service, it turned Flynn's concept of a mantle of safety into an everyday reality. It made possible the legendary "School of the Air," now an institution for bush children across the country. Best of all, the ever-changing equipment in the corner of

(Continued on following page)



Figure 8. A 1936-1940 "Traeger."



Figure 9. The nameplate of the 1936-1940 "Traeger," reads "Australian Aerial Medical Services... Manufactured for AAMS by A.H. Traeger in collaboration with Philips Lamps...(Australasia) LTD.

(The Pedal Radio of the Great Outback, continued)

living room or kitchen lifted the final, ever-present burden of the bush pioneers — the blight of loneliness.

However there was one thing about the pedal radio which never changed. Throughout the bush, it came to be called by everyone everywhere, the "Traeger."

Reference:

McKay, Fred. *Traeger, The Pedal Radio Man*. Moorooka, Australia: Boolarong Press, 1995.

Acknowledgement: Thanks to the Rev. Dr. Fred McKay for his invaluable help and cooperation, and especially for providing the original photos.

(Richard Begbie, Woodend, RMB 113, Bungendore 2621, Australia. E-mail: rbegbie@atrax.net.au)

Richard Begbie lives on a farm near Canberra, Australia, where he divides his time between merino sheep, writing, and a fascination with unusual 1920s broadcast receivers, from crystal



Figure 11. By the 1970s, the Adelaide workshop was turning out a different product like this single sideband set.

sets to consoles. He is a columnist for the "Canberra Times," which he describes as Australia's nearest thing to the "Washington Post."



Figure 10. A 1943 "Traeger" transceiver.



Figure 12. Alfred Traeger in his later years.

Traeger — The Pedal Radio Man **By Fred McKay**

**EXCERPTED FROM A REVIEW OF THE MCKAY BOOK BY GRAHAM THORNTON
IN "AMATEUR RADIO," DECEMBER 1995.**

In his review of *Traeger — The Pedal Radio Man*, Graham Thornton hails author Rev. Fred McKay for making more widely known the remarkable contribution of Alfred Traeger (1895-1980) to the inhabitants of the vast Australian outback. The Traeger transceivers had three outstanding features — "effectiveness, reliability, and above all, simplicity of operation." They were a salvation to the lonely outbackers. In all, Thornton points out that it is difficult to call Traeger anything but a genius.

Though a biography and not a technical book, the eleven appendices of McKay's book provide some valuable technical information, according to Thornton. The book covers not only Trae-

ger's invention of the pedal radio and the mechanical Morse keyboard, but also his mastery of modern solid-state technology.

One minor criticism is of McKay's labeling of Traeger as a "radio amateur." Thornton reminds readers that Traeger was more than that — he was a highly skilled professional engineer, and in Thornton's opinion, he might easily be called "the Michael Faraday of Australian Radio."

The 120-page, well-illustrated book is available from Boolarong Press, P.O. Box 308, Moorooka, Q. 4105, Australia, for \$14.95, plus \$6.35 Air Mail, Australian dollars. \$1 Australian is about \$1.50 US; Visa/MC/AE accepted.



WITH THE COLLECTORS

More on Edison's Incandescent Lamp

BY ROBERT B. ENEMARK FROM INFORMATION CONTRIBUTED BY
JAMES BOELLSTORFF, GILES M. CRABTREE, HERB FREDERICKSON, HERB GLASS,
CHRIS KOCSIS, AND EDWARD J. WHITE

In Robert Enemark's original A.R.C. article on his incandescent lamp (May 1998), he asked readers to shed some light on the date of manufacture of his replica. In the July 1998 issue, Chris Kocsis names the dates of the two replicas pictured in Robert's article as 1914 and 1929. This article summarizes additional responses from six fellow collectors. (Editor)

From Lewisburg, Pennsylvania, Giles M. Crabtree wrote that he has a lamp that is identical to mine, dated 1914. He enclosed a photocopy of the label on the bottom which states: "A replica of Thomas A. Edison's first successful Incandescent Electric Lamp, presented by the Edison Lamp Works of General Electric Company in commemoration of the thirty-fifth anniversary of the invention, October 21, 1914."

His lamp resistance is 442 ohms, whereas mine measures 420 ohms when cold. Interestingly, the original helical filament apparently was not used in production because horseshoe-shaped filament loops gave off more light and were easier to manufacture.

Giles also asked what sauerisen cement is. To my recollection, it is a mixture of talc and water glass which cures rock-hard, and withstands a temperature range from liquid air to red heat.

From Pine Bush, New York, Herb Glass reported that he also has a 1914 replica identical to mine. Unfortunately, the base label is ripped and in poor condition.

THE WOODWARD PATENT

From Ontario, Canada, Herb Frederickson, VA3HKF, sent a copy of Henry Woodward's (Toronto) electric light patent, filed Jan. 1875, which precedes Edison's patent of November 1879. However, according to the *Encyclopedia Britannica*, the first incandescent electric lamp was made in 1820 by De LaRue, using a platinum coil in evacuated, glass tubing.

Others in the 19th century experimented with filaments or lumps of powdered carbon, charcoal, carbonized card paper, etc. A Russian almost beat out the Woodward patent, but he was judged to have a somewhat later disclosure date.

Woodward and his partner Evans had assigned their patent to several investors. Their lamp used a specially shaped piece of carbon with wire leads attached at opposite ends in a glass bulb, which had first been evacuated, and then filled with an inert gas mixture of argon and nitrogen. This process lengthened the lamp life and produced a bright light.

However, the inventors failed in their attempt to

produce a practical lamp when their backers did not put up any more money. Sometime later, these investors sold and transferred their patent rights to Edison, who obviously realized that this sale and transfer ended infringement problems.

The Woodward-Evans lamp, while impractical for mass production, led the way for the use of inert gases in lamps of 40 watts or more. It is apparent from this and previous experiments that Edison's lamp was built upon prior art, and that his success was due in large part to his persistence and wealth. Thus, Edison, was the inventor of the first practical incandescent lamp that was a combination of new and old ideas.

OPEN FILAMENT PROBLEM

Edward J. White of Chicopee, Massachusetts, bought an old replica with a filament of 2 turns, $1/2$ " in diameter, but while he was exhibiting it, the filament opened up. He asked how he could weld the wires back together. Unfortunately, I don't have a good answer to that question.

MORE ON 1929 AND 1979 REPLICAS

James Boellstorff of Marshalltown, Iowa, sent several excellent photos of his 1929 and 1979 replicas, including their nice, original boxes and display placards.

Chris Kocsis of Springfield, Virginia, added to his July 1998 article information. He found two 1929 replicas at flea markets, and I believe that the lamp from the Edison Fort Myers Museum, shown in my first article, is identical to Chris' 1929 replica.

Chris also mentioned knowing Dr. Hugh Hicks, who has a display of around 5,000 lamps at his Mt. Vernon Sq. Museum in Baltimore, Maryland. For several years, Hal Wallace of the Smithsonian Institution has been cataloging this collection, much of which is very rare.

This is what A.R.C. is all about — the exchange of information. We urge everyone who seeks information through the magazine to share their responses with all of us. (Editor)

(Robert B. Enemark, W1EC, P.O. Box 1607, Duxbury, MA 02331)

Robert Enemark is a retired consulting engineer, who has been awarded over 50 U.S. and foreign patents. A ham operator since 1941, he collects pre-World War II shortwave sets and telegraph equipment in particular.



VINTAGE RECORDING

Western Electric Model 4A Phonograph Pickup

BY WALTER H. HALL

In the course of collecting things we treasure, it is always a pleasure to find a vintage item of professional quality that has withstood the test of time. The following article describes such an item produced when "state-of-the-art" was a relatively new concept. (Editor)

Among the "vintage" professional quality devices I have collected are some items made by Western Electric. One of these is a large, heavy, transcription-type phonograph pickup identified as Western Electric Model 4A, shown in Figure 1. It came to me about 30 years ago, wrapped in a piece of black velvet cloth as if it were a rare, precious item. It had remained untouched until very recently, when I decided to see how well it had withstood the passage of time.

I unwrapped it and there it was in its slightly blemished beauty. After a thorough cleaning and testing, I found that it was a unique, well preserved, working model of a commercial grade of pickup based on 1920s-1930s technology. Its dimensions are suitable for 16" transcriptions; however, it works well with any size recording. In operational tests using a 12" recording of more recent vintage, it performed well, after I had corrected a problem due to excessive tracking force.

This pickup was intended to provide reliable, long-life service in commercial applications, such as recorded radio programs and soundtracks of early talking pictures.

Generously designed by any standards, it accurately represents the then state-of-the-art by a company recognized as a leader in the field. What may appear to be over-design is perhaps a redeeming feature in that the pickup has survived the passage of many years of quiet waiting without deterioration or degeneration of performance. For example, the pickup head is essentially hermetically sealed and thereby largely unaffected by the aging process in the more than 70 years since it was made.

CONSTRUCTION

As shown in Figure 1, the magnetic pickup head is a separate cast steel housing attached on one end of the tonearm of a 1½" x ¾" formed steel

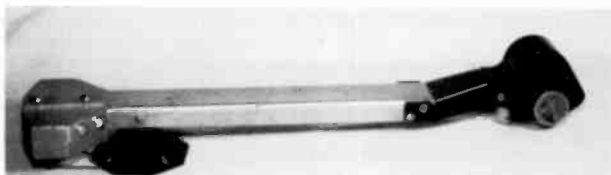

Figure 1. This Western Electric Model 4A transcription-type phonograph pickup head, arm, and counterweight assembly is 17" long.

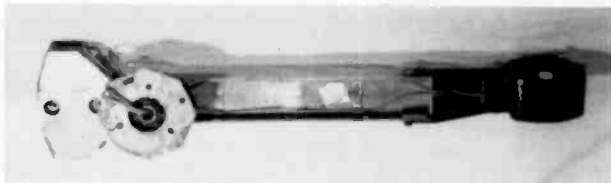

Figure 2. An underside view of the arm, pickup and heavy counterweight of the Western Electric Model 4A phonograph pickup.

channel 12" long. On the other end of the tonearm is attached a large, heavy, lead weight as counterbalance. The composite 17" long assembly is, in turn, mounted to a pivoted base plate equipped with low friction bearings for smooth and quiet horizontal and vertical movement.

The bearing for horizontal movement is a single, generously sized precision ball bearing, which provides a stable platform for the arm. The vertical bearing consists of a steel pin approximately ¾" in diameter held in place by two machine screws and supported by precise, sleeve-type bearings pressed into the side members of the channel. An underside view of the pickup and arm is shown in Figure 2.

The pickup head utilizes a replaceable needle, which is accommodated by means of a knurled-head set screw mounted on a diaphragm. The diaphragm is ingeniously shaped to permit lateral movement while essentially preventing vertical movement, thereby improving the signal-to-noise ratio, since its response to vertically generated surface noise was very low. The needle and its mounting facility are located on the side of the pickup head reminiscent of still earlier nonelectronic phonographs. These old units functioned quite efficiently through the mechanical advantage of a pivoted lever and a diaphragm coupled directly to a horn.

It is probable that designers following this earlier proven principle took advantage of the needle

length and the pivoting diaphragm to enhance the unit's efficiency. In that regard, I did not do a test, but audible "needle talk" was clearly evident.

The entire assembly weighs 4½ pounds, of which the head weight is 9½ ounces, and the lead counterweight 3 pounds. Electrical measurements indicate that the magnetic pickup has a nominal impedance of 250 ohms at 1,000 cycles and an output voltage of 50 millivolts.

Operational tests using average quality, modern-day, 33½" vinyl recordings demonstrated good listening quality; the sound produced was bright, clear, and free of unpleasant distortions that were sometimes associated with reproduction devices of the 1920-1930 era. However the initial tracking force of 5 ounces had to be reduced by using an added counterbalance weight of 1.25 pounds or a total of 4.25 pounds in order to function without damaging the record. Satisfactory tracking was then obtained with a tracking force of 1 ounce; however, further reduction was not found to be feasible.

In any case, as some A.R.C. readers having previous commercial experience with these units may agree, the pickup is an excellent example of

the good design and manufacturing proficiency of an earlier time when electronic technology was still young. The fact that the pickup is still able to perform today with a change only in the counterbalance weight speaks well for the integrity of its design and the wisdom of its designers. Just to make sure that this pickup was used only under conditions which they considered suitable, the designers thoughtfully included in the fine print on the label of the pickup head, this admonition to potential users. "For use only as specified in the contract or the bill covering the sale hereby."

(Walter H. Hall, 405 Ludlow Ave., Spring Lake, NJ 07762)

As a longtime collector of vintage radio and electronic memorabilia, Walter Hall is also a collector of related nostalgia. In a career spanning more than 60 years in the electronics business, he has had the privilege of participating in and enjoying its many facets. Now, at 84, he enjoys the pleasure of a rewarding hobby exploring the never-ending mysteries of this thing called "electronics."

Philco Model 44H

BY RICHARD ARNOLD

The 1934 Philco 44, shown in Figure 1, was introduced in the fall of 1933 to replace the Model 43. It is a 6-tube superheterodyne broadcast and shortwave receiver housed in a 6-legged highboy cabinet. Its 4-point waveband covers the following ranges: Band 1: 520-1500 Kc; Band 2: 1.5-4.0 Kc; Band 3: 4.0-11.0 Mc; and Band 4: 11.0-23.0 Mc. The tube comple-

ment consists of the following types: 6A7 detector/oscillator, 78 (2) 1st and 2nd IF stages, 75 2nd detector and 1st AF, 42 audio output, and 80 rectifier. The radio has four controls — tuning, on-off/volume, band switch, and tone control.

The same chassis is used in the Model 504, except that the 504 has the addition of a phonograph.

When I found this set, the cabinet was in bad shape. Someone had stripped off the veneer from the top and sides and painted them brown covered with a dark yellow varnish. A snow-white grille cloth put in behind the cutouts finished the mess. The chassis was complete and looked good and clean. It even played a little, so I gave the man the \$50 he was asking and took the set home.

Since I was doing the work on weekends, it took me a while to finish, but it turned out to be a labor of love. The cabinet incorporates a variety of woods into the design. I'm not sure what they are, but a similar looking set of the same year — the Model 43H, another 6-legged console — has hand-rubbed walnut, oriental wood and satinwood.

According to the rarity scale in Ron Ramirez's *Philco Radio 1928-1942*, this is a fairly hard-to-find set, so I guess it will be a "keeper."

(Richard Arnold, Box 275, Lone Grove, OK 73443)

Richard Arnold has been collecting radios since 1985. His interest is primarily in cathedrals and 1920s battery sets, and his collection ranges from crystal sets to a 1928 American Bosch in a Pooley cabinet. His prize is the 1932 Jackson Bell Peter Pan featured in the June 1991 A.R.C.



Figure 1. The 1933 Philco Model 44H console.



PHOTO REVIEW



This column presents in pictorial form many of the more unusual radios, speakers, tubes, advertising, and other old radio-related items from our readers' collections. The photos are meant to help increase awareness of what's available in the radio collecting hobby. Send in any size photos from your collection. Photos must be sharp in detail, contain a single item, and preferably have a light-colored background. A short, descriptive paragraph **MUST** be included with each photo. Please note that receipt of photos is not acknowledged, publishing is not guaranteed, and photos are not returned.

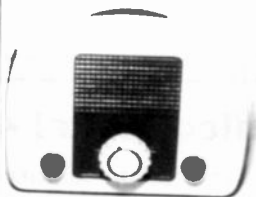
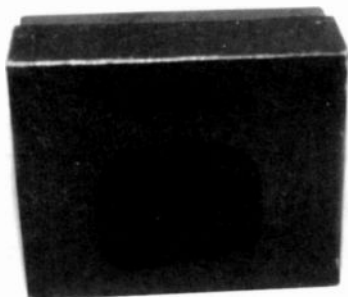

OMEGA GERMANIUM TYPE CRYSTAL SET – This toy radio, shown with its original box, was made in Germany and came in a variety of colors. These radios are quite sought-after by European collectors. (*Erwin Macho – Vienna, Austria*)



PILOT MODEL X131 – This radio was built for the U.S. and the export markets. It has series strung filaments for AC or DC operation. A ballast tube and a very large (50 W) dropping resistor allows operation on 117-, 130-, 150-, 220- or 250-volt power lines. Tubes used include: (2) Type 25L6, (2) Type 25Z6, and a Type 6U5 eye tube plus ballast. The 3 bands are marked in kHz, MHz and meters. A front panel switch selects loop or external antenna. A TV-phono audio input is available at the rear. The field choke type speaker would indicate a mid-to-late 1930s model. The high end of the BC band is marked "Police" (1700KC). (*Ann Brokloff – State College, PA*)



MIGNON "RW-4" – This 1-tube, undamped wave receiver was manufactured by the Mignon Manufacturing Corp. of Newark, New Jersey, and first appeared in April of 1920. Its advertising boasted, "No loose couplers, no loading coils, no variometers, no amplifiers." The set was designed for the use of a Marconi VT triode tube, but it also came equipped with binding posts for connecting a tubular Audion. The \$95 price included the Marconi VT tube. (*Richard A. Andre – Charleston, WV*)

PHOTO REVIEW



RCA ADVERTISING GLASS – This frosted 12 oz. drinking glass is 7" high and features the older type RCA logo. Below the logo is the symbol of the triode in three colors. (*Herman Foote – West Palm Beach, FL*)



YOGI BEAR RADIO – This germanium crystal radio was made in Japan and comes with a compass in the center of the tuning dial. On the original box are the following quotes: "Semi-Permanent Life" and "Hanna-Barbera Productions, Inc., 1966." (*Harry Blesy – Hindsdale, IL*)

INTERNATIONAL RDC CATHEDRAL – This 4-tube AC/DC cathedral uses the following tube complement: one Type 77, 12A5, 78, and 12Z3. It is only 9 $\frac{1}{4}$ " tall, and 6 $\frac{1}{2}$ " wide. The 6-pin plug socket on the back is for battery operation. This unique radio won a white ribbon at a MAARC meet. (*Jim Wilson – Virginia Beach, VA*)



MARQUETTE MIDGET CATHEDRAL – This 5-tube cathedral uses the following tube complement: one Type 57, 58, 27, 47 and 80 rectifier. It is only 13 $\frac{1}{2}$ " tall and 9 $\frac{1}{2}$ " wide. (*Jim Wilson – Virginia Beach, VA*)



Oops! In the May 1999 issue, the rear view of the International RDC above was incorrectly shown with the front of the Marquette. Here we show the two cathedrals correctly paired.



RESTORATION TOPICS

Restoring an RCA Model T-80

BY HOWARD HOOD

For Howard Hood, restoring an RCA Model T-80 was obviously a fun project. Finding two sets from which to create one is the kind of good luck all collectors should have. (Editor)

I have never been one to pass up a free radio. So, when a couple of radios were offered, I was ready to go and take a look. I was warned beforehand that the sets had been a little neglected over the years.

One rainy evening (I live in Washington!) I went to check out the offer. As it turned out, both sets were RCA Model T-80 radios. It's not often you are offered two radios of the same model — the problem of where to get replacement parts should sure be a lot easier! Figure 1 shows one of the two RCA Model T-80 radios before any restoration took place.

That the radios had been "a little neglected" turned out to be correct. It seems that the radios had been stored in a damp garage for an unknown amount of time. Both radios were covered with a white fungus-like material and the plywood mounting boards for the speaker and chassis had lost all glue and separated. Rust was very much in evidence on the chassis and speaker. On the brighter side, all the electronics looked to be in good shape and complete. Restoration would take awhile but it looked as if I could get at least one good T-80 out of the two sets.

DESCRIPTION

Made in 1939, the T-80 is large for a table radio, as it has almost tombstone proportions. It measures roughly 13" tall, 16" wide and 9" deep. The cabinet is two-tone with a light oak top and a darker wood base. The upper portion of the cabinet houses a 6-inch electrodynamic speaker.

The lower part of the radio has a large slide-rule dial with 6 push buttons above. Above and to the left is the magic eye tube, while on the right is an indicator that lights up when the BC band is selected. The knobs to the left of the escutcheon control the power, tone and volume. On the right, they control band selection and tuning.

The T-80 is a superheterodyne that covers three bands — 550 to 1700 Kc, 2.3 to 7.0 Mc and 7 to 22 Mc. The power out is rated at 5.0 watts. A little surprise for a set of this type — there is no

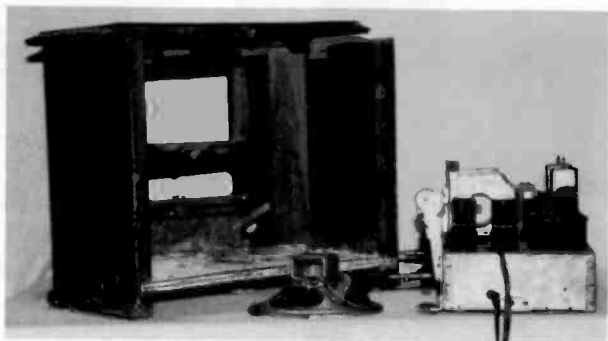

Figure 1. One of the two 1939 RCA Model T-80 radios as found.

separate RF selection. A 6SA7 is used as the 1st detector and oscillator, with a 6SH7 in the IF section. A 5Y3 rectifier supplies the power.

The audio section uses a 6SQ7 as the audio amplifier and a 6SF7 as a phase inverter, while two 6F6 tubes make up the push-pull amplifier. Input transformers for push-pull amplifiers were costly, and manufacturers substituted for them where possible. In this case, RCA used a phase inverter tube to get the required 180 degree phase difference for the push-pull grids. The positive signal voltage going to one of the push-pull grids is also run to the phase inverter grid. The out-of-phase plate voltage of the phase inverter is then fed to the grid of the second push-pull tube.

The T-80 has the famous magic eye tuning that is so popular now with some collectors. In this case the magic eye is a 6U5 connected to the AVC bus. With no signal, the AVC voltage is zero, and the deflection is a wide wedge shape; when a signal is tuned in, the AVC voltage increases and the deflection narrows with the increased grid voltage.

THE RESTORATION

I feel it's all right for a set to look a little used, so I elected not to do a complete refinish job. A little mild soap and water took care of the white fungus on the wood. New plywood parts were made using the original pieces as templates. Various broken wooden spacers and mounting blocks were also replaced. The veneer was reglued and damaged areas repaired and stained to match the original.

The grille cloth was in fairly good shape but had faded badly over the last 60 years. However, after cleaning, it looked good enough to reuse.



Figure 2. The front of the completely restored RCA Model T-80.

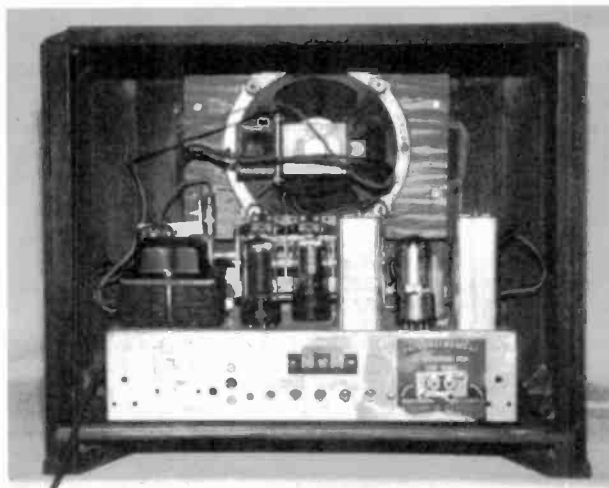

Figure 3. The rear of the completely restored RCA Model T-80.

The next step was the electrical repairs. I picked the best chassis of the two and then checked for electrical problems. The T-80 had the standard problems for old radios. Bad capacitors, resistor value that had changed, brittle insulation, and a few bad tubes rounded out the list. Not too bad for a radio that had been sitting in a damp garage for many years.

All the required repairs were made. In addition, all the metal tubes were replaced with the glass version. Of course, the 6U5 magic eye on both chassis was bad. As a result, the cost of repairs jumped a bit!

RCA used a clutch type of tuning on the T-80. In other words, you had to push in first then turn

the tuning knob. This caused a rubber wheel to make contact with a large metal pulley that did the tuning. The rubber wheel had become hard and, as a result, would slip when contacting the pulley. I solved this problem by gluing a piece of soft rubber to the surface of the wheel.

TESTING

I like to start the testing process slowly by using a Variac to bring up the voltage. I think this method gives you a little more control over what is going on. Bring up the voltage about 25 volts at a time and monitor the set closely. In this case, everything went as it should and, at about 80 volts, I had the sound of music with no hum or smoke.

The only problem encountered was a rough sounding speaker — not a major problem and easily fixed. Figures 2 and 3 show the restored RCA Model T-80, both front and rear.

CONCLUSION

In thinking over this project, I came up with several questions. For a radio covering 550 Kc to 22 Mc, why didn't RCA include a separate RF stage? The increased selectivity and sensitivity would have been an asset. If the company was trying to save money, why the push-pull output? And why that clutch tuning, which is a pain to use? Almost any other tuning system would have been better.

I think the choices were probably an attempt to produce a large multiband radio with big sound output at a reasonable price.

Acknowledgement: Special thanks to Jim and Deb Howard who thought of me before putting the T-80s in the trash bin.

Photo credit: Bryan Hood

(Howard Hood, 5670 S.W. 44th St., Port Orchard, WA 98367)

Howard Hood worked for 30 years as an electronics mechanic for the Department of Defense. He has had his FCC Radiotelephone license since 1965 and his ham license since 1971. He likes to collect radios that show the development of radio technology. He is a member of the Puget Sound Antique Radio Association.



AUCTION REPORT

Southern California Antique Radio Society Auction

Van Nuys, California — February 20, 1999

REPORTED BY DALE DONALSON

Once again the friendly Southern California weather smiled on the SCARS midwinter auction event. Thirty-seven sellers consigned a total of 235 lots to the auction block. These lots represented a wide variety of equipment and included some unique and very high quality items. Bid cards were purchased by 110 people, including most of the sellers. With the addition of family and friends, the auction room was full and active. Twenty-eight SCARS volunteers, along with Dick Tichenor, a professional auctioneer, kept the proceedings moving smoothly from start to finish.

The volunteers arrived at 7:00 A.M. to organize the processing of the lots to be sold and the sale of bid cards, which started promptly at 7:30 A.M. in accordance with the published schedule. Pre-viewing of the merchandise started at 9:00 A.M., and the auction started at 10:01 A.M. with a short briefing on the procedures and rules. The auctioneer then took the helm.

The auction proceedings finished at 1:23 P.M. without a break. During the intervening 3 hours and 22 minutes, the 235 lots averaged one lot sold every 52 seconds. The top item was a Grebe MU-1 with original battery box and B+ power supply in excellent condition selling at \$1,100.

The payment and check-out process proceeded smoothly. New owners claimed 222 of the lots, while 12 lots were bought back by the sellers, and one lot failed to receive any bids. This year, the combined buy-back and no-sale lots represented only 5.5 percent of the total lots, a favorable change from the 1998 15.3 percent. Buy-backs are not included in the listing of auction items. All amounts are rounded down to the dollar, and the total sales,



Active bidding for this well preserved Atwater-Kent 90 cathedral resulted in auctioneer Dick Tichenor receiving a high bid of \$375.

not including the buy-backs, amounted to \$17,537.00. The comparable figure for 1998 was \$18,257.50 for 216 lots.

e = excellent, vg = very good, g = good, f = fair, p = poor, N.I.B. = new-in-box, NT = no tubes, WT = with tubes, wk = works

Air Castle tombstone, wood, 4-tube, e	\$95
Airborne Instruments Lab. M-331 RF signal generator and diode tester, g	40
Airline 62-226 movie-dial console, f	40
Airline 62-327, untested	65
Airline 62-403 movie-dial console, g	165
Airline 2511, in table, e	25
Airline BC/SW, e	35
American microphone, Los Angeles Mfg., g	350
Ampex 900 reel-to-reel tape recorder, g	60
Ampex reel-to-reel stereo tape recorder	30
Atlas horn speaker, w/RCA driver, f	60
ATR 32 U 32V DC to 120V AC power inverter, e..	10
Atwater-Kent 20, WT (g), e	95
Atwater-Kent 33, NT	40
Atwater-Kent 46, g	75
Atwater-Kent 55, w/speaker, f	135
Atwater-Kent 90 cathedral, g	375
Atwater-Kent L speaker, e	115
Bendix 526, small crack in front, f	50
Bogen Challenger public address amp, g	20
Bogen tuner and amp, g	50
Boshei TV/AM/FM battery portable, w/AC and 12V adapters, g	35

A warning: Auction prices are not current values. Our selection of auction items is not necessarily complete. A listing such as this cannot adequately include the condition of cabinets, chassis, transformers, tubes, the operating status of the set, and the inclusion of incorrect, restored or replica components, etc. Auction prices are the result of the excitement of the auction process, the skill of the auctioneer and the specific interests of the participants. Nevertheless, auction prices serve as useful references and as another element in the value determining process. The possibility of error always exists, and if we are notified, corrections will be reported.

Clarion painted Bakelite, f	25
Concertone Network Tape Recorder, NWR-1	155
Continental Co. microphone, carbon dual button, g	160
Continental, g	55
<i>Cornell-Dubilier Capacitor</i> pamphlets, (100), '48-'61, e	12
Crosley 10-137 Coloradio, green	50
Crosley 11, e	20
Crosley 48 Widget, Repwood, cathedral, g	400
Crosley 56TD BC table, wood, g	75
Crosley 66TW, ivory plastic, e	65
Crosley 515 tombstone, wood, g	115
Crosley 1934 green-dial tombstone, e	130
Crosley 1946 table, ivory plastic, g	10
Crosley D25 clock radio, g	75
Delco/GM 1954 clock radio, e	30
Direction (?) AM/FM table, e	10
DuMont oscilloscope, 5", (2), and RCA 5" WO-60C, f	10
Eico 145 signal tracer, g	35
Eico 460 oscilloscope, g	17
Emerson 560, e	30
Emerson 641 Series B table, brown, g	20
Emerson DJ31, g	15
Emud Rekord Jr. 196, dial glass cracked, g	40
Eveready 2 table, metal, f	50
Fada 167 kit radio	75
Fada 652 Catalin, crack on bottom, g	540
Firestone Air Chief 7422-3, g	90
Fisher 50C-3 tube-type preamp, g	80
Fisher FM Tuner, g	25
French-made mfg./model (?), e	45
GE 115W table, cream, g	30
GE 135 table, brown, g	10
GE 409 BC/FM table, brown, g	10
GE A-64 tombstone, e	85
GE clock radio, g	20
GE FD-62 table, e	75
GE K-64 cathedral, g	325
General 600-601 tombstone, e	160
Graybar "GrayBarette-4" cathedral, g	175
Grebe MU-1, w/o chain, w/rare Grebe battery box and B power supply, e++	1,100
Grebe MU-2, NT, f	125
Grommes tube-type receiver, g	17
Grundig AB/FM table, green plastic, g	40
Grundig Majestic, (2)	27, 60
Grunow 532 table, wood, g	80
Hallicrafters HT-37 ham transmitter, g	80
Hallicrafters SR 34, g	50
Hallicrafters SX-71, w/speaker, g	125
Hallicrafters TW 600	30
Hallicrafters TW-1000 8-band "World Wide" portable, g	40
Hallicrafters TW-2000 8-Band "World Wide" portable, g	70
Hewlett Packard 606A signal generator, w/manuals, g	75
Home Brew breadboard, like Atwater-Kent, w/headphones and speaker driver, NT	225
Kenwood 5600 AM/FM stereo receiver, e	40
Kitcraft crystal set, w/headphones, original box and instructions, e	30
Knight 93-320 audio amplifier, 40W, e	30
Knight KG 650 RF generator, f	15
Lambda LNSP5 and LNSP12	15
Lemco No. 340 crystal set, e	250
Majestic 50 cathedral, g	165
Majestic table, Art Deco, chrome grille, e	380
Majestic 19 chairside	95
Midwest 20-38, AC chassis and speakers, f	30
Motorola 50X2, painted Bakelite, g	65
Motorola 67X12 table, g	25
Murdock CS32	175
National RAAS-5	225
National RCP, w/manual, restored, e	165
National TRF-5, wood, NT	50
Orthotone, e	40
Packard-Bell 100A table, ivory, g	30
Panamer Coin-Op motel table, e	50
Parmak table, 3-Band, tri-color dial, wood, g	70
Philco 37-60 cathedral, g	75
Philco 41PT87, f	15
Philco 42PT87, f	20
Philco 46-350 table, leather, f	10
Philco 46-420, table, brown	15
Philco 52-942 table, brown	25
Philco 53-560, e	15
Philco 53-706 table lamp/radio, e	75
Philco 60, (2), g, e	105, 130
Philco 60B cathedral, 1934, g	135
Philco 84 cathedral, g	170
Philco PD-4908/MoPar 803, g	10
Philco Transitone, e	25
Porto Products SR600W, "Smokerette," f	65
Precise 111 tube tester, g	50
QST, (40+), g	17
<i>Radio Retailing</i> , (25), e	30
Radio Shack Realistic AM/FM/8-track player, e	10
<i>Radio Today</i> , (10)	25
Radiola 18, WT (g), g	100
Radiola 25, antenna and manual, WT, e	450
Radiola AR 812, dud 199s, g	100
Radiola IIIA, UX199 adapters, panel crack, NT, g	105
Radiola RC1064 table, brown	15
RCA 1-R-81 table BC/FM, brown, g	10
RCA 1-RF-91 table BC/FM, brown, g	10
RCA 9-X-641 table, brown, g	10
RCA 30 large console, w/built-in antenna and speaker, g	230
RCA 100 drum speaker, e	35
Rek-O-Kut record player, 1950	35



This small but heavy Crosley Model 48 Widget cathedral in its Repwood cabinet sold for a well deserved \$400.

(Continued on following page)

(SCARS Auction, continued)

Rider's, Vols. XI, XIII, XV, f	35
Rola Re-Creator, cone speaker, e	60
Saba 200	20
Saba 300	30
Sam's Photofacts, (2) boxes	5
Sansui 1000A, g	20
Scott, E. H., 1937 Allwave 23-tube radio/amp chassis, g	525
Scott, E. H., Allwave 23 radio/amp, w/owner's manual	350
Sears Silvertone 18 table, g	20
Sears Silvertone 528.33300 chassis, g	30
Sears Silvertone 1392, g	65
Sears Silvertone console	75
Sears Silvertone 2016 table, cream, g	10
Seeburg Type 940A juke box amplifier, f	100
Sentinel tombstone	120
Setchell-Carlson 421RD Dor-A-Phone, e	10
Sonochorde cone speaker, 1925, wk	125
Sony 8-30, w/B&W TV, w/manuals, power cord, etc., g	110
Sony Stereo 1/4" reel-to-reel 464D tape recorder	30
Sparton table, wood	12
Steinite new crystal set, g	135
Stevens Sonoidal cone speaker, 1925, wk	50
Stewart-Warner 102-A cathedral, e	280
Stromberg-Carlson, f	35
Tektronix 545A oscilloscope, w/manual, g	50
Telefunken OPSU 9	45
Transistor radios, assorted, (8), g	25
Transistor radios, assorted, e	40
Tube(s): 46, 81, 26, 27, g	35
Tube(s): 6L6, 6V6, 59, U4, 6SN7, 16, e	45
Tube(s): 12BE6, 12AV6, 12BA6, 20, 35W4, 50C5, e	17



This 1938 Scott Phantom in a refinished Warrington cabinet received a high bid of \$1,300, but that was not enough to convince the owner to part with it.



Mid-1920s horn and cone speakers in varying conditions changed hands for between \$60 and \$125. This Sonochorde cone speaker sold for \$125.

Tube(s): 201A, globe style, (3), g	40
Tube(s): approx. 300 TV type, w/leather case ...	5
Tube(s): UX199, low emission, (2)	45
Tube(s): WE Signal Corps VT-5, new w/spec sheet, e	20
U.S. & TV 99A cathedral, e	100
U.S. Gloritone 99-A cathedral, e	150
United Motor Works 1932 table, wood, g	105
Westinghouse H37	17
Westinghouse RC, 1922, 3-tube, e	350
Westinghouse WR-23 tombstone, e	135
Zenith 5D027 Consoltone, wood, wk, refinished, e ..	50
Zenith 5D030	25
Zenith 5S319, g	190
Zenith 6D815 table, brown, g	20
Zenith 6G501, g	25
Zenith 7635 table, wood, e	260
Zenith 7K01 table, blue, g	25
Zenith 10S567 console, replacement PM speaker, wk	250
Zenith 705 table, wood, refinished, wk	165
Zenith 60614W table, cream, g	60
Zenith BC/SW table, tan, g	40
Zenith H503 portable, w/owner's manual, g ...	30
Zenith H615WZ BC table, cream, g	10
Zenith H725Z1 BC/FM table, brown, g	10
Zenith K725 BC/FM table, brown, g	25
Zenith "sailboat" portable, g	95
Zenith Trans-Oceanic H500 portable, g	70
Zenith Trans-Oceanic L600 portable, g	50
Zenith Trans-Oceanic, (2)	60

Photos by Bill Oglesby and Watana Panutai.

The Southern California Antique Radio Society has quarterly meets in the L.A. area, as well as mini-meets, a 2-day November meeting, and an annual auction. The "California Antique Radio Gazette" is published quarterly. Dues are \$15. Information: Robert Schoenbeck, 9301 Texhoma Ave., Northrop, CA 91325-2330.

(Dale Donalson, 31901 Kingspark Ct., Westlake Village, CA 91361-4117)

Freed Auction Tylersport, Pennsylvania — April 21, 1999

CONTRIBUTED BY RAY CHASE

On April 21, 1999, Ralph D Freed held a general auction at the Tylersport Firehouse, Rt. 563, in Tylersport, Pennsylvania, at which a large collection of radios and test equipment was offered. All of this equipment came from a local collector.

Most of the radios were of the common 1940s and 1950s types, and many were in only fair condition. The test equipment was also common, but clearly, many bargains were to be had, as a review of the prices will show.

A preview list was available from the auction company, but it was not very useful because the descriptions were limited and the items unnumbered. Also there was no relation between the list and the order of sale. The radios and test equipment were sold as a separate side auction while the main auction was in progress. Auctioneers were Don Kerbaugh and Ralph Freed.

Eleven plastic clock radios sold for a total of \$14, and 54 common plastic radios sold for a total of \$76. Forty-one other items of all types of test equipment were offered, 8 of which sold for \$2 each and 33 for \$1 each. Much of this equipment was Hickock or Heath, and it included several 3" and 5" scopes, one of which was a Tektronix 531. There were several Heath VTVMs and an HP410 VTVM. This auction was a good chance to outfit your radio/TV service bench.

g=good, f=fair, p=poor, N.I.B.=new-in-box

AC inverter, 12-volt DC to 115-volt, in box ... \$15
Atwater Kent chassis, WT, (2) 45s gone 8
Audiovox car radios for Chrysler cars, (2) 5
Crosley "dashboard" clock radio, pale green,
some scratches 90
Farnsworth chairside, w/phono, postwar, wood, vg. 5
GE hand-held CB 13
German table stereo/phono, wood, w/2 speakers 17
Hallicrafters S-120, g 11
Orion 13" color TV, w/remote, N.I.B. 45
Philco cathedral, (4) knobs, no speaker, g 24



Some of the many plastic radios of the 1940s and 1950s sold at the Freed auction.

RCA Radiola 18, w/hood, and (2) 10CA spkrs, g 100
RCA Victor 45 rpm player in red suitcase 16
RCA Victor 45 rpm record player in suitcase . 16
RCA Victor 45 rpm record player, (2) 12, 15
RCA Victor 1950s floor model 3
Realistic 40 channel CB set 15
Realistic 100-watt PA amp. new 9
Sun Alpha 115 large guitar amp 5
Telefunken Opus table, 1950s, f 25
Thomas repro clock radio, wood 9
Tube caddy, w/TV tubes, w/few Mullard tubes 40
Tubes, (3) flats 14
VCR-to-TV home broadcast system, new 9
Wega table, small, plastic, 1950s 11
Wega table, wood, 1950s 5
Wireless 3-channel microphone set, in box ... 15
Wireless FM microphone, new 7
Zenith brown plastic, (3) knobs 6
Zenith table, wood, oval dial, no push buttons, f 44

(Ray Chase 1350 Marlborough Ave., Plainfield, NJ 07060; Ralph D. Freed Auctioneers, Inc., P.O. Box 194, Salford, PA 18957. (215)-822-2826)

Dennis Auction Stewartsville, New Jersey — April 2, 1999

CONTRIBUTED BY RAY CHASE

At a regular Friday evening general auction held at the Dennis Auction Gallery in Stewartsville, New Jersey, on April, 2, 1999, a group of interesting radios was offered and sold. The 10 percent buyer's premium is not included in the listed prices below. The auctioneer was Frank C. Dennis.

vg=very good, g=good, f=fair, p=poor, unk=manufacturer unknown

Emerson 522 table, white plastic, w/handle, g ... \$30
Emerson table, small, wood, Ingraham cabinet,
(3) knobs, refinished, vg 350
GE 145 portable, red plastic, AC/DC, g 10
Grundig 3035, large table, multiband, '50s, vg ..250

Magnavox 503 table, AM/FM, wood, '50s, vg.. 15
Philco 38-89 6-tube tombstone, (4) knobs, clean.. 40
RCA Victor All American 5 table, plastic, Nipper
on dial, plastic faded 50
Westinghouse H126 "refrigerator," white, g ... 90
Table radio. unk, wood, '30s, (3) knobs, w/eye
tube, p. 30
Zenith 5H111, brown plastic, Deco style, f 25
Zenith G511-W table, white plastic, crack in
case, dirty, g 20

(Ray Chase, 1350 Marlborough Ave., Plainfield, NJ 07060; Dennis Auctions, 723 Hwy. 57, P.O. Box 5, Stewartsville, NJ 08886. (908) 859-3424)

Christie's South Kensington Auction

London, England — April 8, 1999

COMPILED FROM INFORMATION PROVIDED BY PARKMAN SHAW AND CHRISTIE'S

On April 8, 1999, Christie's South Kensington of London held an auction of mechanical music, radio, and technical apparatus. Most of the radios in the 217-lot auction were from the collection of Pat Leggatt, who died in October 1998. Leggatt was an active member and past chairman of the British Vintage Wireless Society (BVWS). Most of his professional career had been spent with the BBC, where he became head of the Specialist Engineering Department, and, ultimately, Chief Engineer External Relations.

As a collector, his interest centered on the pre-1930 era. His deep technical understanding is reflected in the circuit diagrams prepared — often on the backs of recycled letters — for each set in the collection, accompanied by notes on any unusual aspect of the technical design. Many of the sets in the collection formed the basis of a detailed article in the *BVWS Bulletin*, to which he was a regular and much valued contributor.

Of the 217 items in the auction, 125 were radios, selling for a total of \$123,387. The entire auction total was \$319,866. In fact, two of the Marconi pieces — the magnetic detector and the No. 16 receiver, each selling for \$16,974 — were the top items in the auction.

The following prices include the 15 percent buyer's premium and are rounded to the nearest dollar. An exchange rate of \$1.64 to the pound is used for all conversions.

A few notes for the non-British reader: a note magnifier is an audio amplifier and valves are vacuum tubes.

WT=with tubes, NT=no tubes

Adey Four portable, WT	\$415
AJS Type 6 receiver, WT	2,075
Atherton & Hall Athall Radio Type S.V. 2 receiver, WT	415
Atwater Kent 20 and 33	490
Atwater Kent Type 10C breadboard, WT	1,509
Bligh Duovalve receiver, WT	1,225
Bligh receiver/amplifier in mahogany smoker's cabinet case, Bligh Radio/2 MkV and Audio/2 MkVII	1,791
Brownie 2-stage note magnifier and crystal set, in complementary moulded cases, WT	1,414
BTH Radiola 1 valve-crystal receiver, Type VC Form B	943
Burndept Ethodyne superheterodyne receiver, w/Burndept loop aerial	1,791



This Burndept Home Constructor No. 2 receiver with plug-in coils sold for \$358.



Rare, indeed, is this Marconi Wireless Telegraph Co., Ltd., No. 16 balanced crystal receiver, which sold for \$16,974.

Burndept Ethophone 4-valve receiver, w/repainted Burndept Ethovox horn	1,036
Burndept Home Constructor No. 2, 2-valve receiver, NT	358
Burndept Screened Four, 4-valve receiver, WT ...	490
Coherer, of Marconi type, glass tube, w/connecting wires at each end, 3" long ..	848
Cosmos Radiophone Type VS2, 2-valve receiver and A4 2-valve amplifier in single cabinet ...	1,602
Edison Bell crystal set and note magnifier, each in oak case, WT	1,414
Ediswan Fleming oscillation valve, damaged 1,320	
Efescaphone Rodney 3-valve receiver	1,509
Ekco A22 receiver	717
Ekco Type TA201 TV receiver, 7" screen ...	1,414
Ekco Type TS 701 TV receiver, 7" screen ...	1,697
Elwell, Ltd., Aristophone Type 56 and Aristophone Type 55, WT	754
Federal Type 110 receiver, WT	377
Fellophone 2-valve receiver and 2-valve amplifier, WT	1,320
Fellophone Super Two receiver and Super Two amplifier, WT	1,886
Gamages crystal set	604
Gambrell Baby Grand DC 2-valve mains receiver ..	415
Gecophone Type B.C. 2820 receiver, WT ...	754
Gecophone Type B.C. 3040 receiver, WT ...	490
Gecophone Type B.C. 3350 3-valve receiver	905
Gecophone Victor 3, 3-valve receiver	207
Grebe Synchrophase receiver, WT	604
H.P.R. Wireless Ltd. (Hugh Powell Rees) Simplex 1-valve receiver	604
Henderson & Co. Type HR2A 2-valve receiver, WT ..	754
Kingsway No. 1 crystal set	659
Lamplugh S.T. 100 receiver, WT	1,132
Loewe Type 3H3N receiver, w/2 Loewe multiple valves, w/Loewe loudspeaker, WT ..	1,132



This Marconiphone Type A-2 2-stage amplifier brought a high bid of \$1,225.



This Burmdept Ethophone 4-tube receiver with Burmdept Ethovox horn speaker sold for \$1,036.

Marconi rotary spark discharger cigarette lighter, silver, 3 1/2" high, souvenir for male delegates to the 1912 International Telegraphic Congress, most of lighter mechanism missing.	792
Marconi Wireless Co., Ltd., magnetic detector, ca. 1910, crank replaced	16,974
Marconi Wireless Telegraph Co. of America share certificates, (19)	75
Marconi Wireless Telegraph Co., Ltd., Morse ink-writer	3,395
Marconi Wireless Telegraph Co., Ltd., No. 16 balanced-crystal receiver	16,974
Marconiphone A-2 amplifier, WT	1,225
Marconiphone Crystal Junior and Re-Echo crystal sets ..	905
Marconiphone Type 21 receiver	633
Marconiphone Type 22 receiver, ca. 1928 ...	302
Marconiphone Type 31 receiver, some components replaced	453
Marconiphone Type 81 receiver, "Straight Eight," WT	1,791
Marconiphone V-2 receiver, w/Marconi Log Book ..	1,886
Mark II spark transmitter by W/T Factory ..	1,132
Mark III shortwave tuner by W/T Factory ..	3,772
Pelmerset 3-valve receiver, WT	1,132
Perophone Type UD single-valve receiver, w/D.E.2 L.F. valve	943
Philco Type 444 receiver, "People's" set, grille cloth damaged	566
Philips Type 2007 loudspeaker	415
Pye 25 portable receiver, first of the Pye "Sunrise" models	66
Pye 222 receiver, WT	528
Pye Type 250AC mains receiver, WT	415
Radio Instruments, Ltd., BBC Boat Race receiver, used for shore reception of commentary from the launch following a race, WT, 1927	659

Radio Lamp Co. of America radio lamp, 5-valve, later glass shade	717
RCA Radiola II portable and Radiola 26 superheterodyne portable, WT	754
RCA Radiola III-A and Radiola III, 1924	377
Société Belge Radioélectrique 4-valve receiver, WT ..	302
Sterling AF power amplifier, WT	717
Sterling Anodion Two receiver, Type R. 1599a, WT	1,509
Sterling Anodion Type R 1610, 4-valve receiver, WT	3,528
Système Abelé Berrens 4-valve receiver, WT ...	792
Trego 5-valve receiver, Crosley Pup receiver, Howe crystal set	244
Type MCR 1 miniature communications receiver. Made by British Philco, these units were dropped in enemy-occupied territory in World War II to enable resistance workers to receive coded messages from the BBC	754
Walters crystal/valve receiver/amplifier, w/Crystal set No. 1, single-valve amplifier units, Marconi R valve. Ticket and lead seal indicate that this was the example submitted to the Post Office for registration	1,791
Weconomy Tuner by Western Electric Co. Ltd., WT	848

(Christie's South Kensington, 83 Old Brompton Rd., London SW7 3LD. Tel: 171-581-7611; Fax 171-321-3321)



INTERNET

To WebTV or Not to WebTV — Part 3 (If I can do it, you can do it)

BY DICK DESJARLAIS

Of the three WebTV options described in Part 2 in the June 1999 A.R.C., the WebTV Plus was decidedly the best choice for me to make. For approximately \$50 more than the standard WebTV Internet terminal and wireless keyboard, WebTV Plus provides several distinct features in addition to just e-mail and access to the Internet.

One significant advantage is that WebTV Plus can connect to most Canon 200, 600, and 4000 series Bubble Jet printers and all HP DeskJet 400 and 600 series printers. So, if you have a compatible printer you can readily print out e-mail messages, pictures of the kids, or the content of favorite Internet sites in color or black and white.

For those who are habitual TV surfers, WebTV Plus can search listings of upcoming shows and tell you what's on and what the show is about. You can do your own searching for the type of programming that fits your mood, or tap into the vast potential of the Internet, discovering more about your favorite subjects. WebTV Plus also allows you to program your VCR, so that up to a week in advance you can choose a TV show to record right from the listings. In addition, WebTV Plus comes with "Surf Watch," a built in safeguard to limit access to mature content.

Of course, you must understand that all of this information about WebTV Plus is simply the result of my research. Since at this juncture in my WebTV sojourn I hadn't purchased anything, it stands to reason that to date I have had no hands-on experience to test the efficacy of these highly touted features.

THE PURCHASE

Anyway, when I do get online I first want to get comfortable with e-mail. After I report on that experience, in a later installment, I will get into the inner workings of the other WebTV Plus features I've briefly described. This will include the brave but necessary steps required to control the TV cable box channel selections through the wireless keyboard by connecting the Internet terminal to the "IR Blaster," whatever that is! Not to mention connecting the VCR controls through the keyboard as well.

Having decided on the Sony TV Plus Model INT-W200 and the Sony Wireless Keyboard Model KI-W200, I then signed up for a 4-year warranty



Figure 1. Dick Desjarlais carries his new purchases from his well advertised van into the house for unpacking.

for an additional 50 bucks. This done, I strutted out of Best Buy with the Internet terminal and wireless keyboard cartons firmly tucked under my arm and headed for home.

As you can imagine, John "Flash" Terrey was right on hand to photograph my off-loading of the precious cargo, documented in Figure 1. It took us about twenty seconds to open the cartons and to spread the contents on a card table set up in my living room. Figure 2 shows my bewildered look as I contemplated the jumble of wires, connectors and equipment I keep unpacking.

Since I wanted to connect the WebTV Plus Internet terminal to my TV, VCR and cable box, the first task was to sort out the maze of connectors and wires and select only those compatible with my existing equipment. The operating instructions contain block diagram configurations for every possible combination of equipment, including my own, as shown in Figure 3. But, I think



Figure 2. It's like having a birthday, as Dick unpacks all that technology.

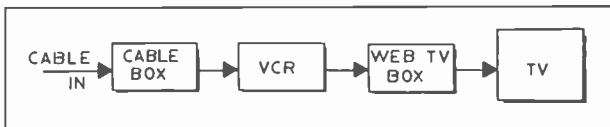

Figure 3. Basic diagram for hooking up the WebTV system



Figure 4. Dick contemplates the stack of technology atop his TV set.

that if you were able to hook up your VCR, you certainly can handle this hookup.

THE HOOKUP

Even so, I was relieved when John, after a quick review, made most of the applicable connections in less than five minutes. It would have taken me a lot longer to puzzle it out. However, that was the end of his involvement in this project as he headed to the door and said, "OK Dick, the rest is up to you." (Privately, it was clear to me that John was as eager to get his hands on this new toy as I was. But, we did have a deal that I would be chronicling my solo efforts from day one with little or no outside help.)

Actually the rest of the hookup was a piece of cake because all I had to do was unplug my one and only telephone, and plug in the signal splitter provided by Sony. The next step was to plug the

Internet terminal and telephone cords into the splitter. This system will enable me to keep the Internet terminal and the telephone plugged in at the same time. However, since I don't have call-waiting, anyone trying to call while I am on the WebTV Plus network will hear a busy signal. In Figure 4, I am contemplating my pyramid of modem technology — TV, VCR, Web TV Internet terminal, cable box — and I am holding the WebTV keyboard.

During the "Introduction to the Internet" workshop mentioned in Part 2, I had been alerted to the possibility that not all calls to the Network would be local and cost free. However, once I got online and inquired through "HELP" and "Q/A," I was given the Network's six connecting numbers. Following the suggestion to check these numbers in the phone book, I was relieved to find that all six were local exchanges. Phew!

While I was at Best Buy, the salesman had set up the activation number with the WebTV Network, logging in the activation number and code. As a convenient result, once I had double checked all the connections and plugged the Internet terminal AC cord into the wall outlet, I was almost ready to press the green power button on my lap-friendly wireless keyboard.

But first, following the instructions, I turned on the TV and switched to Channel 3. Expectantly pressing Web power, I had a brief but anxious wait before the WebTV logo came on the screen. I was now ready to enter the big e-mail world and to surf the Internet! What happens next will appear in Part 4.

(Dick Desjarlais, P.O. Box 629, Littleton, MA 01460-2629)

A.R.C.'s Web Site Expansion — Update Target Date — July 1, 1999

BY JOHN V. TERREY, EDITOR

The target date for the release of Antique Radio Classified's expanded web site is still July 1, 1999. But, I have to be realistic, and the actual release date will possibly lag a week or two. Check the A.R.C. web site regularly since we will post revised target date information there.

New on the site will be searchable auction results and improved shopping for books and subscriptions. Only subscribers can access the classified ads, via their log-on ID and password. The site will continue to have its current collection of articles, radio event listings, photos, etc.

Figure 1 shows the location on your mailing label of your user log-on ID and your password. Although you will not be able to change your log-on ID, you will be able to change your password on the web site.

All of us at A.R.C. are looking forward to this expansion into to modern cyberspace world.

Your Log-on ID is the number following the dash in your Sub#. Your Password is the number between the square brackets.

43*1.....5-DIGIT 14700
G-6J SUB#-24(4830) (14690)
JOHN COLLECTOR EXP=NOV99
5530 MARCONI AVE.
NEW TOWN OH 78432-1438

Figure 1. Your Log-on ID and your Password are on your mailing label.



The Western Electric Loud Speaker and Horn Compendium

Volume 2 in the Museum of Sound Series

By Barry Nadel

REVIEWED BY PAUL JOSEPH BOURBIN

Western Electric equipment is much sought after by collectors and dealers today for a number of reasons. Unlike most of the manufacturers whose products interest collectors, Western Electric had little interest in selling material to the general public. Instead, Western Electric's focus was on producing material for phone companies, theaters, sound studios and radio stations. Often it was one of only a few companies supplying such material.

Since its business was of a commercial nature and not consumer-oriented, Western Electric did not follow mainstream trends. Its goal was to produce high-quality, reliable equipment for people whose livelihood depended upon continuous, stable and rugged equipment with little downtime. Relieved of having to follow the dictates of a fickle and nontechnical public, Western Electric developed its own specifications, designs and lexicon that often were quite independent of others.

Since the equipment was of a commercial nature, Western Electric was also able to control tightly who would install and service its equipment. There are far fewer theaters, studios, etc., than general consumers, so it followed that there was a dearth of available information and most of that was kept in-house.

As a result, a sort of legend has evolved about Western Electric equipment, some based on fact and some on fiction. In an attempt to bring truth out of legend, Barry Nadel has published *The Western Electric Loud Speaker and Horn Compendium*, the second in a series aimed at disseminating solid information about Western Electric audio equipment. This work is the result of many months of pouring through obscure documentation.

The Western Electric Loud Speaker and Horn Compendium

by Barry Nadel

Volume 2 in the Museum of Sound Series



© 1997 by Barry Nadel
The Historical Institute for the Study of Sound • H.I.S.S.
P.O. Box #29303, San Francisco, CA 94129

Volume 2 is much larger than Volume 1 of the series, which gave information for dating Western Electric vacuum tubes. Volume 2 covers 141 speakers, horns, attachments, enclosures and drivers that constitute most, if not all, of Western Electric's production from the 1920s through 1960.

This is not a book for bedtime reading; indeed, there is almost no text. Instead, it lists, in model number order, all of the pertinent Western Electric equipment. For each model a description and specifications are given, as found from available data. Most models are accompanied by some form of il-

lustration, either a line drawing or a picture taken from original literature.

After a brief foreword by the author, there is a preface containing a 1949 price list. This gives the reader a perspective on the value of the equipment when new. Next is a table of contents listing each model, followed by the body of the work — the compilation.

The book ends with a comprehensive bibliography listing the source for each model in the book. This will be useful to those who have access to Western Electric literature.

On the up side, this is one of very few available books documenting Western Electric's horn and speaker production. It contains quite a bit of material on studio monitor speakers and theater horn systems. Mr. Nadel has worked hard to provide a comprehensive listing that will benefit all of those interested in Western Electric audio equipment.

Since each component has a model number, as well as the complete assembly, this book will be helpful in deciding what part went with which

other part. For those of us who need help identifying and understanding Western Electric speakers and horns, we hope the book's perfect binding will hold up to the extensive use it will receive!

On the downside, one would wish for more and better illustrations. The line drawings came out well, but the quality of the photos is quite variable. They seem to have come from old catalogs, service literature, and company bulletins and publications, and they reflect the varying quality of the originals. Perhaps, in the next edition, the illustrations could be improved by using modern photographs of the equipment.

Since Western Electric was independent of mainstream consumer electronics, it tended to have its own language. For instance, a cone speaker, or horn and driver, was called a "loud speaking telephone," yet, horn drivers were referred to as "receivers." Horns without drivers were called "horns." A short glossary would have been helpful to explain Western Electric terminology.

Mr. Nadel has done a fine job compiling data on Western Electric horns, speakers and related equipment. One looks forward to seeing the other books in the series.

The Western Electric Loud Speaker and Horn Compendium is published by The Historical Institute for the Study of Sound (H.I.S.S.), P. O. Box 29303, San Francisco, CA 94129, 1997. It has 58 pages softbound and may be ordered from the author at the above address for \$20, plus \$3 postage and handling (California residents add appropriate sales tax). It is also available from *Antique Radio Classified* and *Antique Electronic Supply*. Be sure to check for shipping information.

Western Electric is a registered trademark of Westrex Corporation.

© Paul Joseph Bourbin, August 1998. All rights reserved.

(Paul Joseph Bourbin, 25 Greenview Ct., San Francisco, CA 94131)

TV Book Search

BY ALCEV MASSINI

As a Brazilian vintage TV collector, I have many sets from the beginning of television in Brazil (1950). Some of them have round CRT.

I subscribe to your magazine in order to have contact with America, the land of television, so that I can find new books about it. However, I have not been very successful in my search.

The books I have found are interesting. For example, Collins' *The Golden Age of Televisions*, is a beautiful book, but lacking many details important to a collector, such as model numbers, dimensions, etc. Wood's *Classic TVs* is a collection of ads and amateur photographs that I wish contained more information.

The funny thing is that the best book I have found about television was not published in the U. S., but in Scotland — *TV is King* by Michael Bennet-Levy. I am beginning to wonder if TV collecting is a common hobby in America.

There are many fantastic books about radio — the Bunis books are an example — but I would like to find a good American book about television — a book with many, many models, historic comments, good photos (in studio), and a price guide, including indoor antennas from the Golden Age. I hope this idea will appeal to a qualified author.

(Alcev Massini, Ave. Dom Pedro II 1804/111, San Andre, Sao Paulo, Brazil)



This view of Alcev Massini's extensive TV collection certainly makes his quest for more books on the subject of TV understandable.



RADIO MISCELLANEA

"Radio Miscellanea" includes items of general interest selected from A.R.C.'s incoming correspondence. "In The Marketplace" items are based on information submitted by the businesses themselves. "From The Internet" items are obtained from internet newsgroups and other internet resources. Submitted items should be verified for accuracy; items may be edited by A.R.C. for publication, and publication is not guaranteed. See the masthead for more details.

1-Tube Radio Explanation

Dear Editor:

I especially enjoyed your April issue and read with interest Richard Parks' 1-tube radio article. What obviously happened is that the filament leads got reversed, causing the cathode to emit positrons rather than electrons. This would explain almost everything. When operating in this mode, however, care must be taken to empty the grid leak pan frequently or else, as was the case with the old battery sets, you run the risk of getting spots on your carpet.

Art Eberhardt, Florissant, CO

June '99 Issue Best Ever!

Dear Editor:

The June 1999 issue of A.R.C. is the best ever! I am referring to two of the best articles I have ever read in your fine magazine: "RCA's Intended Models for the 1923-1924 Season" and "Adventures in RCA TV Land." Simply fabulous reading!

John Wolkonowicz and the other contributors to the RCA article convey a wonderful view into the operations and style of thinking in 1923. I was captivated by the decisions and thinking processes revealed by the RCA management and engineers as they defined the future of radio. The pictures and line drawings are fascinating, especially with the comments about how these radios would be used by the customer. Absolutely first rate article! I only wish it were longer. The authors are to be commended for their research into this era of the RCA we thought we knew so well. Nice work, gentlemen!

Ray Bintliff's "Adventures in RCA TV Land" contains wonderful, insightful detail. It is interesting to see the problems the RCA engineers had with their TV design in 1946. And even more interesting is how they dealt with the problems. Ray certainly captured the essence of that era with its wild energetic spirit that drove the Hartford engineers to get TV on the air from New York. He also captivated this reader. Very nice writing, Ray!

Gregg Scholfield, Dayton, NV

RCA TV Land — a Super Article!

Dear Editor:

I really enjoyed the "Adventures in RCA TV Land" article in the June 1999 issue. Ray Bintliff had some great reminiscences of the postwar TV conversions and the capacitor problems, which I remember in the early Model 630. Most people don't remember that the 630 design was the basis for scores of TV manufacturers' models. One of my best friends, a retired broadcast consulting engineer, started with RCA Service Co. in Los Angeles after World War II converting TRKs, just as Ray did.

This article brought back some great early TV memories and reminded some of the younger collectors that TV has not always been light, dependable, and in color. A super article!

Charlie Harper, Paris, KY

"Radio Head" — On the Web

Dear Editor:

I have subscribed for years, and I am excited about A.R.C.'s putting my ads on the Web, as I am now deaf and can't use the phone. This has been frustrating my radio sales. I should explain that I am a real "radio head"; that is, I have a cochlear implant to restore my hearing.

My questions are: 1) Will there be additional charges for Web ads? 2) Will there be an easy form to submit ads? 3) Can we include hyperlinks to sites that may hold our photos? (4) Where are our Log-on ID and password located on the mailing label?

Pete Perrotti, Rochester, NY

1) All classified ads submitted for a particular issue will be placed online for that issue at no extra charge. 2) There is no special form to submit ads; for the time being, submit them in the usual manner (fax, e-mail, mail). 3) You can include a Web address in your ad, but it will not be hyperlinked at this time. 4) Referring to your mailing label, your Log-on ID is the number after the hyphen in your Sub number, and your password is the number between the brackets []. See "A.R.C. Web Site Expansion — Update" in this issue for more information. (Editor)

April Cover Evokes Memory

Dear Editor:

The April 1999 cover was of particular interest to me. As a radio operator for the U.S. Coast Guard from 1942 to 1946, I used a hand key for transmitting. I served on the Coast Guard cutter *Shawnee* out of Eureka, Cal., spent 6 months in Atlantic City, N. J., at the Coast Guard training station, operated the district station from the Diamond Head lighthouse in Honolulu, and spent 16 months in the South Pacific. Once, a terrible storm at sea interfered with my transmission to New Guinea, but someone in Australia picked up the signal and relayed it for me.

When I was 12, my brother and I learned Morse code on my first homemade code practice key. Though we were not on the air, this practice turned out to be good preparation for my future in the Coast Guard.

Giuseppe Bennett, Oakland, CA

We have learned that Giuseppe subsequently spent 44 years with Montgomery Ward, much of it managing a radio department and later teaching color TV service. His career covers a large segment of 20th century communications technology, and in reference to the April cover, the younger generation is intrigued by what is for him a memory of things past.

More Pot Lube Info

Dear Editor:

I recall having very good luck lubricating potentiometers with a product called Walscolube contact lubricant. It was made specifically for that purpose.

Barry Besmanoff, Buffalo, NY



CLASSIFIED ADVERTISEMENTS

WANTED: Books, Iceberg Patrol and, On the Pacific by Lawton. Also, Station X, by Winsor. Robert Stapleford, 1800 S.W. Randolph Ave., Topeka, KS 66604-3158

WANTED: Antique demonstration, scientific apparatus. Electrical and optical. Early microscopes. Wissner, Box 102, Ardsley, NY 10502 (914) 693-4628. E-mail: wissner@bestweb.net

WANTED: RCA RC-350 tulip grille Catalin radio; any color, doesn't work, or if the case is cracked, that's OK! Henry McCorkle, 806 5th St., SE, Roanoke, VA 24013. (540) 343-9570. E-mail: RoaRec33@aol.com

WANTED: Detroit: Commercephone, Etherphone, Powertone, Maxitone & TECLA. Michigan/Klitzen, Arborphone, International, Kadette & Cavac. Nevins Museum of Radio, Ken Nevins, 406 Jipson St., Blissfield, MI 49228. (517) 486-3019, evenings. E-mail: knevins@tc3net.com

WANTED: Radiola IIIA parts set, chassis, or tube sockets. Also, chassis for Aeriola Jr. Carl Steinberg, 5 Cannan Rd., Monsey, NY 10952. (914) 352-0701

WANTED: H.H. Scott 299B, 222C, LK48 tube amps for parts or repair. Ed Skilton, 517 Palmer Rd., Conshohocken, PA 19428. (610) 825-0557. 4 pm-10 pm, Mon.-Fri.

WANTED: Single AR1 McIntosh all tuners, tube amps, preamps, cabinets, literature, parts, whole systems. Fisher 80 AZ amp, AM80 AM tuners, Eico HFT94 AM tuner, Altec 333 amp, Thorens 121, 124 turntables, Pilot AA901 amp, Fairchild 260 amp, Karlson 15" factory speaker cabs, Scott 310 series tuners, Audiocyclopedia 1st, 2nd editions. Walt Fleming, 182 Plain Hill Rd., Norwich, CT 06360. (860) 889-1957/1937

WANTED: Glass dial to a RCA Catalin 66X7, 66X8, 66X9. Your postage returned. Gregory Sheppard, W3FSP, 4402 Jupiter St., Rockville, MD 20853. E-mail: moreradios@webtv.net

WANTED: Tubes, I need these for my own use. Offering \$32 for N.O.S. 2A3 or \$18 for good used. Offering \$15 for N.O.S. EMM801. Also others (please send list and asking prices). Happy to trade as well! Gary Kaufman, 29 Kewadin Rd., Waban, MA 02468. (617) 630-9806. E-mail: gkaufman@bu.edu

WANTED: 1920-30s Navy equipment - RAA, RAB, RAG, RAH, TAB, TAO, TAV. William Donzelli, 15 General MacArthur Dr., Carmel, NY 10512. E-mail: aw288@osfn.org

WANTED: Zenith chassis 7A02 for Models 7S529, 530, 547, 557, 558, 559. Do not need escutcheon, knobs, or speaker. Matthew Thornton, 4201 W. Bertona St., Seattle, WA 98199. (206) 284-4624

WANTED: Original color version of switch selection chart for Weston TV4AU tube tester. David M. Sites, PSC 74, Box 25, APO, AE 09718

WANTED: Operating instructions for Wilcox Gay Model 8AJ10 Recordette. John Phipps, 1412 Navaho Trl., St. Charles, MO 63304

WANTED: Manuals for AM demonstrators (receive, transmitter, power) made by Welch Scientific. Will pay for copy or original. Art Sabin, 315 S. Plymouth Ct., Chicago, IL 60604. (312) 987-1441. E-mail: 7sabin@jmls.edu

WANTED: Grundig 97 WE; tabletop radio. Contact via e-mail. N. Ahmad, 34 Saccheri Ct., Staten Island, NY 10308. (718) 966-9018. E-mail: NA1050@aol.com

.....
 • A.R.C. Advertising Policy
 • Sellers and Buyers, Please Note!
 • Advertising is accepted only for early items
 • related to radio, communication, etc. All
 • items must be described fairly; reproduc-
 • tions, reprints and not-original items must be
 • so identified. Advertisers must agree to re-
 • spond promptly to inquiries and orders, to
 • resolve problems promptly if the buyer is not
 • satisfied, and to comply with a buyer's
 • refund request on unaltered returned items.
 •

WANTED: Marconi radios. advertising & related items, NBC chimes on a wooden board. Barry A. Janov, 2454 Dempster St., Ste. 416, Des Plaines, IL 60016. (847) 827-9100. E-mail: marconifon@aol.com

WANTED: Working A-10 Type power supply, used in several all-American Mohawk models. Daniel Crowley, 61 Central Ave., E. Hartford, CT 06108. (860) 282-1309

WANTED: Tiny tube ccot pocket size portables. Paying \$200 and more for two-tone plastic models by Zephyr, Global, Starlite, Parrot and others. Also buying damaged beauties. Frequency dial needed for Wales B46. Mike Brooks, 7335 Skyline, Oakland, CA 94611. (510) 339-1751

WANTED: Pilot battery Super Wasp, junker or restorable. Bill Jelinek, 3985 Manor Loop Rd., Rhineland, WI 54501. (715) 362-2909

WANTED: Zenith Model 6-B-129 six volt radio. David L. Muse, 510 Minturn Ave., Hamlet, NC 28345

WANTED: Western Electric 62A amp, 7A auto tranz, 127C tranz 200A panel, 713C driver, 205F. Vincent Gallo, 532 LaGuardia Pl., #600, New York, NY 10012. (212) 274-0432

WANTED: Hallicrafters S-38, Globe Scout 65, Heath VF-1 vfo. Dennis Olmstead, WB9EMD, 431 Ridgewood, Glen Ellyn, IL 60137. (630) 469-0531

WANTED: Kenyon transformer S23616 or T102 and UTC HA or LS audio transformers and RCA 44BX microphones. Bob Lindahl, 10680 S.W. Wedgewood St., Portland, OR 97225. (503) 644-9643. E-mail: bob@webgpsy.net

FOR SALE: Sams Transistor Manuals TSM, complete set of 159, all numbers, most unused and some shopworn - Best Offer. Can bring to Elgin, Lansing, Indianapolis, or Cincinnati meets or within a reasonable distance to your place. Bob Schafbuch, 2811 Highland Ave., Carrollton, KY 41008. (502) 732-9650. E-mail: rjs@kih.net

FOR SALE/TRADE: Philco 20 cathedral looks and works well - \$110. GE GD60 looks and works well - \$45. Philco 920 car radio - \$20. Kadette 66X - \$49. Emerson small tombstone wood - \$65. King Model 82 less spkr - \$100. Consoles for pick up, others available call or write: Tom Guastella, 1633 W. 11th St., Brooklyn, NY 11223. (718) 256-8367

FOR SALE: Electronics books, courses, magazines, parts, etc. List for stamp. Bob Eckert, 133 E. 7th St., Clifton, NJ 07011-1104

FOR SALE: Eico HFT-90 FM tuners (2) working - \$20 ea. Plus shipping. Paul Rosen, 30 Cherrystone Dr., Willowdale, Ontario, Canada M2H 1S1. (800) 387-0233, days. (416) 493-6962, eves.

FOR SALE: Cleaning house! Table radios: Emerson 540, 811; RCA 66X13, 9X641, 10X; Philco 48-200, TH4 (chassis); several others. Zenith L505 portable, Silverstone 9315 hi-fi amplifier. TV boosters: Astatic AT-1, CT1; Bogen BB-1, BB-2; Regency DB-410A, DB-520; several others. UHF converters: Blonder-Tongue BTC99, BTU-2B; Alliance AC-80, BY-90; Granco LCU; Regency RC-600; others. SASE for list, or visit www.geocities.com/TelevisionCity/Set/6312/forsale. Mark Nelson, 17 Wentworth Rd., Natick, MA 01760-1736

FOR SALE: Have 1,500 transistor radios. List is 23 pages. Will mail or e-mail. Doug Ferrero, WB8YNZ, 70173 Hillside Ct., Romeo, MI 48065. (810) 336-0120. E-mail: ynzdsd@bign.net

— 17th Annual —

ANTIQUÉ RADIO SWAP MEET

Sunday, August 15, 1999
Seattle, Washington
9 AM to 1 PM

Shoreline Museum Parking Lot
N. 175th & Linden Avenue, North Seattle
(one mile west of Interstate 5, Exit 176)

Tune in to the largest vintage radio event in
the Northwest, featuring
tons of radios and related gear.

- Buy • Sell • Trade •
- Free Admission To All •

Sponsored by:

Puget Sound Antique Radio Association
P. O. Box 7251, Seattle, WA 98133
(425) 747-1323 or (206) 546-5495
<http://www.eskimo.com/~hhagen/psara.html>

FOR SALE: Back issues; Horn Speaker: (1985) 6-12, (1986) all, (1987) all, (1988) 1, 3, 4, 11, (1989) 3, 5-9 - \$15 inc. S&H. Radio Age: (1988) 2-9, (1989) 2, 3, 5, 8-10, (1991) 9 - \$12 inc. S&H. Maureen Martin, 1407 Memory Ln., Lutz, FL 33549. (813) 949-1835

FOR SALE/TRADE: My Knight-kit collection, R-100A, R-100, T-150, R-55A, R-55, Star Roamer, Space Spanner, O'Hopper, Span Master, (with manuals) and unassembled kits. Want either modern transceiver or digital receiver. Jack McCreary, Kwajalein Missile Range, PO Box 1500, Huntsville, AL 35807. (256) 955-1976. Fax: (256) 955-1979. E-mail: mcrearyj@smcd.army.mil or www.smcd.army.mil/kmr.html

RATE FOR ADDITIONAL WORDS:

29¢ per word

FIRST 20 WORDS FREE!

Cash or stamps OK for small amounts.

Your payment helps to keep A.R.C. healthy!

FOR SALE: DeWald 561-2, yellow, one unmatched knob, 1-1/2-inch hairline - \$750. Literature list. Showing at NEARC Nashua, NH 7/31/99 8 am to 1 pm. Dave Sutherland, PO Box 201, Spofford, NH 03462. (603) 363-4459. E-mail: echocove@cheshire.net

FOR SALE: Old catalogs. Tube reverb, intercoms, hi-fis, more - Offers. Large list - \$1 and SASE. Joseph Bedlovics, PO Box 139, Stratford, CT 06615

FOR SALE: RCA 45 record players. Model 45EY3 - \$60 plus. Model 45-J-2 - \$25 plus. Elwood F. Hunt, 308 Georgetown Rd., Carneys Point, NJ 08069. (609) 299-5259

FOR SALE: Two (2) The Wireless Age Magazines, excellent, October 1922-December 1922. Send SASE. Robert J. Stone, 711 Fisk St., Piqua, OH 45356-3729

FOR SALE: Hallicrafters: SX101A & Heath Apache TX1. SX108. SX110. SX100. SX62. SX71. SX76. SX42 & SP. National: 240D & SP NC46 & SP. NC300. Military: 6 of R390A, all restored & correct. 1051B & G restored & factory recons. Hammarlund: HQ180A & SP, HQ170. HQ145. HQ140X. HQ100A & SP. SP400 JX & PS, like new. HQ129X. HQ110. Teac X1000R reel-to-reel mint. Atwater Kent Model 40 & SP, very fine original. Lots more for sale, call. Alan Carpenter, 6850 N. Camino De Fray Marcos, Tucson, AZ 85718. (520) 575-1900

FOR SALE: My collection of tubes. Includes 300 two number types and about 3,500 others, plus 50 table model radio speakers. A deal for someone that can stop by on vacation to pick up. Willie Carr, N4XE, 2739 Colonial Ave., Roanoke, VA 24015. (540) 343-5606, call before 8 pm

FOAM SURROUND REPLACEMENT KIT

Kit c/o two foam surrounds, shims,
speaker cement and instructions.

8" kit = \$17.95 12" kit = \$21.95
10" kit = \$19.95 15" kit = \$24.95

plus \$4 S/H. N.J. add 6% sales tax

Sound Remedy

331 Virginia Ave.
Collingswood, NJ 08108
(856) 869-0238

WANTED: Phase linear amplifier Model 400 Series II with LED meters, working or not. Gregg Humanic, 540 Wicklow Ln., Monroe, OH 45050. (513) 539-8926

WANTED: Zenith Trans-Oceanic G-500, complete 100% mint condition. Photo appreciated, will return. Kenneth F. Cerva, 3851 Harbor Hts. Dr., Largo, FL 33774. (727) 584-6471

Classified Ad Deadline Noon

July 10 for Aug. 1999 Issue

Aug. 10 for Sept. 1999 Issue

Boxed, Photo, & Display Ads - 1st

WANTED: Chassis: Crosley 95 for O3CA, O3CB, O3CC, O3CP, O3CQ, O3CR. Riders 14-3. Lew Dunning, 3343 Savage Rd., Sarasota, FL 34231. (941) 922-3101

WANTED: Hallicrafters S-27B frequency coverage 36 MHz to 165 MHz, must be clean too, mint. Thomas Dziadus, 2058 Fox Pointe Dr. #2D, Aurora, IL 60504. (630) 236-3965

WANTED: Photocopy of owner/operator manuals for Radiola 80 & Simpson Handiscope Model 466. Bob Vandeberg, 5343 W. Bald Eagle Blvd., White Bear Lake, MN 55110-6410

WANTED: Obsessed collector pays top \$\$\$ for Art Deco, chrome front, mirrored, Catalin & Plaskon radios. Adam Schoolsky, PO Box 23162, Portland OR 97281. (503) 579-1080. E-mail: Radios@ArtDeco.com

WANTED: Antique medical, scientific devices, fans, horn phonographs, Deco radios and, clocks. Richard Cane, 1333 N.W. 127th Dr., Sunrise, FL 33323. (954) 846-7116. E-mail: rbcane@m8.sprynet.com

WANTED: Zenith tombstone 5S29, must be in excellent condition. Larry Boshier, PO Box 193, Paflo Pinto, TX 76484-0193. (940) 325-5333

WANTED: Blue Crosley center Bullseye 11-101U. Bill Jewell, 3800 Ridgehaven Rd., Fort Worth, TX 76116. (817) 377-4664. E-mail: OldRadios@aol.com

WANTED: Heathkit WA-1, W2 amplifiers or part sets, McIntosh Mc60 power transformer. Gary Kaufman, 29 Kewadin Pk., Waban, MA 02468. (617) 630-9806. E-mail: gkaufman@bu.edu

WANTED: Loop antenna for Pries Straight 9 Nine or specifications for building one. Dale R. Johnston, 1305 Guadalupe Dr., Westminster, MD 21157. (410) 848-5279



WANTED: Mayfair 5" R-R portable tape recorder, any condition, looking for this model only. Tracy Sands, 8850 Walker St., Cypress, CA 90630. (714) 527-5728

WANTED: Buying estates, Collins, Hallicrafters, National, Drake, Hammarlund, Johnson, Heathkit, any vintage ham radio equipment and shortwave receivers, transmitters, military radio surplus, tubes, parts, manuals, microphones. Cash waiting! Gary Farhat, 178 Fifth St., Leominster, MA 01453. (978) 537-3913. E-mail: farhats@gls.net

WANTED: AT-200 Kenmore antenna tuner. Wes Chatellier, W5DPM, 1950 Chevelle, Baton Rouge, LA 70806. E-mail: VVDL74A@prodigy.com

A. G. Tannenbaum

Electronic Service Data

PO Box 386, Ambler, PA 19002

Phone: (215) 540-8055

Fax: (215) 540-8327

THE



FOR

Vintage Parts & Service Data
1920's - Present

Credit Cards Welcome

Browse our on-line catalog at
www.agtannenbaum.com

YARD SALE!

(GRILLE CLOTH)

\$20 per yard (51" x 36") for any quantity of yards of these patterns: #15, 16A, 17, 19A, 20, 21, 22, 23, 24, 25, 26, 27 until gone.

~~\$15~~ per yard for #11 - SOLD OUT

4 New Patterns!

#30 and 31 are not what I expected so I'm selling them cheap to recover my costs - \$12/yard! (36" x 44"). (If you can use a low cost generic look, this works.) #32 is a rust-colored Philco 90 type pattern for late 30's Zenith. #33 is for Buddy Boy, Kennedy tombstone and Temple speaker, and others.

Send 55¢ LSASE (4" x 10")
for full set of samples.

MICHAEL KATZ

3987 DALEVIEW AVENUE

SEAFORD, NY 11783

(516) 781-6202 (EVENINGS/WK-ENDS)

FOR SALE: Dual tubular capacitors, 33 uF + 47 uF @ 160 volts - \$14/4 ppd. Checks must accompany order to: Frontier Capacitor, Everett Hoard, Box 218, Lehr, ND 58460

FOR SALE: University 6201 speakers, have 4 pieces in cabinets, also have book shelf 8" coax University I pair - \$150 per pair. Some other audio tube units also. Call or write: Vaughn Rudisill, 17 Pearsall Ln., Deer Park, NY 11729. (516) 667-5247

One Month Free!

BONUS FOR EARLY RENEWALS

If you renew **before** the month shown on your mailing label (your expiration month), you will receive an extra month on your subscription: 13 months instead of 12! 26 months for an early 2-year renewal!

FOR SALE: Beautiful chrome ring mike, carbon double button, w/chrome stand, cloth-covered cord, springs, circa 1920, photo available - \$375. Charles Zafonte, RR3, Box 2075, Fort Kent, ME 04743. (207) 834-6273

FOR SALE: Jukeboxes: Wurlitzer, Seeburg, Rockola - \$200-\$13,500. Sample - \$5, Year - \$30. Jukebox Collector Magazine, PO Box 624ARC, Altoona, IA 50009. (515) 265-8324

FOR SALE: Most Often Needed TV Diagrams for years 1953 thru 1960, 8 books, all for - \$40 plus shipping. Phone or write: Thomas Burnside, 4838 S. Westhaven Dr., Jackson, MS 39209-4711. (601) 922-2235

FOR SALE: Vintage Microphones, over 300 pages, compiled by Victor Bang Jr. - \$29.95, includes shipping if necessary. Available from: Video Tech Service and Repair, 7520 S. Rural Rd. #3, Tempe, AZ 85283. (480) 491-1811

Visit the A.R.C. Web Site!

The URL to access the A.R.C. Web site is:
<http://www.antiqueradio.com/>

Our site includes highlights from current and recent issues:

- Editor's Comments
- Image of the Cover
- Feature Article
- Radio Miscellanea

- Plus:
- Photo Reviews
 - Book Reviews
 - Coming Radio Events
 - Complete Club Listing
 - List of Books for Sale
 - Subscription Information

While visiting our site, you may send e-mail and orders for books, videos and subscriptions.

Let us know what you think about A.R.C. on the Web!

FOR SALE: Caps .025mfd highvoltage 6000volts axial, Diameter=7/8", Length=2", Leads=3/4" - \$1.50 ea. plus postage. Evan Powell, 4717 Conquista Ave., Lakewood, CA 90713. E-mail: Overadio@aol.com

FOR SALE: Howe crystal set - \$155. mil. 6146W. N.I.B. - \$10 ea. (4). Wm. Harder, 911 W. Northrup St., Lansing, MI 48911-3640. (517) 882-2303

FOR SALE: Canadian Marconi 807 tubes new in the box. - \$15 ea. Quantities limited. Jeff Arndt, 1215 Division St., Manitowoc, WI 54220-5734. (920) 684-8830

FOR SALE: Hewlett Packard Electronic Measurement Systems Books 1983-1985-1986 - \$30 all plus S/H. Ed Povraznik, 9606 Biddulph Rd., Brooklyn, OH 44144-3015. (216) 661-0032

FOR SALE: Heathkit IT22 capacitor tester. IT22 signal tracer. Both complete - \$60 includes shipping. Leroy Neal, 603 Butterworth Ave., Dyersburg, TN 38024. (901) 285-5120, after 8 pm CDT

FOR SALE: Majestic Melody Cruiser - \$300. Best 221 Art Deco - \$110. Dahlberg coin op - \$175. **WANTED:** DeWald pin wheel knob. Lynn Palmer, 8702 Green Valley, Houston, TX 77055. (713) 468-1103, after 7 pm

FOR SALE: I am wanting to sell out radios, magazines, tubes and a host of other stuff, 48 page list - \$2. Frank Brewster, 2020 W. 5th St., Baxter Springs, KS 66713. (316) 856-3220, evs.

FOR SALE: Tumer 34X microphone, excellent - \$250 plus \$6 UPS in U.S.A. Thanks. David S. Kendall, 401 Himes St., Huntington, IN 46750. (219) 356-5096. E-mail: ke9wi@fwi.com

FOR SALE: Sentinel 284 Catalin glass dials. Again available and perfectly reproduced - \$23 ea. ppd. Send to: Radioart, PO Box 102, Centerbrook, CT 06409

FOR SALE: Books, Elements of Radio by Marcus Hardback - \$15 plus. Basic Electronics by Rider Publications. Six softcover volumes on basics, tubes, rectifiers, power supply & others! - \$20 plus. Elwood F. Hunt, 308 Georgetown Rd., Carneys Point, NJ 08069. (609) 299-5259

FOR SALE: Due to stroke - See April issue A.R.C.: pages 26, 28, 30, 32, 34 and 36. Make offer. Please send SASE for each list. Robert J. Stone, 711 Fisk St., Piqua, OH 45356-3729

FOR SALE: Sony TVs: two 5" and one 7" - \$20 ea. Norm Kutzke, Box 272, Kawkawlin, MI 48631. (517) 684-0649

Transistor Network™

International Magazine for Transistor Collectors
Articles • Reviews • Classifieds

Subscribe Today!

\$24.95 U.S. (First Class) \$34.95 Canada (Air)

\$43.95 Other Countries (Air)

Subscribers get a free 50-word ad monthly.

Transistor Network

P.O. Box 43, Dept. C, Live Oak, FL 32064-0043

Free Sample copy upon request

www.suwanneevalley.net/~morison

TUBES WANTED



**8430 COUNTRYWOOD FAIRWAY
CORDOVA, TN 38018
Phone: 901-382-9955
Fax: 901-382-9956**

Email: amagee@electron-valve.com

Western Electric

TB=Tennis Ball

VT-2 / 205A/B S250 NOS, S125 used

VT-52 S150 NOS, S80 used

101D / 101F (TB) S185 NOS, S100 used

101D / 101F / 101L (ST) S35 NOS

102D / 102F (TB) S180 NOS, S100 used

102D / 102F (ST) S35 NOS

205D/E (TB) S445 NOS, S285 used

211A/D/E S280 NOS, S150 used

212A/D/E S750 NOS, S250 used

231D S65 NOS, S30 used

242A/B/C S300 NOS, S150 used

252A S1200 NOS, S700 used

261A S155 NOS, S80 used

262A/B S65 NOS, S35 used

274A / 274B S250 NOS, S180 used (Engraved Base)

274A / 274B S200 NOS, S130 used

275A S140 NOS, S65 used

300A S900 NOS, S675 used

300B S875 NOS, S525 used (Engraved Base)

300B S565 NOS (1950's and 1960's printed base)

310A / 310B S20 NOS, S12 used

331A S45 NOS, S23 used

348A / 349A S95 NOS, S45 used

350B S210 NOS, S95 used

417A / 420A / S755 S10 NOS

421A / 422A S35 NOS, S15 used

TRIODES:

2A3 RCA S44 NOS, S20 used

2A3 (Single Plate) S180 NOS, S100 used

10 Balloun S80 NOS, S35 used

45/245 Balloun S65 NOS, S28 used

50 Balloun S220 NOS, S120 used

VT-52 S120 NOS, S60 used

71A Balloun S28 NOS, S14 used

80/280 Balloun S32 NOS, S20 used

211 RCA /United S125 NOS

845 S200 NOS, S95 used

PENTODES:

6550 Tungsol S65 NOS

7591A S34 NOS, S18 used

6L6CC RCA (Black-Plate) S40 NOS

EL34 Mullard S80 NOS, S35 used

EL37 Mullard S75 NOS, S35 used

KT66 Genalex / Mullard S80 NOS

KT77 Gold Lion S160 NOS, S90 used

KT88 Gold Lion S185 NOS, S80 used

PREAMP / DRIVERS:

5691 Red Base S18 NOS, S10 used

5692 Red Base S34 NOS, S20 used

65N7 Sylvania / RCA S6 NOS

65L7 Sylvania / RCA S4 NOS

12AX7 /ECC83 Telefunken S38 NOS, S8 used

12AU7 /ECC81 Telefunken S34 NOS, S8 used

12AT7 /ECC82 Telefunken S30 NOS, S6 used

EB8CC Telefunken (Gold Pin) S40 NOS, S18 used

EF86 / 6267 (GEC, Amperex, Tele) S211 NOS, S8 used

Genalex 2-729 S20 NOS, S14 used

Genalex 2-759 Gold Lion 12AX7 S100 NOS

Highest prices paid for NOS tubes in original boxes. If you have any other tubes that you think we might be interested in, please call.

We will meet or beat any written offer!

We would like to buy any of your Western Electric, H.H. Scott, Marantz, Fisher, or Dynaco amplifiers or preamplifiers.

Electron Valve is also seeking the following recording gear. If you have any of the following pieces or know anyone that does, please contact us.

MICROPHONES:

Neumann U-47

Neumann U-67

Neumann U-87

Neumann KMB4

Neumann M-49

Neumann M-50 Omni

RCA 44

RCA 77

Sony C-37A

Telefunken ELAM 251



TUBES FOR MICROPHONES:

Telefunken VF-14 S600 NOS, S400 used

Telefunken AC701K S120 NOS



OUTBOARD / RACK GEAR:

Fairchild 660 / 670 Compressor

Neve 1066, 1073, 1081, 1272 Mic Pre / EQ

Telefunken V72 / V76 Mic Pre

Pultec EQ's

RCA BABA Compressor

Urei 1176 Compressor

Urei LA2A Compressor

WE BID ON SMALL OR LARGE LOTS.

IF YOU HAVE ANY QUESTIONS OR IF YOU HAVE ANY OF THE ITEMS LISTED HERE, GIVE US A CALL!

FOR SALE: Meck XA701 7-inch TV set, nice, rebuilt, plays; GE GD 500 Midget Bakelite; 4 used good 6 CA7/EL34 tubes; Aquatron VX33 Space Helmet, A-F B-track; Millen 608 scope, works; Mirandella tape recorder, original box, excellent; original user manual for Pilot T601; Temple TV1776, 7-inch TV. **WANTED:** Motorola 7VT1 ir 9T1 TVs, chassis TS18. Charles Harper, 2000 Jackstown Rd., Paris, Kentucky 40361. (606) 484-9393

FOR SALE: Hopalong Cassidy, no back - \$350. Arborphone (rounded corners) - \$100. Colin B. Kennedy XV type 430 - \$450. Grebe Synchronase Type Mu 1 - \$250. JC 820H VHF-UHF allmode ham transceiver excellent - \$1,400. TV-7D/M tube tester, checked out - \$200. I-177B tube tester - \$75. Knight KE-625 6" VTVM with manual - \$75. Much else. I am wanting to sell out and have a 48 page list of radios, books, magazines, test equipment and tubes. Send \$2 for list. Frank Brewster, 2020 W. 5th, Baxter Springs, KS 66713. (316) 856-3220, eves.

FOR SALE: Aeriola Senior - \$285. Two Crosley porcelain tube sockets - \$17. WD-11 tubes. Arthur Harrison, 20 Suttlers Row, Hilton Head, SC 29928. (843) 689-3760

FOR SALE/TRADE: Drake SW4A SWL receiver, military BC375E transmitter, PE73 Dynamotor, Longwave antenna unit. BC348, BC223ax, Heathkit SB310, SB301, Hallicrafters SX130, spkr, manual. Hammarlund HQ105tr, National NCX5, ART13, BD77 Dynamotor for BC191, N.O.S. VT4C never opened, Icom 740, all very nice. Gary Farhat, 178 Fifth St., Leominster, MA 01453. (978) 537-3913. E-mail: farhats@gis.net

FOR SALE: Teenie radio crystal set - \$175. Pilot Wasp coils - \$125. Kadette Plaskon gothic cabinet - \$295. Bill Rolf, 30131 Center Ridge, Westlake, OH 44145. (440) 871-4547

FOR SALE: Submini tubes, old books, send SASE for list. Richard P. Robinson, PO Box 1425, Wallingford, CT 06492. (203) 949-0871. E-mail: richmix@erols.com

FOR SALE: Amateur radio texts and handbooks. New condition. SASE for list. Bill Riley, W7EXB, 863 W. 38th Ave., Eugene, OR 97405-2375

FOR SALE: Nostalgia: For grads of Spraybeery Academy of Radio, Pueblo, CO, AC and DC volts to 500, hi and lo ohms, looks like new and works perfectly, test leads included, rare piece - \$50 ppd. James Fred, 5355 S. 275 W, Cutler, IN 46920

HAS YOUR SUBSCRIPTION

EXPIRED?

It has if your mailing label reads
"EXP=JUL99" or earlier.
Renew now!

**BONUS: Renew before
your "EXP" month and receive
13 issues per year instead of 12!**

"15th Year Special! Renewal rates are:
\$39.49* for Periodicals Mailing
\$57.95 for First-Class Mailing
(Two-year renewals are twice above rates.)

FOR SALE: Air King Pockette small tube portable, chassis #494 - \$95. Westinghouse Model #H-342P5U chassis and knobs only (working!) - \$40. Buyer pays shipping. Dave Hruby, 3435 37th Ave., W. Seattle, WA 98199. (206) 285-3845

FOR SALE: Used tested 544GB tubes. Six for - \$20 ppd. Headphones Western Electric, Brandes or Cannon - \$20 ea. plus. Elwood F. Hunt, 308 Georgetown Rd., Cameys Point, NJ 08069. (609) 299-5259

FOR SALE: Philcos 38-7 - \$75. 36-116X - \$150. GE A63 - \$100. Zenith 950 - \$100. John Golden, 245 Dimarco Dr., Philadelphia, PA 19154. 215-632-0955

FOR SALE: N.I.B. Power One 5 Volt 3 Amp. Power Sply. HBB5/OVP-A - \$25 + shipping. Leroy Marshall, 1178 Foxboro Ln., Bartlett, IL 60103. (630) 483-8833

FOR SALE: Bogen RP100 AM/FM amp - \$15. Zenith J514 - \$25, RCA Living Stereo Bible - \$10, Onkyo TA2025 cassette deck - \$15, RCA 7BX6J portable - \$15. All items plus shipping. Jon D. Andraesen, PO Box 22, Newton, NJ 07860. (973) 579-6261, 7 to 9 pm Eastern. E-mail: jda@nac.net

WANTED



EDISON
METERS,
LIGHT BULBS,
ELECTRIC FANS,
STOCK TICKERS,
& OTHERS



STEREO
WESTERN ELECTRIC,
JENSEN, TONNOY,
SCOTT, McIntosh,
MARANTZ, FISHER,
& OTHERS

DECO STUDIO

8-10 WEST 36TH STREET, 3RD FLOOR
NEW YORK, NY 10018
TEL. (212) 563-8046 FAX. (212) 563-8051
E-MAIL: DECOSTUDIO@MSN.COM

WANTED MICROPHONES
BROADCASTING EQUIPMENT
Amplifiers, mixers, compressors, on-air lights,
Mike flags, equalizers, literature, TV cameras,
Disk, wire & tape recorders. 16" transcriptions.
Turntables, arms, pickups, blank discs, speakers.
Commercial, home & theater audio. Interesting,
early or elaborate radio & TV sets. Buy & sell.

Robert Van Dyke, 2 Squires Ave., East Quogue NY 11942
Tel. 516 728 9835 Fax. 516 723 3538 vandvke@hamptons.com

WANTED: 8-push button for the radio General Electric Mod X-260. Old radios in Brazil: www.bn.com.br/radios-antigos. João Mello, PO Box 101, São Roque SP, Brazil, 18130-000

WANTED: A source of parts for electronic organs. Can anyone help? Alan McFarlane, 1609 South 7th St., Aberdeen, SD 57401. (605) 225-2410. E-mail: mcfarlaj@dtgnet.com

WANTED: Excellent original working Majestic 886 Park Avenue console. Stewart-Warner Gem chassis and knobs. Joseph DiCaro, 4155 Lastrada Hts., Mississauga, Ontario, Canada L5C 3V1. (905) 848-7759. E-mail: fox@globalserve.net

WANTED: Need escutcheons for Craftsmen (Radio Craftsmen) Model 10 tuner. Gary Royal, PO Box 302, Millers Creek NC 28651. (336) 838-8499

WANTED: Detrola consoles, with phonograph and without. Detrola tabletops 159, 209, 223, 254. Scott Flaugher, 41100 Plymouth Rd., Plymouth, MI 48170. (734) 737-4221. E-mail: scott.flaugher@unisis.com



WANTED: Emerson Catalin radios. Nobody pays more than I. What an arrogant and inaccurate thing to say. I mean, like there isn't anyone wealthy enough, dumb enough, desperate enough – or any combination of the three – to pay even a dollar more than I would pay. I mean, c'mon, who am I trying to kid! Please write or call collect: Rain Buttignol, 214 State St., #7, Portsmouth, NH 03801. (603) 427-1384

WANTED: Info and original paper on Silver-Marshall 630-SG shielded grid (UX222) six tube receiver; also correct SM knob for filament rheostat. Tod Prowell, W3URG, 413 North York Rd., Mechanicsburg, PA 17055-6016. (717) 697-5227

WANTED: Service manuals for RCA Radiomarine Direction Finder Model AR8712 and RCA receiver Model 18T. Al Kaiser, 713 Marlowe Rd., Cherry Hill, NJ 08003-1551. (609) 424-5387

SEND ALL A.R.C. MAIL TO
Antique Radio Classified
P.O. Box 2, Carlisle, MA 01741

WANTED: Radiola III in any condition. Martin Lamonde, 394 St. Germain, Apt 3, Quebec City, Canada G1K 4N1. E-mail: mlamonde@exfo.com

WANTED: Cover that fits radio face hiding pushbutton condensers on Zenith 7S529. Scott Scheidt, 3008 Harbor Dr., Modesto, CA 95355. (209) 522-8273. E-mail: scheidt@aol.com

WANTED: Zenith 8S661, Philco 39-17, American Bosch 440T. Heathkit AR (3), Mosley CM-1. Herman Schnur, 3205 Brick Kiln Rd., Greenville, NC 27858. (252) 752-2264

WANTED: Chassis for Philco 38-12, need not work. Operating instructions and schematics for the following; EMC Mod 204 tube tester, Supreme Instrument Co. Mod 576 signal generator. Kent Oakley, 1008 Mormon St., Folsom, CA 95630. (916) 985-4534. E-mail: Kgoakley@aol.com

New Jersey Antique Radio Club
Antique Radio Outdoor Swap Meet
Saturday, July 31, 8:00 AM - 3:00 PM*
Hightstown Country Club (new location)

NJARC has temporarily moved its Summer swapmeet back to Hightstown, N.J. with vendors displaying a spectrum of collectible old-time radios, military and civilian communication equipment, audio equipment, phonographs, and associated parts and literature. The swapmeet is **all-outdoors** (rain or shine) with tables guaranteed to the first 40 reservations.

DIRECTIONS: The Hightstown Country Club is located near Exit 8 of the N.J. Turnpike and just off Route 33. From turnpike Exit 8, go east on Route 33 about 200 yards (past "Mom's Peppermill" restaurant); continue 1/4 mile and take the first jughandle to come back west. After the first traffic light, bear right onto Monmouth St. (watch for small sign on the right), then 300 yards to the Country Club on the left. There is a Ramada Inn across the street.

RATES:

NJARC members \$15/space; non-members \$20/space. There will be a \$2 buyer admission charge.

CONTACTS / RESERVATIONS:

Marv Beeferman, 2265 Emerald Park Drive, Forked River, NJ 08731 (609-693-9430). Phil Vourtsis, 13 Cornell Place, Manalapan, NJ 07726. (732-446-2427).

**Vendors set up at 7:00; no early admittance!*

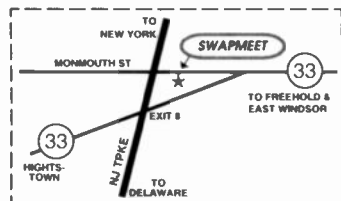

FOR SALE/TRADE: Fisher 70AZ amp, 170W, nice, W/T - \$100/BO. Roy Johnson, 2307 Palm Beach Ave., Pittsburgh, PA 15216. (412) 343-3032

FOR SALE: ARRL handbooks 1982-1993 - \$8 ea. Also old Allied catalogs - \$5, plus postage. Fenton Wood, W5AIR, 109 Shoreline Dr., Star Harbor, Malakoff, TX 75148. E-mail: fenton@tvec.net

**NOTICE TO ALL
CLASSIFIED ADVERTISERS!
OUR CLASSIFIED AD DEADLINE IS
12:00 NOON
ON THE 10th OF EACH MONTH**

FOR SALE: Catalin RCA 66X7, working - Make Offer +S/H. William J. Brinkley, Jr. 4501 4 St. N., St. Petersburg, FL 33703-4730. (727) 526-1014

FOR SALE: Two (2) RCA Nipper crate ends, 21" X 43 1/2". Send SASE. Robert J. Stone, 711 Fisk St., Piqua, OH 45356-3729

FOR SALE: Novelty radios. Photocopied Radiola, Majestic and other radio related manuals. LSASE for list. Herman Gross, 1705 Gordon Dr., Kokomo, IN 46902. E-mail: w9itt@juno.com

FOR SALE: Silvertone metal midget - \$65 ppd. Federal 59 - \$875. Pickup only. John Lowe, 3025 Harpers Ferry Rd., Sharpsburg, MD 21782. (301) 432-2420

FOR SALE: Fishers 50R - \$50; 500 - \$100; 500C; X100B. Dyna Stereo Amplifier - \$225. Pilot 245A. Bel Amplifier 6L6s - \$75. Many more. Hallicrafters, HR40 - \$100; S40B; S53; SX99; S76. Riders, Sams, Most Often Needed Radios, Television. Sams Auto Radios Series, Transistor Radios Series, others. 12" Zenith porch hole television. MS Victor with wood horn - \$5,800. Lots of test equipment. If you're picky, don't call. Charles Seldel, PO Box 1500, Merlin, OR 97532. (541) 474-2596

FOR SALE: Pre-war TV books and mags.: bound Volume 2 Television March 1929-February 1930, A. Dinsdale - \$195; Television, June 1930 nr. 28 - \$25. Television Today 1932, issues 2, 3, 4, 5, 6, 7, 8, 9 - \$125/lot. Georges Newnes Ltd., Television Reception Manfred von Ardenne, London, 1936, 96 Ill. - \$85. All prices postage included. Rudi Sillen, Limberg 31, B-2230 Herselt, Belgium. Tel/Fax: 011-32-14-54-68-89

FOR SALE: Sherwood S-1000 II integrated amp - \$130. Bell 2300 integrated amp - \$130. Dynaco FM-3 - \$50. Pair Selsyns, 115 vac - \$35. **WANTED:** Modern crystal sets, TAB 964. Joe Holdner, 109 Grassy Ridge Rd., Olivebridge, NY 12461. (914) 657-2399

FOR SALE: Revere 400 binocular case radio, excellent - \$100. Minilabs conductivity kit, as new - \$8. Harry Blesy, N9CQX, 9S740 Clarendon Hills Rd., Hinsdale, IL 60521. (630) 789-1793

FOR SALE: Deluxe Mod 410 TRF, wood, chrome front grille, GC w/schematic - \$125. Stromberg-Carlson Mod 420H chassis, recapped, no spkr, but can probably supply one for it, plays exc AM-SW - \$75. Crosley Mod 66TA, 1945, Bakelite, recapped - \$100. Philco 116X chassis, recapped, orig. field coil, output trsfmr., not original spkr, 11-tube - \$125 shipped. Speaker for Philco Mod 87 - \$40. Heathkit cap checker Mod IT-28 - \$35. Heathkit sine-square gen. Mod 1G-82 w/manual - \$50. Heathkit sig. gen. Mod 1G-102 - \$35. Heathkit isolation trsfmr. Mod IT-1 - \$35. Hickok Mod 610A TV-FM sig. gen. - \$75. N.R.I. Mod 33 sig. tracer - \$35. Heathkit Mod TS-2 TV alignment gen. - \$35. Eico Mod 425 push-pull oscilloscope w/manual - \$50. Eico Mod 147 sig. tracer, no leads - \$35. Classic Plastic Radios of the 30s and 40s, softcover, exc - \$50. All prices do not include shipping unless otherwise noted. Thank you. **MESSAGE:** E-mail from Holland. D&K's Antique Radios, 2767 Cottage Rd., Lafayette, IL 61449. (309) 932-9097. E-mail: radios1@yahoo.com

CALL FOR OUR FREE 72 PAGE CATALOG!

ANTIQUE ELECTRONIC SUPPLY 1999 CATALOG
TUBES - PARTS - BOOKS - SUPPLIES



607.820.5411 FAX 607.820.4643 or 800.706.6789

2221 SOUTH MAPLE AVE. TEMPE, AZ 85283

TUBES PARTS SUPPLIES

ANTIQUE ELECTRONIC SUPPLY
LIMITED PARTNERSHIP

your complete source for...

- Tubes:** Over 3500 receiving, transmitting, audio and industrial types. In stock, including many foreign and early types.
- Transformers:** Hard to find power, filament, and output transformers as well as filter chokes for tube equipment. We feature HAMMOND performance transformers as well as many new old stock transformers.
- Capacitors:** High voltage electrolytic and mylar capacitors, multi-section capacitors and more for tube circuits.
- Parts:** Resistors, tube sockets, potentiometers, knobs, dial belt lamps, diodes, speakers, wire, phonograph needles and much more.
- Literature:** Extensive selection of literature and books on antique radios, tubes, circuit diagrams, communication gear, and hi-fi equipment. Some items not available elsewhere!
- Supplies:** Grill cloth, cabinet restoration supplies, batteries, chemicals, tools, test meters, kits and gifts.

6221 S. Maple Ave. • Tempe, AZ 85283 • (480) 820-5411 • FAX (480) 820-4643 or (800) 706-6789
www.tubesandmore.com • E-MAIL info@tubesandmore.com



Radio Era CD-ROM publications can add "sizzle" to your summer antique radio pursuits . . .

John F. Riders "Perpetual Troubleshooter's Manual".

All 23 Volumes with over 40,000 schematics for over 120,000 different models. Truly the work of a lifetime - if you are serious about your antique radio hobby, you owe it to yourself to buy this 6-set CD-Series. Find schematics "instantly" using our database search - - even if you don't know who made it or what the model number is, you can find it with a chassis number. Runs with Windows on a PC. View, enlarge, rotate and print all schematics. An invaluable resource that will bring order to your life over and over again - thousands sold so try a set today.

Complete Set of 6-CD's \$ 450 postpaid USA

Individual sets (4-volumes) 1-4, 5-8, 9-12, 13-16, 17-20 & 20-23 available for \$ 85 per CD

Dial-Cord CD-ROM - Ever been stumped with re-stringing that old receiver and wasted hours? This CD is for you.

RCA HB-3 - Over 7,000 pages of great tube data, graphs, diagrams on just about every kind of tube made!

RCA Radiotron Handbook - Over 1600 pages of design data, great tube radio & amplifier design data - 4th edition!
R390 & R390A Military CD-ROM - has all the technical manuals, history of these remarkable receivers and more!

Radiophile Vols 1, 2, and 3 CD-ROM's - have thousands of pages of books, history and reference materials.

Antique Radio Repair - Vol. 1 - a condensed version with what you will need to learn how to repair old radios.

Antique Radio Repair - Vol. 2 - More John Rider books and publication; on radio theory and troubleshooting info
"Faster than a speeding bullet" - hilarious & informative book on the age of radio and old radio programs.

"Amos 'N Andy" on CD-ROM - Audio CD-ROM with lost 1940's episodes of this great old radio program.

"The Radio Boys" - first two books, "First Wireless" and "At Ocean Point" - great reading for young and old!

"80 Years of QST" - all magazines from the ARRL from 1915 through 1994 - truly the history of radio at its best!

Coming soon - All of the Collins Radio equipment manuals on CD-ROM - keep tuned for new releases

Other services of REA include buying and selling old radios. We offer information, valuation and appraisal services for old radios. We run a schematic service bureau for those who need an occasional service and schematic diagram to fix an old radio. We have other resource information, old sales brochures and even complete manuals for old radio equipment. We do research to find who made "that" old radio, what its model number is and research on historical information about the maker. We buy & sell estates of radios and we offer written appraisals for insurance or estate purposes. We also have thousands of service manuals on amateur (ham) equipment available for fast shipment. We would invite all who are interested to browse our Internet web site at <http://www.radioera.com>. We think you will find something you may be looking for - so we hope you can drop in soon.

SCHEMATIC DIAGRAM SERVICE - over 150,000 schematics available and thousands of radio manuals are now available. MANY WITH ELECTRONIC DELIVERY BY EMAIL - We have thousands of satisfied customers for our old radio publications, try us today!

RADIO ERA ARCHIVES

2043 Empire Central
Dallas, Texas 75235

Inquiries: 214-358-5195
Email: tsm@radioera.com

Fax: 214-357-4693

Hours: 9-5 M-F CST

Visit us on the Internet:
<http://www.radioera.com>

FOR SALE: Hallicrafters S38B, works, missing rear cover & (2) knobs - \$35 delivered. SASE list. Tom Tetzlaff, 23 Nelson Dr., Silver Bay, MN 55614. (218) 226-4192. E-mail: catt@lakenet.com

FOR SALE: Tubes, parts, books/papers. Radios: Bendix 75P6U & 0626A, AK 40 & 55, Halson 25, others. 16 pp. - 55¢ LSASE. **WANTED:** Chassis (A.R.C. Sept. '98, p. 9). W.F. Horn, 13110 Marsh Rd., Bealeton, VA 22712. (540) 439-9781. E-mail: wehcoll@tidalwave.net

FOR SALE: Edwards 1238 relay, good condition, WE CW929 loudspeaking telephone driver works, WW11 Signal Corps VOM 3" Triplett meter worth? - Offers. Andy Burnett, 9203 Lyndonway Dr., Richmond, VA 23229. E-mail: MABurn2@juno.com

FOR SALE: In Door County, Wisconsin, or will ship from buildings full of antique and collectible electronic goodies, books. For expanded list, send two-stamp LSASE, or stop in to: John Enig, Sr., K9HJL, 5425 Cherry Ln., Egg Harbor, WI 54209. (920) 743-3672

FOR SALE: Zenith 6D311 - \$150. H615 - \$40. Philco 49-901 secretary - \$150. Arvin 544A left-handed Bakelite - \$50. 540T - \$60. Ross Mason, 715 S. Pennsylvania, Mason City, IA 50401. (515) 423-4687

FOR SALE: Zenith T-O brown leather 600, vg, plays excellent - \$325. Panasonic SW RF-3000, parts - \$40. Ed Kalpa, 4622 Melbourne Ave., Los Angeles, CA 90027. (323) 661-1221

FOR SALE: 1981 Communications World with complete White's Radio Log, new condition - \$30 U.S. Jethro F. Perry, Box 488, Lewisporte, Newfoundland, Canada A0G 3A0. (709) 535-2205

FOR SALE: Powerstat 7.5 amp variable auto transformer. Neat compact case with fuse, off/on sw., line cord, receptacle - \$25. Mervyn Ellsworth, 2309 N. 25 St., Boise, ID 83702. (208) 345-6878

BUY • SELL • TRADE

CATALIN RADIOS

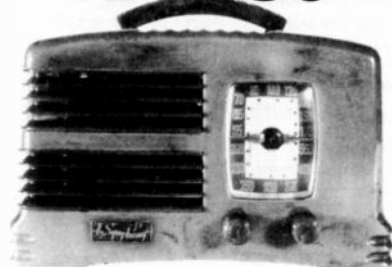

I'll buy single pieces or
whole collections. Top prices paid.

RADIOART

Jim Meehan

P.O. Box 102 • Centerbrook, CT 06409

(860) 526-1762

E-mail: radioart@nplx.net

FOR SALE: Sams Photofacts, complete sets - \$2 ea. plus postage. Bill Olson, 4023 N - 2000 E, Filer, ID 83328. (208) 326-4962

FOR SALE: B&K 960 transistor radio analyst with photocopy of manual - \$35 + UPS. Rod Galloway, 2220 Woodbury Rd., Melbourne, FL 32935. (407) 254-0280

FOR SALE: The Lord Baltimore 3-current chloride silver carbolic battery, pat. 1896, fake medical device - \$125. David Buck, 3630 Wilcox St., San Diego, CA 92106

PHONE NUMBER FOR ANTIQUE RADIO CLASSIFIED (978) 371-0512

Best time to call is weekdays:

9 am to 5 pm Eastern Time

(Please no classified ads by phone. Thanks!)

FOR SALE/TRADE: N.I.B. 5-tube table radio kit, M.J.J., small ivory plastic - \$50 includes shipping. Paul Fulton, 711 Jacquelyn Rd., Westwood, NJ 07675. (201) 664-5260

FOR SALE: Citizens Radio Callbooks, Radio Review, Listeners Guide, 38 issues, 1924-1932 - \$750. Floyd A. Paul, 1545 Raymond Ave., Glendale, CA 91201. (818) 242-8961

FOR SALE: Radio-Electronics correspondence course, 10 volumes, 100 lessons - \$40 plus shipping. Jack A. Freeman, 2512 Sunnycrest Dr., Reidsville, NC 27320. (336) 349-6656

FOR SALE: Any interest? Sanborn two-channel DC recorder. R. Stanley, 11 Kimball Ter., Newtonville, MA 02460. (617) 969-5934

FOR SALE: Mirror-Tone custom Model 650 - \$25 plus postage. Joseph J. Jordan, 57 Waverly St., Jersey City, NJ 07306. (201) 963-4625

FOR SALE: Westinghouse Refrigerator Model 126, white, works, original paint, no cracks - \$115 plus shipping. Ron Marley, 172 Brandi Way, Winchester, TN 37398. (931) 967-7219

FOR SALE: Hickock 539C tube tester w/manual & obs tube data - \$275; 539B - \$225. Plus shipping. Charles Kirsten, Radio Relics, 15556 Sandra Ln., Sylmar, CA 91342. (818) 364-0491

FOR SALE: Ammeter O-3000 DC amperes - \$10 ppd. Radio Engineers Data Handbook - \$25 ppd. Rich Yoch, 22410 Bartlett Dr., Rocky River, OH 44116. Phone/fax: (440) 331-9206

WANTED

EARLY TUBES

Arcturus, DeForest and earlier uncommon types. Also buying balloon shape tubes of all types. Send your list for our offers.

For list of tubes for sale send SASE or e-mail fathauer@home.com
See <http://members.home.net/fathauer>

George H. Fathauer

666 W. 1st St., Ste 4, Tempe, AZ

480/921-9961 fax 921-9957

WANTED: Navy RBM-5-M.F. low frequency receiver. I will pay a fair price for a good clean working or restorable unit. Contact: Sheldon Kane, 360 Rhinecliff Dr., Rochester, NY 14618. Call: (716) 442-6338. E-mail: Auxch@aol.com

WANTED: Will pay many \$ for a working Seeburg Model B phono found in several 1940s radio/phonos including Zenith 12H689. John Sementilli-Darn, 98 Jackson Hill Rd., Middlefield, CT 06455. (860) 616-2230. E-mail: jdann@medspan.com

WANTED: Zenith Royal 810 Symphonette FM/AM transistor radio. Chris Jones, 38 S. Ridge Trl., Fairport, NY 14450. (716) 223-0095



WANTED: The paper cone-type speaker shown above, made by Utah in the shape of an open book. Need not work. Thanks. Dave Crocker, 4B Beechwood Point Dr., Mashpee, MA 02649. (508) 477-1578

WANTED: WWII Japanese military radio of any kind; anything WWII Japanese military hardware, especially aircraft related. Takashi Doi, 1-21-4, Minamidai, Seyaku, Yokohama, 246 Japan. Fax: 011-8145-301-8069. E-mail: taka-doi@a2.ctktv.ne.jp

WANTED: Payphones, 3 slot, Automatic Electric, Western Electric, any color. I pay highest prices. Stanley Schreier, 350 Hendrickson Ave., Lynbrook, NY 11563. (516) 887-4966. Fax: (516) 887-4780

WANTED: A demonstrator radio as seen on page 109 of Ed Romney's Fixing Up Nice Old Radios. Bill Olson, 4023 N - 2000 E, Filer, ID 83328. (208) 326-4962



WANTED: Air King Skyscraper radios, except for that unbearably ugly model with the third (tuning) eye at the top that bears better resemblance to a flounder than to the face of a building. Please write or call collect: Rain Buttignol, 214 State St., #7, Portsmouth, NH 03801. (603) 427-1384

WANTED: Handle for an Emerson Patriot, red or blue. Robert Lutz, 9100 Noland Rd., Lenexa, KS 66215. (913) 894-1327

WANTED: Bendix Model 853 and 953 radios. Radios need not work. Aaron Mall, 903 Dropleaf Ct., Baltimore, MD 21208. (410) 486-8813

WANTED: Geiger counter, using easy to get batteries. Philco 84B chassis and speaker. Need cabinet for Zenith 5S228. Need Philco 640 chassis and speaker. Clayton Mundine, 6112 S. Flores St., San Antonio, TX 78214

WANTED: Record cutting machines, Chrysler Highway Hifi automotive record players, cute portable suitcase phonographs. Kim Gutzke, 7134 15th Ave. S, Minneapolis, MN 55423. (612) 869-4963

— WANTED —
**PICTURES FOR PHOTO REVIEW OR TELEGRAPH REVIEW
PHOTOS MUST BE SHARP IN DETAIL
A SHORT DESCRIPTION IS A MUST!
SEE PHOTO REVIEW PAGES FOR
ADDITIONAL INFORMATION**

WANTED: Three tube assembly for Atwater Kent 4052. Mike Itzo, 2690 65 Ave., S, St. Petersburg, FL 33712. E-mail: Soldradios@aol.com

WANTED: Electron tubes, ball bearings, radio & aircraft receivers & transmitters, connectors, lamps, relays, switches breakers. Hy Ness Company, 709B Delair Rd., Cranbury, NJ 08512-4212. (609) 395-1116. Fax: (609) 395-1117

WANTED: DeForest F-5 chassis, Tuska audio transformers, AK-273. Parts chassis for AK-465Q, junker OK. Bob Nicholson, 2745 S.W. Villa West Dr., #1308, Topeka, KS 66614-5236. (785) 271-5604

WANTED: Old dynamotors or rotary inverter w. 12Vdc input to any output over 100V. Hank Andreoni, c/o 250-D So. Lyon Ave., Hemet, CA 92543

WANTED: Chassis for Mercury Junior cathedral, produced by H.M. Kipp of Toronto, Canada. Brad Winder, Box 160, Hay Lakes, Alberta, Canada, T0B 1W0. E-mail: rubcad58@hotmail.com

Join the
AWA

ANTIQUE WIRELESS ASSOCIATION
THE ORIGINAL AND LARGEST HISTORICAL RADIO-COLLECTOR GROUP

- Publishes *Old Timer's Bulletin* with:
 - Battery and AC receiver restoration
 - Vacuum-tube history and collecting
 - Old-time amateur-radio contests
 - Communications receivers
 - Free want-sell-swap ads
 - Early television
 - Horn loudspeakers
 - Reviews of current books
 - Keys and land-line telegraphy
 - News of U. S. and foreign clubs
 - Information on public radio museums.
- Maintains unique radio-TV museum.
- Produces the annual Rochester meet.
- Co-sponsors local meets.
- Publishes the annual **AWA Review**.



Membership is only \$15 per year (\$27 for two years, \$18 per year for overseas). Mail check to:

Antique Wireless Association, Inc.
Box E, Breesport, NY 14816

FOR SALE: Radiola X, needs speaker - \$450. Heathkit tube stereo amp - \$150. Paul Recupero, 265 Union St., Portsmouth, RI 02871-2209. (401) 847-8589

FOR SALE: Electro-Voice TV booster #3010 SuperTenna Top. Sams Photofacts, cheap. Ann Bichanich, Jay's, 15 W. Lake St., Chisholm, MN 55719

FOR SALE: Ribbon microphone Fostex M88RP bi-directional 40-18,000mint cond., case and cable - \$700. Mark Schackow, 307 4th Ave., E, Lemmon, SD 57638. (605) 374-3424

CLASSIFIED AD NOTICE

Please check your ads carefully before sending them in. Once ads are received, it is not always possible to refund the amount sent, pull the ad or make changes.

FOR SALE: Hewlett Packard HP28S calculator and printer, with manuals and extra paper - \$100, plus shipping. Wini Reauveau, PO Box 73032, Las Vegas, NV 89170-3032. (702) 795-2613

FOR SALE: Heathkit AA-32 stereo tube type amplifier, not tested - \$20 + UPS. Donald Sochurek, W191 S7500 Richdorf Dr., Muskego WI 53150. (414) 679-0212

FOR SALE: RCA radio phono console 1941 anniversary Model V205 BC, SW, 9-tubes, dial push button, 6-knobs, AM - \$100. Sparton table Model 661RP radio phono recorder - \$75. Frank Conti, 37 McGuinness Blvd., Brooklyn, NY 11222. (718) 383-5157

FOR SALE: B&K cathode ray tube tester - \$35 plus postage. Bob Barr, 3130 Bellanca St., Columbus, GA 31909-5117. (706) 322-2180

FOR SALE: Tube testers, other testers, radios, tubes, parts. Radio books, manuals. SASE for list. Harry Cap, 190 Beech St., Bridgewater, MA 02324. (508) 697-8648

FOR SALE: RCA portable TV in a Bakelite case, 9" tube corner to corner, case is 10" cube with handle and tuning controls on top - Best Offer. Etwood F. Hunt, 308 Georgetown Rd., Carneys Point, NJ 08069. (609) 299-5259

FOR SALE: Zenith MH console, good original - \$125. BC779-A Hammarlund Superpro, no power supply - \$75. Lot auto radio service books 5 Delco, 1 Motorola, Sams - \$50. Operadio drum speaker - \$25. Zenith 1000-D - \$125. RCA R90-P deluxe 2 band floor model - \$175. National SW54, general coverage, rusty - \$25. Radiomarine ET 8044 boat radio - \$50. Shipping extra. Richard Foster, 12 Shawmut Ave., Cochituate, MA 01778. (800) 201-2635, afternoons

FOR SALE: Ampran CT-50, extend Amprobe 5000 Amps, fits 4 X 9 buss, 5kv insulation - \$50. Carl Hackenson, 31 Hixson Farm Rd., Sharon, MA 02067. (781) 784-8834

FOR SALE: AK130 with tubes - \$150. Cornell-Dubilier decade capacitors - \$20. Radio/TE lists with photos. R. Allen, 399 Canterbury Tpke., Norwich, CT 06360. E-mail: allens@99main.com

FOR SALE: Two RCA 45 rpm record players, one Bakelite, one cloth covered - \$35 & \$20. Firestone midget Bakelite radio, chunk out of top, nice to restore - \$40. Crosley clock radio Mod E90CE - \$45. Zenith clock radio Mod 1520 missing tuning knob - \$40. Hickok Mod 533A tube tester - Make Offer. Crown 4-band Mod TRF-1400-I - \$10. Audiotronics 312T solid state 4-speed RP - \$25. All plus post. Thank ya'll. Robert Parke, 504 Essex St., Gloucester City, NJ 08030-1215. (609) 742-8221. E-mail: Radiobob29@aol.com

FOR SALE: Antique radio schematics plus data, still only - \$3 ppd. Joseph R. Forth, 321 Long Vue Acres, Wheeling, WV 26003. Ph./fax: (304) 277-3154. E-mail: wa2trt@juno.com

HIGHEST PRICES PAID FOR NEW and USED TUBES

WANTED!

*Western
Electric*

VT25/A VT52 101D/F 104D
205D/E/F 211A/D/E 212A/D/E
231D 239A 252A 262A/B
264A/B/C 274A/B 275A 300A/B
301A 310A/B 311A/B 347A
348A 349A 350B 412A
417A 421A 422A 437A

OTHER TUBES WANTED!

2A3 5AR4/GZ34 6BQ5/EL84 6CA7/EL34
6DJ8/ECC88 6L6G/GC 6SN7GTB 6V6G/GT
10(GLOBE) 12AT7/ECC81 12AU7/ECC82
12AX7/ECC83 (Amperex/Mullard/RCA/Telefunken)
45(GLOBE) 50(ST & GLOBE) KT66 KT77 KT88
211 EF804S 845 5691 & 5692 (Red Base)
6267/EF86 6550 7025 7189 7199 7591/A, etc.

IF YOU HAVE ANY OF THE TUBES LISTED IN THIS AD,
PLEASE Call, Fax or E-Mail DON SINGERHOUSE

Call TOLL-FREE (Tel / Fax) **(888) 715-8823**

E-Mail singtube@frontiernet.net

SINGERHOUSE
SOUND, LLC

PO Box 321, New Richmond, Wisconsin 54017

Est. 1994

WANTED: Russian table and portable radios from the 40s, 50s and 60s, preferably in good working condition. Louie Scribner, 150 E. Connecticut Ave., Southern Pines, NC 28387. (910) 695-8884. E-mail: louie@pinehurst.net

WANTED: Remote for Zenith TV, Space Commander 300, 2 buttons, reasonable (for my kitchen TV). Ken Doyle, 31 Pascack Rd., Park Ridge, NJ 07656-2019. (201) 391-4948

FREE – 20 WORD AD EACH MONTH
To get your free 20 words,
include your SUB# with your Ad.
Additional words are 29¢ each.
Read inside back cover for details.
MANY THANKS!!!!

WANTED: R-32 Victor power pack output amplifier in working condition. Bob Handloser, 340 Corona Ave., Long Beach, CA 90803. (562) 438-0988

WANTED: Owner's manual for 1942 Motorola portable (Model 61L11 or 61L12). Mike Hanke, PO Box 773, Wausau, WI 54402

WANTED: DeForest DV3 audions, need (4) good used. Connecticut J-113 rheostat, J-121 audio xfms. J.C. Woychowski, 81 Penn. Ave., Niantic, CT 06357. (860) 739-6579

WANTED: 1940s TVs: Viewtone, Videodyne, Farnsworth, Meissner, Motorola VT105, DuMont Club/Cliffon (RA102 chassis), Scott with DuMont RA102 chassis, any automatic TV cabinet, Andrea KTE-5, DuMont 180s, RCA TRK parts or complete sets. **FOR SALE/TRADE:** 1948 GE 10" Model 806, Admiral 10" Bakelite table Model 20X12, 1950s Philco Seventeen II (uses the Predicta chassis). Ed Dessau, 40 Verana Rd., Monroe, CT 06468. (203) 452-1981. E-mail: ekdessau@aol.com

WANTED: Mitchell, Mitchell, Mitchell brand radios and appliances. Many models needed! (but not bedlamp or tall clock radios). Thanks. Lee Mitchell, 175 E. Delaware, 8209, Chicago, IL 60611. (800) 869-7869. E-mail: toystoys@webtv.net

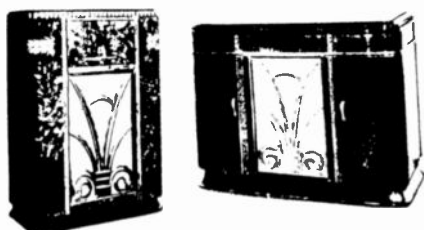

WANTED: Collector seeking 1935 GE Models A-205 and A-208 radio/phone. Can arrange pickup. Still looking for GE E-155 and RCA 15K. Thanks for your time. Dan Gutowski, 9753 Easton Rd., Dexter, MI 48130. (734) 433-1354

WANTED: Sony TR-63, Sony TR-52; any kind of Japanese-made transistor radio which used with oval transistor Takashi Doi, 1-21-4, Minamidai, Seyaku, Yokohama, 246 Japan. Fax: 011-8145-301-8069. E-mail: taka-doi@a2.ctktv.ne.jp

WANTED: Western Electric amplifier, 25 A/B, parts, 560AW cone speaker, parts, tubes: 101D, 104D, 205D/E/F, 216A, 217A. Westinghouse WL-787 tube. UTC input/interstage transformers. Ming Yang, 1995 University Ave., #119, Berkeley, CA 94704. (925) 376-4220. E-mail: yang1240@aol.com

WANTED: Vibroplex Zephyr (3" base). Info/diagrams for Collins PM-2 National AGS power supplies. Brian Roberts, K9VKY, 130 Tara Dr., Fombell, PA 16123. (724) 758-2688

New Wireless Pioneers Books, Magazines, Literature Bought and Sold

New Wireless Pioneers buys and sells books, catalogs, magazines and other literature from the 1800's to 1950 that deal with early radio, wireless and electricity. A selection from our list of specialties:

Pre-1900 Electricity
Pre-1925 Radio or Wireless
Pre-1950 Computers

Pre-1900 Telegraphy
Pre-1940 Television
Early X-Ray

Magazines, Catalogs, Autographs or Ephemera related to the above topics. Also: Pre-1920 Wireless and Telegraph Apparatus – Radio-Related Novelties and Advertising – Early Vacuum Tubes and Electrical Devices.
Some items available in other technical subject areas also.

Several catalogs featuring items for sale are published each year.

New Wireless Pioneers – Jim & Felicia Kreuzer
P.O. Box 398, Elma, NY 14059

Phone: (716) 681-3186 Fax: (716) 681-4540

FOR SALE: Rider's 10-16 - \$15 ea. (78) Photofacts 1009-2040 - \$1 ea., \$50 all. TSMs 24-154 - \$2.50 ea. Books, magazines, RA Handbooks, manuals, LSASE. B&K 960 transistor analyzer - \$25. Fluke 8000 multimeter - \$35. Sencore CR133 CRT tester - \$35. New London 100A FM signal generator - \$100. TS585DU output meter - \$25. Simpson 260 - \$25. Bell & Howell, Heath IMD1210, digital multimeter - \$30. Kikusui 100 MHz scope - \$80. HP logic clip, probe & pulsar w/pouch - \$35. More LSASE. All plus shipping. Robert P. Morrison, 10238 117th Ln., Live Oak, FL 32060. (904) 362-1521, leave msg. E-mail: rrmorison@suwanneevalley.net

FOR SALE/TRADE: Attention audiophiles. I have just acquired the grail of turntables, being the 1980s Oracle Delphi. This was the two speed improved gold tint glass version with belt drive & constant servo motor. It has been completely adjusted and aligned by factory techs. Also included is the Zeta tonearm w/audioquest/technica cartridge. Original value \$3,000, my asking price is - \$1,500 total + shipping. Call: Larry Drago, 383 Lincoln Dr., Cheshire, CT 06410. (203) 272-6030. E-mail: theradioman@webtv.net

FOR SALE: Delco auto radio parts N.I.B. from 50s & 60s (?), approximately 70 switches, tone, volume controls for Pontiac, Chevrolet, Buick, Cadillac, etc.; (10) boxes chrome knobs for Buick, Olds. Also assorted loose knobs, dial glass, transformers - \$75 for all plus shipping. Richard Haneline, 3600 Cuba Blvd., Monroe, LA 71201. (318) 323-9657, between 8 am and 6 pm

FOR SALE: Automatic 613X - \$95. Emerson 511 - \$55. 541 - \$60. R-153 - \$90. GE 210 - \$50. 321 - \$60. Silvertone 4421 - \$100. Stromberg-Carlson 1000-H - \$55. Truetone D2634 - \$60. Lafayette SB7 - \$60. Truetone 6D117 - \$60. Philco PT-30 - \$60. 39-25 - \$100. 48-482-121 - \$100. RCABT-71 - \$90. T-49A - \$90. 18T - \$90. 75X14 maroon - \$75. Westinghouse H-173 - \$60. H-104 - \$100. WR-260 - \$90. Thompson V-50 - \$150. Standardyne - \$125. J. Gary Cameron, 824 Andrews St., Southington, CT 06489. (860) 276-9200

FOR SALE: Philco Predicta 3408 17" table top, very clean & complete - \$475. Predicta #4730 Danish Modern - \$18. Predicta G4242 21" table top, very clean - \$450. Predicta poster 19 1/2 x 12 1/2 copy of the original - \$7.50. All plus UPS. David Weddington, 2702 Albany Ct., Murfreesboro, TN 37129. (615) 890-7498

FOR SALE: Sony stereo transistor tape recorder #TC-230 w/manual & detachable speakers, great condition - \$50. Plus UPS. **WANTED:** Late 30s Zenith or Philco tombstone; Philco 37-116-122 owners manual (or copy). Dick Friedman, 1502 Elmwood, Wilmette, IL 60091. (847) 803-3050

FOR SALE: 55c LSASE for list of new/used receiving/transmitting tubes. Sell or trade for old or unusual tubes or related material for my collection. John H. Walker, Jr., 11015 W. 126th Ter., Overland Park, KS 66213. (913) 782-6455. E-mail: johnh.walker@alliedsignal.com

FOR SALE: Homemade galena crystal sets. Parts. Books. Radio parts, etc. free list. L. Gardner, 458 Two Mile Creek Rd., Tonawanda, NY 14150

FOR SALE: Brand new steel black wrinkle finish enclosure, 8 x 10 x 10 - \$20. Shipping included. Louis L. D'Antuono, 8802 Ridge Blvd., Brooklyn, NY 11209. (718) 478-9612, after 6 pm

FOR SALE: Send for list of items for sale. Roger & Mary Ellen Ruddick, 33 Emily Ln., Ft. Myers Beach, FL 33931. (941) 463-8887

FOR SALE: RCA 721, 1947 TV - \$350 beautiful condition. Many other TV sets, call for wants, also CRTs and chassis. **SERVICES:** Repair TV sets of all types from 40s, 50s, 60s, Predicta, also specialize. Also, don't forget July 10 garage sale. Call or write: Vaughn Rudisill, 17 Pearsall Ave., Deer Park, NY 11725. (516) 667-5247

FOR SALE: Philco 60 cathedral, veneer rippled - \$80. Zenith 6S52 console - \$150. Radio Physics course, Ghirardi 1st Ed, 1930 - \$35. Stewart-Warner Porto Baradio, has bottles, not perfect - \$95. Send or call with your wants. Matt Hussey, 8 Capitol Cir., Rochester, NH 03867. (603) 332-9927

**HAVE YOU MOVED? ARE YOU MOVING?
PLEASE NOTIFY US A.S.A.P.
SEND US YOUR...
OLD ADDRESS
NEW ADDRESS and
SUB #
MANY THANKS!!!!**

FOR SALE: Beitman Most Often Needed TV 1951, 1953, thru 1959 - \$8 ea. Parting out two Philco 40-180, no pushbuttons. Heathkit Model 10-12 scope - \$25. Stromberg 60 chassis - \$30. RCA 58AV radio/phone whole or parts. Pilot T301 - \$30. **WANTED:** Dial for GE E61 tombstone. Brian Kurre, 2222 Nodleigh Ter., Jarrettsville, MD 21084. (410) 692-0450

FOR SALE: Westinghouse tube caddy with (40) N.O.S. tubes - \$50. Ed Kalpa, 4622 Melbourne Ave., Los Angeles, CA 90027. (323) 661-1221

FOR SALE: Radio schematics - \$2.50. Rider's Radio & TV manuals. Xerox copies of service manuals: Zenith, 942 pp. - \$65. Philco, 300 pp. - \$30. Crosley, 322 pp. - \$30. Atwater Kent, 463 pp. - \$35. Rider's Radio Index 1 through 23 - \$20. Books, SASE for list. All plus shipping. Dick Oliver, 28604 Schwalm Dr., Elkhart, IN 46517. (219) 522-4516

FOR SALE: Tube/transistor tester EMC #213, parts, books, cavities, more, offers welcome, SASE list. Bill Tucker, W4FXE, 1965 S. Ocean Dr., 15-G, Hallandale, FL 33009. (954) 456-1349

FOR SALE: Harman Kardon TP-200 Concerto receiver w/HK250 amp - \$350. Dynaco ST-120A chrome amp - \$85. Walter Kiefner, 6233 51st Ave. NE, Seattle, WA 98115. (206) 526-1452

FOR SALE/TRADE: Crosley Showbox 2 Dynacone Type F spkr, good, working - \$125. Philco 39-7, good, working - \$49. Bob Fuerderer, Holly Farm, 813 Rte. 12A, Surry, NH 03431. (603) 352-3005

FOR SALE: Huge Piezo Crystal 42 pounds - \$250. Heathkit and Allied AM signal generators - \$50 ea. New Tektronix 7704 scope with 4 pluggings and all manuals, includes waveform storage computer module, all for - \$500. (5,000) boxed good (most are new) tubes includes 5691/92, 5U4, Amperex etc. etc. - \$3,500 for all. G S Electronics Co., 1270 Rock Creek Cir., Lafayette, CO 80026

FOR SALE: Splittorf RV-580 parts set - \$30. Kevin Kuehn, 1615 13 1/2 Ave., Barron, WI 54812. (715) 537-3225 or (715) 637-9395 evenings

WANTED: Japanese Star or Starline made ham receiver SR-500, SR-550, SR-600, SR-700 and ST-700 transmitter; Lafayette HA-350. Takashi Doi, 1-21-4, Minamidai, Seyaku, Yokohama, 246 Japan. Fax: 011-8145-301-8069. E-mail: taka-doi@a2.ctktv.ne.jp



WANTED: Fada Catalin radios. Help! My entire collection spontaneously combusted during an interview with the "Enquirer." Replenish and repent ye sinners. Please write or call collect: Rain Buttignol, 214 State St., #7, Portsmouth, NH 03801. (603) 427-1384

WANTED: Home brew Reinartz receiver, reasonable condition. Please reply with price and condition. C.F. Crandell, 3412 Rugged Dr., Dallas, TX 75224. (214) 337-2823

WANTED: Bottom and dial scale for maroon Satchell-Carlson 415 or 416 frog-eye. Robert Turcotte, 1890 Arlington Rd., Roanoke, VA 24015. (540) 342-8521. E-mail: turcotte@rev.net

WANTED: Chassis for Philco cathedral 50 or 52. Will buy junk set. TVs from the 40s. Lionel trains from the 60s. Tony DeMara, 40231 Day Dr., Clinton Twp., MI 48038. (810) 263-0325. E-mail: oldtvsandtoys@amentech.net

WANTED: Radio collection under \$10,000 within 250 miles from Cedar Rapids, Iowa. Bill Coolahan, 1450 Miami Dr. NE, Cedar Rapids, IA 52402-2933. (319) 393-8675

WANTED: Circular British Bakelite Ekco AD 65 radio. Also, Bendix 114 and 115. Jeff Rodriguez, 808 Corbett Ave., San Francisco, CA 94131. (415) 826-4657

WANTED: Emerson Model 256 Strad with D dial in good original condition. Ed Cook, 3215 N.E. 111th Cir., Vancouver, WA 98686. (360) 573-1439

WANTED: AT-387, CW-293 and ST-124 for PRC-14. Canvas and antenna reel for TBX-2. Joseph W. Pinner, KC5JJD, 180 Circle Dr., Harriman, TN 37748. E-mail: kc5jjd@sprintmail.com



WANTED

Amrad 3670 as shown, any condition. Also a Type E crystal set, 3500-2 and other pre-1926 Amrad sets & parts.

Andrew Mooradian, 5 Priscilla Lane
Winchester, Massachusetts 01890
tel. 781-729-1873 after 7 pm

WANTED: Rohde and Schwarz Type EK07 receiver. Harry Weber, 4845 W. 107th St., Oak Lawn, IL 60453-5252

WANTED: Atwater Kent 356, RCA 143, Philco 90, Stewart-Warner R-1301-A, excellent condition and original finish. Mark Murphy, 1400 Chicago Ave. #802, Evanston, IL 60201. (847) 328-5036. E-mail: PiscoCal@aol.com

WANTED: Sorona, brass name plate, 1 3/4" x 7/16". Bob Sherwood, 202 D SW, Miami OK 74354. (918) 542-6058. E-mail: sherwood@rectec.net

**FAX NUMBER FOR
ANTIQUÉ RADIO CLASSIFIED
(978) 371-7129 - 24 hours a day
Ads - Subscriptions - Book Orders
See inside front cover for details**

WANTED: Crystal sets, collection now at 443 pieces; seeking more. Erwin Macho, Ambrosweg, 17/A/8, A-1230 Vienna, Austria. Fax: ++431/6874355

WANTED: Zenith Golden Triangle radio. Paying more than normal for mint condition. Gordon Wilson, 11108 50 Ave., Edmonton, Alberta, Canada T6H 0H9. (780) 434-6257. E-mail: wilsons@freenet.edmonton.ab.ca

WANTED: Aircraft radios, transmitters, wind generators, dynamotors, airport radios, light beacons, pre-WWII. James Trøerne, 11909 Chapel Rd., Clifton, VA 20124. (703) 830-6272. E-mail: trøerne@erols.com

WANTED: Receivers: Sansui G-8000, G-9000, G-2200 or Tandburg TR-2075 or TR-2080. Edwin Ellis, 1559 S.W. 23 Ter., Deerfield Beach, FL 33442. (954) 421-9999

WANTED: Number 864 tube, box for QRS red top tube. Jack Ghere, 1753 Community Beach Rd., Odín, IL 62870. (618) 532-5548



BUY/SELL

TUBES

NEW & USED

SEND FOR OUR "WANT LIST"
OR
OUR FREE CATALOG

**ELECTRON TUBE ENTERPRISES
P. O. BOX 8311
ESSEX, VT 05451-8311**

**TEL: 802-879-1844
FAX: 802-879-7764**

EMAIL: etetubes@vbimail.champlain.edu

15th Anniversary Special

Back Issues — 60% Off — \$2.00 Each

Full Calendar Years

A sampling of articles and topics is listed below.

(12 issues in all years except 1984. All originals except for June 1984 through March 1987)

- 1984 A.R.C.'s First Year. The June Sample Copy plus September-December. First Kreuzer's Value Guide,* Heathcote's Collectors' Corner, Crocker's Crosley Review,* With The Collectors' and Meet Reports.* (5 Issues. Photocopies; 16-20 pgs.) \$10
- 1985 First Photo Review,* Radio Novelties,* Collector Profile,* Telegraph Key Review,* Crystal Set Review* and Atwater Kent Breadboard Review.* Also Value Guide A-T, Penna Wireless, Marconi 106, WD-11. (Photocopies; 20-24 pgs.) \$24
- 1986 First Collecting British Crystal Sets.* Collectors' Corner, Value Guide S-Z, Horn Speaker Values, Speaker Review, Precision Ace, Quaker Oats Crystal Set, HQ-120X, First Issue Published by John Terrey. (Jan.-Sept. Photocopies; Oct.-Dec. reprints; 24-28 pgs.) \$24
- 1987 First full-color covers. First Foster's Restoration Topics,* Vintage Television.* Philco 38-3, EHScott 48-Tube Set, Marconi Multiple Tuner, Vacuum Tube Value Guide, Freed Elsemann, Crosley Pup, Fada Bullet, Vitus, Spartan Mirrored Radios. (Jan.-Mar. reprints; Apr.-Dec. originals; 32-36 pgs.) \$24
- 1988 First Old Tyme Radio Services Directory,* Jim Fred's Repairing AC Radios,* Vintage Test Equipment.* Also DuMont Clifton TV, Mechanical TV, Aenola Senior, A-K Model 20, Kennedy 220, Philco Predictas, Marian and Gem Crystal Sets. (40-60 pgs.) \$24
- 1989 Automatic Radio, Clapp-Eastham HR/HZ, Mechanical TV,* Western Electric 1920-1927, Radiola 44, Ace Radio Repair on June cover, Arvin & the Hopalong Radio, Magnavox TRF-5, A-K Crystal Set, A-K 9A, Philco Block Capacitors, Marconi 106D, Patterson PR-10, Onole 7B. (52-68 pgs.) \$24
- 1990 First Radio Adventures.* Also California Earthquake, Transistor Radios, Cleaning Bakelite, EH Scott Telematic, Ekko Round Radios, Radiola Grand, Horn Speaker Survey, Atlantic Radio, GE 901 TV, Philco Block Capacitors, Tuska 224, RCA 816K, RCA Theremin. (68-92 pgs.) \$24
- 1991 First Collecting Foreign Sets,* Out-Of-Sight Radios, Philco 20, 90, Wilcox-Gay Recordio, A.R.C. Index '84-'90, Westinghouse RC-RA-DA-DR-RT-AR, Radio Stock Certificates, German Radios, Subminiature Tube Radios, Early Navy Radio Equipment, Gonset. (84-100 pgs. Index Issue is 148 pgs.) \$24
- 1992 Vintage Microphones, Gonset, Early Navy Equipment, Superhets of the 20s,* The Neurodyne, Telmaco, Atlantic Radio, Vintage Hi-Fi, Battery Eliminators, Radio Fans, A-K 35, RCA 648PTK TV, Repairing IF Transformers, Paragon RA-10/DA-2, A-K 21, 33, WLW, 1991 Index. (88-100 pgs.) \$24
- 1993 Arvin Metal Radios, Repairing RCA Catacombs, Philco Armchair Radios, Kenrad Crystal Set, Transistor Radios, A-K 52, Philco Cabinet Design,* Webster Electric Co., Kyletron Electrostatic Speaker, Vintage Guitar Amp, Tower Cone Speakers, EH Scott Allwave, 1992 Index. (100-104 pgs.) \$24
- 1994 Radiola I, Radiola 60 series, Pot Metal, Fada Neurodyne, Clinton Mfg. Co., Kardon Radios, Philco Cabinet Designers, Palco, SCR-609 & 610, Philco Survey, Permeability Tuning, Weston, Regency TR-1, Charles Herrold, Nipper, 1993 Index. (100-116 pgs.) \$24
- 1995 Zenith Trans-Oceanic, Stelway Capehart, Ken-Rad, Radio Shop J, Freshman Master Speaker, Broadcast Equipment, Philco Survey, Power Transformers, Tube Testers,* Radio Apparatus Co., L.E. Knott Apparatus Co., Ford Museum Auction in color, Ozarka, 1994 Index. (108-116 pgs.) \$24
- 1996 Communications Receivers, KDKA, Philco Designers, Radiola IV, WJZ, Art Deco Radios, Herrold Microphone, Tuning Battery Sets, Paul Godley & Paragon, Soldering, Webb Microphone Collection, Mirrored Glass Radios, Samson Electric Co., Russian Red Star, Echophone EC-1. (100-116 pgs.) \$24
- 1997 Thompson Minuet, Marconi Archive Auction Saga, Frank Krantz, Emerson Multivalve Radios, De Forest Detectors & Tuners, Remote Control Radios, Ekko Stamps, Freshman Polydyne, Vintage Audio Recorders, Selenium Rectifiers, DeForest Reflex Sets, Early Zenith. (100-116 pgs.) \$24
- 1998 Sears Commentator, 300B Tube, Replica Nameplates, Australian Radios, WMAZ, Espey, Nipper, Early Wireless, Rider's Volume 1, Pilot Radio, Browning-Drake, Army-Navy Numbering System, Cortlandt Street Radio Row, Pooley Co., Transistor's Early History. (100-108 pgs.) \$24

* These articles continued for one or more years and some continue today.

15th Year Back Issue Special: U.S. Orders - Above prices include shipping. If using VISA or MasterCard, include name on card, card number and expiration date. Send payment with order. Money back return policy. Most orders shipped the same day received, but allow 2-4 weeks to receive order. Non-U.S. orders - write for shipping costs, or use VISA or MasterCard and specify air or surface (allow 2-3 months for surface shipping).



A.R.C., P.O. Box 2, Carlisle, MA 01741. Tel: (978) 371-0512

Fax: (978) 371-7129 - E-mail: ARC@antiqueradio.com - Web: www.antiqueradio.com



(Feb-99)

Radios by Hallicrafters

2nd Edition

By Chuck Dachis



NEW!
Order
Today!

Over 1,000 Photos
Additional Coverage of Receivers
6 Additional Pages of Special Purpose
and Prototype Items

Updated Pricing

\$29.95 - Softcover

U.S. Orders - Enclose \$3.00 per order for packing & book-rate shipping if total order is under \$35.00. If using VISA or MasterCard, include name on card, card number and expiration date. Send payment with order. Mass residents add 5% sales tax. Money back return policy. Softcover unless stated otherwise. Most orders shipped the same day received, but allow 2-4 weeks to receive order. Foreign orders - write for shipping costs, or use credit card and specify air or surface (allow 2-3 months for surface shipping).



A.R.C., P.O. Box 2, Carlisle, MA 01741. Tel: (978) 371-0512

Fax: (978) 371-7129 - E-mail: ARC@antiqueradio.com - Web: www.antiqueradio.com



(Jul-99)

FOR SALE: 1930s speaker built in produce crate, unusual - \$40. Sparton "Equasonne" - \$60. Radio sale website: <http://members.aol.com/dmrradios/tube.htm/>. D.M. Maurer, 29 S. 4th St., Lebanon, PA 17042. (717) 272-2481. E-mail: dmrradios@aol.com

FOR SALE: 21" round tube color sets, Zenith Model 5030 & 21K4120, as is. Pickup only. Jim Salmon, 108 N. Elm, Claremont, MN 55924-021. (507) 528-2424

FOR SALE: Yaesu FT101EE - \$150. Yaesu FL2100B amp - \$150 with manuals. Robert Braza, N1PRS, 23 Harvard St., Pawtucket, RI 02860. (401) 723-1603

FOR SALE: Elements of Radio Servicing, Marcus, Levy, vg - \$12. 1982 ARRL Handbook, excellent - \$7. Jim Gaudin, 134 Hawthorne Dr., Danville, VA 24541. (804) 791-2286

**E-MAIL ADDRESS FOR
ANTIQUERADIO CLASSIFIED**

ARC@antiqueradio.com

**Ads - Subscriptions - Book Orders
See inside front cover for details**

FOR SALE: R-390A/URR receiver, good condition, plays well, asking - \$195 Neg. You ship or pickup. Iv Sanders, 242 Hunter Ln., Harrisburg, PA 17112-8922. (717) 469-2185

FOR SALE: Radiola horn speaker, works, nice; with pair antique headphones - \$200. Radiola Model III A with (4) 99 tubes, nice - \$150. AK, speaker Type E, nice, works - \$55. Coin operated jukebox selector, nice chrome - \$365. Elvis Presley transistor radio, nice - \$75. Music City radio, mint in box - \$25. Edison Mabry, 402 Pearl Ave., Mansfield, OH 44907-1458. (419) 525-0902

FOR SALE: Visit www.78rpm.com for a full line of turntables, books, vintage records & cylinders. Nauck's Vintage Records, 6323 Inway Dr., Spring, TX 77389. E-mail: nauck@78rpm.com



**Craig L. Graybar
Furniture Works Ltd.**

(414) 258-2390 or (888) 383-2390
SPECIALISTS IN RESTORING,
REPAIRING AND REPRODUCING
CLASSIC STYLED ANTIQUE TV,
RADIO & PHONOGRAPH CABINETS

Send us your plans or your project
via UPS for immediate price quotes



1535 S. 84th St.
West Allis, WI 53214



"We Turn Ideas Into Heirlooms"

FOR SALE: Beautiful working Federal 200 in well crafter upright repro enclosure. N.T. - \$500. Thompson Horn, vg, works - \$150. Dave Rinehart, 85 N. Edison #1, Reno, NV 89502. (702) 856-4122. E-mail: driehart@trane.com

FOR SALE: Rare Raytheon-Belmont 7DX21 7" electrostatic TV - \$225. AK40 WT no lid - \$20. Sam Mannino, PO Box 331, Villanova, PA 19085. (610) 353-6747

FOR SALE: Oscilloscope, Heathkit Model SO-106A w/ reprint manual, gc - \$50 + S&H. Richard Dzick, 31572 Juniper Ln., Warren, MI 48093. (810) 268-4671. E-mail: n8mq@aol.com

FOR SALE: Zenith Trans-Oceanic 8G005 exc, complete - \$195. G500 gw - \$175. Have others. Ted Demski, 5806-225 Pl., SW, Mountlake Terrace, WA 98043. (425) 778-7100

FOR SALE: Sprague Tel Ohmike, Model TO-4, manual - \$50. Industrial Industries Wheatstone Bridge, no manual - \$50. Plus shipping. Wini Reauveau, PO Box 73032, Las Vegas, NV 89170-3032. (702) 795-2613

FOR SALE: Tube sets for Collins 75A-2, Drake R-4 - \$25 ea. N.O.S. postpaid. Joel Levy, 8 Waterloo, Morris Plains, NJ 07950. (973) 285-0233

FOR SALE: Radio Boys to the Rescue, reprint - \$30. Other titles, and dust jackets available. Jim Towey, The Adventure Continues, 249 Hartland Rd., West Granby, CT 06090. (860) 653-7447. E-mail: toweyj@aol.com, <http://members.aol.com/brentwooda>

FOR SALE: Callbooks - Free. Pay shipping, fair condition, foreign 71, 73, 79, 80, 82, 84, 85, 86, 90, 91, 96. U.S. 90, 85, 71, 72. Take all, only. Patrick Walsh, W6JFM, FO5BW, 1715 Griffith Park Blvd., Los Angeles, CA 90026. (323) 662-4061. E-mail: W6JFM@msn.com

FOR SALE: Grunow Teledial table model, one knob not original - \$55 plus UPS. Hugo Kann, 2320 King's Ct., Marion, IA 52302. (319) 377-1090, evenings. E-mail: hmkann@earthlink.net

FOR SALE/TRADE: Hallicrafters S-40B, SX-25, HT-44. Heath/EK-2, HR-10B, HW-12, QF-1, SB-300, SB-401, VF-1. National SW-54. Sam Timberlake, KF4TXQ, PO Box 161, Dadeville, AL 36853-0161. (256) 825-7305. E-mail: stimmer@lakemartin.net

FOR SALE: Heathkit tube checker Model TC-3, nice and working, manual - \$35 plus. Heathkit condenser checker Model C-3, nice, no manual - \$25 plus. Elwood F. Hunt, 308 Georgetown Rd., Cameys Point, NJ 08069. (609) 299-5259

**S.A.R.S. SUMMER SWAP MEET
ATLANTA, GEORGIA**

SATURDAY - JULY 17, 1999

Fairfield Inn - Alpharetta (same as last year)
11385 Haynes Bridge Road
(Exit 9, Ga. Hwy. 400)
From Dawn till 1:00 PM

Vendors - \$5.00
All others - Free!!!

This is an outdoor, tailgate meet.
Info: Gordon Hunter (770) 475-0713

Announcing
A.R.C.'s Expanded Web Site Including
★ CLASSIFIED ADS ONLINE ★

www.antiqueradio.com

Target Date — July 1, 1999

**Look for your password
on this month's address label.**

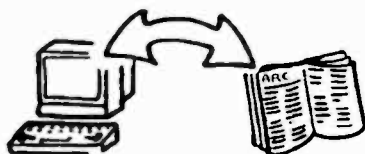

New Features!

Searchable Classified Ads for Subscribers Only
Searchable Past Auction Prices
An Improved Searchable A.R.C. Store

Standard Monthly Additions

The Cover, On The Cover, Editor's Page
One or More Feature Articles (Web Editions)
Book Reviews, Radio Miscellanea
Coming Radio Events & Mark Your Calendar
Radio Club Listing (over 80 clubs, worldwide)
Links to Over 200 Related Web Sites

Archives on the A.R.C. Web Site

Nearly Four Years of Web Editions of A.R.C.

The A.R.C. Web Store

Subscribe and Renew
Order From Over 90 Books and Videos
Request a Free Sample Copy

Also on the A.R.C. Web Site

Frequently Asked Questions (FAQ) about A.R.C.
E-mail A.R.C. With Your Ads and Comments

A.R.C., P.O. Box 2, Carlisle, MA 01741. Tel: (978) 371-0512
Fax: (978) 371-7129 – E-mail: arc@antiqueradio.com – Web: www.antiqueradio.com

FOR SALE: Plastic dial covers for Addison 2, AK 145, Emerson 375, 400, 520, Fada 1000, National 240D, Northern Electric 5000, Zenith G-500, 8G-005, and many others or can make you one - \$15 ppd. Also have light cover for Airtite, dial for Charlie McCarthy, Garod 6AU1, Garod 5A1, dial cover for Hallicrafters S-40, red line and 1234, H-500 with band markings. Doyle Roberts, HC 63 Box 236-1, Clinton, AR 72031. (501) 745-6690. E-mail: drob@artelco.com

FOR SALE: Tubes, have lots of antique types in stock. Have N.O.S. and good used tested. Write, fax, phone or e-mail your needs. Have now #950 sealed in box - \$20 ea. #27-S Syl., these are metal shielded tubes - \$20 ea. WD-11, tipped, brass base N.O.S. in orig. box!! - \$160. Kirk Cline, PO Box 9462, Greensboro, NC 27429-0462. (336) 288-6903. Fax: (336) 282-8366. E-mail: kirk6922@hotmail.com or kirk6922@aol.com

FOR SALE: Novelty Coke radio on cover Bunis 2 novelty book. List LSASE, or e-mail: Stan Lopes, KB6LGV, 1201-74 Monument Blvd., Concord, CA 94520. (925) 825-6865. E-mail: splopes@aol.com

FOR SALE: (5) B&K 283 DVM, no leads - \$20 ea. Triplett 4000 DVM, no leads - \$25. Harry Pewowaruk, 1535 N. 8th Ave., St. Cloud, MN 56303. (320) 252-9910. E-mail: HPewowaruk@aol.com

FOR SALE: Heathkit multiband transceiver Model WH101 SSB, power supply PS-23, wall speaker WS 753, excellent condition - Best Offer. Frank D. Atwood, Nostalgia Radio, 117 E. Main St., Merrimac, MA 01860. (978) 346-8100. Fax: (978) 374-1030. E-mail: atwoodtv@110.net. URL: <http://www.110.net/~pr2858>

FOR SALE: Sharp Bendix 115 burgundy and marbled cream, less common black and butterscotch Emerson 520, Deco Truetone, several clean cheap Bakelites. Ted Chronister, 7073 Carlisle Pike #26, Carlisle, PA 17013. (717) 766-6436

Organize Your Basement!

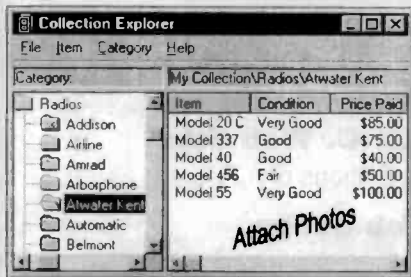

Collection Explorer: Track your radios, tubes, knobs, parts, and literature. *Windows Explorer* look and feel keeps things familiar. Organize your collection by category. Comes pre-loaded with many categories, and you can add unlimited categories of your own. Import/Export to/from other programs. Print reports by category or entire collection. You can even track multiple collections.

Also, create your own custom columns to hold text, dates, numbers, currency. Each item can also have its own memo to hold additional comments, and a photo attached.

For *Windows 95/98*. Send Check or Money Order for \$39US (plus \$3 S/H) to "EPS/Solutions", Radio Collection Software, PO Box 862, Broomall, PA. 19008-0862. Allow two weeks delivery. PA residents add 6% tax.

www.collectionexplorer.com/radios/

FOR SALE: Western Electric 105 line amp - \$3,000. Mint Altec 250A - \$7,500. WE 555W - \$1,500. Vincent Gallo, 532 LaGuardia Pl., #600, New York, NY 10012. (212) 274-0432

FOR SALE: 1933 United Motors 4049 (32 Vdc) tombstone, complete, original & ready for restoration - \$65 + UPS. Rich Stamer, Sound Remedy, 331 Virginia Ave., Collingswood, NJ 08108. (856) 869-0238

— WANTED —

CLUB CONTACT INFORMATION. A.R.C. IS UPDATING ITS CLUB LIST. PLEASE SEND US NAME OF CONTACT PERSON, ADDRESS, DUES, RATES, ETC.

FOR SALE: Old Warner electro-plating device, Model P-M - \$30. Airline 54BR150JR chassis - \$10. Philco 42-340, no dial - \$25. 48-460, cracked - \$10. Crosley 52TG? - \$10. All plus UPS. Charles G. Phillips, 8607 Rembrandt Cir., Newark, DE 19702. (302) 832-9592

FOR SALE: Transmitting tubes, sockets, transformers: 4CX-150A, 3CX-1000A7, 4CX-1000A, 250TH, 450TH, 4-400, 3-1000, 4-1000, 4PR-1000B. F.H. Yonker, P.E., W2IBH, 1229 Inverary Pl., State College, PA 16801. (814) 867-1400

FOR SALE: Silvertone amp #1029 (2) 7199's. Hallicrafters S-120, SX-99 parts set - Offer. Claude Chafin, NOFMO, 4223 E. 42nd Way, Independence, MO 64055. (816) 478-4518

FOR SALE: Juvenile fiction books: Radio Boys/Girls, Tom Swift, Dave Dawson, etc. List SASE. James J. McGrath, W2IOJ, 2 Centerview Ln., West Seneca, NY 14224-2124. (716) 675-0160. Pkt mail: w2ioj@ke2vw.#wny.ny.usa.noam

FOR SALE: ACL SR-222 receiver, clean, working, 20-1000 MHz manual - \$225. Electric radio parts. SASE list. S.T. Carter, II W4NHC, 680 Fernwood Dr., Melbourne, FL 32904-1995. (407) 727-3015

FOR SALE: RCA tube manual RC30 and tube substitution book, plus transistor radio course. All 3 books - \$25. Daniel Seidler, 3721 W. 80 St., Chicago, IL 60652-2415. (773) 284-8221

FOR SALE: Riders manual 1-V abridged - \$45. National III and IV, Riders V thru XIX - \$20 ea. Plus shipping. TV-10D/U tube tester, works good - \$175. Plus shipping. Many more radio related items. Send LSASE with 2 stamps. Thanks. Am having health problems and have to sell all my equipment, and stock. James S. McDowell, 8 Blanchel Ter., Jeffersonville, IN 47130. (812) 283-6387. E-mail: jnmcowell@aol.com

(818) 786-2500

Now Available
1941 Philco Escutcheon Reproductions
\$29.95 + \$3.00 Shipping & Handling (send a money order)
Injection Molded Marbled Brown Plastic
Fits Models: 41-250, 255, 256, 280, 285, 287, 290, 296

Old Time Replications 5744 Tobias Ave. Van Nuys, CA 91411
CA Residents, please add 8.25% sales tax

WANTED: Schematic of Linplex F2 communications receiver by Phase Track Ltd. Motorola Application Note AN-HK-07/H on AM Stereo receiver design. Bob Mahrenholz, 307 Old Fort St., Tullahoma, TN 37388-2942. (931) 455-5217. E-mail: bobm@edge.net

WANTED: RCAR-10 or Cunningham C-10 tube manual from 1930-1931. Any 1920s RCA and Cunningham tube manuals. Dennis Craft, 10513 E. Clinton, Scottsdale, AZ 85259. (480) 860-8951. E-mail: dcraft@uswest.net

**HAVE YOU MOVED? ARE YOU MOVING?
PLEASE NOTIFY US A.S.A.P.
SEND US YOUR...
OLD ADDRESS
NEW ADDRESS and
SUB #
MANY THANKS!!!!**

WANTED: Chassis and speaker for RCA Model Radiola 48. Elwood F. Hunt, 308 Georgetown Rd., Carneys Point, NJ 08069. (609) 299-5259

WANTED: For restoration of RCA 8 T 244 10" TV; HV shield assy, and flat rubber belt for fine tuning knob; also Philco setting wrench, to set those small cones on late 30s Philco, goes through knob. Also, N.O.S. or rebuilt 10 BP4 A, B, C, D or 10 FP4 pix tube. John Grady, 5 Park St., Ayer, MA 01432. E-mail: gradyxray@net1plus.com

WANTED: Tubes, 2A3 RCA/Cunningham, N.O.S. single plate - \$180, used - \$105. 205D/E Western Electric, tennis ball shape, N.O.S. - \$500, used - \$300. 252A Western Electric - \$1,225, used - \$725. 274 A/B Western Electric, engraved base, N.O.S. - \$260, used - \$185. Also buying tube amps, Marantz, McIntosh, Western Electric. Call, fax, e-mail, or write to George Stagakis, c/o George's Radio & TV Repair, 1714A-41st St., North Bergen, NJ 07047. (201) 867-9136. Fax: (201) 867-4044. E-mail: georgestv@aol.com

WANTED: 3KP4 tube for Pilot Model TV-37 TV. John Chernega, 240 Kennedy St., State College, PA 16801. (814) 237-5738 or (814) 238-3647

WANTED: Lamp hood for Radiola 17A. David Wunsch, 111 Louise Rd., Belmont, MA 02478. (617) 489-0079. E-mail: dwunsch@cs.umf.edu



WANTED: Help, I am trying to replace a lost family radio, 1933 Majestic radio Model 291, seen in this photo with my great-grandfather. The radio can be also seen on page 190, Machine Age to Jet Age, Volume 2. The radio & cabinet must be complete, but need not be working. Dave Stott, 29 Willow Bee Ln., Middletown, CT 06457. (860) 344-0697. E-mail: dkstott@compuserve.com

WANTED: Will pay top price. I know it may be worth a few thousand dollars if it's the right one. Ar1 Deco radio designed with Globe approximately 8" to 12" in diameter. Commercial plane looks like it's flying around the world. E-mail & JPEG image, or phone, snail mail photo & price to: Wilbur Pierce, Ste. #3, Marketplace Design Center, Philadelphia, PA 19103. (215) 557-0400. E-mail: snapshot@pond.com

WANTED: Tiny Mite crystal set, crystal detectors. Harry Mac Mullan, 469A Garnet Mine Rd., Boothwyn, PA 19061. E-mail: harry.macmullan@phil.boeing.com

Our Customers Say It Best: "You've Gotta Have an AM-100!"

Whether you are a novice collector with one radio or a seasoned veteran with a roomful, curious visitors always ask the question: "Does it still work?" What better way to prove the point than with a live old-time radio broadcast. With the Comtronics AM-100, you can entertain friends with authentic on-the-air radio demonstrations!

Will it Work for Me? *You be the Judge:*

"Big-band music all the time from any of my radios"

"I can't live without one!"

"The little transmitter works like a champ...the bass response is remarkable!"

"As I'm writing this, I am enjoying vintage Count Basie on my RCA 816K"

This is the Genuine Article. Call Now and
Enjoy the Music

Tusa Consulting Services
19 Augusta Drive, Covington, LA 70435
(504) 892-7348 (504) 892-2075 FAX



Make those old radios come alive
with an AM-100, today

Price: \$199.50 Includes antenna, power supply
and UPS delivery (48 States)
1-yr warranty, 30-day trial

FOR SALE: Pepsi machine novelty - \$32. Beautiful Telefunken 5083-W AM-FM-SW - \$285 + UPS. George Wright, 4181 Enders Way, Doylestown, PA 18901-5611. (215) 340-0413. E-mail: gwright@pemnet.com

FOR SALE: McIntosh 225, exc - \$800. McIntosh MX110, exc - \$450. Pair McIntosh ML-1C speakers - \$400. Norton Thompson, PO Box 422, Paonia, CO 81428. (970) 527-3017

FOR SALE: Radio News 1939-1947, incomplete years, no duplicates, (59) issues, Radio & TV News 1951-1952, (20) issues, all - \$25 plus postage 60 pounds. KLH Model 21 FM rcvr, working, exc - \$200. Henry Loos, 210 Ingraham Ln., New Hyde Park, NY 11040. (516) 354-1943. E-mail hcloos@webtv.net

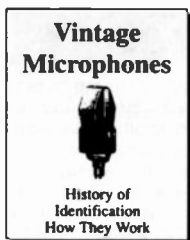

FOR SALE: Vintage Microphones, History of Identification How They Work, over 300 pages compiled by Victor Bang, Jr. - \$29.95 price includes shipping if necessary. Available from Video Tech Service and Repair, 7520 S. Rural Rd., #3, Tempe, AZ 85283. (480) 491-1811

FOR SALE: Good test 45ST - \$100/4 ppd. 71A - \$8. 2A3 - \$20. 83 - \$6. N.O.S. 80ST - \$10. Heathkit AM-FM AJ-32. Pete Putra, 1429 Lawndale Ave., Racine, WI 53403. (414) 632-2543

FOR SALE: Military, amateur, and old radios. SASE for list, condition, price. Frank Sheldon, PO Box 297, Arkport, NY 14807. (607) 324-6646

FOR SALE: Two Communicator 2 transceivers - \$30 for the two + shipping. John Martin, 111 Bancroft Dr., Rochester, NY 14616. (716) 663-4182

**Classified Ad Deadline Noon
July 10 for Aug. 1999 Issue
Aug. 10 for Sept. 1999 Issue**
Boxed, Photo, & Display Ads - 1st

FOR SALE: Hickok signal generator Model 288X. Tubes: 805, 813, HK 54, 35T, 46, 47. Dan Knipe, 3750 Highgrove Ln., Nampa, ID 83687. (208) 888-9575

FOR SALE: Send SASE for radio record players. H.N. Felder, 7517 Granada Dr., Bethesda, MD 20817

FOR SALE/TRADE: Just purchased a small collection of interesting radios and microphones from a New York gentleman who was the fussiest collector I think I have ever met. Everything he purchased had to be perfect. The following sets are one of a kind: AK-90 cathedral, Sparton 410 Junior, early Philco 60B cathedral, Philco 71B, Emerson 707B red, Silverstone 9000, Zenith 6D311, Truetone D2211, Westem Electric microphone Mod 630-A, WE 600B Spring-ring, rare Westem Electric Mod 1-B, RCA microphones, 77DX, 44BX, 74B. Call: Larry Drago, 383 Lincoln Dr., Cheshire, CT 06410. (203) 272-6030. Fax: (203) 272-2002. E-mail: theradioman@webtv.net

FOR SALE: Variac, 0-135V, 7.5A, vgc - \$45. Hallicrafters S-38C, parts/set, no tubes, exc/cabinet, knobs - \$22. HP-415B standing wave indicator, untested - \$30. All + UPS. Stephen L. Bonino, 107 Georgetown Rd., Glassboro, NJ 08028. (609) 881-0244. E-mail: sbon@erols.com

Tube Lore

A REFERENCE FOR USERS AND COLLECTORS

For the serious tube enthusiast, coverage of tubes from 1920 to today: tech data, history of design trends, equivalencies, stocking-up hints, "where-used" information, even auction prices on collectable types. Describes conventional gridless tubes used in radar and other special applications. Contains 186 pages of material unavailable in conventional tube manuals: hints on identifying, dating, testing, reactivating, etc. It's softbound, 8-1/2" x 11" size.

Tube Lore is available from major antique-radio booksellers. It's also orderable directly, at \$19.95 postpaid in North America or \$24.95 postpaid elsewhere, from:

Ludwell Sibley
102 McDonough Rd.
Gold Hill, OR 97525



TUBE COLLECTORS ASSOCIATION FORMED!

This new group is now in operation. Started by dedicated collector-historians, it is international in scope, nonprofit, and noncommercial. It addresses tubes of all vintages and types. For a membership application and sample copy of *Tube Collector*, contact the club at PO Box 1181, Medford, OR 97501. Details are also available from Al Jones, W1ITX, on (707) 464-6470 or Ludwell Sibley on (541) 855-5207.

WANTED: Popular Mechanics R337 schematic of regenerative pocket radio using two 1S4 tubes. George Cortelyou, 1409 Madison St., NE, Albuquerque, NM 87110. (505) 255-3347. E-mail: Georgebc3@webtv.net

RATE FOR ADDITIONAL WORDS:

29¢ per word

FIRST 20 WORDS FREE!

Cash or stamps OK for small amounts.

Your payment helps to keep A.R.C. healthy!

WANTED: Horn speakers, theatre, home, commercial, Altec, JBL, Electro-Voice, Western Electric, Jensen, etc. Woofers, horns, drivers, crossovers, coax, cabinets, etc. Sonny Goldson, 1413 Magnolia Ln., Midwest City, OK 73110. (405) 737-3312. Fax: 3355. E-mail: sonnysound@aol.com

WANTED: British crystal sets, detectors, crystal tins. Also looking for a supply of replacement glasses for detectors. Ian L. Sanders, 16725 Wild Oak Way, Morgan Hill, CA 95037. (408) 778-7547. E-mail: ilsande@ibm.net

WANTED: Examples of N.I.B. Gold Lion tubes. Looking for low demand types for display. Larry Daniel, 1758 Chennault Cir., San Antonio, TX 78226. (210) 923-2634. E-mail: LDaniel102@aol.com

WANTED: Escutcheon or complete cabinet any condition for Echophone radio Mod S-4. Please write to: Orlandini Iginio, Via Lessing, 10, Roma, Italy 00137

WANTED: Philco 16 tombstone, early 17" tin or paper mache Nipper phonographs, horns, parts. John Yanny, 153-19 75 Ave., Flushing, NY 11367. (718) 268-6413, leave message

WANTED: Early- and mid-1930s Bakelite/Plaskon European, Australian, and New Zealand radios. David Mednick, 10 Doe Dr., Wesley Hills, NY 10901-2302. (914) 354-5041. E-mail: davemed@acd-pc.com

WANTED: ARRL lightning calculator! Military radio & radar equip., also parts, servomechanisms, electro-mechanical assys. Krajovic, N3DKS, 546 Sheridan Ave., Pittsburgh, PA 15206

WANTED: Clapp-Eastham HZ amplifier, Tram Diamond CB. Feb. 24, 1925 Wireless Age. Thanks. Ted Depto, The Philco Collector, 913 5th Ave., Patton, PA 16668. (814) 674-8834, after 6 pm

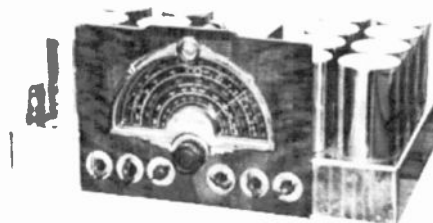

WANTED: McMurdo Silver radios, cabinets, brochures, booklets, etc. Cash or interesting trades. Don Hauff, Box 16351, Minneapolis, MN 55416. (888) OLD-RADIO. E-mail: Dh-auff@isd.net

WANTED: 1920s and 30s QSL cards, magazines, books on early radio and telegraph and wireless. Will pay a good price for good items and arrange pick-up at your door if necessary. Call: Larry Drago, 383 Lincoln Dr., Cheshire, CT 06410. (203) 272-6030. Fax: (203) 272-2002. E-mail: theradioman@webtv.net

WANTED: Escutcheon and instruction manual for Dynaco SCA-35S integrated amp. Also complete SCA-35S wanted. Doug Fox, 603 S. 12th Ave., St. Charles, IL 60174. (630) 584-5915. E-mail: dfoxradio@aol.com

WANTED: Zenith T-V tuner #175-2202-50, cabinet for Philco Model 86. Wm. Seiler, 8819 S. St. Rd. 135, Pekin, IN 47165

A.R.C. BACK ISSUES

April '87 to current issue: Originals available 32 to 100 pages each.

Oct. '86 to Mar. '87: Reprints available Reprinted from original artwork; 28 to 32 pgs. ea. Quality & appearance same as an original copy.

June '84 to Sept. '86: Photocopies available Not original quality, useful for info.; 16 to 28 pages each.

Publication of *Antique Radio Classified* began in 1984 which had only five issues: June, Sept., Oct., Nov., & Dec. 1984. 1985 through current year have had 12 issues each.

\$5.00 each - Postpaid to U.S., Canada and Mexico.

Orders of 6 issues or more may take a 10% discount. Orders for a full calendar year may take a 50% discount. 15th Year Special: 60% discount on orders for a full calendar year. Foreign orders other than Canada and Mexico: \$8.00 each by air. Mass. residents, please add 5% sales tax.

A.R.C. UNCUT, UNFOLDED COVERS

June '91 to present - 9.25" x 12.5" - \$9.95 each Postpaid to U.S., Canada, & Mexico

Mass. residents, please add 5% sales tax. A.R.C., P.O. Box 2, Carlisle MA 01741



Or Call (978) 371-0512



Nipper Clock



Quality wall clock with full color "His Master's Voice" logo Rugged, 3/8" wood grain case Full-length glass front, hunter green and gold Classic Roman numeral time dial Battery operated, quartz movement 100% made in USA, including movement 5-1/4" x 12-3/4" x 2" \$39.95 delivered continental U.S. Massachusetts residents please add \$1.75 state sales tax

Telephone: 508-879-2778

Send check with order or call with credit card, please!

Antique Radio
835-A Pleasant Street, Framingham, MA 01701



Order These Popular Books From Antique Radio Classified

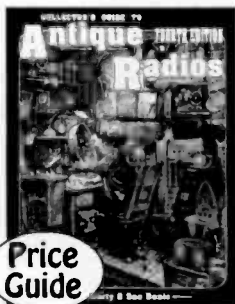

**Price
Guide**

The Collector's Guide to Antique Radios 4th Edition by Marty & Sue Bunis. 8,500+ Battery & AC sets from the '20s to the '60s. Updated prices. Many new photos. 1996. Shipping Now. — **\$18.95**
Combined Ed., CD-ROM by Bunis & Kaczowka. Available Now. — **\$39.95**



**Price
Guide**

The Collector's Guide to Transistor Radios 2nd Edition by Marty & Sue Bunis. This book will help you identify the most sought-after vintage transistor radios. Over 2,900 models, all with current prices. Includes radio club listing. 375 all new color photos, 320 pages. 1996. — **\$16.95**

NEW.....

The Collector's Guide to Antique Radios, Combined Ed., CD-ROM, Bunis & Kaczowka. Combines book editions 1-4. Over 9,000 models with pricing. 1,800 full color photos. Requires a web browser. Runs on both IBM & Mac. 1998. — **\$39.95**

Genuine Plastic Radios of the Mid-Century, Jupp & Piña. Table radios made primarily of brightly covered plastics, with advertisements, vintage black and white photos, 439 color photos. Price guide. 208 pgs. Hardcover. — **\$39.95**



**Price
Guide**

The Radio Collector's Directory and Price Guide, 1921-1965, 2nd Ed. by Robert Grinder. Over 20,000 radios by manufacturer, model number, year, etc. with prices. Radio history, cabinet style chapters. No photos, 264 pages. — **\$26.95**

Transistor Radios, A Collector's Encyclopedia and Price Guide by Robert Lane and David Lane. Identification guide to over 2,500 transistor and novelty radios. History and key to collecting chapters, 170 pages. — **\$19.95**

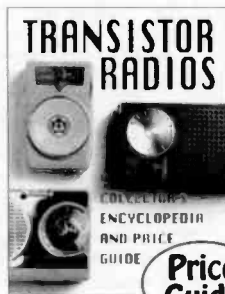

**Price
Guide**

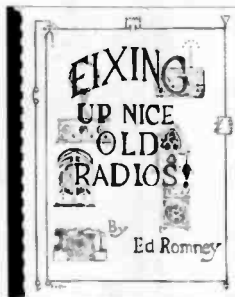

Fixing Up Nice Old Radios by Ed Romney. Written by a retired radio instructor. Plastic binding. 300+ figures, 185 pages. — **\$35.00**

Old Time Radios Restoration and Repair by Joseph J. Carr. A self-paced training guide. History, theory and practical operation of antique and classic radios. 200 illustrations, 256 pages. — **\$19.95**

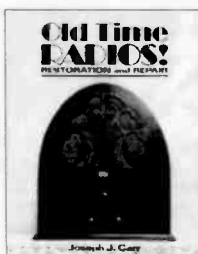

U.S. Orders - Enclose \$3.00 per order for packing & book-rate shipping if total order is under \$35.00. If using VISA or MasterCard, include name on card, card number and expiration date. Send payment with order. Mass. residents add 5% sales tax. Money back return policy. Softcover unless stated otherwise. Most orders shipped the same day received, but allow 2-4 weeks to receive order. Foreign orders - write for shipping costs, or use credit card and specify air or surface (allow 2-3 months for surface shipping).



A.R.C., P.O. Box 2, Carlisle, MA 01741. Tel: (978) 371-0512

Fax: (978) 371-7129 - E-mail: ARC@antiqueradio.com - Web: www.antiqueradio.com



(Jul-99)

Order These Popular Books From Antique Radio Classified

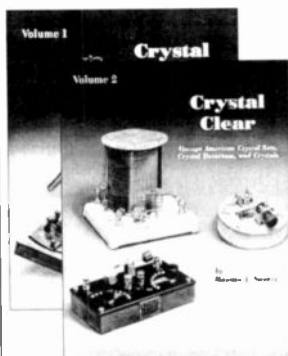

Crystal Clear Volume 1 and Crystal Clear Volume 2 by Sievers. *Comprehensive reference to crystal sets, crystal detectors, and crystals. Each volume contains different illustrations and information Order by volume. — \$29.95*



Flick of the Switch by Morgan McMahon. *The classic photo reference guide for 1930s - 1950s radios. 1000+ photos of radios, 5" x 8", 263 pages. — \$11.95*

NEW TRANSISTOR BOOKS.....

Transistor Radios: 1954-1968, Smith. *Over 1,000 transistor radios identified by manufacturer, marketing organization, type, and style. Color photos and price guide. 1998. 160 pgs. Softcover. \$29.95*

Zenith Transistor Radios, Evolution of a Classic, Smith. *A complete listing of all transistor radio models created by Zenith during 1955-65. Color photos and price guide. 1998. 160 pgs. Softcover. \$29.95*

Hams! We now have 7 ham books - See our full page ad

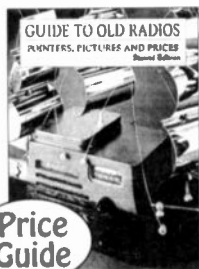

Guide to Old Radios, Pointers Pictures, and Prices, 2nd Ed. by Johnson. *Introduction to radio collecting. Includes hundreds of photos and a price guide. 272 pages. — \$19.95*



Antique Radio Restoration Guide, 2nd Ed. by Johnson. *Beginner's introduction to troubleshooting and repairing AC table model radios. 145 pages. — \$14.95*

Price Guide



The Zenith Trans-Oceanic: The Royalty of Radios by Bryant and Cones. *Presents the fascinating story of the development and use of the Trans-Oceanic. Several photos, documents, ads, etc. 160 pages. — \$24.95*

Communications Receivers, 4th Ed. by Ray Moore. *Information on vacuum tube receivers by 66 manufacturers. 448 radios illustrated 136 pages. — \$19.95*



U.S. Orders - Enclose \$3.00 per order for packing & book-rate shipping if total order is under \$35.00. If using VISA or MasterCard, include name on card, card number, and expiration date. Send payment with order. Mass. residents add 5% sales tax. Money back return policy. Softcover unless stated otherwise. Most orders shipped the same day received, but allow 2-4 weeks to receive order. Foreign orders - write for shipping costs, or use credit card and specify air or surface (allow 2-3 months for surface shipping).



A.R.C., P.O. Box 2, Carlisle, MA 01741. Tel: (978) 371-0512

Fax: (978) 371-7129 - E-mail: ARC@antiqueradio.com - Web: www.antiqueradio.com



(May-99)

RADIO CRAZE

John Sakas P.O. Box 4124 So. Hackensack NJ 07606-4124
 Phone (201)794-0437 ~ Fax 24 Hours (201)794-8359
 visit our web site at <http://www.radiocraze.com>

WANTED

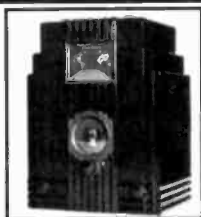

AIR KING SKYSCRAPERS

PAYING **\$14,500.00+** for near mint condition red or blue
\$10,000.00+ for green, lavender or yellow
\$3000.00+ for black and **\$2000.00+** for white or brown
ALSO WANTED ANY COLOR-ANY CONDITION
 COLLECTOR PAYING TOO MUCH, CALL ME LAST

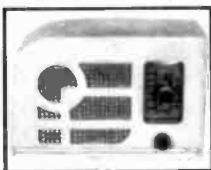

TOM THUMB CATALIN RADIOS WANTED

paying **\$6,750.00+** for mint cond. red, green, orchid, blue
\$2500.00+ for any mint one
ALSO WANTED ANY COLOR-ANY CONDITION

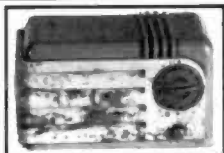

DETROIT PEE WEE & SUPER PEE WEE WANTED

paying **\$600.00+** for mint cond. black, white
\$1,250.00+ for beatle, gray, salt & pepper
\$2000.00+ for red, blue **\$3000.00+** for green or lavender
ALSO WANTED ANY COLOR-ANY CONDITION

WANTED ANY CATALIN RADIO

ADDISON 2 MARK-N & YELL-W \$900.00, YELL-W & RED \$3,500.00,
 ARVIN 532 ANY COLOR \$1,500.00, BENDIX 524 GREEN & BLACK \$675.00,
 DOWALD A501, A502 BROWN \$375.00, YELL-W \$425.00, RED \$1,000.00
 EMERSON A11190 & BT 245 YELL-W \$1,300.00, GREEN \$1,850.00,
 (MARK, RED \$2,500.00, BLUE \$6,250.00, BRIGHT RED \$11,000.00,
 ESPEY MIDGET, ANY NAME, THE PRICE IS YELL, PAX 111
 EMERSON 8M258 YELL-W \$150, GREEN \$1,300, RED \$1,850, BLUE \$3,000
 EMERSON 564 BLACK, \$500.00, GREEN \$500.00, RED \$1,250.00
 FADA L56J55,52,5F50,5F60,116,53X, YELL-W \$900.00, LT (GREEN) \$1,350.00
 MARK-N & YELL-W \$1,500.00, YELL-W & BLUE \$1,700.00, YELL-W & RED \$2,650.00,
 (SPRINKLE) GREEN & YELL-W \$6,250.00, BLUE & YELL-W \$6,450.00,
 FADA 115, 116 & 1000 ALL YELL-W \$6,500.00, MARK-N & YELL-W \$700.00,
 YELL-W & RED \$250.00, PAX (GREEN \$1000.00, BLUE & YELL-W \$2,350.00)
 GAROD A111 MARK-N & YELL-W \$1,500.00, RED \$1,250.00, REFA YELL-W \$1,400.00
 HALSON ANY COLOR \$1,500.00 TO \$5,000.00
 HOTOHAI A 50X ALL YELL-W \$1,100, BROWN & TORT \$2,500.00, RED & YELL-W
 \$5,000.00, GREEN & YELL-W \$5,250.00, HOTOHAI 51 YELL-W & TORT \$1,500.00,
 MARK-N & YELL-W \$1,750.00, GREEN & YELL-W \$2,500.00,
 MINORA KM ANY COLOR \$1,000.00, SENTINEL 294 WAVY GRILL, YELL-W \$700.00,
 SANDHORN RED 1,250.00, BLUE & 500.00
 SPARTON (LOUISIANNE) ANY COLOR \$1,500.00 TO \$5,000.00, EMERS-N \$20,500.00

always buying any catalin or pre-war colored bakelite radios
 We will buy one piece or entire collections
watch out there's a new guy in town

FOR SALE

FOR

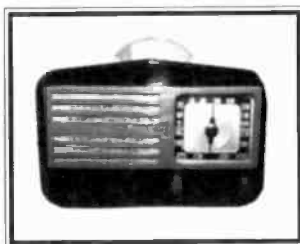

SALE

Garod 1450 Peak Top

Maroon & Yellow Catalin, Working, Mint \$2495.00

FOR

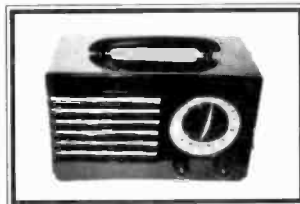

SALE

Emerson 400

Chocolate Brown Catalin, Working, Mint \$695.00

FOR

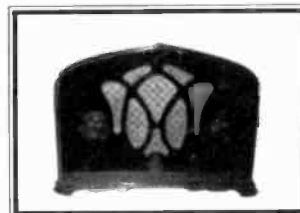

SALE

Emerson 250

Wood, Untested EX+ \$125.00

FOR

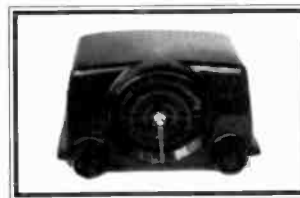

SALE

7 Crosley Color Radios

Red, Orange, White, Dark Blue, Green, Yellow, Black
 most work, all Near-Mint \$2395.00 for the set of 7

ALL PRICES ARE WITHOUT SHIPPING CHARGES

The Collector's Guide To Antique Radios - 4th Edition

By Marty & Sue Bunis



**Order
Today!**

8,500+ Battery & AC sets from the '20s - '60s
400+ color photographs
Updated prices
\$18.95 - Softcover

There are no transistor radios listed in the fourth edition. You will find them in *The Collector's Guide to Transistor Radios* available from A.R.C. for \$16.95.

U.S. Orders - Enclose \$3.00 per order for packing & book-rate shipping if total order is under \$35.00. If using VISA or MasterCard, include name on card, card number and expiration date. Send payment with order. Mass. residents add 5% sales tax. Money back return policy. Softcover unless stated otherwise. Most orders shipped the same day received, but allow 2-4 weeks to receive order. Foreign orders - write for shipping costs, or use credit card and specify air or surface (allow 2-3 months for surface shipping).



A.R.C., P.O. Box 2, Carlisle, MA 01741. Tel: (978) 371-0512
Fax: (978) 371-7129 - E-mail: ARC@antiqueradio.com - Web: www.antiqueradio.com



(Mar-99)

Collector's Guide to Antique Radios *Combined Edition - CD-ROM*

By Marty & Sue Bunis and George Kaczowka



**NEW!
Order
Today!**

Combines Book Editions 1, 2, 3, and 4!
Over 9,000 Models with Pricing
1,800 Full Color Photographs
Model Number Index for All Manufacturers
Photo Index by Category

Runs on both IBM and Mac

Requires a Web Browser, such as Netscape Navigator or Internet Explorer

\$39.95

U.S. Orders - Enclose \$3.00 per order for packing & book-rate shipping if total order is under \$35.00. If using VISA or MasterCard, include name on card, card number and expiration date. Send payment with order. Mass. residents add 5% sales tax. Money back return policy. Softcover unless stated otherwise. Most orders shipped the same day received, but allow 2-4 weeks to receive order. Foreign orders - write for shipping costs, or use credit card and specify air or surface (allow 2-3 months for surface shipping).



A.R.C., P.O. Box 2, Carlisle, MA 01741. Tel: (978) 371-0512

Fax: (978) 371-7129 - E-mail: ARC@antiqueradio.com - Web: www.antiqueradio.com



(Mar-99)

FOR SALE: Emerson 517 Moderne, hairline repaired, 375 Catalin, repairs to cabinet, displays well – \$500. Motorolas: 67X – \$25; 69X – \$35. Philco 42321 – \$30; 48200 – \$35. Silvertone 1 – \$45. Many more, LSASE. Pictures on individual sets. H.B. McMahan, 313 W. Shaw, Tyler, TX 75701-3029. (903) 593-5433. E-mail: hbmcc@juno.com

One Month Free!

BONUS FOR EARLY RENEWALS

If you renew **before** the month shown on your mailing label (your expiration month), you will receive an extra month on your subscription: 13 months instead of 12! 26 months for an early 2-year renewal!

FOR SALE/TRADE: Altec 80 watt 1569-A monoblock amps (uses EL-34 tubes) very powerful, pair of RCA theater mono block amps using four 6L6 tubes in each set. 1929 Tyrman 10-tube Imperial 80, radio. Brunswick Mod 5KR w/Radiola 100A speaker, Mod 4 Echophone cathedral. Early Radio Station WLOU-AM 1350 red, white and blue, neon clock from Louisville, Kentucky; it measures approx. 20" diameter; a pair of like new Western Elec. retro-fit second generation (8 watt) monoblock audio amps (using 6V6 tubes), Neutrowound 6-tube black crackled finish breadboard. Very rare 500-pound RCA Berkshire radio, the Secretary model w/all chrome amp, tuner, and turntable, plus 30" x 15" dealers color plate book of all models. Vintage Pederson Mod 15 Williamson amp; flawless Atwater Kent Mod 10 and Mod 12 breadboards with blue Arcturus tubes, just beautiful! Radiola Grande wit tubes, Clapp-Eastham Radak amp detector Mod HZ w/Mod HR tuner, Western Electric Mod 600A ring/spring mic w/WNBC flags on top; large (mfg. by Signal Co.) loose coupler w/white silk covered windings on dual slide coils, Hallicrafters SR-2000 hurricane receiver/transmitter w/PS, National NCX 5, National NCL 2000, 1-KW Fairchild turntable studio-style. Call: Larry Drago, 383 Lincoln Dr., Cheshire, CT 06410. (203) 272-6030. Fax: (203) 272-2002. E-mail: theradioman@webtv.net

FOR SALE: Federal home broadcaster mic w/box, papers – \$20. Westinghouse tape cartridge player w/6 cartridges – \$20. Sony TFM-117WB – \$15. USAF books on electronics, circuits, 170 pp.-230 pp. manuals plus smaller booklets, 1951-1952. National Radio Products price list bulletin. Characteristics Chart and Socket Connections of RCA Receiving Tubes, 1936. Reasonable offers. Al Varga, 2120 School St., Two Rivers, WI 54241. (920) 793-1993

12 BAND MINIATURE SHORTWAVE RADIOS

7 x 1½ x 5 inches. AM/FM/LW and 9 shortwave bands: 5.9 to 26.6 MHz. Built in 3 inch speaker, two antennas. Operates on 4 AAAs or AC. Very sensitive, brings in the entire world from "Australia to Zambia." Price break-through! Only \$40 postpaid!

Mail your check or money order to:

R.G.B. Enterprises, Dept. 71
P.O. Box 5367, Old Bridge, N.J. 08857, U.S.A.
Call 732-607-0299, Fax 732-679-8524

E-mail: RGBENT@AOL.COM

FOR SALE: Retiring my collection. All radio sets are mint or excellent condition with tubes & working. Radiola III – \$250. AK Model 20 – \$225. Airline 15 – \$225. AK Model 30 – \$225. Planstiehl Model 20 – \$225. Radac mint – \$250. Floyd Boco, PO Box 1657, San Pedro, CA 90733. (310) 831-9336

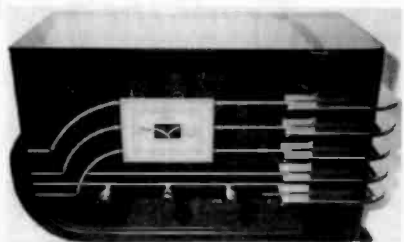

FOR SALE: This is a replication of one of the most beautiful radios ever produced, the 1936 Sparton Model 557 Sleigh. Now reproduced by Crosley. And what a wonderful job they have done, this Sparton classic has been carefully reproduced right down to the precision etching on the cobalt blue mirrored glass, its chrome wraparound fins and black hardwood cabinet with the bottom runners, hence the name "the Sled." This full-sized radio will make a stunning accent piece for your office or home. A colored picture can be seen on my website at <http://members.aol.com/bensradios/Classics/index.htm>. Price is – \$169 including S/H. Visit my web page at: www.radioattic.com/altics/martin.htm. Ben Martin, 18334 Pepper St., Castro Valley, CA 94546. (800) 595-0191. E-mail: bensradios@aol.com

FOR SALE: Splittorf Mikado, 1925, complete! (See Douglas, Vol. 3, p. 126), fantastic condition – \$2,875. Gerald Schneider, 3101 Blueford Rd., Kensington, MD 20895-2726. (301) 929-8593

FOR SALE: Philco 46-1201 Bing Crosby, excellent inside & out – \$45. Trav-Ler #5029, 1948 tube portable, excellent – \$20. Stephen Schaub, PO Box 1258, Peoria, IL 61654. (309) 681-8304

FOR SALE: Antique 12" PM speaker w/good cone and voice coil – \$15 + shipping. Leroy Marshall, 1178 Foxboro Ln., Bartlett, IL 60103. (630) 483-8833

FOR SALE: General Radio 1565-B sound meter, with calibrator and manual – \$40 + shipping. George Fitzpatrick, 204 N.E. 17th Ave., Fort Lauderdale, FL 33301. (954) 467-7036

FOR SALE: Reprints of radio related technical articles. Send stamp or check web page <http://cheshire.net/~rainyday>. Rainy Day Books, PO Box 775, Fitzwilliam, NH 03447. (603) 585-3448

FOR SALE: RCA Tube Handbook HB-3 Volumes 1-10 – \$150. Others available. Hallicrafters S119 – \$95. SX111 – \$100. Military ABA-1 transmitter/receiver, new – \$125. Millen receiver preamp – \$45. Heath GR-88 VHF – \$55. HX-11 – \$135. Free list. Richard Prester, 131 Ridge Rd., West Milford, NJ 07480. (973) 728-2454. E-mail: rprester@warwick.net

FOR SALE: A SASE brings you 11 free abstracts and an ordering form for Crys Tech reports on crystal set coil construction, parts to use, properties and history of crystal detectors. Mail to: Crys Tech, 530 Topeka St., Kingman, AZ 86401

FOR SALE: King radio Mod 81A w/6TV, clean - \$150. Crosley Mod 52TA wd KN A/O N/P @ 8 - \$35. Silvertone No# wood upright 4BDS 8 P/B - \$80. RCA 8X681 A/O N/Bhaspwr - \$70. RCA 75X11 @ 9/P - \$60. Spkr Newcombe Hawley T/Stone Type N/D - \$50. RCA record player Ding Dong 6JM25 companion unit has crack A/O - \$35. Case for Dayton for 3 Kn- window dial & escutcheon @ 10 - \$45. 3EN 6G801N needs front drop w/boat on grille - \$25, plus P & S. Bernie Samek, 113 Old Palmer Rd., Brimfield, MA 01010. (413) 245-7174. Fax: (413) 245-0441

FOR SALE: American Bosch 28 - \$125. AC Dayton AC-63 - \$125. Airline 62-177 tombstone - \$125. Atwater Kent 30 - \$125; 55, green/black - \$90; 60 green/black - \$110. 318 console - \$195. 558 cathedral - \$495. Bremer Tully Counterphase - \$140. Chelsea Super-Five - \$140; Super-Six - \$140. Crosley 5-50 - \$125. Delco 1107, tombstone - \$125. Howard J-3 - \$110. Giffillan - \$110. Freed-Eisemann FE-15 - \$125. Sparton 6-26 - \$125. Kent 422 - \$70. Radiola IIIA - \$150. Sparton tombstone w/tuning eye - \$125. Stromberg-Carlson 410 - \$110. Zenith 7S663R \$100. J. Gary Cameron, 824 Andrews St., Southington, CT 06489. (860) 276-9200

VISIT A.R.C.'s WEB SITE
www.antiqueradio.com
Book Orders - Subscriptions - Articles
and more!

FOR SALE: Philco 38-690; Cathedrals: Philco 71; AK 80 - \$525; AK 84 - \$450; RCA 120 - \$350; Philco 70 - \$325; Zenith LH - \$395; Zenith 210 - \$395; Zenith 805 - \$425. Sparton 15 tube console 1567, has volume expander - \$950. Uncut grandfather clock, says Jackson Bell on clock face - Call. To reference our Zenith models, order our 60-page 11 x 17 Zenith Brochure Book for - \$28.95 ppd. The Story Of Zenith: I have a small quantity of this 32-page booklet Zenith originally put out as a promotional item in 1954 and reprinted about 10 years ago - \$9 ppd. Atwater Kent 612 console; Stromberg-Carlson 231F mirror top chairside - \$895. Most Trans-Oceanics available, call. Many Rider's manuals available including 17, 18, 20, 21, and low #s - Call. Zenith consoles: Aviatrx; 15S373; 15S372; 12H689; 12S568; 12S569; 12S471; 12S370; 12S371; 12S265; 12S268; 12U159; 12U158; 12A58; 980; 115474; 10S470; 10S153; 10S155; 10S156; 10S160; 9S54; 9S55; 9S262; 9S264; 9S365; 9S367; 8S154; 8S463 (5808); 8S359; 7S261 bookcase; 6S362; 7S363; 7S364; 775B; 755 and many others. Zenith chairside: 12S245; 10S147; 9S244; 9S344; 7S343; 7S342; 7S340; 6S147; 7S240; 5S327; 6S239; 6S238; 6S203 phono; 6S241 bar radio. Zenith table Models: 4K535; 5S29; 5S126; 5S127; 5S228; 5S319; 6S321; 6S322; 6S528; 7S432; LH cathedral; L cathedral; 210 and 805 cathedrals; 6D029; 6D630; 7S323; 6S439; 6V27; 6S27; 6S128; 6S222; 6S229; 6J230; 8S443; 10S130; 12S445; 8S531; 288; 711; 807; and many others. Other radios available: Stromberg, Philco, GE RCA, Fada. We can and do ship consoles and we do it right! All radios unrestored electrically unless noted. Satisfaction guaranteed, highest quality assured. Send for our free parts and supplies catalog. We offer complete chassis restoration service on all radios, including complete speaker repair - Call. Visiting Minneapolis? Visit our new store at 5200 Bloomington Ave., just 5 minutes from the airport. We accept Visa, MC and Discover. Alan Jespersen, PO Box 17338, Minneapolis, MN 55417. (612) 727-2489. Note new Fax: (612) 821-4821, 8 am to 6 pm, Mon.-Sat. E-mail: mte612@aol.com

FOR SALE: Green nylon covered magnet tape. Looks better than silk! SASE or visit site: <http://home.ici.net/~radiodaz/index.htm>. Charles A. Days, PO Box 80205, S. Dartmouth, MA 02748-0205. (508) 979-3758. E-mail: radiodaz@ici.net

FOR SALE: From Arcturus to Zenith. Original attorney copies of radio patents (1902-1941). E-mail or SASE for list. Repr knobs for your Deco Majestics (461, 463 & all the smart sets!) Other Grigsby-Grunow Majestic parts available include: Spray Shield tubes, IF & pwr xfmr's tech info too. Silvertone Skyscraper Model 1947. **WANTED:** Zenith 8S463. Issues of The Radio Weekly magazine, Radio & Electrical Appliance Journal, Talking Machine, Radio Retailing 1924-1939. Majestic, Grunow & Rogers/Majestic Advertising/Promotional items. Radios: Majestic Models: 54A, Mayfair, Majestic International Models M204, 422, 521. Grunow Models: 410, 502A, 510, 592, 594, 654. Grunow chassis 4A, 4C, 5A & 11H. Rogers (Canadian) 1932-1936 radios. Will pick up or deliver to Lansing, Elgin or Rochester. Chip Taylor, 2223 53rd St., Sarasota, FL 34234. (941) 713-6000, 6 am-6 pm EST. Fax: (941) 359-6778. E-mail: chip.taylor@cwix.com

FOR SALE: Fender Bassman 50 head, tweaked for killer guitar tone - \$380. Jensen P12R, P15Q & P15R all very good - \$70 ea. Jensen mids and tweeters, call. Pilot 602 stereo receiver, Amperex 6BQ5s, Telefunken 12AX7s, gold knobs, one channel noisy - \$120. Motorola stereo power amp from console, Mullard 6BQ5s - \$80. Bogen RP-235 stereo receiver (7408/6V6GT) as is, no output tubes, nice triannies - \$55. Heathkit FM-4 tuner (mono) and matching AJ-20 AM tuner - \$55 both. N.O.S tubes: 5687 GE 5-star - \$7. 12BH7 GE, RCA, others - \$10. Many 6/12 volt tuner tubes AK5, AL5, AU6, BA6, BE6, BH6, CB6 etc. - \$1 - \$2 ea. Used tubes: (2) 1L6 strong - \$14 ea. Premium used 12AX7, AU7, AT7, EF86, 7247, 5AR4 (Mullard, Amperex, Bugle Boy, Telefunken Diamond, etc.) call; many other tubes. Call with wants; all plus shipping. C.J. Poulos, 29 Doubleday Rd., Columbia, CT 06237. (860) 228-7680, to 9 pm. Fax: (860) 228-7681 anytime. E-mail: TbStkBgje@aol.com

FOR SALE: Dual electrolytic capacitors. 50-30 mFd at 160 Vdc - \$3.75 ea. for 4 or more, includes P&H. Many other types in stock. Also new manufacture stud mount, clamp mount, twist prong, and octal based capacitors. Call or write for free flyers. DH Distributors, PO Box 48623, Wichita, KS 67201-8623. (888) 684-0050, w/f

FOR SALE: Jensen L-18 electro dynamic powered 18 inch speaker, no shipping, can bring to Elgin in August - Offers. Dennis Schrank, 3129 S. Quincy Ave., Milwaukee, WI 53207. (414) 744-3374. E-mail: radiohd@execpc.com

FOR SALE/TRADE: The following McIntosh audio equipment. (2) MC40s amps, (4) MC-30 amps, (2) MC-240 amps, (1) MR65B tuner, (1) C-20 preamp, (1) MR-26 preamp, (1) MC-5100 amp, (1) MA-230 amp/preamp, plus many others too numerous to mention. Call: Larry Drago, 383 Lincoln Dr., Cheshire, CT 06410. (203) 272-6030. E-mail: theradioman@webtv.net

FOR SALE: Panasonic RQ-300S 120V. R-R tape recorder, 7" x 8" x 4" - \$18; Sam's TV Test Instruments, 1953 - \$9. Dave Minchella, KE2GE, 80 N. Campfire Rd., Henrietta, NY 14467. (716) 359-3337. E-mail: djmradionut@juno.com

Radio Restoration Parts

Vacuum Tube Repair Wafers

These tube repair wafers are solid-state devices for quick and easy repair of early vacuum tubes. The wafer is installed by simply sliding it over the tube pins and reinserting the tube into its socket. If the filament is intact, but there is little or no emission, the filament may be lit for best visual effect. However, the tube can be open filament.

No change in radio operating voltages is required. Any number of tubes may be repaired in a radio. If wafers are installed on all tubes, the B+ voltage may usually be reduced without sacrificing volume or sensitivity. Performance will vary between radio models.

\$10.00/each (\$7.50/ea. 3 or more)

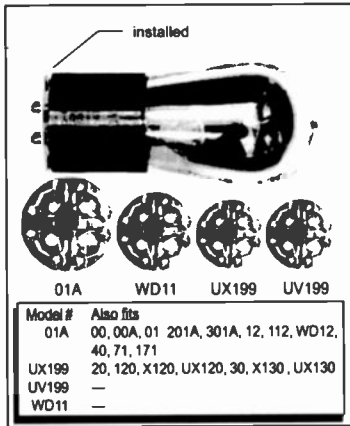

Antique Radio Power Supply

The H15/ H16 power supplies operates most tube type battery radios from low cost batteries. The H15/H16 steps up the voltage from a 6V battery to provide 22.5V, 45V, and 90VDC for the "B" voltage requirements.

A very desirable feature of the H15/H16 is the method of switching power on and off. This function is provided by the switch on the radio. No radio modification required.

The "A" voltage required by the radio can be from "C" or "D" flashlight batteries or from a 6V gelled electrolyte battery when operating 5V tubes. When operating 1.5, 2, or 3V tubes the H15/H16 can be powered by 4 "C" or "D" flashlight batteries or from a 6V gelled electrolyte battery. The gelled electrolyte battery can operate both the H15/H16 and the 6V "A" supply for 5V tubes from one battery.

Order the H15 of parallel filaments or the H16 for series filaments.

The compact size, 4"X4"X3/4", allows the unit to be installed with batteries in the battery compartment of most radios.

H15 or H16: \$99.50. Accessories: "D" cell holders: \$6.00 per set. 6V 10AH battery \$31.00. Battery charger \$45.00. 1.5 - 90V socket \$9.50.

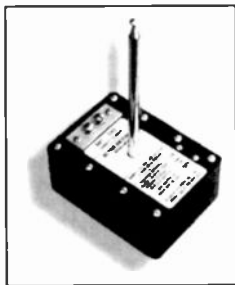

Active Antenna

Allows antique radios which were designed for a long wire outdoor antenna to operate on a 42" indoor whip antenna. Portable, operates from a 9 volt battery.

Only \$34.95

New Atwater Kent Breadboard Switch -

Only \$50

Order from: PTI, 7925 Mabelvale Cutoff, Mabelvale, AR 72103

Orders shipped UPS or Parcel Post, prepaid in continental U.S. Please allow 3 weeks for delivery.

Arkansas residents add 6.125% sales tax.

To Order: Call (501) 568-1995



FOR SALE: 1942-49 WLS Annuals - \$14.50 ea. Catalogs: 1929 Barawik Co., incl. ham & TV, fair - \$35. 1937 Lafayette, avg - \$20. 1934 Grunow incl. Ripley & radio log, exc - \$35. QST Nov. 1925, exc but no cover - \$15. 1932 Gernsback radio repair, exc - \$20. Zenith ESP cards - \$15. Prices plus mailing. The following items cannot ship, but can bring to Chicago in August: HQ 100C, exc - \$135; Porto Smokerette, exc - \$275. LSASE for full list. Dave Davies, 701 W. Albee Rd., Nokomis, FL 34275. (941) 484-6786

FOR SALE: Teletone TV 1497" TV, 1946, electronically perfect, new 7JP4 CRT, case fair, restorable - \$300 OBO. Paul Howes, 757 Ithaca, Boulder, CO 80303. (303) 499-1848, voice or fax

FOR SALE: Radios: Air King Mod 4607A, plays, looks good - \$85. Emerson Mod 38, walnut case - \$135. Crosley 515 tombstone - \$150. Tubes, N.I.B., U.S. brands: 12AX7A - \$9; 6L6 - \$10; 46 - \$8; 12AT7 - \$5. Have 1000s more, call or write: Tony Rinaldo, 308 Lenox Ave., Oneida, NY 13421. Ph./fax: (315) 363-3644

FOR SALE: Zenith Trans-Oceanic 8G005; Y-600; 6S632 wood table; 4G008 (2) for parts; RCA 106 & 100A speaker; Westinghouse WR216 wood table, Deco; RCA 86T nice, Deco, plays; Majestic power supply 7BP6 from 70B console; Stromberg-Carlson 340-H big table set; Philco 37-61 bezel; Hallcrafters S-20R, S-94; 1920s knobs and vernier dials; Western Electric VT-1 original box, open filament; Freshman Master B supply; Balkite A-6 A current supply; Toshiba 10M-860F; Norwood transistor tape recorder TR-405 w/papers; mantle speaker by Farrand metal case; Rola mantle speaker large, wood; GE GD-60; Sentinel 243 1 1/2-volt. Wilbur Gilroy, P.O. Box 459, Lake Winola, PA 18625. (570) 378-2508. E-mail: wlbrg@aol.com

FOR SALE: Novelty radios: Star Wars R2D2 - \$60; Golf cart on wheels - \$45. Shipping extra. Steve Whited, 3637 West 71st St., Indianapolis, IN 46268. (317) 298-9967

FOR SALE: Down-sizing my collection. Choice items: (2) unrestored AK breadboards w/tags, Model 10 #4340 green Radiodyne, unique model, Model 9C #4660, both W/T and nice, AK 20C, compact, W/T nice, Kennedy XV W/T gc, Kolster 6D fruitwood, vy nice w/spare potmetal parts, W/T, Mohawk one-dial Navajo nice W/T, Zenith black dial wooden table 5R216, Philco 1201 w/Bing Crosby ad, Westinghouse spool-leg console, WR-6?, needs work but nice old unit, Delco R1116 2-curve, table model w/large tri-colored airplane dial, exc, Decca 60 rpm table phono DP-15 wood, SW receivers: Howard 435 LF Comet Pro w/meter & 5 coil sets, Sky Buddy sets S-19, S19R, & S119, RCA ACR-136 airplane dial, ACR-155 shutter dial, & SX-17 Super Sky Rider, all gc. Can deliver to July NEARC. Robert Enemark, W1EC, PO Box 1607, Duxbury, MA 02331. (781) 934-5043

**PHONE NUMBER FOR
ANTIQUA RADIO CLASSIFIED
(978) 371-0512**

**Best time to call is weekdays:
9 am to 5 pm Eastern Time
(Please no classified ads by phone. Thanks!)**

FOR SALE: Radiola Super VIII - \$500, PU. Aeriola Senior, good WD 11 - \$200. Radiola 17 with hood - \$45, PU. Radiola 18 - \$40, PU. Radiola 28 with ext. and int. loops, tubes, manual and built in stand - \$150, PU. Radiola V, fair external finish, correct wood base, no tubes - \$300, PU. Westinghouse RADA, RC, working, with tubes - \$275. Westinghouse type CB loading coil for above - \$50. Westinghouse Art Deco grandfathers clock radio, Model WR 8, radio works, clock ? - \$175, PU. Stromberg-Carlson walnut 1929 AC art console, similar to 638 but without internal speaker - \$100, PU. Stromberg-Carlson Model 14 cone speaker, new cone, continuity good, matches above - \$125, PU. Ben Kittredge, 5 Canyon Dr., Westerly, RI 02891. (401) 322-9865, evenings

VACUUM TUBES WANTED

(920) 208-0353

(All tubes are subject to testing and inspection)

WESTERN ELECTRIC:

VT-2 / 205A/B \$225 NOS, \$110 used
VT-25 \$50 NOS, \$25 used
VT-52 \$150 NOS, \$75 used
101D / 101F \$175 NOS, \$100 used (TB)
101D / 101F \$40 NOS (ST)
102D / 102F \$175 NOS, \$100 used (TB)
102D / 102F \$35 NOS (ST)
205D/E \$425 NOS, \$275 used (TB)
205F \$200 NOS, \$100 used
211A/D/E \$300 NOS, \$175 used
212A/D/E \$750 NOS, \$300 used
216A / 217A \$175 NOS, \$90 used
228A \$100 NOS, \$50 used
231D / 257A / 281A / 349A \$50 NOS
242A/B/C \$200 NOS, \$100 used
244A / 249A \$25 NOS
252A \$1100 NOS, \$650 used
261A \$150 NOS, \$75 used
262A Balloon / 275A \$90 NOS, \$50 used
262B \$40 NOS, \$15 used
264A/B/C \$30 NOS, \$15 used
274A / 274B \$210 NOS, \$110 used
274A / 274B \$250 NOS engraved base
276A \$100 NOS

300A / 300B \$850 NOS (engraved base)
300B \$550 NOS, \$275 used (1950-60's)
310A / 311A \$20 NOS, \$10 used
331A / 367A / 272A \$45 NOS
348A \$80 NOS, \$40 used
350B \$200 NOS, \$100 used
345A / 352A \$25 NOS, \$13 used
412A / 418A \$10 NOS
417A / 420A / \$755 \$10 NOS
421A / 422A \$35 NOS
347A / 437A \$75 NOS, \$38 used
UK & EUROPEAN TUBES:
2A3 RCA \$42 NOS, \$20 used
2A3 Single-Plate \$175 NOS, \$100 used
10 Balloon \$70 NOS, \$35 used
10 Balloon "Meshplate" \$100 NOS

112A Balloon \$25 NOS, \$13 used
26/226 Balloon \$10 NOS, \$4 used
45/245 Balloon \$60 NOS, \$30 used
45 Balloon "Meshplate" \$110 NOS
50 Balloon \$200 NOS, \$110 used
50 Balloon "Meshplate" \$275 NOS
71A Balloon \$25 NOS, \$13 used
800/280 Balloon \$30 NOS, \$13 used
211 RCA / Utilo \$110 NOS
800, 808 RCA \$40 NOS, \$20 used
845 RCA \$200 NOS, \$85 used
5691 Red Base \$18 NOS, \$10 used
5692 Red Base \$35 NOS, \$18 used
6550 Tungool \$60 NOS (ST)
7189A US Brands \$10 NOS
7591A \$30 NOS, \$15 RCA used
6L6GC RCA Black Plate \$30 NOS
12AX7 Telefunken \$15 used
12AX7 RCA \$8 NOS
5AR4 Mullard \$35 NOS
EL34 Mullard \$60 NOS, \$30 used
EL37 Mullard \$60 NOS, \$30 used
KT66 Genalex / Mullard \$70 NOS
KT77 Gold Lion/GEC \$120 NOS
KT88 Gold Lion/GEC \$150 NOS

TUBE WORLD, Inc.

2712 Superior Ave.
Sheboygan, WI 53081
(920) 208-0353 Phone/Fax

Call, Fax, Write or Email for our
detailed "Want to Buy List"
Email: tekman@tubeworld.com

WANTED: Zeniths: 715 tombstone, 834/835/935 tombstone, 8S129 tombstone, 12A58 console, empty/complete. Chris Hicks, RR2, Box 342, Clinton Corners, NY 12514. (914) 266-4257

WANTED: Grille and tuning wheel for Penney's 6TP-408 transistor radio. Al Wirtenberg, 15 Wilson Rd., Weston, CT 06883. (203) 544-9270. E-mail: mswaw@mail.snet.net

SEND ALL A.R.C. MAIL TO
Antique Radio Classified
P.O. Box 2, Carlisle, MA 01741

WANTED: Front door for JVC Nivico FA6000, (T-O R3000 knock off). Phil Vaccaro, 2581 Pond Ave., Maplewood, MN 55119. (651) 714-8743. Fax: (651) 714-8753. E-mail: pnvaccaro@prodigy.net

WANTED: Zenith Model 820. Mint condition. Black/gray. Timothy List, 1225 Spring Ash Dr., Centerville, OH, 45458. (937) 885-4238. E-mail: TList73169@aol.com

WANTED: Steering wheel knobs for Crosley E15 radio or will buy junker sets. Henry Trabold, 2058 Nakiska Ct., Toms River, NJ 08755. (732) 244-2345. E-mail: trabold@exit109.com

WANTED: Yaesu FR400DXSD rcvr, FT726 or FT736FR transceiver, Heath HW-16, Knight T-50. Don Traves, WB4CVH, PO Box 2114, Winter Haven, FL 33883-2114. (941) 298-0537. E-mail: wb4cvh@ithink.net

WANTED: Crosley 11-100U to 11-105U and 11-114U to 11-11-119U radios in good condition. John Evans, 8511 Thompson Rd., Highlands, TX 77562. (281) 426-3952. E-mail: jevans35@juno.com

WANTED: Radio News January 1944. Radio Craft January, May 1940, August 1942. WRL Catalog 1963. A.J. Bernard, PO Box 690098, Orlando, FL 32869-0098. (407) 351-5536

WANTED: Parts sets: Airline 62-345, Stromberg-Carlson 1101-HW, Philco PT-6. **FOR SALE:** Atwater Kent Type E speaker - \$50. Dwight Hill, 1209 Royal Pointe Dr., Bloomington, IL 61704. (309) 663-7599

WANTED: Italian made, Ducati radio, any model, any condition. Steven Rossi, 106 Kent Dr., Cortlandt Manor, NY 10567. (914) 736-5354

WANTED: Westinghouse AC-DC chassis #V-2515-4 from AM-FM-phono console #HM-1810 to HM-1815. Any condition. Jerry Cottingham, Box 251, Medina, TX 78055. (830) 966-3713

ARBE-III — Universal Battery Eliminator

\$149.95 Shipped USA

Contact:

Antique Radios Inc.

Box 6352, Jackson, MI 49204

(517) 787-2985 or

Fax (517) 782-7422



WANTED: Old guitars, guitar amplifiers. Fender, Gibson, Rickenbacker, Gretsch, Vox, etc. Sonny Goldson, 1413 Magnolia Ln., Midwest City, OK 73110. (405) 737-3312. Fax: 3355. E-mail: sonnysound@aol.com

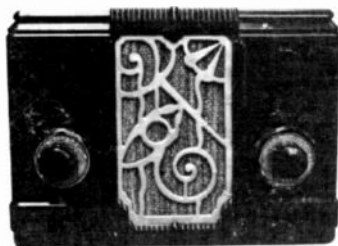

WANTED: Early (prewar II) plastic radios. I collect these objects of beauty to enhance my otherwise dull and uneventful life to which I am forever bound by my sad-but-true unworthiness and shortcomings: physical, emotional, and intellectual. Please write or call collect: Rain Buttignol, 214 State St., #7, Portsmouth, NH 03801. (603) 427-1384

WANTED: Heathkit DX40, VF1, HG10, SB303, Hallicrafters SX101, National NC109, state condition and price. Rick Harrison, WA2ODI, 140 North Putt Corners Rd., New Paltz, NY 12561. E-mail: harrisonmail@worldnet.att.net

WANTED: Knobs for any Jackson-Bell cathedral. Also any information on a radio that was made in late 20s called Miller Products Model 570-T. This tuner was made in California and I need photos and/or schematics for same. Still looking for telephone company line amplifiers Mod 124 or any of the KS series. Please call me collect or mail info to: Larry Drago, 383 Lincoln Dr., Cheshire, CT 06410. (203) 272-6030. Fax: (203) 272-2002. E-mail: theradioman@webtv.net

ZENITH

**Philco
GOT**

GRILLE CLOTH?

**New! New! New!
German-style cloth
Pattern #53**

- ★ 12 Philco patterns
- ★ 8 Zenith patterns
- ★ Generic patterns
- ★ Majestic (Grigsby-Grunow)
- ★ Plus GE, RCA, Stromberg & Westinghouse

Send a 55¢ LSASE for samples and info to:
John Okolowicz, N3VSR
624 Cedar Hill Rd.
Ambler, PA 19002

or
**See them on the web @
www.Grillecloth.com**

E-mail: **Grillecloth@compuserve.com**

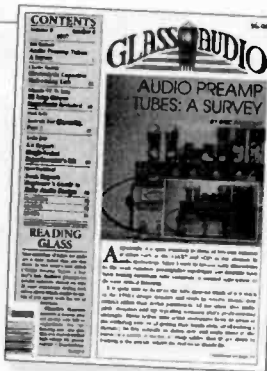

GLASS AUDIO

*Vacuum tubes
for Audio are back ...
and they sound better
than ever!*

Glass Audio brings together
yesterday's tubes and today's
improved components,
making smooth sound possible
for your audio again.

Ask for your first issue FREE to
examine, without obligation!

Glass Audio

PO Box 176, Dept. ARC8
Peterborough, NH 03458-0176 USA
Phone: 603-924-9464

Fax: 603-924-9467 Email: custserv@audioexpress.com

Visit our website at www.audioexpress.com

FOR SALE: Standby Magazine (Prairie Farmer, W.L.S. Station, Chicago). Issues from 1932 to 1953. Send SASE for list. Robert J. Stone, 711 Fisk St., Piqua, OH 45356-3729

FOR SALE: Radio parts, books, radios needing TLC. Send SASE for 6 page photo list. Phil Majewski, PO Box 92, Tamaqua, PA 18252

FOR SALE: Radio and related stuff sale from the Museum of Antiquated Technology. All equipment is untested and sold as-is. Proceeds go to the Museum Improvement Fund. Military radios: Signal Corps receiver and transmitter, BC-659-H, set only - \$65. RCA receiver and transmitter, RT 136/GRC 13, set only - \$75. Aircraft radios, BC-AR-229 and others. Have several modules, transmitters, receivers, power supplies, some modified - \$40 ea. Signal Corps transmitter and rcvr, Russian general radio, Mark 2, version ?, set only - \$125. WWII General Electric dynamotor, 1kv @ .65 amps, inpt.=28 vdc @ 19 amps - \$120. Crosley transmitter and rcvr, BC 654-A, big and Army green - \$140. Heathkit transmitter, DX-100, some knobs missing, fair cond. - \$125. Gonset CB mobile radio, works, fair cond. - \$55. Test equipment: Home made test set with 5 meters in nice wooden box - \$25. Large GE wattmeter, edge read, 0-2000 watts, old, panel mount - \$65. Large GE frequency meter, edge read, old, panel mount - \$65. General Radio Precision wave meter, #724A, with documentation and coils - \$95. Westinghouse outside electrical meter, Model 432, 5-amp service, teens - \$50. Superior Instruments Co., tube multimeter Mod 1150-S, 1930s - \$25. L.R. Bradley electric moisture meter, for wood and plaster, Mod BD-3, w/probe - \$20. Clippard tube voltohmmeter, Mod 406, metal case, slant-top meter - \$25. Millivac DC voltmeter Type MU-17B, metal case - \$25. Minaric Elec. Co., suitcase generator tester, w/cables, volts/amps etc. - \$25. Weston AC/DC voltmeter in nice wood case. 1950s - \$75. Heathkit color bar and dot generator, Mod G-62 - \$25. Weston kW meter in small wood box, big brass terminals for rf? - \$40. Eico scope Mod 460, 1940s - \$35. RCA scope, Mod WO-535A, 1950s - \$30. Heathkit tube checker Mod TC-3 with roll chart - \$40. Eico resistance capacitance comparator Mod 950 w/green eye - \$35. B&K Mfg. Co. CRT cathode rejuvenator and tester, Mod 200, w/cables - \$35. Sencor CRT rejuvenator and tester, Mod CR-133, w/cables - \$25. Mercury mutual conductance tube tester, Mod 1000, nice, all documents - \$45. Stuff and things: Admiral TV chassis, 14", metal CRT w/tubes, no knobs - \$65. TV chassis, 14" CRT, yolk deflector, canvas CRT strap, with tubes and knobs - \$55. TV chassis, 6", static CRT, kit tv?, no knobs, some tubes - \$75. Teletype, 1930s, stand, synchronizer, tape punch/read, covers, very heavy - \$55. Old 3-phase motor starter, slate back in metal box, big & heavy - \$45. Five old speakers, 1930s-40s, good cond., dynamic, 6" to 12" - \$75/lot. Webcor Stereofonic tape recorder, Imperial Radio recorder, 2 large cabs. - \$60. Large RF amp, 2 big cabs., one pwr. sup., one RF out stage & tank ckt. - \$125. Webcor wire recorder, w/amp and speaker, 2 cabs., good cond., all acc. - \$225. Magazines: Approx. 250 vols., fair to good, Radio & Electronics-1950s, Radio & Television-1950s, High Fidelity-1950s, Radio News-1940s, some vols. 1930s, will include boxes of manuals free - \$250/lot. Come clean my house! Discount for purchases of 6 or more items. Make offer on the entire shootin' match! Thank you! Mark A. Vess, 303 High St., Hanson, MA 02341. (781) 294-1647, home. (781) 740-0223, work

WANTED: Sparton 28 Triolian chassis/speaker. Majestic 15 speaker/chassis in restorable condition. John Williams, 2454 Braselton Hwy., Buford, GA 30519. (770) 682-9374

WANTED: AC Majestic electric power unit 9P6 for Model 90 only. Manufactured by Grigsby-Grunow Co., Chicago, U.S.A. Charles Isham, 4173 Independence Dr., Flint, MI 48506. (810) 736-8469

**NOTICE TO ALL
CLASSIFIED ADVERTISERS!
OUR CLASSIFIED AD DEADLINE IS
12:00 NOON
ON THE 10th OF EACH MONTH**

WANTED: Information best paint/finish for R-100 speaker case. Milt Fivree, K4EBT, 1445 2nd Rd. SW, Vero Beach, FL 32962

WANTED: Four tube shields for ST type tubes with grid caps. Gus McKenzie, 3701 Taiga Dr., Anchorage, AK 99516. (907) 345-0980. E-mail: 76243-1710@compuserve.com

WANTED: Amplifier using UV-199 tubes. Tim James, 17365 S.E. Walta Vista Dr., Oak Grove, OR 97267. (503) 653-0407

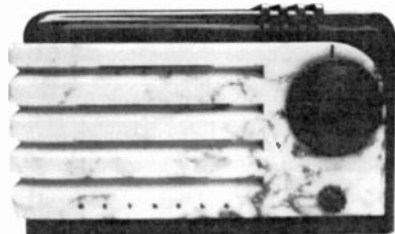

WANTED: More prewar plastics by Detrola, RCA, Kadette, Air King, et al. Take all my money before the relatives do. They are trying to hurry my already imminent demise. Please write or call collect: Rain Buttignol, 214 State St., #7, Portsmouth, NH 03801. (603) 427-1384

WANTED: Conar, NRI, other correspondence course kits, unbuilt with manuals. Will consider built-up if complete. Also, complete radio/TV courses from 40s-70s. Art Sabin, 315 S. Plymouth Ct., Chicago, IL 60604. (312) 987-1441. E-mail: 7sabin@jmls.edu

WANTED: Raytheon RK series tubes. RK16, RK25A, RK25B, RK30, RK32, RK41, RK44, RK45, RK46, RK56, RK58, RK63A, RK100. John H. Walker, Jr. 11015 W. 126th Ter., Overland Park, KS 66213. (913) 782-6455. E-mail: johnh.walker@alliedsignal.com

WANTED: Dial pointer for Emerson BT245. Same as AU190 and maybe other Emersons. Would consider buying complete dial or trashed chassis. Richard O. Gates, PO Box 187, Chesterfield, VA 23832. (804) 748-0382

WANTED: Sherwood AM FM receiver #S-7010A. AKG BX10 reverb. Pacific Recorder Multimax processor. Thanks. John Sampson 75 Glenwood Dr., Leominster, MA 01453. (978) 537-0092. E-mail: SampsonJ@massed.net

WANTED: Scanner programmable like Regency M1040 reasonable and must work good. James Wright, 4307 Hwy. 166N, Maynard, AR 72444. (870) 647-2913

WANTED: Chassis: GE K43, Angelus, Stewart-Warner R111 or R115, Crosley 5-38, Aenola Senior, AK 20c or Bigbox. Cabinet: Philco 20, 70, or 90, Crosley 4-29, Gilfillian GN-1. Richard B. Jehlik, 14441 N. River Rd., Omaha, NE 68112. (402) 457-4604, after 7 pm CST

WANTED: Small table model gramophone with outside horn. Old, original, complete. Good working condition. Dee Bramlett, Jr., 2629 Old Greenbrier Pike, Greenbrier, TN 37073-4507



WANTED: Pilot set pictured and similar, also Pilots with drum-type dials. Pay to \$1,500 or have trades. Pay finders fee for information leading to purchase. Shipping from anywhere no problem. Thanking everyone in advance. Bill Moore, 3049 Box Canyon Rd., Huntsville, AL 35803. (256) 880-1207

WANTED: Zenith Stratosphere 1000, must be exc and orig. Serious reward offered for lead and/or sale. Also, RCA, WE broadcast industry catalogs showing mics, pre-amps, stands, etc. I need these for reference for my book. Looking for Allied catalogs, '49, '50, '51, '54, '57. Have dups from 60s and 70s for trade. The following gear is for trade for above wants. Cash offers also considered. EV 642 shotgun, w/new rubber shock-mount, really cool over 2 feet long, sounds great; RCA 6225 carbon from 20s, great Deco piece, looks like large emerald w/copper embossed screens; RCA BK-4, exc; Astatic D-104 on stand, mint, Western Electric 5' shotgun, perfect, w/orig. type tripod, a show-piece; several Shure 55s, lg. shell and sm. shell. Looking for Western Electric 53-A bottle. Western Electric 618; Neumann CMV-3 bottle; other early bottles; RCA 4-A box camera; 77-A, 77-C, Shure 55-B. Have Mac-225, Scott 299, other cool hi-fi stuff for sale/trade. See other ad this issue. Ward Kremer, 5807 Papaya Dr., Ft. Pierce, FL 34982. Ph./fax: (561) 468-7732. E-mail: WKremer798@aol.com

WANTED: Zenith consoles. 12 and 15 tube sets. Looking specifically for 12S267 and 12S370 and 15S372. Tom Avery, 7180 N.W. Somerse Dr., Corvallis, OR 97330. (541) 745-5651. E-mail: mrlco@proaxis.com

CATALIN	WANTED
WANTED	RADIOS
	
TOP PRICES PAID!	
Michael Lawlor P.O. Box 179 Santa Barbara, CA 93102 (805) 682-2336	

FOR SALE: 201-A tubes, tested good, globe shape - \$10 ea. Standard shape - \$8 ea. Plus shipping. Min. order 5 tubes, no odd brands! Don Hovde, 1000 Ashland Ave. Apt. 2, St. Paul Park, MN 55071. (651) 459-9135

FOR SALE: General Electric M62 tombstone - \$100. Riders 9 - \$12. RCA IMBT6 T-O portable - \$80. (3) new tubes 5977, 6112, 5639 - \$20. Crosley Tridyne Special 1122 - \$60. Airline WG1636 - \$25. Learadio 6615 - \$40. RCA 4QR64X German built with eye - \$75. Zenith J504Y portable - \$35. Hallicrafters S38B - \$45. Silvertone 8010 - \$60. Thomas repro cathedral - \$30. Mitchell Airboy Sr. - \$25. Shakespeare Fish locator - \$25. Zenith H500 - \$150. Airmaster 6-volt farm radio - \$50. Air King tiny tube port. - \$20. Yew meter - \$20. Westinghouse H122A - \$30. Bendix 112 - \$40. (2) crystal sets - \$35. Zenith 1061 chassis - \$35. Walt Wrabek, Rt. 4, Box 370, Menahga, MN 56464. (218) 564-4623

FREE - 20 WORD AD EACH MONTH
To get your free 20 words,
include your SUB# with your Ad.
Additional words are 29c each.
Read inside back cover for details.
MANY THANKS!!!!

FOR SALE: Dayton plate glass see through, all original, plays, a rare find - \$1,250. Crosley C5, all original - \$225. Grunow radio chrome grille tombstone - \$225. Telegraph sounder in wood sounder box on cast iron 3-jointed stand with original cord, nice - \$150. (5) 199 tubes - \$100. Blue mirror hexed clock, blue mirror half moon beach mirror half moon Catalin round ribbed out square, all nice, no hairlines run - \$100 ea. Signal telegraph key & sounder on wood base 4" x 8" - \$1.50. Polar cub 6" brass blade fan - \$100. Ribon air fan Bakelite stand - \$100. 6" polar cub, 4 brass blades - \$85. Will ship next day UPS. Edison Mabry, 402 Pearl Ave., Mansfield, OH 44907. (419) 525-0902

FOR SALE: Turntable (records), Empire, large silver unit, needs cartridge and drive belt - \$50 + ship. R.G. Purcell, 4473 W. 136th St., Cleveland, OH 44135. (216) 251-6511

FOR SALE: Zenith Model 39, 1928 Italianate cabinet, original papers, one owner, must pick up. Richard Minnick, 1318 Judd, Saline, MI 48176. (734) 429-1022

FOR SALE: Western Electric 522W driver, Stancor A-3854 output transformer for crystal cutter, filament transformers. Angelo Pallotta, W2TPW, 1367 D'Angelo Dr., N. Tonawanda, NY 14120. (716) 695-0329

FOR SALE: Longines Symphonette portable - \$95. Admiral TV portable - \$65. NRI one - \$60. Heath scope - \$45. PU. Dewey H. Shaffer, 1948 Rocklick Hollow Rd., New Paris, PA 15554-7532. (814) 839-4728

FOR SALE/TRADE: Heathkit SSB Mod NW101, Globe Scout Deluxe, Swan 500 transmitter, Hallicrafters SX-42, S-94, National NCX 5, NCL 2000, HRO-M, SW-3 w/ PS, HRO 50, Collins 75A-4 w/3 filters 75A-2 and 75A-3, Heathkit SB 300, and SB 401, Hammarlund NQ 120, HX 50, National NC 300, Hallicrafters S-20R, National NC-46, Vintage Hallicrafters SX-28, Manson 390A, B&W Mod 5100, WWI & II BC-148 receiver and telegraph transmitter, Collins 75S-1, 30L1, 32S-3 and PS (will sell individually), Kenwood TS 930S w/sprk, Kenwood FM receiver mobile unit TR 7400A, Collins 1939 6X2 gain unit with 40E exciter which was companion to radio stations. Collins 1000 watt transmitter, Knight T-60 transmitter. National 240-D w/speaker, pair of 1950s Federal rack-mounted military amplifiers. Larry Drago, 383 Lincoln Dr., Cheshire, CT 06410. (203) 272-6030. Fax: (203) 272-2002. E-mail: theradioman@webtv.net

FOR SALE: Heathkit IT-22 cap. tester & IT-12 signal tracer - \$60 includes shipping. Leroy Neal, 603 Bittenworth Ave., Dyersburg, TN 38024. (901) 285-5120, after 8 pm CDT

BUYING NEW AND USED TUBES

We are desperately seeking the following tubes. They must be noted USA or European brands such as RCA, GE, Sylvania, Phillips, etc. All new tubes must be in original boxes. We pay shipping charges. Payment will be made within 10 days of receipt. We also SELL tubes. Send for our FREE catalog at the address below.

TYPE		PAYING		NEW TUBES					
1L6	18.00	6DA6/EF89	2.75	6KV6A	12.00	26LX6	6.00	82	6.50
2A3RCA	30.00	6EM5	1.50	6L6GCUSA	15.00	26Z5W	2.50	83V	5.50
2A6	2.00	6F5G	7.00	6LB6	11.00	27	3.50	801A	16.00
2A7	2.00	6F6	2.00	6LF6	25.00	30	5.00	866JR	6.00
2B6	5.00	6F6GT	5.00	6LR6	15.00	30KD6	6.00	5692 RED	30.00
5AR4/GZ34	26.00	6G56U5	16.00	6Q7G	3.00	30MB6	6.00	6146B	12.00
5Y3GT	1.00	6GM5	6.00	6T5	25.00	31J6C	4.00	7025 RCA	7.00
6AR6	6.00	6JB6	10.00	6V6G	6.75	31LQ6	8.00	7189 USA	12.50
6AD6G	8.00	6JE6/6LQ6	22.00	6V6GT/A USA	6.00	35L R6	8.00	7408	5.00
6AJ8	2.50	6JF6	3.50	12AX7 USA	2.50	36KD6	8.00	7591/A	32.00
6B5	8.00	6KD6	16.00	12AX7A USA	4.00	50A1	16.00	8417	25.00
6CA7USA	16.00	6KM6	4.00	20LF6	28.00	56	2.00	8950	35.00
6D10	2.00	6KN6	6.00	24JE6/24LQ6	8.00	76	4.25	FM1000	2.00

USED TUBES

01A	6.00	6L6GC	2.00	31	1.00	240	9.00	UX201A	7.00
2A3RCA	12.50	6Q7G	1.00	59	1.50	247	9.00	CX301A	7.00
2A6	1.00	12A	7.50	82	2.75	282	12.50	7591/A	19.00
2A7	1.00	26	2.00	183/483	11.00	UV199	15.00	8417	11.00
6AR6	2.00	30	1.00	210	30.00	UX199	13.00	8950	25.00

ELECTRON TUBE ENTERPRISES 11 LINDEN LN BOX 8311 ESSEX, VT 05451

TEL: 802-879-1844 FAX: 802-879-7764

VISIT OUR WEB SITE AT: <http://members.aol.com/etetubes>

WANTED: DeForest 433 through 440 tubes, Westinghouse WL-461, Taylor 833, duds OK John H. Walker, Jr., 11015 W. 126th Ter., Overland Park, KS 66213. (913) 782-6455. E-mail: johnh.walker@alliedsignal.com

WANTED: Western Electric tube amp, line amp, horn, tubes. Will pay market price. Wen Hsin, 1560 Via Leon, Palos Verdes, CA 90274. (310) 377-0056. E-mail: wenh@jps.net

**E-MAIL ADDRESS FOR
ANTIQUE RADIO CLASSIFIED
ARC@antiqueradio.com**

**Ads - Subscriptions - Book Orders
See inside front cover for details**

WANTED: Few good Kellogg Type 401A or 403A tubes. Will buy or trade tubes, radios. Steve Hansman, 855 Arundel Dr. N, Arnold, MD 21012. (410) 974-0561. E-mail: Shans01A@aol.com

WANTED: Obsessed collector pays top \$\$\$ for Deco radios; wood with chrome grilles/trim, Catalin, Plaskon, mirrored. Adam Schoolsky, PO Box 23162, Portland, OR 97281. E-mail: Radios@ArtDeco.com

WANTED: Early plain frame Pathé cone speaker in working condition. I'll be at Rochester! Gary Carter, WA4IAM, 1405 Sherwood Dr., Reidsville, NC 27320. (336) 349-1991. E-mail: gcarter01@sprynet.com

WANTED: Heathkit GR11 FM table radio in any condition. Andrew Mitz, WA3LTJ, 4207 Ambler Dr., Kensington, MD 20895. (301) 897-5531. E-mail: arm@serge.gnode.org. URL: http://www.somerset.net/arm/fm_only.html

WANTED: Radiola 47 parts set, any pre-WWII TV, bipolar motors and dynamos. Tom Burgess, 9 Bellemeadow Ln., Little Rock, AR 72210. (501) 455-0773

WANTED: Arm activator lift assembly for Collora Conquest record changer or junker for parts. Onerio Sabetto, 1717 Burgess Rd., Cleveland, OH 44112. (216) 481-1036

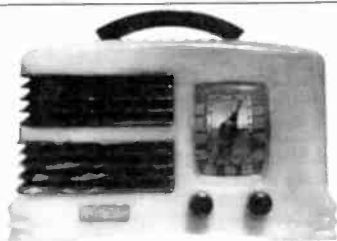

WANTED: Symphony and Detrola Catalin radios. I am not a human being: I am a radio collector. God forbid! Pity me the lost soul that I am and fulfill my humble needs. Please write or call collect: Rain Buttignol, 214 State St., #7, Portsmouth, NH 03801. (603) 427-1384

WANTED: Need CRT 17LP4 for Motorola TV. Robert Nicholson, General Delivery, Manilla, Ontario, Canada K0M 2J0. (705) 357-1466

WANTED: Collector tubes. Need good C301/UV201s and DL and DV types. Also need Arcturus blue types and WD-11s. Buying collector tubes of all types. Please send your list of tubes you want to sell for our offer. George H. Fathauer & Assoc., LLC, 688 W. First St., Ste. 4, Tempe, AZ 85281. (480) 921-9961. E-mail: fathauer@home.com

WANTED: 21" or 15" color TVs, and odd brand B/W. Starrett, Videodyne, Trad. Glenn Bubenheimer, 27851 Terrace, Livonia, MI 48154. E-mail: gbuben@provide.net

WANTED: Chassis with speaker working or restorable condition for Motorola 61T22. Wilbur Kinchens, 2441 N.W. 58 St., Miami, FL 33142. (954) 435-8928

I buy Western Electric

“What do you want to sell me today?”



Chong Ong

Tel : (703) 255-3218
Fax : (703) 255-3718
e-mail : ongki88@erols.com

10223 Valentino Dr. # 7304
Oakton, VA 22124

FOR SALE: Radiola II - \$375. KLH Model 21 - \$125. Atwater Kent Model 9 - \$1,295. Statue of Liberty cone speaker - \$850. Waves will be at the meets in Lansing, Mich in July, Elgin Ill. in Aug. and Rochester in Sept. We are always looking to purchase individual pieces, collections and/or accumulations of radios, phonographs, etc. For more information contact: Waves 110 W. 25 St., 10th flr, New York, NY 10001. Shop hours are from 12 - 6 mon - fri, 10 - 6 sat & sun. (212) 989-9284. Fax: (201) 461-7121. E-mail: c1wave@aol.com

FOR SALE: Have many many transistor radios for sale, will sell one or all. Doug Ferrero, WB8YNY, 70173 Hillside Ct., Romeo, MI 48065. (810) 336-0120. E-mail: ynzdsd@bignet.net

FOR SALE: N.O.S. cloth covered wire, 20 gauge stranded, 7 colors. Write or call toll free for flyer. DH Distributors, PO Box 48623, Wichita, KS 67201-8623. (888) 684-0050, v/f

FOR SALE: Zenith Wavemagnet antenna - \$25; Guild Spice Chest radio - \$85; Realtone Globepacer, 11 bands - \$85; Grebe manual (copy) 74 pages - \$15 + postage. Ernie Nagy, PO Box 822, Elk Rapids, MI 49629-0822. (231) 264-9412. E-mail: elnagyl599@webtv.net

FOR SALE/TRADE: Hallicrafters Sky Challenger II w/ speaker, S72, National NC46 - \$225 ea. plus UPS. **WANTED:** D.A.V., B.F. Goodrich mini keychain license tags paying - \$1.50 ea. John Williams, Jr., PO Box 1545, Scarborough, ME 04070-1545. (207) 775-4212

FOR SALE: Hallicrafters SX-99 with R48A speaker - \$200. TO-H500 - \$150. B&K 400 and 440 CRT testers, untested, both for - \$25. TV-20 tube tester - \$25. 60B test set for telegraph by WE - \$45. Morse relay, Wutco - \$35. Tubes galore. John R. Tebeau, 2572 Oak Villa Rd., Thomson, GA 30824. (706) 595-8211. E-mail: TebeauJ@aol.com

FOR SALE: New sweep tubes: 6LQ6, 6KD6, 6JS6, 6KV6 - \$25. Postage, \$4. Bob Putnak, 1507 4th St., Monongahela, PA 15063. (724) 258-6236. E-mail: tubeaudio@home.com

FOR SALE/TRADE: Many hard to find vintage radio, audio, and transmitting tubes at half the price of catalog dealers. Let me know. Call: Larry Drago, 383 Lincoln Dr., Cheshire, CT 06410. (203) 272-6030. E-mail: theradioman@webtv.net

FOR SALE: Westinghouse RA case, DA panel, Silvertone 4500, Paco amp - \$25 ea. **WANTED:** Pathoclcasts. Ted Hutson, 11 1/2 Winthrop Ave., Beverly, MA 01915. (978) 922-3405. E-mail: tedhutson@yahoo.com

FOR SALE: Addison #2A Catalin, works, repaired crack maroon, yellow - \$575. Rider's 9, 10, 14 - \$15 ea. Richard Bednarcik, 28 Steele Ave., Lincoln Park, NJ 07035. (973) 694-6374

FOR SALE: B&K #520 transistor tester - \$30; Belmoor 4 amp. 12 volt filtered power supply - \$30; Telefunken caprise radio Model 5451W - \$85. Herb Love, 6 Linda Ln., Pearl River, NY 10965. (914) 735-9172

FOR SALE: RCA tube manual, 1959 - \$10. RCA tube base diagrams, 1948 - \$10. ARRL handbook, 1948 - \$15. CQ magazines, 1948, complete - \$15. Classic Radio & Television, 541 Riverside Dr., Box 61, Augusta, ME 04330. (207) 623-2059

FOR SALE: Toothed drive belt for the Zenith 7000 - \$5 plus \$1.50 shipping. Rescreened original dial masks for 1938 and 1939 Zenith shutter dials - Call. Rubber gasket for the dial glass for Zenith and other brands - \$3 per foot. Brass inserts for Zenith Trans-Oceanics and 1942 Zeniths - \$5 each; or 2 for - \$8. Also H500 and 600 knobs with inserts - \$15. We stock a large selection of quality repro grille cloth. Lucite dial lens for the 1942 Zeniths - \$16. Repro arms for your RCA chrome chair, pair - \$60. Call for details. Universal Dial Belt Kit - \$995 ppd. Complete speaker repair - Call. Send for free parts and supply catalog. Visa, Discover and Mastercard accepted. Alan Jesperson, PO Box 17338, Minneapolis, MN 55417. (612) 727-2489, 8 am-6 pm Mon-Sat. Fax only: (612) 821-4821. E-mail: mte612@aol.com

**IF YOUR EXPIRATION DATE IS
JULY OR BEFORE, RENEW TODAY!
EARLY RENEWALS
RECEIVE AN EXTRA ISSUE!**

FOR SALE: Knight Ranger Bakelite table model radio, T-50, exc w/ papers - \$115; National NC300 untested - \$140; Radio handbook hardback 1946, by editors and engineers - \$30; all of the above + S&H. Ron Crowe, PO Box 117, Handley, WV 25102. (304) 442-8179. E-mail: rgcrow@wvnet.edu

FOR SALE: Philco stereo Model H-1814, 1960 tube type, w/2 electrostatic speakers - \$75. Concord Model 444, 1964 reel-to-reel 3 speed stereo tape recorder - \$75. Goodmans, England 15-inch woofer - \$75. Zenith console Model #9H-081, 1946 9 tubes has BC & 2 FM bands, but record player is missing, large black dial - \$75. Eico #460 5 inch oscilloscope - \$35. Heathkit oscilloscope IO-D-203 - \$50. Silvertone #7024 table radio - \$75. Garrard Type A-II, 4 speed record changer - \$75. Sony Model TV-413, 3 1/2" b&w TV/AM/FM - \$75. Regency MR-10 radio, 152-174 MHz band - \$45. About (125) Sams AR (auto radio) books - \$6 ea. About (3,000) Sams Photofact folders - \$3 ea. Rotating Gyro speaker cabinet, takes (3) 12" woofers & (3) tweeters - \$100. Mura CB SWR meter N.I.B. - \$15. Grab Bag Special: Hundreds of pounds of parts, mostly new, some in original packaging, including jacks, plugs, wires, cables, needles, lamps, controls, meters, relays, misc. hardware, and much more other stuff. A generous 5 pound box (no 2 alike) for - \$10 ea. All prices plus UPS. Bob Lynn, 26 E. Orchard St., Somerville, NJ 08876. (908) 685-9070

FOR SALE: Grebe Mu w/chains, no cabinet, vg - \$125 PU. Brunswick A.C., same as Radiola 18 - \$70 PU. Matching Brunswick spkr - \$40 PU. W-E7A, w/tennisball tubes vg - \$300 PU. Aeriola Sr. vg - \$70 P&H. Aeriola amp, vg - \$70 P&H. Radiola III, vg - \$70 P&H. Crosley 51, vg - \$70 P&H. AK 20 small & large junkers - \$10 ea. PU. R. Robbins, 253 Standish Rd., Merion Station, PA 19066

FOR SALE: HP 608C RF signal generator - \$150. Drake R4B communications receiver with matching speaker - \$225. Radiola 17 - \$85. Bosch 260 console - \$75. Federal orthosonic - \$125. Zenith 7000 Trans-Oceanic - \$145. John F. Dubino, KA1-SBN, 73 Devens St., Greenfield, MA 01301. (413) 774-5826

FOR SALE: Grundig components amp rec & stereo decoder - \$150. Analyzer Military 1-56-J - \$50. James E. Inglett, 94 Leawood Dr., Midway, AR 72651-9208. (870) 431-8430. E-mail: cen62047@centuryinter.net

EXTRAVAGANZA '99

Hosted by the Michigan Antique Radio Club
July 8-11, 1999



Holiday Inn South Convention Center
6820 S. Cedar Street, Lansing, MI 48911
(517) 694-8123



Come join us for our 14th annual convention

CONVENTION THEME: "ON THE AIR"

A CELEBRATION OF THE HISTORY OF RADIO & TV BROADCASTING



FEATURES:

- EXPANDED 4-DAY EVENT
- FREE BUS TRANSPORTATION TO & FROM LOCAL MUSEUM'S "ON THE AIR" EXHIBIT ON THURSDAY ONLY!
- SAT. AUCTION WITH RICH ESTES
- 4 INFORMATIVE PROGRAMS
- INFORMAL SOCIAL HOUR FRIDAY
- EQUIPMENT CONTEST
- HUGE OPEN AIR FLEA MARKET

To mail check or to request a convention brochure, write: EXTRAVAGANZA '99, Suite 100, 3520 Okemos Rd. #6, Okemos, MI 48864. For additional information contact: Jim Clark @ (517) 349-7187 or E-mail: HGGW75A@PRODIGY.COM, or check out the MARC Homepage on the WWW at www.antiqueradios.com/marc

EXTRAVAGANZA '99 Registration

Note: Everyone attending EXTRAVAGANZA must register! The monies collected as a result of registration are a major source of revenue that help pay for this event. Your cooperation is appreciated.

Family Registration (All registrants must live at same address)		TOTAL
Current MARC member	\$ 12	\$
Non-MARC member	\$ 18*	\$
Outdoor Flea Market sellers		
1st outside Flea Market space (\$20)		\$
Additional outside spaces	<input type="text"/> # spaces x \$10 each	\$
8' table to rent	<input type="text"/> # tables x \$10 each	\$
Under Tent Flea Market sellers		
8' table with 2 chairs	<input type="text"/> # tables x \$20 each	\$
Make check out to MARC for this amount	TOTAL	\$

* Includes MARC membership from July-December 31, 1999.

FOR SALE: Zenith X404P AM radio, leather carrying case with shoulder strap - \$35. RCA 2BX63 AM radio - \$20. Hallicrafters S-94 civic patrol, manual copy - \$50. Heathkit TC-2 tube checker, CRT adapter, manual - \$35. Sencore TC109 tube checker - \$25. Conar 681 TV pattern generator, manual - \$25. John Osborne, 2 Lake St., Winthrop, ME 04364. (207) 377-2519

FOR SALE: (73) copies A.R.C. in sequence 1983[?]-1999 - \$75. (25) Elementary Electronics, most have James Fred antique radio articles - \$28. Prepaid. M.B. Gaskins, 227 Risen Ave., Campbellsville, KY 42718. (270) 465-3755

FOR SALE: Crosley Model 435, 6-volt, (4) tubes, made for use with Wincharger. H. Eltz, 4265 S. Bladen, Juniata, NE 68955

FOR SALE: Dynakit SCA-35 stereo control amplifier, (4) 6BQ5 tubes for output. Dynakit Model FM-1 FM tuner with multiplex FMX-3 stromatic, both above exc working - \$250 + UPS with manuals. Pr. of Wharfedale Model W70 3-way speaker systems in French Provincial style cabinets, excellent working - \$300 pr. + UPS. Garrard Auto turntable Type A Mark II, excellent with stereo cartridge - \$50 + UPS with manual. Phil Guinan, 106 Page Rd., Litchfield, NH 03052. (603) 889-6213

FOR SALE: Bang! Bang! Fourth of July specials; seldom seen Crosley/Deforest Model C-3. Three tube 1927 receiver with gold window escutcheons, nice, nice clean condition - \$155. General Electric 1932 Model K-51, has carved wooden sliding doors, in excellent working condition - \$225. Inter-Ocean Woodehom horn speaker, nice original condition, works - \$140. Dave Crocker, 4B Beechwood Point Dr., Mashpee, MA 02649. (508) 477-1578, before 9 pm please

FOR SALE: Zenith Blackface shudder dial, poor to fair. Zenith portable Zenette Model 402, works. Arvin Table G 1421, metal, works. Firestone 4A61 plastic RCA K80, fair. Albert R. Engle, Jr., PO Box 831, Lake Panasoffkee, FL 33538. (352) 568-7614

FOR SALE: Back for a Hopalong Cassidy radio - \$45. Arvin 540T metal radio - \$45. Archer 2 transistor radio - \$25. One Rockola 456, two Wurlitzer 2200, 2600 jukeboxes, all three - \$800. Bob Furtado, 23 Garden Rd., Alameda, CA 94502. (510) 521-3084

FOR SALE: Crosley radio chassis for parts or restore. Models 125-N, 1931 cathedral, Model 146CS, 1947 console - \$35 each. Bill Van Pelt, 4401 S. Plateau Tr., Sioux Falls, SD 57106. (605) 362-7243

WANTED: Collins Radio Company Catalogs, promotional literature, manuals 1933-1983. Jim Stitzinger, 23800 Via Irapa, Valencia, CA 91355. 1-805-259-2011

ELECTRON TUBES: Over 1 Million Tubes in Stock. Buy & Sell. Daily Electronics, 10914 NE 39th St. #B-6, Vancouver, WA 98682. 800-346-6667. 360-896-8856. 360-896-5476, fax

WANTED: Broadcast-type MICROPHONES. Early carbon, condenser, ribbons, etc. Cash or trade. James Steele, P.O. Box 620, Kingsland, GA 31548-0620. (912) 729-2242. E-mail: JSteele@k-bay106.com. Microphone collectors Internet site: <http://www.k-bay106.com/mics.htm>.

FOR SALE: Kolster 6D WT - \$90. Crosley 516 WT - \$90. (20) Radio and Television, 1939-1954 - \$15. (20) Radio Electronics 1948-1959 - \$15. Robert Paul, 9150 Boone Rd., Yoder, CO 80864. (719) 478-5611

FOR SALE: Hallicrafters TW-1000 portable - \$130. Sony MR-9100W portable FM stereo/AM - \$75. Grundig YB-400 PE L.N. boxed - \$150. Realistic DX-160 - \$40. Gerald Silver, 10863 W. Clairmont Cir., Tamarac, FL 33321. (954) 720-1972

— WANTED —
**PICTURES FOR PHOTO REVIEW OR
TELEGRAPH REVIEW
PHOTOS MUST BE SHARP IN DETAIL
A SHORT DESCRIPTION IS A MUST!
SEE PHOTO REVIEW PAGES FOR
ADDITIONAL INFORMATION**

FOR SALE: Vacuum tubes, all kinds 42,000 on hand. Send want list & SASE for prompt response. Tom Ivas, 2932 West 99th St., Evergreen Park, IL 60805. Ph/Fax: (708) 423-0528. E-mail: tivas@xnet.com

FOR SALE: Fada 52 yellow on maroon - \$1,000. Emerson 564 maroon red - \$1,500. Bendix 526C - \$600. E-MOR World Globe pedestal blue metallic - \$2,000. Tom Thumb repro (2) red - \$750 ea. Tom Thumb camera radio - \$500, extra camera. Radiolamp America, Chicago, 4 brass mushroom, white, brass, marble - \$600 ea. 1958 N.I.B. Hotpoint remote console TV - \$300. Crosley G1465 (24) yellow on black. David F. McMorran, 48 E. Central St., Natick, MA 01760. (508) 655-4747, day. (781) 237-0290, evs.

FOR SALE: Replace expensive 45 tube with a - \$16 tube adapter and a low cost tube. James Sinwell, 511 Newport Dr., Greensburg, PA 15601. (724) 834-0763

FOR SALE: New antenna Hy-Gain multiband verticals - \$100 + \$35 shipping. Also new LGB passenger train set w/trans Model 20301 - \$400. + \$35 shipping. John Nosbaum, W9BJP, 2743 Wilmette Ave., Wilmette, IL 60091. (847) 256-0547

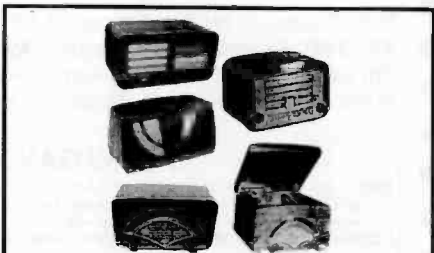

WANTED: Wood Table Radios 40s. ZENITH 8H034, 6D030, 6R084 rec/player. EMERSON 578A, 578. Teletone 117. DETROLA 572 or Detrola's offbrands #572 Val-Keen, Aria, Freedom, Seiberling or Truetone. Detrola 582-tall rec/player. Thanks. Will buy parts sets if cabinets are good. Needing work is alright, my dad has projects he can use doubles for. Steve Cabella/modi, 500 Red Hill Ave., San Anselmo, CA 94960. (415) 461-6810

WANTED: 1930 to 1942 Police Radio communications equipment. Any 6 VDC mobile communication equipment. Raymond Miller, 953 N. 1st St., Albemarle, NC 28001. (704) 982-0228

WANTED: The following audio related items: WE D-95036 amp, 24, KS-12027/25/24 horns, 4151, 4165, 4181, 4194, 555, 594, 595, 596, 597, 713, 750A, 728, 754 speakers, any old WE supplies or crossovers; Lansing 415, 801, 284, 287, N-400, N-800, 808, supplies; RCA old 1483 crossover; any style Tannoy speakers or parts especially amps; home speakers built by isophon; Motiograph power supplies and bass speakers; Jensen V-18, HF-18, L-18, PLM/PLJ-18, M10/20 Q speakers, F-5, F-7 crossovers, F5 type supplies. Trades available. Ray Miller, RR #2, Brantford, Ontario, Canada N3T 5L5. (519) 578-7322. Fax: (519) 449-5478

WANTED: Jensen speaker for McMurdo Silver III. Can trade Scott speaker, AC10 amp. Dave Poland, 6546 Upper Lake Cir., Westerville, OH 43082. (614) 890-5422. E-mail: dep44@hotmail.com

WANTED: Collections, bulk and estate sales of radios, tubes, literature, advertising, etc. Radio Daze, John & Kathy Slusser, 7 Assembly Dr., Mendon, NY 14506. (716) 624-9755. Fax: (716) 624-7857. E-mail: info@radiodaze.com. Web: www.radiodaze.com

WANTED: Rider's Vol. I and II. Help me rescue some TRFs! Thanks. Dave Springer, 1115 Brookfield Ln., Wausau, WI 54401. (715) 355-0271, before 9 CST

WANTED: Western Electric 1920s cone speakers, 548AW, 560AW, coneless OK. Ming Yang, 1995 University Ave., #119, Berkeley, CA 94704. (925) 376-4220. E-mail: yang1240@aol.com

WANTED: 1.75" O.D. thin metal knob escutcheons used on various 1932-33 vintage radios. One is labeled "volumn-increase" and one is labeled "0-100" increments and "station selector." Originals or reproductions acceptable. **FOR SALE:** 1962 vintage A.M.T. slot car 14 Vdc power pack transformers, N.O.S. - \$25. Bob Snively, 516 S. 16th St., Richmond, IN 47374. (765) 935-3746

WANTED: Restorable Philco 90 cathedral, any condition, basket cases OK. James S. Fisher, 344 Harrison Ave., Manville, NJ 08835. (908) 725-7476. E-mail: y-rlless@juno.com

WANTED: OUTSIDE HORN PHONOGRAPHS. Mint, junkers or parts, horns, boxes, reproducers, etc. Jahan L. Acciavatti, PO Box 806, Upton, MA 01568-0806. (508) 476-3229

FOR SALE: 1941 PHILCO ESCUTCHEON REPRODUCTIONS. Beautiful injection molded marbled brown plastic - just like the originals. Fits Models 41-250, 255, 256, 280, 285, 287, 290 and 296. Cost - \$29.95 plus \$3 shipping. California residents please add 8.25% sales tax. Send a money order to Old Time Replications BA, 5744 Tobias Ave., Van Nuys, CA 91411. (818) 786-2500. Fax: (818) 909-0241. Guaranteed satisfaction or your money back.

PHONO NEEDLES & CARTRIDGES (magnetic/ceramic). Over 500 cartridges and 5,000 needles. J. J. Papovich, 165 Trellis Ln., Sewell, NJ 08080. (856) 464-6741

BOXED CLASSIFIED ADS WORK! This is a boxed classified ad. These ads can be run more than two months. See the inside back cover for details. Boxed ad deadline: the 1st of the month.

WANTED: Large Amperex tube manual from the late 1960s. Also odd or unusual tube types. Will pay \$200 for Eimac 500T tube. John H. Walker, Jr., 11015 W. 126th Ter., Overland Park, KS 66213. (913) 782-6455. E-mail: johh.walker@alliedsignal.com

HAS YOUR SUBSCRIPTION

EXPIRED?

It has if your mailing label reads
"EXP=JUL99" or earlier.
Renew now!

*BONUS: Renew before
your "EXP" month and receive
13 issues per year instead of 12!*

**15th Year Special!* Renewal rates are:
\$39.49* for Periodicals Mailing
\$57.95 for First-Class Mailing
(Two-year renewals are twice above rates.)

WANTED: Welch Scientific manuals for AM demonstrators (receive, transmitter, power). Will pay for copy or original. Art Sabin, 315 S. Plymouth Ct., Chicago, IL 60604. (312) 987-1441. E-mail: 7sabin@jmls.edu

WANTED: Still looking for 4-tube chassis to fit Peter Pan/Jackson Bell. Also looking for Philco 89B speaker. Will trade WE tennis ball tube. Byron Bernor, 33855 McEnery Cyn, Acton, CA 93510. (661) 269-5459. E-mail: rajo@prodigy.net

WANTED: Service info & instruction manual for: Superior Instrument Co. Model 76, CR bridge & signal tracer; B&K Manufacturing Co. B&K Model 440 CRT, cathode rejuvenator & tester. Reply to: Vincent E. Lobosco, 1517 Farley Ave., Fanwood, NJ 07023. (908) 322-4512

WANTED: Rider's radio volume 23, also old hom speaker parts and incomplete units. Charles Combs, 508 E. Daniel, Albany, MO 64402. (660) 726-3038

WWII MILITARY TELEVISION WANTED. Army/ Navy SCR, ATJ, ATK, ARK, ARJ, CEK, CRV. Receivers, cameras, monitor, transmitters, dynamotors. Maurice Schechter, 590 Willis Ave., Williston Park, NY 11596. Ph/fax: (516) 294-4416

Victrola Repair Service: Windup phonograph repairs, parts, springs, needles via U.P.S. Rod Lauman, 19 Cliff St., St. Johnsbury, VT 05819. (800) 239-4188, eves.

WANTED: Vintage Electronic Music Synthesizers and modules by the following manufacturers, especially the listed models. Aires Modular, System III. ARP 2500. Buchia Modular, 100, 400. E-mu Modular. EML Electrocomp 100, 101, 200. EMS Synth A, Synthi AKS, VCS3. Korg Modular PS-3100, PS-3200, PS-3300. Moog Theramin, Modular, Series 15, 35, 55. Oberheim SEM modules 2-, 4- & 8-Voice Systems. Paia Modular 2700, 4700. Roland Modular Systems 100, 700. Serge Modulars, System 79. Synton Modular System. Call and surprise me; make my day! John V. Terrey, 498 Cross St., Carlisle, MA 01741. (978) 369-9770. Fax: (978) 371-7129

FOR SALE: Motorola 55X15 Mothers Day - \$50; Philco 49-900 - \$40. Shipping extra. Victor Marett, 3201 N.W. 18 St., Miami, FL 33125-1837. (305) 634-9569. E-mail: antonio1@gate.net

FOR SALE: Bulova Companion, Mod 240 circa 1957, nice tan leather case, plays, very clean, made by Electronics Guild for Bulova - \$100; Globe Scout, Mod 65A transmitter, nice cabinet - \$150; Heathkit Cheyenne transmitter, Mod MT-1 - \$95; Western Electric Codeophone 700, reel-to-reel answering machine - \$60; Johnson Messenger 23-channel CB (made like a telephone), plugs into AC, Mod 242-0132, tan - \$75; two Saba Meersburg StereoK receivers, AM/SW/FM, European voltage, Germany 220 V, one plays, one doesn't, one set of speakers - \$325 for all or \$200 for working one and speakers - \$125 for non-working one; National Select-0-ject, Mod SAF-1, signal interference booster - \$65. All of the following books are originals: Sams Transistor Substitution Handbook - \$18; Sams Tube Substitution Handbook No. 20 - \$15; Sams Auto Radio Removal Handbook, circa 1955 - \$20; Sams Electrical Measuring Handbook - \$12; Sams FM from antenna to audio - \$20; Sams CB Servicing Guide by Leo Sands - \$18; Victrola wind-up phonograph, Mod 2-60, circa 1925 - \$175; two Astatic mics with 2U8 stand and cord - \$50 ea.; two Zenith 500 transistors, need work - \$95 for both; Heathkit Q Multiplier, Mod OF-1, w/manual - \$45; Heathkit VFO, Mod VF-1 w/manual - \$40; Heathkit transistorized power supply, Mod HP-10, manual only - \$20; SX-43 Hallicrafters - \$175; Heathkit SB-600 power supply w/ built-in speaker, nice - \$80; B & K Precision CB signal generator, Mod 2040 w/manual - \$95; Hallicrafters S94 Civic Patrol, nice - \$55; Hallicrafters R44 speaker, nice cabinet, speaker works, needs reconed - \$65; also have radio dial belts and T-O parts, call. All above + UPS or U.S. mail. Also see ad in June A.R.C. on page 42. Ron Crowe, PO Box 117, Handley, WV 25102. (304) 442-8179. E-mail: rgcrow@wvnet.edu

FOR SALE: Heathkit SSB transmitter SB401 with all crystal and HD15 phone patch - \$100. Joseph B. Kelber, 503 S. Scranton Ave., Scranton, KS 66537. (785) 793-2323

FOR SALE: Various tubes (n9tew tube sales). 200+ Sams auto & transistor manuals. See you at Lansing & Elgin. Bob Bieker, 9528 Farmer Dr., Highland, IN 46322. (219) 924-0945. E-mail: n9tew@jorsm.com. Web: <http://www.jorsm.com/~n9tew>

FOR SALE: Scott, both chassis of an Allwave radio 23 and original manual. Mony Nisel, 20 Crestwood, Montreal, West Quebec, Canada H4X 1N2. (514) 483-4937. E-mail: monyise@aei.ca

**FAX NUMBER FOR
ANTIQUE RADIO CLASSIFIED
(978) 371-7129 - 24 hours a day
Ads - Subscriptions - Book Orders
See inside front cover for details**

FOR SALE/TRADE: Items with no price are preferably for trade, but cash offers always considered. Really cool late 50s tube stereo hi-fi system, turntable, Rek-O-Kut Model N-33H w/Shure studio dynetic arm; Scott 299 tube amp in orig. metal H.H. Scott logo case; Knight 136-M tube stereo tuner, all exc w/manuals, sound very sweet, you can hook them up to pr. of Bozak B-310 speakers. Will sell system or individual. High class mono-system from early 50s, Thorens TD-124 turntable, w/Rek-O-Kut 16" pro-transcription arm, comes w/GE VR-2 and Fairchild X-3; Sherwood S-1000-B tube amp, powerful, clean, lots of volume compensation, etc.; Sony turntable 2225, beautiful walnut base, very hi-tech with Sony clone of Shure SME tonearm, one orphan Altec 604-B co-ax speaker, serial #389, exc; Lafayette 225 stereo tube amplifier w/case - \$175; Wollensack 1616 stereo solenoid-operated deluxe recorder, w/mic, cable, orig. vinyl carrying case, exc collectible, restored ready to go - \$275 OBO; Eico Model 668 tube checker, metal case, scroll works fine - \$90; Heathkit C-3 cap checker, bright eye tube, works fine - \$35. Looking for Webster Eko-tape recorder. Mics for sale: Astatic D-104s, several, nice to exc - \$75 and up; Electro-Voice Model 342 pro-shotgun w/rubber spider mount, over 2' long, works fine - \$475 OBO. **WANTED:** Zenith Stratosphere 1000, must be all orig. and very good condition. Serious reward for good lead and/or sale. Always looking for vintage mics: RCA, Neumann, Telefunken, Sony, Western Electric, Altec, what-have-you. Demand items sold to highest bidder, but don't be bashful, make offer! The more you buy, the cheaper it gets! Ward Kremer, 5807 Papaya Dr., Ft. Pierce, FL 34982. Ph./fax: (561) 468-7732. E-mail: WKremer798@aol.com

FOR SALE: Original Bunis Volume 1, mint condition - Best Offer. Jeffrey M. Goldstein, 4 Curry Ct., Wilmington, DE 19810. (800) 456-3669, ext 8071. E-mail: jeffrey.goldstein@phwilim.zeneca.com

FOR SALE: Plastic dial covers, any radio - \$12 postpaid. Send bezel or tracing. Convex glass 2" to 8 7/8" inquire. Bill Turner, 1117 Pike St., Saint Charles, MO 63301. (636) 949-2210. E-mail: dialcover@webtv.net

FOR SALE: Collector tubes. Send SASE or e-mail for list. George H. Fathauer & Assoc., LLC, 688 W. First St., Ste. 4, Tempe, AZ 85281. (480) 921-9961. E-mail: fathauer@home.com

THE TUBE SHOP

"Your one stop for new old-stock tubes"



Box 231160

Boston, MA 02123-1160

Phone: 617-369-0980

Fax: 617-262-0148

Fax: 617-353-1466

E-mail: tubeshop@quik.com

Hi-fi, antique radio, amateur
radio, guitar amps, jukeboxes

WANTED: Catalin parts, paying \$20-\$100 per knob or grille, handle, chassis or damaged cabinet. Radio Ray Carroll, 158 Oakwood Dr., Wayne, NJ 07470. (973) 696-1149

WANTED: Philco 41-81. Ichiro Yamada, 10-21 Chiyodai-cho, Kawachi Nagano-shi, Osaka, Japan 586-0027. Ph./fax: 011-81-721-52-4695, mid/eve., local. E-mail: yamada1r@silver.ocn.ne.jp

WANTED: E.H. Scott! E.H. Scott! E.H. Scott! Interested in **Scott battery and AC sets, military, accessories, advertising and literature. Radio Daze, John & Kathy Slusser, 7 Assembly Dr., Mendon, NY 14506. (716) 624-9755. Fax: (716) 624-7857. E-mail: info@radiodaze.com. Web: www.radiodaze.com**

WANTED: 78 rpm stylus for Shure phono cartridge. Preston Meeks, 13839 Aspen Cove Dr., Houston, TX 77077. (281) 531-0227. E-mail: pmeeks@pdq.net

WANTED: TV signal boosters, especially Oak, RMS, Jerrold, TeleKit, ITI, or what-have-you. Write: Mark Nelson, 17 Wentworth Rd., Natick, MA 01760-1736. E-mail: aj2x@aol.com

WANTED: RCA 5T4 table set circa 1936. Will pay or trade well! Dave Smith, Box 81, Olney, IL 62450. E-mail: k9uim@otbnet.com

WANTED: Old tube audio, Western Elec, McIntosh, Marantz, Altec, Quad, Leak, Jensen, Tannoy, JBL coaxial, triaxial speakers, Garrard 301, Thorens 124, SME 3009/3012 arms, working or parts. Cash paid, will pick up. James M. Cochran, PO Box 164802, Miami, FL 33116-4802. (305) 273-6288. E-mail: jimcochran@adelphia.net

WANTED: 1970s handheld battery-operated LED calculators, all makes, models. Erik Hedegaard, 1084 Washington Ave., Pelham Manor, NY 10803. (914) 738-9422. E-mail: floete@aol.com

WANTED: Zenith annual reports for 1956, 57, 58, 59 and 61. Eldon A. Horton, 8187 LaHabra Ln., Indianapolis, IN 46236. (317) 823-6374. E-mail: radio@inetdirect.net

WANTED: Meissner 2 or 3 tube regen radio from 1950s, Models 2BK/3BK, Hal Layer, KK6HY, PO Box 27676, San Francisco, CA 94127. E-mail: hl@sfsu.edu

CLASSIFIED AD NOTICE

Please check your ads carefully before sending them in. Once ads are received, it is not always possible to refund the amount sent, pull the ad or make changes.

WANTED: Detrola grandfather clock and Detrola Deco chairside. Bezel and 3 knobs for Simplex R. Dennis Smith, Box 113, Trenton, NJ 48183. (734) 675-5847

WANTED: Phonograph related advertising items: Vogue picture records, original dealer advertising from Edison, Victor, Columbia. Needle tins and cutters, Nipper advertising items, calendars. Record brushes and dusters. Pocket advertising mirrors. Dealer lapel pins, posters, puzzles, fans, broadsides. Edison, Columbia, and any wax cylinder records. Phonograph toys, toy phonographs. Thanks. Bernie Seinberg, 714 Moredon Rd., Meadowbrook, PA 19046-1907. (215) 886-6124 or fax: (215) 638-2265. E-mail: phonoman-bernie@worldnet.att.net

WANTED: American Bosch 440T, Ten-Tec 315, Heathkit AR (3), Mosley CM-1. Herman Schnur, 3205 Brick Kiln Rd., Greenville, NC 27858. (252) 752-2264

WANTED: Radios with chrome grilles, Climax radios, miniature cathedrals. Can pick up at Elgin. Jay Malkin, 1250 Galapago #206, Denver, CO 80204. (303) 623-6451

WANTED: Sony CRF-320 information, manuals, lid. Chassis, speaker, knobs for GE Model K-64. Michael Crain, 3 Hillside Ave., Harveys Lake, PA 18618. (570) 639-2794. E-mail: mcra1952@aol.com

WANTED: Paying \$8 ea. for RCA 230; RCA 232; RCA 234 globe tubes. Robert Perlstein, W11V, PO Box 642, Old Orchard Beach, ME 04064. (207) 934-9206. E-mail: Perls@compuserve.com

One Month Free!

BONUS FOR EARLY RENEWALS

If you renew **before** the month shown on your mailing label (your expiration month), you will receive an extra month on your subscription: 13 months instead of 12! 26 months for an early 2-year renewal!

WANTED: Zenith 25-tube Stratosphere or cabinet, any condition. Will trade from vast supply of fine radios or buy. Will pick up. Alan Jesperson, PO Box 17338, Minneapolis, MN 55417. (612) 727-2489. E-mail: mte612@aol.com

WANTED: Firestone 4-A-12 AM/FM Bakelite, Aircastle-262, old microphones, TV cabinets, Paramon Spiderweb antenna. Steve Puryear, 1310 Osprey Ave, Orlando, FL 32804. (407) 894-7743

WANTED: Instructions or schematic for EICOL-150 sig tracer, Globe Model H & Demco Satellite CB's. Also Metrotec. Ted Depto, 913 5th Ave., Patton, PA 16668. (814) 674-8834

WANTED: Desperately seeking information, photos, manual for Federal #230 radio/phonograph in Pooley cabinet. TCM, PO Box 363, Rotterdam Junction, NY 12150-0363

WANTED: Rider Vols. 1-5, 16-23. Knobs for Crosley 527. 817 pwr supply for 135 V-B-2V-A. Book for Eico 324 sig gen. Crosley grille cloth. Clem Petrick, RR 1 Box 79, Portland, ND 58274-9730

WANTED: Gold plated sound box for Victor Talking Machine Company Orthophonic phonograph. Eric Beheim, 25114 Oak Ln., Descanso, CA 91916

WANTED: Tiny Mite crystal set, crystal detectors. Harry Mac Mullan, 469A Garnet Mine Rd., Boothwyn, PA 19061. E-mail: harry.macmullan@phl.boeing.com

WANTED: Wollensak T-1580 4-track stereo tape recorder. Need not operate but must be complete. Walt Heskes, 49 Marlin Ave. W, Edison, NJ 08820. (732) 205-9143

WANTED: Sparton Mirror-lid TV 4900 Series, knobs. Buying early TV knobs by pound. Fred Ringwald, 2909-A Mesa Rd., Colorado Springs, CO 80904. (719) 635-8595. E-mail: fred.ringwald@wcom.com

WANTED: Seattle made radios. RCA Broadcast News. Allied, Lafayette radio catalogs. Audio transformers. V. Vogt, 330 S.W. 43rd St., #247, Renton, WA 98055. (206) 295-4418. E-mail: burninvernon@webtv.net

FOR SALE/TRADE: RCA consoles: 9K, 10K, 15K, have metamorphic dials, magic-eyes, organ-pipes. **WANTED:** International Kadette. Nevins Museum of Radio, Ken Nevins, 406 Jipson St., Blissfield, MI 49228. (517) 486-3019, evenings please. E-mail: knevins@tc3net.com

FOR SALE: (15) E.H. Scott consoles for sale. Nearly perfect AM FM Philharmonic chassis and 3 speakers, with or without cabinet - \$2,250. **WANTED:** Cabinet for 25-tube Zenith Stratosphere, or complete rough set, will pick up. **FOR SALE:** Owner's manuals and service manuals for most Scott radios. Call for info. Alan Jespersion, PO Box 17338, Minneapolis, MN 55417. (612) 727-2489, Mon.-Sat, 8 am-6 pm. Fax: (612) 821-4821. E-mail: mte612@aol.com

FOR SALE: Tubes. No. 12A, used - \$10. Majestic G-15/24. (4) 201A - \$20. (3) new SA199 in box - \$90. One UX199, used - \$15. NO 43, used - \$5. (2) 37, used - \$25. (4) 26, used - \$25. (1) 80, used - \$10. (1) 222, used - \$10. (1) V45, brass - \$30. (1) Majestic frosted G85-As - \$35. (1) Raytheon used VT224 2 caps - \$35. (4) cobalt blue No. 56, 57, 58, 45 - \$55. (5) 201A, used - \$25. (2) 56, used - \$20. (1) 75, used - \$10. (1) Raytheon VT224, 2 caps - \$45. Edison oil bottle 4" tall clear - \$12. Pale green - \$20. Thomas A. Edison on bottle. (1) tube continental CE23-D - \$5. Fan, Bakelite, brown, 10" in original box - \$100. 12" fan with shutters - \$150. Edison Mabry, 402 Pearl Ave., Mansfield, OH 44907. (419) 525-0902

FOR SALE: Taking offers on Crosley grandfather and Zenith shutterial console. Trade for Catalins! Don Niess, 133 N. 17th St., Wheeling, WV 26003. E-mail: donniess@aol.com

FOR SALE: Rider's Television Manual #1 exc cond. - \$45. \$2-\$40. U-pay UPS. Ted Stewart, W6NBP, 2157 Braemar Rd., Oakland, CA 94602-2003. E-mail: tedstew@earthlink.net

THANKS!

*Thanks for suggesting
A.R.C. to your friends.*

*Did you know that nearly 20% of
our new subscriptions come from
referrals from subscribers?*

So spread the word about A.R.C.!

*Give the center coupon to a
collector, or ask us to send a
friend a free sample copy.*

*Help A.R.C. and
radio collecting grow!*

FOR SALE: Electro-Voice microphone on desk stand - \$80, plus shipping. Steven Thompson, 504 Cardell Cir., Mableton, GA 30126. (770) 819-1743

FOR SALE: Zenith consoles and chairsides. Restored inside and out. Free Elgin delivery. Johnny Johnson, 7075 W. 32nd Ave., Wheat Ridge, CO 80033. (303) 274-5474

FOR SALE: Two WE216A good filament, duds - \$45 ea./BO/trade. Igor Golioto, 17 Addison Dr., Fairfield, NJ 07004. (973) 463-4973. E-mail: golioto@gdats.com

FOR SALE: Radio Amrad colorful advertising promotional button - \$35; Dual turntable Model 1237. 45/33.3 rpm - \$100. Mike Grimes, K5MLG, 3805 Appomattox Cir., Plano, TX 75023. (972) 867-6373

FOR SALE: Grundig table radio, anniversary Model Classic 960. AM, FM, SW, factory upgraded from tube to solid state, like new condition. With new instruction manual - \$125. Kenwood R-500 communication receiver, very good condition except that the chrome thru panel part of on-off part of switch is missing, with instruction manual - \$250. Drake R-8 communications receiver, built in speaker, rear connection for external used only a few hours, like new condition, internal speaker, rear connector for external with instruction manual & service manual - \$300. RCA video recorder & playback, with remote. Model VR558HF, several years old but seldom used, like new condition, with instruction manual - \$200. Tube tester, Mercury 1101. Will not check 4 pin but most others and has cable to check most CRTs, manual and tube list book - \$75. Code practice keyer with oscillator and built in speaker uses 9 Volt battery, MFJ No. 557 - \$15. Except for tube tester, all items were bought new by me. All items include shipping cost. R. Dunker, 341 E. Pine, Paxton IL 60957-1129

FOR SALE: Bench Type digital multimeter - \$40. AC Variac transformer 5 amp - \$30. All items like new. Richard Oglebay, 164 S. Tropical Trl., Merritt Island, FL 32952. (407) 454-3466

FOR SALE/TRADE: Pilot cathedral Model 103 for Philco cathedral speaker Model 20, 70, or 90. Edga McBee, 114 S. Ashley Park, Wichita, KS 67209. (316) 729-2946

FOR SALE: Best offer on (2) N.I.B. Songbird Meshplate 250s, (1) N.I.B. WE 101F TB, (1) N.I.B. WE 102F TB by 7/15, (4) N.I.B. RCA 7027A - \$130, (5) N.I.B. 6U5 - \$25 ea., (10) N.I.B. 6E5 - \$10 ea., (10) N.I.B. 6AB5/6N5 - \$7 ea., (1) Zenith T-O #7G605 Bomber, grade 8.5 working - \$600, (1) WE Data Sheet Manual 1930s 300+ pp, 205D, 274, 252, 212 and many others excellent - \$250. Always buying tubes. Roland Barbeito, 9 Hawks Cir., Westfield, MA 01085. Ph./Fax: (413) 572-4745. E-mail: quinn99@mediaone.net

FOR SALE: Tubes. N.O.S. 4E27, 803, 807, 8005. Used 615, J616, 625, 801, 807, 837, 866A, 872A, 5923, 5819, 6655, 1625, 1616, 8013, 6857, 8005. **WANTED:** Speakers for Gloritone 26 and 27. Ralston Bailey, Rt. 1 Box 479, Benton, TN 37307. (423) 338-5923

FOR SALE: Collins mechanical filter N.I.B. - \$75. Heath Lab scope #10-12 - \$75. Detrola AM/SW 561 - \$75. Aerotron #500 aircraft transceiver - \$75. Glob 6 & 2 meter VFO - \$75. Ernest Odeneal, K5QJF, 271 Lee St., Greenville, TX 75401. (903) 455-2113 or 5786. E-mail: odeneal@webwide.net

FOR TRADE: My nice transistor radios, crystal sets, for your mini reel wire and tape recorders. Jon Golden, Box 4077, Wayland, MA 01778. (508) 653-4140. E-mail: jldman@ziplink.net

FOR TRADE: Copies Emerson Service Notes, Vol. 1, 100 pp. for Vol. 2/later. Gary A. Micanek, 226 Henry Ave., Manchester, MO 63011. (314) 227-7047. E-mail: micanek@aol.com

FOR TRADE: Zenith 12S265 and Stromberg Carlson 231R for quality battery sets. Jim Berg, 4261 Wilcox Rd., Box A, Northport, WA 99157. (509) 732-4047. E-mail: jimfberg@webtv.net

FOR TRADE: I have many tubes to trade, including antique tubes. I need All-American Five tubes, plus 12AX7, 6G5, 0B2. I will also trade for fair condition restorable 40s & 50s radios. Call or send tube want list. Also needed: manuals for Hammarlund HQ110, and Gonset GR-212. Thanks. Bill Redner, 1 Lantern Ln., Marlton, NJ 08053. (856) 983-0876

FOR TRADE: My good, used sweep tubes for your V.I.B. 6U5/6G5, 75, 6A7 tubes. A. Bruno, 24 Butternut Dr., New City, NY 10956. (914) 354-8899

FOR TRADE: Come and pick up your Ampex 7.5/15 AG440C 2-track stereo and leave behind your Crown 7.5/15 CX822 2-track stereo in its case. The Ampex takes up 16U in a 20U 16" deep cabinet on casters. The empty 4U at the bottom has the original op/maint manual in its 2" Ampex ring binder. Everything works fine, including the 3.75/7.5/15/30 servo capstan. It's just too heavy for me to take anywhere. I think I could carry the Crown. Fred Kaepfel, 23740 Fairmount Blvd., Shaker Heights, OH 44122. (216) 464-7840

FOR TRADE: 1946 Model 921 Majestic Melody Cruiser, or RCA621-TS TV. Mike Cutler, 2419 Ave. O, Galveston, TX 77550. (409) 763-0938

SERVICES: Hickok factory authorized contact person, providing affordable, professional service, calibration and technical assistants. **FOR SALE:** For Hickok tube testers. New beautiful, custom, master crafted, all wood carrying cases. Sides, front, and back of solid maple or oak. Top and bottom of 1/4" furniture plywood, covered with your choice of matching or contrasting veneer or Formica. Solid brass hardware. Special introductory offer. Put your old Hickok doll in a beautiful new dress. Manuals for most Hickok and military test equipment. See previous issue or additional services. **WANTED:** Hickok radio test equipment for repair and resale, such as 118 A cardmatic, with or without cards, R & D, 1234, and 1575, 539C, 3000A, 156 traceometer, and Supreme videolizer for display. **MESSAGE:** Thanks for your continued support. Looking forward to providing affordable service that satisfies in Y2K. Wendell E. Hall, 3 Mockingbird Cir., Jeffersonville, IN 47130. (812) 282-9709. Shop Ph./Fax: (812) 256-2090. E-mail: hickok@bellsouth.net

SERVICES: Reproduction Philco cathedral cabinet parts. Front panels, bottom moldings, rear arches. Reproduction 70, 90 or 20 (std) cabinets. Grandfather clock finials: Philco 570, GE H-91, Colonial clock top rim and finials. Other parts inquire. Tube shields, Philco 20, 70, or 90. All plus shipping. Dick Oliver, 28604 Schwalm Dr., Elkhart, IN 46517. (219) 522-4516

SERVICES: I will repair your antique car radios. Please contact: Tony LeDoux, PO Box 74, Schoenchen, KS 67667. (785) 625-6075

SERVICES: Reproduction dial covers for almost any radio, also some dials, decals made to order. Doyle Roberts, HC 63 Box 236-1, Clinton, AR 72031. (501) 745-6690. E-mail: drob@artelco.com

SERVICES: Schematic and service information, Rider/Sams 1920-1970 - \$3 ppd. Send make/model. Richard A. Lerche, 1561 Bluebell Ct., Livermore, CA 94550. (925) 447-9365. E-mail: lerche@home.com

SERVICES: Repair/replacement meters prior to 1935. **WANTED:** Meters before 1900, as is, your price! Ye Olde Meter Cellar, Leonard W. Cartwright, 879 Russet Dr., Sunnyvale, CA 94087. (408) 739-6025. E-mail: Lencartwright@msn.com

SERVICES: Rita Hutchings' custom made knobs, pushbuttons, and dial covers! Please note new mailing address: Rita Hutchings, 2100 Pine Valley Cove, Germantown, TN 38138. (901) 754-5565. E-mail: radiorita@hotmail.com

SERVICES: Decals and dial scales for antique radios. SASE for list. Rock-Sea Enterprises, PMB 241, 323-110 E. Matilija St., Ojai, CA 93023. (805) 646-7362. E-mail: dials@juno.com

SERVICES: Repro Atwater Kent tube chart for Models 40, 42, 52 and 57 - \$3 each. Shipping in tube - \$2.50 for any quantity. Bob Curwin, 759 Jody Ln., Hoffman Estates, IL 60194. (847) 490-1414

— WANTED —

CLUB CONTACT INFORMATION. A.R.C. IS UPDATING ITS CLUB LIST. PLEASE SEND US NAME OF CONTACT PERSON, ADDRESS, DUES, RATES, ETC.

HELP: Need vertical output transformer for Silvertone TV 9124, part #A1352, Stancor A-8112, Merit A-3035, Chicago TSO-4, Triad A-99X, A101U, A111X. Source for same. Floyd A. Mills, 1061 Knight Rd., Madison, GA 30650-4485. (706) 557-2570

HELP: Need (1) knob for Pilot X-1252, also service/owner's manual for Hallicrafters S-120. Thanks. Bill Redner, 1 Lantern Ln., Marlton, NJ 08053. (609) 983-0876

HELP: Looking for complete or incomplete Atwater Kent drivers for Model L horns. Mark Murphy, 1400 Chicago Ave. #802, Evanston, IL 60201. (847) 328-5036. E-mail: PiscoCal@aol.com

HELP: Need 3 gang tuning condenser for Crosley 30S console. Roy Johnson, 2307 Palm Beach Ave., Pittsburgh, PA 15216. (412) 343-3032

HELP: I recently purchased console cabinet for Stromberg-Carlson radio in Livonia, Michigan. If there is someone going to radiofest in Elgin, Ill, August 1999 through Houston or Dallas, Texas who can pick up this cabinet and deliver to me, I will be very happy to pay a fee for your service. Arnie Sanchez, 9615 Rockhurst, Houston, TX 77080. (713) 939-9221 after 5 pm, or (281) 588-6386

HELP: Would like to make bell jars, any ideas, advice appreciated. Jay Yelton, 617 S. 19th, Tacoma, WA 98405

HELP: Manuals wanted. Precision #915 tube tester, Hickok #191 X signal generator. Thanks, Henry Tessier, 945 Commercial St., Weymouth, MA 02189. (781) 337-7279. E-mail: radiohenry@aol.com

HELP: Information needed: American Bosch Radio Explorers Club and American Bosch Model 855T tombstone. Curt Schreiber, 3923 East Latoka St., Springfield, MO 65809. (417) 887-5184, collect. E-mail: Curtradio@aol.com

HELP: Looking for any leads on persons, job shops that will make small quantities of record changer idler wheels. Gary Stork, 37530 E. Meadowhill, Northville, MI 48167. (248) 478-0990

HELP: Need output xfmr for Philco 39-31. P/N 32-7978N. James Moore, 1402 Clay St., Brenham, TX 77833. (409) 836-4922

HELP: Need speaker to Magic Tone 508 part 10031A. Gregory Sheppard, W3FSP, 4402 Jupiter St., Rockville, MD 20853. E-mail: moreradio@webtv.net

HELP: Need schematic, service info for Sony Model TFM-7720W radio, will pay. Gerald A. Hostetter, PO Box 1, Mount Joy, PA 17552-0001. (717) 653-4505

HELP: Need schematic and manual copy for Federal Model 61. Thanks. John Pansing, 600 Tait Rd., Dayton, OH 45429. (937) 299-0210

HELP: Seeking original parts for 1926 Freshman Masterpiece Model 5-F tuning console series battery set; three tuning knobs to match mahogany Bakelite; two transformers; speaker driver; mahogany grille; matching console cabinet; owner's manual and radio log. Eric Scheck, 51 Adelaide St., Fairfield, CT 06430. (212) 210-7235, daytime. (203) 333-4799, evenings. E-mail: eric.scheck@jw.com

HELP: Need pair of tuning knobs for Zenith Trans-Oceanic 8G005Y. Kenneth F. Cerva, 3851 Harbor Hts. Dr., Largo, FL 33774. (727) 584-6471

HELP: Need setup chart for Superior TV12 tube tester for old 4 & 5 pin tubes. Ken Meyer, PO Box 510, Aviston, IL 62216. E-mail: meyejk@papadocs.com

MESSAGE: Check our web site for specials www.olderadiosrus.com. Jack Hofeld, Antique Radio Store, 7420 Clairemont Mesa Blvd. #103-531, San Diego, CA 92111. (858) 268-4155.

MESSAGE: Lansing show, before or after, help me dispose of the last of my 50 year collection of radios, TVs & electronics. Token cost or free. G.R. Marcelletti, 31087 56th Ave., Paw Paw, MI 49079. (616) 657-4257

MESSAGE: Visit the Retrocom virtual CB museum www.Retrocom.com, Browning, Hallicrafters & more Dave Mierzwinski, 13345 W. Dakota St., New Berlin, WI 53151

MESSAGE: Radio yard sale July 10. Liquidation of entire contents of shop from Hicksville. Contents include radios, televisions, tubes, 1920s, 1930s, 1940s, 1950s. Parts include: Whole chassis, controls, CRTs, speakers transformers. Vaughn Rudisill, now located at 17 Pearsall Ave., Deer Park, NY 11729. (516) 667-5247

MESSAGE: The Arthur Radford Appreciation Society exchanged information, circuit diagrams, spare parts newsletters and photographs on all the Radford range of amplifiers, speakers and test equipment. Membership can be obtained by contacting Philip Parkinson, Windermere House, Cleadon Village Tyne and Wear SR6 7QQ, England. Tel/fax: (44) 191-5194662. Personal mobile: (0973) 304-578. E-mail: Pparkin352@aol.com

MESSAGE: Have closed radio TV shop in Hicksville and moved everything to Deer Park L.I. Many TVs, radios, parts etc. for sale. Also repairing TVs and radios. Convenient location on Long Island and close to New York City. Vaughn Rudisill, 17 Pearsall Ave., Deer Park, NY 11729. (516) 667-5247

AUCTION: Come visit the restoration of King's Attic. A new auction items and program! www.kingsattic.com James Fraley, PO Box 2846, Wilmington, NC 28402

ABBREVIATIONS USED IN CLASSIFIED ADS

MISCELLANEOUS

amp = amplifier
BC = broadcast
BO = best offer
ca. = circa (approx. date)
ea. = each
F.O.B. = free on board
IB = instruction book
LSASE = A Long SASE
(see SASE)
LW = long wave
M.I.B. = mint in box
MO = money order
Mod = model
N.I.B. = new in original box
N.O.S. = new old stock
(an original, unused vintage item)
NT = no tubes
OB = in original box
OBO = or best offer
P&H = postage & handling
ppd = postage paid
(shipping included)

PS = power supply, also
"pwr sup"
PU = pick up only
rcvr = receiver
SASE = self-addressed
stamped envelope
(send a long, #10,
envelope)
spkr = speaker
SW = shortwave
UPS = United Parcel
Service
vol. = volume
w/ = with
w/o = without
WT = with tubes
xcvr = transceiver
xfmr = transformer
xmtr = transmitter
xstr = transistor
xtal = crystal

BOOKS USED AS REFERENCES

(V.R., p 30) means *Vintage Radio*, page 30
Blast = *Radio - A Blast From The Past*
Bunis 1, 2, 3 or 4 = *Collector's Guide to Antique Radios, 1st, 2nd, 3rd or 4th editions*
Collins = *Radios - The Golden Age*
Douglas V1, V2 or V3 = *Radio Manufacturers of the 1920s, Volumes 1, 2 or 3*
E.O.R. 1 or 2 = *Evolution of the Radio, Volumes 1 or 2*
F.O.S. = *Flick of the Switch*
Grinder/Fathauer = *Radio Collector's Directory and Price Guide*
G.O.R. = *Guide to Old Radios*
Johnson's A.R. = *Antique Radios - Restoration & Price Guide*
M.A.J.A. = *Machine Age to Jet Age*
O.T.B. = *Old Timer's Bulletin* published by
Antique Wireless Association (AWA)
Sideli = *Classic Plastic Radios*
V.R. = *Vintage Radio*

CONDITION

(If good or better, mention non-original parts)
p = poor **f** = fair
g = good **vg** = very good
exc = excellent

A.R.C. does not encourage abbreviations except those listed here. Please spell out all other words. Special note for hams - most subscribers are not hams so we do not recommend ham-type abbreviations.



COMING RADIO EVENTS

ARKANSAS - Jul. 1

**ANTIQUE RADIO COLLECTORS CLUB
OF FORT SMITH - MEETING**
Fort Smith, AR - St. Luke Lutheran Church
Waldron Road, at Free Ferry
7:30 pm
Info: Paul Tucker, 4700 N. "N" St.
Fort Smith, AR 72904 - (501) 782-8178

ARKANSAS - Jul. 8

**ARKANSAS ANTIQUE RADIO CLUB
MEETING**
Little Rock, AR - Books A Million
Markam & Bowman Rd.
7 pm
Info: Tom Burgess - (501) 455-0773

CALIFORNIA - Jul. 3

**CALIF. HISTORICAL RADIO SOCIETY
MEET/AUCTION**
San Francisco, CA - St. Anne's Church of the
Sunset, Corner of Funston (13th Ave.) & Irving
8 am
Info: CHRS Hotline - (415) 821-9800

MICHIGAN - Jul. 8-11

**MICHIGAN ANTIQUE RADIO CLUB
EXTRAVAGANZA '99**
Lansing, MI
Holiday Inn South Convention Center
6820 S. Cedar St. - (517) 694-3123
Thu.: Bus to MHM for Exhibit -
Registration - Program
Fri.: Flea Market - Women's Luncheon -
Contest - Social Hour - Programs - Raffle
Sat.: Flea Market - Auction - Raffle
Sun.: Donation Auction - Raffle
Theme: On The Air
Info: Extravaganza '99, Suite 100, 3520 Okemos
Rd. #6, Okemos, MI 48864 - (517) 349-7187

WASHINGTON - Jul. 3

**RADIO ENTHUSIASTS OF PUGET SOUND
MEETING**
Seattle, WA - Queen Anne Library
400 W. Garfield
2 pm
Info: REPS, 9936 N.E. 197th Street
Bothell, WA 98041 - (206) 488-9516

NEW JERSEY - Jul. 9

**NEW JERSEY ANTIQUE RADIO CLUB
MEETING - 7 PM**
Freehold, NJ - Grace Lutheran Church
West Main St. & Park Ave. (Old Rt. 33)
Info: Marv Beeferman - (609) 693-9430
Phil Vourtsis - (732) 446-2427

NEW YORK - Jul. 4

**GREATER NEW YORK VINTAGE
WIRELESS ASSOC. - SWAP MEET**
Lake Ronkonkoma, NY - 367 Hawkins Ave.
8 am-Noon
Info: Chris Lieppert - (516) 471-9526
Chris Bacon - (516) 821-7618

OKLAHOMA - Jul. 10

**OKLA. VINTAGE RADIO COLLECTORS
MEETING**
Oklahoma City, OK - Oklahoma Station BBQ
Springdale Shopping Center, 4333 N.W. 50th
6 pm - Dinner
7 pm - Meeting
Info: Jim Collings - (405) 755-4139, after 6 pm
Mike Lapuzza - (405) 745-3394, after 7 pm

VIRGINIA - Jul. 7

**TIDEWATER ANTIQUE RADIO ASSOC.
MEETING - 7 PM**
Call for location & directions
Info: Vic Johnston - (757) 825-0757, eves.
Scott Balderston - (757) 549-0449, eves

A free* listing on these pages is available for each coming radio event. Sponsors should provide description of event, date, time, place, directions, & information/contact person. Since listings are on a "space available" basis, no guarantee of listing is made. *Submission deadline - 5th of month. *Club/museum/non-profit events are listed free; other events are obtained from advertisements placed elsewhere in A.R.C. Sorry, we don't have room for hamfests.*

COLORADO - Jul. 11

COLORADO RADIO COLLECTORS MEETING - 1 PM

Denver, CO - VecraBank Bldg.
1380 South Federal Ave.

Info: Larry Weide - (303) 758-8382

NEW MEXICO - Jul. 11

NEW MEXICO RADIO COLLECTORS CLUB MEET

Albuquerque, NM - Anna Kaseman Hospital
8300 Constitution Ave. (W. of Wyoming)

1:30 pm - Tailgate Swap Meet
2 pm - Program, Show & Tell and Auction

Info: Chuck Burch, 39 Chaco Loop,
Sandia Park, NM 87047 - (505) 286-9320

MISSOURI - Jul. 13

ANTIQUE RADIO COLLECTORS & HISTORIANS OF GREATER ST. LOUIS MEETING

Kirkwood, MO - Kirkwood Community Center
111 S. Geyer Rd., Room 201-A

7:30 pm - Meeting (earlier for conversation)
Show & Tell, Swap Table

Info: Derek Cohn, 8141 Stratford Dr.,
Clayton, MO 63105 - (314) 725-2333

N. CAROLINA - Jul. 13

EAST CAROLINA ANTIQUE RADIO CLUB MEETING - 6:30 PM

Greenville, NC - Western Sizzlin
2903 E. 10 St.

Info: Bill Engstrom - (252) 355-8732
Herman Schnur - (252) 752-2264

OHIO - Jul. 13

ANTIQUE RADIO COLLECTORS OF OHIO MEETING - 7:30 PM

Kettering, OH - National City Bank Basement
4100 Far Hills Ave., at Stroop Rd

Topic: Ohio Radios

Info: John Heck - (937) 435-1571
ARCO, PO Box 292292, Kettering, OH 45429

PENNSYLVANIA - Jul. 13

DELAWARE VALLEY HISTORIC RADIO CLUB MEETING - SWAP MEET - AUCTION

Telford, PA - Telford Community Bldg.
Corner of Hamilton & Madison

7:30 pm

Info: Bill Overbeck, PO Box 847,
Havertown, PA 19083 - (610) 789-8199

TEXAS - Jul. 13

HOUSTON VINTAGE RADIO ASSOC. MEETING

Houston, TX - Lal Lai Rest., Tides II Hotel,
6700 S. Main St. at Holcombe

6:30 pm

Info: Bill Werzner - (713) 721-2242

NEW YORK - Jul. 15

HUDSON VALLEY ANTIQUE RADIO AND PHONO. SOCIETY - MEETING

7:30 pm - (Call to confirm details)

Info: Peter DeAngelo - (914) 496-5130

CALIFORNIA - Jul. 17

SOUTHERN CALIF. ANTIQUE RADIO SOCIETY - SWAP MEET

San Diego, CA - Fuddruckers

9 am

Info: Mike Zuccaro - (619) 271-8294

TEXAS - Jul. 17

VINTAGE RADIO & PHONO SOCIETY MEETING

Irving, TX - Senter East Bld.

3 pm

Info: George Potter - (972) 353-4862
VRPS, PO Box 165345, Irving, TX 75016

GEORGIA - Jul. 17

SOUTHEASTERN ANTIQUE RADIO SOC. SUMMER SWAP MEET

Alpharetta, GA - Fairfield Inn
11385 Haynes Bridge Rd. (Exit 9 off GA Hwy 400)

Dawn-1 pm

Info: Gordon Hunter - (770) 475-0713
SARS, PO Box 500025, Atlanta, GA 31150

KENTUCKY - Jul. 17

MID-SOUTH ANTIQUE RADIO COLLECTORS SWAP MEET

Louisville, KY - ITT Institute, 10509 Timberwood
Cir. (Off Hursbourne Ln. near I-64)

7 am-1 pm

Theme: 78s & record players

Info: Allen Ferris - (502) 543-8233

SUBMISSION DEADLINE

5th OF MONTH

Please include date, time, place, directions,
event details & information/contact person.

MARK YOUR CALENDAR

Jul. 1 - AR, Fort Smith - ARCCFS Meeting
Jul. 3 - WA, Seattle - REPS Meeting
Jul. 7 - VA, TBA - TARA Meeting
Jul. 8 - AR, Little Rock - AARC Meeting
Jul. 8-11 - MI, Lansing - MARC 14th Extravaganza '99
Jul. 9 - NJ, Freehold - NJARC Meeting
Jul. 10 - OK, Oklahoma City - OKVRC Meeting
Jul. 11 - CO, Denver - CRC Meeting
Jul. 11 - NM, Albuquerque - NMRC Meet
Jul. 13 - MO, Kirkwood - ARCHGSL Meeting
Jul. 13 - NC, Greenville - ECARC Meeting
Jul. 13 - OH, Kettering - ARCO Meeting
Jul. 13 - PA, Telford - DVHRC Meet & Auction
Jul. 13 - TX, Houston - HVRA Meeting
Jul. 15 - NY, Hudson Valley - HARPS Meeting
Jul. 17 - CA, Escondido - SCARS Swap Meet
Jul. 17 - GA, Alpharetta - SARS Summer Swap Meet
Jul. 17 - KY, Louisville - MSARC Swap Meet
Jul. 17 - TX, Irving - VRPS Meet
Jul. 18 - MD, Burtonsville - MAARC Meeting
Jul. 18 - WA, Seattle - PSARA Swap Meet
Jul. 20 - CA, Sacramento - CHR-Sac. Meeting
Jul. 21 - OH, Cincinnati - CARS Meeting
Jul. 21 - OH, Columbus - COARA Meeting
Jul. 23-25 - WV, Huntington - MRAT ACG Conference
Jul. 24 - NC, Raleigh - CC-AWA Swap Meet
Jul. 24 - OH, Columbus - COARA Summer Meet
Jul. 24 - TX, Schertz - TARC Meeting
Jul. 25 - British Columbia - CVRS Chapter Meeting
Jul. 25 - NE, Merna - NARCC Meeting
Jul. 26 - AL, Birmingham - AHRS Meeting
Jul. 27 - OH, Kettering - SPARK Meeting
Jul. 31 - NH, Nashua - NEARC Meet
Jul. 31 - NJ, Hightstown - NJARC Swap Meet
Aug. 1 - NY, Lake Ronkonkoma - GNYVWA Swap
Aug. 4 - VA, TBA - TARA Meeting
Aug. 4-7 - IL, Elgin - ARCI Radiofest XVIII
Aug. 5 - AR, Fort Smith - ARCCFS Meeting
Aug. 7 - CA, Los Altos Hills - CHR-Sac Meet/Auction
Aug. 7 - WA, Seattle - REPS Meeting
Aug. 8 - NE, Hodrege - NARCC Meeting
Aug. 8 - NM, Albuquerque - NMRC Meet
Aug. 10 - MO, Kirkwood - ARCHGSL Meeting
Aug. 10 - NC, Greenville - ECARC Meeting
Aug. 10 - OH, Kettering - ARCO Meeting
Aug. 10 - PA, Telford - DVHRC Meet & Auction
Aug. 12 - AR, Little Rock - AARC Meeting
Aug. 13 - NJ, Freehold - NJARC Meeting
Aug. 14 - NY, Amherst - NFWA Meet
Aug. 14 - OK, Oklahoma City - OKVRC Meeting
Aug. 14 - WV, Huntington - MRAT Summer Meet
Aug. 15 - WA, Seattle - PSARA Swap Meet
Aug. 16 - GA, Norcross - SARS Meeting
Aug. 28 - IN, Elkhart - IHRS Summer Meet
Sep. 1-4 - NY, Rochester - AWA Meet
†Sep. 10-11 - TX, Houston - HVRA Mega Auction
Oct. 23 - NH, Nashua - NEARC Meet
Oct. 23 - WV, Huntington - MRAT Fall Show/Auction
See expanded listing for many of these events
† = Changed Date

SOUTH FLORIDA

NEW CLUB FORMING
SOUTH FLORIDA ANTIQUE
RADIO COLLECTORS

Info: Thomas Valenti, 1717 N. Bayshore Dr.
#1549, Miami, FL 33132 - (305) 373-7372

MARYLAND - Jul. 18

MID-ATLANTIC ANTIQUE RADIO CLUB
MEETING - 2 PM

Burtonsville, MD - Seventh Day Adventist Church
15121 McKnew (Between Rt. 29 & I-95, off Rt. 198)

Info: Ed Lyon, 11301 Woodland Way,
Myersville, MD 21773 - (301) 293-1773

WASHINGTON - Jul. 18

PUGET SOUND ANTIQUE RADIO ASSOC.
MEETING

North Seattle, WA - Shoreline Museum
N. 175th & Linden Avenue

9 am-Noon - Tailgate Swap Meet
Noon - Meeting, Program, Show & Tell
Info: Pete Petersen, PO Box 7251
Seattle, WA 98133 - (425) 747-1323

CALIFORNIA - Jul. 20

CALIF. HISTORICAL RADIO SOCIETY
SACRAMENTO CHAPTER MEETING - 7 PM

Sacramento, CA - SMUD Building
Corner of Elkhorn & Don Julio

Info: CHR-S Hotline - (415) 821-9800

OHIO - Jul. 21

CENTRAL OHIO ANTIQUE RADIO ASSOC.
MEETING - 7:30 PM

Columbus, OH - DeVry Institute of Tech.
1350 Alum Creek Rd., I-70 Exit 103B

Info: Barry Gould - (614) 777-8534
Chuck Davis - (614) 792-6237

OHIO - Jul. 21

CINCINNATI ANTIQUE RADIO SOCIETY
MEETING - 7:30 PM

Norwood, OH - ITT Technical Institute
4750 Wesley Ave.

Info: Greg Tierney - (937) 732-1844

W. VIRGINIA - Jul. 23-25

A.C. GILBERT HERITAGE SOCIETY
8TH ANNUAL NATIONAL CONFERENCE
Huntington, WV - Museum of Radio & Tech.

Fri.: 5 pm-7 pm - Founder's Welcoming Party
at Holiday Inn

7 pm-10 pm - Dinner "The River Cafe"

Sat.: 9 am-3 pm - Exhibits

6 pm-10 pm - Banquet, Awards Ceremony,
Guest Speakers, Entertainment

Sun.: 1 pm-4 pm - Heritage Farm Museum

Info: Museum of Radio & Technology
4204 Thornapple Ln., Charleston, WV 25313

N. CAROLINA - Jul. 24

CAROLINAS CHAPTER AWA SUMMER SWAP MEET

Raleigh, NC - N.C. State Fairgrounds
L.R. Harrill Center
8 am

Info: Ron Lawrence - (704) 289-1166
kc4yoy@trellis.net

OHIO - Jul. 27

SOCIETY FOR PRESERVATION OF ANTIQUE RADIO KNOWLEDGE SWAP MEET - 7:30 PM

Kettering, OH - Party Room at Cassano's
Pizza, 1700 E. Stroop Rd.

Info: PO Box 482, Dayton, OH 45449
E-mail: sparkinc@juno.com

OHIO - Jul. 24

CENTRAL OHIO ANTIQUE RADIO ASSN. SUMMER SALE & SWAP MEET

Columbus, OH - DeVry Institute of Tech.
1350 Alum Creek Dr. (I-70 exit 103B)
7:30 am-11 am

Info: Barry Gould - (614) 777-8534
Mike Keller - (614) 866-7725

NEW HAMPSHIRE - Jul. 31

NEW ENGLAND ANTIQUE RADIO CLUB SWAP MEET

Nashua, NH - Resurrection Center
Rt. 3 (Everett Turnpike) Exit 6
1 1/2 miles West on Rt. 130, 449 Broad St.

7:30-8 am - Real Early Admission
8-9 am - Early Admission
9 am-1 pm - General Admission

Over 100 tables - 50/50 Raffle - Catered
Old Equipment Contest
Reservations required to sell

Info: Gregg Thompson, PO Box 298
Newtonville, MA 02160 - NEARC: (617) 923-2665

TEXAS - Jul. 24

TEXAS ANTIQUE RADIO CLUB MEETING

Kyle, TX - Railroad BBQ
10 am

Info: Jim Moffett, 218 Shannon Lee, San
Antonio, TX 78216 - (210) 826-4938

NEW JERSEY - Jul. 31

NEW JERSEY ANTIQUE RADIO CLUB OUTDOOR SWAP MEET

Hightstown, NJ - Hightstown Country Club
Route 33, Monmouth Street
8 am-3 pm

Info: Marv Beeferman - (609) 693-9430
Phil Vourtsis - (732) 446-2427

BRITISH COLUMBIA - Jul. 25

CANADIAN VINTAGE RADIO SOCIETY BRITISH COLUMBIA CHAPTER MEETING

Richmond, BC - Steveston Hotel
Info: Fred Tutt - (604) 275-2033

NEBRASKA - Jul. 25

NEBRASKA ANTIQUE RADIO COLLECTORS CLUB - MEETING

Merna, NE - Victoria Springs State Park
Noon - Steak Fry
2 pm - Meeting

Info: Steve Morton - morton@nque.com

NEW YORK - Aug. 1

GREATER NEW YORK VINTAGE WIRELESS ASSOC. - SWAP MEET

Lake Ronkonkoma, NY - 367 Hawkins Ave.
8 am-Noon

Info: Chris Lieppert - (516) 471-9526
Chris Bacon - (516) 821-7618

ALABAMA - Jul. 26

ALABAMA HISTORICAL RADIO SOCIETY MEETING

Birmingham, AL - Homewood Public Library
1721 Oxmoor Road
7 pm

Info: Julian Brook, PO Box 130307,
Birmingham, AL 35213 - (205) 879-1191

ILLINOIS - Aug. 4-7

ANTIQUÉ RADIO CLUB OF ILLINOIS RADIOFEST XVIII

Elgin, IL - Elgin Plaza Hotel, 345 River Rd
(847) 695-5000 - ask for Lori
Daily Open Air Flea Market
Zenith Display - 50/50 Raffle
Awards Banquet and Show
Radio Auction - Donation Auction
Free Admission to Muchow Museum

Info: A.R.C.I., PO Box 1139, LaGrange Park,
IL 60526 - E-mail: arci31280@aol.com

Attend a radio event near you, learn,
meet others in the hobby, and perhaps
find an item or two for your collection!

MENTION A.R.C. WHEN CONTACTING CLUBS!

VIRGINIA - Aug. 4

TIDEWATER ANTIQUE RADIO ASSOC. MEETING

Call for location & directions

7 pm

Info: Vic Johnston - (757) 825-0757, eves.
Scott Balderston - (757) 549-0449, eves.

ARKANSAS - Aug. 5

ANTIQUÉ RADIO COLLECTORS CLUB OF FORT SMITH - MEETING

Fort Smith, AR - St. Luke Lutheran Church
Waldron Road, at Free Ferry

7:30 pm

Info: Paul Tucker, 4700 N. "N" St.
Fort Smith, AR 72904 - (501) 782-8178

CALIFORNIA - Aug. 7

CALIF. HISTORICAL RADIO SOCIETY MEET/AUCTION - 8 AM

Los Altos Hills, CA - Foothill College, Lot "D"

Info: CHRIS Hotline - (415) 821-9600

WASHINGTON - Aug. 7

RADIO ENTHUSIASTS OF PUGET SOUND MEETING

Seattle, WA - Queen Anne Library
400 W. Garfield

2 pm

Info: REPS, 9936 N.E. 197th Street
Bothell, WA 98041 - (206) 488-9518

NEBRASKA - Aug. 8

NEBRASKA ANTIQUÉ RADIO COLLECTORS CLUB - MEETING

Hodrege, NE - KVRN Transmitter Site

2 pm

Info: Steve Morton - morton@nque.com

NEW MEXICO - Aug. 8

NEW MEXICO RADIO COLLECTORS CLUB MEET

Albuquerque, NM - Anna Kaseman Hospital
8300 Constitution Ave. (W. of Wyoming)

1:30 pm - Tailgate Swap Meet

2 pm - Program, Show & Tell and Auction

Info: Chuck Burch, 39 Chaco Loop,
Sandia Park, NM 87047 - (505) 286-9320

Although non-members are welcome at all events, joining may be required at some. Admission is charged at some events.

MISSOURI - Aug. 10

ANTIQUÉ RADIO COLLECTORS & HISTORIANS OF GREATER ST. LOUIS MEETING

Kirkwood, MO - Kirkwood Community Center
111 S. Geyer Rd., Room 201-A

7:30 pm - Meeting (earlier for conversation)
Show & Tell, Swap Table

Info: Derek Cohn, 8141 Stratford Dr.,
Clayton, MO 63105 - (314) 725-2333

N. CAROLINA - Aug. 10

EAST CAROLINA ANTIQUÉ RADIO CLUB MEETING

Greenville, NC - Western Sizzlin
2903 E. 10 St.

6:30 pm

Info: Bill Engstrom - (252) 355-8732
Herman Schnur - (252) 752-2264

OHIO - Aug. 10

ANTIQUÉ RADIO COLLECTORS OF OHIO MEETING

Kettering, OH - National City Bank Basement
4100 Far Hills Ave., at Stroop Rd.

7:30 pm

Topic: My Favorite Radio

Info: John Heck - (937) 435-1571
ARCO, PO Box 292292, Kettering, OH 45429

PENNSYLVANIA - Aug. 10

DELAWARE VALLEY HISTORIC RADIO CLUB MEETING - SWAP MEET - AUCTION

Telford, PA - Telford Community Bldg.
Corner of Hamilton & Madison

7:30 pm

Info: Bill Overbeck, PO Box 847,
Havertown, PA 19083 - (610) 789-8199

ARKANSAS - Aug. 12

ARKANSAS ANTIQUÉ RADIO CLUB MEETING

Little Rock, AR - Books A Million
Markam & Bowman Rd.

7 pm

Info: Tom Burgess - (501) 455-0773
(Call to confirm details)

NOTE: The "Coming Radio Events" pages are tabulated from the best information available to A.R.C. However, changes, cancellations and errors do occur. To avoid disappointment, verify place, date and time especially for events which are new to you.

NEW JERSEY - Aug. 13

NEW JERSEY ANTIQUE RADIO CLUB
MEETING - 7:30 PM

Freehold, NJ - Grace Lutheran Church
West Main St. & Park Ave. (Old Rt. 33)

Info: Marv Beeferman - (609) 693-9430
Phil Vourtsis - (732) 446-2427

NEW YORK - Aug. 14

NIAGARA FRONTIER WIRELESS
ASSOCIATION - MEET - 8 AM

Amherst, NY - Amherst Museum
Tonawanda Creek Road

Info: Larry Babcock - (716) 741-3082
Gary Parzy - (716) 668-2943

OKLAHOMA - Aug. 14

OKLA. VINTAGE RADIO COLLECTORS
MEETING

Oklahoma City, OK - Oklahoma Station BBQ
Springdale Shopping Center, 4333 N.W. 50th

6 pm - Dinner
7 pm - Meeting

Info: Jim Collings - (405) 755-4139, after 6 pm
Mike Lapuzza - (405) 745-3394, after 7 pm

W. VIRGINIA - Aug. 14

MUSEUM OF RADIO & TECHNOLOGY
SUMMER HEAT SHOW & AUCTION

Huntington, WV - MRAT

8 am-5 pm

Info: MRAT, 1640 Florence Ave.,
Huntington, WV 25701 - (304) 525-8890

WASHINGTON - Aug. 15

PUGET SOUND ANTIQUE RADIO ASSOCIATION
17TH ANNUAL ANTIQUE RADIO SWAP MEET

Seattle, WA - Shoreline Museum Parking Lot
N. 175th & Linden Ave.

9 am-1 pm

Info: PSARA - (425) 747-1323
www.eskimo.com/~hhagen/psara.html

GEORGIA - Aug. 16

SOUTHEASTERN ANTIQUE RADIO SOC.
MEETING WITH SHOW & TELL

Norcross, GA - Picadilly Cafeteria
3400 Holcomb Bridge Road

6:30 pm

Info: Gordon Hunter - (770) 475-0713
SARS, PO Box 500025, Atlanta, GA 31150

INDIANA - Aug. 28

INDIANA HISTORICAL RADIO SOCIETY
NORTHERN IN SUMMER MEET

Elkhart, IN - High Dive Pavilion
500 E. Beardsley Ave.

8:30 am

Info: Terry Garl - (219) 679-4280
ihrselk98@aol.com
Ross Smith - (219) 295-7770

TEXAS - Sep. 10-11

HOUSTON VINTAGE RADIO ASSOC.
MEGA AUCTION

Houston, TX - Lai Lai Rest., Tides II Hotel,
6700 S. Main St. at Holcombe

Fri.: 6 pm - Auction

Plastic radios, test equipment, tubes, magazines

Sat.: Noon - Auction

Wooden radios, consoles, horn speakers

Info: Bill Werzner - (713) 721-2242
mingqi53@earthlink.net

NEW YORK - Sep. 1-4

ANTIQUE WIRELESS ASSOCIATION
38TH HISTORICAL RADIO CONFERENCE

Rochester, NY - Thruway Marriott Hotel
Easy access from New York State Thruway

(I-90), I-390, or Rochester Airport
(716) 389-8300 - Theme: Philco

4-day, 3-acre Antique Radio Flea Market

Info: AWA, Box E, Breesport, NY 14816
Secretary's phone - (607) 739-5443

*[If you can go to only one meet,
make it to this one. Editor]*

BUSINESS CARD ADS - \$53.00 FOR 3 MONTHS

PUT
YOUR BUSINESS CARD
HERE!

\$53 FOR 3 MONTHS - \$90 FOR 6 MONTHS
DON'T HAVE ONE? SEND AN EXTRA \$7 AND
WE WILL TYPESET ONE FOR YOU.

ANTIQUE RADIOS



Specializing in

Horn — WANTED
Speakers

DAVE CROCKER
4B Beechwood Point Dr.,
Mashpee, MA 02649 (508) 477-1578

BUSINESS CARD ADS - \$53.00 FOR 3 MONTHS

Antique Radio & Television

Visit our shop in downtown New London
15 Green St., New London, CT 06320
www.tuberadiorepair.com

(860) 442-0233
William Morse

Mon.-Sat. 11 am to 7

Great Northern Antiques

We Buy and Sell
Antiques-Collectibles-Advertising
and Vintage Radios

Alan Jesperson
5200 Bloomington Ave. S
(4 blocks west of Cedar Ave)
Minneapolis, MN 55417

TEL (612) 727-2489
FAX (612) 821-4821
E-Mail: mte612@aol.com



TEL: (972) 276-5458
FAX: (972) 272-1831

THE RADIO MAN

Buy-Sell-Trade
Antique Radios • Tubes • Parts

DICK MORGAN
RES: (972) 564-6464

P.O. BOX 461485
GARLAND, TX 75046-1485

• GENERAL SALES • TELEVISIONS • RECORDERS • PHONES • HEADPHONES •
- SPECIALIZING IN THE REPAIR OF VINTAGE RADIOS -

The Bavarian Radio Works



ROSS A. HOUBRESSER
(781) 447-2991
bavarianradio@mediaone.net

40 WALNUT ST.
WIRTSCHAFT, MA 02582

McI's Fix It Shop

Repairing tube amplifiers, stereo equipment,
antique radios, test equipment & other misc.

Well stocked with many tubes & parts.

266 LaSalle Ave., Buffalo, NY 14215

(716) 856-1200 or (716) 856-1148, lv. msg.

36 years experience **Jackson Speaker Service**

Expert Antique Loudspeaker Repairs
(Cone Types) And Reconing A Speciality.
Speaker Parts And Repair Service On
Virtually Any Speaker Made Including
Stereo, F.A., And Antique Auto Speakers.

217 Crestbrook Dr.
Jackson, Mich 49203

Owner
Ron McGee

Ph - (517) 789-6400, Ans 4th ring
Wk-days 10am-7pm Wk-ends 9-5pm

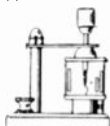

CRYSTAL SETS

PARTS - PLANS - KITS - BOOKS
CATALOG \$2.00

Largest source of Vintage and New
Variable Air Condensers, Variometers,
Vario-Couplers, Tap Switches, Tap
Points, Galena and Germanium
Detectors, Detector Stands, Cat
Whiskers, Terminals, Sliders,
Headsets, Dial Knobs, Coil Forms,
Magnetic Wire, etc.

MIDCO
P.O. Box 222288
Hollywood, FL 33022
(954) 925-3670
BA Turke, Ph.D.E.E.



If you buy, sell or like jukeboxes you need
**ALWAYS JUKIN--THE MONTHLY JUKEBOX
MAGAZINE!** Subscribers in 25 countries,
ALWAYS JUKIN LEADS THE WAY: Articles,
photos, show reports, ads, new products,
price guides, restoration tips, repairs--
everything you need to know about JUKE-
BOXES--the fastest appreciating collectible in
the world!!! Fun & a great investment.
Sample Copy, \$3. \$36 per year.
**ALWAYS JUKIN, 1952 1st Ave. S, Ste. #6AR,
Seattle, WA 98134. (206) 652-4005.
Fax (206) 652-4007
Master/Visa OK**

LOGANS RADIO SERVICE 412-837-5580

BUY • SELL • TRADE • WHEEL AND DEAL
N.O.S. BLACK/WHITE PICTURE TUBES

40's-70's

FOR SALE, CALL OR WRITE

PARTS, TUBES, SCHEMATICS FOR SALE
SCHEMATIC SERVICE - \$2.50 EA.

SERVICE AND RESTORATION SINCE 1952

REAR 526 MT. PLEASANT ST., GREENSBURG, PA 15601

CAPACITORS - TUBES RADIO SERVICE ITEMS

Thousands in jam-packed illustrated
24-page catalog No. 49

**INFORMATIVE
INTERESTING
FUN-TO-READ**

Send \$3 U.S./Canada
\$5 overseas (U.S. funds)
for a Heavy-Paper limited
edition copy NOW!

DON DIERS 4276 North 50 St. Dept. AB9
Milwaukee, WI 53216-1313

Authentic Dial Reproductions

Top quality material & workmanship
Finish your restoration with best dial available Satisfied
customers world-wide A-K to Zenith.

These are not copy machine plastic laminates.

Telephone consultations welcome.

ANTIQUE RADIO RESTORATIONS
109 So. Oak St.
O'Fallon, IL 62269
618-632-7423

Life Member I.E.E.E.
AWA, ARCA, ARCI, MAARC

Clinton Blais, P.E.

RADIO BOOKS FOR SALE

Large selection of books on Radio and Related Technology

Call or write for our List of Catalogs.

Always buying, single items or collections.

Visit our web site: <http://adam.cheshire.net/~rainyday>

RAINY DAY BOOKS

P.O. BOX 775, FITZWILLIAM NH 03447

(603)-585-3448

BUSINESS CARD ADS - \$53.00 FOR 3 MONTHS

Antique Radios



David & Nancy Snow
P.O. Box 6352
Jackson, MI 49204
(517) 787-2985

We Buy, Sell, Repair
ARBE - III Battery Eliminators

ANTIQUÉ RADIO REPAIR

Repair - Restore - Buy & Sell
Schematic Service
Radios \$2.⁵⁰, TVs \$4.⁵⁰

DAMASKE ELECTRONICS
574-W16834 Janesville Road
Muskego, WI 53150
Phone: (414) 679-0838



1298 SE 5th Avenue
PO Box 1939
Melrose, FL 32666
Phone: (352) 475-1950
Fax: (352) 475-1128

RADIO ELECTRIC SUPPLY

We Specialize In Receiving and Special Purpose Tubes

Buy and Sell

Don and Dorothy Gies

http://www.vacuumtubes.net
E-mail: tubes@mindspring.com

MESSAGE: Current flyer is **199.**

For details send **2-stamp LSASE**
for 20-page flyer to:

Olde Tyme Radio Company
2445 Lyttonsville Road, Suite 317
Silver Spring, MD 20910

Fax/phone: (301) 587-5280
Fax anytime, phone 10 am-10 pm local time
E-mail: oldetymeradio@juno.com

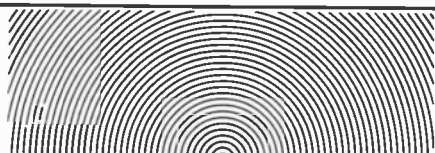

ELECTROMAGNETIC

RADIO TUBES PARTS
P.O. BOX 1258 STEPHEN SCHAUB
PEORIA, IL. 61654-1258 309-681-8304

**IN SOUTHERN CALIFORNIA
GA RADIO SERVICE**

TUBE - TRANSISTOR - LSI
SINCE 1950

SPECIALISTS IN COLLECTOR CAR RADIOS
PHONE/FAX 760-741-9660
140 N. ANDREASEN,
ESCONDIDO, CA 92029

**SPY EQUIPMENT
WANTED!**

- Code Machines
- Secret Radios
- Clandestine Weapons
- Secret Cameras
- OSS, SOE, CIA, KGB!
- I Buy or Trade!

Keith Melton

880 Jupiter Park Dr., Suite 5, Jupiter, FL 33458
(561) 743-1143 Days: Fax (561) 743-7504
E-mail: hkmelton@adelphia.net



PR NOVELTY

Vacuum Tube Audio Specialists
Amplifier Rebuilding • Service
Surplus Parts Brokerage
(New Old Stock and Used)

Paul Dorobinski Audio Technician
Robin Richards General Manager

PO Box 148 • Milwaukee • WI 53281
Office 414 964 3392
Cellular 414 848 8812



STEINMETZ ELECTRONICS
7519 MAPLEWOOD AVENUE
HAMMOND, INDIANA 46324
YES! "WE'RE STILL HERE"

TUBES

SCHEMATICS

SASE FOR LISTS

(219) 931-9316

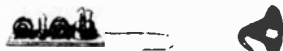

ESTES AUCTIONS

Specializing in Vintage Radios

7404 Ryan Rd.
Medina, Ohio 44256

Bus. Phone 330-769-4992
Fax 330-769-4116
Res. Phone 330-769-3987

WANTED
PRE 1900
ELECTRICITY
MEDICAL • X-RAY
TELEGRAPHY • TELEPHONE
PRE 1925
RADIO • WIRELESS
PRE 1940
TELEVISION



**NEW WIRELESS
PIONEERS**
P.O. BOX 398
ELMA, NY 14059
718-681-3186
FAX: 718-681-4540

BOOKS • TUBES • ARTIFACTS
MAGAZINES • AUTOGRAPHS
CATALOGS • EPHEMERA

Crystal Radios
Reproductions • Kits • Parts
Send \$1 for catalog.
Refundable on first purchase over \$10.

RogRadCo
www.crystalrad.com

23110 Arlington
Dearborn, MI 48128

Phone:
313-277-2529

BUSINESS CARD ADS - \$53.00 FOR 3 MONTHS

TEST EQUIPMENT

BUY - SELL - TRADE
PARTS - ACCESSORIES - CABLES

Boca Electro Magnetic Lab
22340 Greentree Circle
Boca Raton, FL 33433
(561) 750-8911
bocalab@bellsouth.net



Collector, Historian, Seeker of
Stromberg-Carlson Radio Apparatus



Entrepreneur: Art Moderne,
Streamline, Machine Age Design

INSTRUMENTS



Jim & Rhoda
Morris

Radio, Telegraph,
Historical Instruments,
& Books for Sale
Catalogs
& Lists
Available

Antiques of Science & Technology
A of ST Box 1852 Wakefield Ma. 01880 U.S.A.
Tel 781 245 2897 Fax 781 245 3572

Replacements • Reproductions • Radio • Stereo • Harp • Auto • OEM

Antique Radio DIAL SCALES

Send an SASE for brochure and list

Rock-Sea Enterprises
323 E. Matilija St. #110-241
Ojai, CA 93023
<http://members.aol.com/RockSeaEnt/>

Mike Tobin
(805) 646-7362
dials@juno.com



THE ADVENTURE CONTINUES . . .

Series Books: Over 1000 on homepage
Reprints: Radio Boys to the Rescue
Dust Jackets: Recreated for most series

Collector/Dealer/Search Service
Editor: - Ken Holt Homepage
<http://members.aol.com/brentwoods>
Email: toweyj@aol.com

Jim Towey
249 Hartland Road
West Granby, CT, 06090
860-653-7447

ANTIQUE ELECTRONIC REPAIR

Radios • Hi Fi • Jukeboxes
Television • Test Equipment
...and other neat old stuff

since 1976

Mike Zuccaro
619 271-8294

8795 Corvus Pl
San Diego, CA 92126

Proud
Member
AWA & MAPS

"The Early Soundman"

Satisfaction
JOHN P. ANDOLINA JR. is Guaranteed

ANTIQUE PHONOGRAPHS



COLLECTOR & EXPERT IN RESTORATION
OF SPRING WOUND CYLINDER & DISC
PHONOGRAPHS. SUPPLIER OF NEEDLES,
MAIN SPRINGS, ORIGINAL & REPRODUCTION
PARTS.

Honest, Friendly
Advice

28 Glen Oaks Drive
Rochester, NY 14624
(716) 247-3056

Specialist in
Reproducer
Rebuilding

78 RPM Cartridges Repaired



Dead cartridges rebuilt
right. New crystals etc., as needed. Allow 3-4 weeks. Most
crystal and "horseshoe" magnet types \$34.50
100 hr. sapphire setscrew needles (list \$2.50 ea.) . . . 4/\$5.50



Joe Smolala
835-A Pleasant Street
Framingham, MA 01701

Inquiries: (508) 879-2778,
evenings and weekends.
Prices include return
postage. Please include
payment with order.



john d. eckland

Vintage American & European Radio Repair
Expert HI FI Service • Custom Built Amplifiers
988A ADDISON AVENUE PALO ALTO, CALIFORNIA 94301
Davenport 3-0101



All Tube Equipment Repaired



"The Fisher Doctor"

Al Pugliese
718-948-7489

27 Daleham Street
Staten Island N.Y. 10308

VINTAGE FISHER PRODUCTS
Bought • Sold • Traded • Repaired



Modern Radio Laboratories Since 1932

Crystal Set and One Tube Radio Instructions. Exclusive source,
printing and publishing of all MRL Handbooks & literature by
Elmer G Osterhoudt Tested instructions and plans.

Catalog \$2.00 ppd.

MODERN RADIO LABS
P.O. Box 14902-T
Minneapolis, MN 55414-0902

Atlanta, GA area ANTIQUE RADIO REPAIR



JOHN PELHAM, W1JA
1185 BEND CREEK TRAIL
SUWANEE, GA 30024
(678) 778-7812



E-mail: repair@radiophile.com

I accept work from all states via USPS or UPS.
Write, call, e-mail, or surf to
<http://www.radiophile.com/arr.htm> for details!

1930s - 1960s Vacuum-tube radios only

BUSINESS CARD ADS - \$53.00 FOR 3 MONTHS

BETA-TEK

ANTIQUE RADIO SERVICE

- Quality Repair & Restoration of Vacuum Tube Radios
- Free Estimates • Radios Bought & Sold • Battery Eliminators

RAY BINTLIFF, W1RY
2 Powder Horn Lane
Acton, MA 01720-2014
☎ 978-263-7435

e-mail: w1ry@msn.com



(708) 383-1649
BY APPOINTMENT

DO YOU HAVE
A PROBLEM RADIO ?

THE OLD RADIO SHOP

SERVICE OF VACUUM TUBE ELECTRONICS
SCHEMATIC DIAGRAM SERVICE
RESTORATION OR REPAIR • FREE ESTIMATES

ED HUEYER

1025 ERIE ST
OAK PARK, IL 60302



Vintage Electronics



Phono

Cartridges/Needles
Center Post/Idlers
45 Adaptors



Fax Anytime

Phone: Mon.-Fri.
8AM-5PM CST only

128 Buccaneer Drive
Hattiesburg, MS 39402

Ed Crockett

Phone (601) 264-4755
Fax (601) 264-0226

RADIOS & STRANGE MISCELLANEA IF YOU VISIT THE BRIMFIELD FLEA MARKET... STOP BY FIRST!



TEL: 413-245-7174

COUNTRY ROAD BARN - BERNIE SAMEK
OLD PALMER ROAD, BRIMFIELD, MASS.

ANTIQUE ELECTRONIC RESTORATION

35 Years Experience
Radios • Juke Boxes • Vintage TV's
Repair • Buy • Sell
Complete Restorations • Auto and Home • Prompt Service



COOPERS'S RADIO SERVICE

425 Court Street
Rockwell City, Iowa 50579

LARRY COOPER
712-297-7232

Old Time Replications

"TURN TO US WHEN YOU NEED KNOBS"
KNOBS • PUSHBUTTONS • ESCUTCHEONS
PLASTIC GRILLS • HANDLES

LARRY BORDONARO

5744 TOBIAS AVE. VAN NUYS, CA 91411
PHONE (818) 786-2500 • FAX (818) 909-0241

(856) 869-0238



SOUND REMEDY

Loudspeaker Repair Service

Richard G. Stamer
Reliable-Prompt-Guaranteed

331 Virginia Avenue
Collingswood, NJ 08108

PHILCO PREDICTAS WANTED:



BUY • SELL • TRADE • RENT • RESTORE
APPRAISALS / LECTURES GIVEN

DAVID WEDDINGTON
(615) 890-7498

2702 Albany Ct.
Murfreesboro, TN 37129

RADIOGALLERY.COM

QUALITY ANTIQUE RADIO SALES
"CLASSIC MODELS THAT WORK" / NEVER "as is" or "untested"

Big selection on the Internet at: www.RadioGallery.com

SCOTT STAMBAUGH

725 South 14th Street Lebanon, Pa. 17042

E-MAIL: Scott@RadioGallery.com

Free Estimates
Hrs - 9 AM - 5 PM EST
Tues. - Sat

Tel./Fax (860) 928-2628
E-Mail: radiodoc@neca.com
<http://www.neca.com/~radiodoc/>

ANTIQUE RADIO RESTORATION & REPAIR

1920 - 1960's

Reasonable Rates, Tubes, Professional
Overhauls, Cabinet Refinishing, Service
For All Antique Car, Table & Console
Radios, Communication Receivers &
Tube Amplifiers.



BOB ESLINGER

20 Gary School Road
Pomfret Center, CT 06259

WANTED ! JAPANESE MILITARIA

any kind of WW-2 Japanese hardwares - aircraft instruments
radios, optics.

Takashi Doi

Fax : 011-8145-301-8069

E-Mail : taka-doi@a2.ctktv.ne.jp

1-21-4 Miramidai, Seyaku, Yokohama, 246 Japan.



Cayce Vintage Sound Company (803) 791-0733

Your complete source for

Leatherette

"Black Stag" style leatherette stocked.
Others available by special order.

Scott McAuley
117 Sandy Lane
Cayce, S.C. 29033

LSASE for samples
cavisco@aol.com
Expert Vintage Electronic Repair

Amateur Radio Books

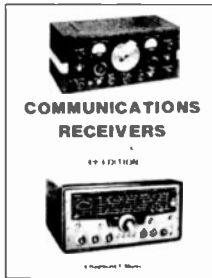

Communications Receivers 4th Edition by Raymond S. Moore. A comprehensive guide to 750, 1932 to 1981, vacuum tube receivers by 66 manufacturers. Three pages of military receivers. 448 radios pictured! Sharper, clearer photographs. 8 1/4" x 11", 136 pages. Softcover. — \$19.95

Heathkit, A Guide to the Amateur Radio Products by Chuck Penson. Documentation of ALL Heathkit's amateur products. 200+ sharp photos. Most products are pictured with a full-page description. 8 1/4" x 11", 256 pgs. Softcover. — \$24.95



The Pocket Guide to Collins Amateur Radio Equipment 1946-1980 by Jay Miller. A pictorial guide to Collins equipment and accessories. 90+ sharp photographs. 3 1/4" x 7", 108 pages. Softcover. — \$19.95

Shortwave Receivers Past & Present Communications Receivers 1942-1997, 3rd Edition by Fred Osterman. This reference is designed for the radio collector, the informed receiver buyer or anyone interested in the history and development of shortwave radios. Over 770 receivers from 98 manufacturers. 8 1/4" x 11", 473 pages. Softcover. — \$24.95

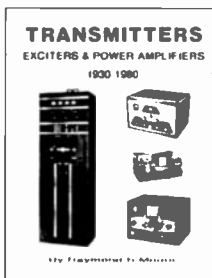

Transmitters, Exciters & Power Amplifiers 1930-1980 by Ray Moore. Pictorial and descriptive guide to amateur high frequency transmitters and amplifiers manufactured in the U.S.A. Over 500 photos. 8 1/4" x 11", 144 pages. Softcover. — \$21.95

Radios by Hallicrafters, 2nd Ed. by Chuck Dachis. This book includes over a thousand photographs (b/w & color) of radio receivers, transmitters, electronics accessories and advertising material. Technical descriptions are provided for every known Hallicrafters model, including dates of production, model numbers, accompanying pieces and original prices. This 2nd edition includes additional coverage of receivers and updated pricing. 8 1/4" x 11", 225 pages. Softcover — \$29.95

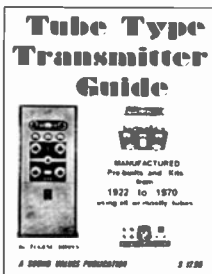

Tube Type Transmitter Guide by Eugene Rippen. Provides a wealth of information on transmitters and transceivers. Includes ancillary items such as linear amplifiers, converters, modulators and VFOs. Over 500 illustrations. 8 1/4" x 11", 145 pages. Softcover. — \$17.95



U.S. Orders - Enclose \$3.00 per order for packing & book-rate shipping if total order is under \$35.00. If using VISA or MasterCard, include name on card, card number and expiration date. Send payment with order. Mass. residents add 5% sales tax. Money back return policy. Softcover unless stated otherwise. Most orders shipped the same day received, but allow 2-4 weeks to receive order. Foreign orders - write for shipping costs, or use credit card and specify air or surface (allow 2-3 months for surface shipping).

VISA A.R.C., P.O. Box 2, Carlisle, MA 01741. Tel: (978) 371-0512



Fax: (978) 371-7129 - E-mail: ARC@antiqueradio.com - Web: www.antiqueradio.com

(Jul-99)

New Books for the Collector



Zenith Radio: The Early Years 1919-1935 by John Bryant and Harold Cones. *The first of a planned 3-book series explains the Zenith story. Never published photos, documents, and information. 300 photos and illustrations, 120 in color. 8 1/2" x 11", 224 pages. Softcover. — \$29.95*

Price Guide

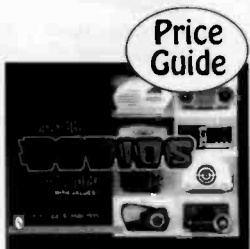

Price Guide

Genuine Plastic Radios of the Mid-Century by Ken Jupp and Leslie Piña. *Illustrates mid-century table radios made of plastic as examples of industrial design and pop-culture. Vintage B&W photos and advertisements. 439 color photos. 8 3/4" x 11 1/4", 208 pages. Hardcover. — \$39.95 NEW*



Radios: The Golden Age by Philip Collins. *Colorful Catalin and Bakelite radios from the late 1930s to the early 1940s. Over 100 color photos. 10" x 8 1/4". 119 pages. Hardcover. — \$12.98*



The Golden Age of Televisions by Philip Collins. *An amazing collection of photos of these early machines that evoke a time when the television was more than merely a box or a screen: it was the center of every home. 10" x 8 1/4". Softcover. — \$15.95*

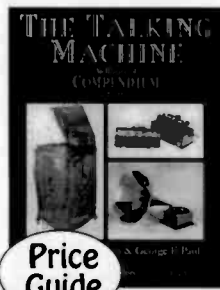

The Talking Machine, An Illustrated Compendium, 1877-1929 by Timothy Fabrizio and George Paul. *Contains over 550 beautiful photos of external & internal horn phonographs. The authoritative text & value guide, complemented with a wealth of visuals, make this book a must in your library. 8 1/2" x 11", 256 pages. Hardcover. — \$69.95*

Price Guide



Radio Art by Robert Hawes. *Illustrated radio history. Although focusing primarily on British sets, this book also contains American sets: Airline, Atwater Kent, E.H. Scott, Emerson, Fada, GE, Majestic, Philco, RCA, Zenith, and others. 250 photos, 150 in color. 9 1/4" x 12", 128 pages. Hardcover. — \$9.95*



Radio! Radio! 3rd Edition by Jonathan Hill. *Comprehensive coverage of British radios from the 1920s to the 1970s. Includes a directory of nearly 3,000 different transistor models made in Britain or imported between 1956 and 1972. 8 1/2" x 12", 320 pages. Hardcover. — \$64.95*

U.S. Orders - Enclose \$3.00 per order for packing & book-rate shipping if total order is under \$35.00. If using VISA or MasterCard, include name on card, card number and expiration date. Send payment with order. Mass. residents add 5% sales tax. Money back return policy. Softcover unless stated otherwise. Most orders shipped the same day received, but allow 2-4 weeks to receive order. Foreign orders - write for shipping costs, or use credit card and specify air or surface (allow 2-3 months for surface shipping).



A.R.C., P.O. Box 2, Carlisle, MA 01741. Tel: (978) 371-0512

Fax: (978) 371-7129 - E-mail: ARC@antiqueradio.com - Web: www.antiqueradio.com



(Mar-98)

Transistor Radio Books



Price Guide

The Collector's Guide to Transistor Radios 2nd Edition by Marty & Sue Bunis. *This book will help you identify the most sought-after vintage transistor radios. Over 2,900 models listed, all with current prices. Includes radio club listing. 375 all new color photos. 5 1/2" x 8 1/2". 320 pgs. 1996. Softcover. - \$16.95*

Transistor Radios: 1954-1968 by Norman Smith. *Over 1,000 transistor radios identified by manufacturer, marketing organization, type, and style. 460+ color photographs and price guide. 8 1/2" x 11". 160 pgs. Softcover - \$29.95*



NEW

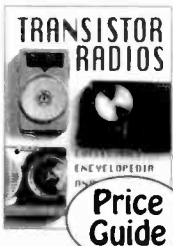

Price Guide

Transistor Radios, A Collector's Encyclopedia and Price Guide by David Lane & Robert Lane. *Identification & price guide to over 2,500 transistor and novelty radios. History & key to collecting chapters. 8 1/2" x 11". 170 pgs. Softcover. - \$19.95*

Collector's Guide to Novelty Radios by Marty Bunis & Robert Breed. *This book is the source for novelty transistor radios in all shapes and sizes. Radios are described in detail with current prices. Over 600 color photographs. 8 1/2" x 11". 224 pgs. Softcover - \$18.95*



Price Guide



Price Guide

Collector's Guide to Novelty Radios, Book II by Marty Bunis & Robert Breed. *All new second volume takes up where the first book left off. New radios are described with current prices. Over 600 all new color photographs. 8 1/2" x 11". 208 pgs. Softcover - \$19.95*

Zenith Transistor Radios, Evolution of a Classic by Norman Smith. *A complete listing of all transistor radio models created by Zenith during the Magic Years from 1955-65. 200- color photographs and price guide. 8 1/2" x 11". 160 pgs. Softcover - \$29.95*



Price Guide

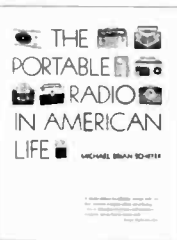

The Portable Radio in American Life by Michael Schiffer. *Approximately 50 pages on transistor radios, beginning with the Regency TR-1 through to the later sets made overseas. 450 photographs, 193 transistor radios pictured. 8 1/2" x 11". 259 pgs. Softcover - \$26.95 Hardcover - \$45.00*

U.S. Orders - Enclose \$3.00 per order for packing & book-rate shipping if total order is under \$35.00. If using VISA or MasterCard, include name on card, card number and expiration date. Send payment with order. Mass. residents add 5% sales tax. Money back return policy. Softcover unless stated otherwise. Most orders shipped the same day received, but allow 2-4 weeks to receive order. Foreign orders - write for shipping costs, or use credit card and specify air or surface (allow 2-3 months for surface shipping).



A.R.C., P.O. Box 2, Carlisle, MA 01741. Tel: (978) 371-0512

Fax: (978) 371-7129 - E-mail: ARC@antiqueradio.com - Web: www.antiqueradio.com



(Mar-99)

Radios

of the Baby Boom Era

Six Volumes — 2000 pages — From Sams' Archives
 1946 to 1960 — 274 Brands — 3494 Illustrations (B&W)
 6769 Models — Catalin, Bakelite, Wood, Transistor Radios & More

All Volumes Available!

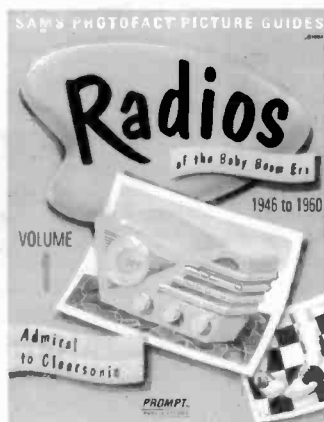

Vol.	Brands	Included
1	56	Admiral to Clearsonic
2	54	Co-op to Geloso
3	58	GE to Monitoradio
4	36	Motorola to RCA Victor
5	35	Realtone to Stratovox
6	35	Stromberg-Carlson to Zenith

1/2 Page for each illustrated radio including:

- Large illustration of the radio including knob functions
- Short description of the radio
- Number of tubes
- Power supply type (AC, Battery, etc.)
- Tuning range
- Manufacturer
- Sams Photofact Set number & year Photofact published.

**Each Volume: \$16.95 – Softcover
 8 1/2" x 11" – Approx. 328 pages**

U.S. Orders - Enclose \$3.00 per order for packing & book-rate shipping if total order is under \$35.00. If using VISA or MasterCard, include name on card, card number and expiration date. Send payment with order. Mass. residents add 5% sales tax. Money back return policy. Softcover unless stated otherwise. Most orders shipped the same day received, but allow 2-4 weeks to receive order. Foreign orders - write for shipping costs, or use credit card and specify air or surface (allow 2-3 months for surface shipping).

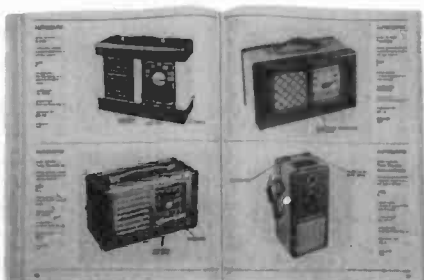

ALSO

- Index by model number listing tubes in radio
- List of similar radio models indexed to pictured radio
- List of manufacturers and suppliers indicating their brand names
- Basic trouble-shooting hints



A.R.C., P.O. Box 2, Carlisle, MA 01741. Tel: (978) 371-0512

Fax: (978) 371-7129 – E-mail: ARC@antiqueradio.com – Web: www.antiqueradio.com



(Mar-99)

Radio Manufacturers of the 1920's

BY ALAN DOUGLAS



"The definitive book on American broadcast receivers of the 1920s"

Volume 1: A-C Dayton - Adams Morgan - Air-Way - All-American Mohawk - American Bosch - Amrad - Amrad S-Tube - Apex - Atwater Kent - Bremer Tully - Browning-Drake - Clapp-Eastham - Crosley - Cutting & Washington - Day-Fan - DeForest - Eagle - ERLA - FADA - Federal - Ferguson. 225 Pages.

Volume 1: \$24.95 - Softcover Only

Volume 2: Freed-Eisemann - Eisemann - Freshman - Garod - Gilfillan - Grebe - Howard - Jones (Lester/Melco) - Jones (Jos.) - Kellogg - Kennedy - King - Kodel - Kolster - Leutz - Magnavox - Majestic - Marti - Metro - Klitzen/Michigan - Midwest - Mu-Rad - Murdock - Music Master - Neutrowound - Operadio - Ozarka - Pfanstiehl - Philco - Pilot - Priess. 266 Pages.

Volume 2: \$29.95 - Softcover Only

Volume 3: RCA - Scott - Silver-Marshall - Slagle - Sleeper - Sonora - Sparton - Splittorf - Steinite - Stewart-Warner - Stromberg-Carlson - Thermodyne - R.E. Thompson - Thorola - Tri-City - C. D. Tuska - Ware - Western Coil - Western Electric - Workrite - Zenith. 292 Pages.

Volume 3: \$29.95 - Softcover

\$39.95 - Hardcover

U.S. Orders - Enclose \$3.00 per order for packing & book-rate shipping if total order is under \$35.00. If using VISA or MasterCard, include name on card, card number and expiration date. Send payment with order. Mass. residents add 5% sales tax. Money back return policy. Softcover unless stated otherwise. Most orders shipped the same day received, but allow 2-4 weeks to receive order. Foreign orders - write for shipping costs, or use credit card and specify air or surface (allow 2-3 months for surface shipping).



A.R.C., P.O. Box 2, Carlisle, MA 01741. Tel: (978) 371-0512

Fax: (978) 371-7129 - E-mail: ARC@antiqueradio.com - Web: www.antiqueradio.com



(Mar-99)

Transistor Radios: 1954-1968

By Norman Smith



**Over 1,000 Transistor Radios
460+ Color Photographs
Price Guide**

\$29.95 - Softcover

U.S. Orders - Enclose \$3.00 per order for packing & book-rate shipping if total order is under \$35.00. If using VISA or MasterCard, include name on card, card number and expiration date. Send payment with order. Mass. residents add 5% sales tax. Money back return policy. Softcover unless stated otherwise. Most orders shipped the same day received, but allow 2-4 weeks to receive order. Foreign orders - write for shipping costs, or use credit card and specify air or surface (allow 2-3 months for surface shipping).



A.R.C., P.O. Box 2, Carlisle, MA 01741. Tel: (978) 371-0512

Fax: (978) 371-7129 - E-mail: ARC@antiqueradio.com - Web: www.antiqueradio.com



(Mar-99)

Collector's Guide to Novelty Radios Book II

By Marty Bunis & Robert Breed



**NEW!
Order
Today!**

**All New Second Volume
600+ Color Photographs
Price Guide**

\$19.95 - Softcover

Collector's Guide to Novelty Radios by Bunis & Breed, First Volume – \$18.95

U.S. Orders - Enclose \$3.00 per order for packing & book-rate shipping if total order is under \$35.00. If using VISA or MasterCard, include name on card, card number and expiration date. Send payment with order. Mass. residents add 5% sales tax. Money back return policy. Softcover unless stated otherwise. Most orders shipped the same day received, but allow 2-4 weeks to receive order. Foreign orders - write for shipping costs, or use credit card and specify air or surface (allow 2-3 months for surface shipping).



A.R.C., P.O. Box 2, Carlisle, MA 01741. Tel: (978) 371-0512

Fax: (978) 371-7129 - E-mail: ARC@antiqueradio.com - Web: www.antiqueradio.com



(Mar-99)

Shortwave Receivers Past & Present Communications Receivers 1942-1997 3rd Edition

By Fred Osterman



**840 Photographs — 473 Pages
Features Over 770 Receivers from
98 American and International Manufacturers**

NEW Edition

270 More Receivers!

28 More Manufacturers!

122 More Pages!

\$24.95 - Softcover

U.S. Orders - Enclose \$3.00 per order for packing & book-rate shipping if total order is under \$35.00. If using VISA or MasterCard, include name on card, card number and expiration date. Send payment with order. Mass. residents add 5% sales tax. Money back return policy. Softcover unless stated otherwise. Most orders shipped the same day received, but allow 2-4 weeks to receive order. Foreign orders - write for shipping costs, or use credit card and specify air or surface (allow 2-3 months for surface shipping).



A.R.C., P.O. Box 2, Carlisle, MA 01741. Tel: (978) 371-0512

Fax: (978) 371-7129 - E-mail: ARC@antiqueradio.com - Web: www.antiqueradio.com



(Mar-99)

Genuine Plastic Radios of the Mid-Century

By Ken Jupp & Leslie Piña



**NEW!
Order
Today!**

**55 Manufacturers from Admiral to Zephyr
Table Models - Portables
439 Color Photos - Price Guide
Advertisements**

\$39.95 - Hardcover

U.S. Orders - Enclose \$3.00 per order for packing & book-rate shipping if total order is under \$35.00. If using VISA or MasterCard, include name on card, card number and expiration date. Send payment with order. Mass. residents add 5% sales tax. Money back return policy. Softcover unless stated otherwise. Most orders shipped the same day received, but allow 2-4 weeks to receive order. Foreign orders - write for shipping costs, or use credit card and specify air or surface (allow 2-3 months for surface shipping).



A.R.C., P.O. Box 2, Carlisle, MA 01741. Tel: (978) 371-0512

Fax: (978) 371-7129 - E-mail: ARC@antiqueradio.com - Web: www.antiqueradio.com



(Jul-99)

CRYSTAL CLEAR

By Maurice L. Sievers

Volume 1

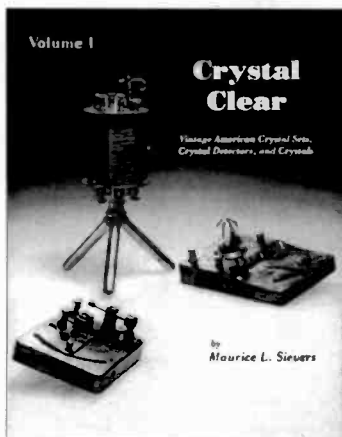

750 Illustrations – 570 Crystal Sets
341 Detectors – 207 Crystals
Perfect for the beginning collector!
Useful for the experienced too!

Crystal Clear is the most comprehensive reference for collectors, historians and anyone interested in early radio. In addition to the many excellent photos and reproductions of ads, *Crystal Clear* includes lists showing all sets by manufacturer, set name, selling price and date of manufacture. 8 1/2" x 11", 282 pages.

\$29.95 – Softcover

Volume 2

Crystal Clear, Vol. 2 supplements the first volume. It identifies an additional 172 crystal radio sets, 91 crystal detectors and 26 crystals by manufacturer, model, year produced, description and original selling price. Further research on many of the crystal sets covered in Volume 1. Detailed history on the Philmore Manufacturing Company and the Western Manufacturing Company. 8 1/2" x 11", 252 pages.

\$29.95 – Softcover

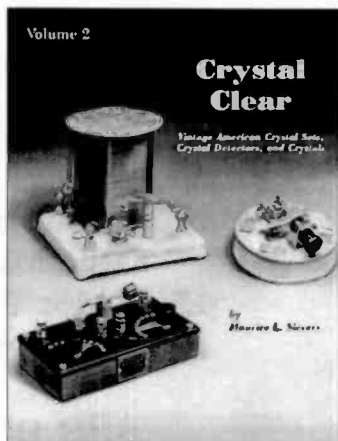

U.S. Orders - Enclose \$3.00 per order for packing & book-rate shipping if total order is under \$35.00. If using VISA or MasterCard, include name on card, card number and expiration date. Send payment with order. Mass. residents add 5% sales tax. Money back return policy. Softcover unless stated otherwise. Most orders shipped the same day received, but allow 2-4 weeks to receive order. Foreign orders - write for shipping costs, or use credit card and specify air or surface (allow 2-3 months for surface shipping).



A.R.C., P.O. Box 2, Carlisle, MA 01741. Tel: (978) 371-0512

Fax: (978) 371-7129 - E-mail: ARC@antiqueradio.com - Web: www.antiqueradio.com



(Mar-99)

The Radio Collector's Directory and Price Guide, 1921-1965, 2nd Ed.

by Robert E. Grinder

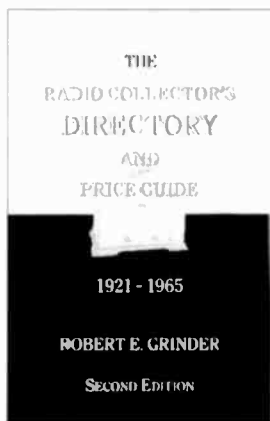

20,000+ Models Listed

U.S. models manufactured from 1921-1965.

Listing includes:

*Model Name,
Year of Production,
Type of Power,
Cabinet Style, and
Current Market Value Range.*

Rewritten Chapters On:

*Early Broadcasting,
Radio Broadcasting Regulation,
Advances Made in Receivers,
The Evolution of Radio Cabinet Styles.*

\$26.95 - Softcover

U.S. Orders - Enclose \$3.00 per order for packing & book-rate shipping if total order is under \$35.00. If using VISA or MasterCard, include name on card, card number and expiration date. Send payment with order. Mass. residents add 5% sales tax. Money back return policy. Softcover unless stated otherwise. Most orders shipped the same day received, but allow 2-4 weeks to receive order. Foreign orders - write for shipping costs, or use credit card and specify air or surface (allow 2-3 months for surface shipping).



A.R.C., P.O. Box 2, Carlisle, MA 01741. Tel: (978) 371-0512

Fax: (978) 371-7129 - E-mail: ARC@antiqueradio.com - Web: www.antiqueradio.com



(Mar-99)

COLLECTOR BOOKS AVAILABLE FROM A.R.C.

BOOKS MARKED WITH "☞" ARE THE MOST POPULAR AND ARE ESPECIALLY RECOMMENDED FOR NEW COLLECTORS!

- Antique Radio Restoration Guide, 2nd Ed.**, Johnson. *Beginner's introduction to troubleshooting and repairing AC table model radios.* 1992. 145 pgs. \$14.95
- The AWA Review.** Collections of articles. Vol. 6: *Hawaiian Wireless, U.K. TV, SCR-RC-BC Dir., NYC Wireless, etc.* Vol. 7: *Poldhu xmitters, Navy equipment, Arc xmitters.* Vol. 8: *Keys, Federal Co., KFS-Federal-Mackay story, Nat'l Electrical Supply Co., Navy Electronics Dir., etc.* Vol. 6-8, ea. \$10.00
Vol. 9: *Marconi, The Int'l Contest for Radar, Magnetron Story, F. Lowenstein, Ham Licensing.* Vol. 10: *Atwater Kent, Race for Radiotelephone, Radio Central 75th Anniversary, The Heinz and Kaufman Story, Collins Radio Co.* Vol. 11: *Scott Radio Products, National sliding coil receivers.* Vol. 9-11, ea. \$20.00
- The Antique Radio Boys and the Garrulous Grebe**, Dryer. *Thrilling adventure story written in the traditions of the '20s and '30s.* 5 1/2" by 8 1/2". 51 pgs. \$4.95
- The Auto Radio, Matteson.** *Info, photos & ads of the auto radio through the 1950s.* 316 pgs. (hardcover) \$34.95
- Audio! Audio!**, Hill. *A comprehensive directory of classic audio amplifiers and control units. Details of over 850 models from nearly 150 British manufacturers from the 1940s to the 1970s. Signed and numbered.* 95 pgs. \$19.95
- Behind the Front Panel**, Kulland. *Reviews radio circuits and radio history. Easy descriptions.* 25 pics. 158 pgs. \$18.95
- Blast from the Past, A Pictorial History of Radio's First 75 Years**, Rhoades. *The performers, programs, & technology that made radio a part of everyday life. 100s of never-before-published photos.* (hardcover) \$39.95
- Classic TVs, 2nd Printing**, Wood. *Prewar to 1950s. Revised price guide.* 140+ color photos, repros of catalogs & ads. 86 pgs. \$18.95
- ☞ **The Collector's Guide to Antique Radios, 4th Ed.**, Bunis. *This guide covers radios from 1920s to 1960s. Over 8,500 prices and many all new color photos are included.* 1996. \$18.95
- ☞ **The Collector's Guide to Antique Radios, Combined Ed., CD-ROM**, Bunis & Kaczowka. *Combines book editions 1, 2, 3, and 4. Over 9,000 Models with pricing. Model number index for all manufacturers, photo index by category.* 1,800 full color photos. Requires a web browser. IBM & Mac. 1998. NEW \$39.95
- The Collector's Guide to Novelty Radios, Bunis & Breed.** *Descriptions with prices. 600+ color photos.* 1994. 224 pgs. \$18.95
- The Collector's Guide to Novelty Radios, Book II**, Bunis & Breed. *New radios & prices. 600+ color photos.* 1998. 208 pgs. NEW \$19.95
- The Collector's Guide to Transistor Radios, 2nd Ed.**, Bunis. *Identifies the most sought-after vintage transistor radios. Includes club listing. Over 2,900 models, 375 all new color photos, with current prices.* 1996. 320 pgs. \$16.95
- ☞ **Communication Receivers, 4th Ed.**, Moore. *Information on 750, 1932 to 1981, vacuum tube receivers by 66 manufacturers. 448 radios illustrated. 3 pages of military receivers.* 136 pgs. \$19.95
- The Compleat Talking Machine, 3rd Ed.**, Reiss. *A guide to antique phonographs. Revised price guide. Covers construction, cleaning and repairing of parts and cabinets. Over 700 pictures.* 249 pages. NEW \$29.95
- ☞ **Crystal Clear - Vintage American Crystal Sets, Crystal Detectors and Crystals, Sievers.**
Vol. 1 - *Comprehensive reference with 750 illustrations, 570 crystal sets, 341 detectors, 207 crystals, 282 pgs.* \$29.95
Vol. 2 - *479 All new & different illustrations, more crystal sets, detectors and crystals identified.* 252 pgs. \$29.95
- Crystal Radio: History, Fundamentals, and Design**, Kinzie. *Plus crystals for detectors.* 121 pgs. \$10.95
- Crystal Set Building and More**, The Xtal Set Society. *Projects and information about crystal radios, mostly dealing with design and electronics issues. Also included are Vols. 6 & 7 of the Xtal Set Society Newsletter.* \$15.95
- Crystal Set Projects: 15 Radio Projects You Can Build**, The Xtal Set Society. 160 pgs. \$14.95
- E.H. Scott Radio Collectors Guide, 1925-1946**, Clark. *The reference for collectors of Scott radios, cabinets and accessories. Lists original prices of cabinets and accessories. Over 200 photos with descriptions.* 88 pgs. \$29.95
- 1940 E.H. Scott Catalog**, King. *Quality reproduction of the custom built receivers. Includes radios & cabinet illustrations.* \$12.95
- Early Radio, In Marconi's Footsteps**, Jensen. *Realistic description of Marconi's work and his surroundings. Early construction projects with diagrams. Color and B&W photographs.* 170 pgs. (hardcover only) \$39.95
- Evolution of the Audio Recorder**, Van Praag. *Comprehensive guide to the audio recorder.* 1997, 518 pages. \$39.95
- Evolution of the Radio**, L-W Books. *Radios pictured and priced, plus reproductions of catalog pages and ads.*
Vol. 1 - *Eight-hundred + radios.* 1991. 227 pgs., 118 pgs. in color. \$22.95
Vol. 2 - *Totally different from volume one with new photos, etc.* 1993. 654 color photos. 226 pgs. \$24.95
- ☞ **Fixing Up Nice Old Radios**, Romney. *Written by a retired radio instructor, this book covers Ohm's law, through battery sets, superhets and communications receivers.* 1990. 300+ figures, 185 pgs. \$35.00
- ☞ **Flick of the Switch**, McMahon. *The classic photo reference guide for '30s - '50s radios.* 1000+ photos. 263 pgs. \$11.95
- Genuine Plastic Radios of the Mid-Century**, Jupp & Piña. *Overview of plastic table radios with advertisements, vintage black & white photos.* 439 color photos. 208 pgs. (hardcover) NEW \$39.95
- ☞ **The Golden Age of Televisions**, Collins. *Nice collection of photographs of these early machines* \$15.95
- ☞ **Guide to Old Radios - Pointers, Pictures & Prices, 2nd Ed.**, Johnson. *Introduction to radio collecting. Includes hundreds of photos and a price guide.* 1995. 272 pgs. \$19.95
- Hake's Guide to TV Collectibles.** *Price guide and photos for 1600 TV shows, comic books, etc.* 1990. 185 pgs. \$14.95
- ☞ **Heathkit, A Guide to the Amateur Radio Products**, Penson. *Documentation of all Heathkit's amateur radio products, a complete history of the company, 200+ sharp photos.* 256 pgs. \$24.95
- International Directory of Antique Radio Collectors.** *Lists collectors, clubs, museums, dealers.* 1996. 92 pgs. \$14.95
- Inventing American Broadcasting**, Douglas. *From the days of Marconi to broadcasting in the 1920s.* 1987. 363 pgs. \$14.95
- L. A. Radio Manufacturing**, Paul. *Radio makers in L.A. from 1922-42. Echophone, Gillfillan & 10 others.* 88 pgs. \$11.90
- Supplement No. 1**, Paul. *Coverage of additional manufacturers, people and sets.* 1993. 48 pgs. \$6.75
- Supplement No. 2**, Paul. *Coverage of additional manufacturers, people and sets.* 1999. 54 pgs. NEW \$10.90
- The Magnetic Cone Speaker Notebook**, Paul. *250+ cone speakers from 120+ companies. Photocopy.* 1995. 58 pgs. \$11.90
- The Mechanics of TV**, Yanczer. *Explanation of mechanical to, details for a working system.* 5 1/2" by 7 1/2", 170 pgs. \$24.95
- Most Often Needed 1926-38 Radio Diagrams and Servicing Information** (reprint). *600+ diagrams for mostly AC radios from '26-'38.* 240 pgs. \$18.50
- Old Gramophones**, Bergonzi. *The development of phonographs and gramophones.* 64 photos. 32 pgs. \$4.95
- Old Radio Sets**, Hill. *The development of the radio from the late Victorian era until the late 60s.* 60 photos 32 pgs. \$4.95
- Old Television**, Emmerson. *The development of the television until the late 60s.* 50 photos. 32 pgs. \$4.95
- ☞ **Old-Time Radios! Restoration and Repair**, Carr. *How to repair vacuum-tube and transistor radios. A self-paced training guide. 200 illustrations, 256 pgs.* \$19.95
- ☞ **Philco Radio: 1928-1942**, Ramirez. *A reference book on Philco. Shows receivers and company history year-by-year. 464 color photos, 364 black & white photos and drawings.* 1993. 160 pgs. \$29.95
- Phono-Graphics: The Visual Paraphernalia of the Talking Machine**, Schwartzman. 119 pgs. \$16.95
- The Pocket Guide to Collins Amateur Radio Equipment 1946-1980**, Miller. *90+ sharp photos.* 3 1/2" x 7". 108 pages. \$19.95
- Portable Radio In American Life**, Schiffer. *Traces the development of the portable radio and how it affected American culture and society.* 450 photos and drawings, 259 pgs. (hardcover: \$45.00) \$26.95
- RCA Radiolas, Radiotrons, and Accessories** (reprint). *Twenty-page booklet summarizing RCA's 1926 product line.* \$4.50

- Radio Art, Hawes.** A chronological, illustrated history of the technical and stylistic progress of the radio. Mostly British, but American sets are featured as well. 250 photos, 150 in color, 128 pgs. (hardcover only) Low Price \$9.95
- Radio Art Postcard Deck.** 30 full-color photographs from Hawes' book \$7.50
- Radio Collector.** (Videotape, VHS). The five-part Emmy-nominated PBS series combined on one 130-minute videotape. Meet collectors, see collections, attend swap meets, learn about radio restoration. \$29.95
- The Radio Collector's Directory and Price Guide, 1921-1965, 2nd Ed., Grinder.** Directory of over 20,000 radios by manufacturer, model no., year, etc., with prices. History, cabinet styles, vacuum tube development chapters. 500 pgs. \$26.95
- The Radio Collector's Foto-Finder, Bintliff.** An alphabetical index to illustrations in the four editions of the "Collector's Guide to Antique Radios" by Marty & Sue Bunis. 1997. 48 pgs. \$12.95
- Radio Collector's Guide, McMahon.** Listing of 9,000+ radios made by some 1200 companies from 1921 to 1932. Gives manufacturer, year, model name and other info. No photos, 264 pgs. \$11.95
- Radio Diagram Sourcebook, Gray.** Valuable tool for identifying radios. Tubes used, replacement dial lamps, and I.F. frequency. Reprint of *Sylvania's tube complement guide* is included listing almost 10,000 radios. 290 pgs. \$18.95
- Radio Horn Speaker Encyclopedia, Paul.** Listing of horn speakers for 320+ manufacturers for the 1920s. Expanded info. on 10 companies. 145+ photos, 80 pgs. \$15.90
- Radio Horn Speaker Notebook, Rev. H. Paul.** The companion to the Encyclopedia. Over 450 horn picture ads are shown, over 325 manufacturers are identified. Photocopy. New Index. 1995. 72 pgs. \$16.90
- Radio Manufacturers of the 1920's, Douglas.** 3 volumes. Vol. 1: A-C Dayton thru Ferguson (softcover only) \$24.95
Vol. 2: Freed-Eisemann thru Pries. 266 pgs. (softcover only) \$29.95
Vol. 3: RCA thru Zenith. 292 pgs. (hardcover \$39.95) \$29.95
- Radio/Radiol, 3rd Ed., Hill.** Comprehensive coverage of British radios from the 1920s-70s. This expanded edition includes the previous versions plus 75 new pages and 50 new illustrations. New transistor radio section. (hardcover only) \$64.95
- Radios by Hallcrafters, 2nd Ed., Dachis.** The most definitive book on the company. Over 1,000 photos (some color) on everything they made. Additional coverage & updated pricing. An invaluable tool for anyone interested in Hallcrafters. 225 pgs. \$29.95
- Radios of the Baby Boom Era.** Pictures and info from Sams Photofacts. 3,494 radios illustrated plus 3,275 additional radios listed. 274 brands. 1946 - 1960. 300+ pages per volume. Vol. 1: Admiral - Clearsonic. Vol. 2: Co-op - Gelsco. Vol. 3: GE - Monitoradio. Vol. 4: Motorola - RCA. Vol. 5: Kealtone - Stratovox. Vol. 6: Stromberg-Carlson - Zenith. (Per Vol.) \$16.95
- Radios: The Golden Age, Collins, (reprint).** Vintage table radios. 100+ color photos. 119 pgs. NEW \$12.98
- Rasco Radio Parts, (reprint).** Catalog No. 18 summarizing 1928's product line. 144 pgs. \$9.95
- Refinishing Old Furniture, Wagoner.** Written by a furniture restoration instructor. A step-by-step guide to furniture (or radio) restoration, from removal of finishes right up to the final polish. 178 pgs. \$14.95
- Saga of the Vacuum Tube, Tyne.** The development of vacuum tubes - 1880 to 1930. From Edison, Thomson and Fleming to de Forest, Philips, Siemens and many more. 100+ tube photos, 495 pgs. \$18.95
- Shortwave Receivers Past & Present, Communications Receivers 1942-1997, 3rd Ed., Osterman.** For the radio collector, the informed receiver buyer or anyone interested in the history of shortwave radios. 700+ receivers listed. 473 pgs. \$24.95
- S. Gernsback Radio Encyclopedia (reprint).** 1927 classic encyclopedia on radio. From "A" battery to Zirconium, with 1000s of entries in between. 100s of illustrations, 175 pgs. \$9.95
- 70 Years of Radio Tubes and Valves, 2nd Ed., Stokes.** The thermionic vacuum tube story from 1883 through 1960. New chapter on audio application tubes, more photos, magazine ads and a new index by tube number. 264 pgs. \$29.95
- 75 Years of WE Tube Manufacturing, Magers.** A log book history 750+ WE tubes. Illustrated. 133 pgs. \$16.95
- The Talking Machine, Fabrizio and Paul.** Contains over 550 photos of internal and external horn phonographs. The text and value guide, complemented with lots of visuals, make this book a must in your library. 256 pgs. (hardcover only) \$69.95
- Transistor Radios: 1954-1968, Smith.** Over 1,000 transistor radios identified by manufacturer, marketing organization, type, and style. Color photos and price guide. 1998. 160 pgs. NEW \$29.95
- Transistor Radios, A Collector's Encyclopedia and Price Guide, Lane.** Identification guide to over 2,500 transistor and novelty radios. History and key to collecting chapters. 1994. 170 pgs. \$19.95
- Transmitters, Exciters and Power Amplifiers 1930 - 1980, Moore.** Pictorial and descriptive guide to amateur high frequency transmitters and amplifiers manufactured in the U.S.A. Over 500 photos. 144 pgs. \$21.95
- Tube Data, Holm.** The most comprehensive list of vacuum tubes and data in an easy-to-use program for IBM compatibles. 27,000+ tubes, includes receiving and transmitting tubes. Lists function, manufacturer, technical data, & more. (3 1/2" disk). \$39.95
- Tube Lore, Sibley.** Trends in tube design, receiving and audio tubes, special-purpose and transmitting tubes, military types, tips on testing, repairing, adapting various tubes, auction prices from six major sales. 186 pgs. \$19.95
- Tube Type Transmitters, Rippen.** Provides a wealth of info on transmitters and transceivers. Includes ancillary items such as linear amplifiers, converters, modulators and VFOs. Over 500 illustrations. 145 pgs. \$17.95
- The Weekend Refinisher, Johnson.** A complete guide to stains and finishes and tips for setting up your own workshop. A handy furniture "first aid" kit for quick repairs. Illustrated. 296 pgs. \$12.00
- The Western Electric Loud Speaker and Horn Compendium, Nadel.** Vol. 2 in the Museum of Sound Series. 53+ Models covered. B&W illustrations, 58 pgs. NEW \$19.95
- Wireless Communication in the U.S., Mayes.** Early development of American radio operating companies. Alternators, coherers, stock promotions, unpublished letters, etc. 160 illustrations, 240 pgs. \$29.95
- The Xtal Set Society Newsletter, Anderson.** Complete set of the Society's newsletter. Order by volume. Vol. 1: 7/91 to 5/92 - Field Strength Meter, FM Xtal Set, Xtal Sets & Wireless, & more. Vol. 2: 7/92 to 5/93 - The Lead Pencil Detector, The Universal Xtal Set, etc. Vol. 1-2 \$9.95
Vol. 4: 1/94 to 11/94 - Measuring Coil Capacitance, home-brew headphones and curve tracers, etc. Vol. 5: AM Receiver Design, Marconi Type 107, Radio Outfit in a Headset, & more. Vol. 4-5 \$10.95
- The Xtal Set Handbook, Anderson.** Formulas for coil inductance, a procedure for measuring coil capacitance, circuit matching theory, & more. Also included is Vol. 3 of the Xtal Set Society Newsletter. \$11.95
- Zenith The Early Years, 1919-1935, Bryant and Cones.** The 1st of a planned 3-book series. Explains the Zenith story. Discover never published photos, documents and info. 300 photos and illustrations. 120 in color. 224 pgs. \$29.95
- Zenith Radio Corporation (reprint).** The instructions for installation and operation for Models 39-39A Models 392-392A, and Electric Zenith Receivers. 3 schematics. 3 photos, 7 1/2" by 5", 16 pgs. \$4.50
- The Zenith Trans-Oceanic: The Royalty of Radios, Bryant and Cones.** Presents the fascinating story of the development and use of the Trans-Oceanic. Several photos, documents, ads, etc. 160 pgs. \$24.95
- Zenith Transistor Radios, Evolution of a Classic, Smith.** A complete listing of all transistor radio models created by Zenith during the "Magic Years" from 1955-65. Color photos and price guide, 1998, 160 pgs. NEW \$29.95

U.S. Orders - Enclose \$3.00 per order for packing & book-rate shipping if total order is under \$35.00. If using VISA or MasterCard, include name on card, card number and expiration date. Send payment with order. Mass. residents add 5% sales tax. Money back return policy. Softcover unless stated otherwise. Most orders shipped the same day received, but allow 2-4 weeks to receive order. Foreign orders - write for shipping costs, or use credit card and specify air or surface (allow 2-3 months for surface shipping).



A.R.C., P.O. Box 2, Carlisle, MA 01741. Tel: (978) 371-0512

Fax: (978) 371-7129 — E-mail: ARC@antiqueradio.com — Web: www.antiqueradio.com



(Jul-99)

Vintage TVs & radios



HARRY POSTER

Stereo 3D & quality cameras

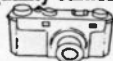

PO Box 1883 S.Hackensack, NJ 07806

hposter@harryposter.com

[FAX:(201)794-9553]

24 Hr Phone:(201)794-9606

We BUY VINTAGE TVs!!!

We buy RADIO-TV SHOPS, CAMERA STORES AND PHOTO STUDIOS!

Always buying *quality cameras, lenses & accs: Leitz, Canon, Nikon, Zeiss, Bolex, Graflex, Alpa, Angenieux & more!* Please FAX or email.

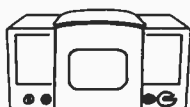
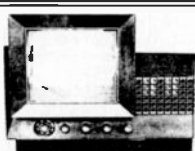

10" TVs from the 1940s

We need 10" table tops from the 1940s. Very clean cabinets—complete or empty! And, we can use from 1 or 100 sets!

Paying \$25 to \$200 each!

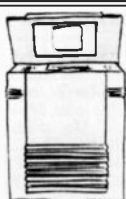

PRE-WAR TVs— 1920s & 1930s

We buy ANY television produced before 1942! Need not work or be complete! GE's with push buttons below the screen, RCA TRK's and TT5, DuMont 180 Series, Zenith Mirror-in-lid, etc!!

Paying \$500 to \$5,000 each!

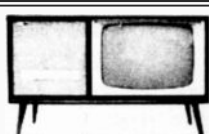
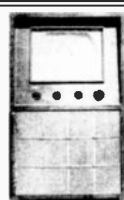

Console TVs: 1940s to 1960s

We do buy very clean B&W and color consoles—small screen and unusual sets; plus Blonde and "Space-Age" sets.

Paying \$50 to \$200 each!

SONY KV13M10, KV20M10 and KV20S10

We need these recent color TVs—only about 3 years old. (These models only.)

Paying \$150 to \$250 each!

SONY 8-301W metal, and 14" GE and Hotpoint metals

We need these 1950s metal portables.

Paying \$50 to \$250 each!

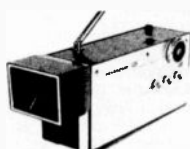
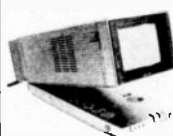

2"- 5" Color TVs, 1960s-1980s

We buy 1960s and 1980s televisions with color picture tubes in small to very small sizes! Panasonic, Sony, and others.

PAYING \$50 to \$200 each!

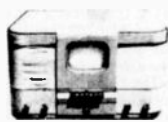

Weird or UNUSUAL TVs-any year!

We want strange B&W and color TVs from the 1940s-1970s! We have plenty of square sets—now we want odd-balls!

PAYING \$50 to \$500 each!

CLASSIFIED ADVERTISING POLICY

ONE FREE 20-WORD AD for subscribers in each issue; additional words are 29¢ each. See details below. Classified ads sent by mail, fax, e-mail or by any other method must be received (not just postmarked!) by Noon Eastern Time on the classified ad deadline date to guarantee inclusion in the current issue. Late ads are held for the following issue. Please enclose correct payment with all ads. Stamps or cash are OK for small amounts. (Canadian and other foreign advertisers, please see "Payment" on page 2 for methods.) "Free words" cannot be accumulated from month to month; free words must be requested when ad is submitted.

Faxed & e-mailed ads: Please see additional information on the inside front cover.

When including ads with other A.R.C. correspondence, write the ads on a separate piece of paper. Include SUB# with ad. Ads may be sent in advance; but, write each ad on a separate piece of paper and indicate the month (or successive two months) you want the ad to run.

To minimize our typing errors: Please write legibly. Use both capital and small letters. Do not use a dash between words. Carefully write the following numbers and letters (especially in model numbers) since some can look alike; for example 1, I and l (the number one, the capital i and the small L.) Also: 0, O, o, Q and D; r and n; 6, b and G; V, U, u, v and Y; A and R; 5, S and s; 2, Z and z. We try to correct spelling errors, so when using an uncommon word or manufacturer which we might mistake as a more common word or manufacturer, note it so that we do not "correct" it. Editor's annotations are in [brackets].

Advertising is accepted only for early items related to radio, communication, etc. All items must be described fairly; reproductions, reprints and not-original items must be so identified. Advertisers must agree to respond promptly to inquiries and orders, to resolve problems promptly if the buyer is not satisfied, and to comply with a buyer's refund request on unaltered returned items.

The publisher reserves the right to edit ads without notification to the advertiser and to reject ads for any reason. Names other than the advertiser will be edited out of ads. Ads with non-radio-related items will be returned or edited unless the non-radio-related items are for trade of radio-related items, or they are incidental to and appear at the end of an otherwise acceptable ad. The publisher is not responsible for errors due to illegibly written ads or for any other reason. See also Publishing Rights on page 2.

Clubs: Since club activities receive free coverage on the *Coming Radio Events* pages, the free 20 words may not be used for club activity ads. A discount on display advertising is available for clubs.

CLASSIFIED AD DETAILS

Deadline: NOON ET—10th of the month!

Classified ads must have a standard heading such as WANTED, FOR SALE, FOR TRADE, FOR SALE/TRADE, SERVICES, MESSAGE, HELP, AUCTION, MEET, etc. This heading is the only bold or all-capitalized words allowed in the ad. Capitalize only manufacturer names, model names, etc. This standard ad format makes scanning the ads easier.

Before writing your ad, please look over the ads in a recent issue of A.R.C., and try to write your ad in the same style. Full name (or company name) and address is **required** in all classified ads; we will add it if you forget.

To encourage varied content of the ads, the same classified ad may be run only once per issue and for only two consecutive months. (To run an ad longer, use a boxed classified or display ad.)

Classified Ad Rates per Month

Subscribers:

First 20 words: **FREE***

29¢ per word for extra words over 20 **plus**

10¢ per word for a shaded ad (count all words including free words).

* Subscribers may take 20 free words on only **one** ad each month.

Non-Subscribers:

47¢ per word **plus**

10¢ per word for shaded ad.

Please do not forget to send in the extra 29¢ per word when your classified ad runs over the free 20 words; your payment will be appreciated, and it will help to keep A.R.C. healthy.

BOXED CLASSIFIED AD DETAILS

Deadline: 1st of the month!

Boxed classified ads can run unchanged for three months or more. No words are free. Ads may be shaded and may include bold and all-capitalized words freely. The ad need not begin with "For Sale," etc. Minimum run is 3 months, prepaid. Discount: 10% for 6 months; 20% for 12 months.

Boxed Classified Ad Rates per Month

Unshaded ads:

40¢ per word for all words,* none free, **plus**

10¢ per word for each bold word **plus**

10¢ per word for each all-caps word.

Shaded Ads (All words are bold at no charge):

50¢ per word for all words* **plus**

10¢ per word for each all-caps word.

Non-Subscribers:

Add 20¢ per word to above costs.

*Three words can be bold-all-caps at no extra charge.

PHOTO & DRAWING DETAILS

Deadline: 1st of the month

for all ads with drawings or photos!

Drawings and photos are encouraged as the response to your ad is much larger and the reader knows better what you want or are selling. Send in your drawing or photograph, and A.R.C. will reduce it or enlarge it as needed.

Photo and Drawing Rates per Month

\$23.00 per month for each photo or drawing (If ad is canceled, this amount cannot always be refunded.)

CHANGES & CANCELLATIONS

Please check your ads carefully before sending them in. Once ads are received, it is not always possible to refund the amount sent, pull the ad or make changes.

IMPORTANT — COUNTING WORDS — IMPORTANT

The **standard headings:** WANTED, FOR SALE, etc., count as **one word** each time used in an ad. **Name, address** and (one) **telephone number**, count as **6 words**, regardless of length. Ham call letters and business name can be included in the 6 words and do not count extra. Full name (or company name) and address is **required** in all classified ads. Each additional word, abbreviation, model number or number group, extra telephone numbers, fax, e-mail, etc. count as one word each. Hyphenated words count as two words.

PERIODICALS

ANTIQUE RADIO CLASSIFIED

A.R.C., P.O. Box 2, CARLISLE, MA 01741
ADDRESS SERVICE REQUESTED

FOR ADC 780
EXP=JUN01

93*6*****ALL
G-7J SUB#=27-777 [3630]
JOE W MCCLUGHAN
PO BOX 310465
NEW BRAUNFELS TX 78131

CLASSIFIED AD
DEADLINE JULY 10th
Noon Eastern Time