



VOLUME 13

DECEMBER 1996

NUMBER 12



A.R.C. — THE NATIONAL PUBLICATION FOR BUYERS AND SELLERS
OF OLD RADIOS AND RELATED ITEMS — PUBLISHED MONTHLY

ANTIQUE RADIO CLASSIFIED

Antique Radio Classified (ISSN:8750-7471) is published monthly, 12 times per year, by John V. Terrey, One River Road, P.O. Box 2, Carlisle, MA 01741. Periodicals postage paid at Carlisle, MA, and additional mailing offices. Telephone: (508) 371-0512, 8:30 AM to 6:00 PM ET weekdays; machine answers phone at other times.

Annual subscription rates within the U.S. are \$36.95 by Periodicals mail and \$53.95 by First Class mail.

Annual foreign rates. By air: Canada - \$58.00; Mexico - \$64.00; Other foreign countries - \$100.00. Surface mail: Canada - \$47.00; Other foreign countries - \$52.00. (Surface delivery to countries other than Canada may take two or more months and cannot be guaranteed.)

Two-year subscriptions are twice these rates and receive an extra month. Sample issues are available free on request.

© Copyright 1996 by John V. Terrey.

POSTMASTER: Send address changes to Antique

Radio Classified, P.O. Box 2, Carlisle, MA 01741.

Printed in U.S.A.

STAFF:

Publisher and Editor: John V. Terrey
Production Manager: Scott J. Young
Office Manager: Lisa A. Friedrichs
Advertising Manager: Cindie P. Bryan
Managing Editor: Dorothy Schecter
Radio Events Editor: Chris Friedrickson
Publishing & Editorial Staff: Ray Bintliff, Dave Crocker, Dick Desjarlais, Bobby Lyman, Jean Meldonian
Founding Publisher/Editor: Gary B. Schneider
Contributing Writers: Mike Adams, Richard L. Arnold, Ray Bintliff, Ron Boucher, Paul J. Bourbin, Norman S. Braithwaite, Dave Crocker, Alan S. Douglas, Richard C. Foster, Ired Geer, Jim Kreuzer, Ron Ramirez, Henry Rogers, Ian L. Sanders, Gary B. Schneider, Daniel Schoo, Dwane Stevens, Frank R. White, Ralph Williams

PURPOSE. Antique Radio Classified is published for people involved in the radio collecting hobby. Its purpose is to stimulate growth of the hobby through the buying, selling and trading of radios and related items, and to provide a monthly forum for the interchange of ideas and information.

CONTACTING ANTIQUE RADIO CLASSIFIED. All correspondence should be sent to:

A.R.C., P.O. Box 2, Carlisle, MA 01741.

Only UPS, Federal, etc. items to street address: One River Road.

Telephone: (508) 371-0512; Fax: (508) 371-7129

E-mail: ARCMagazine@aol.com — Web: www.antiqueradio.com

Please, no classified ads by telephone; thanks.

Your ads, renewals, letters, etc. can be handled faster and more efficiently if your name, address and SUB# are written on each.

Unfortunately, A.R.C. is not staffed to answer letters with questions about antique radios or requests for advice. However, A.R.C. does solicit letters of interest to its readers and publishes them as space permits. A.R.C. assumes that permission is given to edit and to publish all correspondence and articles received unless otherwise indicated.

GUARANTEE. You may cancel your subscription at any time and receive a pro rata refund for issues not yet mailed. If errors to ads are made by A.R.C., upon request a free correction will be run in the next available issue.

PAYMENT. Please send in full payment with your order or A.R.C. does not carry accounts; all subscriptions, ads, etc. must be prepaid (except for the 6 and 12 month display ads indicated below). Pay in U.S. funds. Checks drawn on a U.S. bank, money orders, VISA or MasterCard (\$100.00 min.) are preferred. Make check out to "A.R.C." U.S. stamps or cash are OK for small amounts. Canadian payers may send a Canadian check but specify U.S. funds. Subscriptions will be prorated to amount sent if amount is incorrect.

FAX & E-MAIL PROCEDURES/PAYMENT. Subscriptions, book orders, classified ads, display ads, etc. are welcome by fax or e-mail. Deadlines are the same as for ads received by mail. Please calculate the amount due. Payment by VISA or MasterCard is preferred if your order is over \$10. If under \$10, or if you prefer to send a check or money order, state the amount being sent and that the payment is in the mail. Do not send another copy of your ad with your payment; simply indicate that it is a fax or e-mail payment. If you want confirmation of our receipt of your fax, call immediately after sending your fax.

CHANGE OF ADDRESS. Please notify us 4 weeks in advance of a change of address. Send both your new and old addresses, and include your SUB# and effective date of your new address. Temporary address changes can be made also.

SUBMISSION OF MATERIAL. Antique Radio Classified welcomes and solicits information that pertains or relates to radio history or collecting. This may include articles, book reviews, photos, information on upcoming radio events, meetings, antique radio organizations, radio auctions, sources of old radio and restoration supplies, and other related and interesting material. All material submitted should be carefully researched, typed and accompanied by good photos, if appropriate. Computer disks are appreciated. Writing guidelines are available upon request. Unless prior arrangements are made, all submitted materials may be edited, become the property of Antique Radio Classified and will not be returned. Publication is subject to approval by A.R.C. and to time and space constraints.

MAILING OF ISSUES. U.S. subscribers can receive A.R.C. by First Class or Periodicals mail (Periodicals is the way most magazines are mailed). The mailing of First Class copies is staggered with faraway copies mailed before local copies. Non-U.S. copies are mailed on the first day. Periodicals copies are mailed on the last day. Mailing dates change each month, but mailing is usually completed by the 27th of the month. First Class copies usually are received by the 5th of the month; copies by Periodicals mail, by the 10th.

ETHICS. No person involved in the production of A.R.C. is to act on any information in the magazine until the first delivery day after local copies are mailed.

DISCLAIMER. The publisher is not responsible for any buying and selling transactions incurred, or for any other use of the contents of this publication.

Antique Radio Classified subscription rates, frequency of publication, content, policies, size and ad details, and rates are subject to change at any time by A.R.C.

DISPLAY AND BUSINESS CARD ADS - DETAILS AND RATES

The deadline is the first of the month for display and business card ad artwork, payment and repeat requests.

Advertising is accepted only for early items related to radio, communication, etc. All items must be described fairly; reproductions, reprints and not-original items must be so identified. Advertisers must agree to respond promptly to inquiries and orders, to resolve problems promptly if the buyer is not satisfied, and to comply with a buyer's refund request on unaltered returned items.

Advertising must be prepaid, except as noted below; see "Payment" paragraph above for details. Late ads will be run only if space and time permit. Since artwork is reduced to 63% in the printing process, originals must be the artwork size listed below. Do not send in artwork on art board or send negatives. Ads should be typeset or typed neatly with a carbon ribbon, black ink (not pencil) on white. If used, reverse type must be limited to 25% of the ad. If you want us to prepare your ad, include the one-time cost below for A.R.C. to make up the ad.

Photos should be at an 85-line screen; otherwise, add \$14.00 per photo for screening. Do not cut or trim photos or glue photos to artwork; submit separately.

If you are confused by these requirements and terms, please

contact A.R.C. before beginning to prepare your ad. We will be happy to advise you on your ad ideas, estimate how much the ad will cost, recommend an ad size, etc.

We assume that advertisers want all ads which are submitted to run without delay; therefore, we will run the ad and bill for any additional work required for the ad to meet these specifications. A late ad will run beginning with the next month. "Tear sheets" will be sent only for 1/8-page or larger ads and only if requested when the ad is submitted.

First business card per advertiser is at lower rate.

The 3-month rates represent about an 11% discount, the 6-month rates 23%, the 12-month rates 30%. Placement requests: add 15% but call first. Clubs: write for discount policy.

| Page | ARTWORK SIZE (SEND IN THIS SIZE) | | As Printed (size in magazine) | | Cost for 1-month | Cost for 3-months | Cost for 6-months* | Cost for 12-months** | One Time to make up Ad |
|------------------------|-------------------------------------|----------------|----------------------------------|----------------|---------------------|----------------------|-----------------------|-------------------------|------------------------------|
| | H x W (inches) | H x W (inches) | H x W (inches) | H x W (inches) | | | | | |
| Full | 12 7/16 x 7 1/2 | 7 3/4 x 4 3/4 | 7 3/4 x 4 3/4 | 7 3/4 x 4 3/4 | \$249.00 | \$664.00 | \$1149.00** | \$1999.00** | \$69.00† |
| 1/2 H | 5 1/4 x 7 1/2 | 3 5/16 x 4 3/4 | 3 5/16 x 4 3/4 | 3 5/16 x 4 3/4 | 126.00 | 336.00 | 582.00 | 1013.00** | 35.00† |
| 1/2 V | 12 7/16 x 3 9/16 | 7 3/4 x 2 1/4 | 7 3/4 x 2 1/4 | 7 3/4 x 2 1/4 | 126.00 | 336.00 | 582.00 | 1013.00** | 35.00† |
| 1/4 | 5 1/4 x 3 9/16 | 3 5/16 x 2 1/4 | 3 5/16 x 2 1/4 | 3 5/16 x 2 1/4 | 64.00 | 170.00 | 295.00 | 514.00 | 18.00† |
| 1/8 | 2 5/8 x 3 9/16 | 1 5/8 x 2 1/4 | 1 5/8 x 2 1/4 | 1 5/8 x 2 1/4 | 33.00 | 88.00 | 152.00 | 265.00 | 8.50† |
| Business Card (1st) | 2 x 3 3/4 | 1 1/4 x 2 3/8 | 1 1/4 x 2 3/8 | 1 1/4 x 2 3/8 | not avail. | 45.00 | 78.00 | 136.00 | 6.50† |
| Business Card (2nd...) | 2 x 3 3/4 | 1 1/4 x 2 3/8 | 1 1/4 x 2 3/8 | 1 1/4 x 2 3/8 | not avail. | 59.00 | 102.00 | 177.00 | 6.50† |

* Full page, 6-mos.; ** 1/2 due with order; 1/2 due in 12 mos.; † 1/2 due with order; 1/2 due at 3, 6 & 9 mos.

† For 6 and 12 month ads, no ad make-up charge if no change is made to ad for entire run.



ANTIQUE RADIO CLASSIFIED



EDITOR'S COMMENTS

Preparing the December issue of A.R.C. as we did in November evokes an early holiday spirit, along with a bit of nostalgia. In this last festive month of 1996, we look back on a year of steady improvement in our magazine. We also look forward to more of the same in the New Year. Meanwhile, perhaps we can arrange for Santa to drop our renewed pledge of quality into those subscriber stockings "hung by the fire with care."

Wally Worth certainly takes up a nostalgic theme for those of us in the Boston area when he explores the rise and fall of the Samson Company. Many manufacturers produced only a few models, and we thank our readers for continuing to ferret out the histories of these obscure firms.

Although A.R.C. prides itself on being a medium for information exchange, little did we think that nearly two years after publishing an article on call letters, we would still be publishing follow-ups. Actually, Al Germond goes even further than simply discussing call letters; he gives a fine summary of the evolution of three radio networks — NBC, CBS and ABC. We also include contributions about call letters from nine other readers.

Foreign sets and collectors are represented this month by two articles. Ray Bintliff compiles a follow-up to a March 1995 *Photo Review* photo of a Russian radio. This composite is based on information submitted by five contributors about the Red Star radio, including its possible French and German ancestry.

The other foreign article is a collector profile of Dino Gianni of Milan, Italy, and his extensive collection. Robert Lozier and Vic Franzoni contributed the article and photo montage of Dino's crystal sets, receivers, amplifiers, consoles, radio/phonographs, and military sets.

This month's restoration topic is the Echophone EC-1 communications receiver manufactured by Hallicrafters in 1940. Ray Bintliff describes his success in restoring this basic 6-tube, AC/DC set.

A reminder: The danger of shock when operating AC/DC sets can never be overemphasized, and Ray mentions this fact in his article. Since the chassis on these sets is usually connected directly to one of the two AC line cord wires, A.R.C. recommends that AC/DC sets be operated only via an AC isolation transformer.

Alan Douglas continues with Part 7 of his series on vintage tube testers. This particular installment is probably best for the tube tester devotee who is comfortable tossing around terms like "KS 15750," "TV7" and "micromhos." Actually, Alan covers how to handle a host of glitches that can compromise the operation of old tube testers.

Alan also contributes a description of Radio Rex, a novelty dog and doghouse. He relates the little-known fact that this toy was manufactured by the predecessor to the National Company, once fa-

mous for communications receivers.

Ray Bintliff's *Radio Collector's Guide to Philco Bakelite Block Condensers* is reviewed by Ron Ramirez. Ron reports that this is an excellent book that was long needed for the radio restorer's workbench.

Photo Review this month features additional foreign sets — Australian and British — along with a unique, 1960s, Art Deco wall speaker that looks like a framed painting. *Radio Miscellanea* includes a letter reminding mail-order buyers not to "mess with" items received damaged or not working. There are also a few letters from happy A.R.C. readers.

Finally, we publish the answers to Dave Crocker's second "Radio Quiz," which appeared in the April 1996 issue. Sorry about the delay, but we are often limited by space. Thanks to all who sent in answers and also those who mentioned that they enjoy this feature.

Renew Now and Save. With the new year, comes another necessary increase in A.R.C.'s subscription and advertising rates. Annual U.S. subscription rates will increase \$2.00 per year, classified ad extra words increase 2¢, and display advertising rates increase about 8%. Each year, to keep A.R.C. serving the radio collecting community, we must absorb increased costs of postage, printing, supplies, rent and personnel. We always announce these rate increases in advance so that subscribers and advertisers can take advantage of current rates before the new rates take effect on January 1, 1997.

Coming Radio Events. About three dozen radio events are scheduled during December. International events of note are being held in London, England; Toronto, Canada; and Vienna, Austria. It's not too soon to be looking forward to 1997 and its offerings. "Mark Your Calendar" also lists the dates for many of the major 1997 meets. Of special mention are two events that involve A.R.C. — Radio XXVIII on February 23 in Westford, Mass. (attendance last year was over 900!), and the 2nd annual ski/radio meet at Crested Butte, Colorado, from February 26 to March 1. I hope to see many of you at these events.

Holiday Greetings. From all of us at A.R.C. — John, Scott, Lisa, Cindie, Dorothy, Chris, Ray, Dave, Dick, Bobby and Jean — a happy holiday and a prosperous new year of collecting.

John V. Terrey, Editor

ON THE COVER

The search for a holiday cover for the December issue is always a challenge. This year, our choice is a postcard from the editor's collection. The subject seems appropriate in that a child fascinated with radio in times past is our hope for the future — a new generation of radio collectors.

WITH THE COLLECTORS

The Samson Electric Company Canton, Massachusetts

BY WALLY WORTH

Once again Wally Worth shares his interest in New England companies involved in the manufacture of early wireless and radio equipment. His first article on the L.E. Knott Company of Cambridge, Massachusetts, appeared in the August 1995 A.R.C. (Editor)

The Samson Electric Company was organized in 1883, in Boston, where it made electric lighters for gas lamps until 1904. At that time the company moved to Canton, Massachusetts, and changed its name to the Electric Goods Manufacturers in order to emphasize its broadened line.

In 1916, the company reverted to the name Samson Electric Co. (better name recognition?) and made fire alarms, marine ignition systems, and "wireless receivers." The latter were, in fact, headphones.

In that same year, the company received a contract from "the largest corporation in America in the radio field" for "tiny nickeled receivers" to make these headphones. Which company was this? The Western Electric Co.? Remember the year was 1916, and RCA had not yet been formed.

The headphones consisted of brass punchings formed into a cup, drilled and stamped complete,



Figure 1. A Samson Electric Model T/C and cone loudspeaker installed in a console cabinet.

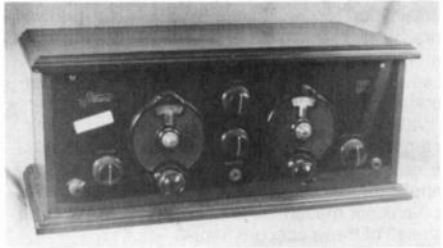

Figure 2. A Samson 4-tube Model T/C kit partially assembled in a home-brew mahogany cabinet.

and then nickel-plated. (Sound like Western Electric phones?) The two magnets and the fine wire coils were assembled, and then the caps and headbands were added. This entire assembly was made within the Samson Electric plant.

The *Canton Gazette* of April 7, 1922, recorded that, at the Samson Electric Co., "Girls were hired to do the final assembly work and were given a two-week instruction course before starting work. They were paid \$12 to \$14 a week."

In 1922, the president of the company was Clarence R. Colby, the sales manager was Orin Smith, and the plant manager was George Galbraith. In 1923, still in Canton, the company was making radio parts and 2-, 3-, and 4-tube radio kits, as well as complete radios.

SAMSON RADIOS

The Samson Electric 4-tube T/C radio, shown in Figure 1, was advertised as having an "improvement in radio circuitry" consisting of a "tuned choke" in the plate circuit, similar to the later impedance coupling. This 4-tube radio was also sold as a kit, complete with all Samson Electric parts, for enthusiasts to assemble themselves.

The company also advertised the Samson Super-Kit, a superheterodyne of eight tubes that was an excellent performing set. (See A.R.C., May 1992, pages 10-11.)

Not many of these sets are seen now, indicating their rarity, but I have a Samson 4-tube kit-set marked "C/T" on the upper right corner of the front panel, with all brand new Samson parts that were never wired up. The front view is shown in Figure 2, and the unwired parts layout is shown in Figure 3. The chassis and panel are mint too. I have decided not to wire this set up myself, but to keep it the way the original assembler left it back in 1924.

Why didn't he finish it? The original assembler did a superb job of mounting the Samson parts, probably according to a blueprint, now missing.

Did he lose interest? I can't believe that! Did he die before he could finish up? Did he go off to college? I'll never know. But to see the arrested development of this set and muse on why it was never finished is, to me, what the radio game is all about.

SAMSON COMPONENTS

Samson excelled in marketing parts for radios, doing all the manufacturing from raw materials to finished article in its own plant. For example, the Samson "Uniform Frequency Condenser" was especially well-constructed. It had a peculiarly shaped rotor to give the "straight-line frequency tuning" then so much in demand to separate the stations on the dials. An advertisement for this condenser is reproduced in Figure 4. Notice also the polished brass shield over the stator plates of these condensers. They were handsome pieces!

The company also manufactured audio frequency transformers in many styles and ratios, 10 in all, some being the fancy helical-wound coils of 2, 3, and 6 to 1 ratios. The transformers were really efficient too.

Samson variometers and variocouplers were always very small and smartly done up with bright green silk-covered wire on genuine Bakelite tubing. They were individually boxed in orange and black cartons.

I've learned a lot about the Samson Electric Co. in a town only 10 miles away from my home. I felt I should research this company, and share what I learned, little as it is.

References:

- Citizens Radio Call Book*, 1926, pp.115-117.
- "The History of the Samson Electric Co." Canton, Mass.: *The Canton Gazette*, April 7, 1922.
- McMahon, Morgan. *Vintage Radio*. Rolling Hills Estates, Calif.: Vintage Radio, 1981.
- Radio Broadcast*, December 1925.

(Wally Worth, 2 West Elm Ave., Wollaston, MA 02170)

At age fifteen, Walter Worth began to save his paper route money to buy parts for 1-tube radios. Fifty years later, he started to collect anything that needed cabinet work. His diverse collecting tastes include crystal sets, 1920 battery

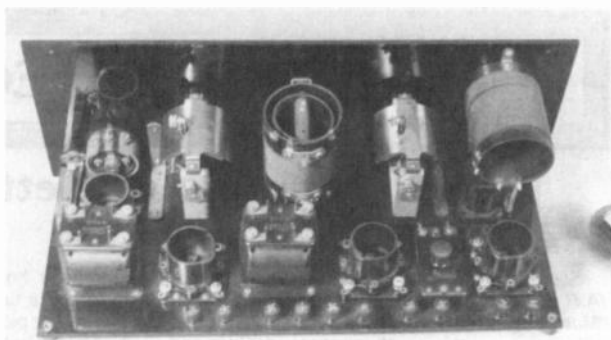
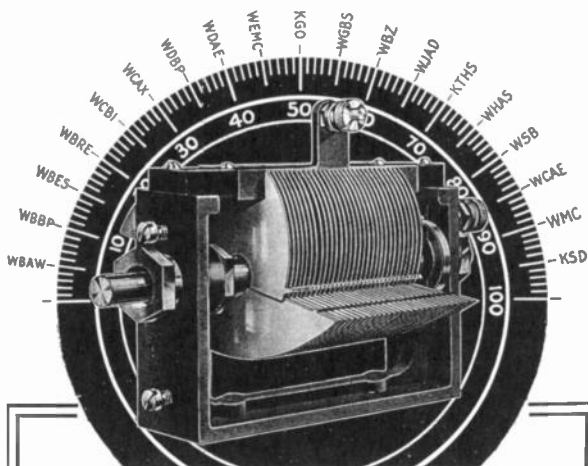

Figure 3. An interior view of the Samson kit. Note that all components are mounted but unwired.



Smallest Uniform Frequency Condenser Easily Fits Into Present Sets

FULL size illustration above shows Samson Condensers are but $2\frac{3}{8}$ " diameter with plates fully extended—half to a third the size of others.

You can easily increase the selectivity of your present receiving set having ordinary condensers, and do away with the crowding of station readings—where 85 out of 100 come in below 50 on dial—by using

Samson Uniform Frequency Condensers

Samson Uniform Frequency Condensers are built to a tolerance of 1/1,000 inch, silver plated all over for high surface conductivity, and—in addition—have gold plated rotor and stator plates to prevent oxidation.

These grounded rotor type instruments have losses lower than the average laboratory standards. This condenser, due to its design does not have the defects caused by either solid metal or dielectric end plates. 500 mmf., \$7.00; 350 mmf., \$6.75; 250 mmf., \$6.50.

SAMSON ELECTRIC COMPANY

Manufacturers Since 1882

Canton, Mass.

Sales Representatives in Thirty Leading American Cities



Figure 4. An advertisement for Samson Uniform Frequency Condensers.

sets, transistor sets, multiband sets, and novelty sets, as well as early tubes and horn and cone speakers.

WITH THE COLLECTORS

More on Call Letters

BY AL GERMOND

Scott Killgore's article "Call Letter Meanings" (A.R.C. February 1995, page 7) and the article "More on Call Letters" (A.R.C. April 1996, page 17) have generated much response. Al Germond responded in detail, but we have also compiled some additions by others into the following article. (Editor)

The "B-C-N" in WBCN (104.1, Boston) more than likely stands for "Boston" Concert Network, rather than "Broadcast" Concert Network, (as suggested in A.R.C., April 1996, p. 17). WBCN was originally part of a network of four FM stations owned by Concert Network, Inc., 171 Newbury St., Boston, controlled by the late T. Mitchell Hastings, Jr., pioneer manufacturer of FM-only automobile receivers. By 1959, the four Concert Network stations — WBCN, WXCN (101.5, Providence), WHCN (105.9, Hartford) and WNCN (104.3, New York) — were linked in a unique off-the-air classical music network.

The "B," "H," and "N" in the calls definitely connect with the respective cities of license. While WPCN would have been available for the Providence affiliate, I speculate it was avoided to prevent confusion with WPFM (95.5), another Providence station. Hastings was also an applicant for a Trenton, N. J., frequency but dropped out of that proceeding.

Programming originated in Boston and was picked up in Providence via off-air relay. Hartford then rebroadcast the WXCN signal while WNCN received the WHCN signal from antennae on the roof of the Hotel Pierre, where the 104.3 MHz transmitter was located.

The New York relay ended in July 1962, when WHBI, Newark, began occupying 105.9, effectively blocking co-channel reception from Hartford. The respective stations were eventually sold, and the current occupant of 104.3 in New York was sold for \$90 million.

Hastings manufactured a high quality FM tuner designed for automobiles starting in 1954, and later marketed a 1-tube portable earphone FM receiver employing slope-detection known as the Hastings FM Junior. It was panned by *Consumer Reports* for lack of sensitivity and low audio quality.

WABC – WCBS – WNBC

The call letters WABC have an interesting history with relevant connections to receiver manufacturing and two radio networks. The earliest use of the WABC moniker was with short-lived, low-power stations in Anderson, Indiana, and Asheville, North Carolina. The latter station, with 20 watts, was licensed to the Asheville Battery

Company, hence the A-B-C connection.

WABC's first metropolitan use was with A.H. Grebe, the pioneer receiver manufacturer. In early 1924, Grebe appeared before Arthur Batcheller, New York's chief radio inspector. Seeking a time-division agreement with WGBS, owned by the Gimbel Bros. Department Store, for the use of 316 meters (950 kHz) in the New York area, Grebe succeeded and secured his own initials in the station's call — WAHG.

The station signed on September 22, 1924, during the first Radio World's Fair in the old Madison Square Garden. Power was 500 watts with the transmitter and antenna atop the Grebe plant in Richmond Hill, Queens. Grebe was an early duopoly operator with another fixed station, WBOQ, and two portable facilities — WRMU on the Grebe yacht and WGMU, an early form of automobile boom box.

Late in 1926, Grebe's stations were reorganized in a new corporation — the Atlantic Broadcasting Corp. The officers of the company included Grebe as president, Douglas Rigney, general manager of the Grebe company as vice president, and Leone Faurote, vice president and general manager. The studios and offices moved to Steinway Hall, 113 West 57th Street, and with those changes, WAHG became WABC, effective 7 P.M. December 17, 1926, with an inaugural concert. The transmitter remained at the Grebe factory.

By late 1928, WABC was using a new 5-kilowatt transmitter on Cross Bay Boulevard, Queens, consisting of two 165-foot towers holding a center-fed Marconi antenna. Earlier, the Federal Radio Commission (FRC) had moved WABC to 970 kHz, but its status as a clear channel station was still unclear. The Davis Amendment to the 1927 Dill-White Communications Act forced the FRC to make many changes in its original allocations scheme. Effective November 11, 1928, WABC moved to 860 kHz and became a clear channel station.

At this time, Grebe sold WABC to United Independent Broadcasters, Inc., headed by William S. Paley. In early 1929, WABC became the Columbia Broadcasting System, Inc. Begun as an adjunct to the Columbia Phonograph Co., in 1927, WOR Newark was the network's first New York area affiliate. Paley had tried to buy WOR from its Newark department store owner, Bambergers, but was spurned, and he turned to Grebe.

For much of 1929, because of contracts, Columbia had two New York area affiliates, WOR and WABC, who carried programs on alternate evenings. The rechristened CBS opened its 47-station, coast-to-coast network in January 1929,

and built studios at 485 Madison Avenue, which it used until 1964.

CBS had no reason to be embarrassed by its flagship station call letters. WCBS was used by a 100-watt Springfield, Illinois, station denoting Capital Broadcasting Station. Meanwhile, WABC upgraded its clear channel facility to 50 kilowatts with a move to Wayne, New Jersey. This station pioneered the use of the vertical radiator antenna similar to WLW's mast at Mason, Ohio. Although there are references to the organization of an American Broadcasting Company during 1928-29, no such entity appeared to challenge CBS on a national basis until the mid-1940s.

It is well known that the National Broadcasting Company owned the Red And Blue Networks and two New York key stations, WEAf and WJZ. In 1941, the Federal Communications Commission investigated radio networks for possible monopolistic practices and ordered NBC to sell one network and key station. After losing before the Supreme Court in 1943, NBC sold the Blue Network and WJZ to Edward J. Noble, the Lifesaver candy magnate who renamed it the American Broadcasting Company (ABC). Now there was some embarrassing confusion in the New York area.

In August 1946, CBS received FCC permission to adopt the WCBS calls for its New York AM- and FM-owned stations. However, Springfield, Illinois, broadcasters recall a high-powered CBS delegation visiting the Illinois capital and offering favors to

the small station calling itself WCBS. The Springfield station adopted the phonetically similar WCVS calls, and WCBS was first used in New York on November 2, 1946, the same day, ironically, that NBC replaced WEAf with WNBC.

Curiously ABC stuck with its own pioneer calls from the Westinghouse days — WJZ — for another six years. In early 1953, the American Broadcasting Co. merged with Paramount Theatres, and on March 1, 1953, WABC was adopted by the network's New York flagships. WJZ moved to Baltimore where it was adopted by Westinghouse's TV station there. Now ABC is part of Disney, but there is no reason to expect a change at WABC, New York.

References:

Department of Commerce Radio Service Bulletin.

The New York Times. Dec. 5, 17, 18, 1926; Nov. 11, 1928; Feb. 3, 1929; Jan. 9, 1929; Aug. 31, 1946; Nov. 2, 1946; Feb. 25, 1953; Mar. 1, 1953.

Talking Machine World, October 15, 1924.

(Al Germond, 503 Old 63 North, Columbia, MO 65201)

Al Germond, collector of receivers for the past 30 years, holds a Ph.D from the University of Missouri. He owns radio stations in Columbia, Missouri, and Fort Smith, Arkansas.

Even More on Call Letters

The subject of call letters appears to be inexhaustible. The following readers have contributed more information to our archives, and we'll wager that more will come. (Editor)

From Phil Whitney:

I read the article about early station call letters and wonder if perhaps the mention of WOC might be slightly in error as I talked some time ago with a chiropractor who had mentioned that the station, owned by the inventor of chiropractic, had obtained those call letters as identification of the phrase "World Of Chiropractic."

I was also reminded that in 1933, Thomas Stevenson published a radio log of stations then receivable on the broadcast band in the U. S. There were 942 listed stations on the air at the time, but it included stations in Canada, Mexico, and Cuba as well. The two cities with the most stations on the air then were New York and Chicago, with a total of 20 each.

Some of the stations listed were the following: KID in Idaho Falls, Id.; KIT in Yakima, Wash.; KNOW in Austin, Tex.; WHO in Des Moines, Ia.; WOW in Omaha, Neb.; WILL in Urbana, Ill.; WERE in Erie, Pa.; WELL in Battle Creek, Mich.; WHAT in Philadelphia, Pa. By that time the Detroit police station, KOP was off the air. WOW was owned by Woodmen of the World, WMIE represented the Moody Bible Institute, WEVD was owned by the Eugene V. Debs Memorial, WREN broadcast for

the Jenny Wren Co., and WCFL was the voice of the Chicago Federation of Labor. Today, WAGE is in Leesburg, Va., and making money.

(Phil Whitney, 214 Carters Ln., Stephens City, VA 22655)

From Chet Gehman:

In those early days when the high-frequency end of the AM Broadcast band ended at 1500 Kc, police radio stations were assigned the next 100 or so Khz. Some radio manufacturers took a few turns off the RF and/or oscillator coils to cover that service, and many receivers had the word "POLICE" printed at the high end of the dial. Later (I believe it was during the late 1930s), police radio was assigned still higher frequencies, and the vacated channels were designated "experimental."

Mechanical scanned TV stations did their thing in the 1.5/1.6 Mhz band, and at least one high frequency station — WZXR — became available in the New York City area. Eventually, the AM BC band was extended to 1.6 MHz and WZXR became WQXR, broadcasting high quality music on 1560 kHz. Today that spot is occupied by WQEW, offering "civilized" old favorite music. Here in northwest Connecticut, I receive a reasonably strong signal from WQEW using a loop antenna, but unfortunately, fading is severe, especially at night.

(Chester Gehman, 150 Burwell Rd., Winsted, CT 06098)

(Continued on following page)

(Call Letters, continued)

From David Carson:

First, the call letters WSUI, a station for which I worked for eight years during high school and college, had nothing to do with hog calling. The licensee is the University of Iowa, which was known as the State University of Iowa — SUI — when the call was first acquired. The call WSUI replaced WHAA, which had earlier been assigned by the Department of Commerce.

Second, WABC was the CBS flagship station in New York; there was no connection between this call or station and NBC. Predecessor of the present WABC was NBC's Blue Network flagship, WJZ. The NBC Red Network flagship was WEOF, a call inherited when the station was purchased from American Telephone & Telegraph in 1926. NBC continued to use the call WEOF (Water, Earth, Air, Fire) for a number of years.

(David Carson, HCO1, Box 19A, Long Lake, NY 12847-9704)

From Larry Jordan:

The assertion that WSUI derived its call letters from the familiar hog call is amusing, but I'm not sure its accurate. Since it's a university station, it actually stood for State University of Iowa. If you have any evidence to the contrary, I'd be very interested in knowing of it.

(Larry Jordan, 205 North First St., Panora, IA 50216)

From Clifford Stout:

How happy I was when, as a boy in the mid-1920s, my family moved to Grand Rapids, Michigan, home of radio stations WASH and WOOD. WASH announced the "home of Baxter Laundry Co.," while WOOD announced, "WOOD, Owned & Operated by Walter B. Stiles Lumber Co." The station operated on 1270 Kc at that time, and also shared the time! It is now WOOD 1300 Kc — still popular and active.

(Clifford Stout, 2241 E. Broadway Ave., Muskegon, MI 49444-2505)

From Alton DuBois, Jr.:

In the early 1930s, a radio station opened in White Plains, New York. The station call letters were, and still are, WFAS. It was rumored that the station was set up by manager Frank A Seitz' mother. The station was located in the penthouse atop the Hotel Roger Smith, no longer operating under that name. I know this because when I was a kid in high school, I interviewed Mr. Seitz at his studio for our high school newspaper, as I was the science reporter.

The transmitter was in the next room from his office behind a glass enclosure. It was strictly a utilitarian design, consisting of two vertical pillars between which were heavy phenolic shelves, where tubes and coils were mounted. The top of this assembly was a huge output coil. Below the tubes on the floor were the power supply and the audio modulation equipment.

After World War II, the station was moved to an outlying area near town, and a new transmitter was built with a large antenna. For a long time, the old transmitter was kept as a standby.

Frank Seitz left in the 1970s to be advisor to the Communications Department of New York University for some years before he died.

(Alton DuBois, Jr., 67 Peggy Ann Rd., Queensbury, NY 12804)

From Stan Lopes:

Those who are really interested in call letter slogans, might look to the book by Tom Kneitel called *Radio Station Treasury*, CRB Research, P.O. Box 56, Commack, NY 11725, if it is still in print.

A few of the meanings or slogans starting in 1926 are as follows:

KPRC Kotten Port Rail Center, Houston, Texas
KTHS Kum To Hot Springs, Hot Springs National Park, Arkansas

KVOO The Voice Of Oklahoma
KWKC Keep Watching Kansas City
WDBO Way Down in Orlando
WDOD Wonderful Dynamo Of Dixie
WTIC The Insurance City, Hartford, Conn.
WLBL Wisconsin Land of Beautiful Lakes, Madison, Wisc.

There are hundreds more, plus a chronological coverage of all radio station licenses for those interested, along with historical information from day one including trivia like the inventor Mahlon Loomis of Washington, D.C., who built an antenna in the Blue Ridge Mountains of Virginia for transmission of communications without wires — before Guglielmo Marconi was even born! His patent #129,971 by the U.S. Patent Office is probably the actual invention of radio.

(Stan Lopes, 1201-77 Monument Blvd., Concord, CA 94520)

From Joe Papovich:

While I was in Fairbanks, Alaska, I heard KFAR Fairbanks, Alaska. (Key for Alaska's Riches). Here in the Delaware Valley we have — WIP (Watch Its Progress), and WWDR (We Work Dollar Better).

(J.J. Papovich, 53 Magnolia Ave., Pitman, NJ 08071)

From Charles Mooney:

I enclose a list of some of the stations and their owners from the year 1926 — some unusual, some well known and perhaps a few unknown to many. The log — *Andrews Radio Log*, published by Wayne Andrews Co., Oklahoma City, Okla., 4th edition, 2/5/1926 — also lists wavelength in meters and kilocycles and watts of each station. I found this 15-page, 9 x 5 1/2-inch booklet in excellent condition a couple of years ago in an antique shop in Frederick, Maryland:

WREO Reo Motor Car Co., Lansing, Mich.
KNX Los Angeles Evening Express
WIP Gimbel Bros., Philadelphia, Pa.
WOO John Wanamaker, Philadelphia, Pa.
WCAP Chesapeake & Potomac Tel. Co., Washington, D.C.
WBZA Westinghouse Electric, Boston, Mass.
KFAU Boise High School, Boise, Idaho
WEAR Goodyear Tire & Rubber Co., Cleveland, Ohio
KFON Echophone Radio Shop

(Charles Mooney, N3RQY, 13018 Midsummer Ln., Bowie, MD 20715-3030)

The Russian Red Star 54

BY RAY BINTLIFF COMPILED FROM INFORMATION PROVIDED BY SABINO FINO, RICHARD FOSTER, J.C. LACROUTS, ROGER MULLARKEY, AND DANIEL SCHWARTZMAN

One thing often leads to another in the course of A.R.C.'s pursuit of radio information. You may remember a picture of a Russian radio in the March 1995 *Photo Review*. Mike Hackett, the radio's owner, was requesting more information about the set. Soon after, the responses began to come in.

THE RED STAR

The first response came from reader Dr. Dan Schwartzman who described a similar, if not identical, radio that he had received as a gift from some colleagues while on a medical exchange program in Russia. His radio is marked "Zvezda 54," which translates as "Star 54."

A Red Star 54 is shown in Figure 1, with a rear view in Figure 2. A close-up shot of the radio's tube location diagram appears as Figure 3. Schwartzman also pointed out that a similar radio, identified as a "Red Star," ca. 1954, appears on page 177 of the first edition of Scott Wood's *Evolution of the Radio, Volume 1*.

Schwartzman describes his radio as follows: "The radio is painted in a red and black, snake-skin-type, lacquer finish. The dial glass is mirrored and back-painted with yellow trim. There



Figure 1. A Red Star 54 Russian radio.

are 5 bands, with long wave, middle wave, and shortwave, plus individual bands for 25-32 meters, and 41-50 meters. In minute letters are written the names of 24 cities of the Soviet Union from Alma Ata to Voronezh, all in Cyrillic, of course.

"There are 7 tubes, including tuning eye, with most in octal configuration. The tubes are all Soviet types, with no direct equivalent in U.S. or European types. One Soviet tube is marked "6A7," but it is not the same as our Type 6A7.

"Luckily, my set played after some capacitors were changed; however, the reception is a little bit insensitive, although the volume is adequate."

Schwartzman goes on to say that, although dirty, his set was intact when he received it, and the Masonite back shows instructions printed in Russian. The set was already wired for either 220 or 110 volts, with an adaptor plug in place on the back.

He scraped some Russian children's dinosaur stickers off the side and cleaned the finish with automobile polish. The results were fairly good. When the set is turned on, a lamp glows behind the big red plastic star, which is on the top front of the set.

(Continued on following page)

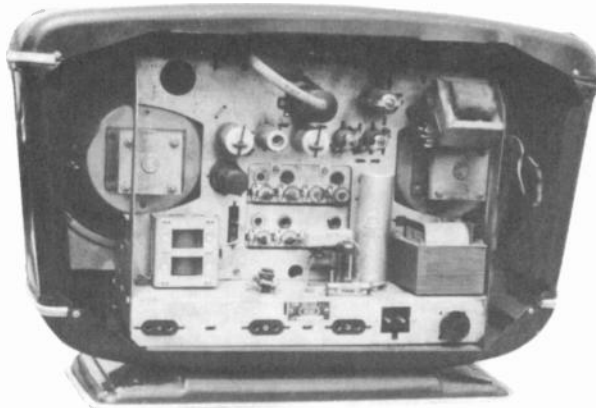

Figure 2. Rear View of a Red Star 54 radio.



Figure 3. A diagram of the location of the Red Star 54's tubes.

(Red Star, continued)

Since returning from Russia, Schwartzman has received a little more information about his Zvezda 54. Apparently, it is extremely rare in Russia, as it was very expensive — the cost was about one month's salary for the average worker. Only those with the economic status of Communist Party supervisors could afford to own one.

While in Elektrostal, he received a more conventional combination phonograph and multiband radio as a gift also, and this is in working condition. In people's apartments, he saw several other older radios, and they closely resembled "knock-offs" of typical German table radios of the late 1940s and 1950s.

He would appreciate hearing from anyone with access to older Soviet vacuum tubes.

EUROPEAN INPUT

Next, Sabino Fina of Avellino, Italy, also identified the radio as a Red Star 54. He provided a schematic diagram of the radio and a cross-reference of Russian and American tube types.

From his information, we concluded that the the Red Star 54 is a 5-band, 7-tube radio with two speakers. The American equivalents of the Russian tube complement are a 6SA7 mixer-oscillator, a 6SG7 IF amplifier, a 6AL5 detector, a 6AK5 AF amplifier, a 6AQ5 audio output, a 6E5 tuning eye, and a 6X4 rectifier. The radio operates on either 110 or 220 VAC and uses

an IF frequency of 465 kHz.

The schematic diagram calls for a 6BA6 American equivalent as the IF amplifier, while the tube location chart for Schwartzman's radio indicates that a 6AK5 equivalent is used in that function.

FRENCH ANCESTRY

From Richard Foster and Roger Mullarkey, we learned that the Red Star radios were very similar to some French radios. Then, Foster tapped some of his European sources and provided a wealth of information about these French radios.

THE SNR EXCELSIOR MODELS

The Société Nouvelle de Radiophone (SNR) Excelsior Models 52 and 55 were made in France in the early 1950s. These luxurious-looking radios, shown in Figure 4 and 5, came in metal cases and were available in six different colors, including a 2-tone green with a lizard-skin pattern.

The magazine *Toute la Radio* for May 1951 carried an advertisement for the Model 52. The pictured radio's exterior appears to be identical to the Red Star radios. However, the chassis and tube complements are quite different.

The Model 52 is a 5-tube, 5-band radio that tunes the long-wave, medium-wave, and short-wave bands, as well as the 25-26-meter and 46.5-51-meter bands. An export version of the Model 52 covered the medium-wave band and four shortwave bands.

The Model 52 used the "rimlock" series of tubes, which resemble American miniatures with an added metal base. This metal base snaps into the socket shell. The rimlock tube types are an ECH42 mixer/oscillator, an EF41 IF, an EBC41 detector, an EL41 audio output and a GZ40 rectifier. In the same order, the American equivalents are the following: Types 6CU7, 6CJ5, 6CV7, and 6CK5. There does not seem to be an American equivalent of the GZ40.

Evidently, schematic diagrams for the SNR radios were never published.

WHICH CAME FIRST?

From the dates cited for the Red Star and the

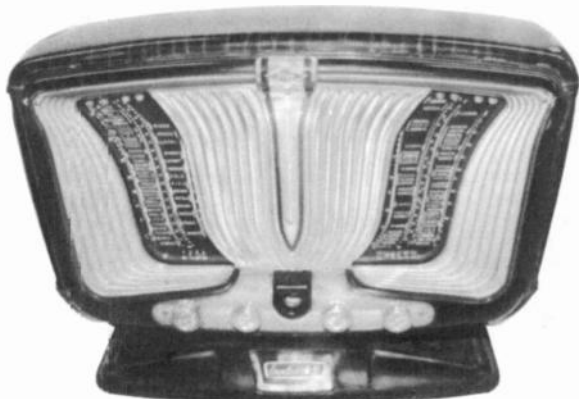

Figure 4. SNR Excelsior Models 52.

SNR radio, it appears that the French radios were the first to be produced and that the Red Star was a Russian copy, possibly issued under a licensing arrangement. Since the Russians copied automobiles and other products (even locomotives), it is quite likely that they drew heavily from the design of the French radios. It is also likely that they substituted Soviet tube types for the French tubes but retained the French radio's cabinet design.

References:

CQ Electronica (Italy), October 1994.

Toute la Radio, May 1951.

Photos courtesy of J.C. Lacrouts and John V. Terrey.

(Ray Bintliff, 2 Powder Horn Lane, Acton, MA 01720; Sabino Fina, Via Cesinali, 80, 83042 Atripalda Av, Avellino, Italy; Richard Foster, 12 Shawmut Ave., Cochituate, MA 01778; J.C. Lacrouts,



Figure 5. SNR Excelsior Models 55.

33720 Podensac, Chateau Camperos, Barsac, France; Roger Mullarkey, 5 Maher Ave., Greenwich, CT 06830; Dr. Daniel Schwartzman, 2334 Old Bethlehem Pike, Quakertown, PA 18951)

Radio Broadcast Quiz Answers — Part 2

REPORTED BY DAVE CROCKER

Radio Quiz Part 2 (A.R.C., April 1996) seems to have caused as much consternation as Part 1, which appeared in the July 1995 issue. However, several intrepid sleuths persisted and got over 30 of the 42 answers. Top scorer was Harry Blesy who calls himself "a nostalgia freak," and suggested that the quiz should perhaps be called a "Radio-TV Quiz."

The top scorer of Part 1 was Tony Verdi, who also did well on this one, as did Gus Stellwag and Bill and Wayne Miedema. Gus once again tried to resist getting involved, but "after almost driving off the New York State Thruway dreaming about old radio shows," he succumbed to the challenge and sent in his answers. He also retaliated with a quiz of his own, which we will publish at a later date. Dave Crocker beware!

Remember that Part 2 also included #36 and #37, which had been omitted from Part 1.

- 36. House Jameson
- 37. Homer Brown
- 41. Nels, Katrin, and Dagmar Hanson
- 42. Mary Hartline
- 43. Wheaties, Breakfast of Champions
- 44. The All-American Boy
- 45. Beulah Witch
- 46. Burr Tillstrom
- 47. Fran Allison
- 48. Danger
- 49. Slightly Read Book Store Shop
- 50. Chichi (Carol Conrad)
- 51. Ralston "Straight Shooters"
- 52. Spin Evans and Marty Marham
- 53. Champion, the Wonder Horse
- 54. Topper
- 55. Nellybelle

- 56. Bullet
- 57. Songbird
- 58. Radio: 'Smilin' Ed McConnell; TV: Andy Devine
- 59. He appeared in a cloud of smoke and said, "Hiya, kids, Hiya, kids, Ha-Ha-Ha!"
- 60. Midnight the Cat played a fiddle while exclaiming, "Nice!"
- 61. Lucky Pup
- 62. Ipana Toothpaste
- 63. Phineas T. Bluster
- 64. Don José Bluster
- 65. Princess Summerfall Winterspring
- 66. Eve Arden

ON THE AIR



- 67. Mr. (Philip) Boynton
- 68. Osgood Conklin
- 69. Tom Corbett
- 70. George Fenneman
- 71. You Bet Your Life
- 72. Table Talk Pies
- 73. Cora Dithers
- 74. Krypton
- 75. The Camel News Caravan
- 76. Styner St.
- 77. John Beresford Tipton
- 78. Mighty Manfred
- 79. Crabby Appleby
- 80. Thorny Thomberry



PHOTO REVIEW



This column presents in pictorial form many of the more unusual radios, speakers, tubes, advertising, and other old radio-related items from our readers' collections. The photos are meant to help increase awareness of what's available in the radio collecting hobby. Send in any size photos from your collection. Photos must be sharp in detail, contain a single item, and preferably have a light-colored background. A short, descriptive paragraph **MUST** be included with each photo. Please note that receipt of photos is not acknowledged, publishing is not guaranteed, and photos are not returned.



RCA MODEL 9X – A 1939 midget set, this radio measures approximately 5" high x 7½" wide x 4" deep. It uses a 4-tube chassis with a line cord resistor. Although this set is quite handsome in wood, its Catalin mates are more highly valued. (*Robert Bailey – Jacksonville, FL*)



FADA MODEL 845 – This beautiful marbled white Catalin with red knobs and handle was given to me by a man who had stored it in a garage attached to his chicken coop. When I received it, the color was a dirty yellow, and it looked like a parts unit until I cleaned it up with gentle liquid soap. (*Carl Kalmbacker – Newark, DE*)



ROLY-POLY ART DECO MODEL RP8 SPEAKER

This poly-planar speaker was manufactured by the ERA Acoustics Corp. of Moonachie, N. J., ca. 1960. This 8-inch round speaker, rated at 20 watts with an impedance of 4-8 ohms, has an overall depth of 1¼". The reproducer "cone" is a planar diaphragm (flat disc) made of rigid polyfoam, and it is driven by a voice-coil type of transducer. The enclosure is a 24" x 18" x 1½"-deep picture frame, deep enough to house the speaker. The baffle is covered with an oil-on-canvas painting, which makes the speaker ornate as well as functional. (*Richard Bartle – Hollister, CA*)

PHOTO REVIEW



WESTERN ELECTRIC MODEL 517W – This rather crudely made, black painted brass horn speaker has a bell diameter of $5\frac{1}{2}$ " , with an overall height of $16\frac{1}{4}$ ". Note the two small holes on both sides of the bell mouth. The decal at the top of the base identifies the horn. I'm seeking more information, which can be forwarded to A.R.C. (*Ed Bell – Raleigh, NC*)



ERICSSON CRYSTAL SET, BRITISH – Made by the L.M. Ericsson Mfg. Co., Ltd., this 1924 circular Bakelite crystal set is only 3" in diameter. Note the post office registration number at the bottom. (*Jim Taylor – Winton-Bournemouth, England*)

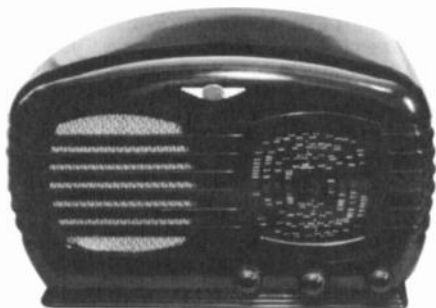

TASMA MODEL 1001 – This 1936 Australian-made Bakelite radio has an AC chassis that requires 240 volts. It uses 4 tubes —Types 6A8, EBF2, EL3, and 5Y3. The set operates on four bands. (*Keith Dennison – Victory Mills, NY*)



BUSH MODEL AC3, BRITISH – This fine example of cathedral radio design was manufactured in 1932 by Bush Radio, Ltd. A TRF set and Bush's first receiver, it measures 18 " x $13\frac{1}{2}$ " x 9 ". (*Jim Taylor – Winton-Bournemouth, England*)

RESTORATION TOPICS

The Echophone EC-1: An Easy Restoration

BY RAY BINTLIFF, K1YDG

The Echophone Commercial, Model EC-1, was first produced in 1940 by Hallicrafters and priced at \$19.95 as a low-priced alternative to the Hallicrafters line of radios. At the time, the Sky Buddy was Hallicrafters' lowest priced receiver at \$29.50. After a quick look at the EC-1, it becomes apparent how Hallicrafters achieved the low price. The radio is a no-frills AC/DC set. However, the radio's performance is better than you might expect.

ELECTRICAL RESTORATION

As found, the EC-1, shown in Figure 1, produced only a loud hum. This problem was easily solved by replacing the 2-section tubular filter capacitor. Next, the paper capacitors were tested, and all but one were found to have excessive leakage. Ironically, the good capacitor was a previous replacement, but of the wrong value, so it was also replaced.

The stick-type carbon resistors were all within tolerance except for a 20 megohm unit that had drifted up in value. More good news — all of the tubes looked good in the tube tester. Only the dial lamp needed replacement.

The radio's line cord was original but had a replacement plug, so again I opted for replacement but with a slight difference. Since the radio is an AC/DC set with one side of the AC line connected

to the chassis, I selected a replacement line cord with a polarized plug and made sure that the neutral side of the line was connected to the chassis. With a non-polarized plug (both contacts of the same size), you run a 50-50 chance of plugging in the radio with the hot side of the line connected to the chassis and thus a potential shock hazard. Mercifully, the radio's metal cabinet is insulated from the chassis, but the possibility of electrical shock from the chassis still exists.

I also made a change to the AC switch wiring. As built, the EC-1 has the AC switch wired from one side of the AC line to the chassis. The other side of the AC line connects to the string of tube filaments. I rewired the circuit by connecting the neutral AC lead to the chassis and connecting the AC switch in series with the "hot" side of the AC line and the start of the filament string.

A few ohmmeter checks of critical circuit locations and the radio was ready to be fired up.

THE SMOKE TEST

The moment of truth had arrived — the radio was switched on. Whoopee! No smoke and the radio played. However, the volume control, main tuning and bandspread tuning produced scratching sounds. A few squirts of tuner cleaner and all was well. The radio sounded great, and I made a mental note to perform an alignment later and perhaps improve its performance a bit.

COSMETICS

Fortunately, the EC-1 was in good condition cosmetically. There were no significant paint chips



Figure 1. The Echophone in restored condition.



Figure 2. A view of the EC-1, minus cabinet top and speaker, reveals the simple layout of this inexpensive set.

or scratches, and all the correct knobs were in place. Only the rear cover was missing, (another good reason to use that polarized AC line plug). But as you would expect to find in a 55-year-old radio, the interior of the radio, including the dial scale, was loaded with dust. No sweat, just pull the chassis and go to work, right? Wrong. The slide switches that control the BFO, standby and phones/speaker functions are riveted to the front of the cabinet but wired to the chassis. So it was necessary to unsolder the ten wires that connect to these switches — more of a nuisance than a major task.

The removal of dust and grime went quite well. The careful use of an air-hose sped up the process and produced excellent results. After it had been cleaned with a damp cloth, the dial scale turned out to be a nice ivory color, not a dingy beige. One note of caution about cleaning dial scales. Some dials do not stand up well during cleaning, and it is a real stomach-churner to see the dial markings disappear along with the dirt. So, try plain water or mild soap and water before getting out the heavy duty stuff or alcohol. Also, first test your cleaning material on some inconspicuous part of the dial. To Hallcrafters' credit, the dial markings on the EC-1 are very durable and consist of black enamel silk-screening on an ivory-colored painted metal plate.

Likewise, the front panel markings are silk-screened white enamel on a dark gray panel. Even after a detergent and water bath, the markings still looked yellow and grimy. So, with great care, I tried Fantastik household cleaner. It worked and the panel markings proved to be "bullet-proof."

One not-so-great feature of the EC-1 is its top-mounted speaker. After the removal of the speaker and speaker grille, a thick layer of dust on the speaker cone proved the folly of such a design.

ABOUT THE EC-1

As stated above, the EC-1 is an AC/DC set of simple design. It uses 6 tubes: a 12K8 mixer/oscillator, a 12SK7 IF amplifier, a 12SQ7 detector/AVC/1st AF amplifier, a 35L6GT audio output, a 12J5 BFO and a 35Z5GT rectifier. It tunes from 0.55 to 30 megacycles in three bands. It features electrical bandspread tuning with a bandspread scale of 0 to 100. In addition to a volume control/power on-off switch, its operating controls consist of a standby switch, a phones/speaker switch and a BFO on-off switch that also disables AVC in the BFO-ON position. These inexpensive slide switches are not as convenient as toggle switches, but they help to keep the price down. The ear-phone tip jacks are located on the rear of the chassis and oddly enough they are labeled "PHONO." Antenna and ground connections are also located on the rear of the chassis.

In most higher-priced short-wave receivers, the BFO frequency is adjustable by a front panel control. As a cost-saving measure, Hallicrafters chose to make this a rear panel screw-driver adjustment.

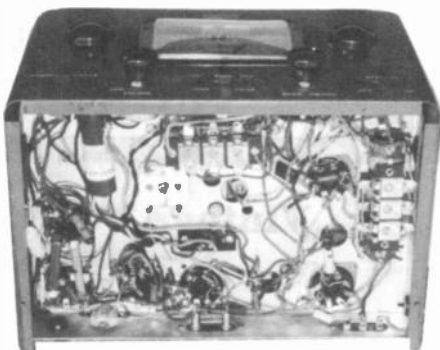

Figure 3. This under-chassis view accents the simplicity of the EC-1. Its uncluttered parts placement makes it a good candidate for the novice restorer.

A rear view of the EC-1 with the top cover and speaker removed appears in Figure 2. An under-chassis view is shown in Figure 3, and Figure 4 provides an underside view of the top cover and speaker. These photographs illustrate the radio's simplicity.

REFLECTIONS

Was this little low-end receiver worth the time and effort to restore? I think so. It may not be a Super Skyrider, but the EC-1 is a very interesting receiver that was designed for entry-level short-wave listeners. Who knows how many careers and lifelong interests in electronics were sparked by the EC-1 and subsequent Echophone models.

The radio's simple design and small size made the restoration task very easy. If you are looking for an uncomplicated restoration project, this kind of radio may be the one for you. An EC-1 or similar radio may have a particular appeal for collectors with an urge to restore a radio for the first time. Why not give it a try?

(Ray Bintliff, 2 Powder Horn Ln., Acton, MA 01720)

Ray Bintliff, K1YDG, holds an Amateur Extra Class license. A member of the A.R.C. staff and a retired RCA engineer, he enjoys repairing and restoring pre-1945 radios and test equipment.

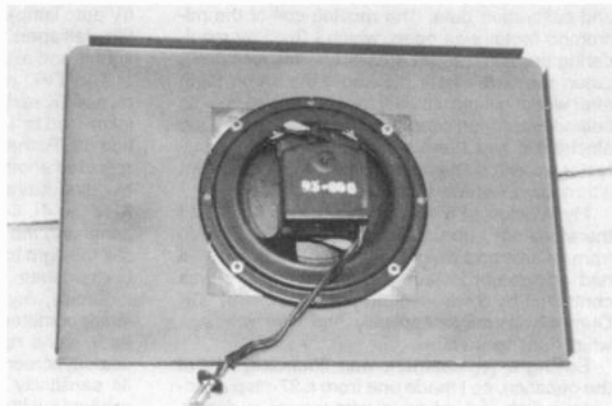

Figure 4. An underside view of the top cover and the PM speaker.



VINTAGE TEST EQUIPMENT

Vintage Tube Testers — Part 7 Problems and Repairs

BY ALAN S. DOUGLAS

This is the seventh in a series of Alan Douglas' articles on vintage tube testers. For easy reference, the previous articles appeared in the July, October and December 1995 issues, and in the March, June and September 1996 issues. (Editor)

Maybe I've just been "lucky" or perhaps owned too many tube testers, but I've seen some odd problems. Old test gear is somewhat like a pet — lots of fun to have around, but if you aren't prepared to deal with trouble you might prefer a ceramic lawn ornament.

CORROSION-RELATED PROBLEMS

My military I-177 was prone to poor contacts in the push-button switches, but that's easy to fix. You should spend some time with toothpicks, cotton and DeOxit anyway when you acquire a new instrument (just clean the contacts, don't douse the whole switch). I don't recall ever having any spats with my Hickok 6000A, which was only two years old when I bought it.

But I was being set up for a fall. I bought my Hickok KS 15750 L1 through a newspaper ad for \$20. It looked gorgeous, and has become my most used tester, but I've had numerous problems with it, all corrosion-related. Maybe the Cuyahoga River backed up into the Hickok factory that day, I don't know. (The Cuyahoga was so polluted then that it once caught fire).

Three wire-wound resistors had opened, and not all had marked values. Fortunately, someone at the factory responded to my request for service and calibration data. The moving coil of the micromho meter was open, which I fixed by resoldering one end (under a binocular microscope!). Later, the bias meter did about the same thing after working intermittently for several years — its balance staff corroded through and fell off. One electrolytic had been installed backward. If this tester weren't so heavy, I'd probably have thrown it through a window long ago.

My Weston 686 10A analyzer was a gift and therefore not subject to dental checkup. Aside from its size and weight — as befits a horse — it had one major defect. Its screen voltage was controlled by a wire-wound pot, a 200-watt 20K Ohmite with microscopically fine wire windings which had opened up.

Buying a replacement was financially out of the question, so I made one from a 37-step attenuator switch and individual wire-wound resistors. The steps are a bit coarse, but it works fairly well,

considering. I recently saw a World War II vintage OD-4 made by Weston for sale with both plate and screen pots open, so *caveat emptor*.

My TV3B, a gift from a friend who found it for \$5 at a flea market, had a sticky meter, four open wire-wound resistors, and a bent panel. Careful inspection revealed a tiny metallic flake in the meter gap, which I removed, and the resistors were either repaired or replaced, but the tester still doesn't work.

MODIFICATIONS

At an Antique Wireless Association flea market years back, I found a Hickok 539C, bought originally by NASA in 1966, with a \$20 price tag. I went around it in ever-smaller circles — asking why do I need a fourth tube tester — but I just couldn't leave it there. So it followed me home, and if nothing else, has kept my KS 15750 honest.

Recently when I went to use the 539C, it didn't perk, and I found the line-test rheostat had opened up (it sure helps to have a big junk box). I also noticed that the NASA boys had replaced the Type 83 rectifier with a Type 5U4, and had altered the meter shunts a little; at least they left careful notes inside about what they had done. I changed the socket back to a 4-pin and plugged in a Type 83 (a 5U4 has too much voltage drop).

Then there were the two TV7s, purchased in "checked" condition, but needing further work nonetheless. The TV7B, a Hickok from 1957, had a wrong fuse lamp installed (it should be a No. 81, 6V auto lamp), and its copper-oxide line-test rectifier fell apart. I squeezed the metal holder a little tighter and slid the rectifier elements back in.

The TV7, made by Supreme in 1953, had a pair of 1K resistors in its line-test circuit that had increased to 1.5K and 1.9K, throwing the calibration off. Rather than fix that, some past tech had replaced another precision resistor with a pot and twiddled it until everything worked (for a while). Also the 4-, 5-, and 6-pin sockets, made by National and the finest that money could buy, were still too tight to accept tube pins, and I finally had to ream them out with twist drills (aargh).

Finally, my otherwise nice \$45 TV2 had its share of meter problems. The signal meter was a badly done replacement, and the (hermetically-sealed) screen voltmeter had magically increased its sensitivity by 10 percent. Spare meters are available, with a little searching, for all the military models. Increasing the external multiplier resistor

by 10 percent "fixed" the screen meter; screen voltage affects the Gm readings quite a lot, so it is worth checking.

CALIBRATION

Here are some Hickok calibration procedures not covered earlier. Once the main Gm range is calibrated, the remaining ranges can be tested by using a Type 6L6 tube as a transfer standard. Vary the bias control until the 6L6 reads 3000 micromhos, and then switch to the higher ranges and see if the reading changes. This method is recommended in the TV7 manual, but I would use it cautiously, as it is valid only for identical grid and plate voltages from one range to the next.

For the 600 Gm range, if your tester has one, the position of the hum-balancing pot across the 83 filament is critical, and this pot may also need resetting if the 83 is replaced with a pair of silicon diodes. For what it's worth, the KS 15750 calibration of the 600 Gm range calls for a 6-volt AC source and 11,530 ohms of series resistance (not 12K). With a 1-volt grid signal, this works out to 500 micromhos.

If your tester has VOM functions, you can adjust the meter to indicate properly on the DC voltage and current ranges, rather than puzzle

out the tube-tester circuitry. You could even replace a defective meter; a 20,000 ohms-per-volt VOM must (by Ohm's Law) use a 50-microamp movement. Other Hickoks may use less sensitive meters; the KS 125750, for instance, uses a 120-microamp meter.

METER REPAIR

One common problem with meters is sticky pointers. This is usually caused by a corrosion particle lodged in the magnet gap, which can be removed by a sliver of masking tape worked up and down. Obviously this takes some care, as it is especially important not to bend the hairsprings or to dislodge the balance weights, but it can be done. Masking tape will also remove the bits of steel wool that a meter magnet can seemingly attract from interstellar distances.

(Alan S. Douglas, Box 225, Pocasset, MA 02559)

Alan Douglas, an electrical engineer, has written well over 100 articles for A.R.C. and other publications. His books "Radio Manufacturers of the 1920s," Volumes 1, 2, 3, are highly regarded resources for the radio-collecting community.

Radio Rex

BY ALAN S. DOUGLAS

Not T. for Tyrannosaurus Rex, but Radio Rex. This popular toy, shown in Figure 1, appeared in 1922, though the paper label lists several patents to one H.C. Berger as far back as 1913. The doghouse pictured is wooden; later ones were lithographed tin or cardboard. Rex himself is hollow celluloid, like a ping-pong ball.

A spring-loaded paddle inside kicks Rex out of his doghouse when the battery current to an electromagnet is interrupted; this occurs when a loose contact on the side of the house is jarred by a loud sound. To operate, carefully latch the paddle, place Rex inside his house, call "Here,

Rex," and clap your hands.

The National Toy Company (later to drop the "toy" part and to be led to radio fame by Jim Millen) had a patent on a mechanical version of Rex the Wonder Dog, devised by National's president William Ready in 1918. Figure 2 shows his patent, filed March 18, 1918, and granted on September 16, 1919.

Thanks to Dr. Ed Taylor for some of this history.

(Alan S. Douglas, Box 225, Pocasset, MA 02559)



Figure 1. Radio Rex and his doghouse.

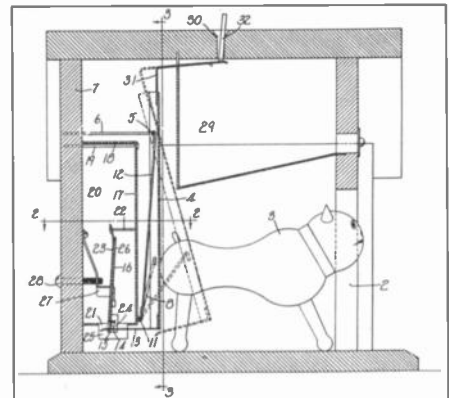

Figure 2. Rex the Wonder Dog was patented on September 16, 1919.

COLLECTOR PROFILE

The Dino Gianni Collection — Milan, Italy

BY VIC FRANZONI AND ROBERT LOZIER, JR.

Robert Lozier had the pleasure of seeing a large portion of the radio collection of Dino Gianni in 1987. Recently Robert's friend, Vic Franzoni, who lives in northern Italy, sent Robert the following collector profile on Dino Gianni. The photos accompanying this article give just a small hint of the quality and extent of Mr. Gianni's collection. (Editor)

Stimulated by memories of his youth when, to keep himself out of mischief, he built crystal sets for his friends and relatives, Dino Gianni seriously started collecting in 1957. His collection is now considered to be one of the top, if not *the* top, radio collections in Italy.

The quantity of material thus far collected is simply enormous. All of the most significant pieces have been fully restored by Gianni himself or a Mr. Calderara. The apparatus is located in two large rooms in different buildings which are kept at a constant temperature and humidity. The remaining material (sets under restoration, duplicates kept for swapping, loose components, stocks of very old valves) is kept in four storage rooms just under his residence.

In the display areas are found 123 factory-made crystal sets, 30 or more early European receivers and amplifiers with externally mounted valves, 35 sets in cathedral style cabinets, 120 various other table model sets of the 1930s, and 150 console radios and radio/phonographs. All the important makes of portable radios, transistor sets and novelty radios are well represented.

The Gianni collection may be called an "anthology" of radio. Although Gianni's main interest is in broadcast sets, he cannot neglect the military equipment because of its great role in the development of radio during the

Libyan war of 1911, World War I, and World War II when great improvements were made.

You will find military spark transmitters and crystal sets of the very early years as well as the advanced German receivers of World War II. His most treasured military item is an Enigma coding machine.

To cover the entire history of radio, one section

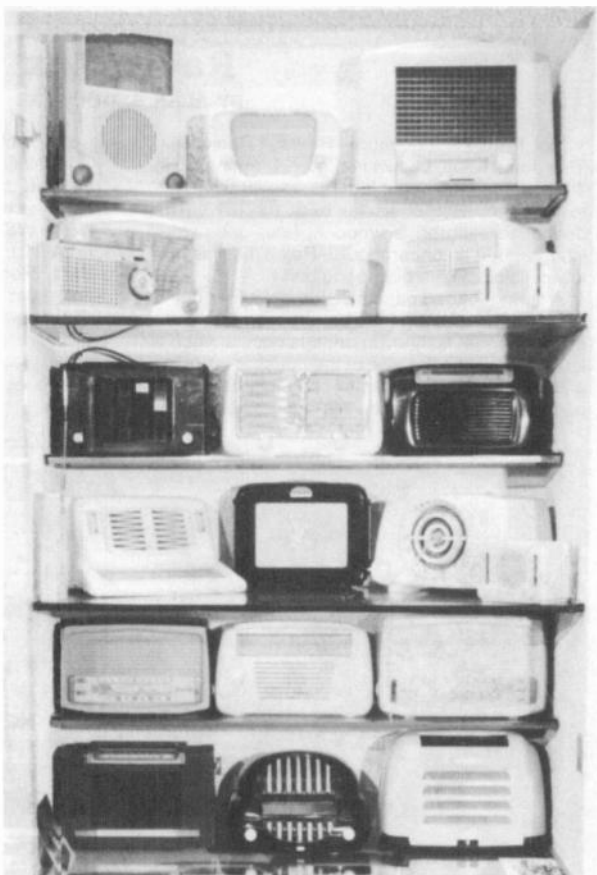

These later Bakelite and plastic radios accent the diversity of the Gianni collection.

of the museum is dedicated to the range of apparatus from which radio was born. He calls it "Radio Prehistory" where devices such as electrostatic machines, early batteries in glass jars, coherers, Leyden jars and complete equipment layouts for various telegraph stations are displayed.

His collection of apparatus is complemented by

a wide selection of early technical books, documents, magazines and advertising ephemera.

In view of the range of equipment thus far collected, it is becoming more and more difficult to find new items that will fit well in the collection. The best collectible vintage equipment is very scarce and extremely expensive, (much more so

(Continued on following page)



Dino Gianni with an array of horn speakers and early battery sets.



A mix of American and European cone speakers grace the top shelf of this display. The next two shelves contain mostly early battery sets, while the bottom shelf holds table models from the 1930s and 1940s.



Another view of Gianni's collection, with early wireless equipment in the foreground and battery sets and cone speakers on the rear shelves.



A few examples of early European receivers with externally mounted valves.

(Gianni Collection, continued)

than in the U. S.). Therefore, without losing sight of his main interests, Gianni is now looking to increase his holdings of scientific instruments that were the precursors of radio equipment as well as to find more equipment made by the various Marconi companies.

Gianni has been a radio amateur for years, and his call is I2HNX. He occasionally works 20 meters but is more often on 2 meters and 440 MHz. His passion for collecting the vintage gear leaves little time for ham radio these days.

Gianni is well known among the serious vintage radio collectors of Europe. He always travels to the great radio meets held in Riquewihl and Bar le Duc, France, and Friednshaten, Germa-

ny. He holds membership in the AWA; GFGF (Germany); AIE, CHCR, Amis de Guglielmo Marconi (France) and is an advisor and treasurer of AIRE, the Italian association for vintage radio enthusiasts. He loans his equipment for public exhibition and will be helping to mount a special exhibition of Marconi equipment this year.

Dino, a civil engineer, is the director of a building construction company. He is active in the construction of new homes and smaller commercial buildings, as well as in the restoration and reconstruction of old historical buildings.

(Robert E. Lozier, Jr., 600 E. Green St., Monroe, NC 28112)



BOOK REVIEW

The Radio Collector's Guide to Philco Bakelite Block Condensers, By Ray Bintliff

REVIEWED BY RON RAMIREZ

To anyone who has ever attempted restoration of a Philco radio made between 1930 and 1938, the uniqueness of Philco Bakelite block condensers becomes immediately evident. At times, the Bakelite blocks have either been bridged by replacements or completely removed from the set and replaced by terminal strips and new capacitors.

In *The Radio Collector's Guide to Philco Bakelite Block Condensers*, Ray Bintliff has expanded greatly on my article in A.R.C., October 1989, page 8. He has added much information and included very helpful charts.

The book opens with a brief history of Philco Bakelite blocks, first used in Philco's new June 1930 line, which included Models 30, 41, 77, 96, and 296. By 1935, Philco had begun using conventional cardboard tube condensers to some extent in its sets. This transition increased over the next few years, since by 1939, Philco sets included only one Bakelite block — the AC line filter condensers.

Ray describes the two general styles of Bakelite blocks — the standard

style, which he prefers to call the "miscellaneous" style, and the universal style. The standard condensers usually only have two or three terminals, although a few used more than three. The universal style condensers all have six terminals, along with a seventh grounding lug in some.

Ray goes on to explain Philco's part numbers for its Bakelite blocks and the significance of the suffixes used in the part numbers. For example, Part No. 3793-DG signifies a universal block with two .015 uF condensers inside, one lead of each condenser being connected to the seventh grounding lug.

Philco service bulletins and parts catalogs giving specifications for its Bakelite blocks were used in compiling the information in the book, as were

other sources such as service manuals. Ray has gone to a lot of trouble compiling this information into extremely useful chart form, listing all 343 known Bakelite blocks by part number and referencing the next section, which gives drawings of all known Bakelite blocks showing the internal wiring of each. Finally, the book has another chart cross-referencing the over 100 drawings to Philco Bakelite block part numbers.

Not all of the Philco Bakelite block part numbers have corresponding drawings in Ray's book. He explains that complete specifications for all the part numbers were unavailable, and some information could not be confirmed. However, the most widely used and most popular Bakelite blocks can be found.

Various techniques of removing the old condensers (and the occasional resistor) from the Bakelite blocks are discussed. Many modern capacitors are small enough to fit easily inside the Bakelite block once it has been gutted. For the few Bakelite blocks that have a resistor inside, resistors are just as easy to replace.

This is an excellent book that has been needed for a long time and no doubt will find a place near every radio restorer's workbench. It is well worth the \$9.95 price and should be considered a must for anyone who does work on Philco sets of the 1930s.

The Radio Collector's Guide to Philco Bakelite Block Condensers, first published in 1994, is now in its second edition. Softbound in an 8½" x 11" format and containing 56 pages, the book is available from A.R.C. and A.R.C. advertisers. Be sure to check with these suppliers for ordering and shipping information.

(Ron Ramirez, 811 Maple St, Providence, KY 42450)

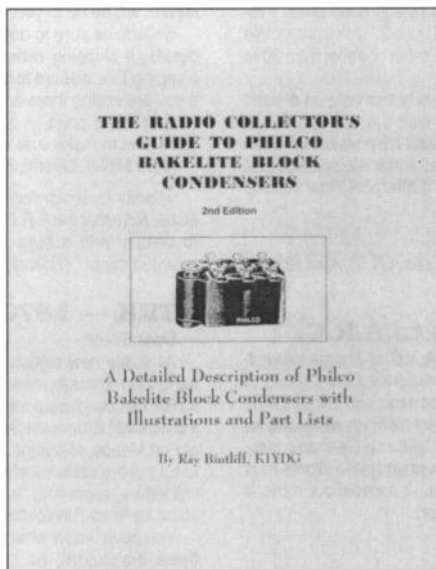

2nd Edition

THE RADIO COLLECTOR'S GUIDE TO PHILCO BAKELITE BLOCK CONDENSERS



A Detailed Description of Philco
Bakelite Block Condensers with
Illustrations and Part Lists

By Ray Bintliff, EYDG



RADIO MISCELLANEA

"Antique Radio Classified" invites its readers to contribute letters and information for inclusion in "Radio Miscellanea" and elsewhere in the magazine. "In The Marketplace" is based on information submitted by the businesses themselves. All topics should be of general interest and sent to A.R.C., P.O. Box 2, Carlisle, MA 01741. All material submitted should be verified for accuracy and may be edited for publication, which is not guaranteed. See the masthead for more details.

More on Soldering

Dear Editor:

In the August issue of A.R.C., there are several pages about soldering. However, there was nothing about litz wire. I know it's not a project for greenhorns, especially if there are several hundred strands, as on my world's largest (?) crystal set. At over 300 strands, I stopped counting, and I think I got 100 percent of the wires soldered.

Seventy years ago, I did soldering the hard way with a small iron, which I poked into the grate of Mom's wood-fired stove. I heated the iron up and was in business. Dad used a gasoline blow torch to heat his big irons.

My first electric iron was a 115-volt one, which I re-wound for 32 volts, as we had a Delco 32-volt system. We are on R.E.A. now and have a number of irons, from 30 to 300 watts.

To do a good job of soldering is not as easy as electric welding. Metal can be welded with the rust on. But to solder, the surface must be spotless. It's possible to solder steel using rosin flux, provided the surface is spotless and soldered as soon as possible. Otherwise, the surface tends to heal over.

H. Eitz, Juniata, NE

Regarding soldering litz wire, see A.R.C., April 1993, p. 23. (Editor)

The Many Routes to A.R.C.

How people find the road to A.R.C. is always interesting. We recently had a phone call from Barry Young of Hancock, Maine, who has a German radio for which he needs parts. He called the Boston German consulate for advice. They referred him to the California German consulate, who referred him to the Bavarian Radio Works near Boston, who referred him to us. A roundabout route is better than no route at all! (Editor)

A.R.C. Ads Sell!

Dear Editor:

I would like to report on the results of my recent ad in the October issue. I sold the Radiola III, the Crosley, dozens of tubes, the Chanalyst, the scope, several years of magazines, and the Majestic sign. I also received 12 letters requesting my magazine listings. I even sold items that were not listed because buyers came from as far as 150 miles away to pick up the items.

Needless to say, I am well satisfied and wish that I had "put my shoulder to the wheel" and advertised months — yes, years ago!

Edward Scribner, Schoharie, NY

Ten Years of A.R.C.

Dear Editor:

I'm thirty-two years old, and it's been ten years of A.R.C. A.R.C. has often made my day! Thanks.

Vincent Tutula, Baltimore, MD

Don't Mess With Damaged Goods!

Dear Editor:

Buyers should be warned that if purchased equipment is not received in the expected condition — don't mess with it! This is the time to let the other party know of the problem. Don't repair or claim to have fixed something before the sender knows what you plan to do.

The receiving party does not have the right (in my opinion) to repair something and expect to get reimbursed unless the sender has agreed to this action beforehand. UPS won't pay claims on something that has been fixed unless they have proof that it was broken. If you fix something before letting the sender know, then the cost of repairs will be up to you.

Sellers, be sure to document your shipping and sales details. If shipping radios, take lots of pictures. When shipping TVs, be sure to take pictures of working screens, if you are selling them as working.

One major point — always be truthful, and take that extra time to make sure everybody is satisfied.

Mark Minks, Liberal, KS

Thanks for reminding A.R.C. readers of this recurring issue. Note that the A.R.C. advertising policy states "...and to comply with a buyer's refund request on unaltered returned items." (Editor)

KTRK — 1670 on Your AM Dial

Dear Editor:

As if one new station (WJDM) in the "expanded" AM band isn't enough, now there are two! Military station KTRK has conducted test broadcasts at 1670 kHz of the Tactical AM Broadcast Service from a temporary location at Fort Meade, Maryland. These broadcasts are intended to try out the system before it is deployed to Bosnia. The call letters, apparently "borrowed" from a U.S. TV station, stand for "truck," indicating how the station will get around.

You never know what what you'll find for music during these broadcasts, as I heard almost everything from "metal" to "50s do-wop" in the span of just a few hours. Like the WJDM tests, there are no commercials.

The station is encouraging anyone who receives a signal at a distance greater than 50 miles from Washington, D.C., or Baltimore, Maryland, to send in a "DX" report stating the time, listening location, and the quality of the sound. The letters "DX" should be written on the envelope addressed to: A.B.S., Room 340, 601 N. Fairfax St., Alexandria, VA 22314.

Tom Tompkins, Shelburne, VT

A.R.C. Flies the Friendly Skies

Dear Editor:

Antique Radio Classified sure is a good way to shorten long airline flights! I took an issue with me on a business trip to Germany and the time flew. Having both A.R.C. and *Electric Radio* along was also a conversation starter.

Edward Zeranski, San Diego, CA



CLASSIFIED ADVERTISEMENTS



WANTED: Radio Vision Model 414. Call with details. Ray Morrow, 1430 Montego Dr., San Jose, CA 95120. (408) 268-5727

WANTED: Jewel, Majestic or other brand transistor marked "Super Eighty." Frank Schoen, Box 2370, Winnipeg, Manitoba, Canada R3C 4A6. (204) 888-6120

WANTED: Old brass gadgets. Scientific and medical apparatus. Antique brass microscopes. Allan Wissner, Box 102, Ardsley, NY 10502. (914) 693-4628

WANTED: Up to \$1,000 paid for certain 78 rpm records! Send \$2 + LSASE for our illustrated want-list with actual prices paid. Nauck's Vintage Records, 6323 Inway Dr., Spring, TX 77389-3643

WANTED: Juvenile books, Ocean Wireless Boys Of the Iceberg Patrol, and On the Pacific. Robert Stapleford, 1800 S.W. Randolph Ave., Topeka, KS 66604

WANTED: Nordmende Galaxy volume knob and service information. Philco 41-295 dial glass. Comical Diamond Discs. Peter Jaber, 281 McDowell, Asheville, NC 28803. (704) 277-2060

WANTED: Record industry dealer magazines: Phonograph and Talking Machine Weekly, Voice of the Victor, etc. Also radio program focused magazines from 1920s, 1930s. Radio Digest Illustrated (mostly newsprint), regional guides, newspaper radio supplements, etc. Still need some Radio Guides. Also repair manuals for pre-tape dictation machines. What have you? Steve Smolian, 1 Wormans Mill Ct., #4, Frederick, MD 21701. (301) 694-5134. Fax: (301) 694-5179

WANTED: Old telegraph keys & related equipment, catalogs, signs, etc. Gerry Maira, 31 Prospect St., Fredonia, NY 14063. (716) 672-5389

WANTED: Italian TV shaped like alligator. Will pay any price short of insanity or will give an insane trade. Send pictures and asking price. Thanks! James S. Maxwell, Jr./Virginia Caputo, Box 367, Lampeter, PA 17537. (717) 464-5572. (717) 464-5573. Fax: (717) 464-5592

WANTED: "Motor Music" radio or nameplate or any 40's vintage motorcycle radio - Top Dollar/Trade. Dinesh Gill, 936 Peace Portal Dr., Blaine, WA 98230. (604) 874-3189

WANTED: Hallicrafters speakers R-48, R-48A, R-50. Ed Kalpa, 4622 Melbourne Ave., Los Angeles, CA 90027. (213) 661-1221

WANTED: Zenith Trans-Oceanic 7G605 (Bomber or Clipper). Randy Smith, 118 S. Cedar Ave., Lancaster, OH 43130. (614) 653-8523

WANTED: Our E.H. Scott collection is at 42+ pieces and growing. Interested in Scott battery and AC sets, military, accessories, advertising, documentation and literature. Radio Daze, John & Kathy Slusser, PO Box 144, Mendon, NY 14506. (716) 624-9755

WANTED: Lists of radio stations pre-1980, including World Radio Handbook Broadcasting Yearbook, White's Radio Log (including photocopies). Ralph Marson, 8070 Busch, Centerline, MI 48015. (810) 754-3808

WANTED: Telefunken and Neuman microphones. Any model, any condition. Call anytime. Frank Czaja, 8968 W. Forest Home, #4, Greenfield, WI 53228. (414) 529-9395

.....
 ••••• A.R.C. Advertising Policy •••••
 ••••• Sellers and Buyers, Please Note! •••••
 • Advertising is accepted only for early items
 • related to radio, communication, etc. All
 • items must be described fairly; reproduc-
 • tions, reprints and not-original items must be
 • so identified. Advertisers must agree to re-
 • spond promptly to inquiries and orders, to
 • resolve problems promptly if the buyer is not
 • satisfied, and to comply with a buyer's
 • refund request on unaltered returned items.
 •••••

WANTED: Zenith porthole televisions: Mayflower or similar table models. Michael Storey, 412 10A St. NW, Calgary, Alberta, Canada T2N 1W8. (403) 283-3746

WANTED: Pathé cathedral schematic, documentation, 8-tube set (58/35/35/24/36/80 + PP47's). Altair Computer S-100 cards, have large collection, need documentation. Also looking for old ferrite core computer memory. Mike Simon, 823 Nancy Way, Westfield, NJ 07090. (908) 233-6016. Fax: (908) 233-1181. E-mail: acsny@ix.netcom.com

WANTED: Six coil shields for a McMurdo Silver Model VI. Paul Capito, 637 W. 21 St., Erie, PA 16502

WANTED: Late 50's to mid-60's radio/TV course, i.e., I.C.S. Please call, leave message. Thanks. Charlie Klein, 1421 Whiteford Rd., Street, MD 21154. (410) 836-3690

WANTED: Volume and hi-fi/Sharp selector knobs for Fairbanks-Morse Model 100 and station selector knob for Montgomery Ward Model 62-177. **FOR SALE:** Montgomery Ward 25BR1548B clock radio, works - \$30. Mark Mowrey, 510 S. 12th St., Clear Lake, IA 50428. (515) 357-3492

WANTED: 1960's walkie-talkies: Dick Tracy Dynacom 5. 3-channel Gonset G12. Marty, 173N Central Ave., Valley Stream, NY 11580. (561) 561-7558

WANTED: Electric fans brass-blade/guard, ornate castings, pinstripping, exposed coils. Cash or radio trades. Dave Friedlund, 36006 S.W. Bald Peak Rd., Hillsboro, OR 97123. (503) 628-1439. E-mail: Davef@Teleport.com

WANTED: Volume control mounted switch replacements, DM. Products #'s SP-4, SP-6 and other brands 1 and 2 pole. Fred Cranshaw, 1624 Bitter Ck., Garland, TX 75040. (972) 494-4099

FOR SALE

W7GIF's Private Collection of Museum Quality Classic American Made Receivers and Transmitters

For discriminating collectors, museums, and those who yearn for tangible reminders of an American era of unmatched innovation and quality in engineering, design, manufacturing, workmanship, and craftsmanship . . . an era worthy of our utmost pride and esteem . . . an era whose qualities seem to have been lost or abandoned. These are superbly preserved crown jewels of this extraordinary American era.

National: SW-3, SW-4, SW-5, SW-54, FBX-7A, HRO, HRO-W, HRO-JR (USCG), HRO-5, HRO-7, HRO-50, HRO-50T1, HRO-60, HRO 500/HF10, HRO-600/VFO601/VFO602, NC-2-40D/spkr, HFS, NC-33, NC-57, NC-60 Special, NC-77X, NC-88, NC-98, NC-100ASD, NC-109, NC-120, NC-125, NC-173, NC-183, NC-183D, NC-188, NC-190, NC-300, NC-303, NC-400, RAS-4, RDF-66, Select-O-Ject, NCL-2000, Collins 353A-31 plug-in mech. filter for HRO-60, RBL-6 (VLF), CRM monitor scope, VFO-62.

Hammarlund: HQ-100C, HQ-105TRC, HQ-110C, HQ-120, HQ-129-X, HQ-140-X, HQ-145, HQ-150, HQ-160, HQ-170, HQ-170C, HQ-170AC-VHF, HQ-180C, HQ-180A, HQ-180-XE, HQ-200, HQ-215/3fltrs/spkr, PRO-310/spkr, SP-400-SX, SP-600, SP-600-JX1, SP-600-JX21, HX-50, HX-500, HXL-1.

Hallicrafters: S-20R, S-38B, S-38D, S-53A, SX-42/R-42, SX-43, SX-62, SX-62A, SX-71, SX-73/R274, SX-88, SX-96, SX-99, SX-100, SX-101, SX-101A, SX-122, SX-115/HT-32B/HT33A, SR-2000/P-2000/HA-20/new spares, splatter guard (modulation monitor), SP-44 panadaptor.

Collins: 75A-1, 75A-2, 75A-4 (last run), R-388 (51J-3), R-390, R-390A, 51J-4, KWS-1, KWM-1/516E-1/516F-1, KWM-2/Waters Q-mult/516F-2, PM-2, 75S-2/32S-2, 516F-2, 75S-3/32S-3/516F-2, 312B-4, 312B-5, 51S-1/6 kHz mech. fltr/312B-3, 30L-1, DX eng. speech proc LC-1-32S, 353C-31 plug-in mech. filter for 75A-1.

Squires-Sanders: SS-1R/SS-1RS/SS-1S-1V.

E.F. Johnson: Challenger, Navigator, Ranger, Ranger II, Viking Pacemaker, Viking Invader, Viking 500, Signal Sentry, KW Matchbox, KW Matchbox/SWR, Matchbox 250-23-3/SWR, SWR meter 250-37.

Heathkit: AT-1, VF-1, AR-3, B-1, DX-35, Warrior HA-10, SB-10, SB-102, SB-600, SB-610, SB-620, SB-630, SB-650, HP-13B, HP-23.

Harvey-Wells: TBS-50D/VFO.

Technical Materiel Corp.: GPR-90/GSB-1/spkr, multicoupler, MSR-6 (rack-mount sideband adaptor).

Millen: Transmatch 92200.

Transcom: CV-157/URR SSB adaptor for R-390/A (very large).

FOR SALE

Page 2

W7GIF's Private Collection of Museum Quality Classic American Made Receivers and Transmitters

Barker & Williamson IST-1K: SSB, ISB, DSB, CW, 1.5 KW PEP/1 KW CW output, continuous coverage 2-30 MHz, completely self-contained, very conservatively rated (govt/mil service), uses 3CX1000-A7, two 4CX350A's, PI-L output with two Jennings vacuum variables, Reeves/Hoffman bandpass filters, capable of "complex-voice" and multi-channel operation, designed for "select" government service, housed in 19" rack cabinet, 6' high on heavy cast iron roller/ball bearing casters with zerk fittings. Est. weight at approx. 800 pounds. Very conservatively rated. Superb example of our very finest, highest caliber, engineering and production era (ca. 1964). For those of you who experienced this era, and even for those of you who didn't, this magnificent American product should evoke emotions and feelings of pride that you may not have experienced for some time. . . or perhaps ever. Complete with new spare 3CX1000-A7 and instruction/operation manual with schematics and description of operation. This is the only known surviving piece of this article in the universe. Pickup only. Suggest armored/escorted transport.

Equipment Condition: Cosmetic/mechanical: With very few exceptions, equipment is rated at 9+ or greater (on a scale of 10). Prospective buyers will be advised in the rare cases where the rating is below 9+.

Electrical Condition: At last operation by the seller, which may have been twenty years ago, all equipment was completely functional and without electrical faults. All equipment while in the seller's possession, for up to 20 years, has been in a dry air-conditioned environment. None of the equipment suffers from known electrical faults. However. . . twenty years of even the gentlest environment can take a toll on electrical and electronic components and materials. Recovery and preservation of the equipment's last known electrical integrity must be accomplished using gentle resurrection/restoration techniques and practices, and will be the responsibility of the buyer(s). The seller welcomes and encourages prospective buyers to perform (or have performed) visual inspections of equipment. Specific equipment that is offered and that typifies equipment condition is depicted on the cover of the world's largest antique tube supplier's 1996 catalogue (SX-88, SS-1R, KWM-1).

Best Acceptable Offers Will Secure Equipment. Packaging and shipping will (generally) be the responsibility of the purchaser. Inspection of the equipment by the purchaser or his delegate(s) is welcomed and will be arranged for mutual convenience. Availability of equipment is subject to prior sale (first acceptable offer). Commitment of offer and acceptance of offer will be conducted by fax only and will be considered as binding. Payments must be in U.S.\$, in the form of certified cashier's check or draft. The seller will not divulge to any prospective buyer the nature of any other offers received, nor will he establish any "target" prices.

Hopefully you'll find something in this collection that fulfills your wish list — Allen F. Richmond, W7GIF

Fax Communication will be available daily between the hours of 2200 to 1700 MST (0500 to 2400 UTC) @ 1-602-486-4793.

Voice Communication will be available daily between the hours of 1700 to 2200 MST (0000 to 0500 UTC) @ 1-602-486-4793.

FOR SALE: (2) General Electric Super Radio III, M.I.B. - \$60 ea. Ed Kalpa, 4622 Melbourne Ave., Los Angeles, CA 90027. (213) 661-1221

FOR SALE: The works. First and last sale. Lost storage space. Changing hobbies. 1920s-1930s radio magazines, call books, tube testers, AK 80 radio, spark coils including Murdock, unbuilt kit, loose coupler, ham books, keys, instruments, lighthouse crystal radio, quack medical, microwave, typewriter, oscilloscopes, sextant, variacs, misc., Packard-Bell GRTH-B transistor radio factory breadboard. Send SASE. Chip Schmidt, 2024 Hilton Dr., Cedar Falls, IA 50613

FOR SALE/TRADE: Kadette Cloquette Moderne or Colonial. **WANTED:** Cloquette Futura, Sheraton, or International tombstone/cathedral. Nevins Museum of Radio, Ken Nevins, 406 Jipson St., Blissfield, MI 49228. (517) 486-3019, evenings please

FOR SALE: Crystal radio kits, complete with face panel and baseboard, 365 variable capacitor, large prewound coil, and many other parts for an old style crystal radio, remit - \$19.50. Carl & Grace Ent., 5636 Romeyn, Detroit, MI 48209

FOR SALE: Marconi 1926 Type 31, 3-tube set - \$1,600. Tom Thumb BBC crystal set, G.P.O. No. 4034, rare - \$850. E.A.C. twin detector crystal set - \$750. Late 1920's G.E.C. Victor 3-tube radio - \$375. Gecophone BC2000 smoker's cab. 2-tube radio; also rarer 3-tube smoker's cab. BC 5464; Amplion AR19 oak horn in original box - \$850. Jim Taylor, G4ERU, No. 5, Luther Rd., Winton, Bourmemouth BH9 1LH, United Kingdom. Phone/fax: UK 01202-510400

FOR SALE: Dyna ST-70 amp with cage - \$275. Meissner signal shifter, exc - \$125. Stromberg-Carlson Model AU-58B amp - \$40. **WANTED:** Collins 51S1 original manual. Thanks! Tom Smith, N5AMA, 13034 Elmington Dr., Cypress, TX 77429-2062. (713) 376-3436, evenings

E. H. Scott Historical Society

The primary source
concerning the radios
and history of E. H. Scott

- Quarterly Bulletin: Scott News
- Service Manuals
- Reproduction Parts and Service
- Scott Video
- E. H. Scott the Dean by Marvin Hobbs

For more information write:
E. H. Scott Historical Society
3712 N. Broadway #4450
Chicago, Illinois 60613

**"Your One-Stop Spot
For All Things Scott"**

FOR SALE: Large instrument selection. Many unusual items. Good prices. LSASE please. Dave Betz, 449 Chandlee Rd., Rising Sun, MD 21911. (410) 658-6130

FOR SALE: Catalin repro glass dials: Addison No. 5, Sentinel 284, Fada 652, DeWald Harp, Bullet 1000 and 115. Also available any size round convex glass, old new stock for tombstones & floor models. Gregg Jewett, 1905 First St., Sandusky, OH 44870. (419) 625-2319

FOR SALE: Sams sets 34 thru 887 - \$2 ea. plus shipping. SASE for list. Leo Pedersen, 1881 Bradley Ln. LPR, Estes Park, CO 80517-6923. (970) 586-4576

FOR SALE: Crystal sets, detectors, crystal tins and other radio items. Send large SASE for list. Norm Hertz, 4904 Amboy Rd., Staten Island, NY 10312. (718) 967-1025

FOR SALE: Audio: Seeburg amp L6. KG-250 stereo amp. KG-50 tuner. Heath tape recorder, two preamps. 1943 Wurlitzer sound system Model 700 and 503 with pair 15" Wurlitzer speakers. 1935 Victor 16mm cine projector, 12" Rola suitcase speaker and amp. Bill Coolahan, 1450 Miami Dr., NE, Cedar Rapids, IA 52402-2933. (319) 393-8075

FOR SALE: Philco 70 cathedrals - \$310-\$265. Philco 620 tombstone - \$95. Transistors: sRoyal 500E - \$35. Zenith Royal 40 - \$25. Realtone TR-1660 - \$25. Vogue picture record #R707 - \$60. William Egan, 10332 S. Komensky, Oak Lawn, IL 60453. (708) 229-9676

FOR SALE/TRADE: Mint Paragon RA10/VT control. **WANTED:** DA2, Grebe CR13, Paragon, pre-1940 transmitters, Clapp-Eastham, Kennedy apparatus. Stu Mount, K20A, 35 Grand St., Highland, NY 12528. (914) 691-7957

FOR SALE: RME 70, speaker, VHF 152A - \$295. NC109, speaker - \$165. Astatic 10-C, new - \$85. Panoramic PCA-2 T-200 Panadapter, collector grade - \$225. Others, free list. Richard Prester, 131 Ridge Rd., West Milford, NJ 07480. (201) 728-2454

FOR SALE: From our service library: original mfg'r's service manuals, Webcor (phonograph, tape recorders, etc.). DuMont TV chassis RA103 and upwards Sparton TV 1952-1953. Motorola car radios, late 1950's-1960's. Your choice - \$50 ea. Plus shipping. Also Zenith Radio Service Volume I, 1928-1940; radios, pictures, schematics, voltages, parts list - \$70. Sams Photofact indexes from 1958-1978 - \$10 ea. Maurer TV, 29 South 4th St., Lebanon, PA 17042. (717) 272-2481

FOR SALE: Large instrument selection. Many unusual items. Good prices. LSASE please. Dave Betz, 449 Chandlee Rd., Rising Sun, MD 21911. (410) 658-6130

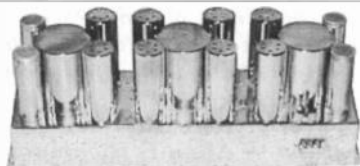

WANTED: Chrome-plated amplifier, 8 to 10 tubes with Jones plug on the side in any condition. If you have this amp or know of its possible location, please contact me. John T. Meredith, 2462 Stantonburg Rd., Suite 152, Greenville, NC 27834. (919) 551-1882

Volume Two Is Here!



ORDER TODAY!

1ST 1,000 AUTOGRAPHED

**OVER
350 PAGES
ALL NEW LISTINGS**

**2,700 RADIOS
EACH INDIVIDUALLY
PICTURED/VALUED**

**200 COLOR
PHOTOS
16 PAGES OF
COLOR PLATES**

Send Check or Money Order Payable to:

Radiomania®

2109 Carterdale Road, Baltimore, MD 21209

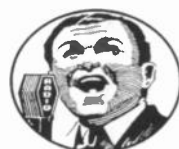

Or Charge Your Order:

**Mail Card Info to Address Above,
or Fax Info to: (410) 466-0815,
or E-Mail to: Radioman@cais.com**



**\$28.95
VOL.2 Only**

**\$49.95
Buy VOL.1&2**

(Free US Shipping)

Maryland Residents add 5% Sales Tax.
Allow 2-4 Weeks for domestic orders.
Add \$4.00 for Priority Mail (US Only)
Canada add \$2.00 shipping,
All other countries add \$3.00 for shipping.
Satisfaction guaranteed or your money back!

FOR SALE/TRADE: Western Electric cone speaker 540AW, new in box - \$500. Ed Bell, 5311 Woodsdale Rd., Raleigh, NC 27606. Fax/ph.: (919) 851-1517

FOR SALE/TRADE: The following Westinghouse RADA - \$275. Harman Kardon Citation I-II and III w/ cabinets and cage, exquisite and in beautiful working condition - \$1,750. EICO HF-50 mono-block amp - \$300. Radiola 26 for parts, Hammarlund SP-600 JX26 - \$700. Radiola III and IIIA with 199 tubes - \$185 and \$200. HRO 50T w/(4) coils - \$485. Conn. Tel. and Tel. Sodian DR-6 w/tube in beautiful mahogany chest - \$1,600. Amplion horns AR-111 - \$700. RCA microphone Mod 77-D - \$1,350. RCA PB-90 mic, resembles 44B microphone - \$1,500. Call: Larry Drago, 383 Lincoln Dr., Cheshire, CT 06410. (203) 272-6030

FOR SALE: Vintage McIntosh MC275, one in exc cond., one has some pitting on chrome, all original, no reissues, with cages - \$6,500 for both. Comes with Penta KT88, pristine C22 original, no wooden cabinet - \$3,000. Two MR71 tube tuners by McIntosh, exc cond., both for - \$1,500. No mods or tweaks added. Pair MI75 (not MC75) in exc cond. - \$2,500. With Penta KT88. C. Ong, 3806 Lake Blvd., Annandale, VA 22003. (703) 573-2288. Fax: (703) 573-5896. E-mail: ongtk88@erols.com

FOR SALE: Precision 10-15 tube tester, big workbench model - \$75. Sencore TC-130 tube tester, like new - \$35. Philco 070 - \$10. Robert Gardner, 2629 South 27th St., Fort Pierce, FL 34981. (561) 466-8857. E-mail: LocknKey@aol.com

FOR SALE: Tube-type mono audio amplifiers. Stromberg-Carlson SAU-33 Signet 33, 25 watt - \$100. Olsen Golden Classic 15 watt - \$30. Eico HF12, 12 watt - \$40. Don McGahan MG10C - \$50. Powers transformer for Philmore CP 7310 TV and RCA 630TS TV - \$25. Onerio L. Sabetto, 1717 Burgess Rd., Cleveland, OH 44112. (216) 481-1036

Catalins Wanted



Fada • Emerson • Motorola
Addison • Air King • Arvin • Detrola
Crosley • Symphony • Tom Thumb
I buy all makes and models.

Michael Lawlor
P.O. Box 179 • Santa Barbara, CA 93102
(805) 682-2336

FOR SALE: Radios, transistors, hi-fi equipment: Emerson BT245 yellow with maroon trim, Fada L56 maroon (not perfect) - \$1,650. DeWald 502, yellow with marble brown insert grille - \$675. Hopalong Cassidy, General Television wood piano 534 - \$395. Emerson CV264, like Little Miracle but red leather - \$125. 1945 Encyclopedia of Plastics by Modern Plastics, 1,178 pages - \$150. EH Scott 30-tube Philharmonic in Warrington cabinet, Pilot X131 wood table - \$290. Federal Jr., rough - \$250. Crosley 52 - \$165. Global GR900, red - \$200. Browni YTR603, royal blue - \$85. Toshiba 6TP314A, black - \$165. Trancel TP194, white, same as Toshiba 5TR193 - \$290. Trancel TR60, white - \$95. GE P830A/P831A, grey - \$45; baby blue - \$65. Channel Master 6514, black - \$25. Marantz 7C cabinet - \$175. Electro-Voice PCI preamp - \$145. Fisher MPX200 - \$175. CM 35D mono blocks and preamp - \$550. Bogen preamp PR100A - \$165. Karg tuner XT1A - \$295. Pair Heathkit W4AM - \$325. Original McIntosh manuals: MC275 - \$140; MC225 - \$100; MR66 - \$90. Marantz 7C manual - \$40. Others. All items unrestored. **WANTED:** Catalin, Bakelite radios, parts. Ross Litrenta, 1 Wilton Rd., Eastchester, NY 10709. Phone/fax: (914) 337-7176

FOR SALE: White plastic "Philco Television" sign, 27 inches long, 9 inches high, poor cond. - \$20. Radios: Sylvania tube port. Model 454, gray, (E.O.R. 2, p. 187) - \$20. Tradio T-U6 hotel radio in bronze Hammertone metal case, no back and lock cylinder - \$50. Philco 1939 remote control, poor cond. - \$30. Philco oscilloscope Model 7021, no probes - \$50. Robert Bailey, 2451-3 Whispering Woods Blvd., Jacksonville, FL 32246. (904) 642-5837, ans. mach. after 4 rings

FOR SALE: Antique tubes: Western Electric 249-B, Taylor 249-B - \$50 ea. Sylvania CHS-4C35 - \$50. National Power NL-710L - \$25. Electronics Inc. 6CF - \$25. Filaments good all tubes, plus UPS. Stephen L. Bonino, 107 Georgetown Rd., Glassboro, NJ 08028. (609) 881-0244

FOR SALE/TRADE: Vintage 1928 amp and preamp made by Samson Electric Co. Mod #s Pam-5-D and Pam 25-D with a pair of #250 tubes, asking - \$750. Larry Drago, 383 Lincoln Dr., Cheshire, CT 06410. (203) 272-6030

FOR SALE: Old calculators, SASE. (2) Mullard KT88 tubes - BO. 4X150A and 4X150G N.O.S., no boxes - \$15 ea. 6099 N.O.S. bulk - \$2 ea. Used 6146 checked good - \$5 ea. Manhattan Electric Supply 110 VDC motor - BO. Guild rolltop desk radio - BO. Trade any for early radios, tubes. **WANTED:** Chassis for Little Giant mini-cathedral; crystal detector, headphones, current squared meter for Kolster Type D decimeter, speaker for Philco 70 grandfather clock. Michael Crain, 3 Hillside Ave., Harveys Lake, PA 18618-9782. (717) 639-2794. E-mail: mcra1952@aol.com

FOR SALE: FCC Rule Book - \$5. Elements of Radio, Marcus Horton - \$10. Radio Manual by Sterling - \$10. Plus UPS. Ed Povraznik, 9606 Biddulph Rd., Brooklyn, OH 44144. (216) 661-0032

FOR SALE: Large radio and literature collection. Crosleys, Radiolas, DeForest, cathedrals, Kadette Jr.'s, crystal sets. Radio and television books, manuals, catalogs, magazines, Radio Boys. Electrostatic CRT's. List - SASE. Bill Rolf, 30131 Center Ridge, Westlake, OH 44145

WANTED: Antique and novelty tube and transistor radios. We buy complete collections or quality individual pieces. Also radio-related vacuum tubes, parts, literature, magazines, advertising, and test equipment. Call or send list. Radio Daze, John & Kathy Slusser, PO Box 144, Mendon, NY 14506. (716) 624-9755

WANTED: Daven MU-20 & MU-6 tubes. Must test good and have the original paper label around tube. Daven television tube type T-2080 with original paper label around base. Daven super amplifier. Daven AC-10 & AC-71 tube. Raytheon kino-lamp television tube. Visitron 5 & Neotron 25 television tube. ICA television amplifier. ICA neon television tube. Larry Dunn, 473 Serento Cir., Thousand Oaks, CA 91360. (805) 492-7111

WANTED: Any Super-Pro BC-794 identification plate. J.M. Roseman, 2716 West 3rd St., Coal Valley, IL 61240. (309) 799-7447

WANTED: Cassette tape for German Westrex 111 portable radio/tape player. Audio Imports Ltd., 663 Fairview, Arcadia, CA 91007. (818) 447-3117

WANTED: Philco 680X, Scott in Roslyn cabinet (empty OK), Stromberg-Carlson 160P, 240S, 634, 523, 952PF, 951N, 734, 744, No. 2, 400S, 400N, and yes, a 74. Note new area code. John England, PO Box 59136, Schaumburg, IL 60159. (847) 823-5287

WANTED: Philco 39-40 or 39-36 dial glass, cracked or photocopy OK, reasonably priced only. Rod Rowland, 4211 Woodland Ave., #202, Drexel Hill, PA 19026-3926. (610) 623-6141

WANTED: J.W. Miller 565 crystal tuner; Heathkit CR-1 crystal receiver. James H. Jacobsen, 760 Paul Ave., Palo Alto, CA 94306. (415) 493-9152

WANTED: Above average Hickock 600A or TV-10D/U tube tester. Michael E. Franzen, 3618 Effie St., Los Angeles, CA 90026-1006. (213) 661-9171

WANTED: 12v vibrator xformers. Fred Cranshaw, 1624 Bitter Ck., Garland, TX 75040. (972) 494-4917

WANTED: Hallicrafters SX-100 bandspread knob. HA-19 crystal cal., speakers R-46A & B R-48 & A. Thanks. Tony Wentkiewicz, NØDZO, 4107 County Rd. 138, Bamum, MN 55707-8713. (218) 389-6907

WANTED: Chassis for Zenith 9S365, chassis no. 5906 in restorable condition. Curt Lutz, 1112 S. 22nd St., Quincy, IL 62301. (217) 224-0405, home; (217) 221-7569, work

WANTED: Back panel for Emerson 149 brown Bakelite, set has three-panel assembly. Ken Ruggiero, 6919 Deborah Ln., Niagara Falls, NY 14304. (716) 731-5240

WANTED: Hammarlund Comet Pro, AVC model. Parts and parts sets. National SW-3, first model, 6- and 2-volt sets. Hallicrafters SX-11 dial plate or parts set. Millen 90801 Exciter. Other pre-1950 ham gear. Dean Showalter, WA6PJR, 72 Buckboard Rd., Tijeras, NM 87059. (505) 286-1370

WANTED: Drake R-4C receiver (mid-production, 6HS6 mixers). State serial no. and cond. Byron Tatum, WA5THJ, Rt. 9, Box 163, Alvin, TX 77511. (713) 331-2956

WANTED: 1937 Zenith chassis #5634 for 6S-152, 6S-157, and others. Knobs and speaker line plug would also be needed. Dan Schwartzman, 721 13th Ave., Bethlehem, PA 18018-3401. (610) 882-0859

WANTED: Philco 42-350 dial glass. Robert Byl, KD6UDA, 628 Lemon Grove Ave., Ventura, CA 93003-4839. (805) 644-3586. E-mail: 75227.2271@compuserve.com

WANTED: Highest prices paid. Record collections, 78's, LPs, 16" transcriptions. John Marinacci, Antique Edison, 301 Murray Ave., Bridgeville, PA 15017. (412) 221-6763

A. G. Tannenbaum

Electronic Service Data

PO Box 386, Ambler, PA 19002

Phone: (215) 540-8055

Fax: (215) 540-8327

THE



FOR

**Vintage Parts & Service Data
1920's - Present**

Free Catalog

Credit Cards Welcome

Browse our web page at

www.voicenet.com/~k2bn

YARD SALE!

(GRILLE CLOTH)

I'm having an end-of-year yard sale on
14 of my 35 patterns through 12/31/96.

\$25 per yard (51' x 36") for any quantity of
yards of these patterns: #13, 15, 16, 16A,
17, 19A, 20, 21, 22, 23, 24, 25, 26, 27

\$15 per yard for #6 and #11 - until sold out.

**Still available - sampler
packages of 5/10 pieces of cloth
(your choice) for \$20/38
postpaid.**

**Send 55¢ LSASE for full set
of samples to:**

MICHAEL KATZ

3987 DALEVIEW AVENUE

SEAFORD, NY 11783

(516) 781-6202 (EVENINGS/W-ENDS)

Radio Auction

Saturday, Dec. 7 - 9:30am

Archbold, Ohio

Location: Yoder & Frey building, Co. Rd. 24. From St. Rt. 2, 1 mile west of Archbold take Rd. 24 north 2 mi. to site. Auction held in heated building with food & restrooms. Note: Mr. Bernath was a radio collector and refurbisher. All radios work and are in very good condition (unless noted). We will also be selling personal property and a large train collection from his estate, as well as a collection of 150 dolls, please call for details.

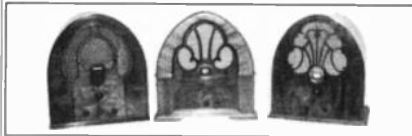

Cathedral / Tombstones

Philco Model 90 Cathedral, 9 Tube, Not Working (Hums), But Looks Excellent • Philco Model 44 Cathedral, 6 Tube, Restored, Excellent • Philco Model 20 Cathedral, 7 Tube, Restored, Excellent • RCA 57 Tombstone, Restored, Excellent.

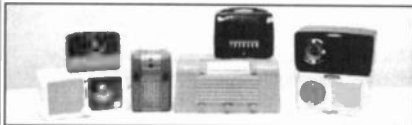

Portables & Tables

Zenith H500 Super Trans-Oceanic Portable • RCA B411 Portable, Woodgrain Plastic • Emerson 560 Portable, Dark Red Plastic • Westinghouse H125 "Little Jewel / Refrigerator" (Unique), Blue/Green. Philco 42-345 Table, Wood, VG Condition • Philco Table, Wood, Model Unknown, Restored, Excellent Cabinet • Guild Lamsmiths 484 Spice Cabinet Radio • Hoffman A300 Table, Blond Oak Wood • Gillfillan 56A Table, Wood • GE 62 Radio / Alarm, White Plastic • GE 515F Radio / Alarm, Burgundy Plastic • Stewart Warner 9162D Radio / Alarm, (Painted) • Radiola 762X11 Table, Brown Plastic • RCA 66X11 Table, Brown Plastic, Cracked Case • Zenith 5C01 Consoltone, White Plastic • Zenith R615, Brown Plastic • Zenith 6S511, Brown Plastic • Jewel 5205, Brown Plastic • Crosley F5RD, Red, Case Broken • Portable Edison Cylinder Player, Parts?

Tubes & Tube Testers

Large Quantity (400+?) of NOS tubes (Octal, 5, 7 & 9 pin) in boxes, along with an assortment of used tubes. Simpson 330 Tube Tester, Exc. • Sencore TL154 Tube Tester • (2) Mercury 1100 Tube Testers.

Visit us on the Web: <http://www.cus.com/frey>

Frey & Sons

AUCTIONEERS- REALTORS

Robert G. Frey, Auctioneer

Box 7, Archbold, Ohio 43502

Phone: (800) 886-3739 Fax: (419) 445-8888

FOR SALE: Radio Boys and other juvenile books, radio technical and fan magazines, catalogues. 17-page list and 20-page radio list. Dave Sutherland, PO Box 201, Spofford, NH 03462. (603) 363-4459

FOR SALE/TRADE: Radios, transmitters, books, parts, tubes, 1930 up. List - \$1 and SASE. Joseph Bedlovies, PO Box 139, Stratford, CT 06497

FOR SALE: Lessing, Man of High Fidelity, paperback copies, new, covers slightly rubbed - \$5 ppd. Rainy Day Books, PO Box 775, Fitzwilliam, NH 03447-0775. (603) 585-3448

FOR SALE: Books, literature on antique radio, telephone, telegraph, amateur radio. SASE for price list. James J. McGrath, W2IOJ, 2 Centerville Ln., West Seneca, NY 14224-2124. (716) 675-0160

FOR SALE: Philco Mod T65-124, plays, good clean cond. - \$45 + ship. Michael Morrell, Rt. 4, Box 5024, Williston, FL 32696

FOR SALE: Radio tubes, very reasonable, send one stamp for 1,000+ item list to: Joe Knight, 3921 Windolyn Cl. S. Bartlett, TN 38133

FOR SALE: Philco 41-250, plays, needs cosmetics - \$75. RCA 61-8, plays, good shape - \$45. Gary Nitkin, 102 Long Highway., Little Compton, RI 02837. (401) 635-2816

FOR SALE: Obsolete & foreign tube-type data (copies) for Hickok 532/533/547/600A/605 tube testers - \$12 ea., or \$19/both. Obsolete tube data for Hickok 6000/6000A/6005 - \$12. Much more, scopes, sig. gens., frequency counters, etc. List - LSASE. Kirk Ellis, KK4YP, 203 Edgebrook Dr., Pikeville, NC 27863. (919) 242-6000, evenings

FOR SALE: A quantity of used Philco black capacitor blocks with mounting screws. These can be rebuilt to your required values. Frontier Capacitor, Box 218 or 403 S. McIntosh St., Lehr, ND 58460. (701) 378-2341. Fax: (701) 378-2551

FOR SALE: Novelty radio that looks like cellular phone - \$20. Pepsi novelty radio - \$25. Norm Hertz, 4904 Amboy Rd., Staten Island, NY 10312. (718) 967-1025

FOR SALE: Black Centurion solid-state AM transistor radio, excellent working condition - \$66. J.R. Brown, #910, 620 N. Grant, Odessa, TX 79761. (915) 362-7811, or (915) 335-4583

FOR SALE: Panasonic Model RE-784A, FM-AM, does not play - \$15. Sony Model ICF-9650W, FM/AM, 7 transistor, plays - \$15. Philco Model R-512, plays - \$10. Silvertone Model 7006, cabinet excellent, power cord missing, untested - \$5. Jewel Model 9187-T clock radio, both work - \$15. All plus postage. Joe Bentrovato, 84 E. Munson Ave., Dover, NJ 07801. (201) 361-7392

FOR SALE: Tube CB's, table radios (working): list (specify) - LSASE. Fisher K10 Spaceexpander - \$100. C. Zafonte, N1FRX, RR3, Box 2075, Fort Kent, ME 04743. (207) 834-6273, eves.

FOR SALE: Reproduction lid tags for Crosley 51 Series, can provide serial # - \$5 ppd. Bob Jensen, 420 Grand Ave., Alliance, NE 69301. (308) 762-7391

FOR SALE: Catalin Sentinel 284 red body, b'scotch grille, near mint, repro dial glass - BO over \$1K by Jan. 1, 1997. Photo SASE. Frank H. Schoile, KB8MA, 214 Pleasant Hill Ct., Centerville, OH 45459. (513) 433-1455

WANTED: Bell PA amp Model Number 3725B. E. Johnson, 1304 Richard Bennette Rd., Crandall, GA 30711. (706) 695-8621

WANTED: One- and two-tube ham/SWL receivers (regenerative). Kits or homemade. Bob Mattson, KC2LK, 10 Jane Wood Rd., Highland, NY 12528-2607. (914) 691-6247. E-mail: rmattson@freemark.com

WANTED: Technical manuals General Radio Signal Generator Model 1001, copy OK. Thanks a million. Charles Rhodes, 10105 Howell Dr., Upper Marlboro, MD 20774. (301) 574-0214

WANTED: Glass dial for Bendix 0526 and a cabinet for a GE H-500. Joe Kelly, 537 Stafford Ave., Erie, PA 16508. (814) 459-3910



WANTED: Motorola Catalins #'s 50XC, 51X15, and 52, as complete or "parts" sets. I am a very serious collector seriously looking for serious stuff (leaving all kidding aside, of course!) Please write or call collect: Rain Buttignol, 214 State St, #7, Portsmouth, NH 03801. (603) 427-1384

WANTED: Radiola 60 chassis with good power transformer and RF transformers. Bill Engstrom, 218 Bent Creek Dr., Greenville, NC 27834. (919) 355-8732

WANTED: Phonograph-related items: Best prices for Vogue Picture Records, Edison, Columbia, and any wax cylinder records, toy phonographs, needle tins and cutters, Nipper, record dusters, puzzles, fans, calendars, pocket advertising mirrors, dealer lapel pins, phonograph toys, posters, broadsides, original dealer advertising items from Edison, Victor, and Columbia. Thanks. Bernie Seiberg, 714 Moredon Rd., Meadowbrook, PA 19046-1907. (215) 866-6124

WANTED: Offering up to \$2,000 U.S. for excellent Detrola Super Pee Wee red or blue beetle plastic. Also looking for Knight Kit Span Master receiver and Remco crystal sets of 1950's. Please respond with picture and/or description. Thank you. James Craft, 101 Carleton St., Saint John, New Brunswick, Canada E2L 2Z2

WANTED: Peerless type portable phono-radio. Prefer Model RP75. Nick Maffei, 260 Church St., 3C4, White Plains, NY 10603

WANTED: Matched set of (5) gold 01-A mint tubes for Atwater Kent breadboard. Tom Reynolds, 5260 McCandlish, Grand Blanc, MI 48439. (810) 695-0160

WANTED: Radio Lamp of America, all brass w/ mushroom shade, any condition. Hal Long, 2303 Lakeview Dr., Yardley, PA 19067. (215) 493-4962

WANTED: Good volume control & switch for Sparton 400 or control only. Bill Johnson, 34 Springlake Pl. NW, Atlanta, GA 30318. (404) 355-6308

WANTED: RCA 103 speaker, preferably in mint or excellent condition. Jim Wilson, 888 Pearse Rd., Schenectady, NY 12309. (518) 372-9625

WANTED: Transformer for Stromberg-Carlson Model 240-R. Back speaker cover board, dial escutcheon knobs for Stromberg-Carlson Model 245-M. Leon Gann, 1134 E. 50 Pl. N, Tulsa, OK 74126. (918) 425-3590

WANTED: Emerson Miracle Six early Bakelite, no cracks, w/back. Karen McCoy, 8104 N.W. 114th, Oklahoma City, OK 73162. (405) 722-0595. E-mail: kcmccoykc@aol.com

WANTED: Phillips/Norelco car record player. Car TV antenna. RCA-bk-4 Starmaker mike. Jay Howard, 4210 Tangle Dr., Charlotte, NC 28211. (704) 365-2830. E-mail: jaycoll123@aol.com

WANTED: Pay \$100 for good matching mahogany petal for Burns speaker! Rick Ammon, 1249 Solstice Ln., Fort Collins, CO 80525-1239. (970) 221-4001. E-mail: wireless@bamboo.verinet.com

WANTED: Grundig Model 960 radio. Sam Giansante, 4255 West Ave. Rd., Elba, NY 14058

WANTED: Eveready radios, speakers. Flashlights, flashlight catalogs, related items. Subscribe Flashlight Newsletter - \$12 year. Bill Utley, PO Box 4095, Tustin, CA 92781. (714) 730-1252

WANTED: New, used 6L6GC, 1614, 1622, 5751, 6SN7W circa WWII, 6180, 8307. Robert Koerner, NY 11, 8910 N. Camino de la Tierra, Tucson, AZ 85742. (520) 742-6130. Fax: 797-6925

WANTED: 30's-40's QSL's, verification letters, etc. Call: Mark Garris, 13700 Brandy Oaks Dr., Chesterfield, VA 23832. (804) 739-7278, leave message

WANTED: Dial glass for 1942 Zenith 10-S-668 console. Eric Beheim, 25114 Oak Ln., Descanso, CA 91916



www.machineage.com

Machine Age provides antique radio dealers the Easiest and Most Professional way to buy and sell on the Internet.

Log in and enjoy:

- An All-New Interface
- World-Famous Radio Dealers
- Free Searchable Classified Ads
- Twentieth Century Design and Technology

Machine Age is free to buyers; low cost to dealers. Call for details:

(800) 818-0570

FOR SALE: Patton Army walkie-talkies, (2) - \$300. Jeep wireless sets, 5.5-7 MHz - \$125. Massive German sets with unequalled sound: Nordmende Fedelio 55, Fedelio 57 or Grundig Parsifal, 3035-56 - \$210; smaller Lowe Opta - \$175; great Grundig transistor portable Ocean Boy 7000 (German Royal 3000) - \$175; small Grundig MW/FM set - \$95. Need coil winder, wooden sets from 20's-40's, Hallicrafters radios, none need work, junker Trans-Oceanics, Zenith batteries. J.R. Sprouse, PSC-2, Box 8968, APO, AE 09012 (Germany)

FOR SALE: Scott Allwave 23 Imperial in Tasman cabinet - \$2,500. Stromberg-Carlson 225h rosewood cabinet - \$650. Both playing in fine original condition. Roy Ditzel, 309 Hillcrest Ave., Baltimore, MD 21225. (410) 796-1953

FOR SALE: Philco tabletop, 38-62 - \$95. Heathkit crystal receiver CR-1, Logix crystal radio kit - unused, pair CB Midland 75-764 - Offers. A.R. Jacobs, 5 Yorktown Pl., Fort Salonga, NY 11766. (516) 261-1576. E-mail: joekey@aol.com

FOR SALE: Offering \$400 U.S. for a Kodak speaker in excellent and original condition. It looks like a Western Electric microphone. Please respond with description and/or photo. Thank you! James Craft, 101 Carleton St., Saint John, New Brunswick, Canada E2L 2Z2

FOR SALE: 1929 Radiola 46, (picture July, p. 4) - \$100. 1934 AK 318 - \$100. PU only. Carl Hackenson, 31 Hixson Farm Rd., Sharon, MA 02067. (617) 784-8834

FOR SALE: Admiral c/r 5S33N - \$20. Bulova 400 c/r - \$20. Crosley color radio case - \$25. Hardy Boys 27, 35, 40, 65, 66, 92 - \$5 ea. Majestic 300A, complete original, windows OK - \$1,350. Philco Deco 41-256, good buttons - \$145. RCA 66BX Trotter - \$55. RCA XF4 blond wood AM/FM - \$65. RCA 8X542 - \$35. Revere 400 - \$95. Temple G418 - \$75. Zenith orange B513 - \$20. Zenith 1950 round 20 TV Cobramatic, AM/FM restored original blond cabinet/doors nice - \$495/offer. Bailey pinball complete original non-coin all wood/glass - \$595. Chicago Coin Texas Ranger Gatling gun 10/25¢, all wood/glass nice - \$695. Happy Thanksgiving, Don Nordboe, 3131 Ave. A, Council Bluffs, IA 51501-1948. (712) 322-2255

FOR SALE: Radios 30's thru 50's, also testers, SASE for list. Sam Giansante, 4255 West Ave. Rd., Elba, NY 14058

FOR SALE: RCA T10-1, no knobs, nice cabinet - \$75. **WANTED:** Tube UCL-11, odd-brand TVs. Glenn Bubenheimer, 27851 Terrence, Livonia, MI 48154. (313) 421-5574

FOR SALE: Dukane Corporation 5A30 15-watt PA spkr - \$20. Donald Sochurek, W191 S7500 Richdorf Dr., Muskego, WI 53150. (414) 679-0212

FOR SALE: Zenith 15U270 - \$1,300 plus shipping. Electro-Voice V2 microphone - \$350 plus shipping. James W. Poitivent, 3 Darby Cir. E, Mt. Holly, NJ 08060. (609) 261-0059

FOR SALE: Sell my white Zenith Royal 500, mint condition in mint case for - \$165 plus shipping. H. Weinborn, 12222 S.E. 41st Ct., Milwaukie, OR 97222. (503) 652-7224

FOR SALE/TRADE: Bozak B-310? speaker, grandiose! **WANTED:** Webber or Arion radios, information/whereabouts, Ann Arbor radios. Nevins Museum of Radio, Ken Nevins, 406 Jipson St., Blissfield, MI 49228. (517) 486-3019, evenings please

FOR SALE/TRADE: My extra AR's, TR's and Photofacts. Send SASE for list or call: L. Rasmusson, 1107 W. Jefferson St., Joliet, IL 60435. (815) 744-4565

FOR SALE: Tubes, schematics, service notes, Riders, Sams Photofact Folders and Transistor Books, etc. for early radios. LSASE for price list. Sam Faust, PO Box 94, Changewater, NJ 07831

FOR SALE: Sonys: (1) CRF-320, exc cond., manual - \$800/OBO/Trade. (1) CRF-160, mint, manuals - \$500/OBO/Trade. Doug McCarthy, 1010 E. Morrow Dr., Phoenix, AZ 85024. (602) 582-4291. E-mail: Dougmct1@juno.com

FOR SALE: Dr. Seibt (Berlin) triple detector unit for Seibt crystal set, nice condition. Mike Katzdorn, 8909 Alliston Hollow Way, Gaitersburg, MD 02879. (301) 963-8106. E-mail: oldradio@erols.com

FOR SALE: Edison disc electronic Voicewriter Model 86000 - Make Offer. Dean Rein, 4307 Hwy. 52, Wausau, WI 54403. (715) 842-8354

FOR SALE: Dial lenses, 7 1/2" diameter, 3/32" thick glass, 1/2" dished, old stock - \$15 ea. Steve Lange, 1351 N. 58 St., Milwaukee, WI 53208. (414) 259-1031

FOR SALE: Axial lead electrolytics. Fresh new Nichicon miniature 10 mFd at 450 Vdc - 98¢ ea. for 10 or more. Includes P&H. Many other types in stock. Write, phone or fax for free flyer. DH Distributors, PO Box 48623, Wichita, KS 67201. (316) 684-0050 v/f

FOR SALE: Several college-level mathematics textbooks: calculus, differential equations, trigonometry, etc., reasonably priced. Marion L. Clemens, 10129 Lapeer Rd., Davison, MI 48423. (810) 653-2439

FOR SALE: Transistor radios for sale: Big box lot of 25! Like Zenith, Commodore, Motorola, Arvin, Airline. Good starter collection! - \$99 ppd. John Gardner, 270 North Main St., W. Hartford, CT 06117. (860) 523-4145

Wanted/For Sale Books, Catalogs, Ephemer

Electricity, Telegraphy, Telephony
Television, Radio, Wireless

Roger Hart

Old Authors Farm

P.O. Box 403

Morrisburg, ON Canada K0C 1X0

Tel: (613) 543-3337 Fax: (613) 543-2380

CATALIN REPAIR

Daniel Blake

· Artist - Master Craftsman

**The only source for expert
Catalin and Plaskon repair**

704-884 -2619 7:30-9am or 8-10pm EST

NEW EDITION!
Shipping Now!

The Collector's Guide To Antique Radios - 4th Edition

By Marty & Sue Bunis



**Order
Today!**

8,500+ Battery & AC sets from the '20s - '60s
400+ color photographs
Updated prices
\$18.95 - Softcover

There are no transistor radios listed in the fourth edition. You will find them in *The Collector's Guide to Transistor Radios* available from A.R.C. for \$16.95.

U.S. Orders - Enclose \$3.00 per order for packing & book-rate shipping if total order is under \$35.00. If using VISA or MasterCard, include name on card, card number and expiration date. Send payment with order. Mass. residents add 5% sales tax. Money back return policy. Softcover unless stated otherwise. Most orders shipped the same day received, but allow 2-4 weeks to receive order. Foreign orders - write for shipping costs, or use credit card and specify air or surface (allow 2-3 months for surface shipping).



A.R.C., P.O. Box 2, Carlisle, MA 01741. Tel: (508) 371-0512

Fax: (508) 371-7129

Web: <http://www.antiqueradio.com/>



(Nov-96)

FOR SALE: Rider's 1 thru 20, 1-5 abridged - \$275. Beitman's 1948 through 1964 - \$165. Zenith chassis #8S586 with tubes - \$35. Crosley chassis #646 with tubes, knobs, escutcheon and speaker - \$35. Grundig chassis - \$20. All plus UPS, M.B. Gaskins, WB4MNZ, 227 Risen Ave., Cambellsville, KY 42718. (502) 465-3755

FOR SALE: Philco 84B - \$100. Philco 66 - \$150. Revere cathedral - \$200. Zenith 5S320 - \$85. Grebe MU-1 - \$250. Plus shipping. Ross Mason, 715 S. Penn, Mason City, IA 50401. (515) 423-4687

FOR SALE: 1926 Victor R-32, 10-tube console - \$145. Philco 41-280 - \$140. Both clean and working. Matthew Hinson, 1663 Bridge St., No. Merrick, NY 11566. (516) 379-3601

FOR SALE: N.O.S.: Scotch UCA, 60 min. one-inch video cassettes - \$22. Used: 60 min. - \$10. 10 min. - \$4. Five min. - \$2.50. Plus shipping. John Walch, 381 Co. Rt. 17, Bernhards Bay, NY 13028. (315) 675-8135

FOR SALE/TRADE: Super German radios: Nordmende Parsifal, Fedelio 55, Othello 57, 58 - \$175. Telefunken 766W (1936), 330WLR Bakelite (1934) - \$250. 1083 Allegro - \$195. Nora W19 Bakelite (1938) - \$275. Grundig 2042, 3012, 3035 - \$150. Lowe Opta - \$175. WWII GI walkie-talkies - \$259. 1950's military Jeep transceiver - \$95. S-38A, S-38D - \$85. 1954 English hand transistor radio - \$55. Phillips Pinetta - \$80. Small Italian Superita plastic - \$50. Grundig Ocean Boy 7000 transistor Trans-Oceanic - \$145. Shipping included!
WANTED: Coil winder '42 sets, cathedrals. J.R. Sprouse, PSC-2, Box 8968, APO, AE 09012

FOR SALE: Marantz 7C, mint - \$2,500. Pair Fairchild 255's - \$900. Western Electric 596A - \$4,500. Vincent Gallo, 532 LaGuardia Pl., #600, New York, NY 10012. (212) 274-0432

FOR SALE: Jewel colors RR tape blank N.O.S 7" 1,200' 47 avl. - \$6 ea. +. Agreed? Renee May, 1242N. El Centro Ave., Los Angeles, CA 90038. Ph./fax: (213) 464-9179

RADIO XXVIII

OUR 28th
GET-TOGETHER
An Indoor Old Radio
Flea Market

6500 square feet — 90+ tables available

Sunday, February 23, 1997
8:00 A.M. 'til 1:00 P.M.

Westford Regency Inn — Regency Room
Westford, Mass. (I-495 at Exit 32)

Look for additional information
January & February A.R.C.

Sponsored by:

The Greater Boston
Antique Radio Collectors

*Not a club, no dues, no newsletter...
just a great group of collectors!*

Thanks to Antique Radio Classified for
organizing this meet.

FOR SALE: (100) radio electronic books. Radios and test instruments. Send large SASE for lists. Rich Yoch, 22410 Bartlett Dr., Rocky River, OH 44116. (216) 331-9206

FOR SALE: Speakers: Sunset lighted and hand-painted octagonal speaker approx. 24", rare & mint - \$475. Music Master 14" mahogany - \$225. Burns black 1 petal cracked - \$225. Holtzer Cabot horn speaker - \$140. DeForest horn, no base - \$75. Radios: Philco 20 deluxe cathedral - \$275. Philco 16B tombstone - \$165. Gloritone 26 cathedral - \$175. Crosley 124 Playboy - \$170. Trav-Ler cathedral, nice - \$350. Philco 90, restored - \$425. Philco 89B - \$175. AK 20C - \$125. Crosley 51, Sears - \$110. Day-Fan 5 - \$90. Radiotrope ornate console \$250. Emerson 1947 TV table set Model 545, wood knobs, Channel 1, and Magnavision magnifier - \$300. Mark DeFrancisco, 108 Mystic Rd., Marlton, NJ 08053. (609) 985-2974, after 2 pm Eastern only

FOR SALE: Sparton Blue Mirror Model 517 some mirror flaking, one knob missing, works - Make Offer. Thorens Excelda Gramophone - \$500. Browning Eagle Mark III with original, Golden and Silver Eagle microphones - \$500. Fada Model 659, hairline on bezel, stress hairlines on grille corners, works, orange and yellow - \$450. Victor III with oak horn, excellent - \$3,000. Emerson Model 540, excellent, brown, works - \$140. Dumont RA-346, white - \$110. Crosley 51, NT - \$110. Crosley 52, nice case, needs parts - \$50. Zenith 7G605, case and grille only, no guts - \$50. Eveready battery foreign - \$45. Zenith Trans-Oceanic 3000-1 - \$140. Radiola III, NT - \$115. Several Zenith Trans-Oceanics - \$60-\$100 ea. Phil Boydston, 640-18 Tete Lours, Mandeville, LA 70471. (504) 845-0867

FOR SALE: LSASE for tube and transistor plastic portables, wood table radios, clean and working. Greg Sheppard, KA3DBG, 4402 Jupiter St., Rockville, MD 20853-3255

BUY • SELL • TRADE

CATALIN RADIOS



I'll buy single pieces or
whole collections. Top prices paid.

RADIOART

Jim Meehan

P.O. Box 102 • Centerbrook, CT 06409
(860) 526-1762

WANTED: Philco's Models: 38-9, 39-117, PT-43, 42-PT95, 41-231, 40-140. Donn Frederick, 8402 Hwy. 30 SE, Chatfield, MN 55923. (507) 867-4868

WANTED: Complete Sams folder for Philco console Model 39-55. Photocopy is alright. Will recompense. Also need remote control unit for same model. Remote unit from 39-116 will also work. Loren H. Dudley, 14 Valley Rd., Bath, ME 04530-2811. (207) 442-8419

WANTED: Manual (or copy) for Morrow Conalrad rcvr No. CM-1. **FOR SALE:** Guild Buccaneer radio - \$125. Ray Barnes, 38 Woodmere Rd., Framingham, MA 01701

WANTED: Zenith Walton radios. Johnny Johnson, 7075 W. 32nd Ave., Wheat Ridge, CO 80033. (303) 274-5474

WANTED: Tune-A-Lite tube and chrome grille radios. Jay Malkin, 1250 Galapago, #206, Denver, CO 80204. (303) 623-6451

WANTED: Zenith, Model Number 8A02, tube shield (1 1/2" dia. x 3 1/2" tall). Thomas Cano, 6409 Forest Village, San Antonio, TX 78250-4093. (210) 520-8862

WANTED: Crosley E15BE-E15WE. Firestone S-7398-5. Philcos: 38-9, 40-124, 41-240, 46-420I. Donn Frederick, 8402 Hwy. 30 SE, Chatfield, MN 55923. (507) 867-4868

WANTED: German, U.S. and Japanese transistor radios, leaflets, brochures, transistor components, related advertising. Rudi Herzog, PO Box 140 108, 30959 Hemmingen, Germany. Phone: 011-49-5045-7464. Fax: 011-49-5101-5100

WANTED: AK 465Q, 735, 24. Johnson Ranger II. Heath HR-10B. George Folse, KB5WWO, 630 Dolhonde St., Gretna, LA 70053. (504) 362-1896

WANTED: Dead or alive! Jensen Alnico 5, PM, Concert, and Special design loudspeakers. Fairest bounty paid! Peter F. DeGregorio, 45 Moritz Pl., Fairfield, CT 06430-3527. (203) 331-9155

WANTED: Philco chassis any condition 40-180, 40-185, 40-190. Dial scale excellent and escutcheon. Andy Maneval, 599 E. Benson St., Cincinnati, OH 45215. (513) 821-4403. E-mail: Amaneval@aol.com



WANTED: Amplion AR-102/45 drivers - \$125; AR-19/111/114 drivers - \$75. Jim Peters, 983 Chapel Ct. South, Glen Ellyn, IL 60137. (630) 790-9699

WANTED: Manual, schematic, any info for Grebe Synchrophase Model MU-1. Repro or reprint OK. Bob Bakinowski, 1524 Saint Tropic, Tucson, AZ 85713. (520) 624-8029

WANTED: German friend looking for Westrex or Tefi sound tape cassettes, literature & players. Robert Lozier, 600 E. Green St., Monroe, NC 28112. (704) 283-2638

WANTED: Emerson 747, 838, 839, Automatic Tom Thumb, many other hybrids and coat-pocket mini-tubes. Will buy or trade early transistor radios. Mike Brooks, 7335 Skyline, Oakland, CA 94611. (510) 339-1751, evenings

WANTED: Western Electric 17B oscillator and preamp J6861 7W-2. Other parts/tubes also. Michael Payne, 803 S. Taylor, Alvin, TX 77511. (713) 331-9217. Fax: (713) 585-2727

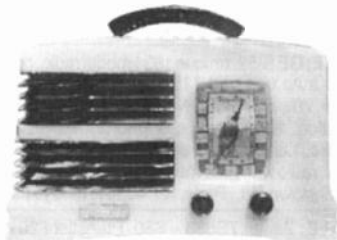

WANTED: Symphony and Detrola Catalin radios. I am not a human being: I am a radio collector. God forbid! Pity me the lost soul that I am and fulfill my humble needs. Please write or call collect: Rain Buttignol, 214 State St, #7, Portsmouth, NH 03801. (603) 427-1384

WANTED: Repairable chassis for Satchell-Carlson 570 and Arvin 440T. Francis W. Buren, 119 Hill, PO 844, Postville, IA 52162. (319) 864-3543

**PHONE NUMBER FOR
ANTIQUE RADIO CLASSIFIED
(508) 371-0512**

**Best time to call is weekdays:
8:30 am to 6 pm Eastern Time**

(Please no classified ads by phone. Thanks!)

WANTED: Atwater Kent variocoupler in good condition, have N.O.S. Federal variocoupler (type used in Model 61) that can be used toward trade. Addison 2A Catalin in black and white. Dr. Pepper radios. Any advertisements, promotional materials or manual for Sparton Bluebird. Gary and Laura Carter, WA4IAM, 1405 Sherwood Dr., Reidsville, NC 27320. (910) 349-1991

WANTED: Working mint Majestic Model 161. Joseph DiCaro, 4155 Lastrada Heights, Mississauga, Ontario, Canada L5C 3V1. (905) 848-7759

WANTED: Telegraph keys wanted. Visit my internet online telegraph/scientific instrument museum: <http://www.chss.montclair.edu/~pererat/telegraph.html>. Tom Perera, 11 Squirehill Rd., N. Caldwell, NJ 07006

WANTED: Crosley 168 or similar small Crosley cathedral, with original finish, in good condition. Stuart Hendin, 10704 Anglohill Rd., Cockeysville, MD 21030. (410) 666-3998

WANTED: Want to buy originals (or copies) of Zenith Trans-Oceanic factory service manuals. B. Brown, 26315 486th Ave., Valley Springs, SD 57068-7308. (605) 582-6762

WANTED: Need copy of a page from 1935, '36, '37 Radio Master Catalog that shows ad depicting Series 101 plugs and sockets manufactured by the Howard B. Jones Company. Frank C. Lombardo, 3355 S.W. 159th Ave., Ocala, FL 34481-4947. (352) 489-1748

FOR SALE: T&H condenser analyzer, very old. SASE. Robert J. Stone, 721 Fisk St., Piqua, OH 45356-3729. (513) 773-2217

FOR SALE: Many novelty, transistor radios made in Japan from the 1960's. Most radios new in box. Free list SASE. Bill Hyde, 34 Cerrado Loop, Santa Fe, NM 87505. (505) 466-6613

FOR SALE: Hallicrafters TW-1000 Worldwide - \$60. Lafayette HA-230 SW receiver - \$50. Eleven 7" reels Memorex Quantum 90 tape, new - \$50. Walter Kiefner, 6233 51st Ave. NE, Seattle, WA 98115. (206) 526-1452

FOR SALE: GE B-52, unique 1934 model radio, operated on 6v for auto use and 115 volts for home use, (see G.O.R., p. 70), plays fine. N.I.B. Coke cooler transistor reproduction. N.I.B. Lafayette phono oscillator. Arvin 758T radio. Cabinet and dial glass for Delco R1227, Aeriola Jr. radio with Frost headphones. Charles Harper, 2000 Jackstown Rd., Paris, KY 40361. (502) 769-0404

FOR SALE: Zenith 7S633 - \$50. Pfanstiehl 20 - \$75. Airline 94-BR1535A - \$35. Trav-Ler 5049 - \$40. Doug Koehn, 2022 Grove, Quincy, IL 62301. (217) 228-1257. E-mail dkoehn@harris.com

FOR SALE/TRADE: 1952 Grundig Type 3012 - \$175. Telefunken Allegro - \$195. 1937 Telefunken w/eye - \$205. 1933 Super 330 Telefunken Bakelite - \$285. Many others. 1954 English transistor - \$55. Hallicrafters S-38A - \$65. Phillips Pinetta AM/SW/FM - \$95. Jeep transceivers w/batteries - \$225. WWII walkie-talkies - \$175 ea. Shipping included. Need 1920/1930's sets (need not be working), coil winder. J.R. Sprouse, PSC-2, Box 8968, APO, AE 09012

FOR SALE: Zenith Trans-Oceanic Model 7G605 airplane grille - \$275. Crosley table radio model E15CE, mint green plastic, nice - \$125. Roscon Super 8 transistor radio Model BT533, yellow & grey - \$65. Toshiba transistor Model 8TM294, blue - \$90. Both transistors with case. Bill Constantine, PO Box 493, Glens Falls, NY 12801. (518) 745-8897

FOR SALE: RCA/Rider Chanalyst, mint condition, original manual, new probes - \$250 plus pack and shipping. Michael Franzen, 3618 Effie St., Los Angeles, CA 90026-1006. (213) 661-9171

FOR SALE: Microphones (all very clean, used or near mint); Western Electric 387W in orig. housing; Shure-Unidyne III 545L dynamic; American D9AT dynamic in original box; Electro-Voice Cardyne II Model 731 - Best Offer, SASE for description of each. Floyd A. Paul, 1545 Raymond Ave., Glendale, CA 91201. (818) 242-8961

10 BAND MINIATURE SHORTWAVE RADIOS!
Listen to the entire world! This unusual shortwave radio, 7 x 1 1/4 x 3 3/4 inches, is one of the smallest and most sensitive radios ever built. It has AM/FM/MV and 7 shortwave bands; you can listen to the entire world! It uses only two AA batteries or 3-volt adapter (not included). The cost including shipping and insurance is: Only \$35.00 per set N.I.B. 12, 9, 3 bands also available. If you purchase 2 or more, 10% discount will apply!
Call 908-607-0299, Fax 908-679-2485.
Mail your check or money order to:
R.G.B. Enterprises, Dept. 71
P.O. Box 5367, Old Bridge, N.J. 08857, U.S.A.

FOR SALE: Large collection of consoles, cathedrals, tombstones, portables, table models, etc. Send LSASE for list. Frank D. Atwood, 117 E. Main St., Merrimac, MA 01860. (508) 346-8100

FOR SALE: McIntosh equipment, working, unrestored, MC75 - \$1,400 pr./BO; MR65B - \$125; MR71 - \$250; Thorens 125 MKII/factory arm - \$150. **WANTED:** Thorens 124. Garrard 301 turntables, McIntosh MC30, 60, mint 75, mint tuners, cabinets, parts, whole systems. Aftac 604B, C factory cabinets. Scott LK 150 cage with w/o amp, Karlson cabinets. Audio Cyclopedia, 60's edition. Wait Fleming, 182 Plain Hill Rd., Norwich, CT 06360. (860) 889-1957

FOR SALE: Tubes, test equipment, radio parts, transistors, radio books and manuals. SASE for list. Harry Cap, 190 Beech St., Bridgewater, MA 02324. (508) 697-8648

FOR SALE: Below wholesale pricing on high voltage capacitors. Flyer available. Santech Electronics, PO Box 187, Tappan, NY 10983. (914) 359-1130

FOR SALE: Mint cathedrals: Philco #19 - \$390; US Radio #24 - \$275. Old slot machine - \$1,300. Richard Bednarcik, 28 Steele Ave., Lincoln Park, NJ 07035. (201) 694-6374

FOR SALE: (20) Radio USA microphone AM/FM - \$35 ea.; and (14) red racing cars AM/FM/clock - \$20. All postpaid. RGB Enterprises, PO Box 5367, Old Bridge, NJ 08857. (908) 607-2299

FOR SALE: Communications receivers: National NC-57-B with Select-O-Ject & S meter - \$250; HRO-7T with power supply and A-B-C-D plug-ins - \$350; NC-183-D - \$350; HRO-50-T1 with B plug-in - \$350; NC-121 - \$100. All above in good working order. SW-54 parts set - \$25. SW-3, 2-volt version with carrying case, not tested - \$450. Hallicrafters: S-38-E, rebuilt 100% - \$85; S-55, rare, AM/FM, not tested - \$150; SX-25 Super Defiant, restorable - \$85; S-95 Civic Patrol, needs filter - \$35. Misc.: BC-348-H, wrong knobs, works - \$85. RME-45 with speaker and 152-A VHF adapter, works - \$450. Heath GR-64, wrong knobs, works - \$60. Coast Guard RC-123 LF (16-650 kHz), mfg. by Federal Radio - \$125. Heath DX-60 unbuild kit - \$250. Navy tuning unit Type CAY-47152 - \$50. Test gear: TV-2 tube tester, works - \$400. Precision 660 tube tester, works - \$60. HP-410-B/R, works, recent cal. - \$85. Charles A. Ochs, Saltmarsh Electronics, PO Box 715, Woods Hole, MA 02543. (508) 457-9220

FOR SALE: Citizen LC shirt pocket TV, #04TA-0AB, with back light accessory, now - \$50, plus UPS. C. Hill, 6934 Orion Ave., Van Nuys, CA 91406. (818) 787-0376

VISIONETTE
MECHANICAL TELEVISION
24 LINES
AUTHENTIC OPERATION
SCANNING DISK CAMERAS AND RECEIVERS
EASY TO BUILD KITS OR READY TO GO
AVAILABLE NOW!
A collection is incomplete without the VISIONETTE
FOR INFORMATION, CALL OR WRITE
PETER YANCZER, 836 BRICKEN
St. Louis, MO 63122
Ph. 1-314-822-1748 or a SASE

RADIO CRAZE

John Sakas po box 4124 So. Hackensack NJ 07606-4124

Phone (201)794-0437 or 1(800)RADIO51 ~ Fax 24 Hours (201)794-8359

come vist our new web site at <http://www.radiocraze.com>

WANTED FOR SALE

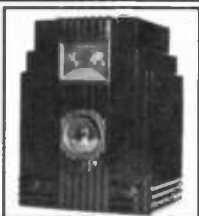

AIR KING SKYSCRAPERS

paying \$10,000.00+ for near mint condition red or blue

\$8,000.00+ for green, lavender or yellow

\$3000.00+ for black and \$2000.00+ for white or brown

WANTED ANY COLOR-ANY CONDITION

COLLECTOR PAYING TOO MUCH, CALL ME LAST

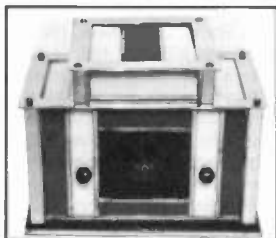

RADIO GLOW WANTED

paying \$2500.00+ for any color combination in mint cond.

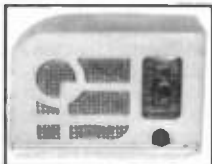

TOM THUMB RADIOS WANTED

paying \$2000.00+ for any mint one and

\$5000.00+ for mint cond. red, green, orchid, blue or gray

WANTED ANY COLOR-ANY CONDITION

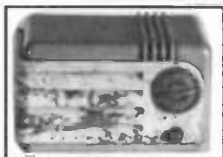

DETROLA PEE WEE & SUPER PEE WEE WANTED

paying \$600.00+ for mint cond. black or white \$1350.00+ for red, gray, blue, green, beetle, salt & pepper or lavender

always buying any catalin or pre-war colored bakelite radios
we will buy one piece or entire collection
watch out theres a new guy in town



F
O
R

S
A
L
E

COLONIAL "NEW WORLD RADIO"

black and gold near-mint \$965.00

F
O
R

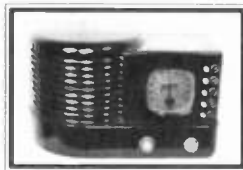

ZENITH 5R 312

brown bakelite with off white trim mint no back \$185.00

F
O
R

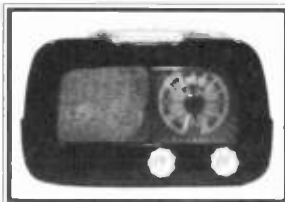

FADA 711

* blueish green catalin with white trim mint \$1425.00

F
O
R



EMERSON 564

jet black catalin, mint \$765.00

S
A
L
E

S
A
L
E

S
A
L
E

ALL PRICES ARE WITHOUT SHIPPING CHARGES

FOR SALE: Atwater Kent radio Model 30. SASE please. Robert J. Stone, 721 Fisk St., Piqua, OH 45356-3729. (513) 773-2217

FOR SALE: Sixty years of radio and TV repair parts to be sold at sacrifice prices. A gold mine to anyone in the repair business. You would have to see it to believe it. Available by appointment six days a week. Frank D. Atwood, 117 E. Main St., Merrimac, MA 01860. (508) 346-8100, or fax (508) 374-1030

FOR SALE/TRADE: RCA Radiola 46 - \$400. **WANTED:** Guitars, amps, parts, etc. Peter F. DeGregorio, 45 Moritz Pl., Fairfield, CT 06430-3527. (203) 331-9155

FOR SALE: Unbuilt Heathkit oscilloscope Model 10-12, all parts are in kit, asking - \$150 + UPS. Phil Guinan, 106 Page Rd., Litchfield, NH 03052. (603) 889-6213

FOR SALE: Philco Mod 96, nine-tube radio chassis w/ electrodynamic speaker (not tested), heavy - \$150 including UPS. H. Andreoni, c/o 250-D So. Lyon Ave., Hemet, CA 92543

FOR SALE: 87 larger bolt-mount mica capacitors, various values, 600v to 5000v - \$40 plus shipping. Gordon Wilson, 11108 50 Ave., Edmonton, Alberta, Canada T6H 0H9. (403) 434-6257

FOR SALE: General Radio 419-A rectifier type wavemeter, beautiful wooden box case, exc++ condition - BO. Clyde Powell, 3822 Edwards Ter., Chattanooga, TN 37412. (423) 867-5022

FOR SALE: Swiss Lenco turntable - \$40. Sencore Super cricket TF46 - \$35. Rogers Majestic R535, exc. David Boardman, 10 Lemaistre, Sainte-Foy, Quebec, Canada G2G 1B4. (418) 877-1316

FOR SALE: Push-pull output with dual triode 6AS7GA, characteristics similar to 2A3 - \$3.75, postage \$3. Jack Shaymow, Vintique Electronics, 52-C Tifford, Deerfield Beach, FL 33442. (954) 427-1222



The California Historical Radio Society

- ✓ *Eight meets per year all over Northern California*
- ✓ *Two or more Journals per year featuring original historical and technical articles*
- ✓ *Join now and get a valuable collection of restoration articles from 20 years of CHRS!*
- ✓ *A mere \$15 per year!*

For more information, or to join...

write to: PO Box 31659
San Francisco CA 94131
or Call 415-978-9100

FOR SALE: Tombstones: Philco 144B cabinet Model 97 chassis 7-tube - \$200; Zenith 6-tube large tombstone unknown Model 6 tube - \$175; Philco Model 84B, dial face faded some - \$100. Cathedrals: Radiochron model unknown 4 tubes, lights, no sound, Deco - \$150; Crosley Model 124 The Playboy - \$250. Table models: Radiola Model 61-3, wood - \$75; Emerson Model BL-200 Bakelite, small crack lower left front corner BC/SW - \$85; Hammarland HQ-120, 1938, black, excellent - \$300; Hallicrafters Model 8R-40 black chrome dial trim - \$85. Beautiful H.E. Scott Allwave 15 PS/ and spkr, no cabinet - Call, we'll dicker. All Philco tombstone Model 37-610, chassis only all light up, no speakers - \$175. Philco Model 239-tube, no knobs - \$75. Westinghouse Model WR314 10-tube - \$75. Unknown 8-tube plus regulator tube, number is Ser. No. 53184, could possibly be an Eveready, lights up, heavy - \$100. E.H. Scott Model 310, very good chrome, blonde cabinet, no record player - \$400. Webster teletube intercoms, all three models 1105 wood, all light up - \$80/all (3). RCA tombstone Model 7T1 - \$150. Consoles: Stromberg-Carlson Model 64 - \$225; Philco Model 37-650 - \$175; two Deco Midwest Model 18-36 - \$395 ea. Zenith Model 5G41 AC/DC portable, lid lifts up with dial in it in front - \$100. Mitchell Lullaby brown Model 1250, no shade - \$75. RCA console Model R-32, lights up, no sound, ornate dial - \$250. Hardcover books: Electronics, by Coyne, 1944 - \$25. Basic Radio, Hoag, 1942 - \$20. Modern Radio Servicing w/dust cover, Alfred Ghirardi, 1935 - \$35. Radio, John Irwin, 1922 - \$35. Radio Electronics, Boyer & Rocke, 1948 - \$20. Rider's 6, 7, 10, 11 & 14 - \$17 ea. Many table radios too numerous to list. Call for your wants or write and I will see if I have particular make and model. Zenith Model 5725, chassis, speaker, escutcheon, knobs, plays - \$60. RCA Victor 9-EY-3, 45 rpm record player in case - \$75. Harman Kardon The Theme, AM-FM receiver Mod A-310, early 60's, top-of-the-line brushed copper, black face trim, lighted edge dial, yellow/white tuning meter, excellent - \$175. E.H. Scott Allwave 23 beautiful chrome and Warrington cabinet recapped, plays great, once belonged to station mgr. at WGN radio, Chicago. I was told he purchased it from E.H. Scott personally - \$3,950. Also E.H. Scott Phantom De-Luxe AM/FM in beautiful Devonshire cabinet, good chrome, asking - \$2,850. Can deliver. P.S. Also numerous test equipment & used & N.O.S. tubes. Thanks to all my good friends at A.R.C. and ones I have dealt with and met at Elgin meet. Richard R. Bruning, 2416 U.S. Hwy. 150 N, Rio, IL 61472-9681. Phone/fax: (309) 344-1968

FOR SALE: 2 lbs. misc. radio/TV knobs, 1920s-1950s - \$15 ppd. Jim Wood, 5936 Plateau Dr., Felton, CA 95018. (408) 458-0552, days

WANTED

WESTERN ELECTRIC
TUBES, SPEAKERS, HORNS & AMPS

TUBES: Telefunken, Genalex, RCA, Radiotron, etc. General Electric, Amperex, JAN, Sylvania, GEC, National Union

McIntosh, Marantz, Dynaco, Jensen, Linn, Levinson, Fisher, Leak, Tannoy, Altec, EV, Thorens, EMT, JBL... Amps, Spkrs., Turntables

MAURY CORB

12325 Ashcroft, Houston, TX 77035

Tel: (713) 728-4343

Fax: (713) 723-1301

RADIO REFLECTIONS



1930's French Deco replicas. Most famous designs have mirror finish on solid wood casings. Both with illuminating dials and AM/FM reception.

#30410 Bluebird
15" x 15" x 8"

#30411 Old Rose
14" x 10" x 7"

RADIO REFLECTIONS

1930's French Deco replicas.

Most famous designs have mirror finish on solid wood casings.
Both with illuminating dials and AM/FM reception.

#30410 Bluebird (round) — 15" x 15" x 8" — \$199.00 each

#30411 Old Rose (seven-sided) — 14" x 10" x 7" — \$249.00 each

(Plus \$8.00 domestic shipping & handling, Michigan residents add 6% sales tax)

Order now, very limited quantities available!!

Visa/MasterCard accepted

Jim Clark Enterprises 3520 Okemos Rd. Suite 6 Okemos, MI 48864
(Phone) 517 349-7187 — (Fax) 517-349-7186

FOR SALE: Radio schematics – \$2.75. Xerox copies: Service Manuals; Zenith, 942 pages – \$60, Philco 217 – \$25, Crosley 322 – \$25, Atwater Kent, Rider's Radio Index 1 thru 23 – \$25. Rider's Radio Manuals. Books: Audel's New Radioman's Guide 1942, ICS Radio Operator's Handbook 1923, Mallory Radio Service Encyclopedia 3rd, 4th, 5th editions, Radio Servicing Course Supreme, The Oscilloscope 1954, The Oscillator At Work 1940. SASE for list. Plus UPS. Dick Oliver, 28604 Schwalm Dr., Elkhart, IN 46517. (219) 522-4516, evenings

FOR SALE: Several old Hallicrafters SW radios and matching speakers. Silver dial to S-120 models. Tom Lucht, 9317 Jaynes, Omaha, NE 68134. (402) 342-5630, days. (402) 571-0688, nights

FOR SALE: (Guld Conquistador, similar to Buccaneer chest – \$85. Crosley 10-138 (Bunis 3, p. 52) – \$60. Nordmende Elektra – \$50. Arvin 61R39 transistor – \$25. Dennis Schrank, 3129 S. Quincy Ave., Milwaukee, WI 53207. (414) 744-3374. Fax: (414) 744-8780

FOR SALE/TRADE: Very unusual Deco table radio: Algene, red alligator leatherette, square clear lucite knobs and grille bars, doors open to reveal pictures of Gable and Lamarr under glass inserts inside, nice original condition – \$450/Offer. Paul Ernst, 238 Meadow Ln., Webster, NY 14580. (716) 787-9879

FOR SALE: N.O.S. 6D10 – \$3. 6JT6 – \$16. 6LQ6, 6JG6 – \$22. C1K, C3J/5632 – \$25. 629 – \$20. Bob Putnak, 1507 4th St., Monongahela, PA 15036. (412) 258-6236

FOR SALE: Art Deco French multibands: Atlantic 1949 – \$75; super 1939 Schneider Freres – \$255; 1966 small Grundig Type 87A – \$75; portable multibands: 1960's Grundig TR2000 – \$145; 1970's Nordmende Transita TS – \$75; 1947 Blaupunkt – \$75. Shipping included! **WANTED:** 1930's Zeniths. J.R. Sprouse, PSC-2, Box 8968, APO, AE 09012

Visit the A.R.C. Web Site!

The URL to access the A.R.C. Web site is:
<http://www.antiqueradio.com/>

Our site includes highlights from current and recent issues:

- Editor's Comments
- Image of the Cover
- Feature Article
- Radio Miscellanea

- Plus:
- Photo Reviews
 - Book Reviews
 - Coming Radio Events
 - Complete Club Listing
 - List of Books For Sale
 - Subscription Information

While visiting our site, you may send e-mail and orders for books, videos and subscriptions.

Let us know what you think about A.R.C. on the Web!

FOR SALE: Rek-O-Kut 12" record cutter, overhead mech., head, R-8A amp, 33 & 78, no case. Rek-O-Kut 16" record cutter, overhead mech., 78 & 45, missing 33 idler & head, stand & micro feed screws. Magnecord PT6 2 case portable, extra parts, heads, 10" arm adapters, manual. Berlant Concertone 20/20 Model TWR-2 mono tape recorder, port. case, mono, 10" reels, manual. Ampex 600 mono tape recorder amp case, amp works, has tape flutter. Auricon Model NR sound-on-film optical recorder. \$85 ea., plus shipping. Alan Graves, PO Box 5469, Eugene, OR 97405. (541) 345-3991

FOR SALE: Westinghouse RC with tubes, vg – \$225. Ron McClellan, 201 W. Boot Rd., West Chester, PA 19380. (610) 363-5637

FOR SALE/TRADE: Ampeg Model J12 guitar amplifier, needs tinkering – \$125. National NC46 w/speaker, good condition – \$200. Crank tabletop Pal Deluxe phono, asking – \$175 plus UPS. Trade in your D.A.V. mini keychain license plate tags for \$2 ea. off any radio or pay you cash. John Williams, Jr., PO Box 1545, Scarborough, ME 04070-1545. (207) 775-4212

FOR SALE: Hewlett Packard 8405A vector voltmeter – \$20. Weston 682 tube tester – \$35. Echophone EC-2 – \$40. RCA 8X521 – \$30. Majestic 290 – \$90. Phaostron MA-1 VOM – \$35. Hewlett Packard 652 oscillator – \$30. Gertsch RT-5 ratio tran. – \$20. RCA 6-BY-4 R/P – \$35. German Babyphon 120 – \$45. (2) novelty radios – \$12 ea. RCA 9Y510 R/P – \$35. (3) Norelco mini-recorders – \$45/all. Webcor EP 2323 – \$20. Simpson generator 317 – \$20. Lafayette generator – \$20. Philco 46-1213 – \$25. (10) Edison disc records – \$25. Thordarson T-30W amp – \$35. Grundig-Majestic 3192 – \$75. **WANTED:** AK 2-tube amplifier for breadboard & shield for Philco 70. Walt Wrabek, Rt. 4, Box 370, Menahga, MN 56464. (218) 564-4623

FOR SALE: Seco 1002 tube tester – \$95. John Kirby, 298 West Carmel Dr., Carmel, IN 46032. (317) 843-2212

FOR SALE: Crosley 5-50, excellent and working, NT – \$75 plus shipping. Dave Gonshor, 7121 S. Jellison St., Littleton, CO 80123. (303) 979-9511

FOR SALE: Good used 6JE6 tube – \$20 ppd. Matt Limpert, 4519 St. Joe Center Rd., Fort Wayne, IN 46835-2223. (219) 485-6352

FOR SALE: Catalin radio, AMC Model 126, yellow, condition very good but has stress crack on bottom at chassis mounting hole, works good – \$1,950 or make offer. Rudy Hecker, 126 Weymouth Ct., Schaumburg, IL 60193. (847) 524-3560, after 6 pm

REPLACEMENT DRIVERS FOR ATWATER KENT HORNS

Driver w/housing for Model M & Pooley horns (this assembly replaces all pot metal) \$65.75 + \$4.75 s&h

Driver w/repair ring for Models G, H, & L (repair ring replaces threads in base) \$59.85 + \$4.75 s&h

All drivers above include diaphragm, gaskets, spacer, and spring. All parts are also sold separately. Send SASE for price list.

M. Harold Ezzone, 4861 Park Drive
West Des Moines, IA 50265 — (515) 221-9447

WANTED: Philco RMS Year Books for the following years: 1937, 1938, 1939, 1940, 1941. Loren H. Dudley, 14 Valley Rd., Bath, ME 04530-2811. (207) 442-8419

WANTED: Templetone BP2-A5 military entertainment radio, generator GN-44, filter FL-10, manual for TS-179/CRN-10, Scott SLR-12A. Henry Engstrom, KD6KWH, PO Box 5846, Santa Rosa, CA 95402. (707) 544-5179

WANTED: Tube chart, or copy, for Sico TD55 tube checker. Ken Armstrong, Box 216, Storm Lake, IA 50588. (712) 732-3012



WANTED: Emerson Catalin radios. Nobody pays more than I. What an arrogant and inaccurate thing to say. I mean, like there isn't anyone wealthy enough, dumb enough, desperate enough – or any combination of the three – to pay even a dollar more than I would pay. I mean, c'mon, who am I trying to kid! Please write or call collector: Rain Buttignol, 214 State St, #7, Portsmouth, NH 03801. (603) 427-1384

WANTED: 5" round 4-ohm dynamic speaker with 3000-ohm field coil for Sparton Bluebird; white knobs for Fada 845 and butterscotch knobs for DeWald 502. R. Gates, PO Box 187, Chesterfield, VA 23832. (804) 748-0382

WANTED: Unused 5AP1 CRTs, magnal sockets. ARC R-11, R-23, R-148, BC-453, any condition; 85 kHz IF transformers; I have one R-19 for trade. Bruno R. Ruchalski, PO Box 2153, Clifton, NJ 07015

WANTED: Pre-recorded open-reel tapes, classical, jazz & rock on RCA, Mercury, Everest, Verve, etc. Richard E. Brown, PO Box 686, Farmington, CT 06034. (860) 677-4828

WANTED: Need information on test equipment, Motorola measurements Model T-10-21-C, McGraw Edison, its use and schematic. Marvin Hess, 204 Queensway Rd., Elma, NY 14059

WANTED: Early Magnavox vacuum tube and/or tube carton. Larry Daniel, 706 Pearson Rd., Wright-Patterson AFB, OH 45433. (937) 754-1567

WANTED: Needed: tuning belt B, rear, for Zenith Trans-Oceanic R-7000-1. Chuck Stadler, 30 Stockton Dr., Monroe, MI 48162. (313) 241-0795

WANTED: Old windup phonographs: Victor, Columbia, Berliner. Advertising items, parts, wood horns, anything related. John Yanny, 153-1975 Ave., Apt. 2G, Flushing, NY 11367. (718) 268-6413

WANTED: Grundig 5490 AM/FM/SW stereo tabletop radio. Jack Murphy, 1400 Chicago Ave., Evanston, IL 60201. (847) 570-0028

WANTED: Transistor radios: ITT 6409-A Yaou 6G819 and 6G-909. Mike Itzo, 515 77th Ave., Saint Pete Beach, FL 33706. (813) 360-1189

WANTED: Speaker grille insert for Radiola 30 cabinet, hole size 9 1/4" x 10 3/4", oblongs horizontally. Carl Ridehoover, PO Box 6161, Macon, GA 31208. (912) 745-6939

WANTED: 7" & 10" TV's. Emerson 614 10" TV. Knobs for a Garod 930TV. JVC Videosphere with clock. Tony & Lynn DeMara, 40231 Day, Clinton Township, MI 48038-4739.

WANTED: Restorable pre-1910 Black Forest cuckoo & trumpeter clocks. Have radios to trade. Darrell Combs, 6587 Pacheco Way, Citrus Heights, CA 95610. (916) 969-0635

WANTED: Delco transistors: #DS-74, 1222501. Fred Cranshaw, 1624 Bitter Ck., Garland, TX 75040. (972) 494-4099

WANTED: Mint Radiola 60; Radiola VIIIB cabinet, any condition. William Boyd, 74 Atsion Ct., Medford, NJ 08055. (609) 722-2369

WANTED: Wimshurst and Holtz rotating disk static machines, Crooke's and Geissler tubes, old electrical stuff. Louie Scribner, 1415 West Leigh Dr., Charlottesville, VA 22901. (804) 977-5521. E-mail: ls@virginia.edu

WANTED: Crosley radio console sales Model 989, Chassis #926. Will buy whole console or just the guts/electronics. Chris Swanson, 335 Poage Farm Rd., Cincinnati, OH 45215. (513) 521-2296, evenings, or (513) 421-4809, during the day. Fax: (513) 421-1942

WANTED: Volume control & switch for RCA T-80 Part No. 84304-36 Stock No. 33512. Frank Waskiewicz, 143 Carl's Path, Deer Park, Long Island, NY 11729. (516) 667 3269

WANTED: Radio-Craft, 2/43; Practical Electrics 11/ '21; 12/21; send for my mile-long want list. Goldman, 3 Amy Ln., Queensbury, NY 12804

Announcing a new On-Line Service:

The On Line Radio Trader

This service provides a monthly source of
COMPUTER-SEARCHABLE ADS
for antique radio collectors.

Use your computer to search the ads for
radio makes and models of interest. Visit
our Web Site for more details.

Suggestions for making this site more useful
to collectors are welcome.

THE ON LINE

RADIO TRADER

Providing computer-searchable ads for radio collectors

OLRT
P.O. Box 862 Broomall, PA. 19008-0862

<http://members.aol.com/OLRTmag/main.htm>
Email: OLRTmag@AOL.com

FOR SALE: (10) table radios, no junkers - \$150. Books: Bunis 1 - \$40; Phil Collins 1 & 2 - \$22; Sideli - \$40; Poster 2, Johnson, Bunis Trans. 1 - \$10 ea. New Photo Catalog, large inventory - \$1 + LSASE 2 stamps. Many sale items. Bob Masterson, Box 172, Valley Cottage, NY 10989. (914) 353-3151

FOR SALE: Fisher 600, uses (4) 7189 tubes, exc., wks. - \$150. Kenwood KW 44, uses (4) 6BM8 tubes, exc., wks., OB - \$125. Mitsubishi HS 330 UR VHS, with manual, n. wk. - \$20. Teac 450 stereo cassette deck, with manual, n. wk. - \$20. Ron McClellan, 201 W. Boot Rd., West Chester, PA 19380. (610) 363-5637

FOR SALE: Book Wireless Telegraphy by A. Frederick Collins, 1905. The author's personal copy with corrections for future editions, got from his daughter, worn but complete. William G. Turner, W2WV, 1243 Oakview Ave., Clearwater, FL 34616. (813) 447-7707

FOR SALE: Hickok color bar gen. 246. Photofacts 1-1709, tubes, RCA & Syl. modules. Ann Bichanich (Jay's), 15 1/2 W. Lake St., Chisholm, MN 55719

FOR SALE: Zenith R7000-1 Trans-Oceanic radio, with manual, chassis 18ZT40 manual, earphone and Royal tag - \$250. Rudy G. Purcell, 4473 W. 136th St., Cleveland, OH 44135. (216) 251-6511

FOR SALE: Old Vibroplexes, lightning and original. Zephyr 6TR394, green - \$40. Capehart Model 25NZ - \$300. Claude Chafin, NØFMO, 4223 E. 42nd Way, Independence, MO 64055. (816) 478-4518

FOR SALE: Radio Boys First Wireless, outside spine faded - \$10 + postage. Earle Drake, Box 1808, Hyannis, MA 02601

FOR SALE: Miniature Crosley and Addison repros - \$14 ea. Zenith Mod 3000 T-O - \$50. All plus shipping. Franklin La Barbara, 13 Lauriston St., Providence, RI 02906. (401) 751-1215

FOR SALE: Deco Bakelites: Zeniths 6D312, 6D311 - \$100 ea. Truetone D2661 - \$50. Farnsworth bullet - \$85. Mark Thomquist, 45 Second St., Glens Falls, NY 12801. (518) 761-4143

FOR SALE/TRADE: Revox A-77 recorders, vg - \$250 ea. WANTED: Microphones: Sennheiser 416, ME-80 w/K3U, Sony ECM-77B. Jay Myers, 1010 Graybar Ln., Nashville, TN 37204-3213. (615) 297-5886

FOR SALE/TRADE: Bonzo paper-maché, some repainted. Harvey Wells ant. tuner radio-related toys. Bob Fuschetto, 1758 Michael Dr., Whitehall, PA 18052. (610) 435-8944, call between 7-9 pm

FOR SALE: 1950 Emerson 662B 14" TV in mint Deco Bakelite cabinet - \$60. Clock radio clearance: Philco 50-527 white, Truetone Wizard brown, Panasonic 720 white, all work, all 3 for - \$55. Eureka Model G 1930's vacuum cleaner, mint working - \$28. All plus S&H F.O.B. Swarthmore. Sam Mannino, PO Box 233, Swarthmore, PA 19081. (610) 353-6747

FOR SALE: Zenith 7-S-363 wood console, black dial - \$195. Kenwood R-300 multiband - \$150. Grundig TR-307 - \$75. All plus shipping. Gerald Silver, 10863 W. Clairmont Cir., Tamarac, FL 33321. (954) 720-1972

FOR SALE: Fourteen old radios; good cond. and 1955 Seeburg, excellent. SASE to: Don Scher, 3705 57th Ave., Vero Beach, FL 32966. (561) 562-5149

FOR SALE: N.O.S. tubes 1D21 - \$12. 56-ST - \$2. 931-VA - \$15. Matched prs. 12BY7-A - \$12. 6189-W - \$3. 2050W - \$8. Volume discounts available on tubes listed next, call, fax, write for prices min. 10 ea.: 12AW6 - \$1; 9001 - \$1.25; OD3-6AC7-6GF5-1LH4-6005W - \$1.50; 6F5GT-6BU8 - \$2.50; 6F4-6EV5-5842 - \$4 ea.; 3B24WB-6EU7 - \$8 ea. Many sub-min. avail. Call, fax, write for information. SASE for tube list. Kirk Cline, 1818 Walker Ave., Greensboro, NC 27403-1760. Ph./fax: (910) 379-7197

300+ STALLHOLDERS
will be exhibiting at the Christmas
**National Vintage
Communications Fair**

Hall 3 • WEMBLEY (London) • UK
• Sunday 1st December 1996 •
10.30am - 4pm

Britain's premier event for buying

VINTAGE
RADIOS,
EARLY
TVS, and
GRAMS

etc. etc.



15
Pre-WWII
TV's For Sale
at Show

For further details/bookings:
NVCF, 2-4 Brook St, Bampton, Devon, ENGLAND
Telephone: (01398) 331532

NEW HI QUALITY

CAPACITORS

Volt 630 Axial Leads

| Value (UF) | *Price/25 |
|------------|-----------|
| .001 | \$ 6.00 |
| .0047 | \$ 6.25 |
| .01 | \$ 6.50 |
| .022 | \$ 7.00 |
| .033 | \$ 7.25 |
| .047 | \$ 7.50 |
| .1 | \$ 8.00 |
| .22 | \$ 15.00 |

SPECIAL

Volt 630 Radial Leads

| Value (UF) | *Price/25 |
|------------|-----------|
| | \$7.00 |

ELECTROLYTICS

| Volt 160 Axial Leads | | Volt 450 Axial Leads | |
|----------------------|-----------|----------------------|-----------|
| Value (UF) | *Price/25 | Value (UF) | *Price/25 |
| 22 | \$16.00 | NEW 10 | \$18.75 |
| 33 | \$21.00 | 22 | \$28.00 |
| 47 | \$24.00 | NEW 47 | \$45.00 |

To order, send check or money order to:

BOB'S ANTIQUE RADIOS

111 East 29th St., LaGrange Park, IL 60526
Telephone: (708) 352-0648 Fax: (708) 352-0647

*** Satisfaction Guaranteed ***

*Sold in 25 piece lots only. S&H included in price.
Ask about super bulk rates. Wholesale

This Holiday Season, Give a Gift To a Friend... Or Treat Yourself !!



-
- Subscriptions Center Coupon
 - Books & Videos..... pgs. 33, 54, 55, 57, 97-105
 - Gift Subscriptions pg. 66
 - New Item: The Collector's Guide to Antique Radios,
4th Edition..... pg. 33
 - Back Issues (*Great for new subscribers*)..... pg. 44
Full Calendar Year of Back Issues - only \$24!
-

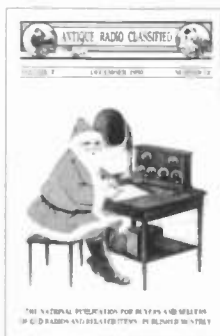

Antique Radio Classified

Is Your
Gift Source !!

— Call Us At (508) 371-0512
or Fax Us At (508) 371-7129



FOR SALE: RCA 40X56 World's Fair - \$800. Crosley 11-102U, green, missing one knob - \$75. Zenith 808 tombstone - \$225. Zenith 5-S-29 tombstone - \$125. Zenith 5-R-216 - \$60. Zenith 6-D-512W - \$60. Zenith 6-D-614 - \$25. Truetone D2018 Boomerang, hairline on side, otherwise excellent - \$80. Emerson 356, Ingraham cabinet - \$125. Bendix 0526E - \$40. Crosley 52 - \$75. Crosley 163 - \$60. Radiola IIIA - \$100. Radiola 60 - \$100. Radiola 18 - \$40. Clarion 420 - \$40. Gary Watkins, 8006 Greenwald, Belton, MO 64012. (816) 322-0773

FOR SALE/TRADE: Standardyne one-tube set with good Emerson multi-valve tube, nice original - \$1,000. Ed Bell, 5311 Woodsdale Rd., Raleigh, NC 27606. Fax/ph.: (919) 851-1517

FOR SALE: Atwater Kent 60C chassis, excellent condition - \$65. Atwater Kent 35, no tubes - \$25. Bosch 48, fair condition - \$45. Cleveland/Acme 7-tube table radio, mid-20's, all orig. - \$95. Ken-Rad 826 tubes, new - Best Offer. Phil Van Praag, W282 S3580 Kingneck Ct., Waukesha, WI 53188. (414) 524-9856

FOR SALE: N.O.S. transistor radio leather cases. SASE or e-mail for list. Pete Hittle, 5415 Bushnell Ave., Sioux City, IA 51106-3834. (712) 276-2316. E-mail: phradio@aol.com

FOR SALE: New list of magazines, paper, and books - SASE. Merrill Bancroft, 169 S. Row Rd., Townsend, MA 01469

FOR SALE: Bogen mic mixers: E-30, M330A, MX30A. Oetrola 393, Philco 40-130, both excellent. Philco 37-610 (Deco, plays) - \$70. Wilbur Gilroy, 129 Belmont Ave., Clarks Green, PA 18411. (717) 586-7356

FOR SALE/TRADE: Stereo reels, send list. **WANTED:** Uher SR3 reel-to-reel, 74B Tandberg, or 62X. Pilot small cabinet consoles. Jim Addison, 180 Horseplain Rd., A-1, New Britain, CT 06053. (860) 223-5141

A.R.C. BACK ISSUES

April '87 to current issue: Originals available 32 to 100 pages each.

Oct. '86 to Mar. '87: Reprints available
Reprinted from original artwork; 28 to 32 pgs. ea. Quality & appearance same as an original copy.

June '84 to Sept. '86: Photocopies available
Not original quality, useful for info.; 16 to 28 pages each.

Publication of *Antique Radio Classified* began in 1984 which had only five issues: June, Sept., Oct., Nov. & Dec. 1984. 1985 through current year have had 12 issues each.

\$4.00 each - Postpaid to U.S., Canada and Mexico.

Orders of 6 issues or more may take a 10% discount. Orders for a full calendar year may take a 50% discount. Foreign orders other than Canada and Mexico: \$6.00 each by air. Mass. residents, please add 5% sales tax.

A.R.C. UN CUT, UNFOLDED COVERS

June 1991 to the present
9.25" x 12.5" - \$9.95 each

Postpaid to U.S., Canada, & Mexico
Mass. residents, please add 5% sales tax.

Send Order To:

A.R.C., P.O. Box 2, Carlisle MA 01741
Or Call (508) 371-0512



FOR SALE/TRADE: The "Prohibition Radio" as seen on p. 167 (new Bunis 4). This Pla Pal radio w/chrome grille has secret compartments on each side with original liquor bottles and (6) shot glasses. The compartment on top conceals vintage poker chips and deck of cards. Considering the overall size of this radio, you would never suspect it had secret compartments; it's beautiful and rare, asking - \$850. Larry Drago, 383 Lincoln Dr., Cheshire, CT 06410. (203) 272-6030

FOR SALE: Radiola 24, complete, works, vg leather case, vg chassis, NT - \$450. Radiola 26, nice, works very well, with fet tubes - \$400. Aeriola Jr., good Perikon detector, paper - \$425. Loop antenna, double rectangle, new green litz, vvg - \$140. AK-20C Model 7570, (see Grinder #2, p. 127), vvg cabinet and chassis, tags, NT - \$200. AK Model H hom, nice, works - \$125. RCA Photomultiplier tube - \$15. 1939 Motorola Airboy, small battery-powered aircraft radio, good, WT - \$35. Dictogrand hom, vg, works - \$165. Weston foot candle meter, Model 914, vvg, works - \$25. Hickok Type 533 tube tester, good, works - \$35. Heathkit GR-98 air traffic control receiver, 108-135 MHz, vvg, works - \$40. 1957 Westinghouse H-602P7, vvg, works, old type transistors - \$55. Brandes Superior headset, vg - \$15. Please add postage. Richard Botzum, RD2, Box 419, Morgantown, PA 19543. Phone: (610) 286-0047. Fax: (610) 296-5315

FOR SALE: Novelties: Victor, RCA, Edison & others. Nipper 6" bank, 1930's, heavy metal - \$150. Nipper Victor chalk dog 6" high with name on base - \$70. Nipper and phonograph on stamped oval tray - \$35. Cast iron Nipper bank facing phonograph - \$75. Nipper dog salt & pepper shakers, porcelain, w/Radio Corp. of America stamped on base, w/cork stoppers - \$95. Nipper S&P shakers, porcelain, no name on base, w/cork stoppers - \$75. S&P shakers Nipper, smaller than previous line, and phonograph, porcelain, w/plastic stoppers - \$50. Nipper and dog on 8 1/4" lead framed glass sun catcher - \$75. Jeanette small glass candy holding "Tune in" radio w/signet hom, 1920's - \$75. Glass locomotive container with cap on end, holding original candies - \$50. Old railroad lantern w/cap and candy still inside - \$50. Cradle-type telephone, w/candy inside - \$50. Edison items from Library of Congress, 1978, 100 year exhibition. Plus shipping. Many other items, write for list. Include LSASE w/55¢ postage. J.J. Papovich, 53 Magnolia Ave., Pitman, NJ 08071. (609) 582-8279

FOR SALE/TRADE: Emerson Wondergram transistorized coat-pocket phonograph - Offers? Perfect ivory Trancel TR80 - \$160. Trancel 6TP-348 - \$150. N.I.B. Orion TR8A7, flawed - \$35. Other undepainted transistors, call. **WANTED:** Admiral 7L12, Zenith R555, Hitachi TH666, solar transistor radios. Arvin 8576. Pen/ radio novelty. Swap transistors for Catalins. Don M. Maurer, 29 S. 4th St., Lebanon, PA 17042. (717) 272-2481

FOR SALE: RME #45 receiver, not working, not stripped - \$75. Hoover Noonan, Rt. 1, Box 187, Pineland, SC 29934. (803) 726-5762

FOR SALE: Fisher Ambassador AM/FM stereo console Model A69, 200 watts, includes record changer - \$35 PU only. H.H. Scott 299C stereo amplifier, 40 watts per ch.; H.H. Scott Stereomaster wideband FM multiplex tuner, both units - \$50 plus shipping. Charles Moran, 124 Edgewood Ave., Clifton, NJ 07012. (201) 779-2853

WANTED: Varicap, tuning diode, Type FV1010 15pf 4.15v. I need cross-reference to another company, maybe I can find substitute. Heath #56-77. William G. Turner, W2WV, 1243 Oakview Ave., Clearwater, FL 34616. (813) 447-7707

WANTED: Hammarlund or Bruno 4-pin plug-in coils. Dick Lowe, Box 296, Santa Clara, CA 95052-0296. (408) 984-1555

WANTED: Crystal sets, collection now at (388) pieces; seeking more. Erwin Macho, Ambrosweg 17/A/8, A-1230 Vienna, Austria

WANTED: Operating instructions, copy: EICO 950B resistance capacitance comparator, also Supreme 504A tube tester. James J. McGrath, W2IQJ, 2 Centerview Ln., West Seneca, NY 14224-2124. (716) 675-0160

WANTED: ARRL handbooks, late '30's to early '60's in good condition. Diego Calut, 630 South Park Rd., Apt. 3-16, Hollywood, FL 33021. (954) 962-1652

WANTED: Band selector knob, Part# 15A-047, for Hallcrafters SX-62, has (2) set screws. Ed Kalpa, 4622 Melbourne Ave., Los Angeles, CA 90027. (213) 661-1221

WANTED: Power transformer, Thordarson P/N T56R01 or Stancor P1503. Call collect: Robert J. Goad, 8441 Flagstone Dr., Tampa, FL 33615-4915. (813) 885-1258

WANTED: Record changers: Collaro Conquest stereo 4-speed as used in 1962 Magnavox; Seeburg or similar 78 rpm, two-post type as used in various 1940's R/P. Changers must work! Rider's Volume XX. Service literature and operators instructions for Ampro 16mm sound projector Premier 20. Wilcox-Gay wood table model Recordio Model A-85, circa 1940. **FOR SALE:** Victor RE-45, cabinet only - \$30. Doug Hershberger, 101 Columbia Dr., Williamsville, NY 14221. (716) 632-2662

WANTED: Asseen at K... tape for German Westrex 11... Audio Imports, Ltd., 663 Fairview, (818) 447-3117

WANTED: Working Grundig 4192, cos. important. Merry Christmas to all. Ed Kalpa, Melbourne Ave., Los Angeles, CA 90027. (213) 6-1221

**FAX NUMBER FOR
ANTIQUE RADIO CLASSIFIED
(508) 371-7129 - 24 hours a day
Ads - Subscriptions - Book Orders
See inside front cover for details**

WANTED: 6SN7GT Tung-Sol; 6SN7GTB: Sylvania, Japanese Raytheon; 5692 RCA-Raytheon red base; 6L6GC; 5751. Robert Koerner, NY11, 8910 N. Camino de la Tierra, Tucson, AZ 85742. (520) 742-6130

WANTED: Bendix radios, ads, signs, etc. Radios need not work. Aaron Mall, 903 Dropleaf Ct., Baltimore, MD 21208. (410) 486-8813

WANTED: Working reel type tape recorders, especially '60's VOM. Joe Andrews, 206 Sycamore Dr., Florence, SC 29501. (803) 662-7285

WANTED: GE K60 and K64 cathedrals; escutcheons for 1934 Motorola S-10 Lazy Boy remote. Richard Arnold, Box 275, Lone Grove, OK 73443. (405) 657-3319

WANTED: Navy transmitters: TCA, TCE, TCX. TBW 800 cycle power supply. TBM modulator CAY-50064. Steve Finelli, 37 Stonecroft Dr., Easton, PA 18045. (610) 252-8211

WANTED: Heath WA-1A, W-2M amplifiers; rough singles OK. Sams AA-6, AA-10, AA-11 (to \$35). Doc Waterman, 800 Walavista Ave., Oakland, CA 94610-1150. (510) 465-5757, days

ANNOUNCING

Tube Lore

A REFERENCE FOR USERS AND COLLECTORS

By Ludwell Sibley

For serious tube users, collectors, and admirers, a new look into tubes from 1920 to the present: history of design trends, tech data, equivalencies, stocking-up hints, even prices. Here's what it contains:

- **Trends in Tube Design** - major styles that shaped the industry - acorns, metals, loktals, miniatures and subminiatures, lighthouse, nuvistors, compactrons. Includes odd design variants and special "reliable" types.
- **Receiving and Audio Tubes:** "prehistoric" types from 25 tiny manufacturers as well as the big guys. Information on a lot of collectible tubes in one place. Basic data on lots of later types not found in ordinary tube handbooks, and early CRTs.
- **Special-Purpose and Transmitting Types** - covers the familiar ones and lots of unknown types. "Regular" tubes, plus magnetrons, klystrons, thytrons, ignitrons, camera tubes, etc. Capsulized characteristics on 2300 "specials" from 5512 to 9019. Helps identify that just-found "whatzit." (Everybody knows a 6922 is a premium 6DJ8, but what about the 7308?)
- **Military Types:** a researched and insightful list of Signal Corps "VT" tubes; the biggest list yet seen of Navy type numbers; coverage of Canadian "REL" tubes.
- **Unique Types of major makers:** De Forest, Eimac, GE, Raytheon, RCA, Sylvania, Western Electric, Westinghouse.
- **User's Guide:** ideas on testing, adapting, repairing, reactivating, reading date codes, detecting the real maker of private-brand tubes, turning random lots into usable repair stock.
- **TV Sweep Tubes:** what tubes are used in eight audio amps and 78 amateur transmitters/linears; hints on substituting as the originals get scarcer and more expensive.
- **Auction Prices:** for collectible and audio tubes, from six major sales.

Contains 186 pages, 8-1/2" x 11" softbound. Price, postpaid: \$19.95 in North America; \$24.95 elsewhere. Orderable from:

Ludwell Sibley
44 E. Main St.
Flemington, NJ 08822

Discounts available to clubs on group orders.

Germany, auction, cassette
portable radio, tape player,
Arcadia, CA 91007
tel: 622
4622
661

s remote sprk/
12 & 15", bi-
ono control unit.
tion on request.
3. VM Model 722
ics Model 242MML
-\$125. Alan Graves,
5. (541) 345-3991
J: RCA 2A3 - \$15; 2A5
26 RCA & Sylvania - \$6
nisc. #27 - \$6 ea.; (5) #45:
/vania ST's - \$40 for all.
6L6 metal - \$22 pr.; RCA
; #417 GE new & Bogen used
- \$20 pr. C.J. P... 1440 Stafford Rd., Storrs/
Mansfield, CT 06268. (860) 429-4416, 7-9 pm

N.O.S.
6L6GC fat box...; #417 GE new & Bogen used
- \$20 pr. C.J. P... 1440 Stafford Rd., Storrs/
Mansfield, CT 06268. (860) 429-4416, 7-9 pm

FOR SALE: Small lot of Heathkit catalogs. SASE for description. Mark Anderson, RD 1, Box 58A, Greenwich, NY 12834. (518) 692-2593

FOR SALE: Brownings: Model 2 & MKIII - BO. Philco 49-1401 Deco (Bunis 2) - \$89. Hickock 600 tester - \$29. R. Taylor, PO Box 10503, Bradenton, FL 34282. (941) 751-1072

FOR SALE: Crystals and Tubes - A History of Radio Receiving in the 1906-1918 Period; just released Crys Tech publication covers the sometimes overlooked evolution of pre-broadcast era receiving, following the establishment of practical wireless communications, 92 pages - \$10 ppd in the U.S.A. Crys Tech, c/o P.A. Kinzie, PO Box 6805, Kingman, AZ 86402

FOR SALE/TRADE: Grebe RORK - \$675; CR3 and RORD - \$2,450. All nice original. Good audios. Ed Bell, 5311 Woodsale Rd., Raleigh, NC 27606. Fax/ph.: (919) 851-1517

FOR SALE: Toshiba 7TP-352M, new in the box, exc cond. - \$150. Mascot II, boys radio with concentric circles, ivory in box with antenna, exc cond. - \$165. Trancel 77M-312S, beautiful in leather case, exc cond. - \$60. Trancel TR-80 ivory, exc cond. - \$135. Sony TFM-121, exc cond. - \$50. General Electric 677, vg - \$90. Regency TR-1, black, exc cond., leather case - \$425. Please add postage. Thanks. Kay Botzum, RD2, Box 419, Morgantown, PA 19543. Phone: (610) 286-0047. Fax: (610) 296-5315

FOR SALE: Scott Radio Labs Model 800B 2-piece AM/SW/amp, heavy chrome chassis, motor drive, etc. with final inspection sticker dated 10/46. Best offer within 10 days. Call evenings until 9:30 CST for details. Phil Van Praag, W282 S3580 Kingneck Ct., Waukesha, WI 53188. (414) 524-9856

**TUBES WANTED
HIGHEST PRICES PAID \$\$\$**

W.E. 101F, 205D, F, Tennis Ball, 274B, 300B, 211, 845, K766, 77, 88, EL34, PX25, 280, 245, 250, Telefunken, Mullard, Bugle Boy ECC81, 82, 83, 801S, 802S, 803S.

-AUDIO EQUIPMENT WANTED-

McIntosh, Marantz, UTC, W.E. Trans, Black Beauty, A & B Resistor, etc.....

FULL RANGE ELECTRON TUBE SHOP

Jonathan Woo
Flat B, 37/F, Block 5, Greenfield Garden,
Tsing Yi, Hong Kong
Tel: (852) 24349466 Fax: (852) 24344963
<http://www.jeis.com/~fullrang/>

FOR SALE: Set of (4) rosette knobs for Philco 90 or 70 - \$30/set. John Schehrer, 508 Gray, Joplin, MO 64801. (417) 781-4028

FOR SALE: Tubes for sale. Larry Cook, 362 E. South St., Richland Center, WI 53581-2721

FOR SALE/TRADE: Zenith 15U269 - \$1,300; 12S265 - \$575. Both nice originals. WANTED: Philco 42-1016. Eddie Burris, 2905 W. 27th Ter., Lawrence, KS 66047. (913) 841-4174

FOR SALE: Zephyr ZR-930, very fine - 50% of Bunis price or trade for Crosley E15BE. John O'Connor, 5805 Elm St., Omaha, NE 68106. (402) 556-1150

FOR SALE: National NC 88, plays, vg - \$65 plus UPS. Kenneth Miller, 10027 Calvin St., Pittsburgh, PA 15235. (412) 242-4701

FOR SALE: LSASE for list of radios, equipment, books. Doyle Roberts, HC63, Box 236-1, Clinton, AR 72031

FOR SALE: All parts from RCA Victor VR-54, Motorola 61-C, Marconi 40's 4 tuber. Dirk van Oudenol, 35469 Stafford Pl., Abbotsford, British Columbia, Canada V3G 2C7. (604) 850-0763

FOR SALE: Browning Eagle w/mic - \$180. Stromberg-Carlson amps: #37 - \$35; #8-80 (stereo/tube) - \$90. Ampex: (2) reel-to-reels - \$200 & \$50; plus Ampex 622 speaker/amp, beaut. - \$225. B&K 707 tube tester - \$115. Zenith T-O 1000 - \$75. (2) globe 484's, good - \$15 ea. Zenith Service Manual & price list reprints, 1929-1938 - \$2/model + LSASE. WANTED: Hitachi ES-90H speaker box, red or white; companion tuner to Heath AA-151 int. amp. Thanks. Michael L. Hagan, 428 Sharron Dr., Waco, TX 76712. (817) 776-4760

FOR SALE: Crosley JM-8BG hybrid - \$100. Hi-Delity 6T250 in box, blue, reverse paint, back cracked - \$40. Gary Watkins, 8006 Greenwald, Belton, MO 64012. (816) 322-0773

FOR SALE: Tubes: 45, N.I.O.B. - \$70; 245/345 (U) - \$50; 2A3, N.I.O.B. - \$50; 2A3 (U) - \$25; 807 (U) - \$5; 829 (U) - \$5; WD12 (U) - \$75; 6A3, N.I.O.B. - \$25. Arcturus Blue 124, 126, 127 (U) - \$20 ea. Plus shipping. J.J. Papovich, 53 Magnolia Ave., Pitman, NJ 08071. (609) 582-8279

FOR SALE: Westinghouse H126 - \$35. Sonora bedlamp - \$60. Televisions: Admiral Bakelite console - \$200. RCA 8X230 - \$60. Don M. Maurer, 29 S. 4th St., Lebanon, PA 17042. (717) 272-2481

FOR SALE: Trancel 6TP243 - \$35. Channel Master 6516 - \$35. (50) others. Paul Steingel, 2153 10th West, Seattle, WA 98119-2844. (206) 284-8412

FOR SALE: About (15) Catalins: Bullets, Temples, Bendix, Commander, RCA, Kadette, DeWalds, a few with minor damage. Also Coronados, beetle, Candy Cane, Emerson and Silvertone midgets, Blue Rainbow, Zenith Crest, several transistors. Also, Tandberg tube tape-deck Model 6, Cleveland neon clock, Lackner Catalin neon-glo clock, Catalin mah-jongg sets, poker chips and racks, Reddy Kilowatt N.O.S. pins and charms, rare Flintstone Rubbles cookie jar. Ted Chronister, 7073 Carlisle Pike, #26, Carlisle, PA 17013. (717) 766-6436

FOR SALE: Photocopy of original Paragon DA-2, 4 pg. booklet - \$2.50 + LSASE. J.C. Woychowski, 81 Penn. Ave., Niantic, CT 06357. (860) 739-6579

Radio Restoration Parts

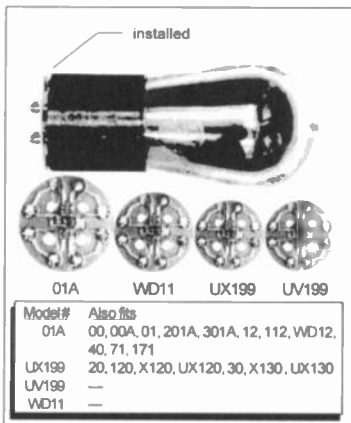

Vacuum Tube Repair Wafers

These tube repair wafers are solid-state devices for quick and easy repair of early vacuum tubes. The wafer is installed by simply sliding it over the tube pins and reinserting the tube into its socket. If the filament is intact, but there is little or no emission, the filament may be lit for best visual effect. However, the tube can be open filament.

No change in radio operating voltages is required. Any number of tubes may be repaired in a radio. If wafers are installed on all tubes, the B+ voltage may usually be reduced without sacrificing volume or sensitivity. Performance will vary between radio models.

\$16.00/each (\$7.50/ea. 3 or more)

New Atwater Kent Breadboard Switch

Exact replacement for Models:

9 • 9C • 10 • 10A • 10B • 10C • 12

and all additional models with board mounted switch.

Newly manufactured under high pressure heat from the same type brown thermoset resin used in the original. Beryllium copper spring contacts are used for long, trouble-free life. Custom built knurl is used to exactly reproduce the original.

\$50.00/each

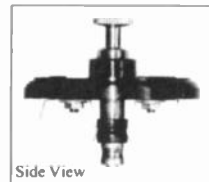

Side View

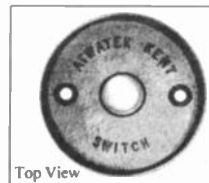

Top View

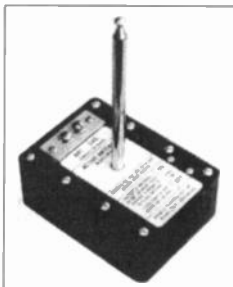

Active Antenna

Allows antique radios which were designed for a long wire outdoor antenna to operate on a 42" indoor whip antenna. Portable, operates from a 9 volt battery.

Only \$34.95

Order from: PTI, 7925 Mabelvale Cutoff, Mabelvale, AR 72103

Orders shipped UPS, prepaid in continental U.S. Please allow 3 weeks for delivery.

Arkansas residents add 5.5% sales tax.

To Order: Call (501) 568-1995



FOR SALE: 78 rpm records, mostly big band. SASE for list. Robert J. Stone, 721 Fisk St., Piqua, OH 45356-3729. (513) 773-2217

FOR SALE: Edison Model C-4 Light-O-Matic radio phono console - \$500 plus packing and shipping or you pick up. Frank D. Atwood, Nostalgia Radio, 117 E. Main St., Merrimac, MA 01860. (508) 346-8100, or fax (508) 374-1030

FOR SALE: Lafayette HE-20A tube-type CB - \$20 plus S&H. Also Echophone EC-1B - \$25 plus S&H. Both work. Loren H. Dudley, 14 Valley Rd., Bath, ME 04530-2811. (207) 442-8419

FOR SALE: (83) novelty radios, some rare, package deal only, worth \$2,500, sell - \$1,500 firm. Send lg. SASE for list. Jim Downes, 607 E. 12th Ave., Covington, LA 70433

FOR SALE: Magazines 35¢ each plus shipping. Sold only in lots indicated by (). Popular Communications Vol. 1 No. 1 - Oct. '94 (145 issues), Radio Electronics '51-'81 (182 issues), Radio & TV News '50-'58 (65 issues), Electronics World '60-'71 (85 issues), Elementary Electronics '69-'81 (27 issues), Ham Radio '81-'87 (36 issues), Shortwave (British) '88-'91 (13 issues), Practical Wireless '88-'89 (10 issues), Monitoring Times '88-'93 (57 issues). Mike Bittner, 27215 Sunnyridge Rd., Palos Verdes, CA 90274. (310) 377-4797

FOR SALE: Sams Photofact Series on Auto Radio repair, Tape Recorder repair, and Transistor Radio repair, approx. 100 volumes each - \$5 single copies; \$3 ten or more plus shipping. A.W. Gray, Rt. 3, Box 753, Troup, TX 75789

FOR SALE: Mikes, EV605, EV613, EV915, Shure S32D, Astatic D-104, JT-20 (no stand) - \$200 all plus ship, OBO. Doyle Roberts, HC63, Box 236-1, Clinton, AR 72031. (501) 745-6690

FOR SALE/TRADE: McIntosh MC225 - \$950. C24 - \$400. C8 - \$150. Dynacos: ST35 - \$175; (6) ST70's - \$275 to \$375; ST120 - \$100; MKII - \$225; (4) MKIII's - \$275; (6550) - to \$375; (KT88) EA, MKIV - \$275; PAS2 & PAS3 - \$150 to \$200; (3) FM3's - \$90 ea. Scotts: LK-150 - \$975; LK72 - \$350; (2) LK-48B's - \$200 ea.; (2) 340B's with cabinets - \$225 ea.; 310E - \$350; LT-10 with multiplexor - \$200. Wharfedale 70's - \$350. Bozak Symphonys - \$950. Bozak raw drivers, inquire. Peter F. DeGregorio, 45 Moritz Pl., Fairfield, CT 06430-3527. (203) 331-9155

FOR SALE: Heathkit, rarest of the rare, HX-11 transmitter, repackaged DX-20, almost mint, manual - \$175. Sam Hevener, W8KBF, 3583 Everett Rd., Richfield, OH 44286. (216) 659-3244

FOR SALE: Volumes 1-22 John F. Rider's manuals, very good condition - Best Offer. F.O.B. Donald R. Clark, 550 West Pacific, Blackfoot, ID 83221. (208) 785-1430

FOR SALE: Radiola 16, good playing condition with tubes - \$150. RCA Model T-64, restored condition - \$125. Frank Waskiewicz, 143 Carl's Path, Deer Park, Long Island, NY 11729. (516) 667-3269

FOR SALE/TRADE: Zenith Trans-Oceanic H-500, exc playing condition - \$85 or nice novelty or pocket transistor. Paul Fulton, 711 Jacquelyn Rd., Westwood, NJ 07675. (201) 664-5260

FOR SALE: Navy Radio TCO-1, GRR5, BC-342, parts unit Cushman CE-3, R-390A, trade R-220 URR w/PS. SP600JX-26, BC-1031 panadapter, DAK DF set trade. Steve Bartkowski, 4923 W. 28 St., Cicero, IL 60650. (708) 863-3090

FOR SALE/TRADE: For audio tubes: Hallicrafters 1000 - \$50. Zenith Trans 5H40 - \$30. Iher tape rec., mint - \$100. Bill Miller, 3410 Hunnicutt Ln., Sacramento, CA 95821. (916) 489-1703

NEW AND USED TUBES WANTED

We urgently need the following tubes. All tubes must be well known brands such as GE, RCA, Sylvania, Tung-Sol, Philips, etc. of U.S. or W. Europe manufacture. New tubes must be in their original boxes. All tubes are subject to inspection. Ship by UPS (ground); we'll mail a check to you upon receipt and testing at prices shown plus your shipping charges. Call or fax for buying procedures and complete bid list. Call before sending more than 10 pieces of one type of tube.

NEW TUBES

| | | | | | | | | | |
|-------------|--------|-----------|--------|------------|--------|----------|---------|-------------|---------|
| 01A | \$9.00 | 6F6G | \$5.20 | 12BH7A | \$5.10 | 274B(WE) | \$85.00 | 6146B/B298A | \$12.00 |
| 1L6 | 8.50 | 6G5/6U5 | 8.00 | 12DW7/T247 | 9.00 | 275A(WE) | 85.00 | 6267/EF86 | 6.00 |
| 2A3 | 24.00 | 6K5G | 5.00 | 20LF6 | 16.00 | 300B(WE) | 250.00 | 6550/A | 12.00 |
| 2B6 | 6.00 | 6KD6 | 15.00 | 26LX6 | 6.00 | 350B(WE) | 100.00 | 6550 (ST) | 34.00 |
| 5R4GY/A/B | 3.40 | 6LGC | 8.40 | 35LR6 | 6.00 | 623 | 35.00 | 7189/A | 5.30 |
| 5U4G | 6.70 | 6LB6 | 7.50 | 45 | 30.00 | 808 | 16.00 | 7591A | 20.00 |
| 5V4G | 4.70 | 6LF6/6MH6 | 18.80 | 50 | 110.00 | 805/331A | 32.00 | 8005 | 50.00 |
| 5Y3G | 3.80 | 6V6 | 6.00 | 71A | 8.20 | 845 | 80.00 | 8068 | 20.00 |
| 6BK4C/6EL4A | 8.00 | 6V6G | 6.50 | 80(ST) | 5.60 | 864 | 5.00 | 8908 | 27.50 |
| 6CA7/EL34 | 11.00 | 10 | 25.00 | 211(VT-4C) | 35.00 | 5691 | 15.00 | 8950 | 25.00 |
| 6F5G | 5.80 | 12A | 11.00 | 274A(WE) | 110.00 | 5692 | 18.00 | M-2057 | 32.00 |

USED TUBES

| | | | | | | | | | |
|-----------|--------|-----------|---------|------------|--------|------------|---------|-------|---------|
| 01A | \$5.00 | 10 | \$16.00 | 171/A | \$7.00 | 245 | \$23.00 | 845 | \$31.00 |
| 2A3 | 12.00 | 12A | 7.00 | 183/483 | 9.30 | 246 | 11.00 | 7591 | 8.60 |
| 5AR4/GZ34 | 6.00 | 20LF6 | 7.30 | 210 | 20.00 | 247 | 8.00 | 8417 | 8.50 |
| 6B4G | 6.50 | 42(GLOBE) | 8.00 | 211(VT-4C) | 14.50 | 250 | 65.00 | 8950 | 12.30 |
| 6LF6/6MH6 | 9.20 | 45(VT-52) | 25.00 | 230 | 6.20 | 280 | 12.00 | V201A | 6.50 |
| 6V6G | 2.10 | 45 | 11.00 | 237 | 8.50 | 282 | 8.00 | WD-11 | 35.00 |
| | | 50 | 80.00 | 240 | 8.50 | 401-CARDON | 9.80 | WD-12 | 24.00 |

ANTIQUE ELECTRONIC SUPPLY™

LIMITED PARTNERSHIP

8221 S. MAPLE AVE. • TEMPE, AZ 85283 • (802) 820-5411 • FAX (802) 820-4843 or (800) 708-8789

WANTED: RCA 4 AP box camera mic, 77C ribbon, 77A ribbon, 88A bullet, black & chrome, Western Electric 53A condenser, Neumann CMV-3, other film and broadcast mics, old mic stands, WE 23C or similar mixer, RCA OP 6, 7 mixer. Cool Shotgun mics. Have nice 77DX, 44BX, 74 Jrs. Altec Coke bottles, WE-639A, 618-A, Mac 225, pair 30s for trade, or buy outrght. Ward Kremer, 301 S.W. 16 St., Ft. Lauderdale, FL 33315. Ph./fax: (954) 524-5652

WANTED: Sanabria brand, TV, or radio, American television items. Pay top prices. Manuel Martinez, Res. Bairoa, Calle 12A - CW4, Caguas, PR 00725



WANTED: Air King Skyscraper radios, except for that unbearably ugly model with the third (tuning) eye at the top that bears better resemblance to a flourer than to the face of a building. Please write or call collect: Rain Buttignol, 214 State St, #7, Portsmouth, NH 03801. (603) 427-1384

WANTED: Tube chart for Signal Corps I-177 tube tester; service data for Magnavox VB8005CH02 laser disk player; manuals for GE16K1 and GE805 TVs and Revox A77. Thanks. Phil Van Praag, W232 S3580 Kingneck Ct., Waukesha, WI 53188. (414) 524-9856

WANTED: Plastic escutcheon for RCA 810™ or 810K, your price. John Marinacci, 1141 Galaxy Cir., Pittsburgh, PA 15241. (412) 221-6763

WANTED: Tube amplifiers, limiters, Precise 111M or Hickok tube tester, record cutting equipment, Sencore test equipment. **FOR SALE:** Tube tester, General Radio 1396B, Sencore CR-70. Kim Gutzke, 7134 15th Ave. S, Minneapolis, MN 55423. (612) 869-4963

WANTED: Need any literature on Simpson Genescope Model 480. Richard Gilman, PO Box 633, Kirg City, CA 93930. (408) 385-9248

WANTED: Automatic record changer part number 35-1285 for Philco radio Model 42-1008. Dick Monfills, 36 Ladyslipper Dr., Shrewsbury, MA 01545

FOR SALE: Pioneer tube AM/FM stereophonic receiver Model ER-420 with manual, very nice - \$50. Delmonico table radio record player Model 1025, fair - \$15. Plus shipping. **WANTED:** Guild Grafonola, tea-cettle and Grebe Synchronphase Seven. Brian Kurlie, 2222 Nodleigh Ter., Jarrettsville, MD 21084. (410) 692-0450

FOR SALE: JVC videosphere, orange, on separate swivel base - \$225. Bill Constantine, PO Box 493, Glens Falls, NY 12801. (518) 745-8897

FOR SALE: Rider's I, 1st edition marked "1931 Troubleshooters Manual," has Index - \$80 pcd. Charles Kirsten, Radio Relics, 15556 Sandra Ln., Sylmar, CA 91342. (818) 364-0491

WANTED: ABC honeycomb inductance coils, ABC Clarion speaker ABC two-step amp. Ed Bell, 5311 Woodsdale Rd., Raleigh, NC 27606. Fax/ph.: (919) 851-1517

WANTED/FOR TRADE: My nice transistors for: Microphones, and 3-D cameras, trade me your small consumer mics that came with 50's-60's tape recorders, or 50's 3-D cameras, viewers, images. Realist, Revere, Wollensak, Kodak, Belplasca, and View Master desired. Tear some of my transistor beauties loose in exchange. Jon Golden, 16 Roundwood Rd., Newton, MA 02164. (617) 332-5460. E-mail: jgoldenrrp@aol.com

WANTED: Manual copies Nat'l RAO & VLF R1134A/WRR3, Radiolas 20 cabinet. Tom Provost, 19 Ivanhoe Dr., Robbinsville, NJ 08691. (609) 259-7634

WANTED: Karlson speaker enclosure, Model #K-15 or information on their construction. Thank you. Vernon Oehlke, Box 112, Ghent, NY 12075. (518) 392-4945

WANTED: For you to enjoy the holidays! Cash for your old meters/galvos before 1910, as is okay. Ye Olde Meter Cellar, Leonard W. Cartwright, 879 Russet Dr., Sunnyvale, CA 94087. (408) 739-6025

WANTED: Cabinet for Zenith Walton set. Table, chairside or console considered. HRO coil sets. Frank Franowsky, 440-A Jemez Rd., Santa Fe, NM 87501. (505) 473-4150

WANTED: Assembly/owner's manuals for a Heathkit Model O-7 oscilloscope and Model IG-72 audio oscillator and band selector (2) and volume knobs for a Montgomery Ward Airline Model 62-177 and volume control and hi-fi/Sharp selector knobs for a Fairbanks Morse Model 100. Dial plastic for a Philco Model 40-130. 1B1 ballast tube. Volume control knob for Zenith Model 6G638. Band switch knob for an RCA Model T60. Mark Mowrey, 510 S. 12th St., Clear Lake, IA 50428. (515) 357-3492

WANTED!

Microphones—all types:
Telefunken, Neumann, AKG, RCA, Sony, etc.
Also buying recording studio equipment,
tube compressors, EQ's: Pultec, Lang,
Teletronix, Urei, Fairchild, RCA, etc.

818.784.7611 • Fax 818.784.7564
Moving Hands Studios - Los Angeles, CA

Logos for Telefunken, Neumann, AKG, RCA, and Sony are displayed vertically on the left side of the advertisement.

FOR SALE/TRADE: AK Kiel table, radio excellent original, works, best I've seen - \$400. Pick up. Ed Bell, 5311 Wooddale Rd., Raleigh, NC 27606. Fax/ph.: (919) 851-1517

FOR SALE: Murdock coupled tuner - \$250. United cabinet crystal radio - \$240. Philco 70 - \$150. Reddy Kilowatt cards, double - \$60. DeForest crystal radio - \$750. Radiola III w/shipping box - \$150. Westinghouse RA-DA - \$275. Shure 55SW microphone - \$75. List available. Jerry Finamore, 1374 Stalfore Dr., Bethlehem, PA 18017-1633. (610) 861-4660

FOR SALE/TRADE: Radios: Federal E-10 Orthosonic - \$75; Tele-Tone table cutie - \$30; Truetone D941B (Bunis 3, p. 239) exc, documented - \$150; Two WECO 560 AW speakers - BO gets two beauties. Transistors: Arvin 61R16 turquoise - \$20; Crestline 6T-220 (Bunis Trans. 2, p. 73) - \$90; GE P746-B turquoise - \$20; Gol-fone golf club novelty and case - \$60; Mellow-Tone TR-6 white, case (see Diplomat HT-6088, Bunis Trans 2, p. 79) - \$60; Micronic Red SR-H437, earphone, clamshell, exc - \$110; Micronic SR-H437 black clamshell, exc - \$100; Micronic SR-H436 brown - \$140; Motorola X-21 ivory w/rhinestone, clamshell - \$100; Panasonic R-1000 Radar-Matic - \$65; Penneys 6TP-322 red/white - \$50; Planatair "world's smallest" germanium - \$40/box; Toshiba 7TH-425 fan (Bunis, Trans. 1, p. 217), black, good cond. - \$125; Trancel 6TP-243, white - \$50; Vista NTR-850, oval, red - \$50; Vista NTR-800, red - \$45; Petite NTR-800, like Vista, black - \$60; Univeral 8, not in guides, nice reverse paint - \$75. Jon Golden, 16 Roundwood Rd., Newton, MA 02164. (617) 332-5460. E-mail: jgoldenrp@aol.com

FOR SALE: H.H. Scott 299 amp, exc - \$135. Stromberg-Carlson AR-420 mono amp, original and absolutely mint - \$175. Dave Kolseth, 2103 Scotland Dr., Clearwater, FL 34623. (813) 734-1301



*Craig L. Graybar
Furniture Works Ltd.*

(414) 258-2390

SPECIALISTS IN RESTORING,
REPAIRING AND REPRODUCING
CLASSIC STYLED ANTIQUE TV,
RADIO & PHONOGRAPH CABINETS

Send us your plans or your project
via UPS for immediate price quotes



1535 S. 84th St.
West Allis, WI 53214



"We Turn Ideas Into Heirlooms"

FOR SALE/TRADE: Western Electric military radio receiver Mod BC603-C, circa 1950 with chrome push-button tuning in excellent condition - \$400. WE Mod 702A crystal oscillators, pair, with 249A tube in each - \$750 for both. Call: Larry Drago, 383 Lincoln Dr., Cheshire, CT 06410. (203) 272-6030

FOR SALE: National NC88 - \$95. Jetrionic Ind. 3-inch oscilloscope OS-8C/U, made for U.S. Navy, gray metal, rare, works great - \$75. Heathkit IT-17 and Eico 625 tube testers - \$30 ea. Heathkit C3 condenser checker - \$30. Tube caddies, wood - \$20; metal - \$25. Fisher 88 record changer - \$25. Atwater Kent variable inductive coupler, has 7-position course switch and 7 position fine switch, complete assembly with knobs - Offers? Good used tubes: 24-A, 56, 57, 58, 78, 84/624 - \$2. Herb Ratner, 3542 Westminster Ct., Holiday, FL 34691. (813) 937-7452

FOR SALE: All-Zenith sale #2: Trans-Oceanics, all working, (2) G-500, both excellent - \$185 ea. H-500, excellent - \$150. L-600, good - \$100. 1000, vg - \$125. 3000-1, excellent - \$185. Royal 500, black, vg - \$95. Royal 285, good - \$55. 1941 wood - \$175. 6G601 - \$85. Add shipping. Ted Demski, 5806-225 Pl. SW, Mountlake Terrace, WA 98043. Phone/fax: (206) 778-7100

FOR SALE: Radiola 103 speaker, vg, working - \$100. Bogen 200-watt amplifier, excellent - \$125. Aeriola Sr., 1-tube, good - \$90. 2-step amplifier for above, home brew - \$50. Halls quack medical box with French battery, walnut case, vg - \$65. 5-tube home brew, 8 knobs, vg - \$45. Wall telephone transistor radio - \$20. GE HJ624, 6-tube Deco - \$20. Zenith K731, 7-tube, working - \$15. All plus S&H. Please call before 9 p.m. Wally Worth, 2 W. Elm Ave., Wollaston, MA 02170. (617) 479-4512

FOR SALE: Firestone Air Chief radio, 13"H x 26" wide - \$150. Schematic book (9 lbs.) - \$60. PU. Dewey H. Shaffer, RD2, Box 104-B, New Paris, PA 15554. (814) 839-4728

FOR SALE: Vibroplex Collector's Guide, W1IMQ's new 125-page revised edition, illustrated, comprehensive - \$21.95 ppd. Artifax Books, Box 88-A, Maynard, MA 01754

FOR SALE: Marconi FE1 tube, good filament - Best Offer by Jan. 15, 1997. Dave Noon, VA3DN, 19 Honeysuckle Cr., London, Ontario, Canada N5Y 4P3. (519) 453-2292. E-mail: david.noon@odyssey.on.ca

FOR SALE: Philco 53-706 lamp/clock radio (Bunis 3, p. 169). Hank Trabold, 2058 Nakiska Ct., Toms River, NJ 08755. (908) 244-2345. E-mail: trabold@exit109.com

FREE ADS ON THE WEB *Radio Classified*

Is an Internet advertising site listed on over 75 major Internet search engines worldwide. To promote our expansion as a radio collecting source, we are posting all radio-related ads for free until Feb. 1st, 1997 with no limit on size. For sale, wanted, help ads and announcements are all welcome. The first 20 photos mailed in (one to a customer) will be run for free in full color. \$5 for each additional.

To place your ad, mail it to: Radio Classified 1238 W. Ivyton St., Lancaster, Ca. 93534. E-mail: oldradio@hidesert.com or fax to (805) 940-8897

URL: <http://www.hidesert.com/radio>

WANTED: Hearing aids, coat pocket mini-tube radios and hybrids, pocket crystal sets. Mike Brooks, 7335 Skyline, Oakland, CA 94611. (510) 339-1751, evenings

WANTED: Beitman's Most Often Needed Radio Diagrams and Servicing Information Books for the years 1926-1938, 1939, 1940, and 1942. Loren H. Dudley, 14 Valley Rd., Bath, ME 04530-2811. (207) 442-8419

WANTED: A-B battery eliminators with either 7-pin round connector or 12-pin rectangular connector and AC receptacle. Matt Endicott, 18 N. Walnut Ln., Schaumburg, IL 60194. (847) 885-3130



WANTED: Fada Catalin radios. Help! My entire collection spontaneously combusted during an interview with the "Enquirer." Replenish and repent ye sinners. Please write or call collect: Rain Buttignol, 214 State St, #7, Portsmouth, NH 03801. (603) 427-1384

WANTED: Edison Standard player, 2/4 with K reproducer. Harold S. Meltzer, 592 Loma Verde Ave., Palo Alto, CA 94306. (415) 493-1016. E-mail: techn1@netcom.com

WANTED: Heathkit XO-1 electronic crossover and/or schematic of same. Please call or write! David Koesche, 61 S. Barrington Rd., South Barrington, IL 60010. (847) 382-7997

WANTED: Detrola, Truetone, or Silvertone with eight motorized push buttons. Need push buttons or whole set. Scott Flaughner, 41100 Plymouth Rd., Plymouth, MI 48170. (313) 451-4221

WANTED: AN/APA-11, AN/ARQ-4, AN/ARQ-5 receivers; also manuals and/or schematics. John A. Benyo, 25 Schley St., Garfield, NJ 07026

WANTED: Hallicrafters HT-6 transmitter. Winston Burt, 185 N. Poland Rd., Conway, MA 01341. (413) 369-4469

WANTED: Zenith Trans-Oceanic bomber 7G605 or R520, Hallicrafters S93 or TW 1000/2000. Ron Fumival, 113 Konzier, Pittsburgh, PA 15237

Wanted Microphones

Out-of-service Broadcast/Recording Gear
Compressors - Limiters - EQ - Tape Machines
for vintage recording studio

Mike States

Box 81485
Fairbanks, AK 99708

(907) 456-3419
Phone/Fax

WANTED: AM-43C/FRC military headphone amp. Michael Payne, 803 S. Taylor, Alvin, TX 77511. (713) 331-9217. Fax: (713) 585-2727

WANTED: Payphones, 3 slots, Gray/Western Electric, separate transmitter and receiver. Stanley Schreier, 350 Hendrickson Ave., Lynbrook, NY 11563. (516) 887-4966. Fax: (516) 887-4780

WANTED: NC173 lid, junk HW16. Gentleman that sent 807s, lost address! Don Anderson, 7174 Glenwood Ln., Hanover Park, IL 60103

WANTED: Voice of Music (VM) reel and cassette recorders. Also VM literature, demo records. Gary Stork, 37530 E. Meadowhill, Northville, MI 48167. (810) 478-0990

WANTED: Slide-out rack for Blaupunkt Derby portable. Thank you. Jim Coe, 6265 W. Patrick Ln., Las Vegas, NV 89118. (702) 871-3090

WANTED: Fisher 400C or CX, WE 753A, information on WE amps. F. Cooney, 30 Columbia Ave., Cranford, NJ 07016. (908) 272-0676

WANTED: Original glass (no cracks, chips or scratches) for RCA 630TS TV. Original table for RCA 630TS TV, must have original finish and identified on underside: RCA Model 6STD. Original owners manual for RCA Model 630TS. Thanks. Larry Dunn, 473 Serento Cir., Thousand Oaks, CA 91360. (805) 492-7111

WANTED: Cabinet for Grebe MU-1 table radio in restorable condition. Richard Morrissey, 561 Congress St., Troy, NY 12180. (800) 807-2629, days. (518) 272-4313, nights

WANTED: Loop antenna for Radiola 28, good UX199 tubes, glass jar capacitor used in Radiola battery eliminator. **FOR SALE:** Mint McIntosh MR78 tuner - \$750 ppd. Robert Schrantz, 610 E. Juanita Ave., San Dimas, CA 91773. Phone/fax: (909) 394-1194

ARBE-III Universal Battery Eliminator

*Ideal Christmas gift for
the radio collector!*

A gift that will give years of service
Completely assembled and tested
Can be used Christmas morning
Professional quality and construction

Comes with five-year warranty,
owners manual and instructions

\$149.95 Shipped USA

Contact:

Antique Radios Inc.
Box 6352, Jackson, MI 49204
(517) 787-2985 or
Fax (517) 782-7422



FOR SALE/TRADE: A.C. Gilbert #4016 crystal set, original, nice - \$875. Ed Bell, 5311 Wooddale Rd., Raleigh, NC 27606. Fax/ph.: (919) 851-1517

FOR SALE/TRADE: E.H. Scott Philharmonic 30-tube set w/power supply, fair chrome, no speaker. Will consider parting out or sell all. Call: Larry Drago, 383 Lincoln Dr., Cheshire, CT 06410. (203) 272-6030

**NOTICE TO ALL
CLASSIFIED ADVERTISERS!
OUR CLASSIFIED AD DEADLINE IS
12:00 NOON
ON THE 10th OF EACH MONTH**

FOR SALE: National Standard HRO w/pwr supply - \$175. Navy TCS transmitter chassis, mint, case needs painted - \$50. Commercial B&W TV monitor has RCA 630 components in yoke & defl circuits. Rodney K. Schrock, 402 Lincoln St., Somersett, PA 15501

FOR SALE: Beautiful Pathé Grecian model cone speaker, frame only, in excellent condition - \$140. Walter Curry, 10035 Country View Rd., La Mesa, CA 91941. (619) 461-9327

FOR SALE: 52¢ LSASE for list of new/used receiving/transmitting tubes. Many thousands added lately. Sell or trade for old or unusual tubes or related material for my collection. John H. Walker, Jr., 16112 W. 125th St., Olathe, KS 66062. (913) 782-6455. E-mail: johnh.walker@alliedsignal.com

FOR SALE: Hallicrafters S-40B, mint condition, as new, restored with owner's manual - Best Offer. Gary Boyd, 6565 Orchid Ave., Cocoa, FL 32927. (407) 639-2632

FOR SALE: EICO HF-35 hi-fi amplifier with orig. manual, tubes - \$195. Bob Putnak, 1507 4th St., Monongahela, PA 15063. (412) 258-6236

FOR SALE: 3pcs. Acrosound ULI1 60-watt mono amps, very rusty, transformers guaranteed - \$600/all 3. DeForest Audion single wing, good filament - \$1,500. Broadcast News mags. from 1950's - \$15 ea. Collins mechanical filters F455J15, F455Q7 - \$125 ea. Digital oscilloscopes fluke 97, Tektronix T202, Createc, these are small portable dual trace, may become collectible in future - \$3,000/all three. 75 pc. Weeco 205D tennis ball tubes, used - Best Offer. Tons of tube ham radio gear, tons of tube hi-fi gear, tons of modern test gear. Books: Valley & Wallman Vac. Tube Amps, 1st ed.; RCA Radiotron Designers, 4th ed.; Audiocyclopedia 2nd ed. - \$100 ea. RCA Tube Manuals RC30 - \$30; RC29 - \$25. Many others. Allied, Lafayette Radio Catalogs 1938-1965 - \$30 ea. 1966 up - \$15. Weeco KS14703 8-inch speakers, same as 755 in original wood wall cabinets and original shipping cartons - \$500 ea. I will be closing my East Coast storage by spring 1997. Maybe a cash and carry sale or auction. V. Vogt, 2311 Pimmit Dr., #247, Renton, VA 98055. (206) 382-5571

FOR SALE: Phonos: Mickey Mouse GE - \$65; Michael Jackson - \$45; VM phono 121 - \$25. Radios: Teletone 148, RCA 66XZ, Philco 50-522. Tube testers: SICO TW11, Superior TV11, Heath FM4, Heath EA3 - \$25 ea. Delco R1230, Aircastle 6W, Sentinel 151BC - \$45 ea. Parts sets: Philips BZD08U, GE 140, GE 67, RCA 4-C-533, Telefunken Gavotte 55, Airline 62-274, Tom Thumb Buddy port. Plus shipping. Jim Smith, 1228 S. 40th Dr., Yuma, AZ 85364. (520) 329-0384. Fax: (520) 782-6252

FOR SALE: Philco 39-116 - \$110. Pick up only. Call: Steve Sideroff, 46 Dutch Lane Rd., Marlboro, NJ 07746-2102. (908) 462-7987, 6-8 pm, leave message

FOR SALE: Bogen Challenger Model RC412 early stereo receiver - \$100. Army transceiver BC654A Crosley - \$200. Bill Rauwolf, PO Box 641, Urbana, IL 61803-0641. (217) 355-3436

FOR SALE: Tube, transistor novelty radios. Some remaining November ad. New additions. SASE. H.B. McMahan, 313 W. Shaw, Tyler, TX 75701. (903) 593-5433

FOR SALE: 1963 Cameca Scopitone film jukebox, good condition, needs minor tuneup, shop manual - \$1,000. Eric Stumpf, PO Box 60245, Santa Barbara, CA 93160. (805) 964-9417

FOR SALE: Transistor radios for sale: Zenith Royal 200, pink - \$28; Royal 50, white - \$23; Midland 10-150, N.I.B. - \$25; Hitachi WH-822 - \$25; box lot of (10) transistor radios, mostly Japanese - \$50. Plus others! John Gardner, 270 N. Main St., West Hartford, CT 06117. (860) 523-4145. E-mail: buggiecar@aol.com

FOR SALE: Sony AIR-8 M.I.B. - \$175. Grundig Yacht Boy 310, German, M.I.B. - \$175. Ed Kalpa, 4622 Melbourne Ave., Los Angeles, CA 90027. (213) 661-1221

FOR SALE: Sams, sets below number 1000, as low as - \$1/set. Indexes also available. Send SASE for list. John E. Kendall, PO Box 436, Fallston, MD 21047

FOR SALE: Radiola 25, no antenna - \$200. Near mint Fisher 500C, works fine - \$225. Bernard Bank, 303 DeVoe Ave., Yonkers, NY 10705. (914) 476-5933

FOR SALE: Last complete set of eight mini replica radios, no longer made! - \$200 ppd. Herb Parsons, 5 Surrey Ln., Peabody, MA 01960. (508) 535-1009

FOR SALE/TRADE: Heathkit W-6M amplifiers with correct tubes - \$1,350 for pair. Heath AA-81 35-watt amplifier - \$250. Call: Larry Drago, 383 Lincoln Dr., Cheshire, CT 06410. (203) 272-6030

FOR SALE: Radio TV News, Radio Electronics magazines from early 40's thru 60's. Call or fax: Russell Hulme, 8405 Soneto Ln., Las Vegas, NV 89117. (702) 233-1379. Fax: (702) 242-3857

FOR SALE: Cyarts 1946 red radio. C. Somerfeld, PO Box 1751, Venice, CA 90291. (310) 827-8121

FOR SALE: EH Scott 30-tube Philharmonic in Warrington cabinet. Ross Litrenta, 1 Wilton Rd., Eastchester, NY 10709. Phone/fax: (914) 337-7176

I am not a dealer, but a serious collector and historian interested in all aspects of E. H. Scott.

Please contact me first if you are
selling your E. H. Scott Radio,
Selec-E-H-RADIO tone
Coils, World's Record Superhet, or
Scott Transfor-mer Co. items.



Always interested in any E. H. Scott stock certificates, literature, and military sets.

**John T. Meredith
2462 Statonsburg Rd., Suite 152
Greenville, NC 27834 - (919) 551-1882**

WANTED: Kadette Jewel, Kadette H, Kadette K150, any color. Have Catalins for trade. Robert Norton, 4227 S.E. 15th, Portland, OR 97202. (503) 233-1956

WANTED: Car radio for 1951 Chevrolet Fleetline. Emerson 888 Vanguard, green. Radiosondes made before 1955. Kadette Jr. Japanese tube portable, also old transistor radio. TVs: Philco Predictas and Sony 8-301 & Watchman. Tubes; 6D5, Arcotron 201 & 301. **FOR SALE:** Japanese WWII tubes; UZ135, UY133A & KX250, all N.I.B. - \$20 ea.; also CRTs BG75A, 3", test good - \$40; & SSF120G, 5", N.O.S. - \$50 postage extra. Noriyoshi Tezuka, 1-11-2-403 Hiroo, Shibuyaku, Tokyo 150, Japan. Fax: 011-813-3440-8396



WANTED: Edison Memorabilia radio, fan, movie projector, light bulb, generator, vote recorder, and etc. Sam Huh, 8-10 W. 36th St., 3rd Floor, New York, NY 10018. (212) 563-8046

WANTED: Dynaco MKIII output transformer, Z216, blown OK. **FOR SALE:** Dynaco PAT 4, nice - \$45. Stereo 80 - \$50. FM3 - \$45. Steve Fritz, 3088 W. 15th Ave., #17, Eugene, OR 97402. (541) 343-1413

WANTED: Sheet music with "Radio" in title or lyrics. Will Nicoll, 4010 W. 68th Ter., Prairie Village, KS 66208

WANTED: Zenith Trans-Oceanics, all models tube and transistor, any condition. Zenith military Trans-Oceanics 520/URR, R520A/URR. All Zenith table models and shutter dial models. Frank J. Manzano, 82 Monhegon Ave., Oakland, NJ 07436. (201) 337-5263

WANTED: Arvin Rhythm Queen, Rhythm King, or bookcase models. Also need works and chassis for a Zenith 10S464 console. Eric Miller, PO Box 778, Linn, MO 65051. (573) 897-4121

WANTED: National NC-80 dial bezel or junker w/good one. Also FB-7 coils. Robert Enemark, W1EC, Box 1607, Duxbury, MA 02331

WANTED: Good cabinet for RCA T10-1 or sell working chassis. Randy Hull, 134 Armstrong St., Apt. 4, PO Box 501, Halifax, PA 17032. (717) 896-2435

WANTED: RCA 140 tombstone chassis and speaker; Philco 90 cathedral speaker. Thanks! Mark Cowart, N4FBL, PO Box 550766, Jacksonville, FL 32255-0766. (904) 724-1364

WANTED: Motorola 50XH1 (Bunis 2, p. 116), must be in good to excellent condition. Also need Bunis 1st Edition. Paul Jackson, 221 9th St., Apt. C-304, Kirkland, WA 98033-6010. (206) 889-8704. E-mail: JacksonPG@aol.com

WANTED: Microphones, cheapies OK, guitar amps, guitars, effects, literature, etc. Alex Pepiak, 330 Third Ave., Belmawr, NJ 08031. (609) 933-0374. E-mail: alpep@aol.com

WANTED: Spark transmitters and loose coupler type crystal receivers; prewar Japanese QSL cards; prewar Japanese steamship N.Y.K. related. Takashi Doi, 1-21-4 Minamidai, Seyaku, Yokohama, Japan. Fax: 011-8145-301-8069

WANTED: Beetle plastic and 2+ color molded plastic radios. Don Moody, 1600-M Glenwood Ave., Raleigh, NC 27608. (919) 821-3530, or fax (919) 821-0217

WANTED: RCA Victor Presidential Model 110-K console, must be in good, complete condition. Please contact with information: Roger Menard, 435 Route 169, Woodstock, CT 06281. (860) 928-4189

WANTED: Cathedrals with good filters and good original grilles. Also want AK metal sets with good filters plus Type E3 speakers. Leonard Prince, 10 Longfield Ct., Savannah, GA 31410. (912) 897-4167

WANTED: Cathedral cabinet for Philco Model 90, 70, 71, 72. State condition and price. Herman Schnur, Rt. 3, Box 151, Greenvale, NC 27858. (919) 752-2264

WANTED: 1960's walkie-talkies. Dick Tracy Dynacom 5. 3-channel Gonset G12. Marty Humey, Jr., 173N Central Ave., Valley Stream, NY 11580. (561) 561-7558

WANTED: Philco 90, excellent condition. Chassis for Philco 70 and RCA 140, 141, 240. Mark M. Murphy, 1400 Chicago Ave., #208, Evanston, IL 60201. (847) 328-5036

WANTED: Atwater Kent breadboard two or four tubes. Please write or fax to: Werner Gertsch, Roseweg 8, CH 2556 Schwadernau, Switzerland. Fax: 011 41 32 373 4516

WANTED: One Eico HF-12 amplifier in good operating condition. I have one and need the second for stereo music. Wieslaw Woszczyk, 3801 Hampton Ave., Montreal, Quebec, Canada H4A 2K7. (514) 488-4878. Fax: (514) 398-8061. E-mail: wieslaw@music.mcgill.ca

2nd Annual Vintage Radio Meet On The Mount February 26 to March 1

Crested Butte Ski Area
Mt. Crested Butte, CO

*Combine two of your passions into a four-day
or more ski vacation and vintage radio fest!*

Wednesday, Feb. 26 - Ski *

Thursday, Feb. 27 - Ski *

Friday, Feb. 28 - Ski

8:00 p.m. Banquet

Saturday, Feb. 28 - Ski

7:00 a.m. to 11:00 a.m. - Swap Meet

* Watch U.S. Extreme Ski Competition on these days

Airfare/Lodging/Lift Packages Available
Look for more info in the Jan. & Feb. A.R.C.
Info now: A.R.C., P.O. Box 2, Carlisle, MA 01741.

Tel: (508) 371-0512; Fax: (508) 371-7129

Sponsored by *Antique Radio Classified*



Our Most Popular Titles Make Great Gifts This Holiday Season



The Collector's Guide to Antique Radios 4th Edition by Marty & Sue Bunis. 8,500+ Battery & AC sets from the '20s to the '60s. Updated prices. Many new photos. 1996. Shipping Now. — **\$18.95**

The Collector's Guide to Transistor Radios 2nd Edition by Marty & Sue Bunis. This book will help you identify the most sought-after vintage transistor radios. Over 2,900 models, all with current prices. Includes radio club listing. 375 all new color photos, 320 pages. 1996. — **\$16.95**



We Now Have 7 Books for Hams!
 Communications Receivers, 3rd Ed. - \$19.95; Ham Price Guide - \$9.95; Heathkit, A Guide to the Amateur Radio Products - \$24.95; The Pocket Guide to Collins Amateur Radio Equipment 1946 to 1980 - \$19.95; Radios by Hallicrafters - \$29.95; Tube Type Transmitters - \$17.95; Transmitters, Exciters and Power Amplifiers - \$21.95.
SEE OUR COMPLETE LIST IN THE BACK OF A.R.C. FOR MORE DETAILS

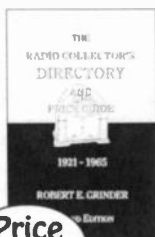

The Radio Collector's Directory and Price Guide, 1921-1965, 2nd Ed. by Robert Grinder. Over 20,000 radios by manufacturer, model number, year, etc. with prices. Radio history, cabinet style chapters. No photos, 264 pages. — **\$26.95**

Transistor Radios, A Collector's Encyclopedia and Price Guide by Robert Lane and David Lane. Identification guide to over 2,500 transistor and novelty radios. History and key to collecting chapters, 170 pages. — **\$19.95**

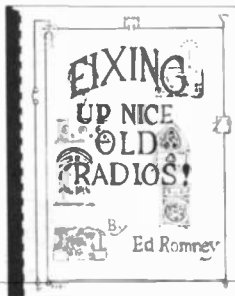
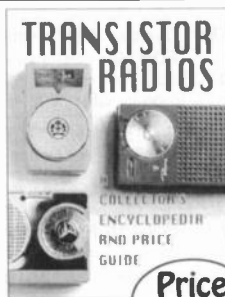

Fixing Up Nice Old Radios by Ed Romney. Written by a retired radio instructor. Plastic binding. 300+ figures, 185 pages. — **\$25.00**

Old Time Radios Restoration and Repair by Joseph J. Carr. A self-paced training guide. History, theory and practical operation of antique and classic radios. 200 illustrations, 256 pages. — **\$18.95**



U.S. Orders - Enclose \$3.00 per order for packing & book-rate shipping if total order is under \$35.00. If using VISA or MasterCard, include name on card, card number and expiration date. Send payment with order. Mass. residents add 5% sales tax. Money back return policy. Softcover unless stated otherwise. Most orders shipped the same day received, but allow 2-4 weeks to receive order. Foreign orders - write for shipping costs, or use credit card and specify air or surface (allow 2-3 months for surface shipping).



A.R.C., P.O. Box 2, Carlisle, MA 01741. Tel: (508) 371-0512

Fax: (508) 371-7129

Web: <http://www.antiqueradio.com/>



(Nov-96)

Our Most Popular Titles Make Great Gifts This Holiday Season

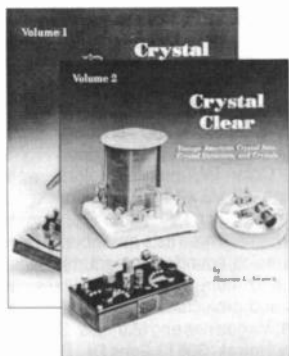

Crystal Clear Volume 1 and Crystal Clear Volume 2 by Sievers. *Comprehensive reference to crystal sets, crystal detectors, and crystals. Each volume contains different illustrations and information. Order by volume. — \$29.95*

Flick of the Switch by Morgan McMahon. *The classic photo reference guide for 1930s - 1950s radios. 1000+ photos of radios, 5" x 8", 263 pages. — \$11.95*



NEW BOOKS.....

International Directory of Antique Radio Collectors.

Lists collectors, museums, dealers, clubs, publications, and more.....

\$14.95

Radio Diagram Sourcebook. *Valuable tool for identifying make or model number, tube types used, etc.....*

\$18.95



Guide to Old Radios, Pointers Pictures, and Prices, 2nd Ed. by Johnson. *Introduction to radio collecting. Includes hundreds of photos and a price guide. 272 pages. — \$19.95*

Antique Radio Restoration Guide, 2nd Ed. by Johnson. *Beginner's introduction to troubleshooting and repairing AC table model radios. 145 pages. — \$14.95*



Price Guide



The Zenith Trans-Oceanic: The Royalty of Radios by Bryant and Cones. *Presents the fascinating story of the development and use of the Trans-Oceanic. Several photos, documents, ads, etc. 160 pages. — \$24.95*

Communications Receivers, 3rd Ed. by Ray Moore. *Information on vacuum tube receivers by 66 manufacturers. 402 radios illustrated, 115 pages. — \$19.95*



U.S. Orders - Enclose \$3.00 per order for packing & book-rate shipping if total order is under \$35.00. If using VISA or MasterCard, include name on card, card number and expiration date. Send payment with order. Mass. residents add 5% sales tax. Money back return policy. Softcover unless stated otherwise. Most orders shipped the same day received, but allow 2-4 weeks to receive order. Foreign orders - write for shipping costs, or use credit card and specify air or surface (allow 2-3 months for surface shipping).



A.R.C., P.O. Box 2, Carlisle, MA 01741. Tel: (508) 371-0512

Fax: (508) 371-7129

Web: <http://www.antiqueradio.com/>



(Nov-96)

FOR SALE: (12) EH Scott consoles, including an early All-wave 23 in a Waverly Grande, call for info. We accept Visa, Discover and MasterCard. Alan Jesperson, PO Box 17338, Minneapolis, MN 55417. (612) 727-2489, 8 am to 8 pm, 7 days. Fax only: (612) 727-1908

FOR SALE: 1927 Brownie two-valve set. This is the set featured on the cover of the May 1992 edition of A.R.C. A rare and highly collectible set, excellent original condition, with valves and coils - \$1,650. British crystal set by J. Rigaut, 1924, very nice condition - \$300. Fellowcraft Super crystal set, 1923, in excellent original condition, (see Nov. 1993 A.R.C., p. 5) - \$550. Beautiful French crystal set by Elvége, ca. 1923, excellent original condition - \$575. Czech crystal set by Josef Benes, 1924, excellent condition - \$350. Ian L. Sanders, 16725 Wild Oak Way, Morgan Hill, CA 95037. (408) 778-7547

FOR SALE: Marconi-phone 3-band tr. radio - \$30. Sharp 6-band - \$75. Newcomb R-P/P-A w/spkrs - \$110. GE tube plastic - \$30. GE transistor - \$200. Sony TC250 w/mike - \$30. N.I.B. UHF TV converter sld. - \$40. RCA braille radio, featured A.R.C. June '96 pp. 15 - \$50. Tonemaster 70's tube repro guitar amp - \$125. Sampson TR-2A wireless guitar transm.-rcvr - \$60. Gen. Radio Variac - \$20. Sony ICF 9740W AM-FM table radio - \$20. Sony TPS L-2 tape player, in box - \$15. Boonton cap. bridge - \$65. Pr. Knight British 15" coax spkrs - \$60. Need V.C.'s Zenith tube wood stereo AM-FM - \$35. Sansui 1000A rcvr - \$85. H.K. TA 3000X rcvr - \$85. (2) ea. Sansui RA-500 stereo reverbs - \$80. Novelty radios: Car - \$10; Playschool Rockin' Robot, mint - \$20. Truetone D-727 1930's table model. Timex-Sinclair 1000 computer, manual, add-on memory. All + shipping. Roger Ruddick, 33 Emily Ln., Ft. Myers Beach, FL 33931. (941) 463-8887

FOR SALE: Crosley Buddy Boy, vg, works - \$400. Jim Watson, 610 Nix Rd., Pensacola, FL 32506. (904) 455-0990. E-mail: oldradio@gulf.net

FOR SALE: Philco 90. RCA: R-70. Radiola AR-812. GE K-50-P. Belmont 6D111. Emerson: BA-199, 560, 587-A. Arvin 444. AK Model L horn. Victrola VV-35. Richard Rubin, 227 Riverside Dr., Apt 5-A, New York, NY 10025. (212) 864-8416. E-mail: wireless@panix.com

FOR SALE: Atwater Kent breadboard 10C, plays - \$795. Brunette doll, Nightie, plays - \$50. Detrola 571-BX-21-94D, white, dark brown bezel, plays - \$45. National Electrical Products, table, metal case, brown, plays (Eveready 2?) - \$75. Silvertone 3041, Midget, black/gold, plays - \$65. Philmore crystal set, dark red - \$95. Zenith 5S228, tombstone, black dial, nice, plays - \$175. Zenith transistors, Royal: 500B black, bag - \$95. 500E maroon and cream, case, plays - \$65. 500H, black - \$95. 500D, black, chip, plays - \$60. Neon sign, "Zenith" (gold), "Color TV," (various colors), works - \$175. Lighted sign, 18 1/2 x 14 1/2, black background, "Zenith Handcrafted Color TV" - \$60. Shipping extra. Many other new items. Three lists available. (1) Pocket transistors, table radios, sound equipment, microphones, test equipment and more. (2) 15,000+ Transmitting/receiving tubes and projector bulbs. (3) 16 Pages of Books, Catalogs, Magazines and Manuals. Send SASE for each list. Ray Nowak, 30513 Ednl Dr., Bay Village, OH 44140. (216) 871-8303

FOR SALE/TRADE: The following vintage tubes: DeForest Type H, Daven MU-20, Radiotron UX852 (resembles DeForest 522), Western Elec. 212D, DeForest 503-A, VT14, Sodian D-21, Meyers RAC-3, 5-201A rainbowed BBT, Wehrmacht gold German valve. Larry Drago, 383 Lincoln Dr., Cheshire, CT 06410. (203) 272-6030. Fax: (203) 272-2002

FOR SALE: Tubes: 6146 W - \$20; 6LQ6 - \$30; 6JB6 - \$20; and other power, octal, mini and antique tubes. Grebe Synchrophase - \$225. Contact: Bob Bieker, 9528 Farmer Dr., Highland, IN 46322. (219) 924-5637, voicemail. E-mail: n9tew@jorsm.com

INTRODUCING ZENITH and Philco Grille Cloths

Authentic reproductions
based on original patterns

- ★ New Zenith pattern for 1929-31 sets.
- ★ Zenith Block, Swirl, Leaf, and Scalloped patterns for shutterdial consoles, Walton tombstones, and Deco sets.
- ★ 30 ADDITIONAL patterns for Philco, GE, RCA, Emerson, and Stromberg.
- ★ COMING SOON!! Philco 511 speaker cloth and silver Deco patterns.
- ★ Your satisfaction or money back.

SEE THEM ALL ON THE WEB @
<http://www.libertynet.org/~gricloth>

Send a 55¢ LSASE for samples and info to:
John Okolowicz, N3VSR
624 Cedar Hill Rd.
Ambler, PA 19002

E-mail: 70313.2564@compuserve.com

PUETT ELECTRONICS ANTIQUE RADIO DIVISION PO BX 28572 DALLAS TX 75228 U.S.A.

**NEW CATALOG NO. 8
NEARLY ALL PRICES REDUCED**

OVER 77 PAGES

CATALOG \$5.00 POSTPAID
\$3.00 DISCOUNT COUPON WITH CATALOG
APPLICABLE TO A \$20.00 OR LARGER ORDER.

ALL PAST CATALOGS ARE OBSOLETE

WE OFFER - MORE THAN 2,000 DIFFERENT ANTIQUE RADIO PUBLICATIONS FROM 1902 TO THE 1960'S REPRINTED BOTH SIDES OF THE PAGE AND BOUND. BOOKS, OPERATING AND SERVICE MANUALS FOR ANTIQUE RADIOS, TEST EQUIPMENT, COMMUNICATIONS RECEIVERS AND HAM GEAR, HISTORICAL BOOKS FOR NEARLY ANY MANUFACTURER. WE OFFER TUBES, OLD-TIME-RADIO SHOWS ON CASSETTES, SCHEMATIC DIAGRAMS AND MUCH MORE. SUBSCRIBE TO OUR PUETT ELECTRONICS ANTIQUE RADIO CLUB - RECEIVE SPECIAL DISCOUNTS AND THE PERIODICAL NEW ACQUISITIONS LIST OFFERING ALL TYPES OF ANTIQUE RADIOS, TEST EQUIPMENT, RARE TUBES, OUT-OF-PRINT RADIO BOOKS, RADIO MAGAZINES, AND MUCH MORE. ORDER YOUR CATALOG TODAY

The Radio Collector's Directory and Price Guide, 1921-1965, 2nd Ed.

by Robert E. Grinder

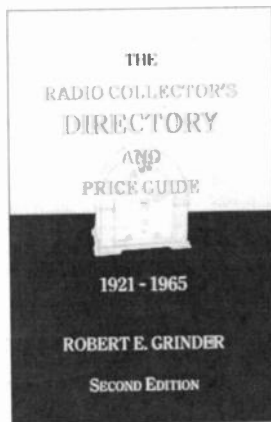

20,000+ Models Listed

U.S. models manufactured from 1921-1965.

Listing includes:

*Model Name,
Year of Production,
Type of Power,
Cabinet Style, and
Current Market Value Range.*

Rewritten Chapters On:

*Early Broadcasting,
Radio Broadcasting Regulation,
Advances Made in Receivers,
The Evolution of Radio Cabinet Styles.*

\$26.95 - Softcover

U.S. Orders - Enclose \$3.00 per order for packing & book-rate shipping if total order is under \$35.00. If using VISA or MasterCard, include name on card, card number and expiration date. Send payment with order. Mass. residents add 5% sales tax. Money back return policy. Softcover unless stated otherwise. Most orders shipped the same day received, but allow 2-4 weeks to receive order. Foreign orders - write for shipping costs, or use credit card and specify air or surface (allow 2-3 months for surface shipping).



A.R.C., P.O. Box 2, Carlisle, MA 01741. Tel: (508) 371-0512

Fax: (508) 371-7129

Web: <http://www.antiqueradio.com/>



(Oct-96)

dio, TV, 40's thru 50's, SASE for
401-3 Talcottville Rd., Vernon,

js Radiophone, Gecophone II,
Addison 5 red/green. NER-4. A.R.
Burlington, Ontario, Canada L7N
E-mail: am@globalserve.net

Month Free!

BONUS FOR EARLY RENEWALS

If you renew before the month shown on
your mailing label (your expiration month),
you will receive an extra month on
your subscription: 13 months instead of 12!
26 months for an early 2-year renewal!

FOR SALE: N.O.S. 50-watt 150Ω wire-wound var.
resistors - \$4. B&K 1040 CB Service Master test unit
panel & leads - \$40. EICO 324 signal tracer - \$29. NRI
signal tracer and signal gen., needs some service - \$30.
Precision E75 signal gen. - \$22.50. Heath visual aural
signal tracer T-3 - \$32.50. Heath T4 signal tracer - \$29.
NRI signal tracer and signal gen., needs service - \$34.
Superior Inst. Co. CR bridge and signal tracer less
probe - \$30. German radio Model 5451-W Telefunken,
plays - \$35. Tunfunk hi-fi, 5-tubes plus eye, needs
repairs - \$30. Have other small sets, need(s) repairs.
Lot batt. cables 4 to 10 leads, 2+ pounds all - \$18. Box
lot German radio parts - \$15. Power transformers
German radios - \$3.50 ea. (3) digital multimeters (1 WE
tester) - \$18/all. Electro-Voice EV 1255 FM stereo
tuner, U.S.A. - \$17. 3M-PA-15 amp - \$18. RCA wall-
mount 100-A magnetic speaker, sel. controls - \$30.
Heath VFO HG-10 - \$25. Heath VFO VF-1 - \$20. H.H.
Scott 342-C FM tuner - \$40. Tube caddies, large, clean
- \$20; (1) rough covering - \$10. Hallicrafters TV-1000-
A port., 7-bands, needs some service - \$40. Philco
37-62, nice, works - \$65. Superior TV11 tube tester roll
chart, port. - \$24. Zen. 7S598 chassis & tubes, less
knob - \$25. Zenith 6L40 Trans-O., chassis only, less
50A1 - \$22.50. Tube sockets 4- to 9-pin N.O.S., (25)
assd. - \$7. Zenith 6A40 Trans-O., needs repairs - \$65.
QST year binders, (6) - \$4 ea. Audio Cyclopedy 3 1/4"
thick, Howard Sams 1700+ pages - \$35. Tube Saga,
soft cover, orig. first copies - \$25. RCA-Marconi stock
certificate - \$35; temporary certificate - \$27.50. General
Radio 4-pin coils and bodies; numbers all Type 384-A-
B-C-D-E, 2 3/4" diam. - \$5 ea. Numbers F-G high
amount bank-wound turns - \$12 ea. #D crossover - \$8.
Magazines, per copy: Radio News, 1949 to 1952 - \$2;
Radio-Craft, 1947 to 1949 - \$1.50; Radio Electronics,
1950-1967 - \$1; Radio Handbook, 11th, 1947, fair - \$9.
7" reels and tape, used - \$2. (100) assd. QSL cards Off
the Walls - \$10 worldwide. Phono Changer Service, 4
1/4" bundle - \$17. Sylvania Tube Tech. Manuals - \$8.
Hawkins 5 Electrical Guides - \$9.50. RCA RC-23 Tube
Manual - \$14. RCA Field Engineers Tech. Manual - \$9.
Home radio course, (23) booklets, U.S. Navy - \$9.
Assd. panel meters. Will have following lists in 1997, a
SASE for each list: Amps Tuners Keys, Mics, Tube
Testers, VTVM VOM Signal Gens., TV test eqpt., probes
test leads, power units, old electrical casts, wire list,
Atwater-Kent parts, photo camera projectors. Have
1,000's of unlisted items. Write wants - SASE. All plus
shipping. Min. parts orders - \$8. F. Krantz, 100 Osage
Ave., Somerdale, NJ 08083-1136. (609) 783-0400

FOR SALE: Microphones: Shure Signal Corps S.W.-
109. Electro-Voice 950 - Best Offers. **WANTED:** Dial
for Arvin 444 metal Midget. Norman Landis, 1315
Marbendale Ct., Kirkwood, MO 63122. (314) 821-7933

FOR SALE: (36) N.O.S. WE tubes: 262B, 101F, 101L,
328A, 311B, 329A, 338A - Offer for lot. Ray Gebhard,
WAØHSX, 821 S. Spring Ave., Sioux Falls, SD 57104.
(605) 334-9125

FOR SALE: Collector quality Hammarlund HQ-120X,
special black finish model, looks and works great,
complete with matching speaker and original manual -
\$300. National NC-173 with matching speaker and
original manual, works great, cabinet nicely resprayed
to match original National light gray - \$180. RME DB-23
preselector, mint - \$50. Approximately (15) 45 rpm
records from the 1950's: major singers and groups,
Elvis Presley, Tony Bennett, etc. All in a compact
leatherette carrying case - \$50. Add UPS on all. Gus
Stellweg, 117 Edgewood Dr., Orangeburg, NY 10962.
(914) 359-0769

FOR SALE: Saba Sabine - \$75. Philco Jr. cathedral -
\$95. Various reel-to-reel - \$50 ea. More, send for list.
Charles Voigt, 94 Cleveland St., Norfolk, MA 02056.
(508) 528-7928

FOR SALE: Military LS10A speaker and amp, new -
\$35. Atwater Kent Series K speaker - \$35. 5U1P CRT
used - \$5. Knight Ocean Hopper radio - \$15. Radio City
Products multi-tester - \$5. Shure Slim-X crystal mike -
\$7. Radios Master Encyclopedia, 1938 - \$15. Sylvania
Technical Manual - \$12. All plus shipping. John Martin,
111 Bancroft, Rochester, NY 14616. (716) 663-4182

FOR SALE: Zenith 10A3, looks like spinet piano,
completely restored, SASE for photo - \$695. Ralph
Hemdon, KN4DF, 4647 Ironbridge Dr., Lexington, KY
40515. (606) 273-1691

FOR SALE: RCA 66X9, green, exc - \$550. Fada 1000,
yellow/red, almost perfect - \$625. Emerson Patriot, red
- \$975. Emerson 520, Lucite grille - \$110. Fada 550 -
\$95. RCA 3BX671 T-O - \$65. Zenith R600, brown
leather - \$175. Motorola 68L1 - \$60; 56X - \$75.
Emerson 547A, ivory - \$50. Philco 49-901 - \$85; 37-84
- \$90. RCA Radiola II - \$100. GE S-22 - \$75. Truetone
2615 - \$75. Crystal set - \$65. New photo-list, many new
additions - \$1 + LSASE 2 stamps. Bob Masterson, Box
172, Valley Cottage, NY 10989. (914) 353-3151

FOR SALE: Mint 1941 "Radio Circuit Manual" (Radcraft
Publications). Best written offer by Dec. 31st. Chuck
Regen, 2724 N. 27th St., Sheboygan, WI 53083

FOR SALE: Stewart-Warner 1925 5-tube battery table
radio with low rectangle case, front panel with 3 half
moon dials, Model 300 with tubes, nice condition - \$85.
Crosley 1924, 3-tube battery radio Model 52, all original,
very nice condition - \$115. Russell Barker, 28 Franklin
St., Holliston, MA 01746. (508) 429-5499

FOR SALE: 1996 NRI Course 1-37 bound. 5 booklets.
Tubes 813 and RK872. William L. Clark, 15476
Wellington Pl. Dr., Basehor, KS 66007. (913) 724-1203

FOR SALE: Crosley Pup with base label and
headphones - \$435. Tubes: (6) 30 VT27 N.I.B.; 631-P1
N.I.B.; (5) 2A3 N.I.B. - \$50 ea. (3) 816 N.I.B. - \$35 ea.
(9) 2A3 - \$25 ea. Eimac VT-127A new - \$75. Mike Itzo,
515 77th Ave., Saint Pete Beach, FL 33706. (813) 360-
1189

WANTED: Silver-Marshall plug-in coils: 131L, 131M, 131N and 131O. Ed Bell, 5311 Woodsdale Rd., Raleigh, NC 27606. Fax/ph.: (919) 851-1517

WANTED: Radio Boys book, Air Patrol by Breckenridge. Jeff Hoskins, 824 E. Madison Ave., Stuart, FL 34996. (561) 283-2291, after 7 pm

WANTED: Would like correspondence with owner of an intact Kodak C-13 and Cockaday LC-26. Steve Hansman, 855 Arundel Dr. N, Arnold, MD 21012. (410) 974-0561

WANTED: For gift: wood or plastic table radio made in Virginia (or list of nearby mfgs.). Merry Christmas. Don Nordboe, 3131 Ave. A, Council Bluffs, IA 51501. (712) 322-7255

WANTED: Radiola 30 4-pin plug-in resistor #UP-591, UV-876 ballast, and five good UX-199's. Have N.O.S. #50 trade? John Dube, 193 North Raymond Rd., Poland, ME 04274. (207) 998-5687

WANTED: Metrodyne All Electric Radio (photo found Douglas, V2, p. 164). Must be restorable to museum quality. James F. Crews, HCR 63, Box 4, Arbovale, WV 24915. E-mail: fcrews@nrao.edu

WANTED: Info. on Kaar engineering PRS9A, National FSR, Silvertone Precision, sockets for 204A tube, hard cover Alan Douglas Vol. 2. Rob West, 27490 Strathmoor, Warren, MI 48092-3040. (810) 751-7271

WANTED: Junker Zenith 7G605 Trans-Oceanic or the cloth grille and wave rod only. Send LSASE for small radio and catalog list. Thanks. Chris Schmidt, 177 E. Village Rd., Elkton, MD 21921

WANTED: Case only: Majestic Charlie McCarthy. Cases and cabinets: Crosley 148, 418 vanity, Radiola balanced amp, something to take a 30" x 7" x 8" superhet panel. Chassis: Tri-City W-2, Eveready 33, American Bosch 16, American Radio Corp. American Super 5, Radiola 100, GE 1933 (E.O.R., p. 141). Tuning condenser: Paramak 13 plate. Dial escutcheon and knobs: Radiola 120, GE K-52. Richard B. Jehlik, 14441 N. River Rd., Omaha, NE 68112. (402) 457-4604, after 7 pm CST

FREE – 20 WORD AD EACH MONTH
To get your free 20 words,
include your SUB# with your Ad.
Additional words are 25¢ each.
Read inside back cover for details.
MANY THANKS!!!!

WANTED: National NC-120 receiver, Bendix ATD transmitter and dynamotor, BC-348 receiver, EICO Model 753 tri-band transceiver and power supplies, Temple (brand) luggage-type portable radio, 1930-1950 Popular Mechanics magazines. Harry L. McCall, KB4CSY, 9135 Glade Valley Rd., Ennice, NC 28633. (910) 657-8248

WANTED: Dial glass for Majestic 5A410. Crosley 5M3 or cabinet only. **FOR SALE:** Puritan #508 – \$25/BO. GE multiband #F80 – \$25/BO. Radiola 33 – \$25/BO. Oscilloscopes – \$25/BO. Others and old test equipment. Philco 38-15CS chairside, nice, untested, asking – \$140. Rider's 9, 10, 11, 13 – \$20 ea. Cleo A. McAlexander, Box 4, Stanleytown, VA 24168. (540) 629-2972, after 5 pm

WANTED: Zenith 7S363 or 12S265. Advise condition & price. Harvey Leners, 5426 So. 185th, Omaha, NE 68135. (402) 895-2331, after 6 pm CST

WANTED: Atomic era/cold war stuff, fallout shelter signs, civil defense signs, literature, posters, radios, etc. Have some nice Victoreen Geiger counters for trade/sale. Literature on RCA AR-8702 radio direction finder, other RDFs and lit. Coin-op for RCA MI 13174 coin radio. Ward Kremer, 301 S.W. 16 St., Ft. Lauderdale, FL 33315. Ph.fax: (954) 524-5652

WANTED: Following Raytheon RK Series tubes: RK15, RK16, RK25A, RK25B, RK30, RK32, RK41, RK43, RK44, RK45, RK46, RK53, RK56, RK58, RK63A, RK64, RK100. John H. Walker, Jr., 16112 W. 125th St., Olathe, KS 66062. (913) 782-6455. E-mail: johnh.walker@alliedsignal.com

WANTED: Coin-operated switch (25¢/2 hr.) for Coradio, gray metal box, coin radio. Chris Van Houten, 728 Keup Rd., Cedarburg, WI 53012. (414) 377-5873

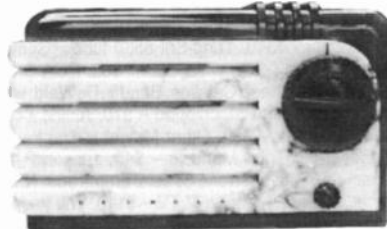

WANTED: More prewar plastics by Detrola, RCA, Kadette, Air King, et al. Take all my money before the relatives do. They are trying to hurry my already imminent demise. Please write or call collect: Rain Buttignol, 314 State St, #7, Portsmouth, NH 03801. (603) 427-1384

WANTED: Pre-1922 crystal detectors & wireless apparatus. Top prices for excellent Electro Importing (E.I.Co.) & Marconi. Dick Kowalski, 32823 Gloede Dr., Warren, MI 48093. (810) 294-6831

WANTED: Instruction manual for ICOM IC-R100. J. Finkelstein, 205 Alapocas Dr., Wilmington, DE 19803

WANTED: Chassis and speaker for my RCA 110 cathedral cabinet (M.A.J.A., p. 168). Will purchase complete set in junker cabinet. Wayne King, 408 Forbes Dr., Shelbyville, KY 40065. (502) 633-6564, evenings

WANTED: Inductors: I need 4-MQE-7 100 millihenry and 2-MQE-5 50 millihenry toroidal inductors, made by UTC. Reid Brody, 232 E. Ohio St., Chicago, IL 60611. (312) 664-9333

WANTED: Amp section of McIntosh MC50W2 with dual 6L6. Have 5U4 power supply section. Need bias voltage meter for WE tube tester KS-15560-L1. C. Ong, 3806 Lake Blvd., Annandale, VA 22003. (703) 573-2288. Fax: (703) 573-5896. E-mail: ongt88@erols.com

WANTED: Electron tubes, ball bearings, aircraft and helicopter parts and instruments, radio and electronic parts and equipment, lamps and synchros. Hy Ness Company, 709B Delair Rd., Cranbury, NJ 08512-4212. Phone: (609) 395-1116. Fax: (609) 395-1117

WANTED: Zenith 67 working tuning capacitor, or will buy whole working chassis. Crosley Showbox Model 706 chassis in working condition. RCA Redbooks 1929-1930, 1940. Original instructions book for Arvin 1247. Tony Parjus, 816 Richard Ln., Gretna, LA 70056. (504) 393-0099

FOR SALE/TRADE: Collins 32-V3 transmitter - \$600. Heath SB401 and SB301 - \$450 for pair; NC-300 - \$200. Call: Larry Drago, 383 Lincoln Dr., Cheshire, CT 06410. (203) 272-6030

FOR SALE: Tubes, N.I.B.: NX112A - \$25. 01-A - \$20. UX216B - \$100. CX340 - \$30. NU27 - \$10. NU71A - \$15. NU76 - \$15. Silvertone 46 - \$16. Many others, all plus shipping. SASE for list. Robert B. Toenjes, 1724 2nd Ave. NW, Waverly, IA 50677. (319) 352-3321

FOR SALE: Western Electric key - \$35. Slate base key - \$100. Philco 44B cathedral - \$300. Philco 18B scalloped edge cathedral - \$395. 1938 Scott escutcheons - \$50. Honeycomb coil winder - \$75. Jensen R15R-C5835 speaker - \$90. Radio questionnaire electric game, 1928 - \$95. Bill Rolf, 30131 Center Ridge, Westlake, OH 44145. (216) 871-4547

FOR SALE: Predicta barber pole - \$575, pick up only. AK breadboard 4340. Tung-Sol 6550 tubes, Genalex KT-88. Trav-Ler T-201, white/pink - \$85. RCA BK-6B mikes - \$85 ea. Cheap Catalins, Bendix, DeWald; white Stewart-Warner Air Pal, chipped - \$70. Airline 84BR-1502B, white, fair - \$60. Other Midget radios too. (2) RCA Receiving Tube Manuals - \$45. Jensen P-12Q speaker - \$65. Mastertone Special amp - \$65. N.O.S. Predicta knobs. Silvertone 7" TV - \$110. Will trade for old microphones or prewar midget plastic radios. Please call before 8 pm. Brad Jones, 4801 Crofton Springs Ct., Greensboro, NC 27407. (910) 547-1919

FOR SALE: Lafayette RK142V reel-to-reel audio tape recorder, knobs missing - \$15. Bob Curwin, 759 Jody Ln., Hoffman Estates, IL 60194. (847) 490-1414

FOR SALE: Majestic #7P420 portable - \$40. Grunow #700 chrome grille - \$250. Crosley #66TA - \$40. David Gamer, 1210 19 1/2 St., S, Apt. 6, Moorhead, MN 56560. (218) 236-5598

FOR SALE: Pair of Sears walkie-talkies, #6460 - \$45. Realistic 16-625 - \$20. DX-360 - \$45. DX-440 w/box - \$90. Variac in case - \$40. Learjet 8-track - \$30. Realistic auto 8-track - \$20. Numark DJ turntable - \$125. Heathkit voltage reference source #ECC-80A - \$35. Bret F. Johnson, 13495 102nd Ter., N, Largo, FL 33774. (813) 595-9287

FOR SALE: Two 1939 canvas Philco radio advertising banners, approx. 3' x 9' - \$150 ea. plus shipping. Brad Becker, 551 Circle Dr., Derby, KS 67037. (316) 788-2934

FOR SALE: H.H. Scott 342-C FM stereo receiver, works but needs something, take chance for - \$35 + shipping? George Wright, 4181 Enders Way, Doylestown, PA 18901. (215) 997-4144

FOR SALE: Original sales literature, from 1950's, Shure microphone catalog, 15 pages - \$10. Electro Sonic Laboratories, broadcast quality microphones, and professional series arms and cartridges, catalogs and brochures, 40 pages - \$20. Magnecord professional tape recorders, catalogs and brochures, 31 pages - \$25. Garrard record changers, two different catalogs available - \$5 ea. Grundig brochures, six all different, package price - \$10. Ellsworth O. Johnson, 364 S. Coeur d'Alene St., Spokane, WA 99204-1063. Phone/fax: (509) 838-2161

FOR SALE: General Motors console Mod 253, Deco style cabinet, door slides vertical, color exceptional, @10 - \$250. Echophone EC-1, A/O, N/D, @10 - \$50. Plus P&S. Bernie Samek, 113 Old Palmer Rd., Brimfield, MA 01010. (413) 245-7174. Fax: 0441

FOR SALE: N.O.S. CRTs: Sylvania 12LP4A, Coronado 14RP4, 16KP4, 17BP4A, 17HP4B, 19BP4A, 21AP4 - \$125 ea. Call 9 am-6 pm Mon.-Fri. or leave message on ans. serv. Monarch Technologies Inc., 21501 Highway 183, Crescent, IA 51526-4091. (712) 322-7927

NEW & GROOVY!

J.D.'S Radiowear

TRANSISTOR
PRINTED FRONT
ONLY IN FOUR
COLORS, ON A
NATURAL, 50/50
T-SHIRT.
\$13.95 +
\$2.00 P & H

T-SHIRTS
ONLY, IN SIZES
M, L, XL AND
XXL (\$1.00 EXTRA).



SEND CHECK OR MONEY ORDER TO:
J.D.'S RADIOWEAR
1161 SW MULVANE
TOPEKA, KS 66604
(913) 232-0128

SEND AN SASE FOR J.D.'S BROCHURE!

COPYRIGHT 1996

The Original

"Chassis Handler"

A patented adjustable support stand for antique radio, ham, and hi-fi repairs. Maneuverable on casters, it features adjustable work height, chassis width, and chassis inversion. Handles even large Scott chassis. (Chassis width to 28")

\$179 shipped to U.S. Destinations

To order or for more details contact:
Carlton Carver — 1645 W. 5th Street
Washington, NC 27889
PH (919) 975-2677 Mon.-Fri. 9 AM-1 PM



Catalin radios in any color
 Jean-Claude Reboul
 (305) 662-1986
 9 Lincoln
 Johnston,
 N.C.

S153, 10S464, 11S474.
 \$200; 39-116 console w/
 reette with ivory trim - \$35.
 3 band, restored - \$155.
 30. General TV 19A5, wood
 G-503Y leatherette flip-up,
 small brown Bakelite - \$65.
 table, navy leather and grey
 orola 55X13, a wood set, hums
 ox, Dom-503F, N.O.S. - \$125.
 yle model TV - \$135. 9" x 12"
 \$40. Dynaco PAT-4, missing knob
 7 color generator, no book - \$40.
 Philco 87 chassis & speaker - \$45. Books: Ghirardi
 Radio Troubleshooter's Handbook, exc - \$35. Zenith
 Radio Service Manual Vols. 1 & 2 - \$75. Rider's Radio
 Vol. 6 - \$25; Vol. 7 - \$20; Vol. 9, 11, 13 - \$15 ea. Radio
 Electronic Master Catalogs, 1957 and 1959 - \$15 ea.
 Prices do not include shipping. Inquiries, call Wed. 6-9
 pm or Sat. 12-4 pm. Credit cards accepted. Vintage TV
 & Radio, 3498 W. 105 St., Cleveland OH 44111. (216)
 671-6712. Fax: (216) 671-2975

**IF YOUR EXPIRATION DATE IS
 DECEMBER OR BEFORE, RENEW TODAY!
 EARLY RENEWALS
 RECEIVE AN EXTRA ISSUE!**

FOR SALE: Beautiful 1942 Panamuse and Philco 40-
 190. **WANTED:** Automatic Electrola, O reproducer/
 carriage. James Burnett, 640 Mason St., Apt. 702, San
 Francisco, CA 94108. (415) 433-1930

FOR SALE: Heathkit GR-81 - \$40. Hammarlund HQ-
 129X w/speaker - \$130. Hallicrafters S-38E - \$40;
 SX-99 - \$90. Lafayette Comstat 23 - \$50. John Malley,
 19 Claremont Ave., Enfield, CT 06082. (860) 745-0733

FOR SALE/TRADE: Garod Commander, yellow with
 red trim, in excellent condition; Motorola S-grille in red
 and black in perfect condition; Emerson tombstone
 Model BT-245 in marbled green with white trim
 and also highly marbled green with white trim; both
 radios are perfect; Fada bullet in yellow and red; General
 Television in yellow, repaired crack; blue mirrored
 Sparton 557 and 558 in perfect condition. Jean-Claude
 Reboul, 7010 S.W. 48 Ln., Miami, FL 33155. (305) 662-
 1986

FOR SALE: Philco 39-116 with remote - \$250. Philco
 67 Clam Shell - \$125. RCA 813K - \$200. Malcolm J.
 White, 18 Sagebrush Dr., Belleville, IL 62221. (618)
 233-1484

FOR SALE: Crosley 34-S console, some good chassis
 parts, good speaker, some cabinet parts - Offers. R.
 Matzko, 3 Coloma Ct., Sterling, VA 20164. (703) 406-
 2713

FOR SALE: Tube radios, 1920s-1950s. Send SASE.
 Jim Ramsey, 322 Ridgeway Rd., Lexington, KY 40502

FOR SALE: (25) vols. Rider's TV Manuals with Index -
 Give me a bid. Riders, specialized books by Rider,
 Sams, etc. Kellog top heater and other tubes. 20, 25, 50,
 100 & 120 watt amps with 1, 2, 3, 4 mic inputs, Stromberg-
 Carlson, Bogen, Dukane, all working with good tubes.
 NIKKO Mod 1050, 50 stereo amp with built-in equalizer
 in original box, never used. Carterphones to connect
 two-way to phone. Various meters. Send LSASE for
 new listings. Edward Scribner, PO Box 279, Schoharie,
 NY 12157-0279. (518) 295-8819

FOR SALE: RCA Radiola 103 speaker - \$125. Atwater
 Kent F-2 cone speaker - \$60. Radiola 100 cone speaker
 - \$60. Zenith 807 tombstone - \$165. RCA R-7 tombstone
 - \$150. Zenith 6D311 - \$150. Belmont 6D111 - \$150.
 Radiola 17 - \$90; 18 - \$90; 20 - \$150. Bendix 0526E
 - \$60; 526A ivory - \$60. Crosley 66TC - \$60. Hallicrafters
 SX-140 - \$75. Sentinel 284WE - \$60. Setchell-Carlson
 427 - \$60. Westinghouse WR12X9 - \$50. J. Gary
 Cameron, 824 Andrews St., Southington, CT 06489.
 (860) 276-9200

FOR SALE: New in box Western Electric 10 Special
 tube - \$60 + UPS. Wayne Abare, 335 Meadowood Ln.,
 W. Melbourne, FL 32904. (407) 727-8559, after 5:30 pm
 weekdays

FOR SALE: Lots of good old tubes from DeForest to
 Wunderlich, also transmitting tubes. AK breadboard
 parts. Tuning coils. Brush BA303 Hushatone ext. speaker
 in box. Set of Masterphone metal toy telephones in box.
 RCA 9JY Bakelite 45 player, mint with instructions.
 Kodak Autographic folding camera No. 2C in box. Also
 some microphones. (EV, AKG, others). Desk and boom
 stands. Please call for pricing. Jon Steinhauer, 1205 E.
 Broadway, Hewlett, NY 11557. (516) 295-3147

FOR SALE: Transistors: Truetone DC3326, reverse
 painted, M.I.B. - \$100. Sony TR-86 - \$125. Toshiba
 7TH-425 - \$80. Sam Samuuelian, 2305 W. Deerfield Dr.,
 Media, PA 19063. (610) 566-7248

FOR SALE: Buddy Boy replacement thumb wheels,
 dials & emblems coming soon; rubber grommets for
 Philco 70/90 tuning condensers - \$4 for three ppd, \$3
 for each additional set. Don Patterson, 636 Cambridge
 Rd., Augusta, GA 30909. (706) 738-7227

FOR SALE: Military R-1051 receiver IF module service
 extension cables, new - \$15 ea. ppd Cont. U.S. Geoff
 Fors, WB6NVH, PO Box 342, Monterey, CA 93942.
 (408) 373-7636

FOR SALE: Zenith Royal 3000-1, near excellent - \$75.
WANTED: LED-type pocket calculators. Larry Gilbert,
 2602 Amapola Dr., Davis, CA 95616. (916) 758-5025

FOR SALE: Bendix #115, identical in size & shape to
 #526C Catalin, but maroon front, swirled cream plastic,
 displays well, works exc, 1 hairline - \$225. **WANTED:**
 Woodphonograph horns - cash or trades. J.L. Acciavatti,
 PO Box 231, Southborough, MA 01772. (508) 476-3229

FOR SALE: Eico wooden enclosure (WE 70) walnut for
 HFT90, N.I.O.B. - \$10. Donald Schurek, W191 S7500
 Richdorf Dr., Muskego, WI 53150. (414) 679-0212

FOR SALE: Setchell-Carlson 427 - \$75. Emerson Van.
 888 rocket - \$65. GE P807J - \$25. Pan. R70 - \$35.
 Zenith Royals: 275, 705 & 710 - \$40. Ernie Odeneal,
 2710 Lee, Greenville, TX 75401. (903) 455-2113, or e-
 mail: 5788.ode@koyote.com

FOR SALE: Weston 500 microamp DC meter, 0-1 f.s.,
 7" x 6", N.I.B. - \$25. Carl Hackenson, 31 Hixson Farm
 Rd., Sharon, MA 02067. (617) 784-8834

FOR SALE: Collection: (12) consoles, 1930's
 breadboard transmitter - \$250. Oscilloscope, oak clock
 (Mass.) - \$175. Paul Recupero, 265 Union, Portsmouth,
 RI 02871. (401) 847-8589

FOR SALE: Hammarlund SP150 parts unit - \$75 plus
 shipping. TM's 11-850 and 11-1897 - \$10 ea. Michael
 Harrington, PO Box 250995, Little Rock, AR 72225

WANTED: CB radios, EICO catalogs, EV-664 microphone with 419 desk stand. Tom Bonomo, 81 Lakewood Cir., San Mateo, CA 94402. (415) 578-1897

WANTED: (2) National NC-150 or MC-500 or equiv. neutralizing condensers. James T. Schlietstett, W4IMQ, PO Box 93, Cedartown, GA 30125. (770) 748-5968

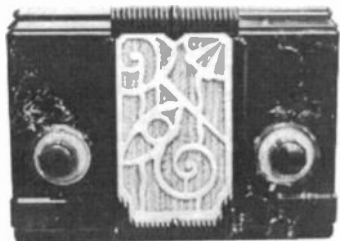

WANTED: Early (prewar II) plastic radios. I collect these objects of beauty to enhance my otherwise dull and uneventful life to which I am forever bound by my sad-but true unworthiness and shortcomings: physical, emotional, and intellectual. Please write or call collect: Rain Buttignol, 214 State St, #7, Portsmouth, NH 03801. (603) 427-1384

WANTED: (1) knobs & antenna for Fada 6 Model R60 neodyne dog coffin. Clear photo/diagram of antenna OK. (2) knobs and push buttons for Crosley 02CA/02CB, chassis Model No. 55, mid-40's console with pull-out changer, reproductions OK. (3) Advice about fixing pot-metal turntables with bad teeth. Jim Falls, ("will work for radios"), 2605 R St., Eureka, CA 95501. (707) 725-4413, days. (707) 725-9827, fax. (707) 443-4835, eves.

WANTED: GE F40 Bakelite, no cracks w/back (see Stein, p. 105). Karen McCoy, 8104 N.W. 114th, Oklahoma City, OK 73162. E-mail: kcmccoyokc@aol.com

WANTED: 1947 Motorola VT-105 or 1948 Philco 48-1001 television, prefer working condition. Reply to: Kevin Walsh, 2328 S.E. Salmon, Portland, OR 97214

WANTED: Set of original or repro knobs (3) for Fada P80 portable flip-lid radio. Milt Margolis, 6500 Harwood Ct., Springfield, VA 22152. (703) 451-4507

WANTED: Any APS-4 items, BC-611 items, PPN2 items, SSR-1 items, SSR-5A items. Steve Bartkowski, 4923 W. 28 St., Cicero, IL 60650. (708) 863-3090

WANTED: Sencore TV analyzer, Sherwood integrated amp/receiver/7868 output tubes, original, working. **FOR TRADE:** Ampex 2010 speaker/amp for Pilot SP-215. Jim Addison, 180 Horseplain Rd., A-1, New Britain, CT 06053. (860) 223-5141

WANTED: TV Guides and similar regional magazines from 1948 to 1953. Jeff Kadet, K1MOD, Box 20, Macomb, IL 61455

WANTED: Philco's Models: 38-9, 38-62, 38-620, 39-6C1, 39-12CBI, TP-41, 40-145. Donn Frederick, 8402 Hwy. 30 SE, Chatfield, MN 55923. (507) 867-4868

WANTED: N.O.S. audio/radio tubes. 5881, 6L6GC, 12AX7, 5AR4/GZ34, etc. Also old Jensen Alnico speakers, all sizes blown or good. John McGrath, 29 Ripley Rd., Belmont, MA 02178. (617) 484-0515, evenings or fax (617) 492-7291

WANTED: Fada #L-96W & #20-W & #845, DeWald #B-401, Trav-Ler #5028-A; Emerson #149 & Woolaroc #3-1A. Send asking price and condition to: J.M. Hoover, PO Box 633, Granby, MO 64844

WANTED: Chassis for Crosley Model 57 and speaker for Majestic Model 20. Please write or call: Jerry Gilchrist, 2145 Sugar Valley Rd., Ohatchee, AL 36271. (205) 892-0703

WANTED: For 1932 Detrola Treasure Chest, I need photos and dimensions of the lid. Dennis Smith, KN8H, Box 113, Trenton, MI 48183. (313) 675-5847

WANTED: Crystal diode toy radios, rockets, planes, etc. Bill Landsiedel, 1355 Terrace Way, Laguna Beach, CA 92651. (716) 376-2077

WANTED: Vitaphone items: Early 16" shellac movie soundtrack discs, films & related materials. Dave Sica, 1459 St. Georges Ave., Rahway, NJ 07065. (908) 382-0618

WANTED: Old guitars/amps by Fender, Gibson, Danelectro, playable condition. Call or write: M. Trocchia, 505 Moore Rd., Neptune, NJ 07753. (908) 774-4457

WANTED: Allied A2509, A2515A, A2508, A2589, Archer Space Patrol walkie-talkies, Knight kit Monitor III, R-195, Star Roamer II, Radio Shack 100-N-1 Electronic Project Kit and any Radio Shack catalogues and books from 1960 thru 1970's. Realistic Clarinette 91, 92, 95, 96, 97, 98, 101, 102, 103, 105 or 110. Preferably mint and manuals. Larry Stowers, KC5SSK, 522 Center Way, Lake Jackson, TX 77566. (409) 299-1897

WANTED: Manuals or copies for the Simpson Model 383A Capacohmter, N.R.I. Model 33 signal tracer. Richard J. LaMark, N2TXL, 6822 Tuckahoe Rd., Williamson, NY 14589-9589. (315) 589-2552

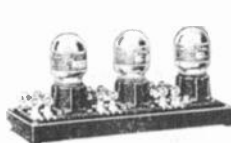

Daven Super Amplifier



BAIRD SHORTWAVE CONVERTER

WANTED: Daven Super Amplifier, must be mint with original tubes (Daven MU-20 type) and original box or just empty original box - top dollar paid. Original Daven resistor manual. Original Daven resistors. Daven neon television tube Type T-2080 with or without original box or just empty box. Baird shortwave converter (C-3-S). DeForest-Jenkins 8-tube television and broadcast receiver (Model J.D. 30). 1920's & 1930's neon television tubes. What do you have? Write or call me. Larry Dunn, 473 Serento Cir., Thousand Oaks, CA 91360. (805) 492-7111

WANTED: Restorable cabinets for Philco 90 & 70, damaged spkr panel acceptable. Carl Bier, 4021 Via Picaposte, Palos Verdes Est., CA 90274. (310) 375-6149

WANTED: Cabinet, knobs & spkr for my Freshman Masterpiece Model 5-F-5, condition of cabinet not critical, will buy junker to get above items. James Mallory, 328 Kingston St., Aurora, CO 80010. (303) 341-1815, eves. only

FOR SALE: Zenith Trans-Oceanic Model 1000-D, written up in the October A.R.C. - \$80. Midland mini radio Mod 10-188, about two inches square, untested - \$55. Motorola transistor #6X31C, one of their first - \$55. Jim Montague, 1907 S. Stanley Ln., Spokane, WA 99212. (509) 535-9576

FOR SALE: Cathedral: U.S. Gloritone 26, very clean - \$450 ppd. Radio Roy, 520 Gladstone, Shreveport, LA 71104. (318) 865-4811

HAS YOUR SUBSCRIPTION

EXPIRED?

**It has if your mailing label reads
"EXP=DEC96" or earlier.
Renew now!**

**BONUS: Renew before
your "EXP" month and receive
13 issues per year instead of 12!**

Renewal rates are:

\$36.95 for Periodicals Mailing

\$53.95 for First-Class Mailing

(Two-year renewals are twice above rates.)

FOR SALE: Book entitled "Jim Clark's E. H. Scott Radio Collectors Guide, 1925-1946" - \$32.95 mailed. Jim Clark, 3520 Okemos Rd., #6, Okemos, MI 48864. (517) 349-7187

FOR SALE: Radiola 111, no tubes, but otherwise complete - \$50. Zenith Trans-Oceanic Royal 1000, looks nice, complete with schematic and all papers it came with, plays weak, untested - \$75. 1,800-ft. reel-to-reel church tapes, fully erased and look new - \$3 ea., plus shipping. (120) Sams Auto Radio Photofact books, must sell all as a package - \$1 ea., plus shipping. Dentron power meter WP-1A, 20 watts to 2 kw - \$40. Fada Radio Model 845, ivory color, no cracks, plays well, one knob missing - \$100, plus shipping. Carl Hawkins, W4PFU, 315 W. Duval St., Live Oak, FL 32060-1724. (904) 364-5240

FOR SALE/TRADE: RCA first tape/cart. machine Mod SCP-3 w/dual amplifiers for stereo, include (3) original(?) cartridges (prerecorded) in handsome suitcase-style enclosure - \$300. Also large chrome-plated RCA prototype with AM/FM, shortwave, television, Victrola glass barrel band selector, needs some assembly, a very neat item. Larry Drago, 383 Lincoln Dr., Cheshire, CT 06410. (203) 272-6030. Fax: (203) 272-2002

Virginia City Radio Museum

109 So. "F" St.

*Wireless and Radio Apparatus from 1915
through the 1950's - Antique Radios,
Speakers, Vacuum Tubes, Microphones,
Telegraph Keys, Photographs, Ham
Equipment & Vintage Ham Radio Station*

We also repair and restore antique radios

*Henry & Sharon Rogers - P.O. Box 511
Virginia City, NV 89440 Tel: 702-847-9047*

FOR SALE: Very nice original Majestic Treasure Chest - \$275. K 165 cathedral. Nighthawk cathedral 6222, 7 tubes - \$225. Art Deco Dictograph Silent Radio B20 made by Fada, high-style cork, wood and chrome cabinet - \$295. Sony TV 5-303W, with case - \$100. Grunow 750 - \$225. Crosley 179 Deco - \$99. Stewart-Warners: 1272 - \$275; 1301a - \$185. RCAs: 10T, T10-1, 140, 125, R7. Stromberg-Carlson 130R - \$295. Gorgeous original finish Zenith 9S262. Stromberg-Carlson 60T, N.O.S. cabinet - \$350. Lionel AC/DC table model - \$175. Rider's Manuals: 8-14 - \$15 ea. High numbers now available. Call for current availability on other numbers. All type Trans-Oceanics including a cowhide 600, electrically restored, if requested, and guaranteed. Zenith AM/FM 2000 - \$150. Zenith consoles: 15S372; 15U270; 15U269; 12A58A export; 12A58; 12S569; 12S471; 12U159; 12U158; 12S370; 12S371; 12S265; 12S266; 12S268; 11S474; 10S470; 10S153; 10S155; 10S157 Zephyr; 10S160; 9S55; 9S54; 9S262; 9S367; 8S154, 8S463 (5808); 8S359; 7S366; 7S261 bookcase; 7S363; 7S260; 7S258; 410 and many others. Zenith chairsides: 5S338; 9S244; 9S242 Zephyr; 10S147 Zephyr; 6S147 Zephyr; 8S451; 7S343; 6S203 with phono; 6S241 bar radio; 6S239. If you are looking for a set not listed, please call for more info. We can and do ship consoles anywhere and we do it right. Zenith table models: Cathedral LH; 5S29; 5S127; 5S228; 5R226 children's sets; 7D226; 6D029; 6D630; 6S321; 6S229; 6S330; 7S323; 7S634R; 6V27; 6S27; 6S128; 6S222; 7S433; 8S443; 9S30; 10S130; 12S445; 807 and many others, call. All radios unrestored electrically unless noted. Shipping extra unless noted. Satisfaction guaranteed, highest quality possible assured. Send for our free catalog featuring reproduction knobs, restoration and shop supplies, owner's manual reprints, grille cloth, etc. When in Minneapolis, be sure to visit our retail location: Great Northern Antiques, 5159 Bloomington Ave., just five minutes from the airport. We accept Visa, Discover and MasterCard. Alan Jespersion/Mike Emery, PO Box 17338, Minneapolis, MN 55417. (612) 727-2489, ans. mach. after 4 rings, 8 am to 8 pm, 7 days. Fax only: (612) 727-1908

FOR SALE: Tektronix scope Model 545B with four plug-in units & Model B cart. - \$195. Bill Lowe, 10 Meadowbrook, Candler, NC 28715. (704) 665-2727

FOR SALE: Novelty transistor wooden-cased telephone (Breed 483), Japanese, plays good - \$25 plus shipping. Charles Combs, 508 E. Daniel St., Albany, MO 64402. Phone/fax: (816) 726-3038

FOR SALE: Western Electric amplifier with two 205Ds. SASE and \$2 for photo. Gene Greneker, 184 Lake Somerset Dr., Marietta, GA 30064. (770) 422-2979

TUBES BOUGHT & SOLD

Industrial • Power • Receiving
Special Purpose • CRT's

— Vast Inventory —

Contact: Donna - Sales Mgr.

(201) 751-2591 / (800) 526-1275

Fax → (201) 481-1524

United Electronics Co. Est. 1935

Tube Manufacturing Equipment For Sale
Assorted Tube Bases For Sale

WANTED: WWII Japanese military radio of any kind; anything WWII Japanese military hardware, aircraft related. Takashi Doi, 1-21-4 Minamidai, Seyaku, Yokohama, Japan. Fax: 011-8145-301-8069

WANTED: Philco 49-900 or equivalent in ivory. 1950's Emerson and Philco plastic tube radios, plus instructions and sales fliers. Motorola 5X1U, 5X11U, 6X11U, 53H, 53X1, 56H, 5T22M, 79XM21. Mint Truetone D2018. KLH 8 accessories, instructions, sales fliers. Marantz, Acrosound, Fairchild, Fisher, Hadley, Karg, REL, etc., tube hi-fi equipment, plus instructions, accessories, sales literature. Unusual tube hi-fi equipment. Paul Creasy, 6216 Worlington Rd., Bloomfield Township, MI 48301. (810) 737-0429. E-mail: 74664.1153@compuserve.com

WANTED: Manual for H/P 8405A voltmeter. **FOR SALE:** Rider's Vols. 6-15 - \$140. H/P 654A test oscillators - \$115. N.I.B. 6AF6GT eye tubes - \$5. N.I.B. Hexacon 60-watt soldering irons - \$11.50. N.O.S. Amphenol ceramic octal sockets - \$2.50. New 0.27/600 volt hermetic glass-sealed capacitors - \$2.50. Lowell Thomas, K6KC, PO Box 15026, Fresno, CA 93702. (209) 227-1605

WANTED: Original knobs for Emerson 636A AC/DC radio (Bunis 3, p. 75). John Pelham, W1JA, 1185 Bend Creek Trl., Suwanee, GA 30174. (770) 476-0473. E-mail: John_Pelham@msn.com

WANTED: Antique medical and scientific devices. Small brass-blade table fans, radios, phonographs. Richard Cane, 1333 N.W. 127th Dr., Sunrise, FL 33323. (954) 846-7116

WANTED: Service manual and/or schematic for Roberts R200 transistor portable. Gary Riola, 10845 Hastings St., Westchester, IL 60154. (708) 409-1430

WANTED: Original or copy of index: Airline Radio Service Manuals 1929-42 Volume 1. Thanks. Lars Roose, 10100 Chapala Ct. NE, Albuquerque, NM 87111. (505) 296-4129

WANTED: Wire recorders, spools of wire, full set of Radio Riders. Tom Earnest, PO Box 62032, San Angelo, TX 76906. (915) 651-9605. Fax: (915) 651-7080



WANTED: This Lewol radio with metal trim & radios with chrome grilles. Jay Malkin, 1250 Galapago, #206, Denver, CO 80204. (303) 623-6451

WANTED: Zenith chassis 5C02 and phonograph for radio/phonograph Model 5R086Z, junker OK. Jim Clifford, KE4DSP, 108 Bayfield Dr., Brandon, FL 33511. (813) 654-7531. E-mail: jclifford@gte.net

WANTED: Speaker panel National Navy receiver RAC2, also parting out junker RAC2 chassis. Richard S. Norton, PO Box 8181, Garden City, NY 11530. (718) 225-7412. Fax: (718) 279-9011

WANTED: Zenith Stratospher count radios. Also Zenith and of We will buy or trade. Alan Je Minneapolis, MN 55417. (61

WANTED: Western Electri 274B, 300B, 348A, 349A North, Orem, UT 84097.

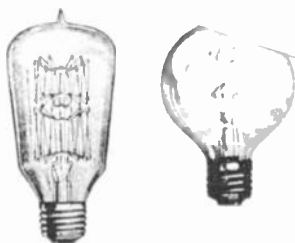

WANTED: Old and unusual light bulbs. Books, magazines, catalogs and videos about early light bulbs. Describe and price, will answer all letters. Richard Bock, 1001 Meadow Ln., Fortuna, CA 95540

WANTED: IF xmr for Philco 80. Assortment old tube shields. Noel S. Iig, 228 Beck Rd., Avon Lake, OH 44012. (216) 933-5668. Fax: (216) 933-8864

CLASSIFIED AD NOTICE

Please check your ads carefully before sending them in. Once ads are received, it is not always possible to refund the amount sent, pull the ad or make changes.

WANTED: Stewart-Wamer 300 parts set, reasonably priced unrestored Philco 90. John Lee, 1658 E. Fifth St., Ontario, CA 91764. (909) 984-4592. E-mail: edsel@linkline.com

WANTED: Hallicrafters SX-100. Gene Peroni, Box 58003, Philadelphia, PA 19102. (215) 665-6182, days

WANTED: 1920's Pearson radios and RCA tombstone radios. Escutcheon and knobs for RCA 87K2 console. Trent Pearson, KB0LSG, 212 1st St. West, Alburett, IA 52202. (319) 842-2390, after 6 pm

WANTED: Unusual brand 01-A's for display collection and old 01-A boxes. Hal Kravig, 2615 Juneway Dr., Memphis, TN 38134. (901) 388-2857. Fax: 388-5102

WANTED: Main tuning capacitor, #26-113, for Heathkit HW-16 transceiver. Louis D'Antuono, 8802 Ridge Blvd., Brooklyn, NY 11209. (718) 748-9612

WANTED: Very early European wireless apparatus, even wrecked, parts, literature. Enigma German cipher machine US R56 radio station. Nagra SN and IVs reel-to-reel tape. Sequerra hi-fi. Francois Humery, 16, hameau des maronniers, Lognes, France. Phone: 00-33 160052836. 609650019. Fax: 00-33 160378400

WANTED: Zenith Trans-Oceanic parts sets: 1000, 3000-1 and 7000. Jim Montague, 1907 S. Stanley Ln., Spokane, WA 99212

WANTED: WWII LS-3 speaker, and Philco 70 with brass escutcheon. Michael Harrington, PO Box 250995, Little Rock, AR 72225

WANTED: General Radio items: 1602-P-1, P-2 and P-3; 874 LK, 874 WM. Call or write: Fred Suffield, 227 Fairway Dr., Sequim, WA 98382. (360) 683-6482

FOR SALE/TP
in exquisite w
E.H. Scott
excellent
\$1,600
08/41

FOR SALE: Atwater Kent Mod 12 breadboard working & cosmetic condition - \$1,750. Also Allwave 12 w/power supply, chrome is - \$750. Connecticut Siodon D-6 w/tube - \$100. Larry Drago, 383 Lincoln Dr., Cheshire, CT 06010. (203) 272-6030. Fax: (203) 272-2002

FOR SALE: Crosley chassis for floor Models AC7C or 5-75 or 6-85. These chassis fit in the same cabinet. Gary Formica, 823 91st St., Niagara Falls, NY 14304. (716) 283-2274. E-mail: radio@ns.moran.com

FOR SALE: Hallicrafters S-41W receiver, white, in good condition, asking - \$50. Call: Sheldon Kane, 360 Rhinecliff Dr., Rochester, NY 14618. (716) 442-6338. E-mail: Auxech@aol.com

FOR SALE: WE dial candlestick telephone, complete including cords, subset, mint museum quality - \$285. Curt Brohad, 1417 Court St., Alameda, CA 94501. (510) 521-4299

FOR SALE: Piano radios: maroon Continental - \$325; wood General Television - \$275. Have parts for piano radios. Geoff Shearer, 14101 Mesita Cliff Rd., NE, Albuquerque, NM 87112. (505) 293-8544. E-mail: GSHea90278@aol.com

FOR SALE: Crosley 11-120U (Bunis 3, p. 53), mint, white, everything works - \$125. Carol Scott, 1402 Cora #1, Ellensburg, WA 98926. (509) 925-1030. E-mail: radioland2@juno.com

FOR SALE: (2) Bogen Challenger amplifiers CHB-35A - \$80 for both. Harry Pewowaruk, 1535 No. 8th Ave., St. Cloud, MN 56303. (320) 252-9910. E-mail: PewowarukH@aol.com

FOR SALE: Dynakit ST-70 - \$250. Plus shipping. **WANTED:** Chassis for GE K52, escutcheon for Philco radio bar, wire recorders. Peter Dieguez, 36-48 34th St., Long Island City, NY 11106. (516) 625-0429

FOR SALE: Privatear pocket radio, original papers and box, (2) tubes, LNC - \$75. Spencer pocket radio, original papers and box, crystal set, LNC - \$75. Kitcraft prod. Model 130, original papers and box, crystal set, LNC - \$100. Universal crystal detector, Pittsburgh, Pa., exc - \$30. Philmore crystal detector No. 310, N.I.B. - \$50. Philmore enclosed detector No. 309, N.I.B. - \$50. Orville Nettifee, 2000 Cardinal Dr., Sioux Falls, SD 57105. (605) 339-1926

FOR SALE: Tube manuals: RC30 - \$30; RC22 - \$10; RC28 - \$15. Transformers: UTC LS-55, LS-25 - \$200. Peerless S-Series for P-P 6L6's - \$250. Patrick Smith, 136 S. Dutoit St., Dayton, OH 45402. (937) 224-4333

FOR SALE: Zenith chassis, Model 805 - \$25 plus shipping. **WANTED:** Chassis for Zenith, 6-S-52, need desperately. Phil Smith, 3051 Oakridge Rd., Columbus, OH 43221. (614) 486-3061, or e-mail: smith.133@osu.edu

FOR SALE: Old Morse telegraph switchboards, wood & brass. Telegraph/book list. Old meters. **WANTED:** Biddle instruments. Henry Weiland, 8946 W. Grantosa Dr., Milwaukee, WI 53225. (414) 463-4681

FOR SALE: Collins 32V2-32V3 Parts 51J2, 51J4. RCA AR88 LF, CR91A. National NC44A, NC46 w/spkr, RCQ for Airport 1938. Lafayette TX HE25 w/manual. Harvey-Wells TBS-50 & VFO coll./qty. Bunnell sounder & key, WE sounder. (5) Heathkit catalogs '58 ('61-'62), '64, '66. WWII radar w/PS. Multi Elmec RX TX PS, mobile PS. WWII Bendix TX RX. Hallicrafters HT44, SX117, SX122 & spkr, R-47, S-36A. Tubes (2) 50, 250. Hickok Mod 14 DC voltmeter. Kellogg Telephone. Luc Dugas, 235 Rte. Neigette, St-Anaclet, Quebec, Canada G0K 1H0. (418) 723-9689

FOR SALE: Heath CR1 crystal set - \$100. Al Lapekas, 6411 Crestwood Ave., Kalamazoo, MI 49004. (616) 342-8201

REFLECTIONS OF THE ELECTRIC AGE

Collectible SHOW & SALE

(for vendors or collectors info please: (416) 969-1642)

RADIO APPLIANCES TELEVISION BOOKS TAPES

BRIGANTINE RM. YORK QUAY CENTRE, HARBOURFRONT, TORONTO, CANADA

This Holiday Season...
Give A Gift Subscription to
Antique Radio Classified

BONUS: December 1996 Free!
All gift subscriptions received before December 31 will be sent the December 1996 issue free!

To Order:

1. Fill out the card in this issue with the recipient's name and address.
2. Enclose a gift card which we will send along with the bonus issue. (We will enclose our card with your name if you wish.)
3. Include payment or charge to VJSA or MasterCard, and send to:
A.R.C., PO Box 2, Carlisle, MA 01741

Or Call (508) 371-0512.

P.S. There are more gift ideas from A.R.C. on page 43.

* If already a subscriber, a 13-month extension will be made to the recipient's subscription.

WANTED: Complete tuning unit for Philco 37-620 or 37-630. Including tuning condenser, band switch, all coils. Will buy junk chassis if tuning unit is useable. Help! Gerald Cromer, K4NHN, 1014 Summerland Dr., Cayce, SC 29033. (803) 794-1483



WANTED: Echophone 60: complete or project set; empty or broken cabinet; or even just the dial escutcheon. Curt Schreiber, 3923 East Latoka St., Springfield, MO 65809. (417) 887-5184, collect. E-mail: Curt-radio@aol.com

WANTED: Crosley 11-103U dial pointer. Philco 20 tube shield. Jim Petarca, 326 Providence St., West Warwick, RI 02893. (401) 821-4620, days only

WANTED: Original, or copies, of Zenith Trans-Oceanic factory service and alignment info. B. Brown, 26315 486th Ave., Valley Springs, SD 57068-7308. (605) 582-6762

WANTED: Montgomery Ward 62-229, works on 32 volts. Ted Rogers, 6938 E. Waco Dr., Syracuse, IN 46567. (219) 457-8886

WANTED: My Kadette Classic chassis doesn't fit my Addison 5F case. Need Kadette case, Addison chassis. Steve Lange, 1351 N. 58 St., Milwaukee, WI 53208. (414) 259-1031

WANTED: BC-639 radio set with power supply. State price & condition. Also need set of cables for TCS radio (3). Call or write, will return call. C.R. Filer, 1163 Hawkbill Ln., Sugarloaf Key, FL 33042. (305) 745-1801

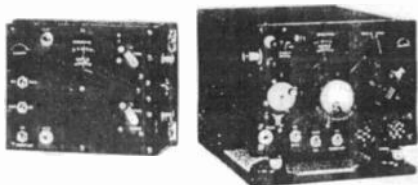

WANTED: Need to identify this 1936-1937 Bendix aircraft radio by part number. Frank C. Lombardo, 3355 S.W. 159th Ave., Ocala, FL 34481-4947. (352) 489-1748

WANTED: Japanese Koyo made subminiature tube portable radios; prewar model ignition engines for model airplane. Takashi Doi, 1-21-4 Minamidai, Seyaku, Yokohama, Japan. Fax: 011-8145-301-8069

WANTED: Sony Micro TV, Model 4-301-UW; prefer working, and cosmetically straight, with original accessories. Will consider other models. Randy Sorenson/CPS, PO Box 1173, Spring Valley, CA 91979. (619) 463-5459

WANTED: We're following for n/ \$45, 101L - \$ 102L - \$10, 1 244A GL - \$90, - \$90, 264A - \$5, - \$70, 272A GL - \$100, 101D - 274A GL - \$250, 27 Eng. - \$600, 300B Q2F - \$10, Eng. - \$175, 306A - \$50, mesh plate - \$40, 328A?A GL - \$15, 348A - \$60, 348A?ng. - \$80, 350B - \$200, 350B? 367A - \$80, 396A - \$3, 398. - \$3, 418A - \$8, 422A - \$45, wanted. New and used. Tim Fairview, OK 73737. (405) 227-2

national
O.T.H.
in U.S.

SALE
made, mir
or SA SF
Linwood
FOR

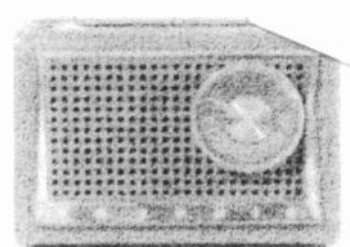

WANTED: Grundig Music-Transistor Boy E-100 as pictured. Robert Crockett, 212 Marmona Dr., Menlo Park, CA 94025. (415) 324-8235. E-mail: crockett@roble.com

WANTED: Information, catalogs, manuals, parts chassis for Midwest 18 tube. George Harris, 3212 36th St., Lubbock, TX 79413. (806) 799-2589. E-mail: gharris@juno.com

The Florida Antique Wireless Group
will proudly sponsor an

******Estate Auction******

from the extensive 40 year collection of
longtime FAWG member and "Silent Key"

****Mr. David T. McKenzie, KØSVJ****

Many fine battery, A.C., and
crystal radios, (Atwater Kent to
Radak to Zenith), many boxes full
of tubes, parts, and lots of rare
and unusual early literature will
be auctioned off.

Saturday, February 1, 1997 @ 10:00 am

at the VFW Hall
4444 Edgewater Dr., Orlando, FL

Contact: FAWG
P.O. Box 738
Chuluota, FL 32766-0738

SASE for more information

Circa 1930's FBX and FB-RO50-T, HRO-60, HRO-5, beautiful cosmetic condition. Dan Dr., Cheshire, CT 06410.

: American Bosch 5A, TM - \$60.
- \$25. Zenith H614Z1, TM - \$25.
Holly Farm, 813 Rt. 12A, Surry, NH
552-3005

1950's Pepsi Cola cooler tube radio, RCA-
- Best Offer. Radio liquidation. List via fax
- Low prices! Steve Blank, 407 Hamilton Ave.,
Ed, NJ 08221. Phone/fax: (609) 926-9277

FOR SALE: (23) Rider's TV manuals, (9) Sams radio
manuals (same size as Rider's) - \$50 for all. Pick up
only. Fred Schultz, 1246 Lincolnway S, Ligonier, IN
46767. (219) 894-3779, 9-5

FOR SALE: Catalins: Stw.-Warner 62 & 36, mint -
\$750; Sentinel 1774, alabaster w/tortoise trim, very
rare, mint - \$1,400; Sentinel 284, wavy grille, red/yellow
w/heavy marbling, mint original - \$1,800. Robert
Norton, 4227 S.E. 15th, Portland, OR 97202. (503) 233-
1956

FOR SALE: Stromberg-Carlson 16-tube two-speaker
Model M-260-L - \$495. Call, ask for Joe: Joe Milano, 57
Hillcrest Dr., Wayne, NJ 07470. (201) 694-3721

BOXED CLASSIFIED ADS WORK! This is a boxed
classified ad. These ads can be run more than two
months. See the inside back cover for details. Boxed
ad deadline: the 1st of the month.



WANTED: Tube Hi-Fi components & commercial
amplifiers by Marantz, McIntosh, Tannoy, Acrosound,
Brook, Brociner, Fairchild, Hadley and others. Also
want Western Electric theater amplifiers, speakers,
tubes, & microphones. Richard Sharisky, PO Box
521, Belmont, MA 02178. Phone (617) 484-5784. Fax
(617) 489-6592

WANTED: Vintage Electronic Music Synthesizers
and modules by the following manufacturers, espe-
cially the listed models. Aires Modular, System III.
ARP 2500. Buchla Modular, 100, 400. E-mu Modular.
EML Electrocomp 100, 101, 200. EMS Synthi A,
Synthi AKS, VCS3. Korg Modular PS-3100, PS-
3200, PS-3300. Moog Theramin, Modular, Series 15,
35, 55. Oberheim SEM modules, 2-, 4- & 8-Voice
Systems. Pala Modular 2700, 4700. Roland Modular
Systems 100, 700. Serge Modulars, System 79.
Synton Modular System. Call and surprise me; make
my day! John V. Terrey, 498 Cross St., Carlisle, MA
01741. (508) 369-9770. Fax: (508) 371-7129.

FOR SALE/TRADE: Novelities: Trades welcomed!
Crayola crayons, M.I.B. - \$75. Cathedral radio repro,
old fashion Pepsi logo embroidered in grille cloth, M.I.B.,
very neat - \$65. Pink '57 Chevy rear end (B&B #551),
M.I.B. - \$75. Oreo cookie (BPL #370), exc - \$40.
Football helmet, CFL, M.I.B., all decals for Canadian
teams, you put on the decal of your favorite team!, very
rare - \$75. All plus ship/hand. Dan Phelan, Consolidated
Electronics, 24 Hinchey Rd., Rochester, NY 14624.
(716) 436-7130

FOR SALE: Make your own high quality vacuum-
formed dial lenses. Twenty-page document with over
thirty photos and illustrations covers everything from
making your own low cost equipment, to making molds
and lenses; now learn the secrets I've developed over
eight years of experience making and selling lenses -
\$8.50 ppd. Mike Dues, 13173 Glenhurst Ave., Savage,
MN 55378. E-mail: 72614.432@compuserve.com

FOR SALE: Unusual Monarch tombstone - \$95. Tonfunk
German, exc - \$95. RCA 281 12-tube console, PU only
- \$125. Steve Wallace, 3707 Pricetown Rd., Fleetwood,
PA 19522. (610) 944-7230. E-mail: kkkk@epix.net

FOR SALE: Books! Books! Books! From our library:
Radio-Telephony, Alfred Goldsmith, 1918 - \$65. Photos
of DeForest, Marconi apparatus, etc. Elementary
Electronics and Magnetism, 1925 - \$35. Telephony, J.
Atkinson, 1948, London, England, British Telephone
Exchanges - \$25. Recording and Reproduction of
Sound, Oliver Read, 1952, a classic - \$35. Men and
Volts At War, John Miller, General Electric in WWII -
\$35. Player piano up-to-date, White, 1914 - \$35.
Essentials of Electricity, electrical trades, 1913 - \$25.
All plus shipping. Rider books next month. Maurer TV,
29 South 4th St., Lebanon, PA 17042. (717) 272-2481

FOR SALE: Quad Electrostatic speaker, single unit,
arcing on transformer, two small tears in grille - Best
Offer. Steve Harrell, 1179 Boylston St., #30, Boston,
MA 02215. (617) 247-0672

WANTED: 1920's and 1930's neon television tubes
with or without boxes or just empty boxes. Television
and broadcast receivers from 1920's & 1930's. 1920's
& 1930's television magazines; Television, Television
News, etc. Scanning discs, empty cabinets, chassis,
parts, etc. for scanning disc TV's. Western Television
Corp., See-All, Baird Televisor, ICA, Find-All, Televi-
sion kits - Jenkins, Daven, Continental Television
Corp., Freed-Eisemann, etc. What do you have?
Larry Dunn, 473 Serento Cir. Thousand Oaks, CA
91360. (805) 492-7111

WANTED: Electro-Voice (pair) Georgian 600,
Patrician 600; pair IMF monitors; Tannoy dual
concentrics; Altec 820's; large Jim Lansing;
McIntosh 2205 amp; bi-directional record tape
recorder, 10 1/2"; Ampex 600 speaker amp (russet);
wire cartridges for RCA wire recorder. Bo Brook,
4858 Willow Lane, Orchard Lake, Mich. 48324.
(810) 681-7133, eves.

WANTED: Hallicrafters Models S-2, S-33, S-35, EP-
132, HT-2, HT-3, HT-8, HT-12, HT-14, and R-8 console
speakers. For descriptions see my book "Radios By
Hallicrafters." Chuck Dachis, "The Hallicrafters
Collector," 4500 Russell Drive, Austin, Texas 78745,
512-443-5027

WANTED: RCA advertising, neon and fluorescent signs, enamel signs, curtains, thermometers, clocks, displays, what have you? I have some RCA 44 & 77 mics, Mac MC225 and pair MC-30 amps to trade for your really cool neon or other neat stuff. See other ads this issue. Ward Kremer, 301 S.W. 16 St., Ft. Lauderdale, FL 33315. Ph./fax: (954) 524-5652

WANTED: Rider's Radio Vol. 23. Jeff Hoskins, 824 E. Madison Ave., Stuart, FL 34996. (561) 283-2291, after 7 pm

WANTED: Any distressed Zenith Trans-Oceanic for parts or restore. Also need working 600L and military R-520/URR. Thank you. Denis Burke, 308 Person St., Runnels, IA 50237. (515) 966-2871

WANTED: Obsolete audio IC UPC1156H or ECG1194, no pullouts. George Cortelyou, 1409 Madison, NE, Albuquerque, NM 87110. (505) 255-3347

WANTED: Schematic for National Panasonic RF-5000 world band radio. Walter E. Johns, 40 Swarthmore Rd., Wellesley, MA 02181. (617) 237-9277

WANTED: Premier Hedgehog audio. Tuska inside tag. Grebe CR-8 cabinet, or sell my chassis. Jim Collings, 12005 Victoria Pl., Oklahoma City, OK 73120. (405) 755-4139

WANTED: Now hear this! Majestic Models 666, 776, 886, 906. Cabinets for: Airline Models 62-197, 14BR-521A, 74BR-1501B. Zenith 5R-317, 6D315U. Kennedy 281. Crosley D-25MN, 555, 51. DeForest F-5. Echophone 3. Thompson S-70. Fada Neutrola Grand. Silvertone 4500A. Speaker for: Thompson Minuet. Dial for: Airline 62-274, Westinghouse H-188, Detrola Pee-Wee. Hoyt 6-volt meter Type 541. Larry Porter, 4115 Beam Rd., Crestline, OH 44827. (419) 663-2540

WANTED: Mitchell, Mitchell, Mitchell brand major and small appliances. Also National NC-125 instructions. Thanks! Lee Mitchell, The Mitchell Collector, 175 E. Delaware, 8209, Chicago, IL 60611. (800) 869-7869

WANTED: Broadcast-type MICROPHONES. Early carbon, condenser, ribbon, dynamic, etc. Cash or trade. James Steele, PO Box 620, Kingsland, GA 31548-0620. (912) 729-2242

Crystal Radio: History, Fundamentals, and Design, new paperback from the Xtal Set Society. Chronicles the fascinating history and development of the crystal detector. Learn about great inventors and radio fundamentals, our best book yet. Send \$10.95 plus \$2.50 shipping to The Xtal Set Society PO Box 3026 St. Louis, MO 63130. (314) 725-1172. For a free copy of our newsletter visit <http://www.1stnet.net/~xtalset>, or write.

ELECTRON TUBES: Over 1 Million Tubes in Stock. Buy & Sell. Daily Electronics, 10914 NE 39th St. #B-6, Vancouver, WA 98682. 800-346-6667. 360-896-8856. 360-896-5476, fax

WANTED: KNOB SETS FOR RCA MODEL 121, BENDIX MODEL 55L2U. WILL BUY RCA RADIO MODEL 128, AK 165, MUST BE EXC ORIGINAL. WILLIAM FLATT, 100 NEWPORT DRIVE, OLD HICKORY, TN 37138. 615-847-8609

WANTED: Kennedy dial and knob assembly for Model V. Ed Bell, 5311 Wooddale Rd., Raleigh, NC 27606. Fax/ph.: (919) 851-1517

WANTED: Amperex tube manuals from the 1950's or 1960's. Also odd or unusual tube types. Will pay \$100 for Eimac 500T tube. John H. Walker, Jr., 16112 W. 125th St., Olathe, KS 66062. (913) 782-6455. E-mail: johnh.walker@alliedsignal.com

WANTED: VOLT 1960's Japanese electronics trade journal. Roger Handy, Box 24527, Los Angeles, CA 90024. (310) 451-4040

WANTED: Non-open 2nd audio interstage transformer for Atwater Kent Model 30, 35, or 48. Rob Loeser, 390 Beech St., South Hempstead, NY 11550. (516) 483-0463

WANTED: Zenith 50-70 Series: tuning condenser stators, 1st. audio transformer, filter condenser case. Charles A. Days. PO Box 80205, S. Dartmouth, MA 02748-0205. (508) 979-3758. E-mail: radiodaz@ici.net

WANTED: Auto radio signs and advertising. 1930's to present. David Edyvean, 2508 Campbell Ave., Schenectady, NY 12306

WANTED: Catalin radio parts, will pay up to \$100 for knobs. Also need Stereo Realist cameras, viewers and projectors. Please call or write: Gaelle Reboul, 7010 S.W. 48 Ln., Miami, FL 33155. (305) 662-2182

WANTED: 1930 to 1942 Police Radio communications equipment. Any 6 VDC mobile communication equipment. Raymond Miller, 953 N. 1st St., Albemarle, NC 28001. (704) 982-0228

MILLEN ORIGINAL PARTS, manuals, equipment. New and used. Bought and sold. James Millen Electronic Equipment Mfg., PO Box 4215, Andover, MA 01810-0814. (508) 975-2711. Fax at (508) 474-8949

WANTED: WE 728B - \$2000/pair. WE 555w - \$2000/pair. Perfect and original only. UTC LS40, LS19, LS21, LS25, HA106, HA104, HA105, WE 608A, 609A, 187A, 159B, 166A/B, 520A, 171C, 285F/L/R, 264C, 270C, 285J/K, 618A/B. Kouji Matsuo, 6-2 Tsurumicho, Beppu-shi, Oita, 874 Japan. Fax: 81-977-23-9579



WANTED: Radio shown above. Airline approx. 1941, Belmont made 5-tube AC/DC, 2 knobs. A.M. Eisenstein, 10815 Falstaff Road, Sebastopol, CA 95472

WANTED: A set of crystals for a Hallicrafters SX-117. Mickey Burns, 4028 Clearbrook, Jackson, MS 39212. (601) 371-2903

FOR SALE: The following National communications receivers: HRO (military) circa 1942 "M" - \$150; NC 100A - \$300; National 183 - \$200; NC 105 - \$300; NC-46 - \$200. Larry Drago, 383 Lincoln Dr., Cheshire, CT 06410. (203) 272-6030

FOR SALE/TRADE: Nice original Belmont 6D11, ivory - \$135. GE CL-500 beetle - \$125. Crosley left bulbseye, tan, exc paint - \$125. Two-tone General Television - \$125. Lafayette Troubadour streamline, ivory - \$100. Hoffman EP-706 solar radio - \$350. Realtone TR-801 Electra, turquoise - \$175. Global GR-711, black, mint - \$175. Marvel 6YR-15A, turquoise, in presentation case - \$175. Emerson Explorer, turquoise - \$125. Roxy UR-105, maroon and tan, R.P.P. dial - \$60. Arvin Checkmark, red - \$40. **WANTED:** Black or white Silvertone Bullet Mod 6178. Red or green Emersonette Mod 250 or 540, minor damage acceptable. Mike Herman, #2-1731 Rockland Ave., Victoria, British Columbia, Canada V8S 1W6. (250) 595-2829

FOR SALE: Scott Phantom Deluxe AM/FM, chrome plating 99.5% perfect, in the Acousticraft cabinet, great condition - Best Offer over \$4,000. **WANTED:** Wind measuring Set #AN/GMQ-11 mfg. for Army in the 1950's. Complete set or transmitter only T-420/GMQ, top \$ paid. John Ringle, II, PO Box 4, Harshaw, WI 54529. (715) 277-2011. Fax: (715) 277-4120

SOLID-STATE VIBRATORS for automobile radios 1932-58. Exact duplicates of originals in metal cans. Synchronous, Non-sync, European. Dealer inquiry invited. Free catalog. Visa, MasterCard, Discover. Antique Automobile Radio Inc., 700 Tampa Road, Palm Harbor, FL 34683. (800) WE FIX AM 933-4926, or Fax (813) 789-0283

PHONO NEEDLES & CARTRIDGES: (Ceramic & magnetic) What do you need? Send SASE. J.J. Papovich, 53 Magnolia Ave., Pitman, NJ 08071. (609) 582-8279

ANTIQUE RADIO RESTORATION Satisfaction - Guaranteed. Ray Sanders, 342 South Third, Cottage Grove, OR 97424. 541-942-0866

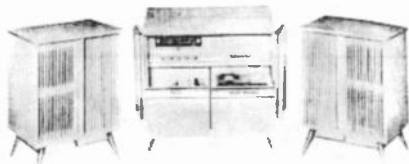

WANTED: RCA hi-fi/stereo console Model SHF-1 (pictured) or similar RCA consoles/home entertainment centers, late 50's-early 60's (especially blond Danish moderne look). RCA Product Catalogs, RCA Engineer, RCA Electronics Age, from 1956-1962. Any help appreciated. John McLawhorn, 112 Walnut St., Cary, NC 27511. (919) 467-8018

HUNDREDS of N.I.B. TUBES: Zenith, RCA, GE, Sylvania, Westinghouse, some AmpereX. Very competitively priced. Quantity discounts. Call or write your needs. Bob Snively, 516 South 16th Street, Richmond, Indiana 47374. Phone 317-935-3746

FOR SALE: 21" Muntz TV console, blond cabinet, mid-50's, appears complete, tube bad, can't ship - Offers? Also Radio Masters catalogs, 1951-52, 1954, 1955, 1959, 1966 - \$35 ea. plus shipping. Maurer TV, 29 South 4th St., Lebanon, PA 17042. (717) 272-2481

FOR SALE: Glass clock as featured on cover of 1992 A.E.S. catalog - \$70. Zenith 3000-1, needs some clean-up - \$60. **WANTED:** For Conar Custom 600 color TV kit featured by N.R.I. from 1968-1970's: Kit #1 (of 5) including: main chassis, front chassis, metal shields, (13) coils, (32) capacitors, diodes, tuners, knobs, potentiometers, cord, front panel, resistors, videl IF and filament transformers, 5JL6, 5JK6 tubes, brackets, grommets, terminal strips, hookup wire, cable, manual, circuit boards, sockets, hardware, etc. I have other kits, but lack Kit #1. Thank you. Bret F. Johnson, 13495 102nd Ter., N, Largo, FL 33774. (813) 595-9287

FOR SALE: Westinghouse H-126 Little Jewel refrigerator, white - \$90. Acrosound TO-300 - \$80. Telefunken Gavotte 1063W - \$60. Mosquito signal injector - \$25. **FOR TRADE:** My Hickok 539C, near mint for your TV-2C. **WANTED:** RCA 1934 manual. Armand Cote, 6 Sycamore Ct., Atkinson, NH 03811-2727. (603) 362-8715. E-mail: Arcote@aol.com

FOR SALE: Marantz Model 1 preamp, one of (50) prototypes, no PS - \$1,200/BO. Hammarlund HQ-110 receiver, excellent - \$95; HQ-200 receiver, mint - \$125. Mark Zaluski, 113 Pike Crescent, Winnipeg, Manitoba, Canada R2K 3C1. (204) 667-3562

FOR SALE: Atwater Kent Model 5 breadboard, 1923 - \$7,500. Crosley Widget, 1931, mint original - \$975. RCA 121, nice - \$450. Edison Fireside phonograph - \$1,500. Call, ask for Harvey: Harvey Rieff, 320 Lacey Dr., New Milford, NJ 07646. (202) 659-0401, work; (201) 262-9466, home

FOR SALE: Taking bids on 15-inch jukebox speaker. Eitz Repair, 4265 S. Bladen Ave., Juniata, NE 68955. (402) 756-6393

FOR SALE: Miraco Super Six, Radiola 812, 60 - \$175 ea. with tubes, \$450/all (3). Ray Miner, 1215B, Ft. Madison, IA 52627. (319) 372-1271

Victrola Repair Service: Windup phonograph repairs, parts, springs, needles via U.P.S. Rod Lauman, 19 Cliff St., St. Johnsbury, VT 05819. (800) 239-4188, eves.

WANTED, ANY CONDITION: RBY, Hallicrafters S-35, PR-1, Collins 478R-1, Squires-Sanders SS-1V panadaptors; also schematics, manuals, ads, articles, technical data on them. John A. Benyo, 25 Schley Street, Garfield, NJ 07026

SPEAKER PARTS: Adhesives, Cone, Dust Caps, Gaskets, Voice Coils (Round and Edgewound) Spiders and Terminals. Refoam Kits - \$14-\$18 for speakers. Cat. avail. \$10.00 (Refund.) 800 order line Visa/MC/Am.Ex. Speaker Parts Co., PO Box 14731, Fremont, CA 94539. 510-490-5842/510-490-1961 FAX

WANTED: BRUNSWICK UPRIGHT PHONOGRAPH w/curved sides in oak or walnut, v. good or better cond. I'll pay your price for the right one! Call or write: Bo Broock, 4858 Willow Lane, Orchard Lake, Mich. 48324. (810) 681-7133, eves.

WANTED: Westinghouse WL-461, Taylor 833, DeForest 433 through 440 tubes, duds OK. John H. Walker, Jr., 16112 W. 125th St., Olathe, KS 66062. (913) 782-6455. E-mail: johnh.walker@alliedsignal.com

WANTED: Books: Collecting Old Radios and Crystal Sets, by Max Alth, Wallace-Homestead, 1977; Guide to Old Radios, by David and Betty Johnson, Wallace-Homestead Book Company, 1989; Radio Collector's Directory and Price Guide, by Robert E. Grinder & George H. Fathauer, Ironwood Press, 1986. Earl Friedman, 27 N.E. 5th Ave., Hialeah, FL 33010-5014. (305) 884-2175, call collect

WANTED: Preiss Straight 8 table, Straight 9, PR3 or PR4; King 71 Commander; MuRad MA17; Case 90A; Fada 7 table or 480B; Freed-Eisemann 800. Bob Puttre, 637 Stratford Rd., Baldwin, NY 11510. (516) 223-9667

WANTED: Manual (copy) for Uher 4000 Report S tape recorder; Sams TR-24. Al Bernard, PO Box 690098, Orlando, FL 32869-0098. (407) 351-5536

WANTED: Tombstone cabinets for Silvertone 1806 and 1809. Tombstone or cathedral cabinet for Philco 610. Thanks. R. Rosengarten, 1448 Lebanon Rd., Clarksville, OH 45113-9711

WANTED: Cherokee 571 (Bunis 4, p. 49), or any brand with similar cabinet. Truetime Junior (Bunis 4, p. 223), undamaged. Dennis Smith, KN8H, Box 113, Trenton, MI 48183. (313) 675-5847

WANTED: Brass dial face for Catalin RCA 9X13, pay your price. Robert Norton, 4227 S.E. 15th, Portland, OR 97202. (503) 233-1956

WANTED: AK 228 chassis and speaker, Radiola 47 without cabinet, bipolar motors and dynamos. Tom Burgess, 9 Belle Meadow Ln., Little Rock, AR 72210. (501) 455-0773

WANTED: Heathkit RX-1 Mohawk receiver. Robert Braza, N1PRS, 23 Harvard St., Pawtucket, RI 02860. (401) 723-1603

WANTED: Crosley Model 48, Widget or Elf. Please call or write: Ron Stoner, 5341 High St., Lincoln, NE 68506. (402) 489-9259

WANTED: Realistic TRF portable in good working condition. State size, physical condition and price. Jon Hannaford, K1SP1, 27 Griffen Dr., Wakefield, MA 01880. (617) 944-8139

WANTED: Radio Callbooks 1900 thru 1927. Bob Arrowsmith, W4JNN, PO Box 166, Annandale, VA 22003. Collect (703) 560-7161

WANTED: Fairbanks Morse console Model 9C or 12B preferred. Charles E. Patterson, 2621 Sweetwater Rd. SP#33, National City, CA 91950. (619) 475-7141

REPLACEMENT GRILLE CLOTH for Radiola 103 speakers, excellent silk-screen copy of the original tapestry - \$32 + \$3.00 S.H. Phil Guinan, 106 Page Rd., Litchfield, NH 03052. (603) 889-6213

WANTED: 18" Jensen speaker w/carrying handle and pedestal circa 1935, 36. Bo Brook, 4858 Willow Lane, Orchard Lake, Mich. 48324. (810) 681-7133, eves.

WANTED: Good 8" speaker for Atwater Kent Mod 627 cathedral. Jeff Hoskins, 824 E. Madison Ave., Stuart, FL 34996. (561) 283-2291, after 7 pm

WANTED: RCA 600 ohm resistor for RCA 30 KV high voltage probe. **FOR SALE:** 10µf. 600-volt industrial oil capacitors - \$4.50 ea. or 3 for \$12. Dennis W. McDonald, 1813 Main Ave., Clear Lake, IA 50428. (515) 357-2446

WANTED: Raised see-through plastic dial for Emerson 511 Moderne. Dale Smrekar, 19208 East Brook Dr., Odessa, FL 33556. (813) 920-3519

WANTED: Non-open 2nd audio interstage transformer for Atwater Kent Model 30, 35, or 48. Rob Loeser, 390 Beach St., South Hempstead, NY 11550. (516) 483-0463

WANTED: Rider Vols. 17, 18; and Sams 20 thru 30. Jerry James, 1413 Gunnison Dr., Wichita Falls, TX 76305. (817) 855-8335. E-mail: owen@cyberstation.com

WANTED: Zenith Model 970 console. Have only the cabinet. Need radio chassis and speakers. Chuck Menard, WB9IFE, 232 North Brashares Dr., Addison, IL 60101. (708) 543-4699

WANTED: Art Deco, Streamline radios with fancy wood, chrome or metal trim and other Deco items 1930's-1940's. Adam Schoolsky, 15149 S.W. Cabernet Dr., Tigard, OR 97224. (503) 579-1080. E-mail: Adam@ArtDeco.com

WANTED: Manual, schematic, for Heathkit Model MP-14 inverter. Jim Farago, 4017 42nd Ave. S, Minneapolis, MN 55406-3528

WANTED: Following Zenith parts. Speaker (49-187) for 15U270, escutcheon (57-601), split second scale (26-145), and broadcast band scale (S5238) for 12S266 or 9- or 12-tube part chassis/set. Mark Rotsch, 311 McClure, Alton, IL 62002. (618) 462-0981

WANTED: NBC chimes, 3 chimes on wooden base, radio or TV. Barry Janov, 2454 Dempster, Suite 416, Des Plaines, IL 60016. (847) 827-9100

WANTED: Harman Kardon Festival III, working or not, must be complete. Rick Blanchard, 2621 Alta Vista, Newport Beach, CA 92660

DRAKE-COLLINS-REPAIRS: Alignment to restorations. Drake "B" & "C" line & amps. All shippable Collins. Sound In Mind, W4PNT, 534 W. Main St., Waynesboro, VA 22980. V. mail: (800) 755-2365. Shop: (540) 249-3161. E-mail: soundnmind@rica.net

TELEVISIONS WANTED: Philco Predictacs; all models. All types of earlier TVs wanted. Send or FAX a description to Sheldon Donig, 340 Laurel Ave., San Anselmo, CA 94960. (415) 454-8851. FAX: (415) 456-9322

WANTED: Collins Radio Company Catalogs, promotional literature, manuals 1933-1983. Jim Stitzinger, 23800 Via Irana, Valencia, CA 91355. 1-805-259-2011

RESTORATION: VALUABLE BAKELITE radios perfectly restored by professional. Cracks and chips eliminated from unpainted sets, U.S. or foreign. Send photo for estimate. Ed Schneck, 1401 Ocean Ave., Brooklyn, NY 11230

FOR SALE: Catalogs 1967 & 70 Lafayette, 1967 Heathkit, 1970 Allied, Shortwave Craft Feb., May, Sept., 1933; Radio Craft July 1933, RCA Tube Manual, 1940, Heathkit A-9C amp manual - \$5 ea. Modern Radio Servicing, Ghirardi. Radio Amateur Handbook, 1944, 1940 Philco Service Book - \$15 ea. Riders #17 - \$25. **WANTED:** Gemsback Service Manuals. Dan Gutowski, 12132 Cavell, Livonia, MI 48150. (313) 261-5058

**NOTICE TO ALL
CLASSIFIED ADVERTISERS!
OUR CLASSIFIED AD DEADLINE IS
12:00 NOON
ON THE 10th OF EACH MONTH**

FOR SALE: The works. First and last sale. Lost storage space. Changing hobbies. 1920s-1930s radio magazines, call books, tube testers, AK 80 radio, spark coils including Murdock, unbuilt kit, loose coupler, ham books, keys, instruments, lighthouse crystal radio, quack medical, microwave, typewriter, oscilloscopes, sextant, variacs, misc., Packard-Bell GRTH-B transistor radio factory breadboard. Send SASE. Chip Schmidt, 2024 Hilton Dr., Cedar Falls, IA 50613

FOR SALE: DeForest Interpanel Set, complete, good cosmetics, oak cabinet, untested - \$2,500 or trade for Hallicrafters products still needed. Chuck Dachis, The Hallicrafter Collector, 4500 Russell Dr., Austin, TX 78745. (512) 443-5027

FOR SALE: Buy neat-o radios on the Internet. Mike Stute, 2140 Sequoyah Way, Carrollton, TX 75006. (972) 242-1271. E-mail: <http://www.worldwide-watches.com>. Choose "Radio-O-Rama".

FOR SALE: (3) rebuilt Philco beam-of-light cartridges - \$50 ea. Looking for Philco home recording blanks, and chassis for Brunswick 33 (11, 12 & 16 same). Donald Cochrane, 858-I Antoinette Ln., S, San Francisco, CA 94080. (415) 875-1725

FOR SALE: 3AP1 CRT's, N.I.B. - \$20 ea. Ohmite dummy res. Ant. #D-100, N.I.B. - \$25. Marconi-Moorhead Audion det. Tubes (2) N.I.B. (as described on p. 173 of Saga) - \$100 ea. Louis deGonzague, 15 Gail Ln., Latham, NY 12110. (518) 783-6327 E-mail: Zenithite@aol.com

FOR SALE/TRADE: General: Pair Claricon transceivers, with instructions, orig. flying bomb 9v batts., earphones, manuals/packings, N.I.B. - \$35. Philco 40-120, very nice shape - \$45. Stromberg-Carlson 1105 portable, good - \$30. Admiral 7P34 portable - \$10. Motorola portable 67L11 - \$20. Philco Transitone PT-2 - \$10. Emerson portable FU427, good - \$10. Philco 41-240, good - \$35. Transistors: Aiwa AR-853, N.I.B. - \$10. Ever-play rechargeable - \$10. Raleigh 766, G.I.B. - \$5. Novelties (trades welcomed!): Spirit of St. Louis, large jukebox AM/FM cass., M.I.B., 1 left, was \$89.95, now - \$75. Fada bullet reproduction AM/FM cassette, maroon/yellow, very pretty, 1 left, unopened, M.I.B., was \$75, now - \$50. Planters peanuts (BPL #301), rare, exc - \$65. Fred Flintstone (BPL #86), rare, exc - \$65. Star Trek shuttlecraft AM/FM digital clock radio, unopened, M.I.B., 1 left, was \$70, now - \$50. Elvis memorial radio (2) (BPL #221), one exc - \$50; the other one is M.I.B. - \$100. Paperweight money radio (B&B, Pl. #597), exc - \$35. Money talks (BPL #211), exc - \$25. Avon Skin So Soft (B&B, Pl. 151), exc - \$20. Mork from Ork (BPL #123), exc - \$25. Big Bird head (B&B #401), exc - \$10. Ball and chain, green, (BPL #515), exc - \$10. Knights helmet (BPL #507), good - \$25. Computer mouse FM/scan, M.I.B., 1 left - \$15. Tropicana orange (2), both vg - \$10 ea. French telephone (BPL #488) - \$20. Polaroid AM/FM film (BPL #179) - \$10. Raggedy Ann/Andy (BPL #131) MBC - \$5. Jukebox (BPL #411), exc - \$20. Benson & Hedges FM/headphone, N.I.B. - \$10. All plus ship/handle, days 10 am til 6 pm EST. Dan Phelan, Consolidated Electronics, 24 Hinchey Rd., Rochester, NY 14624. Phone/fax: (716) 436-7130

Join the
AWA

ANTIQUE WIRELESS ASSOCIATION
THE ORIGINAL AND LARGEST HISTORICAL RADIO-COLLECTOR GROUP

- Publishes *Old Timer's Bulletin* with:
 - Battery and AC receiver restoration
 - Vacuum-tube history and collecting
 - Old-time amateur-radio contests
 - Communications receivers
- Free want-sell-swap ads
- Early television
- Horn loudspeakers
- Reviews of current books
- Keys and land-line telegraphy
- News of U. S. and foreign clubs
- Information on public radio museums.
- Maintains unique radio-TV museum.
- Produces the annual Rochester meet.
- Co-sponsors local meets.
- Publishes the annual **AWA Review**.



Membership is only \$15 per year (\$27 for two years, \$18 per year for overseas). Mail check to:

Antique Wireless Association, Inc.
Box E, Breesport, NY 14816

OLD TECH *Early*
BOOKS *Technical*
& **THINGS** *Books & Apparatus*

Announcing - Catalog No. 1
Available Soon*
Write For Free Copy.

We Specialize In:

- Wireless - Radio - Television - Telegraph
- Telephone - Electricity - Computers - Slide Rules
- Electro-Medical - Calculators - Typewriters
- Atomic Energy - Astronomy - Skiing

We Buy & Sell:

- Books - Juveniles - Catalogs - Magazines
- Manuals - Ephemera - Novelties - Apparatus
- Anything Related!

Send us a list of your general & specific wants.

OLD TECH - BOOKS & THINGS

John V. Terrey, Proprietor
P.O. Box 803, Carlisle, MA 01741 U.S.A.

**Still delayed, but eventually I will get it finished!*

WANTED: Used Western Electric vacuum tubes. I pay the following: 101D TB - \$140, 102D TB - \$60, 104D - \$40, 104D TB - \$150, 205D TB - \$200, 205F - \$75, 217A TB - \$110, 244A GL - \$65, 247A GL - \$65, 262A GL - \$65, 264A - \$30, 264B - \$30, 272A GL - \$65, 274A - \$100, 274A Eng. - \$140, 274A GL - \$200, 274B - \$100, 274B Eng. - \$140, 306A - \$35, 307A - \$35, 348A - \$25, 350B - \$80, 350B Eng. - \$120. Tim Metz, 221 Wheatland, Fairview, OK 73737. (405) 227-2456

WANTED: Battery box for Zenith 3000-1. Thanks. Gerald Cromer, K4NHN, 1014 Summerland Dr., Cayce, SC 29033

WANTED: Wanted desperately operating manuals and schematics for: Jewel radio test set Mod 95; Superior utility tester Mod 40; Supreme, standard analyzer Mod 339; Weston, Mod 537; three WE sockets for WE 215A tube. Dan Bulic, Box 2131, Port Washington, NY 11050

WANTED: Collins S line, will consider unit that needs repair. Please call: John Poland, 2859 Scotts Hill Loop Rd., Wilmington, NC 28405. (910) 686-4236, before 2 pm

WANTED: Sideli's Catalin book, Philco 41-81 or PT87, Minerva W117. Ichiro Yamada, 10-21 Chiyodadai-cho, Kawachi Nagano-shi, Osaka, Japan 586. Phone/fax: 011-81-721-52-4695, mid/eve. local. E-mail: yamadnr1Aosk.threewebnet.or.jp

WANTED: Power transformer AK99, Zenith porthole TV dial, wood Zenith rgt-lwr knob for 9-S-262. Keith Park, 795 Grooms Rd., Rexford, NY 12148. (518) 373-0417

WANTED: Any brand such as Sylvania, Westinghouse, Industro, National, Altec of the following tubes: 274A - \$40, 274B - \$40, 1275 - \$40, 350B - \$40, 211/VT4C - \$50, 845 - \$200. These prices are for new in original box. Used also wanted. Tim Metz, 221 Wheatland, Fairview, OK 73737. (405) 227-2456

WANTED: Fada 1000 bullet chas other 5-S round dial Zenith chr Eslinger, 20 Gary School Rd. 06259. (860) 928-2628

WANTED: Need moulding p cathedral. Any wrecked cabi Lutz, 9041 Gillette St., Lenex 1327

WANTED: Following components for TSC-zb 1000 station: CV-1716 frequency converted, RP-149 repro-lucer and RD-625 recorder. Robert Bennett, 5675 Shadow Hill, Las Cruces, NM 88012

WANTED: National VLF preamp LF-10 for HRO-500 receiver. Spencer Cromwell, 7607 Stevenson Way, San Diego, CA 92120. (619) 582-8280. E-mail: kvrs@aol.com

WANTED: Royal 500 transistor radios, any condition. Eldor A. Horton, 8187 LaHabra Ln., Indianapolis, IN 46235. (317) 823-6374. E-mail: radio@inetdirect.net

WANTED: Atwater Kent Model 711 radio. This is a console with 6 legs, doors, quarter-round window dial with 3C/SW. Will pickup in the Midwest. Also, does anyb'dy have a speaker and/or chassis for an RCA 240 console? Please help! Any leads appreciated. Thank you. Paul Froehlich, 4152 Hwy. J, Cross Plains, WI 53528. (608) 798-4905. E-mail: pafroehl@fac-staff.wisc.edu

WANTED: Need chassis and knobs for Motorola S grille Model #51X16 and any information on how to obtain would be appreciated. Larry Taylor, 108 Milford Ct., Cary NC 27511. (919) 362-5805

WANTED: Westinghouse H-161, Simpson tube checker, Model 555 cabinet for Sparton Model 567. Leor Gann, 1134 E. 50 Pl., N, Tulsa, OK 74126. (918) 425-3590

FOR SALE: 7
4RG51, with
recharge-
\$25/bc-
Cher-
E

GLASS AUDIO

Vacuum tubes for Audio
are back...
and they sound better
than ever!

Glass Audio

brings together yesterday's tubes
and today's improved components,
making smooth sound possible
from your audio again.

Ask for your first FREE
issue, without obligation!

Glass Audio

PO Box 176, Dept. ARC6
Peterborough, NH 03458-0175 USA
FAX (603) 924-9467

• WANTED • EARLY PLASTICS



Top prices paid for prewar plastic radios
by Air King, Kadette, Detrola, RCA, etc.

RADIOART

Jim Meehan
P.O. Box 102 • Centerbrook, CT 06409
(860) 526-1762

lenith 500E-1, good working - \$50. RCA leather case, working, vg - \$30. Everplay (2), one with leather case, unk. wk. - \$10. Ron McClellan, 201 W. Boot Rd., West Chester, PA 19380. (610) 363-5637

FOR SALE: Queen Deluxe boys radio, in box - \$35. Motorola 68X110, table plastic, two-tone tan & brown - \$100. I have 78 rpm Vogue picture disc records that I'll trade for transistors. **WANTED:** RCA 8-BI-9E. Toshiba 7TP-303 (Bunis, p. 218). Philco T51-124. Magnavox AM 23. Arvin, portable 9574P (add shipping cost). Jim Martes, 15400 E. 2nd St. S., Independence, MO 64050. (816) 836-0668

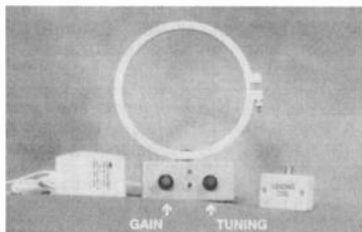

FOR SALE: Our active, tunable power loop will make your antique radio come alive. Guaranteed. \$29.95 + \$6.95 shipping. Loomis Labs, 2012 Citrus Ave., Jessup, MD 20794-9785. (410) 799-7763

FOR SALE: Transistors: Hoffman BP709XS solar radio with papers, plays, chip - \$90. Westinghouse RS16P08A Escort, watch works (sim. to RS21P08) - \$65. Rod Galloway, 2220 Woodbury Rd., Melbourne, FL 32935. (407) 254-0280, after 5

FOR SALE: NBC, 1926-1956 original 30th anniversary 24-page section Herald Tribune - \$25. Ham stuff, tubes, books, more. SASE list. Bill Tucker, W4FXE, 1965 S. Ocean Dr., Apt. 15-G, Hallandale, FL 33009. (954) 456-1349

FOR SALE: Tubes, schematics, service notes, Riders, Sams Photofact Folders and Transistor Books, etc. for early radios. LSASE for price list. Sam Faust, PO Box 94, Changewater, NJ 07831

FOR SALE: More good stuff gleaned from swap fests, flea markets: radios; televisions; transistors; telephones; earphones; military radios, equipment, uniforms; antique and collectible medical, aviation, science books. Novelty radios. For 15-page catalog, send two-stamp LSASE to: John Enigl, K9HJL, 5425 Cherry Ln., Egg Harbor, WI 54209. (414) 743-3672

FOR SALE: Tubes, old car radios. Specials! Grab boxes! Save big money! SASE for list. Mitchell Thermionics, 211 Argosy Dr., Gaithersburg, MD 20878

FOR SALE/TRADE: 1928-43 European radio schematics, more than 1,320 pp., more than 1,400 schematics - \$100 (copies). **WANTED:** 1920's radios, crystal sets, spark transmitter parts, WD-11 tubes (dud). Argirios L. Adamidis, Kampouridi 19, Panorama, Thessaloniki, Greece 55236

FOR SALE: Copies of manuals for PACO, Precision, Simpson, Triplett and other test equipment. Send two-stamp large envelope for lists. **WANTED:** Meter for TV-10C/J Navy tube tester. God bless and merry Christmas to all. Clayton Mundine, 6112 S. Flores St., San Antonio, TX 78214

FOR SALE: 10" Admiral Bakelite console TV case, good - \$100. Melvin Breyfogle, W0MDM, 18 N. 7. St., Estherville, IA 51334. (712) 362-4704/5353

FOR SALE: Tubes - \$2 ea. ppd: 24, 32, 36, 57, 58, 35/51, 224, 1D5G, UX199. James S. Looney, Rte. 1, Box 54, Grundy, VA 24614. (540) 531-8677

FOR SALE: (40) Popular Electronics mag., dates 1958 through 1967, a few each year - \$12 plus shipping. Phone or write: Thomas Burnside, 4838 S. Westhaven Dr., Jackson, MS 39209-4711. (601) 922-2235

FOR SALE: Bendix 526B - \$35. Early Morse code practice set with buzzer, wood base, very good - \$40. American Bosch Model 28, solid mahogany case, early AC set - \$75. Tubes: 80, 71A's, 227 - \$5 ea. Radiola 16 battery set chassis and panel - \$25. Victor VV7-10 Victrola, works, spring with one break - \$25. Possibly more radios. R. Burick, 274 14th St., Ambridge, PA 15003. (412) 266-4516

FOR SALE: Rare jade green marbled TR1 in beautiful condition - \$1,700. Emerson 856 hybrid, many colors - \$125. Novelty teapot by Guild with trivet - \$125. **WANTED:** Red Sony TR63, Westrex sound tapes. Harald Herp, 6615 Michele Ct., Huntingtown, MD 20639. (301) 855-7071

FOR SALE: AK 185 - \$185. Franklin phonograph radio, excellent cond. - \$45. Plus shipping. Alan Piorok, 1050 N. Paulina St., Chicago, IL 60622. (773) 235-1523

FOR SALE: Fisher 400 FM receiver, good condition, good tubes - \$250. Donald Bisbee, 685 S. Roys Ave., Columbus, OH 43204. (614) 279-6163

FOR SALE: Zenith 5529 - \$160. AK 9 - \$1,300. DeForest D10 - \$1,100. Leonard Aquino, 2 Somerset Ln., Putnam Valley, NY 10579. (914) 528-6857, 7:30-10:00 pm EST

**E-MAIL ADDRESS FOR
ANTIQUE RADIO CLASSIFIED
ARCMagazine@aol.com**

**Ads - Subscriptions - Book Orders
See inside front cover for details**

FOR SALE: Due to health problems, a cold car, common sense and last, but certainly not least, a nagging wife, I am clearing a bulging garage, full with '40's and '50's TV's, 7" to 21", older hi-fi, stereo, speakers and accessories, Radio Equasonne 301, Philco 90's, Kennedy 5, Michigan, etc., etc., even an AK car radio complete with a 1932 Packard. Very reasonable single sales or embarrassingly cheap quantity sales. No lists. Robert Shuck, 10512 Winston Ln., Fishers, IN 46038. (317) 849-0381

FOR SALE: Plastic dial covers for many old radios or can make yours, most are - \$15 ea. ppd. Doyle Roberts, HC63 Box 236-1, Clinton, AR 72031. (501) 745-6690

FOR SALE: Extensive Browning CB collection. LSASE for lists. Glenn Hendrix, PO Box 144, Ardmore, OK 73402. (405) 226-4644 or 223-6709

FOR SALE: Philco 41-245 - \$55. Emerson 520 - \$100. Fada 855 - \$40. UPS extra. Victor Marett, 3201 N.W. 18 St., Miami, FL 33125. (305) 634-9569

FOR SALE: Transistor Video by Roger Handy and Eric Wrobel. Fun! Informative! - \$29.95 includes postage. Eric Wrobel, 20802 Exhibit Ct., Woodland Hills, CA 91367. (818) 884-2282

FOR SALE: Over (100) flyback transformers N.O.S., no fly #1 - \$95 + UPS. Robert Bailey, 2451-3 Whispering Woods Blvd., Jacksonville, FL 32246. (904) 642-5837, ans. mach. after 4 rings

FOR SALE/TRADE: The following vintage tube-type hi-fi and stereo items: Scott 121C dynaural equalizer-preamp - \$250. Fisher X-101B amp - \$350. Two Heath W5M mono-block amps - \$450. Rare Heath AA-31 amp - \$200. Pair of Heath A-9C amps (mono block) - \$300. Plus many other Heathkit tuners and preamp under \$100 ea. Call: Larry Drago, 383 Lincoln Dr., Cheshire, CT 06410. (203) 272-6030

FOR SALE: Sony Boy doll, excellent - \$250. Charlie Tuna radio - \$80. **WANTED:** Realtone 870 Satellite. Bob Wood, 3612 N. 12th Ave., Pensacola, FL 32503. (904) 432-3782

FOR SALE: Zenith Model 17 chassis and power units - \$65 + UPS. Allen Jochem, 2205 Broadway, Quincy, IL 62301. (217) 223-6751

FOR SALE: New Johnson Viking II, Model 122, Hy-Gain multiband verticals, low pass RF filter, 52 ohms, pickup only - \$950. John Nosbaum, 2743 Wilmette Ave., Wilmette, IL 60091. (847) 256-0547

FOR SALE: Large Peerless cathedral speaker, electrodynamic, works - \$75. RCA 5T, poor cabinet - \$40. Don Reinsma, 610 Nix Rd., Pensacola, FL 32506. (904) 455-7721

FOR SALE: Beautiful blood-red and butterscotch Catalin checker sets - \$35 or \$85/3, while they last. Also figural napkin rings, Mah-Jongg sets, S&P. Ted Chronister, 7073 Carlisle Pike, #26, Carlisle, PA 17013. (717) 766-6436

FOR SALE: Arvin 243T, yellow - \$70; Arvin 840T, yellow - \$60. Music Master Model 60 - \$45. Fada Neurolette, very nice, untested, no tubes - \$110. Zenith R-510Z1 - \$30. All + shipping. Willard Smith, 1802 13th St., Bedford, IN 47421. (812) 275-5760, eves.

FOR SALE: Zenith 6-S-254 teardrop console, very nice cabinet and chassis, restored electronics - \$300. Grunow Teledial Model 1291, complete and original, works, needs some minor veneer repair - \$350. Hallicrafters Model S20R - \$100. RCA Victrola RE73 console radio-phonograph in excellent original condition, a beautiful piece of furniture. Wayne Zachau, 11188 So. Brancel Rd., Solon Springs, WI 54873. (715) 378-4531

FOR SALE: Atwater Kent service manual, has B.B. schematics & updates, fairly good condition - \$250. RCA Redbooks, (2) of them for - \$100. Altec tube lipstick microphone, good shape, works - \$400. Altec 344A amps, pair for - \$125. Allen mono tube amps, Model 90, 70-watt ultra-linear xfms, Phillips 6550 outputs - \$600/pair. UPS extra. Jerry or Debbie Schliepp, 584 N. Union St., Ripon, WI 54971. (414) 748-2471

FOR SALE: Silvertone Neurodyne, Echophone EC-600, Arvin 840T, Philco 37-610, 38-12 plastic, AK 35 RCA 103 speaker. All items BO + UPS. Ted Cowart, 2804 16th Ave. N, Haleyville, AL 35565. (205) 486-2857

FOR SALE: New car radio for 1952 Pontiac - \$50. Philco 610T, vg - \$85. Webcor 7" reel-to-reel, 1958 - \$30. **WANTED:** Info on early light bulb, may be Sawyer M9M[?]. Greg Bogel, 312 Peg Run Rd., Cherry Tree, PA 15724. (814) 743-9028

FOR SALE/TRADE: Pair of Bogen DB-2. \$350. McIntosh Mod 1700 AM/FM receiver. EICO HF-85 preamp, HF 50 power amp - \$30. Bogen DB-10 amps - \$300. Bell 2122-B amp - Lafayette Mod-LR 400 rcvr - \$225. Call: Larry Drago, 383 Lincoln Dr., Cheshire, CT 06410. (203) 272-6030

FOR SALE: Zenith Trans-Oceanics. All are original, complete and work and 100% cosmetically restored: 8G005 - \$185; G-500 - \$195; H-500 - \$185; R600 - \$185; L600 - \$185. Zenith full-color Trans-Oceanic repro ads - \$7 ea. Hammartund HQ129X Allwave receiver for trade for Zenith radio. Novelty radio Guild Country Belle wall telephone radio - Make Offer. Frank J. Manzano, 82 Monhegon Ave., Oakland, NJ 07436. (201) 337-5263

FOR SALE: Used 807 tubes, tested OK, guaranteed - \$5 ea., plus \$3 shipping. James T. Schliestatt, W4IMQ, PO Box 93, Cedartown, GA 30125. (770) 748-5968

FOR SALE: Zenith Golden Triangle #950, not perfect, but looks, sounds great! - \$100 + UPS. C. Hill, 6934 Orion Ave., Van Nuys, CA 91406. (818) 787-0376

FOR SALE: New vacuum caps 100pf @ 35KV VC100-35, McIntosh-7 metal logo UTC-A-19 - \$20 ea. Philmore one-transistor set - \$35. William Harder, 911 W. Northrup St., Lansing, MI 48911-3640. (517) 882-2303

FOR SALE: Radio collections: List: A, (5) Radiolas & (15) AK's; (1) 8 Philcos & (40) others; (2) (37) transistors; (3) 38 novelty transistors. Plus parts, tubes, books. 15 pps. - LSASE. W.F. Horn, 13110 Marsh Rd., Bealeton, VA 22712. (540) 439-9781

FOR SALE: Atwater Kent 184 tombstone (Bunis 3), works - \$185. Zenith Trans-Oceanic H500 (Bunis 3) - \$100. Crosley 5-M-3 tombstone - \$110. LSASE for photos, radio list & list of 1920's and 1930's radio magazine ads. Gasper Gilardi, 181 Berkeley Ave., Harahan, LA 70123. (504) 738-1415



CLASSIC RADIO WALL CLOCK

Big, 10 inch wall clock with black "radio" dial face and brass colored bezel. Quartz controlled movement, sweep second hand, acrylic dial crystal and bezel. Battery included. \$19.95 includes shipping anywhere in the U.S. via Priority Mail. Massachusetts residents please add \$1 sales tax. Send check with order, please.

Antique Radio
835-A Pleasant Street
Framingham, MA 01701
Tel: 508-879-2778

JV99 BBT - \$50. Same but rainbow
n. Have several. Plus postage. Ed
ie Rd., Raleigh, NC 27606. Fax/ph.:

offers on Zenith 617 in elaborate
) tubes, (2) speakers, spectacular!
12 Shawmut Ave., Cochoituate, MA
2418, weekdays

FOR SALE: Precision Designers Handbook 4th edition;
field type telegraph key with two leg straps and cord,
both in mint condition - \$75 U.S. ea. Jethro F. Perry, 1
Albert St., Box 488, Lewisporte, Newfoundland, Canada
A0G 3A0. (709) 535-2205

Classified Ad Deadline Noon

Dec. 10 for Jan. 1997 Issue

Jan. 10 for Feb. 1997 Issue

Boxed, Photo, & Display Ads - 1st

FOR SALE: Hartsfields. WANTED: Anything Western
Electric: pre-1970 new tubes: 252A: mesh - \$900;
engraved - \$800; printed - \$700; spherical: 104D -
\$155, 205D - \$310, 300B - \$475, 274A - \$150, 271A
- \$125, 275A - \$100, 262 - \$25, 310/348 - \$25, VT52
- \$90, amps, etc. New tubes: 845 - \$125, 2A3 (SP)
- \$90; globe: 245 - \$50; 250/585/586 - \$165. Also buy
used tubes. Ming Yang, 1995 University Ave., #119,
Berkeley, CA 94704. (510) 376-4220. Fax: (510) 376-
8861

FOR SALE: Collection liquidation! It all goes! Bargains!
List via fax or #10 SASE. Thanks! Steve Blank, 407
Hamilton Ave., Linwood, NJ 08221. Phone/fax: (609)
926-9277

FOR SALE/TRADE: The perfect gift just in time for
those holiday parties! A wood "1936" Wurlitzer Mod 412
(12 play 78 rpm) automatic coin-operated jukebox,
meticulously restored in bright red and gold, videotape
is available, looks and sounds great - \$2,800. Larry
Drago, 383 Lincoln Dr., Cheshire, CT 06410. (203) 272-
6030

FOR SALE: Philco Deco #38-10 (Ramirez Philco Radio,
p. 98) - \$90. Vintage guitar amp, Voice of Music - \$150.
Joe Quinn, 30511 Manhasset Dr., Bay Village, OH
44140. (216) 385-8420

FOR SALE/TRADE: QRP Ten Tec transceiver (40/20
meters) with accessories for your AK 735/206 or cash.
A. Bruno, 24 Butternut Dr., New City, NY 10956. (914)
354-8899

FOR SALE: KLH Model 9 electrostatic bass panels -
\$80/pr. Tweeters - \$35 ea. Transformers - \$100 ea.
Stephens 206AXA - \$160. Bozak (2) B-199A, (2) B-
209, (4) B-200X, (2) N-101 - \$200/all. Wharfedale
bookshelf Model 60 - \$100/pr. Bell caillon (6060), uses
6CA7's - \$100. Fisher FM-200B, numbers off glass -
\$100. TV test equip. 50's-70's. Send SASE, all + ship.
Chuck Steika, 8 Camden St., Newburgh City, NY 13790.
(607) 797-9573

FOR SALE: Receivers: Realistic DX-300 - \$135. IC-
71A - \$525. U-100 rotor - \$55. Joel Levy, 8 Waterloo,
Morris Plains, NJ 07950. (201) 285-0233

FOR SALE: Radio parts, tubes, galena crystals and
sets, low priced. L. Gardner, 458 Two Mile Creek Rd.,
Tonawanda, NY 14150

FOR SALE/TRADE: Excellent working AK Mod 12
breadboard with battery eliminator - \$1,750. Grebe
Mod CR-9 - \$850. Siodon DR-6 - \$1,600. Westinghouse
RA-DA - \$250. Western Electric Mod 7A amp w/(3) WE
216A tennis ball tubes - \$750. Rare and original slant-
front Hammarlund AM radio - \$600. Crosley Pup in
original box w/correct WD12 tube - \$850. San Francisco
version Kennedy Mod 525 - \$1,100. Larry Drago, 383
Lincoln Dr., Cheshire, CT 06410. (203) 272-6030

FOR SALE: 1921 Grebe CR-9 - BO over \$75. Freshman
Masterpiece, only - \$75. List of tubes, radios, parts and
transistor sets and list of books, catalogs, magazines,
schematics - LSASE for either, 55¢ LSASE for both.
Trade for Mickey Mouse, Snow White or Andrea radio.
Stan Lopes, KB6LGV, 1201-74 Monument Blvd.,
Concord, CA 94520. E-mail: splopes@aol.com

FOR SALE: Sams Transistor Radio Series 1-73, 56
volumes - \$75. Sams Auto Series 1-83, 74 volumes -
\$100. Hickok 6000 tube checker w/manual - \$100..
Heathkit condenser checker - \$14. Tek 454 150 Mc
Dual trace scope w/cover - \$190. R7844 dual beam 400
mc main frame - \$125. Tek 7A19 plug-in - \$40. All +
UPS. Dan Mason, R. Rt. 1, Box 204F, Santa Fe, NM
87501. (505) 455-3416

FOR SALE: N.O.S. tubes, 01A, ST - \$20; 5Z3 - \$4;
2C43 - \$20; CRP-72, UX112A, VT-154, CX201A,
CX301A - \$80; 83 - \$15; 304TI - \$80; 811A - \$20, 866A
- \$9; 80, tubular - \$8; 1006 - \$8; 5894 - \$40. C1K-
6014 - \$65; 6146 - \$13. Used tubes: 1B3, 1J3, 1K3,
3A3, 3AT2, 3CB6, 3CU3, 6AG5, 6AK5, 6AL5, 6AU6,
6AX4, 6CB6, 12AX4 - 50¢ ea.; 2AS2, 2HA5, 3CN3,
3DC3, 3DB3, 3UC6, 4BZ6, 4CB6, 4DK6, 4EH6, 4EJ6,
4HT6, 4JC6, 4JD6, 4JH6, 6AH6, 6BC5, 6BH6, 6BJ6,
6BZ6, 6CF6, 6CG7, 6DE6, 6DK6, 6EH7, 6EJ7, 6EW6,
6GM6, 6FQ7, 6HZ6, 6JC6, 6JH6, 6CG7, 6FQ7, 5663,
5814 - \$1 ea.; 5Y3GT, 5Z3, 5963 - \$2 ea. 6SN7GT,
5651, 5687 - \$1.50 ea.; 12BY7 - \$4.50; 83 - \$10; 183
- \$8; V199 - \$30. X199 - \$20; UX201A - \$9; 2B1 -
\$20; 5998 - \$8. 6807 - \$65. Arcturus blue glass tubes,
47, 124, 127, 551 - \$15 ea. All tubes cleaned, boxed,
tested good, minimum order \$20 plus shipping. \$100
order gets free shipping plus \$10 worth of free tubes.
Call or fax to George Stagakis, c/o George's Radio and
TV Repair, 1714A - 41st St., North Bergen, NJ 07047.
(201) 867-9136. Fax: (201) 867-4044

FOR SALE/TRADE: Rok-O-Kut M-5 lathe, RKO 16" 78/
33 turntable, v nice, no base. Pair Electro-Voice Regency
enclosures with or without drivers. 3M 8160 flutter
meter. Collins 12Z remote mixer. Ampex AM10 mixer
Mark 225, pair Mac 30s, Ampex VR-7500 1" VCR huge
portable Electro Comp early synth., made in Vernon, Ct.
Why no prices? Would rather trade for following but
don't be afraid to make offer! WANTED: RCA, WE film
and broadcast mics, RCA advertising, Espey radios and
lit. Atomic-era cold war stuff, RCA 45 record players,
Roy Rogers, all Disney, radio direction finders, lit. for
RCA AR 8702-A RDF coin-op & lit. for RCA MI-13174
coin radio. Demand items to highest bid but don't be
bashful, make offers! Please see other want ads this
issue. Merry Christmas! Ward Kremer, 301 S.W. 16 St.,
Ft. Lauderdale, FL 33315. (954) 524-5652. E-mail:
WKremer@aol.com

FOR SALE: Boonton Laboratory capacitance bridge
75AS8, 0.25% accuracy, excellent working & cosmetic
condition - \$85 + UPS. Alan J. Kriss, 1827 Portsmouth
Way, Union, NJ 07083. (908) 688-2092

FOR SALE: Rcvsr: 129X-145X-20R, S-40. Harvey Wells xmtr + pwr supp. Offers. H.N. Felder, 7517 Granada Dr., Bethesda, MD 20817

FOR SALE: Listing: 80 pages—\$2. First Class. Contains antiques, books, catalogs, brochures, manuals, magazines, radios, televisions, ham, test, scientific, photographic, military equipment/parts. Francis H. Yonker, P.E., W2IBH, 1229 Inverary Pl., State College, PA 16801. (814) 867-1400

FOR SALE: Kenwood AT250 tuner — \$215. Vibroplex WWII Deluxe — \$150 firm. **WANTED:** EV 664 microphone. C. Roberts, 30107 118th Ave. SE, Auburn, WA 98092. (206) 833-3313

FOR SALE: Zenith H723 — \$30. RCA 96T — \$70. Crosley 567C — \$55. Amer. Bosch H505 — \$75. Capehart T522 — \$45. RCA RFA15A — \$20. Sparton battery — \$25. Stewart-Warner A72T3 — \$25. For more listings see Sept. A.R.C. page 36. All prices plus S/H. Bud Santoro, 3715 Bower Rd., Roanoke, VA 24018. (540) 774-9153

FOR SALE: Philco speaker, Model G, early console, looks great, field open, repairable — \$8. Jim Gauldin, 134 Hawthorne Dr., Danville, VA 24541. (804) 791-2286

FOR SALE: Radio, misc., SASE list. TeleTone NYC NY Model-145 AC/batt. port., 4-tube, hums — \$20 + UPS. Tom Tetzlaff, 23 Nelson Dr., Silver Bay, MN 55614. No phone

FOR SALE: Rider's Radio Manuals, Volumes 6 through 13 — \$15 ea. plus shipping. Frank Johnson, 530 Eiford Rd., Fairless Hills, PA 19030. (215) 943-8295

FOR SALE: Ivory Stellar 6 xtor pocket, M.I.B. — \$35. Cobalt blue bullet cookie jar, mint — \$85. Kermit, exc — \$75. Bozo, M.I.B. — \$120. Scoobie Doo, exc — \$85. Ballantine bottle — \$100 plus. Teachers vg/exc — \$100. Call: Don May, 16 Gullyer Dr., So. Windsor, CT 06074. (860) 644-0258, before 8 pm EST

FOR SALE: Roland 5P2, maroon AC/DC portable — \$25. Philco 77 lowboy — \$110. Jim Liguori, 7 Sycamore Ct., Atkinson, NH 03811. (603) 362-5712. E-mail: j-iguori@juno.com

FOR SALE: Radio collection. Over 700 tube, transistor, novelty plus related — \$7,000. LSASE list. Joe Ricci, 5433 Oak Tree Dr., Arnold, MO 63010. (314) 296-9747. E-mail: joe1492r@aol.com

FOR SALE: Automobile radio vibrators. Free catalog. See our boxed classified ad. Dan Schulz, Antique Automobile Radio, Inc., 700 Tampa Rd., Palm Harbor, FL 34683. (800) 933-4926. Fax: (813) 789-0283

FOR SALE: Tubes N.O.S. price each plus shipping. (4) 26 — \$15; (1) 811A — \$35; (2) 7534 — \$34; (1) 7199 — \$24; (2) 816 — \$20; (5) 71A — \$30; (1) 45 — \$40. Frank Waskiewicz, 143 Carl's Path, Deer Park, Long Island, NY 11729. (516) 667-3269

FOR SALE: Microphones; very clean, unused or near mint. Western Electric 387W double button in standard housing; Electro-Voice Cardyne II Model 731; American D9AT dynamic cardioid; Shure-Unidyne III, Dynamic, Model 545L; Angomes (?) hand microphone; Wright, Model 300 dynamic, Zimmerman (pillow speaker?); send SASE for information — Best Offer. Floyd A. Paul, 1545 Raymond Ave., Glendale, CA 91201. (818) 242-8961

FOR SALE: Transistors: Zenith Royal 500 — \$60. Emerson 888, grey — \$60; green — \$70. Red Explorer — \$125. Spica ST-600, red — \$75. Hitachi TH666, red — \$45. Standard Micronic Ruby — \$65. Zenith Royal 200 — \$25. Royal 2000 — \$40. Traveler TR280 — \$30. RCA Transicharge — \$25. Admiral GTM 1109A, turquoise, mint — \$40. Zenith Royal 80, blue — \$25. Traveler TR-280 — \$25. Hitachi TH-667 — \$35. Westinghouse Coke machine — \$85. Mark Twain boat — \$60. Remco crystal set — \$70. Toilet — \$20. Restroom — \$15. **WANTED:** Kadette, Detroitla Plaskon, beetle, Catalin, winners. Bob Masterson, Box 172, Valley Cottage, NY 10989. (914) 353-3151

FOR SALE: 65-year accumulation of radio tubes, test equipment, parts. Tube and transistor radios. Rider manuals, etc. Must sell entire accumulation due to illness. Pick up only. Antique Radio Service, George Greenberg, KD4OBV, 1701 Andros Isle, K2, Coconut Creek, FL 33066. (954) 971-9053

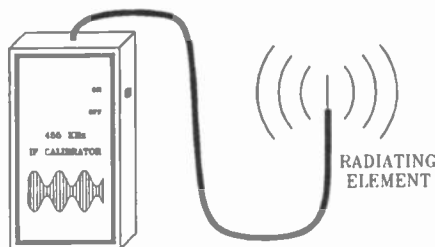

FOR SALE: Hand-held 455 kHz IF calibrator. Battery-operated unit couples a crystal-controlled, tone-modulated signal into any AM radio with a 455 kHz IF. Requires no electrical connection to the radio. Allows precise IF alignment of AM radios. \$29.95 plus \$4.00 shipping, or SASE for more information. Malcolm Green, 28 South Hempstead Rd., Westerville, OH 43081

FOR SALE: Prestolite full-size automotive battery radio, point of origin display not sold to general public, excellent condition and working — \$900. 1976 Sony, new old stock, 7" B/W coin-operated television — \$175 ea. or both for \$300. Jim Weil, 824 Heather Lake Dr., Clarkston, MI 48348-3648. (810) 391-7687, before 10 pm EST

FOR SALE: Books & catalogs: 1924 Radio Call book — \$25; 1926-27 Simplex Radio Supply Catalog — \$25; 1921 Sears catalog — \$15; 1948 Sams 1st Ed. Red Book — \$3; 1941 Womer photoelectric control — \$3; 1961 WICO coin machine parts catalog — \$7.50; 1964 Radio Amateur Call book — \$1.50; Sams RC-12 — \$2; Radio catalogs — \$2 ea.: 1968 Lafayette, 1961 Lew Bonn, 1976, 1978 & 1980 Burstein-Applebee. Following \$1 ea.: 1953, '55 & '57 N.W. Radio, Team Electronics 1975, Team Sight & Sound 70, Resco 62, 1973 Radio Shack, & 1940 Cooper Supply. (3) Amateur magazines: 1935 R/9 1940 & 41 Radio — \$2/all 3. 1938 Radio Noise Reduction — \$2.50. About a doz. transistor project & construction books — \$10/all or ? Joe Svihel, 17227 Co. Rd 54, Avon, MN 56310. (320) 356-7601

FOR SALE: Zenith 6D311 — \$150. Remler 51 Skipper — \$150. Remler 5400 Scottie — \$150. Remler 5560 Scottie — \$80. Remler 93 Scottie — \$70. Two Remler Scottie chassis — \$25 ea. All are in excellent condition, and work. Make offers. Bob Furtado, 23 Garden Rd., Alameda, CA 94502. (510) 521-3084

FOR SALE: Free list, 1930's & 1940's radios. 1950's & 1960's radios. Transistor radios. Novelty radios. SASE. Robert J. Stone, 721 Fisk St., Piqua, OH 45356-3729. (513) 773-2217

FOR SALE: TS-164-AR frequency meter - \$50. National SH3 receiver with vibrator power supply - \$300. Triad HF-18 mono amp with HF-3 preamp - \$250. Fisher 400C stereo preamp with 2 model 100 amps - \$550. Dynaco stereo 70 - \$250. Heathkit W4M amp - \$100. Larry Kays, 6 Old Ivy Dr., Harwich, MA 02645. (508) 430-0462

FOR SALE: Zenith Royal 790 Super Navigator, exc cond. - Make Offer. Gus Nianouris, 1316 Richard St., Miamisburg, OH 45342. (513) 866-1865

FOR SALE: Electrolytics: 47-200 volt, 33-160 volt, 47-160 volt, 150-200 volt, 680-150 volt, .001-600 volt, 140-75 volt, wooden base 4- and 5-pin tube holders - 50¢ ea. Bill Coolahan, 1450 Miami Dr., NE, Cedar Rapids, IA 52402-2933. (319) 393-8075

FOR SALE: 1 pair of advertising RCA drapes, dog & phonograph & RCA all over drapes - \$295. John Marinacci, 1141 Galaxy Cir., Pittsburgh, PA 15241. (412) 221-6763

FOR SALE: Amprex N.O.S. 250R and 300R tubes. Make offer one each. Wayne Himmel, 1029 Cedre St., Westwego, LA 70094. (504) 347-3796

FOR SALE: (7) pair headphones, (5) work, (2) untried - \$20. B.A. hi-fi amp #BA204, works - \$15. Plus shipping. Raymond Humphreys, 904 Jackson, Macon, MO 63552. (816) 385-2821

FOR SALE: Checked 2050 tubes - \$5 shipped. **WANTED:** Gonset #3020 VFO. Bob Kerby, Box 991, Waynesboro, VA 22980. (540) 942-4356. E-mail: w4bld@juno.com

FOR SALE: Military Model TS-352B/U analog multimeter, 0-1KVAC, 0-5KVDC, DC ammeter, ohmmeter, and manuals, vg - \$43 ppd. Ross Wolfrab, 229 N. Oakcrest Ave., Decatur, IL 62522-1810. (217) 428-7385

FOR SALE: Meissner signal shifter, exc - \$125. TV-2 tester - \$225. Thordarson multiband 100W transmitter. **WANTED:** Collins G133 receiver. Thanks! Tom Smith, N5AMA, 13034 Elmington Dr., Cypress, TX 77429-2062. (713) 376-3436, evenings

FOR SALE: RCA: 68R1 AM/FM - \$25; 2C521 - \$15; 3X521 - \$10; 8X72 AM/FM - \$45; 3RC76 AM/FM - \$15. Zenith: C845 AM/FM - \$15; L723 - \$10; E514 - \$10. Emerson #518 - \$35. Motorola #C45-146 - \$15. Stromberg-Carlson AR37 amplifier - \$20. All items plus UPS. Jon D. Andreasen, PO Box 22, Newton, NJ 07860. (201) 579-6261, 6 to 9 pm Eastern

FOR SALE: Complete set: Three different designed Sharp PF-116 radios with oriental-style cabinets - \$500. Gerald Schneider, 3101 Blueford Rd., Kensington, MD 20895-2726. (301) 929-8593

FOR SALE: Kencraft QR666 kit radio, 6 bands, schematic, needs work - \$130. L. Schimmel, 17411 Yakima So., Spanaway, WA 98387

FOR SALE: Tubes, new 50 - \$190; used balloon 45 - \$40. Plus UPS. Robert Gerber, 636 W. Wildrose, Ridgecrest, CA 93555. (619) 375-6912

FOR SALE: Tubes, test equipment, hi-fi, radios, all are new pages. Free for SASE. Chuck Vaccaro, 708 Booth Ln., #D, Ambler, PA 19002. (215) 646-3641

FOR SALE: Plastic dial covers for many old radios. Example: AK 145, 206, Belmont 6D111, Emerson 400, 520, Fada 1000, Zenith 8G005 or can make you one - \$15 ea. ppd. Doyle Roberts, HC63, Box 236-1, Clinton, AR 72031. (501) 745-6690

FOR SALE: Crosley 52SD - \$85. Stewart-Warner 51T136 - \$40. WAUB station clock - \$85. Knight R/C tester w/manual; Heath IG5282 audio generator w/manual - \$30. Hallicrafters PM-23 speaker - \$80. Precision 612 tube tester - \$35. Radiart Jr. 1-tube early regenerative - \$85. **WANTED:** Emerson advertising: dealer displays, clocks, signs, etc. Carl R. Shirley, 824 Fairwood Dr., Columbia, SC 29209. (803) 776-6850. E-mail: shirleyc@gamet.cla.sc.edu

FOR SALE: Philco early AC radio, Model 511, all there including tubes, no rust - \$85. Philco Model 49-1040 short slant-front mini-console TV, 10" picture, very nice - \$75. Crosley Popularity 12" table TV, Model 9-419M, with FM radio, very-very clean piece - \$125. Admiral Model 30A1S very small and narrow console TV, 12" picture, no knobs - \$35. AK Model 55 console, solid throughout, complete - \$65. AK Model 94 console, not a common set, nice - \$85. Automatic SW/BC 7-tube table radio with tuning eye, 1938, nice looking set - \$40. Home-brew 2-piece radio, ca. 1922, tuner with wood variometers, open type vario, 3-tube amp using RCA parts, unique - \$85. Canadian Marconi early 2-piece set consisting of detector box (1-tube) which needs work, but the tuner unit is nice, both pieces - \$250. Also, will swap an original, complete Little Gem tripod crystal set for your Martian tripod crystal set. Dave Crocker, 4B Beechwood Point Dr., Mashpee, MA 02649. (508) 477-1578, before 9 pm please, thanks

FOR SALE: EICO hi-fi, AM, FM, amp, Classic Series, walnut case, rare unit, original owner - Make Offer. Heathkit FM-4 front end tuner HFA-114, never used - \$25. Millen grid dip meter Type 90662-A & case, all coils - \$100. Swan watt meter WM-1500 #10548 - \$50. Johnson T.R. SW electronic 250-39 with instructions - \$35. D-104 mike with G grip, like new - Make Offer. Lambkin freq. meter Type 105B Serial 7332 with crystal calib., like new - Make Offer. BC-221-T freq. meter 110 AC, good shape - \$50. Kantronics field day code reader, good shape - \$100. 8mm Bell & Howell movie projector in case, good shape - \$50. Robert D. Laughlin, K6HVN, 979 74th Ave., SE, Salem, OR 97301. (503) 370-7370

FOR SALE: Zenith Trans-Oceanic 3000-1, very good condition, works good with book - \$185. Ted Demski, 5806-225 Pl. SW, Mountlake Terrace, WA 98043. Phone/fax: (206) 778-7100

FOR SALE: Sale: 12/14-15, details, 612-777-6791. Belmont #6D111 ivory, complete, minimal paint chips - \$180. List - LSASE: Ripley, Box 9374, N. St. Paul, MN 55109

FOR SALE: Receiving tubes. New old stock. Finally had time to put a list together. Send SASE and you'll have your own copy. J. Arndt, 1215 Division St., Manitowoc, WI 54220-5734. (414) 684-8830

FOR SALE: URM-25D signal generator - \$90. Sprague TCA-1 trans-farad capacitor analyzer - \$70. Bonton/HP AM/FM signal generator 202H - \$75. Scalartronics function generator with built-in counter - \$60. Charles Johnson, 21 Holly Hill Dr., Mercer Island, WA 98040. (206) 232-2040

FOR SALE: HK Citation I & II, with all the bells and whistles except the cage, comes with Phillips 6550 tubes - \$1,200 both. Plus shipping. C. Ong, 3806 Lake Blvd., Annandale, VA 22003. (703) 573-2888. Fax: (703) 573-5896. E-mail: ongtk88@erols.com

FOR SALE/TRADE: Hallicrafters SX28, SX43, S-20R, SX25, S-38, SX73, SX88, S-38, S-36, SX-62, S-40, HT44, SX117, SX17. Call for price. Larry Drago, 383 Lincoln Dr., Cheshire, CT 06410. (203) 272-6030

FOR SALE: Zenith Mod 12, NT - \$80. AK 35 comp. untested - \$100. Westinghouse H126 ref. nice - \$125. Philco 95 - \$100. PU only. Tubes N.I.B. 1B3, 1S4, 3A3, 6AU6, 6BA6, 6CD6, 6J5, 7A7 - \$1 ea. Have many 5Y3 GT, 12BA6, 12BE6, 35W4, 50C5, 6DQ6, 6K6GT, 1625, 1626 - \$2. 12AU7, 12AV7 - \$3. 6SL7, 12AY7, 12AT7 - \$4. 6BQ5, 6CG7/6FQ7, 6DQ5, 2HJE6, 5763, 12BY7, 12AY7, 5879 - \$5. 5U4GB (100) - \$6. 6V6GT - \$7. 7025 (5) - \$9. 6L6GB (3) - \$11. 6L6G (1) - \$18. 6L6GC (1) - \$17. WE 5D21 - \$20. 45 N.I.B. (1) - \$50. 5UAG (6) - \$10. 1L6 (3) - \$18. 6LX6 811A - \$20. 7189, 7199 - \$15. Mullard 6BGL - \$10, pr. 7868 - \$40. Pr. 8417 60, 801A (1) - \$40. 8H3 - \$35. Many others used tested. 6BQ5, 6V6 GT - \$3. 6L6 - \$6. 6L6G - \$10. 6B4G - \$15. 5692 red - \$10. 211VT 4C (2) - \$35 ea. CV11 - \$30. Older globe etc. UV199 BB, T fil. OK - \$25. 01-A (1) - \$10. BH (2) - \$5. 227 (12) - \$6. 127 Blue - \$10. 112A (3) - \$18. 235 (2) - \$3. 238 (2) - \$6. 256 (2) - \$2. 171A (2) - \$25. 245 (1) - \$50. 280 (4) - \$22. 281 (2) - \$20. 2H6, tests fair (1) - \$15. Much more, call or write: Tony Rinaldo, 308 Lenox Ave., Oneida, NY 13421

FOR SALE: Special find, #47 bulbs, new, 50 for - \$5. Postage. All you want. Richard Minnick, 1318 Judd Rd., Saline, MI 48176. (313) 429-1022

FOR SALE: Utica TC-3, cord missing - \$25. Eico signal generator 324 - \$20. Peerless speaker, exc - \$50. Arthur Kreitner, 2013 E. Belle Ave., Belleville, IL 62221. (618) 233-5610

FOR SALE: Army Signal Corps signal gen. by Zenith, fair cond. - \$20. General Radio, variable air condenser Model 539-B - \$25. Robert Bailey, 2451-3 Whispering Woods Blvd., Jacksonville, FL 32246. (904) 642-5837, ans. mach. after 4 rings

FOR SALE/TRADE: A pair of Western Electric crystal oven oscillators Mod 702A w/249A tube in each. These items were used by radio stations in the late 20's to set frequency to exact position on the AM dial - \$750. Larry Drago, 383 Lincoln Dr., Cheshire, CT 06410. (203) 272-6030

FOR SALE: Estate items. Heathkits Warrior amp - \$350. HW101 w/PS micsprk - \$175. DX40 - \$45. VF-1 - \$35. Sixer - \$35. VTVM - \$20. RF generator - \$20. XR-1 transistor - \$65. Tungar battery charger - \$35. (2) Ward Leonard movie light dimmers - \$35 ea. Century brass-blade fan - \$65. Supreme 670A voltmeter - \$20. 576 RF generator - \$20. Hallicrafters HT37, nice - \$135. (3) SX43 & R44 - \$50 ea. set. EV644 shotgun mic - \$35. Astatic 6000 chrome finned mic, nice - \$175. CE20A - \$85. Zenith battery tombstone - \$135. Collins 51U rcvr - \$65. BC1206CM Beacon RX - \$75. 50-amp Variac - \$50. Emerson 520 Catalin - \$150. Transistors: Toshiba TR193 blue, fair - \$175; 7TP-352S - \$65. (2) RCAs - \$15 ea. Brownie 4TR603, Japanese, nice - \$65. Howard Miller 24-hour world clock - \$110. National NC300 - \$150. Offers welcome. Fred Watson, KB8NRF, 581 W. Summit St., McClure, OH 43534. (419) 748-8798

FOR SALE: Collins 75S2. 3252. 516-2, mike near new - \$950 UPS. Edward L. Freeman, 631 Orchard Dr., Redlands, CA 92374. (909) 792-6779

FOR SALE: Fada 5 tube AC/DC, beautiful high-gloss simulated Catalin plastic in marbled light, dark, and reddish browns, mint condition, no cracks or chips - \$165 ppd. Ralph Michelson, 4538 Golfview Dr., Brighton, MI 48116. (810) 225-9825

TUBES • PARTS • SUPPLIES YOUR COMPLETE SOURCE FOR...

TUBES:

Over 3500 receiving, transmitting, audio and industrial types in stock, including many foreign and early types.

TRANSFORMERS:

Hard to find power, filament and output transformers as well as filter chokes for tube equipment. We feature HAMMOND performance transformers as well as many new old stock transformers.

CAPACITORS:

High voltage electrolytic and mylar capacitors, multi-section capacitors and more for tube circuits.

PARTS:

Resistors, tube sockets, potentiometers, knobs, dial belt lamps, diodes, speakers, wire, phonograph needles and cartridges and much more.

LITERATURE:

Extensive selection of literature and books on antique radios, tubes, circuits diagrams, communication gear and hi-fi equipment. Some items not available elsewhere!

SUPPLIES:

Grid cloth, cabinet restoration supplies, batteries, chemicals, tools, test meters, gifts and kits.



CALL OR FAX FOR OUR NEW 40 PAGE CATALOG!

ANTIQUE ELECTRONIC SUPPLY™

LIMITED PARTNERSHIP

8221 S. MAPLE AVE. • TEMPE, AZ 85283 • (602) 820-5411 • FAX (602) 820-4643 or (800) 706-6789

FOR SALE: Rare vintage tennis balls by WE, popular audio tubes by Amperex, Mullard, Tung-Sol, Telefunken, RCA, etc. Enquire with wants. C. Ong, 3806 Lake Blvd., Annandale, VA 22003. Fax: (703) 573-5896, or e-mail: ongt88@erols.com

FOR SALE/TRADE: British mono-block amplifier made by Leak, Mod #LT-25 w/(2) preamps - \$575. Harman Kardon Citation I-II-III, excellent - \$1,750. Larry Drago, 383 Lincoln Dr., Cheshire, CT 06410. (203) 272-6030

FOR SALE: Wurlitzer 851 jukebox amp - \$35. H.H. Scott 330C tuner - \$50; 299 amp - \$50. Crosley shortwave adapter #7-1 N.I.B. - \$45. RCA 7JP4 tube N.I.B. - \$50. LSASE for list. Linus Brown, PO Box 553, Anna, OH 45302

SEND ALL A.R.C. MAIL TO
Antique Radio Classified
P.O. Box 2, Carlisle, MA 01741

FOR SALE: From my collection: Philcos 57-C - \$75; 48-464 - \$50; 40-150 - \$125; 41-255 - \$125; 610 round - \$115; 40-145 - \$75; 38-62 - \$80; 41-250 - \$125; 38-10 - \$125; 37-630 - \$110; 38-60 tomb. - \$140; 42-350 - \$95; 37-600 - \$80; 66 tomb. - \$135; 16B & 71 chassis - \$65 ea. All nice & orig. Prices firm. Chuck Childs, 20900 Cagwin Rd., Watertown, NY 13601

FOR SALE: Radios: SW-500 - \$40. S-40 - \$55. S-85 - \$75. DX-120 - \$40. Philco 42-390 floor model. Pete Putra, 1429 Lawndale Ave., Racine, WI 53403. (414) 632-2543

FOR SALE: Parts for radio Brunswick Model #15 Contact 23 CB set, no mic - \$50. You pay shipping. Written inquiries, send SASE. James E. Inglett, Rt. 1, Box 248A, Midway, AR 72651. (501) 431-8430

FOR SALE: AK55, Kiel cabinet, you pick up. **WANTED:** Sams CB-88, Rider's Vol. 23. Ted Depto, The Philco Collector, 913 5th Ave., Patton, PA 16668. (814) 674-8834, after 6 pm

FOR SALE: A Whistler script, rare, unusual and limited. Info.: SASE or e-mail. Mike Tobin, 323 E. Matilija, #110-241, Ojai, CA 93023. (805) 646-7362. E-mail: 104774.3476@CompuServe.com

FOR SALE: Consoles: Majestic 71B, 90B, Philco 65, 41-611, 96, Zenith 8S-661 - \$100-\$175. Dan Merz, 312 Sierra St., Richland, WA 99352. (509) 375-1334

FOR SALE/TRADE: Mickey in car (B106), N.I.B., never unwrapped - \$110; lady bug (B199), N.I.B. - \$65; Hamburger Helper (B284), N.I.B. - \$85; pool table, china, N.I.B. - \$35. Plus shipping. Dan Sipola, 2840 Copeland Rd., Maple Plain, MN 55359. (612) 972-8214. E-mail: philco90@minn.net

FOR SALE/TRADE: Old televisions; Zenith Model A2358E, vg, needs vertical repair. Model Y2257 EZ, fair condition. Crosley Model DT 12MN; Motorola Model 10VT24R; Philco Model 50-T1404; all three average to rough, but restorable. Make offer. Prefer Zenith console radios, will consider others. Must pick up, no shipping. Just 3 miles from I-70. Bob Snively, 516 S. 16th St., Richmond, IN 47374. (317) 935-3746

FOR SALE: Collector liquidating collection of radios, tubes, parts, Rider's manuals, more. SASE to: Bill DeFelice, Box 20, Monroe, CT 06468

FOR SALE: Televisions: Firestone Model 13-G-3, 7-inch, poor cond. - \$45. Motorola Model VT-73 7-inch leatherette portable, good cond., no back - \$75. Robert Bailey, 2451-3 Whispering Woods Blvd., Jacksonville, FL 32246. (904) 642-5837, ans. mach. after 4 rings

FOR SALE/TRADE: 1930's Art Deco metal RCA Radiotron tube sign, Arcturus tube (neon lit) octagon-shaped sign with blue rotating wheel depicting galaxy behind famous Arcturus observatory building, RCA circa 1950 tin radio/hi-fi and TV tube sign, Admiral 24" x 6" neon (green) sign, RCA red and white tablecloth. Call me for price or videotape of them. Larry Drago, 383 Lincoln Dr., Cheshire, CT 06410. (203) 272-6030

FOR SALE: German multibands: Tonfunk GMBH 286, Nordmende Sterling Elektra 58, Blaupunkt Verona 20103. John Koop, 48 Wheelbarrow Ln., Wantagh, NY 11793. (516) 731-6711

FOR SALE: Regency TR-1 bone-white, original case, both excellent condition - taking Best Offer. Karen Renfrow, 1901 W. Belmont, Chicago, IL 60657. (773) 472-8890

FOR SALE/TRADE: Rare Musette cathedral - \$250. Philco 89 cathedral - \$225. Crosley Fiver - \$100. Crosley 635 tombstone - \$110. RCA 810-T - \$95. Emerson 274 Bakelite - \$85. RCA statue, N.I.B. - \$85. Freed-Eisemann Marvel 3 crystal set. Lee Gentry, 834 Paxton Dr., Knoxville, TN 37918. (423) 281-7554

FOR SALE: Test equipment and Heathkit shortwave radio. SASE for list. B.K. Reaveau, PO Box 73032, Las Vegas, NV 89170-3032

FOR SALE: Speakers: Fada, Utah, Jensen. Radios: Arvin 522A, Motorola 10-1Y, Philco 41-255, Hallicrafters S40B, S38E, S108; Zenith M660A, 8H034, (4) Trans-O's, DeForest Audion ceramic tube. J.R. Maninen, RR1, Box 157, Hancock, MI 49930. (906) 487-5571. E-mail: mmaninen@up.net

FOR SALE: Five linear feet of: Photofacts from 1946 to 1956; Rider's XI, XII, and Indices; Philco Service Manuals from 1931-1942 and more - yours for \$25 and shipping, heavy! George Fallenbeck, 608 Brookhaven Way, Niceville, FL 32578. (904) 897-5434

FOR SALE: Roberts transistor radios as used by British royalty. Please ask for my free illustrated list. Enrico Tedeschi, 54 Easthill Dr., Brighton, United Kingdom BN41 2FD. Tel/fax: +(0)1273 401749. E-mail: e.tedeschi@ndirect.co.uk

FOR SALE: Just relocated to North Carolina by the sea, and I have some recent new finds for sale! Zenith brown military version Trans-Oceanic R-520/URR, missing handle, wavemagnet repaired - \$300. Zenith chairside Model 6-S-238, good condition, works - \$250. Zenith console Model 9-S-262, complete, good condition, as found - \$325. Majestic Riviera #996 console Moderne, with tuning eye, rare, as found - \$600. Majestic Model 50, exc - \$200. Hallicrafters TW-500 green leatherette, vg, works - \$100. Stromberg-Carlson Model AWP-8 multiband with weather gauges - \$200. McIntosh 1700 receiver - \$450. Scott #299 amp, missing 1 knob, works great, nice cabinet - \$100. Craftsman Model RC-10 tuner - \$100. GE cathedral Model K-43, exc - \$200. Guild New Englander, exc, works - \$600. Sony TR610, ivory, 1 hairline - \$100. Shipping extra. Turning up new finds every day! Joe Beckley, 4403 Jasmine Cove Way, Wilmington, NC 28412. (910) 790-3296

FOR SALE/TRADE: The following hi-fi stereo tube equipment: Marantz 8-B, N.I.B., never used - \$2,800; Craftsman C-500 triode amp - \$375. Call: Larry Drago, 383 Lincoln Dr., Cheshire, CT 06410. (203) 272-6030

FOR SALE: New expanded photo-list. More transistors. **FOR SALE/TRADE:** QST magazines, 1926-31, Northern Electric 5000 Rainbow - \$125. Bob Masterson, Box 172, Valley Cottage, NY 10989. (914) 353-3151

FOR SALE: Kenwood remote VFO-180; w/manual, cables and original box - \$100 or Best Reasonable Offer. Bell Sound Division, Model PM33 Pacemaker audio amp, vg or better cosmetic condition - \$65 or Best Reasonable Offer. Both plus shipping. Dale Chaney, WB8DTN, 309 Vincent Ave., Troy, OH 45373. (937) 339-7386

FOR SALE: '20's to '50's radios, test equipment, books, mikes, etc. SASE for list. Eric Miller, PO Box 778, Linn, MO 65051

FOR SALE: Microphones: Astatic D-104, chrome, nice - \$100; Turner carbon SR-90-R, chrome - \$50. Plus UPS. Chuck Bray, 1322 Ivy Rd., Bremerton, WA 98310. (360) 373-1013

FOR SALE: Millen Variarm VFO, excellent; Zenith Royal 790 Super Navigator, near mint - Best Offer. Gus Nianouris, 1316 Richard St., Miamisburg, OH 45342. (513) 866-1865

FOR SALE: Thorens TD-165 turntable with ADC XLM/MXII cartridge in original box, tested, working, + UPS - \$39. Mervyn Ellsworth, 2309 N. 25 St., Boise, ID 83702. (208) 345-6878

FOR SALE: HE80 Lafayette 14-tube communication receiver with 6-meter converter, calibrator, Q multiplier, not kit - \$90 plus shipping. Robert F. Haworth, 2112 Tilford Rd., Somerdale, NJ 08083. (609) 783-4175

FOR SALE: MAC 1700 - \$400. Koss ESP-9 electrostatic phones - \$50. DBX NX40 - \$50. Pioneer RG-1 expander - \$60. Surround decoder SSI-360II - \$40. Sherwood amp & tuner - \$100. Yamaha amp & tuner - \$100. R. Brewster, 145 Little Peconic Bay Rd., Cutchogue, NY 11935. (516) 734-5063

FOR SALE: RME VHF152 converter, excellent - \$200. Collins 75A4 PTO, new - \$250. R390A 2, 4, 6, 8 kHz filters - \$50. Nilson & Hornung radio book - \$25. 866 globe (2), 866A (6), 3B28 (2). Arcturus 27T. 201A rainbow. Zenith 5G41 flip portable - \$50. Bakelite 7H042, 5D810Y, K275 - \$50. Consoltone - \$50. RCA B411, brown swirl chrome - \$50. Catalogues: Radio Shack Boston, Allied, Lafayette, Heath, Olsen CB, etc. Write needs. American D4G salt shaker mike - \$25. RCA Brunswick Radiola - \$75. Amplion cathedral speaker - \$35. Pocket transistors chrome Sears, Zenith, Sony, RCA, Emerson. Sams CB 1, 2; Heath Q multiplier - \$25. Silvertone large table radio, radio wood, push buttons R1171, dog bone resistors 75 - \$25. Shipping extra. Joseph Santomas, W2FXM, 121 Broadway, Hammonton, NJ 08037. (609) 561-1161, after 6 pm

FOR SALE: Original Service Bulletins: RCA, Grunow, Philco, GE, Motorola, Crosley, Philco. SASE for list. Gary A. Micanek, 226 Henry Ave., Manchester, MO 63011. (314) 227-7046

FOR SALE: Original setup chart for B&K Mod #465 picture tube tester - \$5 mailed. Don Mier, 4009 N. Foxdale Ave., Covina, CA 91722. (818) 338-9225

FOR SALE: Wear a wristwatch made the same circa as your favorite radio. All are running, restored, and have new straps or circa bracelets and new crystals. All made between 1920's and 1950's. Frank J. Manzano, 82 Monhegan Ave., Oakland, NJ 07436. (201) 337-5263

FOR SALE: Emerson U5A - \$250. Silvertone beetle - \$200. Crosley 54G Repwood - \$350. Pilot Ivory Plaskon tombstone - \$1,000. Stewart-Warner Dancing Ladies speaker - \$300. Western Electric candlestick telephone with dial & box, nice - \$350. Trade for electric fans, porcelain toasters, Electrical World catalogs 1860-1915. Rick Padron, 1005 E. Idlewild Ave., Tampa, FL 33604. (800) 320-3267, or (941) 688-6800

FOR SALE/TRADE: Hammarlund HQ-110, exc - \$125. RCA WV-97A Senior Voltohmyst; magazines (PE, others), SASE list. Dave Minchella, KE2GE, 80 Campfire Rd. N, Henrietta, NY 14467. (716) 359-3337

FOR SALE: Majestic/stone M15A, no kn., feize damage - \$75. Console Mod 70, @ 9, A/O, N/D, ship in (4) boxes - \$125. Philco Mod 89, A/O, N/D - \$165. Bendix Mod 55L20, wht. Bake., red knobs - \$40. Amx Mod 125, brn Bake A/O - \$35. Halson Mod 51, BC/SW, A/O, N/D, looks @ 8 - \$45. Crosley Mod 11123U, red, clock, tabs @, A/O, N/D - \$65. Rola spkr Mod 15, wood, square - \$45. Wilton space helmet Mod 2001, A/O, N/D - \$75. Zen. T-O Mod 6G601MH sailboat, looks @ 8, A/O, N/D - \$50. Brogan stereo Mod RA550 w/papers @ 10+ - \$125. Garrard turntable early unit Mod RC 8814, @ 9 A/O, N/D - \$75. Harman Kardon counterpoint C100 FM tuner A-400 units, @ 10 - \$110/both. Plus pkg. & shpg. Bernie Samek, 113 Old Palmer Rd., Brimfield, MA 01010. (413) 245-7174. Fax: 0441

FOR SALE: Tubes! Write for your wants, all tested before shipment. 245 - \$30. 2A3 (ST) - \$22. 210 - \$20. 280 - \$12. 45 (ST) - \$13. Many antique types up to miniatures. E.J. Chase, 2446 Greenlawn Dr., Toledo, OH 43614. (419) 389-9334

**TOGGLE SWITCHES AT WHOLESALE PRICES
NEW SWITCHES - 125V OR 1/2 RATING AT 250V**

- FULL SIZE TOGGLE SW. 1/2" DIA. - PRICE

| Type | Mod.# | Cont. Rat. | Lead | 100-1000 |
|-------|-----------|------------|---------|-----------|
| SPST | S125 | 6A/125V | 6" Wire | .77 .67 |
| SPST | S128 | 4A/125V | Solder | .57 .47 |
| DPDT | S126 | 5A/125V | Solder | .77 .67 |
| DPDT/ | S127 | 10A/125V | Solder/ | 1.17 1.06 |
| | On-Off-On | 5A/250V | Screw | |

- MINIATURE TOGGLE SWITCHES 1/4" DIA. -

| | | | | |
|-------|-------------|---------|--------|---------|
| SPST | S131 | 6A/125V | Solder | .57 .47 |
| SPDT | S132 | 6A/125V | Solder | .61 .51 |
| SPDT | S129 | 6A/125V | Solder | .77 .67 |
| | Mom-Off-Mom | 3A/250V | Solder | |
| SPDT/ | S134 | 6A/125V | Solder | .77 .67 |
| | On-Off-On | 3A/250V | Solder | |
| DPDT | S133 | 6A/125V | Solder | .77 .67 |
| DPDT/ | S135 | 6A/125V | Solder | .91 .82 |
| | On-Off-On | 3A/250V | Solder | |
| DPDT/ | S130 | 6A/125V | Solder | .91 .82 |
| | Mom-Off-Mom | 3A/250V | Solder | |

Black Plastic Boots for Above Switches 200/\$1.00

- SUB-MINIATURE TOGGLE SWITCHES 1/8" DIA. -

| | | | | |
|------|------|---------|--------|---------|
| SPDT | S136 | 3A/125V | Solder | .82 .73 |
| DPDT | S137 | 3A/125V | Solder | .92 .83 |

- MOMENTARY PUSHBUTTON SWITCHES. 1/4" DIA. -

| | | | | |
|--------|-------------|---------|--------|---------|
| SP-NOR | Open MS-1 | 3A/125V | Solder | .26 .22 |
| SP-NOR | Closed MS-2 | 3A/125V | Solder | .27 .23 |

- ANY ORDERS LESS THAN 100, ADD 12¢ EACH -
LED's Mini or Jumbo, Red, Yellow, Green - \$12/100 - \$9/1000

**Fertik's Electronics - 215-455-2121 Phone/Fax
5400 ELLA ST. • PHILADELPHIA, PA 19120**

FOR SALE: John Sideli's Classic Plastic Radios book, a classic itself, no other book has better photos of Catalins, out of print for quite a while, get one while they last - \$19.95 plus \$3 book rate shipping in the U.S. For quicker shipping and foreign orders, add enough or use Visa, MC or Discover. Vintage TV & Radio, 3498 W. 105 St., Cleveland OH 44111. (216) 671-6712, 1-4 pm, Wed., Thurs., & Sat. Fax: (216) 671-2975

FOR SALE: Catalin radios: Bendix 526X marbled green & black, choice condition - \$625. Fada 115 bullet, maroon with butterscotch trim, 1 hairline on bottom, rest of radio excellent - \$495. J. Gary Cameron, 824 Andrews St., Southington, CT 06489. (860) 276-9200

FOR SALE: Radios: Wood Zenith 6S632 - \$50. Ivory: GE 476 Musaphon - \$35. Firestone S-7402-5 - \$30. Emerson 522 w/handle - \$35. Silvertone 3005 - \$25. Red GE 574 C/R - \$20. Green: Zenith F508 - \$20. Spartan 5G1 - \$25. Portable Philco 46-350, missing dial cover - \$15. Transistors: Americana 620 - \$5. C-M 6528A in box - \$20. RCA 1-BT-58 - \$20. Arvin 9562 - \$40. RCA RHG25E, black leather - \$12. Zenith Royal 59, case, perfect - \$25. Emerson 555V for parts - \$10. Panasonic R-1159 - \$5. Claricon VI, TRM 605 in box - \$10. Magnavox portable R/P 1RP212 - \$15. Misc.: Astatic antenna booster, maroon Deco - \$40. Slaughter 109 Variac w/meter - \$20. Classic Radio & Television, 541 Riverside Dr., Box 61, Augusta, ME 04330. (207) 623-2059

FOR SALE: Altec full-line speaker brochure, 1970 photocopy, pictures (42) different speakers and horns plus transformers, crossovers, prices and all specifications, 84 pp - \$14. Single speakers; EV T-35 tweeter - \$140. Stephens 15" full range coaxial Model 102FR - \$175. University Cobreflex horn with SA-HF driver - \$100. Heathkit hi-fi manuals for A9C, AA30, AA-50, AA-20, AA-80, AN-10 - \$10 ea. Sams CB manuals Vols. 1-10 - \$10 ea. Sams Index - \$10. Gerald Kitchens, 116 E. South, Oreana, IL 62554. (217) 468-2540

FOR SALE: Radiola III - \$125. Riders. Metal sets: Black Arvin RE278, red Motorola 5A7A, red Kent 454. Zenith J615W - \$50. Meck DA601. Garod 5D2. Federal Jr. - \$150. Tubes, transistors, Camaro Model 12, Royal 16. Advertising. Tube testers - \$35. TRS80 computers - \$40. Microsoft Office 95, new - \$350. David J. Grace, 20 Oneida St., Johnston, RI 02919. (508) 549-8405, days

FOR SALE: Tuska 228, vg - \$350. Kennedy VI, g - \$500. Western coil WC15JR, g - \$400. All work w/ tubes. Dave Rinehart, 85 N. Edison Way, Ste. 1, Reno, NV 89502. (702) 856-4122

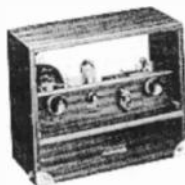

WANTED

Amrad 3670 as shown, any condition. Also a Type E crystal set, 3500-2 and other pre-1926 Amrad sets & parts.

Andrew Mooradian, 5 Priscilla Lane
Winchester, Massachusetts 01890
tel. 617-729-1873 after 7 pm

FOR SALE: Collins M filter 455AM, N.I.B. - \$75. Peerless cathedral spkr - \$65. 2A3 N.I.B., pair - \$75. Ernie Odeneal, 2710 Lee, Greenville, TX 75401. (903) 455-2113, or e-mail: 5788.ode@koyote.com

FOR SALE: Super clean Radiola V - \$350. Precision 1-tube unit with matching amp box - \$500. Small Westinghouse fan - \$25. 60's owl novelty - \$135. 50's PCR Cola - \$450. Large open-view mech. meter mounted on top oval board with tripod base - \$75. DeForest DV3 duds, have (4) along with (5) WD11, WD12, 99, 21 pcs. total, take all - \$75. Mercury transistorized mini phonograph - \$65. Small 60's tape recorders, rare Galaxie & Claricon by NEC, both for - \$200. Sony 5" B&W 60's TV, have (2), - \$80 buys both. Atwater Kent automotive ignition coil box - \$75. Very rare Atwater Kent advertising line cuts, depicts breadboards, horns, battery sets, these are used for printing, complete with original AK box from AK advertising dept. - \$650. 60's Emerson shortwave multiband chrome & black - \$50. Panasonic RF5000A large shortwave - \$275. Like new with box Sony CRF320 - \$1,375 firm. Joseph Nocera, 1222 Finch St., New Castle, PA 16101-4840. (412) 658-7805

RATE FOR ADDITIONAL WORDS:

25¢ per word

FIRST 20 WORDS FREE!

Cash or stamps OK for small amounts.

Your payment helps to keep A.R.C. healthy!

FOR SALE: Freshman Masterpiece booklets. Tuning charts, schematic, trouble shooting info, much more. If you own a Freshman, you need this - \$4.50 ppd. **WANTED:** 1920's radios made in Connecticut: Morrison, Regal, Electrola, Zimmerman, Bristol, Doolittle, Sodian, AC Gilbert. Please write or phone. Bob Sukosky, 62 Strong St., Manchester, CT 06040. (860) 646-8857, 5-9 pm Connecticut Time

FOR SALE: Emerson!, Emerson!, Emerson!, extremely rare Emerson cathedral circa 1930. Have never seen another or found one listed; possibly Emerson's first production model - \$500; Model 148 (Stein, p. 80) - \$325; Model 167 (Stein, p. 80) - \$140. Selling only these this month. Not buying! More next month. The Emerson Guy, 9 Camino Arroyo Pl., Palm Desert, CA 92260. (619) 568-1880

FOR SALE: Radios, parts & junk. Contents of 10' by 30' storage unit accumulated during the '40s and '50s. Some military sets, test equipment & plastic sets. Condition varies from poor to good. No '20s & '30s sets and no communications receivers. Must pick up and take all within 2 weeks so you will need a truck. Call to examine. Subject to prior sale. Price firm - \$500. John Terrey, 498 Cross St., Carlisle, MA 01741. (508) 369-9770

FOR SALE: Tubes N.I.B.: 6AU5GT, 39/44, 57, 50Y7GT, 0Z4, 6V6GT, 6BL7 - \$5 ea. 100's more. Write: James Wright, 4307 Hwy. 166N, Maynard, AR 72444. (501) 647-2913

FOR SALE: N.I.B. U.S. tubes: (4) 7868 - \$85; 6U5 - \$18; 80 (tubular) - \$5; 2A3 - \$45; (100) 5963/12AU7 - \$2 ea.; 6336B - \$22. Used tested tubes: (10) UX199 - \$15 ea.; 45 - \$18 ea.; (10) UX201A - \$10 ea. Zenith Clipper 6G801M, exc - \$110. Drakes Radio Cyclopeda 1955 - \$20. Practical Radio, Marcus/Levy - \$15. Roland Barbeito, 19 Murray Ave., Westfield, MA 01085. (413) 572-4745

FOR SALE: Vitaltone Ships speaker - \$175. Peerless cathedral speaker - \$35. Philco Concert Grand - Offers. Stromberg-Carlson 70 floor speaker, needs cone - \$150. Detrola 4-tube tombstone - \$75. Zenith 775 12-tube console with automatic tuning - \$350. Telefunken Allegro 5183W, very clean - \$125. Philco 38-690 - \$900. Philco RadioBar - \$950. Philco 212 - \$250. Philco 38-116 - \$175. McMurdo Silver II, no cabinet, nice chrome - \$875. McMurdo Silver V in a Clifton cabinet, excellent condition, with original paperwork - \$4,700. U.S. Apex 10B chassis and speaker - \$40. Columbia Q, with lid - \$350. Columbia Viva-Tonal Model 810, comparable to Victor Credenza - \$1,100. Victor I, exceptional original - \$1,500. Edison Standard Model B, no lid - \$325. Edison Home Model D 2/4 minute - \$450. Edison Home Morning Glory Horn - \$125. Edison B80 oak diamond disc, nice - \$425. Victor Victrola VI, oak - \$175. Cylinder records, clean 2 minute - \$5 ea.; 4 minute - \$4 ea. **WANTED:** Escutcheon and speakers for a Zenith 12-U-159, power supply for a Radiola 64. John Hayes, 27 Highland Dr., Henniker, NH 03242. (603) 428-3053, or fax only: (603) 428-3053. E-mail: JHayesamfm@aol.com

FOR SALE: 1) Kennedy V - \$525. 2) Grebe Synchronphase - \$275. 3) Saba 300 - \$350. 4) Emerson Jewel Box - \$395. 5) Federal 58, mint cond. - \$1,100. Contact: Waves, 110 W. 25 St., 10th Fl., New York, NY 10001. Hrs. 12-6 Mon.-Fri., 10-6 Sat. & Sun. (212) 989-9284. Fax: (201) 461-7121. E-mail: c1wave@aol.com

FOR SALE: McIntosh C-22 - \$1,800. MC-30 - \$400. MC-60 - \$700. Dyna ST-70 - \$300. EMT 930st - BO. John Diamantis, 3709 Hetten Ln., Woodbridge, VA 22193. (703) 680-9321

FOR SALE: Cleaning shelves. Toshiba Globe 6TR92, minor defects - \$245. Arvin 540T - \$70. Sears tombstone 19-19 - \$145. Sears 87108 - \$70. Coronado 961, 167 and 951 - \$70 ea. Zenith Royals: 475 - \$25; 755, 760, 790, 780 - \$40 ea. Hallicrafters: 538, 538A, WR-600 - \$45 ea.; 540A - \$70. GE cathedral K50-P - \$195. Zenith 12H090 chassis, speaker, phono, faceplate, etc., completely removed from cabinet, working - \$70. RCA 5T-8 - \$140. Emerson 657 - \$35. Airline 62-185 - \$145. Remler 71 - \$115. Sears 106604C - \$100. Emerson transistor 888 - \$70. Philco 40-145C - \$60. All items plus UPS. Charles R. Boller, 3108 N.W. 91st, Seattle, WA 98117. (206) 782-8318

FOR SALE: Collins 75S1, winged, mint with everything. Zenith T-O most tube type receiver. No junk or parts or 520. Hallicrafters SX17 & speaker SX28, SX99, SX100, S20R, S38, SX71 & speaker. SX130 & speaker clock, mint. SX110, SX101. Hammarlund HQ110, HQ140XA & speaker. HQ145, HQ170. Scott SLMR Marine, restored. R390A (4 off), R392 (2 off). Collins ant. coupler multi-feed. Crosley American overseas white. Crosley Dynaprotel floor model, restored. Telefunken Opus 7, Telefunken Gavotte, both outstanding condition. Much more, call: Alan Carpenter, 524 Ponderosa Dr., Estes Park, CO 80517. (970) 577-0677

FOR SALE: Realtone 1720 microstyle - \$50. 1959 P771A - \$40. Westinghouse H707P6GP - \$20. Zenith Royal 20, in box - \$30. Japan multiband 8-transistor in box - \$30. WERC radio blabber mouth - \$30. Ambassador A880 - \$20. Matsusita T-50 - \$35. Channel Master 6506 - \$25. Hallicrafters SX110 - \$75. All in good condition or better. All + UPS. Terry Browning, 312 11th St., SW, Alabaster, AL 35007. (205) 620-4345

FOR SALE: McElroy Model RRD-900-742, condition good, missing inkwell cover and paper reel spindle. Andrew Mitz, WA3LTJ, 4207 Ambler Dr., Kensington, MD 20895. (301) 897-5531. E-mail: arm@helix.nih.gov

FOR SALE: White Zenith Royal 500H. Radiola IIIA, mint - \$195. Radiola III - \$165. Pilot 3" TV, working - \$350. Radiola adv. sign - \$350. Duro loose coupler, 7 taps - \$750. Floor model McMurdo Silver in cabinet - \$4,500. Emerson yellow & maroon BT-245 - \$2,200. RCA La Siesta radio - \$795. Baseball trophy radio - \$695. Philco 90 - \$595. Crosley Elf - \$495. Philco table model grandfather clock radio, Philco 70 - \$295. Fada 845, white marbled - \$325. Red Hoppy - \$495. Crosley book radios - \$195 ea. N.I.B. rocket radios - \$195. White Westinghouse refrigerator radio, mint - \$150. Martian Big 4, one leg repaired - \$795. Zenith Royal 7000 - \$295; Taiwan - \$350. Crystal Dyne radio - \$450. Red & blue Toshiba lace 5TR-193 - \$450, \$225. Radiola 103 speaker - \$195. Vintage Radio, 87 Sandra Dr., Parsippany, NJ 07054. (201) 316-8424, voice or fax

FOR SALE: Tubes, new & used - \$3 for list. 12AX7's, good used, U.S. - \$3.50 ea.; 6D6, 6C6, 84, 57, 58, 6X5, 12AU7, 6K6, good used - \$2 ea.; AN-5UM 223 multimeters, gray watertight case - \$20 ea. as is. **WANTED:** Tubes, Zenith radios 36-40; Burns, Amplion horns. Thanks. Bob Dobush/Arcturus, 3554 W. 105, Cleveland, OH 44111. Phone/fax: (216) 251-4070

FOR SALE: Zenith sweep tubes; 6JS6 - \$25; 6BH5 - \$10; Compactrons, vintage tubes and more. SASE for list. **HELP:** Desperately need schematic for Breting 9 receiver. Thanks! Steve Lipsky, W2VVN, 1254 Cox Rd., Jenkintown, PA 19046. (215) 884-1807. E-mail: slipsky@worldnet.att.net

FOR SALE: Regency TR-1, black, cracks on back - \$400. Motorola TX23E - \$350. Realistic DX-150 - \$85. Tom Murray, 3177 Lata Rd., #409, Rochester, NY 14612

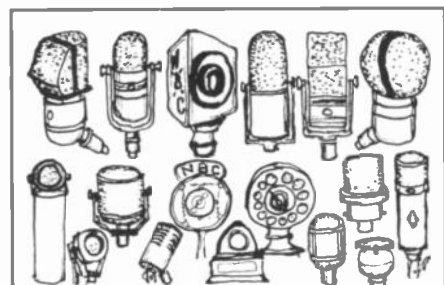

WANTED

FOR MY BROADCASTING MUSEUM

Microphones, stands, call letter plates. Tube amplifiers, mixers, compressors, Hi-Fi equipment. Speakers, on-air lights, equalizers. Disk, wire & tape recorders. Blank recording disks. Catalogs, magazines, manuals. 16" transcriptions, turntables, arms, pickups. Early TV cameras & receivers. Elaborate console, deco, plastic, mirror, novelty & wireless radios. Jukeboxes & parts. Acoustic photographs.

We are looking for all makes of equipment, and especially *Western Electric*, Telefunken, Neumann and RCA. The museum contains various duplicates and items surplus to our needs, and many of these articles are available for sale or trade. The collection is located in my Victorian seaside inn, The Caffrey House, situated on a bay next to the ocean, in the Southampton resort area of Long Island. A trade of equipment for a stay at the hotel is always encouraged.

Robert Van Dyke, 2 Squires Ave., East Quogue NY 11942
516-728-9835

FOR SALE/TRADE: Johnson Challenger - \$150. Heathkit HW-16 - \$175. DX-60B - \$125. R-390-A - \$350. SP600JX-1 - \$400. SASE. Sam Timberlake, PO Box 161, Dadeville, AL 36653. (205) 825-7305

FOR SALE: Heathkit HW-100 transceiver, HP-23 power supply, hand mic, manual - \$125 plus UPS. Call: Dan Langston, 820 Harrington Dr., Milledgeville, GA 31061. (912) 452-1015, evenings

FOR SALE: AK L chassis only - \$65. Crosley 725, needs refinish - \$90. Delco 1106, painted - \$90. GE A-53 - \$80. Zenith G725 - \$30; Zenith 5S127, needs refinish - \$125. Michigan MRC-12 - \$225. Plus shipping. **WANTED:** Crosley Ace V lid, DeForest Audion detector ceramic rheostat, Grebe CR-9 audios; Grebe FORN faceplate; Magnavox AC-3 cabinet, Zenith power transformer for Model 8S443 Part #95-627. Don Sturzenbecher, 2699C Marion Rd., Sioux Falls, SD 57108. (605) 368-2135

FOR SALE: Fall clean-out continues! Dyna ST-70 - \$225; Scott 299C - \$175; both exc. cond. Heath AA-32 - \$75. Many tube tuners. Radios: AK 32 - \$80; RCA Radiola 18, w/5 blue tubes - \$80; others starting at \$10. Tubes, N.O.S. - 25¢ ea. and up. Tube sockets, manuals, unbuild Heathkit, odd tubes, much misc. Large 2-stamp envelope for Dec. list. Charles D. Blair, 815 N. 5th St., Cambridge, OH 43725. (614) 432-4453, 9-5 pm

FOR SALE/TRADE: The following transmitting tubes: (2) Eimac VT127A, Penta PL-254, GL810, A29B, 5956, (3) 1625, Eimac 4-65A, Eimac UH50, 4D-32, 810, 250TH, Eimac 100, 4B341, Eimac 4-250A, 4B-341, VT-266, UE, 572B, (2) 811, 866A, 816, 832A. Call for price. Larry Drago, 383 Lincoln Dr., Cheshire, CT 06410. (203) 272-6030. Fax: (203) 272-2002

FOR SALE: Old radio & hi-fi tubes, #24 through #816, new & used, 1/2 AES prices w/guarantee. McIntosh pr. A116, exc cond. - \$995. (1) MC60 - \$795. Pr. MI-75's for trade. MA 6100, mint - \$450. WE 100F loudspeaker-amp - BO. Pr. Dyna MRK III's - \$475. Pat4 - \$50. FM5a - \$50. Fisher 500C - \$200. FM50B - \$60. AM/FM Series 80 w/cab. - \$175. Scott 350 FM/MPX & 299 stereo amp - \$300 both. HK A-700 int. tube - \$150. A-300 int. tube - \$100. Eico HFT-90 FM, mint - \$50. Sherwood 3000 tube FM tuner - \$50. Tube PA's: Bogen 6L6 rack mount - \$100; Challenger, mint - \$175; McGohan M355 (35wpc tube) - \$100. Nak 500 cass. deck - \$225. Shure Model 315 ribbon mic, ca. '57, mint, orig. box & papers - \$250. Bose 901 Model I's - \$495. Bozaks, 30" x 23" x 21", w/12" B207B, mids B209C w/ (4) xvors - \$495. Victor field coil - \$125. All + ship. Jim Cochran, 12511 S.W. 106th Ter., Miami, FL 33186. Voice/a/fax: (305) 273-6288

FOR SALE: Philco #71 cathedral, working, as found - \$175. Philco #84B cathedral - \$150. Akai 360D reel-to-reel S.O.S., 3 speed, crossfield heads, exc - \$100. Heathkit active processor #AD1706 U/T - \$50. **WANTED:** "Outside" horn phonographs & parts, boxes, horns, reproducers, etc. Call evens.: Jahan Acciavatti, PO Box 231, Southborough, MA 01772. (508) 476-3229

FOR SALE: Info on new research and electrical circuit to cure all diseases - \$5. H. Andreoni, c/o 250-D So. Lyon Ave., Hemet, CA 92543

FOR SALE: (3) Heathkits W5M working amps only - \$495 plus shipping. William McGuigan, Box 2, Barnegat Light, NJ 08006. (609) 494-9316. Fax: (609) 494-7476

FOR SALE: New!! Reproduction 1937 Zenith full-line poster showing the full 1937 line plus all three Stratospheres - \$19 ppd. Exact reproduction of the Zenith 7G605 Trans-Oceanic log chart for the door of your Clipper - \$19.95 ppd. Excellent repro knobs, grille cloth and other radio parts. Universal dial belt kit, 6' of belt material, glue and instructions - \$8.50 ppd. To reference most Zenith models from 1920 to 1946 we offer our 60-page 11 x 17 Zenith Brochure Book with pictures and specs on most models - \$28.95 ppd. Our 1936 Zenith poster reproduction shows the complete 1936 lineup plus all three Stratospheres - \$20 ppd. Send for free catalog. Visa, Discover and MasterCard accepted. Alan Jesperson, PO Box 17338, Minneapolis, MN 55417. (612) 727-2489

FOR SALE: Airline 62-282 - \$150. Crosley 11-116U bullseye - \$150. Westinghouse WR-12X4, nice, rebuilt - \$95. Airline movie dial 62-318 - \$85. Zenith H-725 - \$40. Coronado 525, missing one knob - \$80. Barry Rahman, 1529 27th Ave. S., #104, Fargo, ND 58103. (701) 235-1085. E-mail: radios@rmet.com

FOR SALE: Heathkit equipment: TS-3 TV alignment generator - \$35. T-2 signal tracer - \$25. GD-1B grid dip meter w/coils - \$45. BE-2 battery eliminator - \$45. IT-5230 color/B&W picture tube tester. Tube testers: EICO 625 - \$40. Sencore TC-154 - \$35. Hickok 546 - \$175. Hickok 6000 - \$200. Heathkit TC-2P - \$55. Heathkit TT-1 - \$125. RCA VTVM WV97A - \$35. RCA VTVM WV98A - \$45. H.H. Scott 222C stereo amp - \$95. H.H. Scott 350B FM stereo tuner - \$75. Superior 116B 10A Variac - \$35. Superior 126 15A Variac - \$45. Lafayette VOM #99-50734, 20K ohm/volt - \$20. B&K 160 transistor tester & power supply - \$35. Amprobe AVA83 AC volts/amps strip chart recorder - \$100. 100-watt mono tube power amp - \$125. Harman Kardon A230 tube stereo amp - \$35. Philco 46-1226 radio/phonograph - \$85. GE #250 alum. port. radio - \$35. Fisher 49T tuner & 49A amp, 2 pc. set - \$75. Garrard RC88-4 record changer - \$45. Zenith H724 AM/FM radio - \$35. RCA 6-B-5-A, 1955 tube radio - \$35. RCA 8-BT-10-K, 1956 transistor portable radio - \$35. Bell & Howell 8mm film projector #253AX - \$45. Textbooks: Practical Radio Communication, 1943, Nilsson & Hornung - \$20. FM Simplified, 1947, Kiver - \$20. Fundamentals of Radio, 1942, ed. by Everitt - \$25. Elements of Radio, 1943, Marcus & Horton - \$25. Basic Television - Principles and Servicing, 1949, B. Grab - \$20. Color TV Fundamentals, 1955, Kiver/Fink - \$25. Television Engineering, 1952, D.G. Fink - \$35. Electronic Flash & Strobe, 1970, Edgerton - \$10. Optics, for Engineers & Scientists, 1972, Williams & Becklund - \$15. Close Up Photography, 1969, Kodak - \$5. Books: Sams AR (Auto Radio) manuals - \$5 ea. Sams TSM (Transistor Service Manuals) - \$5 ea. How to Make More Money in your TV Servicing Business, 1962, Marcus - \$10. Patent Notes for Engineers, 1956, Tuska, RCA - \$10. The Satellite TV Handbook, 1983, Easton, Sams - \$5. Television and F-M Receiver Servicing, 1948, Kiver - \$10. How to Understand and Use TV Test Instruments, 1953, Kiver, Sams TN-1 - \$10. Color Television-Simplified Theory, 1956, D.G. Fink/Hershey, Philco - \$20. How to Build Speaker Enclosures, 1966, Badmaieff & Davis, Sams - \$5. All prices plus UPS. Bob Lynn, 26 E. Orchard St., Somerville, NJ 08876. (908) 685-9070

FOR SALE: Philco Model 90 chassis only, no tubes or knobs - \$85 plus. Elwood Hunt, 308 Georgetown Rd., Carneys Point, NJ 08069. (609) 299-5259

FOR SALE/TRADE: RCA U.S. Navy RAC-7 military receiver w/separate power supply in perfect condition w/manual - \$500. Larry Drago, 383 Lincoln Dr., Cheshire, CT 06410. (203) 272-6030. Fax: (203) 272-2002

FOR SALE: My collection of (90) radios. SASE, \$1 for photo listing. Don Michel, PO Box 667, Anna, IL 62906. (618) 833-7500. E-mail: import@midwest.net

FOR SALE: RCA pp 6V6 amp - \$65. Misc. preamps - \$10-\$20. RCA BP-10 - \$35. Dan Merz, 312 Sierra St., Richland, WA 99352. (509) 375-1334

FOR SALE/TRADE: Planters Peanut (B301), vg - \$60. Dough-Boy (B&B75), exc - \$50. Knight rearing horse (B508), vg - \$100. Standing Knight (B509), vg - \$80. Mississippi Pumper (B41), exc - \$85. Giant wrist watch (B493), vg - \$50. Plus shipping. Dan Sipola, 2840 Copeland Rd., Maple Plain, MN 55359. (612) 972-8214. E-mail: philco90@minn.net

FOR SALE: Spartan Model 10BW76PA chassis, speaker, turntable - Best Offer. Ted Biser, Box 2, Lorentz, WV 26229. (304) 472-4202

FOR SALE: Dyna (early) PAS-2 - \$95. Eico HF-20's, pair - \$195. Eico HF-32 - \$60. Garrard RC-80, with Audax arm & cartridge - \$50. Electro-Voice Aristocrats, pair - \$250. Radio Shack Solo 103's - \$35. Sony TR-814, pink & white - \$65. Concord DF-1, Marine DF rcvr - \$45. Ace 3B - \$190. Hickok 5533A - \$75. Hammond (organ) power supply, massive transformer & dual 5U4's - \$40. JVC JT-V77, exc FM stereo analog tuner - \$75. Packing and shipping extra. Joel Camicia, 1811 N.E. 58th Ave., Portland, OR 97213-4103. (503) 287-7832

FOR SALE: Delco R-1233 Ribbon Candy - \$40. GE 50 - \$25. Emerson 461 - \$25. Automatic 237 - \$25. Philco 54 - \$50. Philco 40-130 - \$50. Westinghouse WR100? - \$60. Zenith Z512G - \$10. Crosley 57TK - \$40. Industrial Elec. Corp. Simplon - \$40. GE 615 - \$20. Arvin 7531 - \$35. GE J71 - \$45. Automatic B-44 - \$35. Crosley 56TP-L - \$25. Philco 96 speaker & knobs - \$30. EICO tube tester - \$40. Joe Kelly, 537 Stafford Ave., Erie, PA 16508. (814) 459-3910

FOR SALE: Zenith hearing aid transistor - \$45. Radio questionnaire game, 1928 - \$35. Danny Thornton, 1175 Springdale Cir., Spartanburg, SC 29303. (864) 578-8518

FOR SALE/TRADE: The most beautiful radio I have ever owned, a Spartan peach color mirror Mod 558 with perfect chrome fins - \$2,750. Larry Drago, 383 Lincoln Dr., Cheshire, CT 06410. (203) 272-6030. Fax: (203) 272-2002

FOR SALE: (3) chairsides: Brunswick M26B - \$35; Wells-Gardner #72 - \$35; and Stewart-Warner 9001-F, in Duncan Phyfe cabinet - \$60. Philco Full Dress Predicta TV G-4658 on swivel legs as pictured in Poster's book - \$125. Owl transistor radio - \$25. John Okolowicz, 624 Cedar Hill Rd., Ambler, PA 19002. (215) 542-1597. E-mail: 70313.2564@compuserve.com

FOR SALE: Antique radios, over (250), TVs, test equipment, hi-fi, old electronics of all shapes & kinds, (1,000's) tubes, parts. Huge photo list, more items than most catalogs - \$1.50 + 55¢ SASE; or for same price, preorder '97 photo list. Will include many unlisted and newly acquired radios and interesting items. Radio Ranch, 10745 255th Ave., NE, Belgrade, MN 56312.

FOR SALE: Back issues of A.R.C. '92 to present - Best Offer. Cameron cauterizer, 30's - \$20. Bill Cherenisky, 6 Kate Ln., Metuchen, NJ 08840. (908) 549-2165

MESSAGE: Seasons Greetings to WWWeb page: <http://www.wlr.com> "Bringing Radio History to Eve" K2TQN, 125 Warf Rd., Egg H' 8501. (609) 927-3873. Internet'

MESSAGE: Holiday Greeting and A.R.C. staff who main' healthy and prosperous New 2131, Port Washington, NY 11050

MESSAGE: Would the person at A.F.B., Germany, contact me, you gave me wrong no., still have B-600. Buzz Miller, 725 Mt. Rock Rd., Carlisle, PA 17013. (717) 776-3279

HELP: November 1996 issue page 5. Wooden radio pictured right under gigantic clock radio. What is it? Anyone selling one? Alexander Kruedener, 161 E. 89 St., Apt. 4E, New York, NY 10128. (212) 831-0662

HELP: Need blue ribbon and blue grass radio batteries in good condition for display. Will pay well over actual value in return for your time - \$10 plus postage. Please help if you can. Thanks. Wayne King, 408 Forbes Dr., Shelbyville, KY 40065. (502) 633-6564, evenings

HELP: Need information/literature on the Gridiron Radio made by Empire Radio (Amarillo, TX). Bill Jewell, 6828 Trinity Landing N, Fort Worth, TX 76132. (817) 777-8791

HELP: Is there anyone out there who knows of a Marconiphone IV or V (Canadian)? Herb Fredrickson, RR2, Kemble, Ontario, Canada N0H 1S0. (519) 371-9814

HELP: Need users guide, manuals, schematics, literature. Sencore MU150 Continental 2, tube tester; LTV Electrosystems G276A VLF. Demodulator-receiver; Sylvania R-1451A (WLR6) HF receiver; Sierra 351A signal generator; Technical Materiel Corp. GPR-110S rcvr. Harry Weber, 4845 West 107th St., Oak Lawn, IL 60453-5252

FOR TRADE: Truetone Stratoscope beetle, Stewart-Warner Varsity - blue, Philco 70. **WANTED:** Beetle, Catalin, Kadette, Detrola, transistors. Bob Masterson, Box 172, Valley Cottage, NY 10989. (914) 353-3151

FOR TRADE: Paragon DA-2 detector amplifier for Paragon 10R-R1 one-tube RF amplifier, or Atwater Kent Model 4340 Radiodyne breadboard, will pay any difference. Trade near-mint Kenwood TS-930-SAT, with MC-60 mike, service and operating manuals in original (2) boxes, for Atwater Kent breadboard. **WANTED:** BC-148, 1935, with diamond loop antenna, also Atwater Kent TA units. How about it? Pat Stewart, W7GVC, 1404 Ruth Ave., Walla Walla, WA 99362-3558. (509) 525-1699

SERVICES: Rider Radio Schematics, 1930 through 1950's. Includes alignment data. Send \$3 with make, model and SASE to: George M. Bonanno, WA2KPE, 34 Charles St., Clifton, NJ 07013. (201) 746-5953

SERVICES: Plastic dial covers. Send sample or dimensions - \$10. Radiola III shockmount - \$2 ppd. Bill Turner, WA0ABI, 1117 Pike St., St. Charles, MO 63301. (314) 925-1307

SERVICES: Radio schematics and service info - \$3 ppd. Steve Rosenfeld, PO Box 387, Ocean Gate, NJ 08740. Phone: (908) 269-2022. Fax: (908) 269-2897

AUCTION: C
Two 32¢ st
London T
MESC
Der a

collection of rare audio books, tube manuals.
camps brings list. Tom Miller, PO Box 20138,
er. Station, New York, NY 10011

MESSAGE: Frontier Capacitor will be closed from
ember 15th thru New Years. This will give our staff
much needed vacation. Everett Hoard, Frontier
Capacitor, Box 218 or 403 S. McIntosh St., Lehr, ND
58460.

MESSAGE: Our grandson wanted to help me build a
radio, so I selected plans for a one-tube shortwave set
that I found in an old Radio-Craft magazine. We were
both impressed after we fired it up and were listening to
a Japanese station. These plans and others available
for building crystal sets, one/two-tube radios plus copies
of old radio ads and a list of collectible radios. LSASE to:
Ernie Nagy PO Box 822, Elk Rapids, MI 49629-0822.
(616) 264-9412

MESSAGE: Help us celebrate our 80th birthday and our
61st year in the radio-electronic industry. We are still
making SW-3 and generic plug-in coil forms, converting
864 tubes to WD-11 replacements, battery boards, tube
adapters and selling used test equipment. James A.
Fred, 5355 So., 275 W, Cutler, IN 46920. (317) 268-
2214

HELP: Service information SAIT 745E310a receiver
and Magnecorder PT6-M33 parts and service
information. Thomas Peters, PO Box 3925, McAllen TX
78502

HELP: Need instructions for EMC (Electronic
Measurements Corporation, NYC, NY) Model 208 tube
tester. Doug Fox, 603 S. 12th Ave., St. Charles, IL
60174. (630) 584-5915

HELP: Does anyone know date North America changed
from meters (wave length) to kilocycles (frequency)?
Gordon Wilson, 11108 50 Ave., Edmonton, Alberta,
Canada T6H 0H9. (403) 434-6257

HELP: Need used can capacitors, nut mount, 1 3/8"
dia., 4" high. Mark Murphy, 1400 Chicago Ave., #208,
Evanston, IL 60201. (847) 328-5036

HELP: Need technical information, schematics:
Canadian Westinghouse Model 55; Premier ensemble;
Heathkit Q meter; Jewel radio analyzer pattern 133A.
K.O. Pedde, Box 6268, Fort St. John, British Columbia,
Canada V1J 4H7. (250) 785-3351

HELP: Wanted: Schematic for Emud Rekord Junior
196. Thanks. Michael L. Hagan, 428 Sharron Dr., Waco,
TX 76712. (817) 776-4760

HELP: Need both speakers and all the tube shields for
a Zenith 12A58. Steve Wasser, 121 High Blvd.,
Shillington, PA 19607. (610) 777-4356

FOR TRADE: Signal Corp. BC148, BC151, BC176A.
WANTED: Pre-1935 aviation sets, ground or air. James
Treheme, 11909 Chapel Rd., Clifton, VA 20124. (703)
830-6272

FOR TRADE: Airline 1541 (fruits & flowers) for Coke
cooler radio or Zenith chairsets (12-tube or larger).
Barry Rahman, 1529 27th Ave. S., #104, Fargo, ND
58103. (701) 235-1085. E-mail: radios@rmet.com

FOR TRADE: Privat-ear, maroon, working, original
box, vg--for very high-end/rare transistor. David Mendick,
25 Jefferson St., #7-B, Hackensack, NJ 07601-5038.
(201) 457-0802

FOR TRADE: My tube-type Zenith Trans-Oceanics for
Zenith Universals 5G401, 5G603, 6G601 or similar
Zenith luggage-type portables. Craig Ingram, 45 Quinn
St., Valparaiso, IN 46383. (219) 464-2356

FOR TRADE: Atwater Kiels (2) for horns of distinction.
Scott Cavalari, 1258 Rt. 94, New Windsor, NY 12553.
(914) 561-7913

FOR TRADE: Clapp-Eastham HR for Aeriola Jr. Also
looking for DeForest D7. Carl Steinberg, 5 Cannan Rd.,
Monsey, NY 10952. (914) 352-0701

FOR TRADE: Transistor radios for original Pulsar L.E.D.
watch. Phil Vaccaro, 2581 Pond Ave., Maplewood, MN
55119. (612) 730-8380

FOR TRADE: American Trans-Oceanic D7000Y for
Taiwanese R7000-2. Arnold Giron, PO Box 862533,
Los Angeles, CA 90086. (213) 622-8646

E-MAIL ADDRESS FOR ANTIQUE RADIO CLASSIFIED

ARCMagzine@aol.com

Ads - Subscriptions - Book Orders

See inside front cover for details

SERVICES: Rider/Sams Radio Schematics 1920-
1970's - \$3 ppd. Send make/model to: Richard A.
Lerche, 1561 Bluebell Ct., Livermore, CA 94550. (510)
447-9365

SERVICES: Schematics 1920-1960 mailed or faxed -
\$3 radios, \$4 TVs ppd. Robert Schrantz, 610 E. Juanita
Ave., San Dimas, CA 91773. Phone/fax: (909) 394-
1194

SERVICES: Authorized Hickok contact person. Offer
test equipment repair, calibration & sales of most major
makes including kit and military. **FOR SALE/TRADE:**
Refurbished, calibrated & guaranteed test equipment.
Copies of commercial & military manuals. **WANTED:**
Radio test equipment (need not work). Special needs
Hickok 539B w/good meters for parts. **MESSAGE:**
Moving shop and storage area to larger building, please
be patient. Best time to call is before 8:30 a.m. & after
8:30 p.m. EST. Machine answers after 4th ring. Profit by
our 50+ year experience. Wendell E. Hall, 3 Mockingbird
Cir., Jeffersonville, In 47130. (812) 282-9709

SERVICES: Source for high quality, readable, complete
vintage manuals. Three 32¢ stamps for catalog. Pete
Markavage, The Manual Man, 27 Walling St., Sayreville,
NJ 08872. (908) 238-8964

SERVICES: Repair of all tube-type radios,
communications receivers, amplifiers and jukebox
amplifiers. Jim Sinwell, 511 Newport Dr., Greensburg,
PA 15601. (412) 834-0763

SERVICES: Rider schematics, parts lists, alignment
data - \$3 plus SASE. Include make, model. Dale B.
Allen, 606 Third St., Herndon, VA 20170. (703) 904-
9895. E-mail: RadioDale@dclink.com

SERVICES: Repair/replacement of meters before 1935.
WANTED: Old meters/galvos before 1910, as is okay.
Ye Olde Meter Cellar, Leonard W. Cartwright, 879
Russet Dr., Sunnyvale, CA 94087. (408) 739-6025

SERVICES: Reproduction Philco cabinet parts.
Cathedral, front panels, base moulding rear arch. Philco
grandfather or colonial clock finials & trim pieces. Call or
write your needs. Dick Oliver, 28604 Schwalm Dr.,
Elkhart, IN 46517. (219) 522-4516



NEW YORK - Dec. 1

GREATER NEW YORK VINTAGE WIRELESS ASSN. — SWAP MEET

Lake Ronkonkoma, NY — 367 Hawkins Ave.
N. of L.I. Expressway, lg. white house
9-12 am

Info: Chris Lieppert — (516) 471-9526, or
Chris Bacon — (516) 821-7618

ARKANSAS - Dec. 5

ANTIQUE RADIO COLLECTORS CLUB OF FORT SMITH — CLUB MEETING

Fort Smith, AR — St. Luke Lutheran Church
Waldron Road, at Free Ferry — 7:30 pm

Info: Paul Tucker, 4700 N. "N" Street
Fort Smith, AR 72904 — (501) 782-8178

OHIO - Dec. 1

BUCKEYE ANTIQUE RADIO & PHONO CLUB MEETING

Brunswick, OH — Brunswick Library
3649 Center Rd., Rt. 303

1-4:30 pm

Info: Rich Bradley — (216) 842-5937

ARIZONA - Dec. 7

ARIZONA ANTIQUE RADIO CLUB CABINET REFINISHING SEMINAR

Phoenix, AZ — Home of Michael Ging
27 E. Vernon

2 pm — Cabinet Refinishing Seminar,
with Mark Toppo and Ken Krol

Info: Michael Ging — (602) 254-8489

UNITED KINGDOM - Dec. 1

NATIONAL VINTAGE COMMUNICATIONS CHRISTMAS FAIR

Wembley (London), UK — Hall 3
10:30 am-4 pm

Collection of 20 pre-WWII British TV sets,
including sets by Marconi for BBC in 1936,
and also 25+ TVs from 1940s-50s, on sale

Info: NVCF, 2-4 Brook St., Bampton
Devon, England — Phone: (01398) 331532

CALIFORNIA - Dec. 7

CALIF. HISTORICAL RADIO SOCIETY NORTH VALLEY CHAPTER — MEETING

Redding, CA — Chris Galantine's house
2 pm — Fate of club to be decided

Info: Chris Galantine, 15853 Ontario Place
Redding, CA 96001-9785 — (916) 244-2337

WASHINGTON - Dec. 1

VINTAGE AUDIO LISTENERS AND VALVE ENTHUSIASTS — MEETING

Poulsbo, WA — Classic Radio
1127 N.W. Bright Star Ln. — 10 am-2 pm

Info: Dan Schmale — (360) 697-1936

FLORIDA - Dec. 7

ANTIQUE WIRELESS ASSOCIATION FALL MEET

Bradenton, FL — Stewart Elementary School
7905 25th Avenue NW

8 am-1 pm — Swap Meet

Info: Norm Smith — (941) 792-0003

VIRGINIA - Dec. 4

TIDEWATER ANTIQUE RADIO ASSN. MEETING

7 pm — Call for location & directions

Info: Phil Stroud, 2328 Springfield Ave.
Norfolk, VA 23523 — (757) 481-2561, eves.

OHIO - Dec. 7

RADIO AUCTION

Archbold, OH — Yoder & Frey Building
Co. Rd. 24, from St. Rt. 2, take Rd. 24 North
9:30 am — See display ad in this issue

Info: Frey & Sons, Robert G. Frey, Box 7
Archbold, OH 43502 — (800) 886-3739

SUBMISSION DEADLINE 5th OF MONTH

Although non-members are welcome at all events, joining may be required at some. Admission is charged at some events.

OKLAHOMA - Dec. 7

OKLA. VINTAGE RADIO COLLECTORS TENTATIVE DATE/CHRISTMAS PARTY

Oklahoma City, OK - 8812 Northridge Ter.
Chuck DePaepe's home - 7 pm

Bring covered dish - Art Deco late '30's prize

Info: Jim Collings - (405) 755-4139, after 6 pm
Mike Lapuzza - (405) 745-3394, after 7 pm

WASHINGTON - Dec. 8

PUGET SOUND ANTIQUE RADIO ASSN. MEETING

N. Seattle, WA - Shoreline Museum
749 No. 175th St. & Linden Ave.

9 am - Swap Meet; 12 noon - Meeting

Info: Al Atworth, PO Box 125
Snohomish, WA 98291-0125 - (360) 568-2698

TEXAS - Dec. 7

HOUSTON ANTIQUE RADIO ASSN. CHRISTMAS PARTY

Houston, TX - Lai Lai Restaurant,
Tides II Hotel, Main at Holcombe

3 pm - Swap Meet in parking lot

6-7 pm - Buffet Dinner

Radio Comedy led by Reid Shipp
Fun Auction (donaton)

Info: Bill Werzner - (713) 721-2242

WEST VIRGINIA - Dec. 8

MUSEUM OF RADIO & TECHNOLOGY BANQUET

Huntington, WV - Museum of Radio &
Technology, 1640 Florence Ave.

1:30 pm

Info: Jack Woodrum, 141 W. 9th Ave.
Huntington, WV 25701 - (304) 525-4546

TEXAS - Dec. 7

VINTAGE RADIO & PHONO. SOCIETY CHRISTMAS CHEER

Irving, TX - Senter East Bldg.

6-10 pm

Info: C.F. Crandell - (214) 337-2823

GEORGIA - Dec. 9

SOUTHEASTERN ANTIQUE RADIO SOCIETY MEETING

Norcross, GA - Picadilly Cafeteria
3400 Holcomb Bridge Road

6 pm - Mini-Meet

6:30 pm - Meeting

Info: Charles Pierce - (770) 886-8018, or
SARS, PO Box 500025 - Atlanta, GA 31150

WASHINGTON - Dec. 7

RADIO ENTHUSIASTS OF PUGET SOUND MEETING

Seattle, WA - Queen Anne Library, 400 W.
Garfield - 2 pm - "One Man's Family"

Info: REPS, 9936 NE 197th Street

Bothell, WA 98011 - (206) 488-9518

ILLINOIS - Dec. 9

BELLEVILLE AREA ANTIQUE RADIO CLUB MEETING

Belleville, IL - Belleville Area College

7 pm

Info: Karl Stegman, 4 Cresthaven Drive
Belleville, IL 62221 - (618) 234-7992

MISSISSIPPI - Dec. 8

MISSISSIPPI HISTORICAL RADIO & BROADCASTING SOCIETY - MEETING

Meridian, MS - 2412 C Street - 3 pm

Info: Randy Guttery, 2412 C. Street

Meridian, MS 39301 - (601) 693-5958

MISSOURI - Dec. 10

ANTIQUÉ RADIO COLLECTORS & HISTORIANS OF GREATER ST. LOUIS - MEETING

St. Louis, MO - Kirkwood Community Center
111 S. Geyer Rd., Room 201-A - 7 pm

Info: Scott Teichmann, 103 Pleasant St.
Jerseyville, IL 62052 - (314) 256-6263

ONTARIO - Dec. 8

RELICS OF THE ELECTRIC AGE COLLECTIBLE SHOW & SALE

Toronto, Ontario - Brigantine Room
York Quay, Harbourfront Centre

9:30-11 am - Early Bird admission

11 am-6 pm - Regular admission

3-5 pm - Auction

Speakers: Malcolm Baird on his father &
early TV, & Bill McGregor of Electrohome

Info: (416) 969-1642

OHIO - Dec. 10

ANTIQUÉ RADIO COLLECTORS OF OHIO MEETING

Kettering, OH - National City Bank Basement
4100 Far Hills Ave., at Stroop Rd.

7:30 pm - Early AC Radios and
Speakers/Elections

Info: Ed App - (513) 865-0982
ARCO, PO Box 292292, Kettering, OH 45429

MARK YOUR CALENDAR

Nov. 30 - Germany, Köln - Radio Auction
Dec. 1 - NY, Lake Ronkonkoma - GNYVWA §
Dec. 1 - OH, Brunswick - BARPC Meeting*
Dec. 1 - UK, London - NVCF Xmas Special*
Dec. 1 - WA, Poulsbo - VALVE Meeting §
Dec. 4 - VA, TBA - TARA Meeting §
Dec. 5 - AR, Fort Smith - ARCCFS Meeting §
Dec. 7 - AZ, Phoenix - AARC Seminar*
Dec. 7 - CA, Redding - NVC-CHRS Meeting*
Dec. 7 - FL, Bradenton - AWA Fall Meet*
Dec. 7 - OH, Archbold - Radio Auction*
Dec. 7 - OK, Oklahoma City - OKVRC Party §
Dec. 7 - TX, Houston - HVRA Christmas Party*
Dec. 7 - TX, Irving - VRPS Christmas Cheer*
Dec. 7 - WA, Seattle - REPS Meeting §
Dec. 8 - MS, Meridian - MHR&BS Meeting §
Dec. 8 - Ontario, Toronto - Collectibles Show*
Dec. 8 - WA, Seattle - PSARA Meeting §
Dec. 8 - WV, Huntington - Museum Banquet*
Dec. 9 - GA, Norcross - SARS Meeting §
Dec. 9 - IL, Belleville - BAARC Meeting §
Dec. 10 - MO, St. Louis - ARCH Meeting §
Dec. 10 - OH, Kettering - ARCO Meeting §
Dec. 10 - PA, Souderton - DVHRC Meeting §
Dec. 11-15 - CT, Greenwich - Transatlantic Event*
Dec. 11 - Ontario, Ottawa - OVRC Meeting*
Dec. 12 - AR, Little Rock - AARC Meeting §
Dec. 13 - NJ, Freehold - NJARC Meeting §
Dec. 14 - Austria, Vienna - 3rd Radio Auction*
Dec. 14 - OR, Oregon City - NWVRS Meeting §
Dec. 14 - TX, San Antonio - TARC Meeting §
Dec. 15 - MD, Burtonsville - MAARC Meeting §
Dec. 15 - NM, Albuquerque - NMRCC Meeting §
Dec. 17 - CA, N. Highlands - SHRS Meeting §
Dec. 18 - OH, Cincinnati - SPARK Meeting §
Dec. 18 - OH, Columbus - SPARK Meeting §
Dec. TBA - NY, Goshen - HARPS Meeting §
Dec. 29 - BC, Richmond - CVRS/BC Meeting*
-- 1997 --

Jan. 3-31 - MA, Newton - Transistor Exhibit*
Jan. 11 - AZ, Tucson - AARC Swap Meet*
Jan. 11 - CA, Valencia - SCARF Fest*
Jan. 11 - OK, Oklahoma City - OKVRC Meeting §
Jan. 12 - CO, Denver - CRC Meeting §
Jan. 17-19 - TX, Houston - HVRA Mega Auction*
Jan. 18 - NH, Nashua - NEARC Swap Meet
Jan. 18 - TX, Irving - VRPS Meeting §
Jan. 25 - OH, Columbus - SPARK Swap Meet
Jan. 25 - Ontario, London - LVRC Meeting
Jan. 27 - AL, Birmingham - ALHRS Meeting §
Jan. 28 - OH, Kettering - SPARK Meeting §
Feb. 1 - FL, Orlando - FAWG Estate Auction*
Feb. 8 - AZ, Phoenix - AARC Radio Roundup
Feb. 9 - MN, St. Louis Park - NARC Workshop
Feb. 15 - CA, Los Angeles - SCARS Auction
Feb. 15 - IN, Indianapolis - IHRS Winter Meet
Feb. 23 - MA, Westford - GBARC Radio XXVIII
Feb. 26-Mar. 1 - CO, Mt. Crested Butte - Radio Meet
Mar. 8 - AZ, Tempe - AARC Spring Swap Meet
Apr. 12 - AZ, Carefree - AARC Meeting
Apr. 19 - NH, Nashua - NEARC Swap Meet
May 1-3 - IN, Indianapolis - IHRS/AWA Meet
May 3 - AZ, Gilbert - AARC Auction/Meeting
May 4 - UK, Birmingham - NVCF Show
May 16-18 - OH, Dayton - Dayton Hamvention
Jul. 11-13 - MI, Lansing - MARC Extravaganza '97
Jul. 19 - NH, Nashua - NEARC Swap Meet
Aug. 6-9 - IL, Elgin - ARCI Radiofest 1997
Sep. 3-6 - NY, Rochester - AWA Conference
Oct. 25 - NH, Nashua - NEARC Swap Meet

* See expanded listing this month. § Monthly Meeting
† Date changed from original announcement

PENNSYLVANIA - Dec. 10

DELAWARE VALLEY HISTORIC RADIO CLUB MEETING - SWAP MEET - AUCTION

Souderton, PA - 113 Main St.,
N. Penn Amusements Bldg.

7:30 pm

Info: DVHRC, PO Box 41031, Philadelphia,
PA 19127-0031 - Mike Koste - (215) 646-6488

ONTARIO - Dec. 11

OTTAWA VINTAGE RADIO CLUB - MEETING

Ottawa, Ontario - Ottawa Citizen
Conference Room, 1101 Baxter Rd.

7 pm

Info: Tom Devey, 810 Edgeworth Ave.
Ottawa, Ontario K2B 5L5 - (613) 828-5152

ARKANSAS - Dec. 12

ARKANSAS ANTIQUE RADIO CLUB MEETING

Little Rock, AR - Call for location

7 pm

Info: Tom Burgess - (501) 455-0773

TRANSATLANTIC - Dec. 11-15

ANTIQUÉ WIRELESS ASSOCIATION 75th ANNIV. TRANSATLANTIC TESTS

Greenwich, CT - Station W1BCG on air

2200 Z Dec. 11 to 2400 Z Dec. 15,
1815 Kc CW only

Dec. 13-15: On 80 to 10 meters, all modes

QSL to: SARA, PO Box 4225, Stamford,
CT 06907-0225. Send LSASE or 9 x 12
SASE for certificate

Info: Tim Walker, N2GIG, 19 Woodside Ave.
Westport, CT 06880 - (203) 454-4376

NEW JERSEY - Dec. 13

NEW JERSEY ANTIQUE RADIO CLUB MEETING

Freehold, NJ - Grace Lutheran Church
West Main St. & Park Ave. (old Rt. 33)

7:30-9:30 pm - Meeting & Swap

Info: Don Cruse - (908) 542-2848
Jim Whartenby - (908) 271-7701

AUSTRIA - Dec. 14

AUKTIONSHAUS DOROTHEUM THIRD RADIO AUCTION

Vienna, Austria - Order Auction Catalog
from: Auktionshaus Dorotheum, Subscription
Dept., Dorotheergasse 17, 1010 Vienna,
Austria: +431/51560-289, Fax -508

OREGON - Dec. 14

NORTHWEST VINTAGE RADIO SOCIETY MEETING

Oregon City, OR - Buena Vista Club House
16th and Jackson Streets

10 am - Meeting

Info: Ed Charman, PO Box 82379
Portland, OR 97282-0379 - (503) 654-7387

OHIO - Dec. 18

SOCIETY FOR PRES. OF ANTIQUE RADIO KNOWLEDGE/COLUMBUS CPT. - MEETING

Columbus, OH - DeVry Institute of Tech.
1350 Alum Creek Rd., I-70 Exit 103B

7:30 pm

Info: Sharon/Ken Fullerton - (614) 237-2621

TEXAS - Dec. 14

TEXAS ANTIQUE RADIO CLUB NEW CLUB FORMING - MEETING

San Antonio, TX - Call for details

Info: Joe Koester, 7111 Misty Brook, San Antonio, TX 78250-3498 - (210) 522-1662

NEW YORK - Dec. TBA

HUDSON VALLEY ANTIQUE RADIO AND PHONO. SOCIETY/AWA - MEETING

Meeting date yet to be determined

Call for further information:

Info: Peter DeAngelo - (914) 496-5130
HARPS, Box 207, Campbell Hall, NY 10916

MARYLAND - Dec. 15

MID-ATLANTIC ANTIQUE RADIO CLUB MEETING

Burtonsville, MD - New Hope Seventh Day
Adventist Church gym - 2 pm

Info: Sam Cannan, 1010 Siske Road
Stony Creek, MD 21226 - (410) 255-7728

BRITISH COLUMBIA - Dec. 29

CANADIAN VINTAGE RADIO SOCIETY BRITISH COLUMBIA CHAPTER - MEETING

Richmond, BC - Steveston Hotel

12 Noon - Informal Swap Meet

2 pm - Meeting

Info: Fred Tutt - (604) 275-2033

NEW MEXICO - Dec. 15

NEW MEXICO RADIO COLLECTORS CLUB MEETING

Albuquerque, NM - Sierra Vista Bible
Church, 7509 Paseo Del Norte

1:30 pm - Tube Portables

Info: Bill Schultz, 7213 Donet Ct. NE
Rio Rancho, NM 87124 - (505) 867-8178

MASSACHUSETTS - Jan. 3-31

TRANSISTOR RADIO LIBRARY EXHIBIT "FABULOUS & FASHIONABLE TRANSISTOR RADIOS"

Newton, MA - Newton Free Library
Main Hall, 330 Homer St. - (617) 552-7145

Mon.-Fri.: 9 am-9 pm

Sat.: 9 am-5 pm

Sun.: 1-5 pm

Info: Jon Golden - (617) 332-5460

CALIFORNIA - Dec. 17

SACRAMENTO HISTORICAL RADIO SOCIETY - MEETING

N. Highlands, CA - SMUD Foothill Service
Center, Room D, 5026 Don Julio, 1 mi. W. of I-80

7-9 pm

Info: SHRS, PO Box 162612, Sacramento
CA 95816, or Don Steger - (916) 929-8274

ARIZONA - Jan. 11

ARIZONA ANTIQUE RADIO CLUB SWAP MEET

Tucson, AZ - Dave's Antiques parking lot
3201 S. Dodge Blvd.

8 am

Info: Mike Hilton - (520) 722-1187

OHIO - Dec. 18

SOCIETY FOR PRES. OF ANTIQUE RADIO KNOWLEDGE/CINCINNATI CPT. - MEETING

Cincinnati, OH - Richards Radio & TV
4041 Edwards Rd., I-71, Exit 6 - 7:30 pm

Info: Tim Kaiser, PO Box 81
Newport, KY 41071 - (606) 441-2548

CALIFORNIA - Jan. 11

SOUTHERN CALIFORNIA ANTIQUE RADIO FEST

Valencia, CA - Valencia Travel Village
27946 Henry Mayo Rd. (a k a Hwy. 126)

(805) 257-3333 - fax (805) 257-3417

6 am -12 noon

Info: Byron Bernor - (805) 269-5459
Jerry Simpson - (805) 251-7829, days

Mention A.R.C. when attending events!

OKLAHOMA - Jan. 11

OKLA. VINTAGE RADIO COLLECTORS MEETING

Oklahoma City, OK - P.W.A. 7100 N.W. 63rd
Suite 1010, Conference Room
Wiley Post Airport Complex - 7 pm
Info: Jim Collings - (405) 755-4139, after 6 pm
Mike Lapuzza - (405) 745-3394, after 7 pm

COLORADO - Jan. 12

COLORADO RADIO COLLECTORS MEETING

Denver, CO - VectraBank Building
1380 S. Federal Ave., Community Room
1 pm - Meeting, followed by
Swap Meet in the parking area
Info: Rick Ammon - (970) 221-4001

WISCONSIN

NEW CLUB FORMING

Info: Dale Boyce, 10230 W. Greenwood
Terrace, Milwaukee, WI 53224-3716

A free* listing on these pages is available for each coming radio event. Sponsors should provide description of event, date, time, place, directions, & information/contact person. Since listings are on a "space available" basis, no guarantee of listing is made.

Submission Deadline - 5th of month.

*Club/museum/non-profit events are listed free; other events are obtained from advertisements placed elsewhere in A.R.C.

TEXAS - Jan. 17-19

HOUSTON VINTAGE RADIO ASSN. MEGA AUCTION

Houston, TX - Tides II Hotel, Lai Lai Suite
6700 Main St. - (713) 522-2811

Jan. 17: 3 pm - Auction check-in
7 pm - Auction starts

Fri. Auction for small radios, parts, tubes, books, test equipment, etc.

Jan. 18: 9 am - Auction check-in
12 noon - Auction starts

Sat. Auction for consoles, wood table radios, collectible plastics, & unsold items.

Jan. 19: 8 am - Swap Meet in rear parking lot of Lai Lai Restaurant

Sun. pm - Auction if overflow from Sat.

By Dec. 15 send items for manifest to be mailed in late Dec. or early Jan. to:
Bill Werzner - Fax: (713) 721-5079
Phone: (713) 721-2242

FLORIDA - Feb. 1, 1997

FLORIDA ANTIQUE WIRELESS GROUP ESTATE AUCTION

Orlando, FL - 10 am

See display ad in this issue

Info: SASE to FAWG, PO Box 738
Chuluota, FL 32766-0738

SOUTH FLORIDA

NEW CLUB FORMING

SO. FLA. ANTIQUE RADIO COLLECTORS

Info: Thomas Valenti, 1717 N. Bayshore Dr.
#1251, Miami, FL 33132 - (305) 536-2224

BUSINESS CARD ADS - \$45.00 FOR 3 MONTHS

High End Vacuum Tube Audio Old Vintage
(1920-1965)

Replacement Transformers

Chokes Filament Power Plate

Catalog \$5.00 (Refundable with first order)

E-Mail:
jswitzer@tigerpaw.com

P.O. Box 551
Paris, Illinois 61944



All Tube Equipment Repaired

"The Fisher Doctor"

Al Pugliese
718-948-7489

27 Daleham Street
Staten Island N.Y. 10308

VINTAGE FISHER PRODUCTS
Bought • Sold • Traded • Repaired



WAVES
ANTIQUES
EARLY RADIOS
&
PHONOGRAPHS
BOUGHT • SOLD
RENTALS • REPAIRS

MON-FRI 12-6
SAT-SUN 10-6

FAX 201-461-7121
e-mail c1wave@aol.com

CHELSEA ANTIQUES BLDG. 110 W 25TH ST. NY NY 10001 212 989-9284
PROPRIETORS Bruce and Charlotte Mager

PUT
YOUR BUSINESS CARD
HERE!

\$45 FOR 3 MONTHS - \$78 FOR 6 MONTHS
DON'T HAVE ONE? SEND AN EXTRA \$6.50 AND
WE WILL TYPESET ONE FOR YOU.

BUSINESS CARD ADS - \$45.00 FOR 3 MONTHS

784-9417

784-9417



COSMOS TV

- Low Prices
- TV Repair

- Quality Used TV's
- Antique Radio Repair
- Buy, Sell, Trade

Free Estimates
784-9417

5919 15th Ave. N.W.
Seattle, WA 98107

WANTED: Tube Hi-Fi Components & Commercial Amplifiers of the 1950's & 1960's

Marantz, McIntosh, Scott, Fisher, Brook Acrosound, Brociner, Western Electric Fairchild, Altec, Tannoy, JBL

Richard Sharisky (617) 484-5784, phone
P.O. Box 521 (617) 489-6592, fax
Belmont, MA 02178

Free Estimates
Hrs - 10 AM - 7 PM EST
Tues - Sat

Tel / Fax (800) 928-2628
E-Mail radiodoc@neca.com
http://www.neca.com/radiodoc/



ANTIQUA RADIO RESTORATION & REPAIR

1920 - 1960's

Buy & Sell



Reasonable Rates, Tubes, Professional Overhauls, Cabinet Refinishing Service For All Antique Car, Table & Console Radios, Communication Receivers & Tube Amplifiers

BOB ESLINGER

20 Gary School Road
Pomfret Center, CT 06259



ANTIQUA RADIO RESTORATIONS

109 S. Oak St., O'Fallon, IL 62269
618-632-7423

Electronic Consultant

Dial Reproductions

Hickok Tube Testers, Service & Calibration

Life Member I.E.E.E.
AWA, ARCA, MAARC

Clinton Blais, P.E.

ANTIQUA RADIO RESTORATION

Since 1936 Repair - Buy - Sell
Complete Restorations • Prompt Service

COOPER'S RADIO SERVICE

425 Court Street
Rockwell City, Iowa 50579



LARRY COOPER
712-297-7232



(708) 383-1848
BY APPOINTMENT

DO YOU HAVE
A PROBLEM RADIO ?

THE OLD RADIO SHOP

SERVICE OF VACUUM TUBE ELECTRONICS
SCHEMATIC DIAGRAM SERVICE
RESTORATION OR REPAIR • FREE ESTIMATES

ED HUETHER

1025 ERIE ST
OAK PARK, IL 60302

Old Time Replications

"TURN TO US WHEN YOU NEED KNOBS"
KNOBS • PUSHBUTTONS • ESCUTCHEONS
PLASTIC GRILLS • HANDLES

LARRY BORDONARO

5744 TOBIAS AVE. VAN NUYS, CA 91411
PHONE (818) 786-2500 • FAX (818) 909-0241

WANTED ! JAPANESE MILITARY RADIOS

any kind of WW-2 radios & aircraft instruments

Takashi Doi



FAX : 011-8145-301-8069
1-21-4, Minamidai, Seyaku, Yokohama, Japan

Looking for early, portable electronic calculators (1970-78)

(Any that have LED or other "lighted" displays)

- Will Trade Transistor Radios (or buy outright) •

Especially: Basicom, Berkey/Keystone, Calfax, Columbia, Commodore, Decimo, Educalc, Garrett, Ian Jones, JCE, Kingspoint, M.I.T.S., Monroe/Litton, Olympia, Royal, Sanyo, Sinclair, Sperry Remington, Summit, Victor.

Buy "Mr. Calculator" Ball Fax-(714) 730-6140
14561 Livingston St., Tustin, CA 92780

BETA-TEK ANTIQUA RADIO SERVICE

- Repair of Radios, Communications Receivers & Test Equipment
- Power Supplies for Battery Sets



RAY BINTLIFF
2 Powder Horn Lane
Acton, MA 01720
508 283-7435



THE RADIO MAN

Buy-Sell-Trade
Antiqua Radios • Tubes • Parts

DICK MORGAN
RES: (214) 564-6464

TEL: (214) 276-5458
FAX: (214) 272-1831
P.O. BOX 461485
GARLAND, TX 75046-1485

20 Years
Experience

Telephone/Fax
1-615-456-2529

Specializing in Antiqua Speaker Repair

- Very large stock of vintage speakers
 - Can repair most antiqua speakers
 - Field coils - fast turn-around
- SHOP CLOSED JAN - FEB
reasonable prices

Work
Guaranteed

Hank Brazel
103 N. Lake Point Ct.
Crossville, TN 38555

BUSINESS CARD ADS - \$45.00 FOR 3 MONTHS



Jukebox Collector

Free! Classified ad each month.
Free! Jukebox identification guide
with new sub. 12 issues...\$30
2545 SE 60th Ct. #217
Des Moines, IA 50317
515-265-8324

RADIO DIAL SCALES

SEND SASE FOR LIST

ROCK-SEA ENTERPRISES MIKE TOBIN
323 E. MATILIJIA ST. #110-241 (805) 646-7362
OJAI, CA 93023 RockSeaEnt@aol.com

78 RPM Cartridges Repaired



Dead cartridges rebuilt
right. New crystals etc., as needed. Allow 3-4 weeks. Most
crystal and "horseshoe" magnet types \$34.50
100 hr. sapphire setscrew needles (list \$2.50 ea.) ... 4/\$5.50



Joe Smolski
835-A Pleasant Street
Framingham, MA 01701

Inquiries: (508) 879-2778,
evenings and weekends.
Prices include return
postage. Please include
payment with order.

PHILCO PREDICTAS WANTED:



BUY • SELL • TRADE • RENT • RESTORE

DAVID WEDDINGTON
(615) 890-7498

2702 Albany Ct.
Murfreesboro, TN 37129

ELECTRON TUBE ENTERPRISES

BOX 8311 11 LINDEN LN
ESSEX, VT. 05451

BUY TEL: 802-879-1844 **SELL**

FAX: 802-879-7764

INTERNET: ETETUBES@AOL.COM

WRITE FOR FREE 1996 CATALOG

(Lowest prices for new & used tubes)

INSTRUMENTS

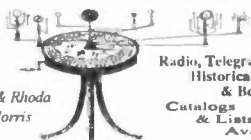

Jim & Rhoda
Morris

Radio, Telegraph,
Historical Instruments,
& Books For Sale
Catalogs
& Lists
Available

Antiques of Science & Technology
A of ST Box 1852 Wakefield Ma. 01880 U.S.A.
Tel 617 245 2897 Fax 617 245 3572

COMMNAV EQUIP
RADIO SETS
NAVAL AIR FIELD
U.S FOREIGN

CHARLES DICCCA KAI GON
501 MYSTIC VALLEY PKWY
MELBORO, MASS 02155
PHONE: 617-396-9354



MILITARY ELECTRONICS

BUY WANTED TRADE

"The Early Sound Man"

Mr. John P. Andolina, Jr.

Antique Phonographs



Collect • Repair • Restore
Edison, Victor, Columbia
Cylinder • Disc Records
Phonograph Advertising
Quality Repairs Since 1973

28 Glen Oaks Dr.
Rochester, NY 14624
(716) 247-3056
Reasonable prices



AWA
Member
REPRODUCERS #101

Fender

Martin

Gibson



McIntosh

We Buy, Sell, and Trade

"PLAY IT AGAIN"

Vintage Guitars, Amps
Stereo Equipment, Alnico Speakers,
and Antique Radios
Tube Equipment Our Specialty

1-203-331-9155

PETER DeGREGORIO



Marantz

45 Moritz Pl., Fairfield, Ct. 06430-3527

Carbon Resistors • Capacitors • Vacuum Tubes

ALLTRONICS

Electronic Component Supply

2300 Zanker Road • San Jose, CA 95131
Voice (408) 943-9773 • Fax (408) 943-9776
BBS (408) 943-0622 • 24 Hrs. • N-8-1

Call or Fax for Catalog

SUNSHINE SOUNDS

WANTED:



Hi Fi TUBE & COMMERCIAL AMPS | SPEAKERS & HORNS

McIntosh, Marantz, Dynaco, Heath,
Altec, Scott, RCA, Fisher, Craftsman,
Grommes, Fender, Ampex, W.E. Vox,
Brook, Acro, Pultec, Fairchild

Altec, Jensen, RCA,
E.V., Western Electric,
JBL, Tannoy

Phone: 405-737-3312 or Fax: 405-737-3355
Sonny - 1413 Magnolia Ln., Midwest City, OK 73110



Modern Radio Laboratories
Since 1932

Circuit Set Instructions, Radio Parts, Supplies,
Receiving Tubes. MRL Handbooks by Elmer G.
Osterhoudt published by us.

Catalog \$2.00

MODERN RADIO LABS
P.O. Box 14902
Minneapolis, MN 55414-0902

BUSINESS CARD ADS - \$45.00 FOR 3 MONTHS

VINTAGE RADIO SERVICES

Ken Hubbard
KA9WRN

Repair of
Vacuum Tube
Equipment

P.O. Box 792
Beloit, WI 53512-0792
(608) 362-1896
6 pm Evenings

Home-Auto

REPAIRS • BUY • SELL • TRADE
PRE '65 AC SETS & CAR RADIOS
FRED'S OLD RADIO EMPORIUM
1612 WEST 7TH AVENUE
CORNICANA, TEXAS 75110

F.L. GORDON, PROPRIETOR
BUSINESS (903) 874-5185 HOME (903) 874-7147



ESTES AUCTIONS

Specializing in Vintage Radios

7404 Ryan Rd
Medina, Ohio 44256

Bus. Phone 330-769-4992
Fax 330-769-4116
Res. Phone 330-769-3987

RADIOS & STRANGE MISCELLANEA IF YOU VISIT THE BRIMFIELD FLEA MARKET... STOP BY FIRST!

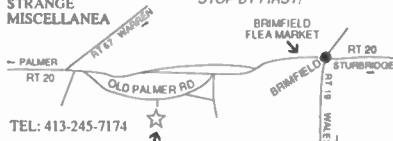

TEL: 413-245-7174
COUNTRY ROAD BARN - BERNIE SAMEK
OLD PALMER ROAD, BRIMFIELD, MASS.



K4GIT

RADIO ELECTRIC SUPPLY

We Specialize In Receiving and Special Purpose Tubes

Send For Price List

Dorothy and Don Gies
Owners

904-475-1950
Phone or Fax

1298 S.E. 5th Ave.
Melrose, FL 32666

We have been supplying quality electronic parts to satisfied customers for 25 years.

Call or write for our monthly flyers.

Phone/Fax (702) 795-7151

STAR-TRONICS

P.O. Box 98102
Las Vegas, NV 89193-8102

Are You Looking For Antique Radios, Parts, Tubes, Schematics and Restoration Services?

For Free Flyer, a 2-Stamp LSASE is required to insure a response to your request. Send to:

Olde Tyme Radio Company
2445 Lyttonsville Road, Suite 317
Silver Spring, MD 20910

Wish to contact us by phone or fax?

Our number is (301) 587-5280.

Please call 10 am to 10 pm (Local Time)

Antique Radios

David & Nancy Snow

P.O. Box 6352
Jackson, MI 49204
(517) 787-2985



We Buy, Sell, Repair

ARBE - III Battery Eliminators

1920-1970
SCHEMATICS + PAGES OF INFO
\$5.00 POSTPAID

MANUAL PRICES - SASE

RADIO/TV/HAM/MISC.

"IF I DON'T HAVE IT, YOU
PROBABLY DON'T NEED IT."

ALTON H. BOWMAN - 4172 EAST AVENUE
CANANDAIGUA, NY 14424-9564

ANTIQUA RADIO REPAIR

Repair - Restore - Buy & Sell

Schematic Service

Radios \$2.⁵⁰, TVs \$4.⁵⁰

DAMASKE ELECTRONICS

S74-W16834 Janesville Road

Muskego, WI 53150

Phone: (414) 679-0838

Wanted! (Top Paid)

Tube type amps by Western Electric, McIntosh, Marantz, Ampex, RCA, Langvin, etc.

Vintage speakers, units, by W.E., Tannoy, Altec, Jensen, JBL, EV, RCA, Goodman, etc.

Western Electric tubes & 6L6, 6550, 7591, KT66/77/88, etc.

David Yo, Tel: (818) 441-3942
PO Box 80371, San Marino, CA 91118-8371



"The Home of Mr Happy Amp"

PR NOVELTY

VACUUM TUBE SPECIALISTS
Amplifier Rebuilding • Service
Surplus Parts Brokerage
(New/Old Stock and Used)

PO Box 140 • Milwaukee • WI 53201
414 964 3392
414 960 8812

Paul Drobniakski Audio Technician
Robin Richards General Manager

BUSINESS CARD ADS - \$45.00 FOR 3 MONTHS

SPY EQUIPMENT WANTED!

- Code Machines
- Secret Cameras
- Secret Radios
- OSS, SOE, CIA, KGBI
- Clandestine Weapons
- I Buy or Trade!

Keith Melton
P.O. Box 5755 Bossier City, LA 71171
(318) 747-9616 Days: FAX (318) 747-9010



If you buy, sell or like jukeboxes you need **ALWAYS JUKIN—THE MONTHLY JUKEBOX MAGAZINE!** Subscribers in 25 countries, **ALWAYS JUKIN LEADS THE WAY:** Articles, photos, show reports, ads, new products, price guides, restoration tips, repairs—everything you need to know about **JUKE-BOXES**—the fastest appreciating collectible in the world!!! Fun & a great investment. Sample copy, \$3. \$33 per year. **ALWAYS JUKIN, 221 YESLER WAY AR, SEATTLE, WA. 98104. (206) 233-9460. Master/Visa ok.**



HAROLD C. BRAMSTEDT
C & N ELECTRONICS
6104 Egg Lake Road North
Hugo, MN 55038

612-429-9397
800-421-9397
Fax 612-429-0292



- Buy
- Sell
- Transmitting & Industrial Tubes

The RCA Shop

Carlton Carver

PROPRIETOR-RCA COLLECTOR

1645 W. 5th St.
Washington, NC
27889
(919) 975-2677

Quality electronic restoration of your mid-thirties RCA radios including all Magic Brain receivers. Oscilloscope sine wave tuning for maximum performance as per RCA service literature.



30 years experience **Jackson Speaker Service**

*Expert Antique Loudspeaker Repairs
(Cone Types) And Rebuilding A Speciality.
Speaker Parts And Repair Service On
Virtually Any Speaker Made Including
Stereo, P.A., And Antique Auto Speakers.
217 Crestbrook Dr. Owner
Jackson Mich 49203 Ron McGee
Ph - (517) 789-6400, Ans. 4th ring
Wk - days 10: am - 7pm Wk - Ends 9 - 5pm*



Get your ZENITH Transoceanics working again... on batteries! It only takes 6, maybe 7 "D" cells. You need the PORTA-POWER, CVA-5 converter. It works on others sets too.

You can get everything you need directly from me at the new low price of \$84.50 plus \$4 shipping. Over 200 sold! Peter Yanczer
TESLA ELECTRONICS (314) 822-1748
836 BRICKEN, ST. LOUIS, MO 63122

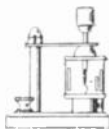

CRYSTAL SETS

PARTS - PLANS - KITS - BOOKS
CATALOG \$1 00

Largest source of Vintage and New Variable Air Condensers, Variometers, Vario-Couplers, Tap Switches, Tap Points, Galena and Germanium Detectors, Detector Stands, Cat Whiskers, Terminals, Sliders, Headsets, Dial Knobs, Coil Forms, Magnetic Wire, etc.

MIDCO
P O Box 2288
Hollywood, FL 33022
(305) 925-3670
BA Turke, PH DE E



TEST EQUIPMENT

BUY - SELL - TRADE
PARTS-ACCESSORIES-CABLES
MILITARY SURPLUS-ELECTRONICS
Illustrated Catalog Quarterly

Boca Electro Magnetic Lab
21218-10 St. Andrews Blvd.
Boca Raton, FL 33433
(561) 750-8911



(510) 490-5842

Fax (510) 490-1961

Speakerworld®

Expert Speaker Reframing and Reconing

2000 Warm Springs Ct. #6
Fremont, CA 94539

Visa/MC

Vintage Radio

- ◆ Repairs
- ◆ Restorations
- ◆ Specializing in all tube type car and home radios
- ◆ FM additions

Bob's Radio & TV

2300 Broad St
San Luis Obispo
California 93401
(805) 543-2946

Full warranty on work performed, walk-ins welcome, stop by and see our antique radio museum

**CAPACITORS - TUBES
RADIO SERVICE ITEMS**
Thousands in jam-packed illustrated
24-page catalog No. 49

**INFORMATIVE
INTERESTING
FUN-TO-READ**

Send \$3 U.S./Canada \$5 overseas (U.S. funds) for a Heavy-Paper limited edition copy NOW!

DON DIERS 4276 North 50 St. Dept. AB8
Milwaukee, WI 53216-1313

Phono Needles/Style
1500 Types
Magnetic - Ceramic -
Crystal Cartridges



Rebuild Astatic
and All Types
of Crystal Ceram-
ic Cartridges



Rebuild Obsolete Idlers
New Idlers and Belts
Fabricate 78 RPM Needles

West-Tech Services

648 N Ridgewood Dr #2
P O Box 1415
Sebring, FL 33871

STEVE KARPIAK C E T
Phone (941) 471-0922

BUSINESS CARD ADS - \$45.00 FOR 3 MONTHS

CANNAN & ASSOCIATES

Appraisers - Auctioneers - Liquidators

"SPECIALIZING IN ANTIQUE
ELECTRONICS"

PROTECT YOUR INVESTMENT - HAVE YOUR VALUED
COLLECTION HANDLED BY AN EXPERIENCED PROFESSIONAL

P.O. Box 28
WSE. NC 27594

PHONE/FAX
(919) 257-5888

TV • VCR • RADIO • TUBES & ANTIQUE ELECTRONICS



Loubriel Repair Service

Joseph Loubriel
Technician

Office 201-387-6665
Fax 201-387-8701
Home 914-351-5868

92 East Quackenbush
Dumont, NJ 07628

Memories on Main Antiques

Open everyday
Multi-dealer
Quality antiques
Early Radios



Visa/Mastercard
Main Street, Isanti, Minnesota

612-444-4488



THE FISHER PROFESSOR

RESTORATIONS OF ALL VINTAGE TUBE
& SOLID STATE HI-FIDELITY UNITS.
QUALITY SERVICE SINCE 1973

ROD PEDERSON
TEL: (519) 681-4973
FAX: (519) 681-2834

122 POPLAR COURT
LONDON, ONTARIO
CANADA N6B 2X5



ELECTROTECHNICS Specializing in Repairs

...of European and Made in U.S.A. Tubes & Transistor
Model Radios, Consoles, Hi-Fi Stereos, Cassette
Players, Communication Receivers, and Amplifiers.

BRAND NAMES: Grundig • Saba • Telefunken •
Philips • Nord Mende • Loewe Opta • Braun • RCA •
Zenith • Sony • Panasonic • Sanyo • Sharp

Reasonable Prices. FAST Service

Call ELECTROTECHNICS Today! 508-771-5275
12 Blossom St., Centerville, MA 02632

Antique Tube Type Radios

Repairs - \$30.00 plus parts
Rebuilds - \$65.00 plus parts
Guaranteed to work well

CHUCKS

167 LYNN DR., NEW HAVEN, WV 25265
PHONE (304) 882-2220

* GRUNDIG • SABA • TELEFUNKEN • NORDMENDE • PHILIPS • SIEMENS •
- SPECIALIZING IN REPAIR OF EUROPEAN RADIO SETS -

The Bavarian Radio Works

HORST A. HOCHSTRASSEN
(617) 447-4299



162 BELLAH ST.
WITMAN, MA 02182

LOGANS TV-RADIO

SINCE 1952

BUY • SELL • TRADE

100's of N.O.S. PARTS, TUBES IN STOCK.
PARTIAL OR TOTAL RESTORATION AVAILABLE.

412-837-5580

REAR 526 MT. PLEASANT ST., GREENSBURG, PA 15601

WANTED

PRE 1900
ELECTRICITY

MEDICAL • X-RAY
TELEGRAPHY • TELEPHONE

PRE 1925
RADIO • WIRELESS
PRE 1940
TELEVISION

BOOKS • TUBES • ARTIFACTS
MAGAZINES • AUTOGRAPHS
CATALOGS • EPHEMERA



NEW WIRELESS PIONEERS

P.O. BOX 398
ELMA, NY 14059
716-681-3186
FAX: 716-681-4540

We Buy Broadcast Audio

Mics, Compressors, Limiters, Decks, etc.

800-423-5499

HAMILTON BROSIOUS ASSOCIATES

25 years industry experience

RADIO BOOKS FOR SALE

Large selection of books on Radio and Related Technology
Call or write for our List of Catalogs.
Always buying, single items or collections.

RAINY DAY BOOKS

P.O. BOX 775, FITZWILLIAM NH 03447
(603)-585-3448

Collector, Historian, Seeker of
Stromberg • Carlson Radio Apparatus

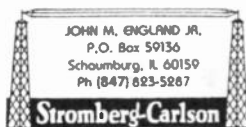

JOHN M. GWGLAND JR.
P.O. Box 59136
Schaumburg, IL 60159
Ph (847) 823-5287

Entrepreneur: Art Moderne,
Streamline, Machine Age Design

Radio Manufacturers of the 1920's

BY ALAN DOUGLAS



"The definitive book on American broadcast receivers of the 1920s"

Volume 1: A-C Dayton - Adams Morgan - Air-Way - All-American Mohawk - American Bosch - Amrad - Amrad S-Tube - Apex - Atwater Kent - Bremer Tully - Browning-Drake - Clapp-Eastham - Crosley - Cutting & Washington - Day-Fan - DeForest - Eagle - ERLA - FADA - Federal - Ferguson. 225 Pages.

Volume 1: \$24.95 - Softcover Only

Volume 2: Freed-Eisemann - Eisemann - Freshman - Garod - Gilfillan - Grebe - Howard - Jones (Lester/Melco) - Jones (Jos.) - Kellogg - Kennedy - King - Kodel - Kolster - Leutz - Magnavox - Majestic - Marti - Metro - Klitzen/Michigan - Midwest - Mu-Rad - Murdock - Music Master - Neutrowound - Operadio - Ozarka - Pfanstiehl - Philco - Pilot - Priess. 266 Pages.

Volume 2: \$29.95 - Softcover Only

Volume 3: RCA - Scott - Silver-Marshall - Slagle - Sleeper - Sonora - Sparton - Splitdorf - Steinite - Stewart-Warner - Stromberg-Carlson - Thermiodyne - R.E. Thompson - Thorola - Tri-City - C. D. Tuska - Ware - Western Coil - Western Electric - Workrite - Zenith. 292 Pages.

**Volume 3: \$29.95 - Softcover
\$39.95 - Hardcover**

U.S. Orders - Enclose \$3.00 per order for packing & book-rate shipping if total order is under \$35.00. If using VISA or MasterCard, include name on card, card number and expiration date. Send payment with order. Mass. residents add 5% sales tax. Money back return policy. Softcover unless stated otherwise. Most orders shipped the same day received, but allow 2-4 weeks to receive order. Foreign orders - write for shipping costs, or use credit card and specify air or surface (allow 2-3 months for surface shipping).



A.R.C., P.O. Box 2, Carlisle, MA 01741. Tel: (508) 371-0512

Fax: (508) 371-7129

Web: <http://www.antiqueradio.com/>



(Nov-98)

Amateur Radio Books



Communications Receivers 3rd Edition by Raymond S. Moore. A comprehensive guide to 732, 1932 to 1981, vacuum tube receivers by 66 manufacturers. New section on military receivers. 402 radios pictured! Sharper, clearer photographs. 8 1/2" x 11", 115 pages. Softcover. — \$19.95

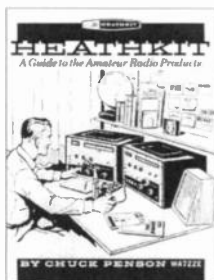

Heathkit, A Guide to the Amateur Radio Products by Chuck Penson. Documentation of ALL Heathkit's amateur products. 200+ sharp photos. Most products are pictured with a full-page description. 8 1/4" x 11", 256 pgs. Softcover. — \$24.95



Radios by Hallicrafters by Chuck Dachis. This book includes over a thousand photographs (b/w & color) of radio receivers, transmitters, speakers, early television sets, electronics accessories and advertising material. Technical descriptions are provided for every known Hallicrafters model, including dates of production, model numbers, accompanying pieces and original prices. A current price guide is included. 8 1/4" x 11", 225 pages. Softcover. — \$29.95

Price Guide

Ham Price Guide by Eugene Rippen. This book serves as a price guide and an identification guide. Handy index to help direct you from model numbers to the manufacturer. Small print. 8 1/4" x 11", 36 pages. Softcover. — \$9.95



The Pocket Guide to Collins Amateur Radio Equipment 1946-1980 by Jay Miller. A pictorial guide to Collins equipment and accessories. 90+ sharp photographs. 3 1/4" x 7", 108 pages. Softcover. — \$19.95

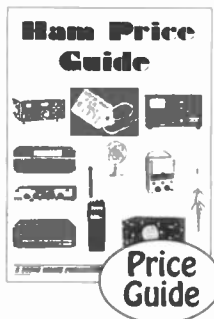

Price Guide

TRANSMITTERS EXCITERS & POWER AMPLIFIERS 1930-1980



Tube Type Transmitter Guide by Eugene Rippen. Provides a wealth of information on transmitters and transceivers. Includes ancillary items such as linear amplifiers, converters, modulators and VFOs. Over 500 illustrations. 8 1/4" x 11", 145 pages. Softcover. — \$19.95

Transmitters, Exciters & Power Amplifiers 1930-1980 by Ray Moore. Pictorial and descriptive guide to amateur high frequency transmitters and amplifiers manufactured in the U.S.A. Over 500 photos. 8 1/4" x 11", 144 pages. Softcover. — \$21.95



Tube Type Transmitter Guide

U.S. Orders - Enclose \$3.00 per order for packing & book-rate shipping if total order is under \$35.00. If using VISA or MasterCard, include name on card, card number and expiration date. Send payment with order. Mass. residents add 5% sales tax. Money back return policy. Softcover unless stated otherwise. Most orders shipped the same day received, but allow 2-4 weeks to receive order. Foreign orders - write for shipping costs, or use credit card and specify air or surface (allow 2-3 months for surface shipping).



A.R.C., P.O. Box 2, Carlisle, MA 01741. Tel: (508) 371-0512

Fax: (508) 371-7129

Web: <http://www.antiqueradio.com/>



(Oct-98)

Books on Radio's Early Days



Empire of the Air by Tom Lewis. *A biographical history of radio focusing on Lee de Forest, Edwin H. Armstrong and David Sarnoff. 1991. Illustrated. 421 pages.*

\$13.00 - Softcover

Hertz: The Beginning of Microwaves by John H. Bryant. *Photos and descriptions of Hertz's apparatus and experiments. A book prepared for the IEEE Hertz Centennial exhibit. 50 pages.*

\$15.00 - Softcover



Wireless Communication in the United States by Thorn L. Mayes. *Early development of American radio operating companies. Alternators, coherers, stock promotions, unpublished letters, etc. 160 illustrations. 240 pages.*

\$29.95 - Softcover

Inventing American Broadcasting by Susan J. Douglas. *A careful weaving of technology, social forces, and business decision making from the days of Marconi to broadcasting in the 1920s. 1987. 363 pages.*

\$14.95 - Softcover

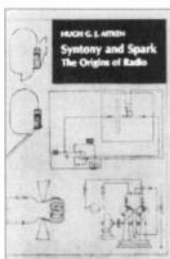

Syntony and Spark by Hugh G. J. Aiken. *Subtitled "The Origins of Radio." Describes the development of radio from Maxwell's work in the 1860s through the contributions of Hertz, Lodge and Marconi. Reprint. 1976. 347 pages.*

\$16.95 - Softcover

U.S. Orders - Enclose \$3.00 per order for packing & book-rate shipping if total order is under \$35.00. If using VISA or MasterCard, include name on card, card number and expiration date. Send payment with order. Mass. residents add 5% sales tax. Money back return policy. Softcover unless stated otherwise. Most orders shipped the same day received, but allow 2-4 weeks to receive order. Foreign orders - write for shipping costs, or use credit card and specify air or surface (allow 2-3 months for surface shipping).



A.R.C., P.O. Box 2, Carlisle, MA 01741. Tel: (508) 371-0512

Fax: (508) 371-7129

Web: <http://www.antiqueradio.com/>



(Nov-96)

Books with Great Photographs



Radio Art by Robert Hawes. *This outstanding book is an illustrated history of radio that celebrates the technical and stylistic progress of the radio. Although focusing primarily on British sets, this book also contains the following American sets: Addison, Airline, Atwater Kent, Bendix, Colonial, Country Belle, Dahlberg, E.H. Scott, Emerson, Fada, General Electric, Grunow, Majestic, Motorola, Philco, RCA, Sparton, Westinghouse, & Zenith. 250 photos, 150 in color. 9 1/4" x 12". 128 pages.*

Hardcover only: \$9.95 — New Low Price

Radio! Radio! 2nd Edition by Jonathan Hill. *Comprehensive coverage of British radios from the 1920s to the 1960s. Illustrated chapter on the history of wireless. Descriptive information on each radio pictured. Over 900 photographs. 8 1/2" x 12". 244 pages.*

**Hardcover only: \$44.95
Individually Signed & Numbered**



Radios Redux by Philip Collins. *Subtitled "Listening in Style," this book showcases the sleek lines and luscious colors of over 80 gleaming sets from the collection of Philip Collins. 121 color photographs. 10" x 8 3/4". 120 pages.*

Hardcover: \$29.95. Softcover: \$17.95



Radios: The Golden Age by Philip Collins. *Collins' first book of the colorful Catalin and Bakelite radios from the late 1930s to the early 1940s. Over 100 color photographs. 10" x 8 3/4". 128 pages.*

Hardcover: \$29.95. Softcover: \$17.95



U.S. Orders - Enclose \$3.00 per order for packing & book-rate shipping if total order is under \$35.00. If using VISA or MasterCard, include name on card, card number and expiration date. Send payment with order. Mass. residents add 5% sales tax. Money back return policy. Softcover unless stated otherwise. Most orders shipped the same day received, but allow 2-4 weeks to receive order. Foreign orders - write for shipping costs, or use credit card and specify air or surface (allow 2-3 months for surface shipping).



A.R.C., P.O. Box 2, Carlisle, MA 01741. Tel: (508) 371-0512

Fax: (508) 371-7129

Web: <http://www.antiqueradio.com/>



(Oct-96)

Transistor Radio Books



Price
Guide

The Collector's Guide to Transistor Radios 2nd Edition by Marty & Sue Bunis. *This book will help you identify the most sought-after vintage transistor radios. Over 2,900 models listed, all with current prices. Includes radio club listing. 375 all new color photos. 5 1/2" x 8 1/4". 320 pgs. 1996.*

\$16.95 - Softcover

(1st edition still available for \$15.95)

Made In Japan by Roger Handy. *A stunning book on the development and growth of the transistor radio featuring over 175 transistor radios in full color. 10" x 9 1/8". 108 pgs.*

\$16.95 - Softcover Out-Of-Print

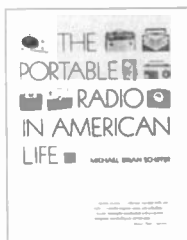

The Portable Radio in American Life by Michael Schiffer. *Approximately 50 pages on transistor radios, beginning with the Regency TR-1 through to the later sets made overseas. 450 photographs, 193 transistor radios pictured. 8 1/4" x 11". 259 pgs.*

\$24.95 - Softcover

\$45.00 - Hardcover

Collector's Guide to Novelty Radios by Marty Bunis & Robert Breed. *This book is the source for novelty transistor radios in all shapes and sizes. Radios are described in detail with current prices. Over 600 all new color photographs. 8 1/4" x 11". 224 pgs.*

\$18.95 - Softcover



Price
Guide



Price
Guide

Transistor Radios, A Collector's Encyclopedia and Price Guide by David Lane & Robert Lane. *Identification & price guide to over 2,500 transistor and novelty radios. History & key to collecting chapters. 8 1/4" x 11". 170 pgs.*

\$19.95 - Softcover

U.S. Orders - Enclose \$3.00 per order for packing & book-rate shipping if total order is under \$35.00. If using VISA or MasterCard, include name on card, card number and expiration date. Send payment with order. Mass. residents add 5% sales tax. Money back return policy. Softcover unless stated otherwise. Most orders shipped the same day received, but allow 2-4 weeks to receive order. Foreign orders - write for shipping costs, or use credit card and specify air or surface (allow 2-3 months for surface shipping).



A.R.C., P.O. Box 2, Carlisle, MA 01741. Tel: (508) 371-0512

Fax: (508) 371-7129

Web: <http://www.antiqueradio.com/>



(Dec-96)

Radios

of the Baby Boom Era

Six Volumes — 2000 pages — From Sams' Archives
1946 to 1960 — 274 Brands — 3494 Illustrations (B&W)
6769 Models — Catalin, Bakelite, Wood, Transistor Radios & More

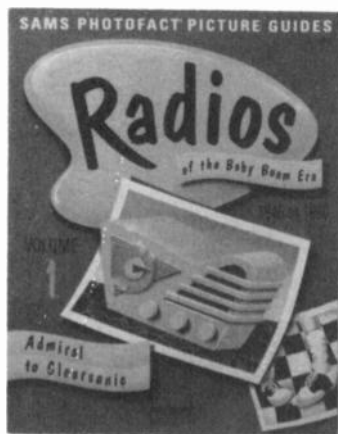

All Volumes Available!

| Vol. | Brands | Included |
|------|--------|-----------------------------|
| 1 | 56 | Admiral to Clearsonic |
| 2 | 54 | Co-op to Geloso |
| 3 | 58 | GE to Monitorradio |
| 4 | 36 | Motorola to RCA Victor |
| 5 | 35 | Realtone to Stratovox |
| 6 | 35 | Stromberg-Carlson to Zenith |

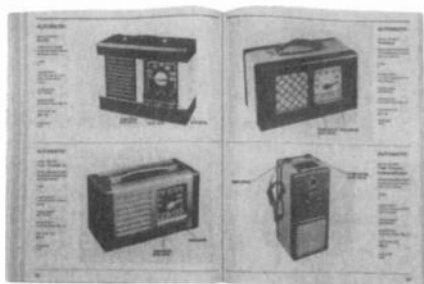

1/2 Page for each illustrated radio including:

- Large illustration of the radio including knob functions
- Short description of the radio
- Number of tubes
- Power supply type (AC, Battery, etc.)
- Tuning range
- Manufacturer
- Sams Photofact Set number & year Photofact published.

ALSO

- Index by model number listing tubes in radio
- List of similar radio models indexed to pictured radio
- List of manufacturers and suppliers indicating their brand names
- Basic trouble-shooting hints

Each Volume: \$16.95 – Softcover
8 1/2" x 11" – Approx. 328 pages

U.S. Orders - Enclose \$3.00 per order for packing & book-rate shipping if total order is under \$35.00. If using VISA or MasterCard, include name on card, card number and expiration date. Send payment with order. Mass. residents add 5% sales tax. Money back return policy. Softcover unless stated otherwise. Most orders shipped the same day received, but allow 2-4 weeks to receive order. Foreign orders - write for shipping costs, or use credit card and specify air or surface (allow 2-3 months for surface shipping).



A.R.C., P.O. Box 2, Carlisle, MA 01741. Tel: (508) 371-0512

Fax: (508) 371-7129

Web: <http://www.antiquradio.com/>



(Oct-96)

CRYSTAL CLEAR

By Maurice L. Sievers

Volume 1

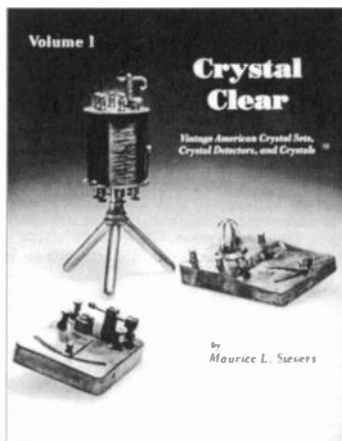

750 Illustrations – 570 Crystal Sets
341 Detectors – 207 Crystals
Perfect for the beginning collector!
Useful for the experienced too!

Crystal Clear is the most comprehensive reference for collectors, historians and anyone interested in early radio. In addition to the many excellent photos and reproductions of ads, *Crystal Clear* includes lists showing all sets by manufacturer, set name, selling price and date of manufacture. 8 1/2" x 11", 282 pages.

\$29.95 – Softcover

Volume 2

Crystal Clear, Vol. 2 supplements the first volume. It identifies an additional 172 crystal radio sets, 91 crystal detectors and 26 crystals by manufacturer, model, year produced, description and original selling price. Further research on many of the crystal sets covered in Volume 1. Detailed history on the Philmore Manufacturing Company and the Western Manufacturing Company. 8 1/2" x 11", 252 pages.

\$29.95 – Softcover



U.S. Orders - Enclose \$3.00 per order for packing & book-rate shipping if total order is under \$35.00. If using VISA or MasterCard, include name on card, card number and expiration date. Send payment with order. Mass. residents add 5% sales tax. Money back return policy. Softcover unless stated otherwise. Most orders shipped the same day received, but allow 2-4 weeks to receive order. Foreign orders - write for shipping costs, or use credit card and specify air or surface (allow 2-3 months for surface shipping).



A.R.C., P.O. Box 2, Carlisle, MA 01741. Tel: (508) 371-0512

Fax: (508) 371-7129

Web: <http://www.antiqueradio.com/>



(Oct-96)

COLLECTOR BOOKS AVAILABLE FROM A.R.C.

☞ BOOKS MARKED WITH "☞" ARE THE MOST POPULAR AND ARE ESPECIALLY RECOMMENDED FOR NEW COLLECTORS!

- Antique Radio Restoration Guide**, 2nd Ed., Johnson. *Beginner's introduction to troubleshooting and repairing AC table model radios.* 1992. 145 pgs. \$14.95
- The AWA Review**. Collections of articles. Vol. 6: Hawaiian Wireless, U.K. TV, SCR-RC-BC Dir., NYC Wireless, etc. Vol. 7: Poldhu xmitters, Navy equipment, Arc xmitters, etc. Vol. 8: Keys, Federal Co., KFS-Federal-Mackay story, Nat'l Electrical Supply Co., Navy Electronics Dir., etc. Vol. 6-8, ea. \$10.00
- Vol. 9: Marconi, The Int'l Contest for Radar, Magnetron Story, F. Lowenstein, Ham Licensing.** Vol. 10: Atwater Kent, Race for Radiotelephone, Radio Central 75th Anniversary, The Heintz and Kaufman Story, Collins Radio Co. ... Vol. 9-10, ea. \$19.00
- The Antique Radio Boys and the Garrulous Grebe**, Dryer. *Thrilling adventure story written in the traditions of the '20s and '30s. 5 1/2" by 8 1/2".* 51 pgs. \$4.95
- The Auto Radio**, Matteson. *Info, photos & ads of the auto radio through the 1950s.* 316 pgs. (hardcover) \$34.95
- Audio! Audio!**, Hill. *A comprehensive directory of classic audio amplifiers and control units. Details of over 850 models from nearly 150 British manufacturers from the 1940s to the 1970s. Signed and numbered.* 95 pgs. \$19.95
- Behind the Front Panel**, Rutland. *Reviews radio circuits and radio history. Easy descriptions.* 25 pics. 158 pgs. \$18.95
- Blast from the Past, A Pictorial History of Radio's First 75 Years**, Rhoades. *The performers, programs, & technology that made radio a part of everyday life. 100s of never-before-published photos.* (hardcover) \$39.95
- Broadcasting's Forgotten Father: The Charles Herrold Story**, Adams. (Videotape, VHS). *One-hour documentary on this amazing inventor. Featuring his family, students, and photos to document his work.* \$29.95
- ☞ **The Collector's Guide to Antique Radios**, 4th Ed., Bunis. *This guide covers radios from 1920s to 1960s. Over 8,500 prices and many all new color photos are included.* 1996. (Shipping Now!) **NEW \$18.95**
- The Collector's Guide to Novelty Radios**, Bunis & Breed. *The source for novelty transistor radios. Full descriptions with current prices.* Over 600 color photos. 1994. 224 pgs. \$18.95
- The Collector's Guide to Transistor Radios**, 2nd Ed., Bunis. *Identifies the most sought-after vintage transistor radios. Includes club listing.* Over 2,900 models, 375 all new color photos, with current prices. 1996. 320 pgs. \$16.95
- Communication Receivers**, 3rd Ed., Moore. *Information on 738, 1932 to 1981, vacuum tube receivers by 66 manufacturers. 402 radios illustrated. New section: 3 pages of military receivers.* 125 pgs. \$19.95
- The Compleat Talking Machine**, 2nd Ed, Reiss. *A guide to antique phonographs. Revised and expanded. Covers construction, cleaning and repairing of parts and cabinets.* Over 700 pictures. 256 pages. **NEW \$29.95**
- Crystal Clear - Vintage American Crystal Sets, Crystal Detectors and Crystals, Sievers.**
 Vol. 1 - *Comprehensive reference with 750 illustrations, 570 crystal sets, 341 detectors, 207 crystals.* 282 pgs. \$29.95
 Vol. 2 - *479 All new & different illustrations, more crystal sets, detectors and crystals identified.* 252 pgs. \$29.95
- Crystal Radio: History, Fundamentals, and Design**, Kinzie. *Plus crystals for detectors.* 121 pgs. **NEW \$10.95**
- E.H. Scott Radio Collectors Guide**, 1925-1946, Clark. *The reference for collectors of Scott radios, cabinets and accessories. Lists original prices of cabinets and accessories.* Over 200 photos with descriptions. 88 pgs. \$29.95
- Early Radio, In Marconi's Footsteps**, Jensen. *Realistic description of Marconi's work and his surroundings. Early construction projects with diagrams. Color and B&W photographs.* 170 pgs. (hardcover only) \$39.95
- Empire of the Air**, Lewis. *Biographical radio history on De Forest, Armstrong and Sarnoff.* 1991, 421 pgs. \$13.00
- Evolution of the Radio, L-W Books.** *Radios pictured and priced, plus reproductions of catalog pages and ads.*
 Vol. 1 - *Eight-hundred + radios.* 1991. 227 pgs., 118 pgs. in color. \$22.95
 Vol. 2 - *Totally different from volume one with new photos, etc.* 1993. 654 color photos. 226 pgs. \$24.95
- Firco Radio Equipment, John Firth & Co., Inc. (reprint).** *Twenty-six-page booklet of the Firth Co.* \$4.95
- Fixing Up Nice Old Radios**, Romney. *Written by a retired radio instructor, this book covers Ohm's law, through battery sets, superhets and communications receivers.* 1990. 300+ figures, 185 pgs. \$25.00
- ☞ **Flick of the Switch**, McMahon. *The classic photo reference guide for '30s - '50s radios. 1000+ photos.* 263 pgs. \$11.95
- Great Radio Personalities (reprint).** *B&W pics of the golden days of radio - Abbott & Costello, etc.* 128 pgs. \$11.95
- ☞ **Guide to Old Radios - Pointers, Pictures & Prices**, 2nd Ed., Johnson. *Introduction to radio collecting. Includes hundreds of photos and a price guide.* 1995. 272 pgs. \$19.95
- Hake's Guide to TV Collectibles.** *Price guide and photos for 1600 TV shows, comic books, etc.* 1990. 185 pgs. \$14.95
- Ham Price Guide**, Rippen. *This book serves as a price guide and an identification guide. Small print.* 36 pgs. \$9.95
- Heathkit, A Guide to the Amateur Radio Products**, Penson. *Documentation of all Heathkit's amateur radio products, a complete history of the company, 200+ sharp photos.* 256 pgs. \$24.95
- Hertz: The Beginning of Microwaves**, Bryant. *Photos and descriptions of Hertz's apparatus and experiments.* 50 pgs. \$15.00
- International Directory of Antique Radio Collectors.** *Listing of collectors, clubs, museums, dealers.* 1996. 92 pgs. \$14.95
- Inventing American Broadcasting**, Douglas. *A careful weaving of technology, social forces, and business decision making from the days of Marconi to broadcasting in the 1920s.* 1987. 363 pgs. \$14.95
- L. A. Radio Manufacturing**, Paul. *Radio makers in L.A. from 1922-42. Echophone, Gilfillan & 10 others.* 88 pgs. \$10.50
- Supplement No. 1, Paul.** *Coverage of additional manufacturers, people and sets.* 1993. 48 pgs. \$6.75
- The Mechanics of TV**, Yanczer. *Explanation of mechanical tv, details for a working system. 5 1/4" by 7 1/2", 170 pgs.* \$24.95
- Most Often Needed 1926-38 Radio Diagrams and Servicing Information (reprint).** *600+ diagrams for mostly AC radios from '26-'38.* 240 pgs. \$18.50
- Old Gramophones**, Bergonzi. *The development of phonographs and gramophones.* 64 photos. 32 pgs. \$4.95
- Old Radio Sets**, Hill. *The development of the radio from the late Victorian era until the late 60s.* 60 photos 32 pgs. \$4.95
- Old-Time Radios! Restoration and Repair**, Carr. *How to repair vacuum-tube and transistor radios. A self-paced training guide.* 200 illustrations, 256 pgs. \$18.95
- Philco Radio: 1928-1942**, Ramirez. *A reference book on Philco. Shows receivers and company history year-by-year.* 464 color photos, 364 black & white photos and drawings. 1993. 160 pgs. \$29.95
- Phono-Graphics: The Visual Paraphernalia of the Talking Machine**, Schwartzman. *Shows the collection of products associated with the phonograph. Beautiful photos from Art Nouveau to Art Deco era.* 1996. 119 pgs. **NEW \$16.95**
- The Pocket Guide to Collins Amateur Radio Equipment 1946-1980**, Miller. *A pictorial guide to Collins equipment and accessories.* 90+ sharp photographs. 3 1/2" x 7". 108 pages. \$19.95
- Portable Radio In American Life**, Schuffer. *Traces the development of the portable radio and how it affected American culture and society.* 450 photos and drawings, 259 pgs. (hardcover: \$45.00) \$24.95
- Price Guide to Plastic Collectibles**, McNulty. *Describes types of plastics, etc. (Radio is 8 of 207 pgs.)* \$17.95
- RCA Radiolas, Radiotrons, and Accessories (reprint).** *Twenty-page booklet summarizing RCA's 1926 product line including the Radiola III, 20, 25, 26, 28, etc.* \$4.50
- Radio Art**, Hawes. *A chronological, illustrated history of the technical and stylistic progress of the radio. Mostly British, but American sets are featured as well.* 250 photos, 150 in color, 128 pgs. (hardcover only) Low Price \$9.95
- Radio Art Postcard Deck.** *30 full-color photographs from Hawes' book.* \$7.50
- Radio Collector.** (Videotape, VHS). *The five-part Emmy-nominated PBS series combined on one 130-minute videotape. Meet collectors, see collections, attend swap meets, learn about radio restoration.* \$29.95

COLLECTOR BOOKS AVAILABLE FROM A.R.C.

BOOKS MARKED WITH "E" ARE THE MOST POPULAR AND ARE ESPECIALLY RECOMMENDED FOR NEW COLLECTORS!

- The Radio Collector's Directory and Price Guide, 1921-1965, 2nd Ed.,** Grinder. *Directory of over 20,000 radios by manufacturer, model number, year, etc., with prices. Radio history, cabinet styles, vacuum tube development chapters. Over 1,200 trade names listed. Thoroughly revised and expanded. 500 pgs.* \$26.95
- Radio Collector's Guide, McMahon.** *Listing of 9,000+ radios made by some 1200 companies from 1921 to 1932. Gives manufacturer, year, model name and other info. No photos, 264 pgs.* \$11.95
- The Radio Collector's Guide to Philco Bakelite Block Condensers, 2nd Ed., Bintliff.** *A detailed description of Philco Bakelite block condensers with illustrations and parts lists. 1995. 57 pgs.* \$9.95
- Radio Craft - 50 Years of Radio (reprint).** *March 1938 issue of Radio Craft magazine. Numerous articles on the development of radio, then 50-year old, and on early radio pioneers. 144 pgs.* \$15.95
- Radio Diagram Sourcebook, Gray.** *Valuable tool for identifying radios. Tubes used, replacement dial lamps, and I.F. frequency. Reprint of Sylvania's tube complement guide is included listing almost 10,000 radios. 290 pgs.* **NEW \$18.95**
- Radio Equip. & Supplies, (reprint).** *1922 radio catalog, accessories, etc. RCA, Clapp-Eastham, etc. 168 pgs.* \$19.95
- Radio-The Golden Age, Collins.** *Full-color book on the colorful Catalin and Bakelite radios from the late 1930s to the early 1940s. 128 pgs.* (hardcover \$29.95) \$17.95
- Radio Horn Speaker Encyclopedia, Paul.** *Listing of horn speakers for over 320 manufacturers for the 1920s. Expanded information on ten manufacturers. Over 145 photos, 80 pgs.* \$14.90
- Radio Horn Speaker Notebook, Rev. H, Paul.** *The companion to the Encyclopedia. Over 450 horn picture ads are shown, over 325 manufacturers are identified. Photocopy. New Index. 1995. 72 pgs.* \$15.90
- Radio Manufacturers of the 1920's, Douglas.** *Three comprehensive volumes.*
- Vol. 1 covers A-C Dayton thru Ferguson. 225 pgs.* (softcover only) \$24.95
- Vol. 2 covers Freed-Eismann thru Priess. 266 pgs.* (softcover only) \$29.95
- Vol. 3 covers RCA thru Zenith. 292 pgs.* (hardcover: \$39.95) \$29.95
- Radio Poster, Sonoran Publishing.** *Color 20" x 26". A radio timeline. 20 radios from the Pup to transistors.* \$10.95
- Radio! Radiol, 2nd Ed., Hill.** *Revised easy-to-read subject index, separate A-Z directory listing of 1,000 + British radio models with clearer photographs than first edition. 978 photos, 244 pgs.* (hardcover only) \$44.95
- Radio Redux, Collins.** *Subtitled "Listening in Style." This book showcases the sleek lines and luscious colors of over 80 gleaming sets from the collection of Philip Collins. 120 pgs.* (hardcover: \$29.95) \$17.95
- Radio/TV Finder, Okolowicz.** *Reference to nearly 7,000 radio and TV pics found in 24 books. No photos, 110 pgs.* \$13.95
- Radio & T.V. Collector's Guide Book, Biraud.** *The "Vintage Radio" illustrated guide to European sets from early wireless to the 1930s (a few later). Text is in both French and English. Vol. 1: History & Manufacturers A to P. 256 pgs.* \$49.95
- Vol. 2: P to Z & T.V., Speakers, Tubes, Loops, Parts & Novelties. 256 pgs.* (Per Volume) \$49.95
- Radios by Hallicrafters, Dachis.** *The most definitive book on the company. Over 600 photos (some color) on everything they made. An invaluable tool for anyone interested in Hallicrafters. 220 pgs.* \$29.95
- Radios of the Baby Boom Era. Pictures and info from Sams Photofacts.** *3,494 radios illustrated plus 3,275 additional radios listed. 274 brands. 1946 thru 1960. Six volumes, 300+ pages per volume. Order by volume: Vol. 1: Admiral - Clearsonic. Vol 2: Co-op - Gelsco. Vol 3: GE - Monitoradio. Vol 4: Motorola - RCA. Vol 5: Realtone - Stratotux. Vol 6: Stromberg-Carlson - Zenith.* (Per Volume) \$16.95
- Refinishing Old Furniture, Wagoner.** *Written by a furniture restoration instructor. A step-by-step guide to furniture (or radio) restoration, from removal of finishes right up to the final polish. 178 pgs.* \$14.95
- Saga of the Vacuum Tube, Tyne.** *The development of vacuum tubes - 1880 to 1930. From Edison, Thomson and Fleming to de Forest, Philips, Siemens and many more. 100+ tube photos, 495 pgs.* \$18.95
- Sound & Vision Yearbook 1995/96.** *An annual directory of radio & TV collectors, primarily European* \$6.95
- Syntax and Spark, Aiken (reprint).** *Subtitled "The Origins of Radio." Describes the development of radio from Maxwell's work in the 1860s through the contributions of Hertz, Lodge and Marconi. 1976. 347 pgs.* \$16.95
- S. Gernsback Radio Encyclopedia (reprint).** *1927 classic encyclopedia on radio. From "A" B 2 Yery to Zirconium, with 1000s of entries in between. 100s of illustrations, 175 pgs.* \$9.95
- 70 Years of Radio Tubes and Valves, Stokes.** *The story of the radio tube from the lab to the public. 247 pgs.* \$25.95
- 75 Years of WE Tube Manufacturing, Magers.** *A log book history 750+ WE tubes. Illustrated. 133 pgs.* \$16.95
- Tomart's Price Guide to Radio Premium and Cereal Box Collectibles, Tumbusch.** *Includes comic character, pulp hero, TV and other premiums. 1991, 3,000+ illustrations, 176 pgs.* \$22.95
- Transistor Radios, A Collector's Encyclopedia and Price Guide, Lane.** *Identification guide to over 2,500 transistor and novelty radios. History and key to collecting chapters. 1994. 170 pgs.* \$19.95
- Transmitters, Exciters and Power Amplifiers 1930 - 1980, Moore.** *Pictorial and descriptive guide to amateur high frequency transmitters and amplifiers manufactured in the U.S.A. Over 500 photos. 144 pgs.* \$21.95
- Tube Type Transmitters, Rippen.** *Provides a wealth of information on transmitters and transceivers. Includes ancillary items such as linear amplifiers, converters, modulators and VFOs. Over 500 illustrations. 145 pgs.* \$17.95
- Vintage Radio, McMahon.** *Photo reference guide of radios before 1930. 1000+ pics, 263 pgs.* (Temp. Out-Of-Print) \$11.95
- The Weekend Refinisher, Johnson.** *A complete guide to stains and finishes and tips for setting up your own workshop. A handy furniture "first aid" kit for quick repairs. Illustrated. 296 pgs.* \$10.00
- Westinghouse Catalog (reprint).** *1920s catalog of the RA-DA and other early Westinghouse equipment. 8 pgs.* \$4.00
- Wireless Communication in the U.S., Mayes.** *Early development of American radio operating companies. Alternators, coherers, stock promotions, unpublished letters, etc. 160 illustrations, 240 pgs.* \$29.95
- The Xtal Set Society Newsletter, Anderson.** *Complete set of the Society's newsletter. Order by volume. Vol. 1: 7/91 to 5/92 - Field Strength Meter, FM Xtal Set, Xtal Sets & Wireless, & more. Vol. 2: 7/92 to 5/93 - The Lead Pencil Detector, The Universal Xtal Set, etc. Vol. 4: 1/94 to 11/94 - Measuring Coil Capacitance, home-brew headphones and curve tracer, etc. Vol. 5: AM Receiver Design, Marconi Type 107, Radio Outfit in a Headset, & more* (Per Vol.) \$9.95
- The Xtal Set Handbook, Anderson.** *Formulas for coil inductance, a procedure for measuring coil capacitance, circuit matching theory, & more. Also included is Vol. 3 of the Xtal Set Society Newsletter.* \$10.95
- Zenith Radio Corporation (reprint).** *The instructions for installation and operation for Models 39-39A Models 392-392A, and Electric Zenith Receivers. 3 schematics, 3 photos, 7 1/2" by 5", 16 pgs.* \$4.50
- The Zenith Trans-Oceanic: The Royalty of Radios, Bryant and Cones.** *Presents the fascinating story of the development and use of the Trans-Oceanic. Several photos, documents, ads, etc. 160 pgs.* \$24.95

U.S. Orders - Enclose \$3.00 per order for packing & book-rate shipping if total order is under \$35.00. If using VISA or MasterCard, include name on card, card number and expiration date. Send payment with order. Mass. residents add 5% sales tax. Money back return policy. Softcover unless stated otherwise. Most orders shipped the same day received, but allow 2-4 weeks to receive order. Foreign orders - write for shipping costs, or use credit card and specify air or surface (allow 2-3 months for surface shipping).



A.R.C., P.O. Box 2, Carlisle, MA 01741. Tel: (508) 371-0512
Fax: (508) 371-7129 **Web: <http://www.antiqueradio.com/>**





P.O. Box 1883 S. Hack., NJ 07606 hposter@worldnet.att.net 24 Hr Phone: 201.794.9606 24 Hr FAX: 201.794.9553

WOW! A **TRANSISTOR NEWSLETTER** is out, with stories and photos. Get your **FREE** Dec '96 issue—send in your **FREE** ad with **FREE** photo. Please call (970)221-4001, or E-mail your ad with jpeg/gif/tiff to: wireless@bamboo.verinet.com

TUBES...we've got 'em...cheap!

01A's. Globe type RCA's and other makers. Good filaments. 4 boxed + 2 loose. 6-01A's...\$75

01A, gold ST type. Good emmission...\$18

26's. These are good, tested 15 ST plus 5 globe. Good type 26/226/326, etc. 20 tubes...\$65

42's. These are good, tested 10 ST plus 1 globe. 11 tubes...\$31

71A's. These are good, tested ST's...3 for \$22
Globe type 171A. Tested...6 for \$94

80's. These are ST type, all tested good, used tubes. Type 80's...12 ST's...\$42

Globe type 80/280. Tested good-6 for \$91

199's. A boxed Radiotron UV-199 plus 2 new, boxed RCA/Cunningham X99...All good filaments...all 3 good tubes...\$44

2 UV-199's +1 UX-199. 3 Duds...\$22

245's. These are good, tested globe Type 45's. Priced at: Type 245...3 for \$86

865's. These are new boxed, VT-55's, military from DuMont and RCA. Large ST type, 4 pin with plate cap. 6.3V filaments. All 100...\$25

Arcturus BLUE. Globes: 3 #124's, #551, #126, PZ big globe; ST: #55 & #59. 8 blue tubes...\$103

5U4-GB. New boxed rectifiers. USA makers, RCA, etc. Priced at 7 for \$30

5U4GA (Raytheon)... New, boxed...6 for \$25

5V4GA (GE)...New, boxed...2 for \$9

EL37 Mullard. Boxed, tested pair. 2 for \$51

HAM Stuff: 931A, pair...2 for \$20

203A pair...2 for \$40 211 pair...2 for \$45

217C...1 for \$18 872A...5 for \$90

Taylor 866 (two) plus Taylor 756...3 as is...\$14

801 plus 802, tested good. Pair...\$40

807, tested good...4 for \$20

809, boxed and tested good...\$15

4, 5, and 6 pin. (No octals/no loctals) These are new and used, untested, ST and Globe types. Double digit #24A, 27, 31, 35, 36, 37, 41, 43, 44, 55, 56, 75, 76, 77, 81, 89, etc, etc! 80 tubes...\$80

500 tubes: octal, loctal, etc. Mostly boxed radio tubes from the '30s&'40s. 500 tubes...\$94

FOR SALE: General Electric Sign—8½" x 11"

This 1950s blue and white screened metal sign proclaims "GE...Aluminized tubes..." The back is a mirror. It mounts on a small tripod. Great counter top display! General Electric sign-\$37

FOR SALE: Quack Medical Device (For your cat or dog!)

We've seen Quack devices, but this 7" wide by 5" high oak box has an **Animal Electropoise** from 1891. With several attachments. And it looks great...Uniquel \$135

FOR SALE: Philco Mystery control.

This wooden box has a celluloid telephone type dial, and uses gears and magnetic vanes to dial your console radio—one of the first wireless remote controls! Exc...\$67

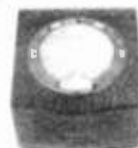

FOR SALE: 8-Track tapes. We just bought a small pile of new, sealed 8-tracks. Assorted sounds-test and use that 8-track you found, or wind down those car windows and let the music play! From the 1970's & 80's, 45 new tapes...\$24

FOR SALE: Western Union Telegraph Set!

This blue and white painted tin child's toy consists of two morse-code keys with flashing bulb, and "International Code" printed on top. Both are in a leatherette case. Some rusting on bright metal surfaces, but very nice condition...\$46



FOR SALE: Orange Sony TV-5111 This unusual TV allows the CRT to spin, so you can use it flat or tall. Plus, this set is orange plastic, trimmed in black. A very unusual, working Sony...\$210

REWARD: \$400

Zenith Radio Nurse wanted! I'm always buying these brown bakelite intercoms, working or not. I like them mint, but I will also buy parts sets.

Uncracked, paying...\$400 each!

CLASSIFIED ADVERTISING POLICY

ONE FREE 20-WORD AD for subscribers in each issue; additional words are 25¢ each. See details below. Classified ads sent by mail, fax or by any other method must be received (not just postmarked!) by Noon Eastern Time on the classified ad deadline date to guarantee inclusion in the current issue. Late ads are held for the following issue. Please enclose correct payment with all ads. Stamps or cash are OK for small amounts. (Canadian and other foreign advertisers, please see "Payment" on page 2 for methods.) "Free words" cannot be accumulated from month to month; free words must be requested when ad is submitted.

Faxed & e-mailed ads: Please see additional information on the inside front cover.

When including ads with other A.R.C. correspondence, write the ads on a separate piece of paper. Include SUB# with ad. Ads may be sent in advance; but, write each ad on a separate piece of paper and indicate the month (or successive two months) you want the ad to run.

To minimize our typing errors: **Please write legibly.** Use both capital and small letters. Do not use a dash between words. Carefully write the following numbers and letters (especially in model numbers) since some can look alike; for example 1, l and I (the number one, the capital i and the small L.) Also: 0, O, o, Q and D; r and n; 6, b and G; V, U, u, v and Y; A and R; 5, S and 8; 2, Z and z. We try to correct spelling errors, so when using an uncommon word or manufacturer which we might mistake as a more common word or manufacturer, note it so that we do not "correct" it. Editor's annotations are in [brackets].

Advertising is accepted only for early items related to radio, communication, etc. All items must be described fairly; reproductions, reprints and not-original items must be so identified. Advertisers must agree to respond promptly to inquiries and orders, to resolve problems promptly if the buyer is not satisfied, and to comply with a buyer's refund request on unaltered returned items.

The publisher reserves the right to edit ads without notification to the advertiser and to reject ads for any reason. Names other than the advertiser will be edited out of ads. Ads with non-radio-related items will be returned or edited unless the non-radio-related items are for trade of radio-related items, or they are incidental to and appear at the end of an otherwise acceptable ad. The publisher is not responsible for errors due to illegibly written ads or for any other reason.

Clubs: Since club activities receive free coverage on the *Coming Radio Events* pages, the free 20 words may not be used for club activity ads. See inside front cover for additional information.

CLASSIFIED AD DETAILS

Deadline: NOON ET— 10th of the month!

Classified ads must have a standard heading such as WANTED, FOR SALE, FOR TRADE, FOR SALE/TRADE, SERVICES, MESSAGE, HELP, AUCTION, MEET, etc. This heading is the only bold or all-capitalized words allowed in the ad. Capitalize only manufacturer names, model names, etc. This standard ad format makes scanning the ads easier.

Before writing your ad, please look over the ads in a recent issue of A.R.C., and try to write your ad in the same style. Full name (or company name) and address is required in all classified ads; we will add it if you forget.

To encourage varied content of the ads, the same classified ad may be run only once per issue and for only two consecutive months. (To run an ad longer, use a boxed classified or display ad.)

Classified Ad Rates per Month

Subscribers:

First 20 words: **FREE***

25¢ per word for extra words over 20 plus

10¢ per word for a shaded ad (count all words including free words).

* Subscribers may take 20 free words on only one ad each month.

Non-Subscribers:

41¢ per word plus

10¢ per word for shaded ad.

Please do not forget to send in the extra 25¢ per word when your classified ad runs over the free 20 words; your payment will be appreciated, and it will help to keep A.R.C. healthy.

BOXED CLASSIFIED AD DETAILS

Deadline: 1st of the month!

Boxed classified ads can run unchanged for three months or more. No words are free. Ads may be shaded and may include bold and all-capitalized words freely. The ad need not begin with "For Sale," etc. Minimum run is 3 months, prepaid. Discount: 10% for 6 months; 20% for 12 months.

Boxed Classified Ad Rates per Month

Nonshaded ads:

36¢ per word for all words,* none free, plus

10¢ per word for each bold word plus

10¢ per word for each all-caps word.

Shaded Ads (All words are bold at no charge):

45¢ per word for all words* plus

10¢ per word for each all-caps word.

Non-Subscribers:

Add 20¢ per word to above costs.

*Three words can be bold-all-caps at no extra charge.

PHOTO & DRAWING DETAILS

Deadline: 1st of the month

for all ads with drawings or photos!

Drawings and photos are encouraged as the response to your ad is much larger and the reader knows better what you want or are selling. Send in your drawing or photograph, and A.R.C. will reduce it or enlarge it as needed.

Photo and Drawing Rates per Month

\$20.00 per month for each photo or drawing

(If ad is canceled, this amount cannot always be refunded.)

CHANGES & CANCELLATIONS

Please check your ads carefully before sending them in. Once ads are received, it is not always possible to refund the amount sent, pull the ad or make changes.

IMPORTANT — COUNTING WORDS — IMPORTANT

The standard headings: WANTED, FOR SALE, etc., count as one word each time used in an ad. Name, address and (one) telephone number, count as 6 words, regardless of length. Ham call letters and business name can be included in the 6 words and do not count extra. Full name (or company name) and address is required in all classified ads. Each additional word, abbreviation, model number or number group, extra telephone numbers, fax, e-mail, etc. count as one word each. Hyphenated words count as two words.

PERIODICALS



ANTIQUE RADIO CLASSIFIED



A.R.C., P.O. Box 2, CARLISLE, MA 01741

RETURN POSTAGE GUARANTEED

**CLASSIFIED AD
DEADLINE DEC. 10th
Noon Eastern Time**