



VOLUME 13

APRIL 1996

NUMBER 4



RCA RADIOLA IV

A.R.C. — THE NATIONAL PUBLICATION FOR BUYERS AND SELLERS
OF OLD RADIOS AND RELATED ITEMS — PUBLISHED MONTHLY

ANTIQUE RADIO CLASSIFIED

Antique Radio Classified (ISSN:8750-7471) is published monthly, 12 times per year, by John V. Terrey, One River Road, P.O. Box 2, Carlisle, MA 01741. Second-class postage paid at Carlisle, MA, and additional mailing offices. Telephone: (508) 371-0512, 8:30 AM to 6:00 PM ET weekdays; machine answers phone at other times.

Annual subscription rates within the U.S. are \$36.95 by Second Class mail and \$53.95 by First Class mail.

Annual foreign rates. By air: Canada - \$58.00; Mexico - \$64.00; Other foreign countries - \$100.00. Surface mail: Canada - \$47.00; Other foreign countries - \$52.00. (Surface delivery to countries other than Canada may take two or more months and cannot be guaranteed.)

Two-year subscriptions are twice these rates and receive an extra month. Sample issues are available free on request.

© Copyright 1996 by John V. Terrey.

POSTMASTER: Send address changes to Antique Radio Classified, P.O. Box 2, Carlisle, MA 01741.

Printed in U.S.A.

STAFF:

Publisher and Editor: John V. Terrey
Production Manager: Scott J. Young
Office Manager: Lisa A. Friedrichs
Advertising Manager: Cindie P. Bryan
Managing Editor: Dorothy Schechter
Radio Events Editor: Chris Frederickson
Publishing & Editorial Staff: Ray Bintliff, Dave Crocker, Dick Desjarlais, Bobby Lyman, Jean Meldonian
Founding Publisher/Editor: Gary B. Schneider
Contributing Writers: Mike Adams, Richard L. Arnold, Ray Bintliff, Ron Boucher, Paul J. Bourbin, Norman S. Braithwaite, Dave Crocker, Alan S. Douglas, Richard C. Foster, Fred Geer, Jim Kreuzer, Ron Ramirez, Henry Rogers, Ian L. Sanders, Gary B. Schneider, Daniel Schoo, Dwane Stevens, Frank R. White, Ralph Williams

PURPOSE. Antique Radio Classified is published for people involved in the radio collecting hobby. Its purpose is to stimulate growth of the hobby through the buying, selling and trading of radios and related items, and to provide a monthly forum for the interchange of ideas and information.

CONTACTING ANTIQUE RADIO CLASSIFIED. All correspondence should be sent to:

A.R.C., P.O. Box 2, Carlisle, MA 01741.

Only UPS, Federal, etc. items to street address: One River Road.

Telephone: (508) 371-0512; Fax: (508) 371-7129

E-mail: ARCMagazine@aol.com — Web: www.antiqueradio.com

Please, no classified ads by telephone; thank.

Your ads, renewals, letters, etc. can be handled faster and more efficiently if your name, address and SUB# are written on each.

Unfortunately, A.R.C. is not staffed to answer letters with questions about antique radios or requests for advice. However, A.R.C. does solicit letters of interest to its readers and publishes them as space permits. A.R.C. assumes that permission is given to edit and to publish all correspondence and articles received unless otherwise indicated.

GUARANTEE. You may cancel your subscription at any time and receive a pro rata refund for issues not yet mailed. If errors to ads are made by A.R.C., upon request a free correction will be run in the next available issue.

PAYMENT. Please send in full payment with your order or ad. A.R.C. does not carry accounts: all subscriptions, ads, etc. must be prepaid (except for the 6 and 12 month display ads indicated below). Pay in U.S. funds. Checks drawn on a U.S. bank, money orders, VISA or MasterCard (\$10.00 min.) are preferred. Make check out to "A.R.C." U.S. stamps or cash are OK for small amounts. Canadian payers may send a Canadian check but specify U.S. funds. Subscriptions will be prorated to amount sent if amount is incorrect.

FAX & E-MAIL PROCEDURES/PAYMENT. Subscriptions, book orders, classified ads, display ads, etc. are welcome by fax or e-mail. Deadlines are the same as for ads received by mail. Please calculate the amount due. Payment by VISA or MasterCard is preferred if your order is over \$10. If under \$10, or if you prefer to send a check or money order, state the amount being sent and that the payment is in the mail. Do not send another copy of your ad with your payment; simply indicate that it is a fax or e-mail payment. If you want confirmation of our receipt of your fax, call immediately after sending your fax.

CHANGE OF ADDRESS. Please notify us 4 weeks in advance of a change of address. Send both your new and old addresses, and include your SUB# and effective date of your new address. Temporary address changes can be made also.

SUBMISSION OF MATERIAL. Antique Radio Classified welcomes and solicits information that pertains or relates to radio history or collecting. This may include articles, book reviews, photos, information on upcoming radio events, meetings, antique radio organizations, radio auctions, sources of old radio and restoration supplies, and other related and interesting material. All material submitted should be carefully researched, typed and accompanied by good photos, if appropriate. Computer disks are appreciated. Writing guidelines are available upon request. Unless prior arrangements are made, all submitted materials may be edited, become the property of Antique Radio Classified and will not be returned. Publication is subject to approval by A.R.C. and to time and space constraints.

MAILING OF ISSUES. U.S. subscribers can receive A.R.C. by First or Second Class mail (Second Class is the way most magazines are mailed). The mailing of First Class copies is staggered over one to four days with faraway copies mailed before local copies. Non-U.S. copies are mailed on the first day. Second Class copies are mailed on the last day. Mailing dates change each month, but mailing is usually completed by the 27th of the month. First Class copies usually are received by the 5th of the month; copies by Second Class mail, by the 10th.

ETHICS. No person involved in the production of A.R.C. is to act on any information in the magazine until the first delivery day after local copies are mailed.

DISCLAIMER. The publisher is not responsible for any buying and selling transactions incurred, or for any other use of the contents of this publication.

Antique Radio Classified subscription rates, frequency of publication, content, policies, size and ad details, and rates are subject to change at any time by A.R.C.

DISPLAY AND BUSINESS CARD ADS - DETAILS AND RATES

The deadline is the first of the month for display and business card ad artwork, payment and repeat requests.

Advertising is accepted only for early items related to radio, communication, etc. All items must be described fairly; reproductions, reprints and non-original items must be so identified. Advertisers must agree to respond promptly to inquiries and orders, to resolve problems promptly if the buyer is not satisfied, and to comply with a buyer's refund request on unaltered returned items.

Advertising must be prepaid, except as noted below: see "Payment" paragraph above for details. Late ads will be run only if space and time permit. Since artwork is reduced to 63% in the printing process, originals must be the artwork size listed below. Do not send in artwork on art board or send negatives. Ads should be typeset or typed neatly with a carbon ribbon, black ink (not pencil) on white. If used, reverse type must be limited to 25% of the ad. If you want us to prepare your ad, include the one-time cost below for A.R.C. to make up the ad.

Photos should be at an 85-line screen; otherwise, add \$14.00 per photo for screening. Do not cut or trim photos or glue photos to artwork; submit separately.

If you are confused by these requirements and terms, please

contact A.R.C. before beginning to prepare your ad. We will be happy to advise you on your ad ideas, estimate how much the ad will cost, recommend an ad size, etc.

We assume that advertisers want all ads which are submitted to run without delay; therefore, we will run the ad and bill for any additional work required for the ad to meet these specifications. A late ad will run beginning with the next month. "Tear sheets" will be sent only for 1/8-page or larger ads and only if requested when the ad is submitted.

First business card per advertiser is at lower rate.

The 3-month rates represent about an 11% discount, the 6-month rates 23%, the 12-month rates 30%. Placement requests: add 15% but call first. Clubs: write for discount policy.

Page	ARTWORK SIZE (SEND IN THIS SIZE)		As Printed (size in magazine)		Cost for 1-month	Cost for 2-months	Cost for 6-months	Cost for 12-months	One Time to make up Ad
	H x W (inches)	H x W (inches)	H x W (inches)	H x W (inches)					
Full	12 7/16 x 7 1/2	7 3/4 x 4 3/4	7 3/4 x 4 3/4	7 3/4 x 4 3/4	\$249.00	\$664.00	\$1149.00*	\$1999.00**	\$69.00†
1/2 H	5 1/4 x 7 1/2	3 5/16 x 4 3/4	3 5/16 x 4 3/4	3 5/16 x 4 3/4	126.00	336.00	582.00	1013.00**	35.00†
1/2 V	12 7/16 x 3 9/16	7 3/4 x 2 1/4	7 3/4 x 2 1/4	7 3/4 x 2 1/4	126.00	336.00	582.00	1013.00**	35.00†
1/4	5 1/4 x 3 9/16	3 5/16 x 2 1/4	3 5/16 x 2 1/4	3 5/16 x 2 1/4	64.00	170.00	295.00	514.00	18.00†
1/8	2 5/8 x 3 9/16	1 5/8 x 2 1/4	1 5/8 x 2 1/4	1 5/8 x 2 1/4	33.00	88.00	152.00	265.00	8.50†
Business Card (1st)	2 x 3 3/4	1 1/4 x 2 3/8	1 1/4 x 2 3/8	1 1/4 x 2 3/8	not avail.	45.00	78.00	136.00	6.50†
Business Card (2nd...)	2 x 3 3/4	1 1/4 x 2 3/8	1 1/4 x 2 3/8	1 1/4 x 2 3/8	not avail.	59.00	102.00	177.00	6.50†

* Full page, 6-mos.; ½ due with order; ½ due in 3 mos. ** Full & ½ page, 12-mos.; ¼ due with order, ¼ due at 3, 6 & 9 mos.

† For 6 and 12 month ads, no ad make-up charge if no change is made to ad for entire run.



EDITOR'S COMMENTS

Though March in New England came in like a lion, there's hope in the air for spring as we go to press. Perhaps spring fever accounts for the growth in the number of events and ads advertised in this issue. The happy result is a larger issue — eight more pages than usual — allowing sixteen contributed articles, as well as *Radio Miscellanea* letters and *Photo Review*.

Our lead article features the RCA Radiola IV receiver. William Boyd's detailed account of this mid-1920s, 3-tube set includes actual on-the-air listening test results. A.R.C. has supplemented Boyd's article with a couple of nuggets from your editor's collection — a Radiola IV brochure and the publicity photo on the cover.

The Edison crystal set, ca. 1923-24, is the subject of another of Ian Sanders' excellent articles on British crystal sets. Ian tells much about the history of Edison Swan, the manufacturer of the world's first valves in 1904 and their subsequent use by Marconi.

Harold Isenring, with his many years of Sears electronic service background, lets us in on the genesis of the name "Commentator" for the Sears Silvertone. Harold also describes several idiosyncrasies which plagued the performance of this set.

At the Houston Vintage Radio Association's Mega Auction, over 500 lots crossed the block, nearly one-half of them vacuum tubes. Proceeds of over \$12,000 included a top bid of \$475 for a Sentinel Catalin.

For *Radio Ramblings...*, Fred Geer writes in a nostalgic vein about a post-World War II console — the Philco Model 46-1209. Fred and his sister were introduced to DX-ing on its broadcast and shortwave bands.

We present six follow-ups this month, as extra space allowed us to catch up on your welcome feedback to articles, questions, and comments in previous issues.

Permeability tuning filled many of our 1994 pages, and new info on this subject continues to surface. Alan Douglas' article reveals that the choice of permeability tuning was primarily economic.

Home brew loop antennas are a Dwane Stevens special interest. He reminds us that, although a loop antenna may appear to be just several turns of wire on wooden sticks, a well designed loop, correctly matched to a receiver, results in improved set performance.

Dwayne's loop antenna concepts inspired Michael Godar to replace the rabbit ears on a modern television set with a loop antenna. Michael now manufactures and distributes the "Super Antenna."

Buford Chidester's information about a Symphonic Globe speaker with the correct and original driver provides several construction details of interest. Dick Desjarlais reports the comments of five readers on his miniature Pastime radio, shown on our May 1995 cover. The most significant point is that the circuit is a reflex circuit, not simply a TRF circuit.

Follow-ups on call letters tell how radio station formats have changed — WIBG (I Believe in God) and WBCN (Broadcast Amusement Network) are now rock stations. Perhaps most amusing is Iowa station WSUI,

which took its call letters from the familiar hog call.

Get your thinking caps on again. The second installment of Dave Crocker's "Radio Quiz" has an additional 42 questions, enough to drive you a little crazy.

The new Indiana Historical Radio Museum, housed in an historic, 1930s filling station, has over 400 radios on display. Our report indicates that the museum has hosted more than 7,000 visitors in less than a year.

As with so many items, an interesting story developed when Larry Babcock saw a Century code practice set at a radio meet. Although Century became a part of Federal in 1908, buzzers with the Century name are found on many early wireless receivers.

Photo Review this month shows sets from the 1920s to the 1960s and includes two farm radios designed for both 110-volt and 6-volt operation. Reader feedback continues with our regular *Radio Miscellanea* page.

Two book reviews are included this month — a 1919 Gilbert Radio Apparatus catalog reprint, reviewed by Jerry Finamore, and another of Eric Wrobbel's pamphlets on transistor radios, reviewed by Wally Worth.

New Books. Transistor radio collectors will be pleased to hear that the Bunises have released the second edition of their transistor radio price guide. As with the new editions of their other price guides, this one contains all new photos and additional models.

For years, Moore's book on communications receivers was the major reference for collectors of communication and amateur radio receivers. In March, Chuck Dachis released his superb, 225-page book on Hallicrafters equipment featuring over 1000 photographs. Only a few months ago, Chuck Penson's excellent book on Heathkit amateur radio products was released. A.R.C. carries the new Hallicrafters and Heathkit books.

The Eliminator. Although its history goes back to 1985, the radio collector parody *The Eliminator* has been included regularly in the April issue of A.R.C. since 1988. This year, *The Eliminator* editor decided to "eliminate" it from A.R.C. We are sorry to see it go, but if you would like to be kept up-to-date on the activities of the AC Radio Renegades, write to the A.C.R.R. at 3426 Coldstream Ct., Lexington, KY 40517.

Coming Radio Events. Spring is the setting for nearly four dozen events throughout the U. S. Look for A.R.C. in New Hampshire in April, at the Dayton Hamvention in May, and perhaps at the May National Vintage Communications Fair in Birmingham, England, and the July Extravaganza in Michigan. We hope to see you at one of these events, so stop by and say "Hi."

Happy Collecting

John V. Terrey, Editor

ON THE COVER

The happy faces on our cover are obviously intended to sell the RCA Model IV to more happy 1920s households. The photo is one of thirty in a salesman's portfolio from the collection of your editor. One of the pleasures of our job is to make unexpected connections between our files and articles contributed by our readers.



THE RADIOLA-IV

SINCE Radio Broadcasting came into being there has been a need among discriminating folk for a complete receiver, likely enough to grace any living room, and at the same time not occupying too much space. Radiola IV meets this demand so generously as to satisfy the most exacting tests of reproduction, and the cabinet will delight the eye on that wall table so little used.

Radiola IV is completely self contained, all batteries necessary to the operation of the dry cell tubes being housed in the same cabinet which holds the apparatus and the highly developed loud speaker.

The left hand door opens to reveal the operating controls, and the top, too, lifts readily, for making connections or changing about the tubes.

When the few simple adjustments have been made, the door may be closed entirely to conceal the apparatus, the broadcasted voice and music pouring through the grille door at the right which closes upon the outlet of the loud speaker.

Radiola IV consists of an efficient tuner in conjunction with a regenerative circuit, detector, two stages of audio amplification and loud speaker of distinctive design. It is provided with jacks for plugging in head telephones for the reception of very distant signals.

This instrument is furnished complete with all batteries, four tubes (one spare), a pair of sensitive head telephones with plug and silk covered wires for connection to antenna and ground.

Price \$275.00



FA-10135



An RCA Radiola IV handout brochure, ca 1925, from the John V. Terrey collection.

WITH THE COLLECTORS

The Classic RCA Radiola IV

BY WILLIAM M. BOYD

The January 1994 A.R.C. carried a cover photo and article on William Boyd's RCA Radiola I crystal set. With this article, he continues his series on RCA Radiola receivers, providing information on restoration of the Radiola IV audio transformers and a list of stations received on his set. (Editor)

"The Radiola IV is a complete dry cell-operated vacuum tube regenerative receiver and amplifier, including a self-contained loudspeaker," states the introductory paragraph of the 1923 Radiola IV manual. The Radiola IV was manufactured by the General Electric Company for the Radio Corporation of America, as noted in the logo shown in Figure 1. The radio sold for \$275 according to an advertisement in *Radio News*, March 1923.

The radio's mahogany-finished cabinet, shown in Figures 2 and 3, is a classic ornate design of superb workmanship. Figure 4 reveals a front view of the control panel with the left door open. In Figure 5, the control panel is removed. Note the driver and neck of the horn assembly in the left compartment, with the horn itself taking up the right compartment.

(Continued on following page)



Figure 1. The logo of the Radiola IV.

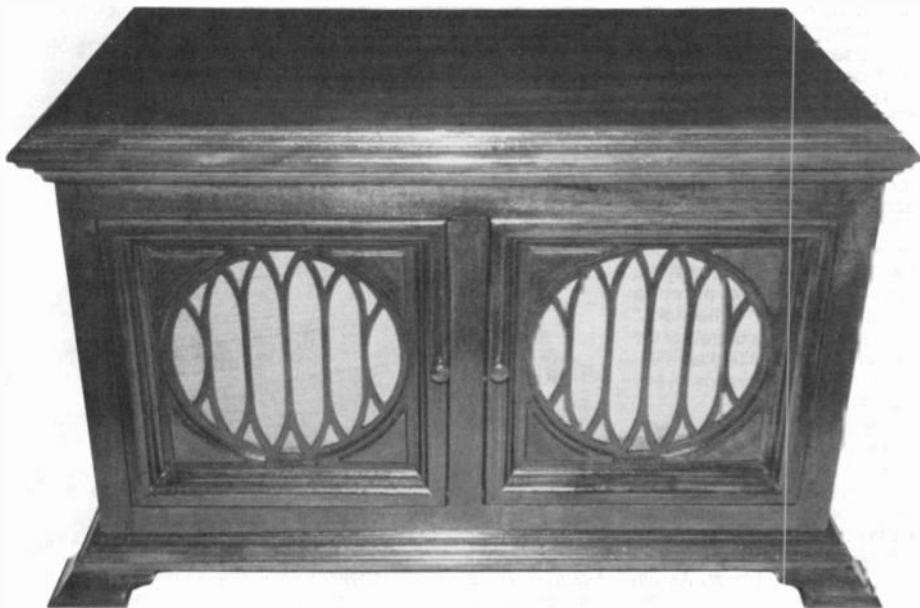

Figure 2. A front view of the radio shows the detailed cabinetry.

(Radiola IV, continued)

The self-contained battery requirements are the following: three A dry cells, 1½ volts each for filaments; four B batteries, 22½ volts each for the plate voltages; and one C battery, 4½ volts for grid bias. Also in Figure 5, note the left rear of the cabinet interior which houses the A batteries, and the right rear which houses the plate batteries. The rear center area holds the C battery in such a position that protruding brass strips make contact with the battery terminals.

Figure 6 shows the control panel and chassis, while Figure 7 provides an under-chassis view of the radio.

The circuit consists of a sensitive 3-tube regenerative design with a detector and two transformer-coupled audio stages. Three Type UV-199 short-pln tubes make up the tube complement. The amplification factor for the UV-199 is 6.6 with a maximum undistorted output of 0.007 watts.

RECEIVER OPERATION

Regarding filament control, the manual for the Radiola IV suggests the following: "When a station is heard, slowly decrease the filament brilliancy until the signal strength begins to diminish, then increase the brilliancy just sufficient to restore full signal strength. Burning the filaments brighter than necessary decreases the life of the vacuum tubes."

The manual also notes, "There are two antenna jacks, one for wavelengths between 200 and 400 meters, and one for wavelengths between 350 and 600 meters. Since most of the broadcasting stations send on wavelengths between 360 and 400 meters, they may be received with the antenna plugged into either of the jacks."

The front panel controls of the Model IV are identified as: Filament, Wavelength, Intensity, and Vernier.

The filament control is adjusted for the required filament voltage — 3.3v. Next, station tuning requires adjustment of the wavelength control for a maximum signal from broadcast stations, while adjusting the intensity control for increased signal strength. As with all regenerative receivers, the intensity control is adjusted to



Figure 3. The open lid of the cabinet reveals a partial view of the radio's interior.

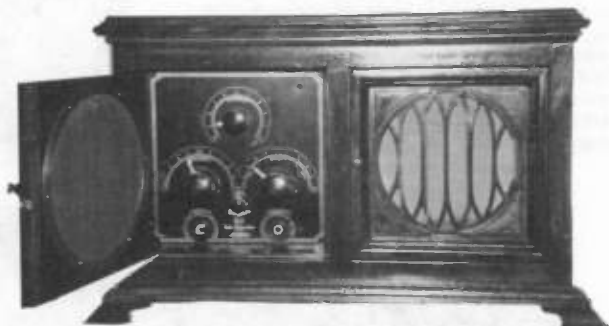

Figure 4. A front view of the radio, including its control panel.



Figure 5. A view of the speaker assembly showing the driver and neck of the horn in the left compartment, with the horn taking up the right compartment.

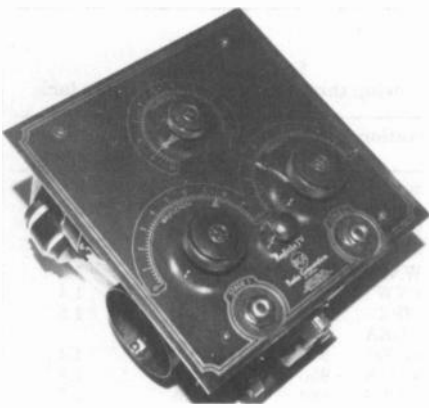

Figure 6. The control panel and chassis.

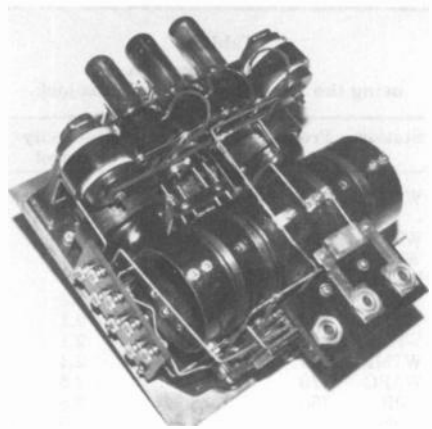

Figure 7. An under-chassis view of the radio.

the verge of oscillation. This is where the receiver is the most sensitive and selective. Fine frequency adjustment is accomplished with the vernier control.

To get the Radiola IV in operation, I used an outdoor 50-foot long wire antenna and the house wiring ground. DC power was provided by a kit-assembled solid-state power supply.

Performance of this 3-tube 1923 receiver is outstanding! Sensitivity is excellent, and selectivity is more than adequate. Tables I and II detail the performance by listing the stations received.

The power supply voltages applied to the Radiola IV are as follows:

- Filament = 3.0v
- Detector Plate = +45v
- Audio Plate = +90v
- Audio Grid Bias = -4.5v

The volume is affected by switching in 40 K, 25 K, and 15 KΩ resistors across the secondary

(Continued on following page)

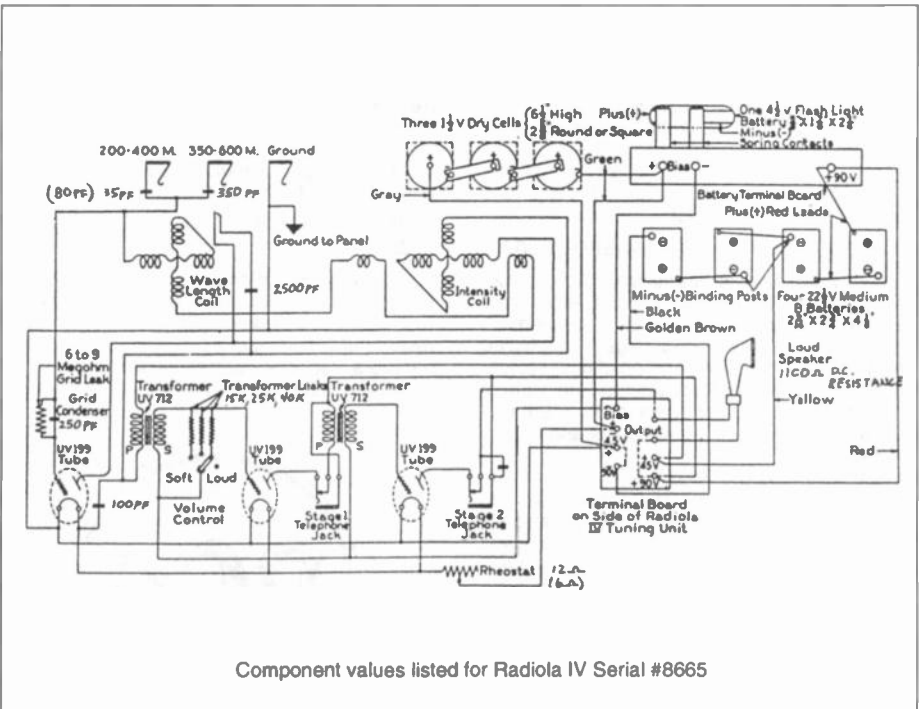

Figure 8. Schematic wiring diagram of the Radiola IV.

Table I
Stations Received
using the 350-600 meters antenna jack.

Station	Frequency	Wavelength Control	Intensity Control
WBZ	1030 kHz	0	1.5
-	1000	0.4	1.5
WZZD	990	0.5	1.7
WWDJ	970	0.9	1.7
WPEN	950	1.1	1.7
WURD	900	2.0	1.8
WCBS	880	2.1-2.2	2.1
WHAS	840	2.7	2.1
WTMR	800	3.3	2.4
WABC	770	3.7-3.8	2.5
WJR	760	3.9	2.5
WSB	750	4.0	2.5
CBC	740	4.3	2.5
WOR	710	5.1-5.2	2.7
WMAQ	670	5.7	2.7
WFAN	660	6.0	2.7
WWJZ	640	6.5	2.7
WIP	610	7.4	3.3

(Radiola IV, continued)

of the first audio transformer with a 3-position switch located on the right side of the chassis, as shown in the schematic in Figure 8. Volume can, in fact, be very loud, and one has to switch to the "soft" position of the volume switch. Speaker distortion is only present on the "loud" position for some local stations.

As the manual points out, headphones may be plugged into Stage 1 or Stage 2 jacks when you are trying to receive very distant stations. In this case, the loudspeaker is automatically disconnected. I found the use of the headphone jacks unnecessary.

Microphonics are not a problem due to the tube performance and the fact that the 3-tube assembly is shock-mounted.

RESTORATION/AUDIO TRANSFORMERS

This hard-to-find set was complete as received, having had some prior restoration. As is often the case, both audio transformers had open windings — in this case, primary windings. I purchased and measured the DC resistance of replacement UV-712 transformers from various Radiola sets and found there are two types of UV-712 transformers having different turns ratios and DC resistance.

Both versions have been used in various Radiola sets (Radiola II, IV, V). The higher turns ratio unit provides increased sensitivity while the smaller turns ratio tends not to overdrive an audio output stage. Both versions work well in the radio. The published transformer specifications indicate a response of 30-3,000 Hz. My measurements indicate a useful bandwidth for about 30 Hz to 10 kHz. Finally, the loudspeaker DC resistance measures about 1,100 ohms.

In summary, the Radiola IV receiver works well, and the operation of the set is straightforward. This conclusion very much agrees with a *Radio News*, March 1923, advertisement which states:

Table II
Stations Received
using the 200-400 meters antenna jack.

Station	Frequency	Wavelength Control	Intensity Control
WSSJ	1310 kHz	0.3	0.9
WING	1300	0.5	0.9
WGMP	1210	1.4	2.0
-	1180	2.0	1.2
WNEW	1130	2.4	1.2
KYW	1060	3.0-3.1	1.4
WBZ	1030	3.4	1.5
KDKA	1020	3.5	
WZZD	990	3.8	1.4
WPEN	950	4.3	1.8
WCBS	880	5.4-5.5	2.0
WTMR	800	7.1	2.0
WABC	770	7.9	2.3
WJR	760	8.3	2.3
WVCH	740	9.5	2.3

"Radiola IV is a self-contained console-type broadcast receiver. The cabinet contains a regenerative receiver, a detector, 2 stages of audio frequency amplification, a new loudspeaker of unsurpassed tone quality and all necessary batteries.

"Radiola IV is not only a highly efficient receiver, embodying the latest developments in design, but is also a thing of beauty that will grace a drawing room or library."

References:

- Radio Data Handbook*, 1937.
- Radiola IV Instruction Book 86945*. New York: Radio Corp. of America, February 1923.
- Radio News*, March 1923.

(William M. Boyd, 74 Atsion Ct., Medford, NJ 08055)

William Boyd, an engineer for the Radio Corporation of America (now Martin Marietta) for over 30 years has been a longtime collector and restorer of antique radios. He specializes in RCA receivers, especially battery sets, most of which are in operating condition.



RADIO RAMBLINGS...

"Me and My Philco" — Model 46-1209

BY FRED GEER

World War II was over and Americans were cash rich. Nothing new had been available since April 16, 1942. People stood in long lines with cash in hand to get their names on an order list for that long-awaited new anything. It was a wild time. Dad had his name on several lists for all the new things we wanted. People bought things, sight unseen, if they were lucky enough to get them.

One day, the dealer down Broadway called and offered us a Philco console with a tilt-out phonograph for \$215. My sister and I flipped out! We could not wait to see our radio. We trusted the Philco name, since our Philco PT-69 with its puttering clock had served us well for seven years.

That night we went to see the radio, which turned out to be a Model 46-1209. Other Philco 46-1209s I have seen come with a tilt-out phonograph compartment door that is square at the bottom, with a plain vertical center bar. My version, as shown in the illustration, has a compartment door that is curved at the bottom corners with a design in the vertical center bar. Its sound was a treat — the lifelike, full, rich bass shook the floor.

My sister and I pooled all our money, and with an extra hundred from Dad, we bought the Philco. Anticipating its delivery, we had a hard time sleeping.

We lived across the street from our school, and I watched from the school window all day hoping to see the radio arrive. I even considered sneaking out if it came during school. Three o'clock seemed as if it would never come.

The radio arrived just after I got home. The delivery people showed me how to work everything and set the push buttons to five St. Louis stations. They explained how to move the loop antenna for best station pickup and how to work the phonograph, which had a moving coil phono pickup.

Sister had bought two records that were played to destruction in the ensuing hours. We danced to them so many times that night that I can still recite the words to "Apple Blossom Time" and "Choo Choo Boogie."

It was 10:00 P.M. Central Time, my bedtime, and the CBS news boomed over KMOX. Even bad news sounded good on this radio. Moving the selector switch from pushbutton to manual tuning, I inadvertently changed stations. Instead

of the familiar "KMOX, the voice of St. Louis," I suddenly heard, "WBT, Charlotte." What a shocking moment! I quickly tuned up and down the dial finding it alive with hundreds of stations. That afternoon, when the radio arrived, it had picked up only the local St. Louis stations.

Then I heard those awful words — "Go to bed! School tomorrow!" How dreadful! What a thought, when the Philco was calling me out to play! I begged, "Just a little longer?" My parents gave in, sensing my fascination with the new radio. I was lost in the excitement of listening to far-off stations from New York to Salt Lake City.

The station I most clearly remember was WLW, Cincinnati. Its intro was "plunk-plunk-plink," like a string being plucked, with "WLW, the Crosley Broadcasting System, Cincinnati, the nation's station" sounding over the plucking. Stations in 1946 gave ID's often.

Getting an atlas, I found all the station locations. "Me and my Philco" formed a relationship that night, because that was when I decided to log all the stations in the world. That night a new hobby was born — DXing.

I was warned that DXing "puts a strain on the radio" by pulling in stations so far away. But you know how radios are. A California station would slip in,

and I had to listen even though the radio was supposedly under great stress. Finally, my parents forced me to bed at 11:30.

The next day, I discovered that shortwave held a special treat. At 3 P.M. CST, "Armed Forces Radio Service" (AFRS) broadcast many of the nighttime radio shows that came on after my normal bedtime. I was in heaven. No more sneak listening! The Philco had made an honest kid out of me.

EPILOGUE

When television came in, our Philco Model 46-1209 ended up as a vocational school shop radio mascot. It was working well in 1972 — the last time I saw it. The Model PT-69 resides on a shelf in my bedroom and still works, but the clock passed on years ago.

(Fred Geer, 6042 Brookridge Rd., Jacksonville, FL 32210)



Illustration by Fred Geer.

WITH THE COLLECTORS

Sears Silvertone Commentator Radio

BY HAROLD ISENRING

This article on the Sears "Commentator" radio has been a long time coming. There is a lot of misinformation about this popular midget radio, most of which concerns production dates. There were, in fact, two models, one prewar version in 1939 and a slightly modified postwar version in 1946. Outwardly, they perform and look the same. (Editor)

In early 1939, Noblitt-Sparks (Arvin) of Columbus, Indiana, a supplier of Silvertone radios for Sears, came up with an excellently designed midget radio to replace the successful "Election Model." (See my article in A.R.C., October 1992, pages 8-9.) The replacement was the "Commentator model," a 5-tube superheterodyne with a built-in loop antenna in a surround plastic cabinet. The postwar version, a Model 7004, is shown in Figure 1. It has four mechanical push buttons that push down, thus assuring cabinet position stability.

There are three cabinet colors — walnut, Model 3351; ivory, Model 3451; and a solid onyx, Model 3551 (not Catalin). The ivory cabinet is solid black plastic sprayed with ivory-colored lacquer. It has red knobs and push buttons. The walnut and onyx models have gold knobs and push buttons. The tubes used are Types 12A8GT, 12K7GT, 12SQ7GT, 35L6GT and 35Z4GT. The radio uses a 120-volt C7 lamp, so a rectifier like 35Z5GT with a tapped heater for a 6-volt pilot lamp is not needed. The price range for these models was \$9.95 to \$12.95.

SOURCE OF THE NAME

Like the "Election Model" before it, this radio needed a name. In early 1939, war clouds were

gathering in Europe. At that time, most Americans could trace their ancestry to Western Europe, and they were very concerned about what was happening in the "old country."

The only sources of news were daily newspapers and theater newsreels. A radio newscast was a rarity, until a successful 5-minute radio news report by Elmer Davis began to be aired every evening at 7:55 CST. The warring nations broadcast their propaganda to the U.S. via short-wave radio, and so shortwave radios became very popular.

The radio networks began to send reporters to Europe to get the truth about the war. These reporters, all famous names by now, began 15-minute evening reports daily. After the news, they usually brought in military and political experts for interviews. Soon these reporters began to comment on the news of the day themselves, and so they were called "commentators." Thus, Sears picked up on this great name for the new radio that could receive newscasts anywhere in the house with its built-in loop antenna. [This radio, and those of similar design were also often called "Candy Cane" radios due to the curved shape of the plastic dial.]

PROBLEMS

Early on, after the set was in the field, a problem of oscillator drift was noted. The set drifted low about 12.6 kHz during the first hour of operation. This made push-button setup a problem. It was recommended that the push-button cams be set while the set was cold and the drift annoyance compensated for by the manual tuning knob as it occurred. Radios of the competition of the era also had drift problems but with a few as low as 2 kHz. By using negative temperature-compensated capacitors, I have reduced the drift in my Model 7004 to 4.5 kHz.

There were some early failures of the C7 pilot lamp. C7 pilot lamp filaments vibrated badly if the set was played loud.

There was also a problem with the models using gold knobs and push-button caps. They were made of solid yellow plastic sprayed with a gold paint. The paint soon wore off exposing the yellow plastic. In later production, the knobs and caps were solid gold-colored plastic which looks as good as new today.

As our country feverishly prepared for war, certain parts



Figure 1. The Commentator Model 7004, a 5-tube superheterodyne with a built-in loop antenna in a surround plastic cabinet.

shortages occurred. Due to the shortage of Alnico for magnets, the PM speaker was replaced with an electromagnetic speaker with a 3000-ohm field. The field was connected in shunt with the B voltage.

Plastic for cabinets became unavailable due to war production. Early in 1942, before the government stopped civilian production of radios, a Model 7020 with a metal cabinet patterned after walnut Model 3351 but without push buttons was produced. [See A.R.C., January 1993, page 7.] An ivory Model 7022 was also made. The metal cabinet prevented the use of the loop antenna in its old position. The depth of the base was increased by 1½ inches, and a Faraday shielded loop was mounted in the metal base. The antenna worked surprisingly well.

In early 1942, as production was nearing an end, Sears ordered that a quantity of parts be squirreled away so that it could be first on the market with a radio after the war was over. The set reappeared in the stores for the 1945 fall and Christmas seasons.

In early 1946, Arvin slightly modified the set to use single-ended tubes [i.e., tubes without the grid cap associated with the Type 12A8GT and 12K7GT]. The new model used 12SA7GT, 12SK7GT, 12SQ7GT, 35L6GT, and 35Z5GT tubes. The postwar production had new model numbers — Model 7004, walnut; Model 7006, ivory; and Model 7008, onyx. The new design worked as well as the old models but with the same drift problem.

After the set was in the field a while, it began

appearing in the shop with a weird problem. The sharp IF amplifier was becoming broad. Some, as viewed on a scope with a swept oscillator, were double-humped.

It turned out that the IF transformers were impregnated with a very low temperature wax. As the inside of the set heated up, the wax melted and gravity pulled the top winding closer to the bottom winding and thus modified the response curve of the IF transformer. In some cases, the top coil actually reached the lower coil producing an over-coupled, double-humped characteristic.

This overcoupling caused each station to appear on two spots on the dial. Arvin responded to this problem by increasing cabinet ventilation. The top of the rear grille cloth was folded back on itself to produce a ¾-inch slot at the top. Arvin, of course, had the IF transformer vendor change to a wax more resistant to higher temperatures.

In spite of its few problems, the Commentator was a very popular radio. I am proud to have a walnut Model 7004 radio in my collection.

(Harold Isenring, 10850 Amy Belle Rd., Colgate, WI 53017)

Since retiring in 1981 as Electronics Service Supervisor from Sears Roebuck after 47 years with the company, Harold Isenring has continued to pursue the hobby, begun in 1935, of refurbishing antique radios. He holds an Advance Class Amateur Radio license W9BT1 and an FCC General Radio Telephone Operator's license. He has written articles for "CQ," "Ham Radic," and "QST" magazines.

The Indiana Historic Radio Museum

CONTRIBUTED BY FRED M. SCHULTZ

On May 20, 1995, the new Indiana Historic Radio Museum opened its doors to the public. After being guests at several other museums, members of the Indiana Historical Radio Society (IHRS) decided that it was time to have their own museum.

The building is conveniently located in Ligonier, halfway between Fort Wayne and South Bend, Indiana. On the National Historic Registry as a 1930s filling station, it has been completely refurbished and now houses over 400 radios and radio-related items. The front office houses the Ligonier Visitors Center, which helps in the day-to-day operation of the building.

With "Preservation for Posterity" as the IHRS logo, the museum leans heavily toward education. Schools have shown a great interest, and many groups have already made use of the facility. In the first four weeks, the museum had over 400 visitors, and as of February 1, that number had grown to 7,000.

Some of the displays featured are the following: farm sets of the 1930s, crystal sets, World War I and II sets, early speakers, tubes, Catalins and telegraphy. Hands-on displays include an opportunity to try to tune a 1920s 3-dial set and to listen to a set that plays old-time radio tapes at the push of a button.

No admission is charged, but the museum has set up a fund at the Noble County Community



Foundation which oversees all donations made to the museum. This fund ensures that the museum will exist for future generations.

Due to new construction, the museum is closed until May, when it will be open Tuesdays, Wednesdays, and Saturdays from 10 A.M. to 3 P.M. An additional day is likely. In March, it was open on Saturdays from 10 A.M. to 2 P.M. or by special appointment. The Indiana Historic Radio Museum is located just two blocks north of the junction of US 6, US 33, and State Road 5 in Ligonier. To schedule a visit outside of regular hours, call (219) 894-9000 for information or Fred Schultz at (219) 894-3779 (tel. and fax).

(Fred M. Schultz, Museum Curator, 800 South Lincolnway, Ligonier, IN 46767)

For information on the Indiana Historical Radio Society write to: IHRS, 245 Oakland Ave., Indianapolis, IN 46201. The "IHRS Bulletin" is published quarterly. Dues are \$20. the club holds quarterly swap meets in various parts of the state.

The Ediswan Crystal Sets (1923-24)

BY IAN L. SANDERS

We are always glad when Ian Sanders adds to his excellent series on British crystal sets. Articles like this one enable us to foster the interests of that segment of our readership who are collectors of foreign sets. (Editor)

"The Ediswan reputation, solidly established upon 40 years' experience and service, is your guarantee of perfect satisfaction. Ediswan means 'the best possible.'" (*Wireless World*, October 10, 1923)

The Edison Swan Electric Company Limited was the result of a merger, in 1883, of the Edison Electric Light Company and the Swan Electric Lighting Company, both suppliers of electric lamps to the British market. Originally called the Edison and Swan United Electric Light Company, the new company adopted its abbreviated name Ediswan in 1916.

Best known as a producer of 1920s British radio valves under the Ediswan brand name, Edison Swan had the distinction of manufacturing the world's first valves, following an order in 1904 by Ambrose Fleming for samples of his experimental diodes. These were subsequently used as detectors by the Marconi Company, and until 1919, Edison Swan produced all valves used by Marconi.

Valves continued to be produced under the Ediswan brand name until 1929, when a merger with British Thomson-Houston and Metropolitan-Vickers took place. The new company, renamed Associated Electrical Industries Limited, replaced the Ediswan name with the name Mazda for all but some specialized and nondomestic valves.

In the early 1920s, Edison Swan also produced a range of receivers and wireless accessories, including headphones. Among these products were two crystal sets named for their year of manufacture — the Model 1923B and various versions of the Model 1924.

THE EDISWAN MODEL 1923B

The Model 1923B crystal set, shown in Figure 1, was introduced in the spring of 1923. The receiver is constructed in a dark wood cabinet with a lid and measures 8 x 5 x 7½ inches. All fittings are lacquered brass, and the ebonite panel carries the Post-Office registration number 433. Advertised in *Amateur Wireless* of April 7, 1923, as "... bang up-to-date and bristling with good features," the Model 1923B was purportedly being turned out of the Edison Swan factory at the rate of one every six minutes.

The wavelength coverage is 200-500 meters, and tuning is of the tapped inductance type; a switch at the left of the panel enables a condenser to be connected in series with the aerial. Early advertisements claimed a guaranteed range of 25 miles, but later ones added the caveat "under favourable conditions."

The detector is of the catwhisker/galena type, but has the unusual feature of a removable ebonite cap which could be screwed over the crystal for protection; see Figure 2. When the set was in use, the cap could be screwed over a threaded



Figure 1. The Ediswan 1923B crystal set was purportedly being turned out of the Edison Swan factory at the rate of one every six minutes.



Figure 2. Close-up of the protective crystal cap in place on the 1923B. When not in use, the cap is screwed on the brass dome at the left of the tuning switch.

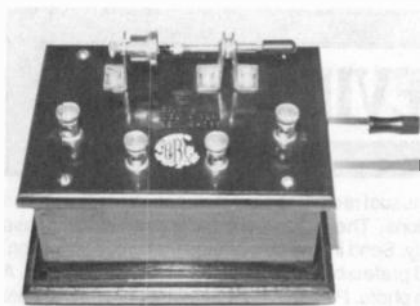

Figure 3. The shortwave Ediswan 1924B crystal set.

brass dome located on the panel in front of the condenser switch.

In 1923, the Model 1923B sold for four pounds, seven shillings, six pence (£4.375), a price which included headphones and accessories.

THE EDISWAN MODEL 1924

A second crystal set, the Ediswan Model 1924B, shown in Figure 3, was offered in the summer of 1924. The Model 1924 is a more compact set than the earlier 1923B, and is of particularly neat external appearance. Smaller than its predecessor, measuring just 2½ x 5 x 3½ inches, the 1924 consists of a black ebonite panel mounted on an open-tray style base. Either walnut or mahogany finish was available. The panel carries the BBC approval stamp and the Post-Office registration number 4385. The aerial, earth and headphone terminals are nickel-plated.

Tuning over a range of 200-700 meters is by means of a pull-out slider located on the right

hand side of the base. The tuning coil is located inside the tray and is unusual in that it is wound with a rectangular cross section to facilitate the linear slide arrangement — itself an uncommon feature in British crystal sets of this period. The detector is of the open catwhisker/galena type.

Different versions of the Model 1924 were available, and Gordon Bussey lists six types — three models, each available in either mahogany or walnut. The set shown in Figure 3 is the shortwave Model 1924B, although the designation 3 only seems to have appeared on the instruction card; see Figure 4. In addition, a 1924L and 1924P were available, both of which incorporated a socket at the back of the set for an external loading coil. The 1924L was a long-wave model, and the 1924P included the loading coil from the BBC's experimental station 5XX operating from Chelmsford.

The Model 1924B was supplied in a distinctive crimson carton, shown in Figure 5, and in 1924 sold for one pound, seventeen shillings, nine pence (£1.89) which included one pair of headphones and aerial and earth equipment. The models 1924L and 1924P models were both priced over two pounds.

References:

- Amateur Wireless*, Vol. 2, No. 44, April 7, 1923, p. 442.
- Bussey, Gordon. *Vintage Crystal Sets*. London, England: IPC Business Press Ltd., 1976.
- Hill, Jonathan. *Radiol Radiol*. Devon, England: Sunrise Press, 1986.
- Stokes, John W. *70 Years of Radio Tubes and Valves*. New York: The Vestal Press, 1982.

Advertisement for Ediswan 1923B crystal set. Source: *Amateur Wireless*, October 13, 1923.

(Ian L. Sanders, 16725 Wild Oak Way, Morgan Hill, CA 95037)

Ian Sanders has been collecting and restoring early 1920s crystal and battery receivers since 1974. He specializes in British sets of this period, and would be happy to try to answer any readers' inquiries on this subject.

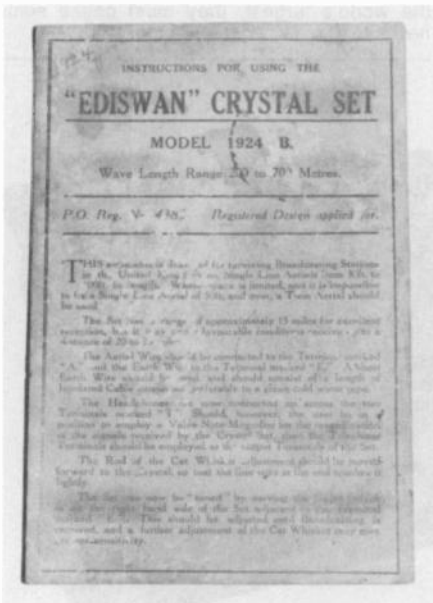

Figure 4. The instruction card supplied with Ediswan 1924B set is the only place where the "B" appears.



Figure 5. The 1924B was supplied in a distinctive crimson package.



PHOTO REVIEW



This column presents in pictorial form many of the more unusual radios, speakers, tubes, advertising, and other old radio-related items from our readers' collections. The photos are meant to help increase awareness of what's available in the radio collecting hobby. Send in any size photos from your collection. Photos must be sharp in detail, contain a single item, and preferably have a light-colored background. A short, descriptive paragraph **MUST** be included with each photo. Please note that receipt of photos is not acknowledged, publishing is not guaranteed, and photos are not returned.



GENERAL ELECTRIC MODEL LCP-609 – This 1941 table radio has a 6-tube "Golden Tone" superhet chassis. It also features the famous GE Beam-A-Scope aerial. The cabinet is of walnut veneer with toning lacquer for contrast. (*Robert Bailey – Jacksonville, FL*)



RCA NIPPER AND PHONOGRAPH – This Nipper and phonograph sit on a playground platform in Merrifield, Va. Though perhaps not the world's largest, they must cause some heads to turn. (*V. Vogt – Renton, WA*)

BRANSTON MODEL R47 HETROLA V – Made in Buffalo, N. Y., in 1925, by Chas. A. Branston, Ltd., this radio is a 5-tube TRF with integral horn speaker under the chassis. Branston had a Toronto office and advertised prominently in Canadian radio magazines. The company also made "medical" apparatus described in a 1923 radio ad as: "The famous Branston Violet Ray High Frequency Generators." (*Bob Murray – Winnipeg, MB, Canada*)



PHOTO REVIEW



RCA VICTOR MODEL 1-T-3 – This early 1960s transistor radio looks like an alternative to the Emerson 888 rocket series radios. It has an alligator-embossed leather case. This radio is nearly silent in between stations, and overall sound quality is good. (Robert Bailey – Jacksonville, FL)

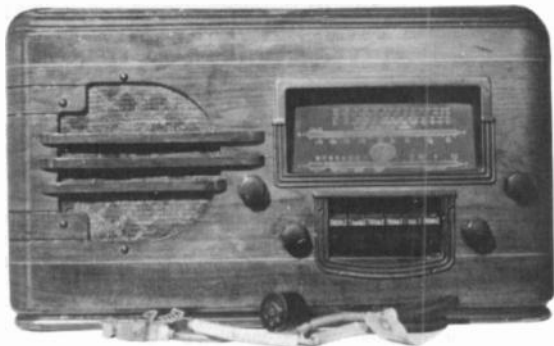

MONTGOMERY WARD AIRLINE MODEL UNKNOWN – This 7-tube farm radio can operate on either 6 volts DC or 110 volts AC. Note the battery connecting cable with alligator clips and plug. The radio features a tuning eye, push buttons and BC/SW. (A. D'Ambra – Rocky Point, NY)



ZENITH MODEL 5-J-217 – This 1937 Zenith black dial set has a dual power supply which allows it to be operated from either 6 volts DC or 110 volts AC. This made it ideal for rural areas where electricity was not yet available. When the REA finally brought electric power to the farm, this set could then be operated from AC. (Bill Harris – Roanoke, TX)



GENERAL ELECTRIC MODEL J-70 – This is an early 1930s, 7-tube, superheterodyne broadcast receiver. Typical of the Great Depression radios, its cathedral-style cabinet has only one piece of fine wood veneer. The sound quality is good. However, there is little bass due to the rigid cone design of its speaker. (Robert Bailey – Jacksonville, FL)

WITH THE COLLECTORS

Permeability Tuning = Lower Cost

BY ALAN C. DOUGLAS

Permeability tuning has been a provocative subject since John Stanley asked for information in the March 1994 issue of A.R.C. Ray Bintliff compiled reader responses in the August and September 1994 issues and here is still more information from Alan Douglas' archives. (Editor)

Here's some additional information on permeability tuning, copied from a letter I received in May 1980 from H. L. Chadbourne of La Jolla, California. Chad, now deceased, was researching the development of communications receivers for a book he intended to write, and he had corresponded with engineers and company founders before changing his focus to pre-1900 wireless. He felt he would never know enough to do a really authoritative book on communications receivers, but he was wrong — I wish he had done it.

The following information from the letter is based on an interview with Dr. Carl Dan Pierson, an engineer with Belmont Radio Corp. from 1940 to 1944 and a short postwar period. He then left to get his doctorate and go into teaching.

"Belmont was started in 1935 as a garage operation by Harold Mattis and another man. After the company was really operating, William L. Dunn was its chief engineer. Belmont was successful, and after a while was able to acquire the Dickens Ave. (main) plant of the bankrupt Grigsby-Grunow (Majestic) Co., across the street from the much larger Zenith Radio. The plant was Belmont's home for the life of the company. By World War II, employment was about 1,000, mainly women on the assembly line. There were six or seven engineers, and eight to ten drafting and technical staff. Employment increased slightly during the war.

"The most costly item on a typical AC/DC chassis was the tuning capacitor, which ran around 95¢. Belmont was able to substitute a permeability tuner which worked as well or better but cost 45¢.

"From the outset Belmont was a private brand name or house supplier. The company did not attempt to market its own line of receivers. Instead it sold its output to Montgomery Ward, Western Auto Supply and other merchandising outlets, who used various brand names on the sets.

"When World War II came, Belmont was given the prime contract for Army ground IFF (identification friend or foe) equipment. Hazeltine had the prime Navy contract, and at first Hazeltine's design was used for the Army gear. Then other designs were introduced, some quite advanced. It was a bit of an honor for a company as small and as new as Belmont to be given a prime contract.

"Belmont redesigned the BC-348 aircraft receiver to incorporate its old favorite, permeability tuning. This was quite a feat. There were 6 bands and 2 tuned circuits before the first RF, followed by a tuned mixer and oscillator, or $6 \times 4 = 24$ coils that

required suitable cores and a mechanism for moving them, plus provision for interstage shielding and a bandswitch. The result was 9 pounds lighter and a little smaller than the standard BC-348, yet worked very well. A few units were shipped to Wright-Patterson AFB, but this version was never put into production.

"Postwar Belmont was divided internally into two parts — government products and consumer goods. Raytheon bought the company because it wanted to cash in on the boom it saw coming (correctly) for TV. However, Belmont, being a house supplier, had no marketing or distribution setup, and Raytheon itself was oriented to defense work. Belmont TVs were all right, but the mechanism to sell them was

Table I.
Cost per set per operation, August 19, 1937

Supervisor	.004
Trucking	.004
Line feeders	.004
Conveyor	.002
Cabinet inspection	.002
Rubbers	.002
Chassis installation	.002
Chassis bolts	.004
Escutcheon plates	.010
Mount speakers	.004
Open speakers	.002
Speaker studs	.007
Knobs	.010
Bags	.002
Pusher	.002
Tighten speakers	.002
Antenna kits	.004
Cabinet inspection	.002
Pusher	.002
Patcher	.002
Stamping tickets	.002
Tighten bolts	.002
Oil off	.004
Stamp cabinet	.004
Speaker screw	.002
Instruction book	.002
Patent label	.002
Kimpack	.002
Packers	.002
Loaders	.004
Truckers	.008
Total produced	1362
Total personnel	63
Total expense	268.63
Total cost per set overall	19¢

(From the files of Fred B. Cassens, Supt. of Zenith Radio Corp.'s Final Assembly Division, ca. 1937.)

absent. So Raytheon sold the consumer goods part of the company to Admiral and moved the government part to Santa Barbara, where it exists today as a western division of Raytheon."

I have paraphrased a few portions of this letter. As you can see, the primary motivation for permeability tuning was economic. A manufacturing cost of fifty cents was a great deal of money in 1940. As an example, see the manufacturing costs for the Zenith console production line in 1937 in Table I, courtesy of the late Fred Cassens. The final assembly and shipping cost was nineteen cents per set, broken down into 30 separate operations, whose costs were figured down to two-tenths of a cent.

Regarding RCA's use of permeability tuning:

the ARB military aircraft receiver, designed and built by RCA, used it. Serge Krauss is quoted in the May 1991 *AWA Old Timer's Bulletin* (p. 19) as saying that RCA's core material was better than that of other suppliers and that RCA eventually had to tell its future competitor how to make it.

(Alan C. Douglas, Box 225, Pocasset, MA 02559)

Alan Douglas, an electrical engineer, has written well over 100 articles for *A.R.C.* and other publications. His books, "Radio Manufacturers of the 1920's, Volumes 1, 2, and 3," are highly regarded resources for the radio collecting community.

More on Call Letters

CONTRIBUTED BY ALAN DOUGLAS, PHIL WHITNEY, AND DICK DESJARLAIS

Scott Kilgore's article "Call Letter Meanings" in the February 1995 issue of *A.R.C.* triggered many memories of early radio stations. A little contest seems to be underway to determine the winner of the best call-letter story "sweepstakes." Perhaps there are more entries out there. (Editor)

From Alan Douglas:

While it's true that many old station call letters have now-forgotten meanings or slogans, for the earliest ones the calls came first and the slogans later. WOC, WBT, WLW, and KOA, for instance, were all assigned alphabetically (not at random), and their slogans were invented later to fit the occasion.

If you look in the 1922 government callbook, you can see that letters were assigned in sequence, skipping those still held by ships or by shore stations. As ships changed registry (or sank), new calls became available. Of course, some of the broadcast licenses changed hands too: KOA was originally owned by the Denver YMCA, and I doubt that it was heard "Klear Over Denver," let alone "America," a slogan adopted years afterward.

At some point around 1923, applicants could request particular calls, but the only obvious one in the June 1922 callbook is KOP, the Detroit Police Department.

WEEL in Boston, by the way, stands for the Edison Electric Illuminating Co., not the Edison Electric Institute.

Here's my entry in the "best call-letter story" sweepstakes. Any Philadelphians about my age (I went to college there in the early 1960s) will remember the loud rock station WIBG. What was never said was that when the station was first owned by St. Paul's Church in Elkins Park, the call letters stood for "I Believe in God"! [Another of today's rock stations — WBCN in Boston — was originally a classical music station, part of the "Broadcast Concert Network."]

(Alan C. Douglas, Box 225, Pocasset, MA 02559)

From Phil Whitney:

I always liked the Goodyear Tire and Rubber Company's WEAR Cleveland, which apparently referred to their tires, and WIOD in Miami, which was identified as "Wonderful Isle of Dreams." When telephone companies owned radio stations, WCAP in Washington stood for "Chesapeake and Potomac"

(a telephone company). WOWL stood for the Owl Battery Company in New Orleans. WNYC's meaning was obvious, since it was owned by New York City. WRC, still operating in Washington, D.C., stood for "Radio Corporation (of America)."

"Sui" was a hog caller's way of rounding up his pigs so the State University of Iowa's radio station call letters were WSUI. WLIT was owned by the Lit Brothers Department Store in Philadelphia. When WABC in New York City began broadcasting in the 1930s, it was owned by the Atlantic Broadcasting Company, but it became the flagship NBC station there later before changing to the American Broadcasting Company. Owned by Atlantic City and located on the steel pier, WPG stood for "World's Play Ground."

Good references for call letter information are the NAB Yearbook, Stevenson's Radio Bulletin of 1933, most magazines of the 1920s to the 1930s, and my book, *Virginia Broadcasting, 120 Years on the Air*, published by the Virginia Association of Broadcasters.

(Phil Whitney, 214 Carters Ln., Stephens City, VA 22655)

From Dick Desjarlais:

A *Yankee* magazine article of September 1972 tells of New England's first radio station — WGI-AMRAD, standing for American Radio and Research Corp., manufacturers of crystal sets. Two rooms of the factory on the edge of the Tufts University campus in Medford, Mass., housed the station, which featured mostly classical music for only a few hours a day.

In the 1921 Christmas season, Bob Emery, well-known to New Englanders for decades as a radio and TV personality, read stories to children, as well as their letters to Santa. Emery was probably the first performer ever to use a telephone regularly on the radio; he was perhaps the first talk show host.

This article claims several other "firsts" for WGI-AMRAD: the first to broadcast college lectures, weather and stock market reports, religious and children's programs, dramas, and a political speech by Boston mayor James Michael Curley. However, the station disappeared from the airways in the late 1930s, and the studio-factory became Tufts' North Hall, which burned down in 1972.

(Dick Desjarlais, c/o A.R.C., P.O. Box 2, Carlisle, MA 01741)

WITH THE COLLECTORS

More on the Symphonic Globe Speaker

BY BUFORD CHIDESTER

Since I am a cone speaker collector, I very much appreciated the good article on the Symphonic Globe speaker in the February issue of A.R.C.

It is important to note that the picture of the internal driver, shown in Figure 3 of the article, is that of an Atwater Kent unit and not of the original driver supplied with this speaker. As shown in Figure 1, the original driver contained a horse-

shoe magnet very similar to the RCA 100s, Western Electric, etc. It has a mechanical, tension-type volume control that extends through the bottom of the globe. The driver assembly is attached by means of a triangle pot metal transition piece.

The slots on the bottom portion of the globe were originally covered in a blue/green silk, similar in color to the globe itself. Over the years, in most cases, the globe color has changed to a darker green, with the silk fading to a very light blue/green. Edges of the slots at the bottom of the globe were actually painted with blue paint before the silk was installed.

Last but not least, the cone material is a fabric commonly known as Burtex, which is constructed of two different fabric textures laminated together. Cone speakers such as the Splittorf, Stevens, Algonquin, Magnet, etc. are good examples of Burtex cones manufactured by the Stevens Company. Usually, these cones were formed by stretching the material over a cone-shaped form, resulting in a seamless cone, unlike most of the paper type cones.

(Buford Chidester, 785 Locust St., Mt. Wolf, PA 17347)

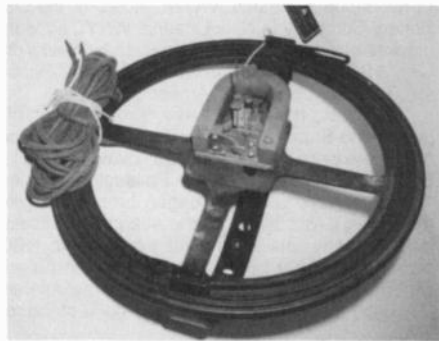

Figure 1. A view of the Symphonic Globe speaker showing the original driver.

Pastime Follow-up

COMPILED BY DICK DESJARLAIS FROM THE RESPONSES OF NIGEL FEATHERSTON, CHET GEHMAN, KENNETH NEVINS, C. ORVAL PARKER, AND JOHN STANLEY.

The May 1995 A.R.C. carried a cover article on Dick Desjarlais' Pastime miniature radio. Reader response was helpful and enlightening. (Editor)

Several sharp-eyed responders to my article on the Pastime miniature console (May 1995) were quick to note that the circuitry for this TRF set is not truly "straightforward." Instead, the circuitry is actually a reflex circuit.

My good friend and colleague Chet Gehman confirmed these opinions with the following definition: "A reflex receiver is one which uses an amplifying device to amplify simultaneously two widely separated frequencies or bands of frequency. More specifically, the recovered modulation (audio) is amplified by a stage (or stages) — RF or IF — preceding the demodulator stage. Applying this definition, the circuit of the Pastime radio is indeed a reflex."

Gehman recalls selling, as well as repairing, several Kadette very compact radios back in the late 1930s when he was a radio service man in the Bronx. He remembers one similar Kadette Jr., having essentially the same circuit with the addition of a

regeneration path and adjustment. It was in a metal case and sold for approximately \$9.95.

C. Orval Parker and others elaborated on the reflex circuit, emphasizing that the pentode unit of the 6F7 tube also amplifies the output of the detector and applies it to the 12A7 tube output section. Parker concluded that, in his experience, the Kadette Jr. set was totally unique, not just cheap.

Parker agrees that the Pastime was available in cases of more than one material, style, or color. His story is worth retelling about a young lady who came to his repair shop with a badly damaged Kadette Jr. in an off-white and red marbleized cabinet. This, her bedside radio, had tumbled to the floor several times. She had put the case back together with nail polish. Even more interesting was the fact that she was using the bedsprings as an antenna, and by changing her place on the bed, she could tune in different stations!

John Stanley observed that the schematic for the Kadette Jr. does not indicate any on/off switch and wondered whether this sets the Pastime apart from the Kadette Jr. However, a colleague who owns two

Kadette Jrs. assured me that physically the "slide" on/off switch and volume control is the same as that of the Pastime.

Several readers commented on the extreme compactness of this set. In back and forth correspondence, Stanley asked if I plan to get the Pastime playing. I replied that I hadn't yet drummed up the courage to take apart this jam-packed, intricate chassis. He easily understood why I am reluctant to disturb, in his words, "this rare piece of radio history."

Stanley also asked other questions: "Where are all of those RF coils and transformers placed? The antenna transformer should be nearly as large as one of the tubes! Was powdered iron used? The schematic shows air core coils and chokes."

The answer is that the schematic is correct — all of the coils, though well hidden, are air core, not powdered iron.

Nigel Featherston commented: "Good grief,

power and antenna on the same plug — a "hot" chassis too — definitely not a good set for the kitchen or bathroom!"

And Kenneth Nevins, owner of Nevins Museum of Radio, a small private museum, wrote that he is doing research on the history of radio in Ann Arbor, Michigan. He has considerable interest in the Pastime Kadette Jr. because the manufacturer, International Radio Corporation, was located in Ann Arbor.

After the Pastime article appeared in the May 1995 A.R.C., it attracted considerable attention at the Michigan Antique Radio Club Extravaganza, where it won first place in a contest. It was also of great interest at the Antique Wireless Association (AWA) Conference in Rochester, N. Y., where it commanded third place in the contest category "Radios from 1925 to 1935."

(Dick Desjarlais, Box 629, Littleton, MA 01460)

Century Code Practice Set

BY LARRY BABCOCK

I found this code practice set, shown in Figure 1, in the flea market at the Mid-Atlantic Antique Radio Club (MAARC) meet in Timonium, Maryland, in June 1995. As soon as I saw it, I knew that I had to own it, but I wasn't exactly sure whether this was a telegraph or radio-related item.

I did know that the Century Telephone Construction Co. and the Frontier Telephone Co. had united to form Federal Telephone and Telegraph in 1908, so I started my research in some old Federal radio catalogs. *Federal Bulletin 117-W*, November 1922, pictured an almost identical item. The only difference was that it used 6 screw terminals instead of the 4-pin jack terminal block found in the unit I had purchased.



Figure 1. A Century code practice set built to train wireless telegraphy operators.



Figure 2. The Century code practice set name tag. The location of Buffalo, N. Y., indicates the unit was built after Century moved to Buffalo and became part of Federal Tel. and Tel.

Calling it a practice set, No. 575-W, the Federal ad said this set was intended for use in teaching wireless telegraphy, and, in fact, had been used by the U.S. Army Officers training camps. I was elated! My find was related to early wireless. The ad went on to state that the set included a 168-W buzzer and a 860-W key. These numbers, used by Century, are also on my set. The code practice set tag, shown in Figure 2, reads as follows:

Century
Telephone Construction Co.
Buffalo, N. Y. USA

Century ceased to exist in 1908 when it merged with Federal. I had not thought that my practice set was that old. However, the *AWA Review* explains that the Century name continued to be used on Century-related products until at least 1918, and Federal calls its buzzer a "Century Buzzer" in Federal catalogs well into the 1920s.

(Larry Babcock, 8095 Center Rd., East Amherst, NY 14051)

References:

- Douglas, Alan. *Radio Manufacturers of the 1920's*, Vol. 1, p. 205. New York: The Vestal Press, Ltd., 1988.
- Federal Telephone and Telegraph Bulletin No. 117-W*, November 1922, pp. 19 and 28.
- Sibley, Ludwell. "Federal As A Telephone Company." *AWA Review*, Vol. 8, 1993, pp. 67-73.

HOMEBREWING

Loop Antennas Revisited

BY DWANE STEVENS

Dwane Stevens' February 1993 A.R.C. article described various designs for loop antennas. The tables in this sequel go one step further, as they give detailed information for the construction of box loop and spiral loop antennas. This data should be of value to the experienced experimenter, as well as to beginners in loop antenna construction. (Editor)

For many vintage radio enthusiasts loop antennas provide a unique attraction. Their physical attributes — wires neatly strung around a support form creating a diamond, square, or rectangle — seem to provide tangible evidence of a radio set's ability to "capture" those invisible radio waves which provide the music and news we enjoy.

My article "Antennas for Vintage Radios," which appeared in the February 1993 issue of A.R.C. on page 5, included a discussion about loop antennas and their construction. Since that time I have come across some additional information about loops which may be of interest to antenna enthusiasts.

A REVIEW OF LOOP ANTENNAS

First, let's review a few principles about loop antennas. For the scope of our discussion about 1920s broadcast receivers, keep in mind that loops were intended for use only on receiver circuits that were specifically designed for them. At the time there were two basic antenna designs for general broadcast receivers — long-wires and loops —

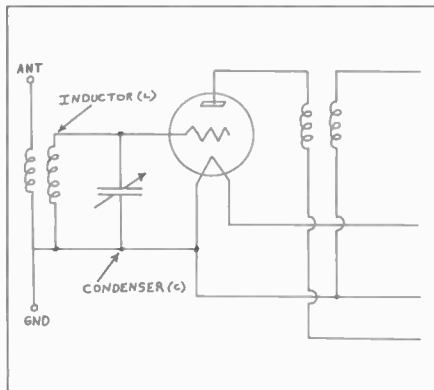

Figure 1. Partial schematic diagram of a radio's front-end connected to a long-wire antenna.

each consisting of a multitude of variations.

A typical radio front-end circuit, as shown in Figure 1, was designed for a long-wire antenna. It comprises an L-C tank circuit (inductor and variable condenser in parallel), which tunes in the desired frequency. The long-wire antenna captures radio signals of various frequencies and injects them into the tank circuit for the tuning process.

In contrast, Figure 2 shows a typical radio front-end circuit designed for a loop antenna. Here the loop serves double duty. First, it acts as an antenna by capturing radio signals as the long-wire did. Second, it also serves as the coil or inductor in the L-C tank circuit. Therefore, the loop is actually part of the frequency tuning circuit, with the resonant frequency being determined by the inductance of the loop and the capacitance of the variable condenser. Because of this relationship, loops were constructed to match variable condensers of differing capacities which were in use at the time. This relationship is described in Tables I, II and III.

Some radios were constructed to use either a long-wire or a loop antenna. The sets usually had a switch that connected the long-wire and an internal coil (inductor) to the variable condenser, or connected the loop only without the internal coil to the variable condenser. This arrangement was to utilize the advantages of each antenna — the long-wire's advantage of greatly increased signal strength from local as well as distant stations, and the loop's advantages of compactness and portability.

As shown in my article "Antennas for Vintage Radios," loops can, of course, be used on either type of radio, but with greatly varying degrees of success on sets intended for a long-wire antenna. For example, I use my loop on sets designed

Table I

Number of turns for box loops with lengths of 18, 20 and 24 inches per side.

Tuning Condenser	Loop winding width in inches			
	3-in.	4-in.	5-in.	6-in.
• Loop winding length: 18 inches per side.				
.00025	19 T.	20 T.	21 T.	22 T.
.0003	17 T.	18 T.	19 T.	20 T.
.00035	16 T.	17 T.	18 T.	19 T.
.0005	13 T.	14 T.	15 T.	16 T.
• Loop winding length: 20 inches per side.				
Tuning Condenser	3-in.	4-in.	5-in.	6-in.
.00025	17 T.	18 T.	19 T.	20 T.
.0003	16 T.	17 T.	18 T.	19 T.
.00035	15 T.	16 T.	17 T.	18 T.
.0005	12 T.	13 T.	14 T.	15 T.
• Loop winding length: 24 inches per side.				
Tuning Condenser	3-in.	4-in.	5-in.	6-in.
.00025	15 T.	16 T.	17 T.	18 T.
.0003	14 T.	15 T.	16 T.	16 T.
.00035	13 T.	14 T.	14 T.	15 T.
.0005	11 T.	12 T.	12 T.	13 T.

Note: Condenser values in microfarads.

Table II

Number of turns versus capacity required to tune to the indicated wavelengths in meters.

No. turns	Condenser Capacity					
	.00005	.0001	.0005	.001	.002	.003
1		65	128	178	250	310
3	130	155	290	400	550	675
6	230	280	500	710	1000	1200
12	430	490	920	1250	1700	2050
24	760	880	1600	2100	3000	3600
48	1550	1775	3150	4300	6000	7000
72	2200	2650	4800	6400	8800	11000
120	3930	4500	7900	10000	14700	17700
240	7600	9000	15650	20500	27200	32900

Note: Condenser values in microfarads

equally spaced over a particular dimension.

Example: Suppose your radio set has a 0.00035 mF variable condenser, and you want to build a box type loop 18 inches square with the space for the winding to be 4 inches wide. Referring to the table under the heading "18-inch per side," you find in the left-hand column the size of the condenser ".00035," and following this to the right on the same line, to the third column under the heading "4-in. wide," you find the number "17." This means that 17 turns of wire are required, equally spaced over a width of 4 inches on an 18-inch

square loop in order to cover the broadcast band.

Table I is taken from a home study course by the National Radio Institute, Washington, D.C. entitled *Complete Course in Practical Radio, Lesson Text No. 15, Receiving Antennas and Their Installation*, copyright 1929, 1930, page 25. The lesson text also presents much technical theory concerning how the loop actually works, but I have only presented a compilation of the construction aspects.

LOOP ANTENNA DESIGN

Recall the two basic types of loop antennas — the spiral or flat square type (shown in Figure 1 on page 5 of my previous article) and the box or single-layer, square type sometimes called the solenoid type (shown in Figure 3 on page 6 of the same article). The spiral loop is the simplest to construct, but is less desirable since the inner turns rapidly become less useful as the enclosed area diminishes.

Table I shows the number of turns required on box loops of various dimensions when used with tuning condensers with values of 0.00025, 0.0003, 0.00035 and 0.0005 mF. The combined capacitor values and loop dimensions are designed to cover the AM broadcast band. The loops are considered square; that is, with four sides of equal length. However, an oblong rectangular loop can be constructed from this table as long as the area in square inches of such a rectangular loop is the same area in square inches of the given square loop. Also, the longer dimension of the loop should not be more than twice its shorter dimension.

Table I provides construction details for loops with dimensions of 18, 20 and 24 inches per side. The loops are wound with #20 insulated wire over widths of 3, 4, 5, or 6 inches. The windings are

Tables II and III are taken from the article "Theory and Design of Loop Antennae" found in the June 1925 issue of *Radio News*, page 2305. This information is probably not as practical for our purpose as the information in Table I because it deals with spiral loops 4 feet per side, a much larger dimension than is usually desired; however, I have included it for all those experimenters and diehards who always want more information.

Table II can be used for designing loop antennae to cover various ranges of wave-length. (Note: In 1920s publications such as *Radio News*, measurements in wavelength were nearly always used. The radio community had not yet made the transition to thinking in terms of frequency.) The table is based on a loop, with an outside dimension of 4 feet per side wound with No. 20 double cotton-covered wire with turns spaced one-half inch apart. [Wavelength can be converted to frequency in kHz by the following formula: Frequency = 300,000 ÷ meters.]

The *Radio News* article states: "Loop antennae, as described above, when used in conjunction with a 7- or 8-tube superheterodyne, have been used successfully to pick up stations with good audibility at distances of 2,000 to 3,000 miles."

As can be seen from the figures in Table II and from the above quoted material, these 4-foot loops could easily provide an interesting challenge to a loop builder.

Table III provides data for large spiral antennae ranging in size from 3 to 8 feet per side.

Remember that the efficiency of a loop is usually about 1 to 10 percent of that of the average long wire antenna. In the 1920s, however, that drawback was many times overlooked because a loop was considered "compact" and "portable" and could be rotated to minimize interference. Besides, if you could afford a 7- or 8-tube "super," you then had enough amplification to make up

(Continued on following page)

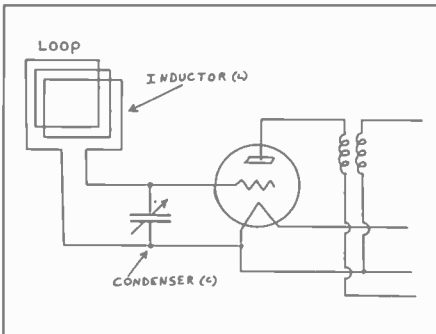

Figure 2. Partial schematic diagram of a radio's front-end connected to a loop antenna.

Table III
Construction details for a spiral antenna.

Loop Winding Length	No. of Turns	Wire Spacing	Inductance	Capacity	Wave Length Meters
8'	3	1/2"	96	75	160
6'	4	1/4"	124	66	170
4'	6	1/4"	154	55	174
3'	8	1/8"	193	49	183

Note: Capacity values in picofarads

(Loop Antennas Revisited, continued)
greatly for the low efficiency of a loop antenna.

(Dwane Stevens, KC5MT, Route 3, Box 25A, Ardmore, OK 73401-9803)

Dwane Stevens has been an amateur radio operator for 17 years and holds an Advanced Class license, while his wife and daughter hold Technician Class licenses. Although new to vintage radio collecting, Dwane enjoys repairing and restoring pre-1940 radios, as well as collecting tubes, repair manuals and old radio magazines.

References:

"Receiving Antennas and Their Installation," *Complete Course in Practical Radio, Lesson Text No. 15*, The National Radio Institute, Washington, D.C., © 1929, 1930.

"Theory and Design of Loop Antennae," *Radio News*, June 1925.

The Super Antenna — A New Invention

BY MICHAEL GODAR

In this article, Michael Godar describes his new invention and credits Dwane Stevens' article on loop antennas (Feb. 1993) for the inspiration. A.R.C. is always pleased to be a partner in any project aiming to improve existing technology, particularly if it also helps with old radio projects. (Editor)

A great idea was set in motion. A new, flat-style antenna was developed. A new company was born. All this was because of an article I read in *Antique Radio Classified*.

As a technician in the TV, VCR and radio repair business for more than 20 years, I'm only too familiar with a common customer complaint about rabbit ear indoor TV antennas: "Our technologies have advanced to such a level that we can send a man to the moon, but why haven't we done something about ugly rabbit ears?"

How true! While television has evolved from one generation to another, the basic design for indoor TV antennas has remained largely the same, with the two protruding metal rods nearly analogous to outdoor TV antennas. Rabbit ears no longer fit into the ever popular entertainment centers, nor do they satisfy the sophisticated taste of today's interior design-conscious consumers.

It never occurred to me to get involved in the antenna business until one day in the winter of 1993 I read an article about loop antennas by Mr. Dwane Stevens in the February 1993 issue of A.R.C. "Maybe I can eliminate the rabbit ears by modifying the old style loop antenna for modern TVs and radio receivers," I thought.

My original concept was an oblong coil antenna centered around a flat-lying 2 x 4 board. I tried different sizes, but all failed in certain frequencies; I also experimented with different loops, but encountered problems in television reception. By then, I had come to realize that even if a loop antenna did work, large-scale manufacturing would be difficult and expensive.

I decided to change design direction, turning my eyes to the multiple dipole array. But, a standard TV dipole antenna measures several feet in length, and to miniaturize and compact the design was no easy task. I concentrated on experimenting with different configurations and metals.

Finally in late June of that year, a working model showed promise. The model was tested in the greater Phoenix area. Later tests were conducted in Los Angeles, San Diego, Las Vegas, Milwaukee and Brooklyn, New York. By August, the design was finalized.

Thus, an entirely different looking indoor antenna was born — one without rabbit ears. Named "Super Antenna," this multiple dipole antenna is housed in a flat, high-impact plastic case, 1 inch in height, which can be placed conveniently atop a TV/VCR set or on the shelf of an entertainment center. Compatible with all TVs, VCRs, AM/FM stereo shortwave and VHF police scanner receivers, an antenna works well with color television VHF and UHF bands. It also works well with 1920s battery radios and all old style radios needing a long wire antenna.

My ideas for an antenna with no rabbit ears originate from my more than 20 years of direct contact with customers. But I owe my inspiration for Super Antenna to A.R.C. and Mr. Dwane Stevens' article about loop antennas.

(Michael S. Godar, G.E.C., Godar Electronics Corp., 39 N. Gilbert Rd., Gilbert, AZ 85234)

Michael S. Godar is a technician and entrepreneur, who had his first fully-operational television repair shop at the age of 14. He presently owns UniTech TV/VCR — a TV, VCR, and radio repair service store in Gilbert, Arizona. He is also the owner of Godar Electronics Co., a division of UniTech TV/VCR, which manufactures and markets the patent pending "Super Antenna." His interests include collecting antique radios, TVs, and electric fans



AUCTION REPORT

HVRA Mega Auction Houston, Texas — January 26-27, 1996

REPORTED BY WILLIAM WERZNER

The Houston Vintage Radio Association (HVRA) held its Mega Auction January 26-27, 1996, at the Tides II Hotel Lai Lai Restaurant in Houston, Texas. This 2-day event drew over 85 collectors — more than expected, since many attendees brought their families along. In all, 514 lots crossed the auction block for a total of \$12,057, setting a new record for HVRA's winter sale. Collectors came from all over Texas, as well as from California, Florida, Indiana, Kansas, Louisiana, Michigan, Ohio, Tennessee, and Virginia.

The Friday evening auction lasted 3½ hours with sales totaling \$3,653. Auctioneer Bill Werzner encouraged the 55 auction bidders to have a virtual field day bidding on several thousand tubes and many N.O.S. parts from at least two estates.

Saturday's auction, running from noon to 5 P.M., drew 64 bidders. A total of 277 lots auctioned included console radios, table sets, and nice test equipment, as well as leftovers from the Friday night auction. Gross sales totaled \$8,404.

Among the highlights were a set of Rider's Volumes 1-18 selling for \$390, a Stromberg-Carlson tombstone with loop antenna and power supply for \$180, and a marbled wine colored Sentinel Catalin with ivory trim for \$475. Unfortunately, detailed information was not recorded at this auction, and the following is only a representative list.

The club is looking forward to its May 3-5 convention with a bigger, better auction.

A warning: Auction prices are not current values. A listing such as this cannot adequately include the condition of cabinets, chassis, transformers, tubes, the operating status of the set, and the inclusion of incorrect, restored or replica components, etc. Auction prices are the result of the excitement of the auction process, the skill of the auctioneer and the specific interests of the participants. Nevertheless, auction prices serve as useful references and as another element in the value determining process. The possibility of error always exists, and if we are notified, corrections will be reported.

Aeriola Sr.	\$150
Airline horn speaker	130
Arvin, red metal	95
Atwater Kent E speaker	55
Atwater Kent speakers, (3)	(2),60; (1) 75
B&K 500 tube tester	35
Baldwin speaker	38
British 1-tube regenerator	75
Crosley 515D	120
DeWald tombstone	35
Emerson, white beetle	25
Firestone Bakelite	60
Grebe Synchronphase #1	230
Hallcrafters 40's TV	55
Klingsor phonograph	270
Medical quack machine	35
Microphone radio	105
Miller coils, N.O.S., large box	30
Peerless speaker, (2)	43, 48
Philco 38-10	40
Philco 89 cathedral	120
RCA 45T1 radio	90
Records, 78 rpm, boxes, (3)	40, 43, 90
Regency MX-7000	120
Rider's Vols. 1 to 18	390
Sentinel Catalin radio	475
Silvertone tombstone	110
Stromberg-Carlson tombstone	180
Trav-Ler portable, 1925	220
TV tube tester	200
Variac 7.5 amp	30
Zenith 706 tabletop	85
Zenith Art Deco	80
Zenith chairside	130
Zenith Cobra radio phono	80
Zenith sign	120

(William Werzner, 11402 Endicott, Houston, TX 77035)

The Houston Vintage Radio Association (HVRA) holds monthly meetings and special regional events. The "Grid Leak" is published monthly. Dues are \$15. For more information write to: HVRA, P.O. Box 31276, Houston, TX 77231.

More Radio Miscellanea

Stokes' Book Errata List

A.R.C. is pleased to announce that author John W. Stokes has given us permission to make available his errata list to *70 Years of Radio Tubes and Valves*. A.R.C. will be happy to send it to anyone whose request is accompanied by a SASE.

This errata list is included in the current printing of the book (third printing, September 1992). An 8-page al-

pha-numeric index to all tubes and valves in the book will be incorporated into future reprintings, according to George A. Fathauer of Sonoran Publishing.

Anthony Jacobi continues to offer his index to the Stokes' book, including the errata sheet, for \$3.75 ppd. in the U. S. only. A.R.C. described his index in the January 1994 issue, page 19. Index orders may be sent to A.P. Jacobi, 8053 Maywood St., Ralston, NE 68127. (Editor)



Gilbert Radio Apparatus 1919 Catalog Reproduced By Antique Radio Press

REVIEWED BY JERRY FINAMORE

Most collectors interested in pre-1925 radio equipment may know that the A.C. Gilbert Co. was a manufacturer, not only of trains and erector sets, but also of wireless radio equipment from 1919 to 1923. They also know that finding any information or reference material on A.C. Gilbert Co. radio equipment is an extremely difficult task. Thus, Jim Fred's Antique Radio Press reproduction of a rare *Gilbert Radio Apparatus 1919* catalog is good news.

Subtitled "Gilbert Wireless Instructions" by Clarence D. Tuska, this is more than just a catalog. It includes two introductory chapters presenting an elementary course on wireless theory and apparatus. These chapters provide a basic explanation of standard radio components, radio wave principles, radio wave transmission, and radio wave receivers, diagrammed and presented in laymen's terms.

The next chapter then shows how to assemble, install, and operate

A.C. Gilbert wireless apparatus. There are five parts to this chapter, covering a house-to-house wireless set, a receiving set (crystal), an Audion detector, a sending set, and a "build your own" radio parts set. The final chapter covers radio operating, Morse code, U.S. radio stations and regulations.

While the catalog has a nice offering of good early wireless information, it may be difficult to use as a reference since the quality of the reproduction is rather poor, providing little detail of the equipment pictured. The illustrations, which are line drawings, reproduced much better.

Gilbert Radio Apparatus, 1919, reproduced in an 8 1/2" by 11" paperback format, is available at \$10.95 plus \$2.00 shipping from James Fred, Antique Radio Press, RR 1, Box 41, Cutler, IN 46920.

(Jerry Finamore,
1374 Stafore Dr., Bethlehem, PA 18017)



Collectible Transistor Radios From Realtone and SoundDesign — A Photo Guide, By Eric Wrobbel

REVIEWED BY WALLY WORTH

Doubtless many of you have read previous books by Eric Wrobbel on Toshiba, Sony and Regency radios. These books are about the so-called "first wave" radios and were a welcome addition to the information available at the time.

In this new book, *Collectible Transistor Radios From Realtone and SoundDesign — A Photo Guide*, Wrobbel explores the early and prolific products of the "second wave," which covers 1959 through the 1960s and beyond to the 1970s under the new brand name "SoundDesign."

The models are presented in nearly chrono-



logical order, starting with the TR-701, believed to be the company's first effort. Many of the models are stunning in design and, therefore, favorites of collectors. The Realtone TR-870 Satellite is given special prominence because of its styling, its 2-band operation, and the "greenhouse" effect of the dial housing.

A red Realtone TR-870 was my favorite set, but I relinquished it to an avid collector for her Christmas present.

The notations on the sizes of the sets are good: "SP" for shirt pocket and "CP" for coat pocket. However, there should be a notation for the larger sets —

perhaps "HC" for hand carried??

The cover is self-explanatory and neat. Most of the pages are well laid out, although the photocopies of some sets are blurred. Nevertheless, with 60 photos on 16 pages, this book, along with the author's other three books, should be on every avid collector's shelf. The addition of hand-drawn scenes and doodles breaks up the stiff format nicely.

The SounDesign section is comprised of only 5 sets, some handsome and some dogs. Still, we must remember that these sets were produced well into the '60s and '70s when all sets were losing definition anyway.

Published by the author in a 5½ x 8½ booklet form, *Collectible Transistor Radios From Real-*

tone and SounDesign — A Photo Guide is priced at \$7 postpaid. It may be ordered from Eric Wrobbel, 20802 Exhibit Ct., Woodland Hills, CA 91367. (818) 884-2282.

(Wally Worth, 2 W. Elm Ave. Wollaston, MA 02170)

We recently received word that Eric Wrobbel has added another booklet to his series on transistor radios — "Collectible Transistor Radios from Standard." This photo-guide identifies all of the collectible Standard transistor radios, including the 13 Standard Micronic Rubys. Priced at \$7 and in the same 5½" x 8½" format as the other booklets, it may be ordered from Wrobbel at the address above. (Editor)

Radio Broadcast Quiz — Part 2

BY DAVE CROCKER

Now that you've had time to get over the challenge of the first radio quiz, which appeared in the July 1995 issue, here is Part 2. Sorry if Part 1 drove you a little crazy, as August Stellweg indicated in the cover letter to his list of answers — "I could not get the answers to two of the questions, but had to give up to preserve my sanity and get back to normal living."

The answers to Part 1 appeared in the October 1995 issue. Perhaps Part 2 will result in a little less loss of sleep.

We include below numbers 36 and 37, which were inadvertently left out of Part 1. Send your answers to Radio Quiz, c/o *Antique Radio Classified*, P.O. Box 2, Carlisle, MA 01742. Answers to the quiz, along with the names of top responders, will be published in a later issue of A.R.C.

36. Who played Henry Aldrich's father?
37. What was Henry's friend's name?
41. What were the children's names on "I Remember Mama"?
42. What was the name of the majorette on "Super Circus"?
43. Who sponsored Jack Armstrong?
44. What was Jack Armstrong billed as?
45. Name the witch on "Kukla, Fran & Ollie."
46. Who worked the puppets on that same show?
47. What was Fran's last name?
48. What was the Fat Man's fortune?
49. What was the name of Papa David's book store?
50. What was Papa David's daughter's name?
51. What were the listeners called on the "Tom Mix Show"?
52. Name the two boy adventurers on the "Mickey Mouse Club."
53. Name Gene Autry's horse.
54. Name Hopalong Cassidy's horse.
55. What was the Jeep called on the "Roy Rogers Show"?
56. Name the dog on that same show.
57. What was the name of Sky King's air plane?

58. What was the announcer's name on the "Buster Brown Show"?
59. What happened when Froggy plunked his Magic Twanger?
60. Name the cat on this show, and what instrument did he play?
61. Name the show starring Foodini and Pin Head.
62. Who sponsored that show?
63. What was Mr. Bluster's full name?
64. What was Mr. Bluster's cousin's name?
65. What was the princess' name on "Howdy Doody"?
66. Who played "Our Miss Brooks"?
67. What was the name of Miss Brooks' boyfriend?



68. What was the principal's name on that same show?
69. Who was the leader of the "Space Cadets"?
70. Name the announcer on Groucho Marx's quiz show.
71. What was the name of Groucho's show?
72. Who sponsored the "Range Rider"?
73. What was Mr. Dithers' wife's name on "Blondie"?
74. Where was Superman born?
75. What was John Cameron Swayze's program called?
76. On what street did the "I Remember Mama" family live?
77. What was the name of "The Millionaire"?
78. What was the name of Tom Terrific's dog?
79. Who was Tom's arch enemy?
80. What was the name of Ozzie Nelson's neighbor?



RADIO MISCELLANEA

"Antique Radio Classified" invites its readers to contribute letters and information for inclusion in "Radio Miscellanea" and elsewhere in the magazine. The topic should be of general interest and sent to A.R.C., P.O. Box 2, Carlisle, MA 01741. All material submitted should be verified for accuracy and may be edited for publication, which is not guaranteed. See the masthead for more details.

Words From Abroad!

Fantastic Magazine

Dear Editor:

I have been a subscriber since June 1995. I am very happy with your fantastic magazine and your services. I receive my magazine promptly by air mail each month! Aitor Elejabaitia, Canary Islands, Spain

Letter from Israel

Dear Editor:

Even though we seem to be at war and the national mood is very down, and it is dangerous to leave home these days, it is always refreshing to read A.R.C. Thank you for a wonderful magazine that gives lots of opportunities to collectors: important information, connection with other collectors worldwide, and super deals.

I hope that the overall mood here will rise because the largest exhibition of antique radios, commemorating 100 years of radio, is opening March 31, 1996, in the National Museum of Science of Israel. Highlights of the exhibit are transmitted through the Internet.

I want to thank all the people who send me letters, prospects, and news from the U.S.A. Anyone who comes to Tel-Aviv is welcome to get in touch with me, and I'll be glad to show him my museum.

Thanks again for your support. Happy collecting.
Bruno Pinto, Tel-Aviv, Israel

Tubes Manufactured in Russia

Dear Editor:

Your readers will be interested to know that the Defense Enterprise Fund (DEF) is sponsoring a Russian/American joint venture, which will result in the production of electron power tubes and glass vacuum tubes for civilian applications worldwide. Old tube types will also be manufactured.

Svetlana Electron Devices, Inc., an American Corporation controlled primarily by R&G International of Huntsville, Alabama, owns a major share of the privatized electron tube complex in St. Petersburg, Russia. In the past, Svetlana's military product lines included electronic components used in Russian military radar and ocean-deployed offensive and defensive equipment. The DEF investment in Svetlana will promote defense conversion in Russia and will contribute to the company's growth in the rapidly expanding foreign industrial and medical markets.

For additional information, call Mr. George Badger at 1-800-578-3852 or 415-233-0429.

Wanted Ad Success

Dear Editor:

I must have received over twenty responses to my ad for Farm radios. I have bought at least eight as a result of one ad!

Charles W. Rhodes, Alexandria, VA

KDKA — The Most Powerful?

Dear Editor:

The March article on KDKA says that KDKA broadcast at a constant 50,000 watts, the most powerful wattage allowed on the AM band. This is true with one exception—Crosley Station WLW operated at one time at 500 Kilowatts until the complaints about blanketing over wide areas forced the FCC to reduce the power to the usual 50 kilowatts.

Harry Cap, Bridgewater, MA

In 1925, the Federal Radio Commission did grant Crosley Station WLW an experimental license to change WLW from 50,000 to 500,000 watts. (See A.R.C., November 1992). A few years later, this license was revoked for the reason stated by Mr. Cap. (Editor)

Shellac and Lacquer Refinishing

Dear Editor:

I'd suggest to anyone interested in refinishing antique radio cabinets that they get into the easiest and best refinishing media there are, especially for amateurs—shellac and brushing lacquer. I'd also suggest that 000- and 0000-grade steel wool will do everything in the refinishing process that various grit sandpapers allegedly do, and at less cost and easier availability. A very good book on the proper use of shellac and lacquer is *Furniture Finishing & Refinishing*, published by Sunset Books.

Two excellent books—Johnson's *The Weekend Refinisher*, available from A.R.C., and Grotz's *From Gunk to Glow or The Gentle Art of Refinishing Antiques and Other Furniture*—reject the use of spar varnish for interior furniture, as suggested by James Newton in "Three Refinishing Secrets" (A.R.C., September 1995). Use of spar varnish can be so complicated and potentially ruinous that it quickly discourages a beginner to the point of giving up on what can be an almost simple, as well as highly enjoyable, pastime.

Tom Seller, Harrison, MI

Doyle's Dials are Dandy!

Dear Editor:

I recently tried one of the A.R.C. advertisers offering a needed restoration service. Doyle Roberts advertises reproducing dial covers for old radios. He has a list of covers he has patterns for, and these can be ordered from a price list by radio brand and model number. He can make others if supplied with a suitable pattern.

I had a Truetone D-727 with a broken plastic dial cover. I sent the broken plastic cover in its bezel for replacement and installation in the bezel. An excellent replacement was returned to me in only one week! It looks like a nice original. I would recommend this dear needed service when restoring those 1930-1950 radios with bad dial covers. Contact Doyle Roberts at HC 63, Box 236-1, Clinton AR 72031. (501) 745-6690.

Charles R. Combs, Albany, MO



CLASSIFIED ADVERTISEMENTS



WANTED: Wooden cabinet for UST Clearsonic Series Radio Model 2L-2001 or maybe 7L-2001 (can't quite make out the first number or letter), made by United States Television Mfg. Corp., New York, New York. John Phipps, 1412 Navaho Trl., St. Charles, MO 63304

WANTED: World Radio Handbook, Broadcasting Yearbook, other radio station lists, before 1980. Ralph Marson, 8070 Busch, Centerline, MI 48015. (810) 754-3808

WANTED: Philco 20 cathedral. Butch Kmet, 1473 S. Lincoln, Salt Lake City, UT 84105. (801) 467-2904

WANTED: Have two UTC LS57, gray & black, buy or swap to get two alike. Alan Douglas, Box 225, Pocasset, MA 02559

WANTED: Pre-WW2 amateur transmitters/transmitter components. Commercial/home brew. George Flanagan, W2KRM, 42 Cygnet Dr., Smithtown, NY 11787. (516) 360-9011

WANTED: Theodore (T.R.) McElroy oscillators, tape machines, Mac keys, key boxes, catalogs, flyers. Tom French, W1IMQ, The McElroy Collector, 151 Barton Rd., Stow, MA 01775. (508) 562-5573

WANTED: Microphones made for dispatch use, such as Shure 520, 707, Astatic T-3, JT-30, EV 605, etc. All conditions. Thanks! Dennis Gruenling, 26 Dupont Ave., Piscataway, NJ 08854. (908) 752-5737

WANTED: Mazda light bulb display base with Edison or Mogul screw sockets. Also, old Thomson-Houston bulbs and sockets. Send description and price. Richard Bock, 1001 Meadow Ln., Fortuna, CA 95540

WANTED: Owners manual for the Fisher Custom 60 console, 3 chassis, 24 tubes, (4) ea. 6B4's. John C. Allport, 1140 Canterbury, Liberty, MO 64068. (816) 781-6561

WANTED: Motorola transistor radio X14W, white. Also comes in black (E) and Red (R). David DiPetro, 1321 20th St., Aliquippa, PA 15001

WANTED: Info on 30s theater horns: projectionist's handbook or catalog showing WE or I.P.C. models. How much did a 555 driver cost? I'm collecting 555 serial nos., over 55,000 with dates stamped, or any 555W. When was the last 555 made? With what tools/fixtures/processes? How many theaters did ERPI equip. by the mid-30s? Alan Douglas, Box 225, Pocasset, MA 02559

WANTED: Philco 37-102 Code 121 2-piece (about 9 1/2" dia.) plastic dial. Need rear piece but will buy entire chassis. Tube socket adapter kit MX-949/U for military tester 1-177-B. You name it and I'll pay it. Donald G. Reardon, 14116 Goodrich Dr. NW, Gig Harbor, WA 98329

WANTED: Trophy Cup presented by Shortwave Craft or other magazine. Does anyone have one? Harry Blessy, N9CQX, 9S740 Clarendon Hills Rd., Hinsdale, IL 60521. (708) 789-1793

WANTED: Tube hi-fi equipment. McIntosh, Altac, Marantz, Fisher, Scott, Dynaco, Heath, Leak, Quad, Audio Research, Conrad, Johnson, etc. Also audio tubes. KT-66, KT-77, KT-88, Western Electric 300A, B, 350B, 274, 275, EL-37, EL-34, 211, 845, 805, etc. Sonny Goldson, 1413 Magnolia Ln., Midwest City, OK 73110. (405) 737-3312. Fax: (405) 737-3355

WANTED: 1938 Zenith robot dial 12S267 console. Mark Hewitt, 6659 Tipperary Trl., Roscoe, IL 61073. (815) 623-8729

.....
• A.R.C. Advertising Policy •
• Sellers and Buyers, Please Note! •
• Advertising is accepted only for early items •
• related to radio, communication, etc. All •
• items must be described fairly; reproduc- •
• tions, reprints and not-original items must •
• be so identified. Advertisers must agree to •
• respond promptly to inquiries and orders, to •
• resolve problems promptly if the buyer is not •
• satisfied, and to comply with a buyer's •
• refund request on unaltered returned items. •
•.....

WANTED: Crystal sets, collection now at (357) pieces; seeking more. Erwin Macho, Ambrosweg 17/A/8, A-1230 Vienna, Austria

WANTED: Sony car radio Model XR-7300 FM/AM cassette car stereo, in good condition w/mounting sleeve. Geo. Boettcher, Jr., PO Box 100, Dingman's Ferry, PA 18328. (717) 686-1200

WANTED: Catalin part for Fada 659/652 Temple radio, lt. green bezel. James Craft, 101 Carleton St., Saint John, New Brunswick, Canada E2L 2Z2. (506) 849-7787

WANTED: Globe King 500, A, B or C AM transmitters, working or near. Average books, fairly priced. Call: Terry Collins, KB9AUP, 18 N. Tomahawk Ave., Tomahawk, WI 54487. (715) 453-4633, eves. (715) 453-3707, wkdays

WANTED: Weston wood-based or wood-enclosed meters with serial # less than 500. O.B. Shallenberge five dial meters, both any condition - your price. Ye Olde Meter Cellar, Leonard W. Cartwright, 379 Russet Dr., Sunnyvale, CA 94087. (408) 739-6025

WANTED: Millen 90801 exciter/transmitter power supplies. Hallicrafters SX-11 dial plate. Bliley 100Kc crystal FM-6-S. National SW-3 first model, 6- and 2-volt versions. Plastic dial escutcheon for RCA 816K. Dean Showalter, WA6PJR, 72 Buckboard Rd., Tijeras, NM 87059. (505) 286-1370

WANTED: Speakers for the following Zenith chassis: 7S204, 7S232, 7S240, 7S242, 7S258, 7S260, 7S261. Also AK-480. Need chassis and speaker for AK-317 console. Jack Mattox, 1443 Platte Ave., Alliance, NE 69301. (308) 762-8831

FOR SALE: Dinky TVs and a few very old tiny tape recorders: Tel Tape, boomerang shape, red acetate case, W. German, earliest I've ever encountered, new in box with manual, warranty, packing paper, headphones and bullet mic. Mohawk Midgetape, blue version, metal case, pentagonal metal cassette, nice condition. Phono Trix, 6 1/2" x 4 3/4", steel case, W. German, cute, carrying case. Cole TR400 Dictator, Japanese super quality steel case, 7" x 6 1/2", reverse painted VU meter, perfect shape with leather case. Grundig Versatile II roll top and also model Niki, maroon & pink w/gold trim. Craig 212 in the box and more Japanese units from the 60s. Entire collection of tiny TVs with parts and new parts. Send SASE for list including Singer TV6U, Symphonic 5050, Sony 301 (no knobs). Robert Rogers, 1407 Riverside Rd., Old Hickory, TN 37138. (615) 847-2475, 4 pm CST

FOR SALE: Splittorf Model R-V-695, less cab., NT. Stromberg-Carlson Model AU-58B 6L6 audio amp. **WANTED:** Stancor 10P transmitter. National HRO 5A1 receiver, UTC LS-57 output transformer. Thanks! Tom Smith, N5AMA, 13034 Elmington Dr., Cypress, TX 77429-2062. (713) 376-3436, evenings

FOR SALE: Geissler tubes and Crookes tubes. G. Faassen, Heideweg 1, 5953 T.L. Reuver, Holland. Tel: 0031-4704-1316. Fax: 6683

FOR SALE: Philco owners need Receiver Saver 200 to extend tube life. SASE brings brochure. Jeff Kincaid, WA6BIL, 5529 West 140th St., Hawthorne, CA 90250

FOR SALE: Sams (AR) Auto Radio Series AR-6 to AR-320, 1955-1980 - \$4 ea. ppd. Also MHF and other Sams. Jesse Armstrong, 220 Oakdale, Pasadena, TX 77506. (713) 473-8925

FOR SALE: 1996 cleanout time. Making list(s) on items to ship. Pick up, cash and carry, and offer. SASE for detail sheet. F. Krantz, 100 Osage Ave., Somerdale, NJ 08083-1136

FOR SALE: CRT's, N.O.S., your choice - \$15 plus S&H: 3ADP1, 3AP1, 5ABP7, 5BPIA, 5UP7, 5VAHP4. Ed Crockett, 128 Buccaneer Dr., Hattiesburg, MS 39402. (601) 264-4755. Fax: (601) 264-0226

FOR SALE/TRADE: I have located the 1955 Verbarnatix reverberation auto system N.O.S. in the original box, complete with manuals, warranty cards, speaker, control head, and Motorola amplifier; this was the hottest auto accessory in the late 50's that made a car sound like an echo chamber - \$275. Call: Larry Drago, 383 Lincoln Dr., Cheshire, CT 06410. (203) 272-6030

FOR SALE: B&K tube tester Model 700 - Offers. **WANTED:** Back for Belmont 6D111. Dave Mock, 3 Larkspur Pl., Montpelier, OH 43543. (419) 485-3933

FOR SALE: Frequency Meter BC-221-AK 125-20,000 Kc, original calibration book, portable, battery-operated - \$100 ppd. Carl Hackenson, 31 Hixson Farm Rd., Sharon, MA 02067. (617) 784-8834

FOR SALE: Atwater Kent breadboards, all like new & operating condition: #4700 10C 5-tube - \$600; #4340 Radiodyne replica beautiful - \$1,350; #3975 3-tube - \$800; #4445 5-tube varometer 9 - \$850. Photos available subject to prior sale. Paul Thompson, 315 Larkspur Dr., Santa Maria, CA 93455. (805) 934-2778

FOR SALE: Unusual colored prewar, plastics by Detroit, Kadette, Emerson, Sparton and many others. This is a rare opportunity to own truly investment quality radios. Send a LSASE for free full color list to, or call: Mark Alzapiedi, 13 Fitch Farm Ln., Sterling, MA 01564. (508) 368-7223

FOR SALE: Radiola RT, vg - Best Offer over \$1,200. Glenn Piar, 4040 Allard Rd., Medina, OH 44256. (216) 239-1857

FOR SALE: Pries straight nine radio, chassis only - \$50 + UPS. Larry Baehl, 1555 Fuquay Rd., Newburgh, IN 47630. (812) 925-9913

FOR SALE: Sams Sets - individually, will trade, hundreds - many under \$100. SASE w/wants or list. Gary A. Micanek, 226 Henry Ave., Manchester, MO 63011. (314) 227-7046

FOR SALE: Book entitled "Jim Clark's E.H. Scott Radio Collectors Guide (1925-1946)" - \$32.95 shipped. Jim Clark, 3520 Okemos Rd., #6, Okemos, MI 48864. (517) 349-2249

FOR SALE: Radio collection, approx. (538) table models, floor models, consoles, radio/phone, clock radios, cathedrals, coin-operated, chairside, lots of tubes and misc. All or none. Jack Svela, 56450 Old Portland Rd., Warren, OR 97053. (503) 397-4890

EXTRAVAGANZA '96

Unique Grebe equipment and related memorabilia for our Grebe Exhibit wanted.



Interested in participating?

Contact:
Grebe Exhibit
Coordinator
Fred Schultz at
(219) 894-3779



10 BAND MINIATURE SHORTWAVE RADIOS!

Listen to the entire world! This unusual shortwave radio, 7 x 1 1/4 x 3 1/2 inches, is one of the smallest and most sensitive radios ever built. It has AM/FM/MV and 7 short-wave bands; you can listen to the entire world! It uses only two AA batteries or 3-volt adapter (not included). The cost including shipping and insurance is: Only \$35.00 per set N.I.B. Quantities are limited! If you purchase 2 or more, 10% discount will apply!

Call 908-679-8026, Fax 908-679-2485.

Mail your check or money order to:

R.G.B. Enterprises

P.O. Box 5367, Old Bridge, N.J. 08857, U.S.A.

WANTED: Old hi-fi speakers auditorium & theatre speakers, corner speakers, coaxial/triaxial speakers. Jensen, Altec, Lansing, Western Electric, Tannoy, Lowther, Electro-Voice, RCA, IPC, Heath. Also horns, drivers & crossovers. Sonny Goldson, 1413 Magnolia Ln., Midwest City, OK 73110. (405) 737-3312. Fax: (405) 737-3355

WANTED: I pay the following for Western Electric. Tube sockets 100M and other types - \$35 ea. 274A or 274B with lettering engraved in base, not yellow print, used - \$130. 274A balloon or globe-shape, used - \$175. Tube book, any volume - \$75. All WE tubes wanted, new or used. Call for my offer on any tubes you may have. Tim Metz, 221 Wheatland, Fairview, OK 73737. (405) 227-2456

WANTED: Type 50/250 tubes, large ST or Globe. 2A3 Single plates. Large quantity N.O.S. Japanese tubes used for audio amplifier. Working condition "canned electronic block" for Radiola 24, 25, 26, 28 and 30. Ryo Kobayashi, 2-4-6, Miyonodai, Sakura, Chiba, 285 Japan. Phone/Fax: 81-43-461-2297

WANTED: 6KD6, 6SN7GT, 5881, 6DJ8, 6922, 7308, 8223, 6FQ7, 6GU7, CCa; manuals Robert Koerner, NY11/7, 8910 N. Camino de la Tierra, Tucson, AZ 85742. (502) 742-6130. Fax: (502) 797-6925

WANTED: Paperwork for Philco 38-4, Zenith 1103 (11S474 chassis?). Ernie Mahler, 8260 S. Willow Ct., Oak Creek, WI 53154. (414) 768-8868

WANTED: Top prices paid for scarcer pre-1926 items. Horn speakers, crystal sets, detectors, wireless, battery sets or what have you? Ed Bell, 5311 Woodsdale Rd., Raleigh, NC 27606. Fax/Ph.: (919) 851-1517

**PHONE NUMBER FOR
ANTIQUÉ RADIO CLASSIFIED
(508) 371-0512**

**Best time to call is weekdays:
8:30 am to 6 pm Eastern Time**

(Please no classified ads by phone. Thanks!)

WANTED: Catalin radios and parts, large Addison Model 5, yellow knobs; DeForest D-10 coils; black Burns horn bell, any condition; pre-1928 radios; xtal sets; Catalin items. John Pisarski, 114 Evans Rd., Norristown, PA 19403. (610) 539-0756

WANTED: Dial face for Coronado Model 686. This is a 1930's wood table radio with a black oval dial face. Tom Boyd, 1014 B Woodland Ave., Austin, TX 78704. (512) 444-7410

WANTED: Vibrator xformers, Merit P4078, Stan P6472, Zenith 95-914. Also auto radio volume controls & IF coils. Fred Cranshaw, 1624 Bitter Ck., Garland, TX 75040. (214) 494-4917

WANTED: Philco 46-1209 chassis. Will consider purchasing entire set if needed. Will pay top dollar and shipping. Scott Starr, 2845 Page Pl., Montgomery, AL 36116. (334) 281-0960

WANTED: Philco Radiobar Model 610; 37-620; 38-10. Any others? Can pickup. Tom Gwilt, 422-12931 Railway Ave., Richmond, British Columbia, Canada V7E 6M5

WANTED: Urgently needed: Original ads or good photostats of Scott Philharmonic and Zenith Stratasphere. Thanks! Rick Ammon, 1249 Solstice Ln., Fort Collins, CO 80525-1239. (970) 221-4001

ORDER TODAY!

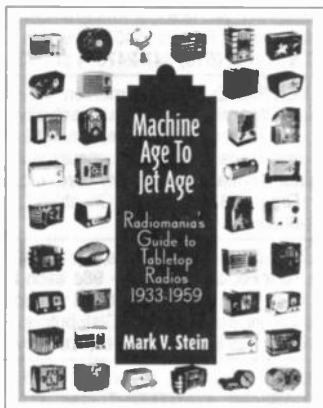

**OVER 250 PAGES
1,400 RADIOS**
Most not in any other reference
**EACH RADIO INDIVIDUALLY PICTURED,
IDENTIFIED AND VALUED**

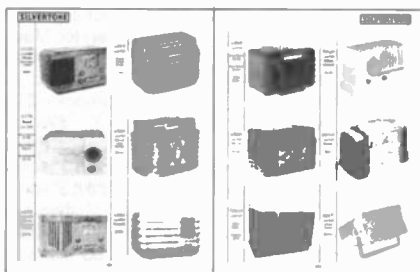

**Special For
ARC Readers!**

\$24.95 List Price

Now \$21.95!

**Only When Purchased from Radiomania Directly
All ARC Orders Autographed by Author**

Add \$1.75 Shipping U.S.A., \$3.50 Canada, \$5.00 All Other Countries

Send Check or Money Order Payable to:

**Radiomania
2109 Carterdale Road, Baltimore, MD 21209**

Maryland Residents add 5% Sales Tax. Allow 2-4 Weeks for domestic orders.



Radiomania™

FOR SALE: Transistor Service Manuals, numbers one through five. RCA presentation pen and pencil set, Cross with cloisonne logo in box. Philco lapel pin, Hi Hat Club top hat and swirl in cloisonne. Key chain for Southern Bell, brass miniature WE square base telephone. Elvis radio microphone with cord. Best offer or trade for postwar Flyer, Marx, or Kusan electric trains or accessories. Robert Rogers, 1407 Riverside Rd., Old Hickory, TN 37138. (615) 847-2475, 4 pm CST

FOR SALE/TRADE: 1950's Emerson Wondergram record player; this mini hand-held unit actually plays 78 & 45 rpm records and sounds beautiful; it is battery-operated and made in England, comes with leather case original manual and warranty card, etc. - \$300. Call: Larry Drago, 383 Lincoln Dr., Cheshire, CT 06410. (203) 272-6030

FOR SALE: Axial lead electrolytics, fresh new Nichicon miniature 10 mFd. at 450 VDC - 98¢ each for 10 or more, includes P&H. Many other types in stock, Write, phone, or fax for free flyer. DH Distributors, PO Box 48623, Wichita, KS 67201. (316) 684-0050, v/f

FOR SALE: Crosley 124, restored - \$175. Vintage CB's - LSASE list. **WANTED:** Theremin. Mint tube CB's. C. Zafonte, RFD 1, Box 75, Fort Kent, ME 04743. (207) 834-6273, eves/weekends

FOR SALE: Test equipment: Hickok 209A VTVM, w/book - \$50; Eico 232 VTVM, no book; Sencore FE20 VTVM, w/book - \$50; Precision EV10A VTVM, w/book, needs work - \$20; Sencore TF17A transistor checker, w/book - \$35. Tube checkers: EMC 201, needs work - \$15; Sencore TC 136 tube checker, no book - \$35. Generators: Sencore CG12 color, no book - \$25; B&K 1245 color, no book - \$30; Eico audio generator 377, no book - \$20; Jackson TVG2 TV signal generator, w/book - \$40; old Clough Brengle Model OC-A signal generator, w/book - \$30; old RCA signal generator Model TMV-97C, no book, battery operated - \$25; old Philco signal generator Model 088, no book, battery operated - \$25. Picture tube checkers: Eico 633, w/book - \$50; Sencore Big Mack Model CR168, w/book - \$75; old Philco Model 8500, w/book - \$25. Oscilloscopes: Philco 2" scope Model 7019, w/book - \$35; old RCA 3" scope Model 155A, no book, no CRT - \$25; Heathkit 3" scope Model 0L1, no book - \$50; Hickok 5" scope Model 506A, no book - \$75; RCA 7" scope Model 56A7, no book - \$60. Plus UPS charges. J.J. Papovich, 53 Magnolia Ave., Pitman, NJ 08071. (609) 582-8279

FOR SALE: Scott Chippendale Grade, cabinet only - \$1,500 or trade for narrower Scott cabinet. Gary Glazier, 3031 El Caminito St., La Crescenta, CA 91214. (818) 248-1693

ARBE-III - Universal Battery Eliminator

\$149.95 Shipped USA

Contact:

Antique Radios Inc.

Box 6352, Jackson, MI 49204

(517) 787-2985 or

Fax (517) 782-7422



FOR SALE: CRT's N.O.S. your choice - \$15 plus S&H: 3ADP1, 3AP1, 5ABP7, 5BPIA, 5UP7, 5VAHP4. Ed Crockett, 128 Buccaneer Dr., Hattiesburg, MS 39402. (601) 264-4755. Fax: (601) 264-0226

FOR SALE: Speakers: (2) 9" for Radiola 100A - \$20 & \$30. Dual Magnavox 12" 250-ohm electromag. - \$60. Brass RCA Radiola escutcheon, 6 1/2" x 2 1/2" - \$12. Black Bakelite knobs; 1/4" with set screws, (3) 0-100 dial. (2) scalloped with 2 1/8" skirt - \$5 ea. Plus S&H. Maureen Martin, 1407 Memory Ln., Lutz, FL 33549. (813) 949-1835

HAS YOUR SUBSCRIPTION

EXPIRED?

It has if your mailing label reads
"EXP=APR96" or earlier.
Renew now!

*BONUS: Renew before
your "EXP" month and receive
13 issues per year instead of 12!*

Renewal rates are:

\$36.95 for Second-Class Mailing

\$53.95 for First-Class Mailing

(Two-year renewals are twice above rates.)

FOR SALE: (60+) Zenith Trans-Oceanics & Universals, all models. Hallicrafters S40, S40B, SX25, SX99, SX100, SX110 & speaker, SX120, SX130 & R51, HT32B xmitter. Motorola R390A, repaired & checked. RCA receiver AHA9WU8035-F10. Call: Alan Carpenter, 6850 N. Camino De Fray Marcos, Tucson, AZ 85718. (520) 575-1960

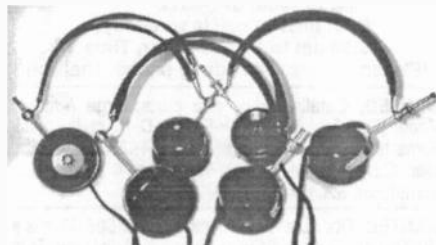

FOR SALE: Headsets w/improved cases containing N.O.S. elements from highest quality sound-powered telephone equipment. Listening tests indicate 200% advantage over next best balanced armature elements (recent military surplus) & 400% advantage over Baldwin's best! Headset w/matching transformer - \$100. Rewound to eliminate transformer - \$200. John Stanley, 6156 Summit Ave., Brown Summit, NC 27214

FOR SALE: Mint cathedrals: Philcos #70 - \$400; #90 - \$700; #20 - \$335. Pathé - \$475. List LSASE. Richard Bednarcik, 28 Steele Ave., Lincoln Park, NJ 07035. (201) 694-6374

FOR SALE: Large collection of wood and plastic radios, some transistors - \$2,000 takes all. Bring pickup truck. No shipping. No lists. Vince Bomba, 331 Akron Ave., Pittsburgh, PA 15216. (412) 344-7926

FOR SALE: DeForest knob, black and white - Best Offer. Guild 638B - \$140 plus UPS. Gerald Kitchens, 116 E. South, Oreana, IL 62554. (217) 468-2540

WANTED: Old guitars, guitar amplifiers, microphones, tube mixers, tube compressors, reverb units, etc. Fender, Gibson, Vox, Puigec, Altec, Gretsch, RCA, Newmann, etc. Sonny Goldson, 1413 Magnolia Ln., Midwest City, OK 73110. (405) 737-3312. Fax: (405) 737-3355

WANTED: One or more Bruno 4-pin plug-in coils. Dick Lowe, Box 296, Santa Clara, CA 95052-0296. (408) 984-1555

WANTED: Broadcast-band coils for grid dipmeter Heath Model GD-1B. Gale Roberts, Box 152, Clyman, WI 53016. (414) 696-3491

WANTED: Radios & equipment made in New Jersey. Bill Hossfield, 50 Oakwood Dr., Ringwood, NJ 07456. (201) 839-9053

WANTED: RA-88 rectifier, long rectangular aircraft style by Western Electric. Jeary Vogt, 3 Brampton Rd., Malvern, PA 19355. (610) 296-2162. E-mail: Jeary@aol.com

WANTED: Speaker for Majestic Model 20. Gilbert Simpson, 18 Beechwood Dr., Ansonia, CT 06401

WANTED: 1920's student or instruction manual from the Coyne Electrical Radio School of Chicago. Tom Arbogast, 3743 Painesville Warren Rd., Southington, OH 44470. (216) 889-3399

WANTED: QST's before 1923 to complete my collection. Edward J. White, WA3BZT, 809 Seymour Rd., Bear, DE 19701-1121. (302) 322-1313

WANTED: Philco 89 Code 123 chassis with tubes not butchered, working or not, (2) Moper 805 auto radio for trade or sale - \$85. Carlos Gimenez, 15091 Shamrock Dr., Fort Myers FL 33912. (941) 482-0198

WANTED: Very good to mint condition issues of Sidell's Classic Plastic Radios of the 1930's and 1940's. Bob Zuch, PO Box 4242, Chatsworth, CA 91313. (818) 719-2608. Fax: (818) 719-2309

WANTED: Knobs for Zenith TV, G2420 Mayflower, (F.O.S., p. 196). Joe Quinn, 30511 Manhasset Dr., Bay Village, OH 44140. (216) 835-8420

WANTED: Information or copy of manual on Midland Mod 23-126 power/swr meter. Thanks. Don Swanson, 8070 Briar oak Dr., Pensacola, FL 32514-7830

WANTED: I'm looking for the following complete items: radio chassis and Electrodyne speaker for Fada Model 75, preferably speaker in good condition, no cracked pot metal and no torn cone, (3) cathedral Philco 80JR and Philco 60 chassis & speakers with speakers in good shape, no torn cones; Philco 38 speaker with good cone not torn, Philco Predicta front face covering & UHF white inner tuning knob for 17" tabletop mcdels. If anyone knows the whereabouts of these items, please write me at this address: Raymond Harms, 14710 U.S. Highway 231, Union Grove, AL 35175

WANTED: Original paper brochures, stock certificates & ephemera of television pioneer John Logie Baird for family archive. Top \$ paid. Iain Baird, 198 Spadina Ave., #201, Toronto, Ontario, Canada M5T 2C2. (416) 504-2489

WANTED: Cabinet and dial knobs for a Hallicrafters SX100 or SX99 or SX96. Will consider a junk radio for these parts. H.I. Stark, K9UBL, 3215 S. Meridian St., Indianapolis, IN 46217. (317) 788-1210

WANTED: CT100 cosmetics. Tell me what you've got! Paul Garbarczyk, 7805 S. McVicker Ave., Burbank, IL 60459. (708) 599-8823

WANTED: Manuals (or copies) for Heath IG82 sine square generator, Conar 250 oscilloscope. Also looking for manuals, sales literature for Edison Voicewriter cylinder dictation machines, shavers; blank recording disks 10" or smaller for record cutting machines. Larry Townsend, 423 Indian Creek Bay, Coolin, ID 83821. (208) 443-2868

A. G. Tannenbaum

Electronic Service Data

PO Box 386, Ambler, PA 19002

Phone: (215) 540-8055

Fax: (215) 540-8327

THE



FOR

**Vintage Parts &
Service Data
1920's - Present**

Free Catalog

Credit Cards Welcome

RADIO GRILLE CLOTH

Now **34** patterns & color combinations
are available to suit most radio needs!
55¢ LSASE for samples

**More Good News!
Even More Variety!**

- 1) **Three** new patterns: one for Crosley Repwoods, one for 100A speaker, and a great new console pattern.
- 2) Selling off my remaining stock of green Philco V cloth, Now only \$15 for a full 1 1/2 square yard piece. Enough for up to 10 sets.
- 3) Still offering sampler packages of 5 or 10 pieces of cloth for \$20 and \$38, postpaid. See prior issues of A.R.C. for details, or call.

**MICHAEL KATZ
3987 DALEVIEW AVENUE
SEAFORD, NY 11783
(516) 781-6202 (EVENINGS)**

**6th Annual VINTAGE
RADIO
CONSIGNMENT
AUCTION**

Saturday, April 13th, 10:00 am

Several radios have already come in & quality consignments are still being accepted. Pictured is a 57" tall 26-tube Scott radio in a carved Belgium case & a Stromberg Carlson chair-side. Also consigned is a Fada model 1000 "Bullet" catalin. Several hundred radios are expected. Call toll-free,

1-800-862-6674

for details on consigning your fine radios. Radios will be coming in right up to auction day, so many surprises are expected. Plan now to attend & call with any questions. Thank you. 10% buyers premium. Announcements auction day take precedence over previous printed material. Absentee bids accepted before auction day. Visa & Mastercard accepted. Lunch available auction day.



ANTIQUE AUCTION CENTER, INC.

203 S. 18th Ave, PO Box 476, Marshalltown, Iowa 50158
PH 515-752-0600 * FAX 515-753-0226

Auctioneers: Gene Harris & Julie Harris Stern, CAI
46 Years Serving America In Iowa, 1950-1996



FOR SALE/TRADE: Trophy baseball radio, circa 1941 - \$475. Maroon Crosley 56-TD Duette - \$225. Pilot TV 37 w/3" screen in very nice condition - \$300. Echo-phone cathedral w/front thumb dial - \$275. Call: Larry Drago, 383 Lincoln Dr., Cheshire, CT 06410. (203) 272-6030

FOR SALE: (902) Sams Photofact Sets 1-1000, missing Zenith folders, pickup only - \$200 OBO. Stan Sarch, 1105 Middleton St., Madison, WI 53717. (800) 831-2266. Fax: (608) 831-7581

FOR SALE: Health forces me to sell my radio repair inventory. Tubes, resistors, capacitors, parts, test equipment to be sold as a lot. Send #10 SASE and \$1 for 6-page computer-printed list. Michael Franzen, 3618 Effie St., Los Angeles, CA 90026

FOR SALE: Early Baird 30 line TV prototype, empty metal cab. - Offers. Uncle Tom crystal set by Grafton China Co., rare - Offers. Jim Taylor, G4ERU, No. 5, Luther Rd., Winton, Bournemouth, BH9 1LH United Kingdom. Tel./fax: 01202-510400

FOR SALE: H. H. Scott 310C Stereomaster tuner - \$40. Scott 399 multiplex receiver - \$115. Scott 233 integrated amp Stereomaster integrated amplifier - \$75. Fisher 400 AM/FM receiver - \$60. Ed Ellis, 1559 S.W. 23 Ter., Deerfield Beach, FL 33442. (305) 421-9999

**FAX NUMBER FOR
ANTIQUE RADIO CLASSIFIED
(508) 371-7129 - 24 hours a day
Ads - Subscriptions - Book Orders
See inside front cover for details**

FOR SALE: Tube tester Supreme Model 599-A, excellent working condition - \$60 postage paid. Call: Don Rathbun, 27851 Bruno St., Hayward, CA 94544. (510) 783-1841

FOR SALE: Oscilloscope, Tektronix Model 535 dual trace, works - \$275. Oscilloscope Heathkit Model 0-11 5-inch 5 MHz, works - \$125. Typewriter, Sears Electric w/spell-check Model 2 - \$15. Harry L. Brown, 4861 Tom Fall Rd., Baxter, TN 38544. (703) 243-0435

FOR SALE: General 5A5 black Bakelite with white handle and trim, vg - \$115. Admiral 15D5 Deco Bakelite, excellent - \$100. **WANTED:** Junker GE 250 or 350 portable for parts to complete restoration. Barry McDaniel, 6 Pecos Ln., Little Rock, AR 72212. (800) 755-3326, days

FOR SALE/TRADE: A lot of WWII tubes, all very good: Type DCH11 (one), DL 11 (one), DF 11 (four), DAF 11 (five) specific for Siemens K 32 GEB - Best Offer. VE301 B people WWII radio for battery and does play with tubes. DKE 38 B WWII radio with swastika for battery and does play with tubes, both radios are in good condition and very rare. **WANTED:** Magnavox speaker with tubes Type A1-R, A2-R and A1, all with amplifier. Which of you have a speaker Type King Am-pi-tone earphones or similar? Reiner Staffeldt, Leydenallee 90, 12167 Berlin, Germany. Fax: 4931/6949457

FOR SALE: Wood: Zenith 6S222 - \$110; Admiral 4220D5 - \$30; Bendix 753M - \$45; Crosley Fiver 20AP - \$45; Silvertone R1161 - \$30. Plastic: Radiola 510A - \$30; Jewel 960U - \$30; Emerson 587A - \$50; Sonora RBU176 - \$35; Crosley 58TK - \$25; Airline 74BR15148 - \$30; Airline B4GWM1058A - \$35; Stromberg-Carlson 1101 - \$45. Mark Thornquist, 45 Second St., Glens Falls, NY 12801. (518) 761-4143

WANTED: Japanese transistors, pocket or coat-pocket size, need not work. Call or write: Bob Davidson, 310 Main St., Concord, MA 01742. (508) 369-2007

WANTED: Book titled Practical Radio Servicing by Marcus & Levy. Ron L. Stollings, PO Box 331, Eldon, MO 65026-0331. (573) 392-3924, evenings

WANTED: Pilot 3" TV grille. **FOR SALE:** Osborn 1 first desk-top portable computer, Serial NR 1528, excellent cond., extras. Steve Snyderman, 4147 Lenox Dr., Fairfax, VA 22032. (703) 978-3086

WANTED: Original or reproduction plastic dial plate for Philco 41-290. Joseph G. Jackson, 6331 Old Forsyth Rd., Macon, GA 31210. (912) 474-7734. E-mail: fwtg68a@prodigy.com

WANTED: Book: Joy of QRP, by Adrian Weiss: Milliwatt. Pat Franzis, 235 Millville Ave., Naugatuck, CT 06770. (203) 723-8976. E-mail: franzis@gdc.com

WANTED: Radios sold by Belknap Mfg. Co. (Old Ky. Home, Bluegrass, Blue Ribbon, and Belknap) and radio-related items such as speakers, earphones, advertising, etc. Also looking for battery sets by Harbison & Gathright (H&G, Kentucky Cardinal), Sun Mfg. Co. (Sun), Bixby and Robert Good. Wayne King, 408 Forbes Dr., Shelbyville, KY 40065. (502) 633-6564

WANTED: National NC #57, 98, 109, 188, 190, reasonable. Hoover Noonan, Rt. 1, Box 187, Pineland, SC 29934. (803) 726-5762

WANTED: Working condition Philco PT-30 radio. Robert Craig, 5519 El Encanto Cir., Santa Rosa, CA 95409. (707) 539-1693



WANTED: Motorola Catalin #'s 50XC, 51X15, and 52, as complete or "parts" sets. I am a very serious collector seriously looking for serious stuff (leaving all kidding aside, of course)! Please write or call collect: Rain Buttignol, 214 State St., #7, Portsmouth, NH 03801. (603) 427-1384

WANTED: N.O.S. or used volume control for a Radiola 17. Jim Wilson, 888 Pearse Rd., Schenectady, NY 12309. (518) 372-9625

WANTED: Speakers. Electro-Voice Georgian (corner cabinet), Heathkit Legato. Power amplifier EICO HF-60. Patrick S. Smith, 136 S. Dutoit St., Dayton, OH 45402

WANTED: General Electric World Monitor BC/SW receiver. Giles Crabtree, Box 110, Lewisburg, PA 17837. (717) 523-6551

WANTED: WWII radar. Will pay top dollar for the following: APS-4 orig. manual, APS-4A orig. manual; C-300 Control Box APS-4A; TS-188 test stand. Steve Bartkowski, 4923 W. 28 St., Cicero, IL 60650. (708) 863-3090

WANTED: Sampson SC4000 Super Alarm AM transistor radio. Roger Reader, 526 13th Ave. North, Onalaska, WI 54650. (608) 783-0723

WANTED: Signal tracer, Hickok 810, Eico, Heath. Good working condition with manuals. Prefer PU. Bill Sinn, WB7TZQ, 1700 El Camino Real 1-6, South San Francisco, CA 94080. (415) 755-6401

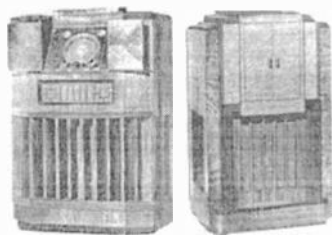

WANTED: E.H. Scott Laureate Grande or E.H. Scott Westerly Grande. Eddie Burris, 2837 Winterbrook Dr., Lawrence, KS 66047. (913) 841-4174. E-mail: burris@cstp.umkc.edu

WANTED: SBE450 UHF; Clegg Zeus power supply & modulator. Robert Milligan, K14MB, 6608 N. 18th, Arlington, VA 22205. (703) 533-0650

WANTED: Mics: Shure 545S, 54PE/D, 588, 533VC. Hi dual imp. Turner BX/D, CX/D, VT-73. EV641, 638, 619, 605. Hi imp. Ready buyer. Tom Ellis, Box 140093, Dallas, TX 75214. (214) 328-3225. Fax: (214) 328-4217

WANTED: Photos, schematic, for Paragon IIIA receiver. Ted Drogoski, 507 Coal Valley Rd., Jefferson Boro, PA 15025-3703. (412) 466-5950

WANTED: Eveready radios, speakers, old flashlights, flashlight catalogs, related items. Subscribe Flashlight Newsletter - \$12 year. Bill Utley, PO Box 4095, Tustin, CA 92681. (714) 730-1252



WANTED!

Microphones—all types:
Telefunken, Neumann, AKG, RCA, Sony, etc.
Also buying recording studio equipment,
tube compressors, EQ's: Pultec, Lang,
Teletronix, Urei, Fairchild, RCA, etc.

818.784.7611 • Fax 818.784.7564
Moving Hands Studios - Los Angeles, CA



FOR SALE: Popular Science 1939-42, 9 issues, all - \$15. Modern Mechanix 1936-1953, 5 issues, all - \$8.50. Mechanix Illustrated, 1939-1968, 7 issues, all - \$9.50. QST 50th Anniversary issues, 1964, 4 issues, all - \$8. Elementary Electronics How To, 6 issues - \$9.50. Electronics mags., 3 asstd. - \$6. Book of First (6,000 inventions) - \$9. Victor Book of the Opera, 1968 - \$9. Coyne Electrical School Book Radio and more - \$9. Asst. Radio mags., lot, some no covers, (10), all - \$10. CQ, 73, Radio 9 issues, all - \$11. (25) DeVry, NRI radio booklets plus (38) TV booklets, all - \$30. Radio News, 1949 to 1952 - \$1.50 copy. Radio-Craft, 1946 to 1948 - \$1.50 copy. Radio Electronics, 1949 to 1968 - \$1.25 copy. Mixed years QSL cards, (100) assorted - \$12.50. Hawkins Electrical Guides, 5 asst., all - \$12. Hawkins Electrical Guides Vol. #1 to Vol. #10, all - \$24.95. (4) basic radio books, all - \$7.50. Rider, (4) Basic Electronics, all - \$6. Howard Sams Tube Substitution Handbook, asst. editions - \$5 ea. CBS Tubes 1957 guide - \$12.50. GE Tube Data Guide - \$7.50. Sylvania Tube Tech Manual 1943 - \$6; 1946 \$8; 1951-3 - \$9.50. Truetone (Belmont) Service Data, 1 1/2", 2 bundles, - \$18 ea. Have other orig. old service data for sale. Magnavox R-3 horn speaker, needs repaint copper - \$125. Acme KI-A dual cone magnetic speaker - \$65. Crosley Dynacone speaker - \$40. Peerless magnetic speaker, wood cath. case - \$30. CB mics, (6), all - \$25. Turner CB mics, (3), all - \$18. Turner plus 3 mic - \$37.50. Turner 254-C - \$35. Turner VT73 - \$37.50. Brush BA 106B - \$25. RCA 88-A, fair - \$35. (8) small transistor radios, all - \$45. Weston 2 range ohmmeter - \$12. McClintock (Weston) DC volt ohmmeter - \$18. Old type 2-prong plugs, removed - \$1/3. Have some old elect. supplies. Old lamps bulbs. Old photo light meters Weston Master 715 - \$18. GE PRI - \$15. DeForest 427 N.O.S. - \$12. Raytheon N.O.S. 227 - \$12. Sylvania 26 N.O.S. - \$9. 1000's of unlisted items. Write wants SASE. Min. parts orders - \$8. All sales plus shipping. F. Krantz, 100 Osage Ave., Somerdale, NJ 08083-1136. (609) 783-0400

FOR SALE: RCA WO-33A scope - \$50. RCA WR-49A signal generator - \$25. Shipping extra. Allen Jochem, 2205 Broadway, Quincy, IL 62301. (217) 223-6751

FOR SALE: (90+) issues of Sencore News from the beginning - \$25 plus postage. Kenneth Miller, 10027 Calvin St., Pittsburgh, PA 15235. (412) 242-4701

FOR SALE/TRADE: Rare, small Japanese tombstone, 1930's, vg-exc condition, elect. untested. Larry Stone, Rt. 3, Box 70-D, Martinsburg, WV 25401. (304) 267-6721

FOR SALE: Two Audax A150X 15" coaxial speakers - \$100 for both plus UPS. SASE brings specs and shipping cost your location. George W. Vance, 401 San Antonio Dr., Bristol, TN 37620

FOR SALE: Radios, misc., SASE list. Beautiful Emerson EA357A tube-portable, not working - \$35 + UPS. Tom Tezloff, 23 Nelson Dr., Silver Bay, MN 55614. No phone

FOR SALE/TRADE: Signal Corps test set I-56-K (tube tester I-77/manual/CS-130 case). Gordon Wilson, 11108-50 Ave., Edmonton, Alberta, Canada T6H 0H9. (403) 434-6257

FOR SALE: Transistor folks, here's a radio nobody else has: AM-FM radio built-in a Polaroid camera case, tan leather, working order, unique, only - \$85 plus \$15 shipping. Also new-in-box GE variable reluctance phonograph cartridge and needle - \$60 ppd. Send \$1 for updated radio book-magazine list. Maurer TV, 29 South 4th St., Lebanon, PA 17042. (717) 272-2481

FOR SALE: MAC 1500 stereo receiver - \$495. You ship. D.C. Payne, 4201 E. Coolidge St., Phoenix, AZ 85018. (602) 955-5107

FOR SALE: Send me your "want" list. Let me know what you need. Wilbur Gilroy, 129 Belmont Ave., Clarks Green, PA 18411. (717) 586-7356

TUBES • PARTS • SUPPLIES

YOUR COMPLETE SOURCE FOR...

TUBES:

Over 3500 receiving, transmitting, audio and industrial types in stock, including many foreign and early types.

TRANSFORMERS:

Hard to find power, filament and output transformers as well as filter chokes for tube equipment. We feature HAMMOND performance transformers as well as many new old stock transformers.

CAPACITORS:

High voltage electrolytic and mylar capacitors, multi-section capacitors and more for tube circuits.

PARTS:

Resistors, tube sockets, potentiometers, knobs, dial belt lamps, diodes, speakers, wire, phonograph needles and cartridges and much more.

LITERATURE:

Extensive selection of literature and books on antique radios, tubes, circuits diagrams, communication gear and hi-fi equipment. Some items not available elsewhere!

SUPPLIES:

Grill cloth, cabinet restoration supplies, batteries, chemicals, tools, test meters, gifts and kits.



CALL OR FAX FOR OUR NEW 40 PAGE CATALOG!

ANTIQUE ELECTRONIC SUPPLY™

LIMITED PARTNERSHIP

6221 S. MAPLE AVE. • TEMPE, AZ. 85283 • (602) 820-5411 • FAX (602) 820-4643 or (800) 706-6789

RADIO AUCTION

600+ pc. collection
of Robert Keffer,
Mohnton, Pa.

Thursday
April 4, 1996 at 9 AM

Preview: April 3, 5-7 pm

Collection to be sold in 450 lots including many table top, portable, transoceanic, lunch-box, transistors and novelties.

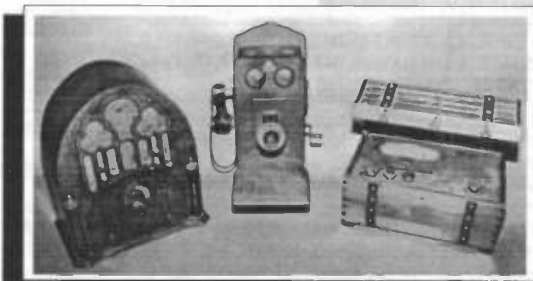

Bakelite, plastic and wooden radios by Crosley, Zenith, Emerson, AtwaterKent, Motorola, Kennedy, Westinghouse, Bendix, Silvertone, RCA, Philco and much more. Catalin's by Fada, Emerson and DeWald. Novelties include Grand Mother

clock by Columaire, the Town Crier, Treasure Chest and Country Belle by Guild. Smokerette by Porto-Productions and a large variety of advertising, cartoon, sports, automobile and related.

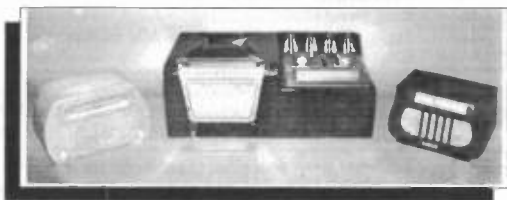

Call 215-393-3036 to request listing .

Terms: Absolute Auction, No Buyer's Premium. Cash or acceptable check w/ID. No Reserves, No Minimum. All merchandise sells "as is, where is" with no warranty. AU-001117-L

Auction Location:
Alderfer Auction Center,
501 Fairgrounds Road,
Hatfield, Pa 19440
(215) 393-3000.



SANFORD
ALDERFER AUCTION COMPANY

501 Fairgrounds Road, Hatfield, PA 19440 • (215) 393-3000

FOR SALE: Parting out RCA D22-1. No mike, nothing tested. M.C. McDonald, 2503 Crook St., Falls City, NE 68355. (402) 245-4152, ans. mach. 4th ring

FOR SALE: Abbotwares horse - \$265. Philco 52 cathedral - \$265. Westinghouse H126 Little Jewel - \$125. Zenith Royal 760, two-band direction finding transistor - \$85. **WANTED:** Speaker for my Radiola 26, Zenith 9S30, AK 5 tube TA, white Burns horn, wood Amplion horn, AK & Zenith advertising items. Jim Peters, 983 Chapel Ct. South, Glen Ellyn, IL 60137. (708) 790-9699

FOR SALE: 12AX7, 6LF6/6MF6, 6KD6, 20LF6, N.I.B. Send SASE. Louis L. Veitre, 643A Sherwood Ct., Lakehurst, NJ 08733-4207. (609) 657-7592

FOR SALE: General Electric portable electronic tuner Model 1CVT620, no instructions - \$10 plus 8 lbs. John Uscinowski, RR#1, Box 379, Greenwich, NY 12834-9519

FOR SALE/TRADE: N.O.S. assorted Walso and EVG phono parts, cartridges, wheels, accessories, etc. too numerous to list. Frank Cass, 20813 Albany, Warren, MI 48091. (810) 754-3387

FOR SALE: Johnson Viking Messenger CB transceiver, with tubes and crystals, uninspected - \$5 plus UPS. Louis J. Philipp, 502 Greenwich Ave., Paulsboro, NJ 08066. (609) 423-4306

FOR SALE: EICO Model HFT-90 FM tuner - \$10 plus shipping. Henry Boersma, 6253 Dolores Dr., Oak Forest, IL 60452

FOR SALE: WWII radios, radars, bomb sights, manuals, more. 50-page catalog - \$2 U.S., \$5 foreign. Sam Hevener, W8KBF, The Signal Corps, 3583 Everett Rd., Richfield, OH 44286. (216) 659-3244

FOR SALE: Yaesu FRG7700 HF receiver, new condition - \$450 OBO. Jim Shoemaker, RR#1, Box 118A, Prescott, KS 66767. (913) 471-4644

FOR SALE: Attn. classic TV collectors, we have a large supply of N.O.S. B&W picture tubes from 14 to 24", most are \$50 ea., a very limited supply of 17dp4 and 21fdp4 (Predicta type) - \$100 ea. and (1) 21fp22 round color - \$150 add shipping charges. 100's of yokes and flybacks B&W & color, ballasts, globar & fused resistors. Box lot of N.O.S. Dumont TV parts, coils, trans., traps, pots, etc., 60+ pieces - \$50 for all. Please SASE with needs. John T. Balliett, RR3, Box 497, Muncy, PA 17756

FOR SALE: Western Electric 10A AM receiver, mint - \$2,400. Lansing Iconic missing 801 driver - \$3,000. Vincent Gallo, 532 LaGuardia Pl., Suite 600, New York, NY 10012. (212) 274-0432

FOR SALE: Zenith tombstone 4T26, Deco, cutouts, exc - \$100. Bunis First Edition - \$30. Plus UPS. Rich Yoch, 22410 Bartlett Dr., Rocky River, OH 44116. (216) 331-9206

FOR SALE: Used tubes: (5) 6LQ6/TE6C - \$15 ea.; (1) 6K6 - \$15 ea.; (6) 6J56C - \$12 ea.; (2) 6JBL - \$10 ea. Allan Ferris, 2479 W. Bluelick Rd., Shepardsville, KY 40165. (502) 543-8233

FOR SALE: Transistor clock radios. General Electric CT455A, nice, not mint - \$65. Minivox RR34 - \$85. Bill Timoszyk, 35283 Leon, Livonia, MI 48150. (313) 421-2076

FOR SALE: Silvertone 1933 #1863, 32-volt, Deco!, 3-tone, wood knobs, Gothic grille, rounded corners - \$95. Ripley, Box 9374, N. St. Paul, MN 55109. (612) 777-6791

FOR SALE: Sams Photofact Transistor Radio Series 24 thru 104, 81 missing - Make Offer. Sanford Mathis, 29390 Somerset Rd., Paola, KS 66071. (913) 294-2669

FOR SALE: GGH mother of pearl celluloid horn speaker - \$750 + packing and shipping. Don Howland, W 4621 Shawnee, Spokane, WA 99208. (509) 466-0939

Radios By Hallicrafters

by Chuck Dachis

Written by the world-renowned Hallicrafter collector

Technical description for every known model

225 pages

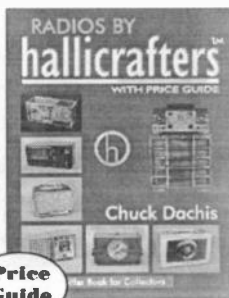

Price Guide

Includes dates of production, model numbers, accompanying pieces, and original prices.

1000+ color and b/w photos

NEW!
Available
Now

\$29.95

U.S. Orders - Enclose \$3.00 per order for packing & book-rate shipping if total order is under \$35.00. If using VISA or MasterCard, include name on card, card number and expiration date. Send payment with order. Mass. residents please add 5% sales tax. Money back return policy. Most orders shipped the same day received, but allow 2-4 weeks to receive order. Foreign orders - write for shipping costs, or use credit card and specify air or surface (allow 2-3 months for surface shipping).



Send Order To: A.R.C., P.O. Box 2, Carlisle, MA 01741
or Call: (508) 371-0512

Fax: (508) 371-7129



WANTED: Wooden sets wih metal grilles or trim. Jay Malkin, 1250 Galapago, #206, Denver, CO 80204. (303) 623-6451. E-mail: klaaslaw@aol.com

WANTED: Early original Vibroplex advertising or brochures. Chuck Brumley, KB2SWI, 32 Glenwood Rd., Saranac Lake, NY 12983. (518) 891-5704

WANTED: All speed record changers 1965 to '80, complete, repairable RCA, BSR, dual, etc. West-Tech Services, PO Box 1415, Sebring, FL 33871. (941) 471-0922

WANTED: Restoring 1942 Philco 421008, need complete phonograph, speaker, face plate, push buttons. Ted Herazy, 509 S. Country Fair Dr., Champaign, IL 61821. (217) 352-0808

WANTED: Metal lid for AK 37 and good Philco 90 speaker. Dale Whitis, 608 S. 9th St., Cambridge, OH 43725. (614) 432-4414

WANTED: Supreme Model 542 pocket volt-ohmmeter. Mel George, PO Box 24934, San Jose, CA 95154. (408) 267-0697

WANTED: Hammarlund 4-prong plug-in coils Type SWK-4 covering 10-20 meters, thru 250-560 meters. Write: Anton George, 7203 39th Ave., Kenosha, WI 53142

WANTED: Suggested circuits and parts to build small electrostatic display TV from late 1940's. Dave Dameron, KG6BP, 819 Boundary Pl., Manhattan Beach, CA 90266-6621. (310) 318-5311

WANTED: Zaney-Gill organ pipe cathedral. Johnny Johnson, 7075 W. 32nd Ave., Wheat Ridge, CO 80033. (303) 274-5474

WANTED: Dead or alive! Jensen Special Design and Alnico 5 loudspeakers. Fairest bounty paid!! Peter DeGregorio, 85 Burroughs Rd., Fairfield, CT 06430-3504. (203) 331-9155

WANTED: Always collecting early WWII radar equipment. Allan H. Weiner, 97 High St., Kennebunk, ME 04043. (207) 985-7547



WANTED: The pictured Emerson table set in any restorable condition. Bob Schafbuch, 2811 Highland Ave., Carrollton, KY 41008. (502) 732-9650

WANTED: Amateur radio equipment good/bad, new/old. Large list - \$1 and SASE. Joe Bedlovies, PO Box 139, Stratford, CT 06497

WANTED: A nice Radiola IV. **FOR TRADE:** Hand-made Hawaiian Koa ukulele for cathedral. Phil Boydston, 640-18 Tete Lours, Mandeville, LA 70471. (504) 845-0867

WANTED: Anything featuring RCA dog Nipper advertising pieces, signs, figurines, needle tins, record brushes, etc. Gwyn Malone, 4498 E. Fox Run Dr., Syracuse, IN 46567. (219) 457-8303

WANTED: Manual or diagram ultrasonic cleaner Sono-gen Model A-300, made by Branson Instrument, Inc. Alton A. DuBois, Jr., 67 Peggy Ann Rd., Queensbury, NY 12804. (518) 792-3130

WANTED: Zenith Model 970 console, have only the cabinet., need radio chassis and speakers. Chuck Mer-nard WB9IFE, 232 North Brashares Dr., Addison, IL 60101. (708) 543-4699

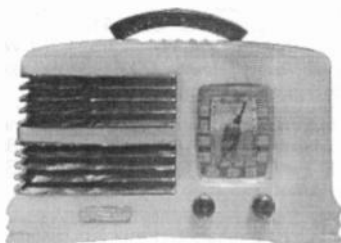

WANTED: Symphony and Detrola Catalin radios. I am not a human being: I am a radio collector. God forbid! Pity me the lost soul that I am and fulfill my humble needs. Please write or call collect: Rain Buttignol, 214 State St, #7, Portsmouth, NH 03801. (603) 427-1384

WANTED: Detrola Model 120. Also Detrola console radio/phonographs and radios. Scott Flaughner, 41100 Plymouth Rd., Plymouth, MI 48170. (313) 451-4221 E-mail: FlaughSM@po5.pl.unisys.com

WANTED: Transformer SCN# P1503 and P1785 or P1992. Postcard quote: Don Anderson, 7174 Glenwood Ln., Hanover Park, IL 60103

WANTED: Original tube-type CB radio operating/owners manuals & CB call books, old tube-type CB radios. Warren Belles, 1421 E. Royal Palm Rd., Phoenix, AZ 85020. (602) 943-4135

NEW HI QUALITY

CAPACITORS

Volt 630 Axial Leads

Value (UF)	*Price/25
.001	\$ 6.00
.0047	\$ 6.25
.01	\$ 6.50
.022	\$ 7.00
.033	\$ 7.25
.047	\$ 7.50
.1	\$ 8.00
.22	\$15.00

ELECTROLYTICS

Volt 160 Axial Leads		Volt 450 Axial Leads	
Value (UF)	*Price/25	Value (UF)	*Price/25
22	\$16.00	22	\$28.00
33	\$21.00		
47	\$24.00		

To order, call or write:

BOB'S ANTIQUE RADIOS

111 East 29th St., LaGrange Park, IL 60526

Telephone: (708) 352-0648

Fax: (708) 352-0647

*** Satisfaction Guaranteed ***

*Sold in 25 piece lots only. Shipping & Handling
Ask about super bulk rates. included in price.

- Whole Sale -

FOR SALE: Philco 37-650 escutcheon and glass - \$7.
WANTED: Escutcheon and speaker for Philco 57 or 58 compact. Brad Winder, Box 160, Hay Lakes, Alberta, Canada T0B 1W0

FOR SALE: Garod 6AU-1 Commander, maroon & yellow, very good condition - \$650 plus shipping only in U.S. Suzanne Wyatt, 4403 Boyd Rd., Dearborn, MO 64439. (816) 992-8811

FOR SALE: (16) QSL amateur radio mags., early 1920's - \$15 ea. (2) Popular Radio - \$15 ea. (1) Brodton Times Atlas (Radio) - \$20. Will trade for L.H.J. W.H.C. Colliers, etc. Russell Hewins, PO Box 1103, Lakeville, MA 02347. (508) 947-2518

FOR SALE: Motorola radio, 52R 11A, Marconi floor model, old records, Victor, Columbia, etc. Mary Brown, Box 133, Hunt's Point, Queen's Co., Nova Scotia, Canada B0T 1G0

FOR SALE: Hallicrafters 5R10A - \$35. Sonora bed-lamp radio, WCU246 - \$35. Mellow-tone Boys radio - \$35. Sorrento T-666 - \$25. Valiant Ten transistor, coral and chrome, nice - \$30. UPS extra. Scott Olson, 2631 Cobblestone Ct., Fargo, ND 58103. (701) 293-9238

FOR SALE: Airline 62-1056, plays - \$30. Hallicrafters S-38C, plays - \$40. Motorola 51D, non-working - \$15. Zenith R-515-G, plays - \$30. GTC battery eliminator - \$20. Dale Cheney, 1070 E. Roland St., Carson City, NV 89701. (702) 883-7308, day or weekends

FOR SALE: Two-tube audio amplifier kits. Breadboard style pine base with plywood front panel, power switch volume control and 4" speaker, octal tubes operate on D cell and (5) nine-volt batteries; works with one-tube regen or crystal, any radio normally requiring headphones; complete kit includes detailed assembly manual, everything except batteries - \$60 ppd U.S.A. only. Mail only please. Gregg Scholfield, 172 Ring Rd., Dayton, NV 89403-8013

FOR SALE: Mylar capacitors: .0033 ufd 600v axial - \$5/50; .0047 ufd 600v axial - \$5/50; .01 ufd 600v radial - \$5/50; .047 ufd 400v axial - \$5/50. Electrolytic capacitors: 100 ufd 450v axial - \$7/2; 47 ufd 450v axial - \$7/4; 10 ufd 450v radial - \$4.50/10; 47 ufd 160v ax - \$5/10. Mixed 1/2 W resistor - \$6/K. Add UPS if prepaying. Flyer available. Santech Electronics, PO Box 187, Tappan, NY 10983. (914) 359-1130

FOR SALE: Bakelite panels cut to order. Send size required for price. Parker Heinemann, 87 Cove Rd., Lyme, CT 06371

FOR SALE: Report No. 5 on solenoid coils for crystal sets is now available. Historical background and discussion of early day coils, how and why they evolved to today's designs, why most modern coils are not satisfactory for crystal sets, how to design a replica or a new, high efficiency coil, and much more. Order postpaid for \$5.50 from: Crys Tech, c/o P.A. Kinzie, PO Box 6805, Kingman, AZ 86402

FOR SALE: Collins: KW-1, 32V-2, 75A-1, 75A-2, 75A-3, R-390 - \$14,500. Collins: 75S-3C WE, 75S-3C, RE, 32S-3A, RE 516F-2, 312B-4, 180S-1, 30S-1, KWM-2, RE 75S-2, 32S-2, 516E-1, 180Z-1, Drake R4-C, T4X-C, M54 - \$6,900. Central Electronics 100v, Hallicrafters HT-32A, Johnson Ranger 1, HRO-5TA1, HRO-SR, NC-100 - \$1,800. All equipment nice or nicer, with manuals. Sold in groups only. Gary Goldsmith, KEGMS, PO Box 5786, Beverly Hills, CA 90209. Ph/auto fax: (310) 696-0177

FOR SALE: Motorola service monitor, VHF, with deviation scope, looks-operates good, - \$1,000 OBO. Jim Shoemaker, RR#1, Box 118A, Prescott, KS 66767. (913) 471-4644

FOR SALE: RCA Model BP-10, in good condition - \$75. Buyer pays shipping and handling. Jim Barrows, 15121 41st Ave. SE, Bothell, WA 98012-6113. (206) 337-4880

FOR SALE: RCA Catalin, maroon, very good case. Send one dollar for picture. Also have copies of test equipment manuals for Eico, Precision, Triplett and others. Send large two-stamp envelope. Clayton Mundine, 6112 S. Flores St., San Antonio, TX 78214

FOR SALE: M.I.B. coffee cup and saucer novelty transistor, (Breed Pl. 360) - \$60 shipped. Arnold Hornstein, 21 Golden Hill Ct., Baltimore, MD 21228. (410) 744-0919

FOR SALE: Tektronix oscilloscopes, good condition, new probes, Models 5440 - \$395; & 453 - \$295. Bob Lindahl, 10680 S.W. Wedgewood St., Portland, OR 97225-5127. (503) 644-9643

• • • • •
• **OLD TIME RADIO BROADCASTS** •
• **ON CASSETTES** •
• Many of your old time radio favorites are available on quality cassettes at a reasonable cost. You select the shows you want and purchase them by the hour. Fast, friendly service too. Send for our catalog listing over 5,400 shows arranged by show category & title, many including original broadcast dates.
• Only \$2.00 (P & H). Send request to:
• **ERSTWHILE RADIO — P.O. BOX 2284**
• **PEABODY, MA 01960**
• • • • •

WANTED



**Batteries, Broadcasting
Microphones, Telephones,
Bi-Polar Motors, Related
Parts, Catalogs, and Early
or Unusual Fans.**

Alan Willms
1823 El Camino Real
Redwood City, CA 94061
(415) 571-9070

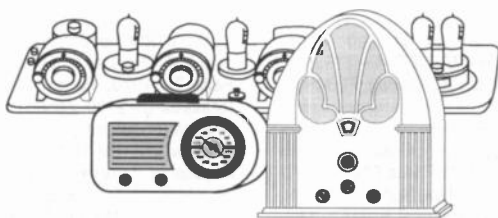

Come visit

ANTIQUE RADIO CLASSIFIED

at the 45th

Dayton Hamvention

May 17-19, 1996

at the HARA Arena, Dayton, Ohio

Exhibit Hours: Friday Noon - 6 pm

Saturday 8 am - 5 pm

Sunday 8 am - 2 pm

Browse through our books...

Renew your subscription...

Become a subscriber...

Chat with your Editor.

We are at Booth #207

**Also visit New Wireless Pioneers at
Booth #206 and look over their old books,
magazines, and catalogs.**

**Last year's show drew over
35,000 attendees!**



**For Info: A.R.C., P.O. Box 2, Carlisle, MA 01741
or Call: (508) 371-0512 Fax: (508) 371-7129**



FOR SALE: Tubes: 5U4GB - \$7.50 new, \$2.50 used; 6CG7/6FQ7 - \$5 new, \$2 used; 6SN7GT - \$4 new, \$1.50 used; 6V6GT - \$6 new, \$2 used; 12AT7, 12AU7 - \$4.50 new, \$1.50 used. Most common TV types (no sweeps), including localts - \$3 new, \$1 used. CRT's: 3BP1, 3DP1, 3JP7, 5BP1, 5FP7A, 5FP14 - \$10 new. Herb Ratner, 3542 Westminster Ct., Holiday, FL 34691. (813) 937-7452

FOR SALE: Philco Jr. - \$50. Tombstones, Coronado 675 - \$75. Coronado 400A - \$90. Philco 610 for parts - \$30. Older table radios, Metrodyne Super 6, missing one xfmr, NT - \$70. Pathé Universal 5, NT - \$60. Thompson 5A, NT - \$75. Sparton 69 - \$35. AK 44 - \$50. Table radios: Belmont 636 - \$70. Clarion C108 - \$40. Philco 39-7, refinished, nice - \$50. GE J71 - \$45. RCA 16X3 - \$25. RCA 45X1 - \$25. Swan 350 & 117XC power supply, with mike - \$250. Rider Channalyt with manual - \$50. Plus UPS. Ron Timperley, 1725 Mission Ct., Huron, SD 57350. (605) 352-4723

FOR SALE: Crosley Dynacone - \$75. RCA Model 100 (good paint) - \$35. Two National Semiconductor data books, Linear and CMOS - \$8 ea. N.I.B. Turner microphones, one 350C - \$15. One 141-11 - \$15. Heathkit metal detector with book - \$25. The following BO: RCA 74B microphone. (2) DeForest duds, tipped, white isolntite bases, with name. May be gone part of April. D.W. McDonald, 1813 Main, Clear Lake, IA 50428. (515) 357-2446

FOR SALE/TRADE: Kadette Clockette, Blue Glass bottom cracked through. WANTED: New Kadette (silver, wood, F.O.S., p. 100) or other interesting Kadette. Nevins Museum of Radio, Ken Nevins, 406 Jipson St., Blissfield, MI 49228. (517) 486-3019, evenings please

FOR SALE: One of the last Heathkit catalogs, No. 214, Christmas 1988, excellent. David Edyvean, 2508 Campbell Ave., Schenectady, NY 12306. (518) 455-3497, weekdays

JOIN THE AWA

ANTIQUÉ WIRELESS ASSOCIATION THE ORIGINAL AND LARGEST HISTORICAL RADIO-COLLECTOR GROUP

- Publishes *Old Timer's Bulletin* with:
 - Battery and AC receiver restoration
 - Vacuum-tube history and collecting
 - Old-time amateur-radio contests
 - Communications receivers
 - Free want-sell-swap ads
 - Early television
 - Horn loudspeakers
 - Reviews of current books
 - Keys and land-line telegraphy
 - News of U. S. and foreign clubs
 - Information on public radio museums.
- Maintains unique radio-TV museum.
- Produces the annual Rochester meet.
- Co-sponsors local meets.
- Publishes the annual *AWA Review*.

Membership is only \$12.00 per year (\$22.00 for two years). Mail check to:

Antique Wireless Association, Inc.
Box E, Breesport, NY 14816



FOR SALE: Amps: Bogen E-30 - \$70. Bell Sound Systems PM-33 - \$40. (2) EICO HF-20 - \$125 ea. Speakers: 12" Magnavox 1000Ωfield - \$30. Philco 91, Monarch 12" coax - needs foamed, (2) Stromberg-Carlson 12" coax Slimline, Philco Model G (from 20's console). Mic: Calrad DM-21 dual imp. w/cable - BO. Fada TV 1070, Philco 40-130 - \$100. RCA 75X16 (brass trim) - \$100. Zenith escutcheon Model 61 - \$15. Chassis, speakers, parts: Majestic 71B, Philco 37-630, Grunow 662. Sterling LS-4, Philco 20, others. Prices negotiable, more radios, tubes and parts. Send want list or SASE. Wilbur Gilroy, 129 Belmont Ave., Clarks Green, PA 18411. (717) 586-7356

FOR SALE: Supreme tube tester Mod 599-A, excellent working condition - \$60 ppd. Don Rathbun, 27851 Bruno St., Hayward, CA 94544. (510) 783-1841, call mornings

FOR SALE: Emerson Artistocrat - \$300. Astatic arm w/ new 33/45-78 turnover cartridge - \$80. (20) assorted transistor radios - \$150. SASE list. Bernard Bank, 303 Devoe Ave., Yonkers, NY 10705. (914) 476-5933

FOR SALE: Tubes, good: WD12 - \$30. (3) UV201A's brass, no tip - \$30 ea. (3) UV201A's Bakelite - \$15 ea. Crosley Ace Type V, excellent original condition - \$175. British Revophone crystal set - \$210. Ian L. Sanders, 16725 Wild Oak Way, Morgan Hill, CA 95037. (408) 778-7547

FOR SALE/TRADE: Mint Gosnet Communicator III with original clean manual, (3) crystals for (2) meters, canvas cover. Looking for AK 2-tube TA units for Model 12 breadboard, AK 9C board, other original boards or good replicas. Offers? Pat Stewart, W7GVC, 1404 Ruth Ave., Walla Walla, WA 99362-3558

FOR SALE: Rider #8 - \$14. Hickok 6000 tester - \$115. 4"x4"x22" Victrola Borgia II console, exc. Agreed? Renee May, 1242 N. El Centro Ave., Los Angeles, CA 90038. (213) 464-9179

A.R.C. BACK ISSUES

April '87 to current issue: Originals available
32 to 100 pages each.

Oct. '86 to Mar. '87: Reprints available
Reprinted from original artwork; 28 to 32 pgs. ea. Quality & appearance same as an original copy.

June '84 to Sept. '86: Photocopies available
Not original quality, useful for info.; 16 to 28 pages each. Publication of *Antique Radio Classified* began in 1984 which had only five issues: June, Sept., Oct., Nov. & Dec. 1984. 1985 through current year have had 12 issues each.

**\$4.00 each - Postpaid to
U.S., Canada and Mexico.**

Orders of 6 issues or more may take a 10% discount. Orders for a full calendar year may take a 50% discount. Foreign orders other than Canada and Mexico: \$6.00 each by air. Mass. residents, please add 5% sales tax.

A.R.C. UNCUT, UNFOLDED COVERS

June 1991 to the present
9.25" x 12.5" - \$9.95 each
Postpaid to U.S., Canada, & Mexico
Mass. residents, please add 5% sales tax.

Send Order To:

**A.R.C., P.O. Box 2, Carlisle MA 01741
Or Call (508) 371-0512**



WANTED: RCA Broadcast News from '30s-'50s, duplicates to trade. Also want: Western Electric magazines, Pickups and Oscillator and broadcast equipment catalogs and transmitter brochures of '30s-'50s. Sam Thompson, W6HDU, 1031 San Antonio Ave., Alameda, CA 94501. (510) 521-1429



WANTED: Emerson Catalin radios. Nobody pays more than I. What an arrogant and inaccurate thing to say. I mean, like there isn't anyone wealthy enough, dumb enough, desperate enough – or any combination of the three – to pay even a dollar more than I would pay. I mean, c'mon, who am I trying to kid! Please write or call collect: Rain Buttignol, 214 State St, #7, Portsmouth, NH 03801. (603) 427-1384

WANTED: Tubes: Taylor T-55, Sylvania 210, 210, UV202, WE VT-25. Hideo Mitsui, Soehi 8340, Sanadamaichi, Nagano-ken 386-22, Japan. E-mail: dsc71076@pcvan.or.jp

WANTED: Zenith 7D127 chassis. Merrill Mabbs, 709 Pluma Dr., Rapid City, SD 57702. (605) 342-4090. E-mail: mmabbs@cpu.net, new Web site: <http://cpu.net/classicradio>

WANTED: Nameplate for Westinghouse 7A amp. Re-pro instruction sheet for DeForest Everyman crystal set. Bruno Pinto, 24 Remez St., #7, Tel-Aviv 62192, Israel. Fax: 972-3-6725285

WANTED: Electricity! Crooke's tubes, Wimshurst and Holtz static electric machine, Leyden jars. Louie Scribner, 1415 West Leigh Dr., Charlottesville, VA 22901. (804) 977-5521. E-mail: lls@virginia.edu

WANTED: Zenith wooden Model 6S321 or 6S322 in excellent condition. Larry Boshier, PO Box 193, Palo Pinto, TX 76484. (817) 325-5333

WANTED: Detector coil for Zenith Mod #10S690, CH. 10B2, PT #58436. Please help. Thanks. Fred S. Hootman, 20812 Lower Hillview Dr., Sonora, CA 95370

WANTED: Allied radio circuits handbook, Microcomputer Design by Donald Martin. Small burned out transformers. Dave Dameron, KG6BP, 819 Boundary Pl., Manhattan Beach, CA 90266-6621. (310) 318-5311

WANTED: Restorable Viking Ranger, Valiant parts rigs. WRL-VFO, UM-1 WRL modulator. Ron Merrell, 10701 W. 54th St., Shawnee, KS 66203. (913) 268-5973

WANTED: General Electric Voice Commander, any band but prefer 150MHz. Also prefer Voice Commander 3 but 2 or 1 considered. Pete Malvasi, WB2BYQ, 75 Church St., Ramsey, NJ 07447. (201) 934-0321

WANTED: Dial assembly i.e. Kurz-Kasch, Pilot, or National Type B or BM. Knight Ocean Hopper any condition. Dale A. Hagert, 3881 Serpentine Cir., Eagan, MN 55122. (612) 688-7155

WANTED: Chassis, escutcheon for Philco 39/39A cathedral battery set. Cabinet similar to Philco 89B (Bunis 3, p. 171). Chuck Regen, 2724 N. 27th St., Sheboygan, WI 53083

WANTED: Ekko broadcasting stamps or albums from 1920s by the Ekko Company of Chicago. Charles Combs, 508 E. Daniel, Albany, MO 64402. Phone/fax: (816) 726-3038

WANTED: Heathkit Q multiplier. George M. Bonanno, WA2KPE, 34 Charles St., Clifton, NJ 07013. (201) 746-5953

WANTED: Broken Zephyr ZR930 tan, need chassis. Also wanted Realtone TR803, Zenith 12S475 console. Claude Chafin, NØFMO, 4223 E. 42nd Way, Independence, MO 64055. (816) 478-4518

WANTED: French, English, European, Russian radios/table multiband. Stewart Struzer, 3210 Dow St., Pompano, FL 33062. (305) 834-4946

WANTED: 8" x 12" speakers with green cones, gold frames. Crosley hi-fi phono, El Dorado TV. John May, 205 Wren, Scotia, NY 12302. (518) 377-9522

WANTED: Micronics Rubys G433, H437 and H438. Will pay cash or trade for British portables. Enrico Tedeschi, 54 Easthill Dr., Brighton, United Kingdom BN41 2FD. Tel/fax: (+1273) 410749

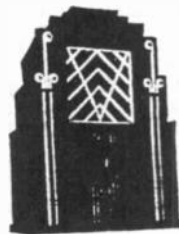

WANTED: This Simplex radio (black with silver trim) & radios with chrome grilles. Jay Malkin, 1250 Galapago, #206, Denver, CO 80204. (303) 623-6451. E-mail: klaaslaw@aol.com

WANTED: Galaxy/Hy-Gain GT-550 accessories LA-550; RV-550; SC550; RF-550; etc. Roger McCarty, KD6CC, 6689 Yellowstone Dr., Riverside, CA 92506. (909) 682-7001. E-mail: rmccarty@deltanet.com

WANTED: Anything to do with Espey Radio Co. radio sets, advertising, manuals, displays, etc. Always looking for RCA & Collins advertising displays, etc. Ward Kremer, 301 S.W. 16 St., Ft. Lauderdale, FL 33315. Phone/Fax: (954) 524-5652

Virginia City Radio Museum

109 So. "F" St.

Wireless and Radio Apparatus from 1915 through the 1950's — Antique Radios, Speakers, Vacuum Tubes, Microphones, Telegraph Keys, Photographs, Ham Equipment & Vintage Ham Radio Station
We also repair and restore antique radios
Henry & Sharon Rogers — P.O. Box 511
Virginia City, NV 89440 Tel: 702-847-9047

FOR SALE: Just found some National Radio Institute Radio News booklets from the 1940's, Radio Servicing articles and photos - \$5 ea. or \$25/7 ppd. Also several from the 1960's at - \$3 ea. or \$15/7. Send \$1 for radio-book-magazine list. Maurer TV, 29 So. 4th St., Lebanon, PA 17042. (717) 272-2481

FOR SALE: Zenith Royal 500D, white - \$50. Emerson 888 Vanguard, black, very nice - \$75. RCA L15 record player Model 6JY1 with box - \$40. Westinghouse H-126 refrigerator radio - \$50. Tony DeMara, PO Box 13, Mt. Clements, MI 48043. (810) 263-0325

FOR SALE: Oriental RCA 75X18, very nice - \$245. Del Tysdal, Rte. 1, Box 157, Glyndon, MN 56547. (218) 287-2562

FOR SALE: RCA 103 tapestry speaker - \$135. Philco Model 211 speaker, round metal case - \$50. Silvertone farm set, Model 6350, with booklet - \$50. Philco 41-608 console with Beam-of-Light phono - \$150. Victor radio/Electrola console RE-57 - \$135. Gary Nitkin, 102 Long Highway, Little Compton, RI 02837. (401) 635-2816

FOR SALE: Guild Grafonola Model 785, complete with legs, plays well - \$150. Scott Starr, 2845 Page Pl., Montgomery, AL 36116. (334) 281-0960

FOR SALE: Crosleys: (4) Bakelite, white, blue, green, Model D25 - \$100 ea. (2) Catalins, yellow, maroon Model 1425 - Offers. Maurice Giroux, 559 Hudson, Laval, Quebec, Canada H7P 2L4. (514) 963-1601

FOR SALE: GE 8417, pair - \$70. SYL5932, pair - \$65. GE VT4C - \$70. 8005 - \$70. E288CCGP - \$40. AT20, pair - \$500. PX4, pair - \$750. PX25 gloves, pair - \$900. U15 - \$60, etc. Kouji Matsuo, 6-2, Tsurumi-cho, Bepu-shi, Oita, 874, Japan. Fax: 81-977-23-9579

FOR SALE: Book, How To Repair Old Radios by Clayton Hallmark, rare hardcover edition - \$20. Greg Mitchell, 8017 Dema Dr., Des Moines, IA 50320. (515) 287-2005

BUY • SELL • TRADE

CATALIN RADIOS

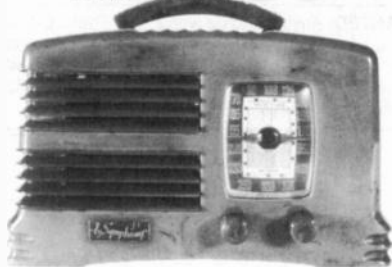

I'll buy single pieces or
whole collections. Top prices paid.

RADIOART

Jim Meehan
P.O. Box 102 • Centerbrook, CT 06409
(203) 526-1762

FOR SALE: Philco console, Model 18, working, pick up only - \$40. Also wood tabletop radios. Philco 41-245 - \$25. Stewart-Warner 9003-B - \$15. GE T-200 AM-FM 6-tube - \$15. All 3 + UPS. Onerio "Lou" Sabetto, 1717 Burgess Rd., Cleveland, OH 44112. (216) 481-1036

FOR SALE: Rare Reader's Digest 10-band transistor, black leather case, original, book - \$75. T. Romano, 8 Howe Ln., Millbury, MA 01527. (508) 865-6293

FOR SALE: Radiotron Designer's Handbook 3rd + used tubes: 83, 311CH, 807, 813, 829B, 843, 4E27, 3B24W, CX301A, CX310, UT144, UX2PI, UXW11, all - \$175 + \$10 UPS. Hank Andreoni, c/o 250-D So. Lyon Ave., Hemet, CA 92543

E-MAIL ADDRESS FOR ANTIQUEN RADIO CLASSIFIED ARCMagazine@aol.com

Ads - Subscriptions - Book Orders
See inside front cover for details

FOR SALE: EV mics: V-2A - \$625/Best Offer; 630 mic - Make Offer. Sony 5-303W TV - \$40. Craig R. Lease, PO Box 118, Flintstone, MD 21530. (301) 478-3019

FOR SALE: X-copies of audio mnl's frm, Altec/WE, Marantz, Dyna, Scott, HK, Eico, Heath, Hadley + many others. Call or write for price. WANTED: Lowther, Hartley or other English speakers, singles OK. Greg K. Lee, 2421B Kestral Blvd., West Lafayette, IN 47906. (317) 463-2758

FOR SALE: Scott 800B upper and lower chassis with Rider and Sams, no cabinet, no speaker, doesn't work (but did), restorable, output transformer replaced with UTC Linear Standard, you pick up or pay freight and packaging plus \$200. Albert W. Burgis, 1201 Indian Rocks Rd., Belleair, FL 34616. (813) 585-5751

FOR SALE: Mint condition Westinghouse Aerola Sr., no scratches, works great with substitute triode, battery pack and isolation transformer to feed hi-fi aux. plug for glorious wide band AM sound included, sparing widow dumpster costs - Best Offer by April 25, 1996. Charley Spencer, W8PQO, PO Box 173, Fennville, MI 49408-0173. (616) 561-6851

FOR SALE: Zenith 6D315, rough - \$75. Westinghouse H-3347U - \$20. Bill Cherenksy, 6 Kate Ln., Metuchen, NJ 08840. (908) 549-2165

FOR SALE: Fifty years collecting. Selling out. Call: James Cole, 240 Gillespie Dr., Abingdon, VA 24210. (540) 628-2835

FOR SALE: Freshman Masterpiece B, beautiful, no tubes. David Rush, WB4FRE, 45 High Pond Ln., Bedminster, NJ 07921. (908) 234-0321

VACUUM TUBES

20's - 50's N.O.S. & USED

Reasonable Prices --- Free List

ANTIQUEN TRIODE
BOX A2, FARNHAM, N.Y. 14061
Fax/Phone (716) 549-5379

ELECTRONICS AUCTION

April 20, 1996 (Saturday) 10:00 A.M.

**Preview Times: Fri. (April 19) 10 am to 10 pm
Sat. (April 20) 8 until 10 am**

Antique radios, battery, early electric, 40's and 50's table models, floor consoles, commercial, new and old meters and test equipment, speakers, microphones, tubes, parts, literature, etc.

**Location: Business Rt. 30 Downingtown Marketplace, Downingtown, Pa.
10 minutes from Exit 23 Pa. Turnpike, 45 minutes from Philadelphia or Wilmington.**

Battery Sets: Federal DX-58, AK-BB 10C, AK-BB 12, Westinghouse RC, Radiola III, National shortwave receiver, Day-Fan 5, AC Dayton XL 30 mint, Stewart-Warner Model 300, Eagle Neutrodyne Type B, Bosch Model 29 Sky Ranger crystal set.

Early Electric: Stewart-Warner Type 900, Radiola 18 on iron stand, Radiola 17, Airline SW converter, Silvertone lowboy Model III.

Speakers and Horns: Magnavox M-1 horn, AK Type M horn, AK Type E, RCA Model 100 and 100A, Temple drum speaker, RCA speaker on stand.

Table Models: Blue Crosley Model 11-119-U, Philco PT-25, Emerson Catalin Model AU-190, Zenith 8H023 both FM bands, Philco drop-leaf table, Airline movie dial, Crosley book radio.

Trans-Oceanic Types: Silvertone, Capehart, RCA U.S. Army Signal Corps suitcase spy radio receiver BC 792A. Blaupunkt Florenz, Vienna, Verona, Sultan Olympic Opta, Mega 809-1.

Cathedrals: Philco 90, Lyric. Tombstones: Zenith black dial, Grunow 660, Westinghouse WR22, Philco 37-620 and 37-640, GE A-64.

Consoles: Sparton 867, Philco 90, Silvertone 70-71, Zenith 12H670, Sparton 1076, GE A-87, Zenith 8S563, Sparton, Radiola 17 highboy, RCA 711 V2, Stromberg-Carlson 1121 PS, several nice cabinets.

Commercial: Hallicrafters Sky Buddy, S38E, SX-28, REL phone and CW transmitter Model 461-C.

Hi-Fi: 2 large Altec horns, McIntosh record compensator Model D8A, Realistic tuner, Knight amp, Knight speakers.

Many turntables including Rek-O-Kut Model TR4311. Navy radio direction finder loop Model DU1, aircraft direction finder Model DZ-2. Several late 40's early 50's TVs, loads of meters & test equipment. Transistor & novelty radios.

Auctioneers Note: This is a very partial listing with hundreds of lots still to arrive! We always have 600 plus lots by sale time. Terms: Cash or Pa. local check. Out-of-state checks with current bank letter of credit unless known to us. 10% buyers premium.

SMITH AUCTION COMPANY

Harold Smith: AU-002163-L, Annette Smith: AU-002706-L, Dennis Childers: AA-002303-L
For information about this sale, future sales & consignments, call 610-269-1036.
Catalogue available in April. \$5.00 by mail, \$3.00 at door.

Outdoor Flea Market 7:00 am to ??? — A special event organized by the Delaware Valley Historic Radio Club, Smith Auction and members from other regional clubs. Come early to buy/sell and preview the auction. All spaces \$15.00 in advance. Reserve by April 15th. Rain or shine. Call Dave Abramson for information. 610-827-9757

FOR SALE: Original rosette and other Philco knobs. Many other old radio knobs, no trash. Elwood Hunt, 308 Georgetown Rd., Carneys Point, NJ 08069. (609) 299-5259

FOR SALE: Simpson DC VTVM Model 651 adapter w/ leather case for 260 meter, like new - \$35. Also Simpson 260 scale expander adapter, N.I.B. - \$10. Dynascan AV-2A H.V. probe for most VTVM's, in box w/instructions - \$12. Wood table radios: Philco 40-120, very nice - \$50. Detrola, permeability tuned - \$35. Silvertone 4565, (7) tubes, tuning eye - \$60. Silvertone 6122, push buttons and tuning eye - \$55. Zenith X323, AM-FM - \$12. Zenith 8H034, AM-2FM's, nice cabinet - \$40. Classic Radio & Television, 541 Riverside Dr., Box 61, Augusta, ME 04330. (207) 623-2059

Classified Ad Deadline Noon

Apr. 10 for May 1996 Issue

May 10 for Jun. 1996 Issue

Boxed, Photo, & Display Ads - 1st

FOR SALE/TRADE: (2) Zenith black, shutter dial, 9S262 consoles for (1) Atwater Kent Type II breadboard tuner. John Koop, 48 Wheelbarrow Ln., Wantagh, NY 11793. (516) 731-6711, pm

FOR SALE: Toshiba TTP30 transistor radio with storage/carrying case (metal) - \$100. Mike Keller, 5861 Riverton Rd., Columbus, OH 43232. (614) 866-7725. E-mail: MKeller614@aol.com

FOR SALE: Tubes: 01-A, BBT rainbows set of 5 duds - \$150. Gold Airline - \$50. Blue - \$50. Have several of each. Plus postage. Ed Bell, 5311 Woodsdale Rd., Raleigh, NC 27606. Fax/phone: (919) 851-1517

FOR SALE: Tube manuals: RCA 22, GE 1963 catalogs, Allied 69, Cameradio 64, Lafayette 72 - \$10 ea. Plus postage. Ed Povraznik, 9606 Bidulph Rd., Brooklyn, OH 44144. (216) 661-0032

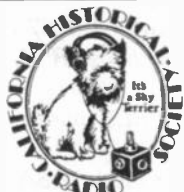

The California Historical Radio Society

- ✓ *Eight meets per year all over Northern California*
- ✓ *Two or more Journals per year featuring original historical and technical articles*
- ✓ *Join now and get a valuable collection of restoration articles from 20 years of CHRS!*
- ✓ *A mere \$15 per year!*

For more information, or to join...

write to: PO Box 31659
San Francisco CA 94131
or Call 415-978-9100

FOR SALE: Belmont 5D-128, white, gd., but knobs are cracked - \$100. Belmont 6D111, white moderne set, nice - \$110. DeWald A501 butterscotch Catalin harp, minor cracks, no dial glass - \$235. Fada radio Model 33, portable leatherette case, gold front panel, with small butterscotch Catalin knobs - \$48. Farnsworth GT-051, bullet style radio, as-is - \$50. Futuramist small aqua blue tube mini-set - \$20. Emerson Vanguard 888 red transistor radio, works! - \$50. Emerson 724 AM/clock radio, cute pea green - \$20. Grundig 85 and 87 AM/FM, each - \$45 or both for \$80. Grundig 1088 AM/FM/SW, restored - \$75. Grundig 4090 AM/FM/SW1/SW2 - \$110. Grundig 7025 console chassis - \$25. Grundig 205a, Satellit 5000 multiband radio - \$89. (2) Kensington transistor globe radios, one perfect, other has bad base - \$59. Admiral 50's AM, white, Bakelite, gd - \$12. Philco 50-920, light gray, sunburst top mounted dial, gd. - \$30. Philco 52-942 Bakelite, elaborate sunburst top mounted dial, exc - \$32. Majestic 5-LA-80, moderne, crack on bottom - \$10. Majestic 6511, 1937 very moderne white wood radio, exc, as-is - \$85. (3) Philco 49-506 Art Deco radios, two complete - vg, other restorable, all - \$85. Philco 53-563 space age styling, very nice black and gold plastic set - \$35. Philco 49-501, restored, works - \$250. Matching Philco 49-1401 AM/phono, matches 49-501 in styling - \$165. Sears Silvertone 57J 6179A, walnut plastic, Art Deco streamlined - \$215. Sears-Silvertone 2002, white - \$30. Sentinel IU-345P, 1952 tan & white swirled plastic, crack on rear door - \$20. Sonora TW-49, 1940 moderne white, exc - \$175. Stromberg-Carlson 1101-H white Bakelite - \$38. Truetone D2018, ivory boomerang - \$125. Westinghouse H743T4 shadow white moderne - \$20. Military radios: T-22/ARC-5 transmitter (7 to 9.1 Mc) and receiver (190 kc to 550 Kc) with dynamotor: clean, unmodified - \$39. Collins R-392/URR (made by Stewart-Wamer Electric) 500 Kc to 32 Mc, with pwr conn. and speaker (LS-166/U), with manuals - \$150. Dynaco D-25XL pair of speakers, gd., one has bad tweeter, both - \$45. Dyna CAB-1D, cabinet for PAT-5, AF-6 - \$20. Dyna CAB-1S, cabinet for PAT-4, FM-5 - \$20. Dynaco FM-3 and SCA-35 tube FM tuner and audio amp, dual wood cabinet, exc - \$165. Dynaco FM-1 FM tube tuner, as-is - \$15. Dyna ST-150, 75 watt/ch. power amp, exc - \$125. Test equipment: HP 3300A function generator, 0.1 Hz to 100kHz, sine, square, and triangle dual outputs - \$65. HP 200ABR oscillator, 20 Hz to 40 kHz - \$19. Tektronix 453 orig. service manual - \$20. Telequipment D67 25 MHz dual trace scope, gd., with service manual - \$145. Sams Photofact Transistor Series #28, 29, 32, 34, 38, 43, 44, 46, 47 and 54, all for - \$22. Allied radio cat. 104, 1941 - \$5. Lafayette cat. #78, 1940 - \$5. War dept. Tech manual radio sets SCR-193a/b/c/d/e - \$10. Tech. manual Radar Fundamentals, 1941 - \$5. Radar Electronic Fundamentals #TM 11-466 - \$5. Surplus Conversion manuals Vol. 1 and 2 by Evenson and Beach, both - \$20. CQ mil.: Anthology, best of CQ 1945-1952 - \$10. CQ Command Sets the ARC-5 schematic bible - \$19. CQ Surplus Conversion Handbook, including Command Sets - \$21. Surplus Schematics handbooks - \$21. Attention dealers: This is my whole collection! Make an offer on the lot that is reasonable and you can take it away! All items are complete, shipped UPS plus handling. Call for information. Please feel free to make reasonable offers on anything listed. Eric J. Mendoza, 555 Kappock St., Apt. 23A, Riverdale, NY 10463-6421. (718) 601-0530, call from 11 am to 10 pm EST

The Radio Collector's Directory and Price Guide, 1921-1965, 2nd Ed.

by Robert E. Grinder

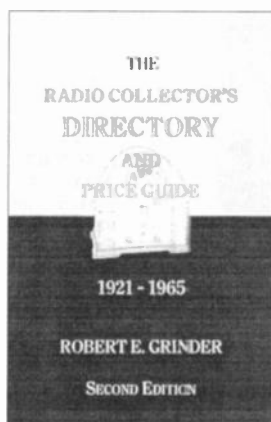

20,000+ Models Listed

U.S. models manufactured from 1921-1965.

Listing includes:

*Model Name,
Year of Production,
Type of Power,
Cabinet Style, and
Current Market Value Range.*

Rewritten Chapters On:

*Early Broadcasting,
Radio Broadcasting Regulation,
Advances Made in Receivers,
The Evolution of Radio Cabinet Styles.*

\$26.95 - Softcover

U.S. Orders - Enclose \$3.00 per order for packing & book-rate shipping if total order is under \$35.00. If using VISA or MasterCard, include name on card, card number and expiration date. Send payment with order. Mass. residents please add 5% sales tax. Money back return policy. Most orders shipped the same day received, but allow 2-4 weeks to receive order. Foreign orders - write for shipping costs, or use credit card and specify air or surface (allow 2-3 months for surface shipping).



**Send Order To: A.R.C., P.O. Box 2, Carlisle, MA 01741
or Call: (508) 371-0512 Fax: (508) 371-7129**



FOR SALE: Riders 1 thru 22 with indexes - \$600. QST's 1932 thru 1971, 40 years - \$400. CQ, 73 and others free with purchase of QST's. ARRL Handbooks 1940 thru 1981, call! TSM's 1 thru 30, call! Patterson PR15 - \$325. HRO 500 - \$1,000. Hallicrafters S108 with box - \$225. Magnavox AW-100 with case, manual, etc. - \$275. Magic-Tone bottle radio - \$300. Saba 90/11K - \$175. All radios are in excellent condition. Jim Weil, 824 Heather Lake Dr., Clarkston, MI 48348-3648. (810) 391-7687, voice/fax

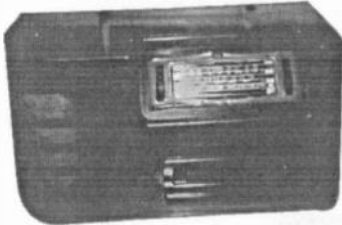

FOR SALE: 1939 Philco, H73, escutcheon broken, very nice condition - \$100. John Magee, 7323 Heritage Ct., Frankfort, IL 60423. (815) 469-9422

FOR SALE: Automobile radio controls by CTS-IRC, N.O.S. Make and mfrs. part numbers: 57 Buick; 7268944 & 137837; 53 Cadillac; 7263321; 54-55 7264638; 53-54 Chev; 7262941 & 7264210; 55-58 7266193; 56, 7266842; 57, 7269199 & 7269211 & 1220961; 67 Chevelle; 7300181 & 7299606; 55 Dodge; 18B532519; 55-56 18K532955; 54, Ford; 18B5300 18; 55, L219656-1; 55-56 Mercury; L219660-2; 57, 33-5570-2; 58, N219689-4; 57 Pontiac; 7269149, all - \$27 ea. ppd. Larry Fullner, 4808 N.E. 74th, Seattle, WA 98115. (206) 524-0332

FOR SALE/TRADE: AK 555, nice, plays, one knob wrong - \$300 plus shipping. Ed Bell, 5311 Woodsdale Rd., Raleigh, NC 27606. Fax/phone: (919) 851-1517



*Craig L. Graybar
Furniture Works Ltd.*

(414) 258-2390

**SPECIALISTS IN RESTORING,
REPAIRING AND REPRODUCING
CLASSIC STYLED ANTIQUE TV,
RADIO & PHONOGRAPH CABINETS**

Send us your plans or your project
via UPS for immediate price quotes



**1535 S. 84th St.
West Allis, WI 53214**



"We Turn Ideas Into Heirlooms"

FOR SALE/TRADE: Atwater Kent Model 24, excellent original - \$300. Plus shipping. Ed Bell, 5311 Woodsdale Rd., Raleigh, NC 27606. Fax/phone: (919) 851-1517

FOR SALE: Need room! Majestic Deco tombstone w/ metal grille. Admiral Bakelite console TV w/back. Deco RCA console radio, Radiola 25, AR812. Antique tube testers, everything excellent condition. Don M. Maurer, 29 South 4th St., Lebanon, PA 17042. (717) 272-2481

FOR SALE/TRADE: Swap or BO; Amrad Duo receiver, WWII Japanese 3-tube receiver, EICO 730 100-watt modulator, Ampex horn, Ampex Equalizer, McIntosh AE2 preamp with D101, 1960 Fender Concert, Pilot Wasp audio amp, and Fairchild meter panel. Michael Payne, 803 S. Taylor, Alvin, TX 77511. (713) 331-9217. Fax: (713) 585-2727. E-mail: We300B@aol.com

FOR SALE: Bulova 672 - \$60. Beautiful Emerson Ingrahams - \$75 ea. Rare Emerson cardboard war set - \$125. Clarion 400 Deco - \$100. Rare Fada Deco mantle piece - \$100. Traveler T-204 with box - \$125. Emud 60 Jr. - \$60. GE GD-60 - \$45. Melrose 571 - \$45. Philco 49-901 - \$125; 46-420 - \$45; 39-25 slant front - \$40; 37-602 - \$50; 40-130 - \$50. Zenith Y600 - \$110. Fada 1000 repro - \$50. Bob Masterson, Box 172, Valley Cottage, NY 10989. (914) 353-3151

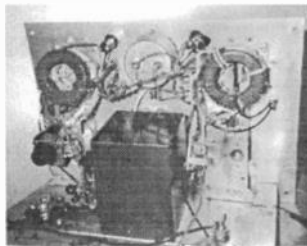

FOR SALE: Schematic & parts list for deluxe crystal set, switchable to transistorized detector/amplifier configuration powered by free AC from ground. Novel age circuit permits fixed-threshold noise clipping & prevents overloading of limited power supply - \$25. John Stanley, 6156 Summit Ave., Brown Summit, NC 27214

FOR SALE: Bogen variable speed turntable - \$20. Majestic 181 chassis and motor board - \$50. Sparton 931 chassis for parts - \$20. New power transformer for RCA Radiola 64 or 67 - \$339.20. RCA Radiola 44 power supply - \$20. All items plus shipping. Doug Houston, 3441 S. Hadley Ln., Ortonville, MI 48462. (810) 627-4141. E-mail: houstond@cc.tacom.army.mil

FOR SALE: Transistors: Zephyr 620 in box, white - \$125. Sony TR-510, black, works - \$100. Jewel TS10, white, works - \$40. Global GR-711, case cracks, good dial and grille - \$25. Zenith Royal 500H, black, works - \$80. Gary Watkins, 8006 Greenwald, Belton, MO 64012. (816) 322-0773

FOR SALE: Zenith R1000 - \$65. Airline 35GSL1564B - \$10. Crosley D25NM, no knobs or dial pointer - \$55. Crosley 56TW - \$25. Philco 52-541-122 - \$10. GE F63 - \$65. RCA 66BX - \$35. Novelities from Breed book: Pl. #179, Blabber Mouse - \$15; Pl. #211, Money Talks - \$20; Pl. #278, Eveready - \$15; Pl. #411, Jukebox, unopened - \$20; Pl. #509, Standing Knight - \$35. UPS extra. Victor Marett, 3201 N.W. 18 St., Miami, FL 33125. (305) 634-9569

Radio Restoration Parts

Vacuum Tube Repair Wafers

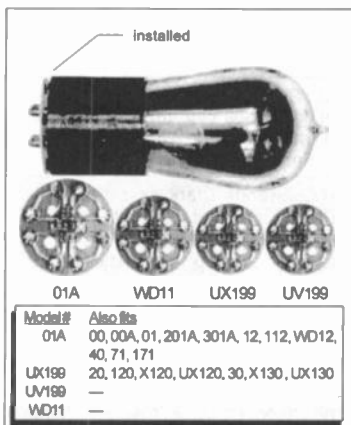

These tube repair wafers are solid-state devices for quick and easy repair of early vacuum tubes. The wafer is installed by simply sliding it over the tube pins and reinserting the tube into its socket. If the filament is intact, but there is little or no emission, the filament may be lit for best visual effect. However, the tube can be open filament.

No change in radio operating voltages is required. Any number of tubes may be repaired in a radio. If wafers are installed on all tubes, the B+ voltage may usually be reduced without sacrificing volume or sensitivity. Performance will vary between radio models.

\$10.00/each (\$7.50/ea. 3 or more)

New Atwater Kent Breadboard Switch

Exact replacement for Models:

9 • 9C • 10 • 10A • 10B • 10C • 12

and all additional models with board mounted switch.

Newly manufactured under high pressure heat from the same type brown thermoset resin used in the original. Beryllium copper spring contacts are used for long, trouble-free life. Custom built knurl is used to exactly reproduce the original.

\$50.00/each



Side View

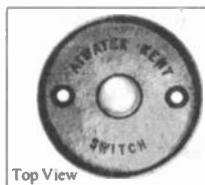

Top View



Active Antenna

Allows antique radios which were designed for a long wire outdoor antenna to operate on a 42" indoor whip antenna. Portable, operates from a 9 volt battery.

Only \$34.95

Order from: PTI, 7925 Mabelvale Cutoff, Mabelvale, AR 72103

Orders shipped UPS, prepaid in continental U.S. Please allow 3 weeks for delivery.

Arkansas residents add 5.5% sales tax.

To Order: Call (501) 568-1995



FOR SALE: Tubes, many types, 2 new pages. SASE for new or all 8 pages. Chuck Vaccaro, 708 Booth Ln., #A, Ambler, PA 19002. (215) 646-3641

FOR SALE: Arvin red Hopalong Cassidy 441T, good cond. - \$350. RCA 1X53, green, nice - \$28. Arthur Kreitner, 2013 E. Belle Ave., Belleville, IL 62221. (618) 233-5610

FOR SALE: Tubes, schematics, service notes, Riders, Sams Photofast Folders and transistor books, etc. for early radios. LSASE for price list. Sam Faust, PO Box 94, Changewater, NJ 07831

FOR SALE: Rare Philco VTVM 7001/man & probes in original carton - \$50 + UPS. Other VOM and VTVM. H.N. Felder, 7517 Granada Dr., Bethesda, MD 20817

FOR SALE: Audio Encyclopedia by Howard Termaine, 2nd edition - \$70. Pioneer receiver SX-838 blue dial - \$175. Precision Fidelity tube preamp C7 - \$200. Audio Magazine, (120) issues, 1966-1977 - \$100. Send large SASE. Ernest Naaz, 242 East 89th St., Apt. C, New York, NY 10128. (212) 289-7681

FOR SALE: Tubular Audiotron with label, good cond. - \$100. Two Western Electric 216As, vg - \$50 ea. L.S. Brach, J5A aircraft key, exc cond. - \$45. National HRO7 rcvr, vg - \$200. Pete Malvasi, WB2BYQ, 75 Church St., Ramsey, NJ 07447. (201) 934-0321

FOR SALE: Sams, below #1000, as low as - \$1 ea. Must sell, overstocked. Send SASE for list. John E. Kendall, PO Box 436, Fallston, MD 21047

FOR SALE/TRADE: Kennedy: 20 Type 440 - \$250. XXX Type 435 - \$425. Both very nice. Plus shipping. Ed Bell, 5311 Woodsdale Rd., Raleigh, NC 27606. Fax/phone: (919) 851-1517

FOR SALE: (1) pc. new Eimac 250 TL tube - \$50 + ship. Marv Glassman, 19300 Romar St., Northridge, CA 91324. (818) 993-4560. Fax: (818) 886-0355

Catalins Wanted



Fada • Emerson • Motorola
Addison • Air King • Arvin • Detrola
Crosley • Symphony • Tom Thumb
I buy all makes and models.

Michael Lawlor
P.O. Box 179 • Santa Barbara, CA 93102
(805) 682-2336

FOR SALE: Crosley D-25TN, tan, very nice - \$250. 1937 Crosley Dealer Radio Display Book, 11" x 15", 70 pages pictures (36) radios - Best Offer over \$75 or Zenith trade. Bill Timoszyk, 35283 Leon, Livonia, MI 48150. (313) 421-2076

FOR SALE: Sony TR84, pink, works - \$45. N.I.B. Garrard phonograph spindle adapter for 45's - \$10. Bill Jewell, 6828 Trinity Landing N, Fort Worth, TX 76132. (817) 294-9061

FOR SALE: Splitdorf chassis, almost like Abbey - Best Offer. DeForest, tube can, (6) - \$15 ea. Joseph R. Forth, 321 Long Vue Acres, Wheeling, WV 26003. (304) 277-3154. E-mail: Schematic1@aol

FOR SALE: Brenda Clark says that sellers can beat the heat this year at Extravaganza '96! For the first time sellers will be able to rent table space underneath the big-top tent in the middle of our flea market. For \$25 you get an 8' table, chair and designated parking space for your vehicle. She recommends that reservations for these inside selling tables be made in advance. For further information or for a convention brochure, write to: Michigan Antique Radio Club, Extravaganza '96, Suite 100, 3520 Okemos Rd., #6, Okemos, MI 48864

FOR SALE: Two books: Collector's Guide To Transistor Radios, Bunis, and Made In Japan, Handy, both together - \$20 ppd. Ken Greenberg, 4858 Lee, Skokie, IL 60077. (847) 679-8641

FOR SALE/TRADE: Mac MR-67 tuner exc, Mac C-11 preamp nice - Offers. Dynakit ST-80 40 w/ch. SS amp, works - \$80. WWII Navy AM/SSB receiver 360/2000Kc, 4 bands, looks Collins, nice, works - \$100. Weston 542 early Bakelite in set tube tester & meter set - \$95. U-Test-M drugstore tube tester, nice, works - \$175. Silvertone wire recorder w/clock timer - \$75. Gard Commander Catalin, exc - Offers. Nice Victoreen Geiger counters with CD logos - sale or trade for other atomic stuff. CD posters, mineral samples, etc. Have RCA 77DX, RCA BF5B, both exc - Trade for other mics & stuff. WANTED: Any Espy radio sets, advertising, displays, manuals, etc. Always looking for RCA signs, clocks, displays, banners, chairs, etc. See want ads this issue. LSASE for new list. Ward Kremer, 301 S.W. 16 St., Ft. Lauderdale, FL 33315. Phone/Fax: (954) 524-5652

FOR SALE: Splitdorf RV 580 - \$150. RCA 110 - \$160. Literature including manuals, catalogs, juvenile books, Sams bound and loose. More, lists for literature and radios. Dave Sutherland, PO Box 201, Spofford, NH 03462. (603) 363-4459



VISIONETTE

MECHANICAL TELEVISION

24 LINES

AUTHENTIC OPERATION
SCANNING DISK CAMERAS AND RECEIVERS
EASY TO BUILD KITS OR READY TO GO
AVAILABLE NOW!

A collection is incomplete
without the VISIONETTE
FOR INFORMATION, CALL OR WRITE
PETER YANCZER, 836 BRICKEN
St. Louis, MO 63122
Ph. 1-314-822-1748 or a SASE

WANTED: Gigantic tubes! The bigger the better. Duds OK. Write me with dimensions. David Rickert, 2107 S. 5th St., Apt. 1, Arlington, VA 22204

WANTED: Wells-Gardner BC-348N, J or Q parts rcvr. Pete Hamersma, WB2JWU, 87 Philip Ave., Elmwood Park, NJ 07407

WANTED: Zenith Trans-Oceanic parts radios in good to fair condition; need 3000-1, 7000 and 7000-1 cases and all parts. Jim Montague, 1970 South Stanley Ln., Spokane, WA 99212. (509) 535-9576

WANTED: A Philco wireless record player. Knox Lee, 630 Shadowbrook Dr., Columbia, SC 29210. (803) 772-6593

WANTED: Driver transformer for RCA 15K or substitute, 1910 ohm primary, 639 ohm secondary. Leon & Patti Bitters, 4209 Logtown Rd., Lena, WI 54139

WANTED: Clock for Philco Model 70 grandfather radio. Guido Montella, 2714 Charleston Dr., Plant City, FL 33565. (813) 752-7174

WANTED: Late 1940's plywood radios. Ultradyne #L-43, Tele-Tone #117, Val-keen #572 (see Bunis 3). Pay up to \$100 in very good condition. Also want Radio Nurse plastic speakers, and Stephans speaker cabinet. Steven Cabella, 500 Red Hill Ave., San Anselmo, CA 94960. (415) 461-6810

WANTED: Info on crossover tube-type numbers for Hewlett-Packard, Honeywell, and others. Send SASE for tube list R, and Teleprinter parts list T. Fred Schmidt, N4TT, Typetronics, PO Box 8873, Ft. Lauderdale, FL 33310-8873. (954) 583-1340. Fax: (954) 583-0777

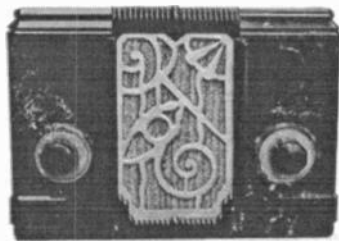

WANTED: Early (prewar II) plastic radios. I collect these objects of beauty to enhance my otherwise dull and uneventful life to which I am forever bound by by sad-but true unworthiness and shortcomings: physical, emotional, and intellectual. Please write or call collect: Rain Buttignol, 214 State St, #7, Portsmouth, NH 03801. (603) 427-1384

WANTED: Hallicrafters TW500 and 1000 parts sets. Military ARB receiver; Philco Model 118 escutcheon. Robert Haworth, 112 Tilford Rd., Somerdale, NJ 08083. (609) 783-4175

WANTED: Heathkit western station, schematics for Heathkit AR1650 and AR1515. Charles Johnson, 21 Holly Hill Dr., Mercer Island, WA 98040. (206) 232-2040

WANTED: Parts for J47 key. Shorting bar with knob. One knurled binding post screw. Ted Biser, PO Box 2, Lorentz, WV 26229. (304) 472-4202

WANTED: IF coils, top tuned dual padder, 260 Kc & 455 Kc. Fred Cranshaw, 1624 Bitter Ck., Garland, TX 75040. (214) 494-4917

WANTED: Antique medical devices especially violet rays, scientific, small table fans and radios. Richard Cane, 1333 N.W. 127th Dr., Sunrise, FL 33323. (954) 846-7116

WANTED: Precision Apparatus Company (PACO) Model 960 transistor tester. Dowdall O'Dacre, 548 Melton St., Pembroke, Ontario, Canada K8A2S1. (613) 732-9597

WANTED: April 1963 edition of the CQ magazine. Jim Schiestett, W4IMQ, PO Box 93, Cedartown, GA 30125. (770) 748-5968

WANTED: Loctals, 14C5, 7C5, 7Y4, 7A7, 7B6, 7B8 and others. Fred Cranshaw, 1624 Bitter Ck., Garland, TX 75040. (214) 494-4917

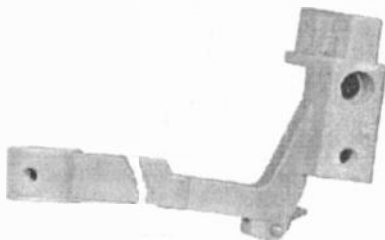

WANTED: Illustrated part for dial mechanism for Philco Model 38-4. Jukebox City, 1950 1st Ave. S, Seattle, WA 98134. (206) 625-1950. Fax: (206) 623-8076

WANTED: Atwater Kent Models 228Q, 385Q, 427Q, 467Q, 469Q, 485Q, 525Q, 558Q, 655Q, 747Q, 978Q. Dennis Craft, 10513 E. Clinton, Scottsdale, AZ 85259. (602) 860-8951, after 5 pm MST

WANTED: Stromberg-Carlson TV-12 complete TV chassis. Also, schematic for a Knight TR-106 transceiver. Mark Weidmayer, 10 Devon Dr., Newtown Square, PA 19073. (610) 325-3816

Visit the A.R.C. Web Site!

The URL to access the A.R.C. Web site is:
<http://www.antiqueradio.com/>

Our site includes highlights from current and recent issues:

- Editor's Comments
- Image of the Cover
- Feature Article
- Radio Miscellanea

- Plus:
- Photo Reviews
 - Book Reviews
 - Coming Radio Events
 - Complete Club Listing
 - List of Books For Sale
 - Subscription Information

While visiting our site, you may send e-mail and orders for books, videos and subscriptions.

Let us know what you think about A.R.C. on the Web!

FOR SALE: Zenith T600 Trans-Oceanic, excellent original condition/working, has manual, advertising pamphlets, foldout schematic - \$125 OBO. 14 x 10 1/2 x 19 inch rack good, needs paint - \$20. Bendix aircraft receiver, Model PAR-3a - \$15. Unusual Emerson with Ingraham cabinet, looks like cosmetic case - BO. Fada white Plaskon FM converter, about 1946 - \$32. Olson N.O.S. mic mixer - \$10. New old stock grille for Motorola 6x31c transistor - \$7. QSTs from the 20s - \$2 ea. Experiments in Industrial Electronics, 1960, Melvin Whitmer - \$3. Loudspeaker Matching, John Rider - \$4. Beam Antenna Handbook, 1955, William Orr - \$5. Servicing Unique Electronic Apparatus, Jac Darr - \$3. Gernsback, 1935 auto radio manuals - \$6. Rider TV Picture Projection and Enlargement - \$6. Alternating Current Machinery, 1906, Part II - \$6. 101 Ways To Use Your VOM and VTVM, 1959, Robert Middleton - \$3. Quad Antennas by Orr - \$5. Poster's Radio and Television Price Guide, 2nd - \$7. VHF Handbook, 1956, William Orr - \$5. **WANTED:** Always looking for Pilot radios and advertising, any condition. Bill Moore, 3049 Box Canyon Rd., Huntsville, AL 35803. (205) 880-1207

FOR SALE: Tubes, radio, TV, 40's thru 50's, SASE for list. Lee C. Dickinson, 401-3 Talcottville Rd., Vernon, CT 06066

FOR SALE: Pioneer stereo AM/FM amplifier, SX34B, 13 tubes, plays well - \$95 plus UPS. Jack Shaywood, Vintique Electronics, 52-C Tilford, Deerfield Beach, FL 33442. (954) 427-1222

FOR SALE: Midgets: Emerson CF-255 (Bunis 3, p. 80), mint - \$85. Arvin 444 AM (Bunis 3, p. 29), white, excellent - \$50. Both work. Philco 38-93A late version, works excellent - \$65. Knight KU-45A stereo receiver (60's tube-type) w/factory wood cabinet vg+ - \$28. Emerson 888 Atlas transistor, white, excellent - \$55. All plus S/H F.O.B. Swarthmore. Sam Mannino, PO Box 233, Swarthmore, PA 19081. (610) 353-6747

FOR SALE: Splish-Splash, April specials! David Grimes 4DL inverse-duplex, in beautiful cabinet with pull-down front - \$425. Grebe CR-18 with coils on top - \$875. AK Model 21 dry cell receiver, very clean, with all good 199's and tags - \$450. AK Model 42 in mint condition on ornate metal speaker stand, unique and working - \$225. Philco Predicta 21" TV, with rare FM tuner on side, has raster and audio - \$400. Heliphone (book-type) crystal set with unique sliding coil - \$350. Jones Co. Model J-65 with (4) 199 tubes exposed out of panel, looks super - \$365. AK Type E-3 (smallest) cone speaker, nice, works - \$85. Cutting and Washington Type 15, one-tube (199) receiver, missing inside tag, but has distributor tag - \$550. Crosley Gemchest, green Chinese style, looks beautiful, possibly different speaker installed - \$300. And yes, the set that sold for \$11,000 in Detroit last fall, the WE CW-936, the first commercially produced radio telephone & telegraph transmitter/receiver, WWI vintage, gorgeous - \$5,800. A.H. Redden's crystal detector on wood base - \$45. Spencer crystal set with weird coil tuning - \$50. Planatair Germanium crystal radio (Japanese) in original box with instructions, tiny - \$50. Thanks. Dave Crocker, 6 Raymond St., Sandwich, MA 02563. (508) 888-6236, before 9 pm please

FOR SALE: Zenith Trans-Oceanics. Early 1000 genuine leather, near mint - \$200. 3000, new in original box - \$300. 7000 American, mint - \$375. 7000 Taiwanese, mint - \$425. 7000 Taiwanese, near mint, doesn't work - \$300. Gary Mac Norius, 14770 N.W. Garden Dr., Miami, FL 33168-4925. (305) 681-6589

FOR SALE: Bell & Howell 16mm projectors, 1945-49-52. Optical sound & magnetic. Bell & Howell cabinet. Auditorium 15" speaker on wheels. Mint condition. Offers. Old time films available: Laurel & Hardy, Bing Crosby, Little Rascals - Offers. Contact: Timothy Mellen, 107 18004 62B Ave., Edmonton, Alberta, Canada T5T 3C1. (403) 481-8917

NEW AND USED TUBES WANTED

We urgently need the following tubes. All tubes must be well known brands such as GE, RCA, Sylvania, Tung-Sol, Philips, etc. of US or W. Europe manufacture. New tubes must be in their original boxes. All tubes are subject to inspection. Ship by UPS (ground); we'll mail a check to you upon receipt and testing at prices shown plus your shipping charges. Call or fax for buying procedures and complete bid list. Call before sending more than 10 pieces of one type of tube.

NEW TUBES

01A	\$9.00	6F6G	\$5.20	12BH7A	\$5.10	274B(WE)	\$85.00	6146B/8298A	\$12.00
1L6	8.50	6G5/6U5	8.00	12DN7/7247	9.00	275A(WE)	85.00	6267/EF86	6.00
2A3	24.00	6K5G	5.00	20L6	16.00	300B(WE)	250.00	6550A	12.00
2B6	6.00	6KD6	15.00	26LX6	6.00	350B(WE)	100.00	6550 (ST)	34.00
5R4GY/A/B	3.40	6L6GC	8.40	35LR6	6.00	623	35.00	7189A	5.30
5U4G	6.70	6LB6	7.50	45	30.00	808	16.00	7691A	20.00
5Y4G	4.70	6LF6/6MH6	18.60	50	110.00	805/331A	32.00	8005	50.00
5Y3G	3.80	6V6	6.00	71A	8.20	845	80.00	8068	20.00
6BK4C/6EL4A	8.00	6V6G	6.50	80(ST)	5.60	864	5.00	8908	27.50
6CA7/EL34	11.00	10	25.00	211(VT-4C)	35.00	5691	15.00	8950	25.00
6F5G	5.80	12A	11.00	274A(WE)	110.00	5692	18.00	M-2057	32.00

USED TUBES

01A	\$5.00	10	\$16.00	171A	\$7.00	245	\$23.00	845	\$31.00
2A3	12.00	12A	7.00	183/483	9.30	246	11.00	7591	8.60
5AR4/GZ34	6.00	20L6	7.30	210	20.00	247	8.00	8417	8.50
6B4G	6.50	42(GLOBE)	8.00	211(VT-4C)	14.50	250	65.00	8950	12.30
6LF6/6MH6	9.20	45(VT-52)	25.00	230	6.20	280	12.00	V201A	6.50
6V6G	2.10	45	11.00	237	8.50	282	8.00	WD-11	35.00
		50	60.00	240	8.50	401-CARDON	9.60	WD-12	24.00

ANTIQUE ELECTRONIC SUPPLY™

LIMITED PARTNERSHIP

6221 S. MAPLE AVE. • TEMPE, AZ 85283 • (602) 820-5411 • FAX (602) 820-4643 or (602) 708-8788

EXTRAVAGANZA '96

Hosted by the Michigan Antique Radio Club

July 12-14, 1996



Holiday Inn South Convention Center
6820 S. Cedar Street, Lansing, MI 48911
(517) 694-8123



Come join us and celebrate our 11th anniversary!

MARC's TOP 10 REASONS WHY YOU SHOULD ATTEND EXTRAVAGANZA '96

1. Flea Market...we have nearly 400 contiguous spaces available for sellers, come help us fill them up!
2. Our meet runs Friday-Sunday as advertised...we STARTED the trend of not allowing early selling (you can really get here Friday morning and not miss anything) and in addition, you don't have to take a whole week off from work to attend our convention!
3. Rich Estes, who conducted the recent Henry Ford Museum Auction, will be the auctioneer for our Friday evening auction!
4. Low costs...we have reduced our family registration to \$12 this year (\$15 last year) and again will offer our flea market spaces after the first one for ONLY \$10 each!
5. The theme of our meet will be Grebe...and we will have Alfred Grebe Jr. as our keynote speaker at our Social Hour Saturday evening!
6. We will have an outstanding Grebe exhibit in support of the theme of our convention, in which we encourage you to participate!
7. For the first time, we will be offering selling spaces UNDER our unique 8ig-Top tent in the center of our flea market!
8. Last year we had attendees in from 29 states, Canada and Australia. If you can only attend one major antique radio show this year, EXTRAVAGANZA '96 should be your choice!
9. You know that large multiband Fada tombstone (22" tall) that everyone is looking for (see photo A.R.C. Jan. 1996 issue, page 61)...we are raffling off an excellent example of this radio at EXTRAVAGANZA '96!
10. HOSPITALITY...we treat you right, just ask anyone who has ever attended an EXTRAVAGANZA convention. We want you here...and bring your family too. We encourage you to attend EXTRAVAGANZA '96 to see and experience for yourself what your friends have been telling you!

EXTRAVAGANZA '96 Registration

Note: Everyone attending EXTRAVAGANZA must register! Additionally, you must be a current MARC member or join MARC at this time in order to participate in the auction or equipment contest and/or to sell in the flea market.

REGISTRATION	TOTAL
Family registration _____ →	\$ 12
MARC membership (if not currently MARC member)	
Balance of 1996 (\$6) _____ →	\$
Flea Market sellers	
1st outside Flea Market space (\$20) _____ →	\$
Additional outside spaces <input type="text"/> # spaces x \$10 each _____ →	\$
8' table inside (under tent)* <input type="text"/> # tables x \$20 each _____ →	\$
<small>*Includes 8' table, one chair & one parking space in the designated non-selling area of our flea market</small>	
Make check out to MARC for this amount	TOTAL \$

To mail check or to request a convention brochure, write: EXTRAVAGANZA '96, Suite 100, 3520 Okemos Rd. #6, Okemos, MI 48864. For additional information contact: Jim Clark @ (517) 349-7187 or fax (517) 349-4059, or check out our MARC Homepage on the WWW at <http://sojourn.com/~micharc/web/index.html>

FOR SALE: Barn cleanout sale: Altec Voice of The Theatre speaker system, 2 huge 40 x 40 x 84" cabinets with (2) 15" drivers in each, twin driver honeycomb tweeter crossover, cables and Bogen MO200A power amp, has (8) 8417 outputs, small Bogen preamp - \$1,500. PU only. Mod 829 AC/DC calibration standard, big and heavy choc full o' goodies, with books pu, Jerrold CM6 marker generator - \$25 + S&H. Eico 425 scope, looks rough, works good - \$25 + S&H. SASE only please. John T. Balliett, RR3, Box 497, Muncy, PA 17756

FOR SALE: Large Silver-Marshall chassis Model Q. Jay Malkin, 1250 Galapago, #206, Denver, CO 80204. (303) 623-6451. E-mail: klaaslaw@aol.com

FOR SALE: Amps: Seeburg MA1-L6 and MA2-L6 - \$80
FOR SALE: Grundig SO-290, Hallicrafters S-47, record changers, Variac 230V-2KVA, Kilowatt linear amplifier tubes-components. Francis H. Yonker, W21BH, 1229 Inverary Pl., State College, PA 16801. (814) 867-1400

FOR SALE: Radios, 30's thru 50's, SASE for list. Sam Giansante, 4255 West Ave. Rd., Elba, NY 14058

ea. RCA MI-12205 - \$140. AMI AA - \$125. Miscellaneous Leeds Northrup bridge - \$15. WE field rheostat - \$15. WE milliammeter in excellent oak box, metal corners - \$35. Del Tysdal, Rt. 1, Box 157, Glyndon, MN 56547. (218) 287-2562

FOR SALE: To settle estate. All radios in excellent, guaranteed working condition with good tubes: AK 20C - \$120. AK 30 - \$100. AK 35 - \$80. Standardyne B-5 - \$100. Neutrodial - \$120. ARBE-III battery eliminators - \$110 ea. Rare Philco 46 cathedral, 110 Vdc, mint - \$550. (3) Arvin metal 444 - \$80 ea. Speakers: AK E, E-2, E-3, guaranteed working - \$75 ea. Tubes, tested good on Precision 10-12: 01-A - \$10; 199 - \$15; 45 - \$20; 26, 71A - \$6; 24A, 27, 80 - \$3. Many other tubes, knobs, parts, call. All items plus shipping. Paul Ernst, 238 Meadow Ln., Webster, NY 14580. (716) 787-9879

FOR SALE: Must sell my entire collection due to money problems. Television: 1947 Airline 84HA3002, untested - \$150. Tuber radios: Zenith 5D625, completely restored inside/out - \$150. 1934 Crosley 5M3 Fiver, needs capacitor, otherwise vg - \$125. 1951 Crosley E15WE, vg - \$60. Mantola G45XJ5, Bakelite, vg - \$50. 1942 RCA Victor 25X and 34X, both vg - \$50 ea. 1946 Stromberg-Carlson 1500-H Dynatomic, vg - \$50. 1940 Philco 40-120, g - \$40. 1938 Philco 38-12, g - \$40. Emerson model unknown but probably 1947 Model 544, g - \$40. Portable tube radios: RCA Victor BP-10, f, untested - \$30. Air King Pockette no model number, g, untested - \$40. Motorola 6P34E 700 Ranger, untested, g - \$30. RCA Victor 6BX6 and 7BX6L, both work, g - \$35 ea. Transistors: Sony TR620, works but weak, otherwise g - \$60. Zenith Royal 500E, with carrying case, vg - \$80. Sony TR84, N.I.B. - \$50. Aiwa AR112, vg - \$20. GE P808E, with leather case, g - \$25. GE P825A, works but weak, g - \$25. Afco, no model number, in box, vg - \$20. Nordemende Transita, f - \$30. Motorola X34E, g - \$15. Panasonic RF6070, g - \$15. Packard Bell, no model number, g - \$20. Silvertone 4204, g - \$15. Victor Co. of Japan 8TA1, with leather case, g - \$20. Silvertone 4211, g - \$30. All prices plus UPS. Bryan Cowan, 1515 O St., #18, Sacramento, CA 95814. (916) 497-0664. E-mail: moo@cwo.com

FOR SALE: Fisher Spacexpander reverb. vintage tube CB's. List - LSASE. Crosley 124 cathedral, restored - Best Offer. Charles Zafonte, N1FRX, RR3, Box 2075, Fort Kent, ME 04743. (207) 834-6273

FOR SALE: Philco Seventeen II 17" black and white portable, same chassis and UHF tuner as Predictas - \$95 plus \$25 shipping. Maurer TV, 29 South 4th St., Lebanon, PA 17042. (717) 272-2481

FOR SALE: Eico 666 tube checker, good - \$75. Eico 667 tube checker, excellent - \$100. Bill Riley, W7EXB, 863 W. 38th Ave., Eugene, OR 97405. (541) 345-2169

"Do you know me?"

I started the world's first broadcasting station. I'm Charles Herrold, and between 1912 and 1917 I was sending music and news to an audience in San Jose, California, on a regular schedule. But while I may have been first, most people forgot all about me. Now there's hope; my story is told in this exciting new videotape from the creator of the award-winning PBS series 'Radio Collector.' It's available from the Perham Foundation. Don't leave home without it!"



"Broadcasting's Forgotten Father: The Charles Herrold Story"

VHS-Hi-Fi, close-captioned, \$29.95 plus \$3.50 S&H.

Order directly from the Perham Foundation,
101 First St., Suite 394, Los Altos, CA 94022.

Or call 1-800-771-KTEH and use your credit card.

All profits go to support the preservation of electronics history.

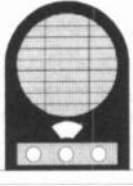

*Society for Preservation of Antique Radio Knowledge
Presents:*

RadioRama 96

A Show, Swap Meet, and Gathering for Antique Radio Enthusiasts.

Cincinnati, Ohio - June 21 & 22, 1996

Host Hotel:

Signature Inn
Turfway Road
Florence, KY 41042
(606) 371-0081

Exit 182 off I-75

10 minutes south of Cincinnati
2nd exit south of I-275

Room Rates: \$49.95

Within walking distance of many restaurants

Thursday:

Hospitality Session 6:00 - 9:00 PM

Friday:

Swap Meet starts at dawn

Open Exhibition 10:00 AM - 5:00 PM "Fantastic Plastics"

Seminar: 7:00 PM "ABC's of Plastic Radios" by B.A. Richard

Saturday:

Swap Meet starts at dawn

General Admission: \$5.00 per family (All at one address)

Vendor Fee: \$15.00 per space
which includes 2 general admissions.

FOR SALE: Farnsworth CK-74 Bakelite bezel & glass dial - \$10 ea. plus shipping. Other unit parts available. Kevin Potter, 638 N. 9th St., Santa Paula, CA 93060. E-mail: us66kix@west.net

FOR SALE: Transistor radios: Sony TR84, green - \$45. Universal PTR62B - \$30. Channel Master 6515A, red - \$30. Plus shipping. Dan Sipola, 2840 Copeland Rd., Maple Plain, MN 55359. (612) 972-8214

FOR SALE: Magazines: Radio Electronics, Radio & Television News, Radio-Television Electronic Service, Radio & TV News, Service-Radio Television & Electronics, Technician & Circuit Digests, late 40's & 1950's - \$1 ea. Also many radio books, 30's, 40's, 50's, various prices, write for list. All plus UPS. Larry Chambers, 5026 Suter Dr., Nashville, TN 37211. (615) 833-2448

FOR SALE: Microphones: EV 630 - \$30. EV 911 Mercury - \$35. Shure 55S Elvis - \$60. Webster-Chicago 1201 double button carbon ring mike - \$165. Western Electric CW-51094 Navy, in original box - \$35. **WANTED:** Sentinel 177U Catalin cabinet. Dennis Schrank, 3129 S. Quincy Ave., Milwaukee, WI 53207. (414) 744-3374. Fax: (414) 744-8780

FOR SALE: Edison Standard phonograph, 2/4 minute gears, working - \$695. Edison Home phonograph with long style case, working - \$795. Huge RCA Nipper dog, stuffed 1970's promo - \$195. All add S/H charges. **WANTED:** Original 10" cone horn for cylinder phono, brown wax records, all windup phono reproducers, motors, etc. Thank you very much! John Andolina, 28 Glen Oaks Dr., Rochester, NY 14624. (716) 247-3056

FOR SALE: Jackson 637 tube tester - \$40. Heath AM-1 antenna imp. meter & manual - \$25. HP 204C oscillator - \$40. Tektronix scopes: #2213 60MHz - \$275; #454 A 150MHz - \$275; #453 50MHz - \$175; all + UPS. Hallicrafters R-274/URR (SX-73) manuals, N.O.S., 100 pages - \$13 mailed. Dan Mason, R. Rt.1, Box 204F, Santa Fe, NM 87501. (505) 455-3416

FOR SALE: Parts. Need an original dial glass for a Philco 41-287 or legs for Atwater Kent 55? How about a meter for Jackson 49 tube tester, logo or push-button assembly for Grundig 5060A, Catalin grille for Air King A600, output transformer for a Fisher 400 or battery cover for a Zenith Royal 500? These are just a few samples of the thousands of parts I stock to help keep your restoration original. Electrical, case and cosmetic parts available. Send brand name & model number of the piece of equipment along with name/description of the needed part. The Radio Junkyard, PO Box 436, Fallston, MD 21047. Fax: (410) 877-1697. E-mail: vintel@aol.com

FOR SALE: Don Colbert says that flea market spaces at Extravaganza '96 are only \$10! That's right, all outdoor flea market spaces after your first one (\$20) are only \$10/each. Come drive Don crazy by filling up the nearly 400 contiguous flea market spaces available at Extravaganza '96! For further information or for a convention brochure, write to: Michigan Antique Radio Club, Extravaganza '96, Suite 100, 3520 Okemos Rd., #6, Okemos, MI 48864

FOR SALE/TRADE: Federal: 110 - \$750. 141 - \$550. Both excellent. Plus shipping. Ed Bell, 5311 Woodsdale Rd., Raleigh, NC 27606. Fax/phone: (919) 851-1517

FOR SALE/TRADE: For swap or BO: Marantz 8B, PR George Gott G50D, PR Dynaco MKII, Fisher 70-A, Quad II with preamp, and N.I.B. 805 tubes. Michael Payne, 803 S. Taylor, Alvin, TX 77511. (713) 331-9217. Fax: (713) 585-2727. E-mail: We300B@aol.com

FOR SALE: New spring photo catalog, lots of sales - \$1 + LSASE 2 stamps. Bob Masterson, Box 172, Valley Cottage, NY 10989. (914) 353-3151

FOR SALE: N.O.S. 1930's Philco speaker - \$50. Sonora bedlamp - \$35. Tan Zenith R500. Tube/transistor radios, list - \$1. **WANTED:** Maroon handwired Zenith R500, Crosley 11-114U, 11-123. Don M. Maurer, 29 South 4th St., Lebanon, PA 17042. (717) 272-2481

Heathkit, A Guide to the Amateur Radio Products by Chuck Penson

**Documentation of
ALL Heathkit's
amateur products**

**Complete history
of the company**

**200+ sharp
photos**



**Most products are
pictured with a
full-page
description**

256 pages

\$24.95

**NEW!
Available
Now!**

U.S. Orders - Enclose \$3.00 per order for packing & book-rate shipping if total order is under \$35.00. If using VISA or MasterCard, include name on card, card number and expiration date. Send payment with order. Mass. residents please add 5% sales tax. Money back return policy. Most orders shipped the same day received, but allow 2-4 weeks to receive order. Foreign orders - write for shipping costs, or use credit card and specify air or surface (allow 2-3 months for surface shipping).



**Send Order To: A.R.C., P.O. Box 2, Carlisle, MA 01741
or Call: (508) 371-0512**

Fax: (508) 371-7129



(Dec-95)

INDIANA

Historical Radio Society



and

The Antique Wireless
Association



Present the 25th Annual Regional Spring Fling Radio Festival

Ramada Inn - Kokomo, IN — May 3rd & 4th, 1996

Friday May 3

Saturday May 4

<u>Event</u>	<u>Time</u>
Flea Market.....	All day
Registration	8 am-Noon
Seminars	8 am-Noon
Ladies Luncheon	Noon-??
Contest	1-4 pm
Enter items	12 pm
Judging.....	2-4 pm
Banquet	7 pm

<u>Event</u>	<u>Time</u>
Flea Market.....	All day
Registration	8 am-Noon
Auction items check-in.....	8-9:30 am
Donation Auction	9:30-11 am
Consignment Auction	11 am-?
Banquet Speaker: Ray Andrejäsich—one of the designers of the Zenith Royal 500, 100 and 3000.	

Accommodations: Ramada Inn (317) 459-8001 [They are holding 50 rooms until April 19.]
Motel-6 (317) 457-8211 [They are holding 40 rooms until 4/15.] Fairfield Inn is currently full on meeting dates.

Mail Registration Deadline is April 30.

All participants must register. All sellers must pay for space. Membership in the IHRS is not required except to enter the contest. Outdoor Flea Market setup OK on Thursday. No reserved spaces. Indoor seller's spaces only available on Friday.

Contest categories: 1. 1920's Table Sets; 2. Communications Receivers through 1948; 3. Most Unusual Radio; 4. Test Equipment through 1950; 5. Indiana-made Radios.

FEE SCHEDULE:

Registration (mail)	\$8/family
Registration (on site)	\$10
Indoor Flea Market Tables	\$10
Outdoor spaces	\$5/1 space, \$15/2 spaces, \$35/3 spaces
Banquet tickets	\$15/person

Please mail check for the appropriate amount to:

**Dr. Michael A. Clark, 6484 East 350 North, Franklin, IN 46131
(317) 738-4649**

For information, call Bob O'Friel: (317) 849-4028

CRYSTAL CLEAR, Vol. 1

By Maurice L. Sievers

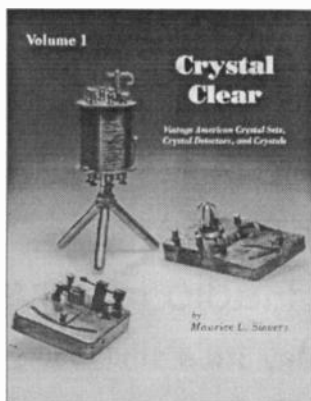

750 Illustrations – 570 Crystal Sets
341 Detectors – 207 Crystals
Perfect for the beginning collector!
Useful for the experienced too!

Crystal Clear is the most comprehensive reference for collectors, historians and anyone interested in early radio. In addition to the many excellent photos and reproductions of ads, *Crystal Clear* includes lists showing all sets by manufacturer, set name, selling price and date of manufacture. 8 1/2" x 11", 282 pages.

\$29.95 – Softcover

* *Crystal Clear, Vol. 2* – \$29.95 *

COMMUNICATIONS RECEIVERS

3rd Edition – Revised & Expanded

By Raymond S. Moore

402 radios pictured!

Sharper, clearer photographs

A comprehensive guide to 700 vacuum tube communications receivers from 1932 to 1981. In addition to Collins, Hallicrafters, Hammarlund and National, 66 other manufacturers from Allied to Tobe are included. New section on military receivers.

The description of each set includes years, band coverage, type, filters, tubes, a photo in many cases and other info. 8 1/2" x 11", 115 pages.

\$19.95 – Softcover

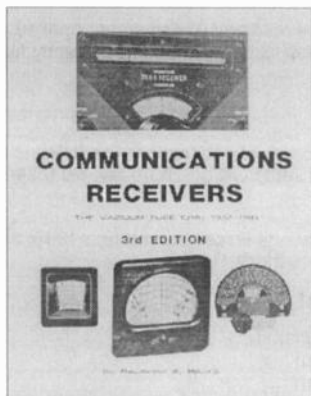

U.S. Orders - Enclose \$3.00 per order for packing & book-rate shipping if total order is under \$35.00. If using VISA or MasterCard, include name on card, card number and expiration date. Send payment with order. Mass. residents please add 5% sales tax. Money back return policy. Most orders shipped the same day received, but allow 2-4 weeks to receive order. Foreign orders - write for shipping costs, or use credit card and specify air or surface (allow 2-3 months for surface shipping).



Send Order To: A.R.C., P.O. Box 2, Carlisle, MA 01741
or Call: (508) 371-0512 Fax: (508) 371-7129



CRYSTAL CLEAR, Vol. 2

By Maurice L. Sievers



479 All New Photographs and Illustrations Cumulative Index of Both Volumes

Crystal Clear, Vol. 2 supplements the first volume. It identifies an additional 172 crystal radio sets, 91 crystal detectors and 26 crystals by manufacturer, model, year produced, description and original selling price. Further research on many of the crystal sets covered in Volume 1. Detailed history on the Philmore Manufacturing Company and the Western Manufacturing Company. 8 1/2" x 11", 252 pages, softcover.

\$29.95

* **Crystal Clear, Vol. 1 is also available for \$29.95 ***

U.S. Orders - Enclose \$3.00 per order for packing & book-rate shipping if total order is under \$35.00. If using VISA or MasterCard, include name on card, card number and expiration date. Send payment with order. Mass. residents please add 5% sales tax. Money back return policy. Most orders shipped the same day received, but allow 2-4 weeks to receive order. Foreign orders - write for shipping costs, or use credit card and specify air or surface (allow 2-3 months for surface shipping).



Send Order To: A.R.C., P.O. Box 2, Carlisle, MA 01741
or Call: (508) 371-0512 Fax: (508) 371-7129



Order These Popular Books From Antique Radio Classified

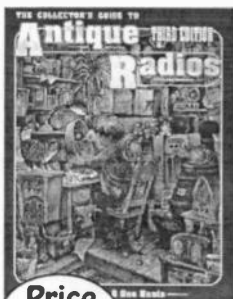

Price
Guide

The Collector's Guide to Antique Radios 3rd Edition by Marty & Sue Bunis. *8,500+ Battery & AC sets from the '20s to the '60s. Updated prices. Over 650 all new photos, 278 pages. 1994. — \$18.95*

The Collector's Guide to Transistor Radios 2nd Edition by Marty & Sue Bunis. *This book will help you identify the most sought-after vintage transistor radios. Over 2,900 models, all with current prices. Includes radio club listing. 375 all new color photos, 320 pages. 1996. — \$16.95*



Price
Guide



Price
Guide

The Radio Collector's Directory and Price Guide, 1921-1965, 2nd Ed. by Robert Grinder. *Over 20,000 radios by manufacturer, model number, year, etc. with prices. Radio history, cabinet style chapters. No photos, 264 pages. — \$26.95*

Transistor Radios, A Collector's Encyclopedia and Price Guide by Robert Lane and David Lane. *Identification guide to over 2,500 transistor and novelty radios. History and key to collecting chapters, 170 pages. — \$19.95*

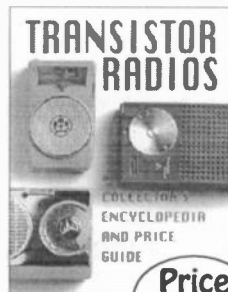

Price
Guide

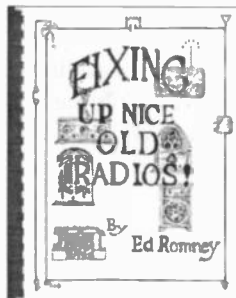

Fixing Up Nice Old Radios by Ed Romney. *Written by a retired radio instructor. Plastic binding. 300+ figures, 185 pages. — \$19.00*

Old Time Radios Restoration and Repair by Joseph J. Carr. *A self-paced training guide. History, theory and practical operation of antique and classic radios. 200 illustrations, 256 pages. — \$18.95*



U.S. Orders - Enclose \$3.00 per order for packing & book-rate shipping if total order is under \$35.00. If using VISA or MasterCard, include name on card, card number and expiration date. Send payment with order. Mass. residents please add 5% sales tax. Money back return policy. Most orders shipped the same day received, but allow 2-4 weeks to receive order. Foreign orders - write for shipping costs, or use credit card and specify air or surface (allow 2-3 months for surface shipping).



Send Order To: A.R.C., P.O. Box 2, Carlisle, MA 01741
or Call: (508) 371-0512

Fax: (508) 371-7129



(Apr-96)

Order These Popular Books From Antique Radio Classified



Crystal Clear Volume 1 and Crystal Clear Volume 2 by Sievers. *Comprehensive reference to crystal sets, crystal detectors, and crystals. Each volume contains different illustrations and information. Order by volume. — \$29.95*

Flick of the Switch by Morgan McMahon. *The classic photo reference guide for 1930s - 1950s radios. 1000+ photos of radios, 5" x 8", 263 pages. — \$11.95*



Guide to Old Radios, Pointers Pictures, and Prices, 2nd Ed. by Johnson. *Introduction to radio collecting. Includes hundreds of photos and a price guide. 272 pages. Available late October. — \$19.95*

Antique Radios Restoration and Repair, by Johnson. *Beginner's introduction to troubleshooting and repairing AC table model radios. 145 pages. — \$14.95*



Price
Guide



The Zenith Trans-Oceanic: The Royalty of Radios by Bryant and Cones. *Presents the fascinating story of the development and use of the Trans-Oceanic. Several photos, documents, ads, etc. 160 pages. — \$24.95*

Communications Receivers, 3rd Ed. by Ray Moore. *Information on vacuum tube receivers by 66 manufacturers. 402 radios illustrated, 115 pages. — \$19.95*

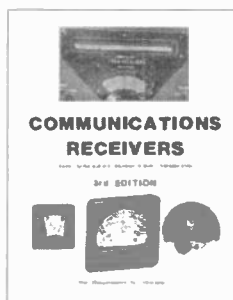

U.S. Orders - Enclose \$3.00 per order for packing & book-rate shipping if total order is under \$35.00. If using VISA or MasterCard, include name on card, card number and expiration date. Send payment with order. Mass. residents please add 5% sales tax. Money back return policy. Most orders shipped the same day received, but allow 2-4 weeks to receive order. Foreign orders - write for shipping costs, or use credit card and specify air or surface (allow 2-3 months for surface shipping).



Send Order To: A.R.C., P.O. Box 2, Carlisle, MA 01741
or Call: (508) 371-0512

Fax: (508) 371-7129



(Jan-96)

FOR SALE: Rare Sony transistor radios: TR-63, yellow; TR-86, green/red; TR-6, very rare, some damage, but still very presentable; TR-72, very rare wood cabinet; TR-75 green; TR-6080, green with case; TR-609, blue with case; TR-608, green with case. Offers accepted. A. Nolf, 539 Kastelec Pl., Burlington, Ontario, Canada L7N 3S9. (905) 333-4557

FOR SALE: Heath 2-meter transceiver, Model HW 30 w/Model GP 11 power supply - \$40 for both pieces. Quack medical device, Philco Ionitron with tube out the top, cute, small, perfect, you figure out what it does - \$25. Small Sony tape recorder, Model 101, or Sony Model TC 105, your choice - \$25 or both for \$40. Also have perfect AIWA miniature TR for - \$20. Have a mint condition MINY tape recorder in leather case - Best Offer. Bill Manny, 1103 N.W. Despain Ave., Pendleton, OR 97801. (541) 276-3152, work days; (541) 276-7439, evenings and weekends

FOR SALE: King Hinners 5-tube battery set 3-dial Neurodyne includes tubes, exc cond. Model #25 - \$115. Crosley Mod 23AR (5) push buttons, (3) knobs, wood grille, lites, no play - \$60. Signal Electric home brew battery set with tubes (includes Silver Marshall audio xfmr #220 - \$75. Atwater Kent 55 chassis & spkr, looks & plays fine - \$65, pick up only. Rider's Radio Manuals, good cond., #'s 4, 6, 7, 8, 9, 10 - \$20 ea. (3) picture tubes 2", 3", 5" - \$20 ea. Chassis & spkr with tubes for RCA 9T console - \$50. Chassis & escutcheon for Philco 37-670 console - \$50. Pearce Simson ship-to-shore radio - \$50. Popeye phone, new in box, collectible, mint - \$24. Mini bottle of Radio Girl perfume, Deco label, full - \$5. Ford 1¢ gumball machine, vg cond. - \$69. Kit radio made by Five Star Radio Co., Cambridge, Massachusetts, assembled, (5) tubes - \$45. Airline superheterodyne farm? radio, has chrome chassis, uses 3-volt battery!, looks nice - \$55. Joseph L. Gambaccini, 192 Division Ave., Shelton, CT 06484. (203) 924-0271



Vacuum tubes for Audio
are back...
and they sound better
than ever!

Glass Audio

brings together yesterday's tubes
and today's improved components,
making smooth sound possible
from your audio again.

Ask for your first **FREE**
issue, without obligation!

Glass Audio

PO Box 176, Dept. ARC6
Peterborough, NH 03458-0176 USA
FAX (603) 924-9467

FOR SALE/TRADE: McMurdo-Silver Mod # 15-17 chrome-plated receiver chassis w/poor chrome but has excellent parts - \$375. Also Masterpiece III parts set - \$275. Larry Drago, 383 Lincoln Dr., Cheshire, CT 06410. (203) 272-6030

FOR SALE: N.O.S. RCA exhibit building cards; I was televised at the RCA exhibit, great graphics - \$25 ea. RCA Model 143 - \$395. Echophone Model 60 - \$595. Philco 49-501 Boomerang radio \$295. N.I.B. red Sony 620 - \$195. N.E.C. NT61 - \$150. Lafayette FS91 - \$185. Pilot TV-37, exc - \$325. Radiola bal. amp - \$225. Radiola 60 - \$175. Radiola UZ1325 - \$150. Radiola 103 - \$185. Zenith T-O bomber 7G605 - \$295. Sentinel wavy grille, red, hairline under dial lens - \$750. Sony 4-203UW, exc - \$195. N.I.B. white Emerson 888 Vanguard - \$175. Black Explorer in box - \$150. Blue Arvin 444 - \$150. Red Crosley 11-115U - \$195. White Crosley left-side bulls-eye - \$150. Zenith maroon Royal 500 - \$75. Brown Sparton Polo radio - \$295. RCA 77 mike with CBS radio flag - \$1,350. Black celluloid G.G.H. Majestic horn - \$275. Siemens field German radio - \$350. Philco butterfly radio 45 - \$175. Philco 70, restored & working - \$295. Radiola 16 - \$135. Radiola IIIA - \$175. Philco Predicta Tandem - \$295. Repwood cone speaker Knight in armor - \$175. Black Regency TR1 - \$395; red TR1 - \$495. Murdock horn speaker, small - \$375. Zenith Royal 7000, exc, working - \$295. Radiola AR-812 superheterodyne, working - \$195. Crosley Super Tridyn Regular - \$75. Freed-Eisemann NR-7, exc working - \$165. Midwest Miraco gold graphics - \$150. All submini radios in stock Crosley book: Emerson, Motorola Pixie Private Ear from \$150-\$450 for Private Ear; Bowman crystal radio - \$2,300. Sams Servicing Tran. Radios Vol. 1-20 & Vol. 24-38, all 35 volumes, many unused - \$350. Zenith radio organ lapel pin - \$45. Same as Spinette, Grebe Synchrophase - \$195. Atwater Kent Model 165 - \$375; 206 - \$250, 90 - \$495. Etched glass - \$350. Peter Pan radio - \$850. Sparton peach mirror 558 - \$3,500; blue 558 - \$3,300. Motorola suitcase radios 68L11, 69L11 - \$50. Deco Philco 37-610 - \$125. Air King tombstone, same chassis & front as plastic - \$300. Chassis for Air King Egyptian, brown knob - \$450. Crosley Radios white neon sign - \$275. Meteor loose coupler - \$295. WE loudspeaker Model 360 - \$195. Brown Silvertone Candy Cane radio - \$95. Arrola radio with P/S - \$150. DeWald yellow Catalin with handle, 1 1/2 hairline on front - \$275. Federal Jr. - \$295. Emerson Momento - \$95 wood. GE J-72 cathedral - \$275. Motorola 5R1 waffle grille - \$45. Stewart-Warner Companion - \$85. Small Mercury mid-gt cath. - \$200. Zenith chairside 5S267 - \$250. Guild Country Belle telephone radio - \$85. World radio receiver - \$95. Crosley 11-125U, blue, chip on bottom - \$50. Tiny Tim yellow & red crystal radio - \$70. Vintage Radio Co., 87 Sandra Dr., Parsippany, NJ 07054. Voice or fax: (201) 316-8424

FOR SALE/TRADE: The following communication receivers recently purchased from museum: National NC 2-40, NC 200, NC 100, NC 105, NC 46, plus Hallicrafters SX 40A, SX 42, SX 62A, S-20, S-20R and Super Skyrider, SX 17, SX 28, SX 120, SX 130, S-38 - all priced fairly. Larry Drago, 383 Lincoln Dr., Cheshire, CT 06410. (203) 272-6030

FOR SALE: Sony TR-610, black - \$100. Zenith Golden Triangle - \$110. WANTED: Bowmar, Busicom, MITS calculators. Larry Gilbert, 2602 Amapola Dr., Davis, CA 95616. (916) 758-5025

The Collector's Guide To Antique Radios - 3rd Edition

By Marty & Sue Bunis



8,500+ Battery & AC sets from the '20s - '60s
Expanded listing of radios from the '60s
Over 650 all new color photographs
Updated prices
\$18.95 - Softcover

There are no transistor radios listed in the third edition. You will find them in
The Collector's Guide to Transistor Radios available from A.R.C. for \$15.95.

U.S. Orders - Enclose \$3.00 per order for packing & book-rate shipping if total order is under \$35.00. If using VISA or MasterCard, include name on card, card number and expiration date. Send payment with order. Mass. residents please add 5% sales tax. Money back return policy. Most orders shipped the same day received, but allow 2-4 weeks to receive order. Foreign orders - write for shipping costs, or use credit card and specify air or surface (allow 2-3 months for surface shipping).



Send Order To: A.R.C., P.O. Box 2, Carlisle, MA 01741
or Call: (508) 371-0512 Fax: (508) 371-7129



FOR SALE/TRADE: National RA8-2 w/speaker, PS and 7-coil rack - \$500. National F7-7 w/3 coil sets - \$600. National 183 - \$300. 1938 HRO prototype, w/five coils & manual, one-of-a-kind in new condition - \$700. Larry Drago, 383 Lincoln Dr., Cheshire, CT 06410. (203) 272-6030

FOR SALE: Grebe, MU-1, cabinet only, no chips/cracks, no escutcheons - \$25 plus shipping. Carol Scott, 1402 Cora #1, Ellensburg, WA 98926. E-mail: scottc@adsnet.net, http://www.adsnet.net/radio

FOR SALE: Rider Radio Volumes I-V Abridged - \$45. VI, VII, VIII, IX, X & Index - \$85. Dick Kowalski, KB8MR, 32823 Gloede Dr., Warren, MI 48093. (810) 294-6831

FOR SALE: Akai 4000DS - \$65. Field telephone - \$19. Matsushita #T-41 - \$20. Panasonic T-50 - \$20. FM transmitter - \$40. Sabtronic #8610A freq. counter - \$25. Zenith Royal 35 - \$10. GE P795-D - \$20. Following in boxes: Realistic Ten-Four #606 AM/CB radio - \$25. SWR meter - \$15. Fentone bullet mike - \$39. Realistic HTX-100 ham transceiver - \$200. Video-audio control center - \$25. Also have Realistic video enhancer - \$45. AK 40, rebuild or parts - \$35. Variac - \$20. **WANTED:** RCA 3 1/4" R/R tape recorder Model #VJ-15G ca. 1967. See ad, A.R.C. March p. 60 details. Bret F. Johnson, 13495 102nd Ter. N, Largo, FL 34644. (813) 595-9287

FOR SALE: Thousands of tested tubes w/warranty! Send for new list with improved discounts and monthly specials. Both xmit and rectubes. I have acquired many common tubes recently. Buy those spare tubes for your tube radio, audio, ham and electronics. Most tubes are used at about 33% of new, many are about \$1. I have bunches of octal, older, 7- and 9-pin tubes. All tubes are tested on TV-7D/U tester and then boxed. I give a 30-day warranty. Send wants or SASE with two stamps for list. Daniel Nelson, 1025 E. Desert Ln., Phoenix, AZ 85040. (602) 243-7421, evenings. E-mail: djn@indirect.com

FOR SALE: Table radios: Crosley 516 tombstone (works!) - \$75. Crosley F-5-MY Musical Chef style - \$35. Emerson 512 - \$30. Silvertone 1 metal, repainted - \$40. Silvertone 9000 - \$25. Transistors: Jewel TS-10 - \$20. Channel Master 6509 - \$25. Kobe-Kogyo KT-1000 - \$45. Realtone 8812 large multiband - \$45. NEC NT-625 - \$55. Motorola 5P32Y yellow tube portable - \$25. Microphones: Shure 55S - \$125. Shure PE-55, pitting - \$45. Astatic 200S - \$30. Zenith transistor hearing aids - \$25/2. Brandes Admiral headphone N.I.B. - \$20. New cloth headphone cables - \$5 ea. Always glad to trade for transistor radios! Send LSASE for long updated list of goodies! Jon Hall, WB4MMV, 39 Spring Oaks Ln., Ruckersville, VA 22968. (804) 985-3827, 8:30-10:30 pm. Fax: (804) 984-3299. E-mail: jon@halls.com

FOR SALE: 1. Music Master horn, (1) crack in bell - \$185. 2. Rider's Vol. VIII, N.O.S. - \$35. 3. Rider's Vol. IX, very good - \$20. 4. Colonial globe radio, brown damaged - \$650. 5. Edison banner home phono w/ original horn and (5) cylinders - \$800. 6. Sparton radio advertising clock - \$295. 7. Philco Model 16B - \$375. 8. Leanavian airport radio receiver - \$250. 9. Zenith tombstone Model 5-S-28 - \$195. 10. Aeriola Sr. no tube - \$135. 11. Radiola III, clean, no tubes - \$110. Contact: Waves, 32 E. 13 St., New York, NY 10003. Hrs. 12-6 Tues.-Fri., 12-5 Sat. (212) 989-9284. Fax: (201) 461-7121. E-mail: c1wave@aol.com

FOR SALE: Old CB base station radios. Johnson 250 Messenger, Johnson Messenger 223, Lafayette HB 444/25 with original silver mike, and also Siltronix VFO, Model 90, perfect cosmetically, all for - Best Offer. Bill Manny, 1103N.W. Despain Ave., Pendleton, OR 97801. (541) 276-3152, work days; (541) 276-7439, evenings and weekends

FOR SALE: Browning R27/S23 - \$275. Black Cat base modulator - \$225. Turner +3 desk microphone - \$30. Glenn Hendrix, PO Box 144, Ardmore, OK 73402. (405) 657-3327

FOR SALE: Magnavox mantle electrodynamic speaker, beautiful cabinet, 1920's - \$75. Large magnifier for 10" TV - \$30. Buddy Boy cabinet and chassis - \$150. RCA P-31 portable - \$125. Motorola 7" TV, wood cabinet cosmetically good, electronically restored - \$200. Rubber grommets that fit under Philco 20, 70 & 90 tuning condensers - \$5 per set p/pd; 2 sets - \$8. Don Patterson, 636 Cambridge Rd., Augusta, GA 30909. (706) 738-7227

FOR SALE: Thompson Minuet Model R81, very uncommon and in excellent condition - \$1,495. Scott red-band Philharmonic (10# 20C) in rare Special West-erly (#72) cabinet, (see photo in March 1996 A.R.C., p. 41) - \$4,995. Scott AW23 (ID#17A) in Laureate Grande cabinet (ID#30) with desirable Volume Range Expander accessory (ID#30); Scott FM Philharmonic (ID#200) in Wellington cabinet (ID#91), radio electronically restored - \$3,900. Zenith 12S471 - \$575. Rare 10S157 Zephyr console, excellent original condition - \$995. Black Motorola Pixie, near mint - \$195. Will consider very early electric toasters in trade. Jim Clark, 1292 Starboard, Okemos, MI 48864. (517) 349-2249

FOR SALE: Zenith Trans-Oceanics. All are original, complete and 100% cosmetically restored following restoration procedures outlined in Zenith Trans-Oceanics book by Bryant & Cones. 7G605 bomber grille - \$395; 8G005YTZ - \$175; G500, made only one year - \$195; H-500 - \$185; A-600 - \$210; B600 - \$210. Zenith full color repro ads, circa 1940's - \$7 ea. Atwater Kent #55 - \$150. Fada 1000 streamline bullet repro, M.I.B., last one - \$75. Frank J. Manziano, 82 Monhegon Ave., Oakland, NJ 07436. (201) 337-5263

FOR SALE: Murdock Model CS32 - \$300. Stewart-Warner Model 5 - \$265. Stewart-Warner horn speaker - \$165. Stromberg-Carlson radio Model 1A - \$325. Amplion horn Model AR19 - \$575. Roger Zelenack, PO Box 460642, Escondido, CA 92046. (619) 480-0452

FOR SALE/TRADE: Heath DX100-B without cabinet - \$325. Marantz Mod #1 preamplifier - \$975. National FBX w/4 sets of coils - \$525. National NC-300 w/ speaker & converter box - \$475. Crosley Pup w/WD12 tube, all original tags, etc. - \$950. Amplion 19 horn speaker - \$950. Collins 75A-3 w/2 mechanical filters - \$500. Rek-O-Kut professional style turntable (stereo tonearm) - \$275. Two Altec Lansing 15" speakers - \$500. Eria cathedral w/clock in grille (casket style) cabinet design, unbelievably beautiful - \$475. Call: Larry Drago, 383 Lincoln Dr., Cheshire, CT 06410. (203) 272-6030

FOR SALE: Radiola III - \$75. Radiola IIIA - \$95. Radiola 33 and speaker - \$70. Radiola 44 - \$75. Radiola 18 - \$80. Radiola 60 - \$85. Crosley 401 Bandbox Jr. with tubes - \$80. Gary Watkins, 8006 Greenwald, Belton, MO 64012. (816) 322-0773

WANTED: Western Electric Loudspeaking Telephone welcome, any models and condition. Jun Mizuno, 933 Portwood Cir., San Jose, CA 95120. (408) 268-4016

WANTED: Tube 275A. Book: Hifidelity Sound Engineering by Crowhurst. Tom Miller, PO Box 20138, London Terr. Station, New York, NY 10011. (212) 675-7704

WANTED: Genuine wood/metal horn, motor board (top wooden case), and reproducer for Victor III talking machine. Ryo Kobayashi, 2-4-6, Miyanodai, Sakura, Chiba, 285 Japan. Tel/fax: 81-43-461-2297

WANTED: Catalin radio. Have very little money, but the rich guys with the clever ads shouldn't get them all. Jim Williams, 6622 Shalestone Ct., Clifton, VA 22024. (703) 631-0071

WANTED: Radiola 33 lid. Information on Bremer-Tully grandfather clock/radio with 47 output. Tony Parjus, 816 Richard Ln., Gretna, LA 70056. (504) 393-0099

WANTED: Squires Sanders SS-1R, SS-1V, SS-1T; Collins 55G-1, 55S-1, 62S-1, 75S-3C, 32S-3A, 75A-4, KWM-1, Millen 90673, Miller AT2500, Hickok 539C, 580 700. Hank Kolesnik, WD5JFR, 4161 Oak Rd., Tulsa, OK 74105. (800) 364-4265

WANTED: Trying again, please help! National SW-3 with coils and power supply. Cash or trade antique cathedrals and/or Howard and other communication radios. Thanks! Steve Lipsky, W2VVN, 1254 Cox Rd., Rydal, PA 19046-1207. (215) 884-1817, alt. (609) 361-8175

WANTED: Old guitar amplifiers, and guitars. Fender, Gibson, Supro, Gretsch, etc. Working or not! Steve Harrell, 1179 Boylston St., #30, Boston, MA 02215. (617) 247-0672



WANTED: Deco radios and parts; Detrola, Kadette, Fada, Air King, others. Also, DeForest interpanels. Ross Lirenta, 1 Wilton Rd., Eastchester, NY 10709. (914) 337-7176

WANTED: Buying tubes. Paying the following for: 6CA7/EL34 GE/US - \$12; 6CA7/EL34 Mullard - \$18; KT66 British - \$25; 614B GE/US - \$10; Few 807 - \$3. Must be new-in-boxes, no exceptions. Dee Almquist, W4PNT, PO Box 371, Crimora, VA 24431. Voice mail: (800) 755-2365. E-mail: soundmind@rica.net

WANTED: N.O.S. tubes: 7025, 6CA7, 6L6GC, 5881, 6V6GT, 6BQ5, GZ34, 7591, 6550. Jensen 10" & 12" Alnico speakers. Old harmonicas, all makes and models. John McGrath, 29 Ripley Rd., Belmont, MA 02178. (617) 484-0515. Fax: (617) 492-7921

WANTED: (2) old battery eliminators A and B in working condition. Vincent Perilli, 14 McCarthy Dr., Ossining, NY 10562. (914) 762-1608

WANTED: Philco 90 cathedral (with Push-Pull 45's) in excellent/mint condition. Thank you. Terry Dowling, 12225 Royal Oak Ln., Ashland, VA 23005. Aol: Radio-Terry, Compuserve: 73312, 1702, Internet: tdowling@freenet.vcu.edu

WANTED: Industrial/special purpose tube manuals or pamphlets. Also any odd or unusual tube types. Will pay \$100 for Eimac 500T tube. John H. Walker, Jr., 16112 W. 125th St., Olathe, KS 66062. (913) 782-6455

WANTED: Philco 48-230, 48-460-1, 49-501, 49-503, 49-506, 50-526, 51-532, 51-930, 52-548, 53-561, 53-563, 53-566, E-818, TP-7, T-1000. Motorola 53H1, 53X1, 5X11U, 5X21U, 72XM21. Ciimax Ruby Supreme. KLH8 and accessories. Mint Philco Predictas, plus instructions, sales literature, service information. Acrosound, Fairchild, Fisher, Hadley, Karg, REL, etc., tube hi-fi equipment accessories, sales literature. 1950's-1960's hi-fi books, plus Allied, Lafayette, Heathkit, etc., catalogs. Paul Creasy, 6216 Worlington Rd., Bloomfield Township, MI 48301. (810) 737-0429. E-mail: 74664.1153@compuserve.com



WANTED: The knob shown. I need seven excellent examples of this knob. Dates from mid to late 1930's. Often found on communication type receivers. John T. Meredith, 2462 Stantonburg Rd., Suite 152, Greenville, NC 27834. (919) 551-1882

WANTED: Zenith Trans-Oceanics, all models, any condition tube and transistor. Zenith military Trans-Oceanics R520JRR and R520AJRR. All Zenith wood table models manufactured between 1915 and 1942. Frank J. Manzano, 82 Monhagon Ave., Oakland, NJ 07436. (201) 337-5263

WANTED: Columbia Grafonola with record ejector and other crank phonographs; Philco 512, 514 or 516 with matching speaker; good electronic turntable to play 78s. Richard Rubin, 227 Riverside Dr., Apt. 5-A, New York, NY 10025. (212) 864-8416. E-mail: wireless@panix.com

WANTED: MESCO (Manhattan Electrical Supply Co.) the same company that made electrical items including radio parts and sets, made an electric toaster circa 1914-1915, and I am looking for one. Jim Clark, 1292 Starboard, Okemos, MI 48864. (517) 349-2249

WANTED: Ozarka radios and literature, speaker for Buddy Boy, any condition, shield for Buddy Boy to make reproduction. Don Patterson, 636 Cambridge Rd., Augusta, GA 30909. (706) 738-7227

WANTED: McIntosh audio equipment, tube amps, preamps, all mint tuners, whole system; Thorens 124, Garrard 301 turntables, Scott 310 tuners. Walt Fleming, 182 Plain Hill Rd., Norwich, CT 06360. (860) 889-1957

WANTED: Old tube-type CB radios and CB operating/owner's manuals. Walter Ryan, 7114 Geysler Ave., Reseda, CA 91335. (818) 344-8735, day/evening

WANTED: Pre-1950 Farnsworth stuff: TVs, early TV tubes, equipment, any related TV literature. Fred Ringwald, MSC#293, PO Box 901, Elmendorf AFB, AK 99506. (907) 392-3217

FOR SALE/TRADE: Edison Standard cylinder phonograph, Edison Home cylinder phonograph, both with black and brass trumpet horns - \$850/both. Larry Drago, 383 Lincoln Dr., Cheshire, CT 06410. (203) 272-6030

FOR SALE: 100's antique radios. Old electronics tubes, test equipment. Huge photolist - \$1.50+. SASE. Radio Ranch, 10745 255th Ave. NE, Belgrade, MN 56312

SEND ALL A.R.C. MAIL TO
Antique Radio Classified
P.O. Box 2, Carlisle, MA 01741

FOR SALE: Pair of World War II Motorola walkie-talkies, both complete and good condition - Best Offer. Bill Manny, 1103 N.W. Despain Ave., Pendleton, OR 97801. (541) 276-3152, work days; (541) 276-7439, evenings and weekends

FOR SALE: Nordmende Condor, portable, AM/FM, PB, green/gold, plays - \$40. Doll brunnette, plays - \$55. American Bosch 48, w/wood cabinet top speaker - \$175. Motorola 69L11, portable, dial in handle, plays - \$60. Paulson Crestone, TRF, small metal radio, 30-40's, center speaker/dial - \$70. RCA 100A speaker, cloth good, works - \$50. Westinghouse WR14, cathedral, plays - \$150. Wilcox-Gay 1J11 Recordette 3 - \$35. Zenith G503Y, black vinyl, flip dial, plays - \$45. Electraphy health generator, medical device, with case, attachments, old battery, instructions and handout, works - \$60. Burdick ED2, electrocardiograph, portable, metal case - \$45. Amecor TX62, 2&6 meter transmitter - \$50. Heathkit Toer, 2 meter transmitter - \$35. Heathkit DX35, transmitter - \$45. Knight R100, receiver, 4 band, looks good, doesn't work - \$50. World Radio Labs ECBK, transmitter - \$45. Bogen MO60 amplifier, 2 ea. 7581 - \$60. JBL D123 speakers, 12", pair - \$130. McGowen M355 PA amplifier, 35W, 2 ea. 7868 - \$35. Webcor LP2712-1 Royal Coronet, reel-to-reel - \$50. Hickok 605 mutual conductance tube tester and analyzer, book - \$80. Jackson 648 mutual conductance tube tester, book - \$65. Knight 600B tube tester, book - \$35. Shipping extra. Many other new items. Three lists available. (1) Pocket transistors, table radios, sound equipment, microphones, test equipment and more. (2) 15,000+ transmitting/receiving tubes and projector bulbs. (3) Books, catalogs, magazines and manuals. Send SASE. Ray Nowak, 30513 Ednl Dr., Bay Village, OH 44140. (216) 871-8303

FOR SALE: UTC LS-66 Mod xformer for 211's, tests OK - \$55 + ship. Tonearms Piezo Japanese, N.O.S. w/ Sonotone style turnover cart. & harness stereo - \$6.95 ea. 6J7, 6K7 metal, used vg - \$1.50 ea. Philco Type G spkr - \$25. Crosley Shelvador chassis w/bezel - \$55. **WANTED:** Zenith 1936-40 tubes. Thanks. R. Dobush, 3554 W. 105, Cleveland, OH 44111. Ph./Fax: (216) 647-3908

FOR SALE: Heathkit 40th Anniversary (1987) catalog, mint - \$5 ppd U.S. Ralph Michelson, KG8FA, 4538 Golfview Dr., Brighton, MI 48116. (810) 229-8339

FOR SALE: Are you repairing your vintage radio? Send SASE for list of information available. Charles Ahr, 2291 Sylvd Ln., Cincinnati, OH 45238

FOR SALE: Old, Lee X-ray tube 18" long w/4" dia. bulb in middle - \$100. Hank Andreoni, c/o 250-D So. Lyon Ave., Hemet, CA 92543

FOR SALE: Compactron adapters, set of (2) adapters which allow 9-pin and 12-pin Compactron sweep tubes to be tested on TV-7 type tube testers. This lets popular tubes such as 6JB6, 6JE6, 6JF6, 6JM6, 6JS6, 6JU6, 6JZ6 6KD6, 6KM6, 6KN6, 6LB6, 6LF6, 6LQ6, 6LR6, 6LX6, 6ME6, 6MJ6, 12BJ6, 20LF6, 21JS6, 23JS6, 24JE6, 27LF6, 30KD6, 40KD6, 8950, 7868 to be tested on TV-7 testers which do not have Compactron sockets. Tube test setup and test data are supplied for the TV-7 tester series only. This includes switch settings and bias values as well as minimum and as new test values. (2) adapters as well as tube test information and pin-out conversion data are supplied. Please send \$25 to: Daniel Nelson, 1025 E. Desert Ln., Phoenix, AZ 85040. (602) 243-7421, evenings. E-mail: djn@indirect.com

FOR SALE: Rare 1928 Steinite Seville highboy, mahogany upright Brunswick Ultona phonograph; collection of Edison Diamond Discs, need space, no reasonable offers refused. Richard Rubin, 227 Riverside Dr., Apt. 5-A, New York, NY 10025. (212) 864-8416. E-mail: wireless@panix.com

FOR SALE: Kron-hite DCA-50R 50-watt transducer tester, nr. mint condition - \$500, incl. shipping con. U.S. Dee Almqvist, W4PNT, PO Box 371, Crimora, VA 24431. Voice mail: (800) 755-2365. E-mail: soundmind@rica.net

FOR SALE: (12) EH Scott consoles for sale including a beautiful original Waverly Grande late 23. Call for info. We accept Visa and MasterCard. Alan Jesperson, PO Box 17338, Minneapolis, MN 55417. (612) 727-2489, 8 am to 8 pm, 7 days. Fax only: (612) 727-1908

FOR SALE: Ham Price Guide, introductory - \$9.95. 3,000 items ham gear identified and described. Over 6,000 real, dated prices for over 2,500 items. Boat anchors through HT's, linears, tuners, mics, power supplies, antennas and more. Use also to decipher cryptic ad descriptions. \$9.95 includes U.S. postage. \$11.50 Canada, \$14.95 other. Also: Tube Type Transmitter Guide, 550 pictured items - \$17.95 U.S., \$19.95 Canada, \$27.95 other. Californians add tax. Sound Values, PO Box 9, Dept. C, Auburn, CA 95604

FOR SALE: CR-9 - \$600. Craftsman C350 preamp/ equalizer - \$60. **WANTED:** WE amps, speaker, good 205, 216 & 264 tubes. Frank Hagenbuch, 1404 Lafayette Pky., Williamsport, PA 17701. (717) 326-0932

FOR SALE: Seco LC3 tube leakage checker, untested - \$10+. Tobe condenser analyzer, old, untested - \$25+. Robert Rossi, 10936 Melbourne St., Allen Park, MI 48101. (313) 386-8321

FOR SALE: Tubes N.I.B. 12AU7 - \$2.50; 6SN7GTB - \$2; 5U4GB - \$6.50 or 10 for \$50. Bob Gidney, 411 W. Spruce St., West, TX 76691. (817) 826-5105

FOR SALE: Reproduction door panel papers for RCA AR812 - \$9 + LSASE. Jim Leckrone, 12174 Lynn St., Bear Lake, MI 49614

FOR SALE/TRADE: Hickok Model 530-B tube tester w/ manual and roll chart, excellent condition. Robert Jackson, 6028 Cheshire Way, Citrus Heights, CA 95610-6716. (916) 726-2264

FOR SALE: For shipping and ad costs only: Westinghouse table Model H875LN6AAM-FM clock. GE AM-FM table model, wood case, unk. #7 tubes. Extra tubes included, both work! Robert Majors, 3508 Williamsborough Ct., Raleigh, NC 27609-6354. (919) 782-1150

WANTED: Knob for Emerson Model 636, see Bunis 3, p. 75. Hank Trabold, 2058 Nakiska Ct., Toms River, NJ 08755. (908) 244-2345

WANTED: New Astatic phono needles (PL) for #89 cartridge, also copy of manual for Heath IGW-47. Harry Pewowaruk, 1535 N. 8th Ave., St. Cloud, MN 56303. (612) 252-9910. E-mail: Pewowaruk@aol.com

WANTED: Remote control for RCA color TV, Model #211CDR835. TV cahssis #CTC10. I also collect RCA radios, TVs, promo, advertisement, etc. Please call or write with info. Jeff Strutin, 1 2nd Ave., Central Islip, NY 11722. (516) 582-2569

WANTED: Military Morse code key with a spring that wraps around leg to allow keying in a vehicle. Also information on a miniature Stuart AR-100 germanium radio. Don Neiss, Jr., 133 N. 17th St., Wheeling, WV 26003. (304) 277-2629

WANTED: Westinghouse WL-41, Taylor 833, DeForest 430 through 440 tubes, duds OK. John H. Walker, Jr., 16112 W. 125th St., Olathe, KS 66062. (913) 782-6455

WANTED: Presto 85E amplifier, Western Electric 394/47A microphones, RCA 4AP1 (4A type) microphones, and other 1930's recording equipment. Trent Ruane, 111 N. Grant, #1, San Mateo, CA 94401-1953. (415) 340-8371

WANTED: Heath FM stereo generator or similar. Knight-kit 83y706 radio broadcaster amplifier. Sam Wolfe, 5101 Alexander Dr., Flower Mound, TX 75028. Phone/fax: (214) 539-6880

WANTED: Four original tube shields for 1936 Delco set, fits 6C6, 6A7. Thanks. Art Eberhardt, Box 209, Loomis, NE 68958. (308) 876-2240, anytime

WANTED: Bottom cover and schematic for Breting 12. Claude J. Dellevar, Jr., 13009 Maclay St., Sylmar, CA 91342. (818) 365-1629

WANTED: Balloon-shaped 80/280/380/480 tubes, N.I.B. - \$15; good used - \$10. H. Kato, c/o Mr. T. Kato, 6868 Chelsea Rd., McLean, VA 22101

WANTED: Who's Who in Radio/TV or Hollywood magazines. Also those wonderful Mitchell, Mitchell, Mitchell radios, appliances. Lee Mitchell, The Mitchell Collector, 175 E. Delaware, 8209, Chicago, IL 60611. (800) 869-7869

WANTED: Admiral 389-5S or any exc prewar Bakelite with push buttons. Karen McCoy, 8104 N.W. 114, Oklahoma City, OK 73162. (405) 722-0595. E-mail: kcmccoykc@aol.com

WANTED: Top \$ paid for early European wireless apparatus. Try me! Francois J. Humery, 16, Hameau des Marronniers, F-77185 Lognes, France. Phone: 00-33160052836. Fax: 00-33160843700

WANTED: RCA 3 1/4" R/R tape recorder Model #YJS-156 manufactured ca. 1967. Slanted front panel, lift-off lid, AC/batt. (4) piano-type keys, vu meter, pea-soup green. Bret F. Johnson, 13495 102nd Ter. N, Largo, FL 34644. (813) 595-9287

WANTED: Rauland Ampical info; Ccllins 51J4 cabinet, front handles; Jan. '32 radio callbook. Dennis Osborne, 711 E. Whitaker Mill Rd., Raleigh, NC 27608. (919) 834-0066

WANTED: Drake SPR-4, R-4C, SW-4A, Yaesu FRG-7, FR-101S. Mike Brillhart, 12551 Maiden Creek Rd., Abingdon, VA 24210. (540) 944-4387

WANTED: 1964 National's Anniversary Photo Album, other National catalogs, flyers, manuals. Buy or trade. Niel Wiegand, WA5VLZ, 12105 Mustang Chase, Austin, TX 78727. (512) 219-8548

WANTED: Bendix radios, ads, signs, etc. Radios need not work. Aaron Mall, 903 Dropleaf Ct., Baltimore, MD 21208. (410) 486-8813

It's Here!

International Directory of Antique Radio Collectors

SAVE \$2.00 !
Pre - Published price
only \$12.95
(after May 1, 1996
price is \$14.95)
add \$2.50 postage

Available from:
XTAL Publishing
P. O. Box 253
Sandy, UT 84091-0253
801-571-5453

Directory listings of:
Collectors - Dealers
Historians - Publications
Stores - Services - Repairs
Restorations - Museums - Clubs

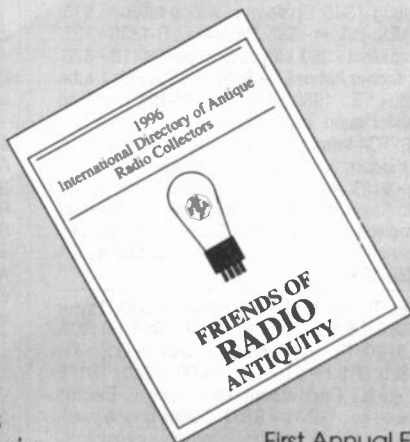

First Annual Edition
includes forms for your
free listings in future editions

FOR SALE: Philco 80 Jr., (1) knob missing - \$65; 89, (2) knobs missing - \$85. Both cabinets need work. Airline 54BR-1506B parts set - \$8. Burton-Webber Model 10 early battery test oscillator - \$20. N.O.S. 6099 tubes - \$2 ea. RCA WR-514A TV sweep chanalyt - \$35. Philco 46-420, dial indicator needs repair - \$27. 1940's QST and CQ - \$1 ea. Michael Crain, 3 Hillside Ave., Harvey's Lake, PA 18618-9782. (717) 639-2794. E-mail: mcrain1952@aol.com

FOR SALE: Book entitled "Jim Clark's E.H. Scott Radio Collectors Guide (1925-1946)" - \$32.95 mailed. Jim Clark, 1292 Starboard Rd., #6, Okemos, MI 48864. (517) 349-2249

FOR SALE: Westinghouse transmitting tube WL 6623 N.I.B. - \$30. Endura transistor attaché-case travel AM clock radio - \$25. Joe Holdner, 443 2nd St., Brooklyn, NY 11215-2561. (718) 768-6212

FOR SALE: Modern Radio Servicing, Ghirardi, 1935, 1st with dj - \$35, have (2) and a later edition. Del Tysdal, Route One, Box 157, Glyndon, MN 56547. (218) 287-2562

FOR SALE: Unusual colored prewar Plaskon radios by: Detrola, Kadette, Silvertone, RCA and more. This is a rare opportunity to own investment quality pieces at bargain basement prices. My loss is your gain! Send SASE for full color brochure with price list to: Mark Alzapiedi, 13 Fitch Farm Ln., Sterling, MA 01564, or call: (508) 368-7223

FOR SALE: Blue Bird battery radio. Automatic Radio, Boston. Auction. SASE and \$1 for picture, rules. Gene Greneker, 184 Lake Somerset Dr., Marietta, GA 30064. (770) 422-2979

FOR SALE: RCA Video disc player SGT200, will include original instruction booklet and extra stylus cartridge, also RCA sampler disc, never sold to public for demonstration only, all for - \$129 plus \$20 shipping. Send large SASE for radio-book-magazine list. Maurer TV, 29 South 4th St., Lebanon, PA 17042. (717) 272-2481

FOR SALE: Transistor radios, all N.I.B.: 1967 Japanese wall telephone - \$125; Capt. America wrist radio - \$75; ladybug - \$45; Spiderman walkie-talkies - \$75; A-Team walkie-talkies - \$65. Panasonic R-1326 - \$25. T-500 transparent - \$80. Lloyds Snapper 9K41B - \$25. N.I.B. kits: Archer AM radio - \$60; Science Fair 1-tube - \$40. Not N.I.B.: 1959 Philco T1000-124 moderne style transistor radio, exc cond. and working - \$175; 1959 RCA 1TC4 transistor clock radio with barometer, in Danish-modern wood case, plays, one plastic lens fogged, vg - \$125. And, a Robie, Sr. radio-control robot, 1975 Radio Shack, this thing is wild and it works, near perfect condition - \$285 or BO. Buyer pays shipping. Dennis Branch, 1238 W. Ivyton St., Lancaster, CA 93534. (805) 723-1569

FOR SALE: Tubes, N.I.B.: (4) HK54s - \$50; Taylor 830B - \$15; GE 8072 - \$65; Pr. 801A - \$50; (4) RCA 6LQ6's - \$120; Pr. Syl 6JS6A's - \$45. N.O.S.: Pr. RK28A - \$20; 8122 - \$100; Pr. 6KD6 - \$40. TS175 freqmeter - \$30. Connecticut Telephone & Electric nice toy phone set, 1920's - \$100. Collins phone patch - \$25. Other stuff, meters, tubes, variable capacitors, misc. manuals, parts, etc. List SASE. George H. Goldstone, W8AP, 1010 Burnham, Bloomfield Hills, MI 48304. (810) 647-3399

FOR SALE: Catalin Emerson 564, red with yellow marblizing, vg, no cracks - Make Offer. Catalin RCA 66X8, red marblized, vg, no cracks - Make Offer. Bakelite RCA 96X3, tan and dark brown, vg, no cracks (see Bunis 3, 96X2 photo) - \$400 OBO. Crosley 52, three-tube 1924 battery radio, vg - \$110. Hallicrafters S-40A, vg, front resembles SX-42, 9 tubes, 44 Mc., working - \$75. JJ-38 key, excellent. Webster Type D power amplifier, two 250's output; SM 328 power amplifier, two 250's output. Harman Kardon TA 5000X AM-FM tuner with power output. All shipping extra. SASE for electronic book list and/or novelty transistor radio list. Bob Warren, Church Street, PO Box 279, Waverly, PA 18471. (717) 587-2405

FOR SALE: Atwater Kent 228 cathedral, rare model - \$850. Atwater Kent 3975 breadboard components - \$650. Philco 70 cathedral, excellent - \$325. McMurdo Silver Masterpiece II, excellent chrome - \$1,100. Dictogrand horn - \$165. Victoreen 14 tube radio phono combo in ornate oak cabinet, rare - \$1,200. DeForest F-5 - \$235. Zenith 760 console - \$125. Kennedy 110, extremely nice - \$1,700. Edison Standard with S reproducer and cygnet horn - \$950. Victor V with oak horn, nice original - \$3,500. Victor L door XVI - \$650. Four-minute cylinder records - \$3.75 ea. John Hayes, 27 Highland Dr., Henniker, NH 03242. (603) 428-3053, or fax only: (603) 428-8315

FOR SALE: Emerson GU446, re-capped new 6U5, excellent original finish, plays well - \$55 + UPS. Zenith collectors: Lab coat from Plant Elite, Engineering, Q.C., Foreman, early style and material, large "Zenith Radio" lightning bolts logo embroidered in red on back, photo - \$115 + UPS. WANTED: Crosley D-25 BE slate-blue clock radio, mint, near mint. Operator's manuals for 1938 Zenith 7-, 12-, 15-tube chassis. Ron Kudasik, 2235 Tanya Dr., Chambersburg, PA 17201. (717) 267-9468, 3-11 pm EST

FOR SALE/TRADE: Philcos: 38-7 - \$75; 53-958 - \$35; 50-526 - \$35. GE's 321 - \$30; L-740 - \$40. Guild Conquistador - \$75. R. Suslovich, Box 9053, McLean, VA 22102-0053. (703) 841-5889

FOR SALE: RF signal generators: HP606A 0.01-65 MHz - \$115. HP-606B - \$150. URM-25D 0.01-50 MHz - \$80. All have AM, CW, calibrated output attenuators, meters, look and work good (except the URM-25Ds which are sort of ugly by design). Wavetek #1002 0-500 MHz signal/sweep gen. - \$135. EHScott: AW-15 speaker - \$60. Antenna switch - \$30. Original wood face plate - \$35. Hickock #121 Cardmatic tube tester with cards, as is - \$35. Fluke bench volt/ohm meters, powered by AC and nicad, #8800A 3.5 digit - \$35; 4.5 digit - \$50. Simpson #269 VOM, high sensitivity 100KΩ/volt - \$45. Power Design power supply 0-50v 1/2A - \$50. Tek 7000 Series plug-in extenders, flexible and rigid types - \$150 ea. Tek: FG-501 - \$85. DM501A - \$135. TM-503 - \$70. All plus shipping costs. HELP: Need copy of manual and schematic Krohn Hite UHR-240 power supply and wideband DC-500kHz tube amp. Stan Krumme, KO6YB, 16432 Lakemont Ln., Huntington Beach, CA 92647. (714) 841-5866

FOR SALE: Cute 5-inch Sony color TV Model KV5100 probably from mid-1970's, works perfectly, can be used on 12 volts with optional cord - \$100 plus \$25 shipping. Also radio book-magazine list now ready, send \$1. Maurer TV, 29 South 4th St., Lebanon, PA 17042. (717) 272-2481

WANTED: Pay your price for AK Model 21, nameplate located inside of lid. Phil Guinan, 106 Page Rd., Litchfield, NH 03052. (603) 889-6213

WANTED: Still looking for a restorable set or chassis only for GE K-63. Junius Bailey, W5FTW, 1002 Reeves St., Abilene, TX 79602. (915) 673-0986

WANTED: Nichinan boy's radio in orange (Bunis - Trans. 2, p. 180). Jack Philpot, 632 E. 160th Ct., South Holland, IL 60473. (708) 596-0580

WANTED: Heathkit GR-78 general coverage receiver. Must be in good to excellent condition. Clyde Hixson, 3907 Columbia St., Des Moines, IA 50313-3647. (515) 243-7930

WANTED: Ampex 300, 350 and 351 electronics & heads; Studer C-37. Maxell & TDK tape. Richard E. Brown, PO Box 686, Farmington, CT 06034. (860) 677-4828

WANTED: Prewar plastics. No cracks & complete. Karen McCoy, 8104 N.W. 114, Oklahoma City, OK 73162. (405) 722-0595

WANTED: (864) tubes, 1G4-1G4GT tubes, 1E4GT tubes, molded Amphenol 4-pin tube sockets, molded Amphenol octal tube socket, ring spring mount. James Fred, R1, Cutler, IN 46920

WANTED: 100, 140, 150 uuf midget receiving type variable condensers. 5-pin brown plastic plug-in coil forms. Rodney K. Schrock, 402 Lincoln St., Somerset, PA 15501



WANTED: Airline GSE-1620 (pictured) or model GSE-1625 (very similar), ca. 1955-56, beige off-white color. Also pocket-size book "Travel Log" ca. 1956 which may have come with the radio. Walt Breville, 1149 Innsbrook Est., Wright City, MO 63390. (314) 745-3453

WANTED: Hickok tube tester, prefer WWII surplus. Must be in excellent working condition. Herman Fothe, 5292 Tiffany Ann, West Palm Beach, FL 33417. (407) 688-2794

WANTED: Unbuilt kits: Heathkit AM-FM radio and others. Call anytime, leave message. Richard Tabler, Jr., 24 Thorndike St., Arlington, MA 02174. (617) 641-1089

WANTED: Chassis for Fada Model 44, with a good tuning mechanism. A.J. Long, 11830 Heath Rd., Chesterland, OH 44026. (216) 729-8451

WANTED: Manual, or leads toward same, for ITT Mackay Marine 3010 receiver. Geoff Fors, WB6NVH, Box 342, Monterey, CA 93942. (408) 373-7636. Fax: (408) 373-2345

WANTED: Working horn speakers, S-C radios. J. Finkelstein, 205 Alapocas Dr., Wilmington, DE 19803

WANTED: Info on RCA's Radiomarine HF Communications Coast Stations. Also, RCA, McKay marine HF equip. Jim Krajovic, 546 Sheridan Ave., Pittsburgh, PA 15206

WANTED: Black JVC Videosphere TV Seiko TV watch. Lee White, 86 Spruce St., Framingham, MA 01701. (508) 788-0359

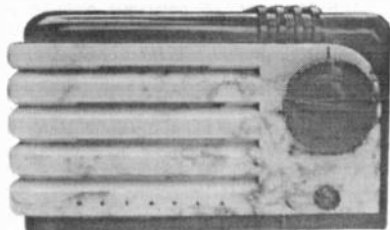

WANTED: More prewar plastics by Detrola, RCA, Kadette, Air King, et al. Take all my money before the relatives do. They are trying to hurry my already imminent demise. Please write or call collect: Rain Buttignol, 314 State St, #7, Portsmouth, NH 03801. (603) 427-1384

WANTED: Tube PA or broadcast mixers, compressors, equalizers by Altec, Ampex, Gates, RCA, others. Kent Elliott, 3143 W. 46th Ave., Kansas City, KS 66103. Phone/fax: (913) 677-1824

WANTED: Power transformer for Silvertone Model 1670B and escutcheon for Philco Model 89. Dan Olson, E. 4913 Sumac Dr., Spokane, WA 99223. (509) 448-8828

WANTED: Zenith Royal 500, especially vintage near my orig. one (Serial 98612), any condition. John Watson, 355 E. Second St., Moorestown, NJ 08057. (609) 234-6986

WANTED: All microphones, cheapies OK, guitars, guitar amps effects, audio tubes catalogues. Alex Pepiak, 330 Third Ave., Bellmawr, NJ 08031 (609) 933-0374. E-mail: alpep@aol.com

WANTED: UTC S14, S15 transformer, many U.S.A. made transformer but old only. Kouji Matsuo, 6-2, Tsurumi-cho, Beppu-shi, Oita, 874, Japan. Fax: 81-977-23-9579

WANTED: Hallicrafters S-29, S-39 or S-72. Bill Gustavson, 1819 Green Tree Ln., Duncanville, TX 75137. (214) 296-7275, leave message

WANTED: Riders Volumes 18, 19 & 20. Bill Koch, RR 1, Box 301, Haverhill, NH 03765. (603) 989-5574

I am not a dealer, but a serious collector and historian interested in all aspects of E. H. Scott.

Please contact me first if you are selling your E. H. Scott Radio, Seleco, E. H. Scott, World's Record Superhet, or Scott Transfor-mer Co. items.



Always interested in any E. H. Scott stock certificates, literature, and military sets.

**John T. Meredith
2462 Statonsburg Rd., Suite 152
Greenville, NC 27834 — (919) 551-1882**

FOR SALE: McIntosh MR73—\$300/BO. MR66—\$125/BO. Scott 310C—\$45. Walt Fleming, 182 Plain Hill Rd., Norwich, CT 06360. (860) 889-1957

FOR SALE: Cheap: Quitting business, liquidating hundreds of TV receiving tubes. Cheap! SASE for info. Ron Russell, 1927 Laxalt Way, Elko, NV 89801. (702) 738-7474

FOR SALE: Meissner 1946 catalogue, eight Xeroxed pages, IF coils, etc.—\$5.50 ppd U.S.A. Richard Norton, Nine Endo Blvd., Garden City, NY 11530. (718) 225-7412

FOR SALE: R392—\$150. Rack FT 220A/BC453-55/ connectors/hand cranks/ BC-450—\$500. URM-105C VOM—\$25. AN-N6 gun camera—\$75. LS166/U speaker—\$20. National NC-109—\$100; NC 188—\$100; NC-66—\$100; NC-2-40D/matching speaker—\$450; BC-224-B—\$75; Belmont FT-154-H shock mounting for BC 348—\$75; National SW-54—\$65. Brush BK-401 sound mirror—\$90. Webster Chicago Model 90 wire recorder/wire—\$50. His Master's Voice gramophone Model #102, sold in England—\$100. Motorola 7UTSRA portable TV w/antenna—\$150. Philco 42-350—\$55. Maguire 561 DW—\$55. Coke machine AM/FM 2001—\$65. (2) owls—\$50 ea. Teachers Highland, cream—\$90. Sony T2-21, excellent—\$45. Mini vox watch radio, rough—\$75. RCA 8-BX-7L—\$35. Dynaco Mk III—\$250. Tube mono preamp—\$50. Stereo control—\$50. Marantz 240 solid-state U.S.A.—\$450; 3250—\$250; 1180 DC—\$225; Ortofon MCA 10—\$50. Tom Murray, 3177 Latta Rd., #409, Rochester, NY 14612. Voice/Fax: (716) 723-1672

FOR SALE: Farnsworth GT-051 bullet, ivory repaint, clean—\$110. Packard Bell 5FP, white urea, small Deco—\$45. GE C-401 Bakelite Deco—\$90. Emerson 610, maroon/gold—\$60. Stromberg-Carlson 1500 Dynatonic, prof. painted (red)—\$75. GE Commentator, Bakelite—\$40. Arkay, Bakelite Deco—\$40. Addison 5A (Catalin) black/butterscotch, nice marblizing, exc—\$1,100. Northern Electric bulls-eye midge, hairline on top—\$75. WANTED: Minor damaged Catalin radios. Have quality transistor radios, Japanese and American to trade. Mike Herman, #2-1731 Rockland Ave., Victoria, British Columbia, Canada V8S 1W6

FOR SALE: Universal dial belt kit. 6' of belt material, glue and instructions—\$8.50 ppd. To reference most Zenith models from 1920 to 1946, we offer our 60-page 11x17 Zenith Brochure Book with pictures and specs on most models—\$28.95 ppd. Laser reprint 1937 total line catalog—\$21 ppd. Our 1936 Zenith Poster reproduction shows the complete 1936 lineup plus all three Stratospheres—\$20 ppd. Zenith T-shirts and sweats, call for info. Visa and MasterCard accepted. Alan Jespersion, PO Box 17338, Minneapolis, MN 55417. (612) 727-2489

FOR SALE: E.H. Scott RCH/CZC46209 50 Kc-24 Mc, black wrinkle panel, clean, works—\$140 + shipping. Dee Almuist, W4PNT, PO Box 371, Crimora, VA 24431. Voice mail: (800) 755-2365. E-mail: soundmind@rica.net

FOR SALE: 40+ wood table radios. (2) Webster wire recorders. SASE for list. Mid-America Antique Radio Store, 233 S. Tulane, Liberal, KS 67901

FOR SALE: Heathkit Model G-5 5-band signal generator—\$5. Short Wave Listening Guide—\$7. Nathan Neth, 17833 S. Harlem Ave., Tinley Park, IL 60477-3605

FOR SALE: Two Vox speakers, about four and a half feet tall, with chrome stands, very nice condition—Best Offer. Bill Manny, 1103 N.W. Despain Ave., Pendleton, OR 97801. (541) 276-3152, work days; (541) 276-7439, evenings and weekends

FOR SALE: Federal recorder record cutter w/g luggage type case, weighs 60 lbs.—\$150 plus UPS. Kenneth Miller, 10027 Calvin St., Pittsburgh, PA 15235. (412) 242-4701

FOR SALE: Admiral 6T01—\$45. 6A23—\$40. Air Chief 4A-10—\$45. 4-A-24—\$50. Airline 14BR-736A—\$65. 15BR1535A—\$50. 62-367—\$95. 74BR1502B—\$75. 95BR421B—\$85. American Bosch 5A—\$55. 828L—\$55. Artone R1046U—\$75. Arvin 444AH, no dial face—\$50. Atwater Kent 33—\$95; 46—\$80; 55 Kiel table—\$175; 55 chassis only—\$55; 84 cathedral—\$350; F2 speaker—\$60. Brunswick 2689 Duncan Phyfe table—\$180. Delco 3201 tombstone—\$95. Echophone S4 cathedral—\$195. Emerson 636A—\$60; 811B—\$30; AX217—\$45. Empire 10A—\$75. Eveready 1—\$165. Fada.740—\$60. GE 66—\$40; 202—\$40; 218—\$40; 220—\$40; 226—\$40; 250—\$35; 321—\$30; 400—\$40; 405—\$30; 512F—\$40; 543—\$45; Ace—\$55; A63 tombstone—\$130; A64 tombstone, fair—\$55. Gilfillan 30—\$55. Gloritone 26P cathedral—\$150. Kennedy 52 cathedral—\$295. Kolster K21—\$130. Mitchell 1263—\$40. Motorola 62X—\$55; 65X11—\$40. National Union G619—\$40. Nordmende Sterling—\$100. Philco 37-62—\$70; 38-12—\$45; 38B cathedral—\$130; 39-6—\$45; 41-221—\$50; 42-PT94—\$50; 42-321—\$45; 46-200—\$45; 46-250—\$45; 46-420—\$50; 48-200—\$45; 48-472-1—\$40; 49-901—\$85; 50-522—\$40; 53-956—\$45; 54C painted—\$60; 60B cathedral, later version, restored—\$165; 80 cathedral—\$125; 84B cathedral—\$125; 89L cathedral—\$130; PT-44—\$70; PT-49—\$50; Radiola 17—\$80; 18—\$65; 20—\$150; 61-3—\$45; 61-8—\$40. RCA 4X648—\$30; 6X2—\$40; 7T1 tombstone—\$175; 8X541—\$40; 9TX31—\$45; 9X561—\$40; 9X571—\$45; 9X641—\$45; 15X—\$45; 45X1—\$45; 46X24—\$45; 654—\$45; 65X1—\$45; 66X2—\$45; 66X13—\$40; 128 tombstone—\$250; BP-10—\$45; T5-2 tombstone—\$95; X-551—\$45; 6T tombstone—\$120. Sentinel 7E32—\$40. Silvertone 1403 cathedral—\$225; 15—\$35; 6425—\$75; 9001—\$45. Stewart-Warner 9000B—\$50. Stromberg-Carlson 1101—\$50. 1101HW—\$40. 1204—\$60. 1400H—\$40. Trav-Ler 5001—\$45; 5002—\$50. Truetone D2021—\$55. Westinghouse Aeriola Sr.—\$150; H30777—\$40; H382T5—\$25; H397T5—\$45. RC (RA/DA)—\$200. Zenith G724—\$40; H615—\$40; H724—\$30; K518—\$45; K526, ivory—\$50; K725—\$45; M504W—\$30; M510R—\$50; TS22R—\$25; K510—\$40; 5D611—\$45; 5R01—\$40. 6D030—\$55; 7H921—\$35; 8508R—\$25; G503—\$45. RCA UZ 1325 horn speaker—\$160. Sams books: 1970's Auto Radio, CB radio, 1960's Transistor Radio, Tape Recorder. J. Gary Cameron, 824 Andrews St., Southington, CT 06489. (860) 276-9200

FOR SALE/TRADE: Motorola circle grille in tortoise, Bendix 526C, microphone radio, Plaskons and Bakelites. Also Catalin clocks and Regency TR-1, red. WANTED: Detrola Super Pee Wee and any other midget beetle or Plaskon radios. Brian Masciocchi, 44 Rolc Ct., Mechanicsburg, PA 17055. (717) 795-7271

FOR SALE: Two Vocaline transceivers JRC-400, book, antennas, cords, 1955, citizen band, both—\$75 firm. Robert Shuck, 10512 Winston Ln., Fishers, IN 46038. (317) 849-0381

WANTED: Audio transformers: UTC HA101X, Triad HS27, Dynaco A420, Acro TO300, Western Electric 608A, 618, and 187A. Many trades available. Michael Payne, 803 S. Taylor, Alvin, TX 77511. (713) 331-9217. Fax: (713) 585-2727. E-mail: We300B@aol.com

WANTED: For cash or trade, 1950's semiconductor components, especially transistors. Send for wants list. Andrew Wylie, 21 Brancaster Ln., Purley, Surrey, CR8 1HJ, England

WANTED: Juvenile books, Radio Boys with the Air Patrol and Jack Heaton Wireless Operator. Robert Stapleford, 1800 S.W. Randolph Ave., Topeka, KS 66604

WANTED: Philco PT-87, Minerva W-117, old Jensen 12" speaker w/80 recti. Ichiro Yamada, 10-21 Chiyoda-dai-cho, Kawachi Nagano-shi, Osaka, Japan 586. Phone/fax: 011-81-721-4695 mid/eve. local. E-mail: yamadnr1@osk.threewebnet.or.jp

WANTED: Osc. and 1st IF coil ass'y. for Grigsby-Grunow Model 15. Ref. Rider's 2-386 N. Byron Bernor, 2479 W. Sierra, Acton, CA 93510. (805) 269-5459

WANTED: Sams CB16, TR46. Will buy or trade my Sams CB1, CB6, TSM1, TSM6. Ai Bernard, PO Box 690098, Orlando, FL 32869-0098. (407) 351-5536

WANTED: Knobs for Philco Predicta TV Model G4720, also Danish modern lags for the same; antenna for boys transistor radio; Gloritone Model 26 chassis; 1950's pinball machine, need not work, but great if it will; TMs 2-67-23. FOR SALE: RCA Voltomyst - \$10 plus UPS. RCA marker adder RF, IF & VF - \$20. Sams Photofacts between 113 & 902, all (92) total - \$25. Riders Manuals IX & XIII - \$25 ea. RCA bench console with large VTVM, TV sweep generator and television calibrator, out of 1950's TV shop, all in one cabinet - \$75. All plus UPS. Ross "Doc" Ellis, 206 Gregg Dr., Battle Creek, MI 49017. (616) 962-1514

WANTED: Looking for atomic bomb stuff: Geiger counters, C-D posters, ore sample displays, bomb shelter advertising & articles, etc. Have some nice Victoreen Geigers for trade. Ward Kremer, 301 S.W. 16 St., Ft. Lauderdale, FL 33315. Phone/Fax: (954) 524-5652

WANTED: A schematic for an early '60s ARC-2500 45 rpm underdash car record player. Rene van Gaalen, 218 Sandpiper, Portland, TX 78374. (512) 643-1589

WANTED: Philco 48-1274-76 working chassis or parts. Tuning dial glass, band switch motor, (1) or more original knobs, (1) or more original push buttons, original record changer. Steve/Sara McDermaid, 442 S. Springer Rd., Los Altos, CA 94024. (415) 428-1912. Fax: (415) 961-7415

WANTED: Highest prices paid for Western Electric tubes new or used. Also wanted 2A3, 10, 45, 50, KT-66, KT-88, 6550 (ST) and Altec equipment. Singerhouse Sound, PO Box 268, New Richmond, WI 54017. Phone/fax: (715) 246-3899

WANTED: Packard-Bell 1941 Model 120-D or 51-C console in vg+ condition. Ronald K. Edge, 2923 Mayfair Ave., N, Seattle, WA 98109. (206) 284-6196

WANTED: Zenith automatic tuning unit for Chassis 5907 in Models 9S307, 9S324, 9S344, 9S367, 9S369. Also Zenith speaker for Model 12U158 console. Jim Agostino, 827 Holly Pl., West Covina, CA 91790. (818) 960-7123

WANTED: Jewel panel meters, patterns #55 and #135. Please check your parts box! John T. Meredith, 2462 Stantonsburg Rd., Suite 152, Greenville, NC 27834. (919) 551-1882

WANTED: Table radios: Detrola, Kadette, Majestic, Fada, Zenith, etc. Transistors too. Send list and prices. Bob Masterson, Box 172, Valley Cottage, NY 10989. (914) 353-3151

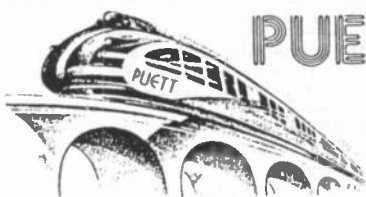

PUETT ELECTRONICS

P.O. BOX 28572 DALLAS TX 75228

NEW CATALOG 77



CATALOG 77/PLL-2 (56-PAGES) ----- \$5.00 POSTPAID

YOU RECEIVE A \$6.00 DISCOUNT COUPON WITH THIS CATALOG!

MORE THAN 1,500 DIFFERENT ANTIQUE RADIO PUBLICATIONS FROM 1902 TO THE 1960'S OFFERED, REPRINTED BOTH SIDES OF THE PAGE AND BOUND!

WE OFFER BOOKS, INSTRUMENT MANUALS, SERVICE DATA, SALES BROCHURES, ATWATER KENT, RCA, CROSLEY, ZENITH, ETC. FACTORY SERVICE MANUALS, SCOTT, MC MURDO SILVER, STROMBERG CARLSON, CAPEHART, FISHER CLASSIC RADIO LITERATURE, DIRECTORY OF ANTIQUE RADIO SERVICES, SCHEMATIC DIAGRAMS, OLD TIME RADIO PROGRAMS ON CASSETTES, TUBES, TUNING DIALS, KNOBS, 30-SERVICES & DISCOUNTS WITH THE PUETT ELECTRONICS ANTIQUE RADIO CLUB AND MUCH MORE - ORDER YOUR CATALOG TODAY!

OUR NEW BOOK "THE WORLDS LARGEST RADIOS" IS NOW AVAILABLE, PHOTOS, SCHEMATICS, BY J.W.F. PUETT - \$14.95 PLUS \$2.00 HANDLING. INCLUDES SCOTT, MC MURDO SILVER, PHILCO, RCA, ZENITH, LINCOLN, FREED EISEMANN, FISHER, MEISSNER, MAGNAVOX, CROSLEY + MANY MORE!

FOR SALE/TRADE: I have just acquired the most beautiful HRO 600 (National's last communication receiver) that I have ever seen, and it works excellent. This unit sold for \$5,600 when new and is now available on a first come-first serve basis for - \$3,150, which includes shipping & handling and manuals. Call: Larry Drago, 383 Lincoln Dr., Cheshire, CT 06410. (203) 272-6030

FOR SALE: N.O.S. tubes at reasonable prices. Large SASE for this month's list. **WANTED:** 7027A's. Charles D. Blair, 815 N. 5th St., Cambridge, OH 43725. (614) 432-4453, 9-5

FOR SALE: Philco 54 - \$70. Philco cathedral 37-60 - \$60. Philco 42 PT 93 - \$35. Zenith 6D-030 - \$45. Automatic 237 - \$40. Emerson 461 - \$35. Emerson 501/5027 - \$25. Philco 96 knobs & speaker - \$35. (2) N.O.S. 45 tubes - \$70. Philco plastic flashlight, N.I.B. - \$25. Joe Kelly, 537 Stafford Ave., Erie, PA 16508. (814) 459-3910

FOR SALE: Aiwa small tape recorder - \$15. (10) Hawkins electrical books from 1914 - \$25. Weston #264 milliamp meter - \$15. Old telegraph relay - \$30. (15) A.R.C. monthlies - \$15. Olympus T-500 microcassette - \$40. GE 10" brass blade fan - \$50. RCA 6A-2605 radio - \$60. Philco #37-61 cathedral - \$60. Philco 620 - \$100. Jensen #A12-PM concert speaker - \$30. Wards quack machine - \$20. RCA 16mm talking projector - \$30. Motorola Air-Boy - \$30. Sterling 7C-356 chassis & speaker - \$40. ATR inverter - \$10. Channel Master 6515 radio - \$25. Realistic 8 trans. - \$30. Bosch #350 radio - \$65. Old Readrite table tester with (3) meters - \$20. Walt Wrabek, Rt. 4, Box 370, Menahga, MN 56464. (218) 564-4623

FOR SALE: TV-2 tube testers. (7) testers at \$325 each, I pay shipping. Also many tubes for sale: 807, 5691, 5692, 45, 10, and others. Tim Metz, 221 Wheatland, Fairview, OK 73737. (405) 227-2456. Fax: (405) 227-4602

FOR SALE: Hickok signal gen. 615. B&K Precision Substitution Master 2902. Syl. IF panels & dif. modules. Tube caddy, full of RCA modules. Ann Bichanich (Jay's), 15 1/2 W. Lake St., Chisholm, MN 55719. (218) 254-4421

FOR SALE: Miscellaneous: Cushcraft 147-11 2-meter antenna - \$45. AR-33 rebuilt rotor - \$65. Rohn 25g top section - \$75. Tri-X W-51 self-supporting tower, complete - \$600 plus shipping. Macom H-1 receiver - \$150. Houston Tracker 8 - \$275. Tracker 7 - \$250. Tracker 5 - \$200. Echo 4000 - \$200. Marantz Model 30 60-watt American-made amplifier (transistor) collectors IDCM - \$200. Mike Russ, 20147 Road 192, Strathmore, CA 93267-9787. (209) 568-0345, Sundays

FOR SALE: Radiotron UV201A - \$25. Western Electric VT-2 (WE-205B) - \$65. Nathaniel Baldwin radio headset Type C, Pat. Sept. 15 - \$25. Zenith 8 transistor Royal 10 - \$20. Toshiba TR-1 8TM294B, case - \$35. Pearl Tone TR-4 T606, case - \$15. Saxony TR-2 - \$10. Plus shipping. Bryl T. Jenkins, Box 489, RR#1, Williams, IN 47470. (812) 388-7346, after 6 pm

FOR SALE: Books: The Practical Handbook of TV Repairs by Art Margolis, TV Field & Bench Servicer's Handbook by John Spillane, Color TV Servicing by Walter H. Buchsbaum - \$10 ea. or all 3 for \$25 ppd. Rich Stamer, 331 Virginia Ave., Collingswood, NJ 08108. (609) 869-0238

FOR SALE: Operadio speaker, metal cathedral cabinet, works - \$95. Jeff Hoskins, 824 E. Madison Ave., Stuart, FL 34996. (407) 283-2291

FOR SALE: (6) old record changers - \$30 for packing plus UPS. Adler 804 calculator - \$10. Craig 4503 tube display calculator - \$25. Joe Svihel, 17227 Co. Rd. 54, Avon, MN 56310. (612) 356-7601

FOR SALE: McIntosh C4 preamps, 7868s, 6BQ5s. Mcintosh MX110, Heath W5M. **WANTED:** MC30, W5M. Dave Barth, 8320 Bevan St., San Gabriel, CA 91775. (818) 286-6503

FOR SALE: Acme boys radio, vvg - \$55. Angel boys radio, good - \$45. Channel Master 6448 Micrette & presentation box. Coronet boys radio, N.I.B. - \$65. Crown TR-770R, vvg - \$30. Harpers GK-301, 4-tube portable, vvg - \$50. Holiday 11P601, Ryukyu, exc - \$45. Marvel 6YR-65, salmon, exc - \$45. Motorola X11R, red, vvg - \$65. Nuvox boys radio, reverse plastic, exc - \$75. Saturn boys radio, vvg - \$60. Sceptre boys radio, horizontal, vvg - \$65. Sylvania 4P14, aqua, vvg - \$50. Tama-Tone boys radio, N.I.B. - \$60. Toshiba 8TM294B, exc - \$75. Valiant boys radio, red, vvg - \$45. Windsor boys radio, box, exc - \$60. Postage extra. Kay Botzum, R.D. 2, Box 419, Morgantown, PA 19543. (610) 286-0047. Fax: (610) 286-5315

**NOTICE TO ALL
CLASSIFIED ADVERTISERS!
OUR CLASSIFIED AD DEADLINE IS
12:00 NOON
ON THE 10th OF EACH MONTH**

FOR SALE: R26/ARC-5 (modified), Navy CCT-64129 (like ARC-5), Signal Corps BC-348-0 (caseless), Knight R55A, National NC200, Hallicrafters S-27-FCC, Heathkit XR-2L. Chassis: AK-85 & AK-H (each with faceplate, knobs), Zenith 12H090 (wavemagnet, knobless), RCA 5T17 (knobs). **WANTED:** Philco 84B chassis and knobs, junker OK. Andrew Mitz, WA3LTJ, 4207 Ambler Dr., Kensington, MD 20895. (301) 897-5531. E-mail: arm@helix.nih.gov

FOR SALE: Cathedral cabinets: Airline - \$30, Victor - \$25. Richard Haneline, 3600 Cuba Blvd., Monroe, LA 71201. (318) 323-9657, 8 am-6 pm

FOR SALE/TRADE: Midwest Miraco Mod MA-4 (see Douglas, p. 176, bottom left corner) - \$400. Radiola Mod 5 with crystal detector on panel in working condition - \$600. Crosley Ace Mod #3-B w/3 WD-12 tubes - \$300. Wokrite George Walker multi-unit set, (1) tube, with coil and coil adapter plus, (see Douglas V 3, p. 245) - \$200. Larry Drago, 383 Lincoln Dr., Cheshire, CT 06410. (203) 272-6030

FOR SALE: Rare Fendel Band Master only 4 tubes - \$200. Ansley #61 amp & F.C. spkr - \$125. Agreed? Renee May, 1242 N. El Centro Ave., Los Angeles, CA 90038. (213) 464-9179

FOR SALE/TRADE: Zenith Global 6G004Y, exceedingly rare (see Bryant/Cones Trans-Oceanic book, p. 68). **WANTED:** T-O 7G605. Have other radios for sale. Nils Hardin, PO Box 1094, Summerland, CA 93067. (805) 963-0116

FOR SALE/TRADE: Complete RCA 70-D-I radio station transcription turntable and two Magnacord tape decks - \$500. **WANTED:** Zenith 6S27 or 6V27 tombstone. Tony Rizzini, 6 Chiswick Rd., Greenville, RI 02828. (401) 949-3741

WANTED: Rider's radio manuals, any Volumes 18 to 23. Jeff Hoskins, 824 E. Madison Ave., Stuart, FL 34996. (407) 283-2291, after 7 pm

WANTED: For Zenith 50-70 Series: Tuning condenser with good stators, 1st audio transformer, filter condenser case. Charles A. Days, PO Box 80205, S. Dartmouth, MA 02748-0205

WANTED: Dial glass for Westinghouse H103, H104 or H138. Need cabinet for GE 516F white clock radio. Will buy junker if cabinet good. Loop antenna to fit Philco 46-420. Thanks. Carl Kalmbacher, 19 Candate Ct., Newark, DE 19711

WANTED: On/off switch for a GE J71. (2) glass rods for a Zenith glass rod radio. Joe Kelly, 537 Stafford Ave., Erie, PA 16508. (814) 459-3910

WANTED: John Firth Vocophone, any condition. Craig Ball, 10101 Oak Hollow Cir., Austin, TX 78758. (512) 837-8129, after 7 pm

WANTED: S-meter for Collins 75A4 (or A3). John Casale, WA2FHL, 3 Pickering Ln., Troy, NY 12180. (518) 272-3631

WANTED: National NC183DTS speaker for NC183D in good condition. Mark Shoup, 27 Dogwood Dr., Newton, NJ 07860. (201) 383-6417

WANTED: I pay the following: 100M or 100L tube socket - \$50. Wire mesh plate tubes: 210 - \$35 used; Cardon 585 - \$120 used; 250 - \$120 used; 310A WE - \$25 new. Other mesh plate also. Tim Metz, 221 Wheatland, Fairview, OK 73737. (405) 227-2456

WANTED: Following 800 Series tubes: 825 (RCA), 827R, 839, 848, 853, 854, 855, 856, 859, 870, 875, 881, 887, 888, 891, 895, 896, 897, 898, 899. John H. Walker, Jr., 16112 W. 125th St., Olathe, KS 66062. (913) 782-6455

Tom Thumb

WANTED: Tom Thumb radios manufactured by the Automatic Radio Manufacturing Co. All models needed. George A. Fathauer, 116 N. Roosevelt, Ste. 121, Chandler, AZ 85226. (602) 961-5176

WANTED: Western Electric tubes, parts and Data-sheet. 101, 102, 104, 205, 211, 212, 216, 242, 252, 262, 271, 274, 275, 276, 284, 300, 310, 339, 347, 348, 349, 350, VT1, VT2, VT25A, VT52. Also Western Electric amp, spkr, socket, xfmr, wire. Others: KT88, 77, 66, RCA50/250/350, 245/345, VT-62/801, 845 European tubes. Will pay top \$\$\$ Jun Mizuno, 933 Portwood Cir., San Jose, CA 95120. (408) 268-4016

WANTED: Sherwood S-5000II; 6-inch turntable, maybe Lafayette PK225, Realistic RN6802; Knight Space Spanner; Precision 10-12 supplements later than 1972; RCA-30 (or later?) tube manual. **FOR SALE:** Hallicrafters Continental, BC and SW, recapped - \$40. George Fallenbeck, 608 Brookhaven Way, Niceville, FL 32578. (904) 897-5434

WANTED: GR 1650B bridge, AN/USM 118A Cardmatic tube tester calibration cell information. Christopher P. Demeroukas, 133 Basswood Rd., Springfield, IL 62707. E-mail: christopher.demeroukas@accessil.com

WANTED: Damaged Bakelite radios and Repwood/Sirocco radios worth \$300+ if perfect, including: Colonial globe, Charlie M., Radio Nurse, Silvertone ElectroLux, Trophy, Ecco, Coke Cooler, Airlite, etc. Mickey, Snow White, World's Fair, S.F. Expo, etc. Send picture & price. Ed Schneck, 1401 Ocean Ave., Brooklyn, NY 11230



WANTED: Zenith Model 1117. I'll pay top price for this set or any other 1100 series Zenith. Martin Blankinship, PO Box 157, Lecompton, KS 66050. (313) 887-6560

WANTED: Schematics/manual (copy OK) for Setton Model 3300 amplifier, Marantz 3300 amplifier. Joe Brady, Box 8 Star Rt., Huntingdon, PA 16652. (814) 643-0603

WANTED: Crosley 54 chassis and cabinet for 6X10 / 2 panel. Bob Barnes, 511 N. Chestnut, Monroe City, MO 63456

WANTED: Owners manual or any other information for Rek-O-Kut N-33H turntable. Doug Fox, 603 S. 12th Ave., St. Charles, IL 60174. (708) 584-5915

WANTED: 1938 Zenith robot dial 7S258 console in good condition. Frank Abbato, 337 Cedar Hill Rd., Peach Bottom, PA 17563-9754. (717) 548-3392

WANTED: Speaker for Zenith console Model 12S265 or similar model using same speaker. Mike Nall, 305N Pine St., Mt. Prospect, IL 60056. (847) 398-1879

WANTED: Wanted to trade: King Comics No. 1 April 1936 for your radio items. Dale Kinster, W1361 Aasen Rd., Bangor, WI 54614. (608) 486-2589

WANTED: Bowman Airophone dial and knob or junker. Merrill Bancroft, 169 S. Row Rd., Townsend, MA 01469. (508) 597-6623

**IF YOUR EXPIRATION DATE IS
APRIL OR BEFORE, RENEW TODAY!
EARLY RENEWALS
RECEIVE AN EXTRA ISSUE!**

WANTED: Bulk N.O.S. Zenith radio parts. Larry Daniel, 706 Pearson Rd., Wright-Patterson AFB, OH 45433. (513) 754-1567

WANTED: 1930 Midwest radio/MIRACO screen grid A-C9 chassis, speaker, knobs and promotional literature. Mark Gutekunst, 2600 Martin Rd., Willow Grove, PA 19090. (215) 657-8958

WANTED: RCA 66X1 radio with good cabinet, really want cabinet only. Antique Radio Store, 8376 La Mesa Blvd., La Mesa, CA 91941. (619) 668-5653

WANTED: Pay phones, 3 slots, Gray/Western Electric, separate transmitter and receiver. Stanley Schreier, 350 Hendrickson Ave., Lynbrook, NY 11563. (516) 887-4966. Fax: (516) 887-4780

FOR SALE/TRADE: The following Radiola speakers: Two Mod 103 w/nice tapestry - \$200/pair; Mod 101 - \$50; 100B - \$50; 100A - \$75. Also Radiola Mod III 2-tube battery set - \$150; Radiola Mod 5 with crystal detector on front panel - \$600. Larry Drago, 383 Lincoln Dr., Cheshire, CT 06410. (203) 272-6030

FOR SALE: Pre-1900 light bulb, large long horseshoe type filament, plaster of Paris, ceramic and brass base with center pin, not a screw-in base, no flaws, works - \$200 OBO. Gerald Kitchens, 116 E. South, Oreana, IL 62554. (217) 468-2540

FOR SALE: Must sell extra small radios. SASE for list. Trade for tubes. Charles D. Blair, 815 N. 5th St., Cambridge, OH 43725. (614) 432-4453

FOR SALE/TRADE: Approx. fifty transistor and novelty radios including N.I.B. Toshiba 8TM41 and other Japanese and U.S. models, mostly from 1950's-'60's. LSASE only for list. Paul Geraghty, 1245 Lyon Ave., Waterloo, IA 50702

FOR SALE: Federal 59, works well, all original, NT, vgw - \$1,100. BC-9-A, 1921, Army Signal Corps by Wireless Improvement, repro manual, (see Douglas 3, p. 213), NT, vg - \$650. Crosley 51, rare wood panel, works, NT, vg - \$160. Crosley 52, NT, g - \$125. Heathkit crystal set, CR-1, works very well, vgw - \$125. Mel-O-Dee, 5-tube TRF, good transformers, NT - \$65. BC-14, WWI crystal set, works, vg - \$750. AK TA module, detector and (2) amps, brown - \$200. AK TA module, (2) amps, green - \$200. Bunnell strap key, all brass, plate base, vg - \$40. Weston 537, radio set tester - \$12. Little Wonder microphones, vgw in box - \$25; and g, no box - \$12. DeForest D-12, original antenna, NT, works, vg - \$1,100. Postage extra. Richard A. Bolzum, R.D. 2, Box 419, Morgantown, PA 19543. (610) 286-0047. Fax: (610) 286-5315

FOR SALE: Mercury Super 10; Atwater Kent 9; Northem Electric R-4; AK-10B; Gecophone II crystal set; Aeriola Jr., good WD-11; DeForest amplifier; Marvel 6YR19, green; and many other transistor sets. A. Nolf, 539 Kastelle Pl., Burlington, Ontario, Canada L7N 3S9. (905) 333-4557

FOR SALE: Hamburger radio, N.I.B. - \$30. Zenith Royal 1000, very good - \$100. Zenith Royal 3000-1, very good - \$150. Admiral Y2137 3-band transistor, very good - \$25. Guild Gramophone, good but not perfect - \$100 plus you ship. Guild Buccaneer treasure chest radio, good, you ship - \$150. Bill Manny, 1103 N.W. Despain Ave., Pendleton, OR 97801. (541) 276-3152, work days; (541) 276-7439, evenings and weekends

FOR SALE: Transistor & novelty radios: Westclox pocket transistor clock radio, looks & sounds good - \$50. Panasonic R1326, unusual style, plays good - \$22. Zenith Royal 700 all-transistor, leather case, looks - sounds great - \$35. Olympic 8 transistor Mod 859, gd cond., playing - \$30. Everplay rechargeable radio Mod 2836A - \$25. Realtone Mod 1801 mini 8 transistor, 1" x 2 1/4" x 2 1/2", (looks like Micronic Ruby), in original jewelry case, Japanese - \$35. Lunchbox radio, 1986 Munchie Tunes, looks, plays fine - \$22. Coke bottle radio in original box, looks, plays fine - \$30. Bookcase-shaped radio (Japanese), looks, plays fine. (top opens to turn on/off) - \$20. Tropicana orange radio, new in box - \$19. Joseph L. Gambaccini, 192 Division Ave., Shelton, CT 06484. (203) 924-0271

FOR SALE: Homebuilt receivers. Reinartz det. and audio, from QST March 1922 - \$100. Breadboard loose coupler, complete - \$150. Spark transmitter from 1920 - \$100. All plus UPS. Crystal receiver (see photo p. 11 A.R.C August 1995) - \$100. Write for info and photos. Neil Spencer, W4PC, 4665 75th Ave. N, Pinellas Park, FL 34665. (813) 546-8711

FOR SALE: Heathkit oscilloscope Mod 0-12 with manual - \$25. RCA Mod 8X541 - \$23. 1952 Mandl's Television Servicing - \$6. 1952 Radio and Television Mathematics - \$6. All plus S&H. Wes Boozer, 9345 Lisa Cir., Gainesville, GA 30506. (770) 864-0653

FOR SALE: Radios, parts, books, tubes, semiconductors, etc. 19 pg. lists, 2 stamps, LSASE. W.F. Horn, 13110 Marsh Rd., Bealeton, VA 22712. (540) 439-9781

FOR SALE: Radiotron 4th - \$75. Hickok 533-A - \$100; 800-A, refurbished with manuals - \$135. Dynaco ST-70, near mint. Telefunken 16CA7s - \$450. Charles Ochs, Salt Marsh Electronics, 19 Millfield St., Woods Hole, MA 02543

FOR SALE/TRADE: RCA 44-A broadcast-type microphone extremely rare in exceptionally beautiful brass & chrome finish - \$1,100. RCA BK-1 A, N.I.B. - \$250. RCA 74B chrome and black microphone w/original NBC top and side call letter flags - \$875. Larry Drago, 383 Lincoln Dr., Cheshire, CT 06410. (203) 272-6030

FOR SALE: Philco 39-7 - \$60. GE P807, mint - \$35. Zenith 275 - \$35; 705 - \$35; 710 - \$25; G723 - \$30. Radiola III-A - \$175. Ernie E. Odeneal, 2710 Lee, Greenville, TX 75401. (903) 455-2113 or 5788

FOR SALE: Simpson 260 VOM - \$50. HP1741A 100 MHz dual-trace storage scope - \$375. Heathkit, with manuals: IB-5281 RCL bridge - \$42; IM-5248 IM distortion analyzer/ACVM - \$58; IM-4100 50 MHz frequency counter - \$50. Millen 90651 grid dipper, 1.7-30 MHz, vg - \$98. Sencore LC53 Z meter, as-is - \$88. Much more, list SASE. Kirk Ellis, KK4YP, 203 Edgebrook Dr., Pikeville, NC 27863. (919) 242-6000, evenings

FOR SALE: Floor model Edison Diamond Disc phonograph Model #S-19 - \$450. Jeffrey Williams, 201 E. 62nd St., Apt. 8C, New York, NY 10021. (212) 754-5865

FOR SALE: Sony 3F-77W, TFM-385W, 2R-31, TR-1814. Zenith Royal 500E. Sears multiband. David Koesche, 61 S. Barrington Rd., Barrington, IL 60010. (847) 382-7997

FOR SALE: Novelties: U.S. Air Force F-125 plane, M.I.B. - \$65. Twix cookies, M.I.B. - \$70. Wilson football with tee, M.I.B. - \$65. Armillary sphere - \$95. Boy playing bagpipes, M.I.B. - \$60. Ballantine's Scotch whiskey - \$60. Pac Man, M.I.B. - \$50. Knight on rearing horse - \$85. Sam Samuelian, 2305 W. Deerfield Dr., Media, PA 19063. (610) 566-7248

FOR SALE: Motorola 7" portable TV Model VT73A - \$90. Can deliver to Kokomo, in meet, May 3 & 4. Fred Schult, 1246 Lincolnway S, Ligonier, IN 46767. (219) 894-3779, 9-5; fax after 5 pm

FOR SALE: Dynaco ST 400 - \$275. Fada bullet and Belmont repros - \$40 ea. Franklin LaBarbara, 13 Lauriston St., Providence, RI 02906. (401) 751-1215

FOR SALE: Zenith G500 Trans-Oceanic, vg+ - \$135. DeWald A500, broken case, no dial glass - \$10. Al Wirtenberg, 15 Wilson Rd., Weston, CT 06883. (203) 544-9270. E-mail: mswaw@aol.com

WANTED: Western Electric 640A/1095 mic, Altec M11 Coke bottle, yokes for M-30 Lipsticks, WE 630 Eightball, RCA PB17, 77A ribbon MI 4020 box camera, need lots of old mic stands. Have exc 77DX & BK5B for trade. Ward Kremer, 301 S.W. 16 St., Ft. Lauderdale, FL 33315. Phone/Fax: (954) 524-5652

WANTED: Marantz Model 15 amplifier. Gene Peroni, Box 58003, Philadelphia, PA 19102. (215) 665-6182, days

WANTED: Electron tubes, ball bearings, Collins radio parts and equipment, aircraft parts & instruments, helicopter parts, lamps, synchros. Hy Ness Company, 709B Delair Rd., Cranbury, NJ 08512. (609) 395-1116. Fax: (609) 395-1117

WANTED: Altair 8800 computer (1975 kit), made by MITS Inc. Wayne Abare, 335 Meadowood Ln., W. Melbourne, FL 32904. (407) 727-8559, after 5:30 pm weekdays

WANTED: Small escutcheon for Belmont or Freshman 525, 1.75" distance between holes. Jorge Llacer, 215 Pomona Ave., El Cerrito, CA 94530. (510) 524-7995

WANTED: Speaker for Majestic Model 20. Call or write. Jerry Gilchrist, 2145 Sugar Valley Rd., Ohatchee, AL 36271. (205) 892-0703

WANTED: E.F. Johnson capacitors 100D70 (153-11-1), 150D70 (153-12-1), 100DD90 (153-514-1). Martin O. Piepenburg, W9OLD, RR1, Box 56B, Monterey, IN 46960. (219) 542-2591

WANTED: Wood top for Edison diamond disc phonograph console, base 20 3/8 wide 22 deep. George E. Hoffman, 605 Eman Ct., Arroyo Grande, CA 93420. (805) 481-2147

WANTED: Manual and schematic for Precision Series ES-500A oscillograph. Copy OK. Robert Decker, 3001 W. Mandalay Ln., Phoenix, AZ 85023-4870

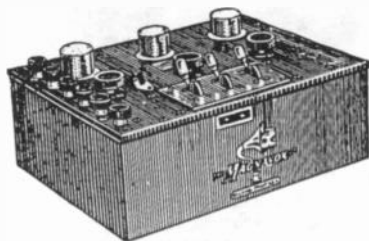

WANTED: Is this an AC-3A or B amplifier? Input and output are on jacks instead of posts as in the AC-3C, and it has five (!) transformers. The Magnavox AC-3C appeared in Jan. 1922. Does anyone have literature showing this model? I need sockets and rheostats to restore it — it was converted to "modern" tubes in 1935. Alan Douglas, Box 225, Pocasset, MA 02559

WANTED: Copy of operations manual for Heathkit T-3 signal tracer. Please, someone. Bob Puttre, 637 Stratford Rd., Baldwin, NY 11510. (516) 223-9667

WANTED: Zenith 9S324, 7S323, 7J328, GE F63, any restorable condition. Scott Boyette, 8551 Henderson Grade, North Fort Myers, FL 33917. (941) 731-6398

WANTED: Push-button escutcheon for 1946 Bendix Model 736A radio. Ralph Blake, 5540 N. 2nd St., Phoenix, AZ 85012. (602) 242-2125

WANTED: Very early galvanometers and pre-1920 test instruments including wavemeters, decimeters, books & paper. Also telegraph apparatus of all types. Pete Malvasi, WB2BYQ, 75 Church St., Ramsey, NJ 07447. (201) 934-0321

WANTED: Phonograph-related items: Top dollar paid immediately for Vogue picture records, Edison, Columbia, and any wax cylinder records, toy phonographs, needle tins and cutters, Nipper, record dusters, puzzles, fans, calendars, pocket advertising mirrors, dealer lapel pins, phonograph toys, posters, broadsides, original dealer advertising items from Edison, Victor and Columbia. Thanks. Bernie Seinberg, 714 Moredon Rd., Meadowbrook, PA 19046-1907. (215) 886-6124



WANTED: Air King Skyscraper radios, except for that unbearably ugly model with the third (tuning) eye at the top that bears better resemblance to a flounder than to the face of a building. Please write or call collect: Rain Buttignol, 214 State St., #7, Portsmouth, NH 03801. (603) 427-1384

WANTED: Power transformer for U.S. Radio Model 80 Radiotrophe. Jack Ghare, 1753 Community Beach Rd., Odin, IL 62870. (618) 532-5548

WANTED: 14" or 21" Music Master, wood bell only. I have neck & driver. Call collect: John Marinacci, 1141 Galaxy Cir., Pittsburgh, PA 15241. (412) 221-6763

WANTED: Western Electric amplifiers, speakers, drivers, tubes and microphones for my collection. Frank Hagenbuch, 1440 Lafayette Pkwy., Williamsport, PA 17701. (717) 326-0932

WANTED: (4) wood knobs and (5) push buttons for Zenith chairside, Model 6S340. Don Clark, RR2, Box 110A, St. Rd. 234, Ladoga, IN 47954. (317) 942-0217

WANTED: Knob for RCA Victor Model 120, 7/8 inch diameter, wood, original or reproduction. Ralph Trotter, Jr., 103 Beach Rd., Bristol, RI 02809

WANTED: Hardy Boys book, The Shortwave Mystery. Hallicrafters S-38, mint and working only. **FOR SALE/TRADE:** Lafayette Dyna-Corn 3-C crystal-controlled, handheld CB, solid metal case, cowhide carrying case, automobile power adapter, three crystals, mint and working — \$45 plus UPS. Turner J-254C ceramic desk mike, N.I.B. — \$25 plus UPS. Or will trade both CB radio and mike for perfect S-38. Gus Stelwag, 117 Edgewood Dr., Orangeburg, NY 10962. (914) 359-0769

WANTED: Meissner signal shifter and EICO and Conar transmitters. Mark Gilbert, Box 88, Old Greenwich, CT 06870. (203) 625-8374

WANTED: Schematic and any additional information for Galvin Model 65T21 receiver. Louis D'Antuono, 8802 Ridge Blvd., Brooklyn, NY 11209. (718) 748-9612, after 6 pm

FOR SALE: Zenith Royal 7000, manufactured in Taiwan, like new, 11 band - \$275. Westinghouse Escort (watch radio/flashlight), everything works - \$100. Philco T-4-124 w/case - \$55. Sampson SC4000 (watch/alarm/radio), very pretty, n/working - \$35. Huckleberry Hound (Breed #99) - \$40. Robark (Breed #245), no bat/cover - \$55. Bass guitar (Breed #399), blue - \$60. Love Is (Breed #205) - \$35. Scooby Do (Breed #103) - \$45. Red tomato (Breed #376), N.I.B. - \$35. Green apple (Breed #356), N.I.B. - \$35. Panda (Breed #222) - \$25. Getty tire w/lugs, no stand - \$75. Tony Tiger, N.I.B. (Breed #317) - \$40. Trades for high end pockets considered. Also will trade my mint Monarch 90 for your mint Zephyr ZR-930. Call: Mike Trocchia, 505 Moore Rd., Neptune, NJ 07753. (908) 774-4457

FOR SALE: RME VHF-152A shortwave converter. Price reduced to \$65 plus shipping or make offer. Gary Berg, 24 Pat Rd., Newburgh, NY 12550. (914) 565-5077

FOR SALE: SASE for book, catalog and paper list. Charles J. Stinger, 404 Ross Ave., Hamilton, OH 45013. E-mail: w8gfa@aol.com

FOR SALE: Reproduction piano radio parts. Plastic music stand - \$25; wood stand - \$15; pedals - \$15/pr. Geoff Shearer, 14101 Mesita Cliff Rd., NE, Albuquerque, NM 87112. (505) 293-8544. E-mail: GShea90278@aol.com

SOLID-STATE VIBRATORS for automobile radios 1932-58. Exact duplicates of originals in metal cans. Synchronous, Non-sync, European. Dealer inquiry invited. Free catalog. Visa, MasterCard, Discover. Antique Automobile Radio Inc., 700 Tampa Road, Palm Harbor, FL 34683. (800) WE FIX AM 933-4926, or Fax (813) 789-0283

PHONO NEEDLES & CARTRIDGES: (Ceramic & magnetic) What do you need? Send SASE. J.J. Papovich, 53 Magnolia Ave., Pitman, NJ 08093. (609) 582-8279

ANTIQUE RADIO RESTORATION Satisfaction - Guaranteed. Ray Sanders, 342 South Third, Cottage Grove, OR 97424. 541-942-0866



WANTED: RCA hi-fi/stereo console Model SHF-1 (pictured) or similar RCA consoles/home entertainment centers, late 50's-early 60's (especially blond Danish modern look). RCA Product Catalogs, RCA Engineer, RCA Electronics Age, from 1956-1962. Any help appreciated. John McLawhorn, 112 Walnut St., Cary, NC 27511. (919) 467-8018

RADIO SCHEMATICS PLUS DATA STILL \$3.00 EACH. TV \$4.00, POSTPAID USA. JOSEPH R. FORTH, 321 LONG VUE ACRES, WHEELING, WV. 26003. (304) 277-3154. E-mail: Schematic1@aol.com

FOR SALE: Signal generator TS-413B/U 75kHz to 40MHz, 1Mc calibrator, microvolt calibrated output, output for counter - \$85. Hickok Traceometer, Model 156A, with manual - \$200. Both units are in good condition and fully calibrated. Both are plus UPS. **WANTED:** Instruments made by Morris E. Leeds and Queen. Lane Upton, 11284 Clinton Bar Rd., Pine Grove, CA 95665. (209) 223-4638

FOR SALE: McIntosh MC60s & miscellaneous gear - \$1,250. Hickok 123R cardmatic tube tester, mint - \$350.00. Kim Gutzke, 7134 15th Ave., S, Minneapolis, MN 55423. (612) 869-9963

FOR SALE: 1929-1968 Buck Rogers comics huge book - \$30. Old callbooks, ham stuff, SASE list. Bill Tucker, W4FXE, 1965 S. Ocean Dr., Apt. 15-G, Hallandale, FL 33009. (954) 456-1349

FOR SALE: Abbotwares Model Z477 horse radio, rebuilt. Eitz Repair, 4265 S. Bladen Ave., Juniata, NE 68955. (402) 756-6393

FOR SALE: Philco 15X metal escutcheon - \$25. Western Electric junction PNP 7D transistors. Ken Voyles, 7425 Brushmore NW, N. Canton, OH 44720. (330) 494-5648

FOR SALE: Kits! Eico audio gen; PAT-4 (part assmbld), Grommes amp. Nice Zenith 4K400D; PAT-4 & FM-5; N.I.B. Garrard RC88/4, Ampex 2070; RCA EY-3's, Bell Tel (WE) desk intercom from 40's (neat!); 3 chassis: Philco 40-155 w/t; Truetone w/e/y, 6 tube; Westinghouse Columaire, 45 output, n/t. N.I.B. Harman Kardon Solo rcvr. **WANTED:** Zenith 6S27 chassis; Heathkit MX-1 or AC-11 mpw adapter; tonearm hdw for Thorens TD-124. Thanks! Michael Hagan, 428 Sharron Dr., Waco, TX 76712. (817) 776-4760

Victrola Repair Service: Windup phonograph repairs, parts, springs, needles via U.P.S. Rod Lauman, 19 Cliff St., St. Johnsbury, VT 05819. (800) 239-4188, eves.

WANTED, ANY CONDITION: RBY, Hallicrafters S-35, PR-1, Collins 478R-1, Squires-Sanders SS-1V panadaptors; also schematics, manuals, ads, articles, technical data on them. John A. Benyo, 25 Schley Street, Garfield, NJ 07026

MESSAGE: The Michigan Antique Radio Club announces that **EXTRAVAGANZA '96** will be held July 12-14, 1996, in Lansing, Michigan. Please **MARC** your calendars now! To be put on the **EXTRAVAGANZA '96** mailing list, send postcard to: **EXTRAVAGANZA '96**, PO Box 585, Okemos, MI 48805-0585

SPEAKER PARTS: Adhesives, Cone, Dust Caps, Gaskets, Voice Coils (Round and Edgewound) Spiders and Terminals. Refoam Kits - \$14-\$18 for speakers. Cat. avail. \$10.00 (Refund.) 800 order line Visa/MC/Am.Ex. Speaker Parts Co., PO Box 14731, Fremont, CA 94539. 510-490-5842/510-490-1961 **FAX**

WANTED: BRUNSWICK UPRIGHT PHONOGRAPH w/curved sides in oak or walnut, v. good or better cond. I'll pay your price for the right one! Call or write: Bo Brook, 4858 Willow Lane, Orchard Lake, Mich. 48324. (810) 681-7133, eves.

WANTED: Radiola 26 tube cover plate and handle. Craig Pitcher, 1308 Kristin Dr., Libertyville, IL 60048. (847) 367-1599

WANTED: Black Bakelite case for Kadette Classic. Alan Voorhees, 10809 McIntry St., Oakland, CA 94605. (415) 553-2313. E-mail: alvo@kqed.org

WANTED: Good Paragon audio transformers. Will pay \$50 ea. Need two for DA-2. Ernie Hite, 2625 Colecreek Ln., Rock Hill, SC 29732. (803) 366-9998

WANTED: Radio Boys book, Aiding the Snowbound by Chapman. Pay cash or trade. Jeff Hoskins, 824 E. Madison Ave., Stuart, FL 34996. (407) 283-2291, after 7 pm

WANTED: Dial for Philips BX 560A. Robert Swart, 1734 San Antonio Ave., Alameda, CA 94501. (510) 523-4842

WANTED: Catalin radio parts, paying \$20 or more per knob. Need a Garod Peak Top chassis. Ray Carroll, 158 Oakwood Dr., Wayne, NJ 07470. (201) 696-1149

WANTED: Philco 90 or 70 cathedral. Cabinet must be in good condition. Scot Ankeny, Jr., Rt. 3, Box 8, Blue Earth, MN 56013. (507) 526-3247, work

WANTED: Kadette Classic, Bendix 115, Fada 845, Fada 700, Addisons, red or blue Super Pee Wee and other nice Deco plastic radios. Call between 10 and 10 Eastern, leave message with color, condition, and price. Pete Fee, 26 Smull Ave., Caldwell, NJ 07006. (201) 403-8913

WANTED: Bottle radios or pieces and parts for Pepsi, Coke, etc. Hal Kravig, 2615 Juneway Dr., Memphis, TN 38134. (901) 388-5102, phone/fax

WANTED: Tube limiters, EQ, consoles; Altec speakers; RCA ribbon and Neumann microphones; tube amps. Mike States, Box 81485, Fairbanks, AK 99708. (907) 456-3419, phone/fax

WANTED: Cathedral case & speaker for Colonial T-345, (Bunis 2, p. 44). Richard Minnick, 1318 Judd Rd., Saline, MI 48176. (313) 429-1022

The Olde Tyme Radio Services Directory is now available. Find the services and parts needed to restore that old radio or t.v., also included are clubs and publications all categorized and sorted by state for easy look-up. Over 225 suppliers listed, and always adding more each year. Send \$4.00ppd. Andrew Mooradian, 5 Priscilla Lane, Winchester, MA 01890

CRYSTAL SETS: The Xtal Set Society Newsletter Volume 5 now available in paperback, \$9.95 plus \$2.50 shipping. Design of Unpowered AM Receivers, Radio Outfit in a Headset, The Matching Secret, and more. Join the Society and receive 6 newsletters, \$9.95. The Xtal Set Society, PO Box 3026, St. Louis MO 63130. (314) 725-1172

WANTED: Collins Radio Company Catalogs, promotional literature, manuals 1933-1983. Jim Stitzinger, 23800 Via Irana, Valencia, CA 91355. 1-805-259-2011

WANTED: 18" Jensen speaker w/carrying handle and pedestal circa 1935, 36. Bo Brock, 4858 Willow Lane, Orchard Lake, Mich. 48324. (810) 681-7133, eves.

WANTED: N.O.S. U.S.A. stereo magnetic cartridges. Also N.O.S. Garrard AT60 idler wheel. John F. Dube III, PO Box 3715, RFD #1, Poland Spring, ME 04274. Phone/fax: (207) 998-5687

WANTED: Nearly 25 years of trading w/fairness & consideration. Your highest offers bettered on my preferred wants! Paying up to: \$3K MacIntosh MI 200AB, \$2,400 Marantz 7, \$3K consolettes, \$3,500 Twos, \$1,600 8B, \$1,200 covers, \$1,400 Fisher SA1000, \$850 FMR1, \$1,200 F/Lincoln, \$1,200 Scott 4310, 4100, 4120. \$1K Regency HF1000, \$8K Patriarchian, \$2K Jensen Imperial, \$1,800 Tannoy red, \$2K Hadley amp, \$6K WE 1086, \$1,800 S. Carlson 475RF system, \$500 K. Monks, rc. \$1K REL \$800, Altec 1570A, \$1,600 Laguna, Capistrano. \$700 Inovac, \$60 2A3, \$45 EL37, \$60 m. base EL34, \$35 8045, \$55 8005. Also: KT66, 77, 88, 7591, 845, 811, 211, 6LF6, 50, Mullard 12AX7. Black Cats, U.T.C., Acro, Partridge xfmrs. Tube covers. Transcription arms. Ampex: 352, 354, 440, ATR. Altec: 340, 350, 260, 287, A7. A.R. LST, LST2, AR1, tweeters. J.B. Lansing. Klangfilm Eurodyn, Klipsborn, Tannoy, Trichannel Vitavox. Beveridge, Brociner, Brook, Cotter, Dynavector, Dyna MKIII, EICO, Fairchild, Futterman, Garrard 301, Grommes, Harvard Labs, Heath, H.K., KLH8, Karg XT3, Leak, Ohm A, Pilot, Puresonic, Quad, Radiocraftsmen, RCA amps, mikes, spkrs, studio tables, Rogers pro., S.C. ASP 422, Sequerra FMI Sinclair TV, SME 3012, Sony Elcaset (et al), WE eqpt. Win cart. Be specific, messages returned on wanted items. Ed Schneck, 1401 Ocean Ave., Brooklyn, NY 11230. (718) 377-7282, M-F, 3-6 pm

WANTED: Sansui TU-1000 tuner and 6L6 mono amps. Realistic 212 preamp and 214 tuner for 1962. Madison Fielding and Crosby rcvrs. Radio Shack catalogs from 1959, 60, 61, 63, 64. One Fisher 80C preamp. Charles D. Maples, 1623 Saddle Dr., Murfreesboro, TN 37130-3410. (615) 893-0255

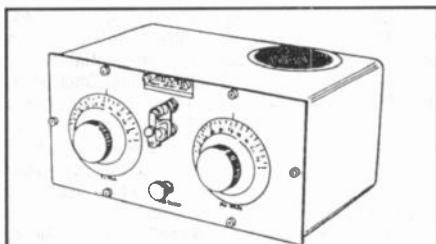

WANTED: Pre-1926 radios by AMRAD. Also, Amrad radio parts, accessories, and literature. Richard Sharisky, PO Box 521, Belmont, MA 02178. (617) 484-5784

WANTED: Radio Callbooks 1900 thru 1927. Bob Arrowsmith, W4JNN, PO Box 166, Annandale, VA 22003. Collect (703) 560-7161

WANTED: Fairbanks Morse console Model 9C or 12B preferred. Charles E. Patterson, 2621 Sweetwater Rd. SP#33, National City, CA 91950. (619) 475-7141

WANTED: Front panel for Pilot A.C. Super-Wasp. Bob Grega, P.O.B. 391086, Solon, Ohio 44139. 216-475-6643 after 6:00 P.M. EST

FOR SALE: This is my first-time ad in A.R.C. (1) Auto radios and auto radio repair parts. We are discontinuing auto radio repair shop. 1950 Ford radio, 1951 Chev. radio, 1957 Merc., 1951 Nash-Ramb., 1967 Chev. II radios for sale. (2) Auto radio repair parts: 1 Delco radio parts, new-in-boxes; 1 asst. of OEM auto radio volume, tone-SW. N.I.B. controls, about (40) total. AC power supplies, capacitors, resistors, all-new. (3) Simpson 2 1/2" square panel meters, N.I.B.; tube testers, N.I.B.; VOM meters, N.I.B.; knobs phono cart. and needles, and stylus, hard-to-find. Many types of switches, N.I.B., some old N.I.B. Centralab switches (band). (4) An asst. of new, old radio parts dated 1924. All are new with instructions, but boxes are crumbly due to old age; 28 old tubes, some are very good N.O.S., and many other misc. old radio parts will also be sold. Send (2) stamps for free lists of items listed that are for sale on this first ad. Billy Azbell's Antique Radios & Victrolas, 2725 Speight St., Waco, TX 76706. (817) 752-1825 or (817) 754-4689, after 6 CST. Fax: (817) 754-4244

FOR SALE: Approximately (100) old radios. These include cathedrals, tombstones and consoles. Sorry no Catalins. I do have some nice plastic Crosley radios circa '48-'52 that were found new-in-the-box several years ago, some have never been opened. I am drastically thinning out my collection. Send large SASE for list. John Miller, 3426 Coldstream Ct., Lexington, KY 40517. (606) 272-9811

FOR SALE: 1939 Zenith 9S367, mint - \$600. Sony ICR100, mint - \$425. Emerson butterscotch BT245, cracked - \$525. Mighty-Mite swirled maroon Plaskon - \$395. 7" Motorola TV - \$75. Scott Phantom chassis, exc. chrome - \$200. **WANTED:** Strong buyer of McMurdo Silver, EH Scott and Lincoln consoles, also black-painted wood radios with chrome. Don Hauff, Box 16351, Minneapolis, MN 55416. (612) 933-9070. E-mail: McMurdoDon@aol.com

FOR SALE: Murdock spark gap and marble-base spark gap with (24) round copper (cooling?) discs - \$250 ea. H.P. Donlie tube, very similar to that on p. 338 of Saga of the Vacuum Tube, looks like experimental lab model, probably one-of-a-kind - \$1,500 or Best Offer. Ruhmkorff Inductor, made in Paris, France, in 1896. This is a large, heavy, impressive and fully functional unit, and extremely rare - \$2,500 or Best Offer. Year sets of Radio Age, 1924 and 1925 - \$200 ea. QST, complete and partial year sets, from 1923 thru 1949, reasonable. Radio News year sets, 1947 thru 1953 - \$15 to \$20 per set. Various radio catalogs back to 1935, such as Allied, Lafayette, etc. Call for prices. Many Heathkit catalogs and manuals from \$5 to \$15. Buyer pays shipping. Dennis Branch, 1238 W. Ivyton St., Lancaster, CA 93534. (805) 723-1569

FOR SALE: Sony ICF-7601 and ICF-SW20 multi-bands. Casio TV-470 handheld color TV, all mint with accessories and boxes - Make Offer. Hugh Carlson, 33834 Cotswold, Farmington Hills, MI 48335. (810) 474-6364

FOR SALE: Hallicrafters S-120 - \$55. HK TA3000X - \$165. Airline 1696A table radio - \$30. Plus more. SASE or call for list. Roger Ruddick, 33 Emily Ln., Ft. Myers Beach, FL 33931. (941) 463-8887

FOR SALE: Electrola Borgia II 4'x4'x2' cabinet by Victor T.M. Co. w/Fisher R3M RVR, xnt - \$500 or up. Agreed? Renee May, 1242 N. El Centro Ave., Los Angeles, CA 90038. (213) 464-9179

FOR SALE/TRADE: Collins Station includes 32S-3A, 75S-3C, 30L-1, 51S-1. I will sell or trade all or any individual item. Call: Larry Drago, 383 Lincoln Dr., Cheshire, CT 06410. (203) 272-6030

CLASSIFIED AD NOTICE

Please check your ads carefully before sending them in. Once ads are received, it is not always possible to refund the amount sent, pull the ad or make changes.

FOR SALE: (2) Zenith 50's rectangular laced shade wrought iron table lamps with Zenith Crest - \$110 ea. Mitchell Lumitone lamp radio, gold base, excellent condition, no cloth shade - \$165. N.O.S. Philco Factory Supervised Service Authorized Member license plate flag, blue and yellow, steel - \$22 ppd. N.O.S.: Sonora RDV 209 wood - \$60. GE 202 Bakelite - \$40. GE 103 wood - \$35. John Vassos RCA, brown Bakelite with white PB's and knobs - \$295. 6' x 20" horizontal RCA Victor Radios porcelain sign, very slight chips - \$695. Radiola III and amplifier - \$235. Charlie McCarthy; Philco 39-116 remote console - \$325. Rider's manuals: 8-14 - \$15 ea. Call for current availability on other numbers. We have available all type Trans-Oceanics except 7G605 and military, electrically restored, if requested, and guaranteed. Excellent color laser reprint of the original Trans-Oceanic 7G605 brochure - \$10 ppd. We have for sale many console radios not advertised: Stromberg, Philco, RCA, Airline and many others, call. Zenith consoles: 22H 1942 AM/FM 22-tube radio/phono; 15S373A; 15S372; 15U269; 12S569; 12S471; 12U159; 12U158; 12S370; 12S371; 12S265; 12S266; 12S267; 12S268; 11S474; 10S153; 10S155; 10S156; 10S157; 10S160; 9S54; 9S262; 9S367; 8S154; 8S463 (5808); 8S359; 7S366; 7S363; 7S260; 7S258; 410 and many others. Zenith chairside: 12S245; 9S344; 6S147; 8S451; 7S343; 6S241 bar radio; 6S239. If you are looking for a set not listed, please call for more info. We can and do ship consoles anywhere and we do it right. Zenith table models: 5S29; 5S228; 5S127; 7D226; 6S322; 6D219; 6S330; 9S30A, export; 7S28; 7S323; 6V27; 6S128; 6S222; 7S432; 807; 808, 809 chrome front, L cathedral and many others, call. All radios unrestored electrically unless noted. Shipping extra unless noted. Satisfaction guaranteed, highest quality possible assured. Send for our free catalog showing restoration and shop supplies, owner's manual reprints, etc. When in Minneapolis, be sure to visit our retail location, Great Northern Antiques, 5159 Bloomington Ave., just five minutes from the airport. We accept Visa and MasterCard. Alan Jespersion/Mike Emery, PO Box 17338, Minneapolis, MN 55417. (612) 727-2489 or fax only (612) 727-1908, ans. mach. after 4 rings, 8 am to 8 pm, 7 days

FOR SALE: H.H. Scott stereo tuner amplifier Model 340B with instruction manual - \$175. Star-Right table fan, (4) 10" brass blades with octagonal cage, oscillating - \$150. Bill Constantine, PO Box 493, Glens Falls, NY 12801. (518) 792-7065

FOR SALE: Grebe Synchronphase AC Six Radio carton - \$60. Motorola TV, TS-18 Bakelite, 6" screen, untested, with Talaide Motorola 46-51 chassis manual - \$185. Motorola TV, TS-4 mahogany, 4 1/2 x 6" screen, untested - \$125. Prewar German Korting radio, Model 24242W with rare tubes, untested - \$60. **WANTED:** Still need: junker Grunow 901/902, chassis 1A oscillator coil. Ben Mast, 3253 O St., NW, Washington, DC 20007. (202) 338-7145

WANTED: RCA AVR5A, AR60 Western Electric, National AGS, anything marked Bureau of Air Commerce. James Treherne, 11909 Chapel Rd., Clifton, VA 22024. (703) 830-6272

WANTED: Chicago White Sox radio, also Pilot Lone Ranger radio. Call collect. Alan Piorek, 1050 N. Paulina St., Chicago, IL 60622. (312) 235-1523

WANTED: Dial glass for Stromberg-Carlson 125-H, has painted on octagonal dial scale. Randy Massey, 20937 Indiana, Trenton, MI 48183. (313) 676-7086

WANTED: ARC 85 kHz IF transformers; Meissner IF transformer replacement manual, 1945-1950; 1946 Hallicrafters catalog. John A. Benyo, 25 Schley St., Garfield, NJ 07026

WANTED: Probe only for a Heath signal tracer IT-12. Stanley H. Thompson, 43 Cozy Corner, Avenel, NJ 07001-1122

WANTED: Working speaker for Philco 86. Harvey Leners, 5426 So. 185, Omaha, NE 68135-1716. (402) 895-2331. E-mail: HLZenith@aol.com

WANTED: Atwater Kent Model 20-C, any condition. Rob Loeser, 390 Beech St., South Hempstead, NY 11550. (516) 483-0463

WANTED: WWII and earlier German communications equipment and parts. Richard Brisson, 159 Grandpre Ct., Navan, Ontario, Canada K4B 1K3. (613) 830-0379. E-mail: hagelin@magi.com



WANTED: Fada Catalin radios. Help! My entire collection spontaneously combusted during an interview with the "Enquirer." Replenish and repent ye sinners. Please write or call collect: Rain Buttignol, 214 State St, #7, Portsmouth, NH 03801. (603) 427-1384

WANTED: Buying dead ham receivers, xmtrs that deserve a second chance at life. Need Viking Ranger, Valiant parts rigs. Ron Merrell, 10701 W. 54th St., Shawnee, KS 66203. (913) 268-5973, before 6 CST

WANTED: Any infos on early wireless-sets builder using single-wing Audion regen. circuit during 1910-1912 period: Paul E. Wallace, boss of the Wallace & Co., located 59 5th Ave., New York City. Looking for: pictures, circuitry diagrams, books, articles, catalogs of Wallace products. Also buying: RJ4-type porcelain rheostats, Murdock var. condensers, types: 360, 366, 367, 368, pre-1920 detectors (zincite, bornite, carborundum) and loose couplers, switch-lever knobs, pointer knobs w/center hole-fitting. Please no junk-stuff. Offers. Call/write anytime to: Guy Kueng, PO Box 8, CH-1211, Geneva-28, Switzerland. Ph./Fax: 01-41-22-796-5848

WANTED: Chassis and turntable for Philco 42-1011 console, not working OK. Frank Wylie, 1999 N. 4th St., Columbus, OH 43201. (614) 297-7460, or e-mail: fwylie@infinet.com

WANTED: Fada bullet cabinet, knobs, dial bezel. FOR SALE/TRADE: RCA Radiotron Sellin Fool doll - \$700. Bob Wood, 3612 N. 12th Ave., Pensacola, FL 32503. (904) 432-3782

WANTED: Plug-in FM Multiplex adapter for an early 1960's Stromberg-Carlson/General Dynamics 910 Series Audiophile Component Ensemble, Model 911M console. I need stereo. Please call: Steven Roth, 217 W. Broadway, F-24, Columbia, MO 65203. (314) 449-4216



WANTED: Majestic Model 566, the Tudor, five-tube console, good shape preferred. Bill Allen, 505 S. 8th St., Eldridge, IA 52748. (319) 285-6472

WANTED: Olympic portable 6-606-A or U and Crosley Trirdyn Super Special. A.M. Eisenstein, 10815 Falstaff Rd., Sebastopol, CA 95472

WANTED: Info on Miller 595 crystal h-fi AM tuner, "Radio, Television Electronic Service" magazine. FOR SALE: NRI course books, newsletters and unbuilt kits, including 19" color TV! Chuck Ulrick, 8282 Afolkey Rd., Dakota, IL 61018. (815) 563-4905, after 6 pm

WANTED: Zenith Model 7S529 in excellent condition. Larry Bosher, PO Box 193, Palo Pinto, TX 76484. (817) 325-5333

WANTED: Sideli Classic Plastic Radios softcover book. Also, need Emerson 400 Catalin case without cracks. Bob Zuch, PO Box 424, Chatsworth, CA 91313. (818) 719-2608, or (818) 700-0980

WANTED: Antenna coil L1 band 4 51B2027 with slug for Hallicrafters SX100. FOR SALE: Hallicrafters Model S38D, reasonable. Call collect: Robert G. Pease, 2 Starfire St., Franklin, NC 28734. (704) 524-5656

WANTED: Bunis book #1 & Sideli Catalin book. Thanks. Karen McCoy, 8104 N.W. 114th, Oklahoma City, OK 73162. (405) 722-0595. E-mail: kcmccoyokc@aol.com

WANTED: National SW-3 (or SW-2, SW-4, SW-5, etc.) in good to excellent condition, with coil sets and power supply. Jack Ellis, 7607 Ensley Dr., Huntsville, AL 35802. Voice/fax: (205) 881-6646

WANTED

Unbuilt Heathkits,
Knight-kits, Eico Kits

— Top Prices Paid —

Arnold L. Chase
9 Rushleigh Road
W. Hartford, CT 06117
(860) 521-5280

FOR SALE: RCA batteries thermometer, old logo with pictures of batteries, works, average condition - \$35. Buddy Cartee, 205 Mason Rd., Chesnee, SC 29323. (864) 578-3532

FOR SALE: 6SN7 tubes, new/used - \$2 ea. or 83 for \$50. Crosley jewel box - \$50. Acme reproducer Type K-2 - \$75. Sony tape recorder - \$50. Hallicrafters S-38, two; one - \$35; \$25. Plus many others. List, LSASE. Ernie Nagy, 1012 S. Collier, Unit 112, Marco Island, FL 33937. (941) 389-9101

FOR SALE: Sparton unrestored Bluebird sitting on original round blue mirrored base - \$4,900. Pick up only. Trade for excellent original Edison Triumph with 2/4 minute "O" reproducer and Music Master horn. Alan Wohl, 247 Prospect Ave., Cedarhurst, NY 11516. (516) 295-5614, evenings

FOR SALE: Philco 49-501, white - \$225. HC Citation III-X tuner - \$75. Hallicrafters S-38E - \$50. Harvey-Wells TBS-50D - \$120. John Malley, 10 Claremont Ave., Enfield, CT 06082. (860) 745-0733

FOR SALE: Palomar tuner model PT-340 - \$70 & \$5 UPS. E. Drake, Box 1808, Hyannis, MA 02601

FOR SALE: Early TVs. RCA 8T241 10", GE 806 10". Plus others, call for details. Can't ship. James S. Fisher, 344 Harrison Ave., Manville, NJ 08835. (908) 725-7476

FOR SALE: Cabinets: Philco 620 tombstone shouldered - \$25 Chelsea Super Five table model slant front - \$40. Plus shipping. Ron Franzen, 4307 Wild Ivy Ct., Arlington, TX 76016. (817) 451-5282

FOR SALE: Radio books 1907-1950, manuals, catalogues, tube manuals, early television literature. Much misc. literature. Large list - SASE. Radio Boys books - \$10 ea. Westinghouse refrigerator radio, green - \$100. RCA 2X61 - \$25. Admiral 69B4 - \$18. Maroon Zenith - \$15. Wooden Zenith 7C05 AM-FM - \$25. Bill Rolf, 30131 Center Ridge, Westlake, OH 44145. (216) 871-4547

FOR SALE: 1962 Radio Electronic Master Catalog of Parts and Equipment, 1,598 pages - \$30. Marion L. Clemens, 10129 Lapeer Rd., Davison, MI 48423. (810) 653-2439

FOR SALE: Tombstones, cathedrals, table models, transistors, tubes, etc. Please send LSASE for detailed list. Eric Hayes, 1248 Denver Ct., Naperville, IL 60540

FOR SALE: E.V. Georgian speakers, utility cabinets with no veneer, 1950's, exc cond. - \$2,000. Sumner McDanel, 3104 S. 147th E. Ave., #0, Tulsa, OK 74134. (918) 437-5403

FOR SALE/TRADE: Two movie theatre 100-watt DuKane Mod 1-A-803 solid-state amplifiers w/manuals, new-in-box, that were to be used as replacements for old equipment until the neighborhood theatre closed. If you know of a theatre still in business or under renovation that could use them, in exchange for their old tube amplifier, call: Larry Drago, 383 Lincoln Dr., Cheshire, CT 06410. (203) 272-6030

FOR SALE: 1931 Philco 70 cathedral, 1931 Sentinel 111 cathedral, Crosley CR9 jukebox repro radio N.I.B., Heathkit VOM, Trimm commercial headset mint, Bakelite stand crystal detector. Negotiable all items. Hugh Carlson, 33834 Cotswold, Farmington Hills, MI 48335. (810) 474-6364

FOR SALE: Hickock oscillator Model OS7, papers - \$30 + UPS. Don Carver, 174 84th Ave., N, St. Petersburg, FL 33702. (813) 577-5355

FOR SALE: Crosley clock radio, similar D-25MN, (Bunis 3), original chartreuse, works, plays well, good to excellent - \$115 plus UPS. C. Hill, 6934 Orion Ave., Van Nuys, CA 91406. (818) 787-0376

FOR SALE: Scott Allwave 12, works, poor chrome, no tuning dials, no speaker, good tubes. Larry Steeno, K9LWI, 1838 Blue Spruce Ct., Green Bay, WI 54311. E-mail: LSteenoo@gnn.com

NORTHLAND ANTIQU RADIO CLUB



AND

PAVEK Museum of Broadcasting

Proudly Announce

RADIO DAZE '96 (Sponsored by AWA)

Friday, May 31st and Saturday, June 1st, 1996

- SPECIAL** — Old Radio Auction
FEATURES: — A visit to the Pavek Museum of Broadcasting
— Video presentation of NARC members' radio collections

NARC

P.O. Box 18362 • Minneapolis, MN 55418

☎ Joe Gruber: 612-489-5552 ☎

Best Western - Golden Valley Inn

4820 HWY 55 • Golden Valley, MN

☎ 612-588-0511 ☎

SWAP MEET/AUCTION/PROGRAMS/CONTEST/LUNCHEON

FOR SALE: Fibber McGee and the Wistful Vista Mystery board game by Milton-Bradley, 1940 - Make Offer. Hugh Carlson, 33834 Cotswold, Farmington Hills, MI 48335. (810) 474-6364

FOR SALE/TRADE: HRO 500 working parts set and a like-nu HRO 500(?) in beautiful condition, with manual - \$1,200/both. Call first on these items. Larry Drago, 383 Lincoln Dr., Cheshire, CT 06410. (203) 272-6030

FOR SALE: Philco 80 cathedral cabinet - \$40. **WANTED:** Chassis for RCA 128 cathedral, 224 console. Curt Schreiber, 3923 E. Latoka St., Springfield, MO 65809. (417) 887-5184, collect. E-mail: Curradio@aol.com

FOR SALE: Weston Laboratory standard meters. Old testing meters. Western Union time transmitting relays, telegraph relays, old books. Henry Weiland, 8946 W. Grantosa Dr., Milwaukee, WI 53225. (414) 463-4681

FOR SALE: Grundig RF260/U AM/SW1/SW2/FM stereo, mint w/manuals. Realistic DX150 rcvr, exc. **WANTED:** Uniden DX1000 rcvr, Aircaste TRS 1000 portable, Sams SD & TSM Series. Gary Richardson, PO Box 712708, San Diego, CA 92171. (619) 670-7590

FOR SALE: Or trade for your crystal sets and germanium diode radios. Atwater Kent 84, 20. Guild Spice Box. General Model ? cathedral. Zenith 5D027, 6-D-315, I 520F, R7000, 12S569 robot dial. Hallicrafters: SX-71, SX-99, S-85, R-46, R-42, Skydrier marine. Collins: 75A2, TCS-12. Philco 60, 89. DeWald A-501, A-502. Motorola Pixie. Truetone RA-G-115S brass horse. Knight Star Roamer, Spanmaster, Ocean Hopper. National NC300. Emerson BM-215, 503. GE A-63. Signal Corp BC640 airport transmitter. Crosley Fiver. Echophone EC-3. Belmont 571. Galen Feight, The Crystal Radio Guy, 3104 S.E. 20th, Portland, OR 97202. (502) 231-9708

"Send in 2 boxtops. . ."



Not really. But you can be the first on your block to get a RADIO BOYS T-shirt. Authentic 1920's illustration in bright blue and black on white, 100% cotton tee. Order today - makes a great gift!

M(38 - 40); L(42 - 44); XL(46 - 48)
\$16.95 ea. plus \$3.00 s&h in U.S.A. (Add \$1.00 for each additional shirt.). N.Y. Residents include \$1.18 sales tax/shirt
Send check or money order payable to W. Sacks to

P.O. Box 1459
Olivebridge N.Y. 12461-0459

Please include phone # with order.

WANTED: Black dial Zenith console in any condition, also need parts. Can pick up at Lansing or Elgin. Scott Headley, 567 Traverse Dr., Costa Mesa, CA 92626. (714) 662-3497

WANTED: Hallicrafters speaker Model PM-23. Steel cabinet with horizontal bars, gray wrinkle surface. Nils Hardin, PO Box 1094, Summerland, CA 93067. (805) 963-0116

WANTED: TV-2/U military tube tester, any condition, working or not. Rich Nicewonger, 26 Evans Ave., Piscataway, NJ 08854. (908) 752-2912

WANTED: EV-664 microphones and 419 desk stands in good condition. Tom Bonomo, 81 Lakewood Cir., San Mateo, CA 94402. (415) 578-1897

WANTED: Chassis for Zenith Zenette Models L, AH, BH, CH, 91, 92, 103, 210. Gary J. Formica, 823-91st St., Niagara Falls, NY 14304. (716) 283-2274. E-mail: radio@ns.moran.com

WANTED: Grundig 4192 table radio, working or not. Ed Kalpa, 4622 Melbourne Ave., Los Angeles, CA 90027. (213) 661-1221

WANTED: Clarion AC60, AC61, AC70 chassis. Will pay your price for clean complete units. Need not be working. Mervyn Ellsworth, 2309 N. 25 St., Boise, ID 83702. (208) 345-6878

WANTED: Finalis (3) for Philco #80 Colonial clock radio. Frank Connors, 16 Windsong, Bedford, NH 03110. (603) 472-9772

WANTED: Good working Philco chassis Model 40-195 and speaker. Also knobs for Atwater Kent tombstone 145. F.E. Oswald, 711 Carl Ave., Altoona, PA 16602

WANTED: Built-in antenna for a 1941 Philco console radio. Dave Bertinot, 680 Havenwood Dr., Baton Rouge, LA 70815-6605. (504) 275-9462. E-mail: 102600.1673@CompuServe.com

WANTED: Military receivers, transceivers, etc. Need schematic for EL-2 Navy rectifier. Please call or write. Answer machine. Return call. C.R. Filer, 1163 Hawk-bill Ln., Sugarloaf Key, FL 33042. (305) 745-1801

WANTED: AK 465Q, 735, 24, 74. TV-2 tube tester. Johnson Ranger II. Heath SB-401. George Folsie, KB5WVW, 630 Dolhonde St., Gretna, LA 70053. (504) 362-1896

WANTED: Western Electric 12A horn. Will pay up to \$10K/pair. Jun Mizuno, 933 Portwood Cir., San Jose, CA 95120. (408) 268-4016

WANTED: WICE 1290 Providence play lists and station jingles from the early 60's. Thanks. John Sampson, 75 Glenwood Dr., Loeminster, MA 01453. (508) 537-0092

WANTED: RCA 44, RCA 77. Altec 639. In any condition. Also need parts for above mics. Mike Dupuis, 116 First Ave., Tuckerton, NJ 08087. (609) 296-4883

WANTED: 12-volt vibrator xformers: Delco 6067, Merit P2861, P2978 Stancor P6489, Hollardson V3902, etc. Fred Cranshaw, 1624 Bitter Ck., Garland, TX 75040. (214) 494-4917

WANTED: Zenith Stratosphere and other high tube count radios. Also Zenith and other pre-1950 advertising. We will buy or trade. Alan Jerspersion, PO Box 17338, Minneapolis, MN 55417. (612) 727-2489

WANTED: N.I.B. Type 78 tubes. RCA 240 chassis/speaker. Stromberg-Carlson Model 84. Thanks. Paul Froehlich, 4152 Hwy. J, Cross Plains, WI 53528. (608) 798-4905

FOR SALE: RCA 45/33 phonograph, Bakelite, appears to be from 1950's, Model 9-ED-IHE, working order, very hard to find - \$90 plus \$15 shipping. Send \$1 for radio book-magazine list. Maurer TV, 29 South 4th St., Lebanon, PA 17042. (717) 272-2481

FOR SALE: Tubes: KY-221, N.I.B. - \$15; VT-143 (2) - \$10; 3B24W - \$8; GL829-B, N.I.B. - \$15. WE 269-A, tennis ball, dud - \$18; WE 259-B, dud - \$10; CX-381 - \$15. 01-A's used: Perfection (G) - \$12; 201A - \$12; Silvertone 71A (ST) - \$12; CX301A - \$15; Silvertone 01-A, ST - \$12; UX171A - \$15; UX201A - \$15; Super Airline GX201A, N.I.B. - \$20; Silvertone 71A - \$12; 203A, N.I.B. - \$20; 829B, N.I.B. - \$15. Used mixed tubes for Best Offer as a lot, one of each: CHS-1625, CHY-1616, VT-236, CRC-876, 6BY-5, CRC-836, 54, VT-166; 6159, 6293. Offers? Sure! Thanks. Del Tysdal, Rt. 1, Box 157, Glyndon, MN 56547. (218) 287-2562

FOR SALE: Copies: Hard To Find Schematics for Radios, also kit radios 1922-1950. Manuals: test equip., ham gear. Contact me for prices, availability. Duane Ballew, KB7QZK, 6813 152nd St. Ct. NW, Gig Harbor, WA 98332. (206) 851-4505

FOR SALE: Rider #16 - \$15. Reprint Most Often Needed Radio Diagrams 1926-1938 - \$5. High Fidelity handbook, hard cover - \$25. Mallory Vibrator Data Book, 1947 - \$5. The Radio Handbook, 1942 - \$7. United Electronics Lab Course, 1956 - \$8. Audels TV Service Manual, 1953 - \$15. Audels Radio Man's Guide, 1958 - \$20. March 1946 & June 1948 Radio News - \$2 ea. (12) misc. issues Radio & TV News, 1949-1951 - \$1 ea. 1912 The Boys of the Wireless book - Make Offer. RCA #X9d, case poor - \$10. Bulova clock radio, case poor - \$10. Sentinel #315W - \$15. Johnson #658 tube tester - \$15. Teletone #122 - \$20. RCA 8X6m, yellow - \$10. Telechron 8H67, case poor - \$10. RCA 6Xd-5, green - \$15. Motorola 309 car radio, missing one knob - \$20. Automatic car radio - \$25. Radio City Products TV flyback/yoke tester - \$20. Simpson Model 303 hi-freq. probe - \$7. Simpson Model 303 hi voltage probe - \$7. Channel Master super fringe transistor radio "red," missing front logo - \$15. Webster-Chicago #362-1 phonograph - \$25. Monarch BSR "Travler" phonograph - \$25. **WANTED:** Rider's Manuals #18, 19, 20, 21, 22 & 23. All of the above items sale price plus UPS. Tom Zenisek, c/o Lucky Awards, Inc., 3300 1st Ave., NE, Cedar Rapids, IA 52402. (319) 366-3686

FOR SALE: Heathkit capacitor checker and restorer, perfect for reforming old stock electrolytics - \$65 plus \$20 shipping. Send \$1 for new radio-magazine sale lists. Maurer TV, 29 South 4th St., Lebanon, PA 17042. (717) 272-2481

FOR SALE/TRADE: Tube testers, Precision 920, Jackson 648, with manuals - \$50 ea. plus UPS. David Buck, 3630 Wilcox St., San Diego, CA 92106. (619) 224-5821. E-mail: whnf46a@prodigy.com

FOR SALE: Zenith 500H - \$80. **WANTED:** Dial glass for RCA 110-K or 110K-2 dial escutcheon for RCA 810K, Simpson 555 tube tester. Knobs for Stromberg-Carlson Model 63. Leon Gann, 1134 E. 50 Pl. N, Tulsa, OK 74126

FOR SALE: RCA 45-EY-26 Alice with wonderful decals, turns and hums - BO. Crosley, mint black, 10-136E, dashboard style - \$125. Zenith H-511, mint black, oval ends, plastic, hums - \$65. Philco 46-1201, slant front R/P, hums and turns, very, very nice - \$125. (33) magazines entitled Model Fun comic book style, 224 pages of how to build, planes, trains, boats, cars, winter 1955 - \$8 ea. Zenith TO-8G005 - \$135. Del Tysdal, 812 Broadway, Fargo, ND 58102. (218) 287-2562

FOR SALE: Craftsmen #10 AM-FM tuner, 12 tube, chrome chassis, excellent working/condition - \$110 U-ship. Bob Bakinowski, 1524 Saint Tropaz, Tucson, AZ 85713. (520) 624-8029

FOR SALE: Hallicrafters S-38E, very good - \$35. Zenith Trans-Oceanic R-600, complete with wavemagnet and unused log, excellent - \$100. Realistic DX-150A communications receiver with manual, excellent - \$85. Heathkit crystal set CR-1 with manual, mint - \$100. Sencore picture tube tester/rejuvenator complete with all sockets, extensions and set-up manuals - \$75. All items plus shipping. Roger Snowdall, 8405 Everett, Raytown, MO 64138. (816) 356-0396

FOR SALE: 300 plus items never offered before. Hallicrafters, Breting, National, Sargent, Swan, Hammarlund, Patterson, Drake and more. Send SASE and fax # if any. No phone calls please. Eugene Rippen, WB6SZS, 105 Donnington, Auburn, CA 95603

FOR SALE: Books: Practical Antenna Handbook - \$15. 1959 GE Bookers' Reference Manual - \$8. Principles of Radio Engineering - \$14. Ultra-High Frequency Techniques - \$15. (26) assorted issues of The General Radio Experimenter - \$20. Plus shipping. Ross Wolfrab, 229 N. Oakcrest Ave., Decatur, IL 62522-1810. (217) 428-7385

FOR SALE: Many novelty, transistor radios made in Japan from the 1960's. Most radios new in box. Free list SASE. Bill Hyde, 34 Cerrado Loop, Santa Fe, NM 87505. (505) 466-6613

FOR SALE: Radios: Consoles, table models, car. Test equipment & misc. Send SASE for list. Linus Brown, 205 W. South St., PO Box 553, Anna, OH 45302

WANTED

WESTERN ELECTRIC

TUBES, SPEAKERS, HORNS & AMPS

TUBES: Telefunken, Genalex, RCA, Radiotron, etc. General Electric, Amperex, JAN, Sylvania, GEC, National Union

McIntosh, Marantz, Dynaco, Jensen, Linn, Levinson, Fisher, Leak, Tannoy, Altec, EV, Thorens, EMT, JBL ... Amps, Spkrs., Turntables

MAURY CORB

12325 Ashcroft, Houston, TX 77035

Tel: (713) 728-4343 Fax: (713) 723-1301

TUBES WANTED

HIGHEST PRICES PAID \$\$\$

101D, F.205D, F. Tennis Ball, 300B, 274B, 211, 845, KT66, KT77, KT88, EL34, PX25, 280, 250, 102F, Telefunken, Bugle Boy, Mullard, ECC81, 82, 83, 801S, 802S, 803S.

— AUDIO EQUIPMENT WANTED —

Fisher, Scott, Dynaco, McIntosh, Marantz, JBL, Altec 604, B, C, D, E, 515, B, C, 288, B, C. UTC trans.; Black Beauty, A&B Resistor, etc...

FULL RANGE ELECTRON TUBE SHOP

Jonathan Woo Yik Fan

Flat B, 37/F, Block 5, Greenfield Garden

Tsing Yi, NT, Hong Kong

Tel: (852) 24349466 - Fax: (852) 24344963

FOR SALE: Transistor radios, Zenith Royals, Admiral, RCA, Sony, GE, etc. SASE for details, reasonable. George Greenberg, 1701 Andros Isle K-2, Coconut Creek, FL 33066. (954) 971-9053

FOR SALE: Regretfully must sell 15-year radio collection. Ninety percent are pristine and in working order. Tabletop tube: 84 sets - \$12,900. Transistors: 187 sets - \$11,995. Entire collection - \$24,000. Buyer takes all. Serious inquiries only Richard Bell, 100 Cane Dr., Lafayette, LA 70508. (318) 232-0825

FOR SALE: Collins 75-S2, 32-S2, (late) 516-F2, stored June 1977, collector quality - \$1,350. Edward Freeman, 631 Orchard Dr., Redlands, CA 92374. (909) 792-6779

FOR SALE: Western Union standard radio-telegraph signal set, instructions & miniature telegraph blank, in original box (toy) - \$35. 1960 Newark Industrial Electronics 1,500-page catalog; Parts & Equipment for the Radio, Television & Electronic Industry - \$35. Beige old 3-slot coin phone - \$160. Cliff Sullivan, 4902 W. Monte Cristo, Glendale, AZ 85306. (602) 978-3551

FOR SALE: Tubes: 5U4G used - \$5 ea.; 12AX7 used - \$3 ea. All test good and are U.S.A. manufacture. J. Arndt, 1215 Division St. Manitowoc, WI 54220. (414) 684-8830, machine on 24 hrs. a day, leave message

FOR SALE/TRADE: Atwater Kent Service Manual - \$60. RCA Service Notes 1933 - \$30. Radio Craft Anniversary Issue, original - \$28. D.H. Moore Radio Identification Bookset - \$75. Grebe Synchrophase 7 Instruction Manual - \$40. Grewol crystal detector - \$35. Westinghouse CB loading coil - \$80. Atwater Kent 735 cathedral - \$200. RCA 741 microphone, early - \$275. Magnavox R-3 and M-1 horns - \$150. Lambert crystal set - \$185. Murdock crystal detector - \$90. Send LSASE for new list to: Jerry Finamore, 1374 Stafora Dr., Bethlehem, PA 18017-1633

FOR SALE: Large private radio collection liquidation, every category. LSASE for lists of your wants. Thanks! Steve Blank, 407 Hamilton Ave., Linwood, NJ 08221. (609) 926-9277

FOR SALE: Rare GE HM-225 TV cabinet. Dud picture tube and junker video chassis also available. Jeff Lendaro, 1107 Logan St., Noblesville, IN 46060-2346. (317) 773-3969. E-mail: lendaroj@indy.tce.com

FOR SALE: New tube inventory, (608) total, (362) different, TV, radio, audio, some industrial. SASE for list. Bill's Sound Center, 7513 S. Westnedge, Portage, MI 49002. (616) 327-7285

FOR SALE: One RAL-7 Andrea, RCA ship's radio receiver, good condition - Make Offer. James E. Mos-teller, PO Box 637, Andrews, NC 28901

FOR SALE: Thinning out my collection of antique, transistor, and novelty radios. LSASE gets my list. Hank Trabold, 2058 Nakiska Ct., Toms River, NJ 08755. (908) 244-2345. E-mail: trabold@exit109.com

FOR SALE: Hand-turned wooden tube display bases cherry, walnut - \$16 dozen shipped. Jake Hellbach, KK5HY, 120 Briant St., Gretna, LA 70053. (504) 392-1883. E-mail: kk5hy@accesscom.net

FOR SALE: University public address horn, Model PH, 20-inch bell, unused; 30-watt driver, Model ID 30 - \$85 and UPS. C. Orval Parker, HC 89, Box 133, Pocono Summit, PA 18346. (717) 646-2750

FOR SALE/TRADE: Sharp Mod FX-200A AM/FM AC/batt. car/portable radio, N.I.B. - \$40 plus UPS. Paul Fulton, 711 Jacquelyn Rd., Westwood, NJ 07675. (201) 664-5260

FOR SALE: Solar capacitor analyzer Type CA, nice with instructions - \$20 plus UPS. Al Manieri, 384 Bates St., Phillipsburg, NJ 08865. (908) 454-3699

FOR SALE/TRADE: Hallicrafters Skybuddy - \$75. Gonset G66B - \$75. Brunswick 1923 phonograph Model 101 - \$150. Emerson 878 - \$50 plus UPS. Trade in your mini keychain license plates made by Disabled American Veterans for \$2 each off any radio. John Williams, Jr., PO Box 1545, Scarborough, ME 04070-1545. (207) 775-4212

FOR SALE: Philco 48-1284 with tubes and speaker, removed from console - \$10 plus 26 lbs. John Uscinowski, RR#1, Box 379, Greenwich, NY 12834-9519

FOR SALE/TRADE: MacIntosh MC-30 mono block power amp in beautiful condition - \$485. Also MC-30 parts amp - \$270. Call: Larry Drago, 383 Lincoln Dr., Cheshire, CT 06410. (203) 272-6030

FOR SALE: 32-page copy of original Operators Manual for Simpson 260-VOM1 - \$10 ppd, includes schematic and parts list. Maurer TV, 29 So. 4th St., Lebanon, PA 17042. (717) 272-2481

FOR SALE: Zenith console Model 10S160, not working, few knobs missing, pick up only - \$35. Onerio "Lou" Sabetto, 1717 Burgess Rd., Cleveland, OH 44112. (216) 481-1036

FOR SALE: Tubes, new and used. Many antique, audio, ham. Recently expanded list. SASE 52¢. Bill McCombs, WBØWNQ, 10532 Bartlett Ct., Wichita, KS 67212-1212

FOR SALE: RCA 68R1 large table AM/FM - \$40. GE 476 white AM Musaphonic - \$20. All items plus UPS. Jon D. Andreasen, PO Box 22, Newton, NJ 07860. (201) 579-6261, 6 to 9 pm Eastern

FOR SALE: Motorola Pixie, a 9+, fine working condition - Best written offer by 5-1-96. Hugo Eckman, 9 Blaine Ave., Augusta, ME 04330. (207) 666-5650

FOR SALE: 1996 is clean-out time. Listed and unlisted items. LSASE for details. Old collectors tubes, light bulbs, old 1930 up test eqpt., amps, radio parts N.O.S., old orig. boxes, old books, catalogs. Want to clean out dual garage, attic, house, basement. All pickups cash and carry, phone first. Radios, tuners, plus more. Selling all unwanted items. F. Krantz, 100 Osage Ave., Somerdale, NJ 08083-1136. (609) 783-0400, 10 am to 8 pm EST

FOR SALE: 64-page book describing the history of Federal Tel. and Tel. radio in the 1920's, (60) photos including all early radios; every mode is listed and described; more information about Federal than exists in any other single spot!, good quality printing - \$6.25 including S&H. Larry Babcock, 8095 Centre Ln., East Amherst, NY 14051

FOR SALE: Over (5,000) tubes, many N.I.B. Tony Jones, 3728 Baxter Ave., Nashville, TN 37216. (615) 227-8136

FOR SALE: Zenith Model N-825 in good condition - \$35 + shipping. Denton Lahner, 116 N. 4th St., Reading, PA 19601

FOR SALE: Zenith 6D312 - \$175. Zenith 6D311 - \$165. Motorola 53H, grey - \$65. Crosley 56TD, ivory - \$125. New spring radio photo list - \$1 + LSASE 2 stamps. Bob Masterson, Box 172, Valley Cottage, NY 10989. (914) 353-3151

FOR SALE/TRADE: Portables: Federal 102 - \$895. Kennedy III - \$875. Radiola 26 with battery box - \$750. RCA P31 - \$275. Quality sets. Plus shipping. Ed Bell, 5311 Woodsdale Rd., Raleigh, NC 27606. Fax/phone: (919) 851-1517

FOR SALE/TRADE: Vogue 9 3/4 in. picture record songs: Doodle Doo Doo & All I Do Is Wantcha by Art Kassel & orchestra. Richard Arnold, Box 275, Lone Grove, OK 73443. (405) 226-5626

FOR SALE: Kennedy X in V cabinet, gold - \$500. Vocolar type horn, maroon color - \$950. Floyd A. Paul, 1545 Raymond Ave., Glendale, CA 91201. (818) 242-8961

FOR SALE: Books. Technical Television, 1962, Prentice Hall; Electronic Designers Handbook, 1957, McGraw-Hill - \$10 ea. Everybody's Radio Manual, 1942, Popular Science - \$5. Handbook TV Repair 1957, Fawcett - \$3. All plus postage. John Martin, 111 Bancroft, Rochester, NY 14616. (716) 663-4182

FREE - 20 WORD AD EACH MONTH

To get your free 20 words,
include your SUB# with your Ad.
Additional words are 25¢ each.
Read inside back cover for details.
MANY THANKS!!!!

FOR SALE: Western Electric D-86326 rare tennis ball tube, in original box, unused, good filament circa 1929 (see 75 Years of WE Tubes, p. 122); WE 205-D tennis ball, used, but filament checks good; Radiotron UV-201A with tip seal, brass base, filament good, believed unused, has Westinghouse Lamp Co. logo on the glass, circa 1920 (see 70 Years of Radio Tubes, p. 20), Knight detector and amplifier, no other ID, 4-pin Bakelite base, ST envelope, magnesium getter, filament good, believed unused. Probably an 01-A clone. Best individual offers by April 30. Will ship per your specification at your cost. Steve Shepard, 6313 Mendius, NE, Albuquerque, NM 87109. (505) 857-0199

FOR SALE: Table radios: Detrola light wood Deco - \$75; Crosley 11-100U - \$140; (2) Airline (Belmont) 04BR-508A - \$95 & \$65; RCA 8-X-541 - \$25; RCA 8-X-542 - \$25. Belmont 6D111 Series B - \$125. Fairbanks-Morse Model 57 - Best Offer. Miscellaneous: Tektronix solid-state oscilloscope T 912 - \$150 OBO. Seeburg wallboxes 160 select curved glass - \$150. 1940's (20) select WS-2Z - \$100. Wurlitzer 3031 (24) select excellent - \$250. Mark Miller, 3899 Woodman, Troy, MI 48084. (810) 649-6108. E-mail: 71241, i106@compuserve.com

FOR SALE: Lots of used original parts used in home brew battery sets. Honeycomb coils, tube sockets, controls, wire and more. Sell by the lot. Elwood Hunt, 308 Georgetown Rd., Carneys Point, NJ 08069. (609) 299-5259

FOR SALE: High end transistor radios. Many Japanese reverse plastic, most are excellent or N.I.B., call or write for list. Marty Bunis, 32 West Main St., Bradford, NH 03221. (603) 938-5051, before 8 pm EST. Fax: (603) 938-2430

FOR SALE: Clearing out my battery table radios. Wood-
en coffin-type cabinets, Freed-Eisemann NR-5 - \$70;
NR-7 - \$85, both have front panel, cracks, otherwise
good. Airline Enchanter 5-tube TRF - \$75. Steinite 7-
tube one-dial AC Model - \$80. All plus shipping - heavy.
Maurer TV, 29 So. 4th St., Lebanon, PA 17042. (717)
272-2481

FOR SALE: Mint test equipment: Hickok 125 VTVM/
manual - \$35. Heathkit LG-1 signal generator/manual.
Heathkit AC-VTVM/manual - \$20. Simpson 630, 650
VOM. Triplett 600 Series manuals - \$5. Simpson 200,
300, 400 Series manuals - \$5. Bill Coolahan, 1450
Miami Dr. NE, Cedar Rapids, IA 52402-2933. (319)
393-8075

FOR SALE: Airline 4-tube small portable, Model 84GCB-
1062A, red & tan, works, good - \$35. Erla 7-tube
chassis with 8 1/2" Jensen speaker, model unknown,
doesn't work - \$15. All plus shipping. Raymond Hum-
phreys, 1044 N. Jackson St., Macon, MO 63552. (816)
385-2821

FOR SALE: Used tubes 1U4, 1U5, 3V4, 5U4GB, 6CG7/
6FQ7, 6EU7, etc. Offers plus shipping. Gregory Shep-
pard, KA3DBG, 4402 Jupiter St., Rockville, MD
20853-3255. (301) 946-6460

FOR SALE: Military manuals ART-13 - \$25. TCK, RAK,
SCR-508 & 608 - \$20. All originals. Steve Finelli, 37
Stoncroft Dr., Easton, PA 18045. (610) 252-8211

FOR SALE: Knight-kit Star Roamer - \$35. (170) new
TV tubes - \$95. Shipping extra. Steve Whited, 3637 W.
71st St., Indianapolis, IN 46268. (317) 298-9967

FOR SALE: Plastic reproduction dial covers for AK 145,
337, Arvin 544, Belmont 6D111, Emerson AE 165, AU
190, 400, 520, USA, Fada 1000, 5F60, Philco 39-30,
Zenith 8G005 and hundreds of others or will make you
one - \$14.50 ea. ppd. Doyle Roberts, HC 63, Box 236-
1, Clinton, AR 72031. (501) 745-6690

FOR SALE: Emerson plastic table radio Model 157,
two-tone black case, ivory front, nice - \$150. Mag-
navox Micro transistor radio Model AM-803, mint w/
presentation case and box - \$100. Sharp transistor
radio Model TR-180, turquoise, six transistor with special
magnet attachment - \$100. World War II Signal
Corps U.S. Army radio receiver BC-342-N with LS3
loudspeaker - \$125. Bill Constantine, PO Box 493,
Glens Falls, NY 12801. (518) 792-7065

FOR SALE: Univox tube guitar amp #U-45B, 1965-7 w/
12" Jensen spkr - \$95. Satchell-Carlson unitized TV
#C102, 15", gold-white - \$60. Arkay audio amp #FL10
w/2-6V6 - \$35. Philco 490-605 portable alligator finish
- \$55. Cobra CB belt buckles - \$5 ea. Babcock R/C
transmitter BC-21, 1950's, N.O.S. - \$20. Grundig-Ger-
man misc. new 45 rpm and thin spindle adapters, whole
box - \$20. 7-inch reel-to-reel tapes, stereo prerecord-
ed, box of 20 - \$100. Home recorded from TV/records
1958-1973, box of (52) - \$70. All plus UPS. Kevin and
Kathy Moe, 616 Lockrem St., Ottawa, IL 61350. (815)
433-4598

FOR SALE: Radio TV Receiver Troubleshooting, Ghirardi;
Victor classical record catalog, 1912; Radio Handbook
1946. Curt Brohard, 1417 Court St., Alameda, CA
94501. (510) 521-4299

FOR SALE: Large collection. All categories. LSASE for
list. WANTED: Catalogs, any subject. Steve Blank, 407
Hamilton Ave., Linwood, NJ 08221. (609) 926-9277

FOR SALE: Shure Bullet microphone, Mod 520 SL, 1950-'51, brushed aluminum mounted in olive green base, near mint - \$55 plus S&H. Jeff Hoskins, 824 E. Madison Ave., Stuart, FL 34996. (407) 283-2291

FOR SALE: Arvin Model 540-T green metal set - \$75. Emerson Model 520 Catalin radio - \$150. Crosley left bullseye Model 11-19U, blue crack - \$70. Remler Model 5400 Scottie radio bottom crack - \$110. Bob Furtado, 23 Garden Rd., Alameda, CA 94502. (510) 521-3084

FOR SALE/TRADE: 1960's Ampeg all-chrome guitar amp Mod #B-15N w/15" chrome-plated speaker - \$400. Mills jukebox amp Mod #MCP 2802-A - \$200. Larry Drago, 383 Lincoln Dr., Cheshire, CT 06410. (203) 272-6030

FOR SALE: Regency TR1 with case and earphone, mandarin red, no cracks, some wear on volume control knob - \$600 OBO. **WANTED:** Two round brass rings for Philco 38-10 or similar 38 Series. Snaps on tuning escutcheon. C.K. Bucy, PO Box 16583, Lubbock, TX 79490-6583. (806) 792-1662, (806) 795-5853

FOR SALE: Magnificent European tube-style receivers. Models available in Saba, Telefunken, Nordmende, Blaupunkt, Philips, Grundig. Details upon request. Harman-Kardon 70W stereophonic tuner/amplifier TA-7000-X. **WANTED:** Buyers in Japan/Far East interested in fine European radios. Lower prices. Wanted knobs for Sony CRF 5090/5100. John Sarkies, 75 Breakwater Shores, Hyannis, MA 02601. (508) 771-5955

FOR SALE: Midola regenerative receiver, three WD12 tubes - \$300. Armstrong SR-8 portable, 1926 - \$150. Brunswick Model PR-6 Panatrop and Radiola console, AC, instruction manuals, bound record albums - \$600. Many others, send SASE for list: Charles Chapman, 1357 N. Broad Creek Ln., Stafford, MO 65757. (417) 736-2772

FOR SALE: Radiola 20 NT - \$145. Radiola AC NT, near mint - \$250. The following wood table models - \$20 ea. All as found unchecked: Minerva W119, RCA RC608, Westinghouse H157, set. Carlson airplane dial, Philco 46-421, Coronado 1682 & 686 (oval dial), Emerson ED354. The following N.I.B. tubes \$1 ea.: 1T4, 1T5, 1U4, 1U5, 1V2, 3LF4, 3Q5, 3S4, 1A4, 1A5, 1A6, 1B5/255, 1C5, 1C7, 1D8, 1E7, 1F5, 1G6, 1H5, 1H6, 1J5, 1L4, 1LA4, 1LH4, 1LN5, 1N5, 1Q5, 1R4, 1R5, 1S4, 1S5. The following at prices indicated: 12A - \$20; 15 - \$10; 19 - \$2; 22 - \$5; 30 & 31 - \$3; 34 - \$1.50; 40 - \$12; 49 - \$6; X99 - \$25; 83 - \$12; 807 - \$6; 6146 - \$5; 6BG6 - \$3; 5U4G - \$12; 6A4 - \$3; 6A6 - \$2.50; 6B5 - \$12; 84/6Z4 - \$3; 79 & 89 - \$1.50. Joe Svihel, 17227 Co. Rd. 54, Avon, MN 56310. (612) 356-7601

FOR SALE/TRADE: Precision Apparatus Co. tube checker Model 912 - \$25. IRC volume control kit, lots of parts in boxes - \$50. Ohmite and Westinghouse calculators - \$6 all. Colman radio dial cord - \$5. 1 lot of 9 transistor radios - \$140. Send for or ask for list. Will trade for Zippo lighters or obsolete lighter fluid cans. Don Brewer, 4901 56th Way N, St. Petersburg, FL 33709, 8 am-10 pm EST

FOR SALE: Radiola 60, 812 portable - \$200 ea. Rider manuals 9, 10, 11, 12 - \$15 ea. Ray Miner, 1215 Ave. B, Ft. Madison, IA 52627. (319) 372-1271

FOR SALE: Conn. Telephone and Telegraph, circa 1922, J-117 vacuum tube designed by Harold Donly for the JR-3-2 radio receiving set (resembles large brass and glass hypodermic needle) with Bakelite knob, rare and unique collector's piece - \$450. Send SASE for Western Electric tube list to: Larry Drago, 383 Lincoln Dr., Cheshire, CT 06410. (203) 272-6030

FOR SALE/TRADE: Western Electric 86C amp, fair shape, untested, trade for HRO, AR-88, or antique radio of equal value. Or will sell for best offer. Jon Chamberlin, 1458 Wilderness, Maumee, OH 43537. (419) 893-1737

The "Radio Collector" Video

Writer-producer Mike Adams and the Perham Foundation Electronics Museum are pleased to present the original, best-selling PBS series, "Radio Collector". Nominated for an Emmy, Best Information Series, "Radio Collector" is now available complete and uncut. All five half hour shows have been newly duplicated from the original broadcast masters.

Order the Popular VHS
Videotape "Radio Collector"
Directly From
the Perham Foundation!



Writer-producer Mike Adams

You'll meet dozens of collectors and experts, see hundreds of radios made between 1900 and 1960, plus you'll learn about radio restoration!

Send \$29.95 plus \$3.00 S&H to:
Perham Foundation,
101 First Street, Suite 394,
Los Altos, CA 94022

For more information,
call us at 408-734-4453
Proceeds support construction
of our new museum!

FOR SALE: Yaesu SP901P speaker, phone patch, excellent condition - \$100 OBO. Jim Shoemaker, RR#1, Box 118A, Prescott, KS 66767. (913) 471-4644

FOR SALE: Really nice National NC-140 receiver - \$75. Complete set of Philco 38-116 tubes and shields - \$35. Vg National SW-3 complete dial/knob unit - \$20. Ron Merrell, 10701 W. 54th St., Shawnee, KS 66203. (913) 268-5973, until 6 CST, then Fax: (913) 268-0461

FOR SALE/TRADE: Grebe CR9, nice. **WANTED:** CR13, DA2, Paragon detectors UX213, pre-1940 ham transmitters. Stuart Mount, K2OA, 35 Grand, Highland, NY 12528. (914) 691-7957

FOR SALE: Tubes: 6EU7 - \$9. 6EV5 - \$5. 6F5M, 6F5GT - \$2.50. These are all N.O.S. military stock. Volume discount available. SASE for complete tube list. Kirk Cline, 1818 Walker Ave., Greensboro, NC 27403-1760. (910) 379-7197

One Month Free!

BONUS FOR EARLY RENEWALS

If you renew before the month shown on your mailing label (your expiration month), you will receive an extra month on your subscription: 13 months instead of 12! 26 months for an early 2-year renewal!

FOR SALE: VG working: Delco R1140, Philco 46-350, Zenith 7S657R, 4K035, Pilot T511, Federal 1030T. Need work: Firestone S7400-2, AK #20 + 2nd chassis, Radiola #18, Philco 38-4, Emerson 560, DM-331 Ingraham, Silvertone 8220. John Goller, K9UWA, 4836 Ranch Rd., Leo, IN 46765. (219) 637-6426

FOR SALE: B&D kit set, 4R in exc cabinet - \$95. Weston lab-type mA meter, heavy! - \$35. Philco port. tube-type 52-641 - \$25. Eico transistor tester, N.I.B. - \$15. Emerson 840 portable, 4-tubes - \$20. Zenith A400 4-tube portable - \$25. Western Electric Inverted Converter - \$30. 5-tube home brew in nice cabinet - \$60. All plus S&H. Please call before 9 pm. Wally Worth, 2 W. Elm Ave., Wollaston, MA 02170. (617) 479-4512

FOR SALE: Philco 40-180 chassis and knobs - \$35. Radiola 111 box only with decal - \$25. Zenith portable phonograph, 16-33-45-78, hums, X-508 - \$45. IASCO 2-transistor radio, Minneapolis, Mn., assembled in box - \$25. Heathkit Jr. Electronic Workshop, 1967, missing speaker - \$35. Car radios (BO): Pontiac, 5 PB, 12v, Super Deluxe 989614-2089-VK; Chevrolet 12-volt; Chevrolet Straight Line Tuning, 5-PB; Mercury, FoMoCo 12V, 8TBM, 5 PB; Chevrolet, Delco, all transistor. Thanks. Del Tysdal, Box 157, Glyndon, MN 56547. (218) 287-2562

FOR SALE: Grundig Satellit 700, like new - \$295. Zenith Trans-Oceanic Royal 1000D, excellent - \$95. Sanyo RP-8880, mint, manual - \$150. Zenith 6-band "The Continental", as is, needs repair - \$20. All plus shipping. Gerald Silver, 10863 W. Clairmont Cir., Tamarac, FL 33321. (305) 720-1972

FOR SALE: Motorola 56B1, brown, funky '50's styling, looks good, not working - \$10 plus UPS. Michael Dalzell, 5073 Winfield Ct., Bensalem, PA 19020

FOR SALE: Tube ham gear, tube hi-fi gear, sweep tubes, spherical Audion, send wants. V. Vogt, 2311 Pimmit Dr., #114E, Falls Church, VA 22043

FOR SALE: Transistor reduced prices. Motorola, 6X31-R, orange - \$35. Motorola, 6X32E-1, dk. gray - \$50. Bulova-Comet 620, ivory - \$100. RCA Victor 9BT9E, ivory - \$60. Lefco hi-fi 8, red & white, (like Cambridge in Lane & Lane) - \$70. RCA Victor, ITP3E, white with Nipper logo - \$45. GE, P745A black, excellent, with case - \$20. GE P800A, white, excellent - \$50. **WANTED:** (2) transistor and boys radios! What do you have? Gary Willoughby, 5930 W. Jefferson Blvd., Los Angeles, CA 90016. (310) 559-0706

FOR SALE: Met-Vic. Cosmos 5-tube VS6 oak Jacobean lowboy, rare - \$2,800. Brit. Navy B11 receiver, 1930, 5-tube, plug-in coils, h/book - \$580 plus UPS. (3) WWII German naval flags, trade for Colonial Globe, Walton, rare Catalans. Jim Taylor, G4ERU, No. 5, Luther Rd., Winton, Bournemouth, BH9 1LH, United Kingdom. Tel./Fax: 01202-510400

FOR SALE: Atwater Kent 555, untested - \$325 plus UPS. **WANTED:** Radio Boys Chapman, To the Rescue. Jerry Katz, Aborn True Value, 438 Harvard St., Brookline, MA 02146. (617) 277-4533

FOR SALE: HQ-160 - \$300. SX42 - \$250. NC-88 - \$200. NC-33 - \$175. Trans-Oceanic 3000 - \$200. Wayne E. White, 5267 Arcadia Ct., Las Vegas, NV 89118. (702) 871-0754

FOR SALE: Complete Heath Zenith H-89A computer, floppy drive, printer, extensive software and more. Paul T. Kwiatkowski, W9IEY, 4708 W. County Line Rd., Grant Park, IL 60940. (708) 258-6274

FOR SALE: Crystal radio kits, complete with face panel and baseboard, 365 variable capacitor, large prewound coil, and many other parts for an old style crystal radio, remit - \$19.50 plus \$3 shipping. Car & Grace Ent., 5636 Romeyn, Detroit, MI 48209

FOR SALE: Eveready Model 21 near mint condition, electronically restored - \$225. Hanley Burke Puretone Six (1926?), unusual, rare, original electronics, cabinet nicely refinished - \$150. All above less tubes plus shipping. Ed Mondor, 121 Gateway Dr., Greenville, SC 29615. (864) 268-0952

FOR SALE: Zenith Trans-Oceanic B600 - \$90. RCA tombstone sim. to T8-18 - \$70. National NC60 special - \$35. Fisher 800B - \$75. Charles Votig, 94 Cleveland St., Norfolk, MA 02056. (508) 528-7928

FOR SALE: Silvertone radio/phono/wire recorder console - \$25 pickup only. **WANTED:** Hickok 533A manual. Walt Kieffer, 6233 51st Ave. NE, Seattle, WA 98115. (206) 526-1452

FOR SALE: Tombstone, GE E-61 - \$75. RCA 6C5 clock radio, new - \$25. Zenith Royal 16 transistor - \$10. Zenith J723 clock-radio, cracked - \$10. Cromwell portable record cutter, player - \$50. Air Chief, battery set, 378-S-7428 - \$25. Camera collection, approx. (30) old cameras, flashes, bulbs, etc. - \$125. All plus shipping. Guy Forstrom, PO Box 159, Quinnesec, MI 49876. (906) 774-8116

FOR SALE: Automobile radio vibrators. Free catalog. See our boxed classified ad. Dan Schulz, Antique Automobile Radio Inc., 700 Tampa Rd., Palm Harbor, FL 34683. (800) 933-4926. Fax: (813) 789-0283

FOR SALE: Plug-in can capacitors (33-33mFd, 350v) with mounting sockets - \$10/4 ppd! Bob Putnak, 1507 4th St., Monongahela, PA 15063. (412) 258-6236

FOR SALE: Used once, Heathkit Model CO-2600, 12" solid-state deluxe ignition analyzer with accessories - \$475, pickup only. John Nosbaum, 2743 Wilmette Ave., Wilmette, IL 60091-2273. (847) 256-0547

FOR SALE: Zenith lunch box transistor radio chassis 7AT44Z1; Star-Lite 5M-A2 plastic tube radio; HP 400D VTVM, 1000pF, 3000v vacuum variable; PK-88 with HX-1000 computer, Heath 2M amp HA-201A - Best Offer or Trade for 900MHZ scanner. Bud Machado, AA6HL, 4110 Crestview Dr., Pittsburg, CA 94565. (510) 493-7143

FOR SALE: B&K 960 transistor radio analyst - \$35. Regency TR99 - \$150. Bulova 672, with presentation case - \$75. Motorola X25E - \$50. Zenith Royal 300Y - \$65. Hitachi TH-862R - \$50. Channel Master 6509 - \$40. Rod Galloway, 2220 Woodbury Rd., Melbourne, FL 32935. (407) 254-0280

FOR SALE: Sams dial cord drives DC1 - \$15; DC 2, DC 3, DC 4, DC 5, DC 6 and DC 8 - \$10 ea. J.J. Papovich, 53 Magnolia Ave., Pitman, NJ 08071

FOR SALE: Mouse Music, novelty computer mouse FM radio with auto scan tuning, N.I.B., only six left, cute and play great - \$28 each includes S&H. Jeff Hoskins, 824 E. Madison Ave., Stuart, FL 34996. (407) 283-2291

FOR SALE: Isolation transformer, heavy duty, new - \$40 plus UPS. C. Hill, 6934 Orion Ave., Van Nuys, CA 91406. (818) 787-0376

FOR SALE: Dumont 164E, 3 in. o'scope, vg, new handle and power cord, manual - \$50 plus UPS. Ray Harland, 2602 Mary Ln., Escondido, CA 92025. (619) 746-4584

FOR SALE: Marconi Wireless Telegraph Company of America temporary stock certificate, dated 1912, orange, no vignette, cancellation holes, rubber stamp "cancelled" - \$30. Milt Faivre, K4EBT, 1445 2nd Rd. SW, Vero Beach, FL 32962. (407) 778-0648

Wanted

(Top Prices Paid)

1. Western Electric Tubes, Amps, Drivers, Horns, Speakers, Parts, etc.
2. Tube-type amps from Marantz, McIntosh, ARC, Quad, Leak, Dynaco, Fisher, etc.
3. Telefunken audio tubes & KT-66/77/88, etc.

Also Wanted... Vintage watches from Patek Philippe, Vacheron Constantin & Audemars Piguet

David Yo — Audio City USA
PO Box 80371
San Marino, CA 91118-8371
Telephone: (818) 441-3942

FOR SALE: Grand 839 8-trans. coat-pocket w/case, CD markings, Japanese - \$15. Donald Sochurek, W191 S7500 Richdorf Dr., Muskego, WI 53150. (414) 679-0212

FOR SALE: Mitchell Wireless Intercommunicator Model 1415, pair, some chips, look good and work - \$115 pair. Music Master VIII 50207A wood speaker - \$225. Rola 30 cathedral speaker - \$200. Both look good, small hole in grille cloth. All plus UPS U.S.A. Ken Armstrong, Box 216, Storm Lake, IA 50588. (712) 732-3012

FOR SALE/TRADE: The following National communications receivers National NC 100A - \$425. HRO M. - \$400. HRO 500 - \$825. HRO SR, prototype, built by National engineer Samuel Samoune in 1938 w/prototype PS, speaker and manual - \$650. F-B-7 w/3 sets coils - \$500. Larry Drago, 383 Lincoln Dr., Cheshire, CT 06410. (203) 272-6030

FOR SALE: Emerson U6D Ingersol cabinet - \$150. Philco 89 121 chassis, needs cloth - \$150. Owl transistor novelty - \$60. GE 145 - \$30. Radiola 61-8, no back - \$30. 2X621 Victor - \$35. S-94 Hallicrafters civil patrol - \$30. Knight KG221A FM receiver - \$25. Motorola 56L1 - \$30. (2) Sky Champions - \$100. **WANTED:** Back to Emerson 520, Zenith 6-D-317, 3-tube shield caps for Midwest 1 5/8 dia., Jackson Bell mirror radio. Robert White, 4077 E. Galbraith Rd., #379, Cincinnati, OH 45236. (513) 984-3812

FOR SALE: Consoles: GE H-87 nice cabinet, plays - \$85. Zenith H-1086 radio-phonograph, excellent cabinet, plays - \$45. Philco 39-80 battery farm radio - \$50. Truetone D-1846 radio-phonograph, rough - \$10. Firestone Airchief S-7404, no speaker - \$15. Table models: GE F-74, nice cabinet - \$50. Philco 41-255, rough - \$25. Delco 6-6011 farm radio, no speaker - \$25. Must pick up, phone first, evenings. Gary Carlson, 130 Terrace Dr., Dekalb, IL 60115. (815) 756-2779

Introducing Exciting New ZENITH Grille Cloths



Authentic reproductions
based on original patterns
using original materials



- Zenith block and swirl patterns for 1938 shutterdial consoles and Walton tombstones are available NOW!
- Zenith leaf pattern from 1938 consoles such as the 6-S-362 is available NOW!
- More Philco patterns available than anywhere.
- 20 additional patterns for GE, RCA, Emerson, Stromberg are also available.
- Satisfaction or money back guarantee.
- Free installation instructions with every order.

Now on the World-Wide Web at
<http://www.libertynet.org/~gricloth/>

John Okolowicz, N3VSR
624 Cedar Hill Rd.
Ambler, PA 19002

E-mail: 70313.2564@compuserve.com

FOR SALE/TRADE: Crosley Pup w/original tags, labels w/WD-12 tube - \$750. Addison Catalin Mod 5 in ebony black w/butterscotch marbling, vertical bars and knobs, beautiful flawless condition - \$2,000. Stewart-Warner Ivory Mod A-51T3 binocular-style radio w/vertical bars - \$285. Larry Drago, 383 Lincoln Dr., Cheshire, CT 06410. (203) 272-6030

FOR SALE: Loewe 3NF tube, one good filament - \$150. AK Model G horn - \$180. (2) wooden variometers - \$40. Knob for DeWald A-501 - \$30. Supreme 592 tester, leads and manual - \$40. Eico 147A with manual - \$40. Heathkit AD1013 audio scope with manual - \$35. Transistors: Boys radio, red and gold - \$35. Liberty Bell, no battery cover - \$25. (2) Emerson 899, black and white, exc cond. - \$50/both. Gerald Kitchens, 116 E. South, Oreauna, IL 62554. (217) 468-2540

FOR SALE/TRADE: Drake C Ling, .25, .5, 1.5, filters, MS. 4AC-4. Viking II, VFO 122. Ray Williams, WA0UKJ, 4521 Whitfield Ln., St. Louis, MO 63134-3821. (314) 428-1963

FOR SALE: Stock certificates. Sentinel radio, Admiral, American Cable & Radio, Television Industries - \$15 ea. Gerald Schneider, 3101 Blueford Rd., Kensington, MD 20895-2726. (301) 929-8593

FOR SALE: RCA tombstone, plastic - \$95. Elgin 1886, Silverine watch - \$165. Pickup only. Dewey Shaffer, R.D. 2, Box 104-B, New Paris, PA 15554. (814) 839-4728

FOR SALE: Icom R-71A rcvr, mint - \$500. Shipped con. U.S. Joel Levy, 8 Waterloo, Morris Plains, NJ 07950. (201) 285-0233

FOR SALE: Rider's Radio Manuals 1 thru 23, all excellent to as new - \$500, will not ship (too nice to chance it). John Snow, W9MHS, 4539 N. Bartlett Ave., Shorewood, WI 53211. (414) 964-0194

FOR SALE: DeWald K701B transistor, 1st year, 2-tone green, excellent, works - \$300. Dennis Hoffman, KW9G, 3519 Hoffman Rd., Chippewa Falls, WI 54729. (715) 831-1855, evenings. E-mail: hoffman@edp.net

FOR SALE: LSASE for list of new/used receiving tubes; octal, loctal, miniature, some older. Sell or trade for old or unusual tubes or related material for my collection. John H. Walker, Jr., 16112 W. 125th St., Olathe, KS 66062. (913) 782-6455

FOR SALE/TRADE: Crosley 66T, white, vg - \$49. Philco 42-350, vg - \$75. Zenith 6D030, vg - \$45. Bob Fuerderer, Holly Farm, 813 Rt. 12A, Surry, NH 03431. (603) 352-3005



WANTED

Amrad 3670 as shown, any condition. Also a Type E crystal set, 3500-2 and other pre-1926 Amrad sets & parts.

Andrew Mooradian, 5 Priscilla Lane
Winchester, Massachusetts 01890
tel. 617-729-1873 after 7 pm

FOR SALE: Large PA/music amps. (3) Schulmerich Mod 6-123A's mono blocks - \$75 ea. and (4) Mod 6-118B dual mono booster amps - \$125 ea. All have massive xfms 6L6G outputs. Untested. Schulmerich chime unit with paper roll player. Charles D. Blair, 815 N. 5th St., Cambridge, OH 43725. (614) 432-4453, 9-5

FOR SALE/TRADE: Two 1950's Rek-O-Kut mod # Rondine L-34 12" turntables w/bases in fair condition - \$325/both. Thorens Mod T.D. 124 turntable - \$295. Altec 418B 15" speaker - \$200. (4) 15" Stromberg-Carlson chrome-plated woofers - \$400. Larry Drago, 383 Lincoln Dr., Cheshire, CT 06410. (203) 272-6030

FOR SALE: Zenith Sights & Sound schematics & (3) tapes. Sams Photofacts 1-1789. Ann Bichanich (Jay's), 15 1/2 W. Lake St., Chisholm, MN 55719. (218) 254-4421

FOR SALE: McIntosh MC-117 stereo receiver, tubes, mint - \$250. Mc-2505 amplifier - \$425. AR turntable - \$200. AR turntable, parts, etc. Mike Russ, 20147 Road 192, Strathmore, CA 93267-9787. (209) 568-0345, Sundays

FOR SALE: Dumont 15" TV/AM/FM/phono console - \$125. Pickup only. P. Seidel, 30 Vista Way, Port Washington, NY 11050-3807. (516) 767-0948

FOR SALE: Booklet National Union Radio Guide, radio log & radio star photos - \$10. Danny Thornton, 1175 Springdale Cir., Spartanburg, SC 29303. (864) 578-8518

FOR SALE: Garod Peaktop, yellow with red trim - \$1,200 BO. Crystal set Prov., R.I., William w/e.p.'s - \$200. Ed Kendall, 679 Westhampton Rd., Northampton, MA 01060. (413) 586-3390

FOR SALE/TRADE: RCA Model 140 - \$250 OBO. Roy Johnson, 2307 Palm Beach Ave., Pittsburgh, PA 15216-3421. (412) 343-3032

FOR SALE: Gilfillan Models: 55C, near mint - \$75; 56E, very good - \$30. Plus shipping. Larry Hescocck, 549 Silverleaf Dr., Oroville, CA 95966. (916) 589-5612

FOR SALE/TRADE: RCA Victrola TV #8-TV-321 Serial A, for parts \$25. Brunswick Panatropo empty cabinet - \$20 or Best Offers. James D. Love, 69 Handy St., #2, New Brunswick, NJ 08901-2724

FOR SALE: Tubes, N.O.S. and used. Large selection of multisection, twistmount capacitors to 450v. Also, some parts and stuff. Send LSASE for expanded 1996 lists. Turner Electronics, 16701 Main St., Suite 121, Hesperia, CA 92345. (619) 244-7743

FOR SALE: Homemade galena crystal radios and parts. Write for details. L. Gardner, 458 Two Mile Creek Rd., Tonawanda, NY 14150. (716) 873-0447

FOR SALE: Industrial Instruments 3-dial decade capacitor in oak box. Model DK-10, fine - \$32+ UPS. Alan J. Kriss, 1872 Portsmouth Way, Union, NJ 07083. (908) 688-2092

FOR SALE: Zenith Royal 670, not playing, poor condition - \$10. Battery eliminator, not tested - \$10. James S. Looney, Rt. 1 Box 54, Grundy, VA 24614-9705. (540) 531-8677, after 7 pm

FOR SALE: Hammarlund grey metal speaker - \$35. Philco chassis speaker #650 - \$35. McMurdo Worldwide 9 - \$35. Don Reinsma, 610 Nix Rd., Pensacola, FL 32506. (904) 455-7721

FOR SALE/TRADE: Thomas Edison earphones made by Telex - \$50. DeForest D01A in orig. can - \$100. Postal Tel. & Western Union call boxes - \$75 ea. Bunnel Pen reg. missing parts - \$110. Spy Pen radio CC2 Fig. 109A - \$50. Hearerver missile CC2 Fig. 42 - \$75. Air Champ CC2 Fig. 2A - \$50. Carborundum detector unit in orig. box CC2 Fig. 218A - \$75. Van xtal set CC1 Fig. 176 - \$175. Midget pie radio CC1 Fig. 91A - \$160. American Leader CC1 Fig. 10 - \$160. Tee-nee Midget CC2 Fig. 115A - \$180. Mercury 7 Astro crystal radio - \$75. Various Kent crystal sets in orig. boxes - \$65 ea. Pee Wee crystal set CC1 Fig. 204 - \$150. DeForest headphones - \$50. Bob Fuschetto, 1758 Michael Dr., Whitehall, PA 18052. (610) 435-8944, call bet. 7 & 9 pm

RATE FOR ADDITIONAL WORDS:

25¢ per word

FIRST 20 WORDS FREE!

Cash or stamps OK for small amounts.

Your payment helps to keep A.R.C. healthy!

FOR SALE/TRADE: Marantz Mod #2 amp - \$1,200. Marantz Mod 10-B tuner, absolutely pristine condition - \$1,895. Knight 60-watt stereo amp Mod 83-YU-777 chrome-plated w/4-EL 37 tubes - \$600. EICO MX99 stereo multiplex autodaptor - \$100. Fisher 500C stereo receiver w/space expander and reverb tank - \$375. Larry Drago, 383 Lincoln Dr., Cheshire, CT 06410. (203) 272-6030

FOR SALE: Tubes N.I.O.B. at 1/2 price. Send LSASE 55¢ postage for list. J.J. Papovich, 53 Magnolia Ave., Pitman, NJ 08071

FOR SALE: Philco chassis Mod 41-287, includes 12" speaker, antenna, knobs, mounting hardware, 9-tube chassis (unrestored) - \$45 plus shipping. Chassis restoration available. Jeff Hoskins, 824 E. Madison Ave., Stuart, FL 34996. (407) 283-2291

FOR SALE: Sterling Deluxe, black and chrome - \$350. GE 114W, white, (Bunis 1, p. 75) - \$45. GrantLine 606-A, white, (Collins, p. 83) - \$150. Zenith R510-R (Bunis 3, p. 274) - \$40. Emerson 652-B (Bunis 1, p. 61) - \$35. Philco 49-902 (Bunis 1, p. 116) - \$35. Stewart-Warner Air Pal, black w/white knobs (Collins, p. 78) - \$135. Bendix 55P3U (Bunis 1, p. 35) - \$45. All radios are in very good or excellent condition. Call evenings before 9:30pm Eastern Time. Mark Chamberlain, 9735 Oxford St., Naples, FL 33942. (941) 591-4835

FOR SALE: Green AK 10 w/tags - \$800. Jewett Super speaker horn - \$150. Radiola VIII - \$125. (6) issues of Service magazine (technical journal) & Philco Round the World Jubilee trade catalog, all for - \$20 shipping included. Gary Hill, 1507 Ridge Ave., New Castle, PA 16101. (412) 654-9335. Fax: (412) 657-8755. E-mail: prsk30a@prodigy.com

FOR SALE: Voice of Music Model 700 reel-to-reel portable, untested - \$10 plus UPS. Jim Clifford, KE4DSP, 108 Bayfield Dr., Brandon, FL 33511. (813) 654-7531

FOR SALE: N.O.S. tubes: 6JE6C/6LQ6, 6JS6C, 6KD6, 6LB6 - \$20 ea. plus shipping. Jim Traynor, 3198 Boudinot Ave., Cincinnati, OH 45211. (513) 662-4344

FOR SALE: AK variometer for early breadboard - \$75. Jim Peters, 983 Chapel Ct. South, Glen Ellyn, IL 60137. (708) 790-9699

FOR SALE: Sams Photofacts still at 50¢ each in lots of 10 plus postage. LSASE for list. John Snow, 4539 N. Bartlett Ave., Shorewood, WI 53211. (414) 964-0194

FOR SALE: Panasonic R-72 Toot-A-Loop transistor. Fluke 710-A Universal impedance bridge. Phone only! Glen Richie, WAJGO, 643 Diamond Rd., Salem, VA 24153. (540) 389-3356

FOR SALE: Deco Tom Thumb, untested, needs new linecord, knobs not like pix p. 21 Poster 2, otherwise complete. Trade on very good condition gen. cvrg. rec. or make offer. Philmore Little Wonder crystal radio, N.I.B. - \$125 OBO. Zenith 5S218, (see Bunis 3, p. 257), refinished, slight dial burn damage from pilot lines - Make Offer. Looking for very good SX88 or HQ150. Willard Smith, 1802 13th St., Bedford, IN 47421. (812) 275-5780, evs.

FOR SALE: Radios, hi-fi equipment, Rochola parts; Fada 252 yellow/red - \$850. DeWald harp (brown) - \$475. Bendix 526 - \$595. Garod Commander (yellow) - \$625. Philco signal generator 7070 - \$65. Philco, Motorola, Emerson TV/radio service manuals, all - \$45. RCA tube 211, new - \$75. Bell tuner 2520 - \$25. Bell mono amp 2360 - \$75. H.H. Scott preamp 121 - \$175. Marantz 3300 - \$300. Marantz 8 transformer cover - \$75. Stentorian speakers (Whiteley Electronics-England) 10"/12" - \$300. Futterman (Harvard) H3 power amp - \$1,200. Western Electric theater dual turntable 8-86850, oak - \$1,750. Scott 4130 (FM tuner, 20-tube) - \$850. Altec 515, needs reconing - \$150. Citation 1 - \$190. Scott solid-state tuner 4312, rare - \$375. Master gumball #2 1¢/5¢ - \$325. Rockola amp Model H - \$125. Rockola 1422; title board - \$150. Push-button assembly - \$225. Set color cylinders - \$200. WANTED: Deco radios, parts, hi-fi equipment. Ross Litrenta, 1 Wilton Rd., Eastchester, NY 10709. (914) 337-7176

FOR SALE: Majestic service manuals for 1928-1934, originals or copies. Majestic 55, restored inside & out - \$375 or trade for Majestic or Grunow items. Stromberg-Carlson horn speaker - \$125. Crosley Buddy Boy cabinet, mint - \$100. Silvertone 3551, plus parts set - \$40. Dumont RA346 - \$35. Bendix 526A, brown - \$35. Telechron BH 59 - \$20. GE 62 - \$20. WANTED: Majestic, Grunow & Music Master literature, advertising, etc. Looking for items to buy or steal between Elgin & Rochester at the end of August! Please note my new address! Chip Taylor, PO Box 20625, Bradenton, FL 34203. (941) 745-2893. Fax: (941) 74-4947

FOR SALE: Wide selection of radio books, catalogs, magazines and ephemera. Send SASE for 23-page list. Roger Hart, 4533 Harvard Ave., Montreal, Quebec, Canada H4A 2X3. (514) 483-3857. Fax: (514) 483-6114

FOR SALE: Emerson BA199 (Collins 1, p. 31), crack no back - \$44. Belmont 6D121 (Collins 2, p. 62), plays, needs repaint - \$110. Motorola 53H (Collins 2, p. 94), white, plays scratchy, needs repaint - \$49. Truotone D2210 Deco, curved metal with chrome straps, plays - \$169. Philco woods; 66S (Ramirez, p. 63), 116B (Ramirez, p. 56) cabinet only. Philco 20 chassis, speaker - \$85. For Zenith trade Philco 16B tomstone (Ramirez, p. 45). Bill Timoszyk, 35283 Leon, Livonia, MI 48150. (313) 421-2076

FOR SALE: QST amateur radio magazines, complete years 1947 to 1965, Oct. 1931, Feb. 1936, Jan. 1939, Dec. 1946. (6) CQ misc. issues 1948-1950. Will sell in one lot only. Plus UPS (they are heavy). Tom Zenisek, 3300 1st Ave. NE, Cedar Rapids, IA 52402. (319) 366-3686, days only

FOR SALE: Dud Globe type tubes 01-A, 80, 26, 27 and more - \$2 ea. Elwood Hunt, 308 Georgetown Rd., Carneys Point, NJ 08069. (609) 299-5259

FOR SALE: Admiral console, R/P, 4215-C7, plays, Deco - \$75. Grundig U/S, Consolette, R/P, plays - \$45. Clarion, table model, wood, Model 550, plays - \$40. RCA, table model, R/P, T-80 - \$40. RCA, wood, 117, red dial, half cathedral, half tombstone, plays - \$75. Radiola 17, N/T - \$45. Record players, all wood, table models: Philco 41-RP2, Westinghouse H-122, Silver-tone 6029 - BO. Dynaco stereo, preamp, PAT-4A, AR, tuner, stereo, both solid-state - BO. 1st edition books, Modern Radio Servicing by Ghirardi, IF replacement manual by Meissner - BO. N.O.S. tubes: 5U4GB - \$6; 6AU6 - \$3; 6BG6 - \$4; 6SL7GT - \$5; 12AU6, 12AV6 - \$2; 12AZ7, 12BA6, 12BE6 - \$3; 866A - \$9; modified tubes equal to 1L6 - \$5 ea.; must buy (7). **WANTED:** Escutcheon for Garod, 6BU-1, back for Royal 250, minimum order - \$35 plus shipping. \$100 order on tubes only gets free shipping plus \$10 worth of tubes free. George Stagakis, George's Radio and TV Repair, 1714A 41st St., North Bergen, NJ 07047. (201) 867-9136

FOR SALE: National Standard HRO, mint condition with some minor home brew tube changes in AVC & audio stages. Home brew noise limiter & regulated pwr supply, all contributing to the performance of this receiver. Slide-in coils in orig. wooden case, 80-10M band spread, notebook of schematic oper. inst. & detailed schematics of all modifications plus (2) extra coil racks 15M & vacant. Serious inquiries only. U pay shipping & packing. Rodney K. Schrock, 402 Lincoln St., Somerset, PA 15501

FOR SALE: AK tuning condensers, coils, etc., AK 35, no tubes, as is - \$35 + \$7.50 shpg., SW-3 replacement plug-in coil forms, coil winding data and National SW-3 manual copy - \$4 + \$2 shpg. James Fred, R1, Cutler, IN 46920. (317) 268-2214

300+ STALLHOLDERS
will be exhibiting at the 5th annual

National Vintage Communications Fair

NEC, BIRMINGHAM • UK

• Sunday 5th May 1996 •

— 10.30am - 5pm —

Britain's premier event for buying

VINTAGE
RADIOS,
EARLY
TVS, and
GRAMS
etc. etc.



For further details/bookings:

NVCF, 2-4 Brook St, Bampton, Devon, ENGLAND

Telephone: (01398) 331532

FOR SALE: RCA Victorola Model #711V2 radio-phonograph w/manual, Philco Model #J43271 turntable/shortwave radio w/remote & manual, Zenith Cobra turntable/SW radio, Cornworth Williams pump organ-refinished 12 voices, Stromberg-Carlson Model #41, 612 record changer w/manual, Andrea Model T-VL16 Sharp Focus TV w/manual, (8) boxes of sorted H&S Photo-facts. Into-It Audio, PO Box 680642, Franklin, TN 37068. (615) 790-4905. Fax: (615) 791-0518, call before fax. E-mail: aol@N2iTSorcery

FOR SALE: Zenith 4B-231 bat. set, vg - \$50. Emud T7, exc - \$95. Plus UPS. Dee Mitchell, R.D. Box 325, Dalton, PA 18414. (717) 378-2862. E-mail: dmitch@epix.net

FOR SALE: DeForest 1909 spherical double wing Audion, open filament otherwise in good condition. Moorehead Audion, pat. date 12-7-06, Standard UV brass base, filament good, looks unused, (see Tyne book Saga, p. 171, Fig. 9-10). Will sell both for Best Offer. Herman Fothe, 5292 Tiffany Ann, West Palm Beach, FL 33417

FOR SALE: Telefunken Gavotte 5253WK, AM, FM, SW1, SW2 - \$150. Grundig Majestic 85/USA AM-FM - \$30. Philco Transitone PT-30, AM - \$45. Lang 406 AM - \$35. Zenith 7L05 AM-FM - \$50. All in very good condition. Shipping extra. Simon Sarkissian, 930 Montgomery Ave., Apt. 407, Rosemont, PA 19010. (610) 525-7675, after 7 pm

FOR SALE: Zenith tombstone #807, (E.O.R. 2, p. 211) needs work, needs knobs - \$105 + shipping. Joe Quinn, 30511 Manhasset Dr., Bay Village, OH 44140. (216) 835-8420

FOR SALE: Over (100) antique and rare tubes including DeForest, Western Electric, BB-T, UV base, Globe, foreign, etc. SASE; National SW-3 (Model 1 Version II using 36-36-37 tubes) beautifully restored to as original condition including one set of amateur bandspread coils and one set of general coverage coils. Also included is a professionally made power supply unit with pp 45 audio amplifier for speaker operation (uses SW-5 circuit) - \$550. Millen 90700 Vari-Arm VFO - \$175. Millen 90501 frequency standard - \$85. F.P. Heinemann, 87 Cove Rd., Lyme, CT 06371. (203) 434-7783 or (813) 262-2568

FOR SALE: AK breadboard, playing with tubes - \$675. Contact: R. Whetstone, HC 84, Box 44, Arthur, WV 26816. (304) 749-7295, after 5

FOR SALE: Tubes and parts. Send your wanted list. Ray Schmidt, 607 1 Ave. SW, Austin, MN 55912. (507) 433-0069, daytime. (507) 433-3250, night

FOR SALE: Trophy baseball radio, near mint with tag (RTGA, p. 59) - Offer. Transistors: Realtone TR-1088 Comet, black, case, stand - Offer. Marvel 6YR-15A, black, case, box - Offer. Jaguar 6T 250, black, case - \$65. Airline 1130B, early, blue/white, horizontal, missing trim - \$40. Pearl Tone, early, pink/white, horizontal, case - \$75. Sorrento hi-fi Deluxe, pink - \$40. Admiral Y2229, blue, U.S. mfrd., mint, case, unused in box - \$50. Arvin 6R16, green, U.S. mfrd. - \$55. Westinghouse H652P6, green, U.S. mfrd., horizontal - \$55. Channel Master 6509 pocket, red, stand - \$55. Champion 2 trans. boy's radio, red/white, (MIJ, p. 108) - \$50. Windsor 2 trans., red - \$60. Suntone DeLuxe, cream/white - \$45. Scott Hagerman, 3 Deer Train Rd., Decatur, IL 62521. (217) 692-2373

FOR SALE: .05/1500Vdc N.O.S. military capacitors, 5 - \$1. TH-22/TG terminal telegraph - \$20. TS-510A/U signal generator, not tested - \$40. AN/PDR-27F Radiac set - \$35. Crosley 9-205-M chassis, no knobs - \$7. BC-221-AK frequency meter - \$15. T-1000B AM-FM - \$15. Hammarlund BC-787/B and RA-74-D power supply - BO. GE wall display for boxed tubes, 2 sets - \$50. Brass horn for cylinder record player, dents, 3 feet long - \$50. N.O.S. Schemat-A-Kit hi-lo switch from early 1960's, Sem-Tek Manufacturing - \$5. WANTED: Radio chassis for Little Giant mini-cathedral, any info; crystal detector, headphones, current squared meter for Kolster Type D decimeter wavemeter; manual for EICO 1030 power supply; chassis and back for Magnavox AM-60 transistor; good speaker for Philco 70 grandfather clock. Any help greatly appreciated! Michael Crain, 3 Hillside Ave., Harveys Lake, PA 18618-9782. (717) 639-2794. E-mail: mcrain1952@aol.com

FOR SALE: Farnsworth CK-74 Bakelite bezel & glass dial - \$10 ea. plus shipping. Other unit parts available. Kevin Potter, 638 N. 9th St., Santa Paula, CA 93060. E-mail: us66kix@west.net

**HAVE YOU MOVED? ARE YOU MOVING?
PLEASE NOTIFY US A.S.A.P.
SEND US YOUR...
OLD ADDRESS
NEW ADDRESS and
SUB #
MANY THANKS!!!!!!**

FOR SALE: Pet Boys radios, N.I.B., mint - \$125 ea. inc. shipping; red, green, ivory or black, trade for Dynakit stereo 70 amps, rusty units or missing PC boards OK, also parts. Dan Steele, 2300 Broad St., San Luis Obispo, CA 93401. (805) 543-2946, 7:30 am to 5:30 pm

FOR SALE: All items N.I.B. Signal Electric sounders Type 113-S. TI calculators, TI-2510 & TI-1500. Allan Haasken, 8422 Berea Dr., Vienna, VA 22180. (703) 560-4869

FOR SALE: Allied's Radio Data Handbook, 1943 - \$40 ppd. Clarion AC-40 cathedral cabinet - \$45 + UPS. Darrell Combs, 6587 Pacheco Way, Citrus Heights, CA 95610. (916) 969-0635

FOR SALE: Two RCA 7581A tubes, N.I.B. - \$45 ppd. Rider's Auto Radio Manuals: Volume 1A, Ford, Lincoln, Mercury; Volume 3A, Chevy, Pontiac, GMC, 1950-1954, both for - \$50 ppd. Howard W. Sams Automatic Record Changer Manuals Vols. 1 to 8, Vol. 3 missing, most 1st edition, includes wire and tape recorders, all for - \$115 ppd. Sams Auto Radio Manuals, Vols. 1, 3, 5, 7, 16, 17, 18, all for - \$125 ppd. Most 1st editions. Maurer TV, 29 So. 4th St., Lebanon, PA 17042

REPLACEMENT DRIVERS FOR ATWATER KENT HORNS

Driver w/housing for Model M & Pooley horns (this assembly replaces all pot metal) \$65.75 + \$4.75 s&h

Driver w/repair ring for Models G, H, & L (repair ring replaces threads in base) \$59.85 + \$4.75 s&h

All drivers above include diaphragm, gaskets, spacer, and spring. All parts are also sold separately. Send SASE for price list.

M. Harold Ezzone, 4861 Park Drive
West Des Moines, IA 50265 — (515) 221-9447

FOR SALE: Johnson Viking 275W matchbox Model #250-23 - \$150 plus shipping. Steve Slater, 3045 Orange, La Crescenta, CA 91214. (818) 248-0416

FOR SALE: (159) Radio News, July '25-Dec. '42 library bound vols., good cond. SASE for list. Radio Relics, 15556 Sandra Ln., Sylmar, CA 91342. (818) 364-0491. Fax: (818) 367-1442

FOR SALE: 1939 Radio and TV Retailing; 1987 Broadcast Electronics equipment catalogs; 1940 RCA Redbook; Heath GR91 communications receiver; Fisher 400 receiver with paper. WANTED: Gordon Hastings FM receiver, Pilot T500U radio. Charles Harper, 2000 Jackstown Rd., Paris, KY 40361. (502) 769-0404

FOR SALE: Table radios, tubes, parts, paper. Total list for LSASE. Eimac tie or lapel clasp - \$20. Orphan Annie coder/decoder pin - \$50. Surprise rad o - \$25. 1 ship. Tubes used, tested: 5U4G - \$5; 6L6GA - \$7. Sema-phone to Satellite hardback - \$75. WANTED: Dial stringing guidebooks 5, 6, 7. 49er helmet radio and/or clock. FOR TRADE: My Zenith Trans-Oceanic RD7000Y1 for 7G605. Stan Lopes, KB6LGV, 1201-74 Monument Blvd., Concord, CA 94520. (510) 825-6865. E-mail: splopes@aol.com

FOR SALE: (150) tube and transistor books, catalogs, schematics. LSASE or e-mail for list. Robert Bixler, 4010 Spokane Ave., #2, Cleveland, OH 44109. E-mail: robcmp@aol.com

FOR SALE: Spring clearance: 10 transistor radios most pre-'65 - \$60. 8 tube sets, junk lot - \$50. VHS video camera ca. 1983, works, new battery - \$175. Bob Masterson, Box 172, Valley Cottage, NY 10989. (914) 353-3151

FOR SALE: Tuska: Model 228 - \$275. 300 - \$375. 301 - \$275. All real nice. Plus shipping. Ed Bell, 5311 Wooddale Rd., Raleigh, NC 27606. Fax/phone: (919) 851-1517

Frankenstein's Radio Laboratory

4010 Fairmont Parkway, Suite 285

Pasadena, Texas 77504

(713) 998-0130 or 24 hour fax# (713) 998-2207

PREMOVING SALE / STOCK UP

We are relocating to Florida this summer.

VALUE	VOLTS	MANUF.	LEADS	SALE PRICE
2.2uf	450v	Rubycon	axial	\$.50
4uf	150v	(N.O.S.) Sprague	axial	.30
4.7uf	450v	ICC	axial	.55
10uf	450v	Xicon	axial	.75
22uf	160v	Rubycon	axial	.60
22uf	450v	Xicon	axial	1.20
33uf	160v	Rubycon	axial	.90
47uf	160v	Xicon	axial	1.20
47uf	450v	Xicon	axial	2.00
50uf	150	CDE	axial	1.30
.001	600	Sprague 715P	radial	.35
.0022	600	Sprague 715P	radial	.35
.0047	600	Sprague 715P	radial	.35
.01	600	Sprague 715P	radial	.45
.022	600	Sprague 715P	radial	.50
.047	400	CMC	axial	.40
.047	600	Sprague 715P	radial	.55
.1	600	Sprague 715P	radial	.85
.1	630	Xicon	radial	.50
.22	600	Sprague 715P	radial	1.30
.22	630	Xicon	radial	.60
.33	630	Xicon	radial	.70
.47	630	Xicon	radial	1.25

Shipping to anywhere in the U.S.A. is a flat rate of \$ 4.00

FOR SALE: Temple drum speaker w/wood base, no face cover, interior ear shape plaster, @9 - \$60. Baldwin metal spkr Mod 99, some flake, @9 - \$150. Indiana (batt.) hyperdye 5 TU a/o N/D - \$120. Radiola 33, plays, complete. Sparton Mod 100 Bakelite, oriental, @9 - \$60. Sonora RB175 a/o, N/D, 3 KN - \$40. Phico M-42-250 a/o, N/D - \$30. 45 rpm RCA 45-EY-4 w/lid a/o, N/D, no c/o - \$85. Hallicrafters MS77 a/o, N/D - \$100. Panasonic Mod 70 red trans., no c/o - \$30. Zenith class. 9S w/2 (3) cone spkrs, in beehive, (4) knobs, lot - \$35. Books: Sams Photofact 1947 21 to 30. Many Record Changers @9 - \$20. Auto Stereo Service & Install, 1994, Hansen - \$12. Cassette Tape Recorders Work, Care, Repair, 73 - \$15. Plus P&S. Bernie Sarnak, 113 Old Palmer Rd., Palmer, MA 01060. (413) 245-7174. Fax: (413) 245-0441

FOR SALE: Bremer-Tully power supply w/spkr Mod 81, 82, Rauland-Borg Corp. Chicago, 1955 Mod SA50 amp, Mod HF-455A AM-FM tuner w/CP24A amp. All tube type; came from school sound system. Riders #6, 7, 8, 10, 12, 13, 14, 15 - \$25 ea. or will trade some, possibly all, for Riders 19, 21, & 22. Original Zenith Service Manuals for 1941, 1942. Zenith Numerical Parts List, No. 1 & 2 - \$35. 1951 Studebaker car radio - \$35. Hallicrafters Mod 8R40, black metal case, chrome trim around rectangular dial - \$85. Sams TSM's, No. 36 thru 155, Sams CB24, Sams TR12 28, 49. Sams MHF 37, 152. Round dial glass for Zenith 10S567 and brass escutcheon to go over glass - \$40. Midland variac Mod 23-148, 0-130v - \$50. Dozens of N.O.S. tubes, dozens of used tubes, all good, very reasonable. Hundreds of plastic old radio knobs, some wooden ones, some Zenith wood knobs. Call for availability. Books: Radio Manufacturers of the 1920's Vols. 1, 2, & 3 by Alan Douglas; Classic Plastic Radios of the 1930's and 1940's, John Sideli. Dozens of new & used capacitors, can type for old radios, hi voltage, various mFds. Richard R. Bruning, 1901 U.S. Hwy. 150 No., Apt. B, Galesburg, IL 61401. (309) 344-1968

FOR SALE: Military: WWII ship speaker, 1943 R-1/ARR-1 receiver, 1945 PT-13 and PT-17 bi-plane training manual, RCA AVR-15 rec, J-37 key, lightning bug, ARC-1 auto tune. Bill Coolahan, 1450 Miami Dr. NE, Cedar Rapids, IA 52402-2933. (319) 393-8075

FOR SALE: Tubes, tubes, tubes. Brand new list of thousands of tubes for sale. Almost anything you could need new or used. Cheapest prices anywhere. Satisfaction guaranteed. Send LSASE for full list. Bruce Phillips (Tubes), 127 Bunker Hill Ave., Stratham, NH 03885

FOR SALE: Hallicrafters SX101 MKIII, vgc - \$225; S-41W, exc - \$125; WR 600, exc - \$60; SX-71, exc - \$225; S-76, exc - \$195. Free lists, equipment/manuals, call/write. Richard Prester, 131 Ridge Rd., West Milford, NJ 07480. (201) 728-2454

FOR SALE: Sears Wayfarer 8227 - \$50. Courier Conquerer CB - \$50. Realistic TRC-231 handheld - \$65. Consoles: Apex 10B - \$60, Tru-tone D700 - \$55. All plus postage. **WANTED:** Howard 450-A, Hallicrafters S-76 (all conditions considered), Bill Regan, 4566 O'Dell Pl., Jamesville, NY 13078. (315) 492-2817

FOR SALE: Guild Spice Chest, Model 484 - \$100. N.I.B. Cannonball headset - \$25. Industrial Instruments Wheatstone Bridge, RN-1 - \$40. All plus UPS. Stephen L. Bonino, 107 Georgetown Rd., Glassboro, NJ 08028. (609) 881-0244

FOR SALE/TRADE: Paragon, Two, excellent - \$300. Plus shipping. Ed Bell, 5311 Woodsdale Rd., Raleigh, NC 27606. Fax/phone: (919) 851-1517

FOR SALE: Catalins, Catalins, Catalins. Remember the silent auction advertised in last month's A.R.C. closes on April 2nd at 8:00 p.m. EST. For more information contact: Bruce Phillips, 127 Bunker Hill Ave., Stratham, NH 03885. (603) 621-6334, days; (603) 772-3796, nights, after 6 pm please. Fax: (603) 669-3677

FOR SALE: AK 9 breadboard, original condition, one broken dial plate, some knurled nuts missing, two tags on bottom - \$850. Classic Radio & Television, 541 Riverside Dr., Box 61, Augusta, ME 04330. (207) 623-2059

FOR SALE: Audio: Mint ST-70 and Mark III, Citation One/manuals, Citation catalog, Fisher 500, H-K 330B, Bogen PA amps, German speakers. Bill Coolahan, 1450 Miami Dr. NE, Cedar Rapids, IA 52402-2933

FOR SALE: (80) JFD and GC assorted woven fabric radio dial belts in kit metal box - \$100 plus. Elwood Hunt, 308 Georgetown Rd., Carneys Point, NJ 08069. (609) 299-5259

www.sscsi.com/machine_age

MACHINE AGE

browse
for antique
radios and other
design objects on-line.

WWW

Consider This Profitable New
Sales Tool For Your Business.

For Free Information
Call (800) 818-0570

e-mail: sandler@sscsi.com

THE TWENTIETH CENTURY DESIGN SUPER-SITE

WANTED

Catalogs from 1950 - 1970
Allied Radio, Lafayette Radio,
Radio Shack

— Top Prices Paid —

Arnold L. Chase — 9 Rushleigh Rd.
W. Hartford, CT 06117
(860) 521-5280

FOR SALE: Hy-Gain/Galaxy PR-550 DeLuxe hybrid phone patch with record feature, manuals, new - \$35. Clyde Powell, 3822 Edwards Ter., Chattanooga, TN 37412. (423) 867-5022

FOR SALE: Senco drugstore type tube tester, as is, U pick up - \$25. Donald R. Schoenhede, 1830 S. Christine, Westland, MI 48186-4455. (313) 595-7762

FOR SALE: Service manuals: Zenith, 900+ pages - \$60; Crosley I or II, Philco - \$25 ea. National Union Ballast Replacement Guide - \$600. Rider Radio Index, 1 through 23 - \$25. Preceding all Xerox copies. Books: Transistor Theory & Practice - \$8; Radio Servicing Course - \$16; Principles of Radio - \$14. Reproduction Philco cabinet parts: Front panel for 70 - \$40; bottom moulding 70 - \$15; rear arch 70, 19, 38/38A, 20, 60 - \$15. Rider's Radio Manuals IV through XV. All plus S&H. **WANTED:** Philco cathedral cabinets, any condition. Dick Oliver, 28604 Schwalm Dr., Elkhart, IN 46517. (219) 522-4516, evenings

— WANTED —

PICTURES FOR PHOTO REVIEW OR TELEGRAPH REVIEW

**PHOTOS MUST BE SHARP IN DETAIL
A SHORT DESCRIPTION IS A MUST!
SEE PHOTO REVIEW PAGES FOR
ADDITIONAL INFORMATION**

FOR SALE: Zenith Trans-Oceanic G500, vg, complete, working - \$125. Kenwood G100 communication exciter, vg - \$295. Toshiba RT-221F - \$25. Magnavox lighted sign - \$85. Ted Demski, 5806 225 Pl. SW, Mountlake Terrace, WA 98043. Phone/fax: (206) 778-7100

FOR SALE: Hammarlund Comet Pro - \$300. Want National SW-5 transformers. 3KP4 CRT (for Pilot TV). John Hurst, KU6X, 2512 Euclid Crescent East, Upland, CA 91784. (909) 981-6759

FOR SALE: TV-50 Genometer (six instruments in one) - \$47.50 plus shipping. Ray Sanders, 342 So. Third St., Cottage Grove, OR 97424

FOR SALE: Early gaivos, meters, etc. Leed Northrup, General Radio, Central Scientific, Weston, Rubicon. Call. John E. Walch, 381 Co. Rt. #17, Bernhards Bay, NY 13028. (315) 675-8135

FOR SALE: Emerson 334 Deco wood - \$85. Crosley 56TU Streamline, white painted Bakelite - \$75. Both excellent restored. Add postage. Larry Kellough, PO Box 849, Canton, CT 06019-0849. (203) 693-8269

FOR SALE: Motorola 2m repeater, ca. 1958. 829B final, no cabinet - BO, PU only. Randy Hull, WB3ECC, 1101 Hagy Ln., Dauphin, PA 17018

FOR SALE: Zenith Model 5-R-21 - \$120. Satchell-Carlson Model 427 - \$65. Plus shipping. Don Sickels, Box 174, Forestville, WI 54213. (414) 856-6651

FOR SALE: Yellow Catalin Emerson tombstone AU-190, 2 severe cracks, 1 repro knob - \$450. **WANTED:** Paying top dollar for: Harpers GK-900; GK-631; Kowa KT-91; Lafayette KT-116; Hoffman T-P411. David Mednick, 1450 Palisade Ave., #5H, Fort Lee, NJ 07024. (201) 461-3082

FOR SALE: Sentinel 335P elec. & battery. Sentinel 289T battery. Transistor float rectifier Model #6. RCA Mark VII CB radio. Ted Gasiorek, 201 Golden Ave., Briggsville, WI 53920. (608) 981-2051

FOR SALE: (50) radio insert sections from the 1924 and 1925 Philadelphia Public Ledger, very helpful information - \$50 plus. Elwood Hunt, 308 Georgetown Rd., Carneys Point, NJ 08069. (609) 299-5259

FOR SALE: Box lots: Five old calculators (Bowmar, Commodore, etc.) - \$38; 1950's record catalogs, (6) pcs. - \$22; Harrison Pre-recorded Tape Catalog, Vol. 1 #1, 1955 - \$20; Elvis novelty radio, white - \$65; RCA 66X11 - \$35; Philco 51-930 - \$45. Postage extra. R.C. Moore, 452 West Park Ave., Aurora, IL 60506. (708) 264-0488

FOR SALE: Pair old 4" cone speakers Panel meters, tubes. Few parts left. Lists. Ron Champagne, Box 778, Blandford, MA 01008-0778. (413) 848-2806

FOR SALE: Huge selection of antique and collection radios, televisions, military, amateur, novelty radios, microphones, earphones, telephones, high-fidelity equipment. Military uniforms, equipment. Antique medical, radio, scientific, aircraft books. New additions. For list, send two-stamp LSASE to: John Enigl, Sr., K9HJL, 5425 Cherry Ln., Egg Harbor, WI 54209. (414) 743-3672

FOR SALE: Catalin: (2) Temples, (2) bullets, green Fada 711, Emerson 520, Bendix, white Patriot mini-hairline. Parts or shelf sitters: cheap Bendix, Emerson 520, Bendix, white Patriot. Also white Air King Duchess with Catalin knobs, mint Stromberg-Carlson 1500H, GE H-500. Transistors: Regency red TR-1 orange Zenith 7AT4521, red 1957 Olympic, tiny Channel Master Mirettes, boys radios. Numerous original Catalin knobs. Also neat glass Deco Statue of Liberty lamp. Tiffany bronze desk set, old circus posters. Ted Chronister, 7073 Carlisle Pike, #26, Carlisle, PA 17013. (717) 766-6436

FOR SALE: Must sendsize radios, tubes and books. Large 8-page list. Send large SASE 2 stamps to: Ronald A. Smith, 145 Carr St., Lakewood, CO 80226

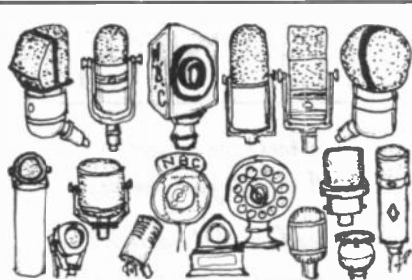

WANTED

FOR MY BROADCASTING MUSEUM

Microphones, stands, call letter plates. Tube amplifiers, mixers, compressors, Hi-Fi equipment. Speakers, on-air lights, equalizers. Disk, wire & tape recorders. Blank recording disks. Catalogs, magazines, manuals. 16" transcriptions, turntables, arms, pickups. Early TV cameras & receivers. Elaborate console, deco, plastic, mirror, novelty & wireless radios. Jukeboxes & parts. Acoustic phonographs.

We are looking for all makes of equipment, and especially *Western Electric*, Telefunken, Neufmann and RCA. The museum contains various duplicates and items surplus to our needs, and many of these articles are available for sale or trade. The collection is located in my Victorian seaside inn, The Caffrey House, situated on a bay next to the ocean, in the Southampton resort area of Long Island. A trade of equipment for a stay at the hotel is always encouraged.

Robert Van Dyke, 2 Squires Ave., East Quogue NY 11942
516-728-9835

HELP: Hinged adjustment cover plate for the front of a 1954 RCA metal tabletop television. Model# 21-S-348 KU. Matthew Hinson, 1663 Bridge St., Merrick, NY 11566. (516) 379-3601

HELP: Identify please: VR27, 10E/8239; VR21, 10E/7838; VR18, 10E/7807. 4-pin staggered base. Noel S. Ilg, 228 Beck Rd., Avon Lake, OH 44012. (216) 933-5668. Fax: (216) 933-8864

HELP: Correspondence with experienced radio station engineer about types of equipment used for broadcasting. Thanks. John Sampson, 75 Glenwood Dr., Leominster, MA 01453. (508) 537-0092

HELP: Need RCA working chassis 40 x 50, RC 436 chassis. Louis Filo, Jr., 3070 Schoenersville Rd., Bethlehem, PA 18017. (610) 866-0385, after 6 pm

HELP: Need chassis, top and sides for Mickey Mouse, 411. Vic Bang, Video Tech Service, 7520 S. Rural Rd., Tempe, AZ 85283. (602) 491-1811

HELP: Need schematic for Heathkit Model A-98 integrated mono amp and operating instructions for Clough-Brengle Model 712 capacitor checker. Kurt Hirsch, 640 N. Galen Dr., La Habra, CA 90631. (310) 697-4989

MESSAGE: Join MSARCI, great newsletters, mini meets, 1 year \$10, 3 years \$27. George Freeman, c/o Treasurer Shirley Schafbuch, 2811 Highland Ave., Carrollton, KY 41008-0341. (812) 273-2879

MESSAGE: Antique Radio Restoration & Repair is now on the WWW. Please come visit at: <http://www.bluefin.net/~mike/olradiodoc.html>. Thanks. Bob Eisinger, 20 Gary School Rd., Pomfret, CT 06259

MESSAGE: Free: Philco 40-185 console, restoration project, schematic included, no tubes. Pick up only. William Donzelli, 304 South Chester, Park Ridge, IL 60068. (708) 825-2630. E-mail: integrat@usr.com

THANKS!

*Thanks for suggesting
A.R.C. to your friends.*

*Did you know that nearly 20% of
our new subscriptions come from
referrals from subscribers?*

So spread the word about A.R.C.!

*Give the center coupon to a
collector, or ask us to send a
friend a free sample copy.*

*Help A.R.C. and
radio collecting grow!*

MESSAGE: Man from Mexico: I still have Signal Leamer telegraph key. Please write. Gary Redfield, 214 Bailey Rd., Crystal City, MO 63019. (314) 933-0542

MESSAGE: Bruce Eddy says there will be plenty of free food and beverages available at Extravaganza '96 again this year. Come grab a coffee and donut under our big-top at Harriet's Place and enjoy the hospitality too! For further information or for a convention brochure, write to: Michigan Antique Radio Club, Extravaganza '96, Suite 100, 3520 Okemos Rd., #6, Okemos, MI 48864

SERVICES: Repair/replacement of meters before 1935. **WANTED:** Old meters/galvos before 1910 as is okay. Ye Olde Meter Cellar, Leonard W. Cartwright, 879 Russet Dr., Sunnyvale, CA 94087. (408) 739-6025

SERVICES: Rider Radio Schematics 1930 thru 1950's - \$3 ppd. Send make/model. Richard A. Lerche, 1561 Bluebell Ct., Livermore, CA 94550. (510) 447-9365

SERVICES: Precision machining from your sample or drawing. Brass, aluminum, steel, phenolic, etc. Jim Dill, Box 5044, Greeley, CO 80631

One Month Free!

BONUS FOR EARLY RENEWALS

If you renew before the month shown on your mailing label (your expiration month), you will receive an extra month on your subscription: 13 months instead of 12! 26 months for an early 2-year renewal!

FOR TRADE: Pepsi bottle radio for early spark transmitter and parts. **WANTED:** Early radio books and magazines for my reference library. John H. Dilks, K2TQN, 125 Warf Rd., Egg Harbor Twp., NJ 08234-8501. (609) 927-3873. E-mail: john.dilks@academia.com

FOR TRADE: Zenith 12S265 excellent for a Federal 61. Jim Berg, 4261 Wilcox, Rd., Box A, Northport, WA 99157. (509) 732-4047

FOR TRADE: Radiola RF. **WANTED:** Grebe CR-13. Amrad 3366 and 3670 reflex receivers, Herald horn. J.C. Woychowski, 17 Hope St., Niantic, CT 06357. (860) 739-6579

FOR TRADE: Lots of Rider manuals, up to Volume 18, for your N.I.B. 6U5/6G5 tubes. A. Bruno, 24 Butternut Dr., New City, NY 10956. (914) 354-8899

FOR TRADE: My extra Radio Boy books by Chapman for yours. Bob Barr, 3130 Bellanca St., Columbus, GA 31909. (706) 322-2180

FOR TRADE: Good used WE 300B & 350B for Nikko Alpha 130 amplifier. David Carson, HC01 Box 19A, Long Lake, NY 12847-9704. (518) 624-4812

FOR TRADE: Philco grandfather, Zeniths 11S474, 7S260, 52, black Burns horn and cash for: Fada 460A, 480A, Leutz or Marti battery sets. Scott Cavalari, 1258 Rt. 94, New Windsor, NY 12553. (914) 561-7913

FOR TRADE: My Electro-Voice mic (circa 1971) Model RE-16 with carrying case for your Philco 90 cathedral. A. Bruno, 24 Butternut Dr., New City, NY 10956. (914) 354-8899

MESSAGE: Who needed Radiola V name plate? How bad you want it? John OBriant, 3439 Clearwater, Bettendorf, IA 52722

MESSAGE: Alabama Historical Radio Society Swap Meet, April 27, 1996. Fairfield Civic Center, 6509 E.J. Oliver Blvd., Fairfield, AL, 9 am-4 pm. Free admission, free parking, secured area. Deadline for space April 1, 1996. Interested vendors call: Julian Brook, Box 130307, Birmingham, AL 35213. (205) 879-1191

One Month Free!

BONUS FOR EARLY RENEWALS

If you renew **before** the month shown on your mailing label (your expiration month), you will receive an extra month on your subscription: 13 months instead of 12! 26 months for an early 2-year renewal!

SERVICES: Shortwave specialist. Professional radio overhauls. 3-year guarantee. Free estimates, brochure. Always buying new tubes. Captain Larry Rau, Occidental Radio Workshop, Box 1139, Occidental, CA 95465. (707) 874-1000

SERVICES: Rider Radio Schematics, 1930 through 1950's. Includes alignment data. Send \$3 with make, model and SASE to: George M. Bonanno, WA2KPE, 34 Charles St., Clifton, NJ 07013. (201) 746-5953

SERVICES: Schematics 1920's thru 1950's, mailed or faxed - \$3 radios; \$4 TVs ppd. Robert Schrantz, 610 E. Juanita Ave., San Dimas, CA 91773. Phone/fax: (909) 394-1194

SERVICES: Repair of TV-7 tubes testers w/calibration: I will fix and then verify calibration of your TV-7 tube tester for \$45 plus all shipping or return it no charge. Daniel Nelson, 1025 E. Desert Ln., Phoenix, AZ 85040. (602) 243-7421, evenings. E-mail: djn@indirect.com

SERVICES: Radio Schematics and Service Data 1920's to 1950's. Send SASE, \$2.50, make & model to: Steve Rosenfeld, PO Box 387, Ocean Gate, NJ 08740. (908) 269-2022, days

SERVICES: Hickok, specializing in service, sales & calibration of Hickok & other major makes of test equipment, including Eico & Heath. Also, military TV2-3-7-20-1177, AN/USM-118B Cardmatic, and Telephone Co. Types WE KS 15874-L2, WE KS 15650-KS 15750-L1-L2. Obsolete & foreign tube test data, technical & operators data, at reasonable cost. **FOR SALE:** New after market calibration cell for Cardmatic tube testers - \$65 w/S&H. Test your calibration cell - \$5 w/S&H. New after market 4-5-6-7 pin test adapters sockets for 6000 series Hickok tube testers w/obsolete tube test data - \$65 w/S&H. New socket savers for 7-pin min. & 8-pin octal - \$15 ea. w/S&H. Affordable, reconditioned & calibrated radio, TV test equipment. Hickok tube testers Models 600-800-6000, 123A Cardmatic w/cards, military AN/USM 118B Cardmatic w/cards, VVTM; signal generators, condenser testers, scopes, freq. counters, B&K TV analyst, all w/manuals. **WANTED:** Clean and complete radio test equipment, must have good meters & transformers, need not operate, manuals a plus. Profit from our experience. Thanks. Wendell E. Hall, 3 Mockingbird Cir., Jeffersonville, IN 47130. (812) 282-9709

HELP: Have incomplete RadioVision and need either complete radio or chassis only. All help appreciated. All help appreciated. Jim Clark, 1292 Starboard, Okemos, MI 48864. (517) 349-2249

HELP: Need schematic and operating instructions for Precision 900 tube tester/multimeter. Cris Van Houten, 728 Keup Rd., Cedarburg, WI 53012. (414) 377-5873

HELP: N.O.S. receiving tubes needed: 7B7 & 7C6, offering \$3 ea.; 1L6 & 1U6, offering \$8.50 ea. Scott Phillips, 368 Clinton St., Binghamton, NY 13905. (800) 314-3957. Fax: (607) 797-0013

HELP: Can anyone furnish me with good 1938-1941 Zenith 8-inch electro-dynamic speakers (with output transformer mounted)? Almost any part number will do. Thanks. Armand Cote, 11 Berge Ln., Derry, NH 03038

HELP: Anyone have any luck piecing together broken Bakelite escutcheons? Can it be glued together? Denis Meany, 81 Madison St., Blue Point, NY 11715. E-mail: Meany@nyfok.ang.af.mil

HELP: Need schematics for Silvertone Model 7019 (132.701901) radio and Sanyo 21T68A TV. Andy Burnett, 9203 Lyndonway Dr., Richmond, VA 23229. (804) 747-1981

HELP: Anyone who can transport tabletop TV from Flushing, N. Y., to anywhere closer to Detroit! Going in this general direction? I can meet you, and pay for your effort. Thanks. Glenn Bubenheimer, 27851 Terrence, Livonia, MI 48154. (313) 421-5574

HELP: Need manuals, copy OK: Philco-Electronic Circuit Master Model 7001; Philco Dynamic Tester Model 7030; Jackson Audio Oscillator Model 605D; Hickok - Volt, Ohm, Capacity Model 209 and 209A; Heathkit Oscilloscope IO-4560, Sentinel Oscilloscope OS-46A/U. Will gladly pay \$5 per copy (or more) if needed. Jim Patton, 2820 Sterling Way, Birmingham, AL 35242. (205) 980-8110

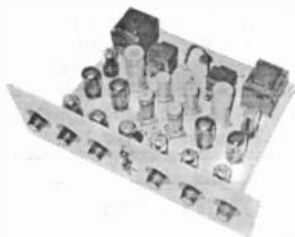

HELP: Need assistance in identifying the stereo amplifier shown. It uses three 6SN7's and two 5881's plus rectifier per channel. Will pay to have manual/brochure/schematic copied. Many thanks. Bryan Hodgson, 14 Evergreen Dr., Voorhees, NJ 08043. (609) 424-0312

HELP: Need alignment instructions for Fisher FM tuner #KM-60, (1961). Pay your price! Thanx. Michael K. Tremper, 110Lynncrest Ter., Cheektowaga, NY 14225-1158. (716) 834-9190

HELP: Need a chassis for RCA 143 or 242. Mark M. Murphy, 1400 Chicago Ave., #208, Evanston, IL 60201. (847) 328-5036

HELP: Radio in 1925 Splitdorf Mikado? (Douglas's "R.M. of 1920's," Vol. 3, p. 126). Gerald Schneider, 3101 Blueford Rd., Kensington, MD 20895-2726. (301) 929-8593



COMING RADIO EVENTS

CALIFORNIA – Mar. 30

CALIF. HISTORICAL RADIO SOCIETY MEET

Benicla, CA – Home Video, 101 E. H St.
8 am

Info: CHRS Hotline – (415) 978-9100

ARKANSAS – Apr. 4

ANTIQUE RADIO COLLECTORS CLUB OF FORT SMITH – CLUB MEETING

Fort Smith, AR – St. Luke Lutheran Church
Waldron Road, at Free Ferry

7:30 pm

Info: Paul Tucker, 4700 N. "N" Street
Fort Smith, AR 72904 – (501) 782-8178

ONTARIO – Mar. 30

LONDON VINTAGE RADIO CLUB MEETING

London, Ontario – Jaycee Building
317 Adelaide St. South

1 pm

Info: Don Hatch, 14 Kingspark Cres., London
Ontario, Canada N6H 4C4 – (519) 472-6167

PENNSYLVANIA – Apr. 4

ALDERFER AUCTION CENTER RADIO AUCTION

Hatfield, PA – Alderfer Auction Center
501 Fairgrounds Road

9 am – Auction

(Apr. 3: 5-7 pm – Preview)

600+ piece collection of Robert Keffer,
of Mohnton, Pa.

Info: Alderfer Auction Co. – (215) 393-3000
To request listing: (215) 393-3036

PENNSYLVANIA – Mar. 30

PITTSBURGH ANTIQUE RADIO SOCIETY 4th ANNUAL SPRING FEVER

Washington, PA – County Fairgrounds
I-79 at I-70

7 am – Check-in

1 pm – Auction

Sponsored by: W. Virginia Chapter-AWA,
Mid-Atlantic Antique Radio Club,
Museum of Radio & Technology, Inc.,
Niagara Frontier Wireless Assn., Buckeye
Antique Radio & Phonograph Club

Info: Spring Fever 4, 4204 Thorn Apple Ln.
Charleston, WV 25313

CALIFORNIA – Apr. 6

SOUTHERN CALIF. ANTIQUE RADIO SOCIETY – MEETING/BRUNCH

San Diego, CA – Ramada Inn North
5550 Kearny Mesa Road – (619) 278-0800

7 am-12 noon

Info: Gilbert Smith – (619) 236-7990

OHIO – Mar. 31

BUCKEYE ANTIQUE RADIO & PHONO CLUB MEETING/SILENT AUCTION

Brunswick, OH – Brunswick Library
3649 Center Rd., Rt. 303

1-4:30 pm

Info: Rich Bradley – (216) 842-5937

WASHINGTON – Apr. 6

RADIO ENTHUSIASTS OF PUGET SOUND MEETING

Seattle, WA – Queen Anne Library
400 W. Garfield – 2 pm

Info: REPS, 9936 NE 197th Street
Bothell, WA 98011 – (206) 488-9518

VIRGINIA – Apr. 3

TIDEWATER ANTIQUE RADIO ASSN. MEETING

7 pm – Call for location & directions
Info: Phil Stroud, 2328 Springfield Ave.
Norfolk, VA 23523

(804) 481-2561, after 6 pm

GEORGIA – Apr. 8

SOUTHEASTERN ANTIQUE RADIO SOCIETY MEETING

Norcross, GA – Picadilly Cafeteria
3400 Holcomb Bridge Road

6 pm – Mini-Meet

6:30 pm – Meeting

Info: Charles Milton – (770) 922-6507, or
SARS, PO Box 500025 – Atlanta, GA 31150

ILLINOIS - Apr. 8**BELLEVILLE AREA ANTIQUE RADIO CLUB MEETING**

Belleville, IL - Belleville Area College
7 pm

Info: Karl Stegman, 4 Cresthaven Drive
Belleville, IL 62221 - (618) 234-7992

ARKANSAS - Apr. 11**ARKANSAS ANTIQUE RADIO CLUB MEETING**

Little Rock, AR - Call for location
7 pm

Info: Tom Burgess - (501) 455-0773

CALIFORNIA - Apr. 9**CALIF. HISTORICAL RADIO SOCIETY NORTH VALLEY CHAPTER MEETING**

Redding, CA - 7 pm

Info: ChrIs Galantine, 15853 Ontario Place
Redding, CA 96001-9785 - (916) 244-2337

NEW JERSEY - Apr. 12**NEW JERSEY ANTIQUE RADIO CLUB MEETING**

Freehold, NJ - Grace Lutheran Church
West Main St. & Park Ave. (old Rt. 33)

7:30-9:30 pm - Meeting & Swap

Info: Don Cruse - (908) 542-2848
Tony or Kathleen Flanagan - (908) 462-6638

MISSOURI - Apr. 9**ANTIQUA RADIO COLLECTORS & HISTORIANS OF GREATER ST. LOUIS - MEETING**

St. Louis, MO - Kirkwood Community Center
111 S. Geyer Rd., Room 201-A
7 pm

Info: Scott Teichmann - (314) 256-6263

ARIZONA - Apr. 13**ARIZONA ANTIQUE RADIO CLUB MEETING**

Chandler, AZ - 3350 S. Holly Court
2 pm - Philco Radios with Dave Lambert

Info: Host Dave Lambert - (602) 963-0262

PENNSYLVANIA - Apr. 9**DELAWARE VALLEY HISTORIC RADIO CLUB MEETING - SWAP MEET - AUCTION**

Souderton, PA - 113 Main St.,
N. Penn Amusements Bldg.

7:30 pm

Info: DVHRC, PO Box 41031, Philadelphia,
PA 19127-0031 - Mike Koste - (215) 646-6488

IOWA - Apr. 13**GENE HARRIS ANTIQUE AUCTION CENTER 6th VINTAGE RADIO CONSIGNMENT AUCTION**

Marshalltown, IA - Gene Harris Antique
Auction Center, 203 S. 18th Ave.

10 am

Info: Gene Harris - (800) 862-6674

TEXAS - Apr. 9**HOUSTON ANTIQUE RADIO ASSN. MEETING**

Houston, TX - Tides II Motel
Lai Lai Restaurant, Holcombe & Main St.
7-10 pm

Info: David Moore - (713) 485-1705

KENTUCKY - Apr. 13**MID-SOUTH ANTIQUE RADIO COLLECTORS SWAP MEET**

Henderson, KY - Days Inn (reserve by 3/31)
2044 U.S. Highway 41 No. - (502) 826-6600

7:30 am-Noon - Swap Meet

12 Noon - Auction & Old Equip. Contest
1 pm - Meeting

Info: Lewis Owens - (606) 233-0376, or
Don Wrigley - (618) 457-5375

ONTARIO - Apr. 10**OTTAWA VINTAGE RADIO CLUB MEETING**

Ottawa, Ontario - Ottawa Citizen
Conference Room, 1101 Baxter Road
7 pm

Info: Tom Devey, 810 Edgeworth Ave.
Ottawa, Ontario K2B 5L5 - (613) 828-5152

OKLAHOMA - Apr. 13**OKLA. VINTAGE RADIO COLLECTORS 4th CONVENTION & SWAP MEET**

Oklahoma City, OK - Student Center
OSU Technical Institute, 900 N. Portland

8 am-1 pm - Flea Mart & Swap Sale

9:30 am - Contest

11 am - Auction

Info: Mike Lapuzza - (405) 745-3394, after 7 pm
OKVRC, PO Box 332, Wheatland, OK 73097

Enclose a SASE when requesting info.

MARK YOUR CALENDAR

Mar. 25 - AL, Birmingham - ALHRS Meeting §
 Mar. 26 - OH, Kettering - SPARK Meeting §
 Mar. 30 - CA, Benicia - CHRS Meet*
 Mar. 30 - Ontario, London - LVRC Meeting*
 Mar. 30 - PA, Washington - Spring Fever 4*
 Mar. 31 - OH, Brunswick - BARPC Meeting §*
 Apr. 3 - VA, TBA - TARA Meeting §*
 Apr. 4 - AR, Fort Smith - ARCCFS Meeting §*
 Apr. 4 - PA, Hatfield - Radio Auction*
 Apr. 6 - CA, San Diego - SCARS Meeting*
 Apr. 6 - WA, Seattle - REPS Meeting §*
 Apr. 8 - GA, Norcross - SARS Meeting §*
 Apr. 8 - IL, Belleville - BAARC Meeting §*
 Apr. 9 - CA, Redding - CHRS-NVC Meeting*
 Apr. 9 - MO, St. Louis - ARCH Meeting §*
 Apr. 9 - PA, Souderton - DVHRC Meeting §*
 Apr. 9 - TX, Houston - HVRA Meeting §*
 Apr. 10 - Ontario, Ottawa - OVRC Meeting*
 Apr. 11 - AR, Little Rock - AARC Meeting §*
 Apr. 12 - NJ, Freehold - NJARC Meeting §*
 Apr. 13 - AZ, Chandler - AARC Meeting §*
 Apr. 13 - IA, Marshalltown - Radio Auction*
 Apr. 13 - KY, Henderson - MSARC Swap Meet*
 Apr. 13 - OK, Okla. City - OKVRC Convention*
 Apr. 13 - OR, Portland - NWVRS Meeting §*
 Apr. 13 - TX, Houston - HVRA Seminar*
 Apr. 13 - WV, Huntington - Museum Meet*
 Apr. 14 - MS, Meridian - MHR&BS Meeting §*
 Apr. 14 - NY, Lake Ronkonkoma - GNYVWA §*
 Apr. 14 - WA, Poulsbo - VALVE Meeting §*
 Apr. 16 - CA, N. Highlands - SHRS Meeting §*
 Apr. 16 - OH, Kettering - ARCO Meeting §*
 Apr. 17 - OH, Cincinnati - SPARK Meeting §*
 Apr. 17 - OH, Columbus - SPARK Meeting §*
 Apr. 18 - NY, Goshen - HARPS Meeting §*
 Apr. 20-21 - CA, Redding - NVC/CHRS Show*
 Apr. 20 - NH, Nashua - NEARC Swap Meet*
 Apr. 20 - PA, Downingtown - Radio Auction*
 Apr. 20 - PA, Downingtown - DVHRS Flea Market*
 Apr. 20 - TX, Irving - VRPS Meeting*
 Apr. 21 - IL, Morton - ARCI Spring Swap Meet*
 Apr. 21 - KS, Kansas City - MAARC Auction*
 Apr. 21 - MD, Burtonsville - MAARC Meeting §*
 Apr. 21 - NM, Albuquerque - NMRC Meeting §*
 Apr. 21 - WA, Seattle - PSARA Meeting §*
 Apr. 22 - AL, Birmingham - ALHRS Meeting §*
 Apr. 23 - OH, Kettering - SPARK Meeting §*
 Apr. 27 - AL, Fairfield - ALHRS Swap Meet*
 Apr. 27-28 - CO, Denver - CRC Show/Meet*
 Apr. 27-28 - WV, Huntington - Museum Show
 Apr. 28 - MI, Clare - MARC Spring Meet*
 Apr. 28 - OH, Brunswick - BARPC Show
 May 3-4 - IN, Kokomo - IHRS Radio Festival*
 May 3-5 - TX, Houston - HVRA Convention*
 May 4-5 - Alberta, Red Deer - CVRS/AL Meet*
 May 4 - CA, Los Altos Hills - CHRS Swap Meet*
 May 4 - NY, Bloomfield - AWA Spring Meet*
 May 4 - OR, Portland - NWVRS Show/Sale*
 May 5 - OH, Brunswick - BARPC Meeting §*
 May 5 - England, Birmingham - NVCF Meet*
 May 11 - FL, Orlando - FAWG Meeting/Auction*
 May 11 - NJ, Schooley's Mtn. - AWA/NJ Meet*
 May 12 - CO, Denver - CRC Meeting*
 May 17-19 - OH, Dayton - 1996 Hamvention*
 May 18 - CA, San Luis Obispo - Joint Meet
 May 18 - AZ, TBA - AARC Meeting
 May 18 - PA, Williamsport - CPRCC Swap Meet*
 May 18 - TX, Irving - VRPS Swap Meet
 May 25 - CA, Valencia - SCARF Meet
 May 25 - Ontario, London - LVRC Meeting
 May 26 - Manitoba, Winnipeg - CVRS/MB Meet
 May 31-Jun. 1 - MN, Golden Valley - Radio Daze '96*
 Jun. 7-8 - MD, Timonium - MAARC Radio Activity
 Jun. 15 - CA, Los Angeles - SCARS Meeting
 Jun. 15 - Quebec, Knowlton - QSVRC Meet
 Jun. 21-22 - OH, Cincinnati - SPARK Radiorama*
 Jun. 27-29 - WA, Seattle - REPS Showcase IV*

(Continued at top of next column)

MARK YOUR CALENDAR

(Continued from bottom left column)

Jun. 29 - Ontario, London - LVRC Meeting
 Jul. 6 - CA, San Francisco - CHRS Meet
 Jul. 12-14 - MI, Lansing - Extravaganza '96
 Jul. 20 - NH, Nashua - NEARC Swap Meet
 Jul. 27 - KY, Louisville - MSARC Swap Meet
 Jul. 27 - WV, Huntington - Show/Auction
 Aug. 3 - CA, Los Altos Hills - CHRS Swap Meet
 Aug. 10 - NY, Amherst - NFWA Summer Meet
 Aug. 16 - OH, Dayton - ARCO Swap Meet
 Aug. 17 - CA, Los Angeles - SCARS Meeting
 Aug. 17 - TX, Irving - VRPS Swap Meet
 Aug. 28-31 - IL, Elgin - ARCI Radiofest 1996
 Sep. 14 - CA, Fairfield - CHRS Picnic & Meet
 Oct. 5 - CA, Redding - CHRS/NVC Meet
 Oct. 5 - KY, Lexington - MSARC Swap Meet
 Oct. 12 - OR, Portland - NWVRS Show/Sale
 Oct. 19 - CA, San Diego - SCARS Meeting
 Oct. 19 - WV, Huntington - Show/Auction
 Oct. 26 - NH, Nashua - NEARC Swap Meet
 Nov. 2 - CA, Los Altos Hills - CHRS Swap Meet
 † Nov. 15-16 - CA, Los Angeles - SCARS Meet

* See expanded listing this month. § Monthly Meeting
† Date changed from original announcement

OREGON - Apr. 13

NORTHWEST VINTAGE RADIO SOCIETY MEETING

Portland, OR - NW Vintage Radio Museum
 7675 SW Capitol Highway
 10 am - Meeting

Info: Ed Charman, PO Box 82379
 Portland, OR 97282-0379 - (503) 654-7387

TEXAS - Apr. 13

HOUSTON ANTIQUE RADIO ASSN. RADIO ELECTRONICS SEMINAR IV

Houston, TX - Tides II Motel
 Lai Lai Restaurant, Holcombe & Main St.

8 am - Breakfast
 9-10:45 am - Lecture
 11-12 am - Laboratory Session
 Bring voltmeter (VOM) and a calculator
 Info: David Moore - (713) 485-1705

W. VIRGINIA - Apr. 13

MUSEUM OF RADIO & TECHNOLOGY SHOW/AUCTION/FLEA MARKET

Huntington, WV - Museum of Radio & Tech.
 1640 Florence Ave.

7:30 am - Museum open, tours all day
 8 am - Traders Market open
 11:30 am - Lunch
 12:30 pm - Auction

Special Displays - Broadcast Station
 14th St. Antique Shops open all day
 Info: Jack Woodrum, 141 W. 9th Ave.
 Huntington, WV 25701 - (304) 525-4546

MISSISSIPPI - Apr. 14

MISSISSIPPI HISTORICAL RADIO & BROADCASTING SOCIETY MEETING

Meridian, MS - 2412 C Street
3 pm

Info: Randy Guttery, 2412 C. Street
Meridian, MS 39301 - (601) 693-5958

OHIO - Apr. 17

SOCIETY FOR PRES. OF ANTIQUE RADIO KNOWLEDGE/COLUMBUS CPT. - MEETING

Columbus, OH - DeVry Institute of Tech.
1350 Alum Creek Road, I-70 Exit 103B
7:30 pm

Info: Sharon/Ken Fullerton - (614) 237-2621

NEW YORK - Apr. 14

GREATER NEW YORK VINTAGE WIRELESS ASSN. - SWAP MEET

Lake Ronkonkoma, NY - 367 Hawkins Ave.
N. of L.I. Expressway, lg. white house
9-12 am

Info: Chris Lieppert - (516) 471-9526, or
Chris Bacon - (516) 821-7618

NEW YORK - Apr. 18

HUDSON VALLEY ANTIQUE RADIO AND PHONO. SOCIETY/AWA - MEETING

Goshen, NY - Cataract Firehouse, Main St.
7-9 pm

Info: John & Linda Gramm, Box 1, Campbell
Hall, NY 10916 - (914) 427-2602, 6-9 pm

WASHINGTON - Apr. 14

VINTAGE AUDIO LISTENERS AND VALVE ENTHUSIASTS - MEETING

Poulsbo, WA - Classic Radio
1127 N.W. Bright Star Ln.

10 am-2 pm

Info: Dan Schmale - (360) 697-1936

CALIFORNIA - Apr. 20-21

CALIF. HISTORICAL RADIO SOCIETY NORTH VALLEY CHAPTER 5th ANNUAL MALL SHOW

Redding, CA - Mount Shasta Mall
In the Thrifty Court, 900 Dana Drive
Sat. & Sun. - All Day, Mall hours

Info: Chris Galantine, 15853 Ontario Place
Redding, CA 96001-9785 - (916) 244-2337

CALIFORNIA - Apr. 16

SACRAMENTO HISTORICAL RADIO SOCIETY - MEETING

N. Highlands, CA - SMUD Foothill Service
Center, Room D, 5026 Don Julio, 1 mi. W. of I-80
7-9 pm

Info: SHRS, PO Box 162612, Sacramento
CA 95816, or Don Steger - (916) 929-8274

NEW HAMPSHIRE - Apr. 20

NEW ENGLAND ANTIQUE RADIO CLUB SWAP MEET

Nashua, NH - Resurrection Center
Rt. 3 (Everett Turnpike), Exit 6
1 1/2 miles West on Rt. 130, 449 Broad St.

8-9 am - Early Admission
9 am-1 pm - General Admission
Over 100 tables - 50/50 Raffle - Catered
Old Equipment Contest
Reservations required to sell

Info: Gregg Thompson, PO Box 298
Newtonville, MA 02160 - NEARC: (617) 923-2665

OHIO - Apr. 16

ANTIQUERADIO COLLECTORS OF OHIO MEETING

Kettering, OH - National City Bank Basement
4100 Far Hills Ave., at Stroop Rd.

7:30 pm - Your Ugliest Radio

Info: Steve Geary - (513) 492-0972
ARCO, PO Box 292292, Kettering, OH 45429

TEXAS - Apr. 20

VINTAGE RADIO & PHONO. SOCIETY MEETING

Irving, TX - Senter East Building - 1-5 pm

Info: George Potter - (214) 315-2553

OHIO - Apr. 17

SOCIETY FOR PRES. OF ANTIQUE RADIO KNOWLEDGE/CINCINNATI CPT. - MEETING

Cincinnati, OH - Richards Radio & TV
4041 Edwards Rd., I-71, Exit 6

7:30 pm

Info: Tim Kalsar, PO Box 81
Newport, KY 41071 - (606) 441-2548

PENNSYLVANIA - Apr. 20

DELAWARE VALLEY HISTORIC RADIO CLUB OUTDOOR FLEA MARKET

Downingtown, PA - Business Rt. 30
Downingtown Marketplace - 7 am-??

Info: Dave Abramson - (610) 827-9757

PENNSYLVANIA - Apr. 20**SMITH AUCTION COMPANY
RADIO AUCTION**

Downingtown, Pa - Business Rt. 30
Downingtown Marketplace

8-10 am - Auction

Preview Fri. Apr. 19: 10 am-10 pm

Info: Smith Auction Co. - (610) 269-1036

ALABAMA - Apr. 22**ALABAMA HISTORICAL RADIO SOCIETY
MEETING**

Birmingham, AL - Homewood Public Library
1721 Oxmoor Road

7 pm

Info: Earl Ridolphi, 2413 Old Briar Trail
Birmingham, AL 35226 - (205) 823-3314

ILLINOIS - Apr. 21**ANTIQUA RADIO CLUB OF ILLINOIS
SPRING SWAP MEET**

Morton, IL - Freedom Hall

8 am-1 pm

Info: Carl Knipfel - (309) 266-9440

OHIO - Apr. 23**SOCIETY FOR PRESERVATION OF
ANTIQUA RADIO KNOWLEDGE - MEETING**

Kettering, OH - Cassano's Pizza
1680 E. Stroop Rd.

7:30 pm

Info: Harold Parshall - (513) 865-5900, days
(513) 268-2909, eves. until 9 pm

KANSAS - Apr. 21**MID-AMERICA ANTIQUA RADIO CLUB
AUCTION**

Kansas City, KS - Rainbow Village
501 Southwest Blvd., behind Best Western

8:30 am - Doors open; 10:30 am - Auction

Info: Bob Lutz - (913) 894-1327

E-mail: lutzee@ix.netcom

COLORADO - Apr. 27-28**COLORADO RADIO COLLECTORS
ANTIQUA RADIO SHOW & SWAP MEET**

Denver, CO - Denver Collectors' Fair
Natl. Western Complex, I-70 at Brighton Blvd.

Sat. Apr. 27: 9 am-5 pm

Sun. Apr. 28: 10 am-3 pm

Info: Matt Lutkus - (303) 469-9604

MARYLAND - Apr. 21**MID-ATLANTIC ANTIQUA RADIO CLUB
MEETING**

Burtonsville, MD - New Hope Seventh Day
Adventist Church gym - 2 pm

Info: Sam Cannan, 1010 Siske Road

Stony Creek, MD 21226 - (410) 255-7728

ALABAMA - Apr. 27**ALABAMA HISTORICAL RADIO SOCIETY
SWAP MEET**

Fairfield, AL - Fairfield Civic Center
6509 E.J. Oliver Blvd.

9 am-4 pm

Info: Julian Brook - (205) 879-1191

NEW MEXICO - Apr. 21**NEW MEXICO RADIO COLLECTORS CLUB
MEETING**

Albuquerque, NM - Sierra Vista Bible
Church, 7509 Paseo Del Norte

1:30 pm - Midget Sets

Info: Bill Schultz, 7213 Donet Ct. NE

Rio Rancho, NM 87124 - (505) 294-5302

MICHIGAN - Apr. 28**MICHIGAN ANTIQUA RADIO CLUB
SPRING SWAP MEET**

Clare, MI - Doherty Hotel

604 N. McEwan - (517) 386-3441

8 am-1 pm

Info: John Reinicke - (810) 626-4895, or

E-mail: Reinickeja@oa.frc.com

WASHINGTON - Apr. 21**PUGET SOUND ANTIQUA RADIO ASSN.
MEETING**

N. Seattle, WA - Shoreline Museum
749 No. 175th St. & Linden Ave.

9 am - Swap Meet

12 noon - Meeting

Info: Al Atworth, PO Box 125

Snohomish, WA 98291-0125 - (360) 568-2698

QUEBEC, CANADA**NEW CLUB FORMING
QUEBEC SOCIETY FOR VINTAGE
RADIO COLLECTORS**

Info: QSVRC-Radiophile Quebec,
c/o Micheal Morin, 799 St. Etienne St.
Granby, Quebec, Canada J2G 9N8

INDIANA - May 3-4

**INDIANA HISTORICAL RADIO SOCIETY
ANTIQUE WIRELESS ASSOCIATION
25th SPRING FLING RADIO FESTIVAL**
Kokomo, IN - Ramada Inn: (317) 459-8001

May 3: All Day - Flea Market
8 am-Noon - Seminars
Noon - Ladies' Luncheon
1-4 pm - Contest
1-2 pm - Enter Items
2-4 pm - Judging
7 pm - Banquet

May 4: All Day - Flea Market
8-9:30 am - Auction Check-in
9:30-11 am - Donation Auction
11 am-? - Consignment Auction
Info: Bob O'Friel - (317) 849-4028

OREGON - May 4

**NORTHWEST VINTAGE RADIO SOCIETY
RADIO SHOW AND SALE**
Portland, OR - Multnomah Art Center
7688 S.W. Capitol Highway

9 am-12:30 pm
Info: Myron White - (503) 629-5513, or
E-mail: myron@ncube.com

ENGLAND - May 5

**5th NATIONAL VINTAGE
COMMUNICATIONS FAIR**
Nec, Birmingham, United Kingdom

10:30 am-5 pm
Info: NVCF, 2-4 Brook St., Bampton
Devon, England - Tel.: (01398) 331532

TEXAS - May 3-5

**HOUSTON VINTAGE RADIO ASSN.
ANTIQUE WIRELESS ASSN.
CONVENTION '96**

Houston, TX - Ramada Hotel Astrodome
South Braeswood - (713) 797-9000
Info: David Moore - (713) 485-1705

OHIO - May 5

**BUCKEYE ANTIQUE RADIO AND
PHONOGRAPH CLUB - MEETING**
Brunswick, OH - Brunswick Library
3649 Center Road, Rt. 303 - 1-4:30 pm
Info: Rich Bradley - (216) 842-5937

ALBERTA - May 4-5

**CANADIAN VINTAGE RADIO SOCIETY
ALBERTA CHAPTER - SWAP MEET/SALE**
Red Deer, Alberta - Westerner Agriplex
(Pavillion)

May 4: 9 am-5 pm
May 5: 10 am-3 pm
Info: Rick Williams - (403) 449-5413

FLORIDA - May 11

**FLORIDA ANTIQUE WIRELESS GROUP
SPRING MEETING**
Orlando, FL - VFW Hall, 4444 Edgewater Dr.
9 am-1 pm - Spring Meet
1 pm-close - Special Estate Auction
Info: Dennis - (407) 895-0146, days
Paul - (407) 365-9305, eves.

CALIFORNIA - May 4

**CALIF. HISTORICAL RADIO SOCIETY
SWAP MEET**

Los Altos Hills, CA - Foothill College
Exit Magdalena off 280 Freeway - 8 am
Info: (415) 978-9100

NEW JERSEY - May 11

**ANTIQUE WIRELESS ASSOCIATION
NORTHERN NEW JERSEY MEET**
Schooley's Mountain, NJ - The Inn at
Schooley's Mountain, on Rt. 517

8 am - Traders Market
12:30 pm - Lunch
Info: Lauren Peckham, Box E,
Breesport, NY 14816 - (607) 739-5443

NEW YORK - May 4

**ANTIQUE WIRELESS ASSOCIATION
NEW YORK SPRING MEET**

Bloomfield, NY - Routes 5 & 20
Annex and American Legion Hall
8 am-12 noon - Flea Market
10:30 am - Annex Auction
12 noon - Buffet Luncheon (reserve ahead)
1 pm - Members' Auction
AWA Museum open right after auction
Info: Bruce Kelley, 59 Main Street
Bloomfield, NY 14469 - (716) 657-7489

COLORADO - May 12

**COLORADO RADIO COLLECTORS
MEETING**
Denver, CO - SouthWest Bank Bldg.
1380 So. Federal Ave., Community Room
1 pm - Meeting,
followed by Swap Meet in parking area
Info: Rick Ammon - (970) 221-4001

OHIO - May 17-19

45th DAYTON HAMVENTION

Dayton, OH - Hara Arena

Exhibit Hours:

May 17: noon-6 pm

May 18: 8 am-5 pm

May 19: 8 am-2 pm

A.R.C. at Booth #207

New Wireless Pioneers at Booth #206

Info: Dayton Hamvention, PO Box 964

Dayton, OH 45401 - (513) 276-6930

OHIO - Jun. 21-22

SOCIETY FOR PRESERVATION OF ANTIQUE RADIO KNOWLEDGE RADIORAMA 96

Cincinnati, OH - Signature Inn, Turfway Rd., Florence, KY 41042 - (606) 371-0081

Fri.: Dawn - Swap Meet starts

10 am-5 pm - Open Exhibition

7 pm - Seminar

Sat.: Dawn - Swap Meet starts

Info: Richard Arter, 307A Junemarie Dr.

Lebanon, OH 45036 - (513) 258-8300

PENNSYLVANIA - May 18

CENTRAL PA. RADIO COLLECTORS CLUB - 3rd SWAP MEET

Williamsport, PA - Trinity Episcopal Church

844 W. Fourth St., Maynard St. Exit

8 am - ?

Info: Frank Hagenbuch - (717) 326-0932

Mike Heffner - (717) 546-2907

WASH. - Jun. 27-29

RADIO ENTHUSIASTS OF PUGET SOUND - RADIO SHOWCASE IV

"Twisting the Dial in 1946"

Seattle, WA - Overlake Hospital

Conference Center-Bellevue

Thurs. event at Museum of History & Industry

Hotel: West Coast Bellevue - (206) 455-9444

Info: REPS Radio Showcase

9936 N.E. 197th St., Bothell, WA 98011

MINNESOTA - May 31-Jun. 1

NORTHLAND ANTIQUE RADIO CLUB PAVEK MUSEUM OF BROADCASTING RADIO DAZE '96

Golden Valley, MN - Best Western

4820 Hwy 55 - (612) 588-0511

Info: Joe Gruber - (612) 489-5552

NARC, PO Box 18362, Minneapolis, MN 55418

A free* listing on these pages is available for each coming radio event. Sponsors should provide description of event, date, time, place, directions, & information/contact person. Since listings are on a "space available" basis, no guarantee of listing is made.

Submission Deadline - 5th of month.

*Club/museum/non-profit events are listed free; other events are obtained from advertisements placed elsewhere in A.R.C.

Although non-members are welcome at all events, joining may be required at some. Admission is charged at some events.

BUSINESS CARD ADS - \$45.00 FOR 3 MONTHS

TV • VCR • RADIO • TUBES & ANTIQUE ELECTRONICS



Loubriel Repair Service

Joseph Loubriel
Technician

Office: 901-387-6665

Fax: 901-387-8701

Home: 914-351-5868

99 East Quechenbush

Dumont, NJ 07628

Antique Radio Hardware

- Knobs, handles, pendants, pulls, etc.
- Original dies for hundreds of different patterns dating back to 1920
- Specializing in solid brass hardware

Will cater to your needs - Even single piece orders
Send \$3 for catalog (refunded from 1st order)

GUY FREDERICK - (616) 456-9378

1121 Powers NW, Grand Rapids, MI 49504

WRIGHT'S ELECTRONIC SERVICE THE RADIO DOCTOR

"You Don't Have To Worry When It's Done Wright"

1920-1980's RADIOS-PHONOS-CAR RADIOS-TUBE AMPS

CHASSIS REPAIRS FROM SIMPLE TO COMPLETE REFURBISHMENT
MOST REPAIRS FROM \$25 MOST REFURBS \$50 TO \$100

WRIGHT'S ELECTRONIC SERVICE
(206) 859-3592

P.O. BOX 8252
FEDERAL WAY, WA 98003



ANTIQUÉ RADIO RESTORATIONS

109 S. Oak St., O'Fallon, IL 62269
618-632-7423

Electronic Consultant

Dial Reproductions

Hickok Tube Testers, Service & Calibration

Life Member I.E.E.E.
AWA, ARCA, MAARC

Clinton Blais, P.E.

BUSINESS CARD ADS - \$45.00 FOR 3 MONTHS

Carbon Resistors • Capacitors • Vacuum Tubes

ALLTRONICS

Electronic Component Supply

2300 Zanker Road • San Jose, CA 95131

Voice (408) 943-9773 • Fax (408) 943-9776

BBS (408) 943-0622 • 24 Hrs. • N-8-1

Call or Fax for Catalog

50 years

CHUCKS

of service!

**Any Tube Radio Repaired and
Guaranteed to work good.**

\$25 plus parts & UPS

CHUCKS

167 LYNN DRIVE - PO Box 598

NEW HAVEN, WV 25265 - Ph (304) 882-2220

78 RPM Cartridges Repaired



Dead cartridges rebuilt right. New crystals etc., as needed. Allow 3-4 weeks. Most crystal and "horseshoe" magnet types \$34.50
100 hr. sapphire setscrew needles (list \$2.50 ea.) ... 4/\$5.50



Joe Smolski
835-A Pleasant Street
Framingham, MA 01701

Inquiries: (508) 879-2778, evenings and weekends. Prices include return postage. Please include payment with order.

PHILCO PREDICTAS WANTED:



BUY • SELL • TRADE • RENT • RESTORE

DAVID WEDDINGTON
(615) 890-7498

2702 Albany Ct.
Murfreesboro, TN 37129

ELECTRON TUBE ENTERPRISES

BOX 8311 11 LINDEN LN

ESSEX, VT. 05451

BUY

TEL: 802-879-1844

SELL

FAX: 802-879-7764

INTERNET: ETETUBES@AOL.COM

WRITE FOR FREE 1996 CATALOG

(Lowest prices for new & used tubes)

INSTRUMENTS



Jim & Rhoda
Morris

Radio, Telegraph,
Historical Instruments,
& Books For Sale
Catalogs
& Lists
Available

Antiques of Science & Technology

A of ST Box 1852 Wakefield Ma. 01880 U.S.A.
Tel 617 245 2897 Fax 617 245 3572

COMMNAV EQUIP
RADIO SETS
NAVAL AIR FIELD
U.S. FOREIGN

CHARLES DICICHA KAI GON
501 MYSTIC VALLEY PKWY
SHEFFORD, MASS 02159
PHONE: 617-394-9354



MILITARY ELECTRONICS

BUY

WANTED

TRADE

"The Early Sound Man"

Mt. John P. Andolina, Jr.

Antique Phonographs



Collect • Repair • Restore
Edison, Victor, Columbia
Cylinder • Disc Records
Phonograph Advertising
Quality Repairs Since 1973

28 Glen Oaks Dr.
Rochester, NY 14624
(716) 247-3056
Reasonable prices



AWA
Member

REPRODUCERS PHILCO



THE FINISHING TOUCH



Jodd E. Hinman Restorations

SHOW WINNING FINISHES

— AUTO INTERIOR WOOD —

- RADIOS
- MECHANICAL
- 78 RPM JUKEBOXES
- ELECTRONICS



203-274-0705

203-268-6060



**182 JUDD FARM ROAD
WATERTOWN, CONN. 06795**



All Tube Equipment Repaired



"The Fisher Doctor"

Al Pugliese
718-948-7489

27 Daleham Street
Staten Island N.Y. 10308

VINTAGE FISHER PRODUCTS
Bought • Sold • Traded • Repaired

SUNSHINE SOUNDS

WANTED:



Hi Fi TUBE & COMMERCIAL AMPS

McIntosh, Marantz, Dynaco, Heath,
Altec, Scott, RCA, Fisher, Craftsman,
Grommes, Fender, Ampex, W.E. Vox,
Brook, Acro, Pultec, Fairchild

SPEAKERS & HORNS

Altec, Jensen, RCA,
E.V., Western Electric,
JBL, Tannoy

Phone: 405-737-3312 or Fax: 405-737-3355
Sonny - 1413 Magnolia Ln., Midwest City, OK 73110



WAVES

ANTIQUES, EARLY RADIOS &
PHONOGRAPHS

BOUGHT • SOLD • REPAIRED
OPEN 12 - 6, SAT. 12 - 5
CLOSED SUN. & MON.
Phone: 212 989-9284

32 EAST 13TH ST., NEW YORK, N.Y. 10003
Fax: 201 461-7121 / E-Mail: CIWaves@aol.com
PROPRIETORS Bruce and Charlotte Mager

BUSINESS CARD ADS - \$45.00 FOR 3 MONTHS

SPY EQUIPMENT WANTED!

- Code Machines
- Secret Radios
- Clandestine Weapons
- Secret Cameras
- OSS, SOE, CIA, KGBI
- I Buy or Trade!

Keith Melton
P.O. Box 5755 Bossier City, LA 71171
(318) 747-9616 Days: FAX (318) 747-9010



If you buy, sell or like Jukeboxes you need ALWAYS JUKIN--THE MONTHLY JUKEBOX MAGAZINE!! Subscribers in 23 countries, ALWAYS JUKIN LEADS THE WAY: Articles, photos, show reports, ads, new products, price guides, restoration tips, repairs--everything you need to know about JUKE-BOXES--the fastest appreciating collectible in the world!!! Fun & a great investment. Sample copy, \$3. \$33 per year. ALWAYS JUKIN, 221 YESLER WAY AR, SEATTLE, WA. 98104. (206) 233-8480. Master/Visa ok.



HAROLD C. BRAMSTEDT

C & N ELECTRONICS
6104 Egg Lake Road North
Hugo, MN 55038



- Buy
- Sell
- Transmitting & Industrial Tubes

612-429-9397
800-421-9397
Fax 612-429-0292

SPEAKER PLACE NEW-FOAM

3047 West Hennetta Road • Rochester, New York 14683

Phone Toll Free	Fax Toll Free	Voice Mail Toll Free
1-800-NEW-FOAM	1-800-2FX-FOAM	1-800-FOAM-MAIL
1-800-639-3626	1-800-239-3626	1-800-362-6624

Mon, Tues. & Thur 10:30-6:00 Woofers Mid Ranges Tweeters
Wed & Fri 10:30-8:30 Crossovers, Grille Cloth, Horns
Sat 10:30-5:00 Voice Coils, Books & Accessories

VISA MC Speaker Repair & Replacement Parts AMEX DISC
Nationwide Service Since 1979

WE RE-FOAM AND RE-CONE SPEAKERS



30 years experience Jackson Speaker Service

Expert Antique Loudspeaker Repairs
(Cone Types) And Rebuilding A Speciality.
Speaker Parts And Repair Service On
Virtually Any Speaker Made Including
Stereo, P.A., And Antique Auto Speakers.
217 Crestbrook Dr. Owner
Jackson Mich 49203 Ron McGee
Ph.-(517)789-6400, Ans. 4th ring
Wk-days 10:am-7pm Wk-Ends 9-5pm



Get your ZENITH Transoceanics working again... on batteries! It only takes 6, maybe 7 "D" cells. You need the PORTA-POWER, CVA-9 converter. It works on others sets too.

You can get everything you need directly from me at the new low price of \$84.50 plus \$4 shipping. Over 200 sold! Peter Yanczer
TESLA ELECTRONICS (314) 822-1748
836 BRICKEN, ST. LOUIS, MO 63122



CRYSTAL SETS

PARTS - PLANS - KITS - BOOKS
CATALOG \$1.00

Largest source of Vintage and New Variable Air Condensers, Variometers, Vario-Couplers, Tap Switches, Tap Points, Galena and Germanium Detectors, Detector Stands, Cat Whiskers, Terminals, Sliders, Headsets, Dial Knobs, Coil Forms, Magnetic Wire, etc.

MIDCO
P.O. Box 2288
Hollywood, FL 33022
(305) 925-3670
B.A. Turko, Ph.D.E.E.

USED TEST EQUIPMENT

Bought & Sold * NOS & Used Parts

HP - TEK - GR - Measurements Corp. - Heath - EICO

Boca Electro Magnetic Lab

21218-10 St. Andrews Blvd.

Boca Raton, FL 33433

(407) 750-8911

Buy

Sell

Trade

(510) 490-5842

Fax (510) 490-1961

Speakerworld®

Expert Speaker Refoaming and Reconing

2000 Warm Springs Ct. #6 Visa/ *Free Return
Fremont, CA 94539 MC Freight by UPS

*For Antique Speakers Only

Vintage Radio

- ◆ Repairs
- ◆ Restorations
- ◆ Specializing in all tube type car and home radios
- ◆ FM additions

Bob's Radio & TV

2300 Broad St
San Luis Obispo
California 93401
(805) 543-2946

Full warranty on work performed, walk-ins welcome, stop by and see our antique radio museum

CAPACITORS - TUBES RADIO SERVICE ITEMS

Thousands in Jam-packed illustrated 24-page catalog No. 49

INFORMATIVE INTERESTING FUN-TO-READ

Send \$3 U.S./Canada \$5 overseas (U.S. funds) for a Heavy-Paper limited edition copy NOW!

DON DIERS 4276 North 50 St. Dept. AB8
Milwaukee, WI 53216-1313

Phono Needles/Style 1500 Types
Magnetic - Ceramic - Crystal Cartridges



Rebuild Astatic and All Types of Crystal Ceramic Cartridges



Rebuild Obsolete Idlers New Idlers and Belts Fabricate 78 RPM Needles

West-Tech Services

648 N. Ridgewood Dr. #11
P.O. Box 1415
Sebring, FL 33871

STEVE KARPIAK C.E.T.
Phone (941) 471-0822

BUSINESS CARD ADS - \$45.00 FOR 3 MONTHS



K4GIT

RADIO ELECTRIC SUPPLY

We Specialize In Receiving and Special Purpose Tubes

Send For Price List

Dorothy and Don Gies
Owners

Box 2790 RR#2
Melrose, FL 32666

904-475-1950
Phone or Fax

**PUT
YOUR BUSINESS CARD
HERE!**

\$45 FOR 3 MONTHS - \$78 FOR 6 MONTHS
DON'T HAVE ONE? SEND AN EXTRA \$6.50 AND
WE WILL TYPESET ONE FOR YOU.

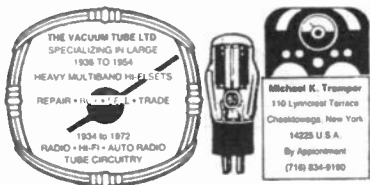

MAGNAVOX STROMBERG-CARLSON MIDWEST HOWARD

FRANK'S RADIO SHOP
National Schools 1952 graduate

Repair & Restore of tube radios and
SW communication receivers

Frank Martinho

3511 Rowley Dr. San Jose, Ca. 95132
Ph (408) 946-0240 - Fax (408) 942-9786

5,000,000 Vacuum Tubes In Stock
Industrial & Receiving Types

Electronics Emporium Inc.
107 Trumbull Street
Elizabeth, NJ 07206

Buying & Selling, Call For Prices & Delivery

800 - OLD TUBE
(653 - 8823)

Ph: 908-351-0100

Fax: 908-351-8600

Allan H. Weiner
Radio Engineer
Antiques of Technology

Electrical, Electronic, Scientific, and
Mechanical Artifacts.

Early WWII Radar a Speciality.

97 High St.

Kennebunk, ME 04043

(207) 985-7547

Buy • Sell • Trade

* GRUNDIG • SABA • TELEFUNKEN • NORDMENDIE • PHILIPS • SIEMENS •
- SPECIALIZING IN REPAIR OF EUROPEAN RADIO SETS -

**The Bavarian
Radio Works**



Ross A. HOGSTRASSER
(617) 447-4299

162 DEVLIN ST.
WHITMAN, MA 02382

LOGANS TV-RADIO

SINCE 1952

BUY • SELL • TRADE

100's of N.O.S. PARTS, TUBES IN STOCK.
PARTIAL OR TOTAL RESTORATION AVAILABLE.

412-837-5580

REAR 526 MT. PLEASANT ST., GREENSBURG, PA 15601

WANTED
PRE 1900
ELECTRICITY
MEDICAL • X-RAY
TELEGRAPHY • TELEPHONE
PRE 1925
RADIO • WIRELESS
PRE 1940
TELEVISION



**NEW WIRELESS
PIONEERS**
P.O. BOX 398
ELMA, NY 14099
716-681-3186

BOOKS • TUBES • ARTIFACTS
MAGAZINES • AUTOGRAPHS
CATALOGS • EPHEMERA

**WHAT...
You have CATALINS?**

I'll Pay Top \$'s - Any Models

Please Send a Photo and Price To:

Kunihiro Suzuki

2173 Takao, Fukuroi-Shizuoka, Japan 437
(Fax) 81 538 43 3188

RADIO BOOKS FOR SALE

Large selection of books on Radio and Related Technology

Call or write for our List of Catalogs.

Always buying, single items or collections.

RAINY DAY BOOKS

P.O. BOX 775, FITZWILLIAM NH 03447

(603)-585-3448

**** WANTED ****

Masco, Newcomb PA Systems
Turner, Shure, Astatic Mics
Jensen 8", 10" speakers,
any condition.

* Gary (203) 777-7426 *

BUSINESS CARD ADS - \$45.00 FOR 3 MONTHS

VINTAGE RADIO SERVICES

Ken Hubbard
KA9WRN

Repair of
Vacuum Tube
Equipment

P.O. Box 792
Beloit, WI 53512-0792
(608) 362-1896
6 pm Evenings

Home-Auto

REPAIRS • BUY • SELL • TRADE

PRE '65 AC SETS & CAR RADIOS

FRED'S OLD RADIO EMPORIUM
1612 WEST 7TH AVENUE
CORNICANA, TEXAS 75110

F.L. GORDON, PROPRIETOR
BUSINESS (903) 874-5185 HOME (903) 874-7147



ESTES AUCTIONS

Specializing in Vintage Radios

7404 Ryan Rd.
Medina, Ohio 44256

Bus. Phone 216-769-4992
Fax 216-769-4116
Res. Phone 216-769-3987

RADIOS & STRANGE MISCELLANEA IF YOU VISIT THE BRIMFIELD FLEA MARKET... STOP BY FIRST!

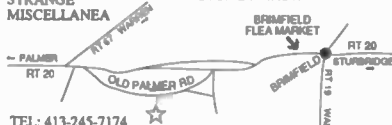

TEL: 413-245-7174

COUNTRY ROAD BARN - BERNIE SAMEK
OLD PALMER ROAD, BRIMFIELD, MASS.

WANTED

SELECTONE

Transformers • Coils • Condensers
Radios

John T. Meredith
2462 Stantonburg Road,
Suite 152
Greenville, N.C. 27834

(919) 551-1882

We have been supplying quality electronic parts to satisfied customers for 25 years.
Call or write for our monthly flyers.

Phone/Fax (702) 795-7151

STAR-TRONICS

P.O. Box 98102
Las Vegas, NV 89193-8102

Are You Looking For Antique Radios, Parts, Tubes, Schematics and Restoration Services?

For Free Flyer, a 2-Stamp LSASE is required to insure a response to your request. Send to:

Olde Tyme Radio Company
2445 Lyttonville Road, Suite 317
Silver Spring, MD 20910

Wish to contact us by phone or fax?

Our number is (301) 587-5280.

Please call 10 am to 10 pm (Local Time)

Antique Radios



David & Nancy Snow

P.O. Box 6352
Jackson, MI 49204
(517) 787-2985

We Buy, Sell, Repair

ARBE - III Battery Eliminators

1920-1970
SCHEMATICS + PAGES OF INFO
\$5.00 POSTPAID

MANUAL PRICES - SASE
RADIO/TV/HAM/MISC.

"IF I DON'T HAVE IT, YOU
PROBABLY DON'T NEED IT."

ALTON H. BOWMAN - 4172 EAST AVENUE
CANANDAIGUA, NY 14424-9564

ANTIQUÉ RADIO REPAIR

Repair - Restore - Buy & Sell

Schematic Service
Radios \$2.⁵⁰, TVs \$4.⁵⁰

DAMASKE ELECTRONICS

S74-W16834 Janesville Road
Muskego, WI 53150
Phone: (414) 679-0838



New/Old Stock Parts
Reproduction Items
Books & Refinishing Supplies

\$2.00 for 20 page catalog.
Refundable with first order.

Vintage Tv & Radio

3498 West 105 St. Cleveland, OH 44111
216-671-6712

Radio & TV Tubes

— New Old Stock —

Call/write for price list & availability

db ELECTRONICS - 105 Rt. 47 South
Cape May Court House, NJ 08210
609-465-5005

BUSINESS CARD ADS - \$45.00 FOR 3 MONTHS

784-9417

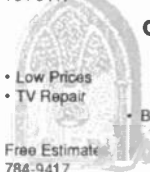

COSMOS TV

- Low Prices
- TV Repair

Free Estimate
784-9417

784-9417



- Quality Used TVs
- Antique Radio Repair
- Buy, Sell, Trade

5919 15th Ave. N.W.
Seattle, WA 98107

WANTED: Tube Hi-Fi Components & Commercial Amplifiers of the 1950's & 1960's

**Marantz, McIntosh, Scott, Fisher, Brook
Acrosound, Brociner, Western Electric
Fairchild, Altec, Tannoy, JBL**

Richard Sharisky (617) 484-5784, phone
P.O. Box 521 (617) 489-6592, fax
Belmont, MA 02178

Free Estimates
Hrs - 10 AM - 7 PM EST.
Tues - Sat

Tel./Fax (860) 928-2828
E-Mail: otradiodoc@aol.com



ANTIQUE RADIO RESTORATION & REPAIR

1920 - 1960's



BOB ESLINGER

Buy & Sell
Reasonable Rates, Tubes, Professional
Overhauls, Cabinet Refinishing. Service
For All Antique Car, Table & Console
Radios, Communication Receivers &
Tube Amplifiers.

20 Gary School Road
Pomfret Center, CT 06259

VINTAGE HI-FI EQUIPMENT & NEW OLD STOCK TUBES WANTED

We also buy Used, New, & Vintage
Speakers, amps, parts, guitars, and pedals
Any condition - working or not
Top prices and shipping paid

GUITAR OASIS

7451 Warner Avenue, Suite 1 - Huntington Beach, CA 92647
Phone (714) 842-7402 - Fax: (714) 842-7462
MON-FRI 9:30-7:00 PST • SAT 12:00-6:00 PST

ANTIQUE RADIO RESTORATION

Since 1936 Repair - Buy - Sell
Complete Restorations • Prompt Service

COOPER'S RADIO SERVICE

425 Court Street
Rockwell City, Iowa 50579



LARRY COOPER
712-297-7232



PR NOVELTY

Glass Audio Specialists
Amplifier Rebuilding • Service
Surplus Parts Brokerage
(New Old Stock and Used)

Paul Dorobinski Audio Technician PO Box 140 • Mukwonago • WI 53201
Robin Richards General Manager 414 964 3392

Old Time Replications

"TURN TO US WHEN YOU NEED KNOBS"
KNOBS • PUSHBUTTONS • ESCUTCHEONS
PLASTIC GRILLS • HANDLES

LARRY BORDONARO

5744 TOBIAS AVE. VAN NUYS, CA 91411
PHONE (818) 786-2500 • FAX (818) 909-0241

WANTED ! JAPANESE MILITARY RADIOS

any kind of WW-2 radios & aircraft instruments

Takashi Doi



FAX : 011-8145-301-8069
1-21-4, Minamidai, Seyaku, Yokohama, Japan



HARD TO FIND BATTERIES

that really run your antique radios!!
1 1/2 to 135 volts of various sizes &
shapes! Also available: new & used panel
meters; VTVM & multimeters; JAN
16mm projectors, UHER reel-to-reel
recorders and more! Wanted: Meters &
reel-to-reel recorders.

S&G ELECTRONICS 618 S 62nd St, Phila, PA 19143
Phone 215-474-7663 — Fax# 215-726-9761

BETA-TEK ANTIQUE RADIO SERVICE

- Repair of Radios, Communications
Receivers & Test Equipment
- Power Supplies for Battery Sets



RAY BINTLIFF
2 Powder Horn Lane
Acton, MA 01720
508 263-7435



THE RADIO MAN

Buy-Sell-Trade
Antique Radios • Tubes • Parts

DICK MORGAN
RES: (214) 564-6464

TEL: (214) 276-5458
FAX: (214) 272-1831
P.O. BOX 461485
GARLAND, TX 75046-1485

20 Years
Experience

Telephone/Fax
1-615-456-2529

Specializing in Antique Speaker Repair

- Very large stock of vintage parts
- Can repair most any cone-type speaker
- Field coils rewound
- Fast turn-around
- Reasonable prices

Work
Guaranteed

Hank Brazel
103 N. Lake Point Ct.
Crossville, TN 38555

Radio Manufacturers of the 1920's

BY ALAN DOUGLAS



“The definitive book on American broadcast receivers of the 1920s”

Volume 1: A-C Dayton - Adams Morgan - Air-Way - All-American Mohawk - American Bosch - Amrad - Amrad S-Tube - Apex - Atwater Kent - Bremer Tully - Browning-Drake - Clapp-Eastham - Crosley - Cutting & Washington - Day-Fan - DeForest - Eagle - ERLA - FADA - Federal - Ferguson. 225 Pages.

Volume 1: \$24.95 (softcover only)

Volume 2: Freed-Eisemann - Eisemann - Freshman - Garod - Gilfillan - Grebe - Howard - Jones (Lester/Melco) - Jones (Jos.) - Kellogg - Kennedy - King - Kodel - Kolster - Leutz - Magnavox - Majestic - Marti - Metro - Klitzen/Michigan - Midwest - Mu-Rad - Murdock - Music Master - Neutrowound - Operadio - Ozarka - Pfanstiehl - Philco - Pilot - Priess. 266 Pages.

Volume 2: \$29.95 (softcover only)

Volume 3: RCA - Scott - Silver-Marshall - Slagle - Sleeper - Sonora - Sparton - Splitdorf - Steinite - Stewart-Warner - Stromberg-Carlson - Thermodyne - R.E. Thompson - Thorola - Tri-City - C. D. Tuska - Ware - Western Coil - Western Electric - Workrite - Zenith. 292 Pages.

Volume 3: \$29.95 (hardcover: \$39.95)

U.S. Orders - Enclose \$3.00 per order for packing & book-rate shipping if total order is under \$35.00. If using VISA or MasterCard, include name on card, card number and expiration date. Send payment with order. Mass. residents please add 5% sales tax. Money back return policy. Most orders shipped the same day received, but allow 2-4 weeks to receive order. Foreign orders - write for shipping costs, or use credit card and specify air or surface (allow 2-3 months for surface shipping).



Send Order To: A.R.C., P.O. Box 2, Carlisle, MA 01741
or Call: (508) 371-0512

Fax: (508) 371-7129



Radios

of the Baby Boom Era

Six Volumes — 2000 pages — From Sams' Archives
 1946 to 1960 — 274 Brands — 3494 Illustrations (E&W)
 6769 Models — Catalin, Bakelite, Wood, Transistor Radios & More



All Volumes Available!

Vol.	Brands	Included
1	56	Admiral to Clearsonic
2	54	Co-op to Geloso
3	58	GE to Monitoradio
4	36	Motorola to RCA Victor
5	35	Realtone to Stratovox
6	35	Stromberg-Carlson to Zenith



1/2 Page for each illustrated radio including:

- Large illustration of the radio including knob functions
- Short description of the radio
- Number of tubes
- Power supply type (AC, Battery, etc.)
- Tuning range
- Manufacturer
- Sams Photofact Set number & year Photofact published.

ALSO

- Index by model number listing tubes in radio
- List of similar radio models indexed to pictured radio
- List of manufacturers and suppliers indicating their brand names
- Basic trouble-shooting hints

Each Volume: \$16.95 – Softcover
 8 1/2" x 11" – Approx. 328 pages

U.S. Orders - Enclose \$3.00 per order for packing & book-rate shipping if total order is under \$35.00. If using VISA or MasterCard, include name on card, card number and expiration date. Send payment with order. Mass. residents please add 5% sales tax. Money back return policy. Most orders shipped the same day received, but allow 2-4 weeks to receive order. Foreign orders - write for shipping costs, or use credit card and specify air or surface (allow 2-3 months for surface shipping).



Send Order To: A.R.C., P.O. Box 2, Carlisle, MA 01741
 or Call: (508) 371-0512 Fax: (508) 371-7129



(Mar-86)

Books on Radio History



Empire of the Air by Tom Lewis. A biographical history of radio focusing on Lee de Forest, Edwin H. Armstrong and David Sarnoff. 1991. Illustrated. 421 pages.

\$13.00 - Softcover

\$24.95 - Video

Hertz: The Beginning of Microwaves by John H. Bryant. Photos and descriptions of Hertz's apparatus and experiments. A book prepared for the IEEE Hertz Centennial exhibit. 50 pages.

\$15.00 - Softcover



Wireless Communication in the United States by Thorn L. Mayes. Early development of American radio operating companies. Alternators, coherers, stock promotions, unpublished letters, etc. 160 illustrations. 240 pages.

\$29.95 - Softcover

Inventing American Broadcasting by Susan J. Douglas. A careful weaving of technology, social forces, and business decision making from the days of Marconi to broadcasting in the 1920s. 1987. 363 pages.

\$14.95 - Softcover



Synphony and Spark by Hugh G. J. Aiken. Subtitled "The Origins of Radio." Describes the development of radio from Maxwell's work in the 1860s through the contributions of Hertz, Lodge and Marconi. Reprint. 1976. 347 pages.

\$16.95 - Softcover

U.S. Orders - Enclose \$3.00 per order for packing & book-rate shipping if total order is under \$35.00. If using VISA or MasterCard, include name on card, card number and expiration date. Send payment with order. Mass. residents please add 5% sales tax. Money back return policy. Most orders shipped the same day received, but allow 2-4 weeks to receive order. Foreign orders - write for shipping costs, or use credit card and specify air or surface (allow 2-3 months for surface shipping).



Send Order To: A.R.C., P.O. Box 2, Carlisle, MA 01741
or Call: (508) 371-0512

Fax: (508) 371-7129



Transistor Radio Books



Price
Guide

The Collector's Guide to Transistor Radios 2nd Edition by Marty & Sue Bunis. *This book will help you identify the most sought-after vintage transistor radios. Over 2,900 models listed, all with current prices. Includes radio club listing. 375 all new color photos. 5 1/2" x 8 1/4". 320 pgs. 1996.*

\$16.95 - Softcover

(1st edition still available for \$15.95)

NEW

Made In Japan by Roger Handy. *A stunning book on the development and growth of the transistor radio featuring over 175 transistor radios in full color. 10" x 9 3/4". 108 pgs.*

\$16.95 - Softcover



The Portable Radio in American Life by Michael Schiffer. *Approximately 50 pages on transistor radios, beginning with the Regency TR-1 through to the later sets made overseas. 450 photographs, 193 transistor radios pictured. 8 1/4" x 11". 259 pgs.*

\$24.95 - Softcover

\$45.00 - Hardcover

Collector's Guide to Novelty Radios by Marty Bunis & Robert Breed. *This book is the source for novelty transistor radios in all shapes and sizes. Radios are described in detail with current prices. Over 600 all new color photographs. 8 1/4" x 11". 224 pgs.*

\$18.95 - Softcover



Price
Guide



Price
Guide

Transistor Radios, A Collector's Encyclopedia and Price Guide by David Lane & Robert Lane. *Identification & price guide to over 2,500 transistor and novelty radios. History & key to collecting chapters. 8 1/4" x 11". 170 pgs.*

\$19.95 - Softcover

U.S. Orders - Enclose \$3.00 per order for packing & book-rate shipping if total order is under \$35.00. If using VISA or MasterCard, include name on card, card number and expiration date. Send payment with order. Mass. residents please add 5% sales tax. Money back return policy. Most orders shipped the same day received, but allow 2-4 weeks to receive order. Foreign orders - write for shipping costs, or use credit card and specify air or surface (allow 2-3 months for surface shipping).



Send Order To: A.R.C., P.O. Box 2, Carlisle, MA 01741
or Call: (508) 371-0512

Fax: (508) 371-7129



(Apr-96)

COLLECTOR BOOKS AVAILABLE FROM A.R.C.

- BOOKS MARKED WITH "NEW" ARE THE MOST POPULAR AND ARE ESPECIALLY RECOMMENDED FOR NEW COLLECTORS!**
- Antique Radio Restoration Guide, 2nd Ed., Johnson.** *Beginner's introduction to troubleshooting and repairing AC table model radios.* 1992. 145 pgs. \$14.95
- The AWA Review.** *Collections of articles.* Vol. 6: *Hawaiian Wireless, U.K. TV, SCR-RC-BC Dir., NYC Wireless, etc.* Vol. 7: *Poldhu xmitters, Navy Equipment, Arc xmitters, etc.* Vol. 8: *Keys, Federal Co., KFS-Federal-Mackay Story, Nat'l Electrical Supply Co., Navy Electronics Dir., etc.* Vol. 6-8, ea. \$10.00
- Vol. 9: Marconi, The Int'l Contest for Radar, The Magnetron Story, F. Lowenstein, Ham Licensing.** Vol. 9 \$17.00
- The Antique Radio Boys and the Garrulous Grebe, Dryer.** *Thrilling adventure story written in the traditions of the '20s and '30s.* 5 1/2" by 8 1/2". 51 pgs. \$4.95
- The Auto Radio: A Romantic Genealogy, Matteson.** *Info, photos & ads from the early days of the auto radio through the 1950s.* 316 pgs. (hardcover) \$34.95
- Behind the Front Panel, Rutland.** *Reviews radio circuits and radio history. Easy descriptions.* 25 pics. 158 pgs. \$18.95
- Blast from the Past, A Pictorial History of Radio's First 75 Years, Rhoades.** *The performers, programs, & technology that made radio a part of everyday life. 100s of never-before-published photos.* (hardcover) NEW \$39.95
- Broadcasting's Forgotten Father: The Charles Herrold Story, Adams.** (Videotape, VHS). *One-hour documentary on this amazing inventor. Featuring his family, students, and photos to document his work.* \$29.95
- Classic TVs, Wood.** *Prewar to 1950s, with price guide.* 140+ color photos, plus repros of catalogs & ads. 86 pgs. \$16.95
- The Collector's Guide to Antique Radios, 3rd Ed., Bunis.** *This guide covers radios from 1920s to 1960s. Over 8,500 prices and over 650 all new color photos are included.* 1994. 278 pgs. \$18.95
- The Collector's Guide to Novelty Radios, Bunis & Breed.** *The source for novelty transistor radios. Full descriptions with current prices. Over 600 color photos.* 1994. 224 pgs. \$18.95
- The Collector's Guide to Transistor Radios, 2nd Ed., Bunis.** *Identifies the most sought-after vintage transistor radios. Includes club listing. Over 2,900 models, 375 all new color photos, with current prices.* 1996. 320 pgs. NEW \$16.95
- Communication Receivers, 3rd Ed., Moore.** *Information on 738, 1932 to 1981, vacuum tube receivers by 66 manufacturers. 402 radios illustrated. New section: 3 pages of military receivers.* 125 pgs. \$19.95
- The Complex Talking Machine, Reiss.** *A guide to restoration of antique phonographs.* 183 pgs. \$19.95
- Crystal Clear - Vintage American Crystal Sets, Crystal Detectors and Crystals, Sievers.**
- Vol. 1 - Comprehensive reference with 750 illustrations, 570 crystal sets, 341 detectors, 207 crystals.** 282 pgs. \$29.95
- Vol. 2 - 479 All new & different illustrations, more crystal sets, detectors and crystals identified.** 252 pgs. \$29.95
- E.H. Scott Radio Collectors Guide, 1925-1946, Clark.** *The reference for collectors of Scott radios, cabinets and accessories. Lists original prices of cabinets and accessories. Over 200 photos with descriptions.* 88 pgs. \$29.95
- Early Radio, In Marconi's Footsteps, Jensen.** *Realistic description of Marconi's work and his surroundings. Early construction projects with diagrams. Color and B&W photographs.* 170 pgs. (hardcover only) \$39.95
- Empire of the Air, Burns.** (Videotape, VHS). *2-hour video based on Lewis' book.* \$24.95
- Empire of the Air, Lewis.** *Biographical radio history on De Forest, Armstrong and Sarnoff.* 1991. 421 pgs. \$13.00
- Evolution of the Radio, L-W Books.** *Radios pictured and priced, plus reproductions of catalog pages and ads.*
- Vol. 1 - Eight-hundred + radios.** 1991. 227 pgs., 118 pgs. in color \$22.95
- Vol. 2 - Totally different from volume one with new photos, etc.** 1993. 654 color photos. 226 pgs. \$24.95
- Firco Radio Equipment, John Firth & Co., Inc. (reprint).** *Twenty-six-page booklet of the Firco Co.* \$4.95
- Fixing Up Nice Old Radios, Romney.** *Written by a retired radio instructor, this book covers Ohm's law, through battery sets, superhets and communications receivers.* 1990. 300+ figures, 185 pgs. \$25.00
- Flick of the Switch, McMahon.** *The classic photo reference guide for '30s - '50s radios.* 1000+ photos. 263 pgs. \$11.95
- Great Radio Personalities (reprint).** *B&W pics of the golden days of radio - Abbott & Costello, etc.* 128 pgs. \$11.95
- Guide to Old Radios - Pointers, Pictures & Prices, 2nd Ed., Johnson.** *Introduction to radio collecting. Includes hundreds of photos and a price guide.* 1995. 272 pgs. \$19.95
- Hake's Guide to TV Collectibles.** *Price guide and photos for 1600 TV shows, comic books, etc.* 1990. 185 pgs. \$14.95
- Heathkit, A Guide to the Amateur Radio Products, Penson.** *Documentation of all Heathkit's amateur radio products, a complete history of the company, 200+ sharp photos.* 256 pgs. NEW \$24.95
- Hertz: The Beginning of Microwaves, Bryant.** *Photos and descriptions of Hertz's apparatus and experiments. A book prepared for the IEEE Hertz Centennial exhibit.* 50 pgs. \$15.00
- Inventing American Broadcasting, Douglas.** *A careful weaving of technology, social forces, and business decision making from the days of Marconi to broadcasting in the 1920s.* 1987. 363 pgs. \$14.95
- Los Angeles Radio Manufacturing, Paul.** *History of radio manufacturers in the L.A. area from 1922 to 1942. Features Echophone, Giffillan, Jackson Bell & 9 others.* 88 pgs. \$10.50
- Supplement No. 1, Paul.** *Coverage of additional manufacturers, people and sets.* 1993. 48 pgs. \$6.75
- Made in Japan, Handy.** *A stunning book on the rise of the transistor radio. 175+ radios in color.* 1993. 108 pgs. \$16.95
- The Mechanics of Television, Yanczer.** *History and explanation of mechanical television, plus construction details for a working system.* 1987. 5 1/2" by 7 1/2", 170 pgs. \$24.95
- Most Often Needed 1926-38 Radio Diagrams and Servicing Information (reprint).** *600+ diagrams for mostly AC radios from '26-'38.* 240 pgs. \$11.95
- Novelty Radios, Breed.** *500+ transistor novelty radios in full color with current prices.* 1990. 217 pgs. \$24.95
- 1994 Price Update - Novelty Radios, Breed and Bunis.** 14 pgs. \$4.95
- Official Radio Service Manual (reprint).** *100s of pre-1930 circuits & notes.* 356 pgs. \$24.95
- Old Gramophones, Bergonzi.** *The development of phonographs and gramophones.* 64 photos 32 pgs. NEW \$4.95
- Old Radio Sets, Hill.** *The development of the radio from the late Victorian era until the late 60s.* 60 photos 32 pgs. NEW \$4.95
- Old-Time Radios! Restoration and Repair, Carr.** *How to repair vacuum-tube and transistor radios. A self-paced training guide.* 200 illustrations, 256 pgs. \$18.95
- Philco Radio: 1928-1942, Ramirez.** *A reference book on Philco. Shows receivers and company history year-by-year.* 464 color photos, 364 black & white photos and drawings. 1993. 160 pgs. \$29.95
- Portable Radio In American Life, Schiffer.** *Traces the development of the portable radio and how it affected American culture and society.* 450 photos and drawings, 259 pgs. (hardcover: \$45.00) \$24.95
- Poster's Radio & Television Price Guide, 1920 - 1990, 2nd Ed.** *875+ TV's, 650 transistor radios and 2,200 other radios listed. 600 sets illustrated, 75 in color.* 1993. 7" x 10". 264 pgs. \$17.95
- Price Guide to Plastic Collectibles, McNulty.** *Describes types of plastics, etc. (Radio is 8 of 207 pgs.)* \$17.95
- RCA Radiolas, Radiotrons, and Accessories (reprint).** *Twenty-page booklet summarizing RCA's 1926 product line including the Radiola III, 20, 25, 26, 28, etc.* \$4.50
- Radio Art, Hawes.** *A chronological, illustrated history of the technical and stylistic progress of the radio. Mostly British, but American sets are featured as well.* 250 photos, 150 in color, 128 pgs. (hardcover only) Low Price \$9.95
- Radio Art Postcard Deck.** *30 full-color photographs from Hawes' book.* \$7.50

COLLECTOR BOOKS AVAILABLE FROM A.R.C.

☞ BOOKS MARKED WITH "☞" ARE THE MOST POPULAR AND ARE ESPECIALLY RECOMMENDED FOR NEW COLLECTORS!

- Radio Collector. (Videotape, VHS). The five-part Emmy-nominated PBS series combined on one 130-minute videotape. Meet collectors, see collections, attend swap meets, learn about radio restoration. \$29.95
- The Radio Collector's Directory and Price Guide, 1921-1965, 2nd Ed., Grindler. Directory of over 20,000 radios by manufacturer, model number, year, etc., with prices. Radio history, cabinet styles, vacuum tube development chapters. Over 1,200 trade names listed. Thoroughly revised and expanded. 500 pgs. \$26.95
- Radio Collector's Guide, McMahon. Listing of 9,000+ radios made by some 1200 companies from 1921 to 1932. Gives manufacturer, year, model name and other info. No photos, 264 pgs. \$11.95
- The Radio Collector's Guide to Philco Bakelite Block Condensers, 2nd Ed., Bintliff. A detailed description of Philco Bakelite block condensers with illustrations and parts lists. 1995. 57 pgs. \$9.95
- Radio Craft - 50 Years of Radio (reprint). March 1938 issue of Radio Craft magazine. Numerous articles on the development of radio, then 50-years old, and on early radio pioneers. 144 pgs. \$15.95
- Radio Equip. & Supplies. (reprint). 1922 radio catalog, accessories, etc. RCA, Clapp-Eastham, etc. 168 pgs. \$19.95
- ☞ Radios-The Golden Age, Collins. Full-color book on the colorful Catalin and Bakelite radios from the late 1930s to the early 1940s. 128 pgs. (hardcover \$29.95) \$17.95
- Radio Horn Speaker Encyclopedia, Paul. Listing of horn speakers for over 320 manufacturers for the 1920s. Expanded information on ten manufacturers. Over 145 photos, 80 pgs. \$14.90
- Radio Horn Speaker Notebook, Rev. H. Paul. The companion to the Encyclopedia. Over 450 horn picture ads are shown, over 325 manufacturers are identified. Photocopy. New Index. 1995. 72 pgs. \$15.90
- ☞ Radio Manufacturers of the 1920's, Douglas. Three comprehensive volumes.
 Vol. 1 covers A-C Dayton thru Ferguson. 225 pgs. (softcover only) \$24.95
 Vol. 2 covers Freed-Eisemann thru Priess. 266 pgs. (softcover only) \$29.95
 Vol. 3 covers RCA thru Zenith. 292 pgs. (hardcover \$39.95) \$29.95
- Radio Poster, Sonoran Publishing. Color 20" x 26". A radio timeline. 20 radios from the Pup to transistors. NEW \$10.95
- Radio! Radiolot, 2nd Ed., Hill. Revised easy-to-read subject index, separate A-Z directory listing of 1,000+ British radio models with clearer photographs than first edition. 978 photos, 244 pgs. (hardcover only) \$44.95
- Radio Redux, Collins. Subtitled "Listening in Style." This book showcases the sleek lines and luscious colors of over 80 gleaming sets from the collection of Philip Collins. 120 pgs. (hardcover \$29.95) \$17.95
- Radio/TV Finder, Okolowicz. Reference to nearly 7,000 radio and TV pics found in 24 books. No photos, 110 pgs. \$13.95
- Radio & T.V. Collector's Guide Book, Biraud. The "Vintage Radio" illustrated guide to European sets from early wireless to the 1930s (a few later). Text is in both French and English. Vol. 1: History & Manufacturers A to P. 256 pgs. Vol. 2: P to Z & T.V., Speakers, Tubes, Loops, Parts & Novelties. 256 pgs. (Per Volume) \$49.95
- Radios by Hallicrafters, Dachis. The most definitive book on the company. Over 600 photos (some color) of everything they made. An invaluable tool for anyone interested in Hallicrafters. 220 pgs. (Available in Now) NEW \$29.95
- Radios of the Baby Boom Era. Pictures and info from Sams Photofacis. 3,494 radios illustrated plus 3,275 additional radios listed. 274 brands. 1946 thru 1960. Six volumes, 300+ pages per volume. Order by volume:
 Vol. 1: Admiral - Clearsonic. Vol. 2: Co-op - Celoso. Vol. 3: GE - Monitoradio. Vol. 4: Motorola - RCA. Vol. 5: Realtone - Stratovox. Vol. 6: Stromberg-Carlson - Zenith. (Per Volume) \$16.95
- Refinishing Old Furniture, Wagoner. Written by a furniture restoration instructor. A step-by-step guide to furniture (or radio) restoration, from removal of finishes right up to the final polish. 178 pgs. \$14.95
- Saga of the Vacuum Tube, Tyne. The development of vacuum tubes - 1880 to 1930. From Edison, Thomson and Fleming to de Forest, Philips, Siemens and many more. 100+ tube photos, 495 pgs. \$18.95
- Sound & Vision Yearbook 1995/96. An annual directory of radio & TV collectors, primarily European. \$6.95
- Syntony and Spark, Aiken (reprint). Subtitled "The Origins of Radio." Describes the development of radio from Maxwell's work in the 1860s through the contributions of Hertz, Lodge and Marconi. 1976. 347 pgs. \$16.95
- S. Gernsback Radio Encyclopedia (reprint). 1927 classic encyclopedia on radio. From "A" Battery to Zirconium, with 1000s of entries in between. 100s of illustrations, 175 pgs. \$9.95
- 70 Years of Radio Tubes and Valves, Stokes. The story of the radio tube from the laboratory to the commercial market. 247 pgs. \$25.95
- 75 Years of WE Tube Manufacturing, Magers. A log book history 750+ WE tubes. Illustrated. 133 pgs. \$16.95
- Tomart's Price Guide to Radio Premium and Cereal Box Collectibles, Tumbusch. Includes comic character, pulp hero, TV and other premiums. 1991, 3,000+ illustrations, 176 pgs. \$22.95
- Transistor Radios, A Collector's Encyclopedia and Price Guide, Lane. Identification guide to over 2,500 transistor and novelty radios. History and key to collecting chapters. 1994. 170 pgs. \$19.95
- ☞ Vintage Radio, McMahon. The classic photo reference guide for collectors of radios prior to 1930. Crystal sets, battery sets, tubes, horns, parts, etc. Over 1000 pictures, 263 pgs. (Temporarily Out-Of-Print) \$44.95
- The Weekend Refinisher, Johnson. A complete guide to stains and finishes and tips for setting up your own workshop. A handy furniture "first aid" kit for quick repairs. Illustrated. 296 pgs. \$10.00
- Westinghouse Catalog (reprint). 1920s catalog of the RA-DA and other early Westinghouse equip. 8 pgs. \$4.00
- Wireless Communication in the U.S., Mayes. Early development of American radio operating companies. Alternators, coherers, stock promotions, unpublished letters, etc. 160 illustrations, 240 pgs. \$29.95
- The Xtal Set Society Newsletter, Anderson. Complete set of the Society's newsletter. Order by volume. Vol. 1: 7/91 to 5/92 - Field Strength Meter, FM Xtal Set, Xtal Sets & Wireless, & more. Vol. 2: 7/92 to 5/93 - The Lead Pencil Detector, The Universal Xtal Set, etc. Vol. 4: 1/94 to 11/94 - Measuring Coil Capacitance, home-brew headphones and curve tracers, etc. Vol. 5: AM Receiver Design, Marconi Type 107, Radio Outfit in a Headset, & more. (Per Vol.) \$9.95
- The Xtal Set Handbook, Anderson. Formulas for coil inductance, a procedure for measuring coil capacitance, circuit matching theory, & more. Also included is Vol. 3 of the Xtal Set Society Newsletter. \$10.95
- Zenith Radio Corporation (reprint). The instructions for installation and operation for Models 39-39A Models 392-392A, and Electric Zenith Receivers. 3 schematics, 3 photos, 7 1/2" by 5", 16 pgs. \$4.50
- The Zenith Trans-Oceanic: The Royalty of Radios, Bryant and Cones. Presents the fascinating story of the development and use of the Trans-Oceanic. Several photos, documents, ads, etc. 160 pgs. \$24.95

U.S. Orders - Enclose \$3.00 per order for packing & book-rate shipping if total order is under \$35.00. If using VISA or MasterCard, include name on card, card number and expiration date. Send payment with order. Mass. residents please add 5% sales tax. Money back return policy. Most orders shipped the same day received, but allow 2-4 weeks to receive order. Foreign orders - write for shipping costs, or use credit card and specify air or surface (allow 2-3 months for surface shipping).



Send Order To: A.R.C., P.O. Box 2, Carlisle, MA 01741

or Call: (508) 371-0512

Fax: (508) 371-7129



(Apr. 96)



HARRY POSTER

BACK FROM OHIO AND NEW YORK TV SHOPS!

FOR SALE:
 RCA
 Radiola III



This is a clean and complete Radiola III, type R1, wooden two-tube radio from 1924. Nice condition with a 15 page taped original instructions. All you need are two tubes! Should be cheap at \$105

FOR SALE: Aeriola Sr.

This early 1920s wooden case opens to expose the controls and a VVD-11 (this one's a dud-but it looks good!) Missing the paper tag inside the lid, otherwise it's a really nice 1923 model with the molded bakelite panel and white lettering. Reasonably priced at only \$160

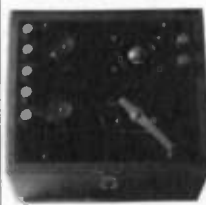

FOR SALE:
 General Electric
 Lighted Clock



This 16" diameter plastic clock plugs into the wall and lights up your shop (or display). Red and black lettering on the white background shows a GE tube box, plus "TV-Radio Service"...\$72



FOR SALE: Cunningham Tubes. Art Deco 26" wide gold and chrome sign, with a "rippled" glass front, orange glass with "Cunningham Tubes" and "RADIO...SERVICE". 1930's lighted sign..\$81

Picture Tube Rebuilding Oven

FORSALE: CRT rebuilding equipment! Here's your chance to rebuild those 10BP4s, 12LP4s, plus Predicta CRTs and all the other B&W (and color) picture tubes for TVs and scopes...and make some money too. We're getting 2 complete ovens and a lathe; start a business or just do your own thing. They're cheap--PLEASE CALL!

FOR SALE: Phonograph Needles CHEAP!

>>Gold counter display rack with over 160 new packages of Reco-ton diamond needles...\$47
 >>Electrovox yellow display. 4 drawers pull out to show about 65 packs of diamond needles \$31
 >>DSC Micro Diamond in blue plastic counter display box with over 80 packs of needles...\$38



FOR SALE: Automatic Radio sign. This is the first Automatic sign I've found! It's a 25" wide by 10" high hanging lighted unit with red, blue and black lettering. Looks and works great...\$84

FOR SALE: DuMont Sign.

Made in blonde and black painted wood, with black and gold lettering on the green painted body, this sign is about 13" high by 10" wide. Be a "Franchised Dealer" today! Circa 1948....\$79



FOR SALE: Crosley "Flag"
 White metal sign about 14" wide, lettered in red. Metal rod holds it 2 feet off the counter top \$35



FOR SALE: D-U-M-O-N-T. Mahogany base with DuMont cut-out blonde letters. It's about 12" wide, just right to put in front of your radio or TV display...\$66



FOR SALE: Westinghouse Sign. This is a lighted counter-top or wall hanger, 14" wide, "Westinghouse Television" in black, orange, and white. \$68



FOR SALE: RCA Tube Sign. 28" wide by 9" high, this has red and black on slightly yellowed white background. Lighted, with RCA logo on bottom right and left..\$66

PLEASE...if you send in an order (after you've called to confirm it), put your name, address, and order instructions (including duty info) in with your order!

CLASSIFIED ADVERTISING POLICY

ONE FREE 20-WORD AD for subscribers in each issue; additional words are 25¢ each. See details below. Classified ads sent by mail, fax or by any other method must be received (not just postmarked!) by Noon Eastern Time on the classified ad deadline date to guarantee inclusion in the current issue. Late ads are held for the following issue. Please enclose correct payment with all ads. Stamps or cash are OK for small amounts. (Canadian and other foreign advertisers, please see "Payment" on page 2 for methods.) *Free words* cannot be accumulated from month to month; free words must be requested when ad is submitted.

Faxed & e-mailed ads: Please see additional information on the inside front cover.

When including ads with other A.R.C. correspondence, write the ads on a separate piece of paper. Include SUB# with ad. Ads may be sent in advance; but, write each ad on a separate piece of paper and indicate the month (or successive two months) you want the ad to run.

To minimize our typing errors: Please write legibly. Use both capital and small letters. Do not use a dash between words. Carefully write the following numbers and letters (especially in model numbers) since some can look alike; for example, 1, I and l (the number one, the capital i and the small L.) Also: 0, O, o, Q and D; r and n; 6, b and G; V, U, u, v and Y; A and R; 5, S and 3; 2, Z and z. We try to correct spelling errors, so when using an uncommon word or manufacturer which we might mistake as a more common word or manufacturer, note it so that we do not "correct" it. Editor's annotations are in [brackets].

Advertising is accepted only for early items related to radio, communication, etc. All items must be described fairly; reproductions, reprints and not-original items must be so identified. Advertisers must agree to respond promptly to inquiries and orders, to resolve problems promptly if the buyer is not satisfied, and to comply with a buyer's refund request on unaltered returned items.

The publisher reserves the right to edit ads without notification to the advertiser and to reject ads for any reason. Names other than the advertiser will be edited out of ads. Ads with non-radio-related items will be returned or edited unless the non-radio-related items are for trade of radio-related items, or they are incidental to and appear at the end of an otherwise acceptable ad. The publisher is not responsible for errors due to illegibly written ads or for any other reason.

Clubs: Since club activities receive free coverage on the *Coming Radio Events* pages, the free 20 words may not be used for club activity ads. See inside front cover for additional information.

CLASSIFIED AD DETAILS

Deadline: NOON ET- 10th of the month!

Classified ads must have a standard heading such as WANTED, FOR SALE, FOR TRADE, FOR SALE/TRADE, SERVICES, MESSAGE, HELP, AUCTION, MEET, etc. This heading is the only bold or all-capitalized words allowed in the ad. Capitalize only manufacturer names, model names, etc. This standard ad format makes scanning the ads easier.

Before writing your ad, please look over the ads in a recent issue of A.R.C., and try to write your ad in the same style. Full name (or company name) and address is required in all classified ads; we will add it if you forget.

To encourage varied content of the ads, the same classified ad may be run only once per issue and for only two consecutive months. (To run an ad longer, use a boxed classified or display ad.)

Classified Ad Rates per Month

Subscribers:

First 20 words: **FREE***

25¢ per word for extra words over 20 plus

10¢ per word for a shaded ad (count all words including free words).

*Subscribers may take 20 free words on only one ad each month.

Non-Subscribers:

41¢ per word plus

10¢ per word for shaded ad.

Please do not forget to send in the extra 25¢ per word when your classified ad runs over the free 20 words; your payment will be appreciated, and it will help to keep A.R.C. healthy.

BOXED CLASSIFIED AD DETAILS

Deadline: 1st of the month!

Boxed classified ads can run unchanged for three months or more. No words are free. Ads may be shaded and may include bold and all-capitalized words freely. The ad need not begin with "For Sale," etc. Minimum run is 3 months, prepaid. Discount: 10% for 6 months; 20% for 12 months.

Boxed Classified Ad Rates per Month

Nonshaded ads:

36¢ per word for all words,* none free, plus

10¢ per word for each bold word plus

10¢ per word for each all-caps word.

Shaded Ads (All words are bold at no charge):

45¢ per word for all words* plus

10¢ per word for each all-caps word.

Non-Subscribers:

Add 20¢ per word to above costs.

*Three words can be bold-all-caps at no extra charge.

PHOTO & DRAWING DETAILS

Deadline: 1st of the month

for all ads with drawings or photos!

Drawings and photos are encouraged as the response to your ad is much larger and the reader knows better what you want or are selling. Send in your drawing or photograph, and A.R.C. will reduce it or enlarge it as needed.

Photo and Drawing Rates per Month

\$20.00 per month for each photo or drawing (If ad is canceled, this amount cannot always be refunded.)

CHANGES & CANCELLATIONS

Please check your ads carefully before sending them in. Once ads are received, it is not always possible to refund the amount sent, pull the ad or make changes.

IMPORTANT — COUNTING WORDS — IMPORTANT

The standard headings: WANTED, FOR SALE, etc., count as one word each time used in an ad. Name, address and (one) telephone number, count as 6 words, regardless of length. Ham call letters and business name can be included in the 6 words and do not count extra. Full name (or company name) and address is required in all classified ads. Each additional word, abbreviation, model number or number group, extra telephone numbers, fax, e-mail, etc. count as one word each. Hyphenated words count as two words.

SECOND CLASS



A.R.C., P.O. Box 2, CARLISLE, MA 01741

RETURN POSTAGE GUARANTEED

EXP=DEC96

G-46 SUB# 22-17477

FRED KILMER

59 ALDA DR
FOUGHKEEPSIE

NY

12603

CLASSIFIED AD
DEADLINE APR. 10th
Noon Eastern Time