



ANTIQUE RADIO CLASSIFIED



VOLUME 11

OCTOBER 1994

NUMBER 10

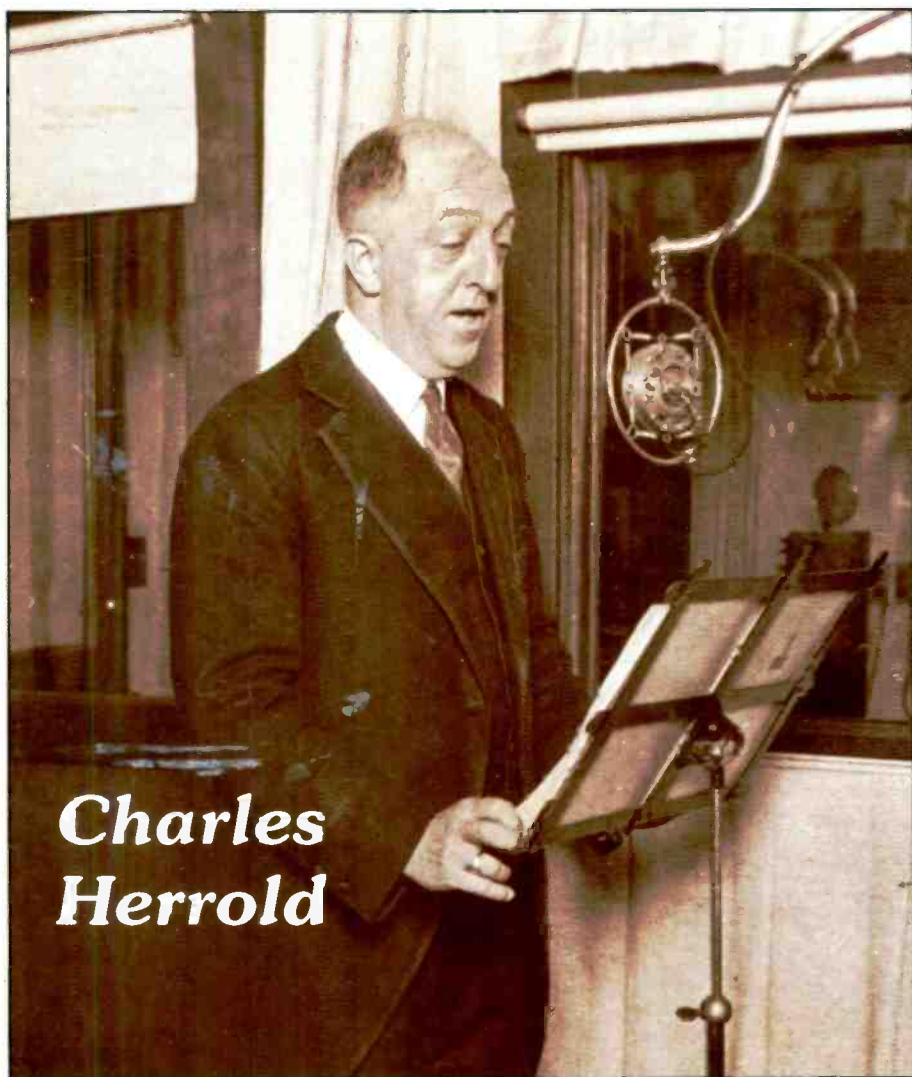

**Charles
Herrold**

© J.C. GORDON, SAN JOSE, CALIF.

A.R.C. — THE NATIONAL PUBLICATION FOR BUYERS AND SELLERS
OF OLD RADIOS AND RELATED ITEMS — PUBLISHED MONTHLY

ANTIQUE RADIO CLASSIFIED

Antique Radio Classified (ISSN:8750-7471) is published monthly, 12 times per year, by John V. Terrey, One River Road, P.O. Box 2, Carlisle, MA 01741. Second-class postage paid at Carlisle, MA, and additional mailing offices. Telephone: (508) 371-0512, 9:00 AM to 5:00 PM ET weekdays; machine answers phone at other times.

Annual subscription rates within the U.S. are \$31.95 by Second Class mail and \$47.95 by First Class mail.

Annual foreign rates. By air: Canada - \$51.00; Mexico - \$50.00; Other foreign countries - \$90.00. Surface mail: Canada - \$41.00; Other foreign countries - \$46.00. (Surface delivery to countries other than Canada may take two or more months and cannot be guaranteed.)

Two-year subscriptions are twice these rates and receive an extra month. Sample issues are available free on request.

© Copyright 1994 by John V. Terrey.

POSTMASTER: Send address changes to Antique Radio Classified, P.O. Box 2, Carlisle, MA 01741.

Printed in U.S.A.

STAFF

Publisher and Editor: John V. Terrey

Production Manager: Scott J. Young

Office Manager: Lisa A. Friedrichs

Publishing Staff: Dave Crocker, Dick Desjarlais, Chris Frederickson, Bobby Lyman, Cindie Platais, Dorothy Schecter

Founding Publisher/Editor: Gary B. Schneider

Contributing Writers: Mike Adams, Richard L. Arnold, Ray Bintliff, Ron Boucher, Paul J. Bourbin, Norman S. Braithwaite, Dave Crocker, Alan S. Douglas, Richard C. Foster, Fred Geer, Jim Kreuzer, Ron Ramirez, Henry Rogers, Ian L. Sanders, Gary B. Schneider, Daniel Schoo, Dwane Stevens, Frank R. White, Ralph Williams

PURPOSE. Antique Radio Classified is published for people involved in the radio collecting hobby. Its purpose is to stimulate growth of the hobby through the buying, selling and trading of radios and related items, and to provide a monthly forum for the interchange of ideas and information.

CONTACTING ANTIQUE RADIO CLASSIFIED. All correspondence should be sent to:

A.R.C., P.O. Box 2, Carlisle, MA 01741.

Send only U.S. Federal, etc. items to street address: *One River Road.*

Telephone: (508) 371-0512; Fax: (508) 371-7129

Please, no classified ads by telephone; thanks.

Your ads, renewals, letters, etc. can be handled faster and more efficiently if (1) each is on a separate piece of paper, and (2) your name, address and SUB# are written on each.

Unfortunately, A.R.C. is not staffed to answer letters with questions about antique radios or requests for advice. However, A.R.C. does solicit letters of interest to its readers and publishes them as space permits. A.R.C. assumes that permission is given to edit and to publish all correspondence and articles received unless otherwise indicated.

GUARANTEE. You may cancel your subscription at any

DISPLAY AND BUSINESS CARD ADS - DETAILS AND RATES

The deadline is the first of the month for display and business card ad artwork, payment and repeat requests.

Advertising is accepted only for early items related to radio, communication, etc. All items must be described fairly; reproductions, reprints and non-original items must be so identified. Advertisers must agree to respond promptly to inquiries and orders, to resolve problems promptly if the buyer is not satisfied, and to comply with a buyer's refund request on unaltered returned items.

Advertising must be prepaid, except as noted below; see "Payment" paragraph above for details. Late ads will be run only if space and time permit. Since artwork is reduced to 63% in the printing process, originals must be the artwork size listed below. Do not send in artwork on art board or send negatives. Ads should be typeset or typed neatly with a carbon ribbon, black ink (not pencil) on white. If used, reverse type must be limited to 25% of the ad. If you want us to prepare your ad, include the one-time cost below for A.R.C. to make up the ad.

Photos should be at an 85-line screen; otherwise, add \$12.00 per photo for screening. Do not cut or trim photos or glue photos to artwork; submit separately.

If you are confused by these requirements and terms, please

ARTWORK SIZE (SEND IN THIS SIZE) As Printed (size in magazine)

Page	H x W (inches)		H x W (inches)		Cost for 1-month	Cost for 3-months	Cost for 6-months	Cost for 12-months	One Time to make up Ad		
	(or 10 1/2)	x 7 1/2	7 3/4	(or 6 5/8)						x 4 3/4	
Full	12 3/16	x 7 1/2	7 3/4	(or 6 5/8)	x 4 3/4	\$199.00	\$531.00	\$919.00*	\$1669.00**	\$63.00†	
1/2 II	5 1/4	x 7 1/2		3 5/16	x 4 3/4	99.75	266.00	461.00	838.00**	31.50†	
1/2 V	12 3/16	(or 11 13/16)	x 3 9/16		7 7/16	x 2 1/4	99.75	266.00	461.00	838.00**	31.50†
1/4	5 1/4	x 3 9/16		3 5/16	x 2 1/4	50.50	134.50	233.00	424.00	15.75†	
1/8	2 5/8	x 3 9/16		1 5/8	x 2 1/4	26.00	69.50	120.00	218.00	8.00†	
Business Card	2	x 3 3/4		1 1/4	x 2 3/8	not avail.	36.00	63.00	113.00	6.00†	

* Full page, 6-mos.: ½ due with order; ½ due in 3 mos. ** Full & ½ page, 12-mos.: ¼ due with order; ¼ due at 3, 6 & 9 mos.

† For 6 and 12 month ads, no ad make-up charge if no change is made to ad for entire run.

time and receive a pro rata refund for issues not yet mailed. If errors to ads are made by A.R.C., upon request a free correction will be run in the next available issue.

PAYMENT. Please send in full payment with your order or ad. A.R.C. does not carry accounts; all subscriptions, ads, etc. must be prepaid (except for the 6 and 12 month display ads indicated below). Pay in U.S. funds. Checks drawn on a U.S. bank, money orders, VISA or MasterCard (\$10.00 min.) are preferred. Make check out to "A.R.C." U.S. stamps or cash are OK for small amounts. Canadian payers may send a Canadian check but specify U.S. funds. Subscriptions will be prorated to amount sent if amount is incorrect.

FAX PROCEDURES/PAYMENT. Subscriptions, book orders, classified ads, display ads, etc. are welcome by fax. Deadlines are the same for faxes as for ads received by mail. Please calculate the amount due. Payment by VISA or MasterCard is preferred if your order is over \$10. If under \$10, or if you prefer to send a check or money order, state the amount being sent and that the payment is in the mail. Do not send another copy of your ad with your payment; simply indicate that it is a fax payment. If you want confirmation of our receipt of your fax, call immediately after sending your fax.

CHANGE OF ADDRESS. Please notify us 4 weeks in advance of a change of address. Send both your new and old addresses, and include your SUB# and effective date of your new address. Temporary address changes can be made also.

SUBMISSION OF MATERIAL. Antique Radio Classified welcomes and solicits information that pertains or relates to radio history or collecting. This may include articles, book reviews, photos, information on upcoming radio events, meetings, antique radio organizations, radio auctions, sources of old radio and restoration supplies, and other related and interesting material. All material submitted should be carefully researched, typed and accompanied by good photos, if appropriate. Computer disks are appreciated. Writing guidelines are available upon request. Unless prior arrangements are made, all submitted materials may be edited, become the property of Antique Radio Classified and will not be returned. Publication is subject to approval by A.R.C. and to time and space constraints.

MAILING OF ISSUES. U.S. subscribers can receive A.R.C. by First or Second Class mail (Second Class is the way most magazines are mailed). The mailing of First Class copies is staggered over one to four days with faraway copies mailed before local copies. Non-U.S. copies are mailed on the first day. Second Class copies are mailed on the last day. Mailing dates change each month, but mailing is usually completed by the 26th of the month. First Class copies usually are received by the 5th of the month; copies by Second Class mail, by the 10th.

ETHICS. No person involved in the production of A.R.C. is to act on any information in the magazine until the first delivery day after local copies are mailed.

DISCLAIMER. The publisher is not responsible for any buying and selling transactions incurred, or for any other use of the contents of this publication.

Antique Radio Classified subscription rates, frequency of publication, content, policies, size and ad details, and rates are subject to change at any time by A.R.C.



ANTIQUE RADIO CLASSIFIED



EDITOR'S COMMENTS

A radio history quiz — Who discovered radio waves? Who invented radio? Who was the first broadcaster? Most would agree that the answers are Heinrich Hertz, Guglielmo Marconi, and Frank Conrad, respectively. Mike Adams, however, would disagree with the third answer, and with A.R.C.'s January 1988 issue which claimed, "Frank Conrad invented radio broadcasting."

In our fascinating lead article this month, Mike argues that Charles Herrold is the "forgotten father of broadcasting" — the first to act on a vision of radio as a powerful tool of communication. Herrold began regularly scheduled broadcasting for entertainment in San Jose, California, in 1912, eight years before Frank Conrad began broadcasting from his garage in Pittsburgh, Pennsylvania.

Mike's article in A.R.C. is only the tip of his campaign to rescue Charles Herrold from obscurity. Mike is also working on a book and has produced a video, which some of you may have already seen on PBS or watched in a preview at last year's AWA conference. Be sure to call your local PBS station for the video scheduling date and time.

The 8-tube Model 28, one of the last TRF models made by American Bosch, is the subject of another article by Richard Arnold. Usually seen as a table model, Richard's set is the less common highboy cabinet by Pooley.

A.R.C.'s past foreign set articles have largely featured British sets. However, this month we have a French set, presented by Charles Fisher. Made from a kit by Helios of Paris, this set is a 5-tube superhet and uses an unusual rack and pinion mechanism for tuning.

Two home brew articles in this issue show the diversity among radio collectors. The first is an old design built with old parts; the second is an old style radio built with modern parts. Chuck Schwark describes the early-1930s regenerative Doerle receiver that he recently built. His search for the proper vintage parts was his most challenging task — no, he could not just run down to Radio Shack and charge them.

On the other hand, Robert Lozier's set uses modern transistor technology. His "cathedral," containing a one-transistor reflex radio, is 15" high and only 4" deep. Robert can even squeeze a loop antenna inside the cabinet.

We report on Radiofest 1994, the August Antique Radio Club of Illinois meet in Elgin, Illinois. A growing event, Radiofest is one of the two largest meets in the U. S. (the other being the September AWA Conference in Rochester, N. Y.). The auction proceeds totaled \$28,990.

Photo Review includes several remarkable items — a Statue of Liberty cone speaker, a Stromberg-Carlson Art Deco set, and a 1950s novelty radio with a television set rabbit ear antenna.

Ray Bintliff reviews a very good book — *Oscilloscopes* by Stan Griffiths. Many of us, too young to remember the battery set days, might instead reminisce with this book about the wonderful Tektronix laboratory equipment we used in the '50s and '60s. Perhaps this book will stir up some activity in Tektronix oscilloscope collecting.

As always *Radio Miscellanea* is a great avenue for the give and take of information. Permeability tuning continues to be a topic of note, and we're delighted to have Mike Drown's response to the *Total* cereal box quiz.

Our *Club Spotlight* is on the Canadian Vintage Radio Society, a relatively new club, already enjoying great success. The extent of this club's goals is truly impressive, and we wish them well.

We also have some radio collectors' community news: The Vintage Radio & Phonograph Society is celebrating its 20th anniversary at its October 14-16 convention in Irving, Texas. And, Vestal Press, a major publisher for collectors of old radios for more than a decade, has sold its old radio book business to George A. Fathauer, the son of the father/son team who founded Antique Electronic Supply.

Renew now and Save! Although announcing a rate increase is never a pleasant task, our policy is always to inform our readers ahead of time, so as not to surprise them at renewal time. The promised 10% postal rate increase in 1995 and our continued growth in the number of articles, club listings and ads in each issue necessitates an increase in subscription rates for 1995. The increase will be \$3.00 for subscriptions by second class mail and \$4.00 by first class mail. Yes, this is more than was reported here last month, but a review of our budget for 1995 dictates this larger increase. Avoid the increase by renewing now for up to five years. Remember that an early subscription renewal, as well as an extension beyond one year, saves even more because you receive 13 issues for the price of 12.

Club Events. Despite the demise of the World Series, October will be a gala month highlighted by the VRPS Convention near Dallas, Texas, from October 14 to 16. In this 3-day affair, VRPS always delivers quality in its contest, auction (over 570 items selling for almost \$36,000 last year) and fine banquet. I plan to attend, so look me up.

Happy Collecting!

John V. Terrey, Editor

ON THE COVER

Our cover shows Charles Herrold at the microphone of his 1920s station KQW. Mike Adams describes this radio pioneer in an article beginning on page 4 of this issue, as well as in a video available from the Perham Foundation, 101 First St., Suite 394, Los Altos, CA 94022, for \$29.95 plus \$3.50 for S&H. Call (408) 734-4453 for details.

EARLY BROADCASTING

The Story of Charles Herrold Broadcasting's Forgotten Father

BY MIKE ADAMS

Suppose the history books are actually wrong — that regularly scheduled broadcasting for an audience really started in San Jose, California, around 1912, not 1916 or 1920. And suppose the inventor of this earth-changing event vanished from history, only to be rediscovered in 1958. Well, according to some very convincing evidence, it's all true. Mike Adams presents that evidence in this transcript of his latest documentary, to be shown on PBS stations nationwide within the next year. But remember, you read it here first. [Editor]

Charles David Herrold, pictured in Figure 1, is one of broadcasting's forgotten fathers. From his College of Wireless and Engineering in San Jose, California, between 1912 and 1917, Herrold transmitted regularly scheduled programs of music and talk designed to entertain a small but loyal audience. This was ten years before licensed broadcasting, even before the word "radio" was popularly used.

Herrold's broadcasts happened at a time when most wireless transmission was by 2-way Morse code communication. And since a workable vacuum tube transmitter was years away from being a reality, he had to invent his own technology, a mechanical system of broadcasting using a crude arc transmitter and a water-cooled microphone.

As a pioneer broadcaster, Herrold was certainly ahead of his time. But most people know very little about his life, his work, or his significance. In his later years, he tried to convince people that he was the "Father of Radio Broadcasting." No one paid attention. He died a forgotten man.

REDISCOVERING CHARLES HERROLD

I have been studying the life and accomplishments of Herrold for more than three years. Because of the pioneering 1958 research by San Jose State University journalism professor Gordon Greb, I've been able to read all the Herrold collected papers, patents, drawings, and correspondence. From surviving family members and former wireless college students, I have located hundreds of photographs that illustrate the Herrold story. A one-hour documentary for PBS television is the result.

Having completed the video, I am getting Part Two of the Herrold project underway — a book I am writing with Professor Greb. A video can never tell the whole story; at best, it can only raise very general issues and present a few sim-



Figure 1. Charles David Herrold, 1875-1948.

ple facts, and then only if they can be reinforced by visuals. The book will fill in the details with more facts, supporting documents, and research-based conclusions.

This is going to be a challenge because while Herrold is well known in northern California, his story has long been relegated to "local booster" status by most historians. The purpose of both the video and the book is to place the Herrold story into a realistic context, an acceptable national one.

There is plenty of anecdotal information surrounding early broadcasting. The often quoted "Radio Music Box" memo purported to be written in 1916 by David Sarnoff is a good example. It begins: "I have in mind a plan of development which would make radio a 'household utility' in the same sense as the piano or phonograph. The idea is to bring music into the house by wireless." Until a few years ago, most researchers accepted as fact historian Gleason Archer's contention that there was such a memo and that it was written on November 9, 1916.

However, recent research suggests that no written evidence exists that the memo was penned in 1916, but rather in the early 1920s when doz-

ens of stations were already bringing music into homes. And while no one can find this memo today, several generations of scholars have never questioned its existence. An important part of the Sarnoff legacy has apparently been based on hearsay.

There is even more evidence that others had preceded Sarnoff in a discussion of the home music box concept long before the wireless telephone became the radio. In his book *Looking Backward: 2000-1887*, published in 1888, novelist Edward Bellamy predicted a similar device in every home using the then available technology — the wired telephone.

In describing the home entertainment center in the year 2000, Bellamy went into a detailed explanation of a system in which a series of concert halls, each with a different genre of the music of the day, would have live orchestras playing 24 hours a day. According to Bellamy, "They have devised an arrangement for providing everybody with music in their homes, perfect in quality, unlimited in quantity — you can hear by merely pressing a button."

Given the new information about Sarnoff and the early influence of Bellamy's extremely popular book can Charles Herrold's documented pre-World War I regularly scheduled broadcasts of music and news now be accorded greater significance?

We are going to try to answer that question and others in the Herrold book. Here is what the authors hope to find: evidence beyond the Herrold papers and northern California that shows any larger national awareness of what Herrold was doing pre-World War I; evidence of what others were doing in broadcasting pre-World War I; the true motivations of the known early broadcasters; who/what (people, social and cultural milieu, articles at the time in national periodicals) may have influenced Herrold actually to go on the air to entertain an audience. And who else publicly talked about seeking an audience for "daily phonograph concerts on the wireless telephone" as early as Herrold did in a 1913, page one story in a San Jose newspaper?

Think about it. Here is a man who, prior to World War I, invented and patented a successful system of broadcasting music and voice out of the technology of the wireless telegraph. Not so

"Broadcasting's Forgotten Father: The Charles Herrold Story" is a one hour documentary produced, written and directed by Mike Adams in association with San Jose PBS station KTEH, which will distribute it to PBS stations nationwide. This video can be purchased from the Perham Foundation, 101 N. First St., Suite 3941, Los Altos, CA 94022. The Perham Foundation Electronics Museum, the major underwriter of the video, is distributing it as a fundraiser for the museum building fund.

original you say? Didn't Fessenden and de Forest send music out over the air as early as 1906? Yes, but these were said to be one-time-only events, designed to promote the inventors' radio/telephone systems.

The real significance of Herrold is that he developed his own audience and served it with entertainment and informational programming on a regular schedule — broadcasting. And even though he apparently did all this before anyone else, he has been left out of the history books. Why? Learn some of the answers in the story of Charles Herrold, "Broadcasting's Forgotten Father."

EARLY BEGINNINGS — THE FORMATIVE YEARS, A PRELUDE TO A LIFE OF INVENTION AND DISCOVERY

Charles David Herrold was born in 1875, in Fulton, Illinois, a Mississippi River town on the Illinois-Iowa border. His father, William Morris Herrold, was a captain in the Civil War. After the war, he had returned to Fulton and opened a flour mill and grain elevator. In 1888, the family moved to rural San Jose, California, where William Herrold bought land in Santa Clara County and ran a successful 83 1/2 acre farm planted in peaches and apricots.

William Herrold had an inventive mind, having patented an automatic prune dipper used on farms in every section of the country. His wife, Mary Elizabeth, was a school teacher and Bible lecturer. These parental influences would help to define Charles Herrold as an inventor and a teacher.

Charles attended high school between 1891 and 1894, and there he began to be recognized by his teachers and classmates for his superior grasp of mechanical and scientific subjects. He constructed telescopes and microscopes and excelled in photography. He tutored fellow students in chemistry in his basement lab, experimented with sound and music, and wrote several compositions for piano.

As a young man at the turn of the century, Herrold learned about Marconi's early work in England and began a study of the writings of Hertz and Maxwell. Most y, he hung out at nearby Lick Observatory and planned a career in astronomy. Figure 2 shows the teenaged Charles with his telescope.

In 1895, at the newly opened Leland Stanford Junior University in nearby Palo Alto, an unusual circumstance caused the 20-year old Herrold to question his original calling. As one of only two students majoring in astronomy, he was forced to seek a new field of study quickly when the only astronomy professor quit. Herrold switched to physics and electricity. This choice would point him in a direction he would follow forever — wireless and radio. After three years he dropped out of college for health reasons. He never returned to complete his degree.

Herrold's two career paths would be decided partly by design and partly by fate. His first choice was to be an inventor. Filled with stories of the fame and fortune of Edison, Marconi, and others, he moved to San Francisco in 1899. There he began to design, patent, and manufacture doz-

(Continued on following page)



Figure 2. Herrold at age 18, a builder of telescopes and microscopes.

(Charles Herrold Story, continued)

ens of electrical and mechanical devices for dentistry, surgery, and deep sea salvage, and even electrical machinery for pipe organs. Gradually he directed his talents toward wireless and even held the title of Chief Engineer of the National Wireless Telegraph and Telephone Company of San Francisco.

But, fate intervened and ended temporarily Herrold's tenure as an inventor. When the 1906 great earthquake destroyed his home and work, he quickly left San Francisco with nothing to show for his years there. He moved to nearby Stockton, California, where he became a teacher at Heald's College of Mining and Engineering. It was here that his second career as an educator began. While there, he started to experiment more and more with radio-telephony. He also began to think about how he could use the wireless to send entertainment into homes.

HERROLD'S WIRELESS TELEPHONE

In 1908, Herrold returned to his family in San Jose filled with new ideas for his future. Knowing that he was a good teacher encouraged him to open a school in 1909. Called the Herrold College of Wireless and Engineering, it was immediately popular with the young boys who were as excited as Herrold himself about the new wireless hobby. The boys, who nicknamed him "Doc" or "Prof," knew that an education at the Herrold College was the key to an exciting and well paying future as a wireless operator.

For Herrold, opening a school was also a practical decision

since the money earned from training students could help to pay for his true passion — inventing. Unknown to most of Herrold's students, their professor was spending more and more of his creative time trying to give voice to the wireless telegraph.

More good timing — Herrold was experimenting in a place that in later years would be very important to the electronics industry. In the Bay Area of Northern California, near Stanford University in what is now called Silicon Valley, a group of inventors and capitalists were at work. Cyril Elwell had just formed the Federal Telegraph Company and obtained permission to develop a high-powered arc transmitter using Danish inventor Valdemar Poulsens' patents. Lee de Forest had left New York and was perfecting his Audion in a garage in Palo Alto. And in San Francisco, the McCarthy brothers were transmitting voice with their spark gap system.

Receiving the major national press attention though was Reginald Fessenden who, in 1906, used an alternator to send a concert of music and voice from Brant Rock, Massachusetts, to a group of surprised wireless operators on nearby ships. This Canadian inventor, who would later invent the radio pager (beeper) and the first practical sonar for ships, did not continue with his radio-telephone experiments after Brant Rock.

While Herrold was surrounded by many students, he shared his inventing work with only a handful of trusted assistants. Ray Newby, pictured with Herrold and their spark system in Figure 3, was a code instructor at the college and assisted Herrold between 1908 and 1922. Newby explained in later interviews how he worked with Herrold to perfect his system of transmitting voice and music.

Like everyone else at the time, Herrold began his voice transmission experiments with the spark gap. And like others, it was quickly discarded as impractical, unworkable. Although according to Newby, the spark when used for voice and music was "rattly," there is still early written evidence that Herrold was beginning to get the attention of, even entertain, a small audience with this early



Figure 3. Herrold and his assistant, Ray Newby, with their spark system in 1908.

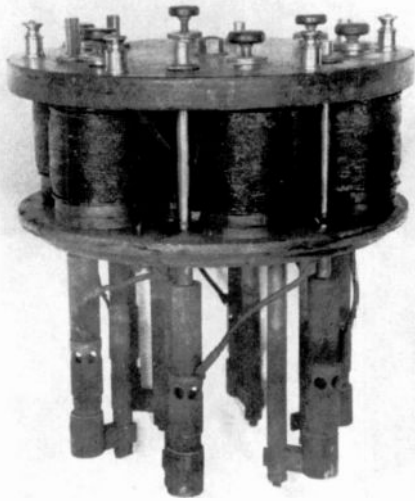

Figure 4. The Arc Fone had 6 series-connected carbon arcs, fired under alcohol and kept trimmed by an electromagnetic lifting system.

technology. According to a notarized statement by Herrold in 1910, "We have given wireless phone concerts to amateur wireless men throughout the Santa Clara Valley."

Herrold realized that if he wanted to attract listeners beyond the wireless amateur, he would have to perfect a radio-telephone good enough to be appreciated by a large audience. Undeniably the first two decades of the century were times of transition for the radio-telephone. In 1910, de Forest was still five to seven years away from perfecting the vacuum tube as a transmitting device, and so early experimenters like Herrold were forced to try out and abandon many spark, arc, and alternator systems.

Of all these electrical/mechanical systems, only Herrold's arc system seemed good enough at the time for the transmission of voice and music. Between 1912 and 1915, Herrold received a dozen patents for the pieces that formed his system. He called it the "Arc Fone," and it is shown in Figure 4. It was a mechanical radio, and it worked.

Herrold's high frequency, direct current Arc Fone started with six carbon arcs connected in series and fired under liquid alcohol. The arcs were kept trimmed by a magnetic lifting device similar to that used for the local street lighting system. The 500 volts DC used to fire the arcs was variously taken from the Herrold College's building elevator circuits and the San Jose transit system's overhead trolley wires.

A carbon microphone of Herrold's patented design was placed in series between the arcs and the ground. It was water cooled to prevent overheating and thus burnout. The arc was coupled to an outside antenna system by the distinctive conical coils used in the Herrold system.

The evidence indicates that as an inventor and broadcaster Herrold knew exactly what he was

doing. He told his assistants that he was developing the arc system for three separate purposes. One was to invent a practical radio-telephone for 2-way communication. For this he established an Arc Fone station at the Fairmont Hotel in San Francisco. Between 1909 and World War I, he and his assistants were on the air every day with concerts of music and talk between his San Jose station, pictured in Figure 5, and the Fairmont. While these transmissions were heard by a large West Coast audience, Herrold did not consider them to be broadcasting. He said they were experiments to learn about and improve his system.

A second Arc Fone activity was designed to impress the U.S. Navy, to get them to buy his radio-telephone system. To this end he set up an Arc Fone at the Mare Island shipyards near Oakland and proceeded to log great distance records. He received telegrams from as far away as Bremerton, Washington, to the north and San Diego to the south, with verification that his music was received hundreds of miles from the transmitting station. When asked in a 1932 radio interview about these two series of daily music and voice transmissions, Herrold said, "This should properly be called 'narrowcasting' rather than broadcasting, since the communication was from one definite point to another."

BROADCASTING FOR AN AUDIENCE

The third Arc Fone activity Herrold called "broadcasting for the people of San Jose." As Newby said in later years, "It became a religion for him to be on every Wednesday night for an hour or so." Called the "Little Hams Program," the Wednesday night broadcasts included written and telephone requests from listeners who asked for specific phonograph records to be played, on-air contests with prizes, Herrold's wife Sybil as the first woman disc jockey, and Newby himself reading news stories from the local paper.

Records were borrowed from a local store, and when they were played on the air, listeners went to the store the next day and purchased them. It was scheduled broadcasting for an audience. And since Herrold would work in radio advertising in later years, it has been suggested that even as early as 1912, he understood that "broadcasting for the public" was a good way to advertise his school and attract paying students. The first use of radio advertising?

These scheduled broadcasts began in 1912 when Herrold believed that his Arc Fone was technically good enough for the public to enjoy. They continued uninterrupted every week until World War I and the cessation of all experimental radio activity in April of 1917.

Herrold's audience consisted of current and former students, as well as young experimenters and their friends and families. He even set up a listening station in a local music store where people shopping downtown could hear the broadcasts on crystal sets using headphones. He clearly knew he was entertaining and informing a public audience.

And while the word "broadcasting" as applied to entertainment programs using radio would not

(Continued on following page)

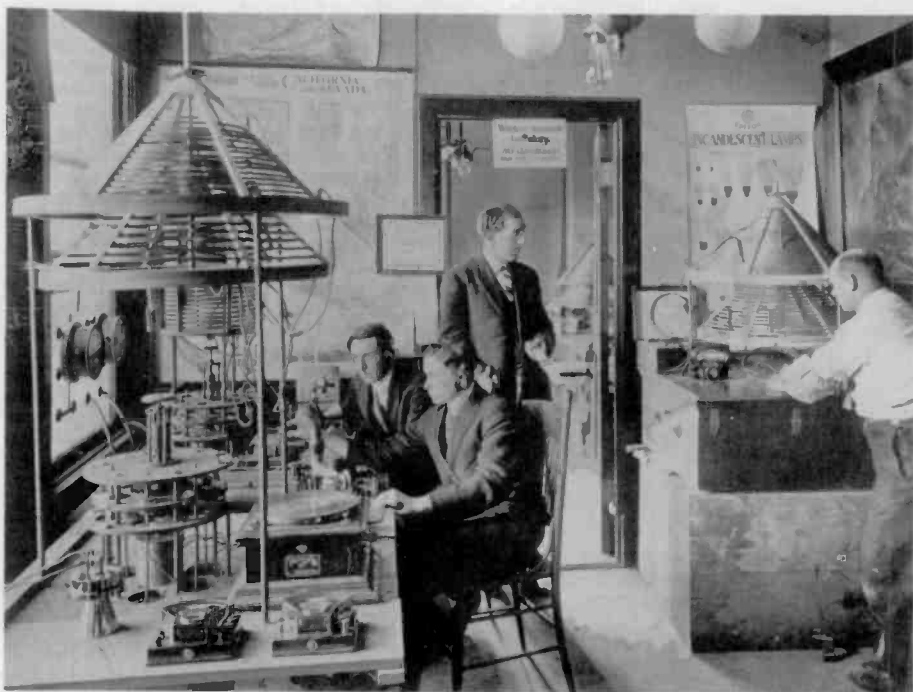

Figure 5. The Arc Fone broadcasting station in the Garden City Bank building in San Jose, California, circa 1909.

(Charles Herrold Story, continued)

find popular usage until many years later, there is still local evidence of a regular service for a growing audience. On February 12, 1913, Herrold described for a San Jose newspaper reporter his "phonograph concerts over the wireless telephone" by saying, "If anyone in your home possesses a wireless outfit, ask any of them to listen any night between 9 and 9:30 and you can hear my station — you can hear the phonograph as distinctly as if it were placed in the room next to you."

Later, in 1932, Herrold said this about his pre-World War I broadcasts, "Broadcasting was an obsession with us and, certainly, the entire Pacific Coast looked upon the radio broadcasts from San Jose as an established institution." The evidence strongly suggests that it was Herrold's intention that his broadcasts be heard by the largest audience possible.

There was another important event that Herrold later claimed offered further proof that he was "broadcasting for the public." It took place in 1915 at the Panama Pacific International Exhibition in San Francisco. There, Lee de Forest was all set up to demonstrate a new system of transmitting voice using his Audion, but his experimental tube system failed to oscillate. At the last minute, de Forest asked Herrold to broadcast music and talk for eight hours every day from his San Jose station. De Forest wanted the broadcasts to be heard by patrons who stopped by the listening stations installed in buildings throughout the exhibition. Later, in a San Francisco newspaper interview, de Forest claimed this to be the first scheduled broad-

cast. For thousands of people, it was the first time they ever heard a broadcast.

LICENSED BROADCASTING IN AMERICA

World War I changed everything about wireless and radio. Between April 1917 and April 1919, most commercial and amateur radio was ordered silent. This included licensed experimenters like Herrold, who held the call 6XF, and Frank Conrad, 8XK, who in 1916 had begun to entertain his neighbors in East Pittsburgh with a small vacuum tube transmitter. Because of national defense, the government required major inventors and manufacturers to pool their wireless patents in order to facilitate and accelerate the organized development of technology necessary for wartime communications.

And while high-powered transmitters for long distance Morse code communication would continue to employ spark and alternator technology, wartime research and experimentation finally proved that de Forest's Audion was clearly superior to an arc for the radiotelephone. Figure 6 shows de Forest with his early vacuum tube transmitter. At the end of the war, there was no question that future transmitters for voice and music would use the vacuum tube.

It was the beginning of the end for Charles Herrold, broadcaster and inventor. The war ended, and the 1920s brought peace and prosperity. In 1920, the Commerce Department began for the first time to license "broadcast stations." In November 1920, in Pittsburgh, Frank Conrad licensed his experimental station 8XK as KDKA



Figure 6. Lee de Forest with his early vacuum tube transmitter, which superceded the Arc Fone technology.

and thus received the very first official permission to entertain the public using radio. And while KDKA and others that quickly followed would use their new Western Electric-built vacuum tube transmitters on the government allocated frequency of 360 meters, Herrold's broad band Arc Fone would not work above 600 meters. His patented system, his life's work, was suddenly obsolete.

Undaunted, Herrold, still operating as the experimental 6XE, finally built a vacuum tube transmitter and received his license to broadcast in December 1921. Figure 7 shows Herrold adjusting the Western Electric transmitter at KQW, while Figure 8 shows him at the microphone. His station, KQW, was to take all of his time and money. Instead of being the only broadcaster, he was one of hundreds.

By 1925, the now fifty year old Charles Herrold was out of money and tired. He transferred his license to the First Baptist Church of San Jose. Within a year the Farm Bureau took the station over and dedicated its programming to serving the farmer and agriculture. In 1949, it was bought by the Columbia Broadcasting System, moved to San Francisco and renamed KCBS. Even today, that station claims publicly to have been on the air since 1909, tracing its lineage to the earliest Herrold days of "wireless phone concerts."

Charles Herrold spent his final days in radio as a free-lance advertising consultant to local stations. Nearing 60 years old, he began in the 1930s to seek the recognition that he had been denied. He wrote an article for the "Public Forum," op-ed page of the *Oakland Tribune*, where he put himself on trial before, as

he said, the "court of public opinion." About his 1912 broadcasts he wrote, "Now if there was any other broadcasting station in the world at that time and if there was any other inventor who had perfected a reliable radio telephone capable of transmitting undistorted music and clear speech day after day in actual broadcasting, I certainly never heard of such."

Herrold died of heart failure in a Bay Area rest home on July 1, 1948. He remained forgotten until 1958 when he was "discovered" by Gordon Greb. Looking for a pioneer to honor for a class project, journalism professor Greb chose Herrold, whose ex-wife Sybil, assistant Ray Newby, and dozens of former students gave him information. He located surviving Arc Fone parts, found photos, and began to record on audiotape the recollections of people present during the Herrold era. In 1959, Greb even convinced KCBS to sponsor a "50th Anniversary of Broadcasting" with parades, dignitaries, and the usual speeches.

Doug Perham, founder of the Perham Foundation Foothill Electronics Museum, took the Arc Fone parts given to him by Herrold in the 1940s and reconstructed the Herrold station as it appeared in the famous 1912 photograph. This exhibit ended up in the Perham Museum in Los Altos, California, a decade later. But today more than 35 years after his story was told at that public event, Charles Herrold is still largely ignored.

CONCLUSIONS

Why has Charles Herrold disappeared from history? There are several answers. One was his timing. He was broadcasting to an audience long before most understood its significance or cared about what it could be. His listeners could never be described as forward thinking, or influential social and cultural leaders, or businessmen looking for the next big investment. His audience consisted of the curious, the young experimenters and their friends and families, as well as commercial wireless operators at ship and shore stations. The wrong audience — the wrong time.

Another was his technology. While it can be

(Continued on following page)



Figure 7. Herrold adjusting the Western Electric transmitter at KQW.

(Charles Herrold Story, continued)

argued that Herrold's real contribution was "programming entertainment for an audience on a regularly scheduled basis," it was his enabling technology that did not survive when faced with the challenge of the superior vacuum tube. It was probably for this reason alone that he missed the chance to be one of the first licensed broadcasters.

Perhaps there are parallels with inventor Francis Jenkins and the failure of his mechanical television system in the late 1920s. Would Jenkins be better known today if his programming had been broadcast using electronic television technology? Would the giant public relations and research and development organization of an RCA support his work and make his name a household word?

Charles Herrold developed a dead-end technology, and while it certainly worked when there was nothing else, like Jenkins he had taken it as far as possible. Given the vacuum tube, an arc would never be practical enough or good enough.

A final conclusion is a more practical one. Herrold was not connected to the East Coast center of capital and commerce that was America in the early part of the twentieth century. He was an independent living in an area better known for its prunes and apricots, its fields and orchards, than as a center of manufacturing. In small town San Jose there was no RCA, no Westinghouse, no Western Electric/AT&T, no General Electric — the main players behind licensed broadcasting for an audience.

At the conclusion of Herrold's 1932 article, his "trial," he summed up the reasons for neither profiting monetarily nor receiving recognition as the "Father of Radio Broadcasting" for his pre-World War I pioneering work: "Now the very vital question will be put to the witness (Herrold) — Why did you not immediately profit by all this development? The answer is a very simple one — The Herrold System of Radio Telephony would not work on wavelengths under 600 and the allocation of 360 meters by the Government was

fatal. Over two decades of work, expenditures of over \$80,000, and a lot of patents went on the scrap pile. My broadcasting station, KQW, passed into the hands of those who could install the most high powered Western Electric equipment. We rest our case, a case which will be carried eventually to the highest court — the court of public opinion of the whole world."

The evidence strongly suggests that broadcasting as we know it — entertainment programming for an audience on a regularly scheduled basis — happened first in San Jose California. It began in 1909, and by 1912, the first radio audience was in place. Will the person who made it happen, Charles David Herrold, earn a better place in the future of broadcast history? Or will he remain one of broadcasting's forgotten fathers?

References:

- Bellamy, Edward. *Looking Backward: 2000-1887*. Boston: Houghton-Mifflin Co, 1888, pp. 89-90.
- Belrose, John S. *Fessenden and the Early History of Radio Science*. Ottawa: McMaster University, 1992.
- Benjamin, Louise. In *Search of the Sarnoff "Radio Music Box" Memo*. *Journal of Broadcasting and Electronic Media*, 37:3 Summer 1993, pp. 325-335.
- Broadcasting and Cable Yearbook, *Broadcasting Magazine*, 1993, p. B-48.
- Gleason, Archer. *History of Radio to 1926*. New York: American Historical Society, 1938, pp. 112-113.
- Greig, Gordon. *The Golden Anniversary of Broadcasting*. *Journal of Broadcasting, Broadcast Education Association*, Winter 1958-59, 3:1, pp 3-13.
- Greig, Gordon. *Transcripts of audio/video interviews with Ray Newby*. Stockton, Calif.: 1959, 1971.
- Herrold, George Herber. *Unpublished Family History*, 1963.
- Oakland Tribune*, March 1932.
- Recorder's Office, County of Alameda, Calif., 1948.
- San Francisco Chronicle*, March 30, 1924.
- San Jose Times-Star*, February 12, 1913, p. 1.
- Transcript of audio interview with Sybil Herrold True, 1959.
- Transcript of Interview with Herrold, KQW radio broadcast, 1932.
- Wireless and Electrical Cyclopedia*. New York: Electro Importing Company, 1910, p. 122.
- (Mike Adams, 112 Crescent Ct., Scotts Valley, CA 95066)

Mike Adams has for his entire life admired, collected and documented the radio. From pirate broadcaster in high school to modest success as a "top-40" disc jockey during the "golden age" of AM radio in the 1960s, Adams has seen the radio from all sides. Now Associate Professor of Radio and Television at San Jose State University, he has written numerous articles for historical radio journals and periodicals, two books on radio and television production, and a video series called "Radio Collector." He has also written several articles for A.R.C., including the synopses of the popular "Radio Boys" series.



Figure 8. Herrold at the microphone at KQW.

WITH THE COLLECTORS

The American Bosch Model 28

BY RICHARD ARNOLD

This article describes an early AC-powered TRF radio that was used in a variety of cabinets. (Editor)

In 1912, the American Bosch Magneto Company, now a division of United Technologies, constructed a plant in Springfield, Massachusetts. The company still operates from that location. American Bosch started producing radios in the mid-1920s and introduced the Model 28 radio chassis in 1928.

This radio chassis was used primarily in floor models but appeared in a low rectangular tabletop cabinet as well. The radio, less the cabinet, sold for around \$130. Figure 1 shows the Model 28 installed in a 1928 Pooley cabinet with a speaker. The cabinet is a Pooley Model 7400 radio desk that sold for \$60 in 1928. Note the desk's pigeon holes above the radio. Later versions with a dynamic speaker sold for \$195. The dynamic speaker assembly contained its own DC power supply.

Pooley cabinets were much in demand in this period. The company's advertising was obviously effective. One advertisement in *Good Housekeeping* magazine of December 1926 reads, "A golden voiced hom, a great radio receiver, built into beautiful cabinets of period design, finished in English brown mahogany or American walnut. This is a Pooley cabinet. Could you wish for more?"

When the radio is installed in a tabletop cabinet, a separate speaker is required. The table model sets are more common than the floor models. They frequently show up at auctions, radio meets, and in advertisements in A.R.C.

The tube lineup of the Model 28 consists of the following Types: 26 - 1st RF, 26 - 2nd RF, 26 - 3rd RF, 27 - detector, 26 - 1st audio, two 71s in push-pull for the audio output stage and an 80 rectifier. With the exception of the detector, all are filament type tubes. The Type 27, with an indirectly heated cathode, is used to minimize hum in the detector stage. Bosch also built a Model 38, a 25-cycle version of the Model 28.

Three front panel controls are used to operate the radio. The left-hand knob operates a vario-



Figure 1. The Model 28 in a 1928 Pooley cabinet with a speaker.

coupler in the antenna circuit. The center knob controls the 3-gang tuning capacitor and an illuminated drum dial. Volume is controlled by the right-hand knob. The volume control consists of a potentiometer connected from the antenna post to ground (across the variocoupler), with the arm of the potentiometer connected to the grid of the 1st RF amplifier tube. This arrangement may not be the best way to control volume, but it is a circuit that was commonly used during the late 1920s.

The tube complement requires the power transformer to furnish four separate filament voltages: 1.5 VAC for the Type 26 tubes, 2.5 VAC for the Type 27 tube, 5 VAC for the Type 71s, and

a separate 5 VAC for the Type 80 rectifier tube. Mixing tubes with different filament voltages was not uncommon during this period of radio development. Otherwise, the radio's circuitry is straightforward. However, the reader may wish to refer to short technical articles in *Radio Broadcast*, October 1928, page 369, and *Citizens' Callbook*, Vol. 10, No. 4, November 1929, page 91.

References:

- Douglas, Allan. *Radio Manufacturers of the 1920's, Vol. 1*. Vestal, N. Y.: Vestal Press, Inc., 1991, pp. 32, 36.
- Good Housekeeping*, December 1926.
- Rider, John F. *Perpetual Trouble Shooter's Manual*, 1931. New York: Radio Treatise Co., Inc., pp. 35, 38.
- Wolf, H.G. and I Jacobsen. *A Blast from the Past*. Stillwater, N. J.: The Antique Radio Co. (Sound of Music).

(Richard Arnold, Box 275, Lone Grove, OK 73443)

Since 1985, Richard Arnold's collecting interest has been primarily in cathedrals and 1920s battery sets. His collection of over 60 radios ranges from crystal sets to a 1928 American Bosch desk radio in a Pooley cabinet. His prize is the 1932 Jackson Bell "Peter Pan" featured in the June 1991 issue of A.R.C.



HOME BREWING

Doerle 2-Tube Home Brew

BY CHUCK SCHWARK

As a member of the Antique Radio Club of Illinois, I became interested in the historical aspects of the early days of commercial and short-wave broadcasting. After reading articles in many of the 1930s radio books and magazines, I decided to try my hand at building a home-brew radio. Vintage parts and junker sets are still available at hamfests, swap meets, and flea markets. Using original parts and hardware for this project would be fun and would give me a sense of what it is like to build a regenerative tube radio from scratch.

THE BEGINNING

Considering that 50 to 60 years was the age of the parts needed for this project, I realized that finding all the right parts was going to take time. In fact, to track down those parts took over a year and a dozen swap meets, auctions, and hamfests.

Radio parts manufacturers like I.R.C., Cornell-Dubilier, Carter, Kurz-Kasch, Eby, Hammarlund, Pilot, National and Yaxley show the variety of parts available 60 years ago. Some of the parts I found needed restoration themselves in order to make the radio look "new." Any corrosion or scratches would detract from the overall look and feel of the set. I wanted to preserve the sense of artistry and design that early builders achieved.

THE CHOICE

After looking through many reprints of old sets, I picked a 2-tube regenerative circuit popularized by Walter C. Doerle in the early 1930s. A combination of two designs in *The Hammarlund 1937 Short Wave Manual* and additional information from two other sources was used in the construction. Hints and tips on design from the *Short Wave Beginner's Book* and coil designs from the *Short Wave Coil Data Book* were also used. To simulate a vintage radio buff's search for parts

where he could find them, I selected many different parts' manufacturers.

BUILDING THE SET

The two Type 30 triode tubes are used as a regenerative detector and an audio amplifier. I wound a set of 5 plug-in coils covering the standard broadcast band and the most popular international shortwave bands. Except for some screws, the oak base and the phenolic front panel, all the parts are either used originals or new-old-stock parts. Front and rear views of the completed radio are shown in Figure 1. [Note the use of an aluminum sheet behind the tuning capacitors, C1 and C2, to eliminate "hand-effect."] The hook-up wire was even recycled from a vintage tube tester chassis. The schematic diagram appears as Figure 2, and a parts list is provided in Figure 3. During construction, I received valuable information from club members and friends.

After construction, I attached the antenna, ground and battery wires to the set hoping it would not melt down on the first try. Unfortunately, one small plume of smoke rose from the regeneration potentiometer. There was no damage to the set, however. After correcting my error, I heard local AM stations coming through loud and clear. Tuning was sharp, and the sensitivity was much better than I had expected.

In the evening, distant AM stations like KMOX in St. Louis and KOA in Denver were not hard to pick up. The shortwave performance was surprisingly good as well. Catching a dozen or more stations from around the world with my home brew wasn't any more difficult than with a commercially built radio.

Since I had no dial calibrations to go by, searching for stations in the shortwave bands gave me a feel for how it was done by early radio experiment-



Figure 1. Front view (left) and rear view (right) of the completed Doerle 2-tube home brew.

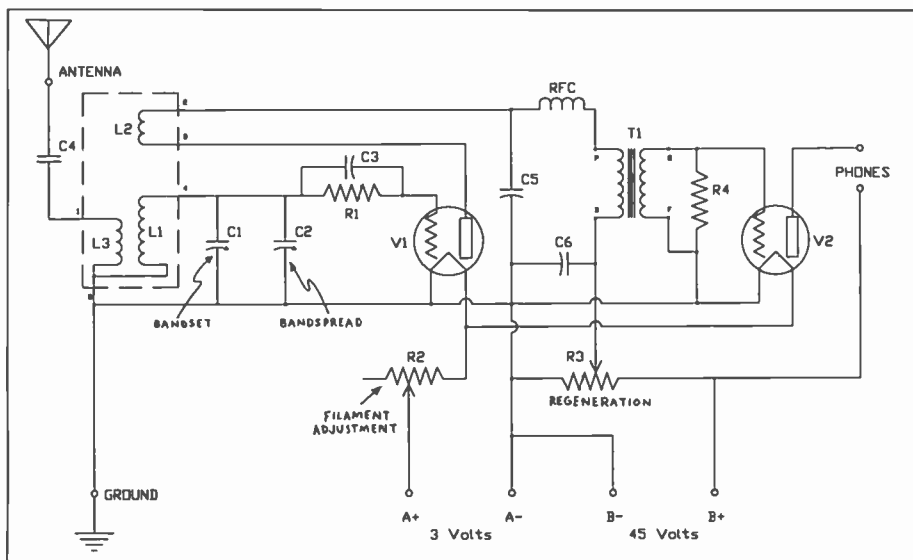

Figure 2. The schematic for the Doerle 2-tube home brew.

ers. This radio has heightened my appreciation and enjoyment of the hobby, and I would encourage others to give building a home brew a try.

References:

The Hammarlund 1937 Short Wave Manual, Third Ed., copyright 1935, Hammarlund Mfg. Co., Inc. Bradley, Ill.: reprinted by Lindsay Publications, Inc.

Short Wave Beginner's Book. New York, N.Y.: Radio & Television, copyright H. Gernsback, 1940. Bradley, Ill.: reprinted by Lindsay Publications, Inc.

Short Wave Coil Data Book. New York, N.Y.: Radio Publications, copyright H. Gernsback,

1937. Bradley, Ill.: reprinted by Lindsay Publications.

(Chuck Schwark, 7454 N Campbell Ave., Chicago, IL 60645)

For Chuck Schwark, electronics has been a hobby and a profession for over thirty years. His early interest in radio was rekindled recently by collector friends, one of whom had been a lab assistant to Lee de Forest during the 1930s. Specializing in AC-powered BC and SW sets, Chuck has been actively collecting and restoring wooden cabinet tabletop and console radios from the 1930s and 1940s.

- C1 - 140 pF variable capacitor
- C2 - 35 pF variable capacitor
- C3 - 100 pF / 400 v mica capacitor
- C4 - 35 pF / 400 v mica capacitor
- C5 - 250 pF / 400 v mica capacitor
- C6 - 0.1 mF / 600 v paper capacitor
- R1 - 3 megohm 1/2 w carbon resistor
- R2 - 10 ohm rheostat
- R3 - 50 K ohm potentiometer
- R4 - 200 K ohm 1/2 w carbon resistor
- RFC - 2.5 μ H choke

- T1 - Audio interstage transformer
- V1 - Type 30
- V2 - Type 30
- Terminal strip (or binding posts)
- Phone jack
- Phones, high impedance (2K ohm)
- L1 See coil chart
- L2 See coil chart
- L3 See coil chart
- 5-pin tube socket
- 4-pin tube socket (Qty. 2)

Coil No.	Frequency Coverage	L1 Turns	L2 Turns	L3 Turns
1	650 kHz-1450 kHz	100	20	10
2	1200 kHz-2.5 MHz	50	20	10
3	2.0 MHz-4.2 MHz	20	10	7
4	3.8 MHz-8.0 MHz	11	5	7
5	8.0 MHz-15.5 MHz	4.5	5	5

All coils are wound in the same direction using #30 AWG enameled wire, close-wound. There is $\frac{1}{16}$ " spacing between windings. For each coil, L1 (grid) is the top winding, L2 (tickler) is in the middle, and L3 (antenna) is on the bottom. Coil forms are plug-in Hammarlund XP-53, 5-prong ribbed type.

Figure 3. Parts List for the Doerle 2-tube home brew.

Kit by Hélios of Paris

BY CHARLES FISHER

An unusual French radio, shown in Figure 1, was made in 1930 from a kit offered by Hélios of Paris, mainly a maker of conventional sets. It embodies the elegant and curious but obscure Autorex tuning mechanism regularly advertised in the French *QST* during the spring of 1930. The speaker shown on the top of the radio is a Musicalpha, an excellent performer.

As shown in Figure 2, the condensers are controlled by racks and pinions tied together at a ring. This ring serves as the tuning control and dial cursor, the latter a clear plastic disc with a black-edged hole on center. Like a computer mouse, the ring can cover the whole dial area.

The condensers are made in balanced halves, as shown in Figure 3, to prevent gravity from interfering with tuning. Tuning points are recorded on the dial face through the hole in the cursor. The geometry of the mechanism spaces out frequencies at the high end substantially, so that tuning approaches straight-line frequency (SLF), even though the condensers are straight-line capacity (SLC).

The 5-tube superhet is a conventional circuit for France in the early 1930s. A double-grid, space-charge tetrode ("bigrille" in French) functions as RF amp, oscillator and mixer — actually a modulator much like the "autodyne" using a Type 24A tube. It feeds a screen grid IF amp much like a Type 24A. The IF transformers are plug-in and tuned to 135 kHz, but original long-wave dial markings suggest that the original IFs were 50 or 60 kHz. Various makes of plug-in transformers were available. Figure 4 shows a rear view of the assembled kit.

A high-gain triode power detector drives an audio output pentode much like the Type 47 that was introduced in 1928! The power supply uses 2 chokes as well as capacitors, accommodates 110, 130 and 220 volts, and uses a French equivalent of a Type 80 rectifier. Hence, the set has one of everything possible in 1930: dual diode, triode, space-charge tetrode, screen-grid tetrode, and pentode.

Performance on a 12" square loop antenna is impressive.

Pre-World War II French radios are scarce because relatively few were made. As far as such luxuries go, European living



Figure 1. A kit radio by Hélios of Paris, ca. 1930.

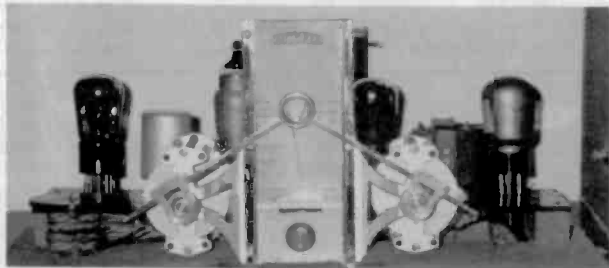

Figure 2. Condensers controlled by racks and pinions tied together at a ring.



Figure 3. Condensers made in balanced halves prevent gravity from interfering with tuning.

standards were much lower than those in the U. S. In 1932, less than 5 percent of the French population owned radios. Made only for an affluent minority, French radios were of higher than average quality compared to their American equivalents. Kits offering performance at big savings were popular.

French radios made *before* 1930 (mostly battery sets) are very rare and valuable by our standards. Even external hardware, decoration and cabinet construction, as well as styling are of amazing quality. I have no pre-1930 French radios.

(Charles Fisher, 161 Belknap Rd., Framingham, MA 01701)

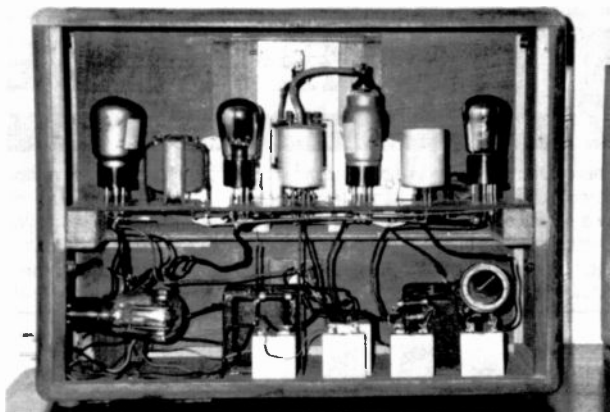

Figure 4. A rear view of the assembled set.

Oscilloscopes By Stan Griffiths

REVIEWED BY RAY BINTLIFF

This book's simple title, *Oscilloscopes*, and its subtitle, "Selecting and Restoring a Classic," provide no hint that the book is mostly about Tektronix oscilloscopes. However, Tektronix products from 1947 through 1969 are covered extensively and quite well.

Oscilloscopes, by Stan Griffiths, begins with a short description of how an oscilloscope works. This first chapter can be useful as a refresher or as introductory material for readers unfamiliar with oscilloscopes. As Griffiths points out, the operation and use of "scopes" have been covered in detail in many other publications, so there is little need for an exhaustive explanation in this book.

It only takes a little reading to discover that this is a practical book. It reflects the author's extensive experience with oscilloscopes — 26 years at Tektronix. Good step-by-step guidance is provided on how to inspect a scope to determine its physical and electrical condition. Such an inspection will improve your chances of buying a good scope and allow you to reject the uncesirable units. Whether you are anticipating the purchase of a scope or already have one (or more), the "how-to" chapters dealing with the cleaning and restoration of scopes should prove very useful.

Most of the book — about 300 pages, including 230 illustrations — is devoted to descriptions

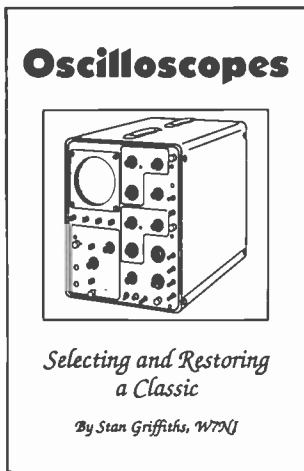

of various models of Tektronix instruments. Specific recommendations as to the suitability for purchase, along with an estimated value (as of 1992), are provided for each instrument. This is a handy buyers' guide. However, the term "guide" must be stressed since the "current" price guide is based on 1992 values.

Detailed troubleshooting instructions and an explanation of capacitor and resistor failures are provided. Although the book is technical in nature, it is written in an informal style that should appeal to both the technical and nontechnical reader. Other useful information includes a glossary, sources of parts and information, and serial

numbering methods.

Although you may neither own nor intend to own a Tektronix scope, *Oscilloscopes*, with its excellent photographs, provides an interesting stroll down memory lane.

Oscilloscopes is published by Stan Griffiths, 18955 A.W. Blanton, Aloha, OR 97007. Priced at \$19.95, this book is softbound in an 8½" x 5½" format and contains 372 pages. Be sure to check with the publisher for ordering and shipping information.

(Ray Bintliff, 2 Powder Horn Ln., Acton, MA 01720)



PHOTO REVIEW



This column presents in pictorial form many of the more unusual radios, speakers, tubes, advertising, and other old radio-related items from our readers' collections. The photos are meant to help increase awareness of what's available in the radio collecting hobby. Send in any size photos from your collection. Photos must be sharp in detail, contain a single item, and preferably have a light-colored background. A short, descriptive paragraph **MUST** be included with each photo. Please note that receipt of photos is not acknowledged, publishing is not guaranteed, and photos are not returned.



PALCONE STATUE OF LIBERTY SPEAKER

— This decorative cone speaker was made in 1925 by Pal Radio Co. in Jersey City, New Jersey. (Ed Bell — Raleigh, NC)



RADIO ZENIT — This Austrian crystal set with variometer tuning was sold in the late 1920s by Max Böhnel-Wien. The brand name was Radio Zenit. (Erwin Macho — Vienna, Austria)

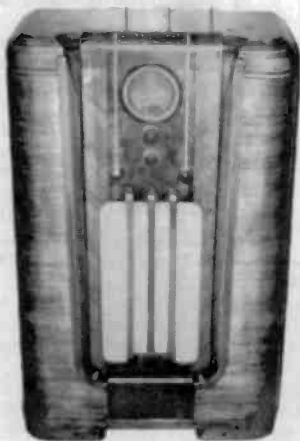

PHILCO MODEL 37-650 — Made in 1937, this floor model features a broadcast band and two shortwave bands. (James Wolfe — Windsor, CO)



PHILCO MODEL 48-1001 — This 1948 Philco used the same chassis and picture tube as the Model 48-1000. It is another example of Philco's fine cabinet styling of the 1940s. (Tony DeMara — Mt. Clemens, MI)

PHOTO REVIEW



JACKSON-BELL MODEL 68 – This beautiful, 8-tube, 1931 cathedral, manufactured in Los Angeles, started my collection. It has a tulip cutout design in the speaker grille and a walnut cabinet. (*Andy King – Seattle, WA*)

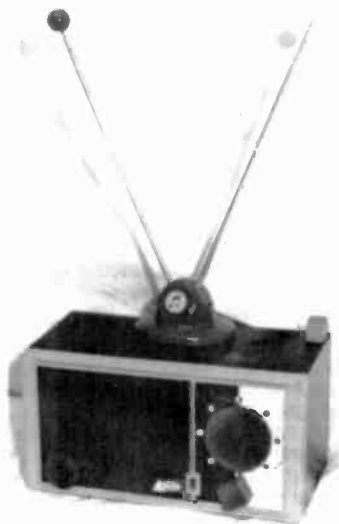

ACME MODEL UNKNOWN – This novelty radio, ca. 1950s, makes a colorful addition to any room. The TV antenna is for effect only and is not connected. (*Joel Levine – Greenlawn, NY*)

STROMBERG-CARLSON MODEL 130-R – This set features a tuning eye and an unusual hexagonal dial face. "Triple Range Tuning" provides standard broadcast plus two shortwave bands for this 7-tube radio. The Art Deco cabinet, 21" wide x 12½" high x 9½" deep, uses three types of wood in its design. (*Wade Jacobs – Mineola, NY*)

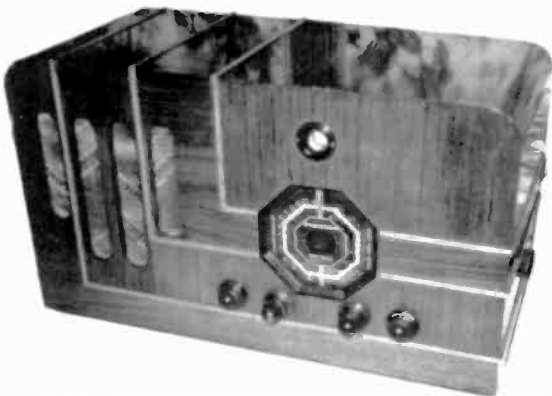

BATTERY SET – MAKE AND MODEL UNKNOWN – This mystery battery set looks commercially made, ca. 1922 or 1923. It uses 4 tubes and has porcelain tube sockets. If you can identify this set, please write to A.R.C. (*Ed Bell – Raleigh, NC*)

MEET & AUCTION REPORT

Antique Radio Club of Illinois Radiofest 1994

Elgin, Illinois — August 3-6

COMPILED FROM REPORTS BY JEFF AULIK AND KARL AYER

The Antique Radio Club of Illinois (ARCI) held its twelfth annual Radiofest on August 3-6, 1994, at the Hoilday Inn in Elgin, Illinois. This largest Radiofest ever drew nearly 1,000 guests.

Once again the flea market filled three sides of the hotel's parking lot, while an overflow lot held 120 additional sellers. About 450 sellers' permits were issued, a number comparable to last year.

This year's main exhibit featured Atwater Kent. Dozens of items represented the entire Atwater Kent era, from fans and small motors to the last of the 1936 line. About the only thing missing was an Atwater Kent refrigerator!

Among the highlights of the auction were a Wireless Specialty Apparatus IP-501A at \$1,700, a Colonial Globe radio at \$1,300, a DeForest P-300 Audion control box at \$800, and a Hopalong Cassidy radio at \$300.

As in past years, top quality presentations were given. "Atwater Kent 1931-1936", "Hallicrafters", and "The Manhattan College Tube Exhibit" were given by Jeff Aulik, Chuck Dachis, and Brother Patrick Dowd, respectively.

Dr. Ralph Muchow kindly opened his museum for tours again this year. Shuttle buses took hundreds of Radiofesters to view his vast collection.

The Thursday night Awards Banquet broke all previous records for attendance — 175. Chicago's Charlie Rex Trio strolled through the tables providing music and entertainment both during and after dinner. "Best of Show" was awarded to Chuck Dachis' Hallicrafters DD-1.

Unfortunately, A.R.C. was unable to attend Radiofest this year and could not gather detailed information on the auction. Printed below is the ARCI

report from which we selected items having the most complete information.

Addison tombstone	\$90
Advertising signs, Federal and Crosley	50
Airline 62-177	35
Airline 62-316	35
All American Mohawk	150
Atwater Kent 30	40
Atwater Kent 40	45
Atwater Kent 55	60
Atwater Kent 60 console	70
Atwater Kent bookends	60
Atwater Kent breadboard	650
Atwater Kent Model 555 chest radio	250
Belmont 6D11	70
Belmont 64T	35
Best 8-tube radio	150
Boy Scout signaler	25
Boys 2-transistor radios	50
Bunnel capacitor	40
Capitol battery set	55
Carter crystal set	310
Channel Master transistor radio DI	45
Clapp-Eastham for parts	45
Cloyster speaker	25
Colonial Globe radio	1,300
Consemma Jr.	60
Crosley 2-tube amp	225
Crosley 58TK	40
Crosley 125	80
Crosley 6615	90
Crosley book radio	80
Crosley Gembox	80
Crosley literature	35



Panoramic view of a section of the Radiofest '94 flea market area.



Jim Kreuzer and Gary Schneider still selling the wares from their "Excellent Adventure," reported in the June 1994 issue of A.R.C.

Dahlberg with clock, pink	175	Kitchenair radio	125
Day-Fan 5 battery set	25	Klitzon 130 and Kellog phones	150
DeForest Type P-300 Audion control box	800	Knight 333	25
DeWald Catalin knobs, (2)	25	Knight Space Spanner	35
Drake shortwave converter	125	Loose coupler and headphones	160
Dray Radio Lab	100	Majestic 9160	35
Emerson Catalin tombstone, yellow	500	Majestic banner	150
Emerson chest radio	110	Majestic horn speaker	70
Emerson radio poster	90	Midwest console	500
Eveready battery box	100	Motorola display	130
Fada 1000	275	Parker, 1929	60
French crystal by SNAP	250	Pepsi fountain dispenser transistor	110
GE A-70 tombstone	110	Philco 38	45
GE J-7 cathedral	200	Philco 38-40	50
Grebe Synchronphase	200	Philco 42-321 table radio	25
Gridiron football radio	350	Philco 46-420	35
Guild Country Belle telephone/radio	60	Philco 50	80
Hallicrafters 7" TV	55	Philco 50 cathedral	100
Hallicrafters SX-43	55	Philco 89 cathedral	80
Hickock Card-O-Matic	45	Philco 170	325
Hitachi H627R	45	Philco neon clock	350
Homebrew battery set	45	Philco Predicta TV	175
Homebrew glass radio	210	Porto Products Smokerette	45
Hopalong Cassidy radio	300	Quack medical device	100
Imperial tombstone	50	Radio Amateur French crystal set	275
International Kadette KRC2	110	Radio Boys and other books	30
Jewel horn speaker	80	Radio Industrie French crystal set	250
Kardon battery set	25	Radio Rex novelty	225
Kellog radio	100	Radio Reve French crystal set	250
Kennedy lowboy	60	RCA 17, 18, and AK 40	90
Kera crystal set	275	RCA 45J2	30
		RCA 100A speaker	25
		RCA 812K	30
		RCA match holder	60
		RCA Nipper drapes	150
		RCA Radiola 17, 18, 33	60
		RCA Radiola 26	250
		RCA Radiola AC	250
		RCA Radiola highboy, (2)	25, 45
		RCA Radiola V crystal set	550
		RCA tubes display	55
		Recordio	35
		Regency TR-1	100
		Remco radio station, 1950's	25

A warning: Auction prices are not current values. A listing such as this cannot adequately include the condition of cabinets, chassis, transformers, tubes, the operating status of the set, and the inclusion of incorrect, restored or replica components, etc. Auction prices are the result of the excitement of the auction process, the skill of the auctioneer and the specific interests of the participants. Nevertheless, auction prices serve as useful references and as another element in the value determining process. The possibility of error always exists, and if we are notified, corrections will be reported.

(Continued on following page)



Flea market tables belonging to Jon Prabel who specializes in Zenith items. Note the RCA TK-11 TV camera and the Christmas banner around the Zenith console.

(Radiofest '94, continued)

Remler Scottie, (2)	50, 160
Rocket radio crystal set	60
SAMS auto radio books	25
Sams manuals, boxes (3)	55
Scott chrome chassis	145
Setchell Carlson 415	25
Sony TR-63	140
Spark coil	55
Spark gap, marble base	35
Sparton radio poster	100
Standard Micronic Ruby	70
Stewart-Warner 501 tubes (5)	80
Sylvania display	35



Jim Miller, a retiree from *The Voice of America*, offering communications receivers and other items in the flea market.

Telegraph sounder and key	125
Telegraph tape machine	400
Telephone radio	45
Toshiba 9TM/40	80
Train novelty radio	25
Transistor radios, various, (16)	30
Tresco 1-tube	80
Tresco 2-tube amp	55
Tri-City battery set	70
Tubes, carton (11)	30
Tung-Sol lamp and shade	50
Tupple speaker	25
Vibroplex telegraph key	90
Ward's movie dial	70
Waters hand-crank phono	35
Westinghouse RA and DA	450
Wireless Specialty Apparatus IP-501A	1,700
Wireless Specialty IP-503 loading coil	400
Zenith 4-K-310	70
Zenith 4-X-31	110
Zenith 5-S-320	65
Zenith 6-G-001	35
Zenith 11	90
Zenith 500H (3)	350
Zenith 500H, black	35
Zenith Royal 500, pink and tan, (2)	120
Zenith Trans-Oceanic H-600	40

Photos by Ron Frisble.

(Jeff Aulik, 1708 Parkview Ave., Rockford, IL 61107; Karl Ayer, P.O. Box 665, Thiensville, WI 53092)

Information on joining the Antique Radio Club of Illinois (ARCI) may be obtained from Carolyn Knipfel, RR 3, 200 Langhorn, Morton, IL 61550. Annual dues are \$12, and a quarterly newsletter is published. Besides the annual Radiofest, ARCI sponsors additional meets each year.

COLLECTORS NEWS

The Vintage Radio & Phonograph Society Celebrates Its 20th Anniversary

CONTRIBUTED BY GEORGE POTTER, VRPS EDITOR

At its annual convention in Irving, Texas, on October 14-16, the Vintage Radio & Phonograph Society, Inc. (VRPS) will celebrate 20 years as an organization devoted to early radio and phonograph. A small group of veteran radio collectors formed SVRPS (Southwest VRPS) in October of 1974, on one Wednesday evening at the Electronics Center in Dallas, Texas.

The enthusiastic collectors attending that first meeting agreed that each should bring a guest to a meeting the following month. The second meeting in November went well, with thirteen attending. The group voted to continue meeting each month on the third Saturday. To this day VRPS continues to meet on the third Saturday of each month.

In April of 1975, SVRPS made plans to participate in its first public showing — Radio Nostalgia week sponsored by KERA FM Radio Dallas — at the Olla Podrida Mall in North Dallas. In November of 1976, SVRPS hosted the society's first

annual convention with an attendance of a little over 100.

On January 13, 1975, the first SVRPS "Newsletter" consisted of a member list and info on the next meeting. The SVRPS "Newsletter" became *The Reproducer* in October 1977. The Southwest Vintage Radio & Phonograph Society became VRPS in February of 1978. To date, VRPS has hosted 18 annual conventions, each one becoming larger and more expensive.

Since 1974, that small group of collectors has grown into a very active organization with over 370 members worldwide. VRPS continues its dedication to the preservation of antique radios and phonographs.

To join VRPS and to receive more information about the October convention, write to: VRPS, Inc., PO Box 165345, Irving, TX 75016. Annual dues are \$13.50 U.S.A., \$17.00 foreign, and include a subscription to *The Reproducer*, published quarterly, and to the newsletter *Soundwaves*.



Vestal Press Sells Radio Books to George A. Fathauer

FROM A PRESS RELEASE

George A. Fathauer, formerly of Antique Electronic Supply, has purchased the rights and inventory of all the antique radio-related books published by The Vestal Press and is starting a new business under the name Sonoran Publishing.

The books include *Radio Manufacturers of the 1920's* by Alan Douglas, *70 Years of Radio Tubes and Valves* by John Stokes, *Crystal Clear* by Maurice Sievers, and *The Complete Talking Machine* by Eric Reiss.

Book projects in the works include a reprinting of *Crystal Clear*, a book about early crystal radios which has been out of print. A new companion volume to *Crystal Clear* containing additional in-

formation is due out in mid-1995.

Books on Antiques
& Collectibles



SONORAN
PUBLISHING, LLC

formation is due out in mid-1995. Another project is a long-awaited revision and expansion of *The Radio Collector's Directory and Price Guide* (1986), by Bob Grinder. It is expected to be available in early 1995. The new version will list information on over 20,000 radios made in the United States between 1920 and 1960.

Sonoran Publishing will sell wholesale only to qualified dealers and is located at 116 N. Roosevelt, Suite 121, Chandler, AZ 85226. Sonoran Publishing can be reached by phone at (602) 961-5176.

(A.R.C. wishes George A. great success in his new enterprise. Editor)



HOMEBREWING

Building A One-Transistor Cathedral Radio

BY ROBERT E. LOZIER, JR.

Robert Lozier's article demonstrates just how far some of us collectors will go to achieve a radio end. Robert had an idea for a one-transistor cathedral radio and went ahead and built it. Some of you readers may want to use his idea as a basis for your own project. However, if you should want to duplicate his project, he offers a drawing package to guide you. (Editor)

Get ready for that wintertime project. Be the first one on the block to build a one-transistor radio — a truly unique design for a completely self-contained, one-transistor cathedral radio that looks great and does a surprising job of bringing in the daytime locals with good loudspeaker volume. You can even have fun with "DX" at night!

About a year ago, a collector friend told me about the one-transistor radio he had built. I was interested because I had memories of building simple transistor radios as a teenager in the late '50s and early '60s. I expected that he would show me a small set that required some sort of external antenna and would drive an earphone.

Much to my surprise, he brought out a self-contained radio housed in a wooden box about 15 inches square and about 4 inches deep. The front panel had a conventional tuning knob, an on/off switch and volume control, as well as a 5-inch diameter loudspeaker behind a grille. He turned the set on, and it did a nice job of bringing in several local stations with decent loudspeaker volume. The audio quality and volume were a little better than the typical 6-transistor pocket radio.

I thought that the performance was amazing considering that there is only one transistor in the circuit. He showed me some of the engineering tricks he had had to play in order to get the required performance.

I built this circuit for myself. After a few problems were cleared up with my friend's help, I had the set working fairly well. Then the old wheels started to spin, and I began to think of how I could squeeze even better performance out of the circuit. After

some effort, I can now pick up 15 to 20 stations at night with loudspeaker volume!

THE CATHEDRAL-STYLE ENCLOSURE

Having this neat circuit, I decided that I needed to package the receiver in an interesting enclosure. The basic box just did not have enough eye appeal. So, one day I got the bright idea of packaging the set in an enclosure reminiscent of American-made, mantel set cabinets of the early 1930s, more commonly called cathedral-style cabinets today.

The cabinet has to be large because of the required air core loop antenna or "frame aerial," as the British would say. It just so happens that the Philco 90 cathedral-style receiver in my collection is about the right height and width to be an enclosure for this loop. Of course, it only needs to be about 4 inches deep.

I decided to use the basic measurements of the Philco 90 and make up a set of full-sized drawings. The objective was not to copy faithfully this vintage



Figure 1. A front view of the one-tube transistor cathedral radio.

radio cabinet but to make a simplified cabinet requiring only cheap materials easily obtainable at local home improvement centers. Figures 1 and 2 show the finished product. The rear views of the cabinet, shown in Figure 3, illustrate the components used, including the built-in loop antenna.

The only power tools needed for this job are a saber saw and a hand drill with a drilling guide that makes it possible to drill perpendicular holes. Having access to a scroll saw and a drill press would make the tasks a little easier. The only other special tool needed is a pair of furniture bar or pipe clamps that can span at least 18 inches. My drawings, which I am making available to anyone interested (see below for details), show how to bend and glue the dome top of the cabinet using only these two clamps and some scrap wood.

The receiver uses an efficient reflex circuit. The one-stage transistor circuit amplifies and detects the desired radio frequency signal. This signal is then fed back to its input where it is again amplified as an audio signal.

The electronics drawing package shows exactly how to lay out the receiver circuit and how to do all of the other detail work to produce a set ready to operate. Many of the electrical parts might be found in a well-stocked junk box or at

Figure 2. A side view of the one-tube transistor cathedral radio.

the next big hamfest. The transistor used is very special but not expensive. It, along with an adjustable inductor, is available from Digi-Key Corp. The catalog numbers and other ordering information are in the drawing package.

This is one project that grabbed my attention and just would not let go, even though I have many more projects demanding my time. It does nothing to advance the cause of world peace in our time, but it sure was fun!

The electronics drawing package contains 4 full-sized pattern sheets and 12 pages of sketches and text detailing the construction of this set. This package will be sent to you, postage paid, in a mailing tube on receipt of your check or money order for \$16.50. Send your order to: Robert Lozier, 600 E. Green St., Monroe, NC 28112.

Robert Lozier, a collector of broadcast receivers for over 25 years, has recently become interested in the development of foreign radio technology. He has given lectures in Italy on radio collecting, as well as elsewhere on restoration and preservation techniques, early television, and the Magnavox Company. His free time is spent in developing restoration techniques and in preparing radio artifacts for exhibition.

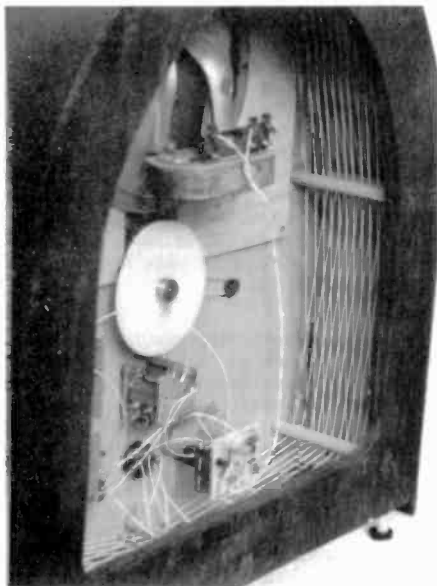

Figure 3. Rear views of the one-tube transistor cathedral radio showing the components used, including the built-in loop antenna.



RADIO MISCELLANEA

"Antique Radio Classified" invites its readers to contribute letters and information for inclusion in "Radio Miscellanea" and elsewhere in the magazine. The topic should be of general interest and sent to A.R.C., P.O. Box 2, Carlisle, MA 01741. All material submitted should be verified for accuracy and may be edited for publication, which is not guaranteed. See the masthead for more details.

Challenge To Doerle Buffs

Dear Editor:

Can anyone tell the story of the Doerle radios of the 1920s and 1930s? Regenerative, plug-in coils, glass and metal tubes, ready-made or kits — Doerles were featured in many articles in Gernsback publications. Was Walter C. Doerle really Hugo Gernsback? What was the connection with the Radio Trading Co. and the Oscar B. Kusterman Co.? Doerle made receivers, transmitters, and amplifiers. I owned a Doerle Model D-7 around 1937, although I can't remember how I managed the \$27.50 to pay for it. Thanks for your attention.

C.L. Richter, Quartz Hill, CA

Coincidentally, Chuck Schwark has an article in this issue on his Doerle home brew. Can someone out there answer Mr. Richter's questions and perhaps write an article on the Doerle company? (Editor)

Permeability Tuning

Dear Editor:

I read with interest your recent articles on permeability tuning [August and September 1994]. I was especially interested in the Airline 84KR-1520A on pages 6 and 7 of the August Issue. The set was made by Kingston Radio (hence KR), a division of Kingston Products Corp., Kokomo, Indiana. Kingston radios can be found in Volume 4 of Rider's manuals, the only year the company made and sold radios under the Kingston name. Before World War II, most of the radios were made for Gamble stores and Western Auto Supply. It was said that Kingston was the largest manufacturer of private brand farm battery radios in the United States. Kingston made radios from 1934 to 1954.

The radio shown on page 7 of the August A.R.C., top right, has been repainted. The name "Airline" should be silk screened in red between the two knobs. When I bought my set, it had to be repainted, so I had a silk screen made and put the name on my cabinet. The set originally came in white with red "Airline" and in blue, red, green, and yellow, all with white "Airline."

Jim Fred, Cutler, IN

Dear Editor:

I would like to make a correction on the article "Radios With Permeability Tuning — Part 2." The Midland Models B6A and B6B were not built in 1940 as indicated since the company built radios only in 1946 and 1947. It's an easy mistake to make looking at the date on the diagram in Rider's, which appears to be 1940. The Models B6A and M6B used 32v for the B voltage, as well as for the A supply. Also the Models M6A and M6D were 6-tube sets, not 5-tube sets as stated in the article. The manufacturer's suggested price on the AC/DC sets was \$29.35. Some Midland collectors have reported superior performance from their sets, while I have received average results at best from my own sets.

Dennis Hilberg, Decorah, IA

Extraordinary Ad Response

Dear Editor:

I thought you might be interested in how I made out from my ad in A.R.C. of November 1992. Two of my old DeForest Audion tubes were listed. Filaments in all of these old tubes are intact. I received a total of 53 requests for these tubes! The lowest bid was \$5 for each. Some bid \$50, some \$100, etc. The best bids were for \$850 for both to \$2,000 for both. After I had sold these, I continued to receive bids for the next 15 months! Best of luck to you and your group.

W.V. Bartow, Sr., Delray Beach, FL
Another A.R.C. success story! (Editor)



Answers to Cereal Box Quiz

Dear Editor:

I believe I can identify all but one of the sets pictured in the Total cereal box quiz (see July 1994 A.R.C.).

Starting in the upper left corner and moving clockwise (omitting the modern set):

1. Philco 49-702 7" table, ca. 1949
2. Automatic TV-P490 7" portable, ca. 1949
3. Philco Predicta Tandem (screen section only), ca. 1959-1960
4. GE or Hotpoint 2-tone metal portable, ca. 1956-1957
5. Airline 94GSE-3015 7" upright portable, ca. 1948
6. Not sure — maybe a Setchell Carlson
7. The set in the background appears to be a generic set by Crosley, Hallicrafters, Silvertone, among others, ca. 1956.

The photographer did a good job hiding any brand name identification. Thanks for the fun, A.R.C. and Mr. Oppatt Mike Drown, Imperial, MO

CLUB SPOTLIGHT

CANADIAN VINTAGE RADIO SOCIETY CVRS

The Canadian Vintage Radio Society (CVRS) was founded on October 26, 1992, because of the large number of radio collectors in Alberta, Canada, who had no club. Originally named the Alberta Vintage Radio Society (AVRS), the society voted to change the name to the Canadian Vintage Radio Society on December 19, 1993.

The society is dedicated to the collection, preservation, restoration and enjoyment of antique radios and related items. Most CVRS members have a great interest in restoration, as well as in radio history. CVRS' long-term goal is to found the Vintage Radio Museum in Alberta.

With about 75 percent of CVRS' 140-plus members in Alberta, the remaining members are scattered from the Yukon to Nova Scotia. The volunteer-run club eventually hopes to cover Western Canada — British Columbia, Saskatchewan, Manitoba and the Northwest Territories — in addition to Alberta.

CVRS president Nap Pepin and his wife Leslie have used their background in operating small businesses, their desktop publishing experience, and their strong interest in vintage radio to help run the society.

Radio Waves, the bimonthly 25-page newsletter of the CVRS, was first issued in February of 1993. The publication contains meeting notes and articles relating to vintage radio or associated items, such as radio history, repair, and restoration. Clever drawings by Kim Voigt amusingly illustrate the publication with the character "Tube Man."

CVRS members are encouraged to submit articles, as well as letters to the editor and classified ads. Classified ads in *Radio Waves* are free to members; each member may include 5 ads in an issue, limited to 50 words per ad. The society holds meetings, swap meets, and workshops.

Other benefits to CVRS members include discounts at select stores carrying restoration supplies and parts, a free business card artwork service, and a schematic service. The club plans to add auctions, bingos and casinos to its events.

Yearly fund-raising activities, starting with raffles, will benefit a trust fund to aid in founding the future Alberta-based Vintage Radio Museum. Possible future services could involve many antique radio clubs; for example, a multi-club database for available and needed radio parts and knobs has been suggested.

The first year (1993) in CVRS' life included a swap meet, a silent auction, a garage sale, guest speakers at meetings, and restoration workshops.

The address of CVRS is: PO Box 43012, Metropolitan Place P.O., Edmonton, Alberta, Canada T5J 4M8.



The CVRS logo.



THE OFFICIAL
PUBLICATION OF THE
CANADIAN VINTAGE
RADIO SOCIETY

RADIO WAVES

TM

The banner from the "Radio Waves" newsletter.

Canadian Vintage Radio Society CVRS

Dues: \$17.00 U.S. or \$21.00 Canadian,
per year; prorated to Dec. 31 from
the month you join

Publication: *Radio Waves*, published bi-
monthly

Membership year: Jan 1 to Dec. 31

Officers:

President: Nap Pepin

Vice President: Dennis Sebastian

Correspondence Secretary/
Treasurer: Leslie Pepin

Recording Secretary: George Earl

Directors (all officers):

Klaus Beckmann

Darold Dusdal

Bill Elmer

Rick Williams

For membership information, applications:
Nap Pepin

144 Calico Dr.

Sherwood Park, Alberta,

Canada T8A 5P9 - (403) 449-5413



FOR SALE: Toy crystals radios, looking for spaceships and unusual rockets. Extras to trade. Call: Lew Magrish, 706 Dumas St., Dallas, TX 75214. (800) 584-0134

FOR SALE: Tested tubes w/warranty! Cheap tubes: Buy those spare tubes for your tube radio, audio, ham and electronic gear. Prices are about 30% of new for tubes with a warranty, many about \$1. I have bunches of octal, older, 7- and 9-pin tubes. All tested on TV/7 tester and boxed. I give a 30-day warranty. Send wants or SASE with two stamps for list. Daniel Nelson, 1025 E. Desert Ln., Phoenix, AZ 85040. (602) 243-7421, evenings

WANTED: Amplion driver for AR 113 or AR 114 horn speaker. Ed Bell, 5311 Wooddale Rd., Raleigh, NC 27606. Fax/phone (919) 851-1517

FOR SALE: 45 Players: RCA 6EY3A - \$50. RCA 8EY31HE - \$60. RCA 45EY3, no lid - \$60. RCA 45EY4 - \$90. Airliner G AA 982A - \$40. Crescent 453A - \$50. All untested, sold as is. 45 cartridges rebuilt - \$28 ppd. 45 player needles, sapphire - \$5; diamond - \$10. Plus shipping. Parts for 45 players. J.J. Papovich, 53 Magnolia Ave., Pitman, NJ 08071. (609) 582-8279

WANTED: Antique demonstration, scientific apparatus. Electrical and optical. Early microscopes. Allan Wissner, Box 102, Ardsley, NY 10502. (914) 693-4628

WANTED: Reasonably priced small AM transistor radios, working or not, will buy your collection. Douglas Ferrero, WB8YNZ, 33673 Chatsworth, Sterling Heights, MI 48312. (313) 268-3677

FOR SALE: Zeniths: 9S262 - \$350, 5-R-135 - \$195. All exc. Rider 11 to 5 abridged 6-15 - \$275. List LSASE. Richard Bednarcik, 28 Steele Ave., Lincoln Park, NJ 07035. (201) 694-6374

WANTED: Philco radio knobs 1930's, 1940's. John Lopez, 825 Lees Dr., Las Cruces, NM 88001

FOR SALE: Send stamp and request vintage parts flyer. U.S.A. only. B-E since 1954. Bigelow Electronics, PO Box 125, Bluffton, OH 45817

FOR SALE: Tubes, components, Sams Facts, misc. catalog - \$1. NRQ Electronics, PO Box 352924-AR, Toledo, OH 43635-2924

SERVICES: Professional overhauls & service for all 1935 to 1960 antique American & European table & console radios, tube amplifiers, jukebox amps. Tubes available. Reasonable rates guaranteed with: Dan Lubczanski, 431 N. Leh St., Allentown, PA 18104. (610) 776-7191

WANTED: The following tube-type CB's in mint condition: Lafayette HB444/25A and 25B, Gemtronics GTX2300 and GTX5000, Robyn Executive RIT240D, and Teaberry Model T. Also looking for a mint Lafayette HA410 (10 meter AM) transceiver and a complete set of CB Horizons or S9 Magazine. Harry Schools, KA3B, 1606 S. Newkirk St., Philadelphia, PA 19145

WANTED: Still looking for A.C. Gilbert Electronic kits. Tracy Sands, 770-C N. Main St., Orange, CA 92668. (714) 639-2111

WANTED: McIntosh and Marantz tube hi-fi gear. Immediate cash paid. Frank Czaja, 8968 W. Forest Home, #4, Greenfield, WI 53228. (414) 529-9395

FOR SALE: Kolster Model K-90 radio shipping cartons, wood, not shippable, must be picked up - \$125 ea. PR Novelty, PO Box 140, Milwaukee, WI 53201. (414) 964-3392

.....
A.R.C. Advertising Policy
Sellers and Buyers, Please Note!
 • Advertising is accepted only for early items
 • related to radio, communication, etc. All
 • items must be described fairly; reproductions,
 • reprints and not-original items must
 • be so identified. Advertisers must agree to
 • respond promptly to inquiries and orders, to
 • resolve problems promptly if the buyer is not
 • satisfied, and to comply with a buyer's
 • refund request on unaltered returned items.
 •.....

WANTED: Juvenile radio books: Radio Boys with Air Patrol and Jack Heaton, Wireless Operator. Robert Stapleford, 1800 S.W. Randolph Ave., Topeka, KS 66604

WANTED: Gernsback Official Radio Service Manuals. Jackson Bell Model 60 chassis. Majestic 31 cabinet. Curt Schreiber, 3923 East Latoka St., Springfield, MO 65809. (417) 887-5184, collect

FOR SALE: 5 wire N.O.S. AK cord - \$15. Elmac TR-75 power xfmr - \$20. All ppd. Geo. Hausske, 1922 E. Indiana St., Wheaton, IL 60187. (708) 668-3845

FOR SALE: 1,150 TV tubes, sml. and lrg., new and used, untested - \$130 ppd. Chas. Filer, Rt. 2, Box 565, Summerland Key, FL 33042. (305) 745-1801

WANTED: Hallicrafters portable TW-55 (Baby Boom III, p. 123), Zenith radio nurse. Dr. Wolfgang Hornik, Hedwigstr. 11, D 80636 München, West Germany. Phone 011-49-89-1292750

WANTED: All types of telegraph items. I will buy whole collection. Rick Hardin, 1750 Coleman Rd., Anniston, AL 36201. (205) 835-0900 day, (205) 237-2008 night. Fax (205) 835-0992

FOR SALE: End of year lists on following, each a SASE: Horn speakers, old coil tuners, AK parts, amps, tuners, crystal sets dets, keys sounders, signal gens., tube testers, tubes, books, mags, tube guides, power supplies, batt. chargers, small and table model tube radios, old lab and display meters, German table radios. Just cleaned out ham radio rooms, walls and file cabs., (5,000) QSL cards for sale, fair, faded, tack holes, (100) assorted - \$40 ppd. in U.S.A. F. Krantz, 100 Osage Ave., Somerdale, NJ 08083

COLLECTIBLE RADIOS

miniatures

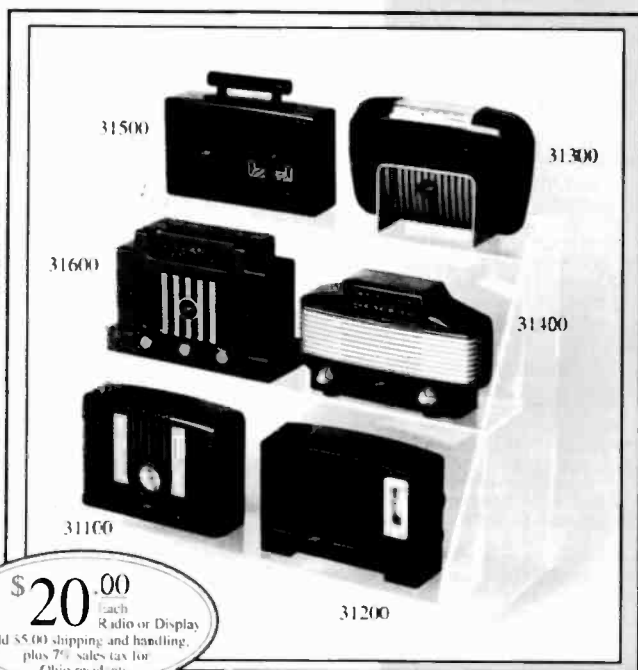

\$20.00

each

Radio or Display
Add \$5.00 shipping and handling,
plus 7% sales tax for
Ohio residents.

OUR BATTERY OPERATED CLASSICS come in the most collectible shapes and colors of the 1940's. Six mid-century styles are simulated catalin and bakelite plastic finishes. All models reflect images of American "Industrial Design" -- bold and streamlined are these broadcast icons of the Golden Era. AM/FM. operates on 2 AA batteries not included, approx. 5" x 2" x 3 1/2".

Display

up to six styles on this beautiful acrylic case. Approx. 9 3/4" x 12" x 6 3/4"

FOR SALE: Butternut HF9VX vertical antenna, 6 through 160 meters, radial kit, WARC bands, mint, cost \$360 - Sell \$180 plus shipping. Charles Zafonte, N1FRX, RFD 1 Box 75, Fort Kent, ME 04743. (207) 834-6273, eves.

FOR SALE: Replacement Sparton 557 and 558 glass fronts and tops. Original glass from the 1930's, perfect in every way. Call: Lew Magrith, 706 Dumas St., Dallas, TX 75214. (800) 584-0134

SERVICES: Repair of TV-7 tube testers and calibration: I will fix and then verify calibration of your TV-7 tube tester for \$45 plus shipping or return it no charge. Please no units with bad meter movements or missing components. Unit must be repairable and not a basket case. Daniel Nelson, 1025 E. Desert Ln., Phoenix, AZ 85040. (602) 243-7421, evenings

WANTED: Crosley crystal set. Pay \$1,000. Thanks to A.R.C. advertising, I found one type. Now I want the other two. Ed Bell, 5311 Woodsdale Rd., Raleigh, NC 27606. Fax/phone (919) 851-1517

FOR SALE: Sams books; AR Series, TM Series, MHF Series, or Photofacts - \$2.50 each + postage. Riders TV manuals #1 and #3 - \$25 ea. TV 4 through TV 24 - \$10 each plus postage. RCA 45 Changer Service Data, RP 168 or RP 190 - \$10 ea. For book list send LSASE w/58c postage. J.J. Papovich, 53 Magnolia Ave., Pitman, NJ 08071. (609) 582-8279

WANTED: RCA 621TS television and information on Echophone Model 6. Kenny Mullis, 1674 Lakeview Cir., Lancaster, SC 29720. (803) 285-6233

FOR SALE: Radios 40's, 50's, 60's. Send large 29c SASE for list. Harvey Leners, 5426 S. 185th, Omaha, NE 68135

FOR TRADE: My (10) old transistor radios, including a red Royal 500E for your cathedral radio. Send SASE. Steve Pazar, 4950 Deerwood Dr., Santa Rosa, CA 95403. (707) 544-8142, e-mail pazar@sr.hp.com

FOR SALE: Vintage tube CB's, LSASE for list. Manuals: Collins R390 Maintenance - \$20; R390A Operator's - \$20. Charles Zafonte, N1FRX, RFD 1 Box 75, Fort Kent, ME 04743. (207) 834-6273, eves.

FOR SALE: New Nichicon 10 mFd./450 axial, ten or more - 98c each includes postage. DH Distributors, PO Box 48623, Wichita, KS 67201. (316) 684-0050 w/f

HELP: Looking for manuals on: 1. Weston Mod VOM 769. 2. Dyna-Jet Mod 700 tube tester 3. Dyna-Jet Mod 500 tube tester. Copies OK. Chas. Filer, Rt. 2, Box 565, Summerland Key, FL 33042

WANTED: Stock market ticker tape machine. Rick Hardin, 1750 Coleman Rd., Anniston, AL 36201. (205) 835-0900 day, (205) 237-2008 night. Fax (205) 835-0992

WANTED: Your list for mine or dollar plus SASE for superlist. Looking for Art Deco table model plastic push-button radios. Want colorful Emersons. Desperately need crystal sets and old communications receivers. Also Zeniths and first Trans-Oceanic. Cash or lots to trade. Steve Lipsky, W2VVN, 1254 Cox Rd., Jenkintown, PA 19046-1207. (215) 884-1817, or (609) 361-8175

FOR SALE: New books, free shipping. #1. The Collector's Guide to Antique Radios, 3rd Edition, by Marty & Sue Bunis, 280 pages, over 8,500 models, over 700 all new full color photos, 1994 values, only - \$18.95 ppd. #2. The Collector's Guide to Novelty Radios, by Marty Bunis & Robert Breed, 224 pages, over 600 all new full color photos, 1994 values, only - \$18.95 ppd. Buy directly from the authors and save expensive shipping charges. We ship all books immediately upon release from the publisher. Be sure to specify which book you want and include \$18.95 for each copy. (Canada, add \$1 per order; foreign, add \$4 per order, surface. U.S. funds only.) Send your check or money order to: Marty & Sue Bunis, 32 West Main St., Bradford, NH 03221

TUBES WANTED

We need the following tubes to replenish our stock. Tubes must be new and in original boxes and of US or Western Europe manufacture. You may ship your tubes to us by UPS or Parcel Post. We'll mail our check upon receipt and testing of tubes. We pay prices shown plus shipping charges. We buy all types of receiving and transmitting tubes. We also need 4, 5 and 6 pin molded sockets. Send us your list for our bid.

TYPE	PRICE	TYPE	PRICE	TYPE	PRICE
01A(ST)	\$ 8.00	6F8G	\$ 5.00	24A	\$ 3.50
2A3	20.00	6GM5	7.00	26	4.50
2A5	5.00	6J5C	5.00	40	8.50
2B8	6.00	6J7G	2.20	42	7.00
5A5A4	5.00	6JE6C	20.00	45	20.00
5U4G	6.00	6JG8A	15.00	48	6.00
5U4GB	5.00	6JR8	12.00	50	60.00
5V4G	3.30	6K5G	5.00	71A	7.00
5V4GA	3.00	6L8G	9.00	75	4.00
5Y3G	3.50	6LF8	16.00	211(VT-4C)	27.00
6A3	13.00	6N8G	8.00	7591A	22.50
6A5/G	12.00	6U5	6.00	8068	17.00
6B4G	12.00	6V6G	5.00	8417	15.00
6CA7/EL34	8.50	10	11.00	8908	25.00
6F5G	5.00	12A	10.00	8950	25.00

ALSO SEE OUR AD FOR USED TUBES WANTED



ANTIQUE ELECTRONIC SUPPLY

LIMITED PARTNERSHIP

6221 S. MAPLE AVE., TEMPE, AZ 85283 PHONE (602) 820-5411 FAX (800) 708-6789

WANTED: Westinghouse TF transmitter. Cash or trade. Ed Bell, 5311 Wooddale Rd., Raleigh, NC 27606. Fax/phone (919) 851-1517

WANTED: Base for EV664 microphone. Need a manual for Gates MO-2639 modulation monitor. Vacuum tubes VT-52, 2A3, 6A3 and 6B4-G. Thanks! Tom Smith, N5AMA, 13034 Elmington Dr., Cypress, TX 77429. (713) 376-3436

FOR SALE: N.O.S. and used radio and TV tubes. Send LSASE for lists. C. Elmer Nelson, 11 S. Church St., Princeton, IL 61356

WANTED: Old microphones. Specifically bullet shapes made by Shure, Astatic and Turner for public address. Plus old RCA/Shure CB mics. Will pay for call/shipping. Dennis Gruenling, 26 Dupont Ave., Piscataway, NJ 08854. (908) 752-5737

FOR SALE: Do you restore or repair old radios? Our catalog #3 is loaded with thousands of parts useful for the collector. Also listed is large section with radio literature. Large 8 1/2 x 11 catalog, 56 pages, is - \$3.50 ppd. Gary B. Schneider, Play Things Of Past, 9511-23 Sunrise Blvd., Cleveland, OH 44133

HAS YOUR SUBSCRIPTION

EXPIRED?

It has if your mailing label reads
"EXP=OCT94" or earlier.

Renew now!

*BONUS: Renew before
your "EXP" month and receive
13 issues per year instead of 12!*

Renewal rates are:

\$31.95 for Second-Class Mailing

\$47.95 for First-Class Mailing

(Two-year renewals are twice above rates.)

FOR SALE/TRADE: Bozak, Dynaco, Fisher, Grado, Scott components for your Argus, International, St. Regis, Airite, IRC, Rotofoor, Jewel, Webber, Arion, Cavac or other Ann Arbor radios. Nevins Museum of Radio, Ken Nevins, 406 Jipson St., Blissfield, MI 49228. (517) 486-3019, evenings

FOR SALE: Crosley D-25-TN - \$55. Zenith Royal 275, missing logo - \$20. Howard 901-A - \$30. Arthur Kreiner, 2013 East Belle Ave., Belleville, IL 62221. (618) 233-5610

SERVICE DATA & REPAIR PARTS

FREE CATALOG

A.G. TANNENBAUM

P.O. BOX 110
EAST ROCKAWAY N.Y. 11518

518 887 0057

24 HOUR FAX 516 599 8523

WANTED: Keys, older electricals, mechanicals, scientifics. Dr. Joe Jacobs, 60 Seaview Ter., Northport, NY 11768. (516) 261-1576

WANTED: German/European multiband transistor radios in xlint. cond., including Magnavox/Philips D-2999. Also Zenith T.O. R7000, Taiwan, in xlint. cond. Ed Kalpa, 4622 Melbourne Ave., Los Angeles, CA 90027

FOR SALE: Stewart-Warner A-6S Dionne Quints radio. Overall excellent condition. Decals excellent, tubes light but no sound - \$950. Steve Harris, 512 Fifth St., Peru, IL 61354. (815) 223-2583, days

WANTED: RCA Broadcast News magazines from '30s-'50s, also Western Electric Pickups and Oscillator magazines. Also want old broadcast transmitter sales brochures and catalogs from '20s-'60s. Also looking for hard-to-find RCA CR-88-B communications receiver. Sam Thompson, W6HDU, 1031 San Antonio Ave., Alameda, CA 94501. (510) 521-1429

WANTED: Buyer: EV, Shure, Turner, Astatic microphones. 1940-1980. Working or not. Contact: T. Ellis, Box 140093, Dallas, TX 75214. (214) 328-3225, anytime. Fax (214) 328-4217

FOR TRADE: Will trade quality vintage fountain pens for Catalin radio. Quentin Kurtz, 2251 Westport, Wichita, KS 67203. (316) 945-8455

FOR SALE: 1933 World's Fair tombstone, needs work - \$75. NRI Course from late 30's-early 40's - \$12. Pilot full-size replicas of various sets. Blueprints, suitable for framing, closeout - \$5 ea. 110-volt power supply for 2-volt sets - \$10 Howard 10-tube chassis from mid-30's - \$25. Fada 290 tombstone chassis - \$25. Radio Trouble Shooter Manual by Ghirardi, nice condition - \$20. **WANTED:** Pilot radios any model, any condition. Westinghouse tombstone/console models 214/314. Bill Moore, 3049 Box Canyon Rd., Huntsville, AL 35803. (205) 880-1207

RADIO GRILLE CLOTH

23 patterns & color combinations now
available to suit most radio needs!
52c LSASE for samples

More Good News! Even More Variety!

- 1) Four new and different patterns now available. A second small diamond pattern, in copper color, a super-Deco looking "W" pattern that will jazz up any Art Deco console, and a plain black/silver cloth in two color tones.
- 2) Two replacements for my #8 Philco nbbed pattern. Very close to the original cloth! Two shades of brown are available.
- 3) Four new, attractive & unique patterns are currently in the works and should be available in September.
- 4) Still offering sampler packages of 5 or 10 pieces of cloth for \$20 and \$38, postpaid. See prior issues of A.R.C. for details, or call.

MICHAEL KATZ
3987 DALEVIEW AVENUE
SEAFORD, NY 11783
(516) 781-6202 (EVENINGS)

WANTED: Early loose couplers and slide tuning coils. Also crystal sets or one-tube radios using these coils, manufactured, home-brew or basket case. James A. Di Ruzza, 2607 Old Troy Pike, Dayton, OH 45404. (513) 233-5004

WANTED/FOR TRADE: Your Zenith 12A58 for my Zenith consoles 6S52, 7S363, 8S359, 12H670. Bob Alexander, 20 Haycamp Rd., St. Paul, MN 55127-6507. (612) 483-6177

FOR SALE: Parting out an R-390A/URR. Working sub-chassis assemblies and parts available. SASE for list or call for specifics. Special thanks to all who helped me with restoration of my other R-390A. Fraser Bonnett, 2270 Nutmeg Ct., Fairborn, OH 45324. (513) 427-0297 NLT 9 pm EST

WANTED: Sony TR-63, any color, any condition. Marty Bunis, RR 1, Box 36, Bradford, NH 03221. (603) 938-5051

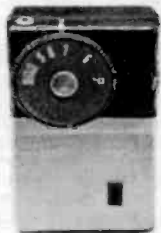

FOR SALE: Harman Kardon Award Series tube amplifier Model A-50K with 7355 output tubes (40 watts per channel). This amplifier also comes with a Harman Kardon T-300X AM-FM and multiplex tuner. Both units come with brushed aluminum face plates and 18 tubes total - \$225. (2) each James B. Lansing signature speakers Model D123, 12" OD 3" voice coil, 16 ohm, with J.B.L. LE20 linear efficiency tweeter and J.B.L.-LX2 crossover network with controls - \$75. Garrard Type A-11 4 speed changer with 2 ea. Empire 108 cartridges - \$25. Units are near mint and all original parts and tubes. All in good working condition + UPS. Mervyn Ellsworth, 2309 N. 25 St., Boise, ID 83702. (208) 345-6878

WANTED: Ivory or turquoise Regency TR-1G pocket transistor radio. Pay up to \$350. Jerald Hueber, 1366 King Richard Pkwy., W. Carrollton, OH 45449. (513) 866-6958

WANTED: Schematic diagram for KLH Model 16 amplifier, vintage 1960's. Lawrence Golub, 102 Wild Plum Longwood, FL 32779. (407) 788-0117

FOR SALE: Edwin H. Armstrong describes "The Super-Heterodyne - Its Origin, Development and Recent Improvements" in this rare Xeroxed 16-page 1924 IRE document. It's a key piece of radio history! - \$8 ppd. Gil Arroyo, 2766 S.W. 167 St., Seattle, WA 98166

WANTED: Still need Riders 2C to complete my set and flexible resistance line cords. Please help. Wilbert K Kimple, 3015 Kelsey Creek Rd., Spartanburg, SC 29302 (803) 585-6465

WANTED: Audio and amateur-related service and operating manuals. Trades considered. Pete Markavage The Manual Man, 27 Walling St., Sayreville, NJ 08872. (908) 238-8964

WANTED: Any crystal set. Collection now at 312 pieces; seeking more. Erwin Macho, Ambrosweg 17/A/E, A-1230 Vienna, Austria

FOR SALE/TRADE: (60)+ auto radios. Most are tube or tube/transistor. (30) complete, (30) missing knob, tube, etc. If you do cars and radios, these are for you!! Also, box of knobs and new parts and box of (60)+ Sams auto manuals. Will trade for best single radio offered. Prefer Catalin, Addison/Fada/other Decco plastic, rare early transistor like Thunderbird or Regency, or make a cash offer. You pick up radios or pay packing and UPS costs. Send SASE for list or \$2 for list and photos. Bruce Phillips, 127 Bunker Hill Ave., Stratham, NH 03885. (603) 772-3796, 5-10 pm only

WANTED: Oscillator coil for 260 Kc, IF receiver, Model 19 Philco. Will pay your price. Claude Pennington, PO Box 1916, Macon, GA 31202-1916. Call collect (912) 746-1231

WANTED: EV, Shure, Turner, Astatic microphones, 1940-1980. Working or not. Contact: T. Ellis, Box 140093, Dallas, TX 75214. (214) 328-3225, anytime. Fax (214) 328-4217

FOR SALE: (1) WE 300B N.I.B., (1) WE 203DN.I.B., (1) RCA 2A3 N.I.B.; all tubes - \$450 ppd. John Hemdal, 1211 Meanwell Rd., Dundee, MI 48131. (313) 529-2387

WANTED: Tape or wire recorders with 2" or smaller reels. Trades or cash. Thanks. Guy Doss, 736 Los Padres Blvd., Santa Clara, CA 95050. (408) 241-2437

WANTED: Zenith Royal 200, and 250 vg to mint. Jupiter shirt-pocket radio and Heath GW-11D CB. Mike Russ, WA6NGF, 20147 Rd. 192, Strathmore, CA 93267. (209) 568-0345

FREE: Large quantity of 50-60's era test equipment (some prewar), all immaculate, powered test bench, some military surplus, numerous boxes of parts & surprises. Must take all. Located in Lompoc, Ca. Norm Brady, 975 Cobblestone Dr., Orange Park, FL 32065. (904) 276-5427

FOR SALE: RCA 40X57 San Francisco Expo - \$750 Regency TR-1, red, hairline - \$375. Zenith Royal 500, maroon - \$75. Zenith 7-S-240A shutter dial chairside - \$300. **WANTED:** Knobs for Cutting & Washington 11A Gary Watkins, 8006 Greenwald, Belton, MO 64012. (816) 322-0773

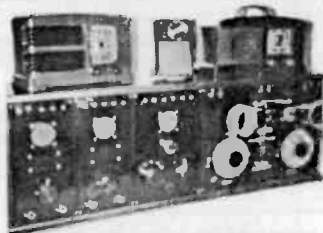

WANTED/TRADE: DeForest Interpanel parts or part set, early batteries. Detrola plastic or wood, any color/condition. Catalin, transistors, parts. Call or write Ross Lirenta, 1 Wilton Rd., Eastchester, NY 10709. (914) 337-7176

FOR SALE: National NCX-500 for parts - \$50. Phill Grant, 119 Hoeshop Rd., Bernardston, MA 01337. (413) 648-9077, eves

SERVICES: Restoring burned out filament 201A tubes into "brand new" working condition. Send LSASE. Jacob Anthes, Box 52, Lutz Rd., Gildden, WI 54527. (715) 264-5004

WANTED: Output transformer for early 70s Marshall Major guitar amplifier. Bill Fox, HCR 60, Box 83, Gouldsboro, ME 04607. (413) 569-6783

WANTED: Dial lens (round plastic) for Olympic Bakelite (Collins G. A. R.). Also BC for Fred Flintstone, pink. Call: Don May, 16 Gulley Dr., South Windsor, CT 06074. (203) 644-0258

HELP: Looking for tubes: 6U5/6G5, 6E5, 6T5, 6N5, 6F6's and more. Radio knobs, Zenith radios A-600, B-600, T-600, H-500, G-500, 8-G-005. James MacDonald, RR#1, Glendale, Nova Scotia, Canada B0E 3L0. (902) 625-2161

WANTED: Collins 75A2, F455B08, F455C08 mechanical filters, speaker. DX20 schematic. B&W Type JEL coils. Brian Roberts, K9VKY, 3068 Evergreen Rd., Pittsburg, PA 15237. (412) 931-4646

WANTED: Barium ferrite blocks, rods, rings, etc. Also German silver wire. Bryan Knudsen, PO Box 211, Kenosha, WI 53141

FOR SALE: Heliphone pocket receiver crystal set in wooden case sink(?) and as shown in 1922 Radio News, book included - \$150. MO preferred. John Shafer, 2275 S. Canal St., Newton Falls, OH 44444. (216) 872-7777

WANTED: Boys radio parts, one sceptre-type logo plate, (any name); one angel bottom logo plate; one angel two transistor top plate; three black king-type nameplates; three coronet type backs; always buying boys radios and parts sets, trades welcome. Gary Willoughby, 5930 W. Jefferson Blvd., Los Angeles, CA 90016. (310) 559-0706

FOR SALE: New Blonder-Tongue Singer channel (11) TV distribution amplifier mfg. in the 1960's, Serial 431. Complete with original tubes. Amplifier has never been used and is in like-new condition - \$100 plus shipping. Joe Bonica, RR 4, Box 1523, Wells, ME 04090. (207) 646-7651

WANTED: Back for Admiral 10" console TV, Model No. 24A12. TV Guides from 1950's. Steve Cavell, 30144 Torry Ave., Flat Rock, MI 48134. (313) 379-3254

WANTED: Philco 90 cathedral speaker in good condition. Mark Cowart, N4FBL, PO Box 550766, Jacksonville, FL 32255-0766. (904) 724-1364

FOR SALE: Jukebox Collector Magazine, trial subscription three months - \$9.95, or 1 year - \$29.95. Jukebox Collector Magazine, 2545 S.E. 60th Ct., #105, Des Moines, IA 50317

WANTED: Colonial radios from the 1930's. Randy Giles, 4020 San Ardo Cove, San Diego, CA 92130. (619) 792-7376

WANTED: SBE-450 UHF transceiver, linear systems, Gonset 6-meter amp. (Pair 826s) #3065/3090 or 3212. Robert Milligan, KI4MB, 6608 N. 18th St., Arlington, VA 22205-1802. (703) 533-0650

FOR SALE: Sony TR4100 6-xstr radio, excellent, working - \$25. **WANTED:** Catalin radios, reasonable; tube hi-fi. Al Wirtenberg, 15 Wilson Rd., Weston, CT 06883. (203) 544-9270

FOR SALE: Grebe Synchrophase 7, NT - \$125. Craftsman 800 - \$40. Craftsman RC-2 amp - \$25. Silvertone 1984 - \$100. List. Dave Sutherland, PO Box 201, Spofford, NH 03462. (603) 363-4459

WANTED: A copy of SME-3009 manual or \$20. Takashi Shinohara, 3 Foxhill Ln., Stony Brook, NY 11790. (516) 689-3516

WANTED: Metal tube cover for RCA Radiola 26 portable. Dave McClellan, 1086 Trailridge Ln., Atlanta, GA 30338. (404) 399-6704

HELP: Need schematic and manual for C.T.I. electronic voltmeter Mod VT-20. Copy OK. T.R. Apple, 1498 Cobblegate Ln. Reynoldsburg, OH 43068-3208. (614) 864-3634

SCANNING DISKS ARE SPINNING AGAIN ALL OVER THE WORLD

USA NEW ZEALAND
SPAIN ENGLAND
JAPAN GERMANY
ITALY CANADA



You too can have your own **VISIONETTE 24** line mechanical television camera and receiver. Kits and completed units are available. Send a SASE to:
Peter Yanczer, 835 Bricken, St. Louis, MO 63122

FOR SALE: Collection of pre-1925 radios. Includes Adams Morgan, Atwater Kent, Federal, Grebe, Kennedy, Northern Electric, RCA, Western Electric and others. Send SASE for list. Sold as a collection only. Carl Osborn, W6RXP, 140 Blue Jay Dr., Sedona, AZ 86336. (602) 282-4543

FOR SALE: Several 4-tube amps from electronic pianos. Use 7868's in P-P. Each with correct 12" speaker - \$15 ea. plus UPS. Mike Kitner, 735 Factory, Carlisle, PA 17013. (717) 249-3851

WANTED: Information or references for early underdash or firewall automobile radios. I own a GM, Motorola, and Philco. Don Niess, Jr., 133 North 17th St., Wheeling, WV 26003

WANTED: Mini-cathedrals 12" or less. Call or write with picture, price and condition. Thanks. Alan Piorek, WB9RAD, 1050 N. Paulina St., Chicago, IL 60622. (312) 235-1523

FOR TRADE: Signal Corps Code Training Set AN/GSC-T1, complete and working, for nice Belmont 6D111. Bob McPhee, 3713 Concord Dr., Augusta, GA 30906. (706) 798-1828

FOR SALE: RCA 77dx microphone, perfect - \$800. **WANTED:** Triad HS14 transformer. Michael MacDonald, 215 East 73 St., #3D, New York, NY 10021. (212) 517-9235. (212) 517-9255, fax before 10 pm EST

WANTED: DuMont 30", 30BP4. Philco 20, 90 junkers, cabinets, rusty; GE 810(?) with 10FP4. John Grady, PO Box 1154, Littleton, MA 01460

WANTED: Eveready radios, speakers, old flashlights, flashlight catalogs, related items. Subscribe Flashlight Newsletter - \$12 year. Bill Utley, Box 4095, Tustin, CA 92680. (714) 730-1252

FOR TRADE: Transistor radio, looks like Ballantines whisky bottle, very good. Walter Mosley, Box 1131, Crosby, TX 77532

WANTED: Music rack & one foot pedal for 1940 Continental piano (Collins' Golden Age). Oscar Chapa, 1001 Citrus Ter., Apt. A-1, Harlingen, TX 78550. (210) 428-9384

WANTED: A Philco 90 cabinet or specifications for building one. **FOR SALE:** Majestic 70 - \$100. Edgar McBee, 2249 S. Kansas, Wichita, KS 67211. (316) 265-5884

FOR SALE: Antique, collectible radios, televisions, transistors, microphones; earphones; quack medical devices; antique hearing aids; rare aviation books; tube cans, boxes military radios; test equipment; telephones, telephone equipment, novelty radios, World's Fair items. For updated list, send two stamp LSASE to: John Enigl, Sr., K9HJL, 5425 Cherry Ln., Egg Harbor, WI 54209. (414) 743-3672

MESSAGE: Majestic Model 72 - Free. Joseph J. Jordan, 57 Waverly St., Jersey City, NJ 07306. (201) 963-4625

WANTED: Small brass horn to fit Edison home phonograph Model C. Paul Kraut, Rt. 1, Box 13A, Genesee, ID 83832. (208) 285-1191

FOR SALE/TRADE: Weston Electrical Instrument Corp. mirror meter Model 155, patented January 1, 1895. I need test equipment and ham tranceiver. Joseph Wood, 6511 Chester, Hodgkins, IL 60525

FOR SALE: Eico ST-97 stereo tuner - \$25. B&K Model 666 tube tester - \$30. Eico Model 232 VTVM - \$10. REM cathode recovery unit and CRT tester - \$20. D.B. Allen, 606 Third St., Herndon, VA 22070. (703) 904-9895

WANTED: Good brass-base, tipped UV-99s. Arthur Harrison, 20 Suttlers Row, Hilton Head, SC 29928. (803) 689-3760

WANTED: URM-90 bridge, ZM-11 bridge, meter for ZM-3 analyzer, Hickok Traceometer. Christopher P. Demeroukas, 133 Basswood Rd., Springfield, IL 62707. (217) 529-4692, before 9 pm please

FOR SALE: SX25 in excellent condition cosmetically and electrically with matching speaker - \$200 plus S/H. Polaroids - \$1 and SASE. Bud Santoro, 3715 Bower Rd., Roanoke, VA 24018. Fax/voice: (703) 774-9153

WANTED: Galaxy FM-210 2-mtr crystal xcvr; HF crystals for CW; Swan 600T xcvr. Wade Sick, WB0OKA, 303 Highland, PO Box 304, Stanton, IA 51573. (712) 829-2414

CLASSIFIED AD NOTICE

Please check your ads carefully before sending them in. Once ads are received, it is not always possible to refund the amount sent, pull the ad or make changes.

WANTED: Good dial face for American Bosch 505. Will consider reasonably priced set or chassis. Clyde Watson, 8311 Via de Sereno, Scottsdale, AZ 85258. (602) 948-6466

WANTED: Danish modern home entertainment center, AM-SW-FM-TT, tuning eye. Prefer Grundig, Blaupunkt, Nordemende, etc. Jay Meyers, 1010 Graybar Ln., Nashville, TN 37204. (615) 297-5886

FOR SALE: 200+ antique radio, thousands of tubes, parts, old electric, items. Photo list - \$1. M. Ohmann, Box 314, Albany, MN 56307

FOR SALE: Amateur radio equipment, LSASE for list 7-19A-94, metal table bromes list 7-7-94. HFC, Chuck Bray, 1322 Ivy Rd., Bremerton, WA 98310. (206) 373-1013

WANTED: Dial pointer for Airline chassis 64BR-1808A, Airline Part #BEB-2G-10511 or complete parts chassis. Victor Gregowski, 8350 Smiths Creek Rd., Wales, MI 48027. (810) 367-2087

WANTED: Nickel-plated candlestick telephones with strange shapes. Stanley Schreier, 350 Hendrickson Ave., Lynbrook, NY 11563. Tel: (516) 887-4966. Fax: (516) 887-4780

FOR SALE: Four high end stereo receivers - \$100. Seven VCRs - \$100. Vince Bomba, 331 Akron Ave., Pittsburgh, PA 15216. (412) 344-7926

WANTED: Power transformer (Part No. AO-24956-1) for Hammond organ M143; original microphone for Heathkit Cheyenne mobile transmitter. Ray Barnes, 38 Woodmere Rd., Framingham, MA 01701. (508) 877-6040

WANTED: Schematic and or manuals for Majestic 130A and Admiral 200. Both have power supply problems. Photocopied material OK. Also anything Roy Rogers, Gene Autry, cowboy memorabilia. Tom Zee, 3300 1st Ave. NE, Cedar Rapids, IA 52402. (319) 366-3686

WANTED: Hallicrafters, Hammarlund, and Knight communications receivers, and vintage CB equipment from the 1950's and 1960's. I am also looking for a Drake SW4A SW receiver in working condition with vg to excellent cosmetics. Thanks. Richard McCaslin, 50 Ledyard St., New London, CT 06320. (203) 444-7299

WANTED: Zenith 5D810 radio and H664 or J644 radio/ phono, good condition. Stan Ward, 56 3rd Ave., Berea, OH 44017. (216) 243-7197

WANTED: 7,000 American-made Zenith Trans-Oceanics, parts radios or otherwise. Jim Montague, 1907 S. Stanley Ln., Spokane, WA 99212. (509) 535-9576

FOR SALE: Magnatone #210 git amp. w/7" vbl[?] git spkr installed - \$100 + postage. Renee May, 1242 N. El Centro Ave., Los Angeles, CA 90038. (213) 464-8278

WANTED: Vertical output transformers 5:1 ratio need 2, must be N.I.B. must be same part #, will pay top dollar. Want info on earth induction compass as used by Lindbergh. Magazine articles, photos, schematics. Was there ever a machine to wind basket-weave coils? Need constructional info. Need all above for research, will pay well. Thanks. No phone calls. Alan Grant, PO Box 102, Erieville, NY 13061

WANTED: 3 Pigs radio by Hudson-Ross Company. Johnny Johnson, 2201 Newton St., Denver, CO 80211. (303) 455-3421

FOR SALE: Majestic Mod 71 - \$150. Pickup only. Ozarka battery console, legs broke off, untested - \$100. Zenith Model 6R886 AMRP - \$30. Stromberg-Carlson 61-H, hums - \$75. Sonora Model LMS-190 - \$40. Atwater Kent Model 545 - \$125. Dennis Atkinson, Upper Park St., Phillips, ME 04966. (207) 639-3111

FOR SALE: RCA Catalin 66X9 - \$450 firm. Philco 49-501, Bunis price \$275, repainted same color ivory, excellent cond. - \$225. James Tewmey, 819 Moberly Rd., Harrodsburg, KY 40330. (606) 734-5579

FOR SALE: Radiola III, excellent, good audios - \$105. Paragon IV, excellent, good audios - \$495. Mitchell radio lamp (Collins, p. 55), no cracks, no shade, working - \$225. Jim Peters, 983 Chapel Ct. South, Glen Ellyn, IL 60137. (708) 790-9699

FOR SALE: GE Model 218, vg - \$65. Emerson 543, Deco - \$50. Motorola portable in alligator, 67L11 - \$50. RCA 1X51 - \$40. Arvin 2581 - \$30. GE 102 - \$35. RCA, Chicago plant - \$35. Philco 46-420 - \$35. Detrola-like DeWald 55 - \$50. Repro crystal set in box - \$50. Motorola clock radio, aqua - \$20. Philco 52-641 portable - \$20. GE metal portable 41? - \$20. Bulova 120, ivory - \$30. Delco R1156 wood - \$35. Zenith 7H820, 2 FM bands - \$35. Arvin 950 T12 - \$20. Emerson 539 - \$35. Radiola III N/T - \$45. Samson T/C model - \$75. Western Electric 7A with tubes - \$350. Radiola W3, excellent - \$200. Radiola 100A - \$35. Radiola 18, repro hood - \$70. All plus S&H. Call before 9 pm please. LSASE for others. Wally Worth, 2 W. Elm Ave., Wollaston, MA 02170. (617) 479-4512

WANTED: Case for Kennedy Model XV, (15), slant front, 19" x 8 1/4", 12 holes. John O'Briant, NØXBF, 3439 Clearwater, Bettendorf, IA 52722. (319) 332-7749

WANTED: Music Master large wooden horn speaker, condition not important. Severin T. Dvorsky, 380 Morrison Dr., Pittsburgh, PA 15216. (412) 344-6633

FOR SALE: Excellent port. Wynford Hall, LW, AM, FM, SW, VHF WX, AC/batteries - \$65. S.E. Watkins, K4OWN, 13003 Fennimore Ter., Midlothian, VA 23113. (804) 379-0521

FOR SALE: Rider #7 - \$15. QST magazines, (19), 1955-1964, all - \$6. Heathkit alignment generator with probes, Model IG-52, looks good, untested - \$20. All items plus UPS. Phone or write: Thomas Burnside, 4838 S. Westhaven Dr., Jackson, MS 39209. (601) 922-2235

WANTED: Tektronix oscilloscope Model 503 or 504, working or not or H.V. transformer Part #120-199. Matt Kachmarchi, RD2, Box 150, Cherry Tree, PA 15724. (814) 948-7526

WANTED: Chassis Philco Model 40-165 without tubes, could be junker for parts. Also set of push buttons and knobs for a Crosley 02CA console radio. Thanks. Carlos Gimenez, 15091 Shamrock Dr., Fort Myers, FL 33912. (813) 482-0198

FOR SALE/TRADE: Rider's 1-5 abridged, 6-11, 13, 16. RCA Victor, PP45 amp, no tubes. **WANTED:** Tube audio equipments, tubes, drivers, transformers, caps. Khanh Do, 1161 Copper Verde Ln., Modesto, CA 95355. (209) 525-8359, home. (209) 835-9759, work

ORLANDO, FLORIDA
VINTAGE RADIO
SHOW & SALE

SUNDAY, NOVEMBER 6, 1994

SOCIAL HALL
at the
ORLANDO CENTRAL FLORIDA
FAIRGROUNDS



For information call:
Brougham Enterprises, Inc.
Voice Mail: (407) 579-6347
Evenings between 6-9pm: (407) 293-1415
— Admission \$1 or Tables \$10 —

ATWATER KENT
DRIVER/HOUSING SAVER



This precision-made, driver/housing repair kit replaces broken threads in horn bases on Atwater Kent Models G, H, and L.

Send \$17.00, plus \$2.50 S&H to:

Harold Ezzone, 1826 Glenwood Circle
Des Moines, IA 50320 (515) 244-7697

Write me with your A.K. horn needs

FOR TRADE: Trade my Philco 90 in good working condition for GE K-80 or RCA 140. Alan Piorek, WB9RAD, 1050 N. Paulina St., Chicago, IL 60622. (312) 235-1523

FOR SALE: H.H. Scott Type 350B and 296 FM stereo amp combo, 24 tubes - BO. Steve Kopp, 1 Inwood St., Ellenville, NY 12428

WANTED: Good dial glass and 78 rpm pickup for Admiral 7RT43W-N. Neal Simpson, 27-1 Queen Rd., Lambertville, NJ 08530. (609) 397-3346

WANTED: Mechanical ciphering devices using rotors, spindles, rotating discs or cylinders (e.g. M-209, C-38). Richard Brisson, 159 Grandpre Ct., Navan, Ontario, Canada K4B 1K3. (613) 830-0379

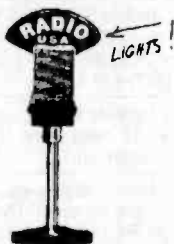

FOR SALE: "RADIO USA" standing mike radio as shown AM/FM with lighted RADIO USA sign, N.I.B. - \$35 postpaid. Also red racing car AM/FM with quartz clock built into sunroof, N.I.B. - \$20 postpaid. Richard Brill, PO Box 5361, Old Bridge, NJ 08857. (908) 679-8026, and fax (908) 679-8524

WANTED: Schematic for British "Advance" signal generator. B4B7. Ted Stegeman, 4621 W. Mitchell Ave., Cincinnati, OH 45232. (513) 542-3247

WANTED: Amplifier chassis for Wurlitzer 800, mechanism for a 500. Steve Pazar, 4950 Deerwood Dr., Santa Rosa, CA 95403. (707) 544-8142. E-mail: pazar@sr.hp.com

FOR TRADE: 1924 5-tube Freed-Eisemann battery chassis including globe tubes for midget all metal cased radio. Ernest D.M. Yeaw, RR#3, Tatamagouche, Nova Scotia, Canada B0K 1V0. (902) 657-2554

WANTED: Zenith black dial tombstones and chair-sides. Mark Hewitt, 4396 Straw Ln., Roscoe, IL 61073. (815) 623-8729

WANTED: Operating manual and probes for Heathkit oscilloscope Model 10-18. Need signal generator. Fred La Lone, 16875 Wells Rd., Buchanan, MI 49107

FOR SALE: Books: Practical Radio-TV Manual - \$5. Understanding Electronics by Warring - \$2.50. Electronic Projects by 73 Magazine - \$5. Radio Trouble Shooting by Marcus & Levy - \$10. The Fundamentals of Radio by Williams - \$8. For a list of other books, send SASE. Add postage. Clark Trissell, 3530 Pawnee, Lincoln, NE 68506. (402) 488-5263

FOR SALE: Zenith 14E chassis, speaker and power supply. Also solar capacitor analyzer Type CA. Offers.

WANTED: JVC VCR Model HR-D566U. Looking for one or more of these units working or not. Also Zenith TV tuner #175-2207-50G. Early Sylvania 8417 tubes; these are 4 1/4" to 4 1/2" tall. Thank you. Al Manieri, 384 Bates St., Phillipsburg, NJ 08865. (908) 454-3699

FOR SALE: Small tube collection including two spherical audions (one in original box); Western Elec. VT-1, VT-2, 102D, 205D, 216A and others; Gen. Elec. WWI tubes; Meyers, Wunderlich, and others. Send SASE for list. Carl Osborn, W6RXP, 140 Blue Jay Dr., Sedona, AZ 86336. (602) 282-4523

FOR SALE: Fisher X-202 tube-type stereo amp, vgc - \$125. Knight KN-137M AM/FM tuner tube-type w/tuning eye tube bar, gc - \$25. National SW-54 radio BC thru 30 MHz, exc - \$85. Knight KN141C FM tuner w/tuning eye tube, gc - \$35. Knight hi-fi mono tube amp, vgc - \$45. Bogen Model ST-10 small 7-tube PA amp w/ multiple inputs, vgc - \$30. Panasonic RF-B10 FM 8-band SW ultra compact multiband receiver w/box & accessories, vgc - \$65. Sony micro cassette recorder Model M-400B, exc - \$55. Morrow Model CM-1 Conelrad standard broadcast receiver w/inst. manual & schematic tuning meter, metal cabinet, exc - \$65. Panasonic RF20 FM stereo wireless headphones, exc sound & comfort, exc - \$55. I pay shipping on all UPS. David Koesche, 61 S. Barrington Rd., Barrington, IL 60010. (708) 382-7997

WANTED: Arvin Hopalong Cassidy & Airline Lone Ranger. Must be in excellent condition. Reasonable price paid. Charles Booth, 227 Fencepiece Rd., Chigwell, Essex, England IG7 5EB

FOR SALE: Scott Metropolitan AM-FM receiver, Model 16A, contains 28 tubes on 2 chromium-plated chassis, and a Garrard auto turntable Type A, all in a blond wood cabinet 37 inches wide, by 37 inches high, by 20 1/2 inches deep, containing a 15-inch woofer tweeter speaker, a 12-page promotional booklet, 7-page installation manual, original Scott diagram, (2) Sams Folders, Garrard maintenance manual, are included; everything works; the buyer picks it up - \$300. Reginald Collins, KE2HE, 183-69 Brinkerhoff Ave., Hollis, NY 11412. (212) 454-5361, between 9 am and 9 pm

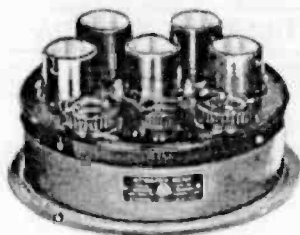

WANTED: Atwater Kent 5 tube TA unit - \$2,000, or contact me with your price. Also wanted AK de/amp TA, detector unit, and AK advertising. Thanks. Jim Peters, 983 Chapel Ct. South, Glen Ellyn, IL 60137. (708) 790-9699

FOR SALE: GE 408 - \$35. Philco 40-145 - \$50. Philco T701-126 - \$25. Bendix 753M - \$29. Zenith H615 untested - \$20. Zenith R3000-1 as is - \$55. Bulova 240 leather tube - \$35. Good 3-speed turntable w/cover - \$20. Detrola 310 - \$69. Detrola 322 - \$60. UPS extra. Victor Marett, 3201 N.W. 18 St., Miami, FL 33125. (305) 634-9569

WANTED: Information: Youngstown, Ohio's 1st station, WMC, 1922, owner Wayne Schaffer, formerly "Pennsylvania Wireless." George A. Freeman, WIKI Building, 102 E. Main St., Madison, IN 47250-3411. (812) 265-6878. Fax: (812) 265-4536

WANTED: Radiobar glassware, 1934 Deco Radiobar needs glasses. Call or write: Tim Saloff, 603 Lakeside Dr., Edinboro, PA 16412. (814) 734-5189

FOR SALE/TRADE: Collins mechanical filter F-455D-31 original box and tags. (4) AK tube shields for Type L TRF. Heath HW17 and HW17M with manuals. Commodore 128 with 1541 drive MPS810 printer Amdek Color-1 monitor with much much ham and other software. Millen 90811 RF amp. Heath HA-14 amp and HP-24 supply. Admiral 6C71-10A1 as pictured in August A.R.C. Pick-up only Va. or northern N.J. Coils most original boxes. Bud VSL-10 OLS-160 OLS-40 OEL-20. B&W20BVL 10 BVL. Miller 40305. Air variables Cardwell D-210-110-XD 2 @. Wooden table radios: Zenith X-334, RCA 4RC96 with satellite speaker, both work. Turntable ELAC Miracord 630. Magazines: (80) Microcomputing 80 through 84, some later. Books: Ghirardi Modern Radio Servicing, First Edition, 1935; Marcus Radio Servicing, 1954; Ballou Radio Fundamentals, 1942; Radiotron Designers Handbook, 1945, 3rd Edition; Q & A, 9th Edition, 1948; FT&R Reference Data for Engineers, 1943; Hand Frequency Modulation, first edition, 1942; Rider Frequency Modulation, 1942; Terman Radio Engineering, 1937; Cooke Mathematics for Radiomen, First Edition, 1942; Roche Scheraga Video Handbook 1949; Manly Television Servicing 1949; Henney Radio Engineering Handbook, 1941; Jordan Fundamentals of Radio, 1942; Muller Experimental Electronics, first edition, 1942; Sarbacher Edson Hyper and Ultrahigh Frequency Engineering, First Edition, 1943; Kiver UHF Radio Simplified, First Edition, 1945; AT&T Principles of Electricity for Telephones and Telegraph, 1938. Owners Manuals: Original Radiola III, excellent; AK TRF Model L chassis receiver, some water damage. Getting old here so reducing inventory. I collect oddball tubes and ARRL and Radio handbooks, also vacuum tube related manuals. Joe Monego, W2OFB, Route 1, Box 299, Keysville, VA 23947. (804) 736-9969

WANTED: Allied catalog(s) from the 1950s. Dub Egbert, W0MMM, 17333 Tramonto Dr., Pacific Palisades, CA 90272. (310) 459-1965

WANTED: Urgently, ham radio pre-1927 prefix/country lists, also collections pre-1930 QSL cards (no post-1924 U.S.A.). Dirk van Oudenol, VE7OVO, 35469 Stafford Pl., Abbotsford, British Columbia, Canada V2S 4N4. (604) 850-0763

FOR SALE: Microphones: Shure (3) 315 - \$100 ea., Model 51 - \$60, 10/4 new - \$40. Altec 633C - \$40. Altec 674A - \$100. RCA broadcast BK-6B - \$125. Electro-Voice 676 - \$100, 636 - \$90, 674 new - \$110. Astatic T-3 with Model 6 stand - \$40. Leroy Garman, 1000 Walker St., #218, Holly Hill, FL 32117 (904) 257-6218

FOR SALE: Maine and N.H. amateurs. Rohn 40 foot, HDBX 40, self supporting tower, already dismantled, guy wires included - \$200. You pick up and carry from Kennebunkport, Maine. Reginald Collins, KE2HE, 183-69 Brinkerhoff Ave., Hollis, NY 11412. (212) 454-5361, between 9 am and 9 pm

WANTED: Presto disc recorders, amps, literature, catalogs, parts, etc. Also Berlant-Concertone 20/20 stereo tape recorder. Alan Graves, PO Box 5469, Eugene, OR 97405. (503) 345-3991

WANTED: 1930 or 1931 Baby Grand Philco radio in good to excellent original condition Harold Graves, 6500 Cougar Dr., Nashville, TN 37209. (615) 356-6811

FOR SALE: Motorola 56A, Bakelite table radio. Two sets of Aeriola, Sr., Jr., and DeForest dial plate silkscreens with ample supply of silver-plated dial plates. Make offer or trade any of the above for wooden Motorola farm radios or telephone, telegraph stuff.

WANTED: U.S. Army Telephone Set TG-5A and/or a copy of the manual or lid circuit diagram for this set. Sonny Campbell, W5VFG, 2729 Winterstone Dr., Plano, TX 75023. (214) 596-9037

NEW BOOKS FOR COLLECTORS OF AMPLIFIERS, SYNTHESIZERS & JUKEBOXES

The History of Marshall, Michael Doyle. Forward by Billy "F" Gibbons. *Essential reading for musicians, technicians and collectors alike. Follows the rise of the company. Complete list of all Marshall products ever made. 62 color pages. 254 pages. Softcover.\$32.95*

Amps! The Other Half of Rock 'n Roll, Ritchie Flegler. *How the amplifier evolved & how it works. Fender, Vox, Ampeg, Marshall histories, etc. 20-page full color photo gallery. Troubleshooting chapter. 120 pages. Softcover.\$24.95*

Vintage Synthesizers, Mark Vail. *Looks at the history (1962-1992) of the electronic music synthesizer. Over 200 photos. Dealer tips on finding and buying synthesizers. Price guide. 300 pages. Softcover.\$19.95*

Jukeboxes - Obscure, Mysterious and Innovative American Jukeboxes, Adams. *First volume of a history of the lesser known manufacturers of phonographs, music boxes and jukeboxes. 182 pgs.\$29.95*

Jukebox Art, Pearce. *The evolution of the jukebox from the coin-operated record changer to the flashing lights of the rock-and-roll generation. 250 photos. 128 pgs. Hardcover. \$29.95*

Jukebox Art Postcard Deck. *30 colorful photos from Pearce's book.\$9.95*

U.S. Orders - Enclose \$2.50 per order for packing & book-rate shipping if total order is under \$35.00. If using VISA or MasterCard, include name on card, card number and expiration date. Send payment with order. Mass. residents please add 5% sales tax. Money back return policy. Most orders shipped the same day received, but allow 2-4 weeks to receive order. Foreign orders - write for shipping costs, or use credit card and specify air or surface (allow 2-3 months for surface shipping).

Send Order To: A.R.C., P.O. Box 2, Carlisle, MA 01741

Phone: (508) 371-0512 — Fax: (508) 371-7129



(Jun 94)

FOR SALE: (40) issues of QST dated 1920's, most in excellent condition - \$220. **WANTED:** Copy of manual for Heathkit SB-614 monitor scope. John Poland, 2859 Scotts Hill Loop Rd., Wilmington, NC 28405. (910) 686-4236

FOR SALE: Crosley Pup, good WD-12 - \$400. Larry A. Voris, Route 2, Box 246A, Statesville, NC 28677. (704) 632-9034

WANTED: A few UV199 or UX199 tubes. Filaments intact. Cormac Thompson, Box 710, Prosser, WA 99350

FOR SALE: Another beautiful Browning-Drake Model 5R available - \$150. Nice Airline Model CH-47, early AC console with instruction book - \$150. Many other consoles and table models, fifty or more clean original sets always available, thinning my constantly growing large collection. Sorry, no shipping. Come see my inventory! "Dickering done here." All inquiries to include SASE. Francis W. Pond, 98 High Rd., Lee, NH 03824-6200. (603) 659-3831, no calls after 9 pm EDT

FOR SALE: Volkswagen bus "record player," plays by riding on record, cute, N.I.B. - \$45 ppd. Gary Redfield, 214 Bailey Rd., Crystal City, MO 63019. (314) 933-0542

WANTED: Gold colored dial for 5-tube Teledial Grunow or complete chassis L.W. Weatherby, 811 So. Jordan, Liberal, KS 67901

WANTED: WE tubes 211D/E, 104D/F, 252A, 271A, 275A, 281A, 285A, 272A, 244A, 205D/F, 300A/B, 301A, 274A/B, 422A, 412A, 351A, 284D, VT52, 350B, 339A, 290A, 262A, 345A, 306A, 307A, 349A, 347A, 348A, 367A, 442A. Other tubes 45A, 183/483, 50/250/350/450, UV845, VT52, VT62/801A, 2A3H, 5C24, 45 glove. Others hi-fi use out/interstage transformer WE555/W, WE728B, WE713A, Jensen/Altec 12"-15" speaker. Many WE parts. Kouji Matsuo, 6-2, Tsurumi-cho, Beepu-shi, Oita, 874, Japan. Fax 81-977-23-9579

OLD TIME RADIO BROADCASTS ON CASSETTES

Many of your old time radio favorites are available on quality cassettes at a reasonable cost. You select the shows you want and purchase them by the hour. Fast, friendly service too.

The Great Gildersleeve

The Whistler

Suspense

Jack Benny

Sherlock Holmes



Lux Radio Theater

Amos 'N' Andy

Sgt. Preston

The Lone Ranger

Fibber McGee & Molly

Send for our catalog listing nearly 5,000 shows arranged by show category and title, many including original broadcast dates.

Only \$2.00 (P & H). Send request to:

**ERSTWHILE RADIO
P.O. BOX 2284
PEABODY, MA 01960**

MESSAGE: I had a letter of inquiry post-marked Fort Lauderdale, FL. The guy forgot to enclose any name or forwarding address! The inquiry was for 30's thru 50's radios. Would appreciate help locating this gent. Jim Taylor, Antique Toys & Radios, 5 Luther Rd., Winton, Bournemouth, England BH9 1LH. Tel 0202 510400 or 0850 605383

HELP: Seeking advice to improve my Revox A77. Jorge Cubells, Eucaliptus, 15-Campolivar, 46110 Godella (Valencia), Spain

FOR SALE: 1948 Crosley 9-302, AC/DC portable, vg - \$35. 1951 Crosley E15WE, white painted Bakelite, vg - \$70. 1938 Philco 38-12, g, needs minor veneer work and dial - \$35. Pictures available. Bryan Cowan, 1156 Sutter St., #201, San Francisco, CA 94109. (415) 771-2930

FOR SALE: Reproduction trim parts and knobs for most Catalin and novelty radios. I am the only one making parts of synthetic Catalin which looks and feels like the real thing. You have seen them at Elgin and Rochester. Send SASE for list of items in stock. Kris Gimmy, 1441 Nottingham Dr., Aiken, SC 29801

WANTED: Western Electric Type 300B tubes, N.I.B. - \$350, used - \$200. H. Kato, c/o Mr. Omura, 3852 Mohr Oak Ct., Fairfax, VA 22033

WANTED: Dial pointer, 4" black dial Zenith Model 5-S-29, Part No. 59-49. Frank Nelson, 2033 N.E. 52nd Ave., Portland, OR 97213. (503) 287-6349

FOR SALE: (107) issues Antique Radio Classified, February 1985 to December 1993 - \$75 plus UPS. Clarence Filley, W7KE, 1109 S. 2nd St., Hamilton, MT 59840. (406) 363-1946

FOR SALE: Heath TC-2 tube tester, '35 Airline #62-336, Coronado #806A. Back covers table model Zenith, Coronado-Air Wave. T. Gasiorak, 201 Golden Ave., Briggsville, WI 53920. (608) 981-2051

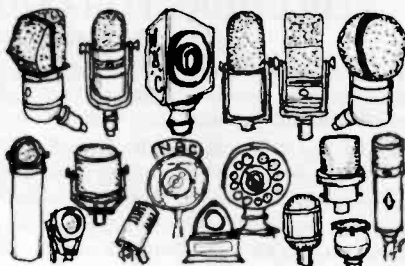

WANTED

FOR MY BROADCASTING MUSEUM

Microphones, stands, call letter plates. Tube amplifiers, mixers, compressors, Hi-Fi equipment. Speakers, on-air lights, equalizers. Disk, wire & tape recorders. Blank recording disks. Catalogs, magazines, manuals. 16" transcriptions, turntables, arms, pickups. Early TV cameras & receivers. Elaborate console, deco, plastic, mirror, novelty & wireless radios. Jukeboxes & parts. Acoustic phonographs.

We are looking for all makes of equipment, and especially Western Electric, Telefunken, Neuhann and RCA. The museum contains various duplicates and items surplus to our needs, and many of these articles are available for sale or trade. The collection is located in my Victorian seaside inn, The Caffrey House, situated on a bay next to the ocean, in the Southampton resort area of Long Island. A trade of equipment for a stay at the hotel is always encouraged.

Robert Van Dyke, 2 Squires Ave., East Quogue NY 11942
516-728-9835

WANTED: 1 or 2 usable 485 tubes priced reasonably. Rod Galloway, 2220 Woodbury Rd., Melbourne, FL 32935

FOR SALE: Bosch 28, excellent condition with eight tubes - \$60 plus \$15 UPS (it's heavy). Kenneth L. Shipley, 3805 Camino Sacramento, Albuquerque, NM 87111. (505) 298-3860

FOR SALE: Sony TR-72 (Tokyo Tsushin Kogyo, Ltd.), 1956-1957, wood/brass/plastic, complete - \$450.

WANTED: Early Crown, Sony and Mitchell transistor radios. Still paying over book price on many early radios. Also looking to buy collections. Tom Christopher, 5350 Alum Rock Ave., San Jose, CA 95127 (408) 926-2808

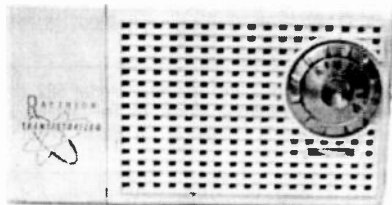

WANTED: Raytheon T-100 Series and T-150 Series. Marty Bunis, RR 1, Box 36, Bradford, NH 03221. (603) 938-5051, before 8 pm EST

FOR SALE: AK 555 beautiful, antique hand-painted oriental speaker pagent. S-38C, S-95 Hallicrafters. H.N. Felder, K3RPY, 7517 Granada Dr., Bethesda, MD 20817

WANTED: Browning Laboratories Model AA20 mono power amplifier(s), ca. 1951. Al Wirtenberg, 15 Wilson Rd., Weston, CT 06883. (203) 544-9270

WANTED: Manual for radio receiver Type BC 175. Part of radio set SCR 189. Paul D. Dilliard, 1313 E. Wheeling St., Lancaster, OH 43130. (614) 653-5268

**NOTICE TO ALL
CLASSIFIED ADVERTISERS!
OUR CLASSIFIED AD DEADLINE IS
12:00 NOON
ON THE 10th OF EACH MONTH**

FOR SALE: Hallicrafters SX-100, excellent condition - \$125. Hallicrafters HT-37 transmitter, excellent condition - \$100. Joseph Falcone, AA8HV, 3000 Town Center, Suite 2370, Southfield, MI 48075. Toll free (800) 436-7026, leave message

FOR SALE: Principles of Radio Communications, Morecroft - \$10. Electron Tubes, Morecroft - \$10. Impedance tuner - \$7.50. CB Radio Handbook, Hicks - \$5. Beitman 1965 TV - \$7.50. GE 0-600v meter #1293291 - \$15. (5) old panel meters - \$24 shipped. Weston 689 ohmmeter - \$15. **WANTED:** Need back, ant. for Detrola 106; dial plate for Hallicrafters S120; Admiral 7P34 front lid; push buttons for Philco 40-150; Arvin 53R2E, need case; Arvin 10R32, 38, 39; case for Sentinel 636; dial face and back for Maguire 571. David Hamm, PO Box 241, Aurora, CO 80040-0241

WANTED: GE A-70 tombstone, working or not Case only for Philco 89 or 89B, fair to good. Dial glass and escutcheon for Philco 42-380. GE Tungar bulb Cat. #195528. Thank you. Ron Robinson, 2200 Ely Ave., Columbia, MO 65202-8742. (314) 445-3772

FOR SALE: Heathkit ETW-3300 plug-in breadboard trainer plus six brand new books. Floyd-Principles Electric Circuits, Cox-Digital Experiments/Troubleshooting, Krieger-Guide Practical Electronics, Intel-Assembly Language Programming, plus-plus. First \$55 gets all, prepaid. Al Contarino, 35 Bonny, No. Andover, MA 01845

HELP: Have Hickok 532 tube tester. Gives weak readings on output tubes, others OK. Charles Combs, 508 E. Daniel, Albany, MO 64402. (816) 726-3038

WANTED: Cabinet for McMurdo Silver Masterpiece V. Al Wirtenberg, 15 Wilson Rd., Weston, CT 06883. (203) 544-9270

FOR SALE: Kenyon Transformers: P-12, P-200, pair of PPL's - Offers? Sola 7104 constant voltage transformer - \$40. Viking RP 83 tube tape recorder electronics, excellent, with schematics - \$100/pr. Omnibab 4-channel tape recorder electronics. transistors - \$80. Pair Realistic 7199 tubes, new - \$25. Silvertone Int. amp, tube, #3029, with matching #2028 tuner - \$75/both. C/ M Labs 35D cower amp, not working, with schematics - \$100. Altec 633 salt shaker mics - \$60 ea. Rauland Borg 1248 8L mic - \$30. Altec 418 15" woofer, blown - \$30. Radio Shack 40-1277 tweeter, N.I.B. - \$5. Stromberg-Carlson PA-2 power supply - \$15. Harvey Radio power supply, HV & filaments - \$50. Richard P. Robinson, PO Box 5055, Woodbridge, CT 06525. (203) 397-5420, messages 24 hrs., please leave details

FOR SALE: Radios, misc., SASE list. Early homemade crystal-radio, (2) knobs & whisker, wooden cabinet & Brandes Superior headphones - \$75 + UPS. Photos - \$1 ppd. Thomas Tetzlaff, 23 Nelson Dr., Silver Bay, MN 55614. No phone

WANTED: Ham band coils & tuning units for BC-610. Tom Tate, W7SUM, 306 View Crest Rd., Glendale, CA 91202-1333. (800) 869-8196

WANTED: Eunis 1st edition of Collector's Guide to Antique Radios. Wm. Dilloo, 438 Anita Pl., Wheeling, IL 60090. (708) 768-1271

SERVICES: Repairs and reconing loudspeakers. Jackson Speaker Service, 217 Crestbrook Dr., Jackson, MI 49203. (517) 789-6400, bus. card ad in back

FOR SALE: Panasonic RF-5000A, multiband, works perfectly, cosmetically fair - \$150 + shipping. Grundig Satellit 400 SW radio L.N. - \$200 + shipping. Panasonic RF-1600 mu tiband - \$75 + shipping. Sharp worldwide multiband - \$50 + shipping. **WANTED:** Panasonic Command Series multiband, RF-2600, RF-2900, RF-4900, Gerald Silver, 10863 W. Clairmont Cir., Tamarac, FL 33321. (305) 720-1972

INCREDIBLE CAPACITOR SALE!!!

Get Rid of That Hum & Distortion with these:
10 mFd 450 volt radial 75¢ ea.
32 mFd 150 volt axial 50¢ ea.
47 mFd 160 volt radial 75¢ ea.
— 10 piece minimum each —

Special good thru Oct. or til stock is gone.
Replacing capacitors: The secrets you need to know! (new flyer) \$3
Add \$3 shipping to any parts order.
Mich. res. add 4% tax. Check or M.O. only.
Send two stamps for our latest flyer.

**Antique Audio (of Michigan)
167 Caster, Plymouth, MI 48170**

VINTAGE RADIO RESTORATION VIDEO TAPE

THE RADIO DOCTOR

WHAT IS IT? THIS IS A SERIES OF VHS VIDEOTAPES THAT COVER ELECTRONIC AND COSMETIC RESTORATION TOPICS.
WHO IS IT FOR? THE BEGINNER AND INTERMEDIATE LEVEL RESTORER. THE LATER TAPES MOVE TO MORE ADVANCED TOPICS.
WHAT IS THE APPROACH? THE GOAL IS TO AUTHENTICALLY RESTORE THE ORIGINAL LOOK AND PERFORMANCE WITH THE LEAST AMOUNT OF MODERN MODIFICATION AS POSSIBLE.

Volume 1: VINTAGE RADIO REPAIR AND RESTORATION
 COVERS THE COMPLETE START TO FINISH ELECTRONIC AND COSMETIC RESTORATION OF A TYPICAL 1930s WOOD TABLE SET

Volume 2: CONSOLE RESTORATIONS

USES SEVERAL DIFFERENT SETS TO COVER SELECTED TOPICS. CONSOLES RESTORED BUT METHODS APPLY TO ALL TYPES OF SETS

EACH VOLUME IS 4 HOURS ON 2 VHS VIDEOTAPES
TAPE PRICES \$23.95 EACH VOLUME PLUS SHIPPING
TAPE SHIPPING \$4 FOR ONE OR BOTH VOLUMES

Volume 3: TOMBSTONE TOPICS ! ! COMING SOON!!
 MORE TROUBLESHOOTING, ELECTRICAL & CABINET TECHNIQUES
 EXPECTED RELEASE FALL 1994-WATCH THIS SPACE FOR INFO

NOW SHIPPING !! ORDER NOW ! NOW SHIPPING !!
COLLECTOR'S GUIDE TO ANTIQUE RADIOS 3rd Ed 1994
 by BUNIS LIST \$18.95 OUR PRICE \$16.00 plus \$H
TRANSISTOR RADIOS: A COLLECTOR'S ENCYCLOPEDIA AND PRICE GUIDE by LANE, 1994. 170 pages 2200 radios
 LIST PRICE \$19.95 OUR PRICE \$17.00 plus \$H
 //////////////////////////////////////
HERE IT COMES ! EXPECTED RELEASE OCT/NOV 1994
COLLECTOR'S GUIDE TO NOVELTY RADIOS by BUNIS 1994
 LIST PRICE \$18.95 ORDER NOW AT \$18.50 ppd
 Book will be shipped immediately when released
GO AHEAD, TRY US !

NEW Bargain Books

- R) **EVOLUTION OF THE RADIO WITH PRICES, VOL. 2, 1993**
 LIST PRICE \$24.95 OUR PRICE \$21.25
- S) **PHILCO RADIO: 1928-1942**, by Ron Ramirez, 1993
 LIST PRICE \$29.95 OUR PRICE \$25.50
- T) **MADE IN JAPAN TRANSISTOR RADIOS OF THE 50s & 60s**, 1993
 LIST PRICE \$16.95 OUR PRICE \$14.50
- U) **POSTER'S RADIO & TV PRICE GUIDE, 2nd Ed 1994**
 LIST PRICE \$17.95 OUR PRICE \$15.25
- V) **COLLECTOR'S GUIDE TO TRANSISTOR RADIOS, 1993**
 by Bunis LIST \$15.95 OUR PRICE \$13.25
- B) **EVOLUTION OF THE RADIO WITH PRICES, VOL. 1, 1992**
 LIST PRICE \$22.95 OUR PRICE \$19.50
- C) **RADIO MANUFACTURERS OF THE 1920's**, by Douglas
 1) **VOLUME 1: A.C. DAYTON TO J.B. FERGUSON**
 SOFTCOVER LIST \$24.95 OUR PRICE \$21.25
 2) **VOLUME 2: FREED-EISENMANN TO PREISS**
 TEMPORARILY OUT OF PRINT
 3) **VOLUME 3: HCA TO ZENITH**
 SOFTCOVER LIST \$29.95 OUR PRICE \$25.50
 HARDCOVER LIST \$39.95 OUR PRICE \$34.00
- D) **GUIDE TO OLD RADIOS**, by Johnson
 LIST PRICE \$16.95 OUR PRICE \$14.50
- E) **COLLECTING TRANSISTOR NOVELTY RADIOS**, by Breed
 LIST PRICE \$24.95 OUR PRICE \$21.25
- G) **RADIOS THE GOLDEN AGE**, by Collins
 SOFTCOVER LIST \$17.95 OUR PRICE \$15.25
 HARDCOVER LIST \$25.00 OUR PRICE \$21.25
- H) **ANTIQUE RADIO RESTORATION GUIDE, 2nd Ed, 1992**
 by Johnson LIST \$14.95 OUR PRICE \$12.75
- I) **RADIOS REDUX: LISTENING IN STYLE**, by Collins
 SOFTCOVER LIST \$17.95 OUR PRICE \$15.25
 HARDCOVER LIST \$29.95 OUR PRICE \$25.50
- O) **OFFICIAL RADIO SERVICE MANUAL**, 1930 reprint
 LIST PRICE \$24.95 OUR PRICE \$21.25
- P) **70 YEARS OF RADIO TUBES AND VALVES** by Stokes
 LIST PRICE \$25.95 OUR PRICE \$22.00
- Q) **CLASSIC TVS: PREWAR THRU 1950s WITH PRICES**
 LIST PRICE \$16.95 OUR PRICE \$14.25

BOOK SHIPPING: \$2.50 for one and \$1 each additional

SEND LSASE FOR OUR COMPLETE LIST
 SHIPPING APPLIES TO USA. OTHERS INQUIRE

OSARK VINTAGE RADIO

3923 East Latoka Street
 Springfield MO 65809

FOR SALE: Emerson black Bakelite, works - \$30.
 Motorola and Philco tube radio/phonos, both in wood cabinets needing restoration - \$20 ea. Four brass base, tipped (broken) tubes - \$7.50 ea. Parts chassis: AK Type L, metal escutcheon - \$30. Majestic 7 Model 70 - \$10. RCA Truetone D-906, push buttons - \$10. Philco 20 - \$3. Firestone Air Chief - \$3. Heathkit TC-1 tube checker, roll chart, wood case - \$45. Free list. **WANTED:** Old control panels from fire alarms, boilers, etc. Chris Cross, Box 94, McConnell, IL 61050

FOR SALE: Photoflash caps 160 mFd. 330v - \$8/50, \$15/100. Two Denshi block kits. Plus postage. Gordon Wilson, 11108 50 Ave., Edmonton, Alberta, Canada T6H 0H9. (403) 434-6257

FOR SALE: Philmore Junior microphone with excellent box - \$65. Nipper S/P, not repros - \$50. Kenneth Bundy, PO Box 3765, Carbondale, IL 62902. (618) 529-5667

WANTED: Manuals for Supreme Model 582 signal generator and Sprague Model 16 Tel-Ohmike. D.B. Allen, 606 Third St., Herndon, VA 22070. (703) 904-9895

FOR SALE: Scott 800B, excellent chrome, AM, FM, shortwave, phonograph, beautiful Chippendale cabinet 22"D x 44"W x 39"H - \$650. Dick Gysan, 8803 Dapple Grey, Oak Ridge, NC 27310. (910) 643-9100

WANTED: Info on how to safely remove glass envelope from 864 tube base and install WD-11 base. Thank you. Harold La Roche, 16426 Heiden Cir., Spring, TX 77379. (713) 370-3451

FOR SALE: Replica radio, Thomas cathedral - \$70 OBO. Robert J. Stone, 721 Fisk St., Piqua, OH 45356-3729

FOR SALE: Rare AK 66, chassis only, good condition, plays but CX350's going gassy - Best Offer. William Donzelli, 303 South Chester, Park Ridge, IL 60068. (708) 825-2600

WANTED: Manual for military iconoscope TV camera. R. Brewster, Apt. Q293, 2455 Geo. Wash. Way, Richland, WA 99352. (509) 375-0757

WANTED: Tuning knob 1934 RCA Model C13-2 or C13-3, 1 1/8" diameter, 1/2" thick, 3/16" shaft, set screw. Has world globe with mid-North America visible on it. Ron Both, 1964 Cheshire Ln., Wheaton, IL 60187. (708) 682-4265

FOR SALE: Tube caddy, GE color TV service, good cond. - \$25 + UPS. Harry C. Nuss, 47 Gravel Hill Rd., Huntingdon Valley, PA 19006

FOR SALE: Dozen, unused, boxed, JAN VT-136 (1625) made by Western Electric, other tubes 50c and up. American capacitors, power xfms for sets with 6-volt filament, as-is radios, good radios, as-is test equipment, new knobs, dials, books, magazines but no cathedrals, no Catalins, no pre-1930 junk. Ten-page list free to residents continental U.S.A. Sue Coulter, 4200 Prince St., Bakersfield, CA 93301

WANTED: Spark transmitter WWI. G.W.H. Faassen, Heideweg 1, 5953 TL Reuver, Holland. Tel 0470-1316. Fax 0470-6683

WANTED: 250K audio taper pot with 1.75" long (min.) flatted shaft and SPST switch. Doug Fox, 603 S. 12th Ave., St. Charles, IL 60174. (708) 584-5915

Radio Restoration Parts

Vacuum Tube Repair Wafers

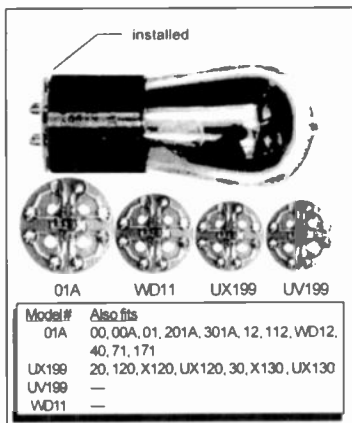

These tube repair wafers are solid-state devices for quick and easy repair of early vacuum tubes. The wafer is installed by simply sliding it over the tube pins and reinserting the tube into its socket. If the filament is intact, but there is little or no emission, the filament may be lit for best visual effect. However, the tube can be open filament.

No change in radio operating voltages is required. Any number of tubes may be repaired in a radio. If wafers are installed on all tubes, the B+ voltage may usually be reduced without sacrificing volume or sensitivity. Performance will vary between radio models.

\$10.00/each (\$7.50/ea. 3 or more)

New Atwater Kent Breadboard Switch

Exact replacement for Models:

9 • 9C • 10 • 10A • 10B • 10C • 12

and all additional models with board mounted switch.

Newly manufactured under high pressure heat from the same type brown thermoset resin used in the original. Beryllium copper spring contacts are used for long, trouble-free life. Custom built knurl is used to exactly reproduce the original.

\$50.00/each

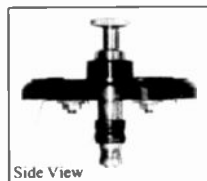

Side View

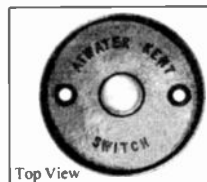

Top View

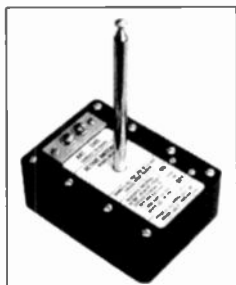

Active Antenna

Allows antique radios which were designed for a long wire outdoor antenna to operate on a 42" indoor whip antenna. Portable, operates from a 9 volt battery.

Only \$34.95

Order from: PT1, 7925 Mabelvale Cutoff, Mabelvale, AR 72103

Orders shipped UPS, prepaid in continental U.S. Please allow 3 weeks for delivery.

Arkansas residents add 5.5% sales tax.

To Order: Call (501) 568-1995



FOR SALE: Yaesu communications receiver Mod FRG-7, covers .5 MHz to 29.9 MHz AM, SSB, CW, 117VAC/12Vdc; beautiful, like new condition with owners manual - \$110 + UPS. Harold La Roche, 16426 Heiden Cir., Spring, TX 77379. (713) 370-3451

FOR SALE: UTC chassis & cage kit #736 includes LS-63, R-1051, R-20 - \$125. Remler Infradyne 3-tube amp, copper box #700 - \$55. W. Harder, 911 W. Northrup, Lansing, MI 48911-3640. (517) 882-2303

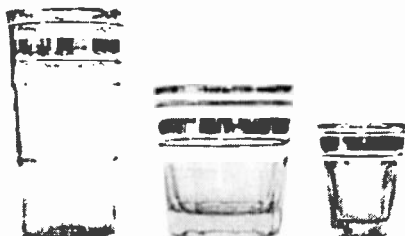

WANTED: Radiobar glassware: Any and all pieces of original glassware with silver and black rings illustrated above. Clyde Watson, 8311 Via de Sereno, Scottsdale, AZ 85258. Call collect (602) 948-6466

FOR SALE: Genuine ticker tape, 1" wide on 7" wide rolls with 2" hub - \$6 ea. ppd. The following plus UPS shipping collect: EV 642 shotgun studio mike, no mount - \$40. Norelco EX433A/54, no back, not working - \$50 EL2701, no knobs, peeling front panel finish but working condition - \$25. Harman Kardon A300 amp, no case - \$35. Detrola 389 AM/SW portable, exc condition - \$50. Emerson B131, one knob not original, AM OK, SW not OK - \$40 Gary Haberman, 29 Woodwaye Rd., Plainview, NY 11803

FOR SALE: 1940 Zenith half-round chairside, Model 7-S-449 AM, 2 SW bands, black slide-rule dial, push-button tuning, 2 function Radiorgan, radio and push buttons work, original grille cloth, refinished wood, maple - \$275. Robert Herbert, 2686 Stillhouse Hollow Rd., Shippensburg, PA 17257. (717) 530-1511

WANTED: Diagram for Guild Model 6420 spinet piano, AM/FM/phono and Model 921 ML roll-top desk. George Wiswell, 1620 Sonny's Way, Hollister, CA 95023

FOR SALE: WWII BC-348, brand new in wooden crate with dynamotor and FT-154 aircraft mount - \$475. Brand new BC-348 w/AC power supply, operates, with FT-154 aircraft mount - \$350. WWII T-85/APT-5 aircraft radar transmitter in sealed box dated March 1945 - \$195. Very rare FT-295A WWII Glider walkie-talkie mount, used - \$150. Sam Hevener, W8KBF, The Signal Corps, 3583 Everett Rd., Richfield, OH 44286-9723. (216) 659-3244

FOR SALE: (20) radios, (5) tube radios, (15) transistor radios, (4) don't work, all for - \$90 plus UPS. Will not separate. Daniel Seidler, 3721 W. 80 St., Chicago, IL 60652. (312) 284-8221

WANTED: H.M.V. The Pigmy Grand Model H5. I need an elbow and reproducer. Please help! Call: Ray Mattiello, 106-05 97th Ave., Queens, NY 11416. (718) 441-0350, eves.

FOR SALE: Radio Lamp, 1939, Radio Lamp Company of America, metal torch type, good! - \$300. Gerald Schneider, 3101 Blueford Rd., Kensington, MD 20895-2726. (301) 929-8593

FOR SALE: This ad all pickup. Will not ship. Gen. Radio RF signal gen. made for U.S. Navy 10 to 50,000 Kc - \$100. Hallicrafters S11 Super Skyriders, untested with orig. speaker - \$125. Hallicrafters HT37 transmitter - \$200. Hallicrafters SW rec. SX101 with converter - \$225. RAK-8 with power unit, 15 to 600 Kc - \$75. Newcomb Model E504 60 watts - \$75. Heath W4 AM amp, WA-P2 preamp, FM3-A FM tuner, all 3 items - \$125. 13" electro dy. speaker in floor model cab. - \$35. (3) floor model speaker and table radio cabs. - \$15 ea. Philco 60 chairside radio - \$100. Majestic highboy floor model cab. for Model 60-70 - \$25. Krantz, 100 Osage Ave., Somerdale, NJ 08083. (609) 783-0400

FOR SALE: Crosley: Elf, incorrect chassis, - Offer; 51 - \$100. Trirdyn - \$100. Majestic 71 - \$75. Radiola 28 top cabinet - \$25. Home brew crystal with one-tube amp - \$100. Fada 265 special cabinet, parts chassis - \$30. Oak ringer box - \$35. WE space saver phone - \$20. Doug Koehn, 3506 14th Ave., Kearney, NE 68847. (308) 237-4769

WANTED: Old advertising teaspoons with radio station themes and call letters on handle. Charles Combs, 508 E. Daniel, Albany, MO 64402. (816) 726-3038

FOR SALE: Practical Radio Communication, 1943, Hornung - \$15. Elements of Electronics, 1955, Hickey - \$8. Rich Yoch, 22410 Bartlett Dr., Rocky River, OH 44116. (216) 331-9206

FOR SALE: Earthquake forces sale of lifetime collection. Make offer! Johnson Viking Invader 2000; Viking 500; Collins 75A-2; R-388/URR; R-391/URR; RME; CEI; other ham, CB, military transmitters, receivers, parts, etc. For information send large SASE: Steve Phillips, PO Box 4916, Chatsworth, CA 91313. (818) 998-5654, (818) 704-6306



WANTED: Chassis to cathedral pictured above. What is it? Cabinet dimensions 16 x 14 1/2 inches. **FOR SALE:** Fada chassis L56 (dial face like Lawlor sketch)? No knobs. White Emerson 838 with case, excellent. Ruby SRH436 with case - nice, WRL Globe Scout 65A with manual, no VFO. Trans-Oceanic L600 with manuals - BO. Also Elvis, Liberty Bell, Westinghouse desk set with pens, Juliette Micro 10, Royal 2000, Excel 6, Zephyr ZR150 "pocket" - \$50 ea. plus shipping. Misc. Kensington 10, Orion 10 "signal", Silvertone rep 1200, Zenith 6B03 with manual test. RCA Isolation WP24A, RCA Senior Voltohmyst WV98C, Simpson 260 Series 6 cracked - Offer. Ghosts and goblins welcome! Chaudé Chafin, NØFMO, 4223 E. 42nd Way, Independence, MO 64055. (816) 478-4518

FOR SALE: Tektronix 453 portable oscilloscope, 50 MHz, dual timebase, delayed sweep; new condition with original manuals, storage cover, new Tektronix P6103 probes, calibrated, cost \$2,050 new - \$325 + UPS. Alan Kriss, 1872 Portsmouth Way, Union, NJ 07083. (908) 688-2092

FOR SALE: Early broadcast mike with 15" horn, WE 360, 1916 pat. - Best Offer or trade. Need bal. amp & horn speaker for Radiola III. H. Hoopes, 10 Bassett Ave., Mine Hill, NJ 07801. (201) 361-7309, eves.

FOR SALE: Hammarlund HQ129 with book in good condition - \$100. Buyer pays shipping and handling. Jim Barrows, W7BCT, 15121 41st Ave. SE, Bothell, WA 98012-6113. (206) 337-4880

WANTED: Stewart-Warner companion radio with metal Greek scene on front. Jay Malkin, 1250 Galapago, #206, Denver, CO 80204. (303) 623-6451

FOR SALE: RCA Superette R-7 (Bunis 2, p. 156) - \$80. Philco 38-610, rare version tombstone, (Ramirez, p. 105) - \$55. Satchell Carlson 408 (Bunis 2, p. 164), works, no chips or cracks - \$55. Motorola 50's CD mark tube portables with original batteries Models 56B1A and 5P31A - \$22 each, \$35 both. Rust-free working chassis for AK99, w/t - \$45. EICO HFT-90 50's 7-tube FM tuner - \$9. Silvertone 6424 push-button tuning eye, beautiful multi-wood table - \$40. Stromberg-Carlson 1204 BC, old FM, no chips or cracks - \$25. Toasters: Toastmaster 2-slice 1B11 - \$21; 1-slice 1A6 - \$22; - \$35 both. All plus S&H. Sam Mannino, PO Box 233, Swarthmore, PA 19081. (610) 353-6747

WANTED: Crosley Model 59 chassis with (3) knobs. The Gas Pump, 9637 Magnolia Ave., Riverside, CA 92503. (909) 689-3137, evenings

WANTED: Front bezel and wood cabinet for Fisher 800c receiver. Gary Ledbetter, 7321 Granalta Cir., Frederick, MD 21702. (301) 473-4563

FOR SALE: Tube tester, B&K Model 700 with charts - \$40. Richard Mountjoy, 1915 S. 39th St., No. 44, Mesa, AZ 85206. (602) 926-8174

FOR SALE: GE F-74, missing antenna?, untested - \$50 + shipping. Mike Mergenov, 6618 Monroe Ave., Eldersburg, MD 21784. (410) 549-3461

MESSAGE: Wax cylinder "shaving" service now available. Cutting accomplished by Edison Ediphone shaver machine. Bob Bakinowski, 1524 Saint Tropaz, Tucson, AZ 85713. (602) 624-8029

FOR SALE/TRADE: Farnsworth AM/FM console with unusual Capehart 16-E record player/changer. Send LSASE for large list of transistors, tube type, literature, etc. Michael Crain, 3 Hillside Ave., Harveys Lake, PA 16618-9782

WANTED: Fada 260, 263, 242, 246, 254, 354, 454 or similars with metal trim. Also wanted: early radio drama transcription discs and current music radio shows on LP/CD (Westwood One, Media America, etc.). Merrill Mabbs, 709 Pluma Dr., Rapid City, SD 57702. (605) 342-4090

FOR SALE: AK 145 tombstone all original, working good for - \$175 plus UPS. Another AK 145 tombstone that needs a tone control - \$150 plus UPS. Philco 84, and 84B cathedral cabinets. Emerson 109, no cracks, excellent running, original knobs and grille cloth - \$175, includes UPS and packing. Emerson 520 Catalin in excellent running condition, no cracks - \$175, plus \$20 packing and shipping UPS. Crosley D-25MN clock radio, all original, no cracks and has back. Frank D. Atwood, Nostalgia Radio, 117 E. Main St., Merrimac, MA 01860. (508) 346-8100

WANTED: Carbon broadcast spring microphone. Thanks. David S. Kendall, KE9WI, 401 Himes St., Huntington, IN 46750. (219) 356-5096, after 6 pm EST

WANTED: Telefunken RE 604 tubes; Castagna tonearm. **FOR SALE:** PR-10 - \$275. Richard E. Brown, PO Box 686, Farmington, CT 06034. (203) 677-4828

FOR SALE: History, Theory, Practice of the Electric Telegraph; Prescott. 1866 (hardcover reprint, 500 pages) - \$18.95 ppd. Artifax Books, Box 88-A, Maynard, MA 01754

TUBES • PARTS • SUPPLIES YOUR COMPLETE SOURCE

TUBES:

3000 audio, receiving and industrial types in stock. Including early and foreign types. Discount prices!

TRANSFORMERS:

Hard-to-find power transformers, audio transformers, and filter chokes for tube equipment.

PARTS:

Resistors, lamps, tube sockets, potentiometers, grill cloth, knobs, vibrators, etc.

CAPACITORS:

High voltage electrolytic and mylar capacitors for tube circuits.

LITERATURE:

Extensive offering of literature and books on antique radios, hi-fi, communications equipment, tube data, and circuit diagrams.

SUPPLIES:

Chemicals, grill cloths, wire, batteries, tools, etc.



"Write or call for our 36 page wholesale catalog"

ANTIQUE ELECTRONIC SUPPLY

6221 S. Maple Avenue, Tempe, AZ 85283, Phone (602) 820-5411, FAX (602) 820-4643
Toll Free Fax (800) 706-6789 (U.S. & Canada)

FOR SALE: Zenith H500-5H40 parts set - \$40. (5) assd. radio-TV-elect. engineering books, all - \$8. Hallcrafters S120 SW rec. - \$20. Heath GR64 SW rec., like new - \$30. CME 50063 preselector .55 to 32 Mc - \$35. Small oak phono cab. converted to a speaker with driver unit - \$40. High voltage insulators base, 8" x 1 3/4" body, 4 for - \$20. Assd. size ant. insulators - 75¢ to \$2 ea. Philco 40-6112 high efficiency ant. N.O.S. - \$32. Philco N.O.S. rear speaker kit - \$22.50. RCA logo hand mica cases, new - \$3.50 ea. 14 pounds of .022-200v wax bypass con.s, all - \$22. 15 pounds assd. value 1/3 to 2 watt resistors, all - \$45 new. Motorola 7" TV less back parts set - \$50. 3A carrier-operated loudspeaker controls panels - \$20. RCA Model 100 speaker, case only, rough - \$15. QST issues, 1940 to 1975, no list, write wants. GE wattmeter for house use - \$25. 1 pound assd. mica con.s - \$5. Zenith Model 1000-D Royal port. SW set, clean, plays - \$150. Bug type key?, 7" x 3" base, plastic cover adjustable - \$40. Variable AC transformers GE 7.5 amp - \$45. Variac 8A - \$45. Var. transf. 4 amp - \$25. Var. transf. 2.25A - \$18. Gen. Radio 2.A parts unit, needs repairs - \$10. Powerstat, 6 amps - \$55. AC line 150v meters - \$4.50. Assd. AC amp meters. Gen. Radio 200CD wide range audio osc. - \$75. RCA WA 44-C audio gen. - \$35. Philco audio sig. gen., old - \$35. AK Type K auto ign. coil wood case, SW, arm missing - \$30. Dayton Dick vib. Type hi-volt coil - \$30. Jefferson vib. Type hi volt coil - \$20. ?? Vib. Type hi volt coil - \$20. (2) Leeds-Northrup light beam shadow meters, wood boxes, both have open coils, both for - \$20. Brown Bakelite variometers, clean, 3" dia. - \$16. Have other variometers. (2) wind-up phono motors, both - \$20. Scope tubes #902 - \$6. 2AP1 - \$7.50. 3BP1 - \$9.50 N.O.S. metal case ballast tubes Types 42B2, 42A1, 49A1, 49A2, 49B2, 55A1, 55B2 - \$3 ea. N.O.S. boxed Raytheon 49B2 - \$4 ea. Small round case 150Ω 600Ω 60KΩ audio transformers - \$2 ea. Lot 6 assd. 600Ω transf. chokes, 6 for - \$5. Following test eqpt. may need leads, batts., or some recal. radio set analyzer cables plugs 7 wire cable lock in handle 2 converters - \$12. (9) wire cable lock in handle, 4 converters to 7 pin - \$20. (2) analyzer cables, handles, both - \$7.50. Weston 666 analyzer lock in test board sockets - \$20. Assd. lock in sockets - \$2.50 ea. Crank type megger meter Holtzer Cabot ZM 14-A - \$25. Signal Corps TS 505-U VTVM - \$30. RCA WV 97-A parts unit, no case - \$8. RCA WV 98-C VTVM - \$15. WV 98-C parts unit - \$10. Eico 221 VTVM - \$15.50. Precise VTVM - \$15.50. Hickok 202 VTVM - \$22.50. Eico 320 signal gen. - \$22.50. Signal Corps TS 505-U multimeter - \$30. PACO VTVM - \$12.50. Heath AC voltmeter - \$10. (6) small VOM, all - \$15. Conar VOM large meter - \$12.50. Heath 1-M-25 VOM less batts. - \$18. Philco VOM panel PTE 299, DC volts 0 to 1000V - \$10. (2) Precise RF audio signal gens., both for - \$25. Seco pre heat tube and gas tester unit - \$15. Have other radio TV test eqpt. These items postpaid: (100) assd. QSL cards fair faded, good - \$35. Full color photo as on front covers of Bunis Antique Radios, Vol. 1, 2, 3 - \$15. Postpaid each, with mat - \$19. Marconi stock certificate - \$32.50. 1000's of unlisted radio parts - write wants. Have a page of lists to send SASE. All items plus shipping to a U.S.A. address. Min. parts orders - \$8. Krantz, 100 Osage Ave., Somerdale, NJ 08083-1136. (609) 783-0400

FOR SALE: Harman-Kardon stereo amplifier Model AX20 (Nocturne) 7 tubes, complete, untested - \$85 plus UPS. Jack Shaymow, Vintique Electronics, 52-C Tifford, Deerfield Beach, FL 33442. (305) 427-1222

WANTED: For Pilot TV-37; magnifying lens, original clip-on or stand-type. Also owner's manual, advertising brochures, etc. Harold La Roche, 16426 Heiden Cir., Spring, TX 77379. (713) 370-3451

FOR SALE: Mikes: Shure, American, Altec, Astatic, Calrad, etc. (Bulnet, table, & shaker styles). Please call for details. Dwain Stevens, Box 130, Dogfork Rd., Pikeville, KY 41501. (606) 478-8248, after 5 pm EST

One Month Free!

BONUS FOR EARLY RENEWALS

If you renew before the month shown on your mailing label (your expiration month), you will receive an extra month on your subscription: 13 months instead of 12! 26 months for an early 2-year renewal!

FOR SALE: RCA Radiotron UV200 brass-based, tipped, filament good, original box - \$25. RCA Radiotron UV 201A, filament good, original box, 3 at - \$12 ea. Volutron UV 201 brass-based, filament good - \$20. RCA Radiotron UV 201A brass-based, tipped, filament good, original box, 2 at - \$25 ea. RCA Radiotron UX 201A, filament good, original box - \$12. Raytheon B-H, tipped - \$10. RCA UV 201A, filament good - \$12. DeForest DL-4, porcelain based, tipped, filament good - \$35. Volutron UV 201A, brass-based, filament good, original box, 4 at - \$20 ea. Volutron UV 201A, filament good, original box - \$12. RCA Radiotron UV 200, brass-based, filament good - \$22. Cunningham C301 brass-based, tipped, orange color bulb, filament good - \$35. DeForest Audion, brass-based, tipped, filament good, marked "Marconi" on other side - \$60. RCA Radiotron UV 201 brass-based, tipped, filament good - \$25. DeForest VT 21 metal based, tipped, filament not good - \$25. Songbird X 112, GX base, filament good original box - \$15. Recitron det. amp osc. brass-based, tipped, filament good, orange bulb - \$25. Cunningham C 301A UV base, brass-based, tipped, filament good, original box - \$25. Perfectone 200A, filament good, original box, 2 at - \$15 ea. RCA Radiotron UV 201A, brass-based, tipped, filament good, glass marked "GE" - \$25. RCA Radiotron UV 201A, filament good, box marked "Sterling" - \$12. RCA Radiotron UV 201A filament good, in Songbird box - \$12. Powertron UX 201A filament good, original box - \$12. Cunningham C300, brass-based, tipped, filament good, colored - \$35. Cunningham CX 301A filament good, Songbird box - \$12. Unknown, appears to be DeForest UV base, brass based, tipped, filament good - \$30. Those tubes not marked in original box are in old collector type boxes with a different name on them. Please add 10% for shipping best method. C-2-C, 77 County Rd., E. Free-town, MA 02717-1629. (508) 763-8568, 5-7 pm

FOR TRADE: My SX-100. Need Tektronix/HP oscilloscope, 4/5 tube TRF's, Trans-Oceanic 600L. Jack McCreary, 7783 Wildcreek Trl., Huntsville, AL 35802. (205) 882-0037

WANTED: Operating manual (or Xerox) of Sony 464D reel deck accessory channel integrator for sound with sound recording. J. Addison, 171 Hartford Rd., A-7, New Britain, CT 06053

WANTED: Yes, still collecting WWII vintage radar equipment units and complete sets. Contact: Allan H. Weiner, 507 Violet Ave., Hyde Park, NY 12538. (914) 471-9500

FOR SALE: Philco Deco console, 12-tube Model 41-300X, vgc, good operating condition - \$160. Can deliver to Rochester. Jeffrey Weber, 8507 Mohr Ln., Fogelsville, PA 18051. (610) 285-2421

FOR SALE: Crosley AM/SW #515 - \$85. Arvin 451T - \$35. Motorola 52M2U - \$35. Trav-Ler 5049 - \$40. Westinghouse H-557P4 - \$30. Airline 94BR1533A - \$40. WE oak ringer box - \$45. Radio Lite-Tenna - \$30. Vintage Jensen speaker - \$25. Fundamentals of Vacuum Tubes, Eastman, 1937 - \$10. Doug Koehn, 3506 14th Ave., Kearney, NE 68847. (308) 237-4769

WANTED: N.O.S. or good used balloon/globe type tubes for my Edison C-4: five 227's, two 245's and one 280. Your help appreciated. Stephen Schaffner, 12118 Amblerwood Dr., Stafford, TX 77477. (713) 933-3417

WANTED: Colored celluloid horns by G.G.H., Burns and others. Please send photos with price. Jay Volke, PO Box 337, Lyons, IL 60534. (708) 442-0817

FOR SALE: FM mono-tube tuners. Scott 311C, Heath AS31. F.H. Montgomery, 505 Congress, #710, Havre de Grace, MD 21078. (410) 939-2099

FOR SALE: Novelty trans. radios: Blue Kool Aid Koolburst N.I.B. - \$25. Mickey & Minnie Music City M.I.B. - \$25. Spiderman (Plate 160), N.I.B. - \$40. Heinz Ketchup bottle, exc - \$35. Also, novelty telephones. Crest Toothpaste man. exc \$25. Sports illustrated sneaker - \$18. Beverly McAfee, 305 Church Rd., York, PA 17402. (717) 764-3720

WANTED: Briggs and Stratton headphones. Recorded open reel tapes for four track stacked head. Richard Spratley, 2112 McLain St., Chesapeake, VA 23324. (804) 545-2402

WANTED: Front Bakelite panel for Rodgers 20 radio. Chassis for Majestic #149. Robert Nicholson, General Delivery, Manilla, Ontario, Canada K0M 2J0. (705) 357-1466

WANTED: Gonset emblem from G66B receiver, or G66B parts set. Charles Zafonte, N1FRX, RFD 1, Box 75, Fort Kent, ME 04743. (207) 834-6273, eves./week-ends

WANTED: Resistor IRC BW-1 $\pm 5\%$ and BT-1 $\pm 5\%$, WE 537B silvered mica tube RCA/GE 5C24, RCA UV-845. Kouji Matsuc, 6-2, Tsurumi-cho Beppu-shi, Oita 874, Japan. Fax 011-81-977-23-9579

FOR TRADE: N.I.B. Delco auto vol/tone controls with switches for your N.I.B. 6U5/6G5 tubes. A. Bruno, 24 Butternut Dr., New City, NY 10956. (914) 354-8899

FOR SALE: 15-inch Geissler tube, pick up only - \$150. Carbon filament lamps, single loop - \$30. Triple hairpin carbon filament lamps - \$75. Asst. collectible lamps, pear shape, globe shape, etc. - priced from \$2 thru \$50 ea. All with tip top. Fleming oscillation valve guillotine pattern - \$350. WD-11 new in box - \$35 ea. Myers RAC3 audition with mounting panel - \$95. Tigerman detecto-amplifier with instruction sheet and in original box - \$175. Cooke and Wheatstone single needle telegraph, circa 1845, museum quality - \$500. Edison universal printer, original dome, circa 1875 - \$2,500. Voltaic pile, French made - \$250. Double current cable key - \$750. Lots of assorted wireless, early telegraphs and Atlantic cable items still available from the Dick Egolf W2WX Collection. Phil Weingarten, 67-61 Alderton St., Rego Park, NY 11374. (718) 896-3545

WANTED: RCA Victor Strato-World Model 3-BX-671, brown leather. Jim Wilson, 888 Pearse Rd., Schenectady, NY 12309. (518) 372-9625

FOR SALE: Radio collector. LSASE will get you list, price and info. Ed. Gavin, 1020 Ohio St., Racine, WI 53405. (414) 633-6895

FOR SALE: Transistor Radios and Hi-Fi, 8 updated or new pages; SASE for free lists. Chuck Vaccaro, 708 Booth Ln., #O, Ambler, PA 19002. (215) 646-3641

5TH ANNUAL OLD-TIME RADIO & PHONOGRAPH SHOW

October 22, 1994
Middletown, NY

WHEN:

Saturday, October 22nd, 8am-4pm.

WHERE:

Holiday Inn, Middletown, NY
(Easy Highway Access - Exit 122, Rt. 17).

ADMISSION:

\$2.00 at the door

Sponsored by Hudson Valley Antique Radio & Phonograph Society. Refreshments available. For information call: 914-427-2602 or 914-446-4091.

★
E. H. SCOTT
HISTORICAL
SOCIETY
★

*For historical, technical, and
restoration information, contact us.*

*We are the primary information
source concerning the radios
and history of E. H. Scott.*

Interested parties write:

**E. H. Scott Historical Society
3712 N. Broadway #4450
Chicago, Illinois 60613**

FOR SALE: Dynaco 70 amplifier, chrome chassis in excellent condition with Dynaco PA-2 preamplifier - Best Offer wins this one. Frank D. Atwood, Nostalgia Radio, 117 E. Main St., Merrimac, MA 01860. (508) 346-8100

FOR SALE: Freshman Masterpiece 1925 - \$100 plus shipping. Robert J. Stone, 721 Fisk St., Piqua, OH 45356-3729. (513) 773-2217

WANTED: Trinity Six (Douglas, V2, p. 238), pay-trade well. AWA member. Giampiero Dalla Pozza, Via Montellungo 23-22100, Como, Italy

FOR SALE/TRADE: Crosley D-25 WE white Art Deco clock table radio, excellent condition. Trade for same model & condition in maroon or black. Paul Fulton, 711 Jacquelyn Rd., Westwood, NJ 07675. (201) 664-5260

FOR SALE: Collins 75A-4, s/n 3744, w/3.1 filter, vernier dial, exceptionally clean with manual - \$850. I'll ship UPS. Rich Bisignano, WA2DGU, 19 Farm Rd., Chester, NJ 07930. (908) 879-6064

WANTED: Majestic chassis and speaker Model 15 or 15A. Should be 5-tube screen grid superhet with 7" between centers of outer shafts. H. Hoopes, 10 Bassett Ave., Mine Hill, NJ 07801. (201) 361-7309

WANTED: Tube audio amplifiers, and especially preamps by Eico, Dynaco, Leak, Marantz, Fisher, etc. Jeffrey Viola, 784 Elton Rd., Jackson, NJ 08527. (908) 928-0666

FOR SALE: 1928 Radio Game - \$100. Stewart-Warner R-109-A cathedral - \$150. Airline 62-144 tombstone in excellent original condition - \$150. Test equipment, radio and literature. Please send a SASE or call after 7:30 PM Montana Time. Neil O'Donnell, 1809 Sampson St., Butte, MT 59701. (406) 494-8162

FOR SALE: Trans-Oceanic H500 - \$50. Olympic Opta AM-FM - \$45. Crosley 58TW - \$45. Zenith 6G05 - \$35. Sony GV-8 - \$350. Charles Voigt, 94 Cleveland St., Norfolk, MA 02056. (508) 528-7928

WANTED: Rider's 20, 21, 22. Mark S. Davidson, 2527 57th Ave. NE, Tacoma, WA 98422-3407. (206) 927-4838. CompuServe 71656, 1221/InterNet MARK. DAVIDSON@TACCESS.ESKIMO.COM

FOR SALE: Radiola T-64, works, BC-SW - \$85. Crosley 51 - \$105. Crosley 56 BC-SW - \$40. Airline 84BR1517 push button - \$40. Philco 41-120 white wood BC-SW - \$45. Motorola 6L1 portable - \$25. Sams Photofacts 951 to 978 - \$20. Clarion chassis & spkr, works - \$80. WE candlestick telephone - \$105. SASE for new list & pictures. Add UPS charges. Clark Trissell, 3530 Pawnee, Lincoln, NE 68506. (402) 488-5263

Radio Grille Cloth

f. fl. SCOTT
Philco, Emerson, RCA
& ZENITH

radios & speakers
Send 1 SASE for FREE
samples to:

John Okolowicz
624 Cedar Hill Rd.
Ambler, PA 19002

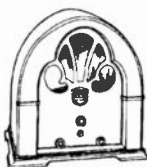

Select from
12 patterns

FOR SALE: Zenith 6D311 (Bunis 2, p. 201), electronically restored - \$65. Clocks: Windsor butterscotch Catalin w/brass case, no chips or cracks, beautiful - \$85. Digital: Telechrom 8B23 copper/brass Deco case - \$43; Mooncrest M-130 aluminum case - \$55; both - \$80. All work. All plus S&H. Sam Mannino, PO Box 233, Swarthmore, PA 19081. (610) 353-6747

FOR SALE: Admiral Bakelite TV, early 1950's, plays - \$35. GE 17C112 TV, nice - \$15. Larry Kellough, PO Box 849, Canton, CT 06019-0849. (203) 693-8269

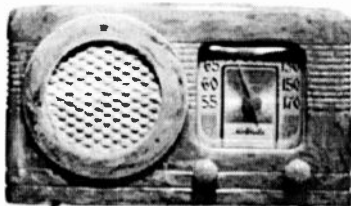

WANTED: Motorola Catalins in just about any condition. I accept calls from all walks of life, including extraterrestrials. Write or phone home. Rain Buttignol, 214 State St., #7, Portsmouth, NH 03801. (603) 427-1384

FOR SALE: (45) Zenith radios to be sold as one lot - \$8,000. For color copy send \$3 and SASE. (40) Bakelite, Catalin, plastic radios to be sold as one lot - \$10,000. For color copy send \$1 + SASE. The Gas Pump, 9637 Magnolia Ave., Riverside, CA 92503. (909) 689-3137, evenings

FOR SALE/TRADE: Zenith Royal 500H, excellent. Has case, manual and earphone, plays. **WANTED:** Dahlberg 4130D pillow radio. Larry Kellough, PO Box 849, Canton, CT 06019-0849. (203) 693-8269

WANTED: AK 84 cabinet. AK-JB & K speakers, any condition. Fada tuning dial 2 3/8". Bob Nicholson, 3423 S. Long, Topkea, KS 66605-2486. (913) 266-9473, after 4:30 pm

FOR SALE: Transistors: Emerson 888 Titan, nice - \$175; Trance TR-80, small crack in clear plastic - \$75; Philco T-7, very nice - \$90; Zenith Royal 500-E - \$50. Table radios: Arvin 341-T \$60; Emerson 520 Catalin - \$130. All plus shipping. Suzanne Wyatt, 4403 Boyd Rd. SE, Dearborn, MO 64439. (816) 992-8811

FOR SALE: Newly acquired. (25) early transistor and novelty radios - \$10-\$45 ea. Arvin K61R58 - \$30. Arvin 10 - \$45. Motorola CX2N docking trans. radio - \$65. Liberty Bell, binocular radio - \$45. Cabin Cruiser radio - \$65. Golf club, TV, phone, many more. Sams Radio hndbk. - \$18. Jeff VanAssche, 103 W. Silvermeadow, Midwest City, OK 73110. (405) 732-5747

WANTED: Breting Model 12 communications receiver, fair to excellent condition, junkers also considered. K. David Stahl, 32 Rice Rd., Sudbury, MA 01776. (508) 443-5931

FOR SALE: Three-speed phonographs U.S. Recording Company Model ED 402A, for schools, dance academies, etc., 15" x 13" x 10", easily carried, weighs 20#. AC power supply uses 5Y3GT, 6SL7GT and 6V6GT. Large 8" speaker in lid with 25 ft. extension 5 watt output. J.J. Papovich, 53 Magnolia Ave., Pitman, NJ 08071. (609) 582-8279

FOR SALE: Altec 2-601 12" speakers. McIntosh: MC-30 amplifier; 1500 receiver. Western Electric: 124 amplifier; WE 350 tubes, at least 5; 22D 5CH mixer, in case; portable VU meter test set; rack mount meter test set; recorder connector; misc. coils and audio transformers. Ampex 351 hi-speed stereo tube type. RCA: (2) LC-1A speaker; (2) LS-1A wall housing; 44 microphone; 77 microphone; M19358A power amplifier; M1414 wall speaker; M112414 wall speaker; OP6 portable; OP7 mixers. Collins 212Y remote amp w/bag. Gates: Bi-Mote 2 ch mixer; Level Devil; Sta-Level; SA398 tube limiter. Knight: 2 KN 530, tube power amps. James F. Phillips, 414 Washington Ave., Defiance, OH 43512. (419) 782-8591. Fax (419) 782-3299

WANTED: Blonde Zenith porthole table model televisions, and Crosley Coloradios. Jerry Traub, 806 McDonald Ave., Santa Rosa, CA 95404. (707) 545-9425

WANTED: Bendix radios, need not work. Call or write: Aaron Mall, 903 Dropleaf Ct., Baltimore, MD 21208. (410) 486-8813

FOR SALE: Sams 2R-31 - \$10. Holiday Deluxe - \$10. RCA PT-1 - \$10. Zenith Royal 45 - \$10. Panasonic R-1000 - \$45. Jerry J. Schaefer, 932 No. 4th St., Grand Forks, ND 58203. (701) 772-2991

FOR SALE: Many transistor and novelty radios from 1960's. Most items new in box. Free list, SASE. Bill Hyde, 1335 Roberts Dr., Las Cruces, NM 88001. (505) 526-8010

WANTED: Copy instructions for Hickock 540 tube tester; Knight RF Z-bridge; Micronta Dynamic transistor checker. R.J. Eastwick, N2AWC, 224 Chestnut St., Haddonfield, NJ 08033

WANTED: Owners or service manual for Eico 460 scope. Also EL37 tubes. Mitch Colby, 2730 Schurz Ave., Bronx, NY 11590. (718) 829-3063

FOR SALE/TRADE: For sale or trade for Philcos: Bendix 636-A, painted - \$25. RCA 3RF91 - \$20. Fada 265-A - \$110. Crosley 11-107U - \$50. Farnsworth ET-066 - \$50. Sentinel 1U363 - \$15. Zenith G-730 - \$15. K-526 - \$20. Admiral SX21 - \$20. 279 - \$10. Monacor S-1H - \$25. Phillips B1X08A/70F - \$25. Arvin 64-R78 - \$10. GE P1700A - \$7. Weston Model 433 - \$10. Mike Anderson, 1371-B Baker Dr. SE, Albuquerque, NM 87116. (505) 254-9957

FOR SALE: Detrola 300-A short wave converter, 1-24 tube and 2-27 tubes, all original, needs cabinet work - \$100 and I will ship UPS. Frank D. Atwood, Nostalgia Radio, 117 E. Main St., Merrimac, MA 01860. (508) 346-8100

**PHONE NUMBER FOR
ANTIQUE RADIO CLASSIFIED
(508) 371-0512**

**Best time to call is weekdays:
9 am to 5 pm Eastern Time**

(Please no classified ads by phone. Thanks!)

FOR SALE: Crystal, battery sets, books, magazines. Send 29¢ U.S. stamp for list, or call. Roger Hart, 4533 Harvard Ave., Montreal, Quebec, Canada H4A 2X3. (514) 483-3857

FOR SALE: Radios, earphones, speakers, AK parts, books, Riders, 1920's parts. SASE for list. Harry Cap, 190 Beech St., Bridgewater, MA 02324-3508. (508) 697-8648

WANTED: Fisher multiplexor MPX100 or 10, one Marantz 9, manual for HP7563A voltmeter. Jan Björkman, Fridhem 2794, 640 45 Kvicksund, Sweden. Fax: 46 16 354935

WANTED: Still looking for Collins 75A2, speaker and accessories. Cash, trade, up or down. Brian Roberts, K9VKY, 3068 Evergreen Rd., Pittsburgh, PA 15237. (412) 931-4646

WANTED — CLAPP-EASTHAM SETS

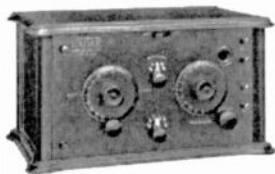

R43 Regenerative Set



R23 Tuner & A23 Det./Amp.

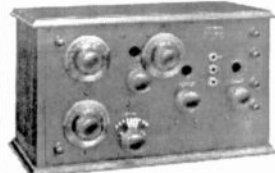

C3 Regenerative Set



A3 2-Step Amp.

Also Looking For:
Blitzen Receiver,
D Receiver,
OZ, F.A.R. or Z,
ZRFDA, ZRFD,
ZR, HRF, ZR,
C64, RHM

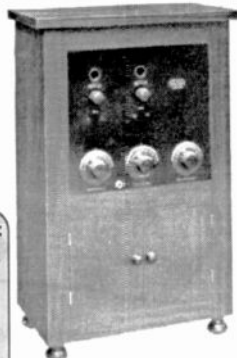

**C63 Regenerative Set
Console with Speaker**

As it may be a long time before I find any of these sets, remember to call me if and when you can part with yours. I am putting together a broad collection of early broadcast and wireless equipment from many manufacturers, and adding to it each month. I buy single sets or collections - also, books, catalogs, manuals and other related documentation. Now that I have moved my business (A.R.C.) out of my home, I have roooooom!

Call and surprise me; make my day! — Please leave a message if my answering machine answers. Thanks.

John V. Terrey, 498 Cross Street, Carlisle, MA 01741 — (508) 369-9770

WANTED: Wood parts for Zenith 10S155. Need the bottom front face board and both corner pieces (blocks) or parts set. Purchase or trade, possible pick up Penna., Calif., Oct./Nov. **FOR SALE/TRADE:** Zenith 9S365 chassis. Grebe long-leg console. Belive 1929 Model 285 7-tuber. Missing speaker. Very clean chassis. All or parts. 1956 Grundig Majestic 8098 U.S.A. floor console, has four bands, rotating ferrite antennae, P-E Rex Deluxe record changer, push buttons galore, original papers, rebuilt, plays well, size 46L x 31H x 18W. Delivery to the big 3 meets/95 - Best Offer. Bill Timoszyk, 35283 Leon, Livonia, MI 48150. (313) 421-2076

WANTED: RCA plastic portables 2B400, 2B401, 2B402, 2B403, 2B404, 2B405, (BB4, p. 281). Bill McConnell, 1141 W. Pioneer Pkwy, Suite 104, Arlington, TX 76013. (817) 469-6622

FOR SALE: Television Broadcast History, companion to PBS series, illustrated hardcover w/jacket, new condition - \$20. Nice Sencore TF40 Cricket w/manual - \$35. Channel Master 6514, nice but chipped - \$25. **WANTED:** Zenith Royal 500's, TV Guides. Don Maurer, 29 South 4th St., Lebanon, PA 17042. (717) 272-2481

WANTED: Hallicrafters SX-11 and SX-15. Robert Braza, N1PRS, 23 Harvard St., Pawtucket, RI 02860. (401) 723-1603

WANTED: Schematic/info RCA Institutes home study course BC superhet kit, ca. 1958. Alvin Bernard, PO Box 690098, Orlando, FL 32869-0098. (407) 351-5536

FOR SALE: Hammarlund Super Pro SP400X w/rack-mounted PS, manual, and spare power supply. Dan Greeson, KH6P, 98-1145 Kahapii St., Aiea, HI 96701. (808) 486-8879

FOR TRADE: RCA Redbooks (service manuals) 1923 thru 1940 for your Philco 90 cathedral or AK 206/735 tombstone. A. Bruno, 24 Butternut Dr., New City, NY 10956. (914) 354-8899

Catalins Wanted



Fada • Emerson • Motorola
Addison • Air King • Arvin • Detrola
Crosley • Symphony • Tom Thumb
I buy all makes and models.

Nobody pays more!

Michael Lawlor
P.O. Box 179 • Santa Barbara, CA 93102
(805) 682-2336

WANTED: 1-GZ-41 tube, mini not peanut. Carlos Gimenez, 15091 Shamrock Dr., Fort Myers, FL 33912

WANTED: Static electricity machines, Leyden jars, induction coils, early brass electrical, related parts, trades. Louie Scribner, 1415 West Leigh Dr., Charlottesville, VA 22901. (804) 977-5521

FOR SALE: Radio Troubleshooters Manual (Ghirardi) - \$18. Pilot Lone Ranger chassis & back - \$35 or sell separate. Lambda power supplies, professional grade - \$15 ea. N.I.B. seal unbroken reel-to-reel tapes, prerecorded, wide selection available - \$5 ea. Professional quality radio station turntable & reel-to-reel - BO. **WANTED:** Pilot radios, any condition, any model. Westinghouse 214/314 tombstone/console. Bill Moore, 3049 Box Canyon Rd., Huntsville, AL 35803. (205) 880-1207

WANTED: Schematic for Tonfunk Violetta W 360E radio. Sanford Mathis, KØTVX, 29390 Somerset Rd., Paola, KS 66071. (913) 294-2669

WANTED: Quack medical devices, especially violet rays, and induction coils. Also scientific apparatus. Richard Cane, 1333 N.W. 127th Dr., Sunrise, FL 33323. (305) 846-7116

FOR SALE: Knobs (radio only before 1940), 10 lbs., 1" to 4", includes (12) vernier, (1) airplane dial and others - Very best offer plus shipping. John Snow, 4539 N. Bartlett Ave., Shorewood, WI 53211

FOR SALE/TRADE: For swap or BO: RME 9D receiver brass base WD11, brass base 201A. Electro-Voice studio Georgian speakers. Michael Payne, 803 S. Taylor, Alvin, TX 77511. (713) 331-9217

WANTED: Power transformer for McMurdo Silver Vomax Model 900 VTVM. Horizontal mount, 120 VAC primary. 5 VAC at 2 amps, 6.3 VAC at 1.6 amps, and 640 VCT at 50 Ma. secondaries. Sam W. Wrenn, 2314 Seminole Dr. #1207, Arlington, TX 76010

WANTED: Complete sets of Sams Photofacts Numbers 1 thru 100 and 140 thru 200. Robert Schrantz, 610 E. Juanita Ave., San Dimas, CA 91773. (909) 394-1194

FOR SALE: 1938 Zenith Distributors Catalog, 170 pages with illustrations of all the 1938 models. This is a quality reprint of an exceedingly rare catalog printed for district representatives, demonstrating the complete 1938 Zenith line of radios. The Stratosphere is pictured along with many unusual models, service data, sales tips and advertising plans. This printing is limited to only 100 copies. A must for all Zenith collectors!!! Please send \$27.50 plus \$2 postage to: New Wireless Pioneers, Box 398, Elma, NY 14059. (716) 681-3186. Fax (716) 681-4540

WANTED: E. H. Scott Special Communications Receiver. It may be sometime before one of these receivers becomes available. When you are ready to part with yours, please contact me. John T. Meredith, 1644 Parkside Circle, Niceville, FL 32578. (904) 897-7734. Refer to O.T.B. Nov. 92.

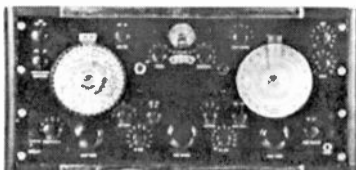

FOR SALE: Sencore Model FE 149 Senior Field Effect Meter in original box with manual (batt. not included), excellent to like new condition - \$65, you ship. John Snow, 4539 N. Bartlett Ave., Shorewood, WI 53211. (414) 964-0194

FOR SALE/TRADE: For swap or BO. Matched quads of Senco 350-B N.I.B., JAN 6B4G N.I.B., Sylvania 7591A N.I.B., and Amperex 5AR4 N.I.B. Michael Payne, 803 S. Taylor, Alvin, TX 77511. (713) 331-9217

WANTED: Copy of operator instructions only for B&K Dyna-Quik 550 tube tester. Thanks. Bob Barr, 3130 Bellanca St., Columbus, GA 31909

FOR SALE: Lists on the following. A LSASE for each list. German radios. Horn speakers sound system drivers. Crystal set tuning coils. FM-TV test eqpt. AM-FM tuners sound amps. Tube closeouts. Books magazines closeouts. Lab and switchboard meters. Watch case meters used, N.O.S. Bundles of radio service notes. 1000's of new used parts unlisted. 100 assd. QSL cards, fair, good tack holes - \$32.50 postpaid. Homemade crystal set 2 tap switches - \$30 Old photo flashbulbs. B&S wire gauge - \$5. Assd. soldering guns and irons. Ungar handle and tip - \$5. Ungar new tip 47 watt - \$3.50. Assd. test leads, 2 sets - \$5. Full color photo as on cover of Bunis Radio Coll. Book Vol. 1, 2, 3 - \$15; with mat - \$19 postpaid each. Min parts orders - \$8. All plus shipping, to a U.S.A. address. Krantz, 100 Osage Ave., Somerdale, NJ 08063

FOR SALE: The Country Belle by Guild, AM-FM version, exc - \$70. Kent 3-tube metal midget, looks like Arvin #422 - \$70. Tonemaster, pink, 50's, Japanese tube, small table radio - \$25. Silverstone #7000 left-hand dial - \$50. Brewster #1084, brown, exc - \$50 Travler #5356 maroon Plaskon midget with white knobs - \$70. Airline #04WG-754C, (Bunis 2, p. 15) - \$70. Nora, German, white Plaskon, small chip - \$70. All prices negotiable. Plus shipping. Dave Masterson, 792 Marion Rd., Cheshire, CT 06410. (203) 271-9852

WANTED: Boxes of tubes, 1930's through 1950's, schematic for Supreme Model 85 tube tester. Mark Gutekunst, 2600 Martin Rd., Willow Grove, PA 19090. (215) 657-8552

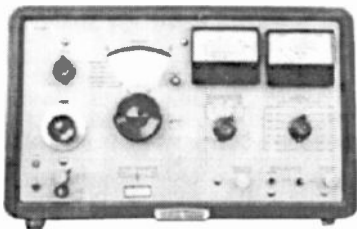

FOR SALE: HP606A RF signal generator, 50kHz to 65MHz, calibrated/meter output level 3 volts to 1 microvolt, AM modulate 0% to 100% adjust, internal xtal to zero beat every 100kHz and 1 MHz, aligned and working fine - \$130. 50MHz cscope, dual trace with delayed triggered sweep, solid-state - \$100. HP-200 CD audio generator, runs from 6Hz to 600kHz, puts out 20v or less - \$60. HP1120A 500MHz fet probe with kit, and manual - \$130. All working. Shipping and packing extra. Stan Krumme, 16432 Lakemont Ln., Huntington Beach, CA 92647. (714) 841-5866

FOR SALE: Post War Communications Receiver Manuals by Howard W. Sams, Volumes 1 & 2, with a total of 472 pages covering all the popular models produced from 1945-1952 by Heathkit, Gonset, National, Harvey-Wells, Hallicrafters, Hammarlund and Collins. Shown are schematics, alignment procedures, voltage & resistance charts, etc. These are quality 1994 limited edition reprints with a spiral binding. Price is \$36 including postage for both volumes, or \$20 ea. New Wireless Pioneers, Box 398, Elma, NY 14059. (716) 681-3186. Fax (716) 681-4540

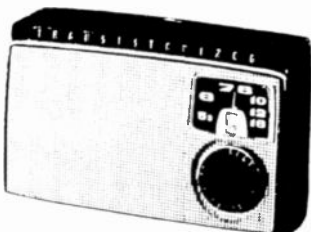

WANTED: Offering \$1,000 for cosmetically excellent Sony TR-55 transistor radio (pictured above) or for cosmetically excellent Regency TR-1 in a pearl white, pink, lavender, lime or meridian blue pearlescent deluxe (translucent) cabinet. Also always looking for other Regency TR-1, TR-1G, or TR-4 sets; any solar-powered Admiral; Arvin 8576; Bulova 250; Emerson 999; Firestone F-4D; Hoffman Home & Travel Solaradio; any Mantola; any Mitchell; Motorola 56T1; Motorola 7X23E; Motorola 7X24S; Motorola 7X24W; any coat pocket Raytheon; Sonora 610; Sylvania Thunderbird; Sony TR-63 or any Sony marked "Tokyo Tushin Kogyo, Ltd."; Toshiba "lace" grille; Toshiba 6TP-309; Toshiba 8TP-90; Toshiba 9TM-40; Toshiba sphere-shaped "rice bowl"; Standard SR-F22; and tan or pink Zenith Royal 500. Thanks. Bill Burkett, PO Box 2488, Sun City, AZ 85372. (602) 974-4535, or toll free (800) 507-7234, or fax (602) 974-4323

FOR SALE/TRADE: Miscellaneous collectible and usable tubes. Some good, some display only. 1-stamp LSASE for list. Sam W. Wreath, 2314 Seminole Dr. #1207, Arlington, TX 76010

FOR SALE/TRADE: 1932 Olympic games cathedral radio, cabinet only; solid, not perfect - Best Offer. Bill Timoszyk, 35283 Leon, Livonia, MI 48150. (313) 421-2076

WANTED: Junker Philco table radio 38-9 for parts. Bill McConnell, 1141 W. Pioneer Pkwy., Suite 104, Arlington, TX 76013. (817) 469-6622

FOR SALE: Emerson Model 600 7" TV - \$200; Model 621 10" TV with AM-FM - \$75. Emerson table radios: Model 522 - \$50, Model 539 - \$50, Model 541 - \$50, Model 559A - \$30, Model 718B - \$25, Model 869 - \$25, Model 888 - \$35. All prices plus shipping. Ray Miller, The Emerson Guy, Box 306, Avalon, CA 90704. (310) 510-1700

FOR SALE/TRADE: Rare 1939 RCA TRK-5 TV chassis. Will convert easily to TT-5 configuration, needs work - Best Offer, cash or trade. **WANTED:** Schematic, tube source for 1931 British Gecophone BC-3244 mini-console. Kennedy XV cabinet. Sparton 557 dial scale. Dial glass for Stewart-Warner Catalin. Emerson 774B pointer. Mike Schultz, 820 Willow St., Southampton, PA 18966. (215) 364-1727

FOR SALE: Dial belt frustration ? 36-page book, copy, of correct belt to radio model - \$10 ppd. John Snow, 4539 N. Bartlett Ave., Shorewood, WI 53211. (414) 964-0194

FOR SALE: Stewart-Warner Air Pal, #B51T1, painted Bakelite, (E.O.R. 1, p. 185) - \$75 + UPS. C. Hill, 6934 Orion Ave., Van Nuys, CA 91406. (818) 787-0376

WANTED: Speaker for Sparton 201. Heathkit SB 220 amplifier. Arvin Model 40. George Folse, KBSWWO, 630 Dolhonde, Gretna, LA 70053. (504) 362-9228

WANTED: UTC transformers: LS55, LS19, LS25, LS38, LS40, LS54, LS61, HA100X or will swap to match. Michael Payne, 803 S. Taylor, Alvin, TX 77511. (713) 331-9217

FOR SALE: N.O.S. 12AX7 - \$6 each plus good, used 5U4 and 6V6 at \$3. Shipping - \$3. Stan Marlin, Box 1035, Assiniboia, Saskatchewan, Canada S0H 0B0. (306) 642-3824

FOR SALE: Crosley Buddy Boy brass tag - \$10. Unusual Bakelite Mitchell lamp radio - \$35. Transistors: Motorola X1CN - \$10. Philco T700 - \$10. Unusual maroon Bakelite Sparton UHF converter - \$10. Incredible selection of low & high end chokes and power transformers - \$1.50-\$10 ea. Harman Kardon Citation II factory cage - \$37.50. Fisher 30A amp - \$35. Pilot multiplex unit - \$15. Allied Radio catalogs, most years - \$10. 1950 World Radio Labs catalog - \$10. General Instrument cable TV tuner with remote - \$15. Nordemende Globe Traveler - \$95. Zenith 5S127, needs help - \$45. **WANTED:** Philco 37-665B tombstone, Pilot radios, any model, any condition, Westinghouse 214/314 tombstone/console. Bill Moore, 3049 Box Canyon Rd., Huntsville, AL 35803. (205) 880-1207

WANTED: One clean Federal 57 and/or Zenith suitcase portable. Seriously looking for any early CRL (Chicago Radio) equipment and/or literature. William Wade, 657 14th Ave., Prospect Park, PA 19076. (610) 534-3477

WANTED: Hammarlund Noise Silencer accessory for HQ-180 Series receiver; also HC-10 converter. Rick Krzemien, N6NVG, 5398 Concerto Cir., Concord, CA 94521-3250. (510) 687-2719

FOR SALE: Car radio vibrators. Free catalog. See our boxed classified ad. Dan Schulz, Antique Automobile Radio, Inc., 700 Tampa Rd., Palm Harbor, FL 34683. (800) 933-4926 or Fax (813) 789-0283

FOR SALE: Stromberg-Carlson sound equipment amplifier #AU29-75W. Sams Photofacts. Ann Bichanich (Jays), 15 1/2 W. Lake St., Chisholm, MN 55719. (218) 254-4421

TUBES - CAPACITORS - MISC.

For Repairs, Restorations & Projects

**ALL-NEW 50% LARGER 1994-1995
FULLY ILLUSTRATED 24 PAGE
CATALOG #49**

INFORMATIVE, INTERESTING & "FUN-TO-READ"

Jammed to-the-raffers with thousands of tubes, capacitors, radio service items, etc.

Send \$3 (cash, stamps or check)

Canada \$3 - Overseas \$5 (U.S. funds) Airmailed
FOR YOUR COPY NOW!

DON DIERS 4276 North 50 St. Dept. A2
Milwaukee, WI 53216-1313

WANTED: EICO Model 955 capacitor checker, preferably with cables and manual. Bill McConnell, 1141 W. Pioneer Pkwy., Suite 104, Arlington, TX 76013. (817) 469-6622

FOR SALE: Radiola 100A speaker, restored, repainted, new grille cloth, works - \$60 plus UPS. James S. Fisher, 344 Harrison Ave., Manville, NJ 08835. (908) 725-7476

FOR TRADE: 44BX mic, nice condition, trade for 77A thru DX with original network identification plate. John Harding, 550 Crain Hwy., N, Unit 25, Baltimore, MD 21061. (410) 761-1072

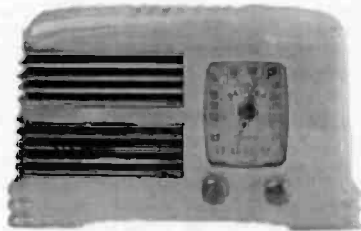

WANTED: Detrola and Symphony Catalin radios. I wonder how many more people out there, beyond those have already written, think I'm a complete moron. For insults, information or really great and expensive radios to sell, please write or call collect: Rain Butnigun, 214 State St., #7, Portsmouth, NH 03801. (603) 427-1384

FOR SALE: Arvin, white, Model 444, good condition, plays - \$65. EICO oscilloscope Model 460, vgc n/ manual or leads - \$70. Variac, 0-140v, 10 amps - \$45. All plus UPS. Stephen L. Bonino, 107 Georgetown Rd., Glassboro, NJ 08028. (609) 881-0244

FOR SALE: General Radio megohm bridge 544B - \$25. Small Zenith wood knob - \$8. Faradon condenser UC1831 - \$25. American Art Mache Model 804 horn speaker (O.T.B. Feb. 92) - \$225. Cunningham metal base 01-A - \$15. Some Radio Retailing magazines - SASE. **WANTED:** AR 19 base. Floyd A. Paul, 1545 Raymond Ave., Glendale, CA 91201. (818) 242-8961

WANTED: Cards or photocopies of cards for Hickock Cardmatic 123 tube tester. Andrew Mitz, WA3LTJ, 4207 Amber Dr., Kensington, MD 20895. (301) 897-5531. E-mail: arm@helix.nih.gov

FOR SALE: Philco 37-690, Hallicrafters S53A, Freshman Masterpiece, McMartin LT252B, Roberts 990, Scott 296, NC-300. Francis H. Yonker, W2IBH, 1229 Inverary Pl., State College, PA 16801. (814) 867-1400

FOR SALE: JRC NRD 515 w/memory unit, sprk, mint - \$575, shipped. Joel Levy, 8 Waterloo Dr., Morris Plains, NJ 07950. (201) 285-0233

WANTED: Hallicrafters high profile cabinet that fits HT-20, HT-31, HT-33, or entire units. Ron Eveland, W6HFZ, 13169 Briarwood St., Cerritos, CA 90703-7367. (310) 860-3623

FOR SALE: Hot Point 1957 B&W TV - \$75 plus shipping. Robert J. Stone, 721 Fisk St., Piqua, OH 45356-3729. (513) 773-2217

FOR SALE: Crosley 26 with matching speaker, brown metal farm radio, very nice, works - \$80. Ralph Trotter, N1RAK, 103 Beach Rd., Bristol, RI 02809. (401) 253-7749

SERVICES: Wind-up phonograph and radio restoration and repair. Victor, Columbia, Crosley, Philco ex. All UPS. Reasonable prices. Call: Ray Mattiello, 106-05 97th Ave., Queens, NY 11416. (718) 441-0350, eves.

FOR SALE: Send for list of radios from early 30's through 40's. Reasonable prices. Robert J. Stone, 721 Fisk St., Piqua, OH 45356-3729. (513) 773-2217

FOR SALE: Sony TR63, green, chip on corner - Best Offer. **WANTED:** Mint Colonial globe. Dennis Yates, The Hewarths, Sandiacre, Nottingham, England NG10 5NQ. Tel.: (602) 393139

WANTED: Need one escutcheon, four large knobs, and eight push-button knobs for Philco 41-280 to complete. Dennis Wright, 3507 7th St. E, Lewiston, ID 83501. (208) 746-2319

FOR SALE: Hallicrafters HT-41 - \$325. Hallicrafters S-108 - \$135. E.H. Scott RDO marine w/4 tuning units - \$230. National H.F.S. - \$170. E.H. Scott 16A in Chippendale console - \$400. George Schwarz, 18504 Arrowhead, Cleveland, OH 44119. (216) 486-6489

FOR SALE: Belknap - \$40. Bulova 350 - \$30. Bulova clock 190 - \$20. Crosley 167 - \$60. Dunlop 500 - \$50. Emerson 920 - \$25. Emerson port. 523 - \$35. GE 123 - \$60. Lafayette HE51 - \$50. Meteor 7001 - \$35. Motorola 59H121 - \$30. National Union 571 - \$35. Philco 50/922 - \$50. Philco PT44 - \$75. Philco 39/7 - \$50. Philco 53/560 - \$25. Philco 46/250 - \$40. Philco 610 - \$150. RCA 3RC11 - \$20. RCA 6BX63 - \$40. RCA 2X62 - \$40. RCA 9575 - \$75. RCA 4X641 - \$35. Silvertone batt. - \$25. Silvertone 25 - \$15. Strom-Carls. 1101H - \$150. Truetone D2919 - \$25. Truetone D 1002 - \$100. Zenith 723 - \$30. Zenith 4K035 - \$45. Zenith 6D2615 - \$100. Zenith 555 Suncharger - \$300. SX 25 and speaker - \$200. Emerson 659 - \$50. RCA 9X571 - \$50. Bendix 526e - \$45. Philco 51-532 - \$35. All plus S/H. Polaroids one dollar and SASE. Bud Santoro, 3715 Bower Rd., Roanoke, VA 24018. (703) 774-9153

FOR SALE: Arvin 2 tube metal set - \$50. Stewart-Warner metal set - \$50. Arvin metal set, case only - \$15. Skymaster peanut tube portable - \$50. Emerson 520 Catalin - \$100. Triplett multimeter - \$15. Lemco crystal set, case only, no lid - \$10. RCA small Bakelite turntable, plugs into radio - \$25. **WANTED:** Remler Scottie radios. Bob Furtado, 23 Garden Rd., Alameda, CA 94502. (510) 521-3084

FOR SALE: Audio Engineering Society Magazines Vol. 1 (1953) to present Vol. 42 (1994) consisting of approx. 320 issues. For collector or library, asking \$1,000 for all. Send 52c SASE. M. Clifford Agress, 891 Fulton St., Valley Stream, NY 11580. (516) 825-8955

MESSAGE: To my fellow collectors who are also trying to find Rider's Radio Volume I, it is with regret that I must inform you there are no extra volumes for sale in the entire world. How do I know? Because I have been looking, calling, advertising, pleading and begging for some kind soul to sell me one. Been looking for almost 4 years with no luck so I'm finally giving up. To those of you who have tried to help, and offered condolences, I thank you. Harold La Roche, 16426 Heiden Cir., Spring, TX 77379. (713) 370-3451

WANTED: National NC183D receiver. James Okubo, W6OU, 529 Kevin Way, Placentia, CA 92670. (714) 528-5652

WANTED: Hickock 539B tube tester and Hickock 1890M transistor tester. Ross Wollrab, 1501 E. Gardner Ln., #722, Peoria Heights, IL 61614. (309) 686-0211

FOR SALE: Precision stainless steel 6-inch dial calipers, accurate to 1/1000 inch, new, in case - \$25 ppd U.S.A. Chase Hearn, 104 Glenwood Dr., Williamsburg, VA 23185. (804) 229-7263

FOR SALE: Coil winding machine - \$200 or BO, prefer pick-up. Radio dial belts - \$3 ea. Rick Yerke, PO Box 392, Moscow, PA 18444. (717) 842-4857

Vacuum Tubes for Audio are Back!

Glass Audio

brings together
the tube & today's improved
components, voltage control
and the new, exciting
premium Soviet tubes, to
make smooth sound again
possible in your living room.

Ask for your first **FREE**
issue, without obligation.

Glass Audio

PO BOX 176, DEPT. ARC
Peterborough, NH 03458-0176 USA
FAX (603) 924-9467



*Craig L. Graybar
Furniture Works Ltd.*

(414) 258-2390

SPECIALISTS IN RESTORING,
REPAIRING AND REPRODUCING
CLASSIC STYLED ANTIQUE TV,
RADIO & PHONOGRAPH CABINETS

Send us your plans or your project
via UPS for immediate price quotes



1535 S. 34th St.
West Allis, WI 53214



"We Turn Ideas Into Heirlooms"

FOR SALE: Delco R1238 - \$125. Admiral 5S21N - \$35. Westinghouse H374TS - \$35. GE 437B, pink - \$35. Motorola 5R1 gray/white - \$55. TV-style clock, early digital type, swirled brown case - \$40. Three nice LED mens watches - \$65. Two postcards Harold Warp Pioneer Village, one shows old radios, TV, other early electric generators 1950's(?) - \$8/pr. Postage extra. R.C. Moore, 452 West Park Ave., Aurora, IL 60506. (708) 264-0488

FOR SALE: Philco Model 76 chassis with tubes and speaker, plays - \$75. Airmaster (circa 1939) table model radio, 3W1209, plays - \$45. 1957 model automobile radios, Chevrolet number 987575 and Ford number 78MF121455 - \$20 ea. Heathkit AJ-31 FM tuner and EA-2 amplifier - \$15 ea. All plus shipping. Junius Bailey, W5FTW, 1002 Reeves St., Abilene, TX 79602. (915) 673-0986. Message (915) 675-6006

MESSAGE: Radio widows! Christmas approaches. Shop for your favorite collector November 13 at DVHRC Swapmeet, Tyro Grange Hall, Buckingham, PA. For info, call or write: Mike Koste, 57 Tennis Ave., Ambler, PA 19002. (215) 646-6488

WANTED: Information, photos, etc. about lowa radio companies. Copies gladly accepted, willing to reimburse. Dennis Hilberg, 804 Ravine St., Decorah, IA 52101

SERVICES: We rebuild electrolytic capacitors. Twist-Locs, wet or dry cans. Starting Oct. 1st, @ \$14, for any single capacitor, simply add \$1 for each additional section. This price good up to 80 uF @ 450v. Any section over 80 uF and exceeding 100v add \$1.50 per such section. Add \$2 for Leslie or octal-based cans. Add \$3 to replace Twist-Loc bases. Add \$1.50 for 475v or 500v each such section. All rebuilt can prices include return postpaid via 1st class mail until Jan. 1st. Frontier Electronics, Box 218, 403 S. McIntosh St., Lehr, ND 58460. (701) 378-2341

A.R.C. BACK ISSUES

April '87 to current issue: Originals available
32 to 100 pages each.

Oct. '86 to Mar. '87: Reprints available
Reprinted from original artwork; 28 to 32 pgs. ea.
Quality & appearance same as an original copy.

June '84 to Sept. '86: Photocopies available
Not original quality, useful for info.; 16 to 28 pages each.

Publication of *Antique Radio Classified* began in 1984 which had only five issues: June, Sept., Oct., Nov. & Dec. 1984. 1985 through current year have had 12 issues each.

**\$4.00 each - Postpaid to
U.S., Canada and Mexico.**

Orders of 6 issues or more may take a 10% discount. Orders for a full calendar year may take a 50% discount. Foreign orders other than Canada and Mexico: \$6.00 each by air. Mass. residents, please add 5% sales tax.

A.R.C. UNCUT, UNFOLDED COVERS

June 1991 to the present
9.25" x 12.5" - \$9.95 each

Postpaid to U.S., Canada, & Mexico

Mass. residents, please add 5% sales tax.

Send Order To:

A.R.C., P.O. Box 2, Carlisle MA 01741

Or Call (508) 371-0512

WANTED: Westinghouse WL-530 Pearl Harbor radar tube, RCA UX859, DeForest 430 through 440 tubes, duds OK. John H. Walker, Jr., 16112 W. 125th St., Olathe, KS 66062. (913) 782-6455

MESSAGE: Send for our free catalog of hard to find parts and equipment. Northwest Electronics, 2509 West 11th, Eugene, OR 97402. (503) 485-3016

FORSALE: 10/5/94: Transistors: Channel Master 6515, Zenith Royal 35, GE # P-977E, 4960A, Westinghouse 962 TCRB AM/CB - \$20 ea. GE-1710C, Realtone MW-3 - \$10 ea. Matsushita T-41, Panasonic T-50, GE-740, GE-P795D - \$25 ea. Aiwa TP-1000 7" stereo recorder - \$100. Akai #GX-4000D, original owner, exc condition - \$150. Also collection of kids lunch boxes with TV characters, etc. Bret F. Johnson, 13495 102nd Ter. N., Largo, FL 34644. (813) 595-9287

WANTED: McIntosh MC-60's. Cash or good trades. Thanks. Mike Fletcher, 1204 Cedar St., Niles, MI 49120. (616) 684-2174

FOR SALE: Zenith chairsides 5S237 - \$75, 6S239 - \$90, 9S262 console - \$225. Philco 610 - \$67.50, \$42.50. John Lyle, 1161 S.W. Mulvane, Topeka, KS 66604-1456. (913) 232-0128

WANTED: Realtone TR-970 Voyager in a gift box, or presentation box. Karl Ayer, N9PXE, PO Box 665, Thiensville, WI 53092. (414) 242-0571

WANTED: Code/cipher books/paper for project. Manual or photocopy for TG-5. Damaged or broken telegraph instruments, purchase/repair. **FOR SALE:** TA-182 telephone/telegraph converter - \$60. Bozak audio amps/preamps ca. 1966, (5) pieces in oak rack, excellent - \$1,000. P/U; SX-28, nice - \$175. (30) pounds old telephone manuals - \$100. Uship; Codebook by N1KPR, excellent - \$15. TS-111-CP wave meter - Offers. Simpson/Triplett VOMs, need some work - Offers. Write SASE or call other wants; telegraph, ham, military. Robert W. Butt, The Key Doctor, 8 Little Fawn Dr., Shelton, CT 06484. (203) 924-1120, 9-9 EDT

FOR SALE: A real neat AM broadcast transmitter that was used by realtors. It features a 90 second digital voice recorder and external audio jack for connecting your own recorder/player. It covers the entire AM broadcast range 530 to 1630 kHz. It also has a built-in frequency counter for precise tuning and is very stable. Range of about 2 blocks. It sold new for \$300 and can be yours for only \$125, plus shipping. **FOR SALE:** Zenith Royal 7000, excellent condition - \$225 OBO.

WANTED: Citizens Band test equipment made by B&K, circa late '70s. Pat Ryan, 2122 Marconi Ave., St. Louis, MO 63110. (314) 664-7080

RADIO & COLLECTIBLES AUCTION!

Mt. Gilead, Ohio Exit (I-71 @ Rte. 95)
20 Miles North of Columbus, Ohio
Friday Evening Oct. 7th - 6 P.M.
(1/2 of a mile West of Exit)

Nice assortment of over 50 radios (consoles/Bakelites 30's-60's) plus nice cylinder records w/player. Older transistor radios, some toys, dolls, World's Fair items (30's), paper goods, art, smalls, glass & misc. Interesting sale!

Auctioneer: Jim Eastwood, Sunbury, Ohio
(614) 965-4778 after 9:30 P.M. EST
Terms: Cash/Check w/I.D.
Licensed/Bonded-Ohio

FOR SALE: Philco, very pristine, soft, supple cowhide leather, #E-675-124 (1957) portable, AC/Bat, (Bunis 3, p. 173) - \$45 + UPS. C. Hill, 6934 Orion Ave., Van Nuys, CA 91406. (818) 787-0376

FOR SALE: Grebe CR3A antenna inductor and switch arms, not original - Offer before 12-15-94. (3) pictures - \$3.50 ppd. Robert Campbell, 2175 S.E. Pine, Hillsboro, OR 97123

MESSAGE: Will the gentleman interested in my Midwest 18-36 please call me? Can deliver to SARS Mega-Meet in Atlanta October 8th or 9th. David Martin, 1502 Wood Thrush Way, Marietta, GA 30062. (404) 578-1279

FOR SALE: Radio schematics - \$2.50. Books: Fundamentals of Radio, 400 pages; Fundamentals of Radio and How Applied, 204; Essentials of Electricity for Radio and TV, 533; Basic Radio, 379 - \$10 ea. Understanding Radio, 603; Applied Practical Radio, (Coyne Volume II), 200; Practical Radio Communication, 925; Elements of Radio, 699 - \$12 ea. TV and Radio Servicing, 568; Principals of Radio, 545 - \$15 ea. Radio Physics Course, 974; Electrical Fundamentals of Communication, 554; Transistors in Radio, Television and Electronics, 424; Radio Service Training Manual, 288 - \$14. Radio Training for Victory (WWII), 282; Audels New Electric Library, 546 - \$8 ea. Audels Radioman's Guide, 1040 - \$18. The Radiotron Designer's Handbook, 3rd edition, 352 - \$30. Photocopies: Philco Service Manual, 354; Crosley Service Manuals Volumes I and II, 352, 340 - \$25 ea. AK Service Manual, 463 - \$35. Rider's Indexes 1 through 23 - \$25. Plus UPS. SASE for list. Dick Oliver, 28604 Schwalm Dr., Elkhart, IN 46517. (219) 522-4516

FOR SALE: RCA 77DX microphone flags. Now taking orders for November delivery of an exact reproduction cast aluminum 1940's mic flag. WOR call letters. Only enough copies will be cast to fill advance orders - \$62.95 includes shipping. Frank Nocera, 1572 Argyle Dr., Fort Myers, FL 33919. (813) 936-7197, weekends

WANTED: Turntable mechanism for Ristaucrat mini jukebox/radio, looks like RCA 45 rpm unit but restacks records. Jim Downes, 607 East 12th Ave., Covington, LA 70433. (504) 893-7057

WANTED: Gold 01-A's, good or dud. Brown Fada 845 knob. Belmont 519 parts set. Gary Carter, WA4IAM, PO Box 5248, Greensboro, NC 27435. (910) 292-5861

FOR SALE: Sams Photofacts book, Auto Radio Series, AR-27, Nov. 1964, 160 pages - \$5 plus postage. Hugo Kann, 2320 King's Ct., Marion, IA 52302

FOR TRADE: Radiola 26, great condition. Includes instructions & advertising. Trade for transistor radio(s). Darryl Rehr, 2591 Military, Los Angeles, CA 90064. (310) 477-5229

WANTED: Interstage audio xfmr, for SC10A. Single stage to push pull 45's. 12K DC ohms pri. 6K each of 2 outputs. Andy Sallet, 10 Wellesley Rd., Nashua, NH 03062. (603) 882-3863

WANTED: Crosley Elf or Widget parts, speaker, chassis. Toshiba Rice Bowl, large ball with flower design or parts set. **FOR SALE:** Transistor sets: Gummy - \$125; Tony Tiger - \$45; R2D2 - \$150; Orange lady bug - \$35; Oreo cookie - \$35; Brass and wood Raytheon - \$250. Lee and Carolyn Bruton, 176 Sagebrush, Golden, CO 80401. (303) 279-1299

FOR SALE: Large number of TV-radio tubes, some audio and rectifier tubes, write your needs. Also have test equipment manuals for EICO, Precision, Heathkit, Triplett, Simpson and Hickok. Copies only. Send large two-stamp envelope for lists. Clayton Mundine, 6112 S. Flores St., San Antonio, TX 78214

FOR SALE: Riders complete index, copy, for Vols. 16 thru 22 (no 23) - \$10 ppd. John Snow, 4539 N. Bartlett Ave., Shorewood, WI 53211. (414) 964-0194

WANTED: LS19 UTC transformer, Grommes 216 BA mono amp, Bigg G50D mono amp by George Goff, Fisher 50A amp, EICO HF60 amp, and Western Electric 728 12" speaker. **FOR TRADE:** Scott LK150, Pilot SA260 and Altec 604's. Michael Payne, 803 S. Taylor, Alvin, TX 77511. (713) 331-9217

**FAX NUMBER FOR
ANTIQUE RADIO CLASSIFIED
(508) 371-7129 - 24 hours a day
Ads - Subscriptions - Book Orders
Charge to VISA/MasterCard
Minimum Charge: \$10.00**

WANTED: Pair of good Magnavox Type A tubes, cabinet for Federal 59. Pat Stewart, W7GVC, 1404 Ruth Ave., Walla Walla, WA 99362-3558

FOR SALE: Crosleys: #D-25MN, maroon - \$150; #11-107U, tan - \$85. #D-25, bl/ue - \$115. List - 2-stamp SASE. Irene M. Ripley, Box 9374, N. St. Paul, MN 55109. (612) 777-6791

FOR SALE/TRADE: Collins R-388/URR with mechanical filters and in excellent working condition - Seeking best offer. Norman S. Braithwaite, PO Box 992443, Redding, CA 96099. (916) 246-4209, evens.

WANTED: Tuning knob for the Toshiba 7TP30, or junker 7TP30. Marty Dzik, 412 Gregory St., Schererville, IN 46375. (219) 322-4104

FOR SALE: Early spark transmitter. Ham built with early quality parts i.e. Marconi hi-voltage transformer, RCA Faradon pyrex capacitor, etc. - \$1,250. Very early Western Electric Dynamotor Type P 1/6 - \$450. WE Weconomy 2-tube tuner HF Det. C1924 - \$650. Various crystal sets including Uncle Tom B.T.H., Eiwel, Davenport, etc. Jim Taylor, G4ERU, No. 5, Luther Rd., Winton, Bournemouth, United Kingdom BH9 1LH. Tel. 0202-510400

FOR SALE/TRADE: Nems Clarke special purpose rcvr Type 1302A Serial 364 rack mount. Sam Champie, KD7XX, 800 W. Madrona, Hermiston, OR 97838. (503) 567-2879, weekends only

FOR SALE: Pedestal reproducer by Hartman Mfg. circa 1924. (See A.R.C. Dec. 93, p. 17) - \$200 OBO. Harry Kundrat, 29 Walton Ave., New Providence, NJ 07974. (908) 665-1873

WANTED: Information on Coherer detector. Wish to build early radio-controlled boat using Coherer. Tim James, 905 S. McLoughlin Blvd., Oregon City, OR 97045. (503) 655-5664

WANTED: Crosley 122 Super Buddy Boy, 58 Buddy Boy, 59 Show Boy or Elf, preferably electrically complete and in restorable condition, but I will purchase cabinets, knobs, chassis, and other parts separately. I have a nice AK 944 cathedral that I would trade for a good restored 122 Super Buddy Boy. Jim Watson, 8220 Scenic Hwy., Pensacola, FL 32514. (904) 476-2563

FOR SALE: Contents of Ye Olde TV Shoppe. Used: Hickock 601A TV alignment generator, Knight RFS sweep generator, Superior TV-50A Gen-O-Meter, B&K 1245 color generator, B&K 1076 television analyst (w/flying spot scanner!). (50) Sprague Twist-Loks in rack, tube caddy w/100 tubes. N.O.S.: (20) yokes & flybacks, (28) replacement phono styli, asstd. brighteners, ant splitters, boosters, baluns, etc. Also (594) receiving tubes, new in cartons. 95% Sylvania. Many extras. Would like to sell entire lot, but will consider offers on individual items 30 days after ad appears. Randy Wells, 286 Almond Way, Healdsburg, CA 95448. (707) 543-0146

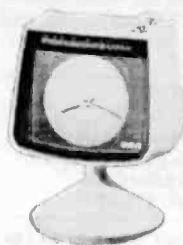

WANTED: RCA "goblet" transistor clock-radio from the 70's as pictured. John Okolowicz, 624 Cedar Hill Rd., Ambler, PA 19002. (215) 542-1597

FOR TRADE: Your extra blue Arcturus UV 099 for my extra blue Arcturus UX 099. John H. Walker, Jr., 16112 W. 125th St., Olathe, KS 66062. (913) 782-6455

FOR SALE: RCA 40X57 San Francisco Expo, works - \$750. Zenith 7S240A shutter dial chairside - \$300. Arvin 740T, red - \$50. Zenith 6D538 - \$50. Westinghouse H126 - \$70. RCA 75X11 - \$35. RCA 75X15 - \$35. Silvertone 1 - \$35. Bendix 636A - \$30. **WANTED:** Knobs for Cutting & Washington 11A. Gary Watkins, 8006 Greenwald, Belton, MO 64012. (816) 322-0773

WANTED: Databooks or spec sheets on any unusual special purpose tubes made by National Union. Will even pay to have copies made if you don't want to part with your data books. John H. Walker, Jr., 16112 W. 125th St., Olathe, KS 66062. (913) 782-6455

FOR SALE: Transistors. Regency TR-1, red, hairline - \$375. Zenith Royal 500, maroon - \$75. Ross RE210 micro with box, etc. - \$60. Polyrad Capri 8TS33, blue - \$50. Olson Micro Super, white - \$50. Nipco, gray/white - \$40. Hitachi TH862R, black - \$20. Silvertone 211, 212, 9204 - \$25 ea. Zenith Royal 200, white, hairlines - \$15. Seminole BP-311, gray - \$15. Bulova 1120, white - \$15. Zenith Royal 20 - \$30. Gary Watkins, 8006 Greenwald, Belton, MO 64012. (816) 322-0773

WANTED: Tube tester with charts, etc. RF signal generator and general service equipment. Bert Reeves, Rt. 1, Box 125X, Telephone, TX 75488. (903) 664-2134. Fax (903) 664-3306

WANTED: Horn speakers, especially Falck, Aerophonic, Madena, J.F. Arnold, Auto Parts, Auditorium, Sonochorde, Radak, Callophone, Clearstone, Cory phone, DeForest, Florentine, Town Crier, Gemso, Hartman, After Dinner, Jolley, Kennedy, Kent, Knott, K&C, Marco, Nanyo, Recola, Overshire, Orotone, Reflectone, Remo, Resonophone, Schroth, Seaman, S-C, Songbird, Trinity, Voluma, Moon, Whitney, Yar, Zenith. Pay good prices for nice horns! Ed Bell, 5311 Woodsdale Rd., Raleigh, NC 27606. Fax/phone (919) 851-1517

FOR SALE: Sony color TV's. All need repair. KV7010U, KV1200U, KV1210U, KV1215, KV1510, KV1511, KV1711, KV1722, KV1910D, KV1920, KV1041R, KV2101. Best Offer. Frank Filippelli, 9 Potomac Dr., Basking Ridge, NJ 07920. (908) 580-1293



WANTED: Any and all Fada Catalin radios; especially those sets you're unwilling to sell simply because others desire them, but that have very little if no importance to you from an aesthetic standpoint. Please write or call collect: Rain Buttignol, 214 State St., #7, Portsmouth, NH 03801. (603) 427-1384

FOR SALE: RCA Model 29K chassis, copper, 9-tube, push buttons, Magic Loop ant., escutcheon with glass, good condition, no tubes - \$20. Stewart Humphreys, Brookwood Ct., 600C, Blue Springs, MO 64014. (816) 229-4394

FOR SALE: Radio cookie box, (A.R.C., Sept. 1994, p. 18) - \$20. Atwater Kent Service Manual 1931 - \$75. Steve Lange, 1351 N. 58 St., Milwaukee, WI 53208. (414) 259-1031

FOR SALE: Capehart chassis 108E; AM/FM MPX-8T with diagram; Zenith Royal 640 portable, fine condition; Weston DC Wheatstone Bridge Model 61-Type 2. John Mednansky, 2437 Ed St., Bisbee, AZ 85603. (602) 432-3036

WANTED: Crank phonographs, parts, horns, junk machines and any related items. Any condition. Thank you. Dave Faehrich, 8215 Stone Rd., Independence, OH 44131. (216) 447-0837

WANTED: Complete sets of the following Citizen's Band Radio magazines: CB, S9, CB Horizons, CB Radio Journal, CB World, CB Yearbook, CB Life, Channel 23, CB Radio Digest, CB Guide, CB Times, 10-4, CB News, National CB News, CB Digest, CB Press, and the ACBA Journal. Although I am in search of complete sets in good or better condition, I will consider purchase of partial collections. Please submit what you have with price, shipping included. Harry Schools, 1606 South Newkirk St., Philadelphia, PA 19145

FOR SALE: Remote control for Philco 39-116 - \$30. Delco table, Model R-1231A, ribbon grille, brown Bakelite, looks & works good - \$50. Cabin cruiser, w/stand, works - \$50. Plus shipping. Raymond Humphreys, 1044 N. Jackson St., Macon, MO 63552. (816) 385-2821

FOR SALE: 1937 LaSalle car radio. Part of dial glass missing, otherwise OK - BO. Kenneth Miller, 10027 Calvin St., Pittsburgh, PA 15235. (412) 242-4701

WANTED: Tube-type amps, preamps, tuners, any condition. **FOR SALE/TRADE:** Newark 1938 Ham catalog, Allied catalog, 1949. Rick Graves, 4500 Ninth Ave. NE, #325, Seattle, WA 98105-4762. (206) 632-9929, fax: (206) 633-6038

HELP: Looking for phono plug, RCA UD-824. (Radio Enters Home, p. 54). David Habermehl, 516 W. Randle, Lebanon, IL 62254. (618) 537-6785, eves.

FOR SALE: Fischer 3593 tube with base. Radio Rentals Model 210 table radio. Bert Reeves, Rt. 1, Box 125X, Telephone, TX 75488. (903) 664-2134. Fax (903) 664-3306

FOR SALE: LSASE for list of new/used receiving tubes; octal, loctal, miniature, some older. Sell or trade for old or unusual tubes or related material for my collection. John H. Walker, Jr., 16112 W. 125th St., Olathe, KS 66062. (913) 782-6455

WANTED: Knobs and dial for Admiral 11S and dial for Earl 24 or 31 or 32. Thanks. Henry Riley, 3321 N. W. 30th Ave., Gainesville, FL 32605. (904) 371-9070

WANTED: Portable suitcase record players, tube limiters, amplifiers, microphones, records. **FOR SALE:** Bluebird, mint - \$2,750. Kim Gutzke, 7134 15th Ave., S. Minneapolis, MN 55423. (612) 869-4963

FOR SALE: Atlas NU/6 - \$50. Atwater Kent 40 and E3 speaker - \$85. AK-F4A speaker - \$60. Airline 62-230 battery table - \$75. Clapp-Eastham AA3007 4-tube - \$150. Hallicrafters S-38B - \$75. National NC-33 - \$75. Philco 41-231 - \$80. Magnavox horn Model M-1 - \$100. RCA R7 tombstone, exc - \$160. RCA T-63, exc - \$120. Silvertone 6023 w/tuning eye - \$100. Stromberg-Carlson 112021 - \$75. Truetone D-724 - \$75. Zenith 6S627 table and 7S529 table - \$80 ea. Rider manuals 6-14 - \$20 ea. Eico 147A signal tracer - \$25. PACOC-20 cap. bridge - \$25. Simpson 383A capachometer - \$25.

WANTED: Scott 16 tuning pointer (large), dial for Truetone D-690 console or copy, escutcheon for Silvertone 6437A console, speaker for Scott Phantom. Ray Lamont, 70 Litchfield Rd., Unionville, CT 06085. (203) 675-6327

FOR SALE: Hallicrafters S-20R, SX-16, RCA 54B2, old microphones (Turner, Shure, etc.), Cisco 9A5, Mantola R-7543 early pocket TV tubes, C-299, UV-201A (CE-CO tube boxes), WE 354A, etc. RCA tube manual RC-11 (1933). G.E. Perkins, RFD #2, Box 34, Milo, ME 04463. (207) 943-5204

WANTED: Lafayette Radio Catalogs 56-64. AM/FM stereo tuners and a Bulova 120 radio, must work and be in good cond. Sal Loiacano, 1310 Randy Rd., Ashland City, TN 37015. (615) 746-2658

WANTED: McIntosh MC60's, trade working AK 4700 (10-C) for pair or pay cash. Thanks. Mike Fletcher, 1204 Cedar St., Niles, MI 49120. (616) 684-2174

FOR SALE: J.D.'s Radiowear breadboard and cathedral stationary, pkg. 12 - \$4.50. Radio collector caps - \$7.50. Cathedral mugs - \$7.50. Deco, breadboard and cathedral T-shirts - \$13.95. Sweatshirts - \$19.95. Cathedral jackets - \$28.95, add \$1 XXL. All prices ppd, all XXL add \$1. J.D.'s Radiowear, 1161 S.W. Mulvane, Topeka, KS 66604-1456. (913) 232-0128

FOR SALE: Link Radio Corp. Type 230-D2 frequency meter/monitor, mfg. 1945, very good/clean, great collector item with manual - \$49.95 plus shipping. Northwest Electronics, 2509 West 11th, Eugene, OR 97402. (503) 485-3016

FOR SALE: Capacitor steal of a deal. .1uF. @ 250v dip - \$1/4. Another steal deal. .33uF. @ 400v dip - \$1/3. Another steal deal, this item only surplus. .018uF. @ 1,000v, glass sealed & oil filled, axial, jan - \$1/2. This ad only, minimum order \$10 ppd. Checks or cash with order. Wow! Any combination OK. Frontier Electronics, Box 218, Lehr, ND 58460



NEW JERSEY ANTIQUE RADIO CLUB

Presents its HIGHTSTOWN, NEW JERSEY FALL MEET/AUCTION

SATURDAY, NOVEMBER 5, 7 AM - 2 PM

NJARC presents its close-the-season meet, rain-or-shine, at Hightstown, with both indoor and outdoor facilities. For a report on our last Hightstown event, see the July 1994 *A. R. C.*, pp. 25-27.

Auction: The indoor catalog auction at 11 AM will feature members' gear and material from two estates. Material includes broadcast radios, communications and military gear, 1947-49 TV sets, 1800 boxed tubes, restoration parts, crisp '50s Photofacts, and some unusual general literature. It is detailed in a catalog, with advance version available now and final edition to be provided on-site. Material may also be brought in on the day of sale.

Location: The Hightstown Country Club, near Exit 8 of the NJ Turnpike and just off Route 33. From the Turnpike, go east on Rte. 33 about 200 yards (past "Mom's Peppermill" restaurant); continue 1/4 mile to the first jughandle, and come back west. At the first traffic light, bear right onto Monmouth St., then 300 yards to the Country Club on the left. Rates to outdoor sellers: NJARC members, \$12 per table; others, \$15; indoor tables, \$20. Food and beverages available. Mention the "radio meet" for reduced room rates at the Town House Motel on Rte. 33 [800-922-0622, or (609) 448-2400]. There is also a Ramada Inn across the street [(609) 448-7000].

Contacts: Marv Beeferman, 2265 Emerald Park Drive, Forked River, NJ 08731, (609) 693-9430; or Ludweil Sibley, (908) 782-4894. Reservations are needed for indoor and outdoor spaces. For an advance auction catalog, please send a #10 (business-size) SASE.

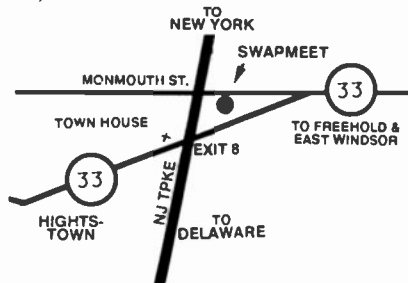

ORDER THESE SELECTED Old Radio Collector Books FROM ANTIQUE RADIO CLASSIFIED!

Every radio collector from the novice to the experienced should have a copy of this book:

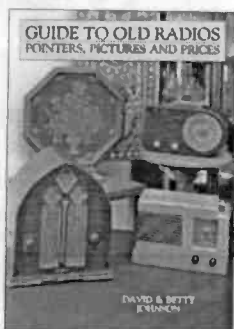

GUIDE TO OLD RADIOS

A primer to collecting. 128 pages, 350 photos and 3300 prices. 7" x 10". Johnson. 1989.

Softcover.....\$16.95

A guide to repairing vacuum tube and transistor sets:



OLD-TIME RADIOS! RESTORATION AND REPAIR

A self-paced training guide. History, theory and practical operation of antique and classic radios. 256 pages, 200 illustrations. 7" x 10". Carr.

Softcover\$16.95

Price guide for over 8,500 battery & AC sets from 1920-1960:

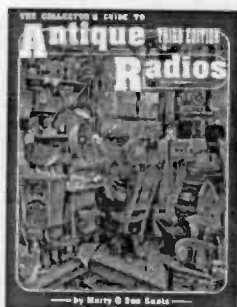

NEW

NEW

THE COLLECTOR'S GUIDE TO ANTIQUe RADIOS - 3RD EDITION

Collectors Marty & Sue Bunis have consolidated data from auctions, ads, flea markets, etc. in this beautifully illustrated price guide. Over 650 new color photos. 8 1/2" x 11". Bunis. Softcover.....\$18.95

A book to help every collector get those old battery and AC sets playing again:

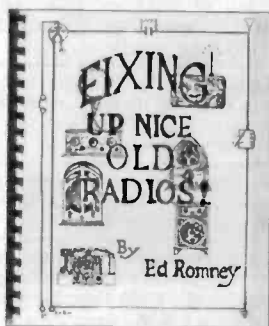

FIXING UP NICE OLD RADIOS

Written by an old radio instructor. 185 pages, 300+ figures. 8 1/2" x 11", plastic binding. Romney. Softcover\$19.00

U.S. Orders - Enclose \$2.50 per order for packing & book-rate shipping if total order is under \$35.00. If using VISA or MasterCard, include name on card, card number and expiration date. Send payment with order. Mass. residents please add 5% sales tax. Money back return policy. Most orders shipped the same day received, but allow 2-4 weeks to receive order. Foreign orders - write for shipping costs, or use credit card and specify air or surface (allow 2-3 months for surface shipping).



**Send Order To: A.R.C., P.O. Box 2, Carlisle, MA 01741
or Call: (508) 371-0512**

Fax: (508) 371-7129



ORDER THESE SELECTED Old Radio Collector Books FROM ANTIQUE RADIO CLASSIFIED!

This book is a must for anyone collecting radios and crystal sets from the 1920s:

This book is a must for anyone collecting radios from the 1930s to the 1950s:



Available Again!
Radio Horn Speaker Encyclopedia
by F. Paul
\$14.90
Softcover
Order Today!



VINTAGE RADIO. Standard photo reference for radios before 1930. 1000+ pictures. 5" x 8". McMahon. Softcover. Temporarily Out-of-Print ~~\$14.95~~

FLICK OF THE SWITCH. Standard photo reference for 1930s to 1950s radios. 1000+ pictures. 5" x 8". McMahon. Softcover. ...\$11.95

A must for collectors of 1920s battery sets:

For collectors of '30s & '40s plastic and other collectible radios:



RADIO MANUFACTURERS OF THE 1920's. Douglas. 1920s battery sets. Three comprehensive illustrated volumes. 8 1/2" x 11".
Vol 1. A-C Dayton - Ferguson.....(softcover only) \$24.95
Vol 2. Freed-Eisemann - Priess...(Currently Out-of-Print)
Vol 3. RCA - Zenith(\$39.95*) \$29.95
(* Hardcover Price)



RADIOS - THE GOLDEN AGE. Collins. Full-color book on the stunning Catalin & Bakelite radios from the late '30s to the early '40s. ..(\$29.95*) \$17.95
RADIOS REDUX. Collins. Showcases the sleek lines & luscious colors of over 80 sets from Collins' collection.(\$29.95*) \$17.95
(* Hardcover Prices)

U.S. Orders - Enclose \$2.50 per order for packing & book-rate shipping if total order is under \$35.00. If using VISA or MasterCard, include name on card, card number and expiration date. Send payment with order. Mass. residents please add 5% sales tax. Money back return policy. Most orders shipped the same day received, but allow 2-4 weeks to receive order. Foreign orders - write for shipping costs, or use credit card and specify air or surface (allow 2-3 months for surface shipping).



Send Order To: A.R.C., P.O. Box 2, Carlisle, MA 01741
or Call: (508) 371-0512

Fax: (508) 371-7129



FOR SALE: Hallicrafters Model S-95, civic patrol VHF receiver, very clean/serviced our shop - \$69.95 plus ship. Northwest Electronics, 2509 West 11th, Eugene, OR 97402. (503) 485-3016

FOR SALE/TRADE: Is anyone interested in a Conertone 20/20 Model TWR-2 professional tape recorder and Components professional turntable Model PBT? Both from mid-50's, complete, but not working. Make offer. James Mason, 90 N.W. 150th Ave., Beaverton, OR 97006. (503) 644-2343

WANTED: Subminiature and hybrid portable radios, like Koyo; Excel DR-451; Private-ear; Emerson 747, 838, 839; Silvertone 4212; Motorola Pixie; Tom Thumb 528, 600; Crosley book type. Takashi Doi, 1-21-4, Minamidai, Seyaku, Yokohama, Japan

FOR SALE: AK Part 3676 detector and amp, N.I.B., choice - \$375 plus shipping. Ed Bell, 5311 Woodside Rd., Raleigh, NC 27606. Fax/phone: (919) 851-1517

FOR SALE: Telefunken reel-to-reel tape deck, works good - \$65. **WANTED:** Zenith Trans-Oceanics 7000, American parts set or otherwise. Jim Montague, 1907 S. Stanley Ln., Spokane, WA 99212. (509) 535-9576

WANTED: Victor Orthophonic reproducers, any condition, even cracked or broken. Thanks. Alan Ford, 1238 Academy St., Scranton, PA 18504. (717) 347-4218

WANTED: Grunow 750 tombstone and other radios with a globe in a round dial. Bruce W. Eddy, 2521 W. Needmore Hwy., Charlotte, MI 48813. (517) 543-3021

FOR SALE: Ham items, parts, textbooks, radio, physics, art books, test equipment, more - SASE lists. Bill Tucker, W4FXE, 1965 S. Ocean Dr., Apt. 15-G, Hallandale, FL 33009. (305) 456-1349

FOR SALE: Bendix military transmitter BC 640B in 6 ft. rack - \$120. John Martin, 111 Bancroft, Rochester, NY 14616. (716) 663-4182

FOR SALE: Original Rider Radio indexes - \$5 and up. Sams Dial Cord Stringing Guides #1, #2 - \$15 ea. RCA Tube Manual #RC-30 - \$20. Aligning Philco Receivers by Rider - \$20. Sams Tube Substitution Handbook - \$4. Radio Masters Books, 1961, 1963 - \$15 ea. Rick Yerke, PO Box 392, Moscow, PA 18444. (717) 842-4857

SERVICES: Rider's schematics: Fax \$3 first page, 75¢ each additional. Mail \$2 first page, 50¢ each additional. Call 10-3 PDT Monday thru Saturday. We bill you. Antique Radio Store, 8376 LaMesa Blvd., LaMesa, CA 91941. (619) 668-5653

**HAVE YOU MOVED? ARE YOU MOVING?
PLEASE NOTIFY US A.S.A.P.
SEND US YOUR...
OLD ADDRESS
NEW ADDRESS and
SUB #
MANY THANKS!!!!**

WANTED: Sams TSMS numbers 21 & 22. Karl Ayer N9PXE, PO Box 665, Thiensville, WI 53092. (414) 242-0571

WANTED: Hallicrafters S-35 panadaptor, any condition including junker. Also manual, schematic, or any data. John A. Benyo, 25 Schley St., Garfield, NJ 07026

FOR SALE: Crystal radio kits, complete with face panel and base board, 365 variable capacitor, large prewound coils, and many other parts for an old style crystal radio - Remit \$19.50 plus \$3 shipping. Carl & Grace Ent., 5636 Romeyn, Detroit, MI 48209

FOR SALE: Fada 740, brown - \$75. Fada 855, maroon - \$70. Hallicrafters S-38 - \$45. Jack Bailiff, 3310 S. Elm-Eugene St., Greensboro, NC 27406. (910) 273-0011

WANTED: Standard Radio Model SR-G45 micro, in vg or better condition. Karl Ayer, N9PXE, PO Box 665, Thiensville, WI 53092. (414) 242-0571

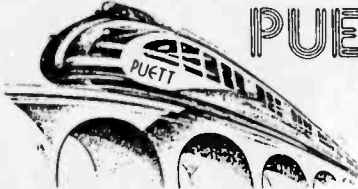

PUETT ELECTRONICS

P.O. BOX 28572 DALLAS TX 75228



NEW CATALOG 77

CATALOG 77/PLL-2 (56-PAGES) ----- \$5.00 POSTPAID

YOU RECEIVE A \$6.00 DISCOUNT COUPON WITH THIS CATALOG!

MORE THAN 1,500 DIFFERENT ANTIQUE RADIO PUBLICATIONS FROM 1902 TO THE 1960'S OFFERED, REPRINTED BOTH SIDES OF THE PAGE AND BOUND!

WE OFFER BOOKS, INSTRUMENT MANUALS, SERVICE DATA, SALES BROCHURES, ATWATER KENT, RCA, CROSLLEY, ZENITH, ETC. FACTORY SERVICE MANUALS, SCOTT, MC MURDO SILVER, STROMBERG CARLSON, CAPEHART, FISHER CLASSIC RADIO LITERATURE, DIRECTORY OF ANTIQUE RADIO SERVICES, SCHEMATIC DIAGRAMS, OLD TIME RADIO PROGRAMS ON CASSETTES, TUBES, TUNING DIALS, KNOBS, 30-SERVICES & DISCOUNTS WITH THE PUETT ELECTRONICS ANTIQUE RADIO CLUB AND MUCH MORE - ORDER YOUR CATALOG TODAY!

OUR NEW BOOK "THE WORLDS LARGEST RADIOS" IS NOW AVAILABLE, PHOTOS, SCHEMATICS, BY J.W.F. PUETT - \$14.95 PLUS \$2.00 HANDLING. INCLUDES SCOTT, MC MURDO SILVER, PHILCO, RCA, ZENITH, LINCOLN, FREED EISEMANN, FISHER, MEISSNER, MAGNAVOX, CROSLLEY + MANY MORE!

New Price Guide - Order Today!
*The Collector's Guide To
Antique Radios - 3rd Edition*

By Marty & Sue Bunis

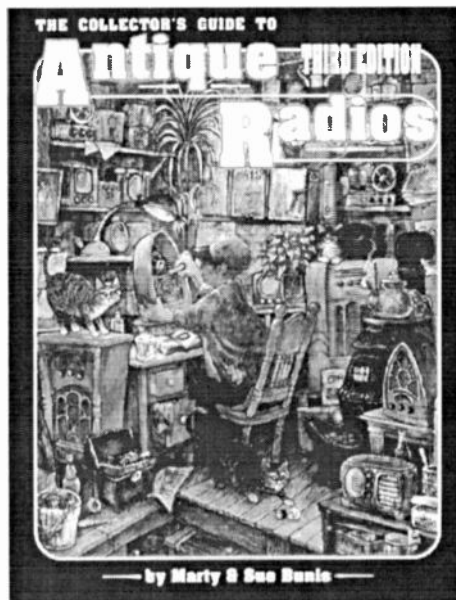

**In
Stock !!**

**Shipping
Now !!**

8,500+ Battery & AC sets from the '20s - '60s
Expanded listing of radios from the '60s
Over 650 all new color photographs
Updated prices

\$18.95 - Softcover

2nd Edition also available for \$17.95

There are no transistor radios listed in the third edition. You will find them in
The Collector's Guide to Transistor Radios available from A.R.C. for \$15.95.

U.S. Orders - Enclose \$2.50 per order for packing & book-rate shipping if total order is under \$35.00. If using VISA or MasterCard, include name on card, card number and expiration date. Send payment with order. Mass. residents please add 5% sales tax. Money back return policy. Most orders shipped the same day received, but allow 2-4 weeks to receive order. Foreign orders - write for shipping costs, or use credit card and specify air or surface (allow 2-3 months for surface shipping).



Send Order To: A.R.C., P.O. Box 2, Carlisle, MA 01741
or Call: (508) 371-0512 **Fax: (508) 371-7129**



FOR SALE: Philco 44 cathedral, excellent. Zenith 7S634R (Bunis 2, p. 205). Philco 41-90 Bakelite farm set. Zenith 8S463 console. Raytheon 1940's broadcast audio console. Parting out Zenith 3000-1 Trans-Oceanic. Charles Harper, 2000 Jackstown Rd., Paris, KY 40361. (502) 769-0404, 6:30 pm-10:30 pm Eastern

FOR SALE: Over (300) Sams Photofacts from 144 to 1550 - 50¢ ea. or 60 for \$20. Also AR's CB's TR's - \$1 ea. LSASE for list. Electronic Technician Circuit Digest, schematics 1 thru 1281 - \$10. James Homan, 401 Valley Dr., Valley Springs, SD 57068. (605) 757-6424

WANTED: Microphones. Pre-1975. Working or not. Also looking for microphone catalogues with pictures. Starting collection. David Avrin, PO Box 24886, Denver, CO 80224. (303) 755-4499

WANTED: Stephens Tru Sonic tweeter driver, either 1" or 1 1/4" ID. 1934/35 RCA escutcheon, knobs, chassis for Model 128 (224 & 226 similar). Has 5 knobs, 6 tubes, 3 bands, airplane dial. Information on electrodynamic Lumiere pleated diaphragm speaker, probably Victor. Peerless Altec power transformer #6288. Chris Galantine, 15853 Ontario Pl., Redding, CA 96001-9785

FOR SALE: Tektronix O-scopes, 15 MHz dual beam portable - \$225. 50 MHz, storage Mod 5441, extra plug ins - \$350. Steve Aiken, 364 Juniper Hill Rd., Albuquerque, NM 87122. (505) 856-6787. Fax (505) 856-6849

FOR SALE: Crosley 725, works, needs refinish - \$90. Delco 1106, works, painted - \$100. Majestic 50, works, missing lower trim - \$150. Michigan MRC-12, NT, refinished - \$250. Radiola 20 chassis, NT - \$90. Radiola Sr. & AC amp., Dud WD-11's - \$375. Western Electric 7A, NT - \$150. 4,000 N.I.B. tubes from 1950's to 1970's. All plus shipping. **WANTED:** Magnavox AC-3 cabinet, Echophone/meteor cabinet, Crosley VIII RF coil and filament rheostat, DeForest Audion detector rheostat. Don Sturzenbecher, Rt. 3, Box 28, Sioux Falls, SD 57106. (605) 368-2135

WANTED: Collector's Guide to Antique Radios, Bunis, first edition, and Blast From The Past. Jack Haslup, PO Box 1963, Cave Creek, AZ 85331. (602) 502-5791

WANTED: Working chassis Philco 39-7. Cabinet unimportant. Neil Loewe, PO Box 492, Arlington Heights, IL 60004. (708) 398-5393

FOR SALE: S.C. 250L, 60; Motorola Pixie with red cabinet; Philco 43; Empire cathedral; other sets, inquire. **WANTED:** AK advertising pieces: cards, key, matches, lamps, dealer bulletins, posters, etc. Larry Chestnut, 8 Heather Rd., Ellington, CT 06029. (203) 872-2424, eves.

FOR SALE: Radios, ready to display: Olympic LP213 - \$60. Zenith H616ZW - \$40. Air King 511-110 - \$45. GE 114 - \$55. CBS Columbia 5155 - \$40. Motorola 60X1 - \$90. Philco 52-942 - \$50. Raytheon C51W - \$40. Zenith K510 - \$40. Airline 84BR1517A - \$55. Philco 50-925 - \$35. Stromberg-Carlson 1204? - \$50. Zenith 6S511 - \$55. GE 50? - \$35. RCA 9X561 - \$45. Other misc. items: Zenith Trans-Oceanic A600, fair cond. - \$40; 7600 parts set - \$22. Zenith Royal 755G - \$30. Royal 760 Navigator - \$45. Radio Shack, unbuild kit 8 transistor radio - \$30. "Transformers" novelty transistor, exc in box - \$20. Emerson Big Miracle grille, brown - \$25. Home-brew battery set - \$50. Operadio, automobile radio - \$25. Philco 38-10 - \$125. Crosley Super Trirdyn - \$50. Gosnet G28 - \$50. Speakers: Goodman Axiom 350 - \$60. EV Sp12 - \$40. All must be sold. Offers considered on any item left after 10/20. All prices + S&H. 5-day approval on all items. John E. Kendall, PO Box 436, Fallston, MD 21047. (410) 483-3884, 10 am-9 pm Eastern. Fax (410) 877-1697, anytime

WANTED: Canadian help. Looking for Sparton 5028 knobs. Celluloid w/streaks. Mark Melcher, 10013 Folsom Blvd.-B, Sacramento, CA 95827. (916) 363-0102

WANTED: Arvin portable #9574P, white. Also would like a Philco transistor T-70 red, and a Zenith Royal 200. Jim Martes, 15400 E. 2nd St. S, Independence, MO 64050. (816) 836-0668

FOR SALE: Fada Model 711. **WANTED:** Chassis for a Grunow 470, and RCA R71. Bill McChesney, 10313 St. Andrews Dr., Oakdale, CA 95361. (209) 848-1197

FOR SALE/TRADE: RCA Model 816K complete chassis with tubes and control panel. Needs cabinet. Robert Haynes, 2205 Cedar Cove Ct., Reston, VA 22091. (703) 860-5393

WANTED: Knobs for Arvin 440T, both tune and volume. Arvin 442, 444, or RE200 volume knob and foil dial face. (Bunis 1, p. 27). Jeff Hoskins, 824 East Madison Ave., Stuart, FL 34996. (407) 283-2291, after 8 pm

Bellingham Antique Radio Museum

The museum wishes to obtain more examples of pre-1927 radios.

We will pay top dollar for single pieces or entire collections.

We have some duplicate material for trade.

Please call Jonathan Winter:
(206) 734-4168

or write to us at:
1421 Saint Paul Street
Bellingham, WA 98226

TRANSISTOR NETWORK

More and more radio people are discovering the excitement of novelty and regular transistor collecting. Why not join the fun? Now is the time to subscribe to the Transistor Network—a monthly transistor newsletter featuring transistor related articles and classified ads. Only \$17.00 for a one year subscription (12 issues) US, \$20.00 Canada, \$30.00 Foreign Air, \$22.00 Foreign Surface. US funds only. Not sure? Send \$1 (refundable toward a subscription) for a sample copy and find out what you've been missing! Transistor Network, RR 1, Box 36, Bradford, NH 03221.

FOR SALE: RCA 50 S/T tube (no box), tests good - \$50. **WANTED:** In-circuit capacitor tester. Bill Jewell, 6828 Trinity Landing N, Ft. Worth, TX 76132. (817) 294-9061

FOR SALE: Hallicrafters Model S-108, very clean and works good - \$100. Emerson Model 108, small wood semi-cathedral, has been pro refinished and electronics restored; it's a beauty - \$90. I still have collectors books, all kinds, electronics of the 30s-40s. Photos of radios - \$2. SASE for list. Send to Chuck's Antiques, PO Box 598, New Haven, WV 25265. (304) 882-2220

WANTED: Transformers, Fred, Thordarson, Triad, Merit. Send for my want list. Stenc Cranshaw, 1624 Bitter Creek, Garland, TX 75040. (214) 494-4917

WANTED: Phillips/Magnavox Model D2999 in vg or better condition. Karl Ayer, N9PXE, PO Box 665, Thiensville, WI 53092. (414) 242-0571

FOR SALE: Transistor RCA Victor, mint. GE vest pocket, mint in display case w/warranty card, head-phone - Offers invited. Ragnar Otterstad, Høsterkobvej 10, DK-3460 Birkerød, Denmark. Fax 011-45-4468-1514

FOR SALE: Radios, books, magazines, 4-page list. LSASE. **WANTED:** 1, 2 gang variable capacitors. Dave Dameron, KG6BP, 819 Boundary Pl., Manhattan Beach, CA 90266-6621. (310) 318-5311

WANTED: Components of SCR-506-A consisting of transmitter BC-653, receiver BC-652, Shockmount FT-253-A, Dynamotor DM-43-A and Spares Chest CH-263. Steve Finelli, N3NNG, 37 Stonecroft Dr., Easton, PA 18045. (610) 252-8211

FOR SALE: Regency HR2-A 2M transceiver - \$55. Heath lab scope - \$65. Heath signal generator - \$35. 100X 2N2222A transistors - \$7.50. Teletype motor, N.I.B. - \$35. Emerson 888 - \$35. Ernie Oderal, 2710 Lee St., Greenville, TX 75401. (903) 455-2113 or 5788

FOR SALE: Capacitors 30 mFd. 150v, small radial, short leads - \$6/10 prepaid in U.S.A. Evan Powell, 4717 Conquista, Lakewood, CA 90713. (310) 429-3793

FOR SALE: B&K Model 850 color generator & analyst, just serviced/clean unit with manual - \$49.95 plus shipping. Northwest Electronics, 25C9 West 11th, Eugene, OR 97402. (503) 485-3016

WANTED: Dial glass for Zenith 6-D-525. Grid leak resistor for AK 20C. Thanks. Bret F. Johnson, 13495 102nd Ter. N., Largo, FL 34644. (813) 595-9287

MESSAGE: DVHRC Swapmeet Nvember 13, Tyro Grange Hall, Buckingham, PA. Last event in Philly area before Christmas. Vendors call or write: Mike Koste, 57 Tennis Ave. Ambler, PA 19002. (215) 646-6488

FOR SALE: Mint copy Greenwood Wireless and Radio 1905-1928 by Floyd Clymer. ICS Radio Operator's Handbook, first edition, 1924, The Principles Underlying Radio Communications, Signal Corps U.S. Army, second edition 1921. (Last two hardback, condition good) - Bes: Offer plus shipping. Wes Chatellier, 1950 Chevelle Dr., Baton Rouge, LA 70806

FOR SALE: RCA 119 - \$60. Crosley 515 - \$80. Philco 40-140 - \$75. Teletone 117 - \$50. James Caudle, 50 Rangeview Acres, Candler, NC 28715. (704) 667-9717

WANTED: Hughes Tonotron storage picture tube and/or any information thereabout. B. Istria, 175 East 96th St., #7K, New York, NY 10128. (212) 427-4796

WANTED: Radiola III/IIIA, Crosleys 50-52, cathedrals low priced, horn speakers. 1960's-70's Heathkit table mic. IC Mostek 3872 for a Regency scanner. **FOR SALE/TRADE:** 1930's large case radios: AEG - \$150. Telefunken, Blaupunkt, Lorenz, Kō-ting - \$175 ea. Philips portable - \$70. 1940's Tesla's Bakelite - \$50. Tesla wooden case pick-up - \$60. Argiros L. Adamidis, 19 Kampouridi St., Panorama, Thessaloniki, Greece 552 36. (031) 342405

USED TUBES WANTED

We need the following tubes to replenish our stock (first digit on 3 digit types is optional). You may ship your tubes to us by UPS or Parcel Post. We'll mail our check upon receipt and testing of tubes. We pay prices shown plus shipping charges. We buy all types of receiving and transmitting tubes. Send us your list for our bid

USED GLOBE OR BALLOON SHAPE TUBES - ALL MUST TEST GOOD

TYPE	PRICE	TYPE	PRICE	TYPE	PRICE	TYPE	PRICE
WD-11*	\$ 35.00	UV-199	\$ 14.00	227	\$ 2.00	248	\$ 10.00
WD-12*	20.00	UX-199	12.00	230	5.50	247	7.50
42	7.50	UV-201A	6.50	231	5.00	250	45.00
112A	8.50	UX-201A	6.50	233	5.00	256	6.50
171/A	8.00	210	14.00	237	8.50	280	8.50
182B	7.50	211(VT-4C)*	12.50	240	8.50	281	8.00
183/483	9.00	226	4.00	245	17.50	282	8.00

* TUBULAR

USED ST SHAPE TUBES NEEDED

TYPE	PRICE	TYPE	PRICE	TYPE	PRICE	TYPE	PRICE
01A	\$ 5.00	6B4G	\$ 6.00	6L8G	\$ 4.00	45	\$ 9.00
2A3	10.00	6F5G	2.50	10	5.50	50	35.00
5AR4/GZ34	3.50	6K5G	2.00	12A	7.00	5932	4.00
6A5G	9.00	6L6(Metal)	2.00	40	4.00		

ALSO SEE OUR AD FOR NEW TUBES WANTED

ANTIQUE ELECTRONIC SUPPLY LIMITED PARTNERSHIP

6221 S MAPLE AVE., TEMPE, ARIZONA 85283 PHONE (602) 820-5411 FAX (800) 706-8789

FOR SALE: Setchell Carlson 427 frog eyes, Truetone Boomerang, Crosley Musical Chef, Motorola 53-H, Zenith Crest, Silvertone 8000, Freshman Masterpiece, original Catalin knobs for L-56, Fada 1000, also about (10) Catalins, bullets, L-56, cloud, Bendix, etc. Ted Chronister, 7073 Carlisle Pike, #26, Carlisle, PA 17013. (717) 766-6436, after 9 pm EST

FOR SALE: All in exc cond. Emerson BT 245, dark red w/white trim - \$3,700. Air King Skyscraper, white w/ large AK knob and clock insert with paper - \$3,600. Sparton #409 mirrored glass radio - \$2,000. Fada 652, yellow with insert grille - \$725. Anthony Scarfoglio, 13 Fourth St., Brooklyn, NY 11231. (718) 858-1231

WANTED: Your collection. If you have a quality collection, mainly pre-1926, it will pay you to contact me. Large or small. Ed Bell, 5311 Wooddale Rd., Raleigh, NC 27606. Fax/phone: (919) 851-1517

WANTED: Square, white marbled knob for Detrola 134. RCA 9SX Little Nipper. Zenith 1203 chassis. Zenith cabinets for 5R317, 6D317, 705, 707, 711. **FOR SALE:** Over 200 radios, TVs, test equipment, next list November. SASE. Dennis Smith, KN8H, Box 113, Trenton, MI 48183

FOR SALE: Hallicrafters 120, works good - \$60. Trans-Oceanic chassis for 500, sell or trade for 600. Trans-Oceanic Y600, working - \$55. Jim Montague, 1907 S. Stanley Ln., Spokane, WA 99212. (509) 535-9576

FOR SALE: Sencore tube tester CG135; RCA WR-99A generator - \$25. Superior TV-50A generator - \$20. Heathkit HO16 code oscillator - \$15; and S4A generator - \$20. Lafayette police monitor, 1972 PF200 - \$30. Copies RCA sound products catalogs 1948, 83 pp. - \$20. New and used tubes: 6JE6, 6JM6, GKD6, GLB6, 6LF6, 6LU8. Set of 12BE6, 12BA6, 12AV6, 50C5, 35W4 - \$7, tested. Used #45 - \$12; #80, 26, 24A - \$4. Kevin L. Moe, 616 Lockrem, Ottawa, IL 61350. (815) 433-4598, evenings



WANTED: Air King radios. Help me to construct a modern day (plastic) temple of the Pharaohs. Please write or call collect: Rain Buttignol, 214 State St., #7, Portsmouth, NH 03801. (603) 427-1384

FOR SALE: GE 7-2506B and P1791E AM/FM transistor radios, complete, working, together - \$15 postpaid. Ken Greenberg, 4858 Lee, Skokie, IL 60077. (708) 679-8641

WANTED: Philco PT-87, 48-360, 49-607. RCA BX-57, Minerva W117. Ichiro Yamada, 10-21 Chiyodai-cho, Kawachi Nagano-shi, Osaka, Japan 586. Phone/fax: 011-81-721-52-4695, eve./mid., local

WANTED: Portable radio/phono from the early 40's in presentable condition. Ed Sage, PO Box 13025, Albuquerque, NM 87192. (505) 298-0840

FOR SALE/TRADE: Large Pepsi bottle radio - \$375. Stewart-Warner neon clock - \$385. Farnsworth ET064 - \$70. Philco 40-150 - \$40. **WANTED:** Ornate or miniature cathedrals, Philco 90 cathedral cabinet. Mark Delauter, 6253 S.H. 120, Metamora, OH 43540. (419) 923-7737

FOR SALE: General Radio VC-10 enclosed ten amp Variac with calibrated dial, new - \$75. Heath 10-4541 scope, assembled but never used, cost \$229 - \$97. Glen Richie, W4JGO, 643 Diamond Rd., Salem, VA 24153. (703) 389-3356



WANTED: Top \$\$ Dick Tracy radio in box. King Harrison, 4755 Walton Creek Rd., Indian Hill, OH 45243. (513) 977-3153, anytime

FOR SALE: B&K 607 tube tester & books - \$25. B&K HV-32 high voltage probe - \$10. RF signal generators; B&K Precision E-200D - \$50. Japan Radio Co. #5025A - \$35. Eico #324 - \$15. All + UPS. **WANTED:** RCA Radiomarine AR-8516. Dan Mason, R.Rt. 1, Box 204F, Santa Fe, NM 87501. (505) 455-3416

FOR SALE: Guild spice chest radio 484 - \$50. RCA Victor 96T5 - \$40. Tucker radio box - Offers. RCA Victor wood portable - \$35. (4) organ amps - \$25 ea. **WANTED:** HP 35/45/97, Valspar transistor radio, Marantz tube. Bill Dahlgren, 3095 Evelyn St., Roseville, MN 55113. (612) 639-0331

WANTED: Speaker for Zenith 6V27, power transformer for Grunow 471 or chassis 4C for same, anything Wengel Radio. Larry Schiebel, 818 W. Lakeside St., Madison, WI 53715. (608) 255-0459

FOR SALE: Silvertone 6050, not working - \$30. Windsor AM/FM transistor replica cathedral - \$20. Motorola 56R, light aqua green cabinet, vg + not working - \$45. All plus UPS shipping. James M. Seal, 3309 Boatman's Mountain Rd., Morristown, TN 37814. (615) 581-8269

WANTED: Loose-couplers or slide tuner crystal sets; spark transmitters and related parts; tube/hybrid pocket/portable radios; early demo. motors; anything Edison, S.S. Titanic, German airships related. Takashi Doi, 1-21-4, Minamidai, Seyaku, Yokohama, Japan

FOR SALE: 1954 Emerson TV Model 571 Series B, 1954 table set. Wood cabinet in good shape. In storage for 20 years, untested - \$100. Electro-Voice shotgun mic with boom hanger, Model 642 Cardiline includes aluminum shipping case - \$125. Sherwood Model S3000 III vacuum tube stereo FM tuner, mint, copper chassis - \$85. Ampex amplifier loudspeaker, 1962 "suitcase" Model 2012, N.O.S. has pair 6V6 output, work fine - \$95 ea. Webster-Chicago wire recorder Model 180-1, complete with mic and spools, working - \$60. Genuine vintage white frame Electro-Voice 12" SRO speakers, 8 ohms, mint - \$225/pair. Mating Lab Crossovers Model 604/5, mint - \$250/pair. Rick Perrotta, 408 N. Sycamore Ave., Los Angeles, CA 90036. (213) 965-1386, eves.

FOR SALE: B&K Model 650 tube and transistor tester, excellent condition with manuals - \$50, you ship. John Snow, 4539 N. Bartlett Ave., Shorewood, W 53211. (414) 964-0194

WANTED: Power supply and amp by Radio Receptor Co. uses 80 rectifier and 210 amp. Used to electrify receivers like AK 35, Radiola 20. Tad Drogoski, 507 Coal Valley Rd., Jefferson Boro, PA 15025-3703. (412) 466-5950

FOR TRADE: Mahogany Regency TR-1 for swirled or colorful pre-war Kadette, Detroit, RCA, etc. **FOR SALE/TRADE:** Australian AWA Fisk Radiola 49 (?) tombstone (1940) - \$350. Fada 260 - \$90. Philco 49-607, N.I.B. - \$100. Emerson Aristocrat chassis - \$75. **WANTED:** Roland "Space Echo" for electric guitar; N.I.B. transistors; Fada temple knobs and bezel. David Mednick, 1450 Palisade Ave., Apt. #5-H, Fort Lee, NJ 07024. (201) 461-3082.

FOR SALE/TRADE: Western Electric 7A amp with (3) 216A's, good fil. - \$300. Meteor 3-tube radio 199's through front panel - \$325. Tower speaker on cover of A.R.C., Sept. 1993 - \$200. RCA U7325 horn - \$100. Tower Little Spitfire horn - \$145. Jaynell horn in metal case - \$125. Rare Hallicrafters S-38OE shortwave, blonde cabinet with gold dial, good working condition - \$110. (3) Eria balloon coils in orig. box - \$75. Small Little Wonder outside horn phone 1909 - \$300. Bob Fuschetto, WA2BCR, 1758 Michael Dr., Whitehall, PA 18052. (610) 435-8944, call bet. 7 pm and 9 pm

WANTED: Clapp-Eastham Radak. Especially: R2, HRF, HRD, Blitzen, Z, ZRF, ZRFDA, C63, R3, R23, A23, R43, Gold Seal, RHM. Ed Bell, 5311 Woodsdale Rd., Raleigh, NC 27606. Fax/phone (919) 851-1517

WANTED: Will pay \$100 for Eimac 500T tube. Industrial/special purpose tube manuals or pamphlets. Also any odd or unusual tube types. John H. Walker, Jr., 16112 W. 125th St., Olathe, KS 66062. (913) 782-6455

WANTED: The following National parts: NC-100 power transformer, band indicator and (4) bar knobs w/metal pointers; NC-200 power transformer; NC-66 back and telescoping antenna; NC-60 plastic faceplate; (3) small metal knobs for NC-155; black square s-meter; ID tags for RAO-5 and NC-156-1 lids. Also manuals for NC-100, NC-156-1, and RAO-5. Would consider buying junkers for parts. Also want National MB-29, MB-30 and Velvetone amplifier. Wayne Childress, 1903 Jerome Pl. #3, Helena, MT 59601. (406) 443-7255.

FOR SALE: Zenith tables; AM and record player 5R086; nice K725 - \$40 ea. and shipping. V. Lisaius, 116 Orton Rd, W. Caldwell, NJ 07006. (201) 226-7943

FOR SALE: Complete 1950s radio station! Shure Model 55 microphone, (2) Gates 16" turntables w/Gray arms, MaCarta cartridge recorder/player, MaCarta cartridge player, Gates SA-38 board, Gates Sta-Level compressor, Gates Limiter, General Radio Frequency Monitor, RCA BW-66E modulation monitor, equipment rack, Gates Dynamote remote control, 8" speaker in wood enclosure and RCA 1R1 1000-watt AM transmitter! No acoustic tile or towers included. Most items work well; the rest offered "as-is" or I will rebuild as required. Will sell for best offer received within 60 days after this ad appears. Randy Wells, 286 Almond Way, Healdsburg, CA 95448. (707) 543-0146

FOR SALE: Emerson CG318 Ingraham - \$85. RCA 85T - \$55. RCA 1x1 - \$40. Westinghouse H-500T5A - \$30. Paul Roche, 7368 Eden Brook Dr., #634, Columbia, MD 21046. (410) 381-0471

WANTED: Pre-1926 Amrad sets, parts, literature, 3670 portable and 3366 Reflex. Andrew Mooradian, 5 Priscilla Ln., Winchester, MA 01890

FOR SALE: Original Zenith radio instruction pamphlets, operating guides, call letter tabs - SASE for list. Ellsworth O. Johnson, 364 S. Coeur d'Alene St., Spokane, WA 99204. Phone/fax: (509) 838-2161

Frankenstein's Radio Laboratory

4010 Fairmont Parkway, Suite 285

Pasadena, Texas 77504

(713)998-0130

ELECTROLYTICS, AXIAL LEADS				EACH	20+
2.2uf	450v	Rubycon		\$65	\$60
4uf	150v	(S.O.S.) Sprague		.30	
4.7uf	450v	ICC		.70	.65
10uf	450v	Nicon		1.00	.95
22uf	160v	Rubycon		.75	.70
22uf	450v	Nicon		1.30	1.25
33uf	160v	Rubycon		1.00	1.03
47uf	160v	Nicon		1.30	1.20
47uf	450v	Nicon		2.25	2.00
50uf	150	CDE		1.30	1.15
80uf	450	CW I		2.75	2.50
VALUE	VOLTS	MANUF	LEADS	EACH	20+
.001	600	Sprague 715P	radial	\$42	\$37
.022	600	Sprague 715P	radial	.42	.37
.0047	600	Sprague 715P	radial	.42	.37
.01	600	Sprague 715P	radial	.54	.49
.022	600	Sprague 715P	radial	.65	.60
.022	1.6k	Goodall	axial	.50	
.047	400	CME	axial	.35	.30
.04	600	Sprague 715P	radial	.73	.68
.1	600	Sprague 715P	radial	1.00	.90
.1	630	Nicon	radial	.65	.60
.22	600	Sprague 715P	radial	1.50	1.35
.33	630	Nicon	radial	.75	.70

Shipping to anywhere in the U.S.A. is a flat rate of \$ 4.00
Buying your surplus components, transformers & tubes.

JOIN THE

AWA

**ANTIQUÉ WIRELESS ASSOCIATION
THE ORIGINAL AND LARGEST HISTORICAL RADIO-COLLECTOR GROUP**

- Publishes *Old Timer's Bulletin* with:
 - Battery and AC receiver restoration
 - Vacuum-tube history and collecting
 - Old-time amateur-radio contests
 - Communications receivers
 - Free want-sell-swap ads
 - Early television
 - Horn loudspeakers
 - Reviews of current books
 - Keys and land-line telegraphy
 - News of U. S. and foreign clubs
 - Information on public radio museums.
- Maintains unique radio-TV museum.
- Produces the annual Rochester meet.
- Co-sponsors local meets.
- Publishes the annual AWA Review.



Membership is only \$12.00 per year (\$22.00 for two years). Mail check to:

Antique Wireless Association, Inc.
Box E, Breesport, NY 14816

FOR SALE: Xerox copies of tube test data booklet for TV-7, A, B & D tube testers - \$10 ppd. Elmer Thom, 11717 Kingfisher Ln., Saint Marys, OH 45885-9335. (419) 394-1104

FOR SALE: Accurate Instr. Co. Mod 157 tube tester, no book, untested, looks almost new - \$20. Sony TC-123 open reel mini recorder, maroon & ivory, looks good, works - \$23. Heath CR-1000A car radio, looks good, untested - \$30. Heath HM-10A tunnel dipper - \$30. Narco VHT-3 aircraft radio - \$40. Shipp. extra. Harold Wright, Rt. 1, Box 259, Chancellor, AL 36316. (205) 347-0393

WANTED: Tubes! Western Electric tennis ball, output and rectifier tubes; Arcturus blue audio tubes; Globe audio output tubes: 10 Globe, 50ST large, 250/350 Globe, 183/483, 42 Globe, single plate 2A3, etc. Collector's tubes, other U.S.A. and European audio tubes. Tubes must be clean, no cracked bases or loose glass particles inside. Must test good! Mark Delauter, 6253 S.H. 120, Metamora, OH 43540. (419) 923-7737

FOR SALE: Novelty transistors. More than 30 choice novelties must go! Most at book price or below. Send \$2 for picture list. Eric Wrobbel, 20802 Exhibit Ct., Woodland Hills, CA 91367. (818) 884-2282

FOR SALE: Mylar caps. .0047 uF, 8KVdc - \$2.50. Sound technology 1500A - \$2,000. Karg SCT4 - Offer. V. Vogt, 330 S.W. 43rd St., #247, Renton, WA 98055. (206) 241-0945

WANTED: Catalin knobs singles or sets or any Catalin parts. Buying or trading. Ray Carroll, 158 Oakwood Dr., Wayne, NJ 07470. (201) 696-1149

FOR SALE: Zenith Model 950 Golden Triangle, should have one by the time this ad comes out, call for condition & price. Gary B. Schneider, 9511 Sunrise Blvd., #J-23, North Royalton, OH 44133. (216) 582-3094

RADIO T-SHIRTS

All shirts are extremely unique, silk-screened on 100% cotton. Available in XL only.

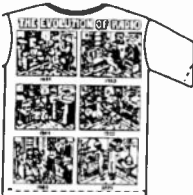

THE EVOLUTION OF RADIO

Six nostalgic illustrations (1924-2024) evolving from the same room. Black on white.

Incredible!

FADA L-56 COLOR CHANGE

Catalin radio actually restores before your eyes to its original color, from body heat or room temperature. Both designs are 4 color, printed on white. Choose from: Maroon/gray changes to red/butterscotch or dark blue/butterscotch changes to ivory/tortoise.



\$19.95 - All prices include shipping
New York State residents include sales tax
Indicate style and quantity

Send check or money order to:
**TARGET DESIGNS - 551 17th Street
West Babylon, NY 11704 - (516) 226-5234**

FOR SALE: Pocket-size transistor radios. Send \$1 for all-new October picture list of collectible early models. Many bargains! Eric Wrobbel, 20802 Exhibit Ct., Woodland Hills, CA 91367. (818) 884-2282

FOR SALE: Used tubes: 5U4GB, 71A, 80 - \$5 ea. 829B, 6146/A - \$10 ea. 6550 - \$20 ea. 826 - \$30 ea. Hank Andreoni, 250-D So. Lyon Ave., Hemet, CA 92543

WANTED: Heathkit speaker Model AS2. Fred Geer, 6042 Brookridge Rd., Jacksonville, FL 32210. (904) 771-7828

WANTED: Gonset G76 & DC supply, 6JB6 tubes, R4C receiver. **FOR SALE:** TR4C transceiver. Stuart Mount, K20A, 35 Grand St., Highland, NY 12528. (914) 691-7957

FOR SALE: Heathkit SQ-1, G1, 64 generators, T3 tracer, AV2 audio voltmeter - \$15 ea. Jim Corliss, 2446 Vista Dr., Upland, CA 91784. (909) 985-9967

FOR SALE: Freshman Masterpiece large console, 3-door, Model 6-F-1, 1926, battery, untried, pickup only - \$50. Raymond Humphreys, 1044 N. Jackson St., Macon, MO 63552. (816) 385-2821

WANTED: Garrard RC-60 78 rpm record changer for a Scott 800B radio-phonograph combination. Gregg Humeric, 540 Wicklow Ln., Monroe, OH 45050. (513) 539-8926

WANTED: 1939 General Electric streamlined brown Bakelite phono attachment for table model. Tonearm and base are very streamlined. Also seek 1938 GE H500U and other machine age units. William Doggett, PO Box 931414, Los Angeles, CA 90093

FOR SALE: (49) radios (1924-1960), (500) mags. (1937-1962), (350) tubes, catalogs, service manuals, etc. Send LSASE for extensive list. Steve Blank, 407 Hamilton Ave., Linwood, NJ 08221. (609) 926-9277

Wanted!



1953
Motorola
52B1U & 42B1



Any Zenith
Royal 500's

*I am looking for all models,
in all colors, in very good or
better condition.*

Dan Danchuk
3201 S. Standard, Santa Ana, CA 92705
or Call Tricia: (714) 540-4363

FOR SALE: The Regency TR-1 Family new booklet. Lots of information and pictures - \$10 includes postage. Eric Wrobbel, 20802 Exhibit Ct., Woodland Hills, CA 91367. (818) 884-2282

FOR SALE: RCA Radiola Super-Heterodyne AR 812. Complete, except for handle & tubes - \$95 or offer. Randy Wells, 286 Almond Way, Healdsburg, CA 95448. (707) 543-0146

WANTED: Calibration instructions for a Precise Electronics Model 111 or 111A tube tester. Harry Alenik, 14003 Judah Ave., Hawthorne, CA 90250. (310) 643-8100

FOR SALE: Radiola 18 in beautiful floor cabinet, similar to Feb. 93 A.R.C. p. 15, has sliding doors over speaker. Also nice AK Mod 60 console. Bill Gebhardt, PO Box E, Liverpool, PA 17045. (717) 444-3403

FOR SALE: Harvey HT 80 transmitter with plug-in coils and crystals and catalogue - \$70. Ameco TX62 transmitter 6 + 2 meter - \$40. Heathkit HW 101 SSB transceiver with HP 23A power supply and Electro-Voice 423A microphone and book - \$90. BLH Precision calibrator Model # 625 - \$25. Johnson-Viking phone patch - \$15. Drake TV1000 low pass filter - \$10. HW 30 2-meter transceiver - \$20. All equipment as is, nothing has been tested. Price is plus UPS shipping. C-2-C, 77 County Rd., E. Freetown, MA 02717-1629. (508) 763-8568, 5-7 pm Eastern Time

WANTED: Set of knobs for Echophone TA-16, also parts for a Polydyne. Paul Recupero, 265 Union St., Portsmouth, RI 02871. (401) 847-8589

FOR SALE: Radios/parts/tubes/semiconductors/phone needles. LSASE 20-pg. list. **WANTED:** AK Model 20 chassis/front panel. W.F. Horn, 13110 Marsh Rd., Bealeton, VA 22712. (703) 439-9781

FOR SALE: Supreme analyzer Model 491. Superior TV-11 tube checker. Sky Buddy S-19R - \$65. Echophone ECI-B - \$45. SX99 - \$85. (2) 6L6G, good used - \$12 ppd. Pete Putra, 1429 Lawndale Ave., Racine, WI 53403. (414) 632-2543

WANTED: Zenith 6-S-27. Crosley Buddy Boy chassis or parts chassis. Thanks. Frank's Antique Radios and Telephones, 440-A Jemez Rd., Santa Fe, NM 87505. (505) 473-4150, call evenings only

FOR SALE: Zenith 1000 1st model transistorized Trans-Oceanic - \$95. Rare Heathkit GR-43A, shortwave buff must have this one - \$245. Apex 5-tube battery panel and chassis - \$30. Zenith 6S52 - \$75. Joe Nocera, 1222 Finch St., New Castle, PA 16101. (412) 658-7805

FOR SALE: Predicta chassis only for parts - \$25 plus S&H. N.O.S. & used tubes. Antique Radios of Grand Junction, 831 N. 1st St., Grand Junction, CO 81501. (303) 242-4555

WANTED: Left battery box door for RCA AR812. Steve Morton, 905 West First, North Platte, NE 69101. (308) 534-4778

FOR SALE: Tube audio: Radio Craftsman 10, 800, RC-1. EICO HFT-90. Heathkit SP-2. Fisher 80R. Pilotuner T601. Bogen TP-50. Harman Kardon Award Series A300. Williamson amps pair, Williamson preamp. Williamson Silva tuner. 15" speaker 1,000 ohm field. Jensen speakers with HF units. Garrod turn tables Model RC-121, AT6. Bill Coolahan, 1450 Miami Dr., N.E. Cedar Rapids, IA 52402. (319) 393-8075

FOR SALE/TRADE: Bulova 840 watch/radio, M.I.B. - \$75. Zenith 500 black w/case; (2) small chips, inner edges - \$50. Novelty radios: Shell oil can (fire/ice) - \$25. Nintendo Gameboy - \$30. Power Rangers 3D helmet - \$30. All ppd. U.S.A. Alexandria Nelson, 9225 Evangeline NE, Albuquerque, NM 87111. (505) 291-9468

FOR SALE: EICO FM tuner in good condition, metal cabinet. Also: RCA Victor 45 speed kids record player. Cartridge holder in good playing condition. Dennis A. Chasser, 5823 Dale Ln., Greendale, WI 53129. (414) 421-3964, after 7 pm

WANTED: FM aerial for Motorola 10 transistor portable radio. Model # TP10DE. Or junker set! Do not phone! Mike Hanke, 1036 So. 15th Ave., Wausau, WI 54401

FREE - 20 WORD AD EACH MONTH
To get your free 20 words,
include your SUB# with your Ad.
Additional words are 19¢ each.
Read inside back cover for details.
MANY THANKS!!!!

FOR SALE: IPC PX4 Glove Osram, IPC PP3-250 Glove Mazda carbon metal plate, IPC PP3-250 Glove Mazda nickel metal plate. All new good condition. **WANTED:** WE tube, transformer, parts, speaker. Jensen Q Type tweeter IRC carbon molded resistor. Daven CP-730-T 100K Ω 2DB step. Other tube 5C24, 3C33, 50/250/350/450. 45 Glove 45A, 183/483, 246, UX-210, UV-845 metal plate. Kouji Matsuo, 6-2, Tsurumi-cho, Beppu-shi, Oita, 874, Japan. Fax: 011-81-977-23-9579

SERVICES: To introduce you to our schematic service, we will send you one schematic of your choice for \$1 cash plus stamp. Applies to radios in the 1920-1960 era, except communications receivers. Regular customers included. Offer ends Dec. 31, 1994. Joseph R. Forth, 321 Long Vue Acres, Wheeling, WV 26003. (304) 277-3154

FOR SALE: Tubes, WE274A, WE300A, 807, 811A, 5R4GA and GB, 6CA7/EL34, 8417, 12AX7, 6J5, 6SN7GTB, all are new and most are U.S. brands. Plus many more. Also still have many radios, antique and novelty. Lists available, please specify which list. Send LSASE. House of Radio, 3508 Florence Rd., Killeen, TX 76542. (817) 526-8942

FOR SALE: Tube type WD-11 sub-units - \$12.50 ppd. Details plus Radiola III/III-A distal free for LSASE. David P. Smith, Box 81, Olney, IL 62450

WANTED: Dial glass w/letters and numbers for RCA 17K console, please call collect if you have one, chassis for Philco 39-10 tabletop. **FOR SALE:** Standard Micronic Ruby, in box - \$100. Emersons 640 and 558, Zenith 15U270, Philco 38-7 radio bar w/glasses, Edison cylinder player. Merritt Livingston, 4709 N.W. 76 St., Oklahoma City, OK 73132. (405) 722-7034

FOR SALE: Plastic reproduction dial covers for AK 145, Emerson AU190, 375, Fada 1000, 115 L-56; Zenith 2615, 6D525 - \$14.50 ppd. Many others in stock. Yours with old cover or drawing. Doyle Roberts, HC63, Box 236-1, Clinton, AR 72031. (501) 745-6690

FOR SALE: Emerson 520 Catalin - \$155. Delco R1127 - \$45. RCA 8BX6 Globetrotter - \$20. **HELP:** Need Zenith 103 chassis (2017) and speaker. Have many trades. Dennis Schrank, 3129 S. Quincy Ave., Milwaukee, WI 53207. (414) 744-3374

FOR SALE: Philco Model 650 console - \$65. Airline Model 62-402 console - \$45. Crosley Model 167, small cathedral plays well - \$95. Radiola Model 66, chassis and speaker - \$45. Wilcox-Gay Recordio, table model 6B30, AM & SW, radio plays well - \$45. **WANTED:** GE S-22, A, C, or contemporary reproduction. Doug Hershberger, 101 Columbia Dr., Williamsville, NY 14221. (716) 632-2662

FOR SALE: Transistors: Motorola 56T1, excellent - \$315. Emerson 888 Explorer, grey - \$110. Traveler TR280B - \$110. Emerson 555, gold & grey - \$70. Olympic 447, red - \$110. Continental TR182, black - \$50. Grundig Satellite 5000 - \$250. GE P715D and P66A - \$45 ea. RCA 1TP2E, white - \$45. Novelties: Franklin piano, black - \$60. JVC yellow balance - \$45. Avon Zany - \$40. Charlie the Tuna - \$85. McDonalds Fries, N.I.B. - \$55. Blabbermouse - \$30. Harald Herp, 6615 Michele Ct., Huntingtown, MD 20639. (301) 855-7071

WANTED: 5-tube radio kit, copy of Packard Bell 5R1, made in late 60s by Electro Kits. Also Packard Bell 5R1s and 531s; junker GE P787 7-transistor with good mixer coil; grille bar, knob, speaker for Crosley 1117. John Lee, 1658 E. 5th St., Ontario, CA 91764. (909) 984-4592. Fax (909) 984-7519

FOR SALE: RCA T8-18 tabletop (similar to Bunis 2, p. 159, middle), allwave with magic tuning eye, all original tags, big - \$190. AK 145 Deco tombstone w/inlaid trim (Bunis 2, p. 30), vg - \$230 OBO. AK 184 tombstone (F.O.S., p. 69), exc - \$230. AK 35, vg - \$45 w/o tubes. Federal OrthoSonic A-10 restored to mint - \$205 w/ tubes, \$165 w/o. RCA Radiola 20 restored, vg, w/o tubes - \$130 OBO. All plus UPS. **FOR TRADE:** 1909 Oliver typewriter, rare with vertical stacked hammers, exc cond. will trade for Clapp-Eastham or Magnavox R-3B (early) straight-neck horn spkr, pre-WW2 German or British telephone or other radio/telephone item. Tell me what you have! **WANTED:** Dial escutcheon for Philco 90; large Atwater Kent allwave console such as 112N (or S), 480, 559, 711, 100% complete only. Will drive up to 100 mile radius of Princeton, N.J. to pick up. George Shields, Jr., 108 Jacques Ln., Somerset, NJ 08873-9530. (908) 297-0363. Fax (908) 297-2007. CompuServe: 74546,1657. Prodigy: DSCC11A

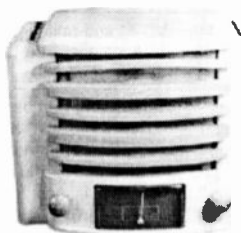

WANTED: Early plastic radios. If you'd like to sell something unusual, I'm probably the sucker to call. Please write or call collect: Rain Buttignol, 214 State St., #7, Portsmouth, NH 03801. (603) 427-1384

FOR SALE: Wooden nickel GE logo - \$1.50 ea. ppd. Danny Thornton, 1175 Springdale Cir., Spartanburg, SC 29303. (803) 578-8518

WANTED: RPM Radio Products Mfg. Co., Chicago, radios; parts and literature. Tom Burgess, 10524 Pat Ln., Mabelvale, AR 72103. (501) 565-1750

FOR SALE: Transistors. Send for free hot list of nice transistors. Jim Martes, 15400 E. 2nd St. S, Independence, MO 64050

FOR SALE: 1940's and 50's portables. Silvertone Mod unknown, DC only - \$10. Crosley Mod 71 - \$15. Emerson Mod 389 - \$15. Zenith Mod G503, plays - \$20. Emerson Mod 338 - \$15. Emerson Mod 657 - \$15. RCA Mod 66BX - \$15. Portables, AC/DC, fair to good condition, most don't play. Also, RCA Model 510, table, wood - \$15. Jeff Hoskins, 824 East Madison Ave., Stuart, FL 34996. (407) 283-2291, after 8 pm



WANTED: This Majestic Model 149 metal grille set & other metal or chrome grille sets by all manufacturers. Jay Malkin, 1250 Galapago, #206, Denver, CO 80204. (303) 623-6451

FOR SALE: Transistor clearance sale: Air-Master, 1950's leather - \$20. Ambassador A-880 - \$30. Arvin: 60R19 - \$20; 61R48 - \$20; 61R35 - \$30. Bulova: 680 - \$25; large AM/FM, Japan - \$30. Channel Master: 6508 - \$20; 6509 - \$22. Clairtone Micro - \$25. Continental TR-1067, N.I.B. - \$45. Corvair 10SK93, N.I.B. - \$18. Four Star TR-610, M.I.B. - \$90. General Electric: P912J - \$20; P800A - \$30; P910D - \$25; P740B - \$25; P1711A, M.I.B. - \$20; P2790D - \$10; P811A - \$18. Juliette Micro 7 - \$35. Orion Micro 8 - \$45. Motorola X-29N - \$25. Magnavox 2-AM-80 - \$25. Master Craft 6 trans. - \$15. NEC NT-625 - \$65. Nipco sharp set, mint - \$60. Nobility, Hong Kong, boxed - \$15. Panasonic R-1076, mint - \$30. Peerless 1200, N.I.B. - \$30. Philco T64-124 - \$20. Raleigh 8 trans. - \$15. Rhapsody RY-867, N.I.B. - \$20. Silvertone 2205 - \$20. Sony TFM-121 - \$55. Starfire, like Tempest HT-1251, M.I.B. - \$40. Sylvania 4P19W - \$18. Transonic, Hong Kong - \$10. Universal 3x5 horiz., boxed - \$18. Urelco 803 - \$25. Westclox 8002 w/clock - \$25. Westinghouse: H697P7 - \$30; H707P6GP - \$30; H842P6GP, M.I.B. - \$25. Zenith Royal 85 - \$30; Royal 675G - \$22. New listings: Bulova (like 792) - \$30. Commodore reverse painted, chips - \$25. Everplay PR-1266 rechargeable - \$45. Telefunken Partner IIK - \$40. Universal PTR-81B - \$30. Tube sets: Philco 38-15, excellent - \$90. Stewart-Warner R-180A, excellent - \$100. Sam Samuelian, 2305 W. Deerfield Dr., Media, PA 19063. (610) 566-7248

WANTED: Colin Kennedy Model VI; will pay top dollar. Also, Airline bronze (gold) 01-A tubes, duds OK. Donald P. Rossbach, 5281 Meadowlark, NW, No. Canton, OH 44720. (216) 497-8944

WANTED: The following junkers: Philco 89, 111, 112; RCA 29K. Thank you. Paul Froehlich, 4152 Hwy. J, Cross Plains, WI 53528. (608) 798-4905

FOR SALE: Radio-related literature, books, technical magazines, etc. LSASE for new list. Radio Daze, John & Kathy Slusser, PO Box 144, Mendon, NY 14506. (716) 624-9755

FOR SALE: Consoles: Zenith 6S152 (E.O.R. 1, p. 200) - \$125. Philco 40-190 - \$110. Westinghouse WR-310 - \$95. All work, pick-up only. Cathedrals: Philcos 84 and 84B (E.O.R. 1, p. 163) - \$125 ea. Joe Quinn, 30511 Manhasset Dr., Bay Village, OH 44140. (216) 835-8420

FOR TRADE: Excellent escutcheon for Philco 15X console for excellent Philco 70 escutcheon. Ken Voyles, 7425 Brushmore NW, N. Canton, OH 44720. (216) 494-5648

WANTED: Receiver, National 1-10, good condition and working. Manual if available. Frederick G. Saffield, 227 Fairway Dr., Sequim, WA 98382. (206) 683-6482

WANTED: Schematic for Beverly by Wells-Gardner Model 88-B. Not in Riders. John Snow, 4539 N. Bartlett Ave., Shorewood, WI 53211. (414) 964-0194

FOR SALE: Used 5691 - \$4; 5692 - \$5; and 5693 - \$3. Other tubes available. Michael Payne, 803 S. Taylor, Alvin, TX 77511. (713) 331-9217

FOR SALE: Used test equipment. 2-stamp LSASE for list. Sam W. Wrenn, 2314 Seminole Dr. #1207, Arlington, TX 76010

WANTED: Faceplate and dial parts for an RCA TU-1 (Berkshire) tuner. Chassis and power xfmr for an H.H. Scott LK-150 power amp. Realistic tube type Model 212 preamp and 214 tuner. Thordarson CHT/Tru Fidelity amp or parts. Bell Imperial 1000 and Crosby R80 receivers. One 12" woofer for a Janszen Model 250. Eico HF89. Charles D. Maples, 1623 Saddle Dr., Murfreesboro, TN 37130. (615) 893-0255

FOR SALE: Amplifier, TV field strength meter, oscilloscope. VM Corporation Model 160 amplifier. Approved Electronic Instrument Corporation Model A-460 television field strength meter. Eico Model 460 oscilloscope. All in working condition - Best Offer, plus shipping by the end of the month. Rich Longley, PO Box 96, Eland, WI 54427. (715) 253-2547

FOR SALE: 1924 Tresco #26-1, one tube receiver, complete. Condition: Good, untested, as found. (See: Douglas Vol. 3, Steinite, p. 135, photo p. 136) - \$175 plus UPS. C. Hill, 6934 Orion Ave., Van Nuys, CA 91406. (813) 787-0376

FOR SALE: Collins 32S1, 75S1, transmitter and receiver 516F-2 power supply 3128-4 station control, and kube excellent condition - \$700. George Folse, KB5WWO, 630 Dolhonde, Gretna, LA 70053. (504) 362-9228

WANTED: Japanese transistor radios in good condition, working or not. Bob Davidson, 310 Main St., Concord, MA 01742. (508) 369-2007

WANTED: Knight (Allied Radio) Ocean Hopper receiver. John Regan, K9SWN, 4N556 Knoll Creek Dr., St. Charles, IL 60175. (708) 584-1460, evenings

FOR SALE: Radios. Several plastic tabletops. 50's, early 60's. Others. All tube. SASE for list. Richard Korb, 43 River St., Holden, MA 01520. (508) 829-2063

FOR SALE: Rider's Manuals: Volumes 1-17. Prices range from \$12.50 to \$85 per volume. LSASE for price list. Sam Faust, PO Box 94, Changewater, NJ 07831

WANTED: Electronic parts & equipment. Radios, tubes. Instruments, bearings, aircraft parts & equipment. Hy Ness Company, 709B Delair Rd., Cranbury, NJ 08512. (609) 395-1116. Fax (609) 395-1117

FOR SALE: Official Radio Service Manual, Gernsback, Vol. 2 - \$30 + postage. R. Chenez, RFD 1, Box 437-J, Plymouth, NH 03264

WANTED: Airline 62-455 Bakelite table-dial, no cracks w/back. Karen McCoy, 8104 N.W. 114, Oklahoma City, OK 73162. (405) 722-0595

WANTED: Crosley hi-fi consoles. 8"x 12" spkr, has gold frame and deep green cone. John May, 205 Wren, Scotia, NY 12302. (518) 377-9522

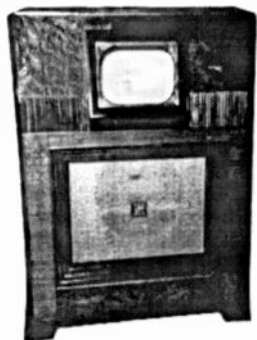

FOR SALE BY AUCTION

Complete Collection
of Fine Radios & TV's

All in Excellent Working Condition
Tombstones, Consoles, Cathedrals, etc.

Plus Tubes, Parts, Picture Tubes, etc.

Years of Collecting

Dispersing of Entire Collection

\$5.00 for huge list complete with pictures & description
refund with purchase — worth it just for the pictures
or SASE for just a listing & no pictures

John Marinacci
1141 Galaxy Circle
Pittsburgh, PA 15241
Ph: (412) 221-6763



FOR TRADE: Many collectible radios: AK, RCA, Philco, etc. for Jackson-Bell models. Richard Gray, 11869 Hi Ridge Rd., Lakeside, CA 92040. (619) 977-6033. Fax (619) 390-8937

FOR SALE: Novelty radios: Parking meter, AC, N.I.B. - \$60. Oscar the Grouch, N.I.B. - \$55. Camcorder, N.I.B. - \$45. Camera, N.I.B. - \$25. Winston radio flashlight, new - \$15. Ghost Buster nitelite, NOC - \$18. Others. Wesley M. Matous, 1824 Glengarry, Carrollton, TX 75006. (214) 242-4168

WANTED: Philco Model 91L console, working, must ship. Larry Wilson, 310 75th Ave. N, #3, Myrtle Beach, SC 29572. (803) 449-5839

FOR SALE: Zenith Radio Service Manual, Volume 1, back cover missing - \$50. RCA Victor Red Books, 1933, 35, 36, 37 - \$30 ea. Try-mo Radio Co., Cortland St., 1935 catalog - \$15. Rider Radio Manuals: Vol. 7, 8 - \$20 ea.; Vol. 9-14 - \$15 ea. Hi-fi Annual & Handbook, 1956 - \$15. Radio Masters 1945 Buying Guide - \$15. Rider PA Manual Vol. 1 - \$40. Sams Auto Radio Service Data Manuals, Vol. 1-5 - \$10 ea. Supreme M.O.N. record players, auto changers - \$10. Sams Red Book, first edition - \$8. Call to reserve. Prices do not include shipping. Vintage TV & Radio, 3498 W. 105 St., Cleveland, OH 44111. (216) 671-6712, Tues.-Friday 11-3 pm

FOR SALE: Used tubes, test good. (2) matched pairs, RCA 7591A - \$35/pr. Jack Campellone, KD4HAK, PO Box 232, Genoa, OH 43430. (419) 855-4420

WANTED: EH Scott Philharmonic radio. Robert Schoenbeck, 9301 Texhoma Ave., Northridge, CA 91325. (818) 993-7174

FOR SALE: Hallicrafters S53A (2 versions), vgc, no mods - \$75 ea. Heath CW filter for SB300/303 - \$50. Vintage ham equipment manuals - send for free list. Richard Prester, 131 Ridge Rd., West Milford, NJ 07480. (201) 728-2454

FOR SALE: Hawkins Electrical Guide with questions, answers, & illustrations, Theo Audel 1914, Volumes 1-10, complete - \$50 or BO. James Tasa, 50 Lombardy St., Lancaster, NY 14086. (716) 684-4629, machine after 4th ring

WANTED: For my collection: Hewlett Packard low frequency function generator Model 202A. Richard Norton, 9 Endo Blvd., Garden City, NY 11530-6799. (516) 745-1411

FOR SALE: Telefunken Jubilate 1161 - \$60. Norelco (Holland) Bi-Ampli B5X14A/54 - \$100. Collins 312-B3 speaker - \$110. John Malley, 19 Claremont Ave., Enfield, CT 06082. (203) 745-0733

FOR SALE: 50's collectibles for sale. Motorola 56H set, ivory, turquoise, brown, bright green, (Collins 2, p. 99) - \$400. Travler T-203 set, turquoise, pink, green, yellow, (Collins 2, p. 96) - \$300. Truetone Boomerang, ivory, (Collins 2, p. 86) - \$175. Don Moody, 1600-M Glenwood Ave., Raleigh, NC 27608. (919) 821-3530

WANTED: Commercial crystal sets, detectors, wireless apparatus. **FOR SALE:** Price guides. Crystal radios, 550 listings, or wireless/telegraph, just - \$8.50 ea. plus 75¢ LSASE. Dick Kowalski, KB8MR, 32823 Gloede Dr., Warren, MI 49093



FOR TRADE: Very rare English Bush cathedral AC3, rarest black/chrome circular Ecko AD36, Philco People's set and matching black/chrome fan heater, Marconi V2A (needing work), brown Air King Australian Radiotelette with Bakelite back, crystal sets, early Gecophone. Sonora Sonorette and Cadillac. Many other colourful/stylish desirable radios for quality Catalin and exciting trades. **WANTED:** Emersons, Little Addison, Fadas, Coke Cooler, Strad, "Mickey," Jackson Bell. Simon Wade, Finchcroft, Broadwater Down, Tunbridge Wells, Kent, United Kingdom TN2 5PE. (44) 892 543505 tele/fax

WANTED: Radio Boys books. #2 Radio Boys at Ocean Point, #8 With the Flood Fighters, #11 Aiding the Snowbound. Prefer with covers. Jeff Hoskins, 824 East Madison Ave., Stuart, FL 34996. (407) 283-2291, after 8 pm

WANTED: Rider's TV Vol. 13, any information on 1952 Shaw 21-inch TV with doors. Fred Ringwald, 3803 Half Turn Rd., #126, Colorado Springs, CO 80917. (719) 550-9419

FOR SALE: Radios. Cleaning out closet. Send SASE for list. Dave Mock, 3 Larkspur Pl., Montpelier, OH 43543. (419) 485-3933

— WANTED —
**PICTURES FOR PHOTO REVIEW OR TELEGRAPH REVIEW
PHOTOS MUST BE SHARP IN DETAIL
A SHORT DESCRIPTION IS A MUST!
SEE PHOTO REVIEW PAGES FOR
ADDITIONAL INFORMATION**

FOR SALE: Heathkit tube checker Model TC-3 - \$15. Heathkit AM tuner Model BC-1 - \$15. Russ Linsin, 11872 Bellefontaine Rd., St. Louis, MO 63138. (314) 741-8832

FOR SALE: Does anyone need a new Heath power transformer #54-45? Please contact me. Harold Lejuez, 46-16 160 St., Flushing, NY 11358. (718) 463-4110

WANTED: Units of APS 3, 42. Also: Varian Sperry Raytheon special purpose tube catalogues, 1940-1960. Jim Krajovic, 546 Sheridan, Pittsburgh, PA 15206

WANTED: Information on World War Two Axis and Allied radars and countermeasures. Also warship de-gaussing. Bryan R. Knudsen, PO Box 211, Kenosha, WI 53141

HIGHEST PRICES PAID

*For 78 R.P.M. Records & 16"
Transcription Collections*

*One Piece or Entire Collection Plus
Sheet Music & LP's, from 40 to 50's*

Must Be In E+ Condition

*Antique Edison
John Marinacchi, Proprietor
301 Murray Ave., Bridgeville, PA 15017
(412) 221-6763*

FOR SALE: Fisher 400 stereo, 20-tube FM receiver, open chassis. Plus: Garrard 4-speed automatic turntable and pair Radio Craftsman speakers. Everything works good. Sell as system only - \$195 plus S&H. Jeff Hoskins, 824 East Madison Ave., Stuart, FL 34996. (407) 283-2291, after 8 pm

FOR SALE: Over 80 table radios. SASE list. Bob Masterson, Box 172, Valley Cottage, NY 10989. (914) 353-3151

WANTED: Batteries for my battery collection. Must be in very good condition. Kenneth Ericksen, 1049 Felspar, #33, San Diego, CA 92109-2844. (619) 483-2183, evenings PST

FOR SALE: Philco Model 53-562, beige, plastic with tubes - \$35. GE Model T125E plastic, tubes, like new - \$25. Large Emerson, table model, wood cabinet, 8-inch speaker, dark stripe through center from front to back, old, tubes - \$35. All sets work, plus shipping. John Kara, 1700 Baltimore Ave., Whiting, NJ 08759. (903) 849-4318

FOR SALE: Communications items: Heathkit lunch box, 2 meter, The Twoer with mic - \$75; Knight T-60 xmtr - \$75; W.R.L. receiver - \$75. Larry Drago, 383 Lincoln Dr., Cheshire, CT 06410. (203) 272-6030

WANTED: Zenith 1000 and 2000, Zenith black dial cube sets, wire recorder reels. Stephen N. Phipps, N7LNY, 10201 West 52nd Ter., Merriam, KS 66203

FOR SALE: Mono amps: Silvertone Powermaster PP6L6GS; Bogen Challenger CHB20A; Grommes G23 - \$29 ea. + shpg. H. Mohr, 1005 Wyoming, Allentown, PA 18103

FOR SALE: RCA Service Notes, replacement parts for radios, speakers and battery eliminators from 1920's. Old radio books, antique test equipment, early 1900's thru 1930's. SASE for list. Herman Fothe, 10 Jackson St., Sloatsburg, NY 10974. (914) 753-2090

FOR SALE: 1950's to 1960's electronics magazines (Popular Electronics, Electronics Illustrated, etc.), send SASE for list or call. Adcom ACE-515 power switcher/line conditioner, N.I.B. - \$75. Stromberg-Carlson speaker switching assembly (15 heavy duty switches) for audio console, N.O.S. - \$20 ea. Dave Minchella, KE2GE, 80 Campfire Rd. North, Henrietta, NY 14467. (716) 359-3337

FOR SALE: Two GE 575A, appear N.O.S., original boxes - \$40 for both tubes, includes U.S. surface UPS. Bill McCombs, 10532 Bartlett Ct., Wichita, KS 67212-1212. (316) 722-7669

WANTED: The following in excellent original condition: GE K-60; Philco 17, 21, 43, 45; AK 93, 155, 275, 217, 447; RCA 10-T; Emerson black USA. John Kern, 2320 Rosedale Rd., Quakertown, PA 18951. (215) 538-2128

WANTED: RCA LC1A speaker. Vern Oehlke, Box 307, Sollar Hts. Rd., Ghent, NY 12075. (518) 392-4945

FOR SALE: 1. H.H. Scott 331B tuner, works fine - \$150. 2. Rek-o-Kut K34H - \$75. Edward Krawczyk, 64 Old Chimney Rd., Up Saddle River, NJ 07458. (201) 825-3828

FOR SALE: Sony CRF-5100 Trans-Oceanic - \$125. B&K 1460 solid-state oscilloscope, mint - \$110. B&K 667 solid-state tube tester - \$65. Akai GX-220D reel-to-reel, nearmint - \$65. **WANTED:** RCA Vol. 1, 1931-1937. Armand Cote, 11 Berge Ln., Derry, NH 03038. (603) 437-4431, before 10 pm EST

FOR SALE: Grunow 1930's table, chrome grille, needs knobs - \$85. Philco grandfather clock radio, needs speaker - \$450. RCA 8K console - \$75. RCA 97X table - \$50. Scott 840B Chippendale cabinet - \$450. Silvertone 12-inch TV, early 1950's - \$35. Zenith chairside 8BOL - \$75. Zenith 1103 console, magic eye, round black dial - \$125. You pick up. Donald J. Cole, 11 Everett Ave., Claymont, DE 19703. (302) 798-9531

OLD TECH



BOOKS
& THINGS

Early
Technical
Books &
Apparatus

**Announcing - Catalog No. 1
Available Soon*
Write For Free Copy.**

We Specialize In:

Wireless - Radio - Television - Telegraph
Telephone - Electricity - Computers - Slide Rules
Electro-Medical - Calculators - Typewriters
Atomic Energy - Astronomy - Skiing

We Buy & Sell:

Books - Juveniles - Catalogs - Magazines
Manuals - Ephemera - Novelties - Apparatus
Anything Related!

Send us a list of your general & specific wants.

OLD TECH - BOOKS & THINGS

John V. Terrey, Proprietor

P.O. Box 803, Carlisle, MA 01741 U.S.A.

**Still delayed, but eventually I will get it finished!*

ARBE-III - Universal Battery Eliminator

- ⇒ Specifically designed for early battery-operated radios.
- ⇒ Custom wound power transformer
- ⇒ Quality components used
- ⇒ Five-year warranty
- ⇒ Proven accurate specifications
- ⇒ Isolated A, B and C supplies for maximum flexibility
- ⇒ Safety features not found in kits
- ⇒ Over 350 satisfied customers
- ⇒ Technical assistance available

Contact:

Antique Radios Inc.

Box 6352, Jackson, MI 49204

(517) 787-2985 or

Fax (517) 782-7422



FOR SALE: Zenith Radionic hearing aid, Model A2A, in original box - \$35. Cliff Sullivan, 4902 W. Monte Cristo Ave., Glendale, AZ 85306. (602) 978-3551

FOR SALE: Bendix Model 526A - \$80. GE Model 200 - \$75. Garod Thriftee Model 5A4, white - \$80. Pictures of each in Bunis 1, all mint. Plus UPS. Stephen L. Bonino, 107 Georgetown Rd., Glassboro, NJ 08028. (609) 881-0244

WANTED: RCA Radiola historical information, books, technical data, sale brochures, operating manuals, literature, etc. Kenneth Erickson, 1049 Felspar, #33, San Diego, CA 92109-2844. (619) 483-2183, evenings PST

WANTED: Philco 49-501 Boomerang, Philco 45, Philco 49-901, Philco 52-538, Motorola 56CD clock radio, Bulova 100, 120, Fada 740, 790, 263W, 60W, various table radios. Please send list. Thanks. Bob Masterson, Box 172, Valley Cottage, NY 10989. (914) 353-3151

FOR SALE: Delco R 1238 (Bunis 2, p. 54) - \$150. Overland Radio Corp., 4 tube battery set made in New York City in 1925, beautiful condition - \$175. What a great gift idea for someone from the Big Apple. Larry Drago, 383 Lincoln Dr., Cheshire, CT 06410. (203) 272-6030

WANTED: Reward. Test equipment manufactured by Readrite, Sterling, Jewell or Weston. Must be complete. Gary J. Formica, 823 91st St., Niagara Falls, NY 14304. (716) 283-2274

FOR SALE: (10) small hand-held microphones, some old - \$35, plus shipping. John Kara, 1700 Baltimore Ave., Whiting, NJ 08759. (908) 849-4318

FOR TRADE: National coil set, original dovetailed box. Prefer interesting trade. Make Offer. Kelly Nichols, RD #1, Box 103K, Greenwood, DE 19950. (302) 349-5059

WANTED: Good cloth double headphone cords. Knobs for Philco 37-630. Delco table radios. Herman Gross, W91TT, 1705 Gordon Dr., Kokomo, IN 46902

FOR SALE: Rider's 4 & 5 - \$50 each. Rider's 6, 7, 8, 9, 10, 11, 12, 13 - \$20 each. Rider's 17 & 21 - \$30 each. Plus postage. Bill Moss Settle, 120 Clarksdale Cir., Glasgow, KY 42141. (502) 651-6525

FOR SALE: AC/DC portables: Westinghouse H-559P4 (green); CBS-Columbia 5220 (green), both work - \$40 for pair. + shipping. Truetone D-700 console, AM/SW, nice - \$100. Silvertone 1972 console, works - \$80. Pickup only. **WANTED:** Bandspeed condenser plates and shaft for Hallicrafters S-20R. Bill Regan, 4566 O'Dell Pl., Jamesville, NY 13078. (315) 492-2817

WANTED: Both knobs for metal Silvertone ivory midget Model #6002. Howard Vandermaald, 2625 N. 77th Ct., Elmwood Park, IL 60635. (708) 456-0320

FOR SALE: EV 660 Super-cardiod mike - \$60. Astatic 10D mike on G stand - \$40. Misc. old equipment, panel meters (about 100!), transmitting tubes, books, manuals, catalogs. List SASE. George H. Goldstone, W8AP, 1010 Burnham, Bloomfield Hills, MI 48304. (810) 647-3399

FOR SALE/TRADE: Amrad WWI SCR 174 spark trans., working; Wurlitzer, working; 12-tube chassis and speaker for the SA120 console; Atwater Kent repro. crystal set; Victrola No. IV, oak, working, nice condition. Bob Fuschetto, 1758 Michael Dr., Whitehall, PA 18052. (610) 435-8944, call bet. 7 pm & 9 pm

FOR SALE: Radio chassis: 1940's Truetone; (10) tubes plus eye, (6) push buttons, no knobs or speaker, no model #, unrestored - \$30. RCA, fits Model C11-1 or C11-3 or Model D11-2, partially recapped, has knobs, no speaker - \$40. Prices plus S&H. Jeff Hoskins, 824 East Madison Ave., Stuart, FL 34996. (407) 283-2291, after 8 pm

FOR SALE: Zenith #L600 - \$75. Philco #42-345 - \$40. Sonora #RDAU-209 - \$40. Westinghouse #H-103 - \$40. Tony Flanagan, 92 Joysan Ter., Freehold, NJ 07728. (908) 462-6638

WANTED: A photo or copy of an ad for an AK 711R or 788R Art Deco console. Jeff Aulik, 1708 Parkview Ave., Rockford, IL 61107. (815) 399-1902

FOR SALE: Tube extender kit, by Vector, 4-pin thru octal, locial, 7- and 9-pin miniature for measuring pin voltages - \$25. I-177 tube tester - \$50; parts set - \$25. ES1 impedance bridge, self contained, AC, DC null detect - \$85. WW11 TCS-12 xmtr 1.5-12 MHz - \$40. All plus shipping. Stan Krumme, 16432 Lakemont Ln., Huntington Beach, CA 92647. (714) 841-5866

FOR SALE: Gloritone cathedral, no speaker or tubes - \$45. A&H tombstone cabinet - \$17. Zenith 12H090 chassis, tubes, speaker - \$25. Silvertone 4786 chassis - \$18. Philco speaker 37-60 - \$17. Early Radiola transformers UV712, UP414 - \$15 ea. AK-E2 speaker, not working - \$10. National Radio Institute, self-study course 1933-1941, booklets average 30 pages, 38 booklets - \$15; 1943-1944, 53 booklets - \$25; 1945-1948, 27 booklets - \$10. Herman Fothe, 10 Jackson St., Sloatsburg, NY 10974. (914) 753-2090

WANTED: Rectangular dial glass for Zenith console, 7" x 6 7/8". I can swap the circular type. A. Bruno, 24 Butternut Dr., New City, NY 10956. (914) 354-8899

WANTED: 1936 Philco escutcheon, oblong, #630, baby grand or tombstone. Have book for 1936, will trade. Mal Neal, 5911 E D St., Tacoma, WA 98404. (206) 472-0370

FOR SALE: Philco 90 chassis - \$90. Zenith 6D525 - \$95. **WANTED:** Original dial for Fada 652. Tom Dell, 214 Pleasant St., Hanover, PA 17331. (717) 637-8875

FOR SALE: RCA Model V205 console, 1941 Anniversary Model - \$150. You pick up. Donald J. Cole, 11 Everett Ave., Claymont, DE 19703. (302) 798-9531

WANTED: 2nd IF transformer and one brown control knob for the Philco 42-380 rcvr. James T. Schliestett, W4IMQ, PO Box 93, Cedartown, GA 30125. Phone/fax: (404) 748-5968

FOR SALE: McIntosh A-116 power amplifier with McIntosh C-108 audio compensator, excellent - \$250 plus UPS. Walt Kiefner, 6233 51st Ave., NE, Seattle, WA 98115. (206) 526-1452

FOR SALE: Large literature collection: Old radio books, magazines, catalogs, tube manuals, A.R.R.L. publications, Radio Retailing, television, Amplifier, sound system, panel meter, microphone catalogues - SASE. Bill Rolf, 30131 Center Rdg., Westlake, OH 44145

FOR SALE: Heathkit SB102 transceiver w/power supply, schematic only, complete, but needs restoration, as is - \$75. Heathkit SB110 6-meter SSB transceiver w/ power supply, manual; fair, needs relay work, as is - \$100. Jim Ford, NM1F, 194 Rocky Hill Rd., Plymouth, MA 02360. (508) 747-2224

FOR SALE: Bulova 100, green – \$50. Jewel 910, near mint – \$60. Motorola 5C dark green – \$40. Arvin 950T – \$30. Westinghouse H126, white – \$80. Westinghouse H122 – \$100. RCA T-60 – \$95. Bulova 300 – \$25. Erud SR60, exc – \$125. Normandy Kadette 57 U.S.A. – \$100. Grundig 96U – \$35. SASE/list. Bob Masterson, Box 172, Valley Cottage, NY 10989. (914) 353-3151

FOR SALE: Replacement record player cartridges: Astatic #s 1-J, OT-J, OT3-M, L-72A, LP-6, L-71A, L24A, L-40, LP 6, L-26, Shure W 56A, W 59A, W 58A, GE R.P.X. 040, all – \$20 ea. Zenith Cobras red or green – \$10. Garod recording stylus – \$15. Recordisc recording stylus QX-5 – \$10. Webster Tandem TIP needle – \$20. Electro-Voice and Astatic needles – \$10. Larry Drago, 383 Lincoln Dr., Cheshire, CT 06410. (203) 272-6030

HELP: Need escutcheon for Philco tombstone 16B and blue on/off knob for Coronado 43-8190. Bill Engaas, 6626 W. Revere Pl., West Allis, WI 53219. (414) 328-0223

FOR SALE: Prewar Andrea KTE-5 TV, unrestored – \$2,000 or Best Offer. David Horvath, Box 702, Phoenixville, PA 19460

FOR SALE: Philco Predicta Model 4710, picture tube type 21 SFA. Best Offer. Guy Frederick, 1121 Powers, NW, Grand Rapids, MI 49504. (616) 456-9378

WANTED: Ham gear, tube type. Complete and working. Please have description and your price. Eugene Rippen, WB6SZS, PO Box 9, Auburn, CA 95604-0009. (916) 885-6147

FOR SALE: Stromberg-Carlson radio with matching floor stand, Code 501-A, Serial 111925 – \$150 OBO. John Yelland, 46 Broad St., Billerica, MA 01821. (508) 667-9444

FOR SALE: RCA 40X56, Golden Gate – \$1,200. Magic-Tone liquor bottle – \$400. Melody Cruiser – \$400. 1930's RCA advertising display depicts Kate Smith, Rudy Vallee and other radio stars, great early piece – \$400. Bing Crosby, Jr. jukebox – \$350. **WANTED:** Hopalong radio with bad front and transistor radios made by Zephyr, Crown, Lafayette, Global, Realtone, Continental, Toshiba, Viscount, Hudson, Valiant and Monarch, and a harp for an RCA 77 microphone. Bob Wood, 3610 N. 12th Ave., Pensacola, FL 32503. (904) 432-3782

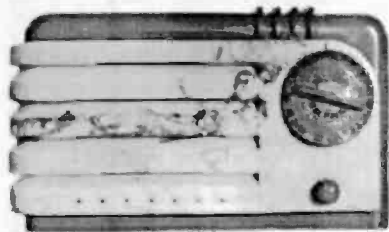

WANTED: Plastic radios from the 30's. If it's prewar (II) and colorful, I'm interested; dull, but nevertheless, interested. Please write or call: Rain Buttignol, 214 State St., #7, Portsmouth, NH 03801. (603) 427-1384

FOR SALE: Scott 800B in Chippendale Grande cabinet. Garrard RC884 changer, magnetic cartridge, exc – \$650 OBO. Mike Lipke, 2177 Violet Ln., Minneapolis, MN 55112. (612) 631-1644

FOR SALE: Radio collection. Send LSASE for list of condition and price. Hank Trabold, 2058 Nakiska Ct., Toms River, NJ 08755. (908) 244-2345

WANTED: Home brews that are clean, complete, prefer the unusual. Also, a very nice Fisher 90X receiver and a clean, working Fairchild 275 power amp. One pair of high end 15" Jensen coax. speakers. Need speaker for Philco 660 console. Finally, any small console or portable TVs from the 40's. Call or write anytime. Tim Phelan, 1521 Virginia Ave., Ellisville, MO 63011. (314) 391-4122

FOR SALE: Hallicrafters Model S38C communications set, tubes, 4 bands, all work – \$45, plus shipping. John Kara, 1700 Baltimore Ave., Whiting, NJ 08759. (908) 849-4318

WANTED: Still looking for a Hallicrafters SR-75. Serious buyer. Dick Parks, 1616 N. Glebe, Arlington, VA 22207. (703) 243-1166

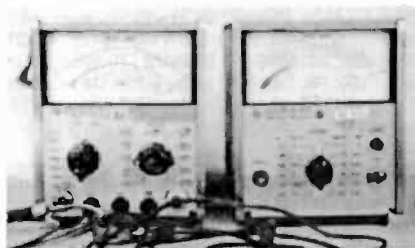

FOR SALE: HP3400A True RMS AC voltmeter, 1 millivolt to 300 volts full scale, 10Hz to 10MHz, working & calibrated, pictured on right – \$95. HP-410C VTVM, measures AC volts to 300v and up to 700MHz, also DC volts and resistance, pictured on left, working and calibrated – \$135. 1177 mutual transconductance tube tester – \$60. Hickock Cardomatic tube tester UN-118B with full card set – \$200. Shipping and packing extra. Stan Krumme, 16432 Lakemont Ln., Huntington Beach, CA 92647. (714) 841-5866

WANTED: Televisions: JVC Videosphere and video capsule, Seiko TV watch, early pocket televisions. Lee White, 25 Hawthorne Ln., Weston, MA 02193. (617) 235-5236

WANTED: Marantz, Acrosound, Fairchild, Fisher, Hadley, Karg, REL, etc., tube hi-fi equipment. Single copies and collections of 1950-1965 hi-fi catalogs, sales fliers, owner's manuals, books, and magazines, such as Audio, Audio Engineering, and Audiocraft. Promotional items, such as signs, banners, clocks, tube caddies, etc., by hi-fi manufacturers and tube producers. Paul Creasy, 6216 Worlington Rd., Bloomfield Township, MI 48301. (810) 737-0429. E-mail: 74664.1153@compuserve.com.

FOR SALE: Philco 89B cathedral – \$80. Philco 71, plays, nice cabinet, grille cloth torn – \$220. Fairbanks-Morse tombstone, nice – \$65. Radiola 18 Service Notes, reprints – \$10. Send LSASE for list of radio-related paper items and smalls. Robert Burick, 21-B North Earl St., Shippensburg, PA 17257. (717) 530-5040

FOR SALE: Complete Elmac station, rcvr. trans. w/ manual – \$100 + UPS. Dahlberg pillow radio. H. N. Felder, K3RPY, 7517 Granada Dr., Bethesda, MD 20817

FOR SALE: Emerson 149 - \$125. Emerson 708 - \$40. Emerson 813, grey - \$35. Emerson 543 - \$50. Emerson 334 - \$35. Zenith 6D0-30 - \$50. Zenith 6D-005 - \$80. Zenith H500 - \$95. Zenith 5D027 - \$45. Bob Masterson, Box 172, Valley Cottage, NY 10989. (914) 353-3151

FOR SALE: Philco Safari, no hood, stand lights up - \$125. H-2010. **WANTED:** Philco cathedrals Models 46 & 21. Ted Depto, The Philco Collector, 818 5th Ave., Patton, PA 16668. (814) 674-8834

WANTED: Audio tubes: Genelex KT88, 77, 66; Tung-Sol 6550; Telefunken/AmpereX/Mullard 6SN7, EL34, 5AR4, 12AX7, 12AT7, 12AU7, 6DJ8, E288CC, 7308, 6922; Philips 6550; RCA, etc. 2A3; Western Electric 300A/B, 252, 274, 211, 205, 101, VT-2, 275. John Birck, 458 E. 600 North, Orem, UT 84057. Voice/fax (801) 224-4809

FOR SALE: Zenith 10-S-153 - \$300. Atwater Kent 46 - \$120. Philco 116 - \$100. Clarion 320 Junior - \$110. RCA 6-T - \$150. Philco 37-2670 - \$300. Zenith H-500 Trans-Oceanic, w/orig. manual & log - \$125. TV-2/U military tube tester - \$300. Supreme 570 signal generator - \$100. Heathkit tube tester - \$25. All excellent/working, all OBO, all plus shipping. Richard Rubin, 227 Riverside Dr., Apt. 5-A, New York, NY 10025. (212) 864-8416

FOR SALE: Popular Electronics 1955-1982. Radio Electronics 1947-1988. Most issues, almost (700) magazines - \$250, plus shipping. Rick Russell, 5216 12th Ave. Dr. W, Bradenton, FL 34209. (813) 792-8882, or fax (813) 748-0295

FOR SALE: Early original Tektronix manuals. N.O.S.B. DM-35-Dynamotor - \$30. N.I.B. tubes: 6W6GT, 2E26, 2C50, 12CT8 - \$2. Matched pairs, 6DJ8 - \$6. 923, 7235, WE 429A - \$8. 3RP1 (McIntosh audio monitor CRT) - \$21. Lowell Thomas, AA6ZD, PO Box 15026, Fresno, CA 93702. (209) 227-1605

FOR SALE: (170) radios, including Zenith, Philco, Emerson and RCA. Some pictures, LSASE for list. Many windup phonos. Front-mount: Standard - \$545, Grafonola - \$595. Earphones. Eugene Rippen, WB6SZS, PO Box 9, Auburn, CA 95604-0009. (916) 885-6147

FOR SALE: Used tubes, tested, clean, lowest prices, good selection. SASE for list. Bill McCombs, 10532 Bartlett Ct., Wichita, KS 67212-1212

WANTED: Early transistors by Zenith and Emerson, especially Royal 200's, 400's, and 500's and Emerson 888's. Top dollar paid for new in the box examples and Zenith Royal 500H's. Also white, tan, maroon and pink Royal 500's. John Kern, 2320 Rosedale Rd., Quakertown, PA 18951. (215) 538-2128

FOR SALE: Sony transistor radio list, Apr. '55 to Mar. '91, listed over (500) models with introduction date and Japanese list price (production qty. for 50's models too) - \$10 ppd. **WANTED:** Sams TSMs Vol. 17-23 and 74-86. DeForest D-12 and D-17M. Zenith flip-top 4F40. Sony ICR-90, -100, -120. Japanese tr. radios made before '60. Gilfillan GN1. Any Japanese WWII set i.e. 1-tube TRX Type 94-6; also TX Type 94-5, 3-tube RX Type 94-5. Old telegraph keys and bugs. WWII German radios i.e. DKE38 and tubes i.e. RV12P2000. Noriyoshi Tezuka, 1-11-2-403 Hiroo, Shibuyaku, Tokyo 150, Japan. Fax: 011-813-3440-8396

SERVICES: We rebuild electrolytic capacitors. Twist-Locs, wet or dry cans. Starting Oct. 1st, @ - \$14 for any single capacitor, simply add \$1 for each additional section. This price good up to 80 uF. @ 450v. Any section over 80 uF. and exceeding 100v add \$1.50 per such section. Add \$2 for Leslie or octal based cans. Add \$3 to replace Twist-Loc bases. Add \$1.50 for 475v or 500v each such section. All rebuilt can prices include return postpaid via 1st class mail until Jan. 1st. Frontier Electronics, Box 218, Lehr, ND 58460. (701) 378-2341

ABBREVIATIONS USED IN CLASSIFIED ADS

MISCELLANEOUS

amp = amplifier
 BC = broadcast
 BO = best offer
 ca. = circa (approx. date)
 ea. = each
 F.O.B. = free on board
 IB = instruction book
 LSASE = A Long SASE
 (see SASE)
 LW = long wave
 M.I.B. = mint in box
 MO = money order
 Mod = model
 N.I.B. = new in original
 box
 N.O.S. = new old stock
 (an original, unused
 vintage item)
 NT = no tubes
 OB = in original box
 OBO = or best offer
 P&H = postage & handling
 ppd = postage paid
 (shipping included)
 PS = power supply, also
 "pwr sup"
 PU = pick up only
 rcvr = receiver
 SASE = self-addressed
 stamped envelope
 (send a long, #10,
 envelope)
 spkr = speaker
 SW = shortwave
 UPS = United Parcel
 Service
 vol. = volume
 w/ = with
 w/o = without
 xcvr = transceiver
 xfmr = transformer
 xmtr = transmitter
 xstr = transistor
 xtal = crystal

BOOKS USED AS REFERENCES

(V.R., p 30) means *Vintage Radio*, page 30
Blast = *Radio - A Blast From The Past*
Bunis 1 or 2 = *Collector's Guide to Antique Radios, 1st & 2nd editions*
Collins = *Radios - The Golden Age*
Douglas V1, V2 or V3 = *Radio Manufacturers of the 1920s, Volumes 1, 2 or 3*
E.O.R. = *Evolution of the Radio*
F.O.S. = *Flick of the Switch*
Grinder/Fathauer = *Radio Collector's Directory and Price Guide*
G.O.R. = *Guide to Old Radios*
Johnson's A.R. = *Antique Radios - Restoration & Price Guide*
O.T.B. = *Old Timer's Bulletin* published by Antique Wireless Association (AWA)
Sideli = *Classic Plastic Radios*
V.R. = *Vintage Radio*

CONDITION

(If good or better, mention non-original parts)
 p = poor
 g = good
 exc = excellent
 f = fair
 vg = very good

A.R.C. does not encourage abbreviations except those listed here. Please spell out all other words. Special note for hams - most subscribers are not hams so we do not recommend ham-type abbreviations.

FOR SALE: Hallicrafters S120 - \$35. Heathkits: HR10 - \$40, Mohican - \$60. Gonset Communicator II - \$30. **HELP:** Comcraft CTR144, need schematic/manual. Eugene Rippen, WB6SZS, PO Box 9, Auburn, CA 95604-0009. (916) 885-6147

FOR SALE: Scott 299, 7189 outputs, vinyl on steel cabinet, clean - \$65. Heathkit MR21A direction finder, end section missing from telescoping ant., fair - \$25. Ship extra. Business SASE gets list of bargain test gear, manuals. **WANTED:** Wood case, good cond. for Revox A77. N.O.S. 6U5 eye tube, straight bulb, not curved. Bill McCombs, 10532 Bartlett Ct., Wichita, KS 67212-1212. (316) 722-7669

WANTED: Schematic for modular component systems (J.C. Penney) Model 3224 Cat. 853-5700 stereo. Remo J. Vinassa, KB5WBW, HC 61, Box 222, Norfolk, AR 72658. (501) 499-7685

WANTED: To correspond with owners of Philco Predic-ta #4730, Danish modern, with the UHF option. David Weddington, 6042 San Rolando, Buena Park, CA 90620. (714) 828-4016, or fax (714) 828-4023

FOR SALE: Westinghouse Aeriola SR receiver and amplifier with instructions in lids - Offer. Something. Tim Metz, 221 Wheatland, Fairview, OK 73737. (405) 227-2456

FOR SALE: Ozarka 4 exposed tubes, 13 chrome terminals, 3 dials, slant front, black wood cabinet, looks terrific - \$325. Larry Drago, 383 Lincoln Dr., Cheshire, CT 06410. (203) 272-6030

FOR SALE: Capacitor steal of a deal, .1uF. @ 250v dip, \$1/4. Another steal deal, .33uF. @ 400v dip - \$1/3. Another steal deal, this item only surplus, 018uF. @ 1,000v, glass sealed & oil filled, axial, jan - \$1/2. This ad only, minimum order \$10 postpaid. Checks or cash with order. Wow! Any combination OK. Frontier Electronics, Box 218, Lehr, ND 58460

Classified Ad Deadline Noon

Oct. 10 for Nov. 1994 Issue

Nov. 10 for Dec. 1994 Issue

Boxed, Photo, & Display Ads - 1st

FOR SALE: EICO 315 signal generator, mint condition, 100% original, manual and tested; this is the best signal generator that Eico made - \$45 + UPS. Mervyn Ellsworth, 2309 N. 25 St., Boise, ID 83702. (208) 345-6878

FOR SALE: Precision 10-12 tube tester/manuals - \$40. Supreme 589A tube tester/manuals - \$40. Homemade DC v/ohmmeter, neat - \$7. Radiola 33 w/T, cheap - \$45. Emerson 149, nice - \$75. 1948 Zenith Cobra Deluxe changer - \$15. Zenith 6S3827, wood table, missing back/knobs - \$25. Two Zenith 6G801's (E.O.R. 2, p. 204), for - \$50 Silvertone Model 1, needs paint - \$25. RCA table models 9-X-641, 8-8-8D, 56X3, all for - \$25. Silvertone 4663, 1938 - \$60. Classic Radio & Television, RR 1, Box 393, Solon, ME 04979. (207) 643-2799

FOR SALE: Philco 52-939, black - \$60. Philco 52-939, ivory - \$65. Philco 49-506 - \$95. Philco PT-42 - \$35. Philco 46-420 - \$45. Philco 46-350 - \$40. Philco 60 cathedral - \$150. Philco 38 cathedral - \$150. Philco 51-629 - \$30. Philco 51-537 - \$30. Philco 41-221 - \$45. Philco D655-123 - \$50. Bob Masterson, Box 172, Valley Cottage, NY 10989. (914) 353-3151

FOR SALE: Fada Temple 252, yellow, hairlines, wrong knobs - \$220. Fada 175A batt. set with tubes, exc - \$160. Fada 224 Deco, ivory - \$40. Crosley 10-135, white, exc - \$115. Crosley E20MN - \$65. Crosley E-10-CE, green - \$85. Bob Masterson, Box 172, Valley Cottage, NY 10989. (914) 353-3151

FOR SALE: The following interesting radios: A streamlined curved side wood Art Deco GE Model H-622 - \$125. Bendix (ivory) Model 111W - \$100. Truetone ivory Model D-941 (E.O.R. 2, p. 193) - \$150. Larry Drago, 383 Lincoln Dr., Cheshire, CT 06410. (203) 272-6030

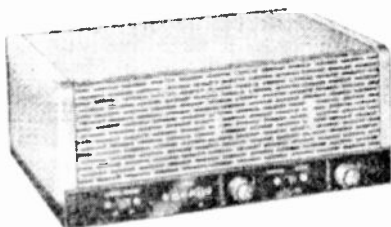

WANTED: Top \$\$ for Lafayette KT- or LA-310. King Harrison, 4755 Walton Creek Rd., Indian Hill, OH 45243. (513) 977-3153, anytime

FOR SALE: OST 1934 thru 1949 in binders - \$285. TU6B for BC-375 3000 to 4500 Kc, unused and clean - \$45. Detrola camera, made in Detroit - \$45. All plus shipping. William Ernst, 1619 Campbell Rd., Comins, MI 48619. (517) 848-5002

WANTED: Battery sets with peepholes, tap switches or unusual circuits. Craig Ball, 10101 Oak Hollow Cir., Austin, TX 78758. (512) 837-8129, 8-10 pm

FOR SALE: Philco 70 restored - \$265. Edison Standard cyl. phono - \$375. Lumitone The Bomb lamp radio - \$110. Lucky xstl wristwatch radio, 60's, Japanese, N.I.B. - \$90. Stewart-Warner #305, battery - \$70. Radiola #18 - \$50. WWII U.S. Army suitcase phono - \$55. 21" Predicta CRT dud - \$30. AK F2 spkr - \$30. 5H4D Trans-Oceanic - \$30. Sonochorde cone spkr - \$18. Bearcat IV scanner - \$12. 1916 Victor VV XI phonograph - \$225, can't ship. Zenith #975 AM/SW console, 1934, as is - \$85. J.L. Acciavatti, PO Box 231, Southborough, MA 01772. (508) 476-3229

FOR TRADE: 1938 Scott Phantom in McMurdo Silver oxford cabinet. Altec Voice of the Theater A7 speaker. Jensen Imperial Reproducer w/15" duplex. Pair, Polk S4 speakers - \$210. **WANTED:** Grebe CR5, 8, RORD, RORR and literature. Frank Hagenbuch, 1440 Lafayette Pkwy., Williamsport, PA 17701. (717) 326-0932

FOR SALE: The following Philcos: Mod 610 shoulder tombstone w/no speaker, Mod ? - \$100. Larry Drago, 383 Lincoln Dr., Cheshire, CT 06410. (203) 272-6030

WANTED: White plastic buttons for a Bulova 180 series clock radio. A Dynamic 8 transistor radio Model DTR-820, have trades. Any Sony or Tokyo Tsushin Kogyo 9v batteries, Realtone batteries and others. Mark Malin, 135 Ocean Pines, Berlin, MD 21811. (410) 641-5877

WANTED: Advent tweeter. Allied early 50's cats. Altec 515 driver, 333 amp. Brook 10. Ionovac cells. Sams AAs. Triode amps. WE 728, 713 drivers, 31 horn. Tom Morgan, 1021 Claremont St., Lincoln, NE 68508. (402) 475-2510

WANTED: Desperate: Need schematic and alignment procedure for Heath Mohigan GC-1A, also Gonset Communicator IV schematic. Both work but would like to check alignment anyhow, also will accept offers. Robert W. Butt, N1KPR, The Key Doctor, 8 Little Fawn Dr., Shelton, CT 06484. (203) 924-1120, 9-9 EDT

WANTED: Wood radios with chrome, aluminum or metal grilles for my collection. Will pay above retail or trade generously. Please don't hesitate to call or write if you think you might have a radio of interest. Mark V. Stein, 2109Carterdale Rd., Baltimore, MD 21209. (410) 466-2814, evenings and weekends until 9 pm EST. Fax (410) 466-0815

FOR SALE: Crosley D25-TN - \$60. Howard 901-A - \$30. Zenith Royal 275, missing logo - \$20. Arthur Kreitner, 2013 East Belle Ave., Belleville, IL 62221. (618) 233-5610

WANTED: Hallicrafters Sky Riders with entire front panel silver color; also S-30, S-33 S-35 pan adaptor, SX-112, HT-2, HT-3, HT-8, HT-12, HT-14, EP-132; wood console speakers R-8, R-12; parts, advertising & memorabilia. Chuck Dachs, The Hallicrafter Collector, 4500 Russell Drive, Austin, Texas 78745

WANTED: AN/TRC-10 radios; AN/PRC-1; AN/PRC-5; M-209 Cipher machines; any radios beginning with letters "SS" (example "SSR-5"). Keith Melton, Box 5755, Bossier City, LA 71171. (318) 747-9616

SOLID STATE VIBRATORS for most automobile radios 1932-57. Exact duplicates of originals in metal cans. Synchronous, Non-sync, European. One-year guarantee. Dealer prices. Free catalog. Order toll free: 1-800-WE FIX AM. Visa, Mastercard. Antique Automobile Radio, Box 892, Crystal Beach, FL 34681. (813) 785-8733

ELECTRON TUBES: Over 1 Million Tubes in Stock. Buy & Sell. Daily Electronics, 10914 NE 39th St. #B-6, Vancouver, WA 98682. 800-346-6667. 206-896-8856. 206-896-5476, fax

WANTED: Collins Radio Company Catalogs, promotional literature, manuals 1933-1983. Jim Stitzinger, 23800 Via Irena, Valencia, CA 91355. 1-805-259-2011



FOR SALE: Your wife dresses up the house for Christmas, the kids dress up the dog. Now you can dress up your classic Zenith for the season. Reproduction of original window banners 4" red ribbon 5' long, reads: Have a Zenith Christmas take me home! \$15 each (add \$1.50 for bow), postage paid. (US). Jon Prael, 2733 Wood Eagles, St. Charles, MO 63303. (314) 947-1543

FOR SALE: Collins radio test equipment: CS12 audio speaker cabinets. AC metered rack control 0 to 150v 28v, 8 amp rack variable supply. Antenna control panel from NASA. N.I.B. S-line log book. Thermal transfer voltmeter with Galvanometer, AC current shunt and thermal balancing unit. Manuals: HP 4193A Vector impedance, spectracon freq. dist. amp 8140 and 8140 VT. S-Line S-meter. Bill Coolahan, 1450 Miami Dr., NE, Cedar Rapids, IA 52402. (319) 393-8075

FOR SALE: AK 735 - \$350. AK 20 - \$100. RCA R73 - \$175. RCA 7X - \$185. Philco 60 - \$175. Clifford Schoen, 549 Fulton St., Seymour, WI 54165. (414) 833-2429

WANTED: Chassis for Philco 42-390 console in working condition. Dan Kerr, 40 Carroll Rd., East Hartford, CT 06108. (203) 289-3685, after 6 pm

WANTED: Ballast tube 23.55, M42HG. Robert Rouette, 4000 Cardinal Leger #14, Trois-Rivieres, Quebec, Canada G8Y 2H2

FOR SALE: Working Bulova 100, green, very good condition - \$45 + UPS. A.J. Long, 11830 Heath Rd., Chesterland, OH 44026. (216) 729-8451

BOXED CLASSIFIED ADS WORK! This is a boxed classified ad. These ads can be run more than two months. See the inside back cover for details. Boxed ad deadline: the 1st of the month.



WANTED: Tube Hi-Fi components & commercial amplifiers by Marantz, McIntosh, Tannoy, Acrosound, Brook, Brociner, Fairchild, Hadley and others. Also want Western Electric theater amplifiers, speakers, tubes, & microphones. Richard Sharisky, PO Box 521, Belmont, MA 02178. Phone (617) 484-5784. Fax (617) 489-6592

WANTED/FOR TRADE: Will trade namebrand high quality radios for old fountain pens by Parker, Sheaffer, Waterman, Mont Blanc, Conklin, etc., or pay cash for the pens. Contact: Frank Weissman, 4 Shadbus Ln., Westport, CT 06880. (203) 454-1267, after 9 pm EST

WANTED: Vintage Electronic Music Synthesizers and modules by the following manufacturers, especially the listed models. Aires Modular, System III. ARP 2500. Buchia Modular, 100, 400. E-mu Modular. EML Electrocomp 100, 101, 200. EMS Synthi A, Synthi AKS, VCS3. Korg Modular PS-3100, PS-3200, PS-3300. Moog Theramin, Modular, Series 15, 35, 55. Oberheim SEM modules, 2-, 4- & 8-Voice Systems. Paia Modular 2700, 4700. Roland Modular Systems 100, 700. Serge Modulars, System 79. Synton Modular System. Call and surprise me; make my day! John V. Terrey, 498 Cross St., Carlisle, MA 01741. (508) 369-9770. Fax: (508) 371-7129.

FOR SALE: Collins ham and military; 51Q; 51J-3; 51J-4; USN SSB convertor; Millen SSB convertor; RAK-RAL7; BC610 coils; SP-600 power transformer and parts; SX-42 with R-42 speaker; Radio handbook 12th; Hiram Percy Maxim, hardcover; Bud field strength meter; USN-LMB freq. meter. Bill Coolahan, 1450 Miami Dr., NE, Cedar Rapids, IA 52402. (319) 393-8075

FOR SALE: Unusual early Arcturus 127 blue tube (taller base, brass pins, tipped), nice - \$20. Ralph Kemper, 297 - 27 3/8 Rd., Grand Junction, CO 81503. (303) 243-2576

WANTED: CB radio tram TR-27E, Browning Eagle. Jukeboxes: buy, sell, repair. Mike Fulper, 6211 Cubbinson Rd., Cumberland, OH 43732. (614) 638-5059

WANTED: GE Model 417, 5-band console, floor model radio. Has (2) shortwave bands, (2) FM bands, AM & a 78 rpm record player. Also looking for wireless record players, especially Motorola. Ray Rice, 525 E. 4th St., Newport, KY 41071, or call (606) 491-7469, anytime

FOR SALE: Zenith 6D628 - \$110. GE 19 teardrop-shaped remote phono, Vassos - \$125. Lionel promo, Pilot Jr., white Plaskon - \$350. Airline 62-446 teledial black Bakelite - \$175. Emerson BA199, no back - \$95. Zenith Glass Rod - \$275. Crosley 11-115U, red - \$175; tan - \$160. Emerson 31 Repwood tabletop ca. 1934 - \$175. Empire mini-cathedral - \$95. Majestic 5T10W Zephyr, white - \$110. Rare Detrola wood & beetle plastic - \$195. Dahlberg pillow, white, missing extension speaker, #4130 - \$150. Wilcox-Gay A-15 metal sunrise grille tombstone, very Deco! - \$275. Emerson DB-315 cone grille Ingraham cabinet - \$95. Zenith Crest - \$125. Farnsworth GT-051 Bullet - \$125. Majestic Studio 59 aluminum grille mini-tombstone - \$450. Extremely rare RCA 96X, Vassos designed, Bakelite with tan Plaskon knobs & grille - \$425. RCA 4X4 kitchen radio white mini-tombstone - \$125. Zenith 5F216 cube - \$110; 6F126 - \$115. Stewart-Warner Varsity 07-5B, white - \$295. Grunow chrome-grille mantle - \$145. Arvin 522A midget metal - \$115; #444 midget metal - \$70. Emerson/Ingraham Memento - \$165. Approximately 200 more! See what we picked at Elgin and Rochester! Send \$1 or (3) 29c stamps for newest photo catalog. Every set illustrated, including those listed above to: Radiomania, 2109 Carterdale Rd., Baltimore, MD 21209. (410) 466-2814, evenings and weekends until 9 pm EST. Fax (410) 466-0815

FOR SALE: N.I.B. Mallory volume controls, 500K and 1 meg., audio taper - \$2.50 ea., SASE for spec. sheet. Plug-in coil forms and winding data, SASE for data sheet. B&K Model 801 capacity analyzer, users manual, checked out - \$30 + \$5 shpg. Radio-electronic books - SASE for 4-page list. RCA Type WR-50B, RF signal generator, includes user manual - \$25 + \$5 shpg. James Fred, R1, Cutler, IN 46920. (317) 268-2214

WANTED: Broadcast-type MICROPHONES. Early carbon, condenser, ribbon, dynamic, etc. Cash or trade. James Steele, PO Box 620, Kingsland, GA 31548-0620. (912) 729-2242

MESSAGE: July 7-9, 1995 are the dates for EX-TRAVAGANZA '95. Mark your calendars now and come help us celebrate our 10th anniversary at one of the largest and best antique radio conventions in the country. Michigan Antique Radio Club, PO Box 585, Okemos, MI 48805.

FOR SALE: IM1 (#243) N.I.B. - \$75. Sprout (?) (#320) - \$30. IR12 (#244) MBC, volume erratic - \$45. A.T. Shost, 1307 Maple Ln., Sedalia, MO 65301. (816) 827-2655

FOR SALE: American Beauty Deluxe receiver Model AB-5, a 3-dial battery set - \$85 + UPS for 30 lbs. Darrell Combs, 6587 Pacheco Way, Citrus Heights, CA 95610. (916) 969-0635

WANTED: EICO 615 adapter for EICO 667 tube tester. Hal Kravig, 2615 Juneway Dr., Memphis, TN 38134. (901) 388-2857. Fax (901) 388-5102

FOR SALE: Chassis: Majestic 90, Columbia C-25-B, Crosley 170, AK 60, all untested, N/T. Zenith 5-S-250 W/T, Silvertone W/T to fit 1907, 193S or 1957 cabinet. Consider buying restorable cabinet for any of above chassis. **WANTED:** Kennedy VI rheostat knob, Philco 60 dial & escutcheon, knobs for Sparton Jr. Willis Watkins, 11517 Belmont, Kansas City, MO 64134. (816) 761-5701

FOR SALE: About (200) console radios to be sold on site in the Albany, N. Y. area. Many different makes and models in conditions ranging from very good to parts sets. Bring your trucks & vans. They all must go. No reasonable offers refused. Call for details and directions. Marty Bunis, 32 West Main St., Bradford, NH 03221. (603) 938-5051, please call before 8 pm Eastern time

WANTED: Hallicrafters Models S20R, SX28, SX32, SX42, SX88, SX100. Will buy or trade novelties and transistors. Ed Eddy, 1209 E. Geneva Dr., Tempe, AZ 85282. (602) 966-1397. Fax: (602) 956-0491

WANTED: Pa-kette crystal set and Pa-kette radio similar to the one on page 15, A. R. C. August 1994. Newman Young, 722 Reed St., Monroe, GA 30656. (404) 267-5586

FOR SALE: Fada Neutrollette, excellent - \$150. Federal 110 - \$600. Grebe MU1, with chairs - \$275. Radiola RC, excellent - \$325. Two 1920 candlestick telephones, one nicked - \$100 ea. General Radio 1000K oscillator - \$60. All plus S&H. Please call before 9 pm. Wally Worth, 2 W. Elm Ave., Wollaston, MA 02170. (617) 479-4512

Wanted: REALTONE model TR-803, 6 transistor pocket radio ivory case in good to excellent condition. John T. Meredith, 1644 Parkside Circle, Niceville, FL 32578. (904) 897-7734



AUCTION: Jack D. Hortman collection of radios, test equipment, tubes, etc. will be held on October 15, at 10:30 a.m. Auction to be held at Gateway Gallery Auction, 643 Kriner Road, Chambersburg, Pa. 17201, 1-717-263-6512. List available September with auction location, motels and restaurants within 1 mile.

FOR SALE: Transistors: Toshiba 9TM40, imperfect - \$185. Bulova 290, cream - \$75. Realtone TR-1088, chip - \$65. Yaou TR-6 - \$125. Travler TR-282A, mint - \$175. TR-286B - \$110. Philco T7-126 - \$125. Toshiba 8TM294B - \$125. Sony TR-730, mint w/presentation case - \$150. Toshiba 6P15, blue - \$75. Domex T-Bird - \$90. Lots more early and desirable transistors! Send \$1 or (3)29¢ stamps for newest photo catalog. Every set illustrated, including those listed above to: Radiomania, 2109 Carterdale Rd., Baltimore, MD 21209. (410) 466-2814, evenings and weekends until 9 pm EST. Fax (410) 466-0815

WANTED: Parts set or cabinet only for Radiola VIII. Who has a VIII? Hal Kravig, 2615 Juneway Dr., Memphis, TN 38134. (901) 388-2857. Fax (901) 388-5102

FOR SALE: Super nice Zenith 3000-1 with battery pack paperwork. Zenith walnut black dial 6D-525. Zenith communication set 5M20. 1929 Zenith ZE power supply - \$275, \$75, \$150, and \$25. Bill Coolahan, 1450 Miami Dr., NE, Cedar Rapids, IA 52402. (319) 393-8075

FOR SALE: Precision ES-550 wide band cathode ray oscillograph, E-400 sweep signal generator, #1210 portable color pattern generator. Amphenol #860 color commander test pattern generator. Jackson #605 sine square wave oscillator. Sprague #T04 Tel-Ohmike capacitor analyzer and resistance bridge, excellent condition. Riders TV tech files, assorted speakers, more, negotiable. C. Noelle, 20 Waverly Ave., East Rockaway, NY 11578. (516) 887-4551

Victrola Repair Service: Windup phonograph repairs, parts, springs, needles via U.P.S. Rod Lauman, 19 Cliff St., St. Johnsbury, VT 05819. (800) 239-4188, eves.

PARTS for collectors. Hard to find Electrolytics, High Voltage Capacitors, High Power Resistors, Plugs, Switches and more. Free Catalogue. A.G. Tannenbaum, P.O. Box 110, East Rockaway, NY 11518. 516-887-0057. FAX 516-599-6523

WANTED: Pilot Super Wasp. Good Original Condition. Battery or AC w/all colls. BOB GREGA, P.O.B. 391086, Solon, OH 44139

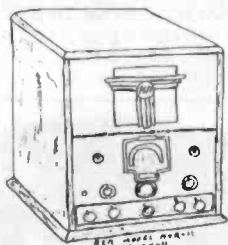

WANTED: RCA Model AVR-11 (AV-11) airport receiver as shown, any condition, housed in a steel tabletop cabinet approximately 20" W x 24" H x 16" D, 1937 vintage. Similar to the ACR-111 but is not the same radio. Chuck Dachis, The Hallicrafter Collector, 4500 Russell Dr., Austin, TX 78745. (512) 443-5027

PANASONIC RF-9000 WANTED: Oversized portable made in 80s. Daryl Jurud, R#1 Box 180, Battle Lake, MN 56515. (218) 864-5725

FOR SALE: Military TV-7 tube testers, government reconditioned, in unopened packages - \$125. Superior TV-50 100 kHz-180 MHz RF gen. - \$25. EICO 145 signal tracer - \$15. Heathkit IG-72 AF generator 20 Hz-20 kHz, metered output - \$25. HP200CD oscillator, 5 Hz-600 kHz, 10v into 600Ω - \$50. Fluke 883AB differential VM - \$70. HP400E ACVM, 10 Hz-10 MHz, 1mv-300v PS - \$60. Coil winding machine - \$38. EICO 950RC bridge - \$35. Heathkit C-3 capacitor tester, tests for leakage, value - \$17. HP3555B transmission test set - \$65. Much more, scopes, frequency counters, tube testers, meters, RF gens, etc. List - LSASE, Kirk Ellis, KK4YP, 203 Edgebrook Dr., Pikeville, NC 27863. (919) 242-6000, evenings

FOR SALE: Emerson 706B, grey case, waffle front, exc - \$60. Hallicrafters SX24, w/speaker, exc - \$130. Price plus UPS. Bob Burleson, 1731 Naudain St., Philadelphia, PA 19146. (215) 545-5726

WANTED: Japanese transistors in excellent condition with good design and colors. Will pay liberally. No easier way to sell. I pay for call and shipping. Thanks. Arnold Finkel, Iron Bridge Rd., Allentown, PA 18104. Call toll free (800) 452-1792

FOR SALE: Delco R-1233 ribbon candy - \$80. Silver-tone 4500 - \$75. Philco 49-501 Boomerang - \$125. Stromberg-Carlson 61Y - \$85. Dahlberg pillow speaker radio - \$225. JVC Videosphere TV - \$100. Jon Steinhauer, 636 Westminster Rd., Baldwin, NY 11510. (516) 223-9878

FREE: RCA 23BK4 B&W picture tube, works. Pickup only. Jon D. Andraesen, PO Box 22, Newton, NJ 07860. (201) 579-6261, after 6

FOR SALE: Reel-to-reel Pentron multi-speed w/reel and mic, case light & dark brown a/o @ 10+ - \$50. Transistors: Telefunken Partner II, @ 10, w/brn case - \$75. Sylvania portable M1288, 2 tone, w/tan case, @ 10 - \$40. Moto M-52B6 metal portable @ 9/P - \$45. Air King M-4603 WD a/m to 1700 dial a/o, n/d, @ 10 - \$50. Detrola molded case M572 BC/SW, 2kn0, @ 10 - \$70. Arvin M-741T table coral a/o, n/d - \$30. TV Emer M1233 7" screen TV-radio, w/c-d, @ 8 - \$30. Cabinet for GE Console, Repwood or die press front, 35" high, @ 9 - \$40. Plus pkg. & shipping. Bernie Samek, 113 Old Palmer Rd., Palmer, MA 01069. (413) 245-7174

FOR SALE: PHONO NEEDLES & CARTRIDGES (ceramic - magnetic). What do you need? Send SASE. J. J. Papovich, 53 Magnolia Ave., Pitman, NJ 08071. (609) 582-8279

WANTED: WWII Japanese Military radio equipment; wireless sets and parts, like spark transmitters, loose-coupler receivers; anything S.S. TITANIC related. Takashi doi: 1-21-4, Minamidai, Seyaku, Yokohama, Japan

ATTENTION: A reprint of the 1921 "MESCO" Manhattan Electrical Supply Co., catalog No. 12 titled "Manual of Wireless Telegraphy and Radio Telegraphy Apparatus," is being considered. This catalog has more than 200 pages, 150 of these pages have one or more line drawings of electrical parts available during the time period. Reprints will be available if there is enough interest shown. James A. Di Ruzza, 2607 Old Troy Pike, Dayton, OH 45404. (513) 233-5004

FOR SALE: Components, meters, transformers, old radios, audio, keys. LSASE for updated list. Roy Krusberg, 7855 Jefferson River Rd., Athens, GA 30607. (706) 548-1050

FOR SALE: Don't let the low prices fool ya! Everything is complete and in good condition. (I need the room). Freshman Masterpiece radios: 3-dial, with internal speakers, pull-down front deluxe cabinet - \$40. 3-dial, slant front panel - \$35. 3-dial vertical panel - \$35. RCA Radiola 100 speaker, works - \$25. Crosley 6-85 console with Dynacone speaker below (1927), nice cabinet - \$65. Sparton 69 Equasonne, with (8) tubes, early AC receiver, clean - \$60. Federal Type H Ortho-sonic, early AC set, with (7) tubes - \$45. Fada dynamic speaker in very fancy wood cabinet, works - \$20. Freed-Eisemann Model 1305-tube, 3-dial, solid cabinet - \$40. Acme dual cone speaker, works - \$30. AK Model 20, all there - \$45. Crosley Tridyn 3R3 (1924), cabinet needs a little wood work on top - \$40. King Model 80 6-tube, nice cabinet, beautiful panel, clean inside - \$55. Sonochorde cone speaker, works - \$25. Lafayette Art Deco style, small cabinet speaker, works - \$25. Panel and chassis for AK Model 33, all there - \$25. Dave Crocker, 6 Raymond St., Sandwich, MA 02563. (508) 888-6236, call before 9 pm

WANTED: Zenith Trans-Oceanic 7G605, G500, dial for H500, battery box for 1000-D. Mark W. Hilliard, N3NBL, 523 N. Law St., Allentown, PA 18102. (610) 432-8089

FOR SALE: Graybar Radiola 60, w/legs, removable for shipping. Parts, meters, tubes. Heath AJ41 tuner. Precision 40 VOM. Eico 221 VTVM. Little Wonder records. Write, details. Need offers, closing out. Ron Champagne, Box 778, Blandford, MA 01008-0778. (413) 848-2806

The 1994 Olde Tyme Radio Services Directory is now available. Find the services and parts needed to restore that old radio or t.v., also included are clubs and publications all categorized and sorted by state for easy look-up. Over 225 suppliers listed, and always adding more each year. Send \$4.00 ppd. Andrew Mooradian, 5 Priscilla Lane, Winchester, MA 01890

FOR SALE: Sams 177 to 1801. Also Sams AR's, TSM's. \$2.50 each plus postage. Maria P. Troutman, PO Box 760, Brewer, Maine 04412-0760

WANTED: Auto Radio Diagrams And Parts. Fred Cranshaw, PO Box 451791, Garland TX 75045-1791. (214) 494-4917

FOR SALE: EMERSON EMERSON EMERSON Approximately 40 Emerson table radios to be sold as a Collection. Estimated value \$3500. Best offer over \$2000. Ray Miller, Box 306, Avalon, CA 90704. (310) 510-1700

WANTED: STEWART WARNER radios 1930 to 1942 and related literature and advertising. Tim Kaiser, P.O. Box 81, Newport, KY 41071. (606) 441-2548

VINTAGE MANUALS AVAILABLE. Lafayette (all), Heath, National, Hallicrafters, Hammarlund, Eico, etc., etc. Over 2,000 manuals available. Satisfaction guaranteed. Call or send two 29c stamps for list. Pete Markavage, THE MANUAL MAN, 27 Walling St., Sayreville, NJ 08872. (908) 238-8964

FOR SALE: Fada 1000 Bullet parts: complete lime green trim set (knobs, ring & handle) - \$350; very clean chassis - \$175; complete orig. back with antenna loop - \$75; junker yellow cabinet - \$25. Also Zenith 807 chassis - \$40. Mark V. Stein, 2109 Carterdale Rd., Baltimore, MD 21209. (410) 466-2814, evenings and weekends until 9 pm EST. Fax (410) 466-0815

FOR SALE: RCA Service 1938-42, Vol. 2 - \$45; 1940 & 41 Philco RMS Yearbooks - \$26 ea. ppd. Gary A. Micanek, 226 Henry Ave., Manchester, MO 63011. (314) 227-7046

WANTED: Looking for an operating manual for my EMC Model 211 tube tester (Electronic Measurements Corp.). Looking for a schematic for my Telefunken Allstrom-Super AGAGIO 55 table radio. Looking for a schematic for a Knight-kit Star Roamer set. Thanks much! Rich Urmano, 40-02 Wilton St., Fair Lawn, NJ 07410. (201) 794-6952

FOR SALE: LSASE for new list, including my collection of bright red radios! Sumter Hickman, KB5QHD, 1008 West 10th St., Plainview, TX 79072. (906) 293-5809

FOR SALE: National NC 173 rcvr. AM/CW general coverage, good working cond., asking - \$135. Rhyne Killian, 4 Walter Cir., Westford, MA 01886. (508) 392-9943

FOR SALE: UX adapters convert to WD11 pin configuration. Body is only 3/8" thick, new condition - \$7.50 ea. plus postage. Leo Gibbs, W8BHT, 701 Brookfield Rd., Kettering, OH 45429. (513) 299-3965

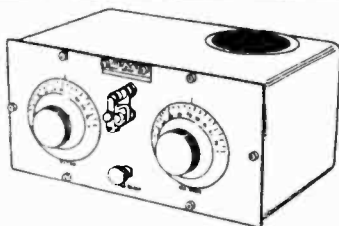

WANTED: Pre-1926 radios by AMRAD. Also, Amrad radio parts, accessories, and literature. Richard Sharisky, PO Box 521, Belmont, MA 02178. (617) 484-5784

WANTED: Radio Callbooks 1900 thru 1927. Bob Arrowsmith, W4JNN, PO Box 166, Annandale, VA 22003. Collect (703) 560-7161

WANTED: Fairbanks Morse console Model 9C or 12B preferred. Charles E. Patterson, 2621 Sweetwater Rd. SP#33, National City, CA 91950. (619) 475-7141

WANTED: Advent 300 12v receiver; Magnecord PT-6BAH binaural tape recorder; Craftsman 500 amp with filter cap under chassis; Sony SLHF-840/860 Beta VCR. Robert Perlstein 17 Vine Street Medford MA 02155 (517) 391-3026

RADIO SCHEMATICS \$3.00 each, Postpaid USA. Send stamp for list of tubes, over 3,000 sets of Sams, books, Riders, test equipment. Joseph R. Forth, 321 Long Vue Acres, Wheeling, WV. 26003. (304) 277-3154

FOR SALE: Motorola 62X - \$70. Motorola 57X11 - \$55. Motorola 6X - \$50. Motorola 5R1 - \$50. Motorola 59R - \$50. Motorola 52X - \$40. Motorola 5X1-3U. black/red, near mint with stand - \$150. Bob Masterson, Box 172, Valley Cottage, NY 10989. (914) 353-3151

FOR SALE: Silvertone table Model 4763 w/magic eye, needs escutcheon - \$80. Airline (mini) Mod 93-BR420 - \$125. Artone ivory (see G.O.R., p. 101), Mod R-1046-U - \$150. Black Setchell Carlson Model 458 R w/remote matching speaker (see G.O.R., p. 123) - \$150. Bendix 0526 A - \$75. Crosley Mod 715 tombstone w/top speaker, excellent condition - \$200. Larry Drago, 383 Lincoln Dr., Cheshire, CT 06410. (203) 272-6030

WANTED: UTC transformers, 6550/KT-88 tubes, Marantz tube equipment, Brook tube amplifiers, Hadley tube amplifiers. Richard Sharisky, PO Box 521, Belmont, MA 02178. (617) 484-5784. Fax (617) 489-6592

WANTED: Vintage tube or solid-state commercial/broadcast/PA equipment, speakers, horns. Kent Elliott, 3143 W. 46th Ave., Kansas City, KS 66103. (913) 677-1824, voice/fax

FOR SALE: Homemade galena crystal radios, and parts. L. Gardner, 458 Two Mile Creek Rd., Tonawanda, NY 14150. (716) 873-0447

FOR SALE/TRADE: Tube audio, send SASE. **WANTED:** MC60, Craftsman 500/550, Scott 399 power transformer, Trusonic horn tweeter. Doug Weiss, 7305 Reynard Ln., Charlotte, NC 28215. (704) 531-7210, mach. 4th ring

FOR SALE: Below wholesale capacitors - Mylars: 10 ufd 30v axial - \$1/4, .47 ufd 630v axial - \$6/40, .47 ufd 400v axial - \$6/40, .0047 ufd 630v axial - \$10/100, .01 ufd 630v radial - \$10/100. Electrolytics: 1 ufd 450v axial - \$5/20, 2.2 ufd 450v AX - \$9/20. Mixed 1/2 W resistors - \$6/1K. Add \$4 for postage. Santech Electronics, PO Box 187, Tappan, NY 10983. (914) 359-1130

Classic Radio

Houston Texas
(713) 460-9820

John & Carole Campbell

Next time you are in Houston, please come see our collection of fine old radios. We are located in the Antique Center of Texas at 1001 West Loop North at Old Katy Road. You will find us on aisle one. Our display is open seven days a week 10 A.M. until 6 P.M.

WANTED: Boxes of old knobs and radio tubes. Please have description and know your price. Eugene Rippen, WB6SZS, PO Box 9, Auburn, CA 95604-0009. (916) 885-6147

WANTED: SBE-450 UHF linear systems; Motorola S1330B signal generator. Robert D. Milligan, KI4MB, 6608 N. 18th St., Arlington, VA 22205-1802

FOR SALE: Western Electric 7A amplifier with 3 good 216A WE tennis ball tubes - \$425. Tim Metz, 221 Wheatland, Fairview, OK 73737. (405) 227-2456

FOR SALE: Brewster Model 9-1084, white - \$75. Brewster Mod 9-1084, brown - \$60. GE Mod E61, cathedral - \$150. GE Little General wood, red w/black trim, Mod E52, (E.O.R. 2, p. 101) - \$60. GE Mod E62 - \$50. AK 20C - \$80. Rare wood Bendix clock radio (E.O.R. 2, p. 48) - \$65. Westinghouse (?) Zenith J-516, white - \$50; brown - \$40. Firestone S-7403-2, ivory, (E.O.R., p. 94) - \$80. GE H-500, brown - \$100. Larry Drago, 383 Lincoln Dr., Cheshire, CT 06410. (203) 272-6030

WANTED: Flybacks. Fly-196, Fly-5082, others. Collecting pre-'53 and 50's color TVs. Glenn Bubenheimer, 27851 Terrence, Livonia, MI 48154. (313) 421-5574



FOR SALE: RCA twin speaker with automobile type cigar lighter, excellent, a beauty, all original, plays, pink plastic - \$150. Motorola 68L11 5-tube battery, ect. excellent, plastic green suitcase, plays, dial top handle - \$150. Westinghouse H-583TJ, red plastic, plays, extra nice - \$75. Radiola III RCA with balance amplifier, nice, batt., audios OK - \$275. Not shown Howard white Bakelite 901A, nice, plays, 8" x 6", square nice dial - \$50. **WANTED:** Zenith 950 Golden Triangle radio, must be nice. Edison Mabry, 715 W. Longview, Mansfield, OH 44906. (419) 526-1175

WANTED: RCA TRK-5 to complete RCA TV collection. Also need good 12AP4 picture tube. Always interested in prewar televisions. Jeff Lendaro, 1107 Logan St., Noblesville, IN 46060. (317) 773-3969

FOR SALE: Emerson 640 tube portable brown marbled plastic - \$55. General Television 51, double-ended tubes, working - \$45. Sparton 500DG, working - \$40. CX-350 tubes, used \$24-\$42. Signal Corp. No 19 MKII tube caddy - \$75. Twenty Radio Boys books: Duffield, Breckenridge, Honeywell, Chapman. Also Tom Swifts. Instructograph, as is - \$10. Heathkit AA151 tube stereo amp - \$30. Echophone EC1, nice - \$75. TUSB tuning unit, no mods, nice - \$45. National NC173, clean chassis, cabinet fair - \$125. G. Stevens, PO Box 704, Longmont, CO 80502-0704. (303) 776-9036

FOR SALE/TRADE: See ad p. 46 Sept. issue. Most items still available. Any reasonable offer or trade welcome, delivery possible. Fred Watson, PO Box 58, McClure, OH 43534. (419) 748-8798

FOR SALE: The following communication items: Hallcrafters S-38C - \$80; 5R-10 - \$75; SX 130 - \$75; HT 18 - \$50; S-94 - \$75; S-40 A - \$100. Heathkit 75 meter SSB transceiver Mod HW-12A with optional auto speaker and converter power supply - \$200. National 157 - \$150. Larry Drago, 383 Lincoln Dr., Cheshire, CT 06410. (203) 272-6030

FOR TRADE: Clean DeForest 7A with loop for old meters/galvos/instruments before 1900. Ye Olde Meter Cellar, Leonard W. Cartwright, 879 Russet Dr., Sunnyvale, CA 94087. (408) 739-6025

WANTED: Montgomery Wards special radio catalogs, 1926 and 1927, fair condition OK. Mike Parker, KB7RSS, 945 S.E. Linn St., Portland, OR 97202

FOR SALE: Large Silvertone table radio with phono and wire recorder - Best Offer. Stephen Sideroff, 46 Dutch Lane Rd., Marlboro, NJ 07746. (908) 462-7987

FOR SALE: Coronado Models 43-6301; C5RA2 438515A; 908. GE FM Translator. Zenith B730R; 8G005YT. Art Collatz, 7818 N. Barker Lake Rd., Winter, WI 54896

WANTED: Zenith R-2000, R-1000, Panasonic RF-2200. Mike Brillhart, 12551 Maiden Creek Rd., Abingdon, VA 24210. (703) 944-4387

FOR SALE: Rider's 1-5 abr. - \$50, 6-11 - \$15. Beitman 1940-42 - \$7. Tube manuals, misc. TSMs - \$5. 2N2089 transistors - \$2. Panadapter - \$35. Cardmatic - \$100.

SERVICES: Repair most models: tube/transistor table, console or auto. **WANTED:** Majestic 210 chassis, Radiola 60, Philco 87 tuning assembly or chassis, bezel Philco 40-190, sets having 2 or three tubes or transistors, parts sets, basket cases. Ray Kushnir, 216 S. Union Ave., Pueblo, CO 81003. (719) 543-8752, 6 - 10 MST

FOR SALE: Fada 1000 Bullet, maroon with butterscotch trim, mint - \$795. Fada 1000 Bullet, butterscotch case only, excellent - \$275. Fada 192A Neutrolette - \$175. Magnus - \$125. Freed-Eisemann #5 - \$75. Home-brew receiver box and amplifier box - \$175. Lafayette tombstone - \$75. Philco 60 tombstone - \$50. Delco 3201 tombstone - \$95. Philco 60 cathedral - \$85. Brunswick cathedral - \$125. Steinite cathedral case only - \$60. Spartan 7-46 console R/P - \$135. GE A66 console - \$125. RCA 19K and 9K consoles - \$135 ea. Acme speaker - \$60. RCA 100A - \$40. Rola - \$25. Loads of tubes, new and used. J. Gary Cameron, 824 Andrews St., Southington, CT 06489. (203) 276-9200

WANTED: Collecting pre-1950 commercially-built ham gear. Transmitters, receivers and accessories. Parts I desperately need: SX-11 dial plate, Millen 4200 Series 500 watt coils, Collins 75A1 dial knob with 3" skirt, cover plate for VFO assembly. Dean Showalter, WA6PJR, 7816 Redberry St., NW, Albuquerque, NM 87120. (505) 899-9376

FOR SALE: Cathode ray tubes, N.I.B.: 3BP1, 3DP1, 3JP7, 5BP1, 5FP7, 5FP14. Any offers? Sweep tubes, N.I.B.: 6CB5, 6BG6, 6DQ6 - \$4; 6DQ5 - \$6; 6HF5 - \$8; 6JB6, 6LB6 - \$10. Herb Ratner, 3542 Westminister Ct., Holiday, FL 34691. (813) 937-7452

FOR SALE: Radiola Regenoflex - \$300. Dictograph with gold painted bell - \$165. 199 tubes - \$14 ea. Crosley 11-103U, orange - \$85. Setchell Carlson 416 - \$50. (600) boxed tubes - \$125. Greg Farmer, 71 Rice Creek Way, Fridley, MN 55432. (612) 571-6062

WANTED: N.I.B. Zenith 1U4 (2), 1U5 (1), 3V4 (1). Alignment instruction Heathkit XR-1 Jim Dolensky, 14N755 Covered Bridge Rd., Dundee, IL 60118. (708) 428-4488

WANTED: Model 17 Philco cathedral, 91 Philco cathedral & Model 19 escutcheon plate. Donald Grant, 1705 Rocky Ford Rd., Ft. Oglethorpe, GA 30742. (706) 861-2877



FOR SALE: Extremely rare 1929 Philco radio/secretary, beautiful original mahogany, ornate design, 65" high x 38" wide, radio all original, works well - Best Offer. For photos & specs, send \$1 and SASE. Richard Rubin, 227 Riverside Dr., Apt. 5-A, New York, NY 10025. (212) 864-8416

FOR SALE: Box BX-34-B containing 72 crystals for BC-610 - \$75. Jim Boellstorff, 608 Newcastle Rd., Marshalltown, IA 50158. (515) 752-8343

FOR SALE: JBL D123 speakers: Grey, 8 ohms, Alnico original cones, exc cond. - \$125 + ship. Tom Crocker, 1706 E. Chevy Chase Dr., Glendale, CA 91206. (818) 246-4757

WANTED: Lee Radio 400 (Bunis 1, p. 93). All Mitchell, Mitchell brand appliances. Lee Mitchell, The Mitchell Collector, 875 N. Michigan Ave., 3412, Chicago, IL 60611. (312) 337-3123, 266-7100

FOR SALE: Radio Craft magazines from 1930s - \$5 ea. Approximately 20 issues with covers good condition.

WANTED: Combination AM/FM tuning meter for Zenith 12H689 Chassis 12B2 phono, Zenith Part #122-16. Vance Rayburn, 2718 Homestead Rd., Madison, WI 53711. (608) 274-3002

FOR SALE: The following best of the best radios: Radiola Grand w/4 WD-11 tubes, mahogany cabinet w/ beautiful brass dials and trim - \$425. Philco 16-B tombstone with 11 tubes, real nice two-tone cabinet, (see Bunis 3, p. 154), needs work - \$250. Delco R1238 Art Deco - \$75. RCA Mod 8X521 Art Deco - \$50. RCA 9X571 bull horn - \$75. RCA 96X1, white - \$250. Emerson U5ABT64(?) with back - \$250. Detrola chrome face as seen on cover of Collins Redux - \$300. Silvertone w/tuning eye, Mod 4763. (Bunis 3, p. 212), needs escutcheon - \$100. Truetone D2610, white - \$175. Zenith 6-D 315 brown Wavematic back - \$150. Zenith 6V-27 tombstone, one beautiful radio - \$275. AK 627, cabinet only - \$100. RCA w/tuning eye, Mod 8772 - \$150. Metz Type 101 AM-SW, AC/DC/portable w/45 rpm record player - \$135. Larry Drago, 383 Lincoln Dr., Cheshire, CT 06410. (203) 272-6030

FOR SALE: HP 855 Series spectrum analyzer with 141S display, RF, IF, program plug ins - \$100. HP 7000A XY recorder - \$50. HP 84443A tracking/counter - \$50. Joe Brady, Box 8 Star Rt., Huntingdon, PA 16652. (814) 643-0603

FOR SALE: Philco 70 cathedral beautifully restored - \$325. Bendix 526 Catalin, needs knobs - \$250. Silver-tone 4500A - \$60. Stewart-Warner 9000B chrome grille - \$65. Philco 42-327 - \$65. Philco 20 cathedral - \$275. Pat Ryan, 2122 Marconi Ave., St. Louis, MO 63110. (314) 664-7080

WANTED: Speaker for Crosley 148, will buy or trade for Riders, tubes, parts, etc. Thanks. Leon Bitters, 4209 Logtown Rd., Lena, WI 54139. (414) 834-3707

FOR SALE: (100) 9 volt batteries - \$50 plus shipping. Kevin Buranen, PO Box 6184, Silver Spring, MD 20916. (301) 871-5880

FOR SALE: Tek scopes 503 - \$50; 535, no plug ins - \$35; 533, no plug ins - \$35; 564B with 3A74/2B67 - \$65; 364 with 3A72/2B67 - \$50. Brush 260 chart recorder - \$50. Ballentine 800 ACVTVM - \$10. Joe Brady, Box 8 Star Rt., Huntingdon, PA 16652. (814) 643-0603

FOR SALE: Transistors: Zenith Royal 56, solar - \$135. Toshiba 8L-420R - \$20. OMGs Suburbia 12 transistor - \$20. Westinghouse H791P6 - \$20. Zenith Royal 750 - \$22. Omega 8TR - \$20. GE P-746B - \$30. GE P-830C - \$20. GE P-851C - \$35. Novelties: Polaroid - \$12; Toilet Paper, N.I.B. - \$30; Santa Maria - \$30; 1931 Classic, N.I.B. - \$20; Smurf - \$8; Barbie Singalong, N.I.B. - \$20. Greg Farmer, 71 Rice Creek Way, Fridley, MN 55432. (612) 571-6062

WANTED: Dark brown plastic dial trim for Philco table Model 41-240. Silver dial and glass for Philco 39-17 table model. Dial glass for Wards Airline console Model 14BR911A. White plastic front for cherry Setchell Carlson frog eye 427-19. Music rack and pedals for Lester Piano radio. Front nameplate for Crosley Buddy Boy Repwood cathedral. Ken Armstrong, Box 216, Storm Lake, IA 50588. (712) 732-3012

FOR SALE: 1929 Hammarlund Comet wood cabinet, needs coils - \$100. Knapp generator, 1916 (see V.R., p. 51) - \$150. Trades welcome. Greg Bogel, 312 Peg Run Rd., Cherry Tree, PA 15724. (814) 743-9028

FOR SALE: New tubes 211, 6336A, 6146, Grammatron 24G, Cunningham CX-301A. **WANTED:** German, Japanese and Australian HRO copies. John Orahodko, 5819 Miller Valley Dr., Houston, TX 77066. (713) 440-5598

FOR SALE: Crosley Fiver #517 - \$50. Philco 19 - \$110. Crosley 148 tombstone - \$130. RCA 86X - \$30. Philco 46-350 - \$25. Philco 38-12 Bakelite - \$50. Emerson 461 - \$35. Emerson 501/502 ? - \$40. GE H-530 - \$85. GE 515 table, C ? - \$25. Belknap (RCA?) - \$40. Traveler 5019 - \$20. Zenith H615Z - \$30. Philco 42-PT93 - \$40. Thanks. Joe Kelly, 537 Stafford Ave., Erie, PA 16508. (814) 459-3910

FOR SALE: Radios in alphabetical order: Admiral 5R11-N-30 - \$50; 5T32N - \$50; 6T01 - \$50. Airline 5B-1548C - \$40. Arvin 950 TZ - \$35. Artone G606 - \$25. AK 30 - \$90. AK 40 - \$60. AK 33 chassis only - \$30. Blaupunkt Vienna - \$60. Crosley 515 tombstone - \$80. E-75-TN - \$30. F5MY - \$50. Dahlberg pillow radio - \$175. Delco R-1233 ribbon grille - \$70. 3201 tombstone - \$95. Electro Home P-107, Canadian - \$70. Emerson 165B - \$50; 414 - \$40; 531A - \$50; 541 - \$40; 543 - \$50; 535 - \$40; 560 - \$40; 578A - \$45; 652B - \$40; 581A - \$50; 602A - \$50; 646B - \$35; 636A - \$55; 754D - \$35; 851B - \$30; B-504 - \$35; CG268 - \$50; 729B - \$40; FU-427 - \$35. Wood Emersons with cabinet by Ingraham - \$50 ea. Eveready 1 - \$95. GE 64 - \$40; 65 - \$40; A-52 tombstone - \$95; 250 - \$25; 535, scratches - \$25; 543 - \$50; 453 - \$25; C242SA - \$25; JFM90 - \$45; L125 - \$40; L740 - \$60; 42-50MC, FM converter, needs dial & dial glass - \$50. GEC by GE in England, SW, mint - \$200. Emerson F63 - \$95. Hallicrafters 541G, metal - \$35. Halton 65-1 - \$50. Kolster 6J - \$175. Jewell Bakelite - \$30. Lafayette B504 - \$25. Motorola 8X265 - \$35; 57X12 - \$50; 59T1 - \$55; 62X - \$60; 65X13A - \$50; 61X11 - \$50; 56R, hairline - \$30; A1N2, small chip - \$35. National Union G619 - \$35. Nordemende Kadette - \$50. Philco 511 - \$95; 38-12 - \$50; 38-14 - \$50; 38-90, case only - \$30; 42-PT94 - \$50; 42-322 - \$50; 46-200 - \$50; 46-420 - \$60; 46-420, N.I.B., case only - \$30; 49-504 - \$45; 46-1203 - \$50; 46-350, no siats - \$25; 49-901 - \$75; 49-909 - \$45; 53-561 - \$35; 46-1201 R/P - \$45; 51-631 - \$30; PT-49 - \$50; D-655-123 - \$25; 37-62 - \$75. Radiola III - \$95; 17 - \$65; 61-8 - \$50. RCA 4X641 - \$50; 6X2 - \$45; 6X7 - \$25; 8X541 - \$35; BX6 - \$35; 9X561 - \$35; 65X1 - \$45; 65X2 - \$45; 66X2, hairline - \$45; X-551 - \$45; 55U - \$40. RJally - \$25; BP-10 - \$45. Silvertone 15X - \$40; 4204 - \$35; 6356 - \$40; 6359 - \$40; 7104 - \$40; 4566 - \$70; 7054 - \$35. Signal kit radio - \$25. Sonora LL5179 - \$50. RDU-209 - \$40. Standard 1040 - \$45. Teletone Bakelite, (1) hairline - \$30. Westinghouse H161 - \$50; H 39775 - \$50; H 30777 - \$50. H476T5 - \$40. WR 12X15 - \$40. Zenith G503 - \$35; M510R - \$50; A515Y, (1) hairline - \$35; H615 - \$30; K510 - \$45; 7H921, no insignia - \$35. S17366 - \$35; S17767 - \$35; A400 - \$30; H500 - \$70; H725 - \$35; H723Z2 - \$30; K725 - \$35; T600 - \$55; S22230 - \$35; 825 - \$35; 6D015 - \$55; 6G001ZYX, rough - \$20. J. Gary Cameron, 824 Andrews St., Southington, CT 06489. (203) 276-9200

WANTED: Junker Colonial Globe, maroon with good top half globe. Conrad Gwaltney, Rt. 1, Box 55, Hiddenite, NC 28636. (704) 632-2921, eves.

WANTED: Cylinder record players and records and pre-1940 candlestick telephones. John Sudduth, 1842 Hwy. 92 N, Fairburn, GA 30213

FOR SALE: X-ray machine floor console control, circa 1931. Deco-style all-metal cabinet with all original gauges, amp meter, voltmeter, dials, push buttons and knobs and switches. Looks like a large Zenith radio console circa 1930's cabinet, silver grey color with black Bakelite knobs etc. Manufactured by the Mattern X-ray Co. of Chicago. Extremely rare one-of-a-kind Deco-style medical collectable - \$450. Frank J. Manzano, 32 Monhegon Ave., Oakland, NJ 07436. (201) 337-5263

FOR SALE: Crystal sets: EAM toy - \$125. Philmore blackbird w/chrome slant front - \$200. Fada detector - \$75. Sure-Set in small oak index box - \$225. Philmore VT-1000 - \$125. Red Rocket - \$65. Larry Drago, 383 Lincoln Dr., Cheshire, CT 06410. (203) 272-6030

FREE!

100 PAGE CATALOG WITH PRICES!

- Communications Receivers
 - Portable Receivers
 - Amateur Transceivers
 - HT's & Mobile Transceivers
 - Amateur & SWL Antennas
 - Scanners
 - RTTY and FAX Equipment
 - Computers
 - Test Equipment
 - Books, Manuals, Accessories
- CALL TOLL FREE: 800-527-4642

TUCKER
ELECTRONICS & COMPUTERS

24 Hour Fax:
314-248-0367
P.O. Box 521419
Dallas, TX 75255-1419

FOR SALE: J.A.N. tubes, new: 6L6Y \$10; 6N7 - \$4; 0D3, 6J7, 6K7, 6L7, 6U7G, 6SA7, 6SK7, 6SQ7, 12SG7Y, 12SK7Y - \$3; 2X2A, 12SN7 - \$2. Used tubes, tested, good: 12BY7, 12AX7, 12AT7, 12AU7, 12BH7, 6BQ5, 6CG7, 6C4, 6X4, 6S4, 6AU6, 6AB4, 6AX5, 6K6, 6V6, 6W6, 6K7, 6J7 - \$1. Herb Ratner, 3542 Westminster Ct., Holiday, FL 34691. (813) 937-7452

FOR SALE: RCA 10" E.M. speaker No. RL-60-1 from mid-1930's, 1250 ohms FC, 3-4 ohms vc - \$18 plus S/H. N.O.S. CRT No. SAP 1 in wood crate - \$25 plus S/H. Radiola 20, good condition, no tubes, w/earphones, not tested - \$75 plus S/H. Simpson Micro ampers meter (0-50) in case w/probes - \$10 plus S/H. Two junker home brews for parts - \$18 for both plus S/H. Merit A-4093 audio trans. PRT1, 9 ohms at 920 MA, sec. 4 ohms - \$3 plus S/H. 1937 Motorola 3-band large & long table radio Model 6T-6Y, electronically restored, beautiful original finish, high quality, super sound - \$85 plus S/H. **WANTED:** Tonearm for Columbia Kolster R/P, has horseshoe-shaped fingers that hold rectangular magnetic cartridge. Empty case for Brunswick automatic Panatrop Model 42. Needs good legs, within criving distance please. Dial Bezel for Clarion Model 47C cathedral. Tube shield for Glortone 26-P cathedral. Karl Doerflinger, 52 Interlocken Rd., East Providence, RI 02914. (401) 434-1116

WANTED: Cabinet for a Western coil & electric Type WC-6 battery receiver. Richard Gentry, PO Box 9274, Phoenix, AZ 85068

WANTED: Zenith Trans-Oceanics: Models 73605, 3000, 7000. Zenith table radios: 6D312, 6D315, 7S633, 7S529, 7S635, 7S933, 6D2615, 6D516. Clock radio #G-516, Clinton wood radio #139, Motorola plastic #41A, Majestic portable #7P-420 with eagle on grille. Admiral portable #6P32 with palm tree on grill e. Frank J. Manzano, 82 Monhegon Ave., Oakland, NJ 07436. (201) 337-5263

FOR SALE: Crosley 52 special deluxe, NT, rough but restorable - \$75. Crosley 50A amp, NT - \$195. Crosley 150 tombstone, restored beautiful cabinet - \$185. Philco 60 cathedral, restored - \$145. Radiola 18 with matching 4-leg sprk cabinet, works & has lamp hood - \$110. Zenith 4V31 tombstone, restored - \$135. Coronad 36L, 1935 tombstone, restored - \$115. AK 185 tombstone, ch. & sprk restored, cabinet rough - \$110. Kadette 36, good working cond. with original finish - \$45. Pilot T601 FM tuner, nice wood cabinet, untested - \$35. Belmont 6D111, nice orig. ivory cabinet - \$125. Magnavox gooseneck horn only, nice decal - \$45. Jewel radic set analyzer pattern 199 for 4-, 5- & 6-pir. tubes - \$30. Old 8mm Univex projector - \$25. Can furnish pictures on all radios for SASE. Riders 8, 9, 10 11 & 12 - \$12 ea. Joe Svihel, 17227 Co. Rd. 54, Avon, MN 56310. (612) 356-7601

FOR SALE: 1937 Philco Model 37-61 tombstone, (4) knobs SW, new coned speaker - \$85. 1937 Philco Model 37-62 table, wood - \$40. 1935 Philco Model 84 cathedral, plays - \$75. 1938 GE Model GD-51 table wood, side knob with push buttons, nice original - \$45. 1946 Arvin Model 444, metal ivory - \$60. 1947 Emersonette Model 540A midget, hairline on side - \$70. 1946 Silvertone Model 6002 midget metal, ivory - \$70. All items plus UPS. George Jones, 1943 Palm Dr., Ferdinand Beach, FL 32034 (904) 261-6533

WANTED: Chassis for Philco Model 19 or ES for parts. Claude L. Fenington, PO Box 1516, Maccn, GA 31202

FOR SALE: National rack mount R.A.S. Mod-5 with power supply and loudspeaker. Includes 6 sets of coils in metal locked cabinet - \$300. National 5TA1 with 4 sets of coils and speaker - \$250. National H.R.O. (variation 4) with 6 sets of coils and speakers - \$200. H.R.O. rack mount (variation 4) with 4 sets of coils, power supply and manual - \$275. Halicrafters SX62A - \$250. Halicrafters SX71 - \$200. 1937 peak vintage receiver and power supply with built-in speaker, resembles SW3 metal boxes - \$250 complete. National 1938 home brew receiver with large brass escutcheons/dials on front, very well made - \$200. Larry Drago, 383 Lincoln Dr., Cheshire, CT 06410. (203) 272-6030

FOR SALE: N.O.S. tubes, RCA 922 - \$18 ea. RCA 6293 - \$14 ea. plus shipping. Kevin Buranen, PO Box 6184, Silver Spring, MD 20916. (301) 871-5880

WANTED: Midwest Radio Corporation radios, parts, tubes, literature. Greg Farmer, 71 Rice Creek Way, Fridley, MN 55432. (612) 571-6062

WANTED: Cabinet for Philco 702. Chassis for Philco 41-258. Knobs and push buttons for a Zenith glass, rod radio. Thank you. Joe Kelly, 537 Stafford Ave., Erie, PA 16508. (814) 459-3910

FOR SALE: Tubes, radio, TV, 40's thru 50's. SASE for list. Lee C. Dickinson, 401-3 Talcottville Rd., Vernon, CT 06068

FOR SALE: Crosley 51, 1924 portable, light rust on hardware, otherwise excellent - \$140. Tele-Tone TV-208 - \$95. Grundig 1055W large Bakelite 3-band - \$55. AK Model 42 - \$65. AK Type F-4 sprk, wood grain - \$60. Philco Jr. cathedral parts set - \$25. Airline 62-149 cathedral parts set - \$10. Arvin 540T red metal - \$65. Packard Bell 5DA, cracks - \$15. Philco PT91 Bakelite - \$20. Majestic 44 - \$85. Majestic 20 - \$35. Halicrafters S38C - \$32. 5R10A - \$50. Cornell-Dublier BF-50 cap. analyzer. (3) controls, (10) push buttons, wood case - \$45. Welch resistance box, glass sides - \$35. General Radio 544-B Megohm bridge - \$50. HP 410B VTVM - \$11. RCA TV sweep gen. - \$8. Oak telephone box, magneto, internal parts - \$35. Precision 10-12 parts set, vg cond. - \$12. Variacs - \$15 ea. Old Stanley wood levels with brass parts - \$30 ea. Add UPS. Steve Leffel, 1790 Edison St., Green Bay, WI 54302. (414) 465-1855

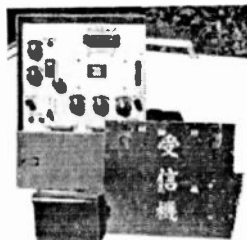

WANTED: Information pertaining to Japanese WWII backpack radio pictured above, plus cost, availability of tubes for same. Thanks! Michael Crain, 3 Hillside Ave., Harveys Lake, PA 18618-9782

FOR SALE: Send SASE for list of information available on vintage radic repair for beginners. Charles Ahr, 2291 Sylved Ln., Cincinnati, OH 45238

WANTED: Philco 70 early model walnut cathedral. Michael Harrington, PO Box 7619, Little Rock, AR 72217. (501) 223-9056

FOR SALE: Tube Audio: Lafayette LA 55 amp + LT-80A tuner, working - \$45 both. Sansui 1000A rcvr with (4) like new 7591A outputs, mint - \$285. Tube CB. Johnson Viking 5 channels, extra xtals, works! Regency CS-27 (?), nice - \$50 both. Rob Taylor, PO Box 10503, Bradenton, FL 34282

FOR SALE: Emerson Little Miracle Catalin chassis - \$175. Larry Drago, 383 Lincoln Dr., Cheshire, CT 06410. (203) 272-6030

WANTED: Jackson tube checker Model 658A. Alan Rollow, HCR 63, Box 885, Jay, OK 74346. (918) 786-4514

WANTED: International Kadette plastic radios wanted by serious collector. Greg Farmer, 71 Rice Creek Way, Fridley, MN 55432. (612) 571-6062

IF YOUR EXPIRATION DATE IS SEPTEMBER OR BEFORE, RENEW TODAY! EARLY RENEWALS RECEIVE AN EXTRA ISSUE!

FOR SALE/TRADE: All prices negotiable: McIntosh 240, no export - \$850; C24 pre - \$110; 1900 rec - \$300. Fisher 800B rec - \$100; 600 rec - \$40. Thorens 125 MKII w/arm - \$225. Fada 1000 maroon/butterscotch - \$775. Majestic 91 console - \$91. Atwater Kent 55, metal cab., vg - \$55. Hallicrafters S108 - \$108; WR7000, table - \$25. Crosley 77 chassis - \$77. Browning RV18 chassis - \$10. Bozak B207A - \$65. Dynaco FM5 - \$40. Bell 3030 int. - \$50; 2425 rec - \$50. Bogen 230 int - \$65. Any offer accepted on these: Scott LT10 monotuner, 342 rec. w/cab., Pilot AF824 pre/tuner, Harman Kardon counter point tuner, Festival rec., N.O.S. Grayt. bases. VTM's, all reasonable: Eico 232, Superior 77, Hickok 215, Precision 840, Lafayette 9950734, Nat. Rad. Inst. 12, Westinghouse PX4. **WANTED:** Fisher AM80 w/cab.; Scott 310C, D, E; McIntosh MR66; C8 stereo; MC 30, 40, 60, 75, etc. Walt Fleming, 182 Plain Hill Rd., Norwich, CT 06360. (203) 889-5018

FOR SALE: Antique tubes, used, tested, good: 6B7, 6D6, 24A, 2525, 27, 35, 37, 38, 43, 56, 58, 77, 84 - \$2; 6A7, 26, 41, 75, 76, 80 - \$3.50; All 7-volt loctals - \$1, used - \$3, new. Herb Ratner, 3542 Westminister Ct., Holiday, FL 34691. (813) 937-7452



WANTED: Paying \$100-\$1000+ for cosmetically decent transistorized radios displaying this Sonly logo (Model TR-72 only needed if "Toyko Tsushin Kogyo, Ltd." is on tuning knob). Also willing to pay \$50 for one complete, working earphone displaying this logo. Bill Burkett, PO Box 2488, Sun City, AZ 85372. (602) 974-4535, or toll-free (800) 507-7234, or fax (602) 974-4323

FOR SALE: Zenith wood 1940 #6S439 - \$145. Zenith Trans-Oceanics: #8G005 - \$125; H-500 - \$125; G500, only made one year - \$125; A600 - \$95; B600 - \$95; L600L, tan leather - \$230. All above Trans-Oceanics are all original, complete, and cosmetically restored. Zenith 6G001 portable - \$45. Zenith 6D015W - \$45. Zenith Y1142, charcoal plastic - \$35. GE #423 burgundy swirl plastic - \$75. Philco 46-250 - \$40. Emerson #883 clock/radio - \$25. Westinghouse #825T - \$25. RCA 56X2, white - \$25. Motorola C2P5, flamingo pink clock/radio, 50's tropical Deco - \$50. Westinghouse H 710 T5, flamingo pink clock/radio, 50's tropical Deco - \$50. Knight Star Roamer, Allied - \$65. Lafayette #PF 200A - \$50. RCA #9Y510 Bakelite radio/phone, plays 45's - \$125. Bendix #636A w/tan knobs - \$75. Olympic radio AM/FM #PR 1590H, turquoise & white - \$50. Sylvania #A22 clock/radio, turquoise & white - \$25. Frank J. Manziano, 82 Monhegon Ave., Oakland, NJ 07436. (201) 337-5263

WANTED: I pay more than anyone for certain items - call! Offering: McIntosh 240 - \$1,000. WE 300 A/B \$350+. 1086 amp - \$4,000. Marantz 7C - \$2,000. Consolettes - \$2,000; 2 amps - \$3,000. Hadley amp - \$1,800. Ionovacs - \$600. Scott: 4100, 4120, 4310 - \$1,000 ea. Leak TL12 - \$1,000. E.V. Patricians - \$4,000. Tannoys - \$2,500. McIntosh MC 225 - \$600. Regency HF 1000 - Call. Metal base EL34 - \$70. Also all tube Marantz, Fisher, Radiocraftsmen, EICO, Grommes, Partridge, REL, Fairchild, Brook, Altec (spkr & amps), HR L.S.T., Kilpshorn, J.B.L., RCA. Tubes: KT88, 66, 7591, 1614, 8005, 50 all types. Pre-recorded R/R tapes. Collecting & trading for 2 decades. Calls returned on items if interest (be specific!). Ed Schneck, 1401 Ocean Ave., Brooklyn, NY 11230. (718) 377-7282, M-F 3-6 pm

FOR SALE: Johnson Viking Valiant transmitter with tubes - \$125. Hammarlund HQ 170 receiver with tubes, uses external speaker, not included, works good - \$125 + shipping. Glen Woody, PO Box 44, Mountain View, AR 72460. (501) 260-8522

WANTED: Dial glass for RCA Model 19K console radio. Chris Russo, 50 North Way, Sea Bright, NJ 07760. (908) 758-9803

FREE CATALOG



TUBES, CAPS, ICs, TRANSISTORS, DIODES, ETC.

QUEST ELECTRONICS

5715 W. 11th AVE., DENVER, CO 80214
PHONE: 303-274-7545 FAX: 274-2317

FOR SALE: Stromberg-Carlson Rosewood 225H - \$325. Brown Bakelite Majestic 51, perfect with Bakelite back - \$300. White Plaskon Emerson 211, (E.O.R. 2), broken foot - \$150. Zenith 5R217 glass rod set - \$325. Black/white trim General Television - \$95. Mantola Plaskon 3-position, brass trim - \$275. Repainted white Zenith 6D311, no cracks - \$165. Stewart-Warner tombstone R 1272, (E.O.R. 2, p. 184) - \$275. Plaskon Majestic Lone Ranger, (2) hairlines, otherwise exc. with back - \$750. Round RCA radio backlighted clock - \$375. Large beautiful original Deco Stromberg-Carlson horizontal table Model 130R, Stromberg-Carlson Deco chairside, exc. original 231F; Truetone (Belmont) 6D110, paint chips, no cracks - \$50. Philco 610 tombstone, sides need refinishing - \$65. 18" Tower ship speaker, excellent - \$195. 20" Vogue speaker, Repwood grille - \$185. Fada Beetle FM tuner - \$95. Philco mystery control box - \$75. No too vintage Westinghouse thermometer - \$40. Lincoln console, oriental motif, non-chrome chassis, with extra chassis, missing speaker. Pilot FM tuner - \$40. Mahogany Howard FM tuner - \$100. Black Emerson 540, invisible hairline - \$95. To reference most Zenith models from 1920 to 1946, we offer our own 60-page 11x17 Zenith Brochure Book, with pictures and specs on most models - \$28.95 ppd. Red and green Zenith dealer window sign - \$475. 1937 cast Zenith radio bank - \$165. Zenith 210 cathedral, refinished - \$425. Zenith cube 5S126, relacquered - \$265. Zenith Radio Nurse, repaired hairline on back, with transmitter - \$395. Zenith 6D315 Wavemagnet - \$265. Zenith Aviatrx, repro knobs. Zenith chrome-front tombstone 809. Zenith consoles: 15U270; 15U269; 15S373A; 12S569; 12S471; 12S371; 12S265; 12S266; 12S267; 12A58; 10S153; 10S155; 10S156; 10S160; 10S491 and 10S589, both with phono; 9S262; 9S367; 8S154; 8S463; 8S359; 7S366; 7S363; 7S260; 7S258; 6S361; 5S56; 75, 410 & many others. Zenith Trans-Oceanics: all tube types available plus: 1000 - \$175; 3000 - \$200; 7000 American - \$295; Taiwanese 7000 - \$350. Zenith chairside: 12S245; 9S344; 9S244; 8S451; 7S240; 7S343, 6S241 bar radio; 6S239, original black & chrome 5S237 & many others. If you are looking for a set not listed, please call for more info. We can & do ship consoles anywhere and we do it right. Zenith table models: 12S445; 4V31; 4B132; 5J217; 5S228; 5S320; 5R216; 5S119; 5G537; 5S127; 6S330; 6D410; 6D525; 5G537; 7S28; 6S527; 6S511; 6S223; 6D511; 6D538; 6D117; 7S634; 7S323; 6S229; 6V27; 6S27; 6B129; 7S28; 8S129, 807 & many others. We accept Visa and MasterCard. All radios unrestored electrically unless noted. Shipping extra unless noted. Satisfaction guaranteed, highest quality possible assured. Send for our free catalog showing restoration and shop supplies, apparel, owner's manual reprints, etc. When in Minneapolis, be sure to visit our retail location just five minutes from the airport. Alan Jespersion/Mike Emery, PO Box 17338, Minneapolis, MN 55417. (612) 727-2489, 8 am to 8 pm Central Time, 7 days. Fax only (612) 727-1908, 8 am to 8 pm. Ans. mach after 4 rings

FOR SALE: German crystal radios, 1950's vintage with catwhisker detector in the original boxes - \$33 ppd. Send payment or for information flyer to: John Hayes, 27 Highland Dr., Henniker, NH 03242. (603) 428-3053

FOR SALE: Detrola Super Pee-Wee, brown, professional crack repair and repaint body to match knobs - \$170. Mike Stambaugh, 506 W. Springettsbury Ave., York, PA 17403. (717) 854-1368

FOR SALE: Lewis, Empire of the Air, brand new hardcover in dust jacket - \$12.50 ppd. Rainy Day Books, PO Box 775, Fitzwilliam, NH 03447. (603) 585-3448

FOR SALE/TRADE: (18) transistor sets - \$150. Miniatures RCA B411, Emerson 558, RCA 8B42, Motorola 5A-1 as lot - \$125. Stromberg-Carlson 635 treasure chest - \$115. RCA 75X11 - \$50. Crosley 9-121 - \$40. Heathkit GR-64 BC/35W - \$25. Trade for cathedral/tombstone. Phil Boydston, 102 Concorde Pl., Mandeville, LA 70471. (504) 845-0867

FOR SALE: Philco Boomerangs, white - \$200; brown - \$175. Larry Drago, 383 Lincoln Dr., Cheshire, CT 06410. (203) 272-6030

WANTED: Unusual horn speakers and pre-1926 radios wanted by serious collector. Greg Farmer, 71 Rice Creek Way, Fridley, MN 55432. (612) 571-6062

MESSAGE: If you collect radios, you'll want to start collecting another early electronic Americana before they're hard to find - portable, electronic calculators. Join the International Association of Calculator Collectors for just - \$12/year and quarterly journal. Sample issue for (3) 29¢ stamps. International Association of Calculator Collectors, 14561 Livingston St., Tustin, CA 92680-2618

FOR SALE: Transistors: Philco Model T-67. Realtone Model 2208. Tabletop white plastic Sylvania 519. GE 518-F white plastic. GE 10A brown plastic. Jeep radio power supply PP112-GR. For list and photos, send large SASE and a buck to help offset: Xerox costs to: John Stratton 701 Waterson Trl., Middletown, KY 40243-1852

FOR SALE: JBL D123 speakers, grey, 8 ohms, alnico, original cones, exc cond. - \$125 + ship. Tom Crocker, 1706 E. Chevy Chase Dr., Glendale, CA 91206. (818) 246-4757

FOR SALE/TRADE: Big band 78 rpm mint records, fragile. Prefer Buffalo, NY pick up. List - LSASE. James J. McGrath, W2IOJ, 2 Centerview Ln., West Seneca, NY 14224-2124. (716) 675-0*60

WANTED: Tape recorders with 3" reels, tape recorders with 2 1/2" reels, and even smaller subminiature tape recorders with 2" or 1" reels, the smaller the better, working or not. I have many good trades. Transistors, tube type or cash. Roger Wood, 124 West Stafford Rd., Stafford Springs, CT 06076. (203) 684-5789, days. (203) 684-5372, nights & weekends



FOR SALE: Detrola 342, excellent, plays - \$50. Emerson 522, excellent, plays - \$65. Philco 50922, extra nice, works - \$75. Edison Mabry, 7:5 W. Longview, Mansfield, OH 44906

FOR SALE: 6SN7, good, used - \$1.50 ea. 27, 24, 35/51, used - \$1.50 ea. All others available new or used. Tube checkers - \$20 ea. as is. **WANTED:** Zenith radios, tubes-all kinds, foreign, industrial, etc. Thanks. R. Do-bush, Arcturus, 3554 W. 105, Cleveland, OH 44111. (216) 647-3908, fax 10 am-1 pm, midnight to 8 am

FOR SALE: 1919 A.C. Gilbert Book of Wireless Instructions, copy with color cover, 64 pages, features all Gilbert radio apparatus for 1919, by C.D. Tuska - \$9.95 plus (2) 29c stamps. Abbottwares horse - \$150. **WANTED:** Cabinet for Kennedy XXX, True Tone horn only, cabinet and panel for Kennedy V, chassis, speaker for AK 84, chassis and knobs for Abbottwares Horse. Charles Haynes, 219 W. Spring St., Marissa, IL 62257. (618) 295-3664

WANTED: Crosley chassis #718 for wooden table Model 718C, cabinet 8HF. Please call: Randy Giles, 4020 San Ardo Cv., San Diego, CA 92130. (619) 792-7376

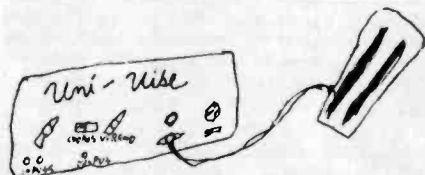

FOR SALE: Fada battery set, 1920's, 5 knobs, (3) X201-A tubes, similar to radio pictured on p. 78 9/94 A.R.C., 2 set headphones inc. - \$200. RCA console, 97K, some veneer flaking on bottom - \$45. Pick up only. Valiant hi-fi 10 x-sistor, orange & white, good grille, tiny chip on side - \$20. (24) assorted Japanese & Taiwanese transistor radios - \$60 takes all. How To Repair Old-Time Radios - \$15. RC-16 tube manual, well used - \$10. Radio Repair, Hertzberg - \$10. Radio & Television News, Sep. '53 - \$5. **WANTED:** Univibe rotating speaker effect. Bill Cherenko, 6 Kate Ln., Metuchen, NJ 08840. (908) 549-2165

WANTED: Philco Transitone #UA52P (as pictured in Collins, Redux, p. 39). Robert Lutz, 9041 Gillette St., Lenexa, KS 66215. (913) 894-1327

FOR SALE: Eight #800 used Radiotron balloon/Globe tubes - \$35 ea. Larry Drago, 383 Lincoln Dr., Cheshire, CT 06410. (203) 272-6030

FOR SALE: (4) issues of Radio Retailing (Dec. 1932, Jan. 1931, April 1928, May 1932), w/covers but rough - \$10 each or \$35/all four. Television News, Vol. 1, No. 2 July 1928 - \$85. Zenith 770B 12-tube console radio - \$395. Midwest 16-34 multiband console in exotic Deco cabinet - \$375. Transistor radios: Pepsi bottle - \$35; Coke AM/FM vending machine - \$35; Kraft Original Macaroni & Cheese Dinner radio - \$40. Aqua GE-910D - \$20. Knox black/silver hi-fi 6 transistor - \$35. Ivory Mastercraft 14 transistor w/chrome handle - \$25. Emerson 704, w/tubes, burgundy/gold - \$35. See you July 7-9 in Lansing, Michigan at Extravaganza '95! Jim Clark, 1292 Starboard, Okemos, MI 48864. (517) 349-2249

WANTED: Audio transformers for Westinghouse RC or DA. Source for the rubber rails? Thanks. Mike Mitchell, 28761 Charreadas, Laguna Niguel, CA 92677. (714) 364-6149

FOR SALE: Reproduction Radiola AR812 door panel instructions for battery connection - \$8 plus SASE. Jim Leckrone, PO Box 263, Bear Lake, MI 49614. (616) 964-2166

FOR SALE: (3) N.O.S. Eimac 4X250B - \$50 ea. (4) N.O.S. sockets for this tube - \$25 ea. Walt Murray, PO Box 231340, San Diego, CA 92194. (619) 271-1858

FOR SALE: E.H. Scott consoles for sale: Scott Super 12 in original McMurdo Oxford; Philharmonic pointer dial in refinished Warrington; early 23 in Windsor; Waverly Allwave 23; Milton Grande Allwave 23; Warrington Allwave 23, refinished; Phantom 19 Warrington; Tasman Allwave 12; Westminster Allwave 15; Regent Allwave 15; Tasman late 23; Lido Allwave 15. We have (3) E.H. Scott cabinet catalogs in excellent condition for sale or trade. We ship consoles anywhere and can probably arrange delivery if desired. Unless noted all radios are unrestored electrically but integrity is guaranteed. Satisfaction guaranteed, shipping extra. Alan Jespersion/Mike Emery, PO Box 17338, Minneapolis, MN 55417. (612) 727-2489, 8 am to 8 pm, 7 days. Fax only 8 am-8 pm (612) 727-1908. Ans mach. after 4 rings

FOR SALE: Freed-Eisemann NR-6 - \$120. Freshman Masterpiece - \$85. Kellogg RFL - \$95. National NC-200 with speaker, nice - \$175. Radiola IIIA - \$95. AK 35 - \$45. AK 24 - Inquire. Tuska 225, no audios or cabinet, nice panel - \$100. Radiola II panel and parts - \$50. Radiola 33, good pot metal - \$45. Philco 18 cathedral - \$250. Grunow Teledial 6Q - \$65. Grunow 5H - \$40. Philco 610 tombstone - \$75. Philco 41-255 - \$55. Philco 48-225, maroon - \$45. Zenith 5-S-125 - \$150. Zenith 15U269 - Inquire. Automatic Tom Thumb - \$115. Philco 38-116 - \$125. Eveready 54 - \$150. Silvertone 1968 - \$95. Crosley 10-135, white - \$85. Parting out Philco 112, Philco 65 and AK 60. Call with needs. General Electric light-up sign - \$225. Philco Auto Radio sign, large - \$175. Seeburg 146 - \$1,400. Victor Alhambra I - \$350. Victor Borgia II - \$1,200. Columbia 20th century - \$2,200. Victor XVI - \$650. Cylinder records, new batch - \$4 ea. **WANTED:** Information on Capehart Amperion. John Hayes, 27 Highland Dr., Henniker, NH 03242. (603) 428-3053

WANTED: Zenith 6D326 (Redux, p. 25), child's console. Mike Keller, 5861 Riverton Rd., Columbus, OH 43232. (614) 866-7725

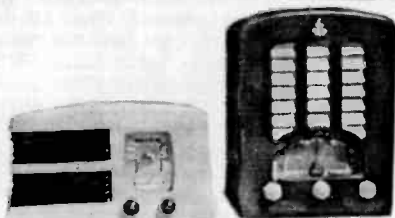

FOR TRADE: Crosley marbled butterscotch with root beer grilles and knobs and Emerson BT245 marbled red louvered tombstone, both excellent and original. **WANTED:** Air King Skyscrapers, especially AK/cuff-link knob models with Egyptian scene. Also unusual colored prewar plastics. Will trade up or down. Mark Alzapiedi, 21 Peach Tree Ln., Leominster, MA 01453. (508) 840-0466

WANTED: Marconi receivers and related items. Many wonderful items to trade or will purchase. Barry Janov, 2454 Dempster, Ste. 416, Des Plaines, IL 60016

WANTED: Panadapter such as Hallicrafters S-35, Heath, etc. Richard B. Ahlvin, 3 Shadow Wood Dr., Vicksburg, MS 39130. (601) 636-9110, evenings

FOR SALE: Philco 20 - \$100. Stewart-Warner R-127-A - \$50. Larry Kays, 6 Old Ivy Dr., Harwich, MA 02645. (508) 430-0462

FOR SALE: Pfanstiehl needles, approx. 1,000 N.O.S. Call or write your requirements with model or cartridge number. Bob Lynn, 26 E. Orchard St., Somerville, NJ 08876. (908) 685-9070

FOR SALE: SASE for list of consoles. Radiola IIIA console, Sparton Equasonne, etc. John Leckrone, Sr., 12174 Lynn St., Bear Lake, MI 49614. (616) 864-3365

WANTED: Wilcox-Gay #A-17 (as pictured in Bunis 2, p. 252). Robert Lutz, 9041 Gillette St., Lenexa, KS 66215. (913) 894-1327

FOR SALE: Tubes, N.I.B. app. 40,000 sold in mixed numbers, lots of 1,000 at - \$200/K. Walt Murray, PC Box 231340, San Diego, CA 92194. (619) 271-1858

WANTED: Any Clark Wireless Telegraph & Telephone Company or TECLA (Thomas E. Clark, Detroit, MI) items be it wireless, radios, literature, otherwise. See you July 7-9 in Lansing, Michigan at Extravaganza '95! Jim Clark 1292 Starboard, Okemos, MI 48864. (517) 349-2249

AUCTION: Vermont estate radio auction of Gerald "Jerry" Cunningham. 9:30 am Saturday, October 1st, 1994, Barre, Vermont. An accumulation of over 60 years of a long-time Barre resident who was known by his radio amateur friends as W1MMV. Directions: in Barre, take Route 302 to Camp Street and follow for 2 miles to Cunningham house. Radios and related items: a large section of Atwater Kents, 1920's breadboards, (2) of Model 10s; Models 20 (3), 33, 42, 45 (2), 44, 40 (3), 21, 32 (2), 60, 67, 30, 35 AK (3), 67 AK 1, F2 Atwater speaker and some odd ones; a Freed-Eisemann Model #48. Colin B. Kennedy Model XV Type 430; Victor Model R-32; Stewart-Warner Model 305; Grebe Synchronphase-seven; Fada Neutroceiver Model 175A; Kolster 6-D; Freshman Masterpiece in sounding cabinet; Browning-Drake Regenaformer, Fada #6 w/ spider-web antenna; Philco 41-295, E.H. Scott, chrome, Pilot Model 173; RCA Model 8772; old oscillograph; antique microphone; Tom Thumb portable radio; early battery RCA Radiola 3-A; Melrose Neutrodyne; AC Dayton XL25; Type E. Federal Orthosonic radio receiver; King Himers Neutrodyne; old Sears battery set Model E; Baldwin Silvertone Neutrodyne; Metrodyne Electric; Day-Fan Fantenna; some plastic ones; old uprights; and Philco w/remote control #40-205; Crosley #5-38; RCA #T-62; Crosley #52 SD; telegraph sounder; Crosley #51 and Trirdyn; other Airline, Philcos, RCAs, assorted horns and speakers; a nice Adler Royal sounding table; Sams Photofacts, (20) boxes; boxes of books and related advertising pamphlets; Philco #40 & 180; another sounding table; Stewart-Warner #30; radio tubes, 100's of them in boxes; radio magazines (QST, CQ, 73); lots of radio cases and parts and pieces; army parts, Crosley adv. books; old car adapter plates and control heads. Also: surveying, household & building items, shop, farm and garden items. Note: if you're a radio buff, you can't afford to miss this sale! Come out and enjoy our Vermont country foliage. Cash or good check. Under tent. Lunch. Rain or shine. Bring chairs. Auctioneer: Richard Atwood, Riverton, VT, (802) 229-9519. For more information contact: Will Cunningham, 12 Summit Cir., Shelburne, VT 05482. (802) 985-4936

FOR SALE: Stunning, impressive 1984 Grundig Satellit 4000. This mint, digital tuning, stereo, radio/recorder is priced at only - \$550. Global radioactivity! Henry B. "Mister Transistor" Cohen, 2459 Eighth St., Fort Lee, NJ 07024. (201) 585-0030. Fax (201) 585-1659

FOR SALE: The following tube amplifiers, tuners, and receivers: Pioneer Stereo Master AM-FM-SW-Marine with tuning eye - \$150. Bell AM & FM tuner Mod 2255 - \$100. Dynakit stereo 70 amp - \$225. Harman-Kardon Mod Epic amp - \$150. EICO Mod 25-10 tuner - \$100. Citation III X tuner - \$150. Bell Carillon Mod 6060 amp - \$225. Scott 382-C receiver - \$100. McIntosh C-8 pre-amp - \$150. Craftsman AM & FM tuner, nice chrome, Mod RC-10 - \$125. Scott 350 stereo tuner - \$150. Scott 222-C stereo master amp - \$100. David Bogen amp Mod PH10 - \$75. Browning tuner Mod 7J 12A w/tuning eye \$125. Clark PA amp Mod PA-10 - \$50. EICO amp Mod HF81 - \$150. Voice of Music tuner Mod 1465 - \$75. Thorn's Mod TD-124 turntable - \$250. Heathkit Mod 9-C amp - \$125. Trades will be considered. Larry Drago, 383 Lincoln Dr., Cheshire, CT 06410. (203) 272-6030

WANTED: 1965 & older B.A., Cramer, Lafayette, Heath, catalogs, plastic dial faceplate for Philco 42-1012. John F. Dube III, RFD #1, Box 3715, Poland Spring, ME 04274. (207) 998-5687

WANTED: Pocket or novelty transistor radios are my game. Always buying more: dead/alive. Ken Wong, 1460 Belleville Way, Sunnysvale, CA 94087. (408) 735-1815

FOR SALE: Zenith 950 Golden Triangle in box - \$250. RCA portable 7BX10, brown - \$85. National Electric, Eveready 2 - \$95. Willard Radio A power unit, A & B charger - \$55. Heathkit transmitter DX40 with VF1 UFO - \$50. Home brew battery set, (1) tube, no top - \$35. Pocket transistors, table radios, test equipment, and more. Send SASE for list. UPS extra. Ray Nowak, 30513 Ednil Dr., Bay Village, OH 44140. (216) 871-8303

FOR SALE: N.O.S. 1950's Kent MG50 crystal diode radio - \$100. Zenith Trans-Oceanic, brown leather A-600L, 1957 - \$115. Steve Dando, 4572 Mark Trl., Copley, OH 44321. (216) 666-7222

Wanted

(Top Prices Paid)

1. Western Electric Tubes, Amps, Drivers, Horns, Speakers, Parts, etc.
2. Tube-type amps from Marantz, McIntosh, ARC, Quad, Leak, Dynaco, Fisher, etc.
3. Telefunken audio tubes & KT-66/77/88, etc.

Also Wanted... Vintage watches from Patek Philippe, Vacheron Constantin & Audemars Piguet

Dcvid Yo — Audio City USA
PO Box 280802
Northridge, CA 91328-0802
Telephone: (818) 701-5633

FOR SALE: The following speakers: AK Series F – \$125. Grigsby Grunow, Hinds gooseneck horn – \$200. Kolster Mod K9 Repwood cone speaker – \$150. Tele-tone wood round w/cutouts Mod 60 – \$125. Stromberg Mod 1-A w/tree bark horn – \$200. DeForest gooseneck horn, no base – \$175. Stewart Warner bronze mantel style Mod 435 – \$100. Radiola Mod 100A, Mod 100B – \$75 ea.; Mod 103 tapestry, nice – \$195. Stewart Warner round pedestal metal with “dancing women” cutouts on front – \$200. Stromberg-Carlson gooseneck horn Mod 2-A – \$175. Voluma “Professional” gooseneck horn Type A Mod A – \$180. Sonochorde pedestal speaker w/pleated silk cloth on one side – \$85. N+K round pedestal speaker, resembles vintage 1936 Desoto Airstream hubcaps – \$185. Radiola 100 – \$85. Larry Drago, 383 Lincoln Dr., Cheshire, CT 06410. (203) 272-6030

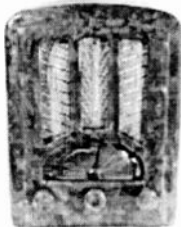

WANTED: Emerson Catalin radios as pictured above and anywhere else under the sun. Actually, it would be a good idea to keep them out of the sun and in my display. Please help me to stock my warehouse. Write or call collect: Rain Buttignig, 214 State St., #7, Portsmouth, NH 03801. (603) 427-1384

FOR SALE: Attention: Think X-mas now! One of a kind hand-painted watches with your favorite radio in striking detail. Choose black or white face; all have black bands. In stock now Philco 90 & 89, Zenith Walton, Atwater Kent IOC breadboard, Crosley Pup, Ozarka 95, Addison red 5-F cat, Motorola 51X15 yellow/red, Radiola 20 with horn, all have 1 year guarantee, just – \$65 ppd in U.S. only. Can also custom hand-paint your watch from supplied color photo only \$5 extra. Photos can't be returned. Please allow 6-8 weeks for delivery. Jay Volke, PO Box 337, Lyons, IL 60534. (708) 442-0817

FOR SALE/TRADE: AK Type M horn speaker, nice. Philmore microphone speaker, N.I.B. Emerson 36 tombstone (Bunis 3, p. 70), Spartan tombstone, airplane dial. Zenith 6D312. **WANTED:** Prewar Zenith wood sets. Bill Timoszyk, 35283 Leon, Livonia, MI 48150. (313) 421-2076

WANTED: Info or manual on a Hickok TV3 B/U tube tester. Also looking for an RCA R-28 chassis, a Crosley 125 chassis, and a chassis for my Zenith Walton cabinet. Thanks! Kent Leech, 16 El Rincon, Orinda, CA 94563. (510) 253-9757

FOR SALE: Jensen Model X speaker – \$110. Rock-Ola E amplifier – \$135. Thanks. Del Tysdal, 812 Broadway, Fargo, ND 58102. (218) 287-2562

WANTED: Hickok tube tester Mod 536 or 539A, 600A. Give condition, cost, include UPS. Write: Anton George, 7203 39th Ave., Kenosha, WI 53142

FOR SALE: Motorola illuminated sign, indoor (fluorescent) 26"x15"x6". Advertising first solid-state television – \$150 prepaid. J.J. Papovich, 53 Magnolia Ave., Pitman, NJ 08071. (609) 582-8279

FOR SALE: Scott 222B tube amp, 60 watts – \$100. (6) different oscilloscopes – \$35 to \$200, call for info. Heathkit WA-P2 mono preamp – \$35. EICO 2715 FM mono 12 watt receiver – \$65. Radiola 42 – \$100. Philco 38-10 – \$75. Bell 2122B 10 watt amp – \$35. Meck RC 6A6 EW3 AM radio – \$25. AR4X speaker (only one) – \$65. Zenith H724 AM-FM tube table radio – \$50. B&K 415 sweep & marker generator – \$55. EICO HFT 90 mono tuner – \$35. Precision #612 tube tester – \$35. Garrard turntable Type A-II – \$50. (34) Sams auto radio (AR) books – \$75. (58) Sams Transistor Radio (TSM) books, incl. #1 – \$250. (6) Sams Tape Recorder (TR) books – \$20. (10) Beitman Radio Books – \$50. Zenith Cobra phono 3L01 – \$85. All prices plus UPS. Bob Lynn, 26 E. Orchard St., Somerville, NJ 08876. (908) 685-9070

FOR SALE: .022 & .033-1600v orange drops – 50¢ ea. .047-1200v orange drops – 60¢ ea. .056-1500v PC leads not orange – 50¢ ea. Quantities available. Harry Pewowaruk, 1535 North 8 Ave., Saint Cloud, MN 56303. (612) 252-9910

WANTED: WW2 radio items of German, Italian, Japanese forces. Also interested in some types of U.S.A. shortwave comm. equip. 1925-1960: Military mobile, Forest or Park Service, aircraft radio, high seas radiotelephone, plus manuals, catalogs, price lists, advertising, photos of any such. Thank you. Hugh Miller, 6400 Malby Rd., Woodinville, WA 98072-8375

WANTED: Westinghouse Vocarola horn speaker, also early RA and DA made in Pittsburgh on ID tag. GE/RCA AA-1520 RF amplifier, AG-1380 loop antenna, UC-1820 Faradon tuning condenser. Stephen C. Brown, 3808 Champaign St., Charlotte, NC 28210. (704) 847-1301

FOR SALE: Radiola 60, no lid – \$50. Rider's 4 thru 6 – \$60. Scott AW12, speaker, coils, escutcheon, power supply – \$400. Farnsworth 1947 TV, poor – \$50. SASE for list. Jim Collings, 12005 Victoria Pl., Oklahoma City, OK 73120. (405) 755-4139

FOR SALE: The Locator index by tube complements of Rider's Vols. 2 through 18, 118 pages – \$13 ppd in U.S.A. SASE for sample information page and index page. **WANTED:** Schematic/owners manual for Knight Star Roamer. Chassis for Hallicrafters 5R31 BC set. Gerald Larsen, 7841 W. Elmgrove Dr., Elmwood Park, IL 60635. (708) 452-7679

AUCTION: Antique radio auction, Sunday, October 30, 1994, 11 a.m. Battery radios, consoles, plastics, Bakelites, transistors, and many more. Our 5th annual. Crosley Pup with tube. Sale held inside at: Eric's Auction Barn, 1000 S. West, Olney, IL 62450. (618) 392-2343

FOR SALE: Rare Leutz 9-tube Phantom with power supply – BO. Majestic 50 cathedral with stand – \$185. Stromberg-Carlson 61W – \$75. Hallicrafters TW25 – \$30. Philco 38-62 – \$50. Philco late 84B – \$85. Puritan 501 – \$25. Zenith 7E02Z, white Bakelite – \$30. Barry McDaniel, PO Box 5544, Little Rock, AR 72215. (800) 755-3326, days

FOR SALE: Over (300) old stock picture tubes, N.I.B. Storage fees up again! Send LSASE. Kenny Smith, Al Smith Company, 3422 N.E. Halsey, Portland, OR 97232. (503) 234-7877

WANTED: Assembly/operation manuals for Heathkit 10-17 oscilloscope. Steve Adams, 919 Poplar St., Moody, AL 35004. (205) 640-2701

FOR SALE: Unassembled Heathkit IO-4560 oscilloscope, N.J.B. Assembled Heathkit IO-4510 dual trace. With manuals. Offers? Paul Geraghty, 1245 Lyon Ave., Waterloo, IA 50702

WANTED: Philco Model 89 chairside radio, also knobs for Model R35 Victor radio. Jack Ghery, 1753 Community Beach Rd., Odin, IL 62870

FOR SALE: Fada 790, brown - \$70. Zenith black dial tombstone - \$140. Garod 5A2, white/blue - \$55. Cabinet for Kennedy cathedral - \$50 or I'll buy your chassis. Looking for microphones and parts. I need a ring for a spring mounted mike, plus other parts, mikes, especially RCAs. Brad Jones, 4801 Crofton Springs Ct., Greensboro, NC 27407

FOR SALE: E.H. Scott items: Laureate power supply - \$75. AW122-dial power supply - \$75. Phantom FM power supply - \$75. Original E.H. Scott literature, send LSASE w/52c postage for complete literature list. See you July 7-9 in Lansing, Michigan at Extravaganza '95! Jim Clark, 1292 Starboard, Okemos, MI 48864. (517) 349-2249

FOR SALE: Tubes, N.O.S. plus few Ind., Mil. and used. Low prices. SASE for list. Heath TC-2 tube tester - \$35. RCA WV-97A VTVM - \$10. EICO 460 scope - \$10. Radios: RCA 8X541 - \$20. Motorola 5T11G - \$7. Charles D. Blair, 815 N. 5th St., Cambridge, OH 43725. (614) 432-4453, 9-5

WANTED: Martian Beauty 1-tube receiver, Martian Special crystal set, Martian Big 4, Industrial Radio Service Baby Ultra. Stephen C. Brown, 3808 Champagne St., Charlotte, NC 28210. (704) 847-1301

FOR SALE: Hallicrafters S-120 shortwave radio, good condition, works - \$25. Dan Salerno, 1104 S. Main St., Taylor, PA 18517. (717) 562-1154, call evenings

FOR SALE: SABA 4000 stereo, factory reverb, remote w/signal search, dark walnut wood, (20) tubes, excellent condition - \$1,800. Jeffrey Weber, 8507 Mohr Ln., Fogelsville, PA 18051

WANTED: 9-S-242, 9-S-244, 9-S-344, 12-S-245 chair-sides, RCA 812K, SX-28, SX-88, Rascal 17. Bob Esinger, 20 Garyschool, Pomfret, CT 06259. (203) 928-2628

FOR SALE: S-19R, to .5H40, mint. Send SASE for transistor, book & tube list, antique radio stamps. John Shidler, NSSZ, 4001 Parkway, Bossier City, LA 71112. (318) 746-8408. Internet atwaterkent@delphi.com

FOR SALE: Craig #500 - \$75. Sony CFM #3335 - \$55. Sony #R-21 - \$30. Panasonic RE-7300 - \$40. Hallicrafters CB-15 - \$30/pr. GE #F-93 - \$90. Zenith 6R311 - \$65. Coronado #1070A - \$110. NEC Galaxie 5-tubes - \$24. Knight Star Roamer, 5 bands - \$60. EMUD (German) #T-7 - \$95. Hallicrafters #S-81, not tested - \$50. Packard Bell phono, AM recorder #1052 - \$45. Brass pointer for 1924 Zenith - Offer. Majestic console #92 escutcheon - Offer. About (100) old knobs, reasonable, send sketch and size with SASE and offer. All above plus UPS. **WANTED:** Chassis for Majestic #151 tombstone and Airline #14BR-531A osc/conv coil for 125A7. Charles R. Boller, 3108 N.W. 91st., Seattle, WA 98117. (206) 782-8318

WANTED: Dial scale for Philco 37-610. Rider's Vol. 2, 15, 17-22. Motorola MC9860P IC for Heath IM-102, or junker meter. **FOR SALE:** Much left from September's ad on page 83. Thanks to those who answered my last ad. Lee R. Savary, KB1PL, 32 South Spring St., Apt. 8, Concord, NH 03301-2427. (603) 228-9055

FOR SALE: The following new radios for October: Stromberg-Carlson Treasure Chest Mod 635 - \$200. AK 185 tombstone - \$200. Westinghouse two-tone rare blue oriental Mod H204 - \$125. Also brown and gold oriental H204 - \$125. Zenith 5D 611 - \$75. AK Mod 20, small wood version - \$125. Emerson 707 B sunburst, red - \$175; 707B, white - \$150. Emerson 587, Series B black, (Bunis 3, p. 74) - \$100. Emerson 646B, white - \$75. Emerson 511 Moderne, white - \$75. Emerson AX-217, maple - \$150. Emersonette, brown, midget - \$150. Motorola, white, 52R - \$75. Admiral (red) 4L25N - \$65. Stromberg 1500H - \$125. GE H-500, brown - \$125. Pilot T-511 - \$75. Stromberg-Carlson C-1 red, black & white - \$75. Truetone D2815, white - \$100. Truetone D2615 Stratoscope, brown - \$120. Philco 38-88 tombstone, rare - \$200. Globe Mod #57 w/half-round dial - \$85. Larry Drago, 383 Lincoln Dr., Cheshire, CT 06410. (203) 272-6030

FOR SALE: Circa 1926 battery sets. Magnavox TRF Model D with oak cabinet - \$150. Mchawk One dial, excellent original finish - \$85. Wallace Kelly, 6910 Verda Vista Pl., Klamath Falls, OR 97603. (503) 882-7595. E-mail wallylk@aol.com

WANTED: 6B (or Amperite AP-45) ballast tube. Knobs for Philco Model 86 and Zenith 15U169. Dial glass for Am-Bosch 620. Thanks. **FOR SALE:** RCA cathedral 142B, extra very nice - \$165. Motorola portables: 5P32Y - \$22; 36B1A - \$25; 66L1U - \$30; 5P21B - \$25; 5P32E - \$22. Stewart-Warner C51T1, repainted and very nice - \$65. Emerson 587B, has bottom crack - \$25. Zenith tombstone 5R135, refinished, has worn veneer small area and fixed in another - \$65. Large Zenith Bakelite AM/FM (2) - \$25 ea. GE 201 - \$30. Farnsworth GT065 - \$35. Telechron 8H59, corner hairline - \$25. Crosley 46FA, nice - \$40. Crosley 11-108U, burgundy, excellent - \$45. All are plus shipping. Lars Roose, 10100 Chapala Ct. NE, Albuquerque, NM 87111. (505) 296-4129, evs. please

WANTED: Riders 18 and up or will buy entire set. Tom Earnest, PO Box 603, San Angelo, TX 76902. (915) 651-9506



FOR SALE: Music Master wood Bell, horn only, real nice decal - \$165. Arvin 442 metal, plays - \$100. Temple G-418, excellent, metal, complete original - \$90; brown, nice, plays - \$60. Clock radio C3300A, excellent, works - \$75. Edison Mabry, 715 W. Longview, Mansfield, OH 44906. (419) 526-1175

WANTED: My wish list: Zenith 5R312 push-button plastic, 7G605 bomber Trans-Oceanic, 6G601 portable. Emerson Little Miracle AX211 and AX212, Teledials, Toasters. Pay cash or lots to swap generously. Offer for superlist or send dollar plus SASE. Steve Lipsky, 1254 Cox Rd., Jenkintown, PA 19046-1207. (215) 884-1817 or (609) 361-8175

WANTED: The following amateur transmitters; Westinghouse TF, companion to the RA-DA; Paragon 2-5-U; DeForest OT-3. Stephen C. Brown, 3808 Champaign St., Charlotte, NC 28210. (704) 847-1301

FOR SALE: Cathedral, tombstones and misc. table radios. Chris Salerno, 124 Jones St., Old Forge, PA 18518. (717) 451-0327, call evenings 6 to 10 pm EST

FOR SALE: Small scalloped-top cathedral (as pictured in Bunis 2, p. 16), nice original condition, plays - \$145. John Koop, 48 Wheelbarrow Ln., Wantagh, NY 11793, (516) 731-6711

AUCTION: Saturday, Oct. 22 at the Seville Antique Auction Barn, Media, Ohio, starting at 10 a.m. with preview at 9 a.m. Directions to sale from I-76 Exit 2 Seville, follow S.R. #3 North 1 mile to sale or from Medina, Ohio, follow S.R. #3 South approx. 6 miles to sale. A nice sale with many beautiful radios, consoles to the hard-to-find transistor radios. Zenith consoles, early Scott console, tombstone and cathedral radios, wood and Bakelite tabletops, DeWald 501 Catalin, Telechron Catalin clock, transistor radios, Regency TR1s, micros, boys radios, novelty radios, crystal sets, early battery sets to include AK-10 breadboard, nice Michigan one tube, Radiola 25 w/loop, Stelnite AC w/199 tubes. Many more battery sets, horn speakers, mantle and box speakers, amateur radio rcvr and xmtrs. Telegraph keys, old headphones, many different pieces of military radio equip., including Russian tank radios, test equipment for radio and television, several thousand tubes, lots of collectible tubes, brass base-tipped, and blue Arcturus, some very early tubes, automobile radios, many are circa 30s and 40s with many accessory parts and books, phonographs, Edison Fireside, Edison Standard, both with large horns, Oak T.T. Victor, other floor models. Bing Crosby jukebox, 1936 Mills jukebox. Records 78 rpm, 45 rr, 33 lps, Vogue #744 and #707, Edison cylinder and Diamond disc records. Other collector records. VIntage hi-fi amps, guitar amps, and guitars. Chalk and cloth Nipper dogs, radio games, Radio Boys books, Radiocraft, Radio News, CQ, QST, and other magazines. Many parts for radio repair, resistors, capacitors, etc. Several pieces of radio advertising. This will be a large sale with some items being sold in group lots. We have a listing for all transistor radios, make-model. Also a list for novelty radios, over a hundred of these and a general listing for the main auction. Please send a SASE for a list. Our next radio auction will be in Feb. of '95. We hope to see you at the auction. Tech. and historical assistance: Robert Dobush, Arcturus Prod.; Cledis Estes, ARS, W8OAZ; Kim Graca, Historian, Collector; Bob Ready, Classic Radios; John Estes, Assisting Auct. Estes Auctions, Richard Estes, Auctioneer (ARS, K8LRY, member AWA, MARC, SPARK), 7404 Ryan Rd., Medina, OH 44256. Phone/fax (216) 769-3987. Sale day (216) 769-4910

FOR SALE: RA-DA - \$495/pair. Clapp-Eastham HR - \$525. Crosley Ace Type V - \$325. Western Electric 7A amp - \$195. Radiola III - \$135. Radiola IIIA - \$165. Leon Lambert xtal set - \$225. WLS Silvertone horn - \$130. RCA UZ1325 horn - \$85. Small Murdock horn - \$155. All are in excellent condition. Ian L. Sanders, 16725 Wild Oak Way, Morgan Hill, CA 95037. (408) 778-7547

FOR SALE: Large collection Sams TSM, AR, VCR, MHF, Computer Facts, TSM, distributor's stock liquidation, quantity pricing. Noel S. Ilg, Ye Olde Radio Shoppe, 228 Beck Rd., Avon Lake, OH 44012. (216) 933-5668. Fax (216) 933-8864

FOR SALE: Zenith Royal 500E, burgundy - \$65. Steeling/Crown PR535C small 4-tube portable - \$30. Wales B-46 small 4-tube portable - \$30. Emerson Wondergram miniature record player - \$45. Emerson 508, Ivory flip-lid tube portable - \$65. RCA 2B404 tube portable - \$15. Majestic 6P1 suitcase portable - \$20. Richard Haneline, 3600 Cuba Blvd., Monroe, LA 71201. (318) 387-6764

WANTED: Telefunken 12AX7/ECC83, mark new - \$10; also ECC803S gold pins, EL-156 Siemens E83CC old, E80CC gold pins, U.S.A. 7729 N.O.S., WE715A/B w/socket N.O.S., WE 420A, 422A, 349A, 293A, 306A, 345A, 351A, 412A Tannoy 15" Monitor, gold, red, silver, black w/Xover, Altec 60 4/B/C, 605A, 515/B, RCA 15" SP MI-1444, MI-9449A JBL 150-4C Garrard 301 (60Hz). Kouji Matsuo 6-2, Tsurumi-cho, Beppu-shi, Oita 874, Japan. Fax: 81-977-23-9579

FOR SALE: Kolster 6B with built-in horn - \$125. Bob Barnes, 511 N. Chestnut, Monroe City, MO 63456

FOR SALE: Analog test instruments for inventors, radio station clock, 1900's catalogs, electrical & alarm books. Henry Weiland, 8946 West Grantosa Dr., Milwaukee, WI 53225. (414) 463-4681

FOR SALE: Toshiba 7TP-352M - \$65. Zenith 500, maroon - \$45. Channel Master 6510 - \$20. Philco 49-905 - \$25. Zenith H511 - \$25. Weston 676 tube tester - \$65. Telequip phono oscillator - \$25. Norelco Electronic Educational Kit - \$25. **WANTED:** Transistor radios. Jon Hall, 39 Spring Oaks Ln., Ruckersville, VA 22968. (804) 985-3827

WANTED: Transistors: Crown TR 666, 670, 800, Global 6R-711, Realtone TR555, Candle TR-8. Thanks. Jeff Hollinger, 606 Valle Vista Ave., Oakland, CA 94610. (510) 451-6067

FOR SALE: H500 Trans-Oceanic, fair cond., untested - \$40. Trans-Oceanic Y600, with original paperwork, poor cond., untested - \$30. Signal telegraph key - \$15; Mesco telegraph key - \$15. Robert Bailey, 2451-3 Whispering Woods Blvd., Jacksonville, FL 32246. (904) 642-5837, ans. mach. after 5 rings

FOR SALE: TV-10 tube tester with roll chart - \$50. Large SASE brings descriptive list of other test equipment of tube and early transistor vintage, some newer. Ed Greeley, PO Box 50871, Mobile, AL 36605. (205) 479-9931

WANTED: 5X chrome tube screening caps for McMurdo-Silver Masterpiece VI. E.H. Scott Chippendale cabinet (Silver Ghosts, p. 67) with or without Philharmonic chassis. Voigt mains energised and permanent magnet loudspeaker drive units, 1936-1950. Single McIntosh MI-75 mono block (rack mount), amplifier (KT88's), or may trade my lonely mint example. 3X knobs and service information on H.H. Scott mono amplifier Model 99B. John Howes, 11 Crendon Pk., Southborough, Tunbridge Wells, Kent, England TN4 0BE. 0892-540022

FOR SALE: Many Sams Photofacts available from Set 306 to 2000 - \$2 per set plus postage. Electronic books, mostly on television. Send SASE for 3-page list. Bill Olson, Rte. 1, 4023N - 2000E, Filer, ID 83328. (208) 326-4962

FOR SALE: Novelties: Wristwatch - \$45; Knight helmet - \$35; Radio Gobot - \$30; Cathedral radio - \$15. Joe Matuska, 2523 Sunset Blvd., Steubenville, OH 43952. (614) 264-7806

FOR SALE: Radios, parts, tubes, manuals, collectibles. SASE for list. David Davies, 701 W. Albee Rd., Nokomis, FL 34275

WANTED: Fada 260, 263, 242, 246, 254, 354, 454 or similars with metal trim. Also wanted: early radio drama transcription discs and current music radio shows on LP/CD (Westwood One, Media America, etc.). Merrill Mabbs, 709 Pluma Dr., Rapid City, SD 57702. (605) 342-4090

WANTED: HW-16, mint or unassembled. Also, other tube ham equipment. John Hoyler, 4604 W. Bayshore Dr., Bacliff, TX 77518

FOR TRADE: Exchange my Sony 320 for your Panasonic 8000; or? **WANTED:** Sideli, Blast, Grinder-Fathauer, Hawes, other historical books, old wrth [?]. Write to: Sabino Fina, 83042 Atripalda (AV), Italy

FOR SALE/TRADE: AK #545; AK #725, clean; Radiola 3, excellent in box; RC unit (RADA); Clapp-Eastham, oak; Western Electric, continuous wave microphone, 1915; Radiola Grand; Radiola 10; Grebe Synchron-phase, early model; Majestic #194 mini cathedral; pink Zenith Royal 500, mint; Firestone sub-miniature tube, yellow; cathedral radio crystal set, black/red rocket crystal in box; Philmore crystal radio (small cube) in original box; Silvertone bullet #6161, white; EKCO #MBP253 portable; Plaskon Puritan radio, ad set; Truetone D2210; Fada #290C console, gorgeous; Zenith #12S471, nice; Setchell Carlson, maroon & white frog-eye Plaskon; Edison table model radio; wild Chinese lamp radio, porcelain & lucite '50's, etc. Please write or call: Rain Buttignol, 214 State St., #7, Portsmouth, NH 03801. (603) 427-1384, or fax (603) 427-2039

WANTED: 1-tube GZ41, set of push buttons and knobs for Crosley console #02CA, also a junker chassis w/o tubes for parts model Philco 40-165. Also Sprague Model TO-6 Tel-Ohmike capacitor analyzer, also Jackson #112 condenser tester for parts. **FOR SALE/TRADE:** Hallicrafters S-37 in all its splendor, 1945, manual is still inside - \$275 + SH or trade for (2) nice metal Arvin 444 AH Ect. Carlos Gimenez, 15091 Shamrock Dr., Fort Myers, FL 33912. (813) 482-0198

FOR SALE/TRADE: Philco 70 - \$300. Will trade for brass electric fans, literature, catalogs & parts Rick Padron, 1005 E. Idlewild Ave., Tampa, FL 33604. (800) 320-FANS

FOR SALE: When in Salt Lake City, buy-sell at: Tom's Closet, 251 S. State #10, Salt Lake City, UT 84121

WANTED: Good, bad indicating meter for a WRI Model 70 tube tester, most NRI checkers seem to use the same meter, 3" square. Will buy junker, tester if necessary. Don Maurer, Sr., 29 South 4th St., Lebanon, PA 17042. (717) 272-2481

FOR SALE: Stromberg-Carlson Model 1101 (Bunis, p. 181) - \$65. RCA Model B411 portable, mint - \$55. Detrola Model 571 (Bunis, p. 58), excellent! Sonora w/4 PB & large round dial on top, (pictured Bunis, p. 172).

WANTED: Need a manual or copy of same for a Pyramid CRA-2; cap. & resistor analyzer. Paul Putnam, 406 Gentian Rd., St. Augustine, FL 32086. (904) 797-3236

FOR SALE: People really do like quality radios! They keep getting harder to find and always more expensive. Most keep them, but I sell them. This month's list: Crosley Duette 56TD (Collins I, p. 76), maroon body, gold grille, perfect, working - \$235. (Collins, p.77) Coronado 43-8190 Plaskon - \$235. Small hairline, perfect original Zenith SW tombstones 6S229 Deco - \$295; 5S127 - \$295. These are great. Ozarka similar to 92, etc. has name Kroltzer - \$975. Carco crystal radio early 645. (Collins' Redux, p. 82) Philco Transitone in green/rare - \$235. RCA Radiolette R-5 - \$295. Early mike with springs, exc - \$350. Loose couplers chambe - \$650. Adams-Morgan Co. with gold-colored coil - \$650. Amrad double panel 2634, 2596 radio, exc - \$1,500. Music Master horn spruce - \$475. Gold-colored Dictograph horn, exc - \$395. Black Dictograph horn - \$275. Ultra rare Clapp-Eastham National Radak Jr. - \$750. Atwater Kent 82, orig. working - \$595. Refinished Emerson Strad., exc - \$650. Spartan 7-sided mirror radio - \$2,200. AK breadboard Model 10, all tags - \$1,200. Orig. AK Model 10A, original, all tags, exc - \$1,200. Federal Jr. crystal radio - \$595. Flivver crystal radio, exc - \$195. Howe crystal radio - \$175. Black Air King with clock, no cracks, all original - \$3,500. Radiola 20 - \$195. Radiola 60, exc - \$175. Radiola 26, exc - \$495. Radiola IIIA, exc - \$175. Westinghouse RA-DA - \$275. DeForest Everyman crystal radio, exc orig. - \$895. Signal loose coupler, exc - \$650. Radiola III - \$125. Philco Butterfly radio Model 45 - \$195. Kennedy Model V, refinished, exc - \$635. Viking (Ozarka) Model 599, 5-tube battery radio, looks like a book, early - \$365. AK Model 92 - \$575. Tower ship speaker (cone), small, working - \$265. Echophone S3, exc - \$365. Grunow chrome-front refinished Model 500 - \$185. Radiola II, mint with original instruction book, headphones, etc. - \$795. Mint Philco 90, original - \$595. Zenith Golden Triangle, works - \$175. Amplion AR111 horn - \$650. Small, very early Audiophone Jr., exc, Bristol comp. - \$295. Fada bullet, yellow, no cracks - \$625. Red Emerson Little Miracle - \$1,600. White Mike radio - \$165. Murdock loose coupler - \$475. Tuska Model 225, double panel - \$525. AK 30 - \$125. Crosley 51 - \$125. Philco Jr. Model 80 - \$185. Delmonico Novum - \$95. Shortwave multiband green Crosley, center bullseye, exc - \$175. Grey Crosley left bullseye radio, exc - \$185. Aqua 10-139 chrome-front Crosley - \$195. Saal Bakelite horn - \$185. Mag. M4 horn - \$175. Magnavox R3 - \$195. Magnavox A1R horn-amp with tipped blue tube - \$375. Atwater Kent 944, mint - \$295. Crosley Musicone speaker, works - \$125. All Philco Predicta models available, some Zenith Trans-Oceanics 1000, 3000, 7000, etc. Many fixer upper battery radios. Spartan, Freed-Eisemann, etc. very cheap. (prefer pickup but will ship. Emerson black 888 TransTimer, works - \$195. Many Zephyrs, black Royal 500 Zenith, no cracks - \$95. N.E.C. NT-61, small hairline - \$135. Red in-the-box Micronic Ruby - \$225. Many more, even Regency TR-1. When you are ready for quality radios, call me or stop by and pick some out. The longer you wait, the harder it will be to obtain them. 25 minutes from Manhattan, easy off, easy on Route 80. Remember call first. Eric & Sirelle Fogel, 87 Sandra Dr., Parsippany, NJ 07054. Voice or fax (201) 316-8424

FOR SALE: Filter capacitors 33 mFd. @250 volts, small size 5/8" x 1", use 2 in series for 16 mFd. @500 volts - 50¢ ea., \$22.50 for 50 pcs., \$40 for 100 pcs. Plus shipping. Gerald Cromer, K4NHN, 1014 Summerland Dr., Cayce, SC 29033. (803) 794-1483



COMING RADIO EVENTS

NEBRASKA - Oct. 1-2

MIDWEST RADIO CLUB
 OLD TIME RADIO DAYS
 RADIO SHOW & SWAP MEET
 Nebraska City, NE - Memorial Building
 810 First Corso - Show indoors

10 am-5 pm - Display hours, both days
 Swap Meet in adjacent parking lot

Guest speakers from historic radio stations
 Seminars on Radio Restoration - Awards
 Info: Randy King - (402) 423-9621, or
 Midwest Radio Club, 3017 Orwell Street
 Lincoln, NE 68516-2763

WASHINGTON - Oct. 2

VINTAGE AUDIO LISTENERS AND
 VALVE ENTHUSIASTS
 NEW CLUB FORMING
 SWAP MEET

Poulsbo, WA - Classic Radio
 1127 N.W. Bright Star Lane
 10 am-2 pm

Info: Dan Schmalle - (206) 697-1936

ILLINOIS - Oct. 2

ANTIQUA RADIO CLUB OF ILLINOIS
 AUTUMN SWAP MEET/MEETING

Elgin, IL - Holiday Inn, 345 River Road
 I-90 and Route 31

7-12 am - Swap Meet, west parking lot
 10:30 am - Meeting

Info: Jeff Aulik, 1708 Parkview Avenue
 Rockford, IL 61107 - (815) 399-1902

NEW YORK - Oct. 2

GREATER NEW YORK VINTAGE
 WIRELESS ASSOCIATION
 SWAP MEET

Lake Ronkonkoma, NY - 367 Hawkins Ave.
 North of Long Island Expressway
 lg. white house across fr. Dairy Barn store
 9-12 am

Info: Steve Conklin - (516) 324-3012, or
 Chris Bacon - (516) 981-6538, or
 Chris Leippert - (516) 471-9526

ARKANSAS - Oct. 6

ANTIQUA RADIO COLLECTORS CLUB
 OF FORT SMITH
 CLUB MEETING

Fort Smith, AR - St. Luke Lutheran Church
 Waldron Road, at Free Ferry
 7:30 pm

Info: Paul Tucker, 4700 N. "N" Street
 Fort Smith, AR 72904 - (501) 782-8178

MARYLAND - Oct. 2

MID-ATLANTIC ANTIQUA RADIO CLUB
 ANNUAL PICNIC & MEET

Myersville, MD - Ed Lyon's Farm
 From East or West: I-70 to Exit 42
 From No. or So.: I-81 to I-70 East to Exit 42
 Follow MAARC signs

9 am til Dusk - Meet (rain or shine)
 All Day - Flea Market & Museum Tours
 1 pm - Picnic Luncheon
 2:30-6 pm - Giant Auction

Restoration/Troubleshooting Clinics
 (Bring your problem radio)

Info: Ed Lyon - (301) 293-1773

CALIFORNIA - Oct. 8

CALIF. HISTORICAL RADIO SOCIETY
 NORTH VALLEY CHAPTER
 SWAP MEET/MEETING

Cottonwood, CA - 17347 Deacon Ln.
 8 miles north of Red Bluff on I5, turn west
 on Hooker Creek Rd., 2 mi. to Deacon Ln.
 8 am-1 pm

Info: Chris Galantine, 15853 Ontario Place
 Redding, CA 96001-9785 - (916) 244-2337

OHIO - Oct. 2

BUCKEYE ANTIQUA RADIO AND
 PHONOGRAPH CLUB
 MEETING

Brunswick, OH - Brunswick Library
 3649 Center Road, Rt. 303
 1:30-4 pm

Info: Jim Davison, 4958 E. 86th Street
 Garfield Heights, OH 44125 - (216) 441-3471

Listings on these pages are free to
 antique radio clubs, as space permits.
 Please include date, time, where, direc-
 tions, & information/contact person.
 Submission Deadline - 5th of month.

KENTUCKY - Oct. 8

MID-SOUTH ANTIQUE RADIO COLLECTORS

FALL 1994 SHOW & SWAP MEET

Lexington, KY - Days Inn
824 New Circle Rd. (Highway 4), at
Eastland Shopping Center, and U.S. 60
MSARC rates: (606) 252-2262

8-11:30 am - Swap Meet
8-10:30 am - Old Equipment Contest
11:30 am - Lunch
12:30 pm - Antique Radio Auction
(Consignments and Donations)
2:30 pm - Meeting

Info: Ron Ramirez - (502) 667-5440, or
Lewis Owens - (606) 233-0376

MISSOURI - Oct. 9

ANTIQUÉ RADIO COLLECTORS & HISTORIANS OF GREATER ST. LOUIS AUCTION

St. Louis, MO - Holiday Inn - Southwest
10709 Watson Road, corner of
Lindbergh Blvd. and Watson Road
ARCH rates: (800) 682-6338

9 am - Preview
11 am - Auction (consign early)
Info: Col. Ed Parise - (314) 770-2662

OKLAHOMA - Oct. 8

OKLAHOMA VINTAGE RADIO COLLECTORS MEETING

Oklahoma City, OK - Spencer's Barbeque
NW 63rd and May Avenue

6 pm - Dinner; 7 pm - Program
Info: Karen McCoy - (405) 722-0595

ILLINOIS - Oct. 10

BELLEVILLE AREA ANTIQUE RADIO CLUB MEETING

Belleville, IL - Belleville Area College
7 pm - Ugliest Radio/Worst Condition
Info: Karl Stegman, 4 Cresthaven Drive
Belleville, IL 62221 - (618) 234-7992

GEORGIA - Oct. 8-9

SOUTHEASTERN ANTIQUE RADIO SOCIETY/MUSIC CITY VINTAGE RADIO & PHONOGRAPH SOCIETY ANTIQUE WIRELESS ASSOCIATION RADIO MEGA-MEET '94

Atlanta, GA - Southern Bell Executive
Learning Center, I-85 to N. Druid Hills Rd. Exit

Oct. 8: 8 am-10 pm - Flea Market
1-3 pm - Equipment Contest Setup
3-4 pm - Contest Viewing
5 pm - Contest Judging
6 pm - Guest Speaker Don Patterson on
Cabinet Restoration - Contest Awards

Oct. 9: 8-12 am - Flea Market
9-10 am - Open Radio Display
10-11 am - Buffing Catalin and Bakelite
1 pm - Hands-On Refinishing Demo
Meet Wrap-up

SARS rates: Hampton Inn - (404) 320-6600
Courtyard Marriott - (800) 321-2211
Info: Charles Pierce - (404) 233-1340,
Charles Milton - (404) 922-6507, or
SARS, PO Box 500025, Atlanta, GA 31150

MISSOURI - Oct. 11

ANTIQUÉ RADIO COLLECTORS & HISTORIANS OF GREATER ST. LOUIS MEETING

St. Louis, MO - Kirkwood Community Center
7 pm

Info: Charles Juedemann, 2015 Hickory
Ridge Rd., Union, MO 63084 - (314) 583-5116

OHIO - Oct. 11

ANTIQUÉ RADIO COLLECTORS OF OHIO MEETING

Kettering, OH - First Natl. Bank Basement
4100 Far Hills Avenue
SE corner of Far Hills Ave. and Stroop Rd.
7:30 pm - Test Equipment

Info: Jim Cross - (513) 298-5827

MISSISSIPPI - Oct. 9

MISSISSIPPI HISTORICAL RADIO AND BROADCASTING SOCIETY MEETING

Meridian, MS - 2412 C Street - 3 pm
Info: Randy Guttery, 2412 C. Street
Meridian, MS 39301 - (601) 693-5958

COLORADO

NEW CLUB FORMING MOUNTAINS 'N PLAINS RADIO COLLECTORS' ASSOCIATION

Free newsletter: MPRCA, 1249 Solstice Ln.
Fort Collins, CO 80525-1239 - (303) 224-5446

PENNSYLVANIA - Oct. 11

DELAWARE VALLEY HISTORIC RADIO CLUB MEETING - SWAP MEET - AUCTION

Souderton, PA - 117 Main Street
N. Penn Amusements Building
7:30 pm

Info: Radio Attic, PO Box 624
Lansdale, PA 19446 - (215) 368-2520

ONTARIO - Oct. 12

OTTAWA VINTAGE RADIO CLUB NEW CLUB FORMING - MEETING

Ottawa, Ontario - Ottawa Citizen
Conference Room, 1101 Baxter Road
7 pm

Info: Tom Devey, 810 Edgeworth Avenue
Ottawa, Ontario K2B 5L5 - (613) 828-5152

ARKANSAS - Oct. 13

ARKANSAS ANTIQUE RADIO CLUB ARKANSAS CHAPTER/ARCA MEETING

Little Rock, AR - The Auditorium
S.W. Bell Bldg., 120 W. 8th Street
7 pm

Info: Tom Burgess - (501) 565-1750

NEW JERSEY - Oct. 14

NEW JERSEY ANTIQUE RADIO CLUB MEETING

Freehold, NJ - Grace Lutheran Church
West Main St. & Park Ave. (old Rt. 33)
7:30-9:30 pm - Meeting & Swap

Info: Don Cruse - (908) 542-2848
Tony or Kathleen Flanagan - (908) 462-6638

ARIZONA - Oct. 15

ARIZONA ANTIQUE RADIO CLUB MEETING

Scottsdale, AZ - Lance Wilson Residence
2 pm

Program: Telephones and Radios
with Richard Mountjoy

Info: Harry Snyder - (602) 488-4287

INDIANA - Oct. 15

INDIANA HISTORICAL RADIO SOCIETY FALL FOLIAGE RADIO MEET

Greenfield, IN - Riley Park
early to noon - Swap & Talk - Flea Market
noon - Luncheon - Meeting & Contest

Info: Glenn Fitch - (317) 565-6911

MARK YOUR CALENDAR

- Oct. 1-2 - NE, Nebraska City - MRC Radio Days*
Oct. 2 - IL, Elgin - ARCI Autumn Swap Meet*
Oct. 2 - MD, Myersville - MAARC Picnic/Meet*
Oct. 2 - NY, Lake Ronkonkoma - GNYVWA §*
Oct. 2 - OH, Brunswick - BARPC Meeting*
Oct. 2 - WA, Poulsbo - VALVE Swap Meet §*
Oct. 6 - AR, Fort Smith - ARCCFS Meeting §*
Oct. 8 - CA, Cottonwood - CHR5-NVC Meet*
Oct. 8 - KY, Lexington - MSARC Show/Meet*
Oct. 8 - OK, Oklahoma City - OKVRC Meeting §*
Oct. 8-9 - GA, Atlanta - Radio Mega-Meet '94*
Oct. 9 - MS, Meridian - MHR&BS Meeting §*
Oct. 9 - MO, St. Louis - ARCH Auction*
Oct. 10 - IL, Belleville - BAARC Meeting §*
Oct. 11 - GA, Chamblee - SARS Meeting §*
Oct. 11 - MO, St. Louis - ARCH Meeting §*
Oct. 11 - OH, Kettering - ARCO Meeting §*
Oct. 11 - PA, Souderton - DVHRC Meeting §*
Oct. 12 - Ontario, Ottawa - OVRC Meeting §*
Oct. 13 - AR, Little Rock - AARC Meeting §*
Oct. 14 - NJ, Freehold - NJARC Meeting §*
Oct. 14-16 - TX, Dallas - VRPS/AWA Convention*
Oct. 15 - AZ, Scottsdale - AARC Meeting*
Oct. 15 - FL, Orlando - FAWG Swap Meet*
Oct. 15 - IN, Greenfield - IHRS Fall Meet*
Oct. 15 - MI, Dearborn - MARC Swap Meet*
Oct. 16 - WA, Seattle - PSARA Meeting §*
Oct. 19 - CA, N. Highlands - SHRS Meeting §*
Oct. 19 - OH, Columbus - SPARK Meeting §*
Oct. 20 - NY, Goshen - HARPS Meeting §*
Oct. 22 - AL, Decatur - SVWA Fall Meet*
Oct. 22 - NY, Middletown - HARPS 5th Show*
Oct. 22 - NC, Greensboro - VRUS Trade/Show*
Oct. 22 - OR, Portland - NWVRS Show & Sale*
Oct. 24 - AL, Birmingham - ALHRS Meeting §*
Oct. 25 - OH, Kettering - SPARK Meeting §*
Oct. 26 - OH, Cincinnati - SPARK Meeting §*
Oct. 29 - NH, Nashua - NEARC Swap Meet*
Oct. 29 - Ontario, London - LVRC Workshop*
Oct. 29 - TX, Houston - HVRA Flea Market
Oct. 29-30 - OH, Akron - BARPC Show*
Nov. 5 - AZ, Tempe - AARC Meet*
Nov. 5 - CA, Redwood City - CHR5 Meet*
Nov. 5 - MN, W. St. Paul - NARC Swap Meet
Nov. 5 - NJ, Hightstown - NJARC Meet/Auction*
Nov. 5 - TN, Nashville - MCVRPS Chat N Chew*
Nov. 5 - WV, Huntington - Museum/ARCA Meet*
Nov. 6 - NY, Rochester - AWA Meeting
Nov. 9 - Ontario, Ottawa - OVRC Meeting §
Nov. 12 - OK, Oklahoma City - OKVRC Swap Meet
Nov. 12 - OR, Portland - NWVRS Meeting §
Nov. 13 - CO, Denver - CRC Meeting*
Nov. 13 - PA, Buckingham - DVHRC Swap Meet*
Nov. 19 - MD, Burtonsville - MAARC Meeting §
Nov. 19 - TX, Irving - VRPS Meeting §
Dec. 3 - FL, Bradenton - AWA Meet
Dec. 3 - TX, Irving - VRPS Christmas Cheer §
Dec. 14 - Ontario, Ottawa - OVRC Meeting §
1995
Jan. 21 - NH, Nashua - NEARC Swap Meet
Feb. 26 - MA, Westford - GBARC Radio XXVI
Mar. 24-25 - NC, Charlotte - AWA Spring Meet
Mar. 25 - PA, Washington - Spring Fever '95
Apr. 8 - KY, Henderson - MSARC Show/Swap
Apr. 22 - NH, Nashua - NEARC Swap Meet
May 19-20 - MN, Bloomington - Radio Daze '95
Jul. 7-9 - MI, Lansing - Extravaganza '95
Jul. 22 - NH, Nashua - NEARC Swap Meet
Oct. 28 - NH, Nashua - NEARC Swap Meet

* See expanded listing this month. § Monthly Meeting

TEXAS - Oct. 14-16

VINTAGE RADIO & PHONOGRAPH SOCIETY
ANTIQUE WIRELESS ASSOCIATION
VRPS/AWA CONVENTION '94
20th ANNIVERSARY VRPS - 1974-1994

Irving, TX - Holiday Inn DFW South,
4440 W. Airport Freeway
VRPS Rates: (214) 399-1010

FRIDAY - Oct. 14

9:30 am-1 pm - Contest Check-in

3-6 pm - Contest viewing

1-3:30 pm - Technical Sessions

4-5 pm - Silent Auction

9:30-5 pm - Fri. Auction Check-in

1-6 pm - Fri. Regular Auction viewing

6-10 pm - Friday PM Auction

SAT. - Oct. 15

9 am-3 pm - Contest viewing

10-11 am - Silent Auction

12 am-5 pm - Sat. Auction

7:30-9:30 pm - Annual Awards Banquet

SUN. - Oct. 16

8-12 am - Indoor Flea Market

Guest speaker: Paul Davis

Info: George Potter - (214) 315-2553, or
VRPS, PO Box 165345, Irving, TX 75016

CALIFORNIA - Oct. 19

SACRAMENTO HISTORICAL RADIO
SOCIETY
MEETING

N. Highlands, CA - SMUD Foothill Service
Center, Room D, 5026 Don Julio
Approx. 1 mile West of I-80

7-9 pm

Info: Secretary, SHRS, PO Box 162612
Sacramento, CA 95816

OHIO - Oct. 19

SOCIETY FOR PRESERVATION OF
ANTIQUE RADIO KNOWLEDGE
COLUMBUS CHAPTER
MEETING

Columbus, OH - DeVry Institute of Tech.
1350 Alum Creek Road, I-70 Exit 103B

7 pm

Info: Gil Zalewski - (614) 866-0094

NEW YORK - Oct. 20

HUDSON VALLEY ANTIQUE RADIO
AND PHONOGRAPH SOCIETY/ARCA
MEETING

Goshen, NY - Cataract Firehouse, Main St.

7-9 pm

Info: John & Linda Gramm, Box 1, Campbell
Hall, NY 10916 - (914) 427-2602, 6-9 pm

FLORIDA - Oct. 15

FLORIDA ANTIQUE WIRELESS GROUP
FALL SWAP MEET & ANNUAL AUCTION

Orlando, FL - VFW Hall
4444 Edgewater Drive

8 am-noon - Swap Meet

noon-4 pm - Equipment Auction

Info: Dennis Williams - (407) 895-0146, 8-5
Paul Currie - (407) 365-9305, 5-10 pm

ALABAMA - Oct. 22

SOUTHERN VINTAGE WIRELESS
ASSOCIATION
FALL MEET

Decatur, AL - 9th Street Methodist Church

7 am

Info: Jim Makar - (250) 233-8357

MICHIGAN - Oct. 15

MICHIGAN ANTIQUE RADIO CLUB
9th ANNUAL FALL SWAP MEET

Dearborn, MI - Armenian Hall, Ford Road
West of US-39

8 am-3 pm

Silent and Donation Auctions

Equipment Contest & 50/50 Raffle

Info: Nancy/Don Colbert - (313) 274-1948

NEW YORK - Oct. 22

HUDSON VALLEY ANTIQUE RADIO
AND PHONOGRAPH SOCIETY
5th ANNUAL OLD-TIME RADIO &
PHONOGRAPH SHOW

Middletown, NY - Holiday Inn
Exit 122 off Route 17

8 am-4 pm

Refreshments - All Indoor

Info: Gramm-O-Phone Antiques
(914) 427-2602

Art Kingsley - (914) 446-4091, 6-9 pm

WASHINGTON - Oct. 16

PUGET SOUND ANTIQUE RADIO ASSN.
MEETING

Seattle, WA - Shoreline Museum
749 North 175th St. & Linden Avenue
1 mile West of I-5, Exit #17E

9 am - Swap Meet

12 am - Meeting: Phillip Bytheway on DXing

Info: Al Atworth, PO Box 125, Snohomish,
WA 98291-0125 - (206) 568-2698

Listings on these pages are free to
antique radio clubs, as space permits.
Submission Deadline - 5th of month.

N. CAROLINA - Oct. 22

VINTAGE RADIO UNIQUE SOCIETY "DIEHARD" RADIO COLLECTORS TRADE/SHOW

Greensboro, NC - The Cottonmill Square
I-40 Exits 214 & 214B, N. on Wendover
1.5 mi., rt. on Clifton to Cottonmill Square
Oct. 21: 6:30 pm - Reception Cottonmill Square
7:30 pm - Key, Mic, Cathedral - Trades
Oct. 22 - All Day Open-Air Traders Market
(Inside if weather bad)
10 am - Ladies' shopping - various - on site
10 am - Contest: Keys, Mics, Cathedrals
Nontest: Shared viewing entries
1-1:30 pm - Contest results/Program
Info: Jerryl Sears, 312 Auburndale Street
Winston-Salem, NC 27104 - (910) 765-4302
Amateur "Talk-In" WB4JGZ - 146.61

OREGON - Oct. 22

NORTHWEST VINTAGE RADIO SOCIETY VINTAGE RADIO/RELATED NOSTALGIA SHOW AND SALE

Portland, OR - Multnomah Arts Center
SW 32nd Ave. & Capitol Highway
9 am-1 pm
Info: Dick Dielschneider - (503) 246-1062,
NWVRS, PO Box 82379, Portland, OR 97282

ALABAMA - Oct. 24

ALABAMA HISTORICAL RADIO SOCIETY MEETING

Birmingham, AL - Homewood Public Library
1721 Oxmoor Road
7 pm
Info: Earl Ridolphi, 2413 Old Briar Trail
Birmingham, AL 35226 - (205) 823-3314

OHIO - Oct. 25

SOCIETY FOR PRESERVATION OF ANTIQUE RADIO KNOWLEDGE MEETING

Kettering, OH - Oak Creek Worship Center
4800 Bigger Road - 7:30 pm
Info: Harold Parshall, 2673 So. Dixie Drive
Dayton, OH 45409 - (513) 298-4044, days
(513) 268-2909, eves.

RHODE ISLAND

NEW CLUB FORMING RHODE ISLAND ANTIQUE RADIO ENTHUSIASTS

New club - RARE - for trading antique
radio *information* rather than hardware.
Informal monthly meetings.
Info: Len Arzoomanian - (401) 232-0869

OHIO - Oct. 26

SOCIETY FOR PRESERVATION OF ANTIQUE RADIO KNOWLEDGE CINCINNATI CHAPTER MEETING

Cincinnati, OH - Richards Radio & TV
4041 Edwards Road, I-71, Exit 6
7:30 pm
Info: Bob Sands - (513) 858-1755

NEW HAMPSHIRE - Oct. 29

NEW ENGLAND ANTIQUE RADIO CLUB MEET

Nashua, NH - Resurrection Center
Rt. 3 (Everett Turnpike), Exit 6
1 1/2 miles West on Rt. 130
9 am-1 pm
Info: Gregg Thompson, PO Box 298
Newtonville, MA 02160
NEARC 24-Hour Info Hotline:
(617) 923-2665

ONTARIO - Oct. 29

LONDON VINTAGE RADIO CLUB MEETING

London, Ontario, Canada - Jaycee Bldg.
317 Adelaide St. South
1:30 pm
Info: Don Hatch, 14 Kingspark Crescent
London, Ontario, Canada N6H 4C4
(519) 472-6167

OHIO - Oct. 29-30

BUCKEYE ANTIQUE RADIO AND PHONOGRAPH CLUB RADIO & PHONOGRAPH SHOW

Akron, OH - Chapel Hill Mall
2000 Brittain Road - (216) 633-1131
Sat. & Sun. during normal Mall hours
Info: Bob Lowry, Tallmadge, OH
(216) 633-5443

ARIZONA - Nov. 5

**ARIZONA ANTIQUE RADIO CLUB
FALL SWAP MEET AND AUCTION**
Tempe, AZ - Antique Electronic Supply
6221 S. Maple Avenue, parking lot
7-11 am (no sales before 7!)
Info: Martin Bergan - (602) 248-0356

*Attend a club event near you, learn,
meet others in the hobby, and perhaps
find an item or two for your collection!*

CALIFORNIA - Nov. 5

CALIF. HISTORICAL RADIO SOCIETY MEET

Redwood, CA - Ampex Corp.
Parking Lot, Bay Road,
3 Blocks South of Woodside Rd. - 8:30 am
Info: Norm Braithwaite - (916) 246-4209

NEW JERSEY - Nov. 5

NEW JERSEY ANTIQUE RADIO CLUB FALL MEET/AUCTION

Hightstown, NJ - Hightstown Country Club
Near Exit 8 of NJ Turnpike, off Route 33

7 am - 2 pm
11 am - Indoor Catalog Auction
Info: Marv Beeferman - (609) 693-9430, or
Ludwell Sibley - (908) 782-4894

TENNESSEE - Nov. 5

MUSIC CITY VINTAGE RADIO & PHONOGRAPH SOCIETY

CHAT 'N' CHEW
Nashville, TN - McDonald's
Music Valley Drive near Opryland - 8 am
Info: (615) 871-6764, or (615) 227-3464

WEST VIRGINIA - Nov. 5

MUSEUM OF RADIO & TECHNOLOGY ANTIQUÉ RADIO CLUB OF AMERICA MEET

Huntington, WV - Museum of Radio & Tech.
7:30 am - Museum open, tours all day
8 am - Traders Market open
1:30 pm - Grand Auction, Auditorium
Info: Geoffrey Bourne - (304) 722-4690

COLORADO - Nov. 13

COLORADO RADIO COLLECTORS MEETING - SWAP MEET

Denver, CO - South West Bank Bldg.
Community Room, 1380 S. Federal Blvd.
1 pm - Meeting; 3 pm - Swap Meet
Info: Barney Wooters - (303) 770-5314

PENNSYLVANIA - Nov. 13

DELAWARE VALLEY HISTORIC RADIO CLUB SWAP MEET

Buckingham, PA - Tyro Grange Hall
8 am-1 pm
Info: Mike Koste - (215) 636-6488

BUSINESS CARD ADS - \$36.00 FOR 3 MONTHS



40 Years Experience

Tom's Antique Radio & TV

REPAIRS & RESTORATION ON ALL
PRE-1960's - RADIOS & TV's
ANY MAKE OR MODEL

THOMAS ROMANO
8 HOWE LANE
MILLBURY, MA 01527
508-865-6293



WRIGHT'S ELECTRONIC SERVICE THE RADIO DOCTOR

"You Don't Have To Worry When It's Done Wright"

1920-1960's RADIOS-PHONOS-CAR RADIOS-TUBE AMPS

CHASSIS REPAIRS FROM SIMPLE TO COMPLETE REFURBISHMENT
MOST REPAIRS FROM \$25 MOST REFURBS \$50 TO \$100

WRIGHT'S ELECTRONIC SERVICE
(206) 859-3592

P.O. BOX 8252
FEDERAL WAY, WA 98003

FENDER and VOX WANTED !

- Cash for guitar amps from 1950-1960's
 - Any condition
 - Information given gladly
- Frank Czaja
8968 W. Forest Home
Apartment #4
Milwaukee, WI 53228
(414) 529-9395



XTAL SET SOCIETY

Our bi-monthly newsletter now in its 4th year is packed full of articles & projects about crystal sets. To join: us remit \$9.95. Back issues Vol I,II, \$9.95ea. Crystal Set Handbook \$10.95, \$2 shipping. Order from ARC or direct (314) 725-1172.

PO Box 3026 St. Louis, MO 63130

Collector, Historian, Seeker of
Stromberg - Carlson Radio Apparatus

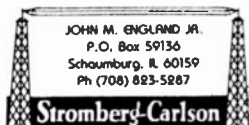

JOHN M. ENGELAND JR.
P.O. Box 59136
Schaumburg, IL 60159
Ph (708) 823-5887

Stromberg-Carlson

Entrepreneur: Art Moderne.
Streamline, Machine Age Design

Antique Radio Hardware

- Knobs, handles, pendants, pulls, etc.
 - Original dies for hundreds of different patterns dating back to 1920
 - Specializing in solid brass hardware
- Will cater to your needs - Even single piece orders
Send \$3 for catalog (refunded from 1st order)
- GUY FREDERICK - (616) 456-9378
1121 Powers NW, Grand Rapids, MI 49504

BUSINESS CARD ADS - \$36.00 FOR 3 MONTHS

John Burkhardt, Jr.



JOHN'S RADIO REPAIR

- Transistors
- Cathedrales
- Pre-Post War Table
- Catalans

2011 Peninsula Dr.
EBCO Park, Suite 3
Erie, PA 16506

Office (814) 833-3929

- GRUNDIG • SABA
- ALL WORK GUARANTEED
- TELEFUNKEN • NORDMENDE

The Bavarian Radio Works

SPECIALIZING IN REPAIR OF EUROPEAN RADIO SETS

Ross A. Hochstrasser
(617) 447-9104

162 BEULAH ST.
WHITMAN, MA 02382



78 RPM Phono Pickups Repaired

"Dead" cartridges rebuilt right! New crystals, etc., as needed. Allow 3-4 weeks. Most crystal and "horseshoe" magnet types . . . \$34.50
100 hr. sapphire needles (list \$2.50 ea.) 4/\$5.75
Single play steel needles (list 25/\$2.00) 100/\$5.25

Inquiries: Call Joe, 508-879-2778,
evenings and weekends.



Prices include Return
Postage. Please include
Payment With Order.

835-A Pleasant St.
Framingham, MA 01701

PHILCO PREDICTAS WANTED!



BUY • SELL • TRADE • RENT • RESTORE

DAVID WEDDINGTON

6042 San Rolando, Buena Park, CA 90620
(714) 828-4016 Phone, or (714) 828-4023 24 hr. Fax

ELECTRON TUBE ENTERPRISES

(Dealers in Surplus Electron Tubes)

Box 8311

Essex, VT. 05451

TEL: 802-879-1844

FAX: 802-879-7764

FREE 1994 CATALOG AVAILABLE

(Lowest prices on New & Used tubes)

PUT YOUR BUSINESS CARD HERE!

\$36 FOR 3 MONTHS - \$63 FOR 6 MONTHS
DON'T HAVE ONE? SEND AN EXTRA \$6.00 AND
WE WILL TYPESET ONE FOR YOU.

Andrew Mooradian

Wanted Pre-1926 Radios by

AMRAD

Also, Radio Parts, Accessories
and Literature

5 Priscilla Lane, Winchester, MA 01890

Mr. John Andolina, Jr.
"The Early Sound Man"

REPRODUCERS rebuilt

(716) 247-3056

28 Glen Oaks Dr.
Rochester, NY 14624

Antique Phonographs Buy - Sell - Trade



AND
RELATED ADVERTISING ITEMS
Any Brand - Any Condition
Also Cylinders, Disc Records
"One Item or Entire Collection"
Quality Repairs Since 1973
Edson, Victor, Columbia



THE FINISHING TOUCH



Judd E. Hinman Restorations

SHOW WINNING FINISHES

— AUTO INTERIOR WOOD —

- RADIOS
- MECHANICAL
- 78 RPM JUKEBOXES
- ELECTRONICS



203-274-0705

203-268-6060



182 JUDD FARM ROAD
WATERTOWN, CONN. 06795

50 Years

Of Service

Antique Radio Restoration

Repairs: \$25.00 plus Parts & UPS.
Schematic Service: \$2.00 Radios, \$4.00 TV's

Hen Kar INC.

838 Woodend Rd., Stratford, CT 06497
Tel — (203) 378-4735

SUNSHINE SOUNDS

WANTED:



Hi Fi TUBE & COMMERCIAL AMPS

McIntosh, Marantz, Dynaco, Heath,
Altec, Scott, RCA, Fisher, Craftsman,
Grommes, Fender, Ampex, W.E. Vox,
Brook, Acro, Pultec, Fairchild

405-737-3312

Sonny - 1413 Magnolia Ln., Midwest City, OK 73110

SPEAKERS & HORNS

Altec, Jensen, RCA,
E.V., Western Electric,
JBL, Tannoy

Looking for early, portable electronic calculators (1970-78)

(Any that have LED or other "lighted" displays)

- Will Trade Transistor Radios (or buy outright) •
- Especially: Basicom, Berkeley/Keystone, Calfax, Columbia, Commodore, Decimo, Educacal, Garrett, Ian Jones, JCE, Kingspoint, M.I.T.S., Monroe/Litton, Olympia, Royal, Sanyo, Sinclair, Sperry Remington, Summit, Victor.
- Guy "Mr. Calculator" Ball Fax-(714) 730-6140
14561 Livingston St., Tustin, CA 92680

BUSINESS CARD ADS - \$36.00 FOR 3 MONTHS

SPY EQUIPMENT WANTED!

- Code Machines
- Secret Cameras
- Secret Radios
- OSS, SOE, CIA, KG31
- Clandestine Weapons
- I Buy or Trade!

Keith Mellon
P.O. Box 5755 Bossier City, LA 71171
(318) 747-9616 Days: FAX (318) 747-901C



If you buy, sell or like Jukeboxes you need ALWAYS JUKIN--THE MONTHLY JUKEBOX MAGAZINE!! Subscribers in 25 countries, ALWAYS JUKIN LEADS THE WAY: Articles, photos, show reports, ads, new products, price guides, restoration tips, repairs--everything you need to know about JUKE-BOXES-- the fastest appreciating collectible in the world!!! Fun & a great investment.
Sample copy, \$5. \$30 per year.
ALWAYS JUKIN, 221 YESLER WAY AR, SEATTLE, WA 98104. (206) 233-9460.
Master/Visa ok.



HAROLD C. BRAMSTEDT
C & N ELECTRONICS
6104 Egg Lake Road North
Hugo, MN 55038

612-429-9397
800-421-9397
Fax 612-429-8292



- Buy
- Sell
- Transmitting & Industrial Tubes

— WANTED —
Old Broadcast Microphones

RCA, Electro-Voice, etc.
Buy/Trade

Peter Triolo
1515 Lake Daniel Dr.
Orlando, FL 32804

Telephone
(407)
423-7500



30 years experience
Jackson Speaker Service
Expert Antique Loudspeaker Repairs
(Cone Types) And Rebuilding A Speciality.
Speaker Parts And Repair Service On
Virtually Any Speaker Made Including
Stereos, P.A., And Antique Auto Speakers.
217 Crestbrook Dr. Owner
Jackson Mich 49203 Ron McGee
Ph - (517)789-640G, Ans. 4th ring
Wk - days 10: am - 7pm Wk - Ends 9 - 5pm



RELIABLE - PROMPT - GUARANTEED

SOUND REMEDY
LOUDSPEAKER REPAIR SERVICE

331 Virginia Avenue
Collingswood, New Jersey 08108

Richard G. Stamer

Telephone
(609) 869-0238

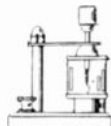

CRYSTAL SETS

PARTS - PLANS - KITS - BOOKS
CATALOG \$1.00

Largest source of Vintage and New
Variable Air Condensers, Variometers,
Vario-Couplers, Tap Switches, Tap
Points, Galena and Germanium
Detectors, Detector Stands, Cat
Whiskers, Terminals, Sliders,
Headsets, Dial Knobs, Coil Forms,
Magnetic Wire, etc.

MIDCO
P O Box 2288
Hollywood, FL 33022
(305) 925-3670
BA Turke, PH DFE

INSTRUMENTS



Jim & Rhoda
Morris

Radio, Telegraph,
Historical Instruments,
& Books For Sale
Catalogs
& Lists
Available

Antiques of Science & Technology
A of ST Box 1852 Wakefield Ma. 01880 U.S.A.
Tel 617 245 2897 Fax 617 245 3572

(510) 490-5842

Fax (510) 490-1961

Speakerworld®

Expert Speaker Refoaming and Reconing

2000 Warm Springs Ct. #6 Visal/ *Free Return
Fremont, CA 94539 MC Freight By UPS

**For Antique Speakers Only*

Triple R Services
Vintage Radio Repairs

Specializing in British Radios
British Radios Found & Sold

Rt. 1 Box 125X
Telephone, Tx 75488
phone (903) 664-2134
fax(903) 664-3306

Antique Radio
Sales and Service

*Old radios repaired,
restored, bought
and sold*

J. Squires
Tel. (709) 570-1895
11 Gulliver Pl.
St. John's, Nfld.
A1E 4K5

RADIO BOOKS FOR SALE

Large selector of books on Radio and Related Technology
Call or write for our List of Catalogs
Always buying, single items or collections

RAINY DAY BOOKS

P.O. BOX 775, FITZWILLIAM NH 03447
(603)-585-3448

BUSINESS CARD ADS - \$36.00 FOR 3 MONTHS

WANTED
 PRE 1900
ELECTRICITY
 MEDICAL • X-RAY
 TELEGRAPHY • TELEPHONE
 PRE 1925
 RADIO • WIRELESS
 PRE 1940
 TELEVISION

BOOKS • TUBES • ARTIFACTS
 MAGAZINES • AUTOGRAPHS
 CATALOGS • EPHEMERA



**NEW WIRELESS
 PIONEERS**
 P.O. BOX 298
 ELMA, NY 14059
 716-681-3186

COMMNAV EQUIP
 RADIO SETS
 NAVAL AIR FIELD
 U.S. FOREIGN

CHARLES DICICCA KAI OON
 501 MYSTIC VALLEY PKWY
 MEDFORD, MASS 02155
 PHONE: 617-394-9354



MILITARY ELECTRONICS

BUY WANTED TRADE



ESTES AUCTIONS

Specializing in Vintage Radios

7404 Ryan Rd
 Medina, Ohio 44256

Phone-Fax 216-769-3987

IF YOU VISIT THE BRIMFIELD FLEA MARKET...
 STOP BY FIRST!

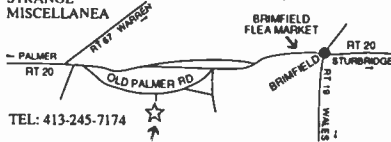

COUNTRY ROAD BARN - BERNIE SAMEK
 OLD PALMER ROAD, BRIMFIELD, MASS.



**ANTIQUE RADIO
 RESTORATIONS**

635 S. Lincoln Ave., O'Fallon, IL 62269
 618-632-7423

*Collectors of Old Radios
 Electronic Consultant, Dial Reproductions
 Hickok Tube Testers, Service & Calibration*

Clinton Blais, P.E.
 Life Member I.E.E.E.
 AWA, ARCA, MAARC

Ron Blais

VACUUM TUBES
Electronic Components

Write or call for list

Network Sales (708) 773-4733

5N105 Rt. 53
 Itasca, IL 60143

Are You Looking For Antique Radios, Parts,
 Tubes, Schematics and Restoration Services?
 For Free Flyer, a 2-Stamp LSASE is required to insure a
 response to your request. Send to:

Olde Tyme Radio Company
 2445 Lyttonsville Road, Suite 317, Silver Spring, MD 20910

Wish to contact us by phone or fax?
 Our number is (301) 587-5280.
 Please call 10 am to 10 pm (Local Time)

Antique Radios



David & Nancy Snow
 P.O. Box 6352
 Jackson, MI 49204
 (517) 787-2985

We Buy, Sell, Repair
 ARBE - III Battery Eliminators

WANTED: Tube Hi-Fi Components &
 Commercial Amplifiers of the 1950's & 1960's

**Marantz, McIntosh, Scott, Fisher, Brook
 Acrosound, Brociner, Western Electric
 Fairchild, Altec, Tannoy, JBL**

Richard Sharisky (617) 484-5784, phone
 P.O. Box 521 (617) 489-6592, fax
 Belmont, MA 02178

ANTIQUE RADIO REPAIR
Repair - Restore - Buy & Sell

Schematic Service
 Radios \$2.⁰⁰, TVs \$4.⁰⁰

DAMASKE ELECTRONICS
 574-W16834 Janesville Road
 Muskego, WI 53150
 Phone: (414) 679-0838

**1920-1970
 SCHEMATICS + PAGES OF INFO
 \$5.00 POSTPAID**

**MANUAL PRICES - SASE
 RADIO/TV/HAM/MISC.**

**"IF I DON'T HAVE IT, YOU
 PROBABLY DON'T NEED IT."**

**ALTON H. BOWMAN - 4172 EAST AVENUE
 CANANDAIGUA, NY 14424-9564**

RADIO - TELEVISION - Hi Fi
 Tubes 1940 & Later
 Send S.A.S.E. for Catalog and Prices

KIRBY

Up To 90% Off List Price
 John Kirby
 298 West Carmel Dr.
 Carmel, IN 46032



BATTERIES

Batteries For All Applications!

Energy Source Distributing Company
3111 Arcadia Avenue, Allentown, PA 18103
Telephone: (610) 797-1133
Fax: (610) 797-8238

WANTED

**SONY CRF320
CRF330**

Chris Clark, 117 Hudson Street, NYC, 10013
TEL. (212) 219-1783

Free Estimates
Hrs - 10 AM - 7 PM
Tues - Sat

Tel/Fax (203) 928-2828



ANTIQUE RADIO RESTORATION & REPAIR

1920 - 1960's

Buy & Sell

Reasonable Rates Tubes, Professional
Overhulls, Cabinet Refinishing Service
For All Antique Car, Table & Console
Radios, Communication Receivers &
Tube Amplifiers

20 Gary School Road

BOB ESLINGER Pomfret Center, CT 06259



john d. eckland

vintage american & european radio repair

969A ADDISON AVENUE PALO ALTO CA, JIFORNIA 94301
415 323 0101

ANTIQUE RADIO RESTORATION

Since 1936 Repair - Buy - Sell
Complete Restorations • Prompt Service

COOPER'S RADIO SERVICE

425 Court Street
Rockwell City, Iowa 50579



LARRY COOPER
712-297-7232

PAUL

ROBIN

DR. NOVELTY
JUKEBOX AMPLIFIER REBUILDING

414 964 3392

Old Time Applications

"TURN TO US WHEN YOU NEED KNOBS"
KNOBS • PUSHBUTTONS • ESCUTCHEONS
PLASTIC GRILLS • HANDLES

LARRY BORDONARO

5744 TOBIAS AVE. VAN NUYS, CA 91411
PHONE (818) 786-2500 • FAX (818) 909-0241

WWII Japanese Military Radios Wanted

**Type 94-5 three-tube RX
Type 94-6 one-tube TRX, etc...**

Takashi Doi

1-21-4, Minamidai, Seyaku
Yokohama, Japan

FIFTIES RADIOS

Sold and Repaired

Restored plastic and
wood table radios.

Many models
in stock

HERB'S TV



68 South Street
Jamaica Plain, MA
(617) 522-6440

BETA-TEK

ANTIQUE RADIO SERVICE

- Repair of Radios, Communications
Receivers & Test Equipment
- Power Supplies for Battery Sets



RAY BINTLIFF

2 Powder Horn Lane
Acton, MA 01720
508 263-7435



THE RADIO MAN

Buy-Sell-Trade
Antique Radios • Tubes • Parts

DICK MORGAN
RES: (214) 231-3099

P.O. BOX 461485
GARLAND, TX 75046 1485

20 Years
Experience

Telephone/Fax
1-615-456-2529

Specializing in: Antique Speaker Repair

- Very large stock of vintage parts
- Can repair most any cone-type speaker
- Field coils rewound • Fast turn-around
- Reasonable prices

Work
Guaranteed

Hank Brazeal
103 N. Lake Point Ct.
Crossville, TN 38555

NEW
2nd Edition

— Jonathan Hill's

Radio! Radio!

Second Edition



"Radio! Radio! is a fine work... one that no serious collector or historian can afford to overlook"

*(Richard Foster,
A.R.C. Sept. 1993)*

244 Pages - 978 Photographs of British Sets

Comprehensive overview of the development of wireless covering the 1920s to the 1960s. Illustrated chapter on the history of wireless. Descriptive information on each radio pictured. Revised, easy-to-read subject index, making it easier to find the particular radio you are interested in. A-Z directory listing of 1,000+ radio models.

Hardcover Only: \$44.95

Individually signed and numbered!!

Dealer Inquiries Invited

U.S. Orders - Enclose \$2.50 per order for packing & book-rate shipping if total order is under \$35.00. If using VISA or MasterCard, include name on card, card number and expiration date. Send payment with order. Mass. residents please add 5% sales tax. Money back return policy. Most orders shipped the same day received, but allow 2-4 weeks to receive order. Foreign orders - write for shipping costs, or use credit card and specify air or surface (allow 2-3 months for surface shipping).



Send Order To: A.R.C., P.O. Box 2, Carlisle, MA 01741
or Call: (508) 371-0512

Fax: (508) 371-7129



REPRINT BOOKS ON EARLY RADIO - WIRELESS - TELEVISION TELEGRAPH - TELEPHONE

RADIO

- Codel, M., *Radio and Its Future*. 1930. A 1930's look into the future. A collection of articles including De Forest, Grunow, Kolster, Sarnoff, Maxim, Colpitts, Paley, Durstine and Codel. 375 pgs.\$28.00
- Rothafel, S., *Broadcasting: Its New Day*. 1925. Explores all aspects of radio and broadcasting, covering radio drama, political use of radio, advertising, religious shows, educational programs, interference between stations (before government control), people in radio, and jobs in the field.\$29.00
- McNicol, D., *Radio's Conquest of Space*. 1946. A chronological treatment of the early days of radio, the scientists and their inventions. A few of the chapters: Spark Gaps & Oscillators, Wireless Spans the Atlantic, Regenerative Receivers, The Advent of Commercial Radio. 388 pgs.\$29.00
- Report of the Chief Signal Officer: 1919*. A record of the telegraph, telephone and radio in WWI.\$46.50
- Signaling and Communicating at Sea*. A two-volume anthology of over 50 articles. Semaphores, pigeons, flashing lights, flags, radio, teletype. 2 vols., 480 & 524 pgs. ...\$73.00
- Summers, H.B., ed., *Radio Censorship*. 1939. Collection of excerpts from articles & books + brief bibliography. ...\$23.50

TELEVISION

- Abramson, A., *Electronic Motion Pictures: A History of the Television Camera*. Mechanical TV to Zworyk into 1940's. 228 pgs.\$24.50
- Hess, G.N., *An Historical Study of the DuMont Television Network*. 1960. Reviews the development of the DuMont laboratories, network background, its development period, and its decline. A search for why the fourth television network failed.\$19.00

TELEGRAPH TELEPHONE

- Bennett, A.R., *The Telephone Systems of the Continent of Europe. 1895*; and Webb, Herbert Laws, *The Development of the Telephone in Europe. 1910*. In one volume - the development of European telephone networks near the turn-of-the-century plus a comparative study fifteen years later. Two vols. in one.\$36.50
- Bright, C., *Submarine Telegraphs: Their History, Construction and Working*. 1898. An account by a chief engineer, of early cable attempts, failures & successes, starting with the 1850 cable between England & France. 819 pgs.\$57.50
- Development of Submarine Cable Communications*. A two-volume anthology of over 50 articles. The 1858 and later trans-Atlantic cables, cable-laying ships, cable routes, technology thru 1973. 2 vols., 500 & 480 pgs.\$71.50
- Electric Telegraph: An Historical Anthology*. The rise and progress of the electric telegraph from the late 19th century to recent times. A collection of early writings. 625 pgs.\$4.00
- Eyewitness to Early American Telegraphy*. Reprints of reports and letters of Alfred Vail from the 1830's and 40's. An invaluable primary resource. 288 pgs.\$25.50
- Kingsbury, J.E., *The Telephone and Telephone Exchanges: Their Invention and Development*.\$40.00
- Prescott, G.B., *Bells' s Electric Speaking Telephone*.\$38.50
- Smith, Willoughby, *The Rise and Extension of Submarine Telegraphy*. An engineer's and designer's autobiographical account of cable laying in the mid-1900s including the 1856-66 Great Eastern missions. 409 pgs.\$32.00

THE FAMOUS M.I.T. RADIATION LAB. SERIES

- #1 *Radar System Engineering*, 748 pgs.\$15.95
- #2 *Radar Aids to Navigation*, 389 pgs.\$15.95
- #5 *Pulse Generators*, 741 pgs.\$15.95
- #7 *Klystrons and Microwave Triodes*, 533 pgs.\$15.95
- #8 *Principles of Microwave Circuits*, 486 pgs.\$15.95
- #9 *Microwave Transmission Circuits*, 725 pgs.\$15.95
- #10 *Waveguide Handbook*, 428 pgs.\$15.95
- #11 *Technique of Microwave Measurements*, 939 pgs.\$15.95
- #12 *Microwave Antenna Theory and Design*, 381 pgs.\$15.95
- #13 *Propagation of Short Radio Waves*, 746 pgs.\$19.95
- #15 *Crystal Rectifiers*, 457 pgs.\$15.95
- #16 *Microwave Mixers*, 381 pgs.\$15.95
- #17 *Components Handbook*, 640 pgs.\$19.95
- #18 *Vacuum Tube Amplifiers*, 761 pgs.\$19.95
- #19 *Waveforms*, 799 pgs.\$19.95
- #20 *Electronic Time Measurements*, 546 pgs.\$19.95
- #21 *Electronic Instruments*, 735 pgs.\$19.95
- #22 *Cathode Ray Tube Displays*, 764 pgs.\$19.95
- #23 *Microwave Receivers*, 618 pgs.\$15.95
- #24 *Threshold Signals*, 400 pgs.\$15.95
- #25 *Theory of Servomechanisms*, 383 pgs.\$15.95
- #27 *Computing Mechanisms & Linkages*, 371 pgs.\$15.95

The above are quality reprints. Send for free list of over 80 reprints of books on early radio, television, broadcasting and telegraph available from A.R.C.

Send payment with order. Mass. residents add 5% tax. Allow 4 to 6 weeks to receive books.

Add \$2.50 for shipping in U.S. Outside of U.S., please add 10% for shipping.

Send order with payment to: Antique Radio Classified, P.O. Box 2, Carlisle, MA 01741

(Apr-94)

New Books for the Collector

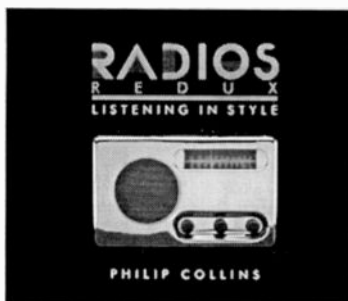

RADIOS REDUX BY PHILIP COLLINS. Subtitled "Listening in Style," this book showcases the sleek lines and luscious colors of over 80 gleaming sets from the collection of Philip Collins. 120 pages, 10" by 8 3/4".....**HARDCOVER: \$29.95. SOFTCOVER: \$17.95**

AND STILL AVAILABLE...

RADIOS: THE GOLDEN AGE BY PHILIP COLLINS. Collins' first book of the colorful Catalin and Bakelite radios from the late 1930s to the early 1940s. 128 pages, 10" by 8 3/4".

.....**HARDCOVER: \$29.95. SOFTCOVER: \$17.95**



**SPECIAL
PURCHASE!**

**NEW LOW
PRICE!**

RADIO ART BY ROBERT HAWES. This outstanding book is a chronological illustrated history of radio that celebrates the technical and stylistic progress of the radio. Although the coverage of the book is mostly British, many American sets are featured as well. 9 1/4" by 12", 128 pages. 250 photos, 150 in color.**HARDCOVER: ~~\$29.95~~ \$19.95**

RADIO ART POSTCARD DECK. 30 full color photographs from Hawes' book**~~\$9.95~~ \$7.50**

ALSO...

JUKEBOX ART BY CHRIS PEARCE. The evolution of the jukebox from coin-operated record changer to the rock and roll generation. 9 1/4" by 12", 128 pages. 120 color photos.**HARDCOVER: \$29.95**

JUKEBOX ART POSTCARD DECK. 30 full color photos from Pearce's book**\$9.95**

U.S. Orders - Enclose \$2.50 per order for packing & book-rate shipping if total order is under \$35.00. If using VISA or MasterCard, include name on card, card number and expiration date. Send payment with order. Mass. residents please add 5% sales tax. Money back return policy. Most orders shipped the same day received, but allow 2-4 weeks to receive order. Foreign orders - write for shipping costs, or use credit card and specify air or surface (allow 2-3 months for surface shipping).



**Send Order To: A.R.C., P.O. Box 2, Carlisle, MA 01741
or Call: (508) 371-0512**

Fax: (508) 371-7129



(Sep-94)

Radios

of the Baby Boom Era

Six Volumes — 2000 pages — From Sams' Archives
 1946 to 1960 — 274 Brands — 3494 Illustrations (B&W)
 6769 Models — Catalin, Bakelite, Wood, Transistor Radios & More

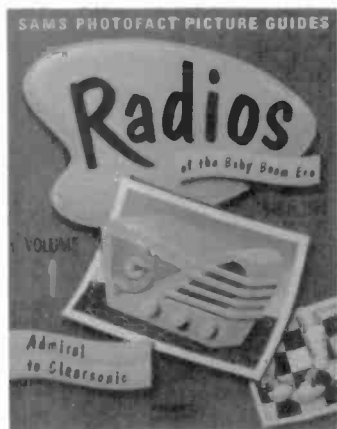

All Volumes Available!

Vol.	Brands	Included
1	56	Admiral to Clearsonic
2	54	Co-op to Gelo
3	58	GE to Monitoradio
4	36	Motorola to RCA Victor
5	35	Realtone to Stratovox
6	35	Stromberg-Carlson to Zenith



1/2 Page for each illustrated radio including:

- Large illustration of the radio including knob functions
- Short description of the radio
- Number of tubes
- Power supply type (AC, Battery, etc.)
- Tuning range
- Manufacturer
- Sams Photofact Set number & year Photofact published.

ALSO

- Index by model number listing tubes in radio
- List of similar radio models indexed to pictured radio
- List of manufacturers and suppliers indicating their brand names
- Basic trouble-shooting hints

Each Volume: \$16.95 — Softcover
 8 1/2" x 11" — Approx. 328 pages

U.S. Orders - Enclose \$2.50 per order for packing & book-rate shipping if total order is under \$35.00. If using VISA or MasterCard, include name on card, card number and expiration date. Send payment with order. Mass. residents please add 5% sales tax. Money back return policy. Most orders shipped the same day received, but allow 2-4 weeks to receive order. Foreign orders - write for shipping costs, or use credit card and specify air or surface (allow 2-3 months for surface shipping).



Send Order To: A.R.C., P.O. Box 2, Carlisle, MA 01741
 or Call: (508) 371-0512 Fax: (508) 371-7129



(May-93)

Radio Manufacturers of the 1920's

BY ALAN DOUGLAS



"The definitive book on American broadcast receivers of the 1920s"

Volume 1: A-C Dayton - Adams Morgan - Air-Way - All-American Mohawk - American Bosch - Amrad - Amrad S-Tube - Apex - Atwater Kent - Bremer Tully - Browning-Drake - Clapp-Eastham - Crosley - Cutting & Washington - Day-Fan - DeForest - Eagle - ERLA - FADA - Federal - Ferguson. 225 Pages.

Volume 1: \$24.95 (only softcover in print)

Volume 2: Freed-Eisemann - Eisemann - Freshman - Garod - Gilfillan - Grebe - Howard - Jones (Lester/Melco) - Jones (Jos.) - Kellogg - Kennedy - King - Kodel - Kolster - Leutz - Magnavox - Majestic - Marti - Metro - Klitzen/Michigan - Midwest - Mu-Rad - Murdock - Music Master - Neutrowound - Operadio - Ozarka - Pfanstiehl - Philco - Pilot - Priess. 266 Pages.

Volume 2: Currently Out-of-Print

Volume 3: RCA - Scott - Silver-Marshall - Slagle - Sleeper - Sonora - Sparton - Splitdorf - Steinite - Stewart-Warner - Stromberg-Carlson - Thermiodyne - R.E. Thompson - Thorola - Tri-City - C. D. Tuska - Ware - Western Coil - Western Electric - Workrite - Zenith. 292 Pages.

Volume 3: \$29.95 (hardcover: \$39.95)

U.S. Orders - Enclose \$2.50 per order for packing & book-rate shipping if total order is under \$35.00. If using VISA or MasterCard, include name on card, card number and expiration date. Send payment with order. Mass. residents please add 5% sales tax. Money back return policy. Most orders shipped the same day received, but allow 2-4 weeks to receive order. Foreign orders - write for shipping costs, or use credit card and specify air or surface (allow 2-3 months for surface shipping).



Send Order To: A.R.C., P.O. Box 2, Carlisle, MA 01741
or Call: (508) 371-0512 Fax: (508) 371-7129



Transistor Radio Books



The Collector's Guide to Transistor Radios by Marty & Sue Bunis. This book will help you identify the most sought-after vintage transistor radios. Over 2,200 models, all with current prices. Over 400 color photos. 5 1/4" x 8 1/4". 56 pgs.

\$15.95 - Softcover

Made In Japan by Roger Handy. A stunning book on the development and growth of the transistor radio featuring over 175 transistor radios in full color. 10" x 9 1/2". 108 pgs.

\$16.95 - Softcover



The Portable Radio in American Life by Michael Schiffer. Approximately 50 pages on transistor radios, beginning with the Regency TR-1 through to the later sets made overseas. 450 photographs, 193 transistor radios pictured. 8 1/4" x 11". 259 pgs.

\$24.95 - Softcover
\$45.00 - Hardcover

Collector's Guide to Novelty Radios by Marty Bunis & Robert Breed. This book is the source for novelty transistor radios in all shapes and sizes. Radios are described in detail with current prices. Over 600 all new color photographs. 8 1/4" x 11". 224 pgs.

\$18.95 - Softcover

*Available Late October/November

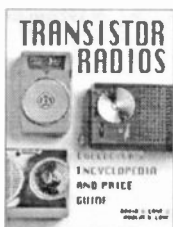

Transistor Radios, A Collector's Encyclopedia and Price Guide by David Lane & Robert Lane. Identification & price guide to over 2,500 transistor and novelty radios. History & key to collecting chapters. 8 1/4" x 11". 170 pgs.

\$19.95 - Softcover

U.S. Orders - Enclose \$2.50 per order for packing & book-rate shipping if total order is under \$35.00. If using VISA or MasterCard, include name on card, card number and expiration date. Send payment with order. Mass. residents please add 5% sales tax. Money back return policy. Most orders shipped the same day received, but allow 2-4 weeks to receive order. Foreign orders - write for shipping costs, or use credit card and specify air or surface (allow 2-3 months for surface shipping).



Send Order To: A.R.C., P.O. Box 2, Carlisle, MA 01741
or Call: (508) 371-0512 Fax: (508) 371-7129



COLLECTOR BOOKS AVAILABLE FROM ANTIQUE RADIO CLASSIFIED

- ☞ BOOKS MARKED WITH "☞" ARE THE MOST POPULAR AND ARE ESPECIALLY RECOMMENDED FOR NEW COLLECTORS!
- Antique Radio Restoration Guide, 2nd Ed., Johnson. *Beginner's introduction to troubleshooting and repairing AC table model radios.* 1992. 145 pgs. \$14.95
- The AWA Review. *Collections of articles. Vol. 6: Tubes, Hawaiian Wireless, U.K. TV, SCR-RC-BC Dir., NYC Wireless, etc. Vol. 7: Tubes, Poldhu Transmitters, Navy Equipment, Arc Transmitters, etc. Vol 8: Keys, Federal Co., KFS-Federal-Mackay Story, National Electrical Supply Co., Navy Electronics Dir., etc. (Per Volume) \$10.00*
- The Antique Radio Boys and the Garrulous Grebe, Dryer. *Thrilling adventure story written in the traditions of the '20s and '30s. 5 1/2" by 8 1/2".* 51 pgs. \$4.95
- The Auto Radio: *A Romantic Genealogy*, Matteson. *Information, photos & ads from the early days of the automobile radio through the 1950s.* 316 pgs. (hardcover) \$34.95
- Behind the Front Panel, Rutland. *Easy-to-read review of radio circuits and 1920s radio history. Simplified descriptions and illustrations.* 25 photos. 158 pgs. NEW \$18.95
- Classic TVs, Wood. *Prewar to 1950s, with price guide. 140+ color photos, plus repros of catalogs & ads.* 86 pgs. \$16.95
- ☞ The Collector's Guide to Antique Radios, 3rd Ed., Bunis. *This guide covers radios from 1920s to 1960s. Over 8,500 prices and over 650 all new color photos are included.* 1994. 278 pgs. NEW \$18.95
- The Collector's Guide to Novelty Radios, Bunis & Breed. *The source for novelty transistor radios. Full descriptions with current prices. Over 600 color photos.* 1994. 224 pgs. (Available Oct./Nov.) NEW \$18.95
- The Collector's Guide to Transistor Radios, Bunis. *Identifies the most sought-after vintage transistor radios. Over 2,000 models, 400+ color photos, with current prices.* 1993. 256 pgs. NEW \$15.95
- Communication Receivers, 3rd Ed., Moore. *Information on 738, 1932 to 1981, vacuum tube receivers by 66 manufacturers. 402 radios illustrated. New section: 3 pages of military receivers.* 125 pgs. \$19.95
- The Compleat Talking Machine, Reiss. *A guide to restoration of antique phonographs.* 183 pgs. \$19.95
- Crosley Catalog (reprint). *1923 catalog covering the early Harko through the XX models.* 32 pgs. \$4.95
- Empire of the Air, Burns. (Videotape, VHS). *2-hour video based on Lewis' book.* \$24.95
- Empire of the Air, Lewis. *A biographical history of radio focusing on Lee de Forest, Edwin H. Armstrong and David Sarnoff.* 1991, illustrated, 421 pgs. \$13.00
- Evolution of the Radio, L-W Books. *Radios pictured and priced, plus reproductions of catalog pages and ads.*
- Vol. 1 - *Eight-hundred + radios.* 1991. 227 pgs., 118 pgs. in color \$22.95
- Vol. 2 - *Totally different from volume one with new photos, etc.* 1993. 654 color photos. 226 pgs. \$24.95
- Firco Radio Equipment, John Firth & Co., Inc. (reprint). *Twenty-six-page booklet of the Firth Co.* \$4.95
- Fixing Up Nice Old Radios, Romney. *Written by an old radio instructor, this book covers Ohm's law, through battery sets, superhets and communications receivers.* 1990. 300+ figures, 185 pgs. \$19.00
- ☞ Flick of the Switch, McMahon. *The classic photo reference guide for collectors of radios from the '30s to the '50s. 1000+ photos of radios.* 263 pgs. \$11.95
- Great Radio Personalities (reprint). *Black & white portraits and info on all the favorites from the golden days of radio - Abbott & Costello, Baby Snooks, and more.* 128 pgs. \$11.95
- ☞ Guide to Old Radios - Pointers, Pictures & Prices, Johnson. *Describes the history of radio and includes 350+ photos and a price guide to 3300 sets.* 1989. 128 pgs. \$16.95
- Hake's Guide to TV Collectibles. *Price guide and illustrations for 1600 TV program premiums, games, puzzles, comic books, action figures, lunch boxes, toys and other collectibles.* 1990. 185 pgs. \$14.95
- Hallcrafters Co. 1932-1982; A Partial Product Listing Covering 50 Years of Production, 5th Ed., Dachis. *Listing of over 500 receivers, transmitters, televisions, speakers and accessories. No photos, 44 pgs.* \$12.50
- Hertz: *The Beginning of Microwaves*, Bryant. *Photos and descriptions of Hertz's apparatus and experiments. A book prepared for the IEEE Hertz Centennial exhibit.* 50 pgs. \$15.00
- Inventing American Broadcasting, Douglas. *A careful weaving of technology, social forces, and business decision making from the days of Marconi to broadcasting in the 1920s.* 1987. 363 pgs. \$14.95
- Lawlor's Radio Values. *Price guide for radios in Collins & Sideli books.* 1991, no photos. 32 pgs. \$12.50
- Los Angeles Radio Manufacturing, Paul. *History of radio manufacturers in the L.A. area from 1922 to 1942. Features Echophone, Gilfillan, Jackson Bell & 9 others.* 88 pgs. \$10.50
- Supplement No. 1, Paul. *Coverage of additional manufacturers, people and sets.* 1993. 48 pgs. \$6.75
- Made in Japan, Handy. *A stunning book on the rise of the transistor radio. 175+ radios in color.* 1993. 108 pgs. \$16.95
- The Mechanics of Television, Yanczer. *History and explanation of mechanical television, plus construction details for a working system.* 1987, 5 1/2" by 7 1/2", 170 pgs. \$24.95
- Most Often Needed 1926-38 Radio Diagrams and Servicing Information (reprint). *600+ diagrams for mostly AC radios from '26-'38.* 240 pgs. \$11.95
- Novelty Radios, Breed. *500+ transistor novelty radios in full color with current prices.* 1990. 217 pgs. \$24.95
- 1994 Price Update - Novelty Radios, by Breed and Bunis. 14 pgs. \$4.95
- Official Radio Service Manual (reprint). *100s of pre-1930 circuits & notes.* 356 pgs. \$24.95
- Old-Time Radios! Restoration and Repair, Carr. *How to repair vacuum-tube and transistor radios. A self-paced training guide.* 200 illustrations, 256 pgs. \$16.95
- Philco Radio: 1928-1942, Ramirez. *A reference book on Philco. Shows receivers and company history year-by-year. 464 color photos, 364 black & white photos and drawings.* 1993. 160 pgs. \$29.95
- Portable Radio In American Life, Schiffer. *Traces the development of the portable radio and how it affected American culture and society.* 450 photos and drawings, 259 pgs. (hardcover: \$45.00) \$24.95
- Poster's Radio & Television Price Guide, 1920 - 1990, 2nd Ed. *875+ TV's, 650 transistor radios and 2,200 other radios listed. 600 sets illustrated, 75 in color.* 1993. 7" x 10". 264 pgs. \$17.95
- Price Guide to Plastic Collectibles, McNulty. *Describes types of plastics, etc. (Radio is 8 of 207 pgs.)* \$17.95
- RCA Radiolas, Radiotrons, and Accessories (reprint). *Twenty-page booklet summarizing RCA's 1926 product line including the Radiolas 11, 20, 25, 26, 28, etc.* \$4.50
- Radio Art, Hawes. *A chronological, illustrated history of the technical and stylistic progress of the radio. Mostly British, but American sets are featured as well.* 250 photos, 150 in color, 128 pgs. (hardcover only) Low Price! \$19.95

COLLECTOR BOOKS AVAILABLE FROM ANTIQUE RADIO CLASSIFIED

☞ BOOKS MARKED WITH "☞" ARE THE MOST POPULAR AND ARE ESPECIALLY RECOMMENDED FOR NEW COLLECTORS!

- Radio Art Postcard Deck.** 30 full-color photographs from Hawes' book **Low Price! \$7.50**
- Radio Collector.** (Videotape, VHS). The five-part Emmy-nominated PBS series combined on one 130-minute videotape. Meet collectors, see collections, attend swap meets, learn about radio restoration. **\$29.95**
- Radio Collector's Guide, McMahon.** Listing of 9,000+ radios made by some 1200 companies from 1921 to 1932. Gives manufacturer, year, model name and other info. No photos, 264 pgs. **\$11.95**
- Radio Craft - 50 Years of Radio** (reprint). March 1938 issue of Radio Craft magazine. Numerous articles on the development of radio, then 50-years old, and on early radio pioneers. 144 pgs. **\$15.95**
- Radio Enters the Home, RCA** (reprint). A 1922 catalog including the Aerovols Jr. and Sr., the RA, DA, RC, Grand, etc., plus parts and accessories. 128 pgs. **\$16.95**
- Radio Equipment & Supplies, Robertson-Cataract Electric Company** (reprint). 1922 catalog of radios, accessories and other equipment. Includes RCA, Clapp-Eastham & others. 168 pgs. **\$19.95**
- ☞ **Radios-The Golden Age, Collins.** Full-color book on the colorful Catalin and Bakelite radios from the late 1930s to the early 1940s. 128 pgs. (hardcover \$29.95) **\$17.95**
- Radio Horn Speaker Encyclopedia, Paul.** Listing of horn speakers for over 320 manufacturers for the 1920s. Expanded information on ten manufacturers. Over 145 photos, 80 pgs. (Available Again) **\$14.90**
- ☞ **Radio Manufacturers of the 1920's, Douglas.** Three comprehensive volumes.
Vol. 1 covers A-C Dayton thru Ferguson. 225 pgs. (softcover only) **\$24.95**
Vol. 2 covers Freud-Eisemann thru Priess. 266 pgs. (Currently Out-of-Print)
Vol. 3 covers RCA thru Zenith. 292 pgs. (hardcover: \$39.95) **\$29.95**
- Radio! Radio!, 2nd Ed., Hill.** Revised easy-to-read subject index, separate A-Z directory listing of 1,000+ British radio models with clearer photographs than first edition. 978 photos, 244 pgs. (hardcover only) **\$44.95**
- Radio Redux, Collins.** Subtitled "Listening in Style." This book showcases the sleek lines and luscious colors of over 80 gleaming sets from the collection of Philip Collins. 120 pgs. (hardcover: \$29.95) **\$17.95**
- Radio/TV Finder, Okolowicz.** This handy guide provides a ready reference to nearly 7000 pictures of collectible radios and TVs found in 24 popular collector books. No photos, 110 pgs. **\$13.95**
- Radio & T.V. Collector's Guide Book, Biraud.** The "Vintage Radio" illustrated guide to European sets (very few British sets) from early wireless to the 1930s (a few later). Text is in both French and English.
Vol. 2 - P to Z & T.V., Speakers, Tubes, Parts & Novelties. 256 pgs. (Vol. 1 is unavailable) **\$49.95**
- Radios of the Baby Boom Era.** Pictures and info from Sams Photofacts. 3,494 radios illustrated plus 3,275 additional radios listed. 274 brands. 1946 thru 1960. Six volumes, 300+ pages per volume. Order by volume:
Vol. 1: Admiral - Clearsonic. Vol 2: Co-op - Gelsco. Vol 3: GE - Monitorradio. Vol 4: Motorola - RCA.
Vol 5: Realtone - Stratovox. Vol 6: Stromberg-Carlson - Zenith. (Per Volume) **\$16.95**
- Refinishing Old Furniture, Wagoner.** Written by a furniture restoration instructor. A step-by-step guide to furniture (or radio) restoration, from removal of finishes right up to the final polish. 178 pgs. **\$13.95**
- Saga of the Vacuum Tube, Tyne.** The development of vacuum tubes - 1880 to 1930. From Edison, Thomson and Fleming to de Forest, Philips, Siemens and many more. 100+ tube photos, 495 pgs. **\$18.95**
- Syntony and Spark, Aiken** (reprint). Subtitled "The Origins of Radio." Describes the development of radio from Maxwell's work in the 1860s through the contributions of Hertz, Lodge and Marconi. 1976. 347 pgs. **\$13.95**
- S. Gernsback Radio Encyclopedia** (reprint). 1927 classic encyclopedia on radio. From "A" Battery to Zirconium, with 1000s of entries in between. 100s of illustrations, 175 pgs. **\$9.95**
- 70 Years of Radio Tubes and Valves, Stokes.** The story of the radio tube from the laboratory to the commercial market. 247 pgs. **\$25.95**
- 75 Years of WE Tube Manufacturing, Magers.** A log book history 750+ WE tubes. Illustrated. 133 pgs. **\$16.95**
- Tomart's Price Guide to Radio Premium and Cereal Box Collectibles, Tumbusch.** Includes comic character, pulp hero, TV and other premiums. 1991, 3,000+ illustrations, 176 pgs. **\$22.95**
- Transistor Radios, A Collector's Encyclopedia and Price Guide, Lane.** Identification guide to over 2,500 transistor and novelty radios. History and key to collecting chapters. 1994. 170 pgs. **NEW \$19.95**
- ☞ **Vintage Radio, McMahon.** The classic photo reference guide for collectors of radios prior to 1930. Crystal sets, battery sets, tubes, horns, parts, etc. Over 1000 pictures, 263 pgs. (Temporarily Out-Of-Print) **\$44.95**
- The Weekend Refinisher, Johnson.** A complete guide to stains and finishes and tips for setting up your own workshop. A handy furniture "first aid" kit for quick repairs. Illustrated. 296 pgs. **\$10.00**
- Westinghouse Catalog** (reprint). 1920s catalog of the RA-DA and other early Westinghouse equip. 8 pgs. **\$4.00**
- Wireless Communication in the U.S., Mayes.** Early development of American radio operating companies. Alternators, coherers, stock promotions, unpublished letters, etc. 160 illustrations, 240 pgs. **\$29.95**
- The Xtal Set Society Newsletter, Anderson.** Complete set of the Society's newsletter. Order by volume.
Vol. 1: 7/91 to 5/92 - Field Strength Meter, HF Broadcasting, FM Xtal Set, Xtal Sets & Wireless, & more.
Vol. 2: 7/92 to 5/93 - The Lead Pencil Detector, Detector Busing, The Universal Xtal Set, etc. (Per Vol.) **\$9.95**
- The Xtal Set Handbook, Anderson.** Formulas for coil inductance, a procedure for measuring coil capacitance, circuit matching theory, & more. Also included is Vol. 3 of the Xtal Set Society Newsletter. **NEW \$10.95**
- Zenith Radio Corporation** (reprint) The instructions for installation and operation for Models 39-39A Models 392-392A, and Electric Zenith Receivers. 3 schematics, 3 photos, 7 1/2" by 5", 16 pgs. **\$4.50**

U.S. Orders - Enclose \$2.50 per order for packing & book-rate shipping if total order is under \$35.00. If using VISA or MasterCard, include name on card, card number and expiration date. Send payment with order. Mass. residents please add 5% sales tax. Money back return policy. Most orders shipped the same day received, but allow 2-4 weeks to receive order. Foreign orders - write for shipping costs, or use credit card and specify air or surface (allow 2-3 months for surface shipping).

Send Order To: A.R.C., P.O. Box 2, Carlisle, MA 01741
or Call: (508) 371-0512 Fax: (508) 371-7129



BUYING TRANSISTOR & DECO RADIOS

VINTAGE TELEVISIONS
BUY • SELL • RENT • REPAIR • PARTS



HARRY
POSTER

DAYS: (201) 794-9606
24 HRS: (201) 410-7525

P.O. Box 1883 • South Hackensack, N.J. • 07606

FAX: (201) 794-9553

Wanted: Dead or Alive! Unusual vintage TVs from the 1920s through the 1960s.



FOR SALE: RCA Experimental 16" COLOR CRT. Approximately 30 color TVs were made in 1952 for a FCC test, when RCA put color gun assemblies into 16" tubes. We have one of these CRTs, complete with prototype coils and magnets. The color matrix was held in position with three bolts which are visible behind the front glass! A fantastic display item and this CRT is definitely **Super RARE—\$595 plus UPS.** Harry Poster



FOR SALE: Scanning Discs—these almost never turn up! The first is a Pohl Television Scanner/60 Lines/ Detroit Mich There's a flattened original box with a black and silver label, plus a 16" poor condition black paper disc, and an orange heavy paper disc—the orange one is probably a good copy of the original. The complete lot: **Pohl discs—\$105.** Plus, we have a 24" metal Daven Television Scanning Disc/Image 1½"/Combination T-4680 with three sets of scan holes. This is a nice original disc with a red and black label. **The Daven—\$385** Please call Harry Poster (See phone and FAX numbers above)

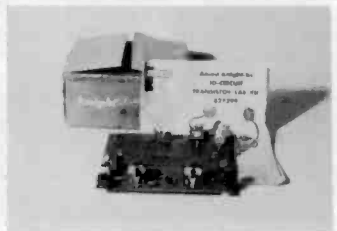

FOR SALE: Allied Knight-Kit 10 circuit Transistor Lab Kit #83Y299. Printed circuit breadboard with 10 cards, parts and controls, plus original transistors. You can build a 2-transistor radio, or nine other projects. In worn box, with original instructions which is dated 1957 **priced at \$70 plus UPS,** it could be your snow-bound amusement. **Harry Poster (Please see above)**

FOR SALE:
"Clear" CRTs.

We have some early 1930s picture tubes, which were made without Aquadac—the grey coating that's inside most CRTs. These make great displays. **DuMont 34-XH \$90 each,** or a pair of slightly different **34-XH tubes—2 for \$155.** Plus, we also have an nice, clear **RCA 906—\$120.** This funnel shaped 3" picture tube was promoted in the early 1930s for do-it-yourself television projects. **Harry Poster**

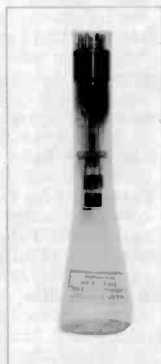

FOR SALE: BENDIX Navigator 410 transistor radiol Made by Nova-Tech in Calif., they described it as a "Direction Finder", with Beacon/Marine/Broadcast bands, and the top rotating antenna even has the Morse code and a **flip-up calibrated rangefinder!** A crack in the rear left corner, but still in the original box with paperwork. **\$55 postpaid.** Please call/write/FAX Harry Poster

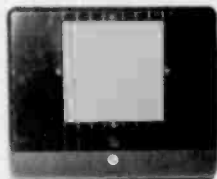

FOR SALE: RCA Bakelite Speaker. This brown bakelite speaker measures 12" high by 15" wide, and it's only 5" deep. It was made to hang on a wall. Below the grill cloth is the raised logo of RCA in the bakelite, plus a celluloid and red logo button. It's in good original condition, ready to be hung next to your RCA collection! **\$69 plus UPS charges.** Harry Poster (Phone and FAX numbers above)

CLASSIFIED ADVERTISING POLICY

ONE FREE 20-WORD AD for subscribers in each issue; additional words are 19¢ each. See details below. Classified ads sent by mail, fax or by any other method must be received (not just postmarked!) by **Noon Eastern Time** on the classified ad deadline date to guarantee inclusion in the current issue. Late ads are held for the following issue. Please enclose correct payment with all ads. Stamps or cash are OK for small amounts. (Canadian and other foreign advertisers, please see "Payment" on page 2 for methods.) "Free words" cannot be accumulated from month to month; free words must be requested when ad is submitted.

Faxed ads: Please see additional information on the inside front cover.

Please write each ad on a separate sheet of paper, especially when included with other A.R.C. correspondence. Include SUB# with ad. Ads may be sent in advance; but, write each ad on a separate piece of paper and indicate the month (or successive two months) you want the ad to run.

To minimize our typing errors: **Please write legibly.** Use both capital and small letters. Do not use a dash between words. Carefully write the following numbers and letters (especially in model numbers) since some can look alike; for example 1, I and l (the number one, the capital i and the small l.) Also: 0, O, o, Q and D; r and n; 6, b and G; V, U, u, v and Y; A and R; 5, S and 2, Z and z. We try to correct spelling errors, so when using an uncommon word or manufacturer which we might mistake as a more common word or manufacturer, note it so that we do not "correct" it. Editor's annotations are in [brackets].

Advertising is accepted only for early items related to radio, communication, etc. All items must be described fairly; reproductions, reprints and not-original items must be so identified. Advertisers must agree to respond promptly to inquiries and orders, to resolve problems promptly if the buyer is not satisfied, and to comply with a buyer's refund request on unaltered returned items.

The publisher reserves the right to edit ads without notification to the advertiser and to reject ads for any reason. Names other than the advertiser will be edited out of ads. Ads with non-radio-related items will be returned or edited unless the non-radio-related items are for trade of radio-related items, or they are incidental to and appear at the end of an otherwise acceptable ad. The publisher is not responsible for errors due to illegibly written ads or for any other reason.

Clubs: Since club activities receive free coverage on the *Coming Radio Events* pages, the free 20 words may not be used for club activity ads. See inside front cover for additional information.

CLASSIFIED AD DETAILS

Deadline: NOON ET— 10th of the month!

Classified ads must have a standard heading such as **WANTED, FOR SALE, FOR TRADE, FOR SALE/TRADE, SERVICES, MESSAGE, HELP, AUCTION, MEET, etc.** This heading is the only bold or all-capitalized words allowed in the ad. Capitalize only manufacturer names, model names, etc. "Wanted" and "For Sale" ads are mixed together to encourage the reading of all ads, including the "Wanted" ads. This standard ad format makes scanning the ads easier.

Before writing your ad, please look over the ads in a recent issue of A.R.C., and try to write your ad in the same style. Full name (or company name) and address is **required** in all classified ads; we will add it if you forget.

To encourage varied content of the ads, the same classified ad may be run only once per issue and for only two consecutive months. (To run an ad longer, use a boxed classified or display ad.)

Classified Ad Rates per Month

Subscribers:

First 20 words: **FREE***

19¢ per word for extra words over 20 plus

10¢ per word for a shaded ad (count all words including free words).

* Subscribers may take 20 free words on only **one** ad each month.

Non-Subscribers:

35¢ per word plus

10¢ per word for shaded ad.

Please do not forget to send in the extra 19¢ per word when your classified ad runs over the free 20 words; your payment will be appreciated, and it will help to keep A.R.C. healthy.

BOXED CLASSIFIED AD DETAILS

Deadline: 1st of the month!

Boxed classified ads can run unchanged for three months or more. No words are free. Ads may be shaded and may include bold and all-capitalized words freely. The ad need not begin with "For Sale," etc. Minimum run is 3 months, prepaid. Discount: 5% for 6 months; 10% for 12 months.

Boxed Classified Ad Rates per Month

Nonshaded ads:

30¢ per word for all words,* none free, plus

10¢ per word for each bold word plus

10¢ per word for each all-caps word.

Shaded Ads (All words are bold at no charge):

40¢ per word for all words* plus

10¢ per word for each all-caps word.

Non-Subscribers:

Add 20¢ per word to above costs.

*Three words can be bold-all-caps at no extra charge.

PHOTO & DRAWING DETAILS

Deadline: 1st of the month

for all ads with drawings or photos!

Drawings and photos are encouraged as the response to your ad is much larger and the reader knows better what you want or are selling. Send in your drawing or photograph, and A.R.C. will reduce it or enlarge it as needed.

Photo and Drawing Rates per Month

\$12.00 per month for each photo or drawing (If ad is canceled, this amount cannot always be refunded.)

CHANGES & CANCELLATIONS

Please check your ads carefully before sending them in. Once ads are received, it is not always possible to refund the amount sent, pull the ad or make changes.

IMPORTANT — COUNTING WORDS — IMPORTANT

The standard headings: **WANTED, FOR SALE, etc.,** count as one word each time used in an ad. Name, address and (one) telephone number, count as 6 words, regardless of length. Ham call letters and business name can be included in the 6 words and do not count extra. Full name (or company name) and address is **required** in all classified ads. Each additional word, abbreviation, model number or number group, extra telephone numbers, etc. count as one word each. Hyphenated words count as two words.

SECOND CLASS



A.R.C., P.O. Box 2, CARLISLE, MA 01741

RETURN POSTAGE GUARANTEED

G-AE SUB# 27-777
JOE W MCCLUGHAN

431 OGDEN LN
NEW BRAUNFELS

TX

EXP=DEC94

78130

CLASSIFIED AD

DEADLINE OCT. 10th

Noon Eastern Time