



ANTIQUE RADIO CLASSIFIED



VOLUME 10

JANUARY 1993

NUMBER 1

Arvin Metal Radios

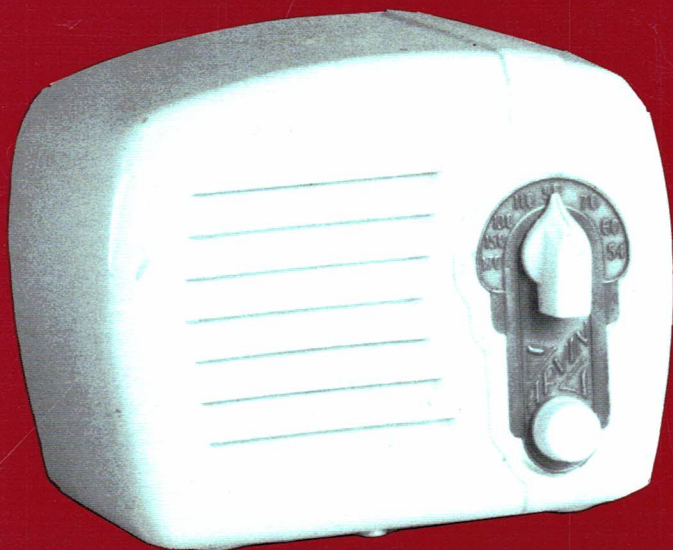

A.R.C. — THE NATIONAL PUBLICATION FOR BUYERS AND SELLERS
OF OLD RADIOS AND RELATED ITEMS — PUBLISHED MONTHLY

ANTIQUE RADIO CLASSIFIED

Antique Radio Classified (ISSN:8750-7471) is published monthly, 12 times per year, by John V. Terrey, One River Road, P.O. Box 2, Carlisle, MA 01741. Second-class postage paid at Carlisle, MA, and additional mailing offices. Telephone: (508) 371-0512, 9:00 AM to 5:00 PM ET weekdays; machine answers phone at other times.

Annual subscription rates within the U.S. are \$29.95 by Second Class mail and \$44.95 by First Class mail.

Annual foreign rates. By air: Canada - \$48.00; Mexico - \$47.00; Other foreign countries - \$85.00. Surface mail: Canada - \$39.00; Other foreign countries - \$43.00. (Surface delivery to countries other than Canada may take two or more months and cannot be guaranteed.)

Two-year subscriptions are twice these rates and receive an extra month. Sample issues are available free on request.

© Copyright 1992 by John V. Terrey.

POSTMASTER: Send address changes to Antique Radio Classified, P.O. Box 2, Carlisle, MA 01741.

STAFF

Publisher and Editor:	John V. Terrey
Production Manager:	Scott J. Young
Office Manager:	Lisa A. Friedrichs
Publishing Staff:	Dave Crocker
Dick Desjarlais	Chris Frederickson
Bobby Lyman	Shirley Sauer
Dorothy Schechter	
Founding Publisher/Editor:	Gary B. Schneider
Contributing Writers:	Mike Adams
Richard L. Arnold	Ray Bintliff
Paul J. Bourbin	Norman S. Braithwaite
Dave Crocker	Alan S. Douglas
Richard C. Foster	David W. Krauter
Jim Kreuzer	Ron Ramirez
Henry Rogers	Ian L. Sanders
Gil Schlehman	Gary B. Schneider
Frank R. White	Ralph Williams

PURPOSE. *Antique Radio Classified* is published for people involved in the radio collecting hobby. Its purpose is to stimulate growth of the hobby through the buying, selling and trading of radios and related items, and to provide a monthly forum for the interchange of ideas and information.

CONTACTING ANTIQUE RADIO CLASSIFIED.

All correspondence should be sent to:
A.R.C., P.O. Box 2, Carlisle, MA 01741.

Send only UPS, Federal, etc. items to One River Road.
Telephone: (508) 371-0512; Fax: (508) 371-7129

Please, no classified ads by telephone; thanks.

Your ads, renewals, letters, etc. can be handled faster and more efficiently if (1) each is on a separate piece of paper, and (2) your name, address and SUB# are written on each. Unfortunately, A.R.C. is not staffed to answer letters

with questions about antique radios or requests for advice. However, A.R.C. does solicit letters of interest to its readers and publishes them as space permits. A.R.C. assumes that permission is given to edit and to publish all correspondence and articles received unless otherwise indicated.

GUARANTEE. You may cancel your subscription at any time and receive a pro rata refund for issues not yet mailed. If errors to ads are made by A.R.C., upon request a free correction will be run in the next available issue.

PAYMENT. Please send in full payment with your order or ad. A.R.C. does not carry accounts; all subscriptions, ads, etc. must be prepaid. Pay in U.S. funds. Checks drawn on a U.S. bank, money orders, VISA or MasterCard (\$10.00 min.) are preferred. Make check out to "A.R.C." U.S. stamps or cash are OK for small amounts. Canadian payers may send a Canadian check in U.S. funds, but please add \$1.00 (U.S.) for bank charges. Subscriptions will be prorated to amount sent if amount is incorrect.

CHANGE OF ADDRESS. Please notify us 4 weeks in advance of a change of address. Send both your new and old address, and include your SUB# and effective date of your new address. Temporary address changes can be made also.

SUBMISSION OF MATERIAL. *Antique Radio Classified* welcomes and solicits information that pertains or relates to radio history or collecting. This may include articles, book reviews, photos, information on upcoming radio events, meetings, antique radio organizations, radio auctions and price reports, sources of old radio and restoration supplies, and other related and interesting material. All material submitted should be neat and verified for accuracy. Unless prior arrangements are made, all submitted materials may be edited, become the property of *Antique Radio Classified* and will not be returned.

MAILING OF ISSUES. U.S. subscribers can receive A.R.C. by First or Second Class mail (Second Class is the way most magazines are mailed). The mailing of First Class copies is staggered over one to four days with faraway copies mailed before local copies. Non-U.S. copies are mailed on the first day. Second Class copies are mailed on the last day. Mailing dates change each month, but mailing is usually completed by the 26th of the month. First Class copies usually are received by the fifth of the month; copies by Second Class mail, by the tenth.

ETHICS. No person involved in the production of A.R.C. is to act on any information in the magazine until the day after local copies are mailed.

DISCLAIMER. The publisher is not responsible for any buying and selling transactions incurred, or for any other use of the contents of this publication.

Antique Radio Classified subscription rates, frequency of publication, content, policies, size and ad details, and rates are subject to change at any time by A.R.C.

DISPLAY AND BUSINESS CARD ADS - DETAILS AND RATES

The deadline is the first of the month for display and business card ad artwork, payment and repeat requests.

Advertising is accepted only for early items related to radio, communication, etc. All items must be described fairly; reproductions, reprints and not-original items must be so identified. Advertisers agree to respond promptly to inquiries and orders, to resolve problems promptly if the buyer is not satisfied, and to comply with a buyer refund request on unaltered returned items.

Advertising must be prepaid, except as noted below; see "Payment" paragraph above for details. Late ads will be run only if space and time permit. Since artwork is reduced to 63% in the printing process, **originals must be the artwork size listed below.** Do not send in artwork on art board or send negatives. Ads should be typeset or typed neatly with a carbon ribbon, black printing on white. No reverse type if A.R.C. is to make up the ad. If you want us to prepare your ad, include the one-time cost below for A.R.C. to make up the ad.

Photos should be at an 85-line screen; otherwise, add \$10.00 per photo for screening. **Do not cut or trim photos or glue photos to artwork; submit separately.**

If you are confused by these requirements and terms,

Page	ARTWORK SIZE		As Printed		Cost for 1-month	Cost for 3-months	Cost for 6-months	Cost for 12-months	One Time to make up Ad
	SEND IN THIS SIZE		(size in magazine)						
	H x W (inches)		H x W (inches)						
Full	12 3/16 (or 10 1/2)	x 7 1/2	7 3/4 (or 6 5/8)	x 4 3/4	\$188.00	\$499.00	\$869.00*	\$1580.00**	\$60.00†
1/2 H		5 1/4 x 7 1/2		3 5/16 x 4 3/4	94.50	252.00	435.00	790.00**	30.00†
1/2 V	12 3/16 (or 11 13/16)	x 3 9/16		7 7/16 x 2 1/4	94.50	252.00	435.00	790.00**	30.00†
1/4		5 1/4 x 3 9/16		3 5/16 x 2 1/4	47.75	127.00	220.00	399.00	15.00†
1/8		2 5/8 x 3 9/16		1 5/8 x 2 1/4	24.50	65.00	112.00	199.00	7.50†
Business Card		2 x 3 3/4		1 1/4 x 2 3/8	not avail.	34.00	59.00	107.00	5.50†

* Full page, 6-mos.: 1/2 due with order; 1/2 due in 3 mos. ** Full & 1/2 page, 12-mos.: 1/4 due with order; 1/4 due at 3, 6 & 9 mos.

† For 6 and 12 month ads, no ad make-up charge if no change is made to ad for entire run.



ANTIQUE RADIO CLASSIFIED



EDITOR'S COMMENTS

To kick off a great New Year, A.R.C. presents Dan Howard's detailed discussion of Arvin metal cabinet radios in our lead article. This thoroughly researched piece traces the history of metal models year by year and describes their various styles and colors. Illustrated with 21 photos, Dan's article provides invaluable information for those who have or hope to acquire Arvin metal radios.

Dan also joins in the controversy over whether Arvin ever produced a chrome-plated model; he finds no evidence of such a model in the extensive research he has done. Is there anyone out there who can document by ads or otherwise, a chrome-plated model?

The Kodol "microphone" — or is it a speaker? — is the subject of an article by Dave Crocker, a member of A.R.C.'s staff. Dave describes what is inside this large microphone-looking speaker, which was touted as "the sensation of the season" in 1925.

Ian Sanders, our regular contributor on sets from across the Atlantic, describes Cosmos Radicphone crystal sets — Types C.1 and C.4 — in the careful detail we've come to enjoy in Ian's articles.

George Potter reports on the Vintage Radio and Phonograph Society (VRPS) Convention and Auctions in Irving, Texas, on October 16-18, 1992. An astonishing total of 900 items was put up in three auctions, with a yield of nearly \$40,000. The format of the very successful VRPS meets differs from that of most clubs in that their auction — their "main event" — precedes the flea market, which is a morning-only affair on the third day of the meet. An impressive old equipment contest parallels the auction activity.

This month, Frank Bock contributes our repair article in which he describes the repair of the potted "catacomb" units found in RCA Models AR810, AR812, and Radiolas 24, 25, 26 and 28. Frank's method employs a heat gun to melt the potting compound.

Our *Photo Review* shows several tombstone and cathedral sets, as well as a collection of unusual European crystal detector boxes. Look also for a nice photo of the unique Crosley Buddy Boy.

Several short letters, notes, and articles containing valuable comments and information appear throughout the issue. Robert Lozier's clever technique for "de-dusting" your sets is on my own "must-do" list. Lloyd Spivey's *Ten Commandments for the Radio Serviceman* offers us all some amusing food for thought.

Advertising Policy Changes. In each issue, we print the A.R.C. Advertising Policy on the inside front and rear covers, and on the first page of the classified ads. As mentioned in our June and December 1992 *Editor's Comments*, we expect

that if a buyer is dissatisfied, the seller will accept the return of unaltered items and send a refund. Since this is the accepted business practice today, this requirement has been added to our advertising policy.

Our conversations with sellers and our own experience indicate that the request for a refund is rare and usually the result of a misunderstanding. Advertisers, please consider this new stipulation before you place your next ad.

Subscription and Advertising Rate Increases. Beginning in the July 1992 issue, A.R.C. announced that the New Year would usher in an increase in A.R.C. rates. Please look over the center coupon, and the inside front and rear covers for the new subscription, display and classified advertising rates. Note especially that the extra word charge for classified ads is increased by 2¢ to 17¢ per word for those words over the monthly free 20 words.

We increase rates reluctantly and only when necessary to maintain A.R.C. as a quality publication. In this regard, we print a number of letters and comments from our readers in *Radio Miscellanea* this month. These include several of the infrequent unfavorable ones. Also included is a chart showing A.R.C.'s growth in pages, classified ads, article pages and subscription rates. By almost any measure, the A.R.C. you receive today is a bargain.

Club Events. The club activity scene is picking up again with 28 January events listed on our *Coming Radio Events* pages. A.R.C. plans to be at the quarterly New England Antique Radio Club meet in Nashua, New Hampshire, on January 23, 1993, and at the Greater Boston Antique Radio Collectors Radio XXIV in Westford, Massachusetts, on February 21, 1993. After this February show, A.R.C. is hosting an open house, along with a chance to see the editor's personal collection. Please note the details on page 71 in this issue.

Our sincere thanks to the many friends who have sent holiday greetings to our staff. And to all of you, both newcomers and those who have supported A.R.C. through the years, we extend our best wishes for a Happy New Year — which, of course, includes Happy Collecting in 1993!

John V. Terrey

ON THE COVER

One of Arvin's first metal cabinet radios, the 1938-1939 Model 40, appears on our cover this month. Dan Howard states in this issue's lead article on Arvin metal cabinet radios that "this set is among the hardest of Arvins to find." This model also was sold sporting the name "Mighty Mite" instead of "Arvin" on its face.

WITH THE COLLECTORS

Arvin Metal Cabinet Radios

BY DAN HOWARD

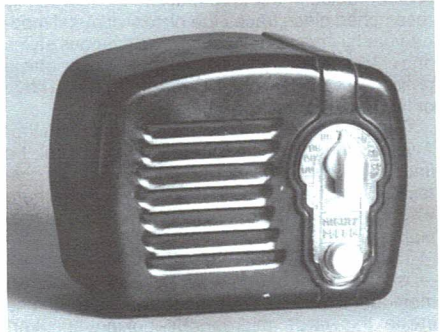
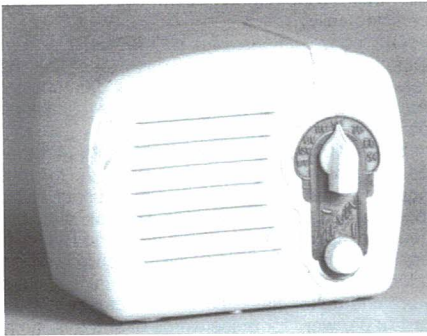

Figure 1. The 1938-1939 Arvin Model 40 (RE-49), left, and the Model 40 Mighty Mite.

Arvin metal cabinet radios first became widely accepted as collectibles in the late 1980s after being pictured in chrome by Philip Collins in *Radios: The Golden Age*.

Since then many people have found Arvins fun to collect because they are available in a number of eye-catching colors and styles and are small enough to display on a bookshelf. And while prices have been going up, most Arvin models are still relatively inexpensive.

Unfortunately, when it comes to Arvin metal radios, many of the standard collector's references have missing or inaccurate information. [Steve Baron who reviewed Collins' book *Radios: The Golden Age* (A.R.C. April 1988, p. 10) questioned the authenticity of the chrome-plated radios pictured in the Collins book.] To help collectors better appreciate what they have or may want to acquire, this article offers a model-by-model presentation of Arvin metal radios.

PART I: PREWAR METAL ARVINS

All metal Arvins produced before World War II were offered in standard paint colors — either walnut (brown with black flecks) for the 1938-1939 models or plain brown for the 1940-1941 models. For about \$2 more, Arvins were available with ivory paint, and the letter "A" was added to the model number (i.e. 402A). According to my research, no other colors were available prior to World War II.

Like many manufacturers,

Arvin printed its model numbers on paper labels which were glued to the radio cabinets. Look for the label on a 1938-1939 radio inside the top of its cabinet. With 1940-1941 and later models, look for a label on the bottom of the cabinet. Because of their usefulness in model identification, I have shown chassis numbers in parentheses after the model numbers.

1938-1939. Arvin's 2-tube Model 40 (RE-49), "The Arvinet," was one of the company's first metal cabinet radios. As shown in Figure 1, its keyhole-shaped dial plate, bar-shaped pointer knob, and ridge which runs front-to-back above the dial make this set easy to identify. Model 40 was released with one of two different names on its dial foil — either "Arvin" or "Mighty Mite."

On page 126 of his book *Arvin: The First Sixty Years*, Coke Coons reports that "Hundreds of thousands of these little sets were sold to jobbers for as little as \$4.10 each, and for years the

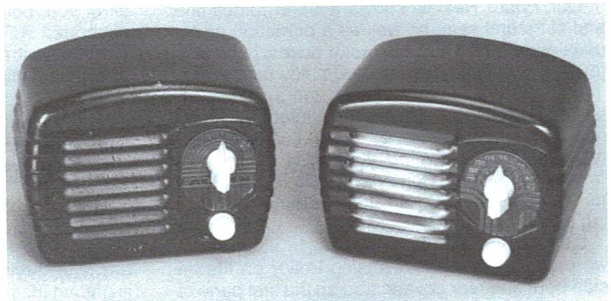

Figure 2. The 1938-1939 Model 402, left, and the Model 422.

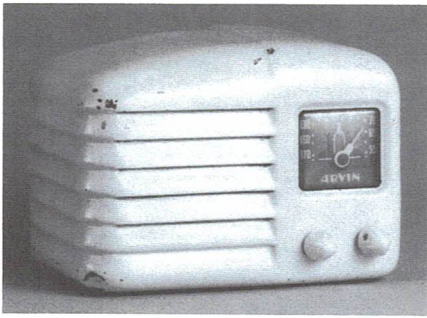

Figure 3. The 1938-1939 Model 502A.

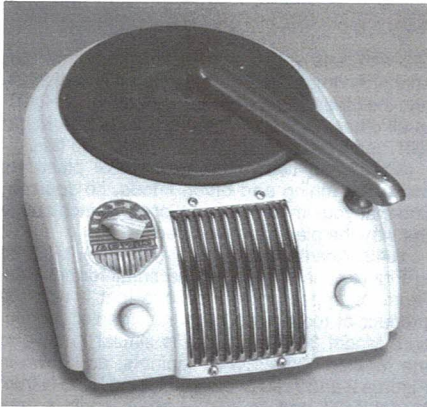

Figure 4. The 1938-1939 Model 302A (RE-64) all-metal radio-phonograph.

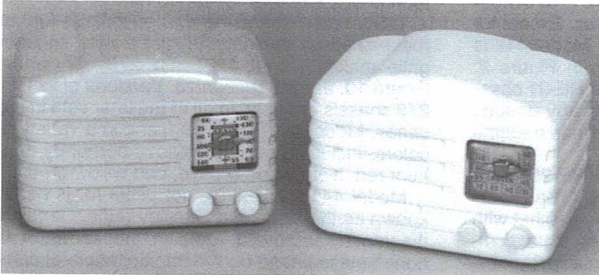

Figure 5. The Model 1940-1941 522A, left, and the Model 524A.



Figure 6. The 1946 Model 444 (RE-200), Arvin's first postwar metal radio, left, and the 1946 Model 444AH (RE-200).

company received inquiries from owners needing parts." In spite of its high sales volume, this set is among the hardest of Arvins to find.

Model 402 (RE-55), shown in Figure 2, is the Model 40's 3-tube big brother. The straight bars on Model 402's dial foil make it easily distinguishable from the later look-alike Model 422, also shown in Figure 2.

Model 502 (RE-48) offers the improved performance of a 5-tube circuit in a traditional window-dial, right-hand-drive cabinet. Early production cabinets have a flat "hump" on the top, while later sets, like the Model 502A shown in Figure 3, feature a rounded hump.

Figure 4 shows Arvin's all-metal radio-phonograph, Model 302A (RE-64). This set combines a single-speed (78 rpm) turntable with a specially designed 4-tube radio chassis. You may recognize the dial foil and knobs from the Model 402. I believe the Model 302's chrome grille makes it the only Arvin that originally came with some chrome.

1940-1941. In 1940, Arvin introduced a new "Arvinet," Model 422 (RE-91). It featured a new 4-tube chassis in the old 3-tube Model 402 cabinet. As shown in Figure 2, the curved lines on the Model 422's dial plate makes it easily distinguishable from the Model 402.

Model 522 (RE-76) and its cousin, Model 524 (RE-99), are often confused with each other. Both radios use 5-tube circuits and the same window-dial cabinet. As Figure 5 shows, the difference lies in the dial faces: Model 522A uses a lithographed dial face with "Arvin" above the pointer, while Model 524A has a foil dial face with "Arvin" below the pointer. Incidentally, Model 522 is one of the few metal Arvins with a lighted dial. The one shown in Figure 5 was repainted mauve by its owner.

Wood's *Evolution of the Radio* includes an Arvin ad on page 79. Although the set in the lower left-hand corner is advertised as a Model 524, the dial face shown is from Model 522. Note also that the page is most likely from a 1941 rather than from a 1949 catalog as indicated.

In general, most prewar models are less colorful but harder to find than the postwar sets.

PART II: POSTWAR METAL ARVINS

After reverting to civilian production following World War II, Arvin presented its first new metal cabinet radios in 1946. In contrast to the prewar production, color variety soon became a major focus. All postwar chassis utilized 4-tube circuits. Look for a production date (i.e., AU 47 = August, 1947) rubber-stamped in red on the label of postwar sets.

1946. Pictured in Figure 6, Arvin's first postwar metal radio, (Continued on following page)



Figure 7. The 1947 Model 442 (RE-91).



Figure 9. The 1949 Model 341T (RE-274).

(Collecting Arvin Metal Radios, continued)

radio, the Model 444 (RE-200), is among the easiest to find. Like the 1940-1941 models, Model 444 was originally offered only in brown and ivory. In 1948, Arvin reintroduced Model 444 in six new colors: banana yellow, gardenia cream (light green), geranium red, leaf green, persimmon, and turquoise.

As shown in Figure 6, Model 444AH (RE-200) features a black plastic handle and matching black knobs. I have seen this set in ivory and turquoise, so I assume that it was available in other colors as well.

Models 444M and 444AM (RE-200M), versions of the Model 444 with miniature tubes, were released in 1947. Model 444M is brown and 444AM, ivory. After these models, Arvin didn't use miniature tubes in its metal radios again until the 1950s.

1947. Although it was first produced in 1947, Model 442 (RE-91), shown in Figure 7, has more in common with Arvin's prewar radios. Except for its black paint and silver dial face, Model 442 is identical to Model 402, as shown in Figure 2. Further, Model 442 uses the prewar RE-91 chassis from Model 422. Lest you have any doubts, my set is marked January 1948. This model seems moderately hard to find.

1948. Models 242T and 243T (RE-251) are among Arvin's most colorful radios. The Model 243T, shown in Figure 8, has a boxy cabinet with oversized knobs in contrasting colors. Color combinations include green with banana-yellow knobs, gunmetal gray with light gray, ivory with light tan,

red with pale yellow, and yellow with light blue knobs. Arvin called the ivory cabinet Model 242T, and the other colors were designated Model 243T. In all other respects, they are alike. While Model 242T is plentiful, Model 243T is harder to find.

Arvin used two different types of plastic to make the tuning and off/on knobs, so you may find that your knob colors no longer match due to the way the plastics have aged.

1949. Arvin's Model 341T (RE-274), pictured in Figure 9, is the last of the small-format sets. From its appearance, I believe that it was the product of tooling left over from earlier production. Model 341T's cabinet is similar in style to the Models 402/422/442 cabinets, as shown in Figures 2 and 7. Its oversized tuning knob is from Model 242T and its skirted off/on knob is from Model 444, shown in Figure 6. Model 341T was available only in sandalwood (light tan) with maroon knobs and seems hard to find.

1950. 1950 marked the change to large-format (brick-shaped) cabinets. A globe-style speaker grille makes Model 440T (RE-278), shown in Figure 10, easy to recognize. Versions of its RE-278 chassis are used in all of the later sets in the series. Model 440T was produced in a variety of colors, including banana yellow, burgundy, fox-hunt red, ivory, sand bronze, and willow green.

Model 441T (RE-278), not pictured, is better known as the Hopalong Cassidy radio. Certainly the most flamboyant radio in the series, it is nonetheless based on the traditional metal cabinet and 4-tube RE-278 chassis. For more infor-



Figure 8. The 1948 Model 243T (RE-251).

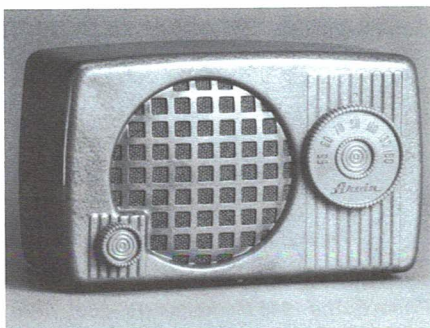

Figure 10. The 1950 Model 440T (RE-278).

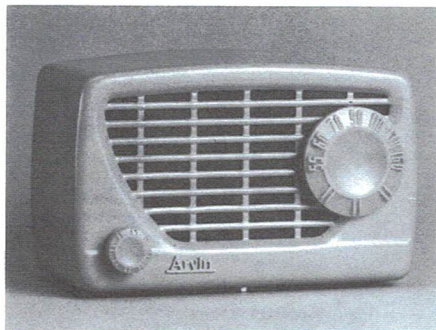

Figure 11. The 1951 Model 540T (RE-278).

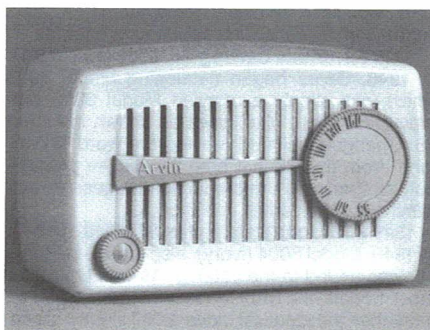

Figure 13. The 1954 Model 840T (RE-278-1).

mation on this radio see A.R.C., July 1989.

1951. Model 540T (RE-278), shown in Figure 11, was available in avocado, cherry, citron, flame, ivory, and pebble. Although this is the most common large-format Arvin, many of the "better" colors seem quite elusive.

1953. Arvin created a "new" model for spring 1953 when it reissued its 1950 Model 440T, shown in Figure 10, in ivory with Hopalong Cassidy-style black and chrome knobs. Arvin designated this "new" radio Model 542T (RE-278), not shown.

Later in 1953, Arvin began advertising the now hard-to-find Model 740T (RE-278/RE278-1). Featuring a large free-form speaker opening, shown in Figure 12, this model was first offered with the RE-278 chassis and later with the RE-278-1. Model 740T was available in cherry, citron, coral, green, ivory, and tan.

1954. The front of Model 840T (RE-278-1), pictured in Figure 13, is dominated by its large plastic nameplate/dial pointer. The frequency is read at the left side of the tuning knob where it touches the pointer rather than at the top as on most radios. No chassis modifications were required. Arvin simply shifted the dial scale on the knob counterclockwise 90 degrees! Model 840T came in a variety of colors including bitter green, cherry, citron, coral, ivory, and sandalwood.

Arvin created another "new" model for 1954 when it reissued 1951's Model 540T, shown in Figure 11, in ivory and dubbed it Model 842T (RE-278-1). Apart from the RE-278-1 chassis and the new name, it was unchanged from the

1951 model.

Both Model 840T and Model 842T were later made available with the miniature-tube RE-278-2 chassis. These were probably the latest production models and were not given new model numbers.

PART III: THE PRIVATE LABEL ARVINS

Many collectors are familiar with the "Silver-tone" brand radios that Arvin produced for Sears, Roebuck and Co. Since all Silvertones were made by outside manufacturers, Sears used the first three digits of the chassis number to indicate the source. Arvin's source number was 132. Look for the chassis number on the back of the chassis and the catalog number on the bottom label.

1942 Silvertone Catalog No. 7020 and 7022 (132.814). In spring 1942, Sears cataloged two metal-cabinet versions of its popular Commentator radio. Model 7020 has walnut paint (brown with black flecks) with gold trim and knobs, as shown in Figure 14. Model 7022 (not shown) has ivory paint and is trimmed in red. [Watch for these models in a future A.R.C. article listing more left-handed radios.]

1946 Silvertone Catalog No. 6002 (132.818). Similar in size and design to Arvin Model 444, Model 6002, "The Silvertone Midget," was available only in ivory. Model 6002, shown in Figure 15, can be distinguished from later models because "Silvertone" was embossed on the front of the cabinet rather than on the dial scale. Model 6002 came with a vented metal back with "ears"

(Continued on following page)

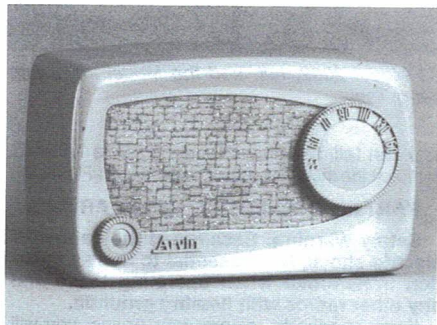

Figure 12. The 1953 Model 740T (RE-278/RE278-1).

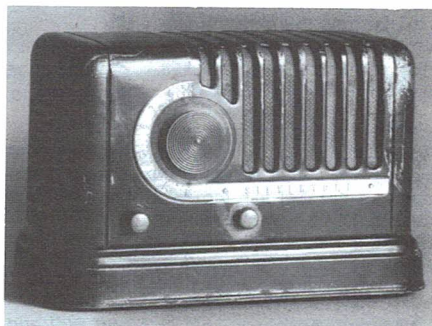

Figure 14. The 1942 Model 7020.

(Collecting Arvin Metal Radios, continued)

on the corners for coiling up the wire antenna.

1948 Silvertone Catalog No. 8003 (132.818-1).

In 1948, Sears began cataloging Model 8003 which was simply a restyled Model 6002 with gray-green (light blue) paint as shown in Figure 16. Changes included moving the word "Silvertone" from the cabinet onto the dial — presumably streamlining the production process — and eliminating the vented metal back.

1949 Silvertone Catalog No. 8004 (132.818-1).

In 1949, Model 8004 (ivory), also shown in Figure 16, was added to the catalog. As was typical for most models, the ivory Model 8004 retailed for \$2 more than the identical Model 8003 in gray-green.

1950 Silvertone Catalog No. 1 & 2 (132.878).

Model 1 (brown with ivory knobs) and Model 2 (ivory with brown knobs), pictured in Figure 17, are the most commonly found private label Arvins. The tuning knob of these models is attached to the chassis before installation. It is adjusted through a hole in the front of the cabinet and cannot be removed from the front. More often than not, I find these sets with the volume control knob (which can be pulled from the front) missing — perhaps the revenge of frustrated kids?

1953 Silvertone Catalog No. 2001 and 2002 (132.878).

In 1953, Sears stopped cataloging Models 1 and 2 and offered two new models. As shown in Figure 18, the new radios, Model 2001 (brown with ivory knobs) and Model 2002 (ivory with tan knobs), feature distinctive cross-hatched speaker grilles.

In addition to the Silvertone brand, Arvin sold some of its sets under other private labels. As yet, I have been unable to determine who retailed them.

Firestone. An Arvin Model 840T was seen recently at a Midwest swap meet bearing the Firestone brand name.

Fleetwood. About a year ago I passed up a chance to purchase a damaged Arvin Model 540T bearing the name "Fleetwood." It is believed that the Fleetwood brand name was used for marketing in Canada.

Kent. I have found two different Arvin Kents, as shown in Figure 19. The first is a 3-tube Model 402A. The second is a 4-tube Model 422A. Except for the name on the dial foil, the Kent Model 402A is identical to the Arvin version shown in Figure 2. The Kent Model 422A, however, has a black plastic carrying handle and black, rather than ivory, knobs. I always find it ironic that companies put handles on AC-only radios!

Midwest. Arvin also sold its Model 402 and Model 422 under the Midwest brand name. As far

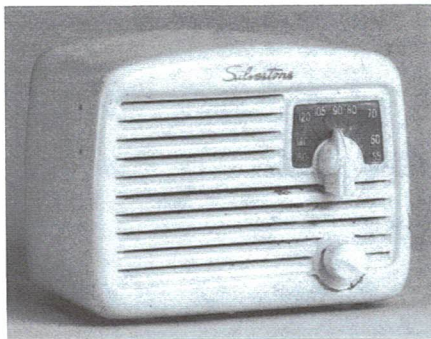

Figure 15. The 1946 Model 6002 Silvertone Midget.

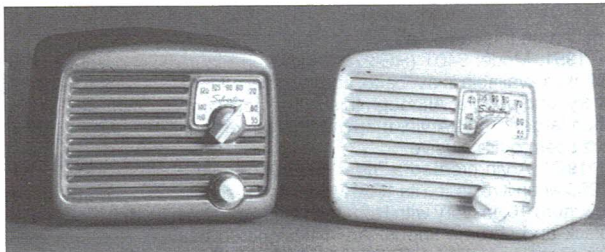

Figure 16. The 1948 Model 8003, left, and the 1949 Model 8004.

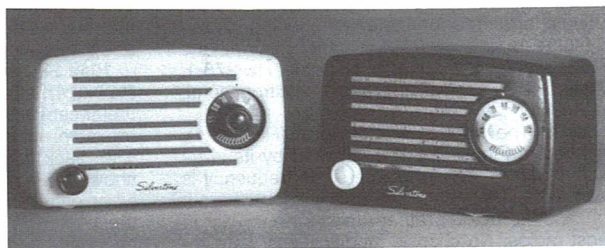

Figure 17. The 1950 Silvertone Catalog Model 2, left, and Model 1.

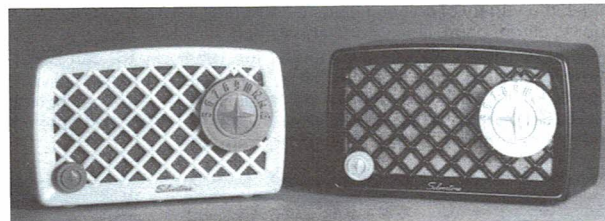

Figure 18. The 1953 Model 2002, left, and the Model 2001 with crosshatched speaker grilles.

as I can tell, the only difference is the Midwest name on the modified dial foil, as shown in Figure 20.

PART IV: COLLECTING METAL ARVINS

Safety Warning: Because of the danger of electric shock, it is essential to use an isolation transformer when operating these and any other radios with floating grounds.

If you choose to restore your Arvins, you will find that all of the sets use relatively simple se-

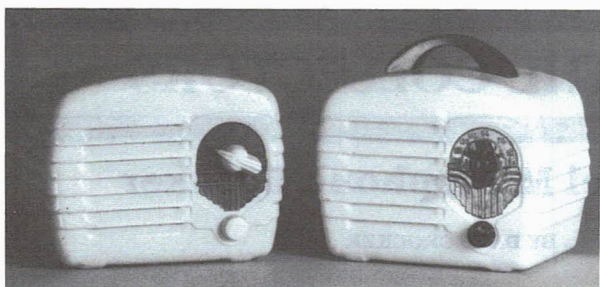

Figure 19. The Kent 3-tube Model 402A, left, and the 4-tube Model 422A.

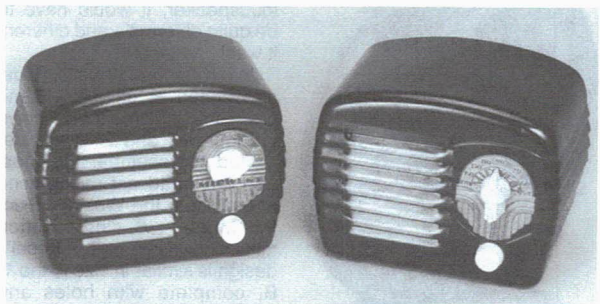

Figure 20. Midwest Model 402, left, and Model 422 differ from Arvin models in name only.

ries-filament circuits and most are thoroughly documented in Rider's and Sam's *Photofacts*.

A review of Sears catalogs and Arvin magazine ads shows that the metal cabinet radios were primarily targeted as "kids" radios or "second" radios, such as would be used in the kitchen, bedroom, or dormitory. My dad and his sister received matching gray-green Silvertone 8003s for Christmas when they were in grade school.

As with most 40- to 50-year-old radios, especially those originally sold for children to use, few mint examples are found today. Parts sets are still fairly easy to find, but, unless you need knobs or other parts, don't buy sets with damaged dial foils. Although I understand that some reproduction foils are becoming available, I have yet to see one with which I am satisfied.

Since the cabinets are easy to repaint (or chrome) and the chassis and knobs are interchangeable among many of the sets, the collector needs to become familiar with each model's original appearance. All of the radios portrayed in this article are shown with original knobs, and I have tried to catalog the advertised colors in the text. The illustrations in service literature and original magazine ads can also provide clues.

Most postwar chassis have a part number stamped on the rear apron, and it should agree with the number on the paper label. If the bottom label is damaged or missing, be suspicious of repainting. While a nicely done repaint is not the end of the world, get what you pay for.

Finally, I have yet to find an ad for an Arvin with a chrome cabinet, and, given the market for which the radios were intended, I doubt that any were produced. The sets do look outstanding in chrome

cabinets, however, and I see chrome as a nice alternative treatment for a cabinet which needs refinishing anyway.

For a good history of the Noblitt-Sparks (Arvin) Company, I recommend Sureck and Arnold's article "Arvin Industries and the Hopalong Cassidy Radio," in the July 1989 A.R.C.

Consultants:

Richard Bell, Kirkland, WA; Steve Berglund, Seattle, WA; Jay Malkin, Denver, CO; Gene Pupo, Spokane, WA; Carl R. Shirley, Columbia, SC.

References:

Baron, Steve. Book Review: *Radios: The Golden Age* by Philip Collins. A.R.C., April 1988.
Coons, Coke. *Arvin: The First Sixty Years*. Columbus, IN: Arvin Industries, Inc., 1991.
Radio and Television Retailing. May, 1948, p. 40; October, 1948, p. 45.
Rider, John F. *Perpetual Troubleshooter's Manual*. Vols. XI, XIII, XIV, XIX, XX. New York: John F. Rider.

Sams, Howard W. *Photofact Picture Guides*. (Set) 1-(Folder) 3, 5-36, 23-3, 34-2, 53-22, 101-10, 143-4, 263-3. Indianapolis: Howard W. Sams & Co., Inc., 1946-1955.

The Saturday Evening Post. Dec. 7, 1946, p. 104; June 7, 1947, p. 103; July 5, 1947, p. 72; Sept. 6, 1947, p. 72; Nov. 6, 1948, p. 98; Mar. 21, 1953, p. 142; Oct. 3, 1953, p. 58; Feb. 6, 1954, p. 89; Oct. 22, 1955, p. 6.

Sears, Roebuck & Co. *Sears Catalog*. Chicago: Spring 1942, p. 666; Spring 1946, p. 578; Spring 1947, p. 506; Spring, 1947, p. 506; Fall, 1948, p. 873; Spring 1949, p. 627; Spring 1950, p. 605.
Sureck, William O. and Arnold, Richard. "Arvin Industries and the Hopalong Cassidy Radio." A.R.C., July 1989.

Wolf, H.C. and Jacobson, I. *Radio: A Blast from the Past*. Stillwater, NJ: Sound of Music Publishing, 1987.

Wood, Scott, ed. *Evolution of the Radio*. Gas City, IN: L-W Book Sales, 1991.

Photo Credits:

Lora Pennington, Seattle, WA

Copyright 1992 by Dan Howard. Reprinted with permission of the author, Dan Howard.

(Dan Howard, 2940 SE 118th Ave., Portland, OR 97266-1602)

Dan Howard and his father, Dick, have been collecting radios since the early 1970s. Dan collects post-Depression sets, while his father collects wireless and battery sets. Since the mid-1980s, Dan has been focusing on coin-operated hotel radios, metal Arvins, and other midget tube-type sets.

WITH THE COLLECTORS

The Kodol Microphone Speaker

BY DAVE CROCKER

It was 1925 in Cincinnati and the Kodol Radio Corporation thought it was time to offer a loudspeaker to accompany the Kodol radios that were selling fairly well. Up until that time Kodol owners had to buy some

If Kodol was to introduce a new loudspeaker, it would have to be quite different – and different it was!

other brand of speaker to operate their Kodol receivers.

The radio public became tired of gooseneck and straightneck horns that failed to fit into living room decor. As a result, manufacturers began cleverly to hide

their horns in ornate containers. If Kodol was to introduce a new loudspeaker, it would have to be quite different – and different it was!

In the summer of 1925, Kodol announced its unique \$15 microphone loudspeaker, shown in Figures 1 and 2. It was designed to resemble the most popular broadcast microphone at that time, the Western Electric Model 1-B single button mike, shown in Figure 3. Kodol's design is similar in size to the 1-B, complete with holes and screens, but it has a taller base to accommodate the driver.

CONSTRUCTION

The Kodol microphone speaker doesn't look like a horn, but in reality it is. It is made entirely of bronze-colored metal. Inside the round framework and screens is a folded horn formed of cast iron, which shows

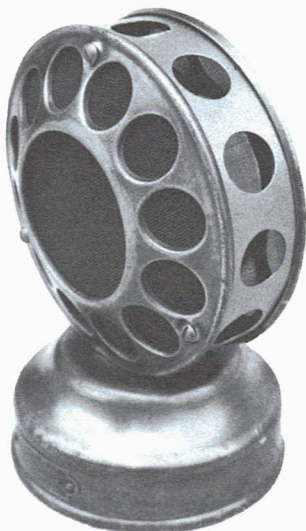

Figure 1. The 1925 Kodol microphone loudspeaker.

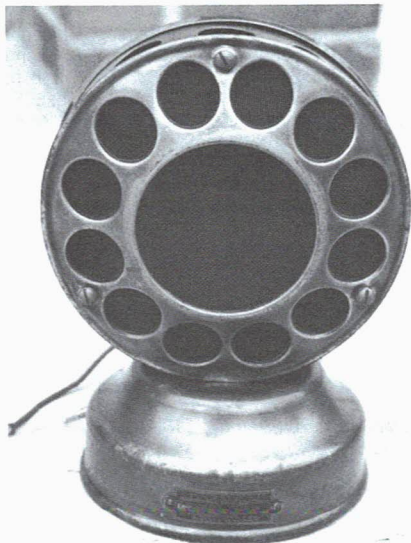

Figure 2. Another view of the Kodol microphone loudspeaker.

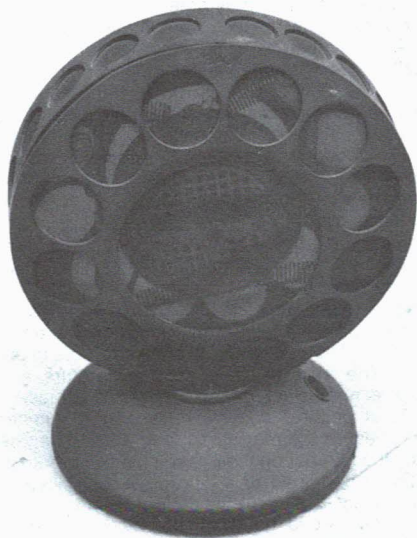

Figure 3. The Western Electric 1-B single-button broadcast microphone.

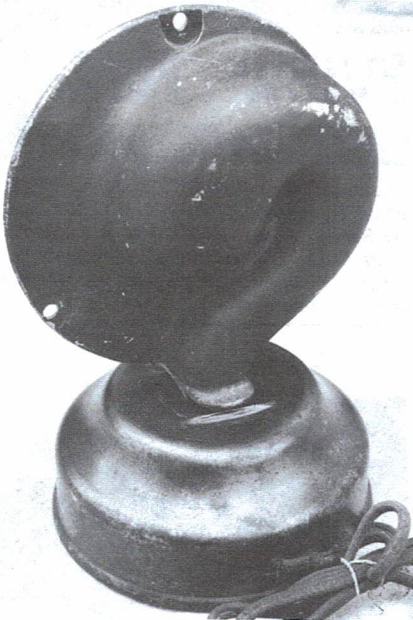

Figure 4. Inside view of the Kodol with screen covers removed showing the "snail-shell" horn casting.

in Figure 4. Kodol referred to this new shape as a "non-vibrating tone chamber," and called it the "snail-shell" horn. The bottom of the casting (see Figure 5) is threaded to accept a well-known driver manufactured by the Utah Radio Products Co. of Salt Lake City.

The bottom rim of the speaker base is cushioned by a cord pressed into a U-shaped ridge. This is to prevent the metal bottom from scratching the surface of the radio or table it sits on.

An advertisement for the Kodol speaker is shown in Figure 6.

It is interesting to note that the Nanyo Company later sold a similar microphone speaker called the "Nanyo." While the base is more ornate, the microphone section above it is identical to that of Kodol. Whether Kodol sold Nanyo the top section when Kodol's interest switched in 1926 from radios to battery eliminators is unclear.

Kodol's advertising lauded its microphone loudspeaker as "the sensation of the season." In September 1925, the company announced two more Kodol speakers. One was a stubby horn with a grille and fabric over the front of the bell. This was called the "Deluxe" and sold for \$25. The other, the "cabinet type," sold for \$27.50 and was a rectangular box tone chamber with a cathedral styled grille design.

All this came about at the time when horn speaker technology had peaked. It was about to be replaced with the more modern paper cone speaker. Nonetheless, Kodol had climaxed this era with a truly unique and distinctive example of loudspeaker design.



Figure 5. Bottom view of the Kodol base showing the Utah driver unit.

The KODEL MICROPHONE Loud Speaker



Two Models
\$15
\$20

THE loud speaker that has the whole country talking. An exact replica of the microphone used in broadcasting. Tremendous volume - - rich clear tone - - Handsomely finished in Roman Gold. At any radio dealer.

Write for descriptive literature
THE KODEL RADIO CORP.
508 E. Pearl St. Cincinnati, O.
Owners of Broadcasting Station W K R C

Figure 6. Kodol advertisement as it appeared in the February 1926 issue of "QST."

(Dave Crocker, 60 South St., Duxbury, MA 02332)

Dave Crocker is on the A.R.C. staff and has been actively collecting radios for over twenty years. A good part of these years has been spent in researching and collecting Crosley radios.

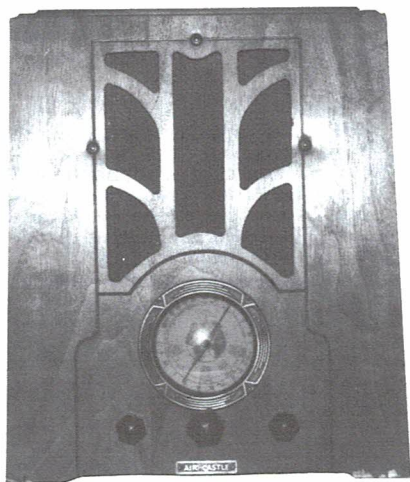

PHOTO REVIEW



This column presents in pictorial form many of the more unusual radios, speakers, tubes, advertising, and other old radio-related items from our readers' collections. The photos are meant to help increase awareness of what's available in the radio collecting hobby. Send in any size photos from your collection. Photos must be sharp in detail, contain a single item, and preferably have a light-colored background. A short, descriptive paragraph **MUST** be included with each photo. Please note that receipt of photos is not acknowledged, publishing is not guaranteed, and photos are not returned.

CRYSTAL DETECTOR BOXES - Pictured are some examples of detector boxes made by Austrian, German and American companies. (Erwin Macho - Vienna, Austria)



AIR CASTLE, SPIEGEL CORP. - This 1935 tombstone has the broadcast band and one shortwave band. Note that the knobs, not original, are Philco reproductions. (Colin Stump - Lancaster, OH)

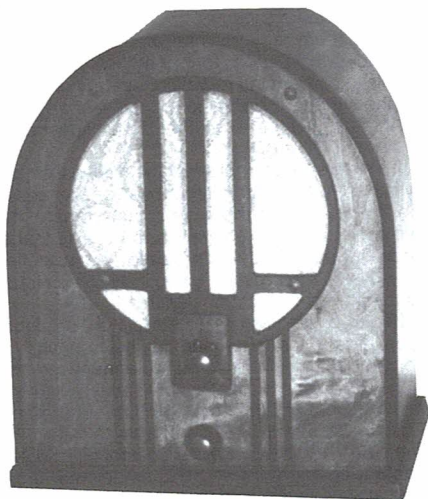

PHILCO CATHEDRAL - This little 4-tube regenerative receiver was made around 1934. The model number is uncertain, but it may be a Model 84. (Kurt Thompson - Jacksonville, FL)

PHOTO REVIEW



REMO TRUMPET HORN - The base of this speaker is cast iron with a fluted design while the finish is a mahogany colored gloss paint. The inverted horn, made of spun aluminum, has the neck and driver inside the bell. The speaker was produced in Meriden, Ct., and sold for \$12.95. This horn is on display at the Vintage Radio and Communications Museum of Connecticut. (*Vintage Radio and Communications Museum - New Britain, CT*)

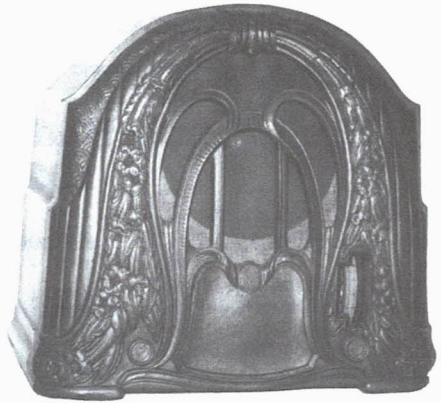

CROSLY BUDDY BOY MODEL 54 - This circa 1930 TRF set is found in Riders Volume 1, and uses tube types 24 (3), 45 (1), and 80 (1). The cabinet is made of molded Repwood and is very heavy. Tuning is by a thumbwheel dial. (*G. Hausske - Wheaton, IL*)

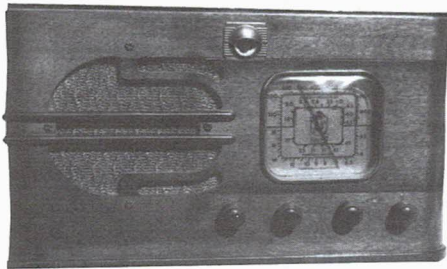

DELCO MODEL R-1127 - This 1938 table radio was found in excellent original condition at a local antique mall. It has 3 bands, and employs 6A8, 6U7, 6Q7, 6K6, and 5W4 tubes with a 6G5/6V5 tuning-eye tube (*Doug Bursley - Mansfield, OH*)

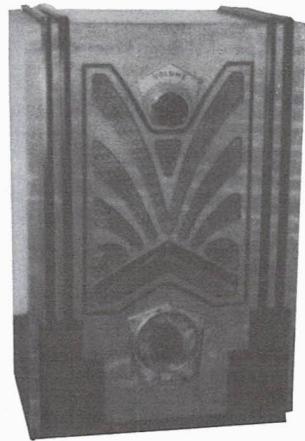

DEWALD ART DECO TOMBSTONE - This set is of about 1933 vintage. The chassis is mounted on its side, and it has a police band switch on the back. (*Barry Cheslock - Arlington, VA*)



RCA RADIOLA MODEL 18 - Manufactured in 1927, this set uses AC power and features a flip-open top for tube access. Also featured on this original condition set is the famous Radiola dial hood. (*David Wiggert - Onalaska, WI*)

The Cosmos Radiophone Crystal Sets 1922-1925

BY IAN L. SANDERS

Cosmos was the brand name used by the Metropolitan-Vickers Electrical Company of Manchester, England. "Metro-Vic," a heavy electrical engineering company, was a member of the "Big Six" — the original six large companies involved in the negotiations with the post office which eventually led to the formation of the British Broadcasting Company (BBC). The Cosmos name was used on receivers until 1928, when a merger between Metro-Vic and British Thomson Houston took place and production of sets was discontinued.

COSMOS RADIOPHONE TYPE C.1.

Looking for a speedy entry into the booming receiver business in 1922, Metro-Vic capitalized on its close ties with the Westinghouse Company in the United States and replicated the trusty Aeriola Junior crystal set design. This receiver, sold under the name "Cosmos Radiophone Type C.1.," is shown in Figure 1 and was ideally suited for the British market. With the exception of minor details, the set differs very little from the original U.S. version. The rugged design and high quality cabinet construction are typical of British crystal sets of the period.

The Type C.1. is enclosed in a mahogany cabinet measuring 8.5 x 7.25 x 7 inches with oxidized aluminum hinges and hasp. The cabinet carries the "Type Approved by Postmaster General" BBC decal on the front and a post office registration stamp at the rear. A compartment was provided for the storage of headphones when not in use, and later this was used to house an optional amplifier unit for loudspeaker operation. The tuning dial is of oxidized aluminum, in contrast to the



Figure 1. Cosmos Radiophone, Type C.1.

plated brass dial found on the Aeriola Junior.

The tuning range is 300-600 meters by means of a variometer. Two aerial terminals (one with

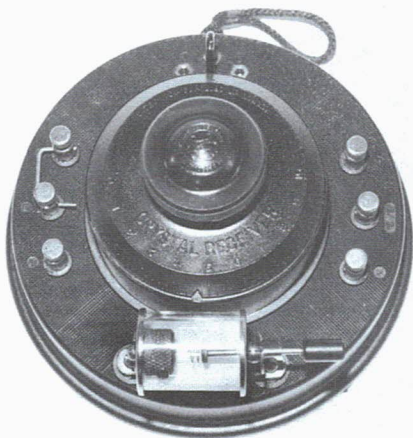

Figure 2. Cosmos Radiophone, Type C.4.

series condenser) were provided to accommodate either a "short" or "long" antenna. The detector is of the perikon, two-crystal type, and a spare crystal was supplied with each set. A 2000-ohm headset was also supplied, and additional headphones were offered at an increased cost for multiple listeners-in.

The advertised range was 15 to 25 miles for the local station, and the price in 1922 was four pounds, ten shillings (£4.5) complete with 100 feet of aerial wire and earthing (grounding) "materials."

A 1-valve and a 2-valve amplifier unit (known as the Type A.1. and A.2., respectively) were

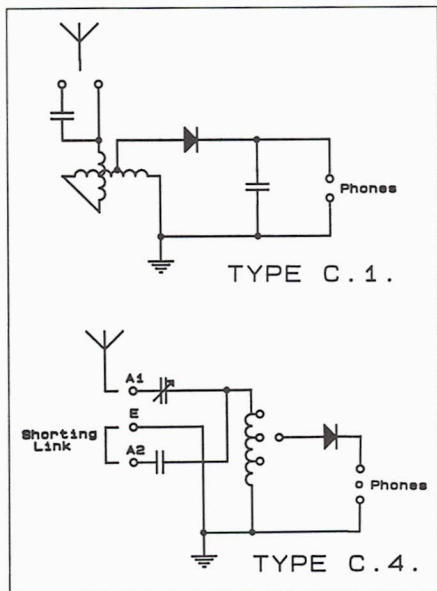

Figure 3. Circuit diagrams for Types C.1. and C.4.

offered for use with the crystal set and were designed to fit in the headphone compartment. The amplifier required no adjustment and was connected to the headphone terminals of the receiver. An external 4-volt accumulator (storage battery) and a 36-volt high tension (B) battery were required.

Another version of the receiver was marketed in Britain by Western Electric and was known as the WE 44001 Crystal Set. The design closely resembles the Aeriola Junior and Cosmos Radiophone models. A companion amplifier was also offered for use with the Western Electric model.

COSMOS RADIOPHONE, TYPE C.4.

In 1925, Metro-Vic introduced a lower cost crystal set, abolishing the wooden cabinet. This was the Cosmos Radiophone, Type C.4, shown in Figure 2. The design was a radical departure from the "borrowed" C.1. style, since it is of open design and constructed on a circular, moulded ebonite body 6.5 inches in diameter. The set was introduced at about the same time as a new 3-valve receiver of similar style — the V.R.4. This

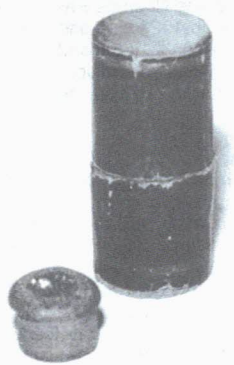

Figure 4. Spare crystal and container for Type C.1.

overlap probably accounts for the fact that the Type C.4 crystal set bore the same number as the V.R. 4, since apparently there was never a C.2. or a C.3. model.

The detector on the C.4. was changed to the conventional glass-enclosed cat's whisker type. Like the C.1., two aerial terminals were provided to allow for the use of different length antennas. The circuit arrangement is rather unconventional in that the unused aerial terminal needed to be connected to the earth terminal (located between the aerial inputs) using a shorting link provided. Circuit diagrams for the C.1. and C.4. are shown in Figure 3.

Tuning is by a variable condenser with the large tuning control mounted in the center of the base. The tuning range is determined by the choice of coil located inside the base and attached by an unusual 4-pin arrangement. Two coils were offered: 300-750 meters covering the

(Continued on following page)

(Cosmos Radiophone, continued)
BBC band and 1300-3000 meters for the long-wave band. A shorting plug at the rear of the receiver allowed one of three taps for 1/3, 2/3 or full inductance of the plug-in coil to be selected.

Although manufactured after the mandatory post office registration requirement, the tuning knob carries the moulded BBC post office approval stamp.

A novel feature of the set is the looped cord attached to the base "... by which to hang it up by the fireside or in any convenient place. The headphones can be hung on the tuning knob. ... Coils can be changed without taking the set down."

Figure 4 pictures the spare crystal and container supplied with the Type C.1, while Figure 5 shows the original box for the Type C.4.

The price of the Cosmos Radiophone C.4. in 1925 was one pound five shillings (£1.25), and the plug-in coil was an additional four shillings, six pence (£0.225).



Figure 5. Original box for Type C.4.

References:

Bussey, Gordon. *Vintage Crystal Sets*. London: IPC Business Press Ltd., 1976.

Douglas, Alan. *Metropolitan-Vickers*, Supplement to Bulletin of the British Vintage Wireless Society, 1989.

Geddes, Keith and Gordon Bussey. *The Setmakers*. London: BREMA, 1991.

Hill, Jonathan. *Radio, Radio*. Devon, England: Sunrise Press, 1986.

(Ian L. Sanders, 16725 Wild Oak Way, Morgan Hill, CA 95037)

Ian Sanders has been collecting and restoring early 1920s crystal and battery receivers since 1974. He specializes in British sets of this period and would be happy to try to answer any reader's inquiries on this subject.

Letters — The SASE Problem Revisited

Dear Editor:

...I have seen a trend develop over the past few months which I feel you should be made aware of.

During the month of November 1991, I sent off twelve SASE's for listings, but have received only eight replies. During early December, it was eight SASE's with only four replies, and this latest month initiated more than twenty letters from me, but to date, only six replies.

I ask that you publish some type of comment or reminder in a future issue addressing this problem. Thank you for your consideration and for your valuable publication.

Wilbert K. Kimple, Spartanburg, SC

Dear Editor:

...There are some among us who need to be reminded that SASE's are sent for a purpose, and that is to reply to that person who sent it. In the past year, there have been four or five in-

stances when I have sent someone an inquiry with a SASE and *never* received a response. ...It has happened too many times for me to think it could be blamed on the postal service.

Fellow collectors, if you want to have a good reputation in this hobby, answer your mail. ...If people are good enough to send you a SASE, please answer them. You never know — that inquiry could have come from a beginner, and if you don't answer, that person may get the idea that all of us are a bunch of jerks!

Thank you for allowing me to get this off my chest. You have a fine publication.

Ron Ramirez, Providence, KY

Dear Editor:

... Advertisers who offer a list in exchange for a SASE *should* send their lists. I realize that this is not a matter of earth shaking importance but it is annoying.

Michael Illfelder, Chicago, IL

AUCTION AND MEET REPORT

VRPS/AWA Convention and Auctions October 16-18, 1992 — Irving, Texas

COMPILED BY GEORGE POTTER

The Vintage Radio and Phonograph Society (VRPS) and the Antique Wireless Association (AWA) held their 17th annual convention and auctions October 16-18, 1992, at the Holiday Inn, DFW Airport South, Irving, Texas. Over 410 attended the event.

Featured were three auctions and a silent auction. The auction proceeds totaled \$39,671.75 for 900 items. Included in the total number of items were 118 passes.

Sunday morning's flea market space, which had been doubled, was well used. Needless to say, collectors were pleased with the many bargains found there.

Some interesting items in the auctions were an Atwater Kent 12 breadboard which sold at \$800; a Majestic Melody Cruiser at \$400, a Mozart Baby Grand horn at \$200, a Sentinel Catalin at \$700, and some Philco 90 cathedrals ranging from \$230 to \$470. All Zenith items sold well, as did cathedrals and horn speakers.

The following is a selection of items from each auction, deleting items with incomplete descriptions and boxes of gear in poor condition. No guarantee is made for the accuracy of the list.

e=excellent, vg=very good, g=good, f=fair, p=poor, unk=unknown, w/T=with tubes, NT=no tubes, N.O.S.=new old stock

At Friday night's auction, 380 items were sold (58 passes) for a total of \$11,838. This auction had a \$10 minimum bid and included military equipment, transistor sets, Bakelites/plastics, tubes, literature, microphones, headsets, and test equipment.

Abbottwares horse radio, missing saddle, etc.	\$110
Airline 74BR, unk	41
Airline 84BR push button, e	55
Airline 9525 push button, g	28
American Microphone, ring type	85
Arvin 144A metal, f	24
Arvin 144A, unk	38
Arvin 444A, metal, red	50
Arvin transistor radio w/case	10
Atwater Kent 55 chassis & speaker, g	40
Atwater Kent early service manuals, (2)	65
Atwater Kent H horn original box only, g	24
Auto Electric Variac, g	15
Automatic Radio 614X, f	16
Aviola radio 601-612, g	40
B converter power supply	25

Baseball transistor radio, g	28
BC-348 military, unk	34
Bendix 110, not working	16
Braun pre-WWII portable radio	85
Cat Whisker book, British sets	12
Conar meter	16
Coronado 43-8190, cracked	37
Crosley 10-135, white, g (2)	30 & 29
Crosley 10-138, unk	45
Crosley 11-100U, red, g	75
Crosley 11-100U, white	55
Crosley 11-103Ua, g	65
Crosley 51 chassis, w/xformers, f	50
Crosley 56TX table set	34
Crosley 58XA, f	10
Crosley 628 B, works, vg	45
Crosley 719E, blue, g	40
Crosley 10138, vg	95
Crosley D25CE 2-dial, g	80
Crosley dashboard radio, g	65
Crosley dashboard radio, unk	34
Crosley E155L, g	85
Crosley service manual, 1929-1939	20
Dahlberg pillow radio/speaker, g	140
DeForest Audion and can	20
DeForest book, Conqueror of Space, f	22
DeForest Training Library	10
Echophone SW set, f	18
Edison porcelain battery jar lid	10
EICO audio signal generator	11
EICO RF signal generator	18
Electro-Voice 664 floor mike	24
Elephant aerial antenna	65
Emerson 558, 4-tube portable	25
Emerson 712, unk	15
Emerson BN 206, vg	24
Erickson wall telephone, copper	170
Farnsworth bullet, g	40

(Continued on following page)

A warning: Auction prices are not current values. A listing such as this cannot adequately include the condition of cabinets, chassis, transformers, tubes, the operating status of the set, and the inclusion of incorrect, restored or replica components, etc. Auction prices are the result of the excitement of the auction process, the skill of the auctioneer and the specific interests of the participants. Nevertheless, auction prices serve as useful references and as another element in the value determining process. The possibility of error always exists, and if we are notified, corrections will be reported.



This nice Fada 652 Catalin sold at \$525.

VRPS/AWA Auction and Meet, continued)

GE & Zenith service manuals, 1950s	30
GE 220 Bakelite	20
GE clock radio, red	17
GE H500	110
GE record changer parts	22
Geissler tube catalog, early, (repro)	34
Gibson Girl WWII emergency transmitter	42
Gonset monitor receiver, unk	16
Greenwood's Historical Album,(the original Vintage Radio)	25
Grille cloth, (7)	15 ea
Grundig SW, 1950s, German	40
Hallicrafters R274/RR, g	170
Hallicrafters S-108, g	39
Hallicrafters S20R	20
Hallicrafters S20R, f	28
Hallicrafters S40, g	35
Hallicrafters SX42, not working	42
Hammarlund HQ-129-X	26
Headphones, box 10+, unk	38
Herald crystal kit, new	50
High heel shoe transistor radio, g	28

Hitachi 621 transistor/box, new	12
Jewel TR1 w/box, N.O.S., e	32
"John" (toilet) transistor radio	14
Laughter Wireless Book, 1909	16
Literature, very early radio, 2 boxes, includes Pilot Super Wasp catalog	95
Lumitone lamp radio, f	45
Mahler electric apparatus	46
Majestic Super B power supply	18
Marconi, biography	12
McMichael, British portable, unk	95
Metz German radio/phono portable	26
Microphone, ring-type, w/stand	75
Model T transistor radio, g	20
Motorola 56B1	10
Motorola 56R, Deco radio	20
National HRO-12, coils only (3)	70
National NC190, bottom gone	35
Pepsi transistor AM-FM radio, unk	16
Philco 38-12, g	24
Philco 38-120	10
Philco 46-420	22
Philco 49-901, g	20
Philco 52-540	10
Philco factory service sign	28
Philco remote control unit	40
Phillco Transitone, plastic	10
Philmore AC/DC kit, N.O.S.	20
Popular Mechanics, '20s-'30s, box	24
QSTs, '30s-'40s, box	26
Radio Boys First Wireless book	13
Radiola 25 meter, g	14
RCA 2X621, g	10
RCA 3X-535, red	20
RCA B411, unk	22
RCA Vols. 1-2 service manuals, others	55
Regal Bakelite	10
Riders Vol. 1	55
RME 45 speaker, g	160
SABA SW foreign set	34
Signal Corps tube tester	32

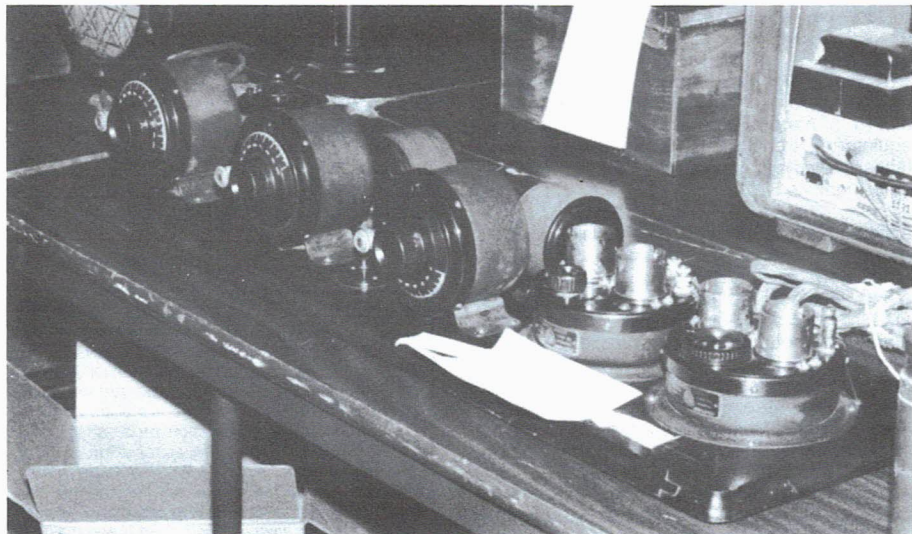

This rarely-seen Atwater Kent 12 breadboard with tags went for \$800.

Signal Jr., code set, box	60
Silvertone CR8010, g.....	10
Snoopy transistor bank/radio	16
Sonora bed lamp radio	16
Sparton Bakelite, white, g	18
Stewart-Warner A51T4	55
Stewart-Warner Portobar radio, g	65
Stromberg-Carlson 1500H.....	55
Toshiba 7T H425 fan radio, vg	120
Truetone D3465	10
Tube adapters, 199s, (4)	14
Tube, N. Elect. 208B.....	30
Tube, UV201A-6, g	20
Tube, UX112, g.....	11
Tubes, radio & TV, box	20
Tubes, Type 26, (13), g	16
Tubes, UV-199, (4), g	44
Tubes, UV199s, (3), only 2 g	15
Tubes, UX-201A, (3), g	18
Tubes, UX199s, (3), (2) g	50
Vibroplex bug key	35
Vibroplex key	15
Wavemeter/box, early	12
Western Electric key & sounder.....	20
Westinghouse H127 refrigerator radio	110
Westinghouse H389, g	10
Zenith 5D011	12
Zenith 403 portable, black	22
Zenith 1000 Trans-Oceanic	70
Zenith 1950s lighted sign.....	130
Zenith battery radio poster	14
Zenith G500 Trans-Oceanic, g (2).....	60 & 48
Zenith GD512, g	100
Zenith K412R, AC/DC, maroon, g	35
Zenith K510 Bakelite.....	13
Zenith R512W, g	18
Zenith R724	15
Zenith R724, AM/FM.....	10
Zenith Royal 500	35
Zenith SR312 AC, g	100

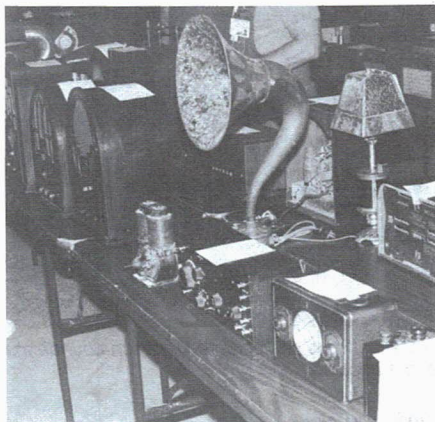

Popular cathedrals, an early, open-coil, electric motor, a decorative horn, and an unusual crystal set lamp were among the items waiting to be sold.

Atwater Kent E speaker, "pull-out"	32
Atwater Kent E speaker, vg (2)	75 & 42
Atwater Kent E-2 speaker (2), f	24
Atwater Kent E-2 speaker, vg	50
Atwater Kent F speaker, vg	55
Atwater Kent F-2 speaker, g	28
Atwater Kent Kiel table, not working	70
Atwater Kent Kiel table, w/T, vg	190
Atwater Kent Model H horn, original box	24
Brandes cathedral speaker, g	45
Brown horn, Type H3, g	85
Browning-Drake battery set, g	48
Brunswick console/phono, g	40
BTH horn Type C-2, g	50
Burns horn, black, no cracks	160
Columbia spring phono	125
Continental piano radio, g	130
Coronado tombstone, no speaker	60
Crosley 5-50 battery set.....	125
Crosley 5-50, NT, f	30
Crosley 6H2 tombstone, g	80
Crosley 7H3 table radio, g	75
Crosley 51, HB cabinet, NT	50
Crosley 52, NT, g	100
Crosley 52, NT, vg	80
Crosley 124 cathedral, f	175
Crosley 127 tombstone, vg	100
Crosley 715 tombstone, p	40
Crosley C-35 radio/phono, f	22
Crosley F speaker, g	24
Crosley Fiver, works	85
Crosley Gembox, NT, f	20
Crosley Repwood cabinet, no chassis	40
Crosley Trirdyn, w/T, g	50
Crosley wood speaker, g	32
Crystal set, manufacturer unk, f.....	100
David Grimes Baby Grand Duplex, f.....	80
DeForest F-5M, g.....	160
Delco R2055 table set, f	20
Edison Dictaphone, g	36
Electric motor, early	180

(Continued on following page)

Saturday's main auction results include Saturday's silent auction items. There were 402 items sold (60 passes) for a total of \$27,833.75.

This auction had a \$20 minimum bid and was for phonographs, records, loudspeakers, wood, metal, console, and Catalin radios, wireless and early broadcast equipment, TVs, and crystal sets.

Airline 17A8, SW, unk.....	\$20
Airline movie dial, table, g	50
Airline tombstone, g	40
Atwater Kent 12 breadboard, tags, NT, g	800
Atwater Kent 20 big box, NT, g	45
Atwater Kent 20 compact, NT, g	65
Atwater Kent 20, compact, NT, vg	50
Atwater Kent 35, NT, f	50
Atwater Kent 35, NT, unk	28
Atwater Kent 37, unk	36
Atwater Kent 42, w/T, e	95
Atwater Kent 43, w/T, g	46
Atwater Kent 44, w/T, g	40
Atwater Kent 49, NT, g	70
Atwater Kent 53, w/T, f	50
Atwater Kent 55C chassis & speaker, g	45
Atwater Kent 84 cathedral, grille cloth out, g	130
Atwater Kent 165 cathedral, g	185
Atwater Kent 976 console, not working	32



Unusual horns and speakers were in abundance at the auction.

(VRPS/AWA Auction and Meet, continued)

Emerson AC table set.....	24
Emerson chrome-front set, g.....	100
Emerson roll-front table set, vg.....	140
Eveready battery. set, with speaker, f.....	60
FADA Catalin Model 652, vg.....	525
Farrar console, p.....	20
Federal Model 1030, g.....	20
Firestone Air Chief table set, g.....	32
Freed-Eisemann NR 6, NT, g.....	65
Freshman floor console, g.....	75
Freshman Masterpiece battery set, g.....	50
Freshman Masterpiece, w/T, vg.....	80
GE console, f.....	75
GE console, telephone dial, f.....	50
GE E61 cathedral, g.....	80
GE R-17 table radio, g.....	65
Geophone 2-tube English, missing parts....	190
Globe battery set, NT, g.....	55
Gloritone 1931 cathedral, f.....	75
Gloritone Model 27 mantle radio, g.....	90
Graybar tombstone, f.....	55
Grebe MU-1 Synchrophase, NT, g.....	190
Grunow AC table radio, unk.....	46
Guild Country Belle tel. radio, g (2).....	45 & 70
Guild rolltop desk radio, vg.....	110
Guild Town Crier AM/FM, g.....	65
Hoffman black/white 50's TV, f.....	26
Home brew 1-tube, 2 dial.....	36
Home brew crystal set, vg.....	55
Home brew with Federal parts.....	40
Home brew, 2 tube, NT, vg.....	40
Home brew, large, 3 dial, NT.....	60
Jackson Bell cathedral, f.....	90
Kennedy V, g.....	250
Lear wood table radio, f.....	20
Majestic 461 cathedral, vg.....	110
Majestic 4706 wood radio, unk.....	20
Majestic Melody Cruiser, e.....	400
Majestic Melody Cruiser, g.....	140
Majestic tombstone, vg.....	100
Metro Electric concert speaker, vg.....	120
Metz Model 212 European radio, unk.....	55
Michigan Jr., w/T, vg.....	200
Mirrortone wood radio, unk.....	48
Mohawk Cherokee, NT.....	44
Motorola 77, AC table radio.....	20
Mozart Baby Grand horn speaker, vg.....	200
Newcombe Hawley speaker, g.....	20

Parmak, 3-tube, NT, f.....	40
Pathé Minuteman w/horn speaker, g.....	125
Peerless cathedral reproducer, speaker, g.....	55
Philco 19 cathedral, vg.....	130
Philco 34 battery eliminator, g.....	105
Philco 37-610 tombstone, g.....	75
Philco 38-12, original, g.....	38
Philco 38-35, f.....	46
Philco 38-40 AM/SW, vg.....	85
Philco 45, w/T, g.....	65
Philco 46-20 radio/phonograph, f.....	38
Philco 60 cathedral, g.....	80
Philco 60, f.....	120
Philco 84B cathedral.....	75
Philco 90 cathedral, g.....	230
Philco 90 cathedral, restored (2).....	470 & 375
Philco 90 console, g.....	95
Philco 610, w/T, g.....	60
Philco 610, works, g.....	55
Philco chairside radio, f.....	32
Philco console, 1939, g.....	80
Philco DC tombstone, no speaker.....	32
Philco Predicta TV, unk.....	110
Philco Predicta, metal cab.....	95
Philco wood table set, g.....	50
Philco 20-tube console, works, vg.....	200
Philmore crystal set, g.....	42
Pilot 3" TV, not working, g.....	140
Pilot 3" TV, works.....	160
Pooley radio cabinet, no radio.....	32
Radiola 18, refinished, g.....	50
Radiola 20 console cabinet, vg.....	30
Radiola 20, NT, g.....	80
Radiola 33, Deco legs, f-g.....	55
Radiola 60, vg.....	80
Radiola 66 console, f.....	55
Radiola 80 console, vg.....	90
Radiola 100 speaker, f (2).....	20 ea.
Radiola 100 speaker, g (2).....	28 & 30
Radiola 100A speaker, vg.....	32
Radiola 100B speaker, g.....	38
Radiola 103 speaker, good grille cloth.....	55
Radiola 103 speaker, orig. tapestry, e.....	160
Radiola AG814, loop antenna, vg.....	55
Radiola III, f.....	86
Radiola IIIA, vg.....	35
Radiola V, NT, no top, g.....	190
Radiomatic, coin-op, wood, g.....	50
RCA 5T tombstone, g.....	45
RCA 5VT battery set, g.....	22
RCA 771 tombstone, restored.....	120
RCA 8K console, f.....	30
RCA 66X3, f.....	38
RCA 66X7 black Catalin.....	200
RCA 88K console, g.....	40
RCA 118 tombstone, unk.....	55
RCA 520 swirl plastic, vg.....	85
RCA clock sign, unk.....	20
RCA Little Nipper table radio, g.....	50
RCA Model 29K console, g.....	28
RCA Red and Blue Seal records, (12).....	20
RCA Red Seal Caruso records, (11).....	28
RCA Red Seal records, 8.....	22
RCA Superhet tombstone, g.....	65
RCA tombstone, f.....	140
RCA UZ-1325 speaker, g.....	70
Saal horn, base broken.....	22
Sentinel Catalin, no cracks, vg.....	700

Silver-Marshall Around the World 4	220
Silver-Marshall single control, battery set	75
Sonora RM219 console, vg	32
Spark coil, early	36
Sparton 931 console, g	45
Sparton Jr. cathedral, vg	200
Sparton, battery, w/T, vg	200
Splitdorf R500, unk.	40
Steinite cathedral, vg	160
Steinite console, g	85
Sterling horn speaker, g	80
Stewart-Warner tombstone, g	200
Symphony cathedral, battery eliminator	100
Temple Model 15 horn, f.....	35
Temple Model 20 air column speaker, vg	110
Thermodyne battery set, NT, g	36
Thompson Neutrodyne battery set, p	25
Thorola Model 4 horn, g	70
Van de Graaff spark generator, vg	270
Victor Black Seal records, (12)	20
Victor oak table phonograph	125
Victor VVXI phonograph, g	175
Vitaphone w/horn speaker, g	190
Westinghouse Aeriola Sr., dud WD-11, f-g... 100	
Westinghouse Aeriola Sr., NT, g	125
Westinghouse RC, unk.	140
Westinghouse tombstone, vg	65
Windsor spkr, 3 ft. across!	100
Wurlitzer cathedral w/Silvertone chassis, g. 170	
Zenith 4B231 tombstone	44
Zenith 5J17, g	110
Zenith 6A10 table set	47
Zenith 6J230 tombstone, g	140
Zenith 6S229 tombstone, g	120
Zenith 6S275 console, g	170
Zenith 7G605 Trans-Oceanic, g	130



Contest '92 entries: in the center, a beautiful "Voice from the Sky" horn, flanked by aluminum headphons from the S.

Zenith 8G005 Trans-Oceanic, g	80
Zenith 10-S-464 console, g	280
Zenith 10-tube console, 1941	60
Zenith 705, restored, w/T	110
Zenith 1940s portable	34
Zenith console, large dial, dial glass gone	95
Zenith G500 Trans-Oceanic, missing tube	85
Zenith P600 Trans-Oceanic, g (2)	85 & 60
Zenith small chairside, w/mag. rack	110
Zenith tombstone 8S129, g	150
Zenith Westchester chairside, g	85
Zenith wood SW set, not working	160

(George Potter, 2069 Sienna Trl., Lewisville, TX 75067)

An Easy Way to Trap More Dust

BY ROBERT LOZIER

A lot of collectors, I myself included, do not have the luxury of separate buildings in which to store or display our treasures. Our only choice is to place them somewhere within the household living area. That means that they must be kept relatively dust free. I find that, even with careful maintenance of filters in the furnace/airconditioner and weekly vacuuming, it is still necessary to take each item off the shelf and give it a detailed dusting about every six months.

When I am in this "dusting mode," I want to get as much dust as possible off my items in the shortest amount of time. Here is the method that works for me: First, take a cheap 20" size box fan — the kind you see selling at the discount stores for about \$20 (actually, I got a used one at a flea market for \$8) — and modify it as follows:

(1) Using duct tape, attach two 20" x 20" disposable furnace filters to the intake side of the box fan.

(2) Spray the surface of the filter pair with Pledge or Endust while the fan is running on its lowest speed.

(3) Set up a card table in the room you are going to clean and place the modified box fan on one edge so that it blows the air away from the

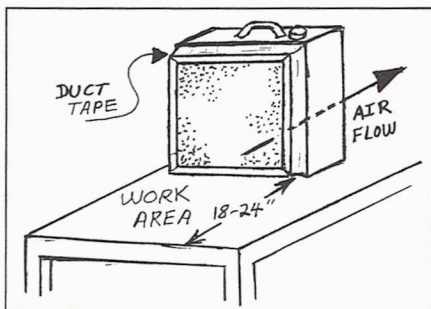

card table. Place the items you want to clean on the card table and begin to dust with a cloth and a fine bristle paintbrush.

You will be amazed at how much dust will be trapped in the filter after a few hours work — dust that would otherwise stay in the room and partially defeat your work just completed.

(Robert Lozier, 600 E. Green St., Monroe, NC 28112)



RADIO MISCELLANEA

"Antique Radio Classified" invites its readers to contribute letters and information for inclusion in "Radio Miscellanea" and elsewhere in the magazine. The topic should be of general interest and sent to A.R.C., P.O. Box 2, Carlisle, MA 01741. All material submitted should be verified for accuracy and may be edited for publication, which is not guaranteed. See the masthead for more details.

Wireless-Era Receivers

Dear Editor:

While I thoroughly enjoyed A. Harrison's article "Constructing Wireless-Era Receivers from Authentic Components" [A.R.C. November 1992], I have a few suggestions to reduce costs: (1) Hardwood, such as cherry and walnut, can be mail ordered from several national suppliers for reasonable prices. (2) You might be able to get the wood work done at your local high school Industrial Arts Department if you supply the wood.

I also suggest that instead of hiding a hole with a screw, use some of the better wood-fillers. These can be bought both prestained and matched to particular hardwood species, or they can be mixed with the appropriate woodstain prior to use. Once the holes are properly filled and the breadboard is sanded and finished, the repairs will not show. (I suggest practicing with scraps of wood similar to the breadboard, first.)

Peter J. Bertini, Somers, CT

Tubes Not Always Interchangeable

Dear Editor:

While trying to repair a flea market Zenith recently, I was vividly reminded that tubes are not always interchangeable, even among the same number.

After having found the IF stage oscillating, I tried all the usual solutions. Screen bypass, lead dress, etc., only changed the characteristics. I still had about -90 volts on the AVC line! While maneuvering the chassis, my hand touched the tube shell, and I got a mild shock. Did I say it was a metal 6K7?

I knew Zenith called for a 6K7G, but so what — metals have a ground pin. My old manual shows Pin 1 as being the shield. Zenith, however, did not provide a ground on Pin 1, but left it floating. I grounded the tube with a screwdriver and it stopped oscillation. I pulled switchies with a 6K7GT in a Grunow, and they both work fine now.

Hugh Davey, Long Valley, NJ

On A.R.C. Correspondence

Dear Editor:

I want to make a suggestion that to me would greatly improve the magazine. Why not publish the complete addresses of those who send letters so that we can correspond when appropriate?

James F. Crews, Arbovale, WV

Our policy of not publishing complete addresses is to encourage correspondence through the magazine, so that all readers can benefit from the information exchange. Please send your responses to A.R.C. If you would like to correspond directly with writers, call A.R.C. for their addresses. (Editor)

Reforming Electrolytic Capacitors

James Di Ruzza shares with us the following response to his articles on reforming electrolytic capacitors (A.R.C. February and October 1992).

Dear Mr. Di Ruzza:

...For over fifty years I have heard explanations — each different from the others — of how to reform. In fact, I did not know there was an accepted formula. Your article is now in my "quality information file."

...It is difficult to locate and expensive to buy high working voltage capacitors now that the electronic equipment is driven by low voltage. Reforming what I have in stock is a required procedure. ...Keep those articles coming. We need the information.

Joseph Lisaius, W. Caldwell, NJ

Kudos & Comments

Dear Editor:

...I'm so pleased to be able to receive A.R.C. I do appreciate the time and effort that you all expend on preparing and publishing this fine source of delight.

I have been collecting and preserving old-timers for five or six years now and was trained in vacuum tube technology in the '50s. My passion for the old-timers exploded when I received my first copy of A.R.C., and I realized what was still available to those of us who still care and wish to "keep 'em alive."

Joseph C. Burke, Weehawken, NJ

Dear Editor,

Please renew me for another year. Love your magazine.

M. Hanke, Wausau, WI

Dear Editor,

I get several magazines but look forward to A.R.C. above all.

Bud Slagel, Hot Springs, SD

Dear Editor,

Congratulations on your 100th! The cover was really nice.

Doug Koehn, Quincy, IL

Dear Editor,

Really liked the cover on the November issue. Would like to see more color covers.

Loren Dudley, Bath, ME

Dear Editor,

Response to first ad phenomena!!!!
Tom Thomson, Pulaski, WI

Dear Editor:

...Giving free advertising to subscribers causes prices to go higher for subscribers.

Keith Nerenhausen, Kaukauna, WI

Kudos & Comments (continued)

Dear Editor:

I'm thirty-five and have been collecting and repairing antique radios since my early teens. I've been an A.R.C. reader since 1985.

I really need to compliment you on your articles, which are not why I subscribed to A.R.C. seven years ago. Particularly, "The Election Model Radio" article (October 1992) was well written, very educational, with clear photos and a fascinating schematic. The thumbnail description of the author and the excerpt from *Radio-Craft* rounded it out beautifully.

For me, it was educational because I didn't know TRFs or sets without octal tubes were made that late. Was this one of the last of its kind, circuit-wise? Thanks to Mr. Isenring's numbering explanation, I learned that my Silvertone 4575 with chassis #101454 must also have been made in Buffalo. All in all, a very worthwhile article.

I also enjoyed the article on the Lafayette DT 320. I just wish the writer had mentioned how many tubes the set has and what types they were.

Anyway, your time and effort on the articles really shows. Good going!

Fred Kaepfel, Newburgh, IN

Dear Editor:

I would like to thank Karen McCoy of Oklahoma and Alan Douglas of Massachusetts for identifying the man on a record album cover I submitted [A.R.C., September 1992.] The information on Dr. James Harris Rogers is greatly appreciated and certainly did add merit to preserving early radio history.

I'd like to thank A.R.C. also for printing this in the *Photo Review* section which proves how worthy A.R.C. is to this hobby!

Gary Arnold, Marion, NC

A few short comments from subscribers:

I miss the 1st class plastic bag shipment.

Your price for A.R.C. is getting too high!

Your first class subscription rate is too much and if you raise the ad rate, I won't advertise either.

I am very disappointed in A.R.C. and have decided not to renew my subscription.

Dear Editor:

The issues keep getting better and better! Don't let the economy cause a cutback! ...Too bad you can't get the price of the publication to hold. ...Seriously, take a look at ways to reduce the costs.

The auction reports and comments are great as I've wondered about some of the high (and low) prices.

You are doing a fine job for the hobby and helping to maintain and protect the history of radio.

Stan Lopes, Concord, CA

Dear Editor:

...Mixing of "For Sale" with "Wanted" drives me — and I'm sure others as well — nuts...

Dick Kowalski, Warren, MI

Dear Editor,

How difficult would it be to print the city and state for each classified in bold face?

Fredric Simowitz, St. Charles, MO

Dear Editor,

...sure wish you would separate "For Sale" from "Wanted" and put new ads first.

William Hawkins, Bloomington, MN

Dear Editor,

You really ought to "classify" in a "classified" publication. We classify our reader ads in our weekly newspaper and we have only about two dozen a week. Anyway... I don't read the ads any more — don't have time to sort through what I don't want. I'm only renewing for the good articles you run.

Harry Church, Lebanon, IL

In reply...

Unfortunately, "classifying" over 700 ads by "For Sale," "Wanted," etc., or by type of radio, geography, etc. would increase both costs and production time. A.R.C. would be delivered later in the month and cost more. Since mixing the ads also encourages all ads to be read, no changes in policy are planned. However, the ad heading — For Sale, Wanted, etc. — is bold-faced so that scanning for one type of ad is easier.

We continually strive to balance the quality of A.R.C. with the cost to produce it. We believe that the chart below and the overwhelmingly positive response from our readers show that we have succeeded. (Editor)

Data for December issues: 1984 to 1992. (1993 Subscription rate used for December 1992 issue.)

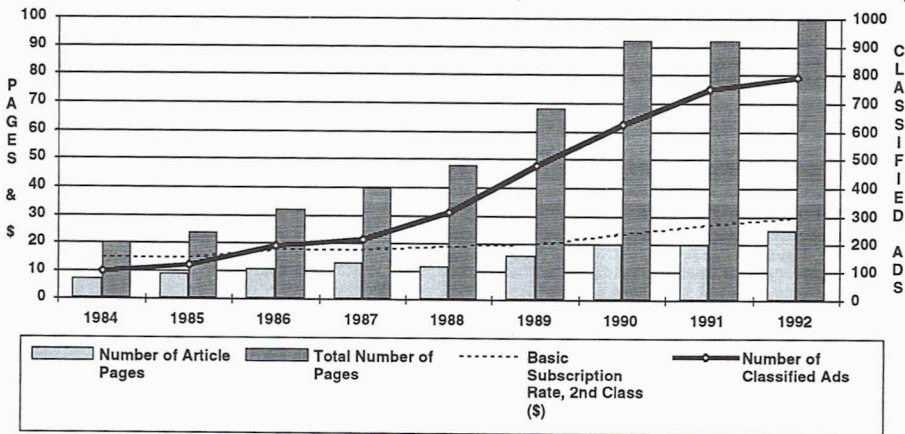

RESTORATION TOPICS

Repairing RCA Catacombs

BY FRANK BOCK

Having a special interest in early superheterodynes, I quickly became familiar with the RCA receivers that used catacombs — Models AR810, AR812, and Radiolas 24, 25, 26, and 28. The catacomb is an electronic module that incorporates most of the receiver's circuitry. There are three different types of catacombs: (1) the AR-810, the AR812, and the Radiola 24 and 26, all of which use six UV199 tubes; (2) the Radiola 25 which uses five UX199s and one UX120; and (3) the Radiola 28 which uses seven UX199s and one UX120. The number of tube sockets, components and wire leads varies with each catacomb type, but the restoration procedures described apply to all three types. For the purposes of this article, the 6-tube catacomb is used as a reference.

Inside the catacombs are audio transformers, capacitors, a grid leak resistor, and various IF/RF transformers that use laminated iron cores. These components are mounted to a Bakelite chassis which also serves as the tube sockets. The chassis assembly is potted with wax into a nickel-plated tin container covered by a steel plate cover that has openings for the tubes. Two screws and two small lead seals secure the steel plate to the tin container. Breaking the seals would expose unauthorized tampering.

IDENTIFYING THE PROBLEM

The problem in a nonfunctional catacomb can usually be found by resistance checks between the 24 tube socket fingers and the 13 leads called "whiskers." All but two RF, IF and audio coils can be checked externally. Schematics are available in the reprint of Gernsback's *Official Radio Service Manual*.

There are two typical problems with catacombs: the first is with open audio transformers, and the second usually occurs with sets that have experienced harsh environments over the years. Temperatures in attics or garages can vary from extreme cold at night to warm or hot during the day. This temperature cycling causes the wax potting to crack, thereby allowing separating or sliding in motion. The fine IF/RF coil wires in the vicinity of or passing through these cracks will eventually break or

separate from their terminals.

A third problem is cited as follows in Gernsback's *Official Radio Service Manual*, page 249: "Occasionally an oscillating catacomb will be found, and the only remedy is to change the catacomb; for no manner of adjusting will stop the oscillations, which cause whistles to be heard on all station settings." Although this problem is supposed to be unfixable, it is also unlikely, and I have never experienced it.

REPAIR STEPS

Repair of the catacomb begins by unsoldering the 13 leads from the terminal strip and removing the 2 screws attaching the catacomb to the frame of the radio. The lead seals can be removed (and saved) by filing off the excess lead protruding from the bottom and pushing them out with a 1/8-inch punch. Remove and reverse (lip facing up) the steel plate; 6 screws secure the plate to the Bakelite chassis. To remove the catacomb from the tin container, the outer wax surface must be melted. Unlike the black tar potting used in Atwater Kent sets, the catacomb wax melts at a low temperature — 250° F.

For my first catacomb repair, I melted the wax on the kitchen stove. This was a difficult and smoky mess, so I used an electric heat gun to repair all subsequent catacombs. Electric heat guns are used for various applications, including paint stripping and heating shrink tubing. Ironically, the higher power units produce lower exhaust temperatures

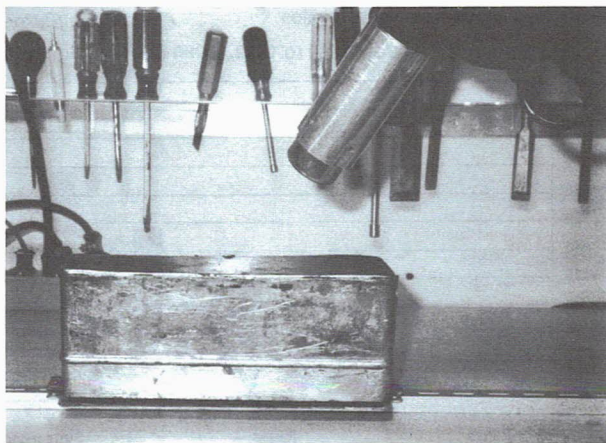

Figure 1. Heating the catacomb to remove it from its container.

(at higher air flow) than the cheaper low power units and would be a better choice for repairing catacombs.

An excellent heat gun is the Milwaukee Model 750 which produces 1680 watts of heat at an adjustable temperature between 500° and 750° F. With this unit kept at one spot at 500°, a catacomb can be removed from the container and melted down in approximately one hour. A lower-power, higher-temperature heat gun will take longer and could possibly overheat the potting.

To remove the catacomb from the tin container, you must place it upside down and heat it with the heat gun for about 10 to 15 minutes; see Figure 1. The entire container surface should be heated uniformly with the heat gun continuously moving about 1 inch per second and with the nozzle approximately 4 inches from the surface. When the container is hot enough, put on gloves and pull the Bakelite chassis from the tin container, alternating the sides being pulled. It may be necessary to wedge a small screwdriver down the side of the container to prevent a suction effect. If the chassis refuses to separate, continue heating the container.

When the chassis has been separated, it should be suspended approximately 3 inches above a wide-diameter wax recovery container like a cookie can, as shown in Figure 2. The steel plate can be tied to a 2-foot long rod that is supported between two 10-inch high boxes. Begin melting the wax by aiming the heat gun nozzle approximately 4 to 8 inches away from the vertical center of the wax. If the wax is melting too slowly or not at all, the heat gun should be moved closer, but with caution! High temperature heat guns may cause

the wax to smoke or burn if too close to the potting, so it may be necessary to back off.

Where there is a break in one of the RF/IF transformer wires, remove enough wax to expose these wires. If an audio transformer is to be removed, melt all the wax around that transformer. If there are cracks in the potting, avoid the temptation of physically pushing off large chunks since you risk breaking more of the fine IF/RF wires.

It may be wise to melt down cracked areas to prevent their causing future damage, although it is unnecessary to melt all the wax and expose the bare coils. When the appropriate amount of wax has been melted off, the rod is removed, the steel plate reversed (lip facing down), and the catacomb placed upside down on the workbench.

If an audio transformer is open, there are four choices. (1) Replace with a good RCA audio. (2) Replace with an A53-C (with its bracket removed). (3) Replace the bad coil assembly with a PT-431 coil assembly (both the A53-C and PT-431 are available from Antique Electronic Supply). (4) Repair the bad coil assembly. The fourth option is the most time-consuming.

To find a broken IF/RF lead wire, trace the circuit to the post to which this wire should be connected. The broken wire should be carefully stripped and soldered back to the post. If the 13 catacomb whiskers' leads are in poor condition, they can be replaced with black cloth-covered wire, also available from Antique Electronic Supply (Part No. SW-704).

When all repairs are made, a thorough resistance check should be made before reassembling the catacomb and mounting it into the receiver. If it is to be potted with the recovered wax, the

(Continued on following page)

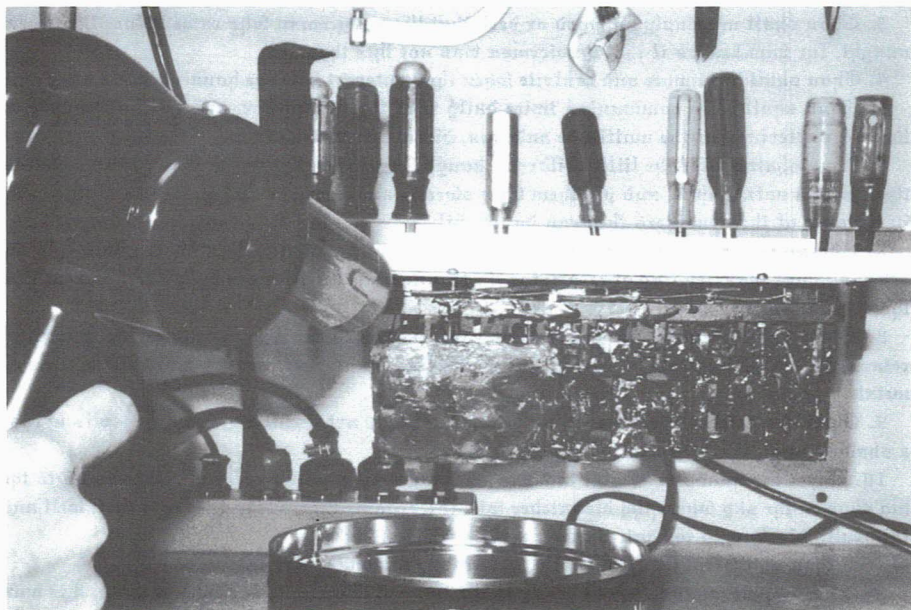

Figure 2. Melting the wax from the catacomb. Note that the wax has been melted on the right side of the catacomb revealing the components.

(Repairing RCA Catacombs, continued)

catacomb should first be tested in the receiver.

Although unnecessary, repotting the catacomb can be achieved by first heating the wax in the cookie can with the heat gun. When the wax is a thin liquid, it should be poured into the catacomb tin container where heating should continue a few more minutes. The wax should be stirred frequently.

The repaired catacomb assembly is then slowly lowered into the tin container (be sure the container and assembly mounting holes are aligned) where it is cooled with no movement or vibration for a few hours. Finally the lead seals can be glued into their original holes and the catacomb mounted back into the receiver.

I have successfully repaired 9 catacombs and have cannibalized 3 others for audio transformers. If you would like to attempt to repair a catacomb and have any questions, feel free to write me.

(Frank Bock, 637 So. 10th St., New Hyde Park, NY 11040)

Reference:

Gernsback, Hugo. *Official Radio Service Manual and Complete Directory of All Commercial Wiring Diagrams 1930*, reprinted. Vestal, NY: Vestal Press, 1984.

Parts Reference:

Antique Electronic Supply, 6221 S. Maple Ave., Tempe, AZ 85283

For another technique in unpotting and restoring RCA catacombs, the reader is referred to Richard Foster's article "Repairing the RCA Catacomb" in the September 1989 issue of A.R.C., pages 4-7.

Frank Bock is an engineer who designs radar transmitters for a Long Island electronics company. For the past 8 years, he has been collecting and restoring 1920s battery sets and early AC sets. He also collects early engineering books. Although he has no interest in servicing catacombs professionally, Frank enjoys sharing his experience with other collectors.

Ten Commandments for the Radio Serviceman

CONTRIBUTED BY LLOYD SPIVEY

The source of these radio-related "commandments" is unknown, according to Lloyd Spivey, who found them in his archives. A few of them, although written for servicemen of another era, might serve as New Year's resolutions for those of us who buy and sell old radios today. (Editor)

1. Thou shalt listen with patience and fortitude to the cries of anguish of thy customers, for to ignore them is to invite oblivion.

2. Thou shalt carry on thy person all necessary parts to make well a sick product, for heaven help thee if thou must go back to the shop for an 8250-066-BN-03.

3. Thou shalt not imply by word or deed that the serviceman who came before thee knew naught, for who knows if that serviceman was not thee thyself?

4. Thou shalt be humble and contrite when thou enterest into the householder's kingdom.

5. Thou shalt be in communion twice daily with thy dispatcher, and he shall convey to thee the sufferings of the multitude and, yea, direct thee to the needy.

6. Thou shalt suffer the little children, though they snatch thy tools. Thou shalt speak to them with a soft tongue, and ply them with sweets, and speak no harsh words to them, for in the eyes of their mothers they can do no evil.

7. Thou shalt be a moneychanger, but never a moneylender. Thou shalt avoid like the seven plagues the extending of credit, for the five uncollected oft loses both itself and the five thou spends to collect it.

8. Thou shalt identify the parts thou hast disgorged from the product for warranty return, for the office staff is, verily, unimaginative and cannot identify a shapeless piece of metal.

9. Thou shalt never speak harshly of a product thou art servicing, for to do so is to cast a shadow upon the judgment of thy customer.

10. When thy hands are feeble and can no longer lift a toolbox, thou wilt pass on to the big shop in the sky where thy dispatcher will interrogate thee, saying, "Hast thou well and faithfully discharged the duties of an earthly serviceman?"

And thou shalt reply, "Yea, verily, here is my summary sheet."

And the dispatcher shall speak softly to the General Manager, saying, "Behold, this man hath already served his time in Purgatory. Let him pass on through!"

(Lloyd Spivey, 1203 Charlotte Ln., Hartford, KY 42347)

CLASSIFIED ADVERTISING POLICY

ONE FREE 20-WORD AD for subscribers in each issue; additional words are 17¢ each. See details below. Classified ads must be received (not just postmarked!) by **Noon Eastern Time** on the ad deadline. Late ads are held for the following issue. Please enclose correct payment with all ads. Stamps or cash are OK for small amounts. (Canadian and other foreign advertisers, please see "Payment" on page 2 for methods.) "Free words" cannot be accumulated from month to month; free words must be requested when ad is submitted.

Please write each ad on a separate sheet of paper, especially when included with other A.R.C. correspondence. Include SUB# with ad. Ads may be sent in advance; but, write each ad on a separate piece of paper and indicate the month (or successive two months) you want the ad to run.

Please write legibly and use both capital and small letters. Do not use dashes between words. Some numbers and letters can look alike, for example 1, I and l (the number one, the capital i and the small L). Write the following characters clearly (especially in model numbers): 1, I and l; 0, O, o, Q and D; r and n; 6, b and G; V, U, u, v and Y; A and R; 5, S and s; 2, Z and z. We try to correct spelling errors, so when using an uncommon word or manufacturer which looks similar to a common word or manufacturer, note it so that we do not "correct" it. Editor's comments are in [brackets].

Advertising is accepted only for early items related to radio, communication, etc. All items must be described fairly; reproductions, reprints and not-original items must be so identified. Advertisers agree to respond promptly to inquiries and orders, to resolve problems promptly if the buyer is not satisfied, and to comply with a buyer refund request on unaltered returned items.

Publisher reserves the right to edit ads without notification to the advertiser and to reject ads for any reason. Publisher is not responsible for errors due to illegibly written ads or for any other reason. Since club activities receive free advertising on the *Coming Radio Events* page, the free 20 words may not be used for club activity ads. See inside front cover for additional information.

CLASSIFIED AD DETAILS

Deadline: NOON ET— 10th of the month!

Classified ads must have a standard heading such as WANTED, FOR SALE, FOR TRADE, FOR SALE/TRADE, SERVICES, MESSAGE, HELP, AUCTION, MEET, etc. This heading is the only bold or all-capitalized words allowed in the ad. Capitalize only manufacturer names, model names, etc. Wanted and For Sale ads are mixed together to encourage the reading of all ads, including the Wanted ads. This standard ad format makes scanning the ads easier.

Before writing your ad, please look over the ads in a recent issue of A.R.C., and try to write your ad in the same style. Full name and address is required in all classified ads; we will add it if you forget.

To encourage varied content of the ads, the same classified ad may be run only once per issue and for only two consecutive months. (To run an ad longer, use a boxed classified or display ad.)

Classified Ad Rates per Month

Subscribers:

First 20 words: **FREE***

17¢ per word for extra words over 20 **plus**

10¢ per word for a shaded ad (count all words including free words).

* Subscribers may take 20 free words on only **one** ad each month.

Non-Subscribers:

33¢ per word **plus**

10¢ per word for shaded ad.

Please do not forget to send in the extra 17¢ per word when your classified ad runs over the free 20 words; your payment will be appreciated, and it will help to keep A.R.C. healthy.

BOXED CLASSIFIED AD DETAILS

Deadline: 1st of the month!

Boxed classified ads can run unchanged for three months or more. No words are free. Ads may be shaded and may include bold and all-capitalized words freely. The ad need not begin with For Sale, etc. Minimum run is 3 months, prepaid. Discount: 5% for 6 months; 10% for 12 months.

Boxed Classified Ad Rates per Month

Nonshaded ads:

28¢ per word for all words,* none free, **plus**

10¢ per word for each bold word **plus**

10¢ per word for each all-caps word.

Shaded Ads (All words are bold at no charge):

38¢ per word for all words* **plus**

10¢ per word for each all-caps word.

Non-Subscribers:

Add 20¢ per word to above costs.

*Three words can be bold-all-caps at no extra charge.

PHOTO & DRAWING DETAILS

**Deadline: 1st of the month
for all ads with drawings or photos!**

Drawings and photos are encouraged as the response to your ad is much larger and the reader knows better what you want or are selling. Send in your drawing or photograph, and A.R.C. will reduce it or enlarge it as needed.

Photo and Drawing Rates per Month

\$10.00 per month for each photo or drawing (If ad is canceled, this amount cannot always be refunded.)

CHANGES & CANCELLATIONS

Please check your ads carefully before sending them in. Once ads are received, it is not always possible to refund the amount sent, pull the ad or make changes.

IMPORTANT — COUNTING WORDS — IMPORTANT

The **standard headings**: WANTED, FOR SALE, etc., count as **one word** each time used in an ad. **Name, address** and (one) **telephone number**, count as **6 words**, regardless of length. Ham call letters and business name can be included in the 6 words and do not count extra. Full name (or company name) and address is required in all classified ads. Each additional word, abbreviation, model number or number group, extra telephone numbers, etc. count as one word each. Hyphenated words count as two words.



SECOND CLASS

A.R.C., P.O. Box 2, CARLISLE, MA 01741
RETURN POSTAGE GUARANTEED

**CLASSIFIED AD
DEADLINE JAN. 10TH**