



# ANTIQUE RADIO CLASSIFIED



VOLUME 6

JULY 1989

NUMBER 7

HERE  
COME  
THE...



## CONSOLES

THE NATIONAL PUBLICATION FOR BUYERS AND SELLERS  
OF OLD RADIOS AND RELATED ITEMS - PUBLISHED MONTHLY

## ANTIQUE RADIO CLASSIFIED

Antique Radio Classified (ISSN:8750-7471) is published monthly, 12 times per year, by John V. Terrey, 498 Cross Street, P.O. Box 2, Carlisle, MA 01741. Telephone: (508) 371-0512; 9:00 AM to 5:00 PM ET; machine answers phone at other times.

Annual subscription rates within the U.S. are \$19.00 by Second Class mail and \$28.00 by First Class mail.

Annual foreign rates. By air: Canada - \$30.00; Mexico - \$28.00; Other foreign countries - \$55.00. Surface mail to Canada, Mexico & other foreign countries - \$25.00 (Surface delivery to countries other than Canada may take two or more months and cannot be guaranteed.)

Two-year subscriptions are twice these rates and receive an extra month. Sample issues are available free on request.

© Copyright 1989 by John V. Terrey.

POSTMASTER: Send address changes to Antique Radio Classified, P.O. Box 2, Carlisle, MA 01741.

### STAFF

Publisher and Editor:

John V. Terrey

Publishing Staff:

Dave Crocker

Betsy Dumka

Chris Frederickson

Bobby Lyman

Scott J. Young

Founding Publisher/Editor:

Gary B. Schneider

Contributing Writers:

Richard L. Arnold

Paul J. Bourbin

Norman S. Braithwaite

Dave Crocker

Alan S. Douglas

Mike B. Feher

Richard C. Foster

Frank Heathcote

David W. Kraeuter

Jim Kreuzer

Ron Ramirez

Henry Rogers

Gil Schlehman

Gary B. Schneider

Howard Stone

Frank R. White

Ralph Williams

John P. Wolkonowicz

**PURPOSE.** Antique Radio Classified is published for people involved in the radio collecting hobby. Its purpose is to stimulate growth of the hobby through the buying, selling and trading of radios and related items, and to provide a monthly forum for the interchange of ideas and information.

### WRITING TO ANTIQUE RADIO CLASSIFIED.

All correspondence should be sent to:

Antique Radio Classified

P.O. Box 2, Carlisle, MA 01741.

Your ads, renewals, letters, etc. can be handled faster and more efficiently if (1) each is on a separate piece of paper, and (2) your name, address and SUB# is written on each.

Unfortunately, A.R.C. is not staffed to answer letters with questions about antique radios or requests for advice. However, A.R.C. does solicit letters of interest to its readers

and will publish them as space permits. A.R.C. assumes that permission is given for publication of all correspondence received unless otherwise indicated.

**GUARANTEE.** You may cancel your subscription at any time and receive a pro rata refund for issues not yet mailed. If errors to ads are made by A.R.C., upon request a free correction will be run in the next available issue.

**PAYMENT.** Please send in full payment with your order or ad. A.R.C. does not carry accounts; all subscriptions, ads, etc. must be prepaid. Pay in U.S. funds; checks drawn on a U.S. bank or money orders are preferred. Make check out to "A.R.C." U.S. stamps or cash are OK for small amounts. Canadian payers may send a Canadian check in U.S. funds, but must add \$1.00 (U.S.) for conversion costs. On request, subscriptions will be prorated to amount sent, minimum term is one year.

**CHANGE OF ADDRESS.** Please notify us 4 weeks in advance of a change of address. Send both your new and old address, and include your SUB# and effective date of your new address. Temporary address changes can be made also.

**SUBMISSION OF MATERIAL.** Antique Radio Classified welcomes and solicits information that pertains or relates to the radio collecting hobby. This may include articles, book reviews, radio photos, information on upcoming radio events, meetings, antique radio organizations, radio auctions and price reports, sources of old radio and restoration supplies, and other related and interesting material. All material submitted should be verified for accuracy and typewritten if possible. Unless prior arrangements are made, all submitted materials become the property of Antique Radio Classified and will not be returned.

**MAILING OF ISSUES.** A.R.C. is available by subscription in the U.S. either by First or Second Class mail (Second Class is the way most magazines are mailed). First Class copies usually are received by the fifth of the month; copies by Second Class mail, by the tenth. The mailing of First Class copies is staggered, with those living farthest away mailed on the first day, and local copies mailed the last day. All non-U.S. copies are mailed on the first day. All Second Class copies are mailed on the last day. Mailing is usually completed by the 25th of the month.

**ETHICS.** No person involved in the production of A.R.C. is to act on any information in the magazine until they receive their copy through the mail.

**DISCLAIMER.** The publisher is not responsible for any buying and selling transactions incurred, or for any other use of the contents of this publication.

Antique Radio Classified subscription rates, frequency of publication, content, size and ad details and rates are subject to change at any time by A.R.C.

## DISPLAY AND BUSINESS CARD ADS - DETAILS AND RATES

Advertising is accepted only for items related to antique radios, communication, electricity, etc. All items must be described fairly; reproductions, reprints and not-original items must be so identified. Advertisers agree to respond promptly to inquiries and orders, and to resolve problems promptly if the buyer is not satisfied.

The deadline for display and business card artwork, payment and repeat requests is the first of the month. All advertising must be prepaid; see "Payment" paragraph above. Late ads will be run only if space and time permits. As artwork is reduced to 63% in the printing process, originals should be the artwork size listed below. Do not send in artwork on art board or send negatives. Ads should be typeset or typed neatly with a carbon ribbon. If you want us to prepare your ad, include the one-time cost listed below for A.R.C. to make up the ad.

"Tear sheets" will be sent only for 1/2 and full page ads, if requested when ad is submitted.

Business card ads are limited to one per advertiser.

Photos should be at an 85 line screen; otherwise, add

\$5.00 per photo for screening. (Do not glue photos to artwork; submit separately.) If you are confused by these requirements and terms, please write or call A.R.C. before beginning to prepare your ad.

We will be happy to advise you on your ad ideas, estimate how much the ad will cost, recommend an ad size, etc.

We assume that advertisers want all ads which are submitted to run without delay; therefore, we will run the ad and bill for any additional work required for the ad to meet these specifications. A late ad will be run beginning with the next month.

The 3-month rates represent about a 10% discount, the 6-month rates, 15%. Clubs, write for discount rates.

Page	Artwork Size (send in this size)		As Printed (size in magazine)		Cost for 1-month	Cost for 3-months	Cost for 6-months	One-time Cost for A.R.C. to make up Ad (if requested)
	H x W (inches)		H x W (inches)					
Full	12 3/8 (or 10 1/2)	x 7 1/2	7 3/4 (or 6 5/8)	x 4 3/4	\$70.00	\$189.00	\$355.00	\$24.00
1/2 H	5 1/4	x 7 1/2	3 5/16	x 4 3/4	35.00	94.00	178.00	12.00
1/2 V	11 3/4	x 3 9/16	7 7/16	x 2 1/4	35.00	94.00	178.00	12.00
1/4	5 1/4	x 3 9/16	3 5/16	x 2 1/4	18.00	48.00	91.00	6.00
1/8	2 5/8	x 3 9/16	1 5/8	x 2 1/4	9.00	24.00	46.00	3.00
Business Card	2	x 3 3/4	1 1/4	x 2 3/8	not avail.	15.00	28.00	2.00



# ANTIQUE RADIO CLASSIFIED



## EDITOR'S COMMENTS

Can *Antique Radio Classified* follow two 68-page issues with another? Well, here is the third 68-pager in a row with great articles, 400+ classifieds, and lots of ads as well as information on collector activities, services, books and parts.

When we receive one good article on a manufacturer, A.R.C. is fortunate; but when we receive a second complementing the first, editors and readers alike are doubly pleased! William Sureck and Richard Arnold have done just that with two Arvin Industries articles. They cover the company history and one of its most popular radios – the Hopalong Cassidy.

The *Vintage Test Equipment* series by Paul Bourbin continues with the Solar Model CC-1-60 Capacitor Analyzer. Not only does Paul explain how to test capacitors, he also gives hints on repairing the tester.

Charles Fisher writes about the unusual Magnavox Model TRF 5, which uses ganged variometers for tuning. As with Charles' Western Electric series, this article also has some excellent photographs.

Dave Crocker drew the illustration on this month's cover to complement his *Radio Ramblings* article "Here Come the Consoles." Since Dave is known by many as "Mr. Crosley" (he has contributed over a dozen *Crosley Review* articles to A.R.C. over the years), it is perhaps prophetic to have Dave write about the coming of the consoles.

An \$11,000 auction at the Houston Vintage Wireless Association Meet is reported by David Moore. The *Photo Review* is also included this month. The *Olde Tyme Radio Services Directory* will resume with Part 4 in the next issue.

**New Books!** Finally out (for August shipping) is Volume 2 of Alan Douglas' *Radio Manufacturers of the Twenties*. I expect to have a book review on Volume 2 in the August issue. After looking at a preview copy myself, I can report that

it is bigger and better than Volume 1.

Not to be overshadowed is David and Betty Johnson's *Guide to Old Radios – Pointers, Pictures and Prices*. This book is available now, and Dave Crocker's review of it appears in this issue. This book is already popular; at the Mystic ARCA-89 meet, all available copies sold the first day of the meet.

**Classified Advertisers.** Congratulations! Only two ads arrived after the classified ad deadline this month and missed this issue. Note, ads that arrive early in our publishing month usually appear earlier in the listings; we have little time to spread out those ads which arrive near the tenth.

A few other guidelines: once we receive an ad, we typeset it immediately and thus cannot pull or correct it; please check your ads carefully. Also, noon on the tenth is the deadline since we typeset them that morning.

**Rate Increase.** Save by renewing or extending your subscription now. Rates go up August 1.

**Horn Speaker Survey.** It's not too late to send in your *Horn Speaker Survey* (see the May A.R.C.). Fill out as many prices as you know, even if you don't have the speaker.

**Meet Activity.** Although the rain closed the flea market a few times at the Antique Radio Club of America 1989 Convention in Mystic, Ct., the sun was out enough to sunburn lots of faces and make possible much swapping and selling.

Eight club meets are scheduled for July from coast to coast. The two-day Michigan *Extravaganza* promises to be a big meet. In August, *Radiofest* will be another big event. And it's not too early to make reservations for the Antique Wireless Association Convention in Canandaigua, N. Y., in October (see ad on page 19); the rooms always completely sell out.

That's all for now. See you in New Hampshire, at *Radiofest* and in Canandaigua!

Happy collecting,

John V. Terrey

## PRINTED WITHOUT COMMENT

The file on Mike Kirby of Panama City, Fl., (see A.R.C., April, May and June, page 3) is growing: Summary of reports so far:

Persons receiving quotes:	53
Persons sending money:	33
Persons receiving refunds:	26
Refund checks which bounced:	15
Bounced checks not yet replaced with a money order:	7
Persons receiving merchandise:	0

Please keep A.R.C. up-to-date on the status of your orders. A.R.C. will forward copies of your letters to the U.S. Postal Inspection Service. If you

send your information directly (Attn: Betty Sheddin, U.S. Postal Inspection Service, 1407 Union Ave., 10th Floor, Memphis, TN 38161), please send a copy to A.R.C. also.

## ON THE COVER

When Dave Crocker submitted his *Radio Ramblings* article "Here Come the Consoles," he also sent in a drawing. I suggested that it would look good on the cover. By the next time I saw him, he had drawn another picture, this one especially for the cover. Although the drawings and his article are a bit tongue-in-cheek, perhaps their time is near – the consoles ARE coming!





## WITH THE COLLECTORS

### Arvin Industries and the Hopalong Cassidy Radio

BY WILLIAM P. SURECK AND RICHARD ARNOLD

**PART 1**  
**A COMPANY HISTORY**  
BY WILLIAM P. SURECK

When radio collectors see a little metal Arvin radio for sale at a swap meet or auction, they tend to give it a curious glance, perhaps a quick once-over, then pass it by in favor of the more popular or historically significant radio models.

While it seems that Arvin radios are less popularly collected than some other brands, the importance of the company to the radio consumer should not be overlooked. Arvin found its niche in the marketplace and became a sales leader to a segment of the radio buying public.

The company that manufactured Arvin radios was known as Noblitt-Sparks Industries. Arvin/Noblitt-Sparks Industries had its start in Indianapolis, Indiana, where it was organized as a partnership on January 1, 1919, under the name Indianapolis Air Pump Co. The company's first product was a hand-operated auto tire pump which it sold to Ford Motors and others.

An adaptation of the last name of founders Quintin Noblitt, an engineer-inventor, and Frank Sparks, a salesman-businessman, (see Figures 1 & 2) became Noblitt-Sparks Industries in 1927. By this time, the company was making a name for itself in the automotive industry with its products, most notably an auto heater.

The Arvin trade name was originally the last name of Richard Arvin, an inventor and salesman who sold Noblitt and Sparks on the idea of his auto heater. The assets of his "Arvin Heater Co. were sold to Noblitt-Sparks after his company folded in 1922. The Arvin name was re-



Figure 2. Dr. Frank Sparks, co-founder of Arvin Industries.

tained for use on consumer goods, and was later adapted as the company name (in 1950) to eliminate consumer confusion with the Noblitt-Sparks name.

By 1931, Noblitt-Sparks had moved its general offices to Columbus, Indiana.

Already a name in the auto industry, Noblitt-Sparks/Arvin began production of auto radios in 1933. In 1934, production of home-use radios began. Then in 1937, a Mr. A. D. Silva, a former chief engineer for Atwater Kent went to work for Arvin. He is said to have really launched the company into the home entertainment industry. Silva designed a complete line of radios from a two-tube metal cabinet set to large consoles and chairside models. Production also began in 1937 on a

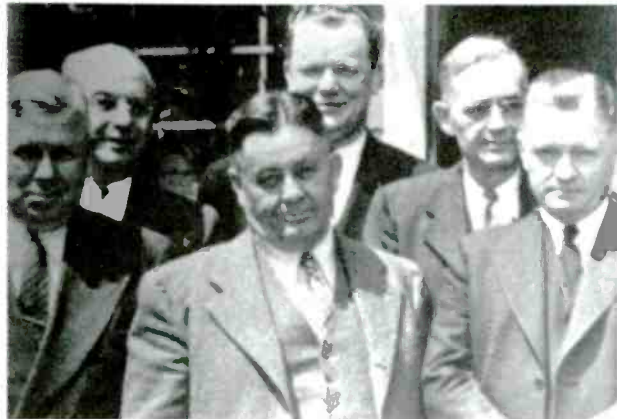
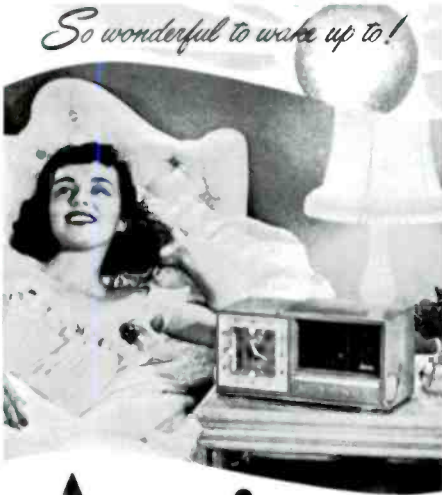

Figure 1. Quintin Noblitt (center), co-founder of Arvin Industries.

*So wonderful to wake up to!*



# Arvin *Sleepytimer*

Figure 3. *Saturday Evening Post*, April 1952.

radio-phonograph console with automatic tuning.

That same year, thirty-three models were offered. These ranged in price from \$19.95 to \$175. However, it was the Mighty Mite set that kept the company in the radio business in 1938 when a recession within a depression business slump occurred. The Mighty Mite sets were sold to jobbers for as little as \$4.10. Thousands of these sets were sold during the last years of the 1930's.

Because of the recession, the number of radio models offered was reduced from 33 to 9. A decision was reached to concentrate on popularly priced table models, including newly offered portables.

Incidentally, 1938 marked the first year that Arvin offered metal cabinet radios for sale. It became one of the few companies ever to offer metal radios. Arvin sold these models from 1938-41 and 1945-mid-1950s. Also in the 1930s, Arvin began advertising its products in leading publications such as *Colliers*, *Liberty* and the *Saturday Evening Post* (see Figure 3.)

In 1941, shortly before the outbreak of World War II, Arvin's consumer products division began production of private brand merchandise for outlets such as Sears and its Silvertone brand. During the war, Arvin produced radio communications devices and a number of other goods for the government.

Six days after Truman's victory announcement in 1945, Noblitt-Sparks/Arvin produced its first radio since 1941 – a Sears Commentator. It sold for \$9.95 and was advertised as "the choice of leading radio commentators H. V. Kaltenborn and Lowell Thomas." About 300,000 of these sets were sold before production ceased.

By 1946, the number of radio models in-

creased from three to eleven. That year saw the start of AM/FM radio production as well.

Arvin joined the rapidly developing television manufacturing industry by producing black and white television sets starting in 1949. Although Arvin went on to begin production of color televisions in 1954, the company ceased TV production the following year, citing low profit margins as a reason for the pull out.

By 1951, Arvin was listed among the top half-dozen manufacturers of radio sets. In 1954, the company announced that its four-millionth tube radio had come off the assembly line. As a foreshadowing of the decline of the tube radio, Arvin came out with an all-transistor radio in 1956.

A new company trademark was introduced in 1957, consisting of the company name spelled in block letters with a bar beneath the letters. This trademark was usually presented in red, but other colors were apparently used.

By the beginning of the 1960s, Arvin was producing 10% of all the radios produced in the United States. Arvin, a highly diversified manufacturer, is still headquartered in Columbus, Indiana.

The first thing one sees on entering Arvin's main office is a display case that contains a mint condition red Hopalong Cassidy radio next to an array of other products the company has produced through the years. Radios were reportedly assembled some forty years earlier in the basement of that building.

And across the U.S., Arvin's radios of yesterday have undoubtedly returned to basements and attics, awaiting rediscovery by collectors.

(William P. Sureck, 810 S. Cleveland Ave., Arlington Heights, IL 60005)



Figure 4. An Arvin employee with the "runaway best seller" Hopalong Cassidy radio of 1950.

(Continued on following page)



Figure 1. Hopalong Cassidy Radio, first production run.

**PART 2**  
**ARVIN INDUSTRIES MODEL 441-T**  
**HOPALONG CASSIDY RADIO**  
**BY RICHARD ARNOLD**

Twice daily, as the lights go dramatically dim and thousands of awestruck children lean forward expectantly, the echoing loudspeakers of the touring Cole Brothers' Circus blare a magic message: Fifteen years ago a great legendary character of western fiction stepped onto the screens of thousands of theaters throughout the world. Today, via radio and television, he has been welcomed into every home in the country. His principles action, courage, honesty and fair play have made him the beloved idol of children everywhere and..." (Spotlights converge on the entrance to the arena, the gum chewing is stilled)... "the outstanding personality in the world today! Cole Brothers' Circus takes pride in presenting, in person, William Boyd - Hopalong Cassidy!!" Around the arena and into the ring at a slow trot on his horse Topper, rides a smiling man in all black western rig, dazzling in silver spurs and six shooters, waving a big black ten-gallon hat.

For those of you who do not know who Hopalong Cassidy was, that was a little insight. For the rest of us who did know him, or even better got to meet him, as I did, this will perhaps bring back some fond memories.

Because of his tremendous popularity, many companies were eager to sign Hoppy to contracts promoting their products. In fact, there were so many black Hoppy western outfits made that for a time the United States had a shortage of black dye.

Arvin Industries, Inc. managed to sign Hoppy

to a contract to put his name and image on one of its radios - the now collectible Model 441-T of 1950/51 vintage. A sales distributor convention was kicked off in Chicago, Illinois, in the early part of 1950. A salesman by the name of Paul Tanner, who I interviewed for this article, was assigned the task of promoting the sales of the new radio. This he did quite well. Tall, with boyish good looks, he cut a striking figure as the Arvin Industries' version of Hopalong Cassidy the cowboy hero. Dressed all in black, under a wide brimmed black Stetson with big pearl-handled six shooters on his side, he sold Hopalong Cassidy radios for

Arvin about as fast as Hoppy could draw his guns.

Only 90,000 radios were made. They were all produced in 1950 and the first six months of



Figure 2. Hopalong Cassidy Radio, with straight right leg on horse.

1951. Production runs were in 10,000 unit increments. The first 10,000 radios were made like Figure 1, showing Topper with both legs in a raised position.

Mr. Tanner met with Hoppy in Detroit shortly after this first production run and found a very angry cowboy. Apparently, Hoppy did not like this original style as it showed inhumane treatment to horses. Mr. Tanner told me that the style was changed to that in Figure 2 as quickly as possible and prior to the second production run. The balance of 80,000 radios were made in the straight right leg version.

The Model 441-T is a four-tube superhet AC/DC that measures 8 1/2 x 5 3/16 x 3 5/8. The front panel is made of a heavy gauge tin foil pressed into the image of Hoppy and his horse Topper. On the rear (See Figure 3) of the all metal radio is a plate that covers most of the rear opening. This plate has a saddle stamped into it which has a slightly protruding pommel that the



antenna wire is looped over, like a real cowboy lariat. This antenna, called a lariatenna, is 20 feet long and has a suction cup attached to the end.

Two colors of radios were made: Fire-engine red and black. I was not able to find out how many of each color were made.

Arvin wholesaled the radios for \$10.08, and they retailed for \$12.95 up to \$16.95.

When contacted, the company was unable to find any files or information on the radio. It had all been disposed of long ago. However, many thanks go to Ms. Peggy Williams at Arvin (to whom I talked many times) for her help and for introducing me to Mr. Paul Tanner, Arvin's "Mr. Hopalong Cassidy." Mr. Tanner provided me with information that made this article more interesting and informative.

Oh, by the way, don't bother asking Ms. Williams or Mr. Tanner if they know where any unopened boxes of Hoppy radios are; they don't, darn it, I already asked.

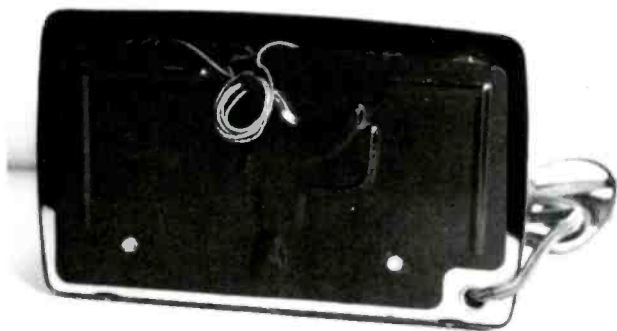

Figure 3. Rear view of the Hopalong Cassidy Radio; note saddle.

References:

Mr. Paul Tanner (Arvin's Mr. Hopalong Cassidy), Columbus, Indiana.

Ms. Peggy Williams, Arvin Industries, Inc.

The Republic Newspaper, Columbus, Indiana, article by Mr. Bob Carroll, Sept. 17, 1988.

Life Magazine, June 12, 1950, Vol. 28, pgs. 63-68.

(Richard Arnold, PO Box 275, Lone Grove, OK 73443)



HI PARDNER---  
PROUD TO HAVE YOU JOIN UP

Quite a radio you have here. It's made for young cow pokes and cow girls who know something good when they see it.

NOW YOU'RE READY TO  
SADDLE UP



It's a mighty tough radio, too, with a solid steel case and a real rugged chassis. It can take real rough treatment if it has to - but then there isn't any point in 'treatin' it mean just because of that.

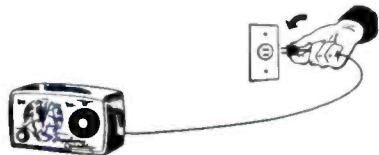

Now, unwind the power cord and plug it in. If your bunk house has AC current you can put the plug in either way and it will play. If you have DC current your radio will play with the plug pushed in just one way.

Figure 4. Excerpts from the instruction pamphlet for the Hopalong Cassidy radio.



NOW UNCOIL THE LARIATENNA

On the back of the radio, all coiled up and hung on theommel of the saddle is your antenna. We call it the "Lariatenna" and if you use it like I tell you, you can rope in more stations than you can stuff in a ten gallon hat.

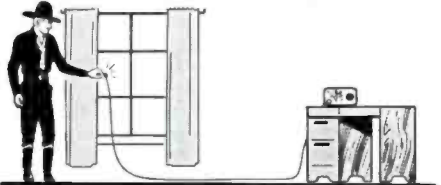

Attach the suction cup to the window glass - or the bunkhouse wall if Mom will let you. And, listen, Pardner, don't attach the "Lariatenna" to a water pipe, or radiator or the like. Those things are what they call "grounded" and this radio is designed to operate without a ground connection.



NOW TURN IT ON

Turn the knob in the lower left corner 'till it clicks. The farther you turn the knob, the more power you feed in - and the more volume you get. The other knob is for tuning in the stations. When you get the station, turn the knob just a little bit, back and forth carefully until you get the deepest tone and the least background noise. Then you're right on the station. Most grown-ups don't turn a radio right. You show 'em how!



# VINTAGE TEST EQUIPMENT

BY PAUL JOSEPH BOURBIN, 25 GREENVIEW CT., SAN FRANCISCO, CA 94131

## The Solar Model CC-1-60 Capacitor Analyzer

How often has the seller of an inoperative radio told you that it, "Just needs a tube"? Rarely is this the case. Most often the cause of trouble in an old set is the failure of one or more capacitors. By their very design, electrolytic and paper capacitors (and oil filled capacitors made in the late forties and early fifties) are unstable and vulnerable to failure. Capacitors were a high failure item even when only a few years old.

Fortunately, modern manufacturing techniques and materials have made more stable designs of capacitors available. Modern electrolytics are still unstable, but are much better than before. Old mica capacitors rarely give trouble as their design and components are not prone to failure.

Many collectors routinely replace all of the electrolytic, paper and oil filled capacitors (at least those with any high voltage across them) in every set that they restore. They feel that even though the capacitor is working fine now, it is just a matter of time before it fails. While an open capacitor may just cause a set to be inoperative or operate poorly, a shorted capacitor can destroy the power transformer or other component rather quickly, requiring an expensive repair. Other collectors feel that a set should be kept as original as possible, and that only failed components should be repaired or replaced. To be able to test a suspected capacitor properly, a capacitor checker is needed.

### TESTING IN THE THIRTIES

A good example of the capacitor checkers that were available in the thirties is the Solar Model CC-1-60 Capacitor Analyzer. This instrument was made by the Solar Manufacturing Corporation in New York. It will test capacitors from .00001 mfd. to 70 mfd. over three ranges and from 25 mfd. to 800 mfd. over an additional high range. Leakage tests are made at 100, 200, 400 and 550 volts. In addition, resistances could be



measured from 50 ohms to 5 megohms over two ranges. (Please remember at that time the letter "M" stood for 1000, like the Roman numeral, and "Meg" stood for million on many old pieces of test equipment; not the "K" for 1000 and "M" for million that we use today.)

The analyzer finds the value of a capacitor (or resistor) by use of an electrical circuit called a "bridge," comparing the unknown capacitor (or resistor) under test with one of known value. When the bridge is "balanced," the value of the unknown can be determined by reading the dial (which gives the value of the know component.) The 6E5 electric eye tube is used as an indicator to show when the bridge is balanced.

The panel, of metal, is well designed for easy use. It is made to be used with banana plugs. The power cord uses a nonstandard plug to attach it



to the base of the instrument. (An electric shaver cord can be used if the holes are opened up.) Changing from resistance to capacitance readings or vice versa is accomplished by moving one of the test leads. The cabinet is made of solid oak and, as it was designed for portable use, has provisions for storing two extra tubes used in the bridge circuit in the lid. The handle is a flat strap of leather.

### USING THE ANALYZER

The use of the analyzer is easy and straightforward. To test capacitors, turn the unit ON and insert the test leads into the proper receptacle marked "COND." If the capacitor to be checked is in a circuit (still mounted in a radio), one side has to be disconnected. Note: this analyzer should not be used to test capacitors while they are connected into a circuit as erroneous readings will be the result.

Set the POWER FACTOR control to the PA-  
PER-MICA setting for all non-electrolytic capacitors, even ones of modern materials. For electrolytics, the pointer should initially be set at ELECTROLYTIC.

Rotate the LEAKAGE switch clockwise to the number that corresponds to the highest voltage which is *below* the rated voltage for the capacitor. Position "0" is ground, position "1" has 100 volts, position "2" has 200 volts, position "3" has 400 volts and position "4" has 550 volts. If the capacitor is unmarked, then determine how much voltage is across the capacitor and use the next *highest* setting. If the neon indicator light stays on or flashes quickly, the capacitor is leaky or shorted. If there is no, or very little flashing, the capacitor is good. On large value capacitors, wait a few seconds for the light to go out as it takes a while for the capacitor to charge. With polarized electrolytic capacitors, be sure that the polarity is correct.

Next, rotate the switch to the red multiplier or black "H" (high) scale that corresponds to the value of the capacitor to be tested. Rotate the large knob slowly until the eye closes as far as possible. This will give you the value of the capacitor if it is still good. Discard any capacitor that reads 20% or more below its rated value. If the eye closes only at the end of the scale, the capacitor is shorted or open as per the reading.

As you can see, this analyzer is also useful when the value of a capacitor is unknown. One can find the value by trying the various scales until the eye closes (provided the capacitor is still functional).

With electrolytics, after the value is ascertained, rotate the "Power Factor" control until greatest variation in the eye is reached. This will give you the power factor, in percent, of the electrolytic capacitor. If the power factor exceeds 20%, the capacitor has become inefficient and should be replaced.

Testing for resistance is even easier. First, insert the probes into the receptacles marked RES, rotate the left switch to the proper resistance

multiplier, attach the probes to the resistance, and rotate the dial until the eye closes.

Another use for the analyzer is to repair variable tuning condensers. Often the aluminum plates of some tuning condensers oxidize with age. The oxidation forms hairlike protrusions on the plates that are conductive. This will either completely short out the tuner or cause it to operate noisily. To remove this oxidation, first isolate the tuning condenser from the rest of the circuit and attach one of the probes to the rotor

and one to the stator. Plug in the probes into the COND receptacles on the panel, and set the left switch to position "4". Turn on the analyzer, and rock the tuning condenser from stop to stop. You will hear a crackling sound and see little flashes as the "hairs"

are arced off. The leakage light will also flash. Continue doing this until there are no more flashes or crackles. Reattach the condenser to the tuning circuit, and it should work fine and quietly! Some repairs use house current to arc condensers, but AC tends to pit the plates more than DC. Also, the output of the analyzer is of a higher voltage and therefore more effective.

### REPAIRING THE ANALYZER

As with most test equipment, the Solar Capacitor Analyzer was ruggedly built, and repairs are few and simple. Quite often the capacitors in the unit have failed, and they should be replaced. Try to replace them with as close to original values as possible. Often the 1 megohm resistor in the 6E5 tube socket is open, and the eye will not function. Other resistors may be bad, especially if the instrument has been abused.

While you are in there, it is a good idea to clean all of the contacts on the switches and controls. The tubes should be tested. If the 6E5 is dim, it can often be brought back to original brilliance by hooking up to a television picture tube rejuvenator and zapping it. You will have to rig up an adaptor, but the results are worth the trouble.

One Grand Plastic Polish is good for cleaning both the knobs and the painted, metal panel. The felt around the edges can be replaced with green felt available at any yard goods store or "contact" felt can be used. (Contact felt is easy as one side is sticky and can be easily pressed into place. It is available in many hardware variety stores.)

The brown leather handle was just a flat piece of leather with "ears" on the ends. Any cobbler should be able to make one. (By the way, it is wise not to pick up any old equipment by the leather handles as the weight will often break the handle.) Saddle soap, followed by Neatsfoot Oil will revitalize the leather. Many applications of oil will be needed if the leather is dry.

As you can see, a capacitor analyzer is a nice piece of equipment to have for radio repair and restoration given the high failure rate of vintage capacitors.

That's it for now. If you have any questions, please let me know.



# WITH THE COLLECTORS

## The First Magnavox – Model TRF 5

BY CHARLES FISHER



*Figure 1. The Magnavox Model TRF 5.*

It looked like the usual uninteresting 1928 five tuber until I saw the stacks of brown pancakes inside. That did it. I took it home.

1924 was the year Magnavox expanded its line of speakers, amplifiers and tubes to include radios – the TRF 50 with built-in speaker, and the TRF 5, identical but without speaker. Outside, the TRF 5 looks more like 1928, with feet, pilasters and heavy moldings – all in a rustic dull walnut finish. Its one-dial tuning was almost unique, see Figure 1.

1924 was also the year when the Superheterodyne really began setting performance standards. While most manufacturers struggled for modest improvements in ordinary circuits, Magnavox brought out its “highly perfected tuned radio frequency circuit” which was something of a hare among the tortoises.

It tunes with variometers, not variable condensers. (See Figure 2) The result is much above average sensitivity at low frequencies, with some sacrifice at the high end. The variometers each consist of one fixed and

one rotating pair of flat D-shaped coils spaced about  $3/16$ " apart. Each section is a flat spiral of 30 turns of silk-covered no. 24 or 25 wire, contained between two bakelite stampings, one about  $1/6$ " thick, one much thinner. They are held together by a few metal clips at the edges. There must be some strong adhesive rigidifying the turns (airplane dope?), as they are not now well adhered to the bakelite, but are evidently quite solid and secure. They are resonated by condensers that look like trimmers, and which have slender white porcelain knobs above the chassis,

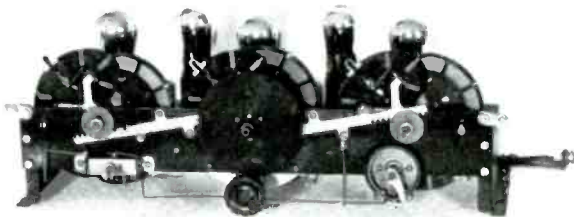

*Figure 2. Front view of the Magnavox Model TRF 5 chassis.*

for occasional user access. (When the variometers are well aligned mechanically, there is seldom a need to readjust the condensers.)

The ganging is by stamped heavy sheet metal racks and pinions. Intermittent ground connections among the parts as well as backlash are prevented by two extension springs applying opposing torque to drums on the outboard variometers. It all works beautifully, and the "one-



Figure 3. The Magnavox insignia on the cabinet.

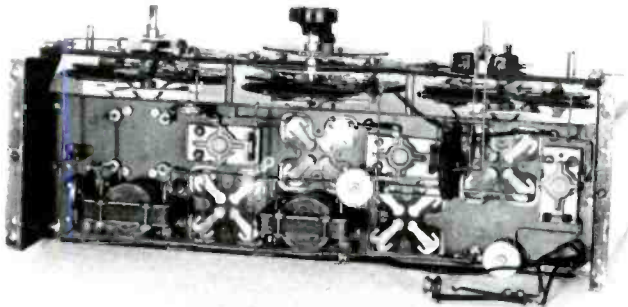

Figure 4. Underside chassis view of the Magnavox Model TRF 5.

dial" tuning is smooth and easy. Selectivity from 1000 kHz down is amazing, almost as good as a superhet of the period. It is difficult to judge the top of the range, because I tested this set one mile from a 50 KW, 1200 kHz station, and other locals at 1030 and 1060 are almost as powerful.

The elegant chassis design and workmanship show emphasis on production engineering rather than hand assembly of stock parts. Most were made by or expressly for Magnavox: audios, capacitors, tube sockets, and of course the variometers.

This set needed only some weak solder joints remelted, along with realignment, to come alive impressively. Fine tuning was noisy, and there was a tendency to

go in and out of regeneration erratically. Replacing the missing anti-backlash springs completely cured both.

Tuning range is limited to a ratio of about 2 1/2 to 1, such as 550-1270 kHz, 590 to 1360, etc., according to the limits chosen on the adjustable capacitors. This was no hardship in 1924, although it may have made these sets obsolete soon after. However, an important design change was made in early production which allowed the coil sections to be more closely spaced. This has the effect of widening the range of inductance and extending the tuning range upward appreciably. (Early version has four-legged spider coil mounts; later version has two straight-edge metal strips supporting full length of coil panels to prevent warping.)

(Charles Fisher, 161 Belknap Rd., Framingham, MA 01761)

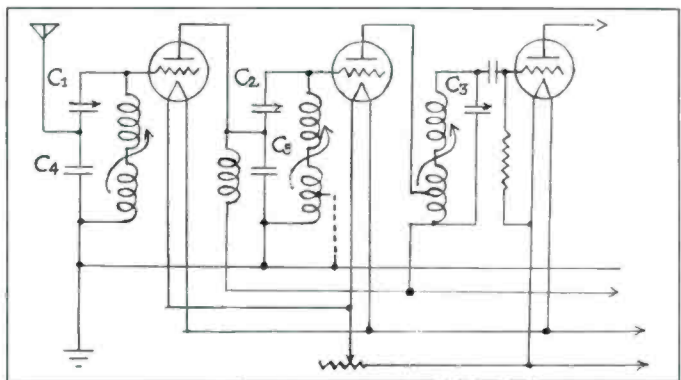

Figure 5. RF stages redrawn from Rider's Vol. 1 to show variometers as variable inductors. C1, C2, C3 are the adjustable fixed-tuning condensers. C4 and C5 are for coupling.

High gain at low frequencies is due to large inductance of variometers when at max. — about three times that normally used with tuning condensers. C1, C2, C3 are correspondingly small. Inherent loss of sensitivity at high frequencies is partly offset by use of the r.f.c. plate load for the first tubes, whose gain therefore rises with frequency.

In the unusual second stage, a small portion of the variometer serves as plate load without sacrifice to selectivity. Rider's shows second variometer grounded at a tap (dotted here). Not so in this early specimen (serial 1525). Probably a production change adding some neutralization to minimize tendency to oscillate at low frequencies — not highs as in normal t.r.f.'s.



# MEET & AUCTION REPORT

## HVRA/AWA Convention '89 Meet & Auction

REPORTED BY DAVID MOORE

The annual convention of the Houston Vintage Radio Association-Antique Wireless Association (HVRA/AWA) was held April 22-23, 1989, in Galveston, Texas. The convention exceeded all previous figures; there were 114 registered guests. The auction saw 384 lots, grossing almost \$11,000. Sales for books and reprints were brisk, selling out of many publications.

The old equipment contest featured quality sets. Michael Payne's Clapp-Eastham spark transmitter/receiver won top honors. The Best Restoration went to Billy Richardson for his Echophone Model A. The Art Deco category was very popular this year with a mint Porto-Products Smokerett, Model SR-600. Bernard Sampson's toy television display (over 50) caught the eye of many hotel visitors and members.

The events of the day were concluded during the awards banquet with Ray Miller, speaking of his early years in broadcasting beginning nearly 50 years ago.

The usual swap session was held on Sunday morning in the hotel parking lot. Many items from the previous day's auction could be seen changing trunks.

Membership in the Houston Vintage Radio Association is invited. Dues are \$15.00 for local members and \$10.00 for others. Their *Grid Leak* is published monthly.

(David R. Moore, 3213 Regal Oaks, Pearland, TX 77581)

Radiola III w/amp and horn .....	\$200
Steinitz .....	155
Silvertone cathedral .....	170
Philco 45 Butterfly radio .....	140
Stewart-Warner 525 .....	130
RCA 128 cathedral .....	50
Aeriola Sr. ....	135
Mengle crystal set .....	140
Philco 90 cathedral .....	350 & 375
AK 44 .....	35
AK 84 cathedral .....	230
Zenith 6V27 tombstone .....	70
Neutrowound, black w/caps .....	200
RCA RC .....	250
Philco 70 .....	275
Philco 20 .....	78
Philco 84 .....	160
Gloritone 27 .....	130
Crosley Showbox .....	30
Baldwin speaker .....	55
Music Air jukebox radio .....	105
Zenith tombstone, 6S27 .....	175
DeForest 01-A tube with can .....	40
Philmore crystal set .....	50
Zenith console, 12S265 .....	275
Westminster cathedral .....	100
Zenith 75-334 .....	170
Majestic 71 .....	90
RCA cathedral .....	175
Rider's Vol. 10 & 12 .....	10 ea.
RCA console K80 .....	85

## LETTERS - 5TH ANNIVERSARY ISSUE

*We just had to print a few of the nice letters we received recently complimenting us on our fifth anniversary issue and its color cover. (Editor)*

Dear Editor,

Kudos to the A.R.C. staff for the great 5th anniversary issue!! Excellent cover, great articles. Keep up the super job for 5 more, and 5 more, and 5 more.....

Charles Harper, Lexington, KY

Dear Editor,

Just a little note to let you know that the color cover on the June issue is just great! Hope to see others in the future.

Richard Bednarcik  
Lincoln Park, NJ

Dear Editor,

I am really enjoying your monthly magazine and wish to commend you on the excellent articles that you are offering to the subscribers. Keep up the good work.

Barry Nadel, San Francisco, CA

Dear Editor,

Congratulations on the five year anniversary! I've subscribed to A.R.C. since the very first issue, and I've watched A.R.C. grow and evolve over those years. You are producing a publication which is very informative and entertaining - It helps to make this hobby fun! I look forward to each and every issue - Keep up the good work!

Doug Heimstead, Fridley, MN

Dear Editor,

Nice color cover on latest A.R.C.

Congrats!  
Bruce Kelly, Holcomb, NY

Dear Editor,

Congrats on your 5th anniversary. Keep up the good work.

Ed Povraznik, Brooklyn, OH

Dear Editor,

I just received my very first issue of A.R.C.. I love it. I'm so glad I found it.

Bill Timoszyk, Livonia, MI

# RADIO RAMBLINGS...

## Here Come the Consoles

BY DAVE CROCKER

*Its time had come.*

*It had to happen.*

*There was nothing left to collect.*

First, there were the early collectors who filled their shelves with early spark and wireless gear with little competition. Next followed the expected transition to early broadcast receivers and crystal sets. The few collectors there had a field day! Early Grebe, Federal, Atwater Kent, Paragon, Amrad, Radiola and Zenith sets were there for as little as 10 to 20 dollars. A.C. Sets? Never!

But, as the radio collector ranks grew, the cathedral became recognized as a "worth having" item. As prices neared the hundred-dollar mark, those with less to spend began picking up early A.C. receivers . . . and the once rejected "tombstone" appeared on collectors' shelves. . . but only the big names like AK, Philco, RCA, etc.

I remember seeing an article in the *Capitalist Reporter* in 1973 stating that "round-tops are worth investing your \$15-\$20 on" . . . and predicted that a Philco 90 would bring as much as \$100 in the near future. I said then . . . "NEVER!" What I say now is, "Never can I afford one."

If I had it to do all over again . . . that is, if I could go back to 1970 when I started to collect, I would concentrate on the cathedral radio. Oh, the models that slipped through my fingers! Here's hoping that someone out there writes an Alan Douglas type book illustrating all the cathedrals.

We collectors put a big period after the tombstone. "That's all that's worth collecting," we said, and for a while it was true. Then interest in the novelty radios opened up the oddball sets. Some collected only grandfather clock radios. Prices climbed higher. AK breadboards reached \$200. Wireless became extinct, and early broadcast receivers seemed a little harder to come by. More collectors and more competition saw some collectors turning to the communication receivers/transmitters of the 30's and 40's. And wouldn't you just know, some guy out on the West Coast started collecting early television sets! Our first thoughts were that TV collecting would lower the esteem of the antique radio hobby. But we were all mistaken. Just notice what a TRK-12 brings today!

Next an incredible leap took place. Catalin and mirrored radios made us turn heads. So fast did their prices climb that before most of us could identify one, the prices were out of sight! Can you imagine . . . a plastic-type radio worth more than an AK Model 5? Or a DeForest Interpanel?

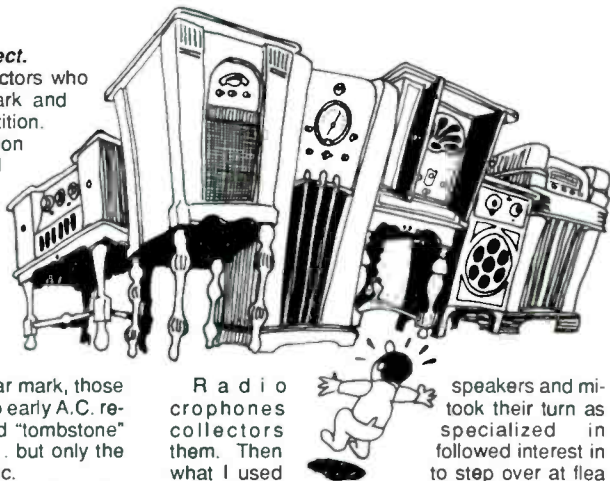

Radio  
crophones  
collectors  
them. Then  
what I used



speakers and mi-  
took their turn as  
specialized in  
followed interest in  
to step over at flea  
markets - the multi-band sets like Zenith Trans-  
Oceanics.

Then came interest in transistors, then a new look at all those passed-over wooden radios of the 30's and 40's, probably due to new collectors' frustrations in not finding or being able to afford "what every collector should have."

And now auctions are listing and selling those streamlined colored plastic sets of the 50's and 60's. And to think I once believed that if it wasn't shown in *Flick of the Switch*, it was not worth collecting.

So that's it? No, not yet. A new phase has just started. Remember those consoles we all thought took up too much space? Well, start grabbing while you can . . . because prices have already started to climb on sets like the "Big Black Dial Zeniths," early push-button Zeniths, most Atwater Kents, Spartans, sets with eight or more tubes, and so on.

Probably interest will arise from just reading this article, but be our own judge. You'll have to admit, back then there were some real nice examples of classic radios, produced as fine pieces of handcrafted furniture . . . probably to please the lady of the house. It is a segment of the history of radio that should not be overlooked. I can only wonder what will be collected . . . after consoles.

Well, that's what the next wave must be, so excuse me while I go home and push all my table radios closer together to make room for some consoles. I won't be caught sleeping this time!

(Dave Crocker, c/o A.R.C., P.O. Box 2, Carlisle, MA 01741)



# PHOTO REVIEW

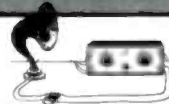

This column presents in pictorial form many of the more unusual radios, speakers, tubes, advertising, and other radio-related items (covering the years 1900-1950's) from our readers' collections. The photos are meant to help increase awareness of what's available in the radio collecting hobby. Send in any size photos from your collection. Photos must be sharp in detail, contain a single item, and preferably have a light-colored background. A short description must be included with each submitted item. Please note that receipt of photos is not acknowledged, publishing is not guaranteed, and photos are not returned.



**RADIO NEWS** - These popular radio magazines were published by Hugo Gernsback. The covers were very colorful and had a humorous touch and a wealth of early radio information. Covers shown from left to right are the December 1923, and the January and May 1926 issues. (Jahan Acciavatti - Southboro, MA)



**1933 CROSLY DUAL FIVE SHERATON** - This is a five-tube superheterodyne circuit radio using the Model 167 chassis. Tubes are: one 2A5, one 57, two 58's and one 80. With tubes, it sold for \$25. (Dave Crocker - Lyndonville, VT)



**GE MODEL S22-C** - This 8-tube AC set in a tombstone case, circa 1934, has all its original parts and still works. The grille cloth is a tapestry like the Radiola 103's speaker. (Walter V. Worth - Wollaston, MA)



---

## PHOTO REVIEW

---



**AMRAD 5-TUBE NEUTRODYNE WITH ARC-TURUS BLUE TUBES A26 AND A28** - Power input for filaments is marked 15 volts with no plus or minus signs, as these tubes accepted AC from a 15v bell transformer. This set was made circa 1923, and has regular batteries for "B". (Walter V. Worth - Wollaston, MA)

---



**1937 KADETTE CLOCKETTE** - This table model manufactured by the International Radio Corporation of Michigan. This "modern" style cabinet is made with walnut and maple veneers. (Alexandria Nelson - Albuquerque, NM)

---



**CROSLY DUETTE** - The Model 56-TD was manufactured in 1946. The highly stylized plastic cabinet is of deep maroon and gold. (Ron Boucher - Goffstown, NH)

---

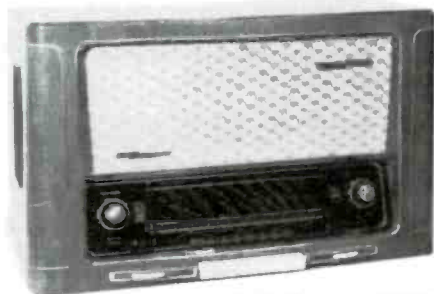

**LARGE GRUNDIG GERMAN 8-TUBE RADIO** - Circa 1922, this radio has a width of 28 inches and has automatic motorized tuning. It has 6 bands (two FM), a rotary antenna and 4 speakers. (Walter V. Worth - Wollaston, MA)

---



**UNKNOWN BATTERY SET** - The manufacturer is a mystery, but the set is too well made to be a home brew or a kit. This set uses four 199 tubes and has a built-in speaker. The panel swings out for easy access to the chassis. The antenna is inside the front door. Can anyone identify this radio? (Ron Boucher - Goffstown, NH)

---

# BOOK REVIEW

## Guide To Old Radios – Pointers, Pictures and Prices by David and Betty Johnson

REVIEWED BY DAVE CROCKER

This *Guide To Old Radios – Pointers, Pictures and Prices* is the reference book I wished were around when I started to collect radios some twenty years ago. I had to wait a few years until the publication of McMahon's *Vintage Radio* which I wore out while memorizing its material. The newer or beginning collector desires as much information as possible about this exciting hobby . . . and this book fills this need.

While many of the books out today may focus on one specific area of the hobby such as early manufacturers, tubes, speakers, TV or ham gear, this one covers a wide spectrum. There are chapters describing the history of radio, the basics of radio's workings, broadcasting, dating sets, how to find them, a price guide and a listing of books for further reading and assistance. Invaluable reading as our hobby grows and well worth the \$16.95 investment.

The book reads well, with nice large photographs and ads to complement the text. So interesting is it, that I'm willing to bet that if anyone picks it up and scans it, they will become hooked on the hobby. Antique dealers will probably grab this guide for pricing what they have or will find . . . an already difficult task for the non-collector. But as we know, this can be both good and bad . . . less and less outlandish prices, but fewer steals as well.

This second Johnson guide on antique radios shows much improvement over their first effort – *Antique Radios, Restoration and Price Guide*, published in 1982. This first book had a few flaws such as sets with incorrect knobs, a few incorrect dates and some misleading prices, which the advanced enthusiast noticed right away. Most of this has been corrected, but the price guide will always be a subject of contention. Most price guides usually are. The price guide will also date this book, for, as expected, in a year or so, prices will change.

At first, the many post-1940 radios shown and priced surprised me. But remember, friends, these are the sets collectors come across at flea markets, yard sales and antique shops now. A great deal of the earlier items are becoming harder and harder to find nowadays. Radios after 1940 are just what the starting collector finds and wants to document. A great deal of the action in this hobby will probably be in this era of manufacture in a short time.

While this book does not elaborate on early wireless equipment, communication receivers or televisions, I heartily recommend it for everyone:

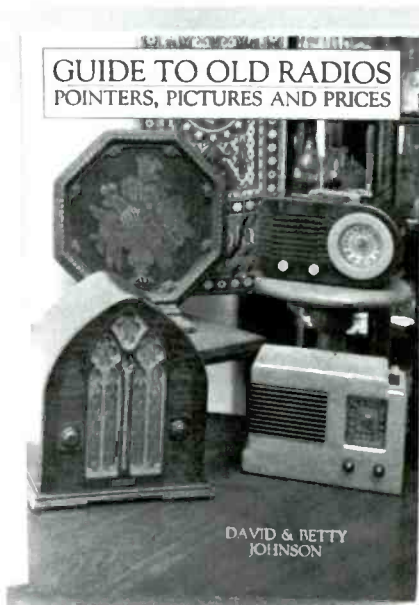

the beginning and the advanced collector, the antique dealer, flea market buff, ham and historian alike. Publications like this one draw attention to and make our hobby respected at last.

And so, a tip of the hat to the Johnsons for a monumental task and a job well done.

*Guide to Old Radios* (\$16.95 + shipping charges) is available from A.R.C., Antique Electronics Supply and other suppliers.

(Dave Crocker, c/o A.R.C., P.O. Box 2, Carlisle, MA 01741)

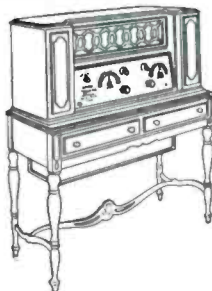

From page 43: 1925 Super Zenith. This horizontal highboy concealed the speaker in the top of the compartment; available as either an AC set or a battery set; original price \$550.00.





---

**CLASSIFIED ADVERTISEMENTS**

---

**FOR TRADE:** WD-11's, Wunderlich, Red Tops, Sonatron tubes; velocity microphone, plus more, SASE. Floyd A. Paul, 1545 Raymond Ave., Glendale, CA 91201. (818) 242-8961

**WANTED:** Cabinet for Gilfillan Model GN-3 as shown on page 91 of Vintage Radio. Jack Gray, 1162 Broadmoor Dr., Napa, CA 94558

**EXTEND OR RENEW  
YOUR SUBSCRIPTION NOW  
BEFORE RATES GO UP!  
Details on coupon in centerfold.**

**FOR SALE:** VT-4-C, N.I.B., dated 11-19-41 - \$15. BC-221-AK, mint - \$20. I-176 VOM test set, exc. - \$20. Old headsets, old mica caps, equipment, parts, books, large SASE for list. Patrick Marinneau, 3443 Illinois Ave., St. Louis, MO 63118

**WANTED:** Motorola two-color Catalin radios and wood consoles. Battery eliminator marked "WLS" from 1930's. Top prices paid, excellent condition only. Contact: Sharon Darling, 1261 Wiley Rd., Schaumburg, IL 60173. (312) 576-6566

**FOR SALE:** Minerva wood table radio W117 - \$18. Zenith plastic table radio H615Z - \$15. B&K television analyst Model 1075 - \$25. B&K Model 440 CRT - \$35. Sylvania Universal 110° test picture tube - \$15. Sylvania 5AXP4 TV set test tube - \$15. Operado 4A25 intercom in carrying case - \$15. Richard Haneline, 3600 Cuba Blvd., Monroe, LA 71201. (318) 387-6764

---

**CLASSIFIED ADVERTISEMENTS**

---

**WANTED:** AK 20. Radiola 20. Crosley 51. Rider's I, II, and V. David Ponicki, 5239 Beverly, Kalamazoo, MI 49004. (616) 344-9717

**FOR SALE:** Audio: Scott Philharmonic Chippendale, excellent original with FM, 15" Jensen coax original grille cloth, great cabinet, and it shakes the floor! Offers or trades. Presto 6 N lathe with 1-D cutterhead excellent - offers. Webcor BO-1 basic maroon & gray wire recorder with 3 reels of wire, mic. - \$100 or BO. Crown 2TK port. Mod. 700, exc., 3 speed - \$250. Ampex 602 mono - \$100. Marantz Model 2, fair, needs power xfmr. - offers. Marantz CD-400-B disc demodulator, mint - \$75. CB and ham, Knight KN2560 CB tube transceivers, exc. - \$75 or BO. Hallicrafters SR-46 6-meter transceiver with Argonne mic on desk stand, like new - \$125 or BO. Johnson Viking Ranger Thunderbolt - offers. Military: Signal Corp TG 24A keyer - \$25. Bendix LM-13 frequency indicator - \$25. Many new radios mostly late 40's tablesets, some portables exc., Zenith brown bakelite AM/FMG-725 - \$75. Zenith Royal 3000 with all paper work, pitted chrome - offers. LSASE 2 stamps for new list. **WANTED:** Always looking for vintage mics RCA 44-77, Altec, WE 639A's, Sony, Neumann, AKG condenser. Also looking for tube compressors & EQ's. Amp Presto 92-B for 6 N lathe. Anybody pick up tubes for Concord MTC-21, Panasonic WV-033-P cameras? Ward Kremer, 301 SW 16 St., Ft. Lauderdale, FL 33315. (305) 524-5652

**WANTED:** Instruction manual or tube chart for Jackson tube tester Model 648-A. Copies OK. R. Selpien, 330 State, Sycamore, IL 60178



**NEW!**

## THE RADIO TRADE DIRECTORY

—1925—

Would your curiosity be aroused to know the companies and their addresses which manufactured radios, crystal sets, speakers, telegraph keys and radio parts, at a time when the advent of radio took the nation by storm? This high quality reprint lists thousands of American manufacturers of radios and parts in 1925, and contains over 200 display ads with product illustrations. Includes over 150 vacuum tube manufacturers, 300 speaker manufacturers, 1000 radio set manufacturers and more!

**ORDER NO. B-529    \$8.95**

*When ordering please include \$3.00 for handling and shipping.*

**ANTIQUE ELECTRONIC SUPPLY**

688 W. First Street • Tempe, Arizona 85281 • (602) 894-9503 • FAX (602) 894-0124

**Write or Call for Complete 24 Page Catalog.**

## CLASSIFIED ADVERTISEMENTS

**WANTED:** Pocket-sized transistor radios. Early Japanese type. Send close up photo, Xerox image, or rough sketch with price to: Roger Handy, PO Box 24527, Los Angeles, CA 90024. (213) 451-4040

**FOR SALE:** Victrola Orthophonic Model VE-10-50X coin-operated automatically changes records - \$750. 1939 Rockola Luxury light-up jukebox - \$1,600. Jim Polsene, 602 Chicago St., Manitowoc, WI 54220. (414) 682-0999

**WANTED:** Dial escutcheon for Stewart-Warner Model 715. Same part as on the Model 520 illustrated on page 30 of Puetts Encyclopedia of Antique Radio, Volume 1. Jim Peters, 983 Chapel Ct. South, Glen Ellyn, IL 60137

### CLASSIFIED AD DEADLINES

Jul. 10 for Aug. 1989 Issue

Aug. 10 for Sep. 1989 Issue

Sep. 10 for Oct. 1989 Issue

**WANTED:** Remler Scottie radios including Pup/Junior plus Remler literature. Emerson 540 (F.O.S., p. 83) in red or green. Steve Neal, 3472 Stancrest Dr., Glendale, CA 91208. (818) 248-3169

**FOR SALE:** Baird stock certificates, ca. 1930's; Baird Television Ltd. Mechanical television developed by Baird, 1929 (see A.R.C. article March '89). \$45 ea. ppd. Limited quantities. J. J. Papovich, 53S Magnolia Ave., Pitman, NJ 08071. (609) 582-8279

## CLASSIFIED ADVERTISEMENTS

**WANTED/FOR TRADE:** Langevin, Western Electric, other tube audio gear & speakers. WE caps, vitamin Q, quality audio xmrs. Have Sams to #200, Rider's VI-XVII. Various radio lit. to trade for audio lit. Joe Roberts, PO Box 19302, Alexandria, VA 22320. (703) 683-2955, eves.

**WANTED:** Atwater Kent Model 10 (#4600), or 10 (#4550, #4560 brown, straight coils). Also AK Model 19 (#4880). **FOR TRADE:** Atwater Kent 84, early production run, beautiful condition. Also Russian 4-transistor portable, with instructions. David Kechkaylo, 3935 Bristol Ct., Melbourne, FL 32904. (407) 723-0980

**FOR SALE:** Radio/electronics as portrayed on worldwide postage stamps. List for SASE. Littlewood, PO Box 681, Brookfield, WI 53008

**WANTED:** Colored Catalin and bakelite radios of 30's, 40's, 50's. I am a collector only, and will pay top price for good radios. FADA, Addison, Sonora, Garod, etc. Sandra Mills, 5782 Florence Terrace, Oakland, CA 94611. (415) 428-0431

**FOR SALE:** Signal Corps receiver BC-344-D, keyer TG-10-F, frequency meter BC-221-AK, Pan-Oscillio receiver. Marion Van Hal, 1328 Orchard, Pella, IA 50219. (515) 628-2347

**WANTED:** Cabinets for: Stromberg-Carlson Model 1-A, Majestic Model 70. Chassis for: 1933 Silvertone Century of Progress, Steinite, large Kennedy and Echophone cathedral. Anything for Thompson Minuet. Larry Porter, 4115 Beam Rd., Crestline, OH 44827. (419) 683-2540

## 28<sup>TH</sup> ANNUAL A.W.A. HISTORICAL RADIO CONFERENCE

Sponsored by the Antique Wireless Association, Inc.

October 4 to 8, Sheraton Inn, Canandaigua, New York

*"In the heart of the beautiful Finger Lakes" (near Rochester)*

5 DAYS OF OUTSTANDING ACTIVITIES for the RADIO COLLECTOR and HISTORIAN

- 3 large auctions plus the world's largest antique flea market
- programs for ladies, dinners and other attractions
- equipment contests, exhibits and seminars
- 10-star program:

- Receiver restoration workshop
- Vacuum tube seminar
- Tesla-coil workshop
- Book and magazine forum
- Historical television seminar
- Loudspeaker workshop
- Construction & operation of NAA
- Present-day merchant marine operation
- Early television receiver demonstrations
- Key and telegraph workshop

Write for details: Antique Wireless Association, Inc.  
Box "E", Breesport, New York 14816

(Note: Advance registration advisable.)

**CLASSIFIED ADVERTISEMENTS**

**FOR SALE:** B&K 290 VOM – \$100. Good condition. RCA signal generator – \$25. S. Goldhur, 1014 B St., Hayward, CA 94541. (415) 537-5149

**WANTED:** Silver-Marshall output transformer (or "tone filter"), Type SM-251. Thanks. Gordon Symonds, 26 Ossington Ave., Ottawa, Ontario, Canada K1S 3B4. (613) 232-2198

**FOR SALE:** Clearing out my old stock! Admiral 5R33, Silvertone 090? (1933 battery set chassis only), Buick Sonomatic 981707 – \$5 ea. J. C. Penney 500, Westinghouse H-130 wooden table radio, Westinghouse H-318T5, Zenith Y509-Y – \$10 ea. Coronado R-675A, Heathkit GR-78 multi-band, RCA 45-EY-2 – \$15 ea. Jewel 935, Motorola C4P, Philco 0-655-123 – \$20 ea. Admiral 5X11N, Emerson 652, GE HJ-1205, Monacor 5-H1, Motorola 52CW4 Art Deco, Westinghouse H-563P4A – \$25 ea. Sentinel 338, Zenith tombstone – \$35 ea. Crosley D-25WE, Wilcox Gay Recordette Sr. – \$40 ea. Airline 04BR-729, Zenith Z1512J Art Deco TV – \$45 ea. Coca-Cola & early telephone radio novelty sets. FADA with yellow Catalin knobs. Plus more radios, early parts, early test equipment, & literature. SASE to: Neil O'Donnell, 1809 Sampson Ave., Butte, MT 59701. (406) 494-8162

**WANTED:** Owner's manuals, schematics (copies OK) for Supreme 401 radio analyzer and Simpson 330 tube tester. Wood finials and turned top pieces for Crosley Playtime grandfather clock radio, will consider partial or damaged cabinet. Dan King, 1230-B Juniper St., Gilroy, CA 95020. (408) 847-1345

**CLASSIFIED ADVERTISEMENTS**

**WANTED:** Zenith radio sales brochures, catalogs and ads, 1930's and 1940's. David Wilson, 1051 Candeleras, Las Cruces, NM 88001. (505) 522-1117

**FOR SALE:** Philco 89 cathedral, works – \$90 plus UPS. Let's swap! My Amrad crystal receiver (2575) plus cash – your Amrad 1-tube (3366). My Kennedy XI – your Zenith 3R. Crocker, RFD 2, Kirby, Lyndonville, VT 05851

**WANTED:** Military manuals or good copies; TS-323/UR, AN/AMT-6c, DAG, US/C-3A IR scope, TN-8/APX & RT-24/APX-2, REB, TS-1871/FPN, AN/SPA-1, TS-100/AP, ARC-50(V). Also want military electronics of all types pre-WWII to present. Wm. Van Lennep, PO Box 211, Pepperell, MA 01463. (508) 433-6031

**RENEW NOW  
AND SAVE TWO WAYS!**

1. **SAVE \$:** Rates go up August 1. If your subscription expires within the next twelve months, extend your subscription now for up to two years at the current rates.
2. **BONUS ISSUE:** If you renew before the end of the month shown on your mailing label (your expiration month), you will receive an extra month on your subscription: 13 months instead of 12; 26 months instead of 24 on a 2-year renewal.

**WANTED:** Reward: \$300 paid for the procurement of 1 clean working Philco 90 cathedral. Jahan L. Acciavatti, PO Box 231, Southborough, MA 01772. (508) 476-3229

**MESSAGE:** Historic Stone Tavern, 121 South Main, Poland, Ohio, opens radio room, buy/sell/trade. Duane Kopchak, PO Box 5212, Poland, OH 44514

**WANTED:** Private collector paying these top prices for mint examples: Zenith 600 series black Trans-Oceanics – \$250. 44BX and 77D mikes, up to \$1200. Also, looking for original Zenith literature from 1930's, Hallicrafters SR76 transceiver (1952), Donald Duck radios. R. L. Winslow, W2DAP, PO Box 192, Chatham, NY 12037. (518) 392-2633



**WAVES**  
ANTIQUES  
EARLY RADIOS  
&  
PHONOGRAPHS  
78 RECORDS  
BOUGHT • SOLD  
OPEN 12 6  
CLOSED SUN & MON.

32 EAST 131<sup>st</sup> ST. NEW YORK N. Y. 10003 212 989-9284  
PROPRIETORS Bruce and Charlotte Mager

**THIS MONTH'S SPECIALS:**

1. Radio Rex, no dog ..... \$20
2. Scott All Wave in carved cabinet ..... 800
3. Cathedral-shaped Avon bottle ..... 20
4. "Disaster" radio, new in box ..... 65
5. Rider's Vols. 20 & 21, new in box .... 35/ea.
6. "Get it better with a Grebe,"  
only one side of crate ..... 45
7. Microphone-shaped Avon bottle,  
with call letters "KAVN" ..... 20

**SEE NEXT MONTH'S LIST FOR MORE!**



**RNI Surplus Specials This Month:  
Collectors!**

- Mercury high intensity arc lamps  
Rare and unusual ..... \$30.00/each
- Navy 12" Signaling searchlights  
All bronze and stainless .. \$50.00/each
- VTVM's ..... \$20.00
- Frequency counters  
Old digital types ..... \$25.00
- Wanted: WE 600A mic in the brass case

Al Weiner, RNI Surplus  
Monticello, ME 04760 207-538-9538



## CLASSIFIED ADVERTISEMENTS

**WANTED:** Documentation for Dumont 30" TV Model RA109 B1, not the same as the RA-109A in Sams #156 or #545. Punch card set for Hickock KS 15874 cardmatic tube tester. John Folsom, 450 Golden Dove Ave. NE, Palm Bay, FL 32907. (407) 725-3462, collect evenings

**FOR SALE:** Large console radios, late 30's, preffer Scott Midwest, Zenith, AK. John Maddox, N6SET, 1660 Hollister St., San Diego, CA 92154. (619) 424-8443

**WANTED:** Neon clocks and signs related to radio, TV and Art Deco radios. Richard Trautwein, 437 Dawson St. Sault Ste. Marie, MI 49783

**FREE - 20 WORD AD EACH MONTH**  
To get your free 20 words,  
Include your SUB# with your Ad.  
Additional words are 10¢ each.  
Read inside back cover for details.  
**MANY THANKS!!!!**

**WANTED:** R126 (200 ohm) and R130 (8500 ohm) for TV-7/U. Elmer H. Melvin, 5050 New Market Rd., Hillsboro, OH 45133. (513) 288-2424

**FOR SALE:** Zenith Trans-Oceanic, Model H500, with original paper work - \$80. Bernard Hassab, 2725 Mall Dr., Sarasota, FL 34231. (813) 924-5191

**WANTED:** Small metal Arvins and Silvertones, especially 2-tube models. Have sets to trade. Dan Howard, 2940 S.E. 118th Ave., Portland, OR 97266-1602. (503) 761-7799

## CLASSIFIED ADVERTISEMENTS

**WANTED:** Philco 37-116 console in good condition. Will pay well for condition, i.e. no rust. Will pick up. John C. Baldwin, 305 Dairy Rd., Kahului, HI 96732. (808) 572-6094

**FOR SALE:** Galena crystal detector, precision made, inclosed - \$25. L. Gardner, 458 Two Mile Creek Rd., Tonawanda, NY 14150. (716) 873-0447

**WANTED:** Several N.O.S. 4-pin 6v standard vibrators. Need the following foreign tubes (N.O.S.): ECF83, ECL113, EF43, EL42, HN309. Also any foreign 6 and 12v vibrators, 5 & 7 pin. Wilford Wilkes, PO Box 103, Brisbin, PA 16620. (814) 378-8526

**FOR SALE:** Make offer. Rider Television Manual, Vols. 1-26. Rider Perpetual Trouble Shooter, 1-12. Sams Photofacts, over 1500 issues. Phone or write: Mike Fenton, 4 Cedarlake, Irvine, CA 92714. (714) 786-5997

**WANTED:** 1949 Admiral TV knobs #33C53-T1, T2, T3, T4. Sams sets #69, 100, 638. Tuning eye EM34/6CD7. Clock crystal for 1966 Zenith clock-radio Model X179G. Latest roll chart, roll book for Jackson tube tester #658A. J. DeLasse, 17 Seldin Ave., Richmond, NY 10314. (718) 981-1218, 761-6559

**FOR SALE:** Hammarlund Comet Pro, coils, manual, mint - \$200. '38 HRO Sr. 5 coils, manual - \$175. **WANTED:** Clapp-Eastham Hz. Meissner coils. Stu Mount, K20A, 35 Grand St., Highland, NY 12528. (914) 691-7957

## The Antique Radio Club Of Illinois And The Antique Wireless Association RADIOFEST '89 - August 10th, 11th, & 12th

The Holiday Inn Holidome  
& Convention Center  
345 River Road  
Elgin, Illinois 60120  
Call (312) 695-5000

- Auction
- Three-Day Flea Market
- Special Exhibit: Zenith
- Hospitality Suite
- Afternoon Presentations
- Friday Evening Awards Banquet



- Donation Auction
- Old Equipment Contest
- Ralph Muchow's Fabulous Radio Museum

Info: Carl Knipfel, Rt. 3-Veterans Rd., Morton, IL 61550, (309) 266-9440

## CLASSIFIED ADVERTISEMENTS

**WANTED:** Top blue cover for 1927 Neutrowound radio, good condition. **FOR SALE:** Two AK radios Models 55-40, good condition. RCA Model 60. Russell Schoen, E7340 Nietzsche Rd., Clintonville, WI 54929. (715) 823-6744

**FOR SALE:** Sams Photofacts - \$2 ea. ppd. (300 to 1200). List numbers, please. Many other books, SASE. J. J. Papovich, 53B Magnolia Ave., Pitman, NJ 08071. (609) 582-8279

**WANTED:** Modern Electrics: 4, 1908; 10, 1911; 7, 8, 1912; 5, 8, 9, 10, 1913. Buy or trade other issues. Send prices or trade needs. Marc Gottlieb, PO Box 1112, South San Francisco, CA 94083-1112

**FOR SALE:** 50 phonograph steel needle package, Bagshaw's Brilliantone, 12 packages - \$10. SASE. Bill Downs, 4805 Sullivan, Wichita, KS 67204

**WANTED:** Hallicrafters HT-17 cabinet or junker with restorable cabinet, any coils for above. John Kelly, N3GVF, 19133 Stedwick Dr., Gaithersburg, MD 20879. (301) 977-9319, (w)

**FOR SALE:** Tested good, used octal and miniature tubes - \$150/lot. Also older tubes. SASE. Jack Harwood, W6DJZ, 7702 Garboso Pl., Carlsbad, CA 92009. (619) 436-1689

**WANTED:** For parts and restoration, wooden table radios. Send description, condition and price. Ray Kushnir, 2213 Alpine Dr., Colorado Springs, CO 80909

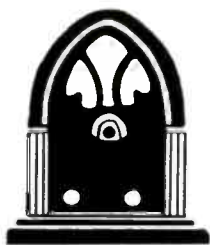

*Craig L. Graybar*  
*Furniture Works Ltd.*

(414) 258-2390

SPECIALISTS IN RESTORING, REPAIRING AND REPRODUCING CLASSIC STYLED ANTIQUE TV, RADIO & PHONOGRAPH CABINETS

Send us your plans or your project via UPS for immediate price quotes

1535 S. 84th St.  
West Allis, WI 53214

*"We Turn Ideas Into Heirlooms"*

## CLASSIFIED ADVERTISEMENTS

**FOR SALE:** Push button call letter insert reproductions. 12 call letters of your choice - \$10 ppd. Send sample or specifications for match. 60 call letters of our choice in five common sizes - \$10 ppd. Duane Kopchak, PO Box 5212, Poland, OH 44514. (314) 831-9482

**HAVE YOU MOVED? ARE YOU MOVING?  
PLEASE NOTIFY US A.S.A.P.  
SEND US YOUR...  
OLD ADDRESS  
NEW ADDRESS and  
SUB #  
MANY THANKS!!!!**

**WANTED:** 1947 Zenith 6-tube AC/DC portable radio. Zenith Number 6G004Y. DeWayne Nall, PO Box 555, Cleburne, TX 76033. (817) 641-5148

**FOR SALE:** Zenith tombstone 6V27 farm radio (F.O.S., p. 192) - \$85. ASI ohmeter 0 to 1000 ohms - \$3. Sprague Kwik-test capacitor checker - \$15. RCA 3" scope W033, works - \$35. Sencore transistor checker TF166 - \$20. RCA card type tube tester WT110A - \$35. 18" magnafilter with brackets - \$45. Stromberg-Carlson AM-FM bakelite radio 112021 - \$40. 45 record player - \$20. Portable wind-up phonograph, cabinet bad - \$15. Add UPS charges. Clark Trissell, 3530 Pawnee, Lincoln, NE 68506. (402) 488-5263

**WANTED:** Gong Set converter Model 2 - 30. This converter is for shortwave reception with a common broadcast car receiver. Carlos R. Mercado, KP4GX, PO Box 4204-Valle Arriba Sta., Carolina, PR 00628

## COMMUNICATIONS RECEIVERS

THE VACUUM TUBE ERA:  
50 GLORIOUS YEARS  
1932-1981

NEW SECOND PRINTING - REVISED  
PRINTED ON COATED PAPER, IMPROVED  
PHOTO REPRODUCTION, NEW PHOTOS,  
CORRECTIONS, PERFECT BOUND, GLOSSY  
COVER, SAME OLD PRICE.

- Book covers industry history
- Specs on 700 receivers
- 51 company histories
- 112 photos
- For collectors, connoisseurs and admirers of receivers

\$14.95 plus \$2 P/S, SASE for details.

RSM Communications  
Box 218-A, Norwood, MA 02062

## CLASSIFIED ADVERTISEMENTS

**WANTED:** Manual or photocopy for Waveforms Model 512 oscillator & General Radio 740-B capacitance bridge. Alan Kriss, 1872 Portsmouth Way, Union, NJ 07083. (201) 688-2092

**FOR SALE:** Lamp collectors. Single loop, not hairpin, carbon filament lamps will operate on 40 thru 110 volts AC or DC from a soft yellow glow thru bright incandescence. Price each - \$15. Studio illumination lamps for scanning disk TV broadcasting 35 volt 500 watts each, 4 in series for 125 volt wall socket power - \$15 ea. plus UPS quantity limited. Phil Weingarten, 67-61 Alderton St., Rego Park, NY 11374. (718) 896-3545

**WANTED:** Philco Farm set 37-623 or 624. Clapp-Eastham Hz amplifier. Crosley 4-29 portable. Zenith 700 Trans-Oceanic. Charles W. Rhodes, 64 South River Rd., Edgewater, MD 21037. (301) 266-3691

**FOR SALE:** Zenith Trans-Oceanic Model 6T4 - \$100. Crosley 51 - \$35. RTL Model L tube checker - \$10. Ron Follmar, 1409 Willis, Alvin, TX 77511. (713) 331-1074

**WANTED:** Scott World's Record radios, etc., manufactured by the Scott Transformer Co., 1925-30. E. H. Scott radios, 1930-40's, any parts and literature. **FOR TRADE:** FADA 1000, Emerson Aristocrat (onyx), Garod Commander and Bendix 526C Catalins, Arvin Hopalong Cassidy, Charlie McCarthy, RCA Mexican 40X53, Philco 90 and 70 cathedrals. (For desired Scott items only.) Jack Sacra, 1720 Solomon Rd., Charlottesville, VA 22901. (804) 293-9985

## CLASSIFIED ADVERTISEMENTS

**WANTED:** Type F field coil speaker for AK 47, also want AM-SW wood table radios, square RCA push buttons and round Detrola push buttons. W. Kimple, 3015 Kelsey Creek Rd., Spartanburg, SC 29302. (803) 585-6465

**FOR SALE:** America's best monthly sales list of vintage radios, TV's and other related items for sale. Send \$1.50 (stamps OK) to: Jim Clark Enterprises, 1292 Starboard, Okemos, MI 48864

**WANTED:** Radio Shack mono amplifiers. Prefer Model #AF-12, AF-15, #R33-303. Also Heath amplifier Model #WA-A1. Robert S. Langer, 277 Main St., Marlboro, MA 01752. (508) 480-0113

**HELP:** I need one original knob for the little Jewel, or two of something that will fit; also need sides. Buying little Jewels. Jim Montague, 921 S. Cuba, Spokane, WA 99202

**FOR SALE:** Sears Roebuck, Silvertone 5-tube model, 4500A black bakelite, metal bottom, with label, heavy, fine - \$45, UPS paid. General Model 502 brown bakelite, half moon speaker grille, left end rounded, fine - \$45, UPS paid. Arvin Model 622 brown bakelite, top rounded, fine - \$45, UPS paid. Edison Mabry, 715 W. Longview, Mansfield, OH 44906-2129. (419) 526-1175

**WANTED:** Zenith 1926 Chinese console radio, and other oriental-style radios in excellent condition. Gerald Schneider, 8750 Georgia Ave., #1410-B, Silver Spring, MD 20910. (301) 565-2840

# ARBE\* - III

\*

## ANTIQUE RADIO BATTERY ELIMINATOR



- FEATURING -

- \* 8 DIFFERENT 'B' AND 'C' VOLTAGES.
- \* ADJUSTABLE HIGH CURRENT 'A' SUPPLY.
- \* SHORT CIRCUIT PROTECTION.
- \* ALL OUTPUTS ELECTRICALLY ISOLATED.
- \* 5 YEAR WARRANTY.

CALL OR WRITE FOR COMPLETE DATA SHEET.

ANTIQUE RADIOS  
P.O. BOX 6352  
JACKSON, MICHIGAN 49204  
517-750-4992 AFTER 7:00PM EST.  
AND WEEKENDS.



**CLASSIFIED ADVERTISEMENTS**

**WANTED:** Oil and mercury vacuum pumps and gauges for radio tube manufacturing and science. Ed Graper, 5960 Mandarin Ave., Goleta, CA 93117. (805) 964-7117

**CLASSIFIED AD NOTICE**

Please check your ads carefully before sending them in. We cannot make changes to ads once they are received.

**FOR SALE:** Tabletop sets: Bendix 2-band; Crosley #25AW; Emerson ED154; RCA Q33; Zenith 3-band. Battery sets: AK 20, 35; Grebe MU-1; Philco 511; RCA-RAD III, RAD 17, RAD 18; Stromberg-Carlson 601; Kolster 6D. Horns: RCA UZ-1325; Thorophone S-5; Operadio; All Type E; RCA 100A; Teletone; Sonochorde. Books: Radio Physics Course by Ghiradi; Signal Corps, Principle of Radio Communications; Hawkins Guide #8! SASE please. P. Currie, PO Box 738, Chuluota, FL 32766-0738

**WANTED:** Prewar factory automobile radios, control heads, antennas, footpedals. Postwar signal-seekers, automobile phonographs. Dan Schulz, PO Box 892, Crystal Beach, FL 34681. (813) 785-8733

**FOR SALE:** Tele-Vision clock looks like 1950 TV - \$30. Warren Burdine, 1606 Idylwild Dr., Prescott, AZ 86301. (602) 778-1608

**WANTED:** Story & Clark radios, ads, information. Terry Browne, 46 Birnamwood Dr., Burnsville, MN 55337

**CLASSIFIED ADVERTISEMENTS**

**WANTED:** Instruction manuals for Eico 460 oscilloscope, Eico 950B resistance capacitance comparator bridge, Eico 1120 capacitance substitution box, Eico 1100 RTMA resistance box. Early transistor radios, foreign sets. Rider's 5 thru 11 and 14-20. Rider's Master Index Vol. 15-20. **FOR SALE:** Trans-Oceanic 8G005BTZ1, works - \$50. Two tube testers, work - \$15 ea. plus UPS. R. King, 3017 Orwell St., Lincoln, NE 68516. (402) 423-9621, mornings

**FOR SALE:** Technical books: Sound Research of Acoustics by John Tyndale, hc, f, 1877, illus. - \$50. Electricity and Magnetism by S. D. Thompson, hc, f, illus. - \$45. History/Theory/Practice of Electric Telegraph 1866 by G. Prescott, hc, f, illus. - \$75. Radio Telephony by W. C. Ballard, hc, e, 1923, illus. - \$35. Study Course Electricity by L. L. Cooke Inst., 22 lessons, hc, e, illus. - \$45. Radio Theory & Operation by M. Loomis, hc, f, 1928, illus. - \$75. J. J. Papovich, 53B Magnolia Ave., Pitman, NJ 08071. (609) 582-8279

**WANTED:** Collins KWM-1, 516F-1, 312B-1 and 312B-2. Masahiro Nada, 6-9-3 Fujiwaradai-Kitamachi Kita, Kobe 651-13, Japan

**FOR SALE:** New and used tubes, electrolytic capacitors, cone speakers. Send SASE for lists. C. Elmer Nelson, 11 S. Church St., Princeton, IL 61356

**WANTED:** Audio xfmr. for Crosley 51. Antenna choke coil for AK 30. **FOR SALE:** AK 70 chassis. Carl Anderson, RFD 1, PO Box 663, Hampden, ME 04444

**TUBES WANTED**

We need the following tubes to replenish our stock. You may ship your tubes to us by UPS or Parcel Post. We'll mail our check upon receipt and testing of tubes. We pay prices shown plus shipping charges.

**USED GLOBE OR BALLOON SHAPE TUBES - ALL MUST TEST GOOD**

WD-11* .....	\$25.00	UV-199* .....	\$10.00	226 .....	\$3.50
112A .....	5.00	UX-199* .....	9.00	245 .....	10.00
171A .....	4.50	200A .....	5.00	250 .....	20.00
* Tubular		210 .....	8.00	280 .....	5.50

**MODERN (ST) STYLE TYPES - NEW ONLY**

01A .....	\$5.50	6B5 .....	\$4.50	50 .....	\$25.00
0A4G .....	6.00	18 .....	3.00	71A .....	5.00
2B6 .....	5.50	42 .....	3.50	80 .....	3.00
6A3 .....	8.00	45 .....	15.00	83 .....	4.50

We buy all types of receiving tubes. Send us your list for our bid. Also looking for 4, 5, & 6 pin tube sockets.

**ANTIQUE ELECTRONIC SUPPLY**

688 W. First St., Tempe, Arizona 85281, 602/894-9503

## CLASSIFIED ADVERTISEMENTS

**FOR SALE:** Philco Model 50 cathedral - \$125. Philco Model 37 battery - \$50. Emerson U5A, ivory - \$150. Bryan Laughlin, 3450 Chili Ave., Rochester, NY 14624. (716) 889-2341

**WANTED:** For Canadian RCA Victor Model A22. Set 2" diameter knobs. Ernest D. M. Yeaw, RR#3, Tatamagouche, Nova Scotia, Canada B0K 1V0. (902) 657-2554

**FOR SALE:** 5 unboxed WE-216A. 7 boxed GE GL-316A. Best offer. Howard D. Hinkle, 1226 Viewmont Dr., Schenectady, NY 12309. (518) 372-2512

### HAS YOUR SUBSCRIPTION

### EXPIRED?

It has if your mailing label reads  
"EXP= JULY89" or earlier.  
**Renew now!**

*BONUS: Renew before the end of  
your "EXP" month and receive 13  
issues per year instead of 12!*

Renewal rates are:

\$19.00 for Second-Class Mailing

\$28.00 for First-Class Mailing

(Two-year renewals are twice above rates.)

**FOR SALE:** 700 used untested miniature tubes, mostly from 1950's and 1960's - \$45/all plus postage. Herman Fothe, 10 Jackson St., Sloatsburg, NY 10974. (914) 753-2090

**WANTED:** 1925 Montgomery Ward Airline Radio catalog, photocopy okay. Any information, etc. on Klar-o-dyne, logo "Strong as a moose, clear as a bell." Dennis Hilberg, 804 Ravine St., Decorah, IA 52101

**FOR SALE:** SE-1075 Navy 1KW 500 cycle quenched spark transmitter, mfg. by International Radio Telegraph, Pa., ca. 1918. Power control panel and four large meters, exc. condition - \$365. Craig Smith, 1935 1st Ave. S., St. Petersburg, FL 33712. (813) 822-7592

## RADIOPHILE

Vintage Radios

- Bought
- Sold
- Serviced

Brooklyn, NY



718-625-7254

Full One Year Warranty On All Our Radios

## CLASSIFIED ADVERTISEMENTS

**FOR TRADE:** AK 10A breadboard. Crosley neon sign, works. Rogers R-250 w/orig. tubes. Air King camera radio. **WANTED:** Federal Jr. crystal set in good cond. Radiola RS. Concert. Radiola 24. Medical Quack machines, pre-1930. David Moore, 3213 Regal Oaks, Pearland, TX 77581. (713) 485-1705

**FOR SALE:** Sky Buddy shortwave set - \$25. Harmon Kardon Award Series tuner & amp - \$90. Weston panel meter, seven inches, steel case - \$20. Wallensack portable recorder - \$20. Akai M7 stereo recorder overhauled - \$70. General Radio signal generator WWII - \$90. Triumph oscilloscope - \$40. WWII Sprague capacitor bridge - \$20. Jackson oscilloscope with manual, good condition - \$60. Rubicon Wheatstone bridge - \$20. Box of 600v ceramic caps. - \$10. RCA signal generator prewar - \$40. ATD auto radio power supply - \$25. Meter at Work by Rider, with jacket - \$10. Following are prewar table models, Packard Bell gold and brown bakelite - \$25. Airline portable, excellent condition - \$30. Philco Transistone portable - \$20. Small Silvertone bakelite - \$20. Motorola portable in metal cabinet - \$20. S. Goldhor, 1014B St., Hayward, CA 94541. (415) 537-5149, days

**WANTED:** Radiola AR1375. Westinghouse RA or RE. Chapman's To the Rescue and Aiding The Snowbound. Brian Roberts, 3068 N. Evergreen Rd., Pittsburgh, PA 15237. (412) 931-4646

**FOR SALE/TRADE:** What do you have? Farnsworth, GE, Motorola, Zenith radios. Levy, 8 Waterloo, Morris Plains, NJ 07950. (201) 285-0233

## ALL A.R.C. BACK ISSUES NOW AVAILABLE

ORIGINALS or REPRINTS (marked \*) available for:

Mar. 85 - Vol. 2, No. 3	Dec. 86 - Vol. 3, No. 12*
Jul. 85 - Vol. 2, No. 7	Jan. 87 - Vol. 4, No. 1*
Oct. 86 - Vol. 3, No. 10*	Feb. 87 - Vol. 4, No. 2
Nov. 86 - Vol. 3, No. 11*	through Current Issue

\* Reprint (same quality as original)

Photocopies will be furnished for all other issues, and for the 1985 issues when originals are no longer available.

Note: Publication of A.R.C. began in '84, which had only five issues. 1985, '86, '87, and '88 had twelve issues each.

\$2.50 each - postpaid to  
U.S., Canada and Mexico

Other foreign orders - \$4.00 each

Send Order with Payment to:

ANTIQUÉ RADIO CLASSIFIED  
P.O. BOX 2, CARLISLE, MA 01741

## CLASSIFIED ADVERTISEMENTS

**FOR SALE:** Grundig satellite 650 large portable communications receiver, 15-watt audio, digital readout, motorized preselector, less than 1 year old, cost over \$1,000, will except best offer over \$575. Wayne Dimmler, 13 Midtown Rd., Carle Place, NY 11514. (516) 747-1325, after 6 pm EDT

**WANTED:** Spherical audions, audiotrons, pliotrons and other early tubes – e.g. from DeForest, Singer, Schicklering, Weagant and others, any size, any condition for my collection. Will pay or exchange. Will be at AWA meeting at Canandaigua in October. Udo Radtke, Im Fuchtei 143, D-4830 Gütersloh 1, West Germany. Phone: 011/49/5241/51921

### CLASSIFIED AD DEADLINES

Jul. 10 for Aug. 1989 Issue

Aug. 10 for Sep. 1989 Issue

Sep. 10 for Oct. 1989 Issue

**WANTED:** Collins 51S-1, Hallicrafters SX-115, Hammarlund HQ-180A, ICOM IC-R71A, TMC GPR-90 receivers. Excellent only. Charlie Bautsch, 18003 Vintage Wood Ln., Spring, TX 77379. (713) 320-0317

**FOR SALE:** National FB-7, PS, and 3 sets of coils, 2.5v model – \$195. Barrows, 15121 41st Ave. SE, Bothell, WA 98012. (206) 337-4880

**WANTED:** Zenith Trans-Oceanic G500 manual, antenna. Jim Riff, 81 N. Ela Rd., Barrington, IL 60010. (312) 576-4897

## HELP ARCA KEEP BILL & JANE BUSY

The Antique Radio Club of America (ARCA) 1989 Convention is over; 300+ collectors and spouses had a great time in Mystic, Ct. We are looking forward to Cincinnati, Ohio, in June 1990!

Before the convention, Bill and Jane were busy mailing convention information and our bulletin (*The Gazette*, 24-30 pages, quarterly). Now, since they are retired, they might have extra time on their hands. Help us keep them busy.

Please write Bill & Jane for information on our nearly 1000-member club. Letters enclosing the \$12.00 annual dues are especially nice to receive.

So, do your part – write:



Bill & Jane Denk  
ARCA  
81 Steeplechase Road  
Devon, PA 19333  
(Please enclose a SASE)

## CLASSIFIED ADVERTISEMENTS

**WANTED:** Hard rubber panel 10 x 14 x 1/4 or larger. Kennedy XI, top price paid. Gordon Wilson, 11108-50 Ave., Edmonton, Alberta, Canada T6H 0H9

**FOR SALE:** Heathkit SB-101, power supply, mike, watt meter, SWR meter – \$225. Bob, KC5BN, PO Box 2166, Canyon Lake, TX 78130. (512) 899-2760

**WANTED:** Fairchild 255 or 255A tube amplifier. Brociner 30C tube preamplifier and 30A tube amplifier. Wanted for collection. Richard Sharisky, PO Box 521, Belmont, MA 02178

**FOR SALE:** Philco Transitone bakelite – \$25. RCA Model 9X561 – \$25. Windsor Replica cathedral – \$20. Dynamic Model 85 tube tester – \$20. All plus UPS. **WANTED:** Zenith 7G605 Trans-Oceanic sailboat. Gary Pirkkala, 2306 Audley Ave., New Castle, PA 16105

**WANTED:** The following Scott Radios: World's Record Super 8 with engraved panel, World's Record Super 9 with engraved panel, Shield Grid 9B (DC set), World's Record AC9, Symphony (AC or DC version), All Wave 13, All Wave 19, All Wave 27 (also known as Imperial Special or Baby Quaranta – see F.O.S. page 167, lower right corner), 40 or 48 tube Quaranta (will have 2 or 3 cabinets), AM/FM Masterpiece (22 tubes and 2 tuning eyes), Telematic, any Scott in Napier console (main chassis sits exposed on top of cabinet housing speaker and power supply). I will purchase these items outright, or I have many good items to trade. Jim Clark, The Scott Collector, 1292 Starboard, Okemos, MI 48864. Or call collect, (517) 349-2249

**FOR SALE:** Sams Auto Radio Books AR-14 through AR-167, like new, 153 books total, asking – \$1 ea. Not interested in selling part of them. The batch for \$150. Carl Hawkins Jr., PO Box 1010, Live Oak, FL 32060. (904) 362-2489

**WANTED:** Sound track parts for Victor projector Model 40. Exciter amp. GE T-8. Photocell: Cetron CE-36-HC. Rodney Holland, Rt. 9, PO Box 100, Mena, AR 71953. (501) 394-3490

## WANTED

### Chicago Symphony Orchestra Broadcasts, pre-1965

Radio Acetate Cut Discs

Transcription Discs

TV appearance,

any format

Films

Steven Smolian

8807 Postoak Road

Potomac, Md. 20854

(800) 228-7833



**CLASSIFIED ADVERTISEMENTS**

**WANTED:** 1938 Arvin Model 40 2-tube, metal case radio set. Kevin Silva, 5362 N. Kercheval Dr., Indianapolis, IN 46226. (317) 542-1023

**FOR SALE:** WE 7A and 518W speaker, no horn - \$150 or BO. N.I.B. 201A's, WD, UX, UV, SASE for list. Nice Radiola III - \$75. Sams series: Auto radio, CB, tape, TSR, early binders, best offer.

**WANTED:** Clean original Philco cabinets 50, 60, 89, 90, 91. Zenith 6D311 chassis only. Jim Mikolajczak, 56 Cushing Rd., Webster, MA 01570. (508) 943-6310

**WANTED:** Books on high fidelity, sound reproduction, acoustics, speakers, etc. Heathkit W6 amps. Barry Nadel, PO Box 29303, San Francisco, CA 94129. (415) 346-3825

**NEW PHONE NUMBER FOR ANTIQUE RADIO CLASSIFIED**  
(508) 371-0512

**Best time to call is week days:**  
9 am to 5 pm Eastern Time

(Please no classified ads by phone. Thanks!)

**WANTED:** Schematic for Kent table radio Model 52P. A. J. Long, 2653 Post Rd. Twinsburg, OH 44087. (216) 425-9662

**FOR TRADE:** British WWI Mark III crystal set. Want IP-501 or similar unit. R. Brewster, 454 Diablo Dr., Pittsburgh, PA 15241. (412) 833-4287

**WANTED:** AK 10 in excellent condition, un-restored. Michael Tasevoli, 10932 Battersea Ln., Columbia, MD 21044. (301) 992-4246

**CLASSIFIED ADVERTISEMENTS**

**FOR SALE:** French crystal set with slide coil tuner - \$70. Mantola portable from the 30's - \$25. Signal tele. practice key - \$18. Home brew slide coil, early - \$70. R. Burick, #6 Whetstone Dr., Gaithersburg, MD 20877. (301) 977-6745 or 869-8722

**WANTED:** Rider Trouble Shooters manuals, 4 and 5. Please state price and shipping cost. Herbert Kligerman, 710 S. Armel Dr., Covina, CA 91723. (818) 331-5558

**HELP:** Manual/schematic wanted for Sprague Tel-Ohmike Model 16 cap. tester. R. D. Walter, 3400 42nd Ave. SW, Seattle, WA 98116. (206) 271-9638

**WANTED:** Carbon-X liquid carbon once made by GC used for recoating worn carbon controls. George Bittner, 147 Longvue Dr., Pittsburgh, PA 15237

**FOR SALE:** Heathkit SB-101 power supply, mike, wattmeter S.W.R. meter - \$225. Bob Eisenman, KC5BN, PO Box 2166, Canyon Lake, TX 78130. (512) 899-2760

**WANTED:** Old household electrical switches, light bulbs, sockets, meters, plugs, 16-18 gauge fabric-covered wire. Young, 4200 Sunshine, Miami, FL 33133

**FOR SALE:** 1939 Johnson five-pin HI-Q coil forms - \$4 ea. **WANTED:** BC-976 Army radio. Wayne Steiner, NØTE, Rt. 1, PO Box 114, Burlington, KS 66839. (316) 364-5353

**WANTED**

**ELECTRON TUBES - ST SHAPE**

50, ST19, large size .....	\$30	80, ST14 .....	\$4
45, ST14 .....	15	2A3, VT-52, VT-62 .....	6

**ANTIQUe GLOBAL SHAPE TUBES**

37/237 .....	5	145/245/345 .....	15
250,350,450 .....	30	210/310 .....	10
80/280/380 .....	10	UV202, Tip, Brass Base .....	25
UV201, Tip, Brass Base .....	12	UV216, Tip, Brass Base .....	20

**TRANSMITTING TUBES**

211/VT-4C/RS237 .....	15	845/845W .....	30
-----------------------	----	----------------	----

**WESTERN ELECTRIC TUBES**

101D, F, G/102D, F, G, E/216A/104D/D86326/D86327 Tennis Ball .....	20	VT2/205B .....	35
VT1/203B .....	20	101D, F/102D, F/104D, ST .....	6
205D, E, Tennis Ball .....	40	205F, ST .....	15
244A .....	6	262A/262B .....	10
252A .....	100	274A/274B .....	30
271A .....	30	300A/300B .....	80
275A .....	30	339A .....	20
348A .....	10	349A .....	6
350B .....	30	211D/211E .....	40
242C/261A/276A .....	25	284D .....	70
212D/212E .....	70		

**TRIAL ELECTRIC PRODUCTS, INC.**

201 Common City Yotsuya, 4-13 Suga-Cho, Shinjuku-Ku, Tokyo 160 Japan

---

**CLASSIFIED ADVERTISEMENTS**

**WANTED:** Novelty crystal sets, by specialist collector. Please write to: Erwin Macho, Ambrosweg 17/A/8, A-1230 Vienna, Austria

**HELP:** I have a Leutz Seven Seas cabinet without a chassis and speaker. The chassis is a Model 7CS. If anyone can help me, I'd appreciate hearing from you. The chassis need not be in working order. Thanks. Brian Dunlop, 2715 Hanovertown Dr., Colorado Springs, CO 80919. (719) 531-7920

**WANTED:** 1949 Motorola VT73A 7" TV back control knobs, feet, mask, antennae and base, manual. R. N. Traynham, 504 W. Henderson St., Bozeman, MT 59715. (406) 586-7776

**FOR SALE/TRADE:** Tube tester, Hickock 600 - \$50. N.O.S. tubes: 1622/6L6M, 6679/12AT7 - \$3, \$10/4. Want 5881's. Jay Myers, 1010 Graybar Ln., Nashville, TN 37214. (615) 297-5886

**WANTED:** E. H. Scott and McMurdo sets, chassis, cabinets, literature, Tauscher sound boards. Mike Greene, 19113 Alpenglow Ln., Brookeville, MD 20833. (301) 774-3203

**FOR SALE:** Tubes, new and used - from \$1 up. Send SASE for list. Henry Nessler, 136-26 61 Rd., Flushing, NY 11367

**WANTED:** Theremin articles, recordings, schematics, programs, info, etc. RCA, Moog, Norlin theremins. Also Stanwyck LHO-2 TV coil (2) specs or equivalent. Also RCA 106 speaker. David McCormack, 613 9th Ave. #3, New York, NY 10036. (212) 757-3961

---

**CLASSIFIED ADVERTISEMENTS**

**WANTED:** Zenith 22H698 or 22H699. Will be at Elgin in August. Dennis W. Choinski, 1435 Oakes Rd. #5, Racine, WI 53406

**FOR SALE:** Photofacts and manuals. Send \$2 for purchase refundable numbers list and price sheet. Lee Morrison, PO Box 199, Stony Point, NC 28678

**Renew Now & Save!****Renew now before rates go up****PLUS****receive a bonus issue  
for renewing early!****See coupon in centerfold.**

**WANTED:** Capehart Series H extended control box, also Capehart sales brochures and info. Bill G. Davis, 800 Rosemount Rd., Oakland, CA 94610. (415) 834-5708

**WANTED:** Speaker cabinet to match Collins 75A-4. Mike O'Brien, 1031 E. University St., Springfield, MO 65807. (417) 887-0373

**FOR SALE:** Large selection of old radio tubes, used and N.O.S. Also TV tubes. SASE for price list. Jack Hofeld, 61 Trinidad Bend, Coronado, CA 92118

**WANTED:** Antennae coil or chassis RCA radio 1936 Model 10T or 10K Part No. 12879. Elmer Mueller, 9815 Surrey Ln., St. Louis, MO 63137



# WANTED

Old motors (pre-1910),  
other early gadgets  
(patent models, scientific,  
mechanical and  
technological artifacts),  
telegraph,  
adding machines, etc.

Peter Thomashow  
350 West 20th Street, #4F  
New York, NY 10011

Phone: (212) 989-0213

Fax: (212) 255-8630

## CLASSIFIED ADVERTISEMENTS

**WANTED:** 5459 ballast tube. 12+ tube 1945-1953 multiband table model radios. David Collins, 115 Chestnut St., Medina, NY 14103

**FOR SALE:** Dozen radios under \$50, assorted parts and magazines. Send SASE for list. P. Majewski, PO Box 92, Tamaqua, PA 18252

**MESSAGE:** Wanna eat your carpet and heave it, too? Free newsletter for people who've had it with carpeted audio salons. 25c stamp: Audio Carpetorium, 111-32 112th St., South Ozone Park, NY 11420-1026

**HELP:** Still need dial scale, pointer, and bezel for Philco 41-300 radio. Andy Czymbor, 3799 East Burt Rd., Burt, MI 48417. (517) 624-5185

**SEND ALL A.R.C. MAIL TO**  
Antique Radio Classified  
P.O. Box 2, Carlisle, MA 01741

**WANTED:** TV stand for RCA 8TS30, wood only.

**FOR SALE:** Sams #51 to 60 in binder - \$15. Schematics 1930-1960 - \$2 & SASE. Tony & Lynn DeMara, 40231 Day, Mt. Clemens, MI 48044-2535

**FOR SALE:** Philco 37-602. Zenith K725. Transistone TP-4. Echophone receiver. Radiola 61-8. Tubes - 75c ea. Joseph Zambri, RD4, PO Box 216, Towanda, PA 18848. (717) 265-4825

**WANTED:** AWA Review Vol. 1 and 2. R. Chenez, 47 Lake St., Apt. A605, Gardner, MA 01440

**FOR SALE:** Catalin and bakelite radios. SASE for list. David Brenner, 71 Burdette Rd., Atlanta, GA 30327

**WANTED:** Used audio components and Ampex tape decks. **FOR SALE:** Philco 610 tombstone. Ron Smiley, 217 Oakmont, Nicholasville, KY 40356

**WANTED:** Collector wishes to purchase E. H. Scott sets, parts and literature. Jack Sacra, 1720 Solomon Rd., Charlottesville, VA 22901. (804) 293-9985

# TELEGRAPH

All Instruments

WANTED



## REINKE & SONS

5301 Neville Ct., Alexandria, Va., 22310

(703) 971-4095

## CLASSIFIED ADVERTISEMENTS

**FOR SALE:** Zenith Trans-Oceanics and small Hallicrafters in good working condition. Repaired, nice RCA 910KG - \$175, pick up only for RCA. New and used tubes from 25c. New 450v and 600v American-made capacitors, many misc. parts for chassis repair. Wooden knobs, no specific makes for half moon shafts. List available from: Sue Coulter, 4200 Prince St., Bakersfield, CA 93301

**WANTED:** The New England Antique Radio Club wants you! Don't miss our big Summer Swap & Sell Meet and Auction Saturday July 22, Resurrection Center, Nashua, N.H., 8 am to 12 noon - Swap & Sell Meet and Radio Contests. 1 pm to 5 pm - Radio Auction. Be there for a full day of radio excitement! For all the details and auction confirmation info, call or write: NEARC, 422 Day St., Manchester, NH 03104. (603) 623-8996

**FOR SALE/TRADE:** Crosley Repwood radio Model 54, complete, very good condition - \$150. Aircraft radio T-18, ARC-5, very good condition - \$40. Majestic service manual copies, most models 10 thru 460. Service Notes, copies, 1930-1935 GE radios and radio phonos Models 11-31 thru TMV-97-C. Diagrams, service notes, schematics, etc. for most transistor radios. Joseph Gambacini, 192 Division Ave., Shelton, CT 06484. (203) 734-0271

**WANTED:** Dial glass for Philco Model 38-7. speaker assembly including wires and plug in to chassis for Majestic Model 75 Queen Ann console. Preston D. Pipkin, 823 Patterson Rd., Durham, NC 27704. (919) 596-5911

### *Please Save this Want List!*

**WIRELESS SPECIALTY APPARATUS CO.**

Eaton Circuit Driver - Type Triode D  
(The 1-tube unit with a meter)

**ADAMS MORGAN CO.**

RA-6, RB-2 & Type THREE

**GREBE**

The following small units:

RORC (2-step Amp)

RORD (Det/Amp with external rheostats)

RORG & RORL (Det/Amp)

RORJ (2-step Amp)

KT-1 (Portable Receiver)

CR-7 (Internal-tube version)

As it may be a long time before I find some of the sets listed in these ads, remember to call me when you can part with yours. I am putting together a collection of early broadcast and wireless equipment and adding to it each month. I buy single sets or collections. Also: books, catalogs, manuals and other related documentation.

*Call and surprise me; make my day!*

John V. Terrey, 498 Cross Street  
Carlisle, MA 01741 - (508) 369-9770



## CLASSIFIED ADVERTISEMENTS

**WANTED:** Fender, Gibson, Gretsch, amplifiers, electric guitars. Top dollar paid. Photo helpful. Brock, PO Box 751, Cheyenne, WY 82003. (307) 634-5638

**HELP:** Does someone have a Brunswick BR60 with Radiola 813 in a sideboard style cabinet? Need info on cross-brace between legs. P. Burton, PO Box 912, Belchertown, MA 01007. (413) 323-5019

**WANTED:** Rider's Radio Manuals 19, 20 and 21. Power supplies for RCA Radiola 17 and AK 40. Dan King, 1230-B Juniper St., Gilroy, CA 95020. (408) 847-1345

**FOR SALE:** Two good WD-11 tubes - \$35. Radiola III with good but replacement audio transformer - \$60. Old, unused rheostat-pots; 750, 5K, 7.5K, 10K, 15K, 20K - \$15/4. My assortment of old, unused carbon resistors - \$15/150. Shipping extra. Include SASE with all correspondence, or I will not respond. Arthur Harrison, 501 Arbor Dr., Columbia, MO 65201. (314) 474-8729

**WANTED:** Tuning knob for Pepsi cooler radio made by RCA, Model No. PCR-5. Also need bottle opener for same, or borrow yours so I can get molds made for above. Can anybody help? Jimmy Downes, 607 East 12th Ave., Covington, LA 70433. (504) 893-7057

**FOR SALE:** 1932 RCA console radio, refurbished; tubes, cabinet, reception; excellent - \$350. Robert Garcia, 109 Stoughton St., Dorchester, MA 02125. (617) 825-1119

## WWII RADAR RELICS FOR SALE

### FREQUENCY METER BC-439

100-120 Mc designed by Fred M. Link. These units are organic (part of) the SCR-270 Radar - the so-called Pearl Harbor Radar. 115v 60~ operation, uses 6A8, 6J5, 6K7, 6V6, 6X5 tubes. 4000 KC crystal.

Condition varies from used repairable, to N.I.B. O.S. with spare tubes. Approx. 8"W x 18"H x 8"D.

Prices vary from \$25 for a fair used unit, to \$100 for a N.I.B. O.S. with spare tubes and checked out.

Included with all units, are Xerox copies of the pages in the SCR-270TM that apply. A real working WWII radar relic.

Profits from the sale of these units will be used for Radar Hist. Newsletter and for a radar memorial at Ft. Hancock, Sandy Hook, NJ



Don Helgeson  
POB 3087  
Skokie, IL 60076  
(312) 676-4604

## CLASSIFIED ADVERTISEMENTS

**WANTED:** Eveready radios & speakers. Old flashlights, old catalogs listing flashlights. Bulb lighted clocks. Bill Utley, 7616 Brookmill, Downey, CA 90241. (213) 861-6247

**FOR SALE:** Catalog One is still available, offering over three-thousand scarce titles on radio and television. Included are works by Hertz, Maxwell, Faraday, and others. Many titles on television are available celebrating the fiftieth anniversary of commercial television service in the United States. Thomas Dady, 2223 Sixth St., N.E., Minneapolis, MN 55418. (612) 789-5074

**WANTED:** Crosley Victory and Crosley colored radios. FADA #652. Red/yellow Garod tube radios. Belmont tube cathedral radios. Zenith Trans-Oceanic 7G605 plane or ship. J. Foskin, 6 Dorothy Pl., Groton, MA 01450

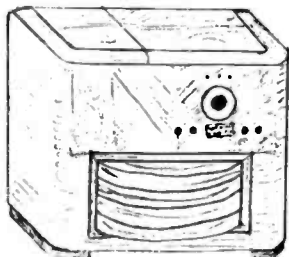

**WANTED:** Emerson BR224 console radio-phonograph. Robert Wiczkowicz, PO Box 86, Craryville, NY 12521. (518) 325-5307

**FOR SALE:** FADA 1000, maroon-butterscotch, excellent - \$800. Rider's 1 thru 14 - \$225. Dale Parsons, 5312 Koontz Dr., Cross Lanes, WV 25313. (304) 776-2180

**WANTED:** Dial and frame, also push-button frame for Philco 41-245. Please call collect. Ross Ellis, 206 Gregg Dr., Battle Creek, MI 49017. (616) 962-1514

**FOR SALE:** Seeborg LPCI - \$175 ea. Rowe MMI - \$150 ea. Pinball Allardin Castle - \$200. Others. Nick Fantetti, 9560 Miami Dr., Loveland, OH 45140. (513) 683-6093

**WANTED:** GE Model K64 and Stewart-Warner Model 102A chassis or junker needed. Doug McManus, 20 Deland Pk. A, Fairport, NY 14450. (716) 388-1275

**FOR SALE/TRADE:** FADA bullet chassis. Wooded prototype FADA Temple. Other Deco bakelites. Send SASE. Peter Thomashow, 350 W. 20th St., 4F, New York, NY 10011. (212) 989-0213

**WANTED:** AK 20 or 20C. Radiola 20. Rider's I, II, V. David Ponicki, 5239 Beverly, Kalamazoo, MI 49002. (616) 344-9717, mornings

## CLASSIFIED ADVERTISEMENTS

**WANTED:** Complete record changer for Zenith Model 10S690. Record changer Model 169BT80. Must work mechanically. Also wanted, new old stock Zenith red 78 rpm Cobra cartridge. Paul Mattei, 3055 Vera Cruz Ave. N, Crystal, MN 55422. (612) 593-3844

### NEW PHONE NUMBER FOR ANTIQUÉ RADIO CLASSIFIED (508) 371-0512

**Best time to call is week days:  
9 am to 5 pm Eastern Time**

(Please no classified ads by phone. Thanks!)

**WANTED:** Philco 89 chassis and speaker. Knobs for AK 318 and Philco Model 50 and 51. Marv Malak, 1534 So. 32nd St., Milwaukee, WI 53215. (414) 647-2722

**FOR SALE:** Orange Drop capacitors, new 1988 factory stock 600 VDC 10%: UF price ea.: .001 - 30¢, .0015 - 30¢, .002 - 30¢, .003 - 30¢, .004 - 30¢, .005 - 30¢, .006 - 40¢, .01 - 60¢, .015 - 60¢, .02 - 60¢, .03 - 60¢, .04 - 60¢, .05 - 75¢, .06 - 75¢, .1 - 75¢, .25 - \$1.25, .47 - \$2. Minimum order - \$50 plus \$2 shipping. John Folsom, 450 Golden Dove Ave. NE, Palm Bay, FL 32907. (407) 725-3462, collect evenings

**WANTED:** Chassis and speaker for Stewart-Warner R-100A console, no tubes also 4 knobs for RCA Victor 121 cathedral. D. Hall, 1500 Turner St., Old Hickory, TN 37138

**FOR SALE:** 199 tubes - \$12 ea. 201A's - \$6 ea. RCA portable car radio M-116 - \$65. DeForest D10 outside antenna crystal - \$750. Federal #60, excellent condition - \$1,250. Pat Cutini, 2114 Main Rd., Corfu, NY 14036. (716) 762-8270

**WANTED:** Schematic of Gong Set converter Model Super 12. Converter covers following bands: 20 meters, 11 meters, 15 meters, SW broadcast, 10 meters, 75 meters, 40 meters. Carlos R. Mercado, KP4GX, PO Box 4204-Valle Arriba Sta., Carolina, PR 00628

**FOR SALE:** TS-174/U freq. meter, 20-250 MHz, with AC supply - \$50. J. Stueber, 8920 Lexington Ave., Albuquerque, NM 87112

### - FOR SALE -

RCA AR-88 communication receiver in good working condition • Hallicrafters communication receiver SX-110 with speaker • Bendix 0526-E table model radio • Wilcox-Gay portable AM-SW-PA-Phonograph-Disc Recorder (above unique radio requires some restoration, mainly case cover)

We are moving house, so have to part with above at best prices.

Make offer/s to: Pete Henman,  
P.O. Box 6096, Beverly Hills, CA 90212

Or call leaving a message with your offer  
(213) 553-0491

## CLASSIFIED ADVERTISEMENTS

**WANTED:** Ten Tec QRP PM transceiver. Audio amp signalizer for PM transceiver. Collins transmitter and receiver, 32v, 75A4. Stancor Thorobred transformers, plate, modulation, filament, chokes. Howard 430, working or parts. Hallicrafters HT-6 transmitter, coils, working or parts. Russell Olmsted, K4UJZ, 608 W. Thompson Ln., Murfreesboro, TN 37129. (615) 893-5344

**FOR SALE:** AC and battery set cabinets made to order. 50 AC sets for sale. Crosley 4-29 cabinet w/ lid. Simpson multimeters - \$5-10. List. Bill McCuskey, PO Box 140, LaConner, WA 98257. (206) 466-4683

**WANTED:** Emerson TV Model 621, 622 or 628. Tuner or chassis and cabinet handle for Philco TV Model 48-2500. Knobs for Hallicrafters Model T54. Precision CR30 cathode ray tester. Sun screen for Philco Safari TV, black. RCA WR 70 marker adder. Knobs for Stewart-Warner TV 9100A. Front cover for metal cabinet National TV NC-TV7M. John Folsom, 450 Golden Dove Ave. NE, Palm Bay, FL 32907. (407) 725-3462, collect evenings

**FOR SALE/TRADE:** Rider's 1 to 10 except 2; 16; 1-5 abridged. **WANTED:** Rider's 17 to 22. Radiola 60 knobs. Richard Gray, 9181 Chesapeake Dr., San Diego, CA 92123. (619) 560-4162

**WANTED:** Tube socket and filament rheostat (assy.???) for my Grebe CR-5. H. Spaulding, 1567 Lilac Way, Upland CA 91786. (714) 981-1448

# WANTED WWII GERMAN

ELECTRONICS, OPTICS,  
AND FIELD EQUIPMENT

Historical Display Being Assembled

"Not to glorify, but to preserve  
and remember  
the U.S.'s great struggle"

CALL OR WRITE: Steve Puntillo  
1911 Rowley Avenue  
Madison, Wisconsin 53705  
(608) 233-1569 Home, 251-6121 Work

Call either number between  
1:00 a.m. and 11:00 p.m. Central Time.

Send photo of your unit if possible.

## CLASSIFIED ADVERTISEMENTS

**FOR SALE:** Metrodyne 7-tube with four green coils, wood with black bakelite front, with Egyptian design with ladies, silk-screened front, no tubes, good condition - \$275. Radiola Model 33 metal case, fine sloping front and back, 7-tube, brown nice finish, plays, fine - \$125, UPS paid. Firestone red pocket radio, 6 1/4" x 4 3/4" x 2 1/4", very fine, uses small A- and B- battery with folder - \$45, UPS paid. Tom Thumb Jewel Box type brown alligator leather bat., etc., plays fine, carrying strap missing - \$200, UPS paid. Edison Mabry, 715 W. Longview, Mansfield, OH 44906-2129. (419) 526-1175

**WANTED:** A restorable 3-dial Freshman Masterpiece chassis with a 7" x 17 1/2" (approx.) front panel. I have a good mahogany console cabinet. All replies answered. William H. Stuber, 406 S. Maple Ave., PO Box 153, Woodward, IA 50276. (515) 438-2008

**FOR SALE:** 68 years collection: 10,000+ items, antiques, radios, televisions, phonos, sound, military, ham, catalogs, flyers, books, 48 pages - \$1 refundable. F. Yonker, W21BH, 7 Old Farms Rd., Saddle River, NJ 07458. (201) 825-1895

**WANTED:** Selector switch knob for a Paragon A2 amplifier. Dieter Hollander, 33 Ellington Dr., Scarborough, Ontario, Canada M1R 3X6. (416) 755-5018

**FOR SALE:** Meissner 8C - \$45. Silver-Marshall SM-330, SM-331 transformers - \$10 ea. Hickock 752A - \$175. Motorola 65 car radio - \$50. Jack Smith, 288 Winter St., N. Andover, MA 01845. (508) 686-7250

## rainy day books

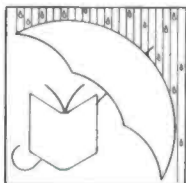

OUR NEW ADDRESS:  
Box 775  
Fitzwilliam, NH 03447

frank bequaert  
lucia bequaert

### Technical Books Catalogs and Magazines Bought and Sold

Wireless - Radio - Telephone  
Broadcasting - Telephone  
Electronics - Computers  
Electric Power - Electric RR  
Civil Engineering - Machine Tools  
Metallurgy - Mining

*New Lists Always Being Issued  
Let Us Know Your Interests*

## CLASSIFIED ADVERTISEMENTS

**FOR SALE:** Zenith Royal 3000 Trans-Oceanic, upper door section missing - \$100, 20 lbs. Philco 42KR5 wood clock radio, like plastic one on p. 133 F.O.S. - \$45, 12 lbs. Hallicrafters S-53 - \$45, 18 lbs. RCA Stratoworld 3-way brown leatherette portable - \$30, 20 lbs. 2 Lemco crystal sets, parts of box missing - \$50/both ppd. Send SASE for parts, literature, tubes, novelties, etc. Stan Lopes, KB6LGV, 1201-74 Monument Blvd., Concord, CA 94520. (415) 825-6865

**IF YOUR EXPIRATION DATE IS  
JULY OR BEFORE, RENEW TODAY!  
EARLY RENEWALS  
RECEIVE AN EXTRA ISSUE!**

**WANTED:** Majestic (Grigsby-Grunow) radios, cabinets, power supplies, sales lit, advertising, etc. Horn speakers. Reasonably priced tombstones & cathedrals. **FOR SALE:** High quality copies of the following: 1942 Zenith dealers sales brochure & sales promotion booklet, 59 pgs. - \$7.50. Atwater Kent service manual, parts and price list, 1928-29, includes theory, planning and use of service dept., troubleshooting, AK speakers, Models 10-55, 183 pgs. - \$27. Atwater Kent service data supplement, parts & price list, Models 81 thru 99-P, 1932, 47 pgs. - \$6. Atwater Kent resistance values color code chart, shows all values for 24 different AK models - \$2.50. All prices include postage. Radio schematics - \$2. Tubes - 50¢ - \$2. Many radios, parts, etc. Send SASE: Chip Taylor, PO Box 20132, Bradenton, FL 34203. (813) 745-2821



**WANTED:** Japanese WW2 radios, accessories, manuals. Japanese electronics/audio magazines, new/old, any quantity. Alan Douglas, PO Box 225, Pocasset, MA 02559

**FOR SALE:** Grebe Synchronphase MU-1 battery set, 1925, neodyne circuit, untried, but both audio transformers OK, interconnecting tuning chain included but small pulleys missing, exc.; a beautiful looking battery set - \$165. Sentinel 312P portable, 1950, not working, vg, green marbled plastic, gold grille and lettering - \$60. Also many other radios, books & tubes. Send 2 stamps for complete listing to: Ron Boucher, PO Box 541, Goffstown, NH 03045. (603) 497-2988



## CLASSIFIED ADVERTISEMENTS

**FOR SALE:** Sentinel tube-novelty etc. radio, looks like three large books open, top back is radio 6 1/2 high x 12 x 7", fine, plays - \$275. RCA Model 8-B-43, maroon snake-skin plastic, 6 1/2" x 4 x 3 1/2 tube, battery fine, jewel box type - \$55. Same in Airline Model 84GCB-1062A - \$55. Edison Mabry, 715 W. Longview, Mansfield, OH 44906-2129. (419) 526-1175

**WANTED:** Copy of manuals or schematics for 1950's novice transmitters and receivers by Philmore (NT-200, NR-300), Ameco (AC-1), and Walter Ashe (WAT-25, WAP-25, WAR-25). Alvin J. Bernard, N14Q, PO Box 690098, Orlando, FL 32869-0098. (407) 351-5536

**FOR SALE:** AK 184 tombstone, very nice, (F.O.S., p. 69). Philco 37-89 tombstone, very good. Benrus clock radio 10-1-1, with instr. book. Lyric white bakelite. Majestic 5B01A silver/black bakelite. Zenith A600 Trans-O, very nice. Crosley E90CE, 50's green clock radio. Delmonico early 4" transistor TV. Many early transistor radios, send SASE for list. **WANTED:** Teletone TV149 seven-inch TV. Charles Harper, 2081 Harmony Ct., Lexington, KY 40502. (606) 268-8549

**WANTED:** 1948 National HFS and 1946 National NC 1-10A radios. Also manuals or copy for Drake R4 and Superior signal tracer. Fred Hegel, PO Box 29-1192, Port Orange, FL 32029. (904) 767-8502

**FOR SALE:** CRT's: 2, 3, 5 inch - \$3 to \$20. Send SASE. Joe Koosman, 130 RD1, Hopewell, NJ 08525

## CLASSIFIED ADVERTISEMENTS

**WANTED:** Atlantic cable things & old National SW receivers for cash or can trade old sets. Robert Enemark, PO Box 1607, Duxbury, MA 02331. (617) 934-5043

### CLASSIFIED AD DEADLINES

Jul. 10 for Aug. 1989 Issue  
Aug. 10 for Sep. 1989 Issue  
Sep. 10 for Oct. 1989 Issue

**FOR SALE/TRADE:** Airline cathedral has dual-speaker and 4 bands, original condition and working - \$275. Green Bendix - BO. EverReady Model 20 chassis - \$10. Zenith tombstones: 835, 10S130, 7J232. Zenith 9S262 console, pick up only - \$110. **WANTED:** Pilot tombstones & cathedrals, pre-WWII German & European radios. Bill Moore, 1005 Fieldstone Ct., Huntsville, AL 35803. (205) 880-1207

**WANTED:** Pre-1950 small screen TV's by National, Hallicrafters, Meck, Temple, Automatic, Teletone, Firestone, Pilot and others. **FOR TRADE:** Catalins: Bendix, DeWald harp, Arvin, RCA, Emerson 520. Novelty: Mike radio, Magic-tone bottle, Spice Chest. TV's: Many, call. Don Hauff, 9988 107th Ave. N., Maple Grove, MN 55369. (612) 425-0089

**FOR SALE:** Paco Model C-25 "In Circuit Capacitor detector", 2-400 mfd. - \$50. Also a Knight ohm-voltmeter built from a kit. Both in good working order. F. Liddell, 8100 Kishiox Rd., Blaine, WA 98230. (206) 371-0397, 4 rings til machine answers

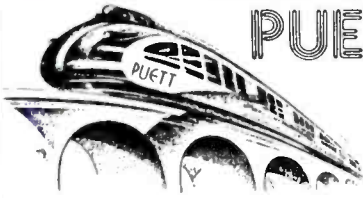

# PUETT ELECTRONICS

P.O. BOX 28572 DALLAS TX 75228



OUR PAST CATALOGS AND PRICE LISTS ARE NOW OBSOLETE.

CATALOG 77 (20-PAGES) OUR BASIC CATALOG \$2.00 POSTPAID.  
YOU RECEIVE A \$3.00 DISCOUNT COUPON WITH CATALOG 77.

CATALOG 77/PLL-2 (56 PAGES) -- \$5.00 POSTPAID.  
YOU RECEIVE A \$6.00 DISCOUNT COUPON WITH CATALOG 77/PLL-2.

WE NOW HAVE MORE THAN 1,500 DIFFERENT ANTIQUE RADIO PUBLICATIONS AVAILABLE! CATALOG 77/PLL-2 LISTS EVERYTHING WE HAVE TO OFFER!

WE OFFER BOOKS, INSTRUMENT MANUALS, SERVICE DATA, SALES BROCHURES, ATWATER KENT, RCA, CROSLLEY, ZENITH, ETC. FACTORY SERVICE MANUALS, STROMBERG CARLSON, CAPEHART, SCOTT, McMURDO SILVER, FISHER CLASSIC RADIO LITERATURE, DIRECTORY OF ANTIQUE RADIO SERVICES, SCHEMATIC DIAGRAMS ON NEARLY ANY RADIO, OLD-TIME RADIO PROGRAMS ON CASSETTES, TUBES, TUBE MANUALS, BOOKS ON WIRELESS AS OLD AS 1902, TUNING DRIVE BELTS, TUNING DIALS, TUNING-DIAL GLASS COVERS, KNOBS, OUR OWN PERIODICAL "ANTIQUÉ RADIO TOPICS" WITH THE ANTIQUÉ RADIO NEW ACQUISITIONS LIST, AND MUCH MUCH MORE!! ORDER OUR CATALOG TODAY!!!!!!



---

**CLASSIFIED ADVERTISEMENTS**

**FOR SALE:** Bosch Concert Ambatone Reproducer. Western Electric 540 AW cone speaker. Western Electric 518 base and driver. 1923 Montgomery Ward radio catalog. Lyle Scheid, RR#1, PO Box 17, Iroquois, SD 57353. (605) 546-2356

**WANTED:** Driver for the built-in horn on a Freshman Masterpiece. Thomas Bisel, 2266 Halyard, St. Louis, MO 63129

**FOR SALE:** Bosch Amberola, good tubes, excellent, untested - \$150. Radiola 60, excellent, plays - \$95. GE Model 410, nice, plays - \$20. All plus UPS. Ferdinand Estree, 660 Fine View, Kalamazoo, MI 49007. (616) 344-0231

**WANTED/TRADE:** Zenith 6S321 or 6S322 gold airplane dial table radio. Will trade for this set if you desire. Don Catton, 609 10th St., Silvis, IL 61282

**FOR SALE:** Scott 800B - \$300. See Flick of Switch, top of page 170. Call. Don Reinsma, 720 N. 18th Ave., Pensacola, FL 32501. (904) 433-2309

**WANTED:** Someone who is able to repair a French Lemouzy tombstone in good condition, but not operating. I will ship wherever. Larry Schiebel, 5834 Balsam Rd., #3, Madison, WI 53711. (608) 276-7768

**FOR SALE:** BC-224 - \$50. BC-348Q w/manual - \$50. Zenith 1000, missing top dial cover - \$35. Kolster 6D chassis - \$35. Radiola AR-812 w/six 99 tubes - \$145. Two Sparton AC 63's, cabinets rough, one missing PS - \$45/all. Early Readrite No. 700 tube/set tester - \$20. Zenith 7H822Z AM/FM plastic - \$15. Philco and Coronado farm radios - \$45 ea. Pair Electro-Voice speakers including T35 tweeter, 848 HF mid-range, 15w (K) low-range, and X336 cross-over, components only - \$250. Thanx. Brian Dunlop, 2715 Hanover-town Dr., Colorado Springs, CO 80919. (719) 531-7920

**WANTED:** Stromberg-Carlson 240 dial indicator, 12" speaker Pc 27385 505W. For 846A, 3A magnetic pick up. FADA RA 3430 dial indicator, two small knobs, tube cover, electric eye tube and socket. Earl 41 dial indicator & wheel and tuning mount. Philco 70 sheet metal tube shield. Harris Schnare, 166 Lowell St. Arlington, MA 02174. (617) 648-7447

**FOR TRADE:** Porsche Panorama magazines, 1974 to date. Brass 8" fan, 3 speed, Ft. Wayne Electric Works, wood systems model. Eimac 304 TL tubes. Pair of Empire 1000 marble topped spkrs. KLM Model 20 stereo system with spkrs. Hallicrafters R-46B spkr. HRO 60 coils, A, B, D & G. **WANTED:** TL 922A. Crosley Model 124 chassis & spkr. Minolta CLE & lenses. Cathedrals, tombstones & Zenith consoles. A. Bruno, 24 Butternut Dr., New City, NY 10956. (914) 354-8899

---

**CLASSIFIED ADVERTISEMENTS**

**WANTED:** Old crank style phonographs, parts, horns or junk machines. Any condition. Dave Faehnrich, 8215 Stone Rd., Independence, OH 44131. (216) 447-0837

**FOR SALE:** Radiola 60, see G.O.R. color section, excellent original condition. Speaker, Model 100-A, one grille cloth torn. Both \$85 plus UPS. Jamie Saloff, 3440 RT6N, Edinboro, PA 16412. (814) 734-5189

**WANTED:** Transistor radios. Early shirt-pocket size models; send close-up photo, Xerox image, or rough sketch with price to: Roger Handy, PO Box 24527, Los Angeles, CA 90024. (213) 451-4040

---

**- WANTED -**

**PICTURES FOR PHOTO REVIEW  
PHOTOS MUST BE SHARP IN DETAIL  
A SHORT DESCRIPTION IS A MUST!  
SEE PHOTO REVIEW PAGES FOR  
ADDITIONAL INFORMATION**

**WANTED:** Cathedrals and tombstones in very good condition. Bob Silva, PO Box 2364, Oak Bluffs, MA 02557. (508) 693-6436

**FOR SALE:** AK 55 in Kiel table, finish is original to complete, chassis is excellent and clean - \$195. Pilot T341, 11-tube AC/DC 8-band table set - \$40. Bosch 5A table set, clean, not working - \$45. All prices plus UPS. Wally Worth, 2 W. Elm Ave., Wollaston, MA 02170

**WANTED:** German, Japanese, Italian WW2 radio equipment and parts, any condition, plus any related paper. My interest is completing original outfits, repairing, and operating "on the air" not just a static display! Thank you! Hugh Miller, KA7LXY, 6400 Maltby Rd., Woodinville, WA 98072-8375, or try (206) 487-3047, weekends

**WANTED:** Radio Test Panel Jewell Pattern 579. RCA Universal Bridge Model TMU-132A. Orval Parker, HCR Box 133, Pocono Summit PA 18346

**WANTED:** Wood knob for 1929 Crosley console, has 3/16 shaft and 8 petal design. Alexandria Nelson, 9225 Evangeline NE, Albuquerque, NM 87111. (505) 291-9468

**FOR TRADE:** Xerox Diablo Hyterm printer (daisy wheel) for cathedral, tombstone or Zenith console. A. Bruno, 24 Butternut Dr., New City, NY 10956. (914) 354-8899

**WANTED:** Johnson Viking Valiant and Ranger ham xmtrs., excellent or better condition. Richard L. Evans, WA3FOQ, PO Box 491, Souderton, PA 18964. (215) 257-8906

**FOR SALE:** Used tubes, tested good. Low prices. Send SASE for list. E&E Enterprises, 954 Johnston Dr., Aurora, IL 60506

---

**CLASSIFIED ADVERTISEMENTS**

---

**WANTED:** Hallicrafters R-48A speaker. National NC-200 manual, literature (repro OK), companion speaker. Sayre Winkie, 1836 Washington Ave. SE, Cedar Rapids, IA 52403. (319) 364-1414

**FOR SALE:** Chicago radios: 1926 Randolph, unusual, rare, 1925 Adladin Big 4 - \$125/both. Kevin Bosomworth, 2225 Bridge, Albert Lea, MN 56007. (507) 377-2887

**SEND ALL A.R.C. MAIL TO**  
**Antique Radio Classified**  
**P.O. Box 2, Carlisle, MA 01741**

**FOR SALE:** Ace Radio Repair Man print in full color (A.R.C. front cover June 1989), 7 1/2" x 9" - \$15, mounted on white mat - \$19. RCA nipper print, 17 1/2 x 17" - \$12. Marconi-RCA stock certificate - \$32. These are new unsold radio sets made in USA early 60's, in orig. cartons: Admiral AM, GE AM, Granco FM; from early 1960 - \$27.50 ea. Small repo AM-FM 7 3/4" high cathedral style radio - \$18.50. Shipping is included on above, USA only. These will make nice gifts. Krantz, 100 Osage Ave., Somerdale, NJ 08083

**WANTED:** Treasure Chest radios: Emerson, Crosley and/or Majestic. Philip Collins, 10965 Rochester Ave. 201, Los Angeles, CA 90024. (213) 479-0167

**WANTED:** Back issues pre-1933 Radio, Pacific Radio News. Original Meissner signal shifter. John Nagle, 12330 Lawyers Rd., Herndon, VA 22071. (703) 620-3066

---

**CLASSIFIED ADVERTISEMENTS**

---

**FOR SALE:** Novelties, 3 Hoppys, Dalberg pillow, Continental piano, microphone, chromes. Call for prices. Len Grove, 4584 W. Ivanhoe St., Chandler, AZ 85226. (602) 961-4281

**WANTED:** Emerson plastic radios, 1930 to 1950, working and mint condition. Carl R. Shirley, 824 Fairwood Rd., Columbia, SC 29209. (803) 776-6850

**MESSAGE:** Will the person who called and wanted to trade the crank phonograph with outside horn for my Radiola IIIA, RCA horn and Orchestron wooden horn please contact me? David Faehrich, 8215 Stone Rd., Independence, OH 44131. (216) 447-0837

**WANTED:** Belmont Boulevard pocket radio. Other small portables with tubes. Also Sony T63. Michael B. Schiffer, 2718 E. 10th St., Tucson, AZ 85716. (602) 325-3532

**FOR SALE:** Radio magazines such as Radio Craft, Radio News, Wireless Age, etc. SASE for list. Harry Pewowaruk, 1535 8th Ave. No., St. Cloud, MN 56301. (612) 252-9910

**WANTED:** Instructions and tube data for Supreme 89D tube tester. copy OK. E. A. Heckler, 1314 N. Sparkman, Hartselle, AL 35640. (205) 773-5988

**FOR SALE:** Early Canadian Marconiphone battery sets, also HMV (British) gramophone. A. R. Nolf, 539 Kastelic Pl., Burlington, Ontario, Canada L7N 3S9. (416) 639-4768

## **New Wireless Pioneers Books, Magazines, Literature Bought and Sold**

New Wireless Pioneers buys and sells books, catalogs, magazines and other literature from the 1800's to 1950 that deal with early radio, wireless and electricity. A selection from our list of specialties:

**Pre-1900 Electricity**  
**Pre-1925 Radio or Wireless**  
**Pre-1950 Computers**

**Pre-1900 Telegraphy**  
**Pre-1940 Television**  
**Early X-Ray**

Magazines, catalogs, autographs or ephemera related to the above topics. Also: Pre-1900 Wireless and Telegraph Apparatus - Radio-Related Novelties and Advertising - Early Vacuum Tubes and Electrical Devices.

*Some items available in other technical subject areas also.*

**Several catalogs featuring items for sale are published each year.**

**New Wireless Pioneers - Jim & Felicia Kreuzer**  
**P.O. Box 398, Elma, NY 14059**  
**(716) 681-3186**



---

**CLASSIFIED ADVERTISEMENTS**

---

**FOR SALE:** Radiola 20; cabinet has vg original finish w/mint escutcheons; all components original, clean, working; repro manual included - \$100. Radiola 18, cabinet professionally refinished; chassis near mint; w/hood, RCA 100A spkr., tubes; pick up preferred, but will ship - \$120. Clarion Jr. 40 cathedral cabinet; w/speaker, grille cloth, escutcheon, knobs; thin overcoat varnish, otherwise vg - \$50 or BO. All prices plus shipping. Robert Rathbone, RD#1, PO Box 127, Ossipee, NH 03864. (603) 539-2762

**WANTED:** Cabinet and knobs for Zenith Model 10-S-160, in ad on page 191 of A Flick of the Switch, in northern Illinois area. Anthony B. Parks, PO Box 452, Franklin Grove, IL 61031. (815) 456-2446

**FOR SALE:** W.U. Tel. Co. rheostat box - \$8. AK Type E frame, no cone - \$8. Knight C27 CB unit - \$8. 8 bottles Edison oil - \$5 ea. 2 RCA 45 changers - \$8 ea. Checks for cost only. Items shipped UPS trans. collect. John Martin, 817 Cook Ave., Billings, MT 59101

**WANTED:** Howard receivers, Philco 355T, Airline Movie Dial 62-318, Zenith Major AM-FM radio. Trans-Oceanic parts: 7G605 owner's manual, front lid instructions, handle, wavemagnets. Royal 1000 front door, log book, owner's manual, antennas. Royal 7000 power cord. Speaker for Zenith 5S127. Fisher 800C rear grille. Scott 800B remote control. Crosley Dynacone speaker. Sunglow Melody chest schematic. Bill Morris, 13901 Oakridge Dr., Carmel, IN 46032. (317) 846-4824

**FOR SALE:** Tubes, used and new, 20's on up. **WANTED:** Unusual tubes, Zeniths pre-1941. Bob Dobush, 3554 W. 105, Cleveland, OH 44111. (216) 228-4953

**WANTED:** Catalogs of radio companies; must have pictures and model numbers. Also need complete set of Sams Photofacts at reasonable price. Marty Bunis, 422 Day St., Manchester, NH 03104. (603) 623-8996

**FOR SALE:** 50's Dumont Chinese, GE Mickey Mouse. GE white casein. '38 Zenith tombstone. SASE. Ripley, PO Box 9374, North St. Paul, MN 55109

**WANTED:** Zenith Trans-Oceanic parts, dial glass for Royal 7000, front door panel and handle-antenna for 3000-1. Gary Pirkkala, 2306 Audley Ave., New Castle, PA 16105

**FOR SALE:** Selling 40 year accumulation. Send SASE for list. Joe Duffin, 4 West Central Ave., Moorestown, NJ 08057

**WANTED:** Front tag and cabinet for a Western Electric 4B. Echophone S-3 escutcheon and chassis. Marc Ingenthron, 9748 Outlook, Overland Park, KS 66207. (913) 642-4767

---

**CLASSIFIED ADVERTISEMENTS**

---

**WANTED:** WD-11, four 199 and socket/mount Radiola II, copy Aeriola Sr. cover instructions, Philco 620 schematic. Jim Dillon, 201 Seward St., Juneau, AK 99801. (907) 586-3223

**FOR SALE:** Chrome Silvertone (Collins, p. 100 top right) - \$95. FADA 192-A Neurotorell, good condition - \$60. Mike Duea, 13173 Glenhurst Ave. S., Savage, MN 55378. (612) 894-7256

**WANTED:** Tube sockets for UV204A, Eimac 1500TH and Western Electric 212D. Zahl radar tube VT-158 made by Eimac, any Industrial/Special purpose tube manuals or pamphlets. Pre-1930 receiving/transmitting tube manuals. March 1986 issue of A.R.C. I like to collect strange type tubes; what do you have? John H. Walker, Jr., 16112 W. 125th St., Olathe, KS 66062. (913) 782-6455

**FOR SALE:** Tubes galore, all new in original cartons: 1A4P - \$2, 1AX2 - \$1.50, 6B5 - \$2.50, 32L7 - \$3, 45Z3 - \$2, '77 - \$2.50, EB91 - \$2, EBC81 - \$4, E80CF - \$3, EL38 - \$4.50, UCC85 - \$3.50. Many others. Send SASE for updated price list. Also, Zenith 3000-1 Trans-Oceanic - \$50. **WANTED:** Chassis for Philco 55. Bev Ritchie, 5 E. Garland Ave., Fresno, CA 93704

**FOR SALE:** Cathedrals, tombstones, Catalin, novelties, consoles and grandfather clock radios. Send SASE for list. John Kern, 2320 Rosedale Rd., Quakertown, PA 18951. (215) 538-2128

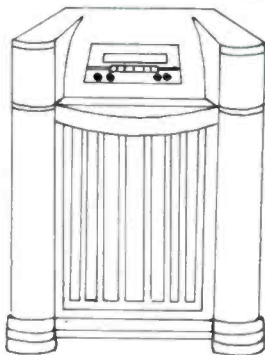

**WANTED:** Philco 42-1008 console radio-phonograph. Gregg Humanic, 540 Wicklow Ln., Monroe, OH 45050. (513) 539-8926

**FOR SALE:** Juke Box Service Manuals, 1960's 1970's Wurlitzer Seeburg AMI Rockola. Hallicrafters communication receiver SX140, 3 1/2 to 54 megacycles - \$50. Precision tube tester Mod. 1015 - \$40. Seeburg transistorized stereo amplifier TSA1. Hewlett Packard oscilloscope 1707B - \$250. Heathkit transistor tester IT121 - \$45. Heathkit FM stereo generator IG37 - \$70. Write for details. Jack Naimann, 365 Bronx River Rd., Yonkers, NY 10704. (914) 237-4650

## CLASSIFIED ADVERTISEMENTS

**FOR SALE:** Atwater Kent Models 20(C), 33, 30 and E3 speaker - \$125/all; Model 20(C) with E3 speaker - \$75. Kevin Bosomworth, 2225 Bridge, Albert Lea, MN 56007. (507) 377-2887

**WANTED:** Atwater Kent speakers for Models 30, 768, 67C, 60C. Gil Warrenton, 1290 5th St., Vero Beach, FL 32962. (407) 778-8392

**FOR SALE:** AK drum type spkr., good condition - \$60. WE 540-W cone spkr., less cone but rest OK - \$25. Radiola 17, P.S. parts - \$20. AK L chassis 8 tubes inc. good shape - \$60. Xtal radio Fliver style with xtal + diode - \$70. A few Zenith color TV parts in boxes. Xfms., yokes, etc., only - \$45. William J. Key, W1DWD, 58 Sycamore Dr., Halifax, MA 02338. (617) 294-1831

**WANTED:** Two-tube chassis for 1940 Arvin Model 40 Mighty Mite (F.O.S., p. 60). Carl Reinke, 2724 N. 27th St., Sheboygan, WI 53083

**FOR SALE:** Zenith Trans-Oceanic 3000-1 with logs - \$100. 1960's Popular Electronics magazines (96) - \$15/all. Evan Haydon, 4308 N. 15, Lincoln, NE 68521. (402) 435-4083

**HELP:** Third time I've tried. Need junker Freed-Eisemann NR80 or parts for same. P. Burton, 39 E. Walnut St., Belchertown, MA 01007. (413) 323-5019

**FOR SALE:** Zenith Trans-Oceanic Model Y600, complete, very good working condition - \$75 plus UPS. T. H. Killoran, 8316 54th Dr. NE, Marysville, WA 98270. (206) 659-5362

## CLASSIFIED ADVERTISEMENTS

**WANTED:** National SW3, SW5 or AGS receiver. Bob Mattson, KC2LK, 10 Jane Wood Rd., Highland, NY 12528. (914) 691-6247

**FOR SALE/TRADE:** Large red Addison Catalin, excellent, for 30's Crosley Coke bottle radio or Coke cooler radio+ or BO. Clifford Watts, 51 Glendale Rd., Brantford, Ontario, Canada N3T 1P5

**WANTED:** Old tube chart or supplement booklet for Jackson tube tester, Model #648R. E. H. Melvin, 5050 New Market Rd., Hillsboro, OH 45133. (513) 288-2424

**IF YOUR EXPIRATION DATE IS  
JULY OR BEFORE, RENEW TODAY!  
EARLY RENEWALS  
RECEIVE AN EXTRA ISSUE!**

**WANTED:** Operators manual for tube testers Precision Model 912-P and military Model I-177-B. Caleb Drenning, 340 Barefoot Dr., California, MD 20619

**FOR SALE:** Rider, Howard Sams, RCA, GE, Philco service data from 1920 to 1960, write wants - SASE. Parts, tubes, speakers, coils, volume controls, dial belts, bulbs, audio, power transformers. Plus 1000's of new and used parts. Sales service since 1930. SASE for list. Krantz, 100 Osage Ave., Somerdale, NJ 08083

**WANTED:** Metal slide-button latch for Radiola I Type ER-753-A (V.R., p. 109). Carl Reinke, 2724 N. 27th St., Sheboygan, WI 53083

# Radio Addict

NEEDS MORE 40's, 50's, 60's COLORFUL PLASTICS.

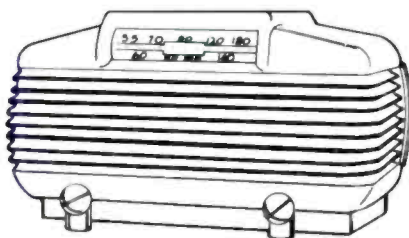

MOSTLY BUY, SOME TRADE, NEVER SELL.

LES WAGENHEIM  
c/o LEADWORKS INC.  
32400 AURORA RD.  
SOLOM, OH 44139  
1-800-321-2863 EXT. 200  
OHIO 216-349-5000

## CLASSIFIED ADVERTISEMENTS

**WANTED:** Hallicrafters transistor portables WR-1000, 2000, 3000, etc. for my collection. R. W. Miller, 5217 43rd Ave. Ct. NW, Gig Harbor, WA 98335

**FOR SALE:** Amps, tuners, stereo, eqpt.; all as removed from repair shops untested, no owners manuals. Fisher (Sears) transistor AM-FM stereo tuner amp - \$40. Philco 41-280 10-tube BC & SW band chassis - \$25. Philco 46-1203 Code 122 chassis - \$10. Philco 20 chassis, original parts less tube shield - \$30. Heath Williamson amp in 2 chassis W3-M - \$20. Fisher AM-FM tuner & amp Model 250T - \$35. Fisher Ambassador 470T tuner amp & chassis, 4 pieces - \$50. Collins FM-AM tuner, 15 tubes, some papers - \$35. Fisher Regent AM-FM tuner 31-R chassis - \$35. RCA monitor amp Type BA 4C - \$30. Zenith 9B22Z tuner and amps - \$35. Meissner FM tuner - \$15. All plus shipping. Krantz, 100 Osage Ave., Somerdale, NJ 08083

**WANTED:** Novelty radio collectors. I have 50+ transistors to trade. Send your list. No SASE needed. Clifford Watts, 51 Glendale Rd., Brantford, Ontario, Canada N3T 1P5

**FOR SALE:** Gosnet Communicator 3, clean with manual, tunes 143 to 148 Mc - \$45 plus \$5 UPS. Ed Povraznik, 9606 Biddulph Rd., Brooklyn, OH 44144

**WANTED:** Old meters, instruments, galvos, working or not for collection open to public showing. Leonard W. Cartwright, 113 Sea Terrace Way, Aptos, CA 95003. (408) 662-2977

## JOIN

# A. W. A.



ONE OF THE WORLD'S LARGEST AND OLDEST  
HISTORICAL RADIO COLLECTOR ORGANIZATIONS.

- \* International "Meets"
- \* Nationwide "Meets"
- \* Sponsors world's largest radio Conference and Flea market
- \* Maintains unique radio and television museum
- \* Publishes quarterly journal featuring columns covering:
  - Battery & AC receiver restoration
  - Loudspeaker operation
  - Commercial receiver column
  - OT amateur transmitter operation
  - Vacuum tube collector's column
  - Early television receiver column
  - Current radio book & magazine reviews
  - Free Want-Sell-Swap column
  - Radio obituaries
  - Reports on public radio museums
  - Information on collector clubs in U.S.A. and foreign countries

All this for only \$10.00 per year. Mail check to:  
Antique Wireless Association, Inc.  
Box 2-E, Breesport, New York 14816

## CLASSIFIED ADVERTISEMENTS

**FOR SALE/TRADE:** Kraft Miracle Whip and Ray-O-Vac battery radios, NIB - \$25 ea. or trade. Clifford Watts, 51 Glendale Rd., Brantford, Ontario, Canada N3T 1P5

**WANTED:** Majestic 886 console. Emerson AX-212. RCA Mexican scene 40X-53. Barry Friedman, 22725 Garzota Dr., Valencia, CA 91355. (805) 296-2318

## One Month Free!

### BONUS FOR EARLY RENEWALS

If you renew before the end of the month shown on your mailing label (your expiration date), you will receive an extra month on your subscription: 13 months instead of 12! 26 months for a 2-year renewal!

**FOR SALE:** Phaostron Model 666 VOM, leather carrying case - \$30. N.R.I. professional tube tester Model 70, oakwood case, manual and antique tube chart, real nice - \$45. Clegg 22'er rcvr./xmtr. with manual - \$32. Ward Becht, 625 Tufts Ave., Burbank, CA 91504. (818) 842-3444

**WANTED:** Good N.I.B. 2B6 tube. Chief Pontiac battery radio made in Pontiac, Mich. Chrome radios in any condition. My new address is: Craig Korpak, 9130 Silver Lk. Rd., Linden, MI 48451. (313) 735-7264

**FOR SALE:** Many types of radio, TV and industrial tubes. DH Distributors, PO Box 48623, Wichita, KS 67201. (316) 684-0050

**WANTED:** (2) workable WD-11 tubes. (2) Model 32 tubes to suit Model 420 Rogers. (Note heaters on top). Dial drum, dial band, drive shaft plus worms for metal box. 801 Stewart-Warner receiver. Any Atwater Kent cathedrals, particularly Models 165, 708, 555. RCA Model R28P, 6 tube, 1933. Barry Houston, 46 Croydon St., Christ Church 2, New Zealand

**FOR SALE:** Complete M.I.T. Radiation Lab Series, 27 volumes, plus Index volume - \$1,200. S. T. Carter, II, PO Box 033177, Indialantic, FL 32903-0177. (407) 727-3015

## FOR SALE

### Citizens Radio Call Book Magazines

- Vol. 7 1926 Spring & September
- Vol. 8 1927 Mar., Sept., Nov.
- Vol. 9 1928 Jan., Mar., Sept., Nov.
- Vol. 10 1929 Jan., Mar., Sept., Nov.
- Vol. 11 1930 Jan., Mar., Sept., Nov.
- Vol. 12 1931 Jan., Mar.

### Radio Listener's Guide And Call Book

- Vol. 1 - 1926 Winter edition
- Vol. 2 - 1927 Winter edition

Les Rayner, 5512 N 71st Place  
Scottsdale, AZ 85253 - (602) 947-1375



**CLASSIFIED ADVERTISEMENTS**

**WANTED:** Philco 37-610 chassis and spkr. Battery or AC tombstones. Henry Harmonie, 4617 Hawk, Amarillo, TX 79103. (806) 372-6576

**FOR SALE:** Stromberg-Carlson tuner RS402 - \$15. Eico stereo preamp HF85 - \$15. Knight record/playback preamp, KP70, no case - \$7.50. Heathkit stereo preamp, no case - \$6. Knight stereo tuner, no case - \$8. Wilcox Gay old FM band tuner - \$15. Eico int. amp, HF32 - \$18. Pilot receiver 602 - \$15. Hallicrafters S72R, missing front lid - \$30. Silvertone multiband portable, leather type case - \$25. Military wire recorder ICVRW7 - \$10. Heathkit laboratory generator L61 - \$9. Eico capacitor checker 950B \$7.50. Sprague Tel-Ohmite T04 - \$30. Tele Check b&w test tube - \$10. Million signal generator - \$10. Vitameer picture tube checker - \$9. Leeds & Northrup Compnay tester or bridge (?), oak case - \$25. Quackery medical device, cabinet missing one side - \$35. Shell quick tube/vibrator tester - \$30. Leak Point One stereo preamp, missing cover - \$30. All as is. UPS extra. Jerome & Debbie Schliepp, 831 Berlin Rd., Ripon, WI 54971

**WANTED:** Sams Index, Rider Index. Any dial belt info and data especially Zenith chassis # and model #, G.C. catalogs 1940-50 era. Also J.F.D. cat. same. QSL card of WØHPS, E. Hoard paying \$5-4or-50[?]. All letters ans. Thanks. E. Hoard, PO Box 38, Lehr, ND 58460

**FOR SALE:** Hammarlund HQ-120. **WANTED:** Any bakelite paneled transmitter manufactured for amateur service by collector. Parker, W1YG, 87 Cove Rd., Lyme, CT 06371. (203) 434-7783

**CLASSIFIED ADVERTISEMENTS**

**FOR SALE/TRADE:** Rare Pacific Electronics 610A WW2 AM/SW wood table - \$135. Sparton Jewel investment grade - \$385. RCA SHF-5 16-78 rpm phonograph - \$95. Just bought large transistor tube inventory. SASE please. Steve Lipsky, 1254 Cox Rd., Rydal, PA 19046

**WANTED:** S-Meter for National NC1E3, schematic for Crosley Fiver Jr., Model 5M3, info. about cat-eye mod. for a Hallicrafters SX-25. John Berkovitz, 905 Camel Dr., #319, Gillette, WY 82716. (307) 682-1620

**FOR SALE:** Hammarlund brass plate, var. cond. - \$5 ea. Asst. audio xfms. - \$6 ea., no choice. Weston Elect. cast iron front, 8 1/2" meter dial scale, marked elect. storage batt. co. (Philco), 14 lbs., glass cracked - \$30. Nice display. 1/2" coil bell wire - \$2.50. I am junking. RCA 17, 1B, 26, 33, 62. AK 55C parts for sale. Tubes all used, good fil: 5BP1, 5UP1, 5FP7 - \$15 ea. 3API - \$10. Zenith 33X power unit, needs rewire job - \$18. GR 220 120v Variacs, 4 amps - \$20. Power supply for Temple 9-tube radio, 24A type tubes - \$20. Electro Model B, 0-6v DC, 20 amps, needs clean up - \$20. Tubes mil. type: VT137/1626 - \$2; 807 VT 100-A - \$4; GL-IPZ4 - \$2; HY 615 VT232 - \$3; VT 235 - \$3; VT 136 1625 - \$5; 807 - \$3 ea. 304-TL VT129 - \$5 ea. 01-A tubes - \$5 ea. WE 215-A tubes - \$12 ea. WE 215-A - \$12 ea. 201-A asst. odd or no name brands, shapes, sizes, good fil - \$6 ea. RCA 877 N.O.S. - \$3.50. 954/VT120 Acorn tubes - \$3 ea. 13-pin Nixie tube - \$5. 14-pin Nixie tube - \$4. 201-A brass base, no tip, good fil - \$10. All plus shipping. Min. orders - \$7.50. Krantz, 100 Osage Ave., Somerdale, NJ 08083

**WANTED****Top Prices Paid**

**Radio & Audio Tubes:** 2A3, 45's, 50's, 845, 8005, KT66/88, etc.

**Western Electric Tubes:** 101, 102, 104, 203, 305, 211, 212, 242, 244, 252, 262, 264, 271, 274, 275, 276, 284, 285, 300, 301, 310, 339, 345, 347, 348, 349, 350, 421, 422, VT25A, VT52, etc.

**W.E. Speakers & Tweeters:** 555, 594, 595, 596, 597, 713, 728, 754, 755, 756, 757, TA4151, 4153, 4181, 4191, 4194, etc.

**W.E. Consoles & Amps:** 25B, 41, 42, 46, 86, 91, 92, 94, 95, 105, 106, 117, 118, 120, 121, 124, 129, 130, 131, 142, 143, etc.

**W.E. Horns:** 22, 24, 25, 26, KS-6368, 12024, 12025, 12027, etc.

**W.E. Microphones & Parts, etc.**

**Also looking for:**

*Tube-type equipment by McIntosh, Marantz, Westrex, Langevin, Altec, etc.  
Vintage speakers, units, by Jensen, Altec, JBL, Tannoy, etc.*

**Audio City USA, PO Box 786, Northridge, CA 91328-0786  
(818) 701-5633**

---

**CLASSIFIED ADVERTISEMENTS**

---

**FOR SALE:** GE brown swirl or marbled radio with tan knobs, good condition, Model J54 - \$40 plus UPS. Tom Burnside, 4838 S. Westhaven Dr., Jackson, MS 39209. (601) 922-2235

**WANTED:** The following tubes for a German radio: DCH 11, DF 11, DAF 11, DL 11 and UY 11. Earle Drake, PO Box 1808, Hyannis, MA 02601

**FOR SALE:** Zenith radio cab. #H615Z Model 6G05 - \$100. Hallicrafters S40B - \$75. Wards Airline table Model #62-715 - \$100. Trio communications receiver #JR-200 - \$50. Sony stereo solid state cassette-corder #T.C. 121 - \$50. Panasonic 9 transistor AM/FM #RF-90 - \$25. Delfonic 8 track tape deck, also - \$20. General Elect. 8 track tape deck, both like new - \$25. Stark tube checker Model 911, also OK - \$50. Tube checker which handles the real old time tubes - \$30. Tubes - 92 various tubes, some radio and the balance older type TV tubes - \$75/lot. Frank Liddell, 8100 Kispiox Rd., Blaine, WA 98230. (206) 371-0397

**FOR SALE:** Zenith collectors please note. 12-page Xerox copy booklet, Installation and Operating Instructions for Zenith Model 9S54/55 chassis #5903-5903A 1936 - \$2.75 ppd. Donald J. Sochurek, W191, S7500 Richdorf Dr., Muskego, WI 53150. (414) 679-0212

---



**FOR SALE:** Scott Philharmonic AM Beam of Light radio, Gothic Grande console, complete with tweeters and original manuals. Console near mint condition, chassis excellent and electronically restored. This may be the finest Gothic Grande Scott in existence, in storage most of its years. For the serious collector, appraised value \$4,400 which is the asking price. Send \$3.00 for six photos, history and complete description. William Ross, 1124 Tower Rd., Winnetka, IL 60093. (312) 441-6462, eves.

**WANTED:** Desperately need Airway Type F parts. Will buy cabinet for paper on lid and chassis or entire set. What have you got? John Case, 255 Lawrence Ave., Columbus, OH 43228

---

---

**CLASSIFIED ADVERTISEMENTS**

---

**FOR SALE:** Stromberg-Carlson 1A, EC - \$85. RCA 103 small tombstone, vgc - \$60. Also, several transistor portables and colored plastics, tube type. Paul Ernst, 3465 Eddy Rd., Marion, NY 14505. (315) 589-9471

**WANTED:** Photo, sketch, or description of knobs used on Majestic 463. Dial glass, escutcheon, and push buttons for Philco 39-40 console. David Walker, 3401 Velda Dr., Belleville, IL 62223. (618) 235-8690

**FOR SALE:** Thirty nice radio chassis, all in the 30's, cheap, they all work good: RCA, GE, Atwater Kent, Philco. Wanted to buy out speaker repair shop, tools, paper, the works. Chucks, PO Box 598, New Haven, WV 25265. (304) 882-2220

**WANTED:** SX28 or 28A cosmetically clean, electronically satisfactory with speaker - \$175 to \$200. E. Lohn, 9 Middleridge Ln. So., Rolling Hills, CA 90274. (213) 534-1837, office. (213) 541-4461, home

**SEND ALL A.R.C. MAIL TO**  
**Antique Radio Classified**  
**P.O. Box 2, Carlisle, MA 01741**

**WANTED:** Arvin Model 956T1 (twin speaker) and Philco Model 40 thru 48 420. Bill Timoszyk, 35283 Leon, Livonia, MI 48150. (313) 421-2076

**FOR SALE:** Green and black Bendix Catalin, good, clean condition - BO over \$350 by July 10th. Allen Jochem, 2205 Broadway, Quincy, IL 62301. (217) 223-8556

**WANTED:** Black crackle National speaker, SW3-FB7 coils. Pat Stewart, W7GVC, 1404 Ruth Ave., Walla Walla, WA 99362

**FOR SALE:** Radio Amateur's Handbook 1949 edition, good condition - \$5 includes shipping. H. W. Vayo, 117 E. Remington Rd., Ithaca, NY 14850

**WANTED:** Early quack medical violet ray devices and any other interesting types. Richard Cane, 8391 NW 21st St., Sunrise, FL 33322. (305) 741-6838

---

**WANTED**  
**TRANSMITTING TUBES FOR MUSEUM**

Do you have any old amateur or commercial transmitting tubes worthy of saving for posterity? If yes, help us do same. Contact:

*The Olde Transmitting  
Tube Museum*

P.O. Box 97, Crescent City, CA 95531  
(707) 464-6470

---

---

**CLASSIFIED ADVERTISEMENTS**

**FOR SALE:** Dial scale repros. AK, Model 82, 84, 90, 545, 567 - \$10; Model 55, 60, etc. - \$8.50. Philco Model 20, 60, 66, 70, 71, 84, 90, 91, 89 (Code 123) - \$10; Model 620, 625, 630, 642 - \$15; Model 37-38, 37-60, 37-89, 38-39, 38-60 (Code 125), 37-84, 37-93, 38-93 - \$10; Model 37-610, 37-611, 37-620, 37-623, 37-624, 37-630, 37-640, 37-641; also 38 Series - \$15. Radiola Model 16, 17, 18, 41, 60 and Brunswick equiv. - \$10. Spar-ton Model AC-6, AC-7 - \$9. Include \$2 ship/insurance ea. all above. We will eyelet to your tuning ring free. At Elgin or here. Antique Radio Restorations, 635 S. Lincoln Ave., O'Fallon, IL 62269. (618) 632-7423

---

**NOTICE TO ALL  
CLASSIFIED ADVERTISERS!  
OUR CLASSIFIED AD DEADLINE IS  
12:00 NOON  
ON THE 10th OF EACH MONTH**

---

**FOR TRADE:** Trade only. Zenith Royal 2000. Zenith Trans-Oceanic Super Deluxe Y600L chassis 6T40Z with operating guide, sales brochure, wave magnet, dial-o-map. Zenith Trans-Oceanic Royal 1000, mint. Zenith Trans-Oceanic Royal 3000-1, mint. Zenith Trans-Oceanic Royal 7000-1 with plastic cover and name tag, mint. National Panasonic RF 5000, vg. **WANTED:** Prewar II German radios. Eric Marx, 2460 Bandon Dr., Grand Blanc, MI 48439-7906

**WANTED:** Horn speakers, complete or parts. Crosley 52 parts. Zenith 8S154 parts. Richard Anthony, 2551 Andler Rd., Placerville, CA 95667

**FOR SALE:** Emerson 2 color Model 520 Catalin - \$275 ppd. Rider's 9 through 13 - \$12 ea. Bill Rolf, 30131 Center Ridge, Westlake, OH 44145. (216) 871-4547

**WANTED:** Small portable radio that uses subminiature type tubes. Alan Schreiber, 12805 Powderhorn St., Austin, TX 78727. (512) 835-2056

**FOR SALE:** Michigan 1-tuber, has good #30 tube - \$150. Zenith 4-F-133 tombstone, 6v, mint condition, has wood Z knobs - \$50. Zenith Trans-Oceanic 8G005YT, fine condition, works (F.O.S., p. 195) - \$85. GE K-52 cathedral, excellent original condition, working (F.O.S., p. 90) - \$175. Science & Invention magazines, 37 issues, no covers, 1921 thru 1927 - \$37. All UPS extra. **WANTED:** Majestic cathedrals, tombstones and Deco sets. Bill Allen, 2904 Greenway Dr., Bettendorf, IA 52722. (319) 355-1760

**FOR SALE:** Murdock #500 base driver and aluminum curved pipe, no bell - \$35. Federal #61 - \$1,200. Music Master #140, some gold in front panel - \$450. Malone Lemmon - \$400. Music Master Ware, 4 exposed 199 tubes - \$450. Certified check or money order. Photo - \$1.25. Pat Cutini, 2114 Main Rd., Corfu, NY 14036. (716) 762-8270

---

**CLASSIFIED ADVERTISEMENTS**

**FOR SALE:** Early transistors. Zenith Trans-Oceanic 3000-1, mint - \$160. Zenith Royal 20 - \$20. Zenith royal 16 - \$20. Jewel Vanguard TRI, 1956 - \$45. RCA Deluxe transistor TI-D - \$30. RCA 4RG56 - \$20. GE P2720A rechargeable - \$10. Plastic table models. GEC-416 - \$10. Arvin GT15N - \$10. Zenith C624 - \$15. Admiral 5X12N - \$15. Zenith 7H02Z - \$15. Harald Herp, 6615 Michele Ct., Huntingtown, MD 20639. (301) 855-7071

**WANTED:** Knobs for the following: Philco 50A set of (3) Jessie French G Junior (pair) Philco black knob w/molded pointer 610, 655 etc. Paul Rosen, 30 Cherrystone Dr., Willowdale, Ontario, Canada M2H 1S1. (416) 493-6962, eves.

**FOR SALE/TRADE:** FADA bullet, Model 1000, yellow body with cherry red trim - \$850. Michael Lawlor, PO Box 50, South Pasadena, CA 91031. (818) 799-2921

**FOR SALE:** Telefunken, Jubilee - \$35. Zeniths: portable - \$18; bakelite #6D510 - \$40; Silver-tones: portable, #110.391-1 - \$18; transistor, 1956, pink, mint, OB - \$25; Sentinel portable, #285-P - \$15; Crosley Trans-Oceanic, #46-A - \$40. Many more. All plus UPS. Jamie Saloff, 3440 RT6N, Edinboro, PA 16412. (814) 734-5189

**WANTED:** Brown bakelite cover with brass veneer knob for tuning capacitor on AK 12. Bob Silva, PO Box 2364, Oak Bluffs, MA 02557. (508) 693-6436

**FOR SALE:** Brush Sound mirror Model BK 403 early tape recorder, excellent original condition. Offers. Bob Shuck, 10512 Winston Ln., Indianapolis, IN 46256. (317) 849-0381

**WANTED:** M-4 driver unit for Magnavox horn speaker. Rider's Radio Manual Vol. 18-23. Wat Panutai, 1628 La Golondrina Ave., Alhambra, CA 91803. (818) 458-2730

**FOR TRADE:** Have 1919 Chelsea tuner and wireless spark gap (1914?); need base and/or driver (any condition) for Amplion horn, also the crystal detector parts for top of Federal Jr. Please help. Crocker, RFD 2, Kirby, Lyndonville, VT 05851

**WANTED:** Audio output xfmr. for Eveready 1, 2, 3 or Bosch 28, power xfmr. for Sonora A30, A32, or A40. John Swett, 8116 Olmway, Olmsted Falls, OH 44138. (216) 235-1463

**FOR SALE:** Atwater Kent Model H horn speaker with brand new variable diaphragm driver - \$75. Philmore crystal detector Type 7002, brand new in original box old stock - \$25 ea. Radiola III bakelite panel, very good condition, no chips or blemishes - \$25. All above plus UPS. Phil Weingarten, 67-61 Alderton St., Forest Hills, NY 11374. (718) 896-3545



---

**CLASSIFIED ADVERTISEMENTS**

---

**WANTED:** Restorable Radiola 21 and Radiola 26. Richard Gray, 9181 Chesapeake Dr., San Diego, CA 92123. (619) 560-4162

---



**FOR SALE:** Very rare and unusual baby grand radio/phone, early 30's untested, as found condition - \$1,200. Also, Majestic grandfather clock, Sherwood Model 156, radio not working, nice orig. condition - \$500. Scott Allwave Deluxe in West-erly Grande cabinet, radio working, cabinet & chrome need cleaning, very good cond. except for tear in speaker cloth at bottom - \$1,450. Scott 16, Acousticraft cab., radio working, cabinet needs re-finishing - \$750. Scott Allwave 2 dial w/coils, Plymouth cabinet needs refinish & some work, radio working - \$850. Capehart Model 400, cus-tom installation (no cabinet), works, changer in very good cond., walnut face plate for tuner and changer, comes with one remote, one 12" treble and one 15" base, can accommodate 2 more re-mote sets, UPS'able - \$1,250. Scott AM-FM Phantom, tuner and power only, no tube shields - \$200. Scott 23 tuner only, some tube shields missing - \$150. Scott 12 Deluxe tuner only, some tube shields missing - \$100. RCA 128 Beehive, very good cond., works, comes w/spare chassis & speaker - \$325. Boxing/wood crating & shipping extra. **WANTED:** Capehart pancake record changer, whole or part. **FOR TRADE:** For trade only. Have Scott Warrington cabinet only (Philhar-monic, no escutcheons) for Scott cabinet that can accommodate (or has) a record changer. No Chip-pendale, Sheraton or similar. Ed Gardner, 103 Lordship Rd., Stratford, CT 06497. (203) 381-9619

---

---

**CLASSIFIED ADVERTISEMENTS**

---

**FOR SALE:** Rider's Vols. 6-10, gc - \$70. National Union Rider's Vol. 4 - \$25. Radio Boys in the Secret Service, '22, gc - \$8. All plus shipping. Paul Gunzenhauser, Rt. 1, PO Box 133, Garden Grove, IA 50103. (515) 443-2161

---

**WANTED:** AK Model E speaker for AK 37 radio. Must be excellent in appearance and operation. Keith Teeter, 504 Coralie Dr., Walnut Creek, CA 94596. (415) 935-3069

---

**FOR SALE:** Hammarlund Comet Pro & coils - \$225, and manual. **WANTED:** Bliley xtals. Antique ham TX, home brew or commercial. Stu Mount, K20A, 35 Grand St., Highland, NY 12528. (914) 691-7957

---

**WANTED:** Surplus radio conversion manuals, originals or copies. Also surplus radio handbooks. Rainy Day Books, PO Box 775, Fitzwilliam, NH 03447. (603) 585-3448

---

**FOR SALE:** SASE for list of radios, generators, test equipment, military, TV, etc. Michael Crain, RD 1, PO Box 472, Harveys Lake, PA 18618

---

**WANTED:** Oval shape plastic dial cover for a Gilfillan Model #117X-9264 console radio. Mi-chael Koch, 495 Dallas Dr., Thousand Oaks, CA 91360. (805) 497-4379

---

**NOTICE TO ALL  
CLASSIFIED ADVERTISERS!  
OUR CLASSIFIED AD DEADLINE IS  
12:00 NOON  
ON THE 10th OF EACH MONTH**

---

**WANTED:** Restoring: Freed-Eisemann NR-5. Does anyone have a good audio xfmr. (unknown ratio) for sale? Steve Imms, 51A Old Shannock Rd., Wakefield, RI 02879. (401) 783-5387

---

**FOR SALE:** Westinghouse Rectigon battery charger, Style 376336, circa 1923. Please, SASE when writing. Manuel Mello, PO Box 113, Cambr-idge, MA 02140. (617) 492-1022

---

**WANTED:** Hickock adapters Model 1704 and Code No. 1050-107. E. H. Melvin, 5050 New Market Rd., Hillsboro, OH 45133. (513) 288-2424

---

**FOR SALE:** Sams Photofacts, N.O.S. and used in binders, 600+ sets #20-500+ - \$100 or BO. Linus Brown, Rt.#2, PO Box 49, Wapakoneta, OH 45895. (419) 738-8069

---

**WANTED:** SW3 and/or bandsread coils, other plug-in coil receivers or transmitters, keys. Niel Wiegand, WA5VLZ, 911 North Bend Dr., Austin, TX 78758. (512) 837-2492

---

**FOR SALE:** Large home brew crystal set panel and phones - \$50 ppd. Photo - \$1.25. Certified check or money order. Pat Cutini, 2114 Main Rd., Corfu, NY 14036

---

**CLASSIFIED ADVERTISEMENTS**

**FOR TRADE:** McMurdo Masterpiece Three Tuner for Masterpiece Four Tuner or for chrome Lincoln radio. Also will trade 8 tube Masterpiece Four amplifier for Lincoln or other rare chrome sets. **NEW ADDRESS:** Craig Korpak, 9130 Silver Lk. Rd., Linden, MI 48451. (313) 735-7264

**WANTED:** Glass dial or photocopy of any rectangular 5-band radio with following bands: (75-360M) (50-160M) (31-51M) (20-11M) (13-20M). Photocopy of circuit diagram or similar, for Philips battery operated receiver 8X 675V, made in Holland, 1949. Address of old Radio Museum, Antiques Electronic Supply, or Antique Radio Club, in Holland. Mario Portalatin, 1628 NW 16th St., Suite #3, Miami, FL 33125. (305) 545-9121

**SERVICES:** Antique Radio Service. I repair home radios, auto radios, one-tubers to Scott Philharmonics. SASE for brochure. Richard C. Foster, 12 Shawmut Ave., Cochrutuate, MA 01778. (508) 653-2418

**FOR SALE:** Antique electronic's collection 1900-1945 radios, parts, books, equipment, magazines. Phone for information. Ask for Gene. Gene Corn, 3 Barton St., Greenville, SC 29609. (803) 878-4156

**WANTED:** Grundig-Phillips AG 1003 record changer, found in Grundig 7063W3D console radios, or entire set. Alexander Kruedener, Jr., 161 East 89 St., Apt. #4E, New York, NY 10128. (212) 831-0662

**FOR SALE:** Phono Needles & Cartridges (ceramic - magnetic). What do you need? Send SASE. J. J. Papovich, 53 Magnolia Ave., Pitman, NJ 08071. (609) 582-8279.

Desperately needed: Skyriider Commercial, S-30, S-33, S-35, EC-4, EC-6, HT-8, HT-12, HT-14, silver panel skyriders, other old or unusual gear, parts manuals, memorabilia of the Hallicrafters Co., and 1934 "H", "Z", "K", "J", line of Silver-Marshall radios. **The Hallicrafter Collector** - Chuck Dachis, 4500 Russell Drive, Austin, TX 78745

**FOR SALE:** 90 Minute VHS Tape of 9 separate film shorts from the 30's to the 60's, dealing with the history of electronics, including one comedy short about prewar television. Subjects include television from scanning dish to the Philco Safari, telegraph, telephone, wireless, radio, radar, facsimile, and military electronics. Shown are film clips of Marconi and Frank Conrad. \$29.00 including shipping. Order from: David B. Johnson, 2336 S. Kenilworth, Berwyn, IL 60402

**TUBES AND MISC.** Large stock of **NEW** and **GOOD** used radio tubes, etc. Send \$1 (stamps OK) - **REFUNDABLE** for latest flyer. Don Diers, 4276 - BC1, North 50 St., Milwaukee, WI, 53216-1313

**CLASSIFIED ADVERTISEMENTS**

**FOR SALE/TRADE:** 1924 Brunswick BR-160 radio/phono - \$750. 1936 Seeburg Symphonola jukebox Model D, 95% complete, strong Deco lines - \$1,800. Will deliver within 1000 miles of San Francisco for 35¢ a mile. **WANTED:** 1940 Ford push-button radio. Anthing related to 1933 Radiobar Model 528, I'll pay dearly for the glass-ware. No secret, outpaying most for Deco radios, especially mirrored glass radios from basket case to mint. Ed Sage, PO Box 1234, Benicia, CA 94510. (707) 746-5659

**WANTED:** Raytheon 7" wooden TV. Have trades or pay cash. Jerald Hueber, 1368 King Richard Pkwy., W. Carrollton, OH 45449. (513) 866-6958

**FOR SALE:** Zenith Trans-Oceanic B600, original except AC plug, literature, excellent - \$65 plus UPS. 11th Edition Sylvania Technical Manual, 1959 - \$10 ppd. Sept. and Oct., 1931 Radio News, very good - \$6 ea., \$10/both ppd. General Electric portfolio "Lighting - A Century of Progress," 16 separate colored photographs of 1933 World's Fair buildings lighted, mint - \$20 ppd. 1928 edition Radio Telegraphy and Telephony, Robinson, very good - \$29 ppd. Electronic Circuits and Tubes, 1947, Cruft Laboratory, Harvard, 994 pages, excellent - \$25 ppd. Radiotron Designer's Handbook, RCA, 1953, (first edition, 1932), 1482 pages, excellent - \$35 ppd. Money order or certified check ships immediately. John J. Hohn, 1823 Gaston St., Winston-Salem, NC 27103. (919) 724-6350

**WE'RE STILL HERE!** Tubes: "Oldest," "Latest." Schematics. SASE for lists to Steinmetz Electronics, 7519 Maplewood Ave., Hammond, IN 46324

**WANTED:** Early tube hi-fi components and studio equipment by Acrosound, Brook, Brociner, Fairchild, Hadley, Marantz. Also want Western Electric amplifiers, speakers, tubes, microphones. Richard Sharisky, PO Box 521, Belmont, MA 02178. (617) 484-5784

**DAN'S SCHEMATIC SERVICE.** Radio diagrams, 1921 to 1951 - \$2.50 PPD. T.V. diagrams, 1938 to 1952 - \$3.50 PPD. Send make and model number of set, or chassis layout sketch with tube types, if model number is unknown, to: Dan's Schematic Service, P.O. Box 53061, San Jose, CA 95123.

**FOR SALE:** ZENITH DIAL BELTS, new - \$10.00 ppd. Need model and/or chassis # or send old belt. E. Hoard, Box 38, Lehr, ND 58460

**WANTED:** Two-color Catalin radios from the 30's and 40's. Top prices paid. I am not looking for bargains, just good radios for my collection. FADA, Motorola, Garod, Emerson, Addison, etc. Michael Lawlor, P.O. Box 50, South Pasadena, CA 91031. (818) 799-2921.

**CLASSIFIED ADVERTISEMENTS**

**FOR SALE:** 2 Dyna audio component sets. One is early fact. wired tube type. Also have complete and clean Browning Golden Eagle CB set. Wade, 657 14th Ave., Prospect Park, PA 19076

**NOTICE TO ALL  
CLASSIFIED ADVERTISERS!  
OUR CLASSIFIED AD DEADLINE IS  
12:00 NOON  
ON THE 10th OF EACH MONTH**

**WANTED:** Cabinet for Freed-Eisemann FE15, Branston size 50 lateral wound coil, and knobs for Zenith Trans-Oceanic Model H500. Esterline-Angus chart recorder with windup clock drive, wood case preferred, metal OK. I am still looking for old tipped light bulbs, mercury arc rectifiers and a Sky Rider S39 manual. Bruce Ashcraft, 1300 Burrows Rd., Campbell, CA 95008-6302. (408) 374-5228

**FOR SALE:** Five-tube 1926 Kardon broadcast RX, mint condition. Ray Power, 1751 Boulevard, Westfield, NJ 07090. (201) 233-7023



PHILCO Super High-Fidelity 890XX

**WANTED:** Philco 38-690XXX, or 37-690X. Vernon Oehke, Box 307, Ghent, NY 12075. (518) 392-4945

**WANTED:** Keys, bugs and telegraph instruments. Also related parts and publications. Will purchase or trade like kind. I am a collector not a dealer. This is an affair of the heart, not the wallet. Warren Berbit, K2UVV, 46A Mile Road, Suffern, NY 10901

**INDIVIDUAL PHOTOFACT FOLDERS.** From sets under #1400 - \$4. Over #1400 - \$6. Pre-paid First Class postage included. Also full stock Sams specialized books. Allen J. Loeb, 414 Chestnut Lane, East Meadow, NY 11554. (516) 481-4380

**FOR SALE:** Reproduction dial glasses for Catalins. FADA 652 and Sentinel 284 - \$35 ea. plus \$2 postage. Radioart, Box 102, Centerbrook, CT 06409

**SOLID STATE VIBRATORS** for most automobile radios 1932-57. Exact duplicates of original styles in metal cans. Long SASE for catalog, dealer pricing on request. Antique Auto Radio, Box 892, Crystal Beach, FL 34681. (813) 785-8733.

**CLASSIFIED ADVERTISEMENTS**

**FOR SALE:** Collection of 1920's/30's radios and accessories for donation to worthy nonprofit organization. Following sets w/tubes, working condition. You pay shipping. Radiolas: 17 and 18 - \$90 ea., 20 - \$120, 33 (no legs w/100B spkr.) - \$110, 60 w/103 spkr. - \$150, Aeriola Sr. w/WD-11 - \$125; Freed Eisemanns: NR-5 and NR-6 - \$100 ea., NR-7 - \$90, NR-45 - \$125, NR-60 - \$65; AK 37 W/E spkr. - \$100, AK 46 w/F-2 spkr. - \$100; Crosley 51 - \$90, Ace 5 - \$110, Freshman Masterpiece - \$80, Browning Drake 5-R - \$135, Philco 70-A - \$250, Walbert Isofarad - \$95, USL DC-6 w/green leaf Sylvania tubes - \$130. Arborphone 27 - \$95. Following tubes used, test good, priced each: UV/UX 201-A - \$5, UY 227 - \$4, UY 224/224-A - \$6, UX 245 - \$10, UX 226 - \$4, UX 171-A - \$5. Following speakers good working condition: Radiolas: UZ 1325 - \$90, 100 - \$75, 100-A - \$35, Herald - \$65, Baldwin - \$85, Music Master - \$120, Na-aid Midget - \$45. RCA SW antenna kit in box - \$50. Harvey Faulkner, 116-A Central Ave., New Castle, DE 19720. (302) 571-9729

**BOXED CLASSIFIED ADS WORK!** This is a boxed classified ad. These ads can be run more than two months. See the inside back cover for details. Boxed ad deadline: the 5th of the month.

**WANTED: SONY** Radios and small TV's... the older the better! Please call or send details: Jay Lewin, 400 East 54th St., New York, NY 10022. (212) 935-5656

**WANTED:** Small wood radios 1948 and prior. Condition of cabinet (within reason), grille cloth, missing knobs etc. not important, but must play, be otherwise complete and be very reasonably priced. R.J. Hulbert, PO Box 37, Creston, CA 93432. (805) 239-7762

**WANTED:** Broadcast-type MICROPHONES. Early carbon, condenser, ribbon, dynamic, etc. Cash or trade. James Steele, PO Box 620, Kingsland, GA 31548-0620. (612) 729-2242

**WANTED:** Collector searching for RCA combination radio-phonograph Model RAE 79 (don't laugh). Any in captivity that might be for sale? Jim Weston, 3750 - 21st St., San Francisco, CA 94114

**WANTED: FADA, DEWALD, SONORA, and Mirror Sets.** Bill Cress, 28 Worcester Dr., Wayne, NJ 07470. (201) 694-5154.

**MILITARY RADIO BATTERY** Adapter Units. No modifications required. Form-fit. Direct connect socket. Use standard batteries. For radio sets: BC-611, AN/CPRC-26, AN/URC-68, AN/PRC-6, 8, 9, 10, 25, 28 & 77, AN/PRT-4, AN/PRR-9. We have Operator Technical Manuals too. Act Now! Send for FREE details: TNM Enterprises, PO Box 2330-AR, Anaheim, CA 92814-0330.



**CLASSIFIED ADVERTISEMENTS**

**FOR SALE:** Crosley Model V - \$135. "Reporter" cathedral - \$115. **FOR TRADE:** Radiola II, Kennedy 281, Crosley Repwoods. **WANTED:** Crosley crystal set, Ace Precision TTR, AVA, AV2, AT2, etc., a John Firth set with built in horn. Craig Ball, 204 N. 5th St., Marshalltown, IA 50158. (515) 752-0406, call after dark

**WANTED:** Stewart-Warner 102A cabinet. Philco 20 cabinet. Chassis for Emerson Q236. Chassis for Crosley 123, 48, 54. Brandes H horn only. Base for Bristol Audiophone Sr. Horn only for Brandes table talker. Bob Barnes, PO Box 275, Monroe City, MO 63456

**FOR TRADE:** Catalins: Motorola Aero Vane and FADA 1000, excellent condition. **WANTED:** Emerson AU190, Zenith 701 or 801, Emerson Mickey Mouse and World Fair radios. Jim Thompson, 4238 15th Ave. So., Minneapolis, MN 55407. (612) 822-4000

**WANTED:** Owners Guide for 1962 Zenith Trans-Oceanic Model 3000-1. Or will swap copies of my Dial-O-Map for copies of your guide, or my copies of 1950 T-O Owners guide for what I need. Have 1930's era sales folders for trade; see ad June A.R.C., p. 47. Steve Hartwich, 4620 Belleview, #2-S, Kansas City, MO 64112. (816) 753-2613, 7-midnight CDT

**FOR SALE:** Transistors: Snoopy W&B - \$10; Sesame Street - \$20; 1966 Buick Riviera dealer promo - \$125. List avail. Richard L. Bednarck, 28 Steele Ave., Lincoln Park, NJ 07035. (201) 694-6374

**CLASSIFIED ADVERTISEMENTS**

**WANTED:** UZ-1320 driver. Philco dial escutcheon (1936 or '37, 3 band) and 37-620 dial scale. Binding posts for Aeriola or Westinghouse DA. **FOR SALE:** Hand-painted Philco 513 (blue) with matching speaker. Other radios. Aeriola detector. Tubes, parts, manuals, etc. SASE. Bob Husted, 270 NW 3rd Ct., Boca Raton, FL 33432

**FOR TRADE:** Numerous wood, bakelite, plastic (no Catalin) AC radios for your old banjos, mandolins, guitars. Describe instruments fully and advise interests. All letters answered. Bill Burkett, PO Box 1204, Peoria, AZ 85380. (602) 979-0452

**WANTED:** Any or all equipment and literature on Thomas P. Giblin, the Standard Radio and Electric Company of Pawtucket, R. I., the Coto Coil Company, WJAR Radio in Providence or the first transatlantic flight by the Navy NC-4 in 1919. All of which Thomas P. Giblin had something to do with. Leonard J. Arzoomanian, 61 Columbus Ave., North Providence, RI 02911. (401) 232-0869

**FOR SALE:** DuMont RA-103 chassis for parts, has power transformer, tuner, square dial plate, eye, knobs; no HV or pix tube - \$25 pick up only. R. J. Eastwick, N2AWC, 224 Chestnut St., Hadonfield, NJ 08033. (609) 429-2477

**WANTED:** Turntable for Zenith 6S305, 9S307 cabinet and speaker, or will sell my working shutter dial chassis. **FOR SALE:** Grundig Majestic cabinet with speakers. Stewart-Warner A61P3 untested batt./AC portable. Best offers. Dan Hays, 4 Monterey Dr., Newark, DE 19713. (302) 368-2138

**1984 to 1987 Index to Antique Radio Classified**

*Turn your collection of A.R.C. into a valuable reference.*

**Only \$4.00 Postpaid!**

*(The 1988 Index appeared in the February 1989 issue, available for \$2.50 postpaid)*

The Index is 20 pages long and contains 1000+ entries.

The Index covers Volume 1, Number 1 (June 1984) through Vol. 4, No. 12 (December 1987).

Indexed are all 41 issues (1140 pages) of A.R.C.



Listed are all photos and references to radio sets, speakers, keys, other components, novelties, important persons, etc.

For example:  
Atwater Kent: 41 entries  
Crosley: 91 entries  
Sparton: 17 entries

A separate listing of articles is also included.

Send payment with order. Mass. residents add 5% tax. Foreign orders add \$1.50 for shipping. Mail to: Antique Radio Classified, P.O. Box 2, Carlisle, MA 01741. Allow 3 weeks for delivery.



## In Our Showroom

Grebe CR-9  
 Philco 84 cathedral-restored  
 Bendix 526MC catalin-works  
 GE Model E-81 Colorama  
 Crosley Model D24TN clockradio  
 Zenith 3-R  
 Zenith porthole TV  
 Rare 1960 Floor Model Predicta

### ORIGINAL FACTORY SERVICE BOOKS

RCA Service Notes 1923-28...\$50  
 RCA Service Notes 1933...\$25  
 RCA Service Data 1938-42...\$35  
 Zenith Vol.1 1931-40...\$55  
 Zenith Vol.2 1941-42...\$45  
 Zenith Service Shop Notes  
 1938-42...\$20  
 Philco Wiring Diagrams  
 Volume 1 1928-36...\$35

### OTHER BOOKS

Gernsback Official Service  
 Manual Vol.2 1931-32...\$25  
 Applied Practical Radio &  
 TV - 5 volumes...\$35  
 Rider's-The Service Man's  
 Manual 1929...\$20  
 Rider's Manual Volume 17...\$20  
 Prin. of Radio Communication  
 Morecroft, 1927...\$7  
 Radio For the Millions, 1946...\$5

Ohio residents add 7% tax  
 Prices do not include shipping



**Tubes · Books · Parts  
 Refinishing Supplies  
 Grill Cloth**

Call or write for free flyer.  
 Store open by appointment.

## Vintage Tv & Radio

3552 West 105th St Cleveland, Ohio 44111  
 216-671-6712

**FOR SALE:** Small oak wall phone, complete with magneto - \$150. 7" Admiral TV, good case, missing trim, untested - \$40. Emerson 510, working, clean - \$30. Zenith 5D0272, black, dial, working, rectangular, wood - \$30. N.O.S. box of 75? belts for 1930's radios, with list - \$25. Newcomb-Halley 5R power speaker, clean - \$35. Columbia phono reproducer - \$25. RCA 45 only record changer working - \$25. (10) 4 min. blue Amberol cylinder records, vf-exc. - \$25. (50) Edison 1/4 Diamond Disk records - \$2 ea. Good used 01-A's - \$4, 26's - \$3, 27's - \$3. Add shipping. Jahan L. Acciavatti, PO Box 231, Southborough, MA 01772. (508) 476-3229, evs.

### — WANTED —

**PICTURES FOR PHOTO REVIEW  
 PHOTOS MUST BE SHARP IN DETAIL  
 A SHORT DESCRIPTION IS A MUST!  
 SEE PHOTO REVIEW PAGES FOR  
 ADDITIONAL INFORMATION**

**FOR TRADE:** 1937 and 1938 full line Zenith fold outs. 1934 RCA color lithos in original folder. As is green Emerson Catalin tombstone. Restored Charlie McCarthy. Zenith 7S28 tombstone. Cast iron Zenith radio bank, 3" high, looks like 8S154.

**FOR SALE:** Bakelite radios: Page 68, Radios of the Golden Age, brown - \$130; repainted Belmont (R.O.G.A., p. 69) - \$125; Zenith 6D0 15, with original box (R.O.G.A., p. 71) - \$130. Detrola Pee Wee, hairline crack, brown with creme - \$100. Plastic mike radio (R.O.G.A., p. 102) - \$125. FADA plastic 845, swirly white w/red knobs & handle, harline on bottom - \$250. Zenith logo T-shirts and some sweatshirts, sizes run small - \$11.95 ppd. for T-shirts, call on sweats. Wooden cabinet for Continental piano radio - \$70. Mint Zenith 808A - \$225. Eveready Model 1 with matching speaker, very clean - \$220. Japanese lacquer tube set, Pagoda - \$85. Crosley Buddy Boy cabinet only, very nice - \$85. Zenith 805, parts set or major restoration - \$80. Majestic Treasure Chest radio parts set - \$60. Majestic grandfather clock radio Model 20, complete minus grille cloth, small veneer chip on bottom - \$275. Abbottsware horse radio, crack in right rear leg, otherwise mint - \$275. RCA radios base lit sign, 14" wide, etched lucite, nipper/phono logo "RCA Victor His Master's Voice Radios" on lucite, "Only RCA Makes the Victrola" on base - \$450. 31 issues of "The Voice of Majestic" 8-page tabloid format newsletter, 1929 to 1932, each issue with Majestic advertising and world news - \$150. White ceramic lamp from 1930's, looks like a Deco tombstone radio, given away with the purchase of a radio - \$165. 1940's wooden radio clock, looks like desk clock, Globe Electronics, 14" wide, with radio hidden in base - \$150. Also available many consoles: Philco 38-690, RCA 15K, Zenith 15U270, 12A5B, Emerson, Philco 37-116. Can deliver or ship almost anywhere. Satisfaction guaranteed. Will be at Elgin and Canandaigua. Alan Jesperson, PO Box 17338, Minneapolis, MN 55417. (612) 727-2489, ans. mach. after 4 rings

---

**CLASSIFIED ADVERTISEMENTS**

---

**WANTED:** Power supply for AK 40. Two brass based no tip 01-A's. Rider's Radio Manuals Volumes 19, 20 and 21. Dan King, 1230-B Juniper St., Gilroy, CA 95020. (408) 847-1345

**FOR SALE:** SW45, power supply, 23 meter coils. Regency TR7, not working. Riley-Klotz horn. G. W. Stevens, PO Box 704, Longmont, CO. (303) 776-9036

**WANTED:** Commercial built crystal sets. Must be in very good condition. Bob Silva, PO Box 2364, Oak Bluffs, MA 02557. (508) 693-6436

**FOR SALE/TRADE:** H.H. Scott tuner LT-110-B - \$55. H.H. Scott tuner 350-B - \$55. H.H. Scott preamp 299-C - \$55. H.H. Scott amp 299 - \$50. Harman Kardon amp A 300 - \$35. Eico amp 2036 - \$25. Heathkit tuner PT-1 - \$20. Heathkit tuner AJ-13 - \$20. Heathkit amp A-9B - \$20. Perpetuum Ebner amp KV-21G - \$20. Lenco turntable L-78, made in Switzerland - \$25. Eric Marx, 2460 Bandon Dr., Grand Blanc, MI 48439-7906

**WANTED:** Keys and bugs for private collection and use. Jerry Scherkenbach, 5952 South Elaine Ave., Cudahy, WI 53110. (414) 481-8831

**FOR SALE:** Zenith 5S29, 9S54, 5808, 10S566. Crosley 716 tombstone, following chassis 10S567, 10S464, 7S363, 6J322. Grunow 12B. Tungsol neon radio service light. Westinghouse advertising clock, made of glass and cardboard. Edison Amberola. Original radio knobs. Bill Coolahan, 1450 Miami Dr. NE, Cedar Rapids, IA 52402. (319) 393-8075

**WANTED:** RCA WT-100A, Seco 107(A) tube testers, military MX-949/U tube tester adapter NR OK. B. J. Fuerst, 218 Flournoy St., Oak Park, IL 60304-1511

**FOR SALE:** Aerotron WD-11, brand new, stored 50 years, four tubes sold as set - \$200. General Radio tuning fork 1,000 cycle oscillator, works - \$40. GR 758-A Wavemeter 55-400 MHS, repaired cracked case - \$20. WE-212D - \$70. RCA early 204A still in Railway Express crate, dated 1924, believe new; magazines: Ham Radio 1969-1989, few missing, call - \$200. Trade Road & Track 1957-1987 for antiques. All plus UPS. Paul C. Crum, W9LC, 6272 N. Cicero Ave., Chicago, IL 60646. (312) 282-3033

**WANTED:** Meissner signal shifter with plug-in coils and a front panel from a DX-100 transmitter in good condition. B&W 75W plug-in coils (5 prongs) models 80 JEL and 40 JEL end link. Also need a Stancor 10P AM/CW transmitter that was a kit in 1939. James Schliestett, W4IMQ, PO Box 93, Cedartown, GA 30125. (404) 748-5968

**FOR TRADE:** Want to exchange tapes of radio history. Merrill Bancroft, 169 S. Row Rd., Townsend, MA 01469

---

**CLASSIFIED ADVERTISEMENTS**

---

**FOR SALE:** Brand new; vibration meter, orig. cost, just under \$5,000. Portable, hand carry. CEC, Electrodynamics Corp., sub of Bell & Howell, Type 1-157-0001 and 2, w/2 transducers, cables, bat. & AC power packs, sol. state, w/filters, books.; 39 ea. dry cell packs, push & turn, GE PL19E500938GL, rev; new. New, manual for GE Lockout Repeater 19D411442 GI-G4 dual transceivers, VHF-UHF; new manual F/Motorola Symcon-10, FM-VHF, deluxe binder. Approx. \$20,000. New factory boxed, Motorola, partsbase & mobile, W/T, some GE & RCA, includes 11 ea. (RCA) deskset, remote (beige) MI-559524-3; 3720942-3(731219). George Belling, W6CTG, 3740 Atlas Ave., Oakland, CA 94619. (415) 531-1640

**WANTED:** Two brass-based 01-A tubes, no tips, ducts OK. Speaker cone for Radiola 100-A. N.O.S. body-end-dot coded resistors, 220, 750, 2K, 10K, 15K (2), 150K and 1 megohm. Dan King, 1230-B Juniper St., Gilroy, CA 95020. (408) 847-1345

**MESSAGE:** ARCA flea market dealer who had Zenith and Jewel clock radios. If items available, please contact: Martha Chaput, 83 Standish Rd., Squantum, MA 02171. (617) 328-3576

**WANTED:** Hallicrafters spokewheel knobs. Radiola 812 panel medallion. Muter grid leak drip pan. T. Wickstrom, 1664 E. Shore Dr., St. Paul, MN 55106

**FOR SALE:** Electronics of all years, 20's to 40's. Many battery radio of all makes from one tube up. Some military. Tubes; all kinds: tipped, brass, ceramic. No list. This is a very large quantity collection to be sold to a dealer or serious collector as one lot - \$2,500. Books: Extremely large collection of radio, telephone, telegraph and wireless from approx. 1900 up. No list. Entire collection sold as a lot only - \$750. Laurence W. Johnson, 77 County Rd., E. Freetown, MA 02717. (508) 763-3206, 5-8 pm

**WANTED:** Horn speakers in very good condition. Bob Silva, PO Box 2364, Oak Bluffs, MA 02557. (508) 693-6436

**FOR SALE:** It has been determined that these radios and test equipment are no longer needed in my collection. BC-1306, needs power connector, otherwise complete - \$150. RBM rcvr. LF/type with cable and AC supply - \$150. RBM rcvr. HF type w/cable AC supply - \$150. SCR 511 pogo stick w/PE 157 supply, T-39 chest unit, BC-746 tuning unit - \$250. Test equip. IE-17 for BC-611, complete w/wood chest - \$195. SCR 245, BC-223, BC-312, PE55 with cables - \$250. Steve Bartkowski, 4923 W 28 St., Cicero, IL 60650. (312) 863-3090. (312) 294-6523

**WANTED:** Manual for Sweep Systems Inc. Model 450 TV sweep generator. Louis Johnson, 3928 Red Oak Dr., Doraville, GA 30340



## CLASSIFIED ADVERTISEMENTS

**WANTED:** A Course in Radio Fundamentals Book by ARRL, ca. 1960, good or better condition. Richard L. Evans, WA3FOQ, PO Box 491, Souderton, PA 18964. (215) 257-8906

**FOR SALE:** Hawkins Electrical Guide, Volumes 1-10, good condition - \$25. Zenith Trans-Oceanic Model T-600, works good, with Zenith earphones, manual, hang tag - \$85. Stewart-Warner 301A shortwave converter, no case or knobs, with tubes - \$15. Hallicrafters S-38E, good condition, works good - \$35. Tubes: 2ES, 24A, 30, 35, all new - \$3 ea. Add UPS. Call for details. Rick Weibezahl, 305 Belvidere Ave., Washington, NJ 07882. (201) 689-3276

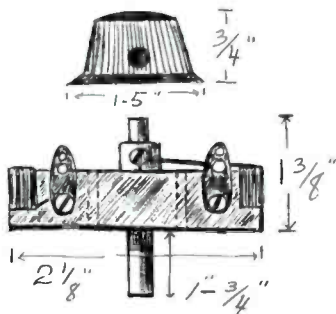

**WANTED:** Two good condition wirewound rheostats with two mounting holes, six or ten ohms. Brass plated terminals, 1.5" high, knurled nut and hole in body for lead. Fluted black knobs with and without the white arrow. D'Arcy Brownrigg, PO Box 292, Chelsea, Quebec, Canada J0X 1N0

**WANTED:** Two brake shoes (that's 4 pads!) in good breaking condition for Sony TC650. Will pay \$10 plus ship. **FOR SALE:** S38D - \$30. SX111 - \$80. Please call first. Doug Thomas, Rt. 8, PO Box 257A, Live Oak, FL 32060. (904) 658-2378, eves.

**FOR SALE:** Zenith H500 - \$75. Royal 97 Super Navigator - \$20. RCA X551 bakelite - \$35. 56X3 wood - \$35. Airline 84BR-1502 midget bakelite - \$30. Dahlberg pillow speaker radio 4130 coin-operated - \$75. Eico 324 RF generator - \$20. Heath IT-12 - \$20. All working with good cases, plus UPS. Rod Galloway, 2220 Woodbury Rd., Melbourne, FL 32935. (407) 254-0280, after 5

**FOR SALE:** Navy receiver RDZ-1, 220 MHz, works - \$75. Navy signal generator - \$35. Will deliver within 150 mi. Doug McManus, 20 Deland Park A, Fairport, NY 14450. (716) 388-1275

**WANTED:** Ruined Catalin radio cases; cracked, warped, burned, split in two, hopeless condition; grilles, knobs, chassis not necessary; just cases of Catalin material. Write or call: Dion Warren, PO Box 4433, Santa Barbara, CA 93140. (805) 966-9733

## CLASSIFIED ADVERTISEMENTS

**FOR SALE:** Philco Superhet 11, chassis, inc. tubes, speaker, knobs, escutcheon, untested - \$40. Lear AM radio/record player, 78 rpm, table model, treasure chest style, cabinet fair, untested, model unknown - \$75. Sonora RDAU-209, AM wood table radio, working - \$30. Wilcox-Gay Recordio 6A10, untested, case rough - \$30. Harmon-Kardon A230 Ballad, stereo amp. chassis inc. tubes, front panel, knobs, working - \$50. GE PM speakers, full range, 9" X 20" oval, pair - \$30. H.H. Scott 99A transcription amp. mono, working - \$45. Electro Voice Regency speaker, large corner cabinet, mahogany finish, pick up only - \$85. Bogen R604 AM/FM tuner, VM Triomatic record changer, both built into EV Peerage mahogany cabinet, pick up only - \$45. Will sell previous 3 items together, pick up only - \$150. Books, Rider's Radio Vol. 7 & 13 - \$12 ea. Gernsback Official Radio Service Manual Vol. 7 - \$5. Please add shipping charges to all items. **WANTED:** Wood tuning & tone knobs for Zenith 6S254 console radio. Plastic push buttons for RCA 96T2. A. Ford, 1238 Academy St., Scranton, PA 18504. (717) 347-4218

**WANTED:** Hallicrafters T-54, 505 and National TV-7 B&W TV, excellent or better condition. Richard L. Evans, WA3FOQ, PO Box 491, Souderton, PA 18964. (215) 257-8906

**WANTED:** One good '13 tube and one good Silver-Marshall 210 IF transformer. Paul Bourbin, 25 Greenview Ct., San Francisco, CA 94131

**FOR SALE:** PACO G-30-PC RF signal generator kit by Precision, never opened from factory, pre-assembled, wired, calibrated head. A 35-year-old unit for \$75 and I ship. John Snow, 4539 Bartlett, Shorewood, WI 53211

**WANTED:** GE Model M-61 chassis and speaker. GE Model M-51 speaker. Philco Type 16 speaker and cabinet. Zenith Super VIII chassis and eliminator. "Charlie Tuna" transistor radio, back for "mike radio" single station. Radiola 60-LID, good condition veneer, escutcheon for Philco Jr. Model 81. **FOR SALE:** Rider's and Sams. SASE for list. Thank you. Call or SASE. George E. Brehm, 13402 Leibacher Ave., Norwalk, CA 90650-3524. (213) 864-8857

**WANTED:** Schematic for Zenith 9-S-232 and Philco 20B. Copy OK. Stanley Caesar, 512 Country Club Cir., Midwest City, OK 73110

**WANTED:** Turner 33X microphone. Howard 430 receiver. Howard 435A receiver. No modifications please. Art Robertson, W0IWW, 12110 W. Rice Pl., Morrison, CO 80465. (303) 979-3225

**FOR SALE:** Sams Post War Comm. rcvr. manual CR-1, NC-57 is missing - \$7 book rate. SASE for list of publ. and other items. Ed Montgomery, 1092 Willowbranch Ave., Jacksonville, FL 32205. (904) 384-0815

---

**CLASSIFIED ADVERTISEMENTS**

---

**FOR SALE:** Zenith Super Seven - \$150. Westinghouse H-417T5, unusual - \$35. Coronado #RA48-8158A, green - \$40. Karola 32v farm set, nice - \$60. Motorola #67X11, bakelite, nice - \$50. Sailing Ship light, silver color - \$50. GE 430, wood case - \$45. Steinite, restorable, 2 dial - \$50. Toy, Postal Telegraph Junior Set with Morse Code, blue - \$15. Bell amp, red knobs, grey case, #3715 - \$50. Zenith Trans-Oceanic 8G005TZI? - \$45. Majestic, twin six auto radio #66 - \$50. Motorola 52X11 - \$45. Silvertone, wood case, #101-527 - \$45. Arvin #9562, transistor, portable, has unique design feature - \$25. Philips battery record player, 3 speed, portable - \$20. RCA Victor, metal case, portable 8" TV #8-PT-7031 - \$80. **WANTED:** Chassis and speaker Clarion Jr. AC 60. All sold as is. Buyer assumes all responsibility. All + UPS. Darrell Combs, 6587 Pacheco Way, Citrus Heights, CA 95610. (916) 969-0635, after 5 pm PST

---

**FOR TRADE:** Thorola horn. Will bring to Canandaigua. R. Brewster, 454 Diablo Dr., Pittsburgh, PA 15241. (412) 833-4287

---

**WANTED:** To purchase any information or receivers of Matthews or Pioneer Radio Companies. George Harris, 3212 36th St., Lubbock, TX 79413. (806) 795-5604

---

**WANTED:** Espey 3" TV kit ca. 1949, partial or complete, good or better condition. Also need co. history. Espey made hi-fi and other radios in 40's and 50's in N.Y.C. TV kit may have been used as technician trainer. Richard L. Evans, PO Box 491, Souderton, PA 18964. (215) 257-8906

---

**FOR SALE:** Wire recorder, Webster-Chicago Model 78, with instruction manual and original carton - \$25. Bob Puttre, 637 Stratford Rd., Baldwin, NY 11510. (516) 223-9667

---

**FOR SALE:** 1918 Marconi Victor course in wireless telegraphy; six double-faced records with instructions in container. Signal Elec. Mfg. practice key and buzzer. Bunnell leg key. Brandes headset. E.F. Johnson sounder. Two old Willard Battery jars. All items for \$175 plus UPS. Nelson J. Christenson, 15 Vinebrook Ave., Cornwall-On-Hudson, NY 12520. (914) 534-5615

---

**WANTED:** RCA Victor Service Data Books 1939, 1941, 1942. (Three red books). Gilbert Smith, 248 South 36th St., San Diego, CA 92113-1613. (619) 233-8646

---

**WANTED:** Will pay generous amt. for a Philco 70 chassis and spkr. or a power transformer Part No. 5117 used in 70 and Model 470, also tuning cond. Part No. 03076 ALS. Pay generous amt. for photo and schematic of chassis and cabinet of a Showers radio also want 2 Pilot No. 391 transformers. Rudy Hoffart, 19380 Newton Ave., Cleveland, OH 44119. (216) 531-4697, call collect, 10 pm except Mon. and Fri.

---

**CLASSIFIED ADVERTISEMENTS**

---

**WANTED:** Wavelength tuning cards and regenerator unit for Marconiphone V2A. Also correct valves. Richard Russell, 6519 Eddinghill, Palos Verdes, CA 90274. (213) 541-1019

**FOR SALE/TRADE:** Majestic Model 996 (not Park Avenue 886), but similarly unusual. **WANTED:** E. H. Scott. Jack Sacra, 1720 Solomon Rd., Charlottesville, VA 22901. (804) 293-9985

---

**WANTED:** Philco remote control for 39-55, 39-116, 40-216, etc. Curt Kimball, PO Box 1191, Sterling, CO 80751. (303) 522-2557, eves.

---

**WANTED:** Sentinel L-284 grille insert (R.T.G.A., p. 79). Emerson 511. Steve Veney, PO Box 129, LaPaz, IN 46537. (219) 784-2890

---

**FOR SALE:** Radios: Zenith Super VIII complete, needs restoration - \$225. Gloritone 27S, excellent, original, working - \$175. GE B-1 battery set, VGC, w/tubes - \$125. Guild Country Belle wall phone radio, excellent - \$175. Philco 70, completely restored - \$395. Jefferson cathedral, very small, vgc - \$125. Radio Nurse, bad front, good back and handle, has remote unit - \$250. Speakers and misc.: 1955 N.O.S. miniature TV banks, painted metal, very nice - \$10 ea. 1948 Zenith metal dealer window sign, measures 11"x15", very attractive and colorful - \$75. CBS Radio Service sign, double sided, measures 2'x4', very nice - \$75. Floor standing loop antenna from the 1920's, stands 4' high, vgc - \$150. Peerten radio speaker, cathedral shaped, vgc, working - \$60. Atwater Kent E-3 drum speaker, vgc, working - \$40. Snyder horn speaker, vgc, working - \$75. Tubes: Meyers audions with sockets open - \$50 ea. WD-11, bakelite base, tipped, good - \$45. WD-11 BB, tipped, open - \$25. WX-12, good - \$20. UV 199 BB, tipped, used - \$25. (4) C-299V BB, tipped, N.I.B. - \$35 ea. (13) C-299V, bakelite base, N.I.B. - \$20 ea. (11) UX 199, bakelite base, used, good - \$12.50 ea. (8) UV 199, bakelite base, used, good - \$12.50 ea. CX 220, bakelite base, used, good - \$12.50. (2) UX 200, bakelite, used, good - \$7.50 ea. (7) UX 200, bakelite, N.I.B. - \$15 ea. 01-A's, bakelite, used - \$7.50 ea. (2) 01-A's, bakelite, N.I.B. - \$15 ea. Common number Arcturus blue tubes, used, good - \$10 ea. **WANTED:** Paragon IIIA cabinet. Chassis for Westinghouse RC. Grebe RORD. Bells for Trimm small and large horns. Majestic horn bell. David Christensen, 1732 W. Minnehaha Ave., St. Paul, MN 55104. (612) 646-0908

---

**WANTED:** Radio Doings, a weekly radio program guide published in Los Angeles during the 1920's. Thanks. Mike Taylor, 225 No. Adlena Dr., Fullerton, CA 92633. (714) 871-6665

---

**WANTED:** Bearcat 210XL scanner schematic with voltages. Will buy or copy. Richard L. Evans, PO Box 491, Souderton, PA 18964. (215) 257-8906

**CLASSIFIED ADVERTISEMENTS**

**WANTED:** Edu-Kit by Progressive Electronics Co. Remember "Build 15 Radios at Home" ad ca. 1950? Must be complete, any condition. Big premium if N.I.B. Richard L. Evans, PO Box 491, Souderton, PA 18964. (215) 257-8906

**HELP:** Need schematic for Knight (Kit) receiver R-55A. I will pay all costs plus schematic cost. Karl Stegman, 4 Cresthaven Dr., Belleville, IL 62221. (618) 234-7992

**— WANTED —**

**PICTURES FOR PHOTO REVIEW PHOTOS MUST BE SHARP IN DETAIL A SHORT DESCRIPTION IS A MUST! SEE PHOTO REVIEW PAGES FOR ADDITIONAL INFORMATION**

**WANTED:** Chassis, dial glass and two butter-scotch knobs for FADA Model 652 Catalin (R.T.G.A., p. 67) or your radio with broken cabinet. Also need white tuning knob for RCA Model PCR-5 Pepsi cooler radio and bottle opener. Looking for black bakelite base and knobs for Colonial Globe radio. Jimmy Downes, 607 East 12th Ave., Covington, LA 70433. (504) 893-7057

**WANTED:** Centralab control stock, particularly AK-7 and AK-11 shafts and ABT series pots. Turntable for Victor RE-75, dial glass for same. **FOR SALE:** Rider's 1-18, missing Vol. 14 — \$195. Philco RMS Yearbooks 39, 40, 41 — \$25/set. QST's '26, '27, '28, '42, all with covers, vgc, 20 issues total — \$47/all. Want bandswitch knob for Zenith 3000 Trans-Oceanic. Mark Oppat, 167 Caster, Plymouth, MI 48170. (313) 455-4169

**ABBREVIATIONS USED IN CLASSIFIED ADS**

amp. — Amplifier  
 BC — Broadcast  
 BO — Best Offer  
 ca. — circa  
 ea. — each  
 (F.O.S., p. ?) — See page ? in the book *Flick of the Switch*  
 LSASE — A Long SASE (see SASE)  
 LW — Long Wave  
 MO — Money Order  
 N.I.B. — New In Box  
 N.O.S. — New Old Stock (Unused, that is new, original, vintage items)  
 O.T.B. — *Old Timers Bulletin* published by Antique Wireless Assoc. (A.W.A.)  
 OB — Original Box

ppd. — Postage Paid (included in price)  
 PS — Power Supply, also "pwr sup"  
 rcvr. — Receiver  
 SASE — Self Addressed Stamped Envelope (Suggest sending a long, No. 10, envelope)  
 SW — Shortwave  
 UPS — United Parcel Service  
 (V.R., p. ?) — See page ? in the book *Vintage Radio*  
 w/ — with  
 w/o — without  
 xcvr. — Transceiver  
 xfmr. — Transformer  
 xmtr. — Transmitter  
 xstr. — Transistor

BY POPULAR REQUEST

**CLASSIFIED ADVERTISEMENTS**

**FOR SALE:** Attention, collectors! Patent date reference chart determines the approximate date of your collectibles and antiques from the last patent number. Invaluable aid at tag sales, flea markets, etc. \$2 ppd. Jo-Gam Enterprises, PO Box 81, Shelton, CT 06484

**WANTED:** Need tubes: 307A finals - 959 acorn, also R1004/GRC-109 receiver. Ted Althof, KA3TVH, 504 East 9th Ave., Tarentum, PA 15084. (412) 224-0905

**WANTED:** Pilot TV-37 3" TV. Excellent or better condition. Richard L. Evans, PO Box 491, Souderton, PA 18964. (215) 257-8906

**FOR SALE:** Philco cathedrals: Model 60, nice original condition, plays — \$135. Model 51, untested — \$110. AK Model 46, interior exc., outside good, plays — \$75. Gloritone cathedral, nice original, untested — \$135. All above plus UPS. Philco 37-640 console — \$95. Pick up only. **WANTED:** AK 447 tombstone. John Hayes, 27 Highland Dr., Henniker, NH 03242. (603) 428-3053

**FOR SALE:** Boston Scale & Machine Model 105 Tuner and Model 100 detector/2-step amplifier. (V.R., p. 117). Very rare set! Both in exc. cond. except has repro tag and repro knobs on tuner. Transformers original and OK. Asking \$800. Photos available for an SASE. John V. Terrey, 498 Cross St., Carlisle, MA 01741. (508) 369-9770

**WANTED:** RCA Victor 101 tombstone. Crosley 182 AC/DC set with chrome grille. Steve Baron, 435 Park Ave., Lexington, KY 40502. (606) 269-2832

**WANTED:** RME-70 manual or copy, DB-20 and manual or copy. V. Gildersleeve, 202 Burkle, Poteau, OK 74953. (918) 647-9044

**FOR TRADE:** Bremer Tully Compact Jr. Counterphase, Crosley 51, 4-tube Zenith tombstone or Kennedy XXX-435 chassis complete original for an Emerson Q236 chassis. Bob Barnes, 511 N. Chestnut, Monroe City, MO 63456. (314) 735-2945

**WANTED:** Novelty AC and transistor radios; this is an affair of the pocketbook; it's your love versus my money. I may not be that rich, but I will be more than reasonable. Lee and Carolyn Bruton, 1202 So. Pratt Parkway, Longmont, CO 80501. (303) 651-0254

**FOR SALE:** Stewart-Warner 206DC AC/DC wood tabletop AM/SW — \$30 plus UPS. Please call first. Doug Thomas, Rt. 8, Box 257A, Live Oak, FL 32060. (904) 658-2378, eves.

**WANTED:** National SW-3, also SW-2, -4, -5. Excellent or better condition. Richard L. Evans, WA3FOQ, PO Box 491, Souderton, PA 18964. (215) 257-8906



## DISPLAY ADVERTISEMENTS

# 1990 Vintage Radio Calendar

*Return to the days of yesteryear  
with the 1990 Vintage Radio  
Calendar.*

*Classic radios from the 1920s –  
1950s are beautifully showcased  
in this 12-month full color  
calendar.*

*Historical, technical and other  
interesting information  
accompanies each vintage radio.  
Large date boxes provide ample  
space to jot down all those timely  
reminders. The 1990 Vintage  
Radio Calendar is certain to be a  
treasure in any home or office.*



**TO ORDER:** Send Check or Money Order for \$11.45 per calendar (incl. shipping & handling)  
WI Residents please add 5% sales tax (\$.45 per calendar)

**TO:** Boyce Publishing Corporation  
Dept. ARC  
P.O. Box 23420  
Milwaukee, WI 53223-0420

Please allow 4 to 6 weeks for delivery.



# DISPLAY ADVERTISEMENTS

## COLLECTOR'S BOOKS

Antique Radio Restoration & Price Guide .....	\$12.95
Seventy Years of Radlo Tubes & Valves By John W. Stockes (SC) .....	19.95
Radio Enters The Home, 128 pgs. 8½ X 11 .....	12.50
Radio Equipment & Supplies - 168 page reprint .....	12.50
1927 Radlo Encyclopedia - Gernsback, 179 pgs. ....	11.95
Crosley Radio Catalog, circa 1923, 32 pages .....	4.50
Westinghouse Apparatus, circa 1920's, 8½ X 11 .....	4.00
Short Wave Radio Manual Official 1934, 260 pages .....	12.95
How To Repair Old-Time Radios .....	9.95
Vintage Radio Handbook, 263 pages, 1000 illus. ....	11.95
Flick Of The Switch 1930-1950, 312 pgs., 1000 illus. ....	11.95
Most Often Needed Diagrams 1926-1938, 600 models .....	11.95
1921-1932 Collector's Guide, 264 pg., 9,000 models .....	11.95
Atwater Kent Radio Parts Book, 24 pages, Model 9 plus 50 speakers .....	4.95
The William B. Duck Co. Catalog #18 (1921) - 256 Pgs. ....	18.95
Radio Collector's Directory & Price Guide, 321 pages. ....	15.95
Wireless & Electrical Encyclopedia, The Electro Importing Co. ....	4.95
Early Wireless by Anthony Constable, HB. ....	15.95
Instructions for Operating Grebe Radios, 64 pages pocket size .....	4.95
Radlola Super - Hetrodyne 2nd Harmonic .....	4.95
Atwater Kent Instruction Book Vol. II, an exact color duplication of the original .....	8.95
Grebe Synchronphase Instruction Manual, 70 pages, an excellent reproduction .....	10.95
Official Radio Service Manual, 1930 Gernsback, 8½ X 11, 356 pages .....	19.95
The Story of Nipper and His Master's Volce, 64 pages, illustrated .....	6.50
Radio Collectors Pin (high metal relief and porcelain) .....	4.95
RASCO Radio Parts - Catalog #18, 145 pgs. ....	8.95
Radio Station Treasury 1900-1946 — 8½X11 176 pgs. ....	12.95
The Continuous Wave-Technology and American Radio, 1900-1932, by Hugh G. J. Alken, 588 pgs. ....	20.95
Syntony & Spark, by Hugh G. J. Alken, 368 pgs. ....	14.95
Televlson, The Story of Scanning Disc Television — E. E. Taylor, 52 pgs. ....	4.95
Radio Speaker Encyclopedia, 8½X11, by Floyd A. Paul .....	11.90
Fifty Years of Radio, March 1938 issue of Hugo Gernsback's famous publication - 134 pgs .....	14.95
Radio Manufacturers of the 1920's, Vol. 1, Very Large, by Alan Douglas .....	19.95
Radios — The Golden Age, 120 pgs. Full Color, by Phil Collins .....	14.95
David Sarnoff, biography, HB, 372 pages .....	14.95
Man of High Fidelity, <i>Edwin H. Armstrong</i> , PB, 272 pages .....	3.50
The Golden Age of Radio in the Home, <i>HB John Stokes</i> .....	NEW 24.95
Thomas A. Edison - A Stroke of Luck, PB, 562 pages .....	NEW 13.95
Saga of the Vacuum Tube by <i>Gerald Tyne</i> , 494 pages .....	15.95
Tesla's Experiment, PB, 162 pages .....	8.95
Tesla Coll Secrets, PB .....	6.95
The Complete Talking Machine, 8½X11, 183 pages .....	NEW 19.95

**All orders under \$35.00 enclose \$1.50 postage — Orders over \$35.00 shipped free.**

WE HAVE DETERMINED THAT ALL OF THESE PUBLICATIONS ARE THE VERY BEST OFFSET QUALITY.  
ALLOW 3-4 WEEKS FOR DELIVERY

ORDER FROM  
**Antique Radio Club of America, Inc.**  
 Charleston West Virginia Area Chapter  
 4204 Thorn Apple Lane  
 Charleston, West Virginia 25313

REVISED 3/30/89

PICTURE THIS SCENE:

BOB: What I miss on this island most Bing, is that old portable radio we used to have when we took the girls to the beach. Remember, it had a good tone.

BING: Wouldn't do you any good Bob, You can't buy batteries for those old radios any more.

BOB: I'd heard that, but I also heard that a company in St. Louis sells a converter that lets you operate those set's on ordinary batteries that are available just about anywhere.

BING: Sounds to good to be true. What else do you know about it?

BOB: Well I also heard that the converter costs less than a couple of those big battery packs would if they were available today and that the recommended batteries cost around five dollars and last for months.

BING: Say Bob, I'm impressed. We've got to get one of those. Wow!

\*\*\*\*\* \* \*\*\*\*\*

Yes sir! You should have one too. For any battery set that calls for a 1.5 to 9 volt "A" battery and a 67 1/2, two 45's or a 90 volt "B" battery. Sets like the Zenith Transoceanics and other suitcase portables, so popular in the late 30's and the 40's and 50's. Also farm radios using similar batteries. The converter goes in the battery compartment along with 5 or 6 "D" cells, which are the only batteries required to operate the radio. Power to the converter and radio are controlled by the receiver switch but absolutely no radio modifications are required. The converter measures approximately 3 x 5 x 2 inches. It has plug connections and can be easily transferred from one radio to another. Suitable battery holders ( not supplied ) are recommended for installation.

For sets requiring a 1.5 volt "A" battery, order # CVA-1 \$79.95  
For sets requiring a 6, 7.5 or 9 volt "A" battery, order # CVA-9 \$79.95

Installation kit: (consists of battery holders, connectors  
and instructions ) order # BK-1 \$9.95

ORDER FROM:

Include \$3.50 for UPS. ANTIQUE ELECTRONIC SUP. TESLA ELECTRONICS CO.  
688 W. FIRST ST. 835 BRICKEN  
===== ST. LOUIS, MO 63122  
ENJOY THOSE RADIOS!!! TEMPE, ARIZONA, 85281 (314) 822-1748  
(602) 894-9503







# COMING RADIO EVENTS

## ARKANSAS - July 6

ANTIQUÉ RADIO COLLECTORS CLUB  
OF FT. SMITH - CLUB MEETING

Ft. Smith, AR - Red Cross Bldg.  
1709 S. Greenwood - 7:30 pm

Info: Wanda Conatser - (501) 646-7147

## ARKANSAS - July 13

ARKANSAS ANTIQUÉ RADIO CLUB  
CLUB MEETING

Little Rock, AR - The Auditorium  
S.W. Bell Bldg., 120 W. 8th St. - 7 pm

Info: Tom Burgess - (501) 565-1750

## MARYLAND - July 15

MID-ATLANTIC ANTIQUÉ RADIO CLUB  
MEETING

Laurel, MD - Applied Physics Lab  
Johns Hopkins Univ. - 7:00 pm

Info: Joe Koester, 249 Spring Gap South  
Laurel, MD 20707 - (301) 725-4229

## WASHINGTON - July 16

PUGET SOUND ANTIQUÉ RADIO ASSOC.  
MEET - MEETING - MUSEUM OPEN

North Seattle, WA - Ronald School  
N. 175th St., 1-mile W. of I-5

11 am: Swap Meet - 1 pm: Meeting

Info: Max Kaplan, 14902 84th Ave. Ct. NW  
Glg Harbor, WA 98335 - (206) 851-4187

## MICHIGAN - July 21-22

MICHIGAN ANTIQUÉ RADIO CLUB  
EXTRAVAGANZA '89

Lansing, MI - Dillon Inn, 525 W. Canal Rd.  
For room reservations: (517) 627-8381

July 21: 8 am - Open-Air Flea Market  
Programs - Women's Luncheon  
7 pm - Equipment Auction

July 22: Dawn-Noon - Open-Air Flea Market  
Programs - Luncheon & Contest Awards  
2 pm - Donation Auction  
50/50 Raffle Both Days

Equipment Contest: "Radios of the Ages"

Info: Jim Clark, 1292 Starboard  
Okemos, MI 48864 - (517) 349-2249

## N. HAMPSHIRE - July 22

NEW ENGLAND ANTIQUÉ RADIO CLUB  
SWAP & SELL MEET - AUCTION

Nashua, NH - Resurrection Center  
449 Broad St. - Rt. 3, Exit 6, 1 1/2 ml. West

Swap & Sell Meet: 8-12 am  
8 am - Early Admission - \$5  
9 am-noon - General Admission - \$1

Contests: TRF Receivers  
Pre-World War II Crystal Sets

Auction - Free Admission  
12 noon-1 pm - Preview  
1-5 pm - Auction

Public Welcome - Catered - Free Parking  
(Reservation required to sell)

Info: Marty Bunis, 422 Day St.  
Manchester, NH 03104 - (603) 623-8996

## ILLINOIS - Aug. 10-12

ANTIQUÉ RADIO CLUB OF ILLINOIS &  
ANTIQUÉ WIRELESS ASSOCIATION  
RADIOFEST '89

Elgin, IL - Holiday Inn  
345 River Rd. - (312) 695-5000  
Exit Rt. 31 South on I-90

Friday Evening Awards Banquet  
Special Zenith Exhibit - Donation Auction  
Afternoon Presentations - Auction

3-Day Flea Market - Old Equipment Contest  
Ralph Muchow's Radio Museum

Info: Jeff Aulik, 803 N. Chicago Ave.  
Rockford, IL 61107 - (815) 399-1902

## TEXAS - Sept. 8-10

VINTAGE RADIO & PHONO. SOCIETY  
ANTIQUÉ WIRELESS ASSOCIATION  
VRPS/AWA CONVENTION '89  
Duncanville, TX - Holiday Inn Southwest  
Old Equipment Contest - Two Auctions  
Flea Market - Awards Banquet - Swapfest  
Info: VRPS, PO Box 165345, Irving, TX 75016

Non-members welcomed at all meets!  
Admission charged at some meets.  
Mention A.R.C. when contacting clubs!  
Enclose a SASE when requesting info.

Attend a club event near you and learn, meet others in  
the hobby, and perhaps find an item for your collection!

## RADIO CLUB LISTINGS

*CLUBS: Send antique radio club and meet information to A.R.C. for free listing here, as space permits. Sorry, we don't have room for hamfests. Always send a SASE when writing to clubs!*

**Antique Wireless Association (AWA).** P.O. Box "E", Breesport, NY 14816. Pub: *The Old Timer's Bulletin*, quarterly. Dues: \$10.00. National and regional conventions. Museum.

**Antique Radio Club of America (ARCA).** William Denk, 81 Steeplechase Rd., Devon, PA 19333. Pub: *The Antique Radio Gazette*, quarterly. Dues: \$12.00. National and regional conventions. Regional chapters.

**Antique Radio Club of Illinois (ARCI).** Carolyn Knipfel, Route 3, Morton, IL 61550. Pub: *ARCI News*. Dues: \$12.00. Annual Radiofest and additional meets each year.

**Antique Radio Collectors Club of Ft. Smith, Arkansas.** Wanda Conatser, 7917 Hermitage Dr., Ft. Smith, AR 72903. Monthly Meetings.

**Arkansas Antique Radio Club (AARC).** Tom Burgess, P.O. Box 9769, Little Rock, AR 72219. Pub: None. Dues: \$5.00. Monthly meets.

**London Vintage Radio Club (LVRC).** Ron Underhill, 69 Southdale Rd., St. Thomas, Ontario, Canada N5R 1C1. Newsletter. Dues: \$10. Six meetings yearly. First swap meet Sept. 9.

**Michigan Antique Radio Club (MARC).** Larry Anderson, 3453 Balsam NE, Grand Rapids, MI 49505. Pub: *MARC Newsletter*, quarterly. Dues: \$10. Annual Extravaganza and other quarterly regional meets.

**Mid-Atlantic Antique Radio Club (MAARC).** Joe Koester, 249 Spring Gap South, Laurel, MD 20707. Pub: *MAARC Newsletter*, monthly. Dues: \$12.00. Monthly meetings.

**New England Antique Radio Club (NEARC).** Marty Bunis, 422 Day St., Manchester, NH

(Continued in next column)

## MARK YOUR CALENDAR

July 21-29 - London, England Trip - AWA

July 6 - AR, Ft. Smith - ARCCFS \$\*

July 13 - AR, Little Rock - AARC \$\*

July 15 - MD, Laurel - MAARC \$\*

July 15 - CA, San Francisco - CHRS Meet

July 16 - WA, Seattle - PSARAS\*

July 21-22 - MI, Lansing - Extravaganza '89\*

July 22 - NH, Nashua - NEARC Meet\*

Aug. 10-12 - IL, Elgin - ARCI Radiofest '89\*

Aug. 12 - CA, Los Altos - CHRS Swap Meet

Aug. 19 - NY, Elma - NFWA/AWA

Sept. 9 - Ontario, Foldens - LVRC Swap Meet

Sept. 8-10 - TX, Duncanville - VRPS/AWA\*

Sept. 10 - MD, Laurel - MAARC Picnic/Auction

Oct. 4-8 - NY, Canandaigua - AWA

Oct. 21 - NH, Nashua - NEARC Meet

Nov. 5 - NY, Canandaigua - AWA

Nov. 11 - CA, Los Altos - CHRS Swap Meet

\*See expanded listing this month.

\$ Monthly Meeting.

031C4. Dues: \$5.00. Pub: *Escutcheon*, quarterly. Quarterly meets and auctions.

**Pittsburgh Antique Radio Society, Inc. (PARS).** David W. Kraeuter, Secretary, 506 E. Wheeling St., Washington, PA 15301. Pub: *The Pittsburgh Oscillator*, quarterly. Dues: \$10. Quarterly meetings.

**Puget Sound Antique Radio Association (PSARA).** M.A. Kaplan, 14902 84th Ave. Ct. NW, Gig Harbor, WA 98335. Pub: *The Horn of Plenty*, monthly. Dues: \$15/yr, \$12/yr for out-of-state.

**Vintage Radio & Phonograph Society (VRPS).** Larry Lamia, P.O. Box 165345, Irving, TX 75016. Pubs: *The Reproducer*, quarterly.

*Sound Waves*, monthly. Dues: \$13.50. Monthly meetings, Spring Auction, Annual Convention.

(PLEASE MENTION A.R.C. WHEN WRITING CLUBS)

## BUSINESS CARD ADS - \$15.00 FOR 3 MONTHS

WANTED - OLD RADIOS BEFORE 1930



- Early Crystal Sets
- Battery Radios
- Horn Speakers
- Radio Magazines & Books
- Radio Tubes & Parts
- Early Radio Advertising

G.B. Schneider Phone: 216-582-3094  
9511-23 Sunrise Blvd. North Royalton, Ohio 44133

## ANTIQUE RADIO REPAIR

30's & 40's RADIOS

DAUGHERTY ELECTRONICS

1736-A Elaine Road  
Columbus, Ohio 43227  
(614) 239-1282

REPAIR RESTORATION REFINISHING

ANTIQUE RADIO

Al Rozenstraten  
Res: 842-6095  
Bus: 893-1028

SPRINGDALE TV, 16782 SPRINGDALE, HUNTINGTON BCH, CA

Blade & Cage

Electric Brass Desk  
Fans Bought, Sold, Restored



M.L. YOUNG  
4200 Sunshine Rd.  
Miami, FL 33133

(305) 661-6245

**BUSINESS CARD ADS — \$15.00 FOR 3 MONTHS**



**Antique Radio Service**  
**REPAIR BUY RESTORE SELL**  
*Woodwork a Specialty*

RICHARD FOSTER  
 12 SHAWMUT AVE.  
 COCHITUATE, MA 01778

508 - 653 - 2418

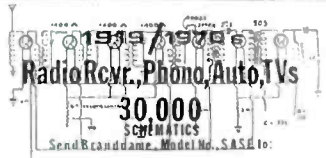

**J. Earl Scaramella**  
 P.O. Box 1  
 Woonsocket, RI 02895-0001

**RADIO DIVISION**

215-435-8501  
 PA Transportation Co., Inc.  
 P.O. Box 112  
 Hellertown, PA 18055

mail-order TUBES

\$1/list

**SPECIAL PURPOSE TUBES PICTURE TUBES**      **SEMI-CONDUCTORS RECEIVING TUBES**

**Donna L. O'Connor**

(201) 751-2591  
 (201) 471-8120

824 MAIN ST.  
 BELLEVILLE, NJ 07109



- \* Radios
- \* 78 RPM Jukeboxes
- \* 78 RPM Turntables
- \* Radio Tubes
- \* Shure
- \* Needles & Cartridges
- \* Astatic
- \* Needles & Cartridges
- \* Parts & Accessories

(815) 229-6900

**ASTATIC**

**VINTAGE RADIO And Electronics**

**SCOTT A. WEBSTER**  
 Owner

1414 - 17th STREET  
 ROCKFORD, IL 61104



**ANTIQUE JUKEBOXES, MICROPHONES**

Deco & Deluxe Console & Table Radios  
 Broadcasting, Hi Fi & Recording equipment  
 16" Transcriptions & Blank recording disks  
*Buy, Sell & Trade.*

Robert Van Dyke 516-728-1327  
 2 Squires Ave., East Quogue NY 11942



Sales

Service

*Radiophile*  
**The Vintage Radio Store**

Stephen Depres P.O. Box 020775  
 Brooklyn, N.Y. 11202-0017 (718) 625-7254  
 Call For Appointment

**TUBES & STUFF**

EXTENSIVE STOCK OF NEW AND GOOD USED TUBES ETC.

Send \$1 (stamps O.K.) - Refundable for latest lists *now...*

**DON DIERS** — 4276-AB2 N. 50 St.  
 Milwaukee, WI 53216-1313

**Ed Romney N4DFX**

Expert old radio repair by former  
 Massachusetts Radio School Instructor  
 Broadcast Engineer  
*Reasonable rates*

Box 386 - Drayton, SC 29333  
 (803) 583-3081

**DAN'S SCHEMATIC SERVICE**

RADIO DIAGRAMS  
 1921 to 1951 - \$2.50 PPD  
 T.V. DIAGRAMS  
 1938 to 1952 - \$3.50 PPD  
*Send make and model number or chassis layout sketch with make and tube types if model number is unknown, to: P.O. Box 53081 San Jose, CA 95123*

**VINTAGE TV and RADIO REPAIR and RESTORATION**  
**ELECTRONICS and COSMETICS**

DAVID B. JOHNSON



(312) 484-2743



2336 S. KENILWORTH AVE.  
 BERWYN, IL 60402 • (312) 484-2743

**CLASSIC RADIO SERVICE**

**Repair and Restoration**

55 60 70 80 90 100 120 130 140 150

25 Maple Rd. - Box 764  
 Woodacre, CA 94973

415-488-4596

**CLASSIC RADIO SERVICE**



**BUSINESS CARD ADS — \$15.00 FOR 3 MONTHS**

**WANTED**

**RADIO — WIRELESS**  
Pre-1925  
**ELECTRICITY — TELEGRAPHY**  
Pre-1900

Books, Magazines, Autographs, Catalogs, Ephemera  
One Item or Entire Collection

**New Wireless Pioneers**  
6270 Clinton, Elma, NY 14059 USA  
(716) 681-3186

(201) 794-9636



P.O. Box 1883 • South Hackensack, New Jersey 07606

**ANTIQUA RADIO REPAIR**

*Repair - Restore - Buy & Sell*  
Schematic Diagrams \$2.00

**DAMASKE ELECTRONICS**

S74-W16834 Janesville Road  
Muskego, WI 53150  
Phone: (414) 679-0838

VOGUE PICTURE RECORDS

Bought \* Sold \* Traded  
Paying market prices

Michelle Manganaro  
PO Box 535  
Coopersburg, PA 18036  
(215) 965-5538

50 years **CHUCKS** of service!

Any Tube Radio Repaired and  
Guaranteed to work good.  
\$26.00 plus large parts & UPS

**CHUCKS**  
167 LYNN DRIVE - PO Box 598  
NEW HAVEN, WV 25265 - PH (304) 882-2220

**RADIO-TV TUBES**

Dick Bergeron  
Box 311  
Essex Center, Vt. 05451  
Tel: 802-879-0611

**FREE PRICE CATALOG**

*Over 1400 types, all new in original boxes*

Are You Looking For Antique Radios, Parts,  
Tubes, Schematics, Etc.?

For Free Flyer, a 2-Stamp LSASE is required to insure a  
response to your request. Send to:

*Olde Tyme Radio Company*

2445 Lyttonsville Road, Suite 317, Silver Spring, MD 20910

Wish to contact us by phone?

Our number is (301) 585-8776.

Please call 10 am to 10 pm (Local Time)

**Antique Radios**



**David & Nancy Snow**  
P.O. Box 6352  
Jackson, MI 49204  
(517) 750-4992

We Buy, Sell, Repair

**ARBE - III Battery Eliminators**



*The Incomparable* **Caphart**

**Kenny Bunny**

*Exotic Radios & Phonographs*  
*Pasadena Antique Center*

480 SO. FAIR OAKS  
PASADENA, CA 91105

RES. (213) 733-7733  
(818) 449-7706



VINTAGE MECHANICAL &  
MUSICAL ANTIQUES

**MEMORY MACHINES**  
KURT NAUCK, PROP.

1726 W ALABAMA  
HOUSTON, TEXAS 77098  
PHONE (713) 522-5389

**SCHEMATICS 1920-1960**  
**RADIO/TV/HAM/MISC.**

**FULL DESCRIPTION OF SET IN**  
**FIRST LETTER PLEASE - \$3.50 EA.**

**ALTON H. BOWMAN**  
RD2 (CHAPIN VLG.)  
CANANDAIGUA, NY 14424



**OLD**

**JUKE BOXES D'EPOCA**  
**SLOT MACHINES - PINBALLS**  
**VENDING MACHINES - RADIOS**

VIA DUCHESSA JOLANDA T3/A  
10138 TORINO ITALY  
TEL 011/39-11-7713048

# Order Now - Shipping in August

## Volume 2!

### Radio Manufacturers of the 1920's

BY ALAN DOUGLAS

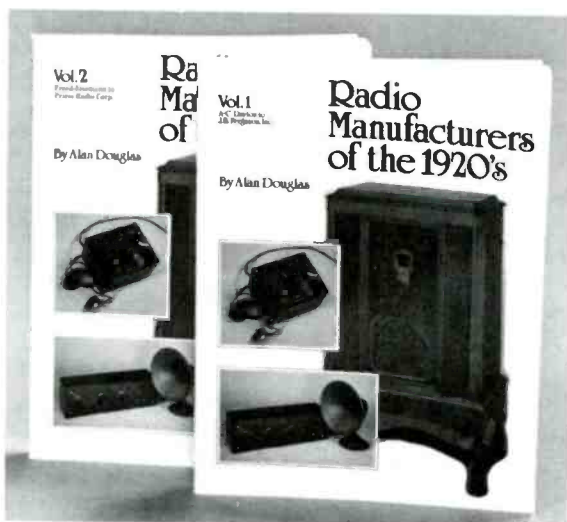

**"The definitive book on American broadcast receivers of the 1920's"**

**40 more pages covering radio manufacturers than in Volume 1.**

**Volume 2 covers:** Freed-Eisemann - Eisemann - Freshman - Garod - Gilfillan - Grebe - Howard - Jones (Lester/Melco) - Jones (Jos.) - Kellogg - Kennedy - King - Kodel - Kolster - Leutz - Magnavox - Majestic - Marti - Metro - Klitzen/Michigan - Midwest - Mu-Rad - Murdock - Music Master - Neutrowound - Operadio - Ozarka - Pfanstiehl - Philco - Pilot - Priess

**Volume 2: \$24.95 (\$39.95 in hard cover) – Shipping: Mid-August.**

*(Watch A.R.C. for possible delays in shipping schedule)*

**Volume 1 covers:** A-C Dayton - Adams Morgan - Air-Way - All-American Mohawk - American Bosch - Amrad - Amrad S-Tube - Apex - Atwater Kent - Bremer-Tully - Browning- Drake - Clapp-Eastham - Crosly - Cutting & Washington - Day-Fan - DeForest - Eagle - ERLA - FADA - Federal - Ferguson

**Volume 1: \$19.95 (\$29.95 in hard cover) – Shipping Now!**

*U.S. Orders: Enclose \$1.50 shipping per order if under \$35.00. Mass. residents please add 5% sales tax. Allow 2-4 weeks to receive order after shipping date.*

*Foreign Orders: Surface shipping per book: \$6.00 (\$8.00 hardcover); allow 2-3 months.*

**Send order with payment to:**

**Antique Radio Classified, P.O. Box 2, Carlisle, MA 01741**

# NEW!

## GUIDE TO OLD RADIOS POINTERS, PICTURES AND PRICES

BY DAVID & BETTY JOHNSON

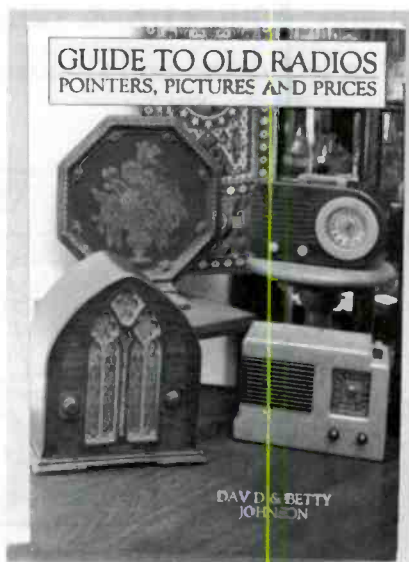

**350 Illustrations – 3300 Prices – Completely New Book**  
**Perfect for the beginning collector!**  
**Useful for the experienced as well!**

From early crystal sets to AC sets, David and Betty Johnson explore the evolution of radio from its infancy to its heyday. The authors help collectors solve the difficulties of identifying and dating radios and provide pointers on where to find the best buys.

The price guide comprises half of the book and includes 3300 collectible radios and related items, with model names and numbers, descriptions, and price ranges for each. Also included in the price guide: amplifiers, speakers, test equipment, books & manuals.

**Price: \$16.95 – SHIPPING NOW!**

*U.S. Orders: Enclose \$1.50 shipping per order if under \$35.00. Mass. residents please add 5% sales tax. Allow 2-4 weeks to receive order after shipping date.*

*Foreign Orders: Surface shipping per book: \$5.00; allow 2-3 months.*

**Send order with payment to:**  
**Antique Radio Classified, P.O. Box 2, Carlisle, MA 01741**



**The Antique Radio Club Of Illinois  
and  
The Antique Wireless Association**

*proudly announce*

**RADIOFEST '89**

**August 10th, 11th, & 12th**

**The Holiday Inn Holidome and Convention Center  
Elgin, Illinois**

**Holiday Inn – Elgin  
345 River Road  
Elgin, IL 60120  
(312) 695-5000**

*ALL PETS MUST BE LEASHED*

Exit Route 31 South  
on I-90 Northwest Tollway  
30 minutes west of Chicago



RADIOFEST has established itself as one of the premier antique radio meets in the country. This year will be no exception, as RADIOFEST '89 is again held at the Holiday Inn Holidome and Convention Center in Elgin, Illinois, one of the finest convention facilities in the state. Please plan to attend and join us in an opportunity to add to your collection, view exhibits, participate in the contest or flea market (all policed by uniformed security personnel) and visit Ralph Muchow's fabulous radio museum. We welcome the AWA as co-host.

If you have any questions or comments, contact any of the RADIOFEST '89 committee:

Jeff Aulik  
803 N. Chicago Ave.  
Rockford, IL 61107  
(815) 399-1902

Dave Johnson  
2336 S. Kenilworth  
Berwyn, IL 60402  
(312) 484-2743

Dan Gustafson, c/o GSA  
211 E. Ontario  
Chicago, IL 60611  
(312) 664-1999

Carl Knipfel  
Rt. 3-Veterans Rd.  
Morton, IL 61550  
(309) 266-9440

**SEE YOU IN AUGUST!**

# PRELIMINARY RADIOFEST '89 EVENTS CALENDAR

## Thursday, August 10th

- 6 am - 5 pm Registration in Rcom 103  
10 am - 5 pm **Special display:** Zenith  
2 pm Presentation: Joe Rausch on  
Cabinet Reveneering

## FLEA MARKET IN WEST PARKING LOT ALL DAY

## Friday, August 11th

- 6 am - 5 pm Registration in Room 103  
10 am - 5 pm Tours of Ralph Muchow's Museum  
10 am - 5 pm **Special Display:** Zenith  
9 am - 10 am Contest Registration  
10:15 - 11:30 am Contest Judging  
11:30 am Contest Viewing (Contest entries must be  
removed before 4 pm)  
2 pm Presentation: Dan Gustafson - 50 Years  
of Electronic Television  
5 pm - 6 pm Cocktails  
6 pm Buffet Banquet

## FLEA MARKET IN WEST PARKING LOT ALL DAY

## Saturday, August 12th

- 6 am - Noon Registration in Room 103  
10 am - Noon **Special Display:** Zenith  
10 am Donation Auction  
11 am Presentation: Communications Receivers  
by Joe Schroeder

## FLEA MARKET IN WEST PARKING LOT UNTIL NOON

# OLD EQUIPMENT CONTEST

## Categories:

- |                        |                            |
|------------------------|----------------------------|
| 1. Telegraphy          | 7. Cathedral               |
| 2. Television          | 8. Smallest Radio          |
| 3. Advertising         | 9. Consoles                |
| 4. Art Deco:           | 10. Crystal Detectors      |
| a) Catalin & Plastic   | 11. Battery Sets:          |
| b) Mirror              | one to three tube          |
| c) Chrome & Wood       | 12. Battery Sets:          |
| 5. Novelty             | four or more tubes         |
| 6. Pre-1962 Transistor | 13. Pre-1920 wireless gear |

## Registration Information

If you need accommodations, contact the Holiday Inn at Elgin (312) 695-5000 or (800) HOLIDAY, and mention that you are with RADIOFEST '89.

	Fee	No.	Total
Family registration (\$10 at gate)	\$ 8.00		
Fri. Nite Awards Banquet (including tax & tip)	\$19.00		
	Total Enclosed		\$

Deadline for pre-registration is July 21, 1989

Make check payable to Antique Radio Club of Illinois (ARCI)

Mail to: Carl Knipfel, Rt. 3-Veterans Rd., Morton, IL 61550

Name \_\_\_\_\_

Street \_\_\_\_\_

City/State/Zip \_\_\_\_\_



# EXTRAVAGANZA '89

Sponsored by the  
Michigan Antique Radio Club

July 21 & 22, 1989

Dillon Inn  
525 W. Canal Road  
Lansing, Michigan 48917  
(517) 627-8381



## EVENTS

*See Reverse Side For Times and More Details*

- ★ Two-Day Open-Air Flea Market
- ★ Hospitality Area
- ★ 50/50 Raffle Both Days
- ★ Programs
- ★ Equipment Auction, Conducted by Steve Waldron
- ★ Donation Auction
- ★ Equipment Contest (Categories are:)

### "RADIOS OF THE AGES"

- |                      |                     |
|----------------------|---------------------|
| 1. Pre-1920's Radios | 3. 1930-1939 Radios |
| 2. 1920-1929 Radios  | 4. 1940-1949 Radios |

— Trophies & Ribbons For Winners —

\* Please, no consoles (as space is limited)

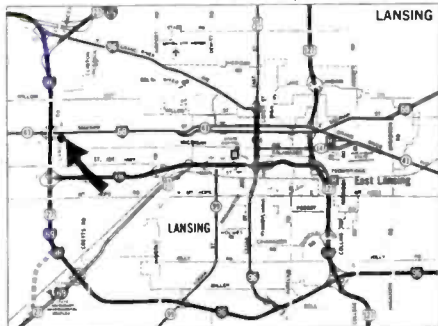

For More Information, Contact:

Jim Clark  
1292 Starboard  
Okemos, MI 48864  
(517) 349-2249

**COME JOIN US AT OUR FOURTH ANNUAL  
EXTRAVAGANZA EVENT**

# EXTRAVAGANZA '89

## PROGRAM SCHEDULE



### Friday, July 21

- 8 am - on Registration  
\$10.00 ... MARC Member seller's fee  
15.00 ... Non-member seller's fee  
1.00 ... Non-seller's admission fee
- 8 am - on OPEN-AIR FLEA MARKET  
8 am - 10 pm Hospitality Area (Motel Lobby)  
Noon - 1 pm Women's Luncheon  
1 pm - 6 pm Auction Check-in of Equipment  
1:30 pm - 2:30 pm The Development of Stereo Radio, Oran Sauder  
2:30 pm - 3:30 pm Primitive Amateur Radio Presentation &  
Demonstration, Bruce Tanner  
6 pm - 6:45 pm Open Forum Club Meeting  
7 pm Friday's 50/50 Raffle Drawing  
7 pm - conclusion Auction, Conducted by Steve Waldron  
*10% fee on all items sold.*

### Saturday July 22

- Dawn - Noon OPEN-AIR FLEA MARKET  
8 am - 10 am Contest Check-in  
8 am - 3 pm Hospitality Area (Motel Lobby)  
9 am - 10 am Collecting German Radios, Eric Marx  
10 am - 11 am The Historical Roots of Radio, Joe Turner  
10 am - 11 am Contest Judging (Popular Vote)  
Noon - 1 pm Luncheon, at which contest awards will be  
announced  
1 pm - 3 pm Contest Room Viewing  
2 pm Saturday's 50/50 Raffle Drawing  
2 pm - conclusion Donation Auction  
*An Auction of Those Items You Have  
Donated to the Club at the Meet*

Tear off and Return Lower Section

## EXTRAVAGANZA '89 REGISTRATION FORM July 21 & 22, Lansing, Michigan

- ( ) MARC members seller's registrations @ \$10 ea. \_\_\_\_\_  
( ) Non-members seller's registrations @ \$15 ea. \_\_\_\_\_  
( ) Non-seller's admission fees @ \$1 ea. \_\_\_\_\_  
\* ( ) Saturday Luncheon Reservations @ \$6.<sup>50</sup> ea. \_\_\_\_\_

TOTAL ENCLOSED: \_\_\_\_\_

Name \_\_\_\_\_

Address \_\_\_\_\_

City/State/Zip \_\_\_\_\_

Make check payable to MARC.

Mail form and check to: Larry Anderson, 3453 Balsam NE, Grand Rapids, MI 49505

\* You must make reservations for the Saturday luncheon by July 1st to be assured of a meal at the luncheon.

# COLLECTOR BOOKS AVAILABLE FROM ANTIQUE RADIO CLASSIFIED

☞ BOOKS MARKED WITH "☞" ARE THE MOST POPULAR AND ARE  
ESPECIALLY RECOMMENDED FOR NEW COLLECTORS!

- Antique Radios – Restoration and Price Guide, Johnson. *Beginner's introduction to collecting antique radios, how radios work, radio repair & restoration.* 1982. 99 pgs. ....\$14.95
- Auto Radio: A Romantic Genealogy, Matteson. *Information, photos & ads from the early days of the automobile radio through the 1950's.* 316 pgs., hardcover. ....\$34.95
- Communications Receivers, Moore. *Information on 700 receivers by 50 manufacturers produced from 1932 to 1981 are included in this 112-page book. 100+ radios are illustrated.* ....\$14.95
- Crosley Catalog (reprint). *1923 catalog covering the early Harko through the XX models.* 32 pgs. \$4.50
- ☞ Flick of the Switch, McMahon. *The standard photo reference guide for collectors for radios from the 30's to the 50's. 1000+ photos of radios.* 263 pgs. ....\$11.95
- Golden Age of Radio in the Home, Stokes. *Covers New Zealand radios.* 168 pgs., hardcover ...\$24.95
- Great Radio Personalities (reprint). *Black & white portraits and info on all the favorites from the golden days of radio – Abbott & Costello, Baby Snooks, and more.* 128 pgs. ....\$11.95
- ☞ Guide to Old Radios – Pointers, Pictures & Prices, Johnson. *The latest book by the Johnsons describes the history of radio and includes 350+ photos and a price guide to 3300 sets.* 128 pgs. . NEW \$16.95
- Hertz: The Beginning of Microwaves, Bryant. *Photos and descriptions of Hertz's apparatus and experiments. A book prepared for the IEEE Hertz Centennial exhibit.* 50 pgs. ....\$15.00
- Los Angeles Radio Manufacturing, Paul. *History of radio manufacturers in the Los Angeles area from 1922 to 1942.* 88 pgs. ....\$10.50
- Most Often Needed 1926-38 Diagrams (reprint). *Circuit diagrams for 600 of the most common radios of the period.* 240 pgs. ....\$11.95
- Official Radio Service Manual (reprint). *100's of pre-1930 circuits & notes.* 356 pgs. ....\$19.95
- Radio Collector's Guide, McMahon. *Listing of 9,000+ radios made by some 1200 companies from 1921 to 1932. Gives manufacturer, year, model name and other info. No photos.* 264 pgs. ....\$11.95
- ☞ Radio Collector's Directory/Price Guide, Grinder/Fathauer. *An introduction to collecting plus a price guide. Over 8500 models are listed, many with current prices.* 321 pgs. ....\$15.95
- Radio Horn Speaker Encyclopedia, Paul. *Listing of horn speakers for over 320 manufacturers for the 1920's. Expanded information on ten manufacturers.* 80 pgs. Over 145 photos. ....\$11.90
- Radio Enters the Home, RCA (reprint). *1922. The Aeriola Jr. and RC era.* 128 pages. ....\$12.95
- Radio Equipment & Supplies, Robertson-Cataract Electric Company (reprint). *1922 catalog of radios, accessories and other equipment. Includes RCA, Clapp-Eastham & others.* 168 pgs. ....\$13.95
- ☞ Radios-The Golden Age, Collins. *Full-color book on the colorful Catalin and bakelite radios from the late 1920's to the early 1940's.* 128 pgs. ....\$14.95
- ☞ Radio Manufacturers of the 1920's, Vol. 1, Douglas. *The first of three comprehensive volumes. Vol. 1 covers A-C Dayton thru Ferguson.* 225 pgs. .... (hardcover: \$29.95) \$19.95
- ☞ Radio Manufacturers of the 1920's, Vol. 2, Douglas. *Second of three comprehensive volumes. Freed-Eismann thru Priess. Order now for August shipping.* .... NEW (hardcover: \$39.95) \$24.95
- Radio Craft – 50 Years of Radio (reprint). *Reprint of Golden Jubilee issue of 1938.* 144 pgs. ....\$14.95
- S. Gernsback Radio Encyclopedia (reprint). *1927 classic encyclopedia on radio.* 175 pgs. ....\$11.95
- Saga of the Vacuum Tube, Tyne. *Standard reference to vacuum tubes prior to 1930. Several 100 photos.* 495 pgs. ....\$15.95
- 70 Years of Radio Tubes and Valves, Stokes. *The story of the radio tube from the laboratory to the commercial market.* 256 pgs. Over 400 photos and illustrations ....\$19.95
- ☞ Vintage Radio, McMahon. *The standard photo reference guide for collectors for radios prior to 1930. Over 1000 pictures.* 263 pgs. ....\$11.95
- Westinghouse Catalog (reprint). *Early 20's catalog featuring the RA-DA and other early Westinghouse apparatus.* 8 pgs. ....\$4.00

All books are softcover except those marked "hardcover".

Enclose \$1.50 shipping per order for U.S. orders under \$35. Foreign orders – write for quote first. Send payment with order. Allow 3 to 4 weeks for shipping. Mass. residents please add 5% sales tax.

ANTIQUE RADIO CLASSIFIED  
P.O. Box 2, Carlisle, MA 01741

(ARC: July 89)



**PLEASE CALL  
 FOR MY LATEST OFFERS ON . . .**

**TV'S** Pre World War II . . . paying OVER \$1000.  
 Even for kits!

- Old or Unusual . . . 1940's-1960's
- Color . . . early 9", 15", 16", 19", 21" ROUND CRT's (1950's)

**RADIO-CATALINS**, chrome, unusual, World's Fair

- Mickey Mouse, Snow White . . . 1930's . . . paying \$1000.
- Sparton Mirror Radios . . . paying OVER \$800 (\$15,000 for console!)
- Novelty . . . tube and transistor types

**WE ALSO BUY** Stereo "3D" cameras, viewers, View Master,  
 oak and mahogany furniture, black and chrome Deco items,  
 1950's unusually shaped lamps, tables, furniture.

Member: MAARC/ARCA/MARC/PARS/AWA/VRPS/IHRS/NFWA/NZVRS/NERC/GNYVWA/HRSA

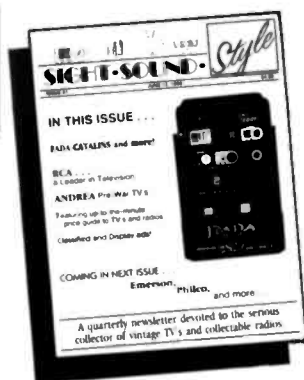
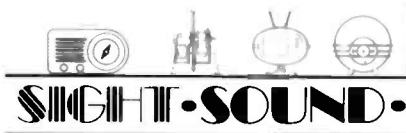

**IF YOU COLLECT,**  
 buy or sell Televisions . . .  
**SUBSCRIBE TODAY!**

**IF YOU COLLECT,**  
 buy or sell CATALIN, novelty  
 or mirror radios . . .  
**SUBSCRIBE TODAY!**

**SIGHT SOUND STYLE** is a 16-page quarterly magazine. Each issue features articles, pictures and prices of early Televisions! **PLUS CATALIN** and novelty radios are described, pictured and priced! Lots of Classified and Display ads offering TV's and great radios!

1 Year First Class . . . **\$14**      1 Year Overseas . . . via airmail . . . **\$34**

Annual price guide (Shirt-pocket Index and pricing-October) . . . **\$10**

**CLASSIFIED ADS . . . ONLY 15¢ PER WORD!**

**SSS P.O. Box 2224**

S. Hackensack, NJ 07606



# CLASSIFIED ADVERTISING POLICY

**ONE FREE 20-WORD AD** for subscribers in each issue; additional words are 10¢ each. See details below. All classified ads must be received (not just postmarked!) by the ad deadline. Late ads are held for the following issue. Please enclose correct payment with all ads. Stamps or cash are OK for small amounts. (Canadian and other foreign advertisers, please see "Payment" on page two for methods.) "Free words" cannot be accumulated from month to month; "free words" must be "taken" when ad is submitted.

Please write each ad on a separate sheet of paper, especially when included with other A.R.C. correspondence. A 3" x 5" card is suggested if the ad is short. Ads may be sent in advance; again, write each ad on a separate piece of paper and indicate the month (or two months) you want the ad to run.

**Please write legibly and use both capital and small letters. Do not use dashes between words.** Some numbers and letters can look alike, for example 1, l and I (the number one, the capital i and the small l.) Write the following characters clearly (especially in model numbers): 1, l and I; 0, O, o, Q and D; r and n; 6, b and G; V, U, u, v and Y; A and R; S, S and s; 2, Z and z. We try to correct spelling errors, so when using an uncommon word or manufacturer which looks similar to a common word or manufacturer, note it so that we do not "correct" it. Editor's comments are in [brackets].

**Advertising is accepted only for items related to antique radios, communication, electricity, etc. All items must be described fairly; reproductions, reprints and not-original items must be identified as such. Advertisers agree to respond promptly to inquiries and orders, and to resolve problems promptly if the buyer is not satisfied.**

Publisher reserves the right to edit ads without notification to the advertiser and to reject ads for any reason. Publisher is not responsible for errors due to illegibly written ads or for any other reason; if requested, the ad will be run in the next available issue at no charge for errors made by A.R.C. All ad rates and details are subject to change by the publisher. See page two for additional information.

## CLASSIFIED AD DETAILS

Classified ads must have a standard heading such as **WANTED, FOR SALE, FOR TRADE, FOR SALE/TRADE, SERVICES, MESSAGE, HELP**, etc. This heading is the only bold or all-capitalized words allowed in the ad. Capitalize only manufacturer names, model names, etc. Wanted and For Sale ads are mixed together to encourage the reading of all ads, including the Wanted ads. This standard ad format makes scanning the ads easier.

Before writing your ad, please look over the ads in a recent issue of A.R.C., and try to write your ad in the same style.

To encourage varied content of the ads, multiple insertions of the same classified ad are limited to two successive months. (To run an ad continuously, use a boxed classified or display ad.)

### Classified Ad Rates per Month

Subscribers:

First 20 words: **FREE\***

10¢ per word for extra words over 20 plus

10¢ per word for a shaded ad (count all words including free words).

\* Subscribers may take 20 free words on only one ad each month.

Non-Subscribers:

20¢ per word plus

10¢ per word for shaded ad.

Please do not forget to send in the extra 10¢ per word when your classified ad runs over the free 20 words; your payment will be appreciated, and it will help to keep A.R.C. healthy.

## BOXED CLASSIFIED AD DETAILS

*Deadline: 5th of the month!*

Boxed classified ads can run unchanged for three months or more. No words are free. Ads may be shaded and may include bold and all-capitalized words freely. The ad need not begin with For Sale, etc. Boxed classified ads are placed with the display ads on the lower portion of the page.

Minimum run is 3 months, prepaid.

### Boxed Classified Ad Rates per Month

Nonshaded ads:

12¢ per word for all words,\* none free, plus

10¢ per word for each bold word plus

10¢ per word for each all-caps word.

Shaded Ads:

22¢ per word for all words\* plus

10¢ per word for each all-caps word.

Note: All words in shaded ads are bold.

Non-Subscribers:

Add 15¢ per word to above costs.

\*Three of the total words can be bold-all-caps at no extra charge.

## PHOTO & DRAWING DETAILS

*The deadline for ads with drawings or photos is the fifth of the month.*

Drawings and photos are encouraged as the response to your ad is much larger and the reader knows better what you want or are selling. Send in your drawing or photograph and A.R.C. will reduce it or enlarge it as needed.

### Photo and Drawing Rates per Month

\$5.00 per month for each photo or drawing

## IMPORTANT — COUNTING WORDS — IMPORTANT

The standard headings: **WANTED, FOR SALE**, etc., count as one word each time used in an ad. Name, address and (one) telephone number, count as 6 words, regardless of length. Ham call letters and business name can be included in the 6 words and do not count extra. (Note: "Jim, (111) 111-1111" also counts as 6 words.) So, please include complete name and address in your ads.

Each additional word, abbreviation, model number or number group, extra telephone numbers, etc. count as one word. Hyphenated words count as two words.



# ANTIQUE RADIO CLASSIFIED



A.R.C., P.O. Box 2, CARLISLE, MA 01741  
RETURN POSTAGE GUARANTEED

SECOND CLASS  
POSTAGE PAID  
at Carlisle, MA

# TO:

POSTMASTER: Deliver Promptly

CLASSIFIED AD  
DEADLINE JULY 10TH