



ANTIQUE RADIO CLASSIFIED



VOLUME 6

JANUARY 1989

NUMBER 1

RASCO HAS IT

WABC WJZ WOC WHO W2XK W2XJ W2XU W2XV W2XW W2XV W2XU W2XJ W2XK

RASCO RADIO PARTS

CATALOG **NO 17**

Radio Specialties Inc.

RASCO 96-98 PARK PLACE NEW YORK RASCO

THE NATIONAL PUBLICATION FOR BUYERS AND SELLERS
OF OLD RADIOS AND RELATED ITEMS - PUBLISHED MONTHLY

ANTIQUE RADIO CLASSIFIED

Antique Radio Classified (ISSN:8750-7471) is published monthly, 12 times per year, by John V. Terrey, 498 Cross Street, P.O. Box 2, Carlisle, MA 01741. Telephone: (508) 369-9770, 9:00 AM to 9:00 PM only, thanks.

Annual subscription rates within the U.S. are \$19.00 by Second Class mail and \$28.00 by First Class mail.

Annual foreign rates. By air: Canada - \$30.00; Mexico - \$28.00; Other foreign countries - \$55.00. Surface mail to Canada, Mexico & other foreign countries - \$25.00 (Surface delivery to countries other than Canada may take two or more months and cannot be guaranteed.)

Two-year subscriptions are twice these rates and receive an extra month. Sample issues are available free on request.

© Copyright 1988 by John V. Terrey.

POSTMASTER: Send address changes to Antique Radio Classified, P.O. Box 2, Carlisle, MA 01741.

STAFF

Publisher and Editor:	John V. Terrey
Publishing Staff:	
Dave Crocker	Betsy Dumka
Chris Frederickson	Bobby Lyman
Scott J. Young	
Founding Publisher/Editor:	Gary B. Schneider
Contributing Writers:	Richard L. Arnold
Norman S. Braithwaite	Dave Crocker
Alan S. Douglas	Mike B. Feher
Richard C. Foster	Jim Fred
Frank Heathcote	David W. Kraeuter
Jim Kreuzer	Harry Poster
Ron Ramirez	Henry Rogers
Gil Schlehman	Gary B. Schneider
Howard Stone	Ralph Williams
John P. Wolkonowicz	

PURPOSE. Antique Radio Classified is published for people involved in the radio collecting hobby. Its purpose is to stimulate growth of the hobby through the buying, selling and trading of radios and related items, and to provide a monthly forum for the interchange of ideas and information.

WRITING TO ANTIQUE RADIO CLASSIFIED.

All correspondence should be sent to:

Antique Radio Classified
P.O. Box 2, Carlisle, MA 01741.

Your ads, renewals, letters, etc. can be handled faster and more efficiently if (1) each is on a separate piece of paper, and (2) your name, address and SUB# is written on each.

Unfortunately, A.R.C. is not staffed to answer letters with questions about antique radios or requests for advice. However, A.R.C. does solicit letters of interest to its readers and will publish them as space permits. A.R.C. assumes that permission is given for publication of all correspondence re-

ceived unless otherwise indicated.

GUARANTEE. You may cancel your subscription at any time and receive a pro-rated refund of that part of your subscription not yet mailed. If errors to ads are made by A.R.C., the ad will be run in the next available issue, free, upon request.

PAYMENT. Please send in full payment with your order or ad. A.R.C. does not carry accounts; all subscriptions, ads, etc. must be prepaid. Pay in U.S. funds; checks drawn on a U.S. bank or money orders are preferred. Make check out to "A.R.C." U.S. stamps or cash are OK for small amounts. Canadian payers may send a Canadian check in U.S. funds, but must add \$1.00 (U.S.) for conversion costs. On request, subscriptions will be prorated to amount sent, minimum term is one year.

CHANGE OF ADDRESS. Please send us both your new and old address and notify us 4 weeks in advance of the change in order to receive uninterrupted copies of A.R.C. Include your old address, SUB# and expiration date along with your new address. Note when your new address is effective. Temporary address changes can be made also.

SUBMISSION OF MATERIAL. Antique Radio Classified welcomes and solicits information that pertains or relates to the radio collecting hobby. This may include material such as articles, upcoming radio events, meetings, radio books and publication reviews, new radio clubs and organizations, radio auctions and price reports, sources of old radio and restoration supplies, and any other material that would be of interest to the hobby. All material submitted should be typewritten and verified for accuracy. Unless prior arrangements are made, all submitted materials become the property of Antique Radio Classified and will not be returned.

MAILING OF ISSUES. A.R.C. is available by subscription in the U.S. either by First Class or Second Class mail (Second Class is the way most magazines are mailed). First Class copies usually are received by the fifth of the month; copies by Second Class mail, by the tenth. The mailing of First Class copies is staggered, with those living farthest away mailed on the first day, and local copies mailed the last day. All non-U.S. copies are mailed on the first day. All Second Class copies are mailed on the last day. Mailing is usually completed by the 25th of the month.

ETHICS. No person involved in the production of A.R.C. is to act on any information in the magazine until they receive their copy through the mail.

DISCLAIMER. The publisher is not responsible for any buying and selling transactions incurred, or for any other use of the contents of this publication.

Antique Radio Classified subscription rates, frequency of publication, content, size and ad rates and details are subject to change at any time by A.R.C.

DISPLAY AND BUSINESS CARD ADS - DETAILS AND RATES

The deadline for display and business card ad artwork, payment and repeat requests is the first of the month. Late ads will be run only if space and time permits. As artwork is reduced to 63% in the printing process, originals should be the artwork size listed below. Do not send in artwork on art board or negatives. Ads should be typeset or typed neatly with a carbon ribbon. If you want us to prepare your ad, include the one-time cost listed below for A.R.C. to make up the ad. Please read payment terms above. "Tear sheets" will be sent only for 1/2 and full page ads, if requested when ad is submitted.

Page	Artwork Size (send in this size)		As Printed (size in magazine)		Cost for 1-month	Cost for 3-months	Cost for 6-months	One-time Cost for A.R.C. to makeup Ad (if requested)
	H x W (inches)		H x W (inches)					
Full	11 13/16 x 7 1/2		6 5/8 x 4 3/4		\$70.00	\$189.00	\$355.00	\$24.00
1/2 H	5 1/4 x 7 1/2		3 5/16 x 4 3/4		35.00	94.00	178.00	12.00
1/2 V	11 13/16 x 3 9/16		6 5/8 x 2 1/4		35.00	94.00	178.00	12.00
1/4	5 1/4 x 3 9/16		3 5/16 x 2 1/4		18.00	48.00	91.00	6.00
1/8	2 5/8 x 3 9/16		1 5/8 x 2 1/4		9.00	24.00	46.00	3.00
Business Card	2 x 3 1/2		1 1/4 x 2 1/4		not avail.	15.00	28.00	2.00

The 3-month rates represent about a 10% discount, the 6-month rates, 15%. We have no agency discounts.

Photos should be at an 85 line screen; otherwise, add \$5.00 per photo for screening. (Do not glue photos to artwork; submit separately.) If you are confused by these requirements and terms, please write or call A.R.C. before beginning to prepare your ad. We will be happy to advise you on your ad ideas, estimate how much the ad will cost, recommend an ad size, etc.

We assume that advertisers want all ads which are submitted to run without delay; therefore, we will run the ad and bill for any additional work required for the ad to meet A.R.C.'s specifications. A late ad will be run beginning with the next month.

Advertising is accepted only for items related to antique radios, communication, electricity, etc. All items must be described fairly; reproductions, reprints and not-original items must be so identified. Advertisers agree to respond promptly to inquiries and orders, and to resolve problems promptly if the buyer is not satisfied.



ANTIQUE RADIO CLASSIFIED



EDITOR'S COMMENTS

This is *Antique Radio Classified's* 54th issue. This also is the 27th issue that I have published – one half of the total – from here in Carlisle, Mass. Over four years ago, Gary Schneider, the originator of A.R.C., stated the publication's philosophy, hoping that A.R.C. would "become the standard publication by which the collector can buy, sell or trade radio-related items on a large national basis." Today, with three times the readership of any other monthly publication in the hobby and with twice the number of ads, A.R.C. truly is the standard.

The lead article in this issue covers the Automatic Radio Mfg. Co. Although not a familiar name to many collectors, the company actually dates back to the early 20's. Wally Worth's fine article is on the popular Tom Thumb sets, which were made by Automatic Radio from the late 20's to the late 40's.

A new column – *Radio Ramblings...* – begins this month. Mike Adams, the current president of the Southern California Antique Radio Society (SCARS) and the producer of a PBS television series on collecting, introduces it. Although some may feel a negative tone in his article, it does give us food for thought about the rapid growth in the prices of more recent vintage sets. Additional reflective/whimsical-type articles are in line for future issues. Feel free to join the dialogue.

Two auctions are reported this month, one in New York and one in Massachusetts. Please remember that auction prices should not be considered current retail prices; they should be combined with other prices and information to determine the value of a set.

Jim Fred contributes the fifth article in his series *All You Need To Know About Repairing AC Radios*. This time he covers "Vacuum Tube Basics." In addition to simple series and parallel battery and tube connections, he presents a brief chronology of the evolution of tube types from the early battery set types, such as the WD-11, to the

AC/DC set series-wired tubes, like the 50L6.

Several of you noticed some problems with the "Battery Set Power Supply" article by John Eng last month. Page six of this issue includes corrections and comments.

One of those calling us to task on the power supply article was Orval Parker, who also sent in the suggestion for an inexpensive isolation transformer solution which we have included this month. Actually, Orval had sent in the idea some months ago, and we had misplaced it. Orval does have a little experience in the field since he built his first crystal set 66 years ago at the age of 15. Does this make Orval our oldest contributor?

I continue to receive reports of tragic experiences in buying and selling plastic radios. My conclusion is: **PLASTIC RADIOS DO NOT SHIP WELL and often do not survive.** With these radios, a relatively heavy chassis is attached to a brittle plastic cabinet by only a few screws; even if the radio is packed well, when the package is dropped (which it almost always is), the stress on the plastic cabinet where the radio chassis is attached often breaks the plastic at the screw holes. The same problem potentially exists with radios which have heavy components such as a chassis or speaker or where all components are mounted on the front panel. When shipping these radios, I urge: **REMOVE THE CHASSIS AND OTHER HEAVY COMPONENTS FROM THE CABINET, AND SHIP EACH PART SEPARATELY, DOUBLE BOXED.** Sellers, please use this shipping method; buyers, please insist on it!

Clubs, please note the *Radio Club Listings* published this month. If your club is missing or if there are any errors in your listing, drop us note ASAP, and we will add/correct your listing.

That's all for this first issue of the new year. A.R.C. thanks all of you for our success and pledges to continue service as the premier monthly publication for collectors of old radios.

Happy New Year!

John V. Terrey

OOPS

At times I feel like I am publishing a "What's wrong with this picture?" book when the mail arrives. With over 4000 readers, nothing gets by. A few things were "wrong" or at least misleading in the "Battery Set Power Supply" article by John Eng published in the last issue.

Please read the corrections/clarifications to the article on page six of this issue. Although the supply works as printed, one should note that the "C" output provides a positive voltage, not a negative one. In fact, the supply might be better called an "A, B and another B" power supply.

ON THE COVER

This is the cover of the 1927 catalog of the Radio Specialty Co. of New York City. The company advertised itself as "Radio's oldest, established exclusive radio mail order house. Our motto is 'Quick Shipment.' All orders are shipped within 24 hours. Quick, prompt, courteous service. We carry a larger variety of radio parts and findings than any other radio house in the country." The 100-page Catalog No. 17 boasted of 500 illustrations and 75 hookups.

Another Rasco catalog, No. 19 for 1929, appeared on the October 1986 cover of A.R.C.



WITH THE COLLECTORS

BY WALTER V. WORTH, 2 WEST ELM AVE., WOLLASTON, MA 02170

THE AUTOMATIC RADIO MFG. CO. AND THE TOM THUMB RADIOS

David Housman, A. J. Housman and John Grady formed the Automatic Radio Mfg. Co. in 1920. At first the company bought parts from newly-created RCA and others. First-year sales were \$10,000.

One of their first products was the battery-powered "Blue-bird," a one-tube set with two dials. Later came table or mantel sets of five and six tubes named "Arc," "Hudson" and "Liberty Bell" — all TRF's; the last two sold as chassis models only.

The first "Tom Thumb," shown in Figures 1 and 2, came in 1929 as a portable set in a black leatherette-covered wooden case about 12"x13"x8" deep with four tubes, built-in loop antenna and wooden horn speaker. The panel was a thin brass "antiqued" sheet the full size of the case. A, B & C batteries were placed in the bottom half of the case with Deco swirls and Tom Thumb engraved thereon. Tuning was by a single dial in the center, with rheostat on the right and antenna trim capacitor on the left. On-off switch and phone jack were also on the front panel.

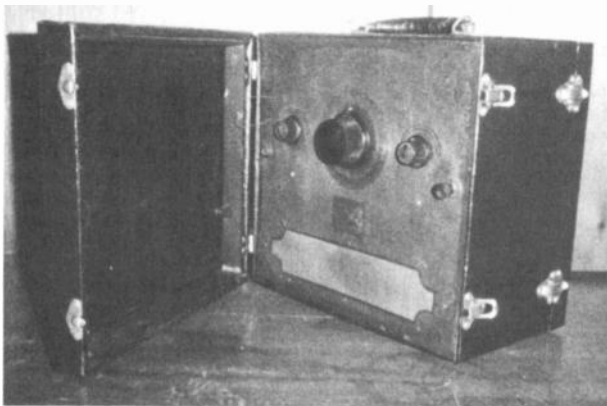

Figure 1. 1929 Tom Thumb four-tube portable

Three 199 tubes and one 222 S.G. RF tube were used in a simple TRF circuit powered by dry cells. The loop was in the hinged-front cover to afford a directional ability and complete with binding posts to connect an outside antenna if necessary.

There were also Tom Thumb Srs. and Tom Thumb Jrs., as well as table radios with built-in clocks.

The first automobile radio, powered by the car's battery and B batteries, for the 1927 Hupmobile was installed by David Housman. Thus began a long line of automotive radios pioneered by Automatic Radio.

In the 1940's, the Automatic Radio Mfg. Co. also made radios for bicycles (Figure 3), camera-radios (Figures 4 and 5), and three-way plastic-cased portables (Figure 6) that looked like the camera-radios, all named Tom Thumb. They also entered the television field (Figure 7).

Starting in the 50's, the company manufactured tractor radios for the working farmer, radio-phonograph combinations and many modern automobile radios and stereo cartridge players, until 1978.

They also made auto air

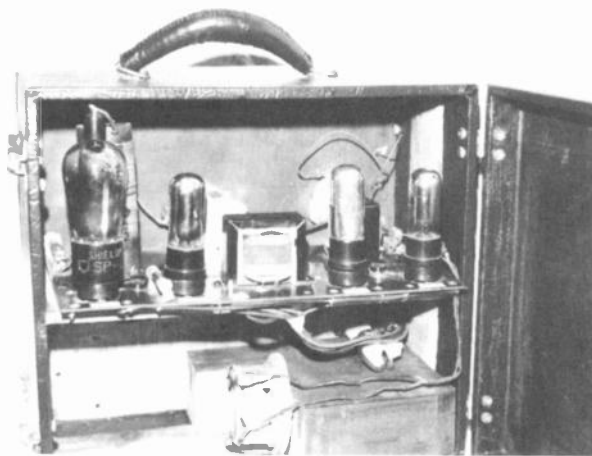

Figure 2. Interior view of 1929 Tom Thumb, showing one 222 SG, three 199's and wooden horn.

conditioners and home fans in their Vornado division. I bought one of their air conditioners in 1960, and installed it myself. I had to bring the car to the Melrose factory for inspection and warranty.

David Housman's sons - Edward L. and Herbert E. (who are twins), Frank M., and Charles J. - carried on the business from the 50's and 60's to the present.

The original company was located on the seventh floor of a building on "A" St., South Boston, in 1920, then moved to Canal St., Boston, again on upper floors. Then it moved to 122 Brookline St., Boston, on the fourth, fifth and sixth floors where it stayed in the 40's and 50's, employing nearly 1,000 workers. The last move was to 2 Main St., Melrose, Mass., where the company is to this day.

Before its 50th anniversary in 1969, the company had grossed over 40 million dollars in that year alone. Today Automatic Radio manufac-

tures only solid-state devices and test equipment, and imports from overseas most of the radios and stereos it sells.

I called on the company as a salesman of Gears etc. from the late 50's to the late 70's. I recently visited the Melrose factory and spoke with "Bert" Housman about the old days of radio and told him of my interest in collecting their older radios. He furnished me with a copy of their 1970 50th-year commemorative folder showing photos of many of their products and giving the history of the company. Included in the photos is the only known picture of the "Bluebird," their first product. The company has a small collection of some of its earlier radios and a few of the auto radios and stereo players, but has no museum as such.

I have found collecting Tom Thumb radios to be exciting as Automatic Radio is the only radio manufacturer I know which started as early as

(Continued on following page)

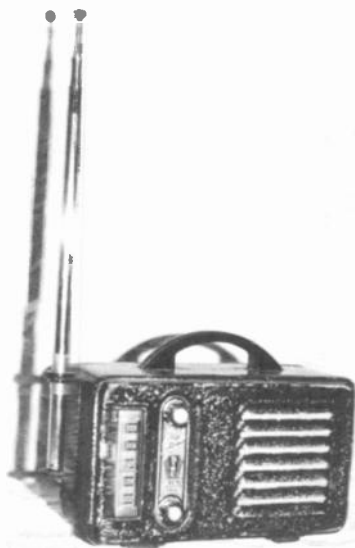

Figure 3. 1947 four-tube Tom Thumb bicycle radio in maroon crackle finish which attached to the handlebars.



Figure 4. Tom Thumb portable camera-radio, ca. 1947



Figure 5. Rear view of Tom Thumb camera-radio which used four miniature tubes.



Figure 6. Plastic 1948 portable by Tom Thumb with spring-loaded front door. It was powered by AC, DC or batteries.



Figure 7. Automatic Radio portable TV, Model P490, ca. 1948.

(Automatic Radio, continued)

1920 and continues in business today at a local site.

Canandaigua 1988 had several Tom Thumbs selling for up to \$400, indicating a healthy market. I still avidly collect Tom Thumbs and would welcome any additional information about the company or its products.

(Walter V. Worth, 2 West Elm Ave., Wollaston, MA 02170. 617 479-4512)

Battery Set Power Supply Corrections

A.R.C. seems to have more problems with its power supply articles than with any other topic. We received several letters and calls, pointing out discrepancies in the Battery Set Power Supply article by John Eng in last month's issue. Here is a sampling and a summary. (Editor)

Dear Editor,

I want to call your attention to errors in the battery set power supply by John Eng:

(1) In the battery radios I know, the "C" supply is negative with respect to ground. How can I get a minus voltage from this supply?

(2) In the metering circuit, the negative side is shown connected to the positive polarity. With positive on both sides of the meter, it will not read anything.

Arthur Obermeyer, St. Louis, Mo.

Dear Editor,

The supply published in the December issue cannot be used in the version shown to supply "C" voltage which must be of negative polarity. The supply produces a positive voltage instead.

Perhaps an isolation transformer may be applicable to this problem.

Orval Parker, Pocono Summit, Pa.

Dear Editor,

This circuit puts out "C+", not "C-".
Alan Douglas, Pocasset, Ma.

In summary:

(1) The supply will work as shown; however, all output voltages are positive.

(2) Traditionally, a "C" supply is one that supplies negative tube grid bias. The voltage yielded by the "C" part of the Eng supply is positive and would be better labeled as a second, lower, "B" voltage, perhaps for a detector tube.

(3) The meter switch diagram is misleading. The "C+" written on the schematic is the switch position label, not where the negative side of the meter should be connected; the negative side of the meter is switched to the "C" supply "ground" as shown by the ground symbol.

(4) The statement in the fourth paragraph — "All the supplies are independent from each other. Any grounding or DC return is to be done externally for greater flexibility for various power supply hookups." — is not entirely correct. The "B" and "C" outputs share a common negative connection; however, the "A" supply is independent.

(5) Note: There are two, independent ground symbols, and they are not connected together.

(6) The supply acts like an adjustable A-battery plus an adjustable B-battery with an adjustable tap.

(7) Missing is a negative "C" voltage which could be produced by a duplicate of the "A" voltage circuit, connected to a separate, third secondary low voltage winding. Neither negative or positive for this new "C" output should be connected to the grounds of the existing circuitry so that it would truly be independent.

This supply is close to what is needed; write in with your solution. (Editor)

RADIO RAMBLINGS...

Whither Radio Collecting?

BY MIKE ADAMS

It's time we all talk about this dream I've been having lately. Actually, it's more like a recurring nightmare. It begins innocently enough: I attend our quarterly swap meets, and as president of SCARS (Southern California Antique Radio Society), I count all the people there. Noticing that the meets get larger each time, I should be satisfied. Then I interact with fellow SCARS officers, and I am told the news that our club grows larger every year. I should be overjoyed. And I can't help but notice that the number of books, periodicals and organizations devoted to our hobby has exploded almost exponentially in just a couple of years. This should be a time of great euphoria in the radio collecting scene. But wait — something is wrong — I can't remember what comes next.

The next morning, I awake and spend much of the day wondering why a dream about all the recent successes in our hobby would leave me with such an empty feeling. How does this dream end, and what can I do about it? Will this be like Orwell's *Time Machine*? Will I see the future and be able to tell you about it, and if so, will you believe me?

It's nighttime again, and I am both looking forward to and dreading the inevitable. I'm looking forward to sleep; perhaps tonight is the night for the long-awaited conclusion to my strange dream, but I'm worried about what lies on the other side. Again, the same dream with thousands of people lining up to get into radio collecting. Our nationally televised swap meets are creating huge traffic jams. Special bookstores have opened that only sell books about collection, restoration and preservation of radio and television devices. Everybody wants to join in.

Now this is the time that I normally wake up, before the dream ends. Tonight will be different though. Tonight I will see into the future of radio collecting. Things are clear again. It is the year 1998. Yes, I am at the world's largest SCARS meet, in an equally large parking lot; some are old faces with many new ones. But wait — "Where are the radios?" I asked a long time fellow collector. "Well, you see," he started slowly, "some strange things happened back in 1988. Everybody wanted to collect so eventually all the radios were gone. So many people wanted just a few sets that the supply just ran out." I didn't want to hear more, but suddenly we were joined by more old friends who began to describe collecting in 1998 as just a social phenomenon where people trade photos of their sets and talk about the old days.

I learned so much more in my dream that night. I guess I was prepared to ask all the right questions. What about early wireless? Simple. After about 1988, not much traded hands be-

cause of two reasons. First, those who had early wireless sets knew about their great value and scarcity; thus, they kept them and passed them on to their children or to one of the major museums. And second, after acquiring such valuable early gear, these collectors lost interest in the clubs and periodicals because, clearly, there were no more wireless to be found.

What about wooden broadcast receivers, both table models and consoles? I learned about another interesting but predictable turn of events. If you remember way back in the late 1970's, everybody was combing America's attics for these newly discovered treasures. Everybody in the fledgling hobby of radio collecting thought that a Philco cathedral or a nice Scott console would look nice in his home. Folklore had it that millions of these sets existed in barns, attics and basements, but sociologists have suggested that due to the great migration from the eastern states to the Sunbelt during the 1970's, much old furniture and radio equipment was pitched as grandma moved into her mobile home. There was some hope as late as 1987 that some of these sets might be restored, but most tackled were poorly restored. In fact, several restoration experts left the business in 1989, because the only sets available at swap meets had been "restored" at least three times and were beyond economical restoration. And the good sets were in the hands of people who were going to keep them.

There was a ray of hope for the collecting community in the mid-1980's; these sets were beyond the price of all but the wealthiest collector. I heard stories of how in 1989, one very wealthy person bought up every popular plastic set by paying prices you would not believe. He did this because these sets became *de rigueur* art objects for wealthy young professionals and commanded astronomical prices in upscale antique boutiques. The same thing happened to transistor sets by the early 1990's.

Although this dream was a bit hazy, radio collecting seems to be suffocating under the weight of its own success. Radios were a finite commodity, and the demand simply outstripped the supply.

Back to reality. I am starting an open forum on the state of radio collecting because I am convinced that in the rush to get that rare radio at any price, we do face the very real possibility of future extinction because of our success. I would like to hear from A.R.C. readers and to have A.R.C. print these letters and articles in future issues. I believe that because of A.R.C.'s tremendous readership, it should address these questions.

(Mike Adams, 112 Crescent Ct., Scotts Valley, CA 95066)

AUCTION REPORT

BOVINA CENTER, NEW YORK - NOV. 12, 1988

CONTRIBUTED BY PHILLIP W. PETRI AND RAYMOND CHASE

An antique radio collection of about 100 radios, test equipment and tubes was auctioned on November 12, 1988, at the Bovina Creamery, Bovina Center, New York. Auctioneers Chuck McIntosh and Bob Burgin of the McIntosh Auction Service conducted the sale. The few attending this poorly advertised auction came from quite a distance to the remote auction site on a very cold day. Of the under 25 bidders, only about 10 were active; generally, prices were low with a few surprises. Disposing of the 121 lots took nearly three hours.

Grebe Synchronphase MU-1, original manual, vg-exc., ca. 1925, works	\$100
AK Model E, round speaker, 1925, vg	45
AK 74 low boy console, fine cab., works vg	65
AK 20, no tubes, rust inside, fair	32.50
AK 40, metal case	10
AK 44, metal case	15
AK 70, high boy, fine cabinet, console	45
AK Model 74, low boy console, fine cabinet	55
Setchell Carlson Model 415 (116 chassis), white plastic, nice Deco, table	20
Westinghouse Columnair Jr. WR12, 1934, 11"x13"x54", wood, Deco style grandfather, vg	70
Crosley 25AW tombstone, 3-band, table, wood, cleaned and tubed, works, 4 knob	62.50
Philco 37-650 console, 4 knobs, 3-band, 1937, Deco dial, works	40
RCA 125 tombstone, tubes and cleaned, 3-band, 4 knobs, works	120
Farnsworth ET 066 wood table, 2-knob, fair ...	10
Imperial TRF, 1925, wood, bakelite, g	22.50
RCA T-80 wood table 3-band, 1939	22.50
Zenith 539 wood table 3-band	25
RCA Victor 28X wood table, 2-band, slide rule dial, fair	17.50
Philco D65 AC/DC portable, mirrored makeup case, teen radio from 50's g	12.50
Avalon table, early 30's	12.50
Emerson BA-20 table	10
Elect. Corp. of America table model 108, brown bakelite, 4 knobs, g	17.50
Zenith 49C2 table, bakelite	12.50
Westinghouse H-126 Refrig. radio, works	20
Zenith 602-614 Console-Tone wood table, Deco style	15
Wards Airline 64 BR 2-band, works, fair	15
Apex Neutrodyne, table, 20's, metal coffin	15
Crosley Show Box, 20's, metal, fair	20
Emerson BJ-214 two-band table, late 30's	30
GE wood table model w/push buttons	35
Philco small table, Deco, 30's, wood, nice trim, works, vg	50
GLF 571, brown plastic, no line cord, works, white grille, loctal tubes, vg Deco	22.50
Brandes speaker box, approx. 6x12x12", vg ..	14

Stromberg-Carlson 1200H table, bakelite, 40's ..	17.50
GE 200 table, 40's, bakelite, works	15
Motorola 61A table push button, brown bakelite, works	30
Emerson brown bakelite table, 3 knobs, works ..	32.50
Admiral red bakelite, AC/DC, portable, pop-up dial ..	10
Silvertone, console, 3-band, 30's Art Deco, rotary dial, works, g	75
Crystal set, home brew, breadboard, teens to 20's, kit, poor	35
Early 50's Pepsi machine transistor, g	22.50
Neufeld and Kuencke driver in bell-shaped paper mache speaker, about 6x6x8"	20
Firestone Air Chief 2-band push button, wood, 4 knob	10
Home brew battery set, 1920's, 3 good WD-12 tubes, clean	45
General Radio Type 358 wavemeter, with dovetail box, original calibration charts, 4 coils ..	17.50
Crosley 77 small low boy console, wood, 3 knobs, late 20's, g	45
Zenith 6S294 console, wood, fair	70
RCA 100A loudspeaker, ca. 1926	5
Emerson DM 331 wood table	10
Airline 62-40Z all wave 11-tube console, 25 Hertz, 4 knobs, slide rule dial, vg	25
Airline A32 console, 2-band, wood, works	60
U.S. Radio Co. (Marion, In.) 9B console, late 20's, wood, 4 knobs, vg	50
Automatic 612X table	15
AK L console, Model 70 chassis, vg	50
Westinghouse WR 29 small console, 2 band, Deco style, good shape	10
Airline 63-BF console, 2 band, 6-volt farm radio ..	12.50
Sparton wood table, 4 knobs & push buttons, poor ..	40
Silvertone 93W G1104C console, 3 band, fair	15
Philco plastic table	11
AK 70 console high boy, good original cond. ..	50
Miraco console, 9 tube, no speaker, fair	15
Small glass bank in shape of a 40's portable ..	11
Beolit European portable multiband, plastic, very nice	17.50
201A tubes, each	1-3
Boxes of misc. tubes	5 & 22.50
WD-11's, good filaments in orig. box. (2)	8
Sparton 567 console, wood, 3 knobs, Deco style ..	15
RCA 6T2 tombstone	27.50
Various table model radios, wood & plastic ..	1-7
Book "Edison Biography," late 20's	7
Book Radio Boys' "Trailing A Voice", w/dj	5
His Master's Voice Nipper embroidered linen ..	14
Pair of headphones	3

(Phillip W. Petri, Box 52, Cooperstown, NY 13326; Ray Chase, 1350 Marlborough Ave., Plainfield, NJ 07060; McIntosh Auction Service, Bovina Center, NY 13740)

PEABODY, MASS. - NOV. 19, 1988

CONTRIBUTED BY DAVE CROCKER

This was Garrett Auctioneers', Peabody, Mass., second Music Memorabilia Auction, consisting of radios, phonographs, TV's, electric games, organs, nickelodeons, music boxes, etc. Garrett Healey auctioned some 436 pieces in the almost-six-hour event.

Familiar radio collectors were in the minority although 180-200 bidders were present. Prices were somewhat on the low side, with a few exceptions and surprises (usually mailed-in bids).

A spring 1989 auction welcomes radio and phonograph consignments. A 10% buyer's premium and 5% Mass. tax was charged in addition to the prices below.

Box lot: misc. tubes of 30's	\$10
Box lot: Bristol horn bell and phonograph parts	32.50
Telegraph sounder	15
Philco vanity radio, red plastic	30
Miracle mike, boxed	10
American Bosch 5A	27.50
Silvertone push button, wood	37.50
Climax, Art Deco	70
Emerson leatherette portable	12.50
Sentinel wood push button	35
Philco Transistone, wood	20
Automatic, wood, 1939	12.50
Airchief, bakelite	27.50
Air Castle, batt. radio	20
Teletone, wood AM-FM	12.50
Bendix brown bakelite	22.50
AK Model 32	45
Philco Model 511	30
Halson cathedral, nice	70
Silvertone cathedral, SW/AM	90
AK Dynamic speaker for AK 55	30
RCA 100A speaker, (3), ea.	22.50
Crosley Super Musicone	40
AK Type E3 speaker, (2)	55 & 75
AK Type E2 speaker	37.50
Crosley Dynacone	40
Audiophone, wood Type 6	20
RCA 103 speaker, (2)	45
Thompson horn	75
Stromberg-Carlson wall cone Type 11, recovered ..	25
Chelsea Super 5, 3 dial	60
Grebe Synchrophase, no-chain-type (2) ..	150 & 130
Crosley 51 w/wood panel, missing parts	35
Freed-Eisemann NR-5, nice	80
RCA Radiola 13, no hood, (2), ea.	50
AK Type 37, (3)	80, 40 & 35
AK Type 44	50
Freshman Masterpiece, 3 dial, late model	70
Stewart-Warner 300	40
American Bosch Model 28	35
Radiola III, no tubes	52.50
Radiola III-A, no tubes	50
Radiola 17, no hood	35
Radiola 28, no antenna	60
Browning-Drake regenerator, nice	85
Peerless wood cathedral speaker	30
Newcomb-Hawley speaker	45
Crosley Show Box, knob missing	25
Devil's Dare pinball, works	325
16 metal Regina discs	50

Lafayette Superhet, 1937	55
Leatherette port. phonographs, (4)	15-30
Guild "Country Belle"	22.50
Wall phone radios, not Guild, (2)	10 & 15
DeWald 2-tone bakelite, tiny	60
Admiral 10" console TV, brown bakelite, nice100	
Philco Predicta Model G4242M, fair, crack	90
Admiral brown bakelite 7" table TV, nice	55
AK 1935 console, AM/SW	75
Majestic 50 with table, (2)	125
Philco 60 Jr. cathedral	115
Philco 20 Deluxe	150
Tom Thumb cathedral	120
Echophone cath., thumbwheel dial	130
AK console Type 52, metal	50
Zenith chairside	125
Philco 93B cathedral	80
Emerson cathedral, nice	120
Gloritone cathedral	95
Majestic cathedral	80
Zenith 8S-154 console	95
Eveready 52 console, repwood	50
Victor 245 consoles, (3)	35
Radiola console, tapestry front	45
AK 20C in console	90
Addison brown bakelite	75
Zenith port., like Trans-Oceanic, boat on cloth ..	45
Philco 55 console	50
Crosley grandfather clock, nice	225
AK grandfather clock, nice	425
Emerson 520 br./cream Catalin	80
Sentinel marbled br. plastic	35
Mickey Mouse, 1970's, plastic	65
Pepsi drink dispenser, transistor, plastic, 60's, w/leather strap [yes, 13-hundred dollars] ..	1,300
Westinghouse cold drink machine novelty	100
Westinghouse H-126 refrig. radio, (3) ..	60, 55 & 65
FADA Bullet, butterscotch, yellow, knob missing ..	350
Hopalong Cassidy, black bakelite	150
Tom Thumb Catalin, green	250
Emerson Mickey Mouse, Art Deco type, chrome ..	475
Bendix blk. & yellow Catalin	325
Mike radio, watts, plastic	195
Philco 19 cathedral	160
Bing Crosby Jr. jukebox	155
Dahlberg pillow radio	140
Edison Concert cyl. phono	1,450
Bally pinball machine, working, ea.	150
Zenith neon radio, TV signs, broken, pair	85
Edison Triumph cyl. phono	500
Victor 8 cyl. phono & case	600
Victor Monarch w/comp. horn	725
Victor Amberola	275
Large phono horns, brass, copper, painted, ea. ..	50-80
Perfected phono wicker cabinet	325
Columbia table disc Grafanola	140
Philco 80 cathedral	75
Zenith early push-button console, 1930	200
Victor VV-80 phono	100
Victor VV-13 table phono	170
Victor VV-X1, oak	175
Victor VV-XA	100
Victor VV-9C	135
Victor 420 orthophonic phono	75
Cecilian phono console	70



PHOTO REVIEW

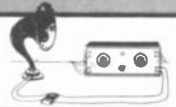

This column presents in pictorial form many of the more unusual radios, speakers, tubes, advertising, and other radio-related items (covering the years 1900-1950's) from our readers' collections. The photos are meant to help increase awareness of what's available in the radio collecting hobby. Send in any size photos from your collection. Photos must be sharp in detail, contain a single item, and preferably have a light-colored background. A short description must be included with each submitted item. Please note that receipt of photos is not acknowledged, publishing is not guaranteed, and photos are not returned.



UNUSUAL TUBE - The construction is quite similar to that of the Audiotron. The filament is connected to a candelabra base. The lead for the double filament protrudes at the base. (Bob Deuel - Ashland, OR)



TUNG-SOL NEON SIGN - This colorful display piece with red and blue neon on a black background advertises Tung-Sol tubes. (Bill Weber - Melba, ID)

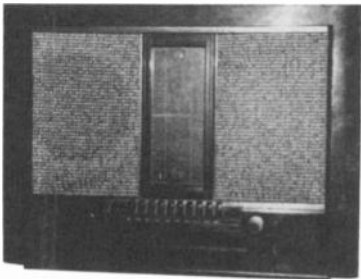

PHILIPS AACHEN SUPER D-63 - It uses motorized tuning. Tubes include: EF13, ECH11, AF3, AL4, AF7, ABC1, AZ1, EM11. It was built on June 24, 1939. (Eric Marx - Grand Blanc, MI)



PHILCO TOMBSTONE - Found in my grandmother's attic some 20 years ago, it required replacing the line cord. It played then, and it plays now. (John V. DiLiddo - Biddeford, ME)



KODEL SR - The Kodak Radio Corp. of Cincinnati, Oh., made and sold this loudspeaker as an exact replica of a transmitting microphone used in broadcasting stations of 1925-26. It used a new ingenious snail-shell horn that was to eliminate vibrations and distortions. Two units were available. The smaller one (the Kodak Jr.) sold for \$15. The larger one (the Kodak Sr. pictured) sold for \$5 more. (Richard Arnold - Lone Grove, OK)

PHOTO REVIEW



KIDDY TELEVISION - This German-made wind-up toy television is a bit rusted, but old tin-toy scenes of cowboys revolve across the screen area. (Harry Poster - So. Hackensack, NJ)

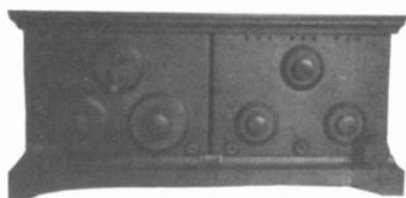

RADIOLA V - Model AR-1300, 175-700 meters. Manufactured by General Electric Corp for RCA. All knobs have GE logo. Lower right has a Murdock honeycomb multiple headphone plug. Note the lid on the top which is often missing from these sets. (Charles Ryan, Mogadore, OH)

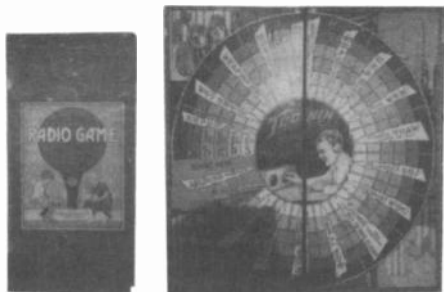

ALL FAIR RADIO GAME: "TOONIN" - Manufactured by Alderman, Fairchild Co., of Rochester, NY, as featured on the cover of A.R.C., July 1987, this was one of the many radio board games of the 20's. Photos show the box cover (left) and the game board open (right). (George Bergen - Miami Shores, FL)

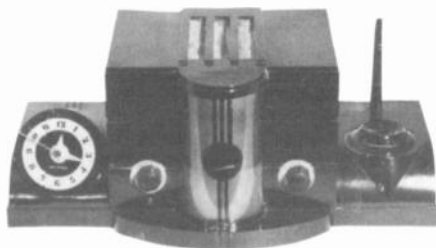

AIRITE "EXECUTIVE SET" - Features their patented self-closing inkwell, plus clock and radio illuminated inside by a 15-watt light bulb. (Harry Poster - So. Hackensack, NJ)



GLOBE NAVIGATOR - A novelty radio manufactured in 1939, it is tuned by rotating the world globe above. (Bob Barnes - Monroe City, MO)

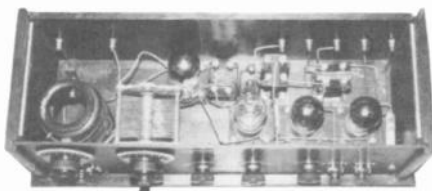

ARLINGTON RADIO - Made by the Wells Manufacturing Co. of Fond du Lac, Wisc., its circuit consists of (1) 201 RF amplifier, (1) 200 detector and (2) 201 AF amplifiers. It is a non-regenerative set and uses rather primitive AF transformers. (Donald Hatch - London, Ontario)



All You Need To Know About Repairing AC Radios - Part 5

BY JAMES A. FRED, RT. 1, BOX 41, CUTLER, IN 46920

Vacuum Tube Basics

This is the fifth part of a series on basic AC radio repair. Jim Fred has been involved in radio for over fifty years, and in this series presents useful hints for both the new collector and the veteran. *Antique Radio Classified* is pleased to have Jim contribute this series.

Refer to Parts 1 and 2 of this series (Feb. and Apr. 1988) for details on tools, test equipment, safety, etc. **IMPORTANT: do not plug the radio in until you have read the safety tips and warnings in these two installments!**

Part 3 (July 1988) covered the TRF radio and Part 4 (Sept. 1988) covered the Superheterodyne radio. (Editor)

Before proceeding to troubleshoot large radios with many tubes and complicated circuits, I think we should talk about vacuum tubes. I'll discuss filament voltages, tube bases, tube substitution, and simple series and parallel wiring, rather than getting into technical engineering stuff.

Let's go back to 1922, and review the tubes, DC, available then. We will start with the WD-11 and WX-12. (Even though Western Electric tubes were used by the military before 1922, they were not popular in home sets.) The WD-11 and WX-12 tubes had identical elements, i.e. plate, grid and filaments, but had different bases and pins. The filament voltage was 1.1 volts DC at .25 amperes, intended for use with a number 6 dry cell. Three cells in parallel as in Figure 1 provided the correct voltage and current for these tubes. A number 6 dry cell was about 2 1/2 inches in diameter by about six-inches tall and can still be purchased today. These cells were readily available then because three cells in series (often called "Hot Shot" batteries) were used in early ignition systems of automobiles and gas engines and in early telephones. They could be easily purchased and soon became popular as filament batteries for radios.

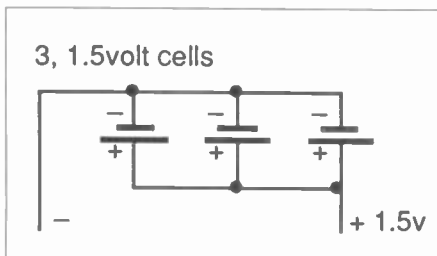

Figure 1. Batteries connected in parallel.

The fragile and microphonic WD-11 was soon replaced by the 200A and 201A triode with a 5-volt, .25 amp. filament. The automobile storage battery (6 volt) rapidly became the favorite filament supply. These tubes were soon joined by the 112A, and the 71A also with 5-volt DC filaments. In a home without electricity, the automobile storage battery of six volts DC became the source of power. I've heard many old timers tell stories of how once or twice a month they had to take the battery to town to get it charged; charging would take several days as well as another trip to town to retrieve the battery. Since this was quite expensive as well as time consuming, the 99 and 120 tubes were developed. These tube filaments needed from 3 to 3.3 volts at .060 amperes and .125 amperes. Here again we could use the number 6 dry cell for filament power, three in series as shown in Figure 2. Other DC filament tubes were also developed, but these were the most popular.

Of course, with all these battery radios, "B" batteries of 45 to 135 volts were necessary. These batteries were not rechargeable and were thrown away when they were exhausted.

In 1927, radios operating from the AC power line were introduced. Most city homes had AC lines entering their homes, but only electric light bulbs used the power. After radios were introduced, other electrically operated appliances soon began to appear. Sixty cycle AC power could not be applied to a battery radio because a loud hum would come from the speaker, preventing reception of the program. One reason was that the plate of the tube required pure DC; building a "B" battery eliminator to replace the "B" batteries used by a battery set easily took care of this. In two or three years the "B" battery eliminator became obsolete because a "B" power supply was built on the chassis with the rest of the radio.

The second source of hum was the tube fila-

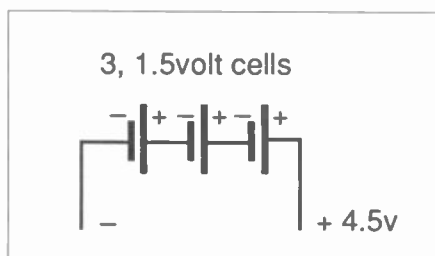

Figure 2. Batteries connected in series.

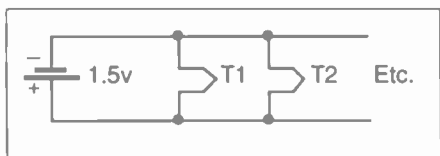

Figure 3. Tube filaments connected in parallel with each other and with a battery.

ment. As the 60 cycle current alternated from plus to minus, the filament would alternately get hot and cold sixty times a second. Engineers soon found two ways to minimize this action. One way was to use a heavy filament wire whose thermal inertia slowed down the heating and cooling effect. One such tube was the Type 26 tube used in the RF amplifier circuits. The second way was to enclose the filament in a ceramic sleeve. The ceramic sleeve, called cathode, was coated with a rare earth compound. When the filament heated up, it made the cathode hot which released electrons from the cathode coating. One of the first cathode type tubes was the Type 27 tube; it was called a triode because the filament and cathode were considered as one element. Other early cathode type tubes were the 24 and 35. The filament voltage of the 26 was 1.5 volts AC. The filament voltage of the 27 was 2.5 volts. Other 2.5 volt tubes were the 45, 2A3, and 47.

Most of the very early AC-operated radios used 26's, 27's, and 71A's, with an 80 rectifier tube. Other early tubes used were the 50, 81, and 10. In the early 1930's, vacuum tube design advanced rapidly. The next generation of radios used the 56, 57, 58, 55, 2A5, 2A6, 2A7, etc. These tubes had 2.5 volt filaments and drew currents from .8 to 2.5 amperes. This meant that the power transformer had to supply a large amount of filament power. To make more efficient and cheaper-to-operate radios, engineers decided that 6.3 volts would be a more desirable filament voltage. A whole new line of 6.3-volt cathode type tubes were introduced which could operate on either AC or DC filament voltage. This also made the automobile radio possible.

Some of the new 6.3 volt tubes were the 77, 78, 76, 75, 85, 36, 37, 38, 39/44, 41, etc. Then it was decided to do away with two-digit tube num-

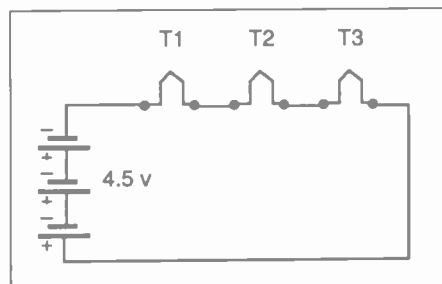

Figure 4. Tube filaments connected in series with each other, and with three batteries in series.

bers and replace them with numbers like 6C6, 6D6, 6F6, 6A7, etc. Many of the 6.3-volt tubes had characteristics similar to the 2.5-volt tubes, making it possible in some cases to replace the power transformer and use a set of tubes with different filament voltages. Since the current drawn by the 6.3-volt tubes was .3 to .7 amperes, some power was saved, and smaller wire could be used in the power transformers; this made some savings in component cost possible.

In 1934, design work was being finalized for a new concept in vacuum tubes. The base would have eight pins with a large center keyed guide pin. This allowed the tube to be inserted into the socket only one way; this tube became known as the octal tube. In 1935, the octal tube was introduced with a metal shell instead of glass envelope. Small signal amplifier tubes, i.e. the 6K7, had the grid cap on top. Soon, however, several changes were made. The power amplifier tubes and rectifier tubes were made with glass envelopes, and the grid cap was abolished. The grid connection was made to one of the base pins. The tubes made for portable battery sets continued to have glass envelopes.

Still later the octal tube was introduced. The octal tube had no phenolic base; instead the elements - i.e., plate, grid, etc. - were welded to wire pins brought through the bottom of the glass envelope. A metal guide pin, with key, allowed the tube to be inserted properly. The socket had a spring in the center that gripped the guide pin tightly to hold the tube firmly in its socket. RF and IF amplifier tubes with glass envelopes had to have close-fitting metal shields, grounded to the chassis, to prevent interference between stages.

During World War II, the seven- and nine-pin miniature tubes were developed for military use. Many thousands of surplus octal and octal tubes were in the government warehouses when the war ended. The first postwar radio receivers were built using these tubes. Later every home and auto radio built had the miniature tubes.

If you collect and repair AC-DC radios, you will hear about the All-American Five radios. These sets first used a 6A8, 6K7, 6Q7, 35Z5GT and either a 35L6GT or a 50L6GT. When single-ended tubes came along, the All-American Five used a 6SA7, 6SK7, 6SQ7, 35Z5GT, and either the 35L6GT, or the 50L6GT. When seven-pin

(Continued on following page)

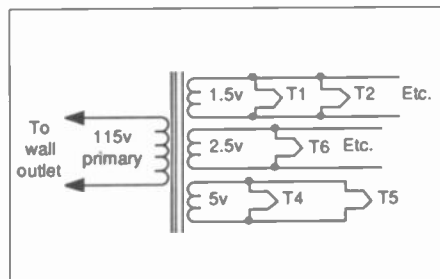

Figure 5. A multi-filament-voltage transformer with tube filaments connected in parallel.

(Vacuum Tubes, continued)

miniature tubes came along, the All-American five became a 6BE6, 6BA6, 6AV6, 35W4, and either a 50C5 or a 50B5. There were also equivalent local tubes.

I would be remiss if I didn't discuss the difference between series and parallel tube filament circuits. We will start with parallel circuits because radios sets made during the first ten years used parallel circuits. For instance, the WD-11 tube needed 1.1 volts DC for its filament so a number 6 dry cell of 1.5 volts supplied the filament power when the tubes were wired in parallel. When the tube filaments were wired in series, several batteries also would be wired in series as shown in Figure 4.

When AC-operated filament tubes came into use, the tubes had different filament voltages. For instance the 26 tube needed 1.5 volts AC; a 27 needed 2.5 volts AC, and a 71A needed 5 volts AC. A power transformer with separate secondary windings provided the necessary voltages. All the tubes, with the same voltage filaments, could be connected in parallel across the same transformer winding as shown in Figure 5. Remember: devices requiring the same voltage, but different current, must be connected in parallel. Devices needing the same current, but different voltages, can be connected in series.

In 1930, the country was in the midst of a depression. People could not pay \$150 to \$600 for a radio receiver. A less expensive radio that would still give satisfactory reception anywhere in the U.S. had to be designed. One solution was

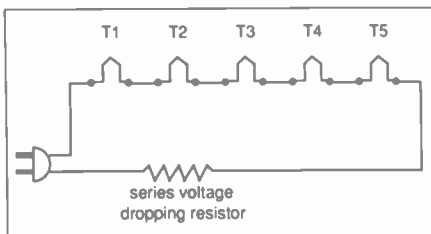

Figure 6. Tube filaments in series with dropping resistor connected with the power line.

to do away with the expensive power transformer. Engineers found that by using tubes whose filaments all drew the same current, you could put tubes in series as shown in Figure 6, even though each tube required different voltage. The value of the series voltage dropping resistor was chosen to give the correct voltage across the series string of tubes. Thus, the inexpensive AC-DC radio was born.

If you only collect and repair radios made from 1935 to 1950, you will have no trouble finding tubes for your radios. Thousands of most tube types are still available. In the few cases where tubes are hard to find, you can use adapters or find substitute tubes.

We have received a lot of favorable comments about this series of articles on repairing AC radios. Write Jim at the address at the beginning of this article and let him know what you would like to see him include in this series. Editor.

A Low Cost Isolation Transformer

BY ORVAL PARKER

There is a great shock or injury hazard when it is necessary to test or repair an AC/DC type radio. All collectors should be aware that such operation should be conducted with the set powered through an isolation transformer. Test equipment can also be damaged without isolation, but most isolation transformers available are quite expensive; so with limited use needed, we can look at alternative approaches. Two single secondary transformers connected back to back are often advised [as shown in Part 2 of Jim Fred's series on repairing AC radios], but a simpler solution exists. If the surplus electronics catalogs are checked, it will be found that many transformers intended for both 120- or 240-volt operation have two separate primaries as well as the output secondary. Typically such a transformer would have a schematic as illustrated; possibly the terminal arrangement will be indicated for the alternate connections. For isolation conversion one of the primaries can function as primary, and the other primary becomes the isolated output winding.

It also is possible to adjust the output voltage by connecting the secondary winding in series with the input winding as indicated by dotted connecting lines. A transformer with 12- or 24-volt secondary, possibly center tapped, weighing

two to five pounds, is about right for this project. The cost will be about five dollars. Mounted in a small case with input power cord, switches and output receptacle, it can be convenient and safe. Best to be safe, rather than sorry or worse.

(Orval Parker, HCR Box 133, Pocono Summit, PA 18346)

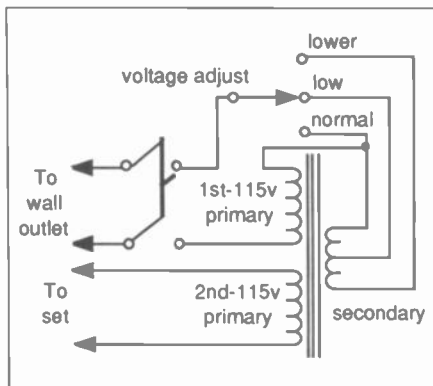

Figure 1. Schematic: Conversion of dual primary transformer to isolation type.



CLASSIFIED ADVERTISEMENTS

WANTED: Audio transformer for Radiola 20. Grid leak & front screws for RCA RADA. Power supply or power transformer for USR & TV 80. Rick Peterson, 603 Tournament, Berwick, LA 70342

FOR SALE: Rubber belt replacements - \$5 ea. Enclose make, model number. Large selection. Steve Karpiak, 1333 Madison St. #9, Hollywood, FL 33019. (305) 587-6720; (305) 923-2336, night

WANTED: Chassis wanted. FADA Model KF; Lyric S6, S7, or S62; AK 80, 82, 84, 90, or 92; Kennedy 110 parts set. Tom Burgess, Box 9769, Little Rock, AR 72219. (501) 565-1750, eves.

FOR SALE: Marconi Wireless Telegraph Co. of America. We have a small quantity of Original Stock Certificates, signed by the vice-president and treasurer of the company, sealed, issued, and cancelled. Marconi first proved that messages actually could be sent by wireless, and sparked the imagination of those who became the first ham radio operators. These certificates, dated in the 1910's, are colorful with an exceptionally nice vignette of Miss Liberty sitting between globes of the East and West hemispheres, with transmission towers on each side. Each is suitable for framing and is ready to add to the decor of any room or shack. Original Marconi Certificates cost much less than limited edition art works, represent the beginning of a great hobby, may increase in value (Scripophily, the collection of old stock and bond certificates, is in its infancy and becoming more popular), represent the beginning of a giant corporation (RCA was formed with the express purpose of buying out the Marconi Wireless Telegraph Co. of America), make a unique addition to any home, and make a great gift. 10-day unconditional money back guarantee. Price complete and delivered (we pay shipping charges) - \$49.95 (Pa. residents must add \$3 for sales tax). Checks received after the Marconi Certificates are sold out will be returned uncashed. Send check (personal checks OK) or money order to: Authentic Certificates, Box 177, Main St., Virginville, PA 19564. (215) 562-5065

SERVICES: Repairs: R-390, R-390A radios aligned, repaired. Mil-Spec Communications. Paul V. Zecchino, Box 461, Wakefield, RI 02880

FOR SALE/TRADE: Phase modulator FMX for Meissner signal shifter. General Electric SSB selector Type YRS-1. Parker Heinemann, W1YG, 87 Cove Rd., Lyme, CT 06371. (203) 434-7783

WANTED: Antennae coil or chassis, 1936 RCA radio Model 10T or 10K, Part No. 12879. Elmer Mueller, 9815 Surrey Ln., St. Louis, MO 63137

FOR SALE: Philco cathedral. Zenith chairside. 150 more + books, magazines, etc. SA2SE for catalog to: John Kendall, PO Box 436, Fallston, MD 21047

WANTED: B eliminators, tube type, especially RCA and Silver-Marshall. Farm radios, 2 volt. Tracy Sands, 1520 W. Juno Ave., #C, Anaheim, CA 92802. (714) 491-8546

FOR SALE: 1947 Philco projection TV - \$450. Opaque, black, acrylic sheets 12 x 16 x 1/8" meets the following requirements: AS4, 5, 6, 7 of ANSI Z26.1, great for reproducing small front panels on radios, shiny on both sides - \$4 per sheet plus \$3 UPS charge. Steve Puntillo, 1911 Rowley, Madison, WI 53705. (608) 233-1569

FOR SALE: Tie clasps and lapel, pins, N.O.S., radio-related, Philco, RCA, and more. Send a LSASE for complete illustrated list to: Mr. Michael S. Sabodish, Sr., 11-A Matawan Ave., Cliffwood, NJ 07721

.....
SELLERS ... PLEASE NOTE
A.R.C. ADVERTISING POLICY...
 ALL ITEMS MUST BE DESCRIBED FAIRLY.
 REPRODUCTIONS, REPRINTS AND NOT-
 ORIGINAL ITEMS MUST BE SO IDENTIFIED.
 ADVERTISERS AGREE TO RESPOND
 PROMPTLY TO INQUIRIES AND ORDERS.
 AND TO RESOLVE PROBLEMS PROMPTLY
 IF THE BUYER IS NOT SATISFIED.

WANTED: Transistor or tube-type novelty radios. I get new traders all the time. Cliff Watts, 51 Glendale Rd., Brantford, Ontario, Canada N3T 1P5

WANTED: Collecting National regenerative receivers, parts and accessories. Especially need a National speaker of early 30's vintage to match SW5 series. National 5880 ABS power supply for SW45. Need Hallicrafters SX28A T-3 and Sky Buddy S19R bandspread dial. Will buy complete sets if price is right. Also collecting high quality vintage headphones. Dean Showalter, WA6PJR, 36308 Panorama Dr., Yucaipa, CA 92399. (714) 797-1782

FOR SALE: Entire contents of private radio repair shop plus private collection of approx. 50 radios. Sell as one complete package only. Send large SASE, 50¢ stamps, for long list. Asking \$5750. Preston D. Pipkin, 823 Patterson Rd., Durham, NC 27704. (919) 596-5911

CLASSIFIED ADVERTISEMENTS

WANTED: Any A.C. Gilbert radio sets, parts or literature from the 1920's. Robert Stapleford, 1800 Randolph, Topeka, KS 66604

FOR SALE: Good used tubes - 75¢ ea., plus shipping. Also, RCA (5T), Hallicrafters S-38A, National Multi receiver RAO-7. Best offers. Joseph Zambri, RD4, Box 216, Towanda, PA 18848. (717) 265-4825

WANTED: 1" and 2" oscilloscopes. Western Electric Broadcast carbon microphones and WE 7A amp. Al Weiner, Monticello, ME 04760. (207) 538-9538

FOR SALE: 1920's Mohawk cabinet - \$20. Columbia Grafanola motor - \$35. 1920's Teletone speaker - \$30. Jeff H. Gentry, 708 Locust Ave., Charlottesville, VA 22901. (804) 295-1841

WANTED: RCA Model 19 as pictured in A Flick of the Switch, p. 155. Write to: Ron Miedema, 2728 Madelyn S.W., Grand Rapids, MI 49509

FOR TRADE: My 7" Zenith black dial w/all hardware for your 5" Zenith black dial w/all hardware. Richard Arnold, Box 275, Lone Grove, OK 73443

WANTED: Tiny transistor radios. Standard, Sony, Panasonic, etc. Good to better condition is important. Karl Ayer, PO Box 665, Thiensville, WI 53092. (414) 242-0571

WANTED: Amplion horn speaker with celluloid petals. Do any exist or are they mythical? Alan Brehaut, 22A Cain St., Timaru, New Zealand



*Craig L. Graybar
Furniture Works Ltd.*

(414) 258-2390

SPECIALISTS IN RESTORING, REPAIRING AND REPRODUCING CLASSIC STYLED ANTIQUE TV, RADIO & PHONOGRAPH CABINETS

Send us your plans or your project via UPS for immediate price quotes

1535 S. 84th St.
West Allis, WI 53214

"We Turn Ideas Into Heirlooms"

CLASSIFIED ADVERTISEMENTS

WANTED: Rider's radio manuals Vols. 15, 17-23. Rider's TV manuals Vols. 4, 5, 6, 9, 12. Rider's TV manual index. Sams Photofacts from 1946-1960. Regency TR-1 transistor radio, and any German radios. John Okolowicz, 624 Cedar Hill Rd., Ambler, PA 19002. (215) 542-1597

CLASSIFIED AD DEADLINES

Jan. 10 for Feb. 1989 Issue

Feb. 10 for Mar. 1989 Issue

Mar. 10 for Apr. 1989 Issue

FOR SALE: Due to bad health selling entire collection. No common stuff, 60 radios & speakers, large library, etc. SASE for list. Hardin McCauley, 8471 Patterson St., St. John, IN 46373. (219) 365-5979

WANTED: Zenith advertising, manuals, owner's manuals or other ephemera. Owner's manuals or photocopies or other information, etc. on the Philco 37-690 or 38-690 or fellowship with other owners thereof. **FOR SALE:** Catalans: Mint condition FADA 711, maroon & white - \$600 or trade; very nice Sentinel 284, red with butterscotch - trade. Advertising: Motorola tin sign, red & black, 6"x18" - \$85; jointed wooden GE doll, looks like majorette, slightly as is - \$425; late 30's-early 40's mint fluorescent RCA tube-radio repair sign - \$95; base-lit brass & lucite "General GE Electric Radios - Radio - Phonographs" sign, 2'x1', wonderful - \$295. Transistors: Zenith Trans-Oceanic 3000-1, mint - \$175; AM-FM microphone radio dated, 1987, radio art with "Good Morning Vietnam," movie theater promo - \$95; small very streamlined Silvertone Model 109, brown bakelite with white knobs, extra mint - \$135; "Radio Tube Trick" game, mint - \$25; 2 metal Arvins: Model 422, white, some chips - \$60; 442 black, near mint - \$90; Sentinel TV 6" vertical wooden table model - \$120; Detrola AC-DC "WJR" chrome front Model 568 - \$165; Zenith 5J217 tombstone - \$135; Zenith tombstone 5R135, rare, mint - \$110; Zenith 6V27 - \$125; Zenith 5S128 tombstone, 10"x18", slightly as is - \$125; many & varied other radio stuff for sale - gimme a call & get your wishes in my Rolodex. Alan Jespersion, POB 17338, Minneapolis, MN 55417. (612) 727-2489, ans. mach. after 6 rings

TELEGRAPH

All Instruments
WANTED



REINKE & SONS

5301 Neville Ct., Alexandria, Va., 22310

(703) 971-4095

CLASSIFIED ADVERTISEMENTS

WANTED: Type 6 & 100-77 ballast tube. Speaker for Atwater Kent Model 83. Backboard & gauge, Garod V. Cabinets for Stromberg-Carlson neutrodyne, Alder Royal neutrodyne. Speaker for Thompson Minuet. Speaker grille for Model 26 Radiola. Larry Porter, 4115 Beam Rd., Crestline, OH 44827. (419) 683-2540

WANTED: Old tilt start mercury vapor rectifiers, Renotrons or like. Glass only. Bruce Ashcraft, 1300 Burrows Rd., Campbell, CA 95008. (408) 432-4678

WANTED: Old-style pocket-sized transistor radios. Send close up photo, Xerox image, or rough sketch with price to: Roger Handy, PO Box 24527, Los Angeles, CA 90024. (213) 451-4040

WANTED: Unusual telegraph bugs like verticals, right angles, midgets, over and under, foreign, patent models. Gil Schlehman, 335 Indianapolis, Downers Grove, IL 60515

FOR SALE: Send SASE for list of Radio News magazines 1919-1928. Richard C. Foster, 12 Shawmut Ave., Cohituate, MA 01778

FOR SALE: Stevens cone speaker - \$30. Stromberg-Carlson Model 11 cone speaker - \$10. **WANTED:** Stromberg-Carlson 401-A "B" socket power unit. Victor Baker, 1450 East Ave., Rochester, NY 14610. (716) 442-3507

WANTED: Manual or copy to operate Model #103A mercury tube tester. Pat Cutini, 2114 Main Rd., Corfu, NY 14036

CLASSIFIED ADVERTISEMENTS

WANTED: Dumont TV chassis Model RA-103, continuous tuning type, with FM & green tuning indicator. Charles Krauss, 80 Hurd St., Mine Hill, NJ 07801. Please call: (201) 361-7460, eves.

**HAVE YOU MOVED? ARE YOU MOVING?
PLEASE NOTIFY US A.S.A.P.
SEND US YOUR...
OLD ADDRESS
NEW ADDRESS and
SUB #
MANY THANKS!!!!**

WANTED: The entire 1934 H and Z line of Silver-Marshall radios. Other very old Hallicrafter items. Chuck Dachis, The Hallicrafter Collector, 4500 Russell Dr., Austin, TX 78745

FOR SALE: 6000 new and used tubes - inquire for price. 1923 to 1965 schematics and service information - \$5 up to 5 pages. George Found, 26 Queenston Crescent, Kitchener, Ontario, Canada N2B 2V5. (519) 576-2570

WANTED: Tiny personal portables with miniature and subminiature tubes, especially Emerson 747, Tom Thumb. Michael Schiffer, 2718 E. 10th St., Tucson, AZ 85716. (602) 325-3532

WANTED: Pilot Super Wasp with coils, working condition or repairable. Earl R. Homan, K6YGH, PO Box 416, Duarte, CA 91010. (818) 359-1246

FOR SALE: Send \$1 (refundable) for lists of new and good used tubes and stuff. Don Diers, 4276-A9 North 50 St., Milwaukee, WI 53216-1313

WANTED

Top Prices Paid

Radio & Audio Tubes: 2A3, 45's, 50's, 845, 8005, KT66/88, etc.

Western Electric Tubes: 101, 102, 104, 203, 305, 211, 212, 242, 244, 252, 262, 264, 271, 274, 275, 276, 284, 285, 300, 301, 310, 339, 345, 347, 348, 349, 350, 421, 422, VT25A, VT52, etc.

W.E. Speakers & Tweeters: 555, 594, 595, 596, 597, 713, 728, 754, 755, 756, 757, TA4151, 4153, 4181, 4191, 4194, etc.

W.E. Consoles & Amps: 25B, 41, 42, 46, 86, 91, 92, 94, 95, 105, 106, 117, 118, 120, 121, 124, 129, 130, 131, 142, 143, etc.

W.E. Horns: 22, 24, 25, 26, KS-6368, 12024, 12025, 12027, etc.

W.E. Microphones & Parts, etc.

Also looking for:

*Tube-type equipment by McIntosh, Marantz, Westrex, Langevin, Altec, etc.
Vintage speakers, units, by Jensen, Altec, JBL, Tannoy, etc.*

**Audio City USA, PO Box 786, Northridge, CA 91328-0786
(818) 701-5633**

CLASSIFIED ADVERTISEMENTS

WANTED: Power unit for an AK Model 40 radio. Also want any old radio for parts. C. Juedemann, 262 Churchill Ln., Ballwin, MO 63011. (314) 256-3727

WANTED: Coil winding data for National AGS. 1930-1941 amateur transmitters. F. P. Heine-mann, W1YG, 87 Cove Rd., Lyme, CT 06371. (203) 434-7783

HAS YOUR SUBSCRIPTION

EXPIRED?

It has if your mailing label reads
"EXP= JAN88" or earlier.

Renew now!

*BONUS: Renew before the end of
your "EXP" month and receive 13
issues per year instead of 12!*

Renewal rates are:

\$19.00 for Second-Class Mailing

\$28.00 for First-Class Mailing

(Two-year renewals are twice above rates.)

WANTED: I have 130 different crystal sets in my collection. Do you have one? Erwin Macho, Ambrosweg 17/A/8, A-1230 Vienna, Austria

WANTED: Hallicrafters Model HT-20 transmitter, in reasonable operating condition. Skip Hardy, K14YA, 1705 Fox Run Ct., Vienna, VA 22180. (703) 255-0759

CLASSIFIED ADVERTISEMENTS

FOR SALE: General Radio D.C. amplifier and electrometer Type #1230A, mint condition, weighs 13 lbs., will ship - \$35. Wes Chatellier, 1950 Chevelle Dr., Baton Rouge, LA 70806

WANTED: Amplifier for Colin Kennedy 110, tube socket, schematic, historic information. George Palermo, 1444 First, Sarasota, FL 34236. (813) 365-7777

WANTED: Tube hi-fi equipment, mono or stereo: Electro Voice, Scott, Fisher, Marantz, McIntosh. John P. Wolkonowicz, 11 Hartford Rd., Worcester, MA 01606. (508) 853-5082

FOR SALE: New and used tubes, electrolytic capacitors, cone speakers. Send SASE for lists. C. Elmer Nelson, 11 S. Church St., Princeton, IL 61356

SERVICES: Classic Radio Service® repair and restoration, auto or domestic. Fine craftsmanship since 1955, any make, model, year. Specializing in tube and vibrator types. All factory parts. Classic Radio Service®, PO Box 764, Woodacre, CA 94973. (415) 488-4596

WANTED: Eveready radios & speakers. Collecting antique flashlights & flashlight catalogs too. Bill Utley, 7616 Brookmill, Downey, CA 90241. (213) 861-6247

FOR SALE: Reprints of Crosley's 1929 Blue Book of Radio: Simplicity of Radio - \$3 ppd. Tom Croley, 1808 Linwood Ave., Ann Arbor, MI 48103. (313) 665-7233

Radio Addict

NEEDS MORE 40's, 50's, 60's COLORFUL PLASTICS.

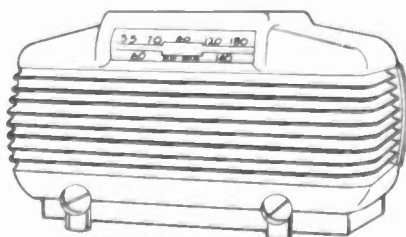

MOSTLY BUY, SOME TRADE, NEVER SELL

LES WAGENHEIM
c/o LEADWORKS INC.
32400 AURORA RD.
SOLON, OH 44139
1-800-321-2863 EXT. 200
OHIO 216-349-5000

CLASSIFIED ADVERTISEMENTS

FOR SALE: Midwest Model 16-35, mint chassis and cabinet - \$350. Photo - 50¢. Must pick up. Lester P. Rayner, 5512 N. 71st Pl., Scottsdale, AZ 85253. (602) 947-1375

FOR SALE: A rare find Navy receiving set RAK-7/RAL-7. 2 receivers w/power supplies and control box. Tunes 15-600Kc & .3-23 Mc. Boxes appear to be unpacked since 1949. Complete set - \$300 plus shipping of approx. 600 lbs. Ken Mays, 724 Swan Dr., Charleston, SC 29407. (803) 766-8451

WANTED: ARRL Amateur Handbooks or "Radio" Handbooks before 1950. Send condition and prices. Charles Simmons, W6PDH, PO Box 6238, Buena Park, CA 80622. (714) 994-6843

FOR SALE: Radio News magazines 1921 to 1935, misc. issues. Radio Craft, misc. issues 1929 to 1945. Radio Listeners' Call Books. Radio Retailing, misc. issues 1931 to 1939. Misc. issues of Wireless Age, Radio Broadcast, QST, Electrical Experimenter, etc. Also many radio books, catalogs, Rider manuals, and other paper items. Also Aeriola Sr., Radiola IIIA, Crosley, a few AK parts, other radio parts, two wood horn speakers, Amplitone spkr., novelties. Small quantity of tubes including some WD-11's. Send large 2-stamp envelope for 5-page list. All items subject to prior sale. Gary B. Schneider, 9511 Sunrise Blvd., #J-23, North Royalton, OH 44133. (216) 582-3094

WANTED: Tube hi-fi and sound equipment. WE speakers. Related literature. Joe Roberts, Box 19302, Alexandria, VA 22320. (800) 843-8253, days; (703) 683-2955, home

WANTED: Government, military, forest service, and aircraft radio equipment, and related items pre-1950. My main collecting interest is WW2 German, Japanese, and Italian equipment. In U.S. equipment, I am interested in mobile and aircraft types, examples BC-224A, BC-474, PPN-2, RAX, TBY. Also very interested in era 1938-1947 paper for research and reference: manuals, mfrs. advertising, aviation and radio magazines, newsletters, shortwave station lists, Berne or FBIS listings. Thank you! Hugh Miller, KA7LXY, 6400 Maltby Rd., Woodinville, WA 98072-8375

WANTED

Chicago Symphony Orchestra Broadcasts, pre-1965

Radio Acetate Cut Discs
Transcription Discs
TV appearance,
any format
Films

Steven Smolian
8807 Postoak Road
Potomac, Md. 20854
(800) 228-7833

CLASSIFIED ADVERTISEMENTS

FOR SALE: BC 611 WW2 H.T. - offers or trade.
WANTED: Scott Philharmonic. Neil Dorfman, 7028 Clements, W. Bloomfield, MI 48322. (313) 661-8770

One Month Free!

BONUS FOR EARLY RENEWALS

If you renew before the end of the month shown on your mailing label (your expiration date), you will receive an extra month on your subscription: 13 months instead of 12! 26 Months for a 2-year renewal!

WANTED: Tube ham receiver and/or transmitter. State condition, price and telephone. Bob Mattson, KC2LK, 10 Jane Wood Rd., Highland, NY 12528. (914) 432-4854, work. (914) 691-6247, home

FOR SALE: AK 82 grandfather clock radio, excellent condition, original - \$750. AK 80 cathedral, very good, original - \$250. Will trade. **WANTED:** Black New World Globe radio. GE K60 & K80. Kadette radios. AK 155 & 275. Prewar Emersons. John Kern, 2320 Rosedale Rd., Quakertown, PA 18951. (215) 538-2128

WANTED: Any Type 201 tube in the original box for my collection. I will pay at least \$10 for any molded base and at least \$25 for any brass based/ tipped 201A I need. Write to me for my want list. Also, ask for my want list of all boxed tubes prior to 1934. Steve A. York, 1100 Byrd St., Melbourne, FL 32935



RADIO - A BLAST FROM THE PAST

The 1900 Radios pictured provide one of the most thorough references that can be purchased today covering the years 1927-42.

For your copy, send \$26.50 (ppd in US) to:



TIMELESS RADIOS
310 Ellwood St.
Easton, PA 18042
(215) 253-3608

CLASSIFIED ADVERTISEMENTS

FOR TRADE: Scott Allwave 12 in Napier console cabinet. Radio is complete, unrestored, in good condition. Cabinet needs minor veneer repair, tube cover and coil cans need replating. Trade for best offer of 1940's jukeboxes or pre-1941 slot machines. Alvin Heckard, RD1, Box 88, Lewistown, PA 17044

SEND ALL A.R.C. MAIL TO
Antique Radio Classified
P.O. Box 2, Carlisle, MA 01741

WANTED: Philco Predicta TV, working or not. Lambert Eulenfeld, 1408 Azalea Dr., Jay, FL 32205. (904) 389-1408

FOR SALE: Philco 18 cathedral, re-capped and working - \$250. John Corcoran, 2045 Central, Wilmette, IL 60091. (312) 251-4593

WANTED: General Radio 916A RF bridge, any accessories for GR1001A standard signal generator. Gordon Symonds, 26 Ossington Ave., Ottawa, Ontario K1S 3B4. (613) 232-2198

FOR TRADE: Rider's 2 & 3. Need 20, 21, 22 and 23. One for one swap. A. Bruno, 24 Butternut Dr., New City, NY 10956. (914) 354-8899

WANTED: Zenith radio collector looking for tombstone and table models for the years 1935 thru 1939, have ready cash for desirable material, also looking for a cabinet for 9S30, 7S28 and 6S27. Thanks. John C. Allport, c/o Schnabel, 210 Cleveland St., Cary, IL 60013

CLASSIFIED ADVERTISEMENTS

WANTED: Loopstick ferrite antenna coils for 365 mfd. condenser. Julius Luscheck, 8964 Flintwood Dr., Harrison, OH 45030

FOR SALE: Westinghouse Electronics At Work, nine volumes and quiz, plus ABC's booklet - \$15. Kenneth Miller, 10027 Calvin St., Pittsburgh, PA 15235. (412) 242-4701

FOR SALE: Philco 49-501. FADA Bullet with inset grille, yellow and red. FADA 652 yellow case. FADA 1000 yellow case, cracked but cheap! Wooden FADA 252, prototype for FADA 652. Other assorted Deco bakelite and plastic fifties sets. Send SASE or call for prices. Peter Thomashow, 350 West 20th St., Apt 4F, New York, NY 10011. (212) 989-0213

WANTED: Escutcheon plate for Philco Model 80. Please write to: Laurence Dreyfuss, 539 Belle Ave., San Rafael, CA 94901

FOR SALE: Horn speaker RCA UZ 1325, excellent condition - \$75 plus UPS. Bud Bedker, 66 Cloverside Ct., West Seneca, NY 14224. (716) 674-2890

WANTED: Amplifying transformers, Model 376 and 377? for Freed-Eisemann NR6. Melvyn Goldberg, 78 Chiltern Hill Rd., Toronto, Canada M5G 1X5. (416) 782-2140

FOR SALE: Meissner signal-splicer, Model 9-1022, 2 coils, original box, instructions - \$12 delivered. Joe Duffin, 4 West Central Ave., Moorestown, NJ 08057

TUBES WANTED

We need the following tubes to replenish our stock. You may ship your tubes to us by UPS or Parcel Post. We'll mail our check upon receipt and testing of tubes. We pay prices shown plus shipping charges.

USED GLOBE OR BALLOON SHAPE TUBES - ALL MUST TEST GOOD

WD-11*	\$25.00	UV-199* ...	\$10.00	210	\$8.00
112A	5.00	UX-199*	9.00	245	10.00
171A	4.50	200A	5.00	250	20.00
* Tubular				280	5.50

MODERN (ST) STYLE TYPES - NEW ONLY

01A	\$5.50	18	\$3.00	50	\$25.00
0A4G	6.00	42	3.50	71A	5.00
2B6	5.50	45	15.00	83	4.50

We buy all types of receiving tubes. Send us your list for our bid.
 Also looking for 4, 5, & 6 pin tube sockets.

ANTIQUE ELECTRONIC SUPPLY

688 W. First St., Tempe, Arizona 85281, 602/894-9503

CLASSIFIED ADVERTISEMENTS

WANTED: Early motors and electromagnetic devices. 19th- and early 20th-century demonstration pieces. A.C. Gilbert electricity and magnetism kits, also chemistry and atomic energy. Top prices paid!! Peter Thomashow, 350 West 20th St., Apt. 4F, New York, NY 10011

WANTED: National Type H drum dial. National SW-5 rcvr. National NC-5 or HFC converters and Philco Model 60B cathedral. David Combs, W5VJW, 2000 Victory, Wichita Falls, TX 76301. (817) 767-0077

FOR SALE: Kodol Kuprox Trickle B recharger, in original sealed carton, has special tube and instruction sheet. We have 2 of these, plus 1 opened - \$30 ea. George Fathauer, 688 W. First St., Tempe, AZ 85281. (602) 894-9503

FOR TRADE: McMurdo-Silver Masterpiece V in Bristol cabinet for Scott Philharmonic AM-FM or AM beam of light. Possibly trade for other Scotts. T. Peterson, 10291 Mississippi Blvd., Coon Rapids, MN 55433. (612) 422-8889, after 6

WANTED: Spark items, R.E.L., Gross, Collins Aero ham xmtrs., old breadboard xmtrs., etc. **FOR SALE:** Wireless Experimenters Manual, 1920, Elmer Bucher - \$25. Stu Mount, K2OA, 35 Grand St., Highland, NY 12528. (914) 691-7957

MESSAGE: Hope all my friends and customers had a great holiday season, and wishing everyone a happy and prosperous 1989! R. J. Eastwick, N2AWC, 224 Chestnut St., Haddonfield, NJ 08033. (609) 429-2477

CLASSIFIED ADVERTISEMENTS

HELP: Need alignment procedure and dial cord stringing diagram for Sears Model 6424, Chassis 101.570, Rider 11-58. Sidney Allen, Jr., 1908 Rosecrest Dr., Greensboro, NC 27408

FOR SALE: Sams Photofacts Nos. 92, 102, 113, 119, 121, 125, 278, 316, 348, 438 - \$25 plus UPS. George Greenberg, 821 Porter St., Philadelphia, PA 19148. (215) 468-0293

FREE - 20 WORD AD EACH MONTH
To get your free 20 words,
include your SUB# with your Ad.
Additional words are 10¢ each.
Read inside back cover for details.
MANY THANKS!!!!

FOR SALE: SE-183A triple crystal detector, vg - \$600. Look in A.R.C., Nov. '88, p. 7. John Anderson, 10920 NE 18 St., Bellevue, WA 98004. (206) 453-1944, leave message

WANTED: Hollywood Radio and Television Institute's course lessons, and also Superhet Radio Kit. B. Ali, 710B Highpoint, Waterloo, Ontario, Canada N2V 1G9

FOR SALE/TRADE: Stromberg-Carlson 11-A radio-phono combination, all original tubes, (phono unavailable). T. R. Fowler, PO Box 160, Colonial Heights, VA 23834. (804) 526-5101

WANTED: Gonset 6-meter Communicator II. Knight Ocean Hopper. Lysco transmitter. William H. Jones, RD#3 Box 474, Roberts Rd., Clinton, NY 13323



JIM CLARK ENTERPRISES
 DEPT A.R.C.
 1292 Starboard
 Okemos, MI 48864
 (517) 349-2249



*** Specializing in E.H. Scott and Scott Transformer Co. radios, literature, etc. Contact me if you have any Scott items now, or in the future.**

- For Sale -

1. Philco Predicta shipping carton\$ 65
2. RCA 21CT55 color TV (1954)\$795
3. Air King tombstone, whiteCALL
4. Grebe CR-8\$245
5. Midwest 11-tube table set\$225
6. Home brew crystal set\$ 65
7. Federal 110\$395
8. Atwater Kent gas measure stick\$ 30
9. Seamon Jones horn speaker\$195
10. Michigan MRC-3 battery set\$179

- Wanted -



Any Scott using this escutcheon

We publish America's best Monthly Sales List of radios, TV's, speakers, magazines, etc. for sale - Send \$1.50 (stamps OK) for current list.

CLASSIFIED ADVERTISEMENTS

WANTED: Espy, Viewtone, Transvision, Dumont, Remington, TV's & Midwest radios. Bernard Sampson, 2905 Rusk, Houston, TX 77003. (713) 228-6741

FOR SALE: Rare and desirable radio, telegraph, telephone, & electricity books; and related literature. For our latest list, please send your name & address to: New Wireless Pioneers, 6270 Clinton St., Elma, NY 14059

WANTED: Philco 70 cathedral. RCA 128, 140, 143 tombstones. GE K-80 tombstone. Zenith 834/835 tombstone w/chrome grille. Dave Montgomery, 13500 Pacific Hwy. S, Seattle, WA 98168. (206) 243-6419

FOR SALE: Large water-cooled transmitting tubes, used but good. Fed. Tel. & Rad. F-320B - \$25. Two Amperex 222A - \$20 ea. Also large rectifier tube, Elec. Inc. EL-16B - \$20. Or all for \$75. Prices are postpaid. Nelson Christenson, 15 Vinebrook Ave., Cornwall-on-Hudson, NY 12520. (914) 534-5615

WANTED: RF transformer for Federal 58 DX. Also escutcheon for Philco 16. Don Hatch, 14 Kingspark Cr., London, Ontario, Canada N6H 4C4. (519) 472-6167

WANTED: WWII German communication radio equipment and any other WWII German electronic equipment, optics, mine detectors, movie cameras, or German or U.S. microphones. Write to: Steve Puntillo, 1911 Rowley, Madison, WI 53705. (608) 233-1569

CLASSIFIED ADVERTISEMENTS

WANTED: Wireless spark coil with vibrator, rated one inch or more (E.I. Co. Bulldog or similar). Spark transmitter condenser. Spark key. Steve Roush, 290 Paradise Blvd. #34, Indialantic, FL 32903

FOR SALE: Philco Model #91 cathedral, excellent condition - \$350. R. Yerke, PO Box 392, Moscow, PA 18444. (717) 842-4857

WANTED: For repair of antique radios: 2A3, 2A5, 26, 45, and 47 tubes; any quantity. Prefer N.O.S. but will consider used. Contact Vintage Radio & Electronics 1414 17th St., Rockford, IL 61104. (815) 229-6900

WANTED: Hammarlund SP-600 manual or schematic. Also wooden Hallicrafters 505 TV. Morgan McMahon, 26356 Eastview, San Juan Capistrano, CA 92675. (714) 364-1587

FOR SALE: Arvin 532A, yellow Catalin, tortoise grille and knobs (Blast From the Past, p. 294) - \$585. **WANTED:** Majestic 463, 411. RCA Mexican scene 40X-53. FADA blue/orange Bullet. Climax Ruby. Barry Friedman, 22725 Garzota Dr., Valencia, CA 91355. (805) 296-2318

WANTED: Vacuum pumps, gauges, radio tube manufacturing equipment, catalogues and information. Ed Graper, 5960 Mandarin Ave., Goleta, CA 93117. (805) 964-7117

WANTED: Does anyone out there have a 25D8 V. tube? N. Garner, Rd. #4 Box 134, Canton, NY 13617

WANTED WESTERN ELECTRIC TUBES, SPEAKERS, HORNS & AMPS

TUBES: 300A, B, 274A, B, 262A, B, 275A, 350B, 284D, 252A, 271A, 242A, 348A, 349A, 301A, 339A, 205D, E, F, VT52, VT1, VT2, 211, 212, 104D, 216A.

SPEAKERS: 555, 594, 596, 597, 713, 754, 755, 728, 4151, 4153, 4181, 4194, 753, 757.

HORNS: 22, 24, 26, 25, 12, 6368, 15A, 13A.

AMPLIFIERS: 86, 1086, 91, 22, 94, 95, 105, 106, 120, 121, 130, 131, 124, 129, 142, 143.

VICTOR VICTROLAS, EDISON, ETC.

TUBES: TELEFUNKEN, GENALEX, RCA, RADIOTRON, ETC.
GENERAL ELECTRIC, AMPEREX, JAN, SYLVANIA, GEC, NATIONAL UNION

MCINTOSH, MARANTZ, DYNACO

CITATION, LANGEVIN, ROGERS, LEAK, TANNOY, ALTEC, EV,
THORNES, EMT, JBL, AMPS, SPEAKERS, TURNTABLES

MAURY CORB
12325 ASHCROFT
HOUSTON, TEXAS 77035

TEL: (713) 728-4343

CLASSIFIED ADVERTISEMENTS

WANTED: New or very good interstage transformer with dual primary of each section being approx. 100 ohms and secondary of 8 ohms for RCA Mod. 211K No. 2 Hi Freq. speaker (see Rider 13-78). L. A. Mann, 3130 N. Druid Hills Rd., Decatur, GA 30033

FOR SALE: RCA 74DX microphone. RCA 3-inch image Orthicon tube. Crosley 51 radio. Crosley Musical Chef radio. **WANTED:** RCA Stratoworld, Model 1-MBT-6. Admiral Allworld, Model 909. Charles Harper, 2081 Harmony Ct., Lexington, KY 40502. (606) 268-8549

WANTED: Power unit for SW Model 530/535. Will take power unit 715 and 720 also. Al Webb, 8230 S. Linder Ave., Burbank, IL 60459. (312) 425-7153

FOR SALE: Zillions of early Photofacts, Rider's, more. Best offer or trade for automobile radios. Dan Schulz, PO Box 892, Crystal Beach, FL 34681. (813) 785-8733

WANTED: Chapman's To The Rescue and Aiding The Snowbound. HRO LF coils. 160M crystals. Brian Roberts, 3068 N. Evergreen Rd., Pittsburgh, PA 15237. (412) 931-4646

FOR SALE: Prewar European sets, early black bakelite Emerson - \$20. Western Electric 7A amp, Nazi black bakelite tombstone - \$285. AK 627 and 558 cathedrals - BO. Telefunken Opus, Canadian Philco 60, very nice - \$150. Misc. cathedrals. **WANTED:** Pilot radios, shortwave cathedrals. Bill Moore, 1005 Fieldstone Ct., Huntsville, AL 35803

**ALL A.R.C.
BACK ISSUES
NOW AVAILABLE**

ORIGINALS or REPRINTS (marked *) available for:

- | | |
|-------------------------|---------------------------|
| Sep. 84 - Vol. 1, No. 2 | Jul. 86 - Vol. 3, No. 7 |
| Nov. 84 - Vol. 1, No. 4 | Oct. 86 - Vol. 3, No. 10* |
| Mar. 85 - Vol. 2, No. 3 | Nov. 86 - Vol. 3, No. 11* |
| Apr. 85 - Vol. 2, No. 4 | Dec. 86 - Vol. 3, No. 12 |
| Jul. 85 - Vol. 2, No. 7 | through |
| Aug. 85 - Vol. 2, No. 8 | Current Issue |
| Sep. 85 - Vol. 2, No. 9 | |

* Reprint (same quality as original)

Photocopies will be furnished for all other issues, and for those above when originals are no longer available.

(Note: Publication of A.R.C. began in '84, and Vol. 1 had only five issues. 1985, '86 and '87 had twelve issues.)

**\$2.00 each - postpaid to
U.S., Canada and Mexico**
Other foreign orders - \$3.00 each

Send Order with Payment to:
**ANTIQUe RADIO CLASSIFIED
P.O. BOX 2, CARLISLE, MA 01741**

CLASSIFIED ADVERTISEMENTS



1928 ATWATER KENT REPRINTS.
Radio Service Manual...\$11.95
Radio Parts Manual...\$10.95

TONING LACQUER, in 5 colors:
Van Dyke Brown, Med. Walnut,
Cherry Brown, Br. Mahogany,
Lt. Fruitwood...\$5.25/can
CLEAR GLOSS LACQUER, used as
topcoat over toner...\$5.25

CATALIN CLEANER, a special
formula which restores
original beauty.
8 oz.\$5.95

DECAIS, reproduction lacquer
denals. 4 sheets available.
Philco/RCA: Atwater Kent/
Stewart Warner; Emerson;
Zenith.....\$2.50 ea.

PHILCO PUSHBUTTONS, wine
colored repros used on
1940's Philcos. 7/16" sq.
x 3/4" long.....\$2.00 ea.

ANTENNA WIRE, cloth covered
reproduction wire for 20's
loop antennas and on AC DC
sets.....\$.18/ft.

PREDICTA 17" and 21" rebuilt
picture tubes. 1 yr warranty
\$55 ea. with dud exchange.
Others available.

Ohio residents add 7% tax
Prices do not include shipping

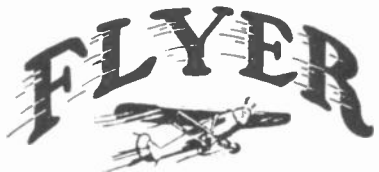

**RADIO & TV
CATALOG**

Call or write for free flyer.
Store open by appointment.

Vintage Tv & Radio

3552 West 105th St Cleveland Ohio 44111
216-226-4054

CLASSIFIED ADVERTISEMENTS

FOR SALE: Stromberg-Carlson No. 601-B, no cabinet, will part out - make offer. Robert Sukosky, 62 Strong St., Manchester, CT 06040. (203) 646-8857

WANTED: WWI equipment, unusual portables, and fancy horns. **FOR SALE:** 1920's radios, including some Kellogg tube sets. SASE for list to Rosenthal, 5 The Strand, New Castle, DE 19720

**IF YOUR EXPIRATION DATE IS
JANUARY OR BEFORE, RENEW TODAY!
EARLY RENEWALS
RECEIVE AN EXTRA ISSUE!**

WANTED: Old QSL cards and letters from SW and MW stations of 1930's thru 50's, verifying reception by SW listeners/DX-ers. (Not ham QSL's.) Need color photos of original Philco 16-B (code 125-126) cabinet for re-restoration. Also want cabinet only for G-E K-80. Lloyd B. Zimmerman, 8448 No. Harding Ave., Skokie, IL 60076

FOR TRADE: FADA 1000, yellow, red trim & knobs, no cracks, some scratches. Trade for: AK breadboard. Early crystal and 1- or 2-tube factory sets or brass base 01-A and WD-11 tubes. Will respond to all correspondence describing trade of equal value. W. Vanderlaan, 425 Major Andre Rd., Virginia Beach, VA 23462

WANTED: Reward! \$25 plus your asking price for the Tesla Supplement from May 1912 Modern Electrics or \$25 for its loan (you get it back). References available, or \$15 for good photocopy. TCBA, RR6, Box 181, Glens Falls, NY 12801

ANTIQUE RADIO TUBES

THOUSANDS IN STOCK
LOW PRICES - NO MINIMUM

Resistors - Capacitors - Knobs
Dial Cord - Speakers

Write or Call for prices.

MIDWEST SUPPLY ELECTRONICS

1165 Lafayette Avenue
Terre Haute, IN 47804
(812) 232-0187

CLASSIFIED ADVERTISEMENTS

FOR SALE: UPS extra. Philco 70 cathedral - \$175. AK 80 cathedral - \$275. RCA R-70 cathedral - \$175. Grebe CR-5 - \$365. AK 20 Big Box, NT - \$65. Sears single-dial neotrodyne - \$45. Zenith 27, needs work - \$35. Scott Philharmonic chassis, power supply with 15" RCA theater speaker, needs some work, chrome fair + - offers over \$550. Motorola 7" suitcase portable TV, NT - \$150. Zenith A eliminator ZE-4 - \$25. National NC 2-40D w/spkr., fair - \$45. Hallicrafters SX-16, fair + - \$45. National speaker, 50's - \$25. Haynes-Griffin Superhet - \$150. AK variometer - \$25. Commodore, early calculator - \$20. Radio magazines, send for list. Motorola 17" compact bakelite TV - \$50. AK Type K ignition coil - \$125 or BO. Westinghouse dual scale voltmeter in small bakelite case - \$20. Weston milliammeter, table type - \$15. Heathkit FM tuner, 50's? - \$20. Heathkit color bar + dot gen. - \$25. Home brew RC bridge - \$20. Homebrew TV tester - \$20. RCA sig. gen. - \$20. Eico sweep gen. - \$20. Eico VTVM - \$15. U.S. Navy CW 46051-A receiver with 9 RU-17/RU-19 coil sets and home brew supply - \$175 or BO. Large B supply, regulated, home brew - \$20. Maguire white bakelite set - \$25. Richard C. Foster, 12 Shawmut Ave., Cochrutuate, MA 01778

WANTED: Instruction book, other info on the Ultradyne kit superhet. Photocopies OK. Tod Prowell, W3URG, 1073-15 Lancaster Blvd., Mechanicsburg, PA 17055. (717) 697-5227

FOR SALE: NRI service manuals one and two, PRG 1950, 1598 pages - \$50 plus UPS. Warren Burdine, 1606 Idylwild Dr., Prescott, AZ 86301. (602) 778-1608

KURLUFF ENTERPRISES \$ WANTED TO BUY \$ Juke Boxes

Always looking for Wurlitzer, Seeburg, AMI etc.
Dead or Alive - Large quantity ok.
In-state, out-of-state, out-of-country ok.
Shipping No Problem.

\$\$\$ FAST CASH \$\$\$

Neon Signs - Wall Clocks
Bar and Restuarant Fixtures.

Surplus Electron Tubes

Always need Windups
Victor Credenza - Victor II - Operas - Edisons -
Cylinders in quantities.

Movie Memorabilia - Posters.
One Sheets - Lobby Cards - Stills, Etc.

KURLUFF ENTERPRISES
clo Charlie Dripps
4331 Maxson Road
El Monte, CA 91732
(818) 444-7079

CLASSIFIED ADVERTISEMENTS

FOR TRADE: AK 10 with M horn, AK 20, AK 32; all in excellent condition for 1930's Collins amateur transmitter in reasonable condition. Parker Heinemann, 87 Cove Rd., Lyme, CT 06371. (203) 434-7783

WANTED: Admiral Model 5F11 or 5F12, battery/electric portable radio. (About 1950). Price adjustable in proportion to condition. I'm not a collector or dealer. Just want this radio. Kenneth Girardi, 809 N. Alpine Rd., Rockford, IL 61107. (815) 229-1008



FOR TRADE: Atwater Kent Model 49 battery set with Type E speaker. Both pieces are in the original AK boxes from the factory. Radio and speaker are in mint condition, and boxes are in above average condition. Owners manual and other literature included. Will trade for Zenith Black Dial radio(s). Mike Headley, 20172 Woodstock Ct., Yorba Linda, CA 92686. (714) 777-4077

WANTED: Dial glass for Philco Model 42-350. Gang tuner for Model 17 or Model 18 Radiola. Cabinet and speaker for Philco chassis Type 16, Code 122. Chassis for Zenith Super VIII. **FOR SALE:** Sixty 16" E.T. transcriptions of old radio programs. **FOR SALE:** Novelty transistor radios AM/FM: Baseball, basketball, tennis, golf, and soccer balls. Six transistor Globe, Abbotsware horse radio, microphone AM/FM with "on the air" light on top, Blabber Mouse, Pound Puppy, jukebox, candlestick telephone. Inquiries welcome. LSASE please for prompt reply. Shipping and handling charges extra. Thank you. George E. Brehm, 13402 Leibacher Ave., Norwalk, CA 90650-3524. (213) 864-8857, answer machine

WANTED: I have cabinet Philco radio Model U21013. Need any information. Matt Hogan, PO Box 516, Williston Park, NY 11596

**WANTED: ZENITH RADIO NURSES!
PAYING \$650 - \$800...**



HARRY POSTER
(201) 794-9606

Box 1883, So. Hackensack, NJ 07606

CLASSIFIED ADVERTISEMENTS

WANTED: Absolute top cash paid for chassis for Pete: Pan mantle style radio. Volume shaft on left, tuning shaft on right 7 1/8" apart. Also need information on year, Model #, etc. Help! Mike Headley, 20172 Woodstock Ct., Yorba Linda, CA 92686. (714) 777-4077

FOR SALE: Philco Farm tombstone, good cond. with tech. manual copy - \$50. Airline table AC, 93 WG, roto push-button dial, fairly good volume, knob missing - \$45. Radio Shack Pro-2020 scanner, 20 channels to 512 MHz with manual, like new sacrifice - \$95. Above plus UPS. **WANTED:** HQ-120 and ocean cable artifacts, etc. Robert Ene-mark, Box 1607, Duxbury, MA 02331. (617) 934-5043

WANTED: Push-button assembly with button knobs for Philco Transitone 30T All-Wave. E. Barbacow, 330 Ceylon Rd., Carmichaels, PA 15320. (412) 966-7934

FOR SALE: 1937 vintage Weston Model 776 oscillator - \$80. Simpson Model 303 VTVM, mint - \$42. Ward Becht, 625 Tufts Ave., Burbank, CA 91504. (818) 842-3444

WANTED: Four original WD-11 tubes for Radiola III. For museum display only, need not work. L. Auman, Rt. 1 Box 368, Dover, OH 44622

FOR SALE: Recordio by Wilcox Gay, 1930's; plays P.A., phono, radio; records phono and radio, completely original, needs tubes checked - best offer over \$100, F.O.B. Charlotte, 3610 Country Club Dr., Charlotte, NC 28205

Please Save this Want List!

NATIONAL AIRPHONE

Monodyne One-Tube Set
Monodyne Model A Amplifier
Interference Eliminator
Monodyne Model GT-20 Portable Set
Radiotrola "Baby Grand" Receiver

TELMACO

Type B-R Receiver
Type B-A 2-Stage A.F. Amplifier
Type TA-2, TDA-1, TDA-2 Det./ Amp. Units
Telmacophone Type TH-1 Horn Speaker

BRISTOL

4-Tube Receiver in Case

As it may be a long time before I find some of the sets listed in these ads, remember to call me when you can part with yours. I am putting together a collection of early broadcast and wireless equipment and adding to it each month. I buy single sets or collections. Also: books, catalogs, manuals and other related documentation.

Call and surprise me; make my day!

John V. Terrey, 498 Cross Street
Carlisle, MA 01741 - (508) 369-9770

CLASSIFIED ADVERTISEMENTS

WANTED: Manual for RCA Rider Chanalyst Model 162-C, copy OK. Gordon Wilson, 11108-50 Ave., Edmonton, Alberta, Canada T6H 0H9

WANTED: HS-30 headset and T-17 mike for GRC-9 dynamotor to Art-13 power cable. F. W. Nicholas, PO Box 37094, Phoenix, AZ 85069

FOR SALE: AK 266 chassis with tubes - \$35. Two-tube homebuilt, bus bar wired, 201A tubes; nice, clean, good wires and cabinet - \$35. Three-tube homebuilt, bus bar wired, uses 199 tubes (2 missing), set and cabinet fair - \$25. Vibroplex bug, nice - \$35. Secret Invention, small hidden VHF trans/rec with instructions for operating as mine reading act., purchased in 1950's - \$100. Wooden case with dial in microfarads labeled Baldwin Instrument Co., has phones, nice unrestored case - \$30. **WANTED:** I am located 20 miles west of New York City. Want radio capable of receiving clear channel WSM 650 Nashville, Tenn. Can you supply set or advise where available? J. Young, 11 Willow Ct., Totowa, NJ 07512. (201) 256-1342

WANTED: Hallicrafters S-72 All Band portable, like Trans-Oceanic. Crosley Pup, 52, 4-29 Portable. Early superhets, not RCA, Grebe tube socket CR-9. Kit sets OK. **FOR SALE:** WD-11 replacement, N.O.S. WE-215-A (VT-5) on WD-11 base, direct replacement - \$15 + postage. Charlie Rhodes, 64 South River Rd., Edgewater, MD 21037. (301) 266-3691

FOR SALE: Scott Phantom Deluxe in Victorian style cabinet - \$300. Jim Wilson, 1325 Sunset, Round Lake Beach, IL 60073. (312) 546-6102

CLASSIFIED ADVERTISEMENTS

FOR SALE: GE Model 422 purple swirl, excellent. **WANTED:** Front glass Philco 48-482. C. R. Sundgren, 1519 S. Tacoma, Kennewick, WA 99337. (509) 586-8157

WANTED: Manual or schematic (or copy) for WWII receiver R45/ARR7 Hallicrafters. W. Britton, 225 So. 17, St. Helens, OR 97051

WANTED: First model Zworykin iconoscope, the round one. Majestic Melody Cruiser. Piano radios. DeForest audion. Richard C. Foster, 12 Shawmut Ave., Cochituate, MA 01778

FOR SALE: 65 years collection: Radio Masters catalogs, manuals, flyers, books, antique radios, televisions, phonos, ham, military-aviation equipment, uniforms deluxe. 48 pages - 45¢ LSASE. Francis H. Yonker, 7 Old Farms Rd., Saddle River, NJ 07458

WANTED: Triad R26A power transformer, UTC GC48C choke, UTC GC102 choke. Also, Acrosound and UTC power and output transformers. Richard Sharisky, Box 521, Belmont, MA 02178. (617) 484-5784

FOR SALE: 1929 Sparton 931 AC, small high boy console, exc. cond. except top needs refinishing, with tubes, not wkg., pick up only - \$95. **WANTED:** Instr. or service manuals V-M V-9022 rec. changer. Sams #112 for Westinghouse Model 2152-16 TV. Stromberg-Carlson RBS-1 U.S.N. Type CCT 46217 rcvr. Repros OK. Thanx. Bill Ross, 1124 Tower Rd., Winnetka, IL 60093. (312) 441-6462

NEW FOR 1989!



- **DECALS** — Emerson, Zenith, Atwater Kent, and Stewart Warner
- **ELECTRONIC BALLAST** — Replace resistance cords, tubes, etc.
- **SOLID STATE VIBRATORS** — 6-12 volt, 3 and 4 pin for auto radios
- **WOOD KNOBS** — Late 20's style repro knobs with metal insert and set-screw
- **BROWN PLASTIC KNOBS** — N.O.S. brown knobs for 30's-40's radios
- **CLOTH COVERED WIRE** — Custom manufactured 20 AWG hookup wire in 5 colors
- **BOOKS** — 65 titles available, including all the latest

Write or call for new 24 page wholesale catalog.

ANTIQUE ELECTRONIC SUPPLY

688 W. First Street, Tempe, AZ 85281, Phone (602) 894-9503, FAX (602) 894-0124

CLASSIFIED ADVERTISEMENTS

FOR SALE: Price + UPS compute & send ck. or SASE for additional items. Voltmeter, H.P. Mod. 400D, fine, 20# - \$40. Phonograph arm, Brush Mod. PL 20, w/o cartridge, in original box, pat. date 1931, 6# - bid. Datasouth printer, parts kit, Model DS180, new, controller pcb, op. front panel & panel cable, (bad) print head, w/maint. manual, 9# - \$250. Wm. Arnold, 27832 Lincoln Rd., Bay Village, OH 44140. (216) 835-0520

WANTED: The New England Radio Club wants you to be at its big Winter Swap & Sell Meet January 22, Holiday Inn, Nashua, N.H. Larger room! Longer hours! More tables! Auction! Contest! Be there! Info: NERC, 422 Day St., Manchester, NH 03014. (603) 623-8996

WANTED: Good blue Arcturus 30, 31, and 32 tubes to complete Lincoln Farm radio chassis. N. Braithwaite, PO Box 2443, Redding, CA 96099. (916) 246-4209

FOR SALE: Restorable cabinet for Earl highboy, Freshman, Model 22 or 31 not sure, photos available. P. Burton, Box 912, Belchertown, MA 01007. (413) 323-5019

WANTED: Hallicrafters HT-6 coils, schematics, manual. Larry Rosine, WØOG, 13719 Alhambra, Leawood, KS 66224. (913) 897-4015

WANTED: Westinghouse DA for parts. Aeriola Sr. dial and pointer. Philco 1930's escutcheon and (27-503) dial scale or similar. RCA UZ-1320 driver, Radiola V nameplate. Bob Husted, 270 NW 3rd Ct., Boca Raton, FL 33432. (407) 368-8358

FOR SALE: Grille cloth, new, custom-made material in diamond pattern, good match for 1930's radios - \$6 for 10"x12" piece, postpaid. Send SASE for sample. Michael Katz, 200 East 30th St., Apt. 8E, New York, NY 10016. (212) 725-0736

WANTED: Issues of Pacific Radio News, later called Radio. Bliley variable frequency crystal vicinity 3585 kHz. Early regenerative receivers: SW2, SW4, Super Wasp; DeForest. John Nagle, K4KJ, 12330 Lawyers Rd., Herndon, VA 22071. (703) 620-3066

WANTED

I would like to purchase the following

Sony Shortwave Receivers:

1. Sony 330K (with tape recorder)
2. Sony 320K (without tape recorder)
3. Sony CRF-1

MATHEW WOLF
5353 W. ALABAMA, SUITE 303
HOUSTON, TEXAS 77056-5922
713/871-9000

CLASSIFIED ADVERTISEMENTS

WANTED: General Radio Type 231A 3.7:1 open-frame ATF. H. Brown, 2 Central Ave., Morris Plains, NJ 07950. (201) 538-2014

WANTED: Instruction manuals for the following: Knight signal tracer; Tektronix Type 531 oscilloscope Model 53C, Serial 990; Hickock tube tester Model 799; Hickock tube tester Model 800A. Copies of above will be OK. James G. Watson, 198 Dunkard Ave., Westover, WV 26505. (304) 292-1858

FOR SALE: Philco Predicta 17" Debutante, not working, otherwise complete and in good condition - \$200. Philco Predicta 17" Princess, working, very good condition with original antenna and console table stand - \$400. Philco Predicta 21" table model Holiday, not working, otherwise complete, very good condition, UHF tuner - \$200. Philco Predicta 17" and 21", rebuilt picture tubes - \$50 ea. Philco Predicta yokes and flyback transformers - \$50 ea. Delco TV Model TV-101, not working, very good condition - \$50. All televisions and picture tubes are pick up only. Televisions, PO Box 961, Lansdale, PA 19446

CLASSIFIED AD DEADLINES

Jan. 10 for Feb. 1989 Issue

Feb. 10 for Mar. 1989 Issue

Mar. 10 for Apr. 1989 Issue

WANTED: Back cover for Philco Predicta console #H4730M and chrome front radios. Jimmy Downes, 607 East 12th Ave., Covington, LA 70433

COMMUNICATIONS RECEIVERS

THE VACUUM TUBE ERA:
50 GLORIOUS YEARS
1932-1981

NEW SECOND PRINTING - REVISED
PRINTED ON COATED PAPER, IMPROVED
PHOTO REPRODUCTION, NEW PHOTOS,
CORRECTIONS, PERFECT BOUND, GLOSSY
COVER, SAME OLD PRICE.

- Book covers industry history
- Specs on 700 receivers
- 51 company histories
- 112 photos
- For collectors, connoisseurs and admirers of receivers

\$14.95 plus \$2 P/S, SASE for details.

RSM Communications
Box 218-A, Norwood, MA 02062

CLASSIFIED ADVERTISEMENTS

FOR SALE: Stan's Surplus Stuff. SASE appreciated for listing. New tubes & used, etc. Stan Lopes, KB6LGV, 1201-74 Monument Blvd., Concord, CA 94520. (414) 825-6865

WANTED: 10,000-ohm 50-watt rheostat, Ohmite J-0332 or equivalent. Also black leatherette material. Alan Kriss, 1872 Portsmouth Way, Union, NJ 07083. (201) 688-2092

FOR SALE: Liquitex™ Parchment White acrylic paint (recommended by Henry Brown, A.R.C. Nov. 88). Why chase all over town? 2-oz. tube - \$3.30 + \$1 postage. D.R.K. Computer Consultants, 886 Eggert Dr., N. Tonawanda, NY 14120

FOR SALE: Scencore test equipment, USA, with manuals; Digital voltmeter, large display, DVM37 - \$100. Touchtone in or out of circuit transistor tester TF26 - \$100. Yoke and flyback tester and two-level hi-volt probe - \$125. Cathode ray tube tester and rejuvenator CR161 - \$150. Color generator CG22 - \$20. All like new. Present cost approx. \$2500. Take all for only \$390 ppd. Gene Claus, 2305 W. Rice, Sioux Falls, SD 57104. (605) 332-3747

WANTED: Top cash paid for Zenith radios, 1935-1941, floor models or table tops. Call or write: Mike Headley, 20172 Woodstock Ct., Yorba Linda, CA 92686. (714) 777-4077

FOR SALE: Over 50 radio magazines before 1926. Several cathedrals, manuals, parts. SASE for list. P. Majewski, PO Box 92, Tamaqua, PA 18252

CLASSIFIED ADVERTISEMENTS

FOR SALE: Rider's Radio Serv. manuals Vols. 7 to 14 - \$18 ea. Howard Sams, RCA, GE, RCA, Philco service data. Tubes for early radios from 1920 to 1960. Knobs, coils, audio and power transformers, dial belts, volume controls. 1000's of parts. Meissner How To Build, 1949 - \$9. Drake's Radio-TV Elect. Dictionary - \$5. Audel's Radio Man's Book; 1940, 1944, 1948, 1952; per copy - \$8 ea. Radio Theory Simplified, 1926, Merle Duston - \$8. Radio Simplified, 1922, Kendall & Koehler - \$9. Pop. Mechanics 1948 to 1956, 16 copies - \$15/all. G-R Variac, 5 amps - \$12. RCA Variac 220v-120v, 4 amp - \$22. Tube tester RCP Model 308 w/instr. book, works - \$25. Precision E200 signal gen., works - \$25. Radio craft, 1946 to 1948, 10 copies - \$15. Radio Electronics, 1951 to 1955 - \$1/per copy. Spark gaps from a quack machine, pair, air cooled - \$10. Ford T type spark coils - \$8. Jefferson elect. spark coil, untest. - \$10. Spark transformer and condenser's, 25 lbs. - \$30. Spark coil and condensers, 17 lbs. - \$15. This is a nice item to add to your cathedral radios (new), AM-FM radio, 7 3/4" x 7", less batts - \$19. All items plus shipping and handling. Min. orders - \$7.50. Krantz, 100 Osage Ave., Somerdale, NJ 08033

SEND ALL A.R.C. MAIL TO
Antique Radio Classified
P.O. Box 2, Carlisle, MA 01741

WANTED: Books and literature pertaining to Canadian manufactured radios, not U.S. Ernest D.M. Yeaw, RR#3, Tatamagouche, Nova Scotia, Canada B0K 1V0. (902) 657-2554

PUETT ELECTRONICS

P.O. BOX 28572 DALLAS TX 75228



48 PAGE CATALOG - \$2.00

A \$3.00 DISCOUNT COUPON WILL BE SENT WITH YOUR CATALOG IF YOU INCLUDE THIS CODE NUMBER WITH YOUR CATALOG ORDER:

ARC007-77

PUETT ELECTRONICS IS IN ITS FIFTEENTH YEAR - HELPING ANTIQUE RADIO COLLECTORS TO PRESERVE THE GOLDEN AGE OF RADIO!!!!!!

CATALOG 7 SEVEN

OUR NEW CATALOG --- MORE THAN 1,000 DIFFERENT ANTIQUE RADIO PUBLICATIONS, BOOKS, INSTRUMENT MANUALS, COMMUNICATIONS RECEIVER MANUALS, CATALOGS, SERVICE DATA, SALES BROCHURES, TECHNICAL DATA, FACTORY SERVICE MANUALS, AND OUR REPRODUCTIONS OF MANY FAMOUS RADIO BOOKS AND LITERATURE PRINTED ON BOTH SIDES OF THE SHEET AND WITH ATTRACTIVE COVERS! HUNDREDS OF DIFFERENT TYPES OF TUBES WHICH ARE USED IN ANTIQUE RADIOS, RIDER MANUAL INDEXES, TUBE MANUALS, TUNING DRIVE BELTS, LARGE LIST OF CLASSIC RADIO LITERATURE, SCHEMATIC DIAGRAMS ON NEARLY ANY RECEIVER, DIRECTORY OF ANTIQUE RADIO SERVICES, A.A. SERVICE MANUALS, APPRAISALS, HUNDREDS OF OLD TIME RADIO PROGRAMS ON CASSETTES!!!!!! ANTIQUE RADIO TOPICS, A 14-SERVICES PUBLICATION SUBSCRIBERS GET 15% OFF ON ALL CATALOG ITEMS, 20% OFF ON TUBES!!!!!!

DECALS

Original style reproductions Lacquer base
 Soak in water, slide onto cabinet.
 Gold body, black outline, except *
 This ad is one-third of decal size.
 \$6.00 per item











ONE ITEM









Add on *
PHILCO
Northern Electric

\$2.00 per item

POWER SWITCH STATION VOLUME LOCAL BAND
 CONTROL SELECTOR TUNING BASE TONE LOOP GANES
 TUNING PEGS RCA VICTOR CLOCK TROTTER ONE PS
 ONE PS ONE PS ONE PS ONE PS ONE PS ONE PS ONE PS ONE PS

Complete sheet \$30.00. Add \$2.00 per order for shipping. Canadian funds.

GRANDPA'S RADIO SHOP
 26 QUEENSTON CRESCENT
 KITCHENER, ONTARIO, CANADA, N2B 2V5
 (519) 576-2570

CLASSIFIED ADVERTISEMENTS

FOR SALE: Cathedral radios - \$5 ea. (Avon bottles) N.I.B., 864 tubes, UX base, low noise, equal to WD-11; an unbused tube fits WD-11 brass base or use James Fred's adapters - \$5 ea. Small 4UF/600 volt capacitors - \$4 ea. E.M. speakers, 4 thru 15 inch; many AC chassis; N.I.B. Philmore phono cartridges - \$7.50 ea.; Motorola RW-1 record duplicator-wireless (78 rpm) phono, with N.I.B. pick up and recording head - \$45. Record: My Radio Man, Carol Chappelle, 78 rpm, Risque, chipped at edge but 99% playable - \$7.50 firm. Children's small 78 rpm picture disks - \$5 ea. 1906 children's record, small 78 rpm - \$5. N.I.B. 1DP1 CRT's - \$10 ea. Bliley Model 1-A crystal-controlled oscillator, IF frequencies - \$50. Philco 088 (battery) RF oscillator, original instructions - \$30. RCA WV-65 (battery) VTVM - \$15. Sams AR manuals - \$3 ea. Grommes 50-watt (transistor) amplifier - \$25. CCT 20086 power supply, military S.W. - \$20. 6-12v input military plate supply - \$10. Recond speakers for round-dial Zeniths: 49AB249, 49U352 - \$25 ea. 100 1935-1970 car radios - \$200/all. Jim Farago, PO Box 6313, Minneapolis, Mn 55406. (612) 722-0708

WANTED: Issues of Radio Index (RADEX) magazine, 1930's and 1940's; and World Radio Handbook, 1947 thru 1958. Contact: Jerry Berg, 38 Eastern Ave., Lexington, MA 02173. (617) 861-8481

FOR SALE: Need reading material for the winter months? Send 2-stamp SASE for 7-page list of over 850 radio magazines, books and misc. literature. Gary B. Schneider, 9511 Sunrise Blvd., #J-23, North Royalton, OH 44133. (216) 582-3094

Wanted

Highest Prices Paid for Your Two-Color Catalin, Mirrored Sets, Glass (Radio Glo), Novelty - Charlie McCarthy, Hoppy - Microphones and Unusual Transistors.

BRENDA WILK
409 S. Fible
Kirkville, MO 63501
(816) 665-9304

WANTED Early Radar & ECM Equipment

AN/APR-1, 2, 4, 5 Receivers
AN/APA-6 Analyzer
Radarhist Subscribers

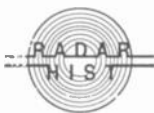

Don Helgeson
POB 3087
Skokle, IL 60076
(312) 676-4604

CLASSIFIED ADVERTISEMENTS

FOR SALE: Trans-Oceanic tubes: 1L6 - \$6.50, 3V4 - \$5, 50A1 - \$11, 1N1239 S/S plug-in replacement for SU4/5Y3 - \$4, 6AS7G, 5Z3 (antique envelopes) - \$5, 6E5 "eye" tubes, 7591A, 6080 - \$8, 6082 - \$10. Need unusual tubes? Try me. No lists. Send wants. No transmitting tubes. Precision Apparatus E-200-C signal generator - \$20. Sencore sweep circuit troubleshooter SS 105 - \$10. Eico 950B resistance-capacitance comparator bridge - \$10. Eico 944 flyback transformer/yoke tester - \$10. New disc ceramic capacitors .01 x 1kv. - \$1/3. Add UPS. **WANTED:** 3TF7, 3TF7A, 3TF11. Quantity and price first letter. Joe Bunyard, 1601 Lexington St., Waco, TX 76711

WANTED: Manual for E. F. Johnson Navigator transmitter. Henry Holtermann, 20091 Port Circle, Huntington Beach, CA 92646

FOR SALE: "Boat Anchors." Early Stromberg TV combo "Chinese" - \$200. RCA projection TV - \$200. Two Akai 355X recorders - \$80. Wollensak #1981 recorder - \$40. Garrard Rotel, Accutrac, Kenwood turntables - \$50/5. GE monitor refrigerators - \$50. Collard grand piano - \$200. 8'8" harpsichord - \$700. Pipe organ - \$600. Or BO. Instruments need repair. Call: Bill Wiley, 968 W. Market St., Akron, OH 44313. (216) 867-7505. eves.

FOR SALE: AK 55, very good - make offer. Collins speaker for 75A3/4. Excellent unmodified ARR-15. B&W 350/24Q Audio Phase Shift, (3) - \$10 ea. Gary Cain, 1775 Grand #302, St. Paul, MN 55105

BITS WITH GRIP

Save time and money...by using Apex Anti-Cam-Out Phillips Bits. Each bit has little teeth that hold the bit in the Phillips-head screw slots when you apply torque, so it is less likely to slip out, chewing screws and damaging your work surface.

1/4" Hex Drive x 1" long
Fits power or hand drivers

Set of two Anti-Cam-Out Phillips Bits #1 and #2 for removing/driving \$2.95 Postpaid

Save more: Order two sets for \$4.95 Postpaid

Order today. Satisfaction guaranteed

Also available: Allen (ASE and metric), Torx, Tri-Wing, Metric Phillips, Much More.

Made in the USA.
Write for free price list.

SHOCKEY'S
Dept. 22, 5841 Longford Rd.,
Dayton, Ohio, 45424. (513) 236-2983

CLASSIFIED ADVERTISEMENTS

WANTED: User/service manuals: Radon VMR-1 VOR, Marconi: TF791D and AMI 400 Deviation meters, FR-135/USM-107, Ferret 620 test speaker, Hallicrafters S-85, SX-24, S-20R, National NC-125, Gonset 3136 Communicator III, Gonset 3226 VFO, Eldico R104. **FOR SALE:** 3300 tubes, all checked. Antique radio parts. SASE for lists. Richard Dreher, W5VTJ, PO Box 691443, Tulsa, OK 74169. (918) 627-7481

WANTED: Complete chassis with knobs, Model 652 FADA. Top price for front case cover and pair plastic knobs Zenith Trans-Oceanic portable 7G605, airplane on grille. 32-volt DC radio, vacuum cleaner, motors or fans; write with price and condition. Don Nordboe, 3220 West Bdw, Council Bluffs, IA 51501. (712) 322-2255

SEND ALL A.R.C. MAIL TO
Antique Radio Classified
P.O. Box 2, Carlisle, MA 01741

FOR SALE: Silvertone roundtop. Echophone cathedral. Geneva 30 cathedral. Gloritone 26P. Philco M37-38 ball. Airline shadow dial chassis. Delco Model 32C1. Radiola 18 with speakers. Airline 62.617 teledial [batt. ?] Hallicrafters Models 92-20. Lyric 9-tube table model. [Silverline?] 1801. Philco 26B. Gloritone. Revere. GE roundtop 182. Grebe MU1 with battery case. Stewart-Warner shortwave converter Model 301A, 1930. Jim Stratton, N6902 Post, Spokane, WA 99208. (509) 328-8471

HELP: I badly need a schematic and any information I can get on an Ultradyne Model 6A, T.W. Meiklejohn Co. Inc., Fond Du Lac, Wis., Dist. "Dan Coombs Elec. Lab, K.C. Mo." The cabinet is also factory-made in K.C. Mo. The set has many control knobs and meters, and appears to be an early 8-tube superhet that has been modified to 6-tube (?); bakelite and cast-brass chassis; engraved bakelite panel, long. Larry Schiebel, 5834 Balsam Rd. #3, Madison, WI 53711. (608) 276-7768

WANTED: Good restorable Zenith tombstone, (or possibly one that is in real good shape already), can be rough as long as complete. Thanks. Larry Schiebel, 5834 Balsam Rd. #3, Madison, WI 53711. (608) 276-7768

WANTED: Information and parts for Westinghouse RA and DA restoration. AWA Review vols. I and II. HP200A audio oscillator. Parts for AK 10 BB. Dave McClellan, 1086 Trailridge Ln., Atlanta, GA 30338. (404) 399-6704, eves. collect

FOR SALE: All in good working order, pick up only. 1951 Revere T-100 tape recorder - \$15. 1959 Acrosound Ultralinear 60W mono audio amp - \$20. 1970 Telex 235 7" reel playback deck with 2- & 4-track stereo heads - \$50. 5BP1A 'scope CRT in box - \$5. Fred Kaepfel, 209 Cherry, Port Byron, IL 61275. (309) 523-3427

CLASSIFIED ADVERTISEMENTS

FOR SALE: I am a private collector making room for future purchases. All following radios & equipment in good working order. You pay shipping. RCA maroon plastic, gold grille portable Model 145, AM only - \$25. RCA brown bakelite RC1080C, AM only - \$15. Zenith portable leatherette, AM only, 6G001YZ - \$30. Zenith console 8S-563 round black dial bc-SW-pb - \$120, pick up only. Knight multi-tester KG640, Solar exam-eter, Heathkit Dynamic tube checker - \$20/all three. Zenith mic & rec headgear - \$15. Concord P.A. system mic & base - \$20. John R. Parker, 6426 N. Silvery Ln., Dearborn Heights, MI 48127. (313) 561-6376

WANTED: Zenith Trans-Oceanic R7000-1, 12 band, chassis #2WKR70, air, VHF, etc.; good working condition. Les Clarke, 120 West 44th St., Apt. 1209, New York, NY 10036. (212) 354-0136, call eves.

FOR SALE: 20's, 30's, 40's radio & telephone manuals, publications, magazines. SASE for list. Jerry Valentine, 10803 NE 143 St., Kirkland, WA 98034. (206) 488-4830

FOR SALE: Grebe Synchrophase - \$80. Crosley Trirdyn Regular #1121 - \$45. Day-Fan 6 - \$60. Wells 6-tube semicylindrically-coupled coils - \$75. Radiola III - \$40. Radiola IIIA - \$55. Radiola III, wrong cabinet - \$25. Browning Drake 5R - \$75. Robert Enemark, Box 1607, Duxbury, MA 02331. (617) 934-5043

WANTED: Knurled brass dial pointer knob for AR-812. Lids for FADA 175A & F.E. NR-60. Small can AK AFT's. AK interstage for #46, 53. AFT for FADA 175A. Pot metal parts for FADA R60. AK tuner pulleys, working DA or parts. Crosley AFT's and subpanel RFL-75 parts. Harkness AFT's. AK F-2 speaker. F.E. NR-7 AFT's or Amertran AF-6 & AF-7. Harvey Faulkner, Jr., Thornhollow Rd., Newark, DE 19711

WANTED: Military radio communications 1930's thru 1945. My chief collecting interest is WW2 German, Japanese, and Italian equipment. In the U.S. gear I'm mostly interested in some mobile and aircraft types, examples BC-224A, JT-350, RAX, TBY; also have a liking for Forest Service and aircraft radios of same era. Also highly interested in 1930's-40's paper for research and reference: manuals, equipment advertising materials, aviation and radio magazines, limited circulation publications such as Bendix Radio Engineer, U.S.N. Electron, Radio Operators' Union Bulletin, shortwave station listings, Berne or FBIS listings of world broadcast stations. Thank you! Hugh Miller, KA7LXY, 6400 Maltby Rd., Woodinville, WA 98072-8375

WANTED: Radio test panel, Jewell pattern 579. Universal bridge, RCA Model TMU-132A (SN 9600). Orval Parker, HCR Box 133, Pocono Summit, PA 18346

CLASSIFIED ADVERTISEMENTS

FOR SALE: Small wood & plastic radios. I need Riders. Chucks, PO Box 598, New Haven, WV 25265

WANTED: Hallicrafters S210, SX42, SX62, portables. Post-1939 Stromberg-Carlson table SW's. Any condition. 73 magazine "surplus" issues, ARRL hints and kinks, all volumes. Paul Caudell, 420 East 9, Bloomington, IN 47401

WANTED: Atwater Kent Model 35 and speaker, Type H. Both must be in excellent, working condition, and complete with original parts and finish. David Kechkaylo, 3935 Bristol Ct., Melbourne, FL 32904. (407) 723-0980

FOR SALE: Sets need work. Majestic Continental - \$50. Grundig Telefunken radio phono - \$50. RCA 8X541 - \$20. Emerson wood - \$30. Westinghouse Model ? - \$50. Jim Spreda, 1741 Ellis St., Stevens Point, WI 54481. (715) 341-3251, after 6 pm

WANTED: AN/ART-13 and its look-alike and design alike ATC. Two WWII aircraft transmitting sets with transmitter, T-47 and 52286, and its supporting units. Such as dynamotor, antenna tuners, control box, etc. Russell J. Howard, N7CCR, 3821 S. Fruda Pl., Tucson, AZ 85746. (602) 578-0429

FOR SALE/TRADE: RCA 66X8 red Catalin, AK 206 cathedral, Silvertone 3551 (Beetle Plastic) in the original box. **WANTED:** Addison 5F, Sparton Bluebird 506, AK 5. Jim Thompson 4238 15th Ave. S., Minneapolis, MN 55407. (612) 822-4000

CLASSIFIED ADVERTISEMENTS

WANTED: Early Aeriola's, Radiola's & Crosley Pup, good to vg condition. Johnny's TV Repair, Osborne Plaza, Osborne Ave., Riverhead, NY 11901. (516) 727-8020

FOR SALE: Philco Model 84B cathedral. Silvertone tombstone. Russell Schoen, E7340 Nietzsche Rd., Clintonville, WI 54929. (715) 823-6744

WANTED: Crosley express tube W-41187. Part number 72 for Crosley Model 1126 radio. Jack D. Hcrtman, PO Box 456, Biglerville, PA 17307

FOR SALE: Jefferson 290 tube tester - \$7.50. 30 different brands old tube cartons - \$25. Add UPS. **FOR TRADE:** Crosley (Sears) G-6 for RFL-60 or tinfoil train. Geo. Hausske, 1922 E. Indiana, Wheaton, IL 60187. (312) 668-3845



WANTED: Emerson radio Model AX-212, 1938; a wood, Art Deco design. Fine maple wood is bent and turned on a lathe to equal designs molded in plastic. The speaker grille is from a single piece of wood. Norris Cranmer, 3100 Tambay Ave., Tampa, FL 33611. Call evenings & weekends: (813) 839-7583

1984 to 1987 Index to Antique Radio Classified

Turn your collection of A.R.C. into a valuable reference.

Only \$4.00 Postpaid!

The Index is 20 pages long and contains 1000+ entries.

The Index covers Volume 1, Number 1 (June 1984) through

Vol. 4, No. 12 (December 1987).

Indexed are all 41 issues (1140 pages) of A.R.C.



Listed are all photos and references to radio sets, speakers, keys, other components, novelties, important persons, etc.

For example:
Atwater Kent: 41 entries
Crosley: 91 entries
Sparton: 17 entries

A separate listing of articles is also included.

Send payment with order. Mass. residents add 5% tax. Allow 2 weeks to receive Index. Mail to: Antique Radio Classified, P.O. Box 2, Carlisle, MA 01741

CLASSIFIED ADVERTISEMENTS

FOR SALE: New Philco dials for Models 37-610, 37-611, 37-620, 38-620, 37-623, 38-623, and 37-630 - \$15 ea. plus \$1.50 shipping. These dials are three-band, two color and may fit sets other than above. Antique Radio Restorations, 635 S. Lincoln Ave., O'Fallon, IL 62269. (618) 632-7423

WANTED: Crosley Super Buddy Boy Model 123. Bob Barnes, PO Box 275, Monroe City, MO 63456. (314) 735-2945

FOR SALE: Orange Drop Capacitors, new 1988 factory stock 600VDC 10%: UF - price each: .001 - 30¢, .0015 - 30¢, .002 - 30¢, .003 - 30¢, .004 - 30¢, .005 - 30¢, .006 - 40¢, .01 - 60¢, .015 - 60¢, .02 - 60¢, .03 - 60¢, .04 - 60¢, .05 - 75¢, .06 - 75¢, .1 - 75¢, .25 - \$1.25, .47 - \$2. Minimum order - \$50. **WANTED:** Olympic TV Model 922 or 928, power transformer Olympic TR1474, Stancor P8153, Merit P 3059 or RCA 9407621. CRT's 15GP22, 7DP4, 30BP4. John Folsom, 450 Golden Dove Ave. NE, Palm Bay, FL 32907. (407) 725-3462, eves.

FOR SALE: Plastics, novelty, metal, transistors, 1930-present. Large selection. Write for list. Bary Borton, 106 Wright Ave., Toronto, Ontario, Canada M6R 1L2. (416) 537-2005

WANTED: Crosley TV Service Manual for Model 9-423M-LD. Also Radio-Television Retailing magazine, issues from late 1940's to early 1950's. Bob Carlson, 815 Third Ave., International Falls, MN 56649. (218) 283-2543

WANTED: Cabinet for Stewart-Warner 102A or 102B cathedral. Super Buddy Boy cabinet Model 123 or a musical cabinet; these are Crosleys. Philco 38 3-knob chassis, AC. Cory phone base. Brandes table talker horn. Please, fellows, I need help. Bob Barnes, 511 N. Chestnut, Monroe City, MO 63456. (314) 735-2945

FOR SALE: HT 9 xmtr. HT 37 - HT 40. Joseph Szabat, W3LST, 228 Plummer St., Oil City, PA 16301. (814) 677-4042

FOR SALE: Philco power supply B603 - \$30. Zenith Cobramatic phono/radio - \$25. Thorla Model 57 cabinet. Grimes Type BG cabinet - \$20. Crank phonograph LeLutin - \$25. Jay Gee, 192 Division Ave., Shelton, CT 06484. (203) 734-0271

WANTED: Please, DeForest Interpanel schematics, literature, pictures, measurements, (copies OK) parts, pieces. Also info and loop antenna for DeForest D-17. Thanx. Dale Davenport, c/o KFSA, PO Box 488, Ft. Smith, AR 72902. (501) 782-9126

FOR SALE: Estate sale teletype equipment. Military test equipment microphones - Send SASE for list. Small items. R. Olmsted, K4UJZ, 608 W. Thompson Ln., Murfreesboro, TN 37129. (615) 893-5344

CLASSIFIED ADVERTISEMENTS

WANTED: Owner manual for Crosley 51. Xerox copy OK. Also Zenith 6S321 or 6S322. Don Catton, 609 10th St., Silvis, IL 61282

FOR SALE: Capacitors, dipped mylar - 10¢ ea. Transmitting tubes, new and used. Lists SASE. Specify list wanted. Craig Smith, 1935 1st Ave. S, St. Petersburg, FL 33712. (813) 922-7592, days

FOR TRADE: Aeriala Senior and FADA 1000 for Philco 70 or 90 cathedral. Oscar L. Smith, Jr., Rt. 9 Box 16, Dublin, GA 31021. (912) 275-3657, call after 6 pm

FOR SALE: 400 old stock tubes, untested - \$90 plus UPS. Thomas Burnside, 4838 S. Westhaven Dr., Jackson, MS 39209. (601) 922-2235

FOR SALE: Large collection of radio, TV, ham books and manuals. Many old radio magazines. SASE. Rider's manuals - \$10 and up. American Flyer trains - SASE. Medical quack devices - \$25 ea. Bill Roff, 30131 Center Ridge, Westlake, OH 44145. (216) 871-4547

WANTED: Record player unit for 1936 RCA D-22. Crosley WLW 37 tube special console. Zenith 12S267 console. Grunow Teledial 15. Zenith Super VII for parts. Marconi Model 87 console. Philco 90 escutcheon. **FOR SALE/TRADE:** 2 AK BB tuners, damaged. Parting out Trirdyn. Klaus Beckmann, General Delivery, Tofield, Alberta, Canada T0B 4J0. (403) 662-3518

FOR SALE: AK 10 with Model H horn. AK 20 Big Box. Kennedy Model 10. Garod Georgian with original speaker, headset, manual. Charlie Walker, 12506 Minuteman, San Antonio, TX 78233. (512) 655-8525

FOR SALE: Pilot Radio Corp. Pilotone preamplifier, Model PA-912 - \$5 plus UPS. Donald J. Sochurek, W191, S7500 Richdorf Dr., Muskego, WI 53150. (414) 679-0212

WANTED: Pre-1940 UHF books, tubes, home brew Radio Handbook transmitter or lab model demonstrator with lots of UHF plumbing! Hal Layer, N6SPD, PO Box 27676, San Francisco, CA 94127

FOR SALE: Complete set Rider's TV manuals. Working Hickock 288X and Triplett 1632 signal generators. John Aikin, 3605 Overhulse Rd., NW, Olympia, WA 98502. (206) 866-8407

WANTED: Photofacts. Rider's radio 18 and up. Tom Earnest, PO Box 603, San Angelo, TX 76902

WANTED: RCA shortwave receiver with coils #AR1145, RCA B eliminator #AP-1080, RCA loudspeaker #102. Inside lid instruction sheet for DeForest Everyman xtal set, repro OK. Al Reymann, 657 Pt. Phillips Rd., Bath, PA 18014. (215) 837-9633

CLASSIFIED ADVERTISEMENTS

FOR SALE: Large collection of radios and related items, no common stuff. Send SASE for list. Hardin W. McCauley, 8471 Patterson St., St. John, IN 46373. (219) 365-5979



WANTED: Philco remote control radio Model #41-316, in operating condition. See photo left. Contact S. C. Abramson, 1190 Colgate Dr., Monroeville, PA 15146

FOR SALE: National NC-57 and Panasonic RF-2900 (digital) both nice receivers - \$50 ea. plus UPS. John Mutch, 7931 Crestwood Dr., Boise, ID 83704

WANTED: Philco speaker, working 36-1483, 6 1/2" round w/8 mtg holes and 4-prong male plus. John Hutchins, 9417 N. Rich Rd., Alma, MI 48801

FOR SALE: Custom-made radio-related tie clasps & lapel pins. Send a LSASE. Michael S. Sabodish, 11-A Matawan Ave., Cliffwood, NJ 07721

WANTED: 10" speaker for Zenith Black Dial console, Model #7S363, speaker Model #49-U-208, must be complete with working field coil and transformer. Contact: Randy Smith, 822 W. 7th Ave., Lancaster, OH 43130

ABBREVIATIONS USED IN CLASSIFIED ADS

amp. - Amplifier
 BC - Broadcast
 BO - Best Offer
 ca. - circa
 ea. - each
 (F.O.S., p. ?) - See page ? in the book *Flick of the Switch*
 LSASE - A Long SASE (see SASE)
 LW - Long Wave
 MO - Money Order
 N.I.B. - New In Box
 N.O.S. - New Old Stock (Unused, that is new, original, vintage items)
 O.T.B. - *Old Timers Bulletin* published by Antique Wireless Assoc. (A.W.A.)
 OB - Original Box

ppd. - Postage Paid (included in price)
 PS - Power Supply, also "pwr sup"
 rcvr. - Receiver
 SASE - Self Addressed Stamped Envelope (Suggest sending a long, No. 10, envelope)
 SW - Shortwave
 UPS - United Parcel Service
 (V.R., p. ?) - See page ? in the book *Vintage Radio*
 w/ - with
 w/o - without
 xcvr. - Transceiver
 xfmr. - Transformer
 xmtr. - Transmitter
 xstr. - Transistor

BY POPULAR REQUEST

CLASSIFIED ADVERTISEMENTS

WANTED: Philco cathedral table radio. Trade or sell 5-tube 3-knob TRF sets. Clay Fry, 12731 NW 21 Ave., Vancouver, WA 98685. (503) 228-4627

FOR SALE: B&K 1450B oscilloscope with manual and probe in very good working condition - \$70. Dumont 304A oscilloscope with instructions in good condition - \$25. 1935 RCA TMV-122 oscilloscope with manual in very good condition but missing nameplate - \$40. Original rabbit ears antenna without base for Motorola VT-73 portable TV - \$14. Please add shipping to all orders. Doug Heimstead, 1349 Hillcrest Dr., Fridley, MN 55432. (612) 571-1387

WANTED: Audio Engineering (audio) magazines to complete my collection, need 1949-1960 various issues. Bruce Leslie, Pro Recording Service, 13709 Mapleleaf Dr., Cleveland, OH 44125. (216) 662-1435

WANTED: Tube sockets for 204A and Western Electric 212, Zahl Radar tube VT-158, 831 triode, Admiral phono cartridge #409A11. Info on Westinghouse CL-2 and GE 2H21 tubes. **FOR SALE:** HF-300 tubes, used - \$6 ea. John Walker, 16112 W. 125th St., Olathe, KS 66062. (913) 782-6455

FOR SALE: Large assortment tubes, none rare. Send your want list and SASE for quotation. Harry Cap, 190 Beach St., Bridgewater, MA 02324

WANTED: AK cathedrals and tombstones. AK breadboard parts. Bob Nicholson, 3423 S. Long, Topeka, KS 66605. (913) 266-9473

ARBE* - III

* ANTIQUE RADIO BATTERY ELIMINATOR

* ADJUSTABLE HIGH CURRENT A SUPPLY

* 8 DIFFERENT B & C VOLTAGES

* 5 YEAR LIMITED WARRANTY

\$139.95 SHIPPED WITHIN CONTINENTAL U.S.A.
 MICHIGAN RESIDENTS ADD 4% SALES TAX

ANTIQUA RADIO INC.
 P.O. BOX 6352
 JACKSON, MICHIGAN 49204

PHONE 517-750-4992
 AFTER 7:00 P.M. EST.

CLASSIFIED ADVERTISEMENTS

FOR TRADE: Best offer. Zenith Universal portable radio with wave magnet, ant. hinged back cover. Magnus bakelite electric toy organ, works. **WANTED:** Loop antennas. Novelties. Otto W. Nill, 192 Grant Ave., Islip, NY 11751

FOR SALE/TRADE: Western Electric R-7 transmission measuring set - \$40. Philco #70 cabinet - \$50. Zenith tombstone #6-S-229 - \$35. Coin-O-Matic by Hotel Radio of Detroit, cabinet only - \$20. Philco 41-255 - \$45; 42-355 - \$45. Grundig AM-SW-FM tabletop - \$25. RCA 66X1, 66X3 - \$60/pair. P. Currie, PO Box 738, Chuluota, FL 32766-0738

WANTED: Elmac AF-68; will trade excellent PMR-8 and M-1070. Alvin J. Bernard, NI4Q, PO Box 690098, Orlando, FL 32819. (407) 351-5536

WANTED: Wide range inductance bridge. Nothing fancy, repairable unit OK. John Osborne, 2 Lake St., Winthrop, ME 04364

FOR SALE: Tuska 225, late - \$325. Grebe CR9 - \$325. Shepco 1-tube - \$150. Plus UPS. Bob Kerns, 6363 Nash Rd., North Tonawanda, NY 14120. (716) 731-4267

FOR SALE: Tubes, new and used. **WANTED:** Zenith radios, pre-1941. Old or unusual tubes, U.S. or foreign. R. Dobush, 3554 W. 105, Cleveland, OH 44111. (216) 228-4953

WANTED: Philco 70 field coil and on/off knob. Jim Dirksen, 750 Franklin Rd., Apt 8-D, Marietta, GA 30067. (404) 428-5809

1989 NEW YEAR'S RESOLUTIONS

- Join ARCA** - The Antique Radio Club of America. 800+ Members - Established 1972 - Quarterly Journal. Send \$12.00 for 1989 membership to Bill & Jane at address below.
- Attend ARCA-89**, The 1989 Convention of the Antique Radio Club of America in Mystic, Conn. on June 1, 2, and 3, 1989. Send your name and address to Bill & Jane at address below to receive details when they are available. They love to get mail!



Bill & Jane Denk
ARCA-1
81 Steeplechase Road
Devon, PA 19333

ARCA members will receive info so need not write.
Non-members are welcome at all ARCA meets.

CLASSIFIED ADVERTISEMENTS

WANTED: Horn speakers, complete or parts. Pre-1950 technical literature concerning electronics development. Richard Anthony, 2551 Andler Rd., Placerville, CA 95667

FOR SALE: Zenith 6D311, minor cracks - \$110. Arvin 441T Hopalong Cassidy, ex. - \$280. Mike Dues, 13173 Glenhurst Ave. S, Savage, MN 55378. (612) 894-8937

FOR SALE: Philco 84 cathedral, needs spkr. - \$80. Radiola 33 chassis, working, less tubes - \$25. Radiola 100A spkr., works - \$35. Radiola 103 tapestry spkr., working - \$60. Victrola VV80 upright phono, professionally refinished, motor cleaned & adjusted, exc. - \$175. Brunswick upright phono, motor cleaned & adjusted - \$125. 1929 RCA Victor RE 45 electric phono/radio, working - \$75. Can't ship last 3 items. **WANTED:** Dial escutcheon for Echophone 30 cathedral. Jahan L. Acciavatti, PO Box 231, Southborough, MA 01772. (508) 476-3229, eves.

WANTED: Escutcheon plate and knobs for Sparks-Withington 410, instr. book for U-Test-M tube tester 049230. Kent Oakey, 1008 Mormon St., Folsom, CA 95630. (916) 985-4677

FOR TRADE: Radiola 60. AK 44 with E2 speaker. AK 70. S-53A. S-38A. Philco 20. Trade for aircraft cameras, radios, instruments, etc. James Treherne, 11909 Chapel Rd., Clifton, VA 22024. (703) 830-6272

FOR SALE: Elaborate Philcos, Scotts, Zeniths, Capeharts, Strombergs, others. Jukeboxes, broadcasting equipment, microphones. Also buying. Robert Van Dyke, 2 Squires Ave., East Quogue, NY 11942. (516) 728-1327

FOR SALE: AK 33 console with built-in cone speaker, very nice - \$150 with tubes. Cabinet for Zenith Super 7, excellent - \$75. Zenith 9S262 console cabinet, 1938 - \$35. Pick up only. **WANTED:** RCA Victor 101 tombstone. Lyric AC-DC radios. Zenith shadowgraph unit, 1933-34. Steve Baron, 435 Park Ave., Lexington, KY 40502. (606) 269-2832

WANTED: Buyers for restored period furniture styled radios, 1920 to 1940 - stamp for list. Old player piano rolls and cylinder records - \$3 ea. Old quack medical cure all electric apparatus - stamp for list. Station dial for Zenith Model 706. John Porter, 701 N. Main, Osceola, IA 50213. (515) 342-6220

WANTED: Instruction manual for Hickock Model 600 tube checker. A. J. Long, 2653 Post Rd., Twinsburg, OH 44087. (216) 425-9662

WANTED: Horizontal output transformer 1950 Philco TV Model NU 50T1401. Ken Clark, 2835 Sea Spray St., Sarasota, FL 34231. (813) 922-3205

CLASSIFIED ADVERTISEMENTS

WANTED: Early quack medical violet ray devices. Also ring mount microphones and parts. Richard Cane, 8391 NW 21st St., Sunrise, FL 33322. (305) 741-6838

FOR SALE: Crosley Trirdyn 3-R-3 three-tube batt., nice walnut case with tubes, fine, plays - \$95. Steinitz 57600 1928 etc., Six tubes, fine, plays - \$85. Hop-A-Long Cassidy, good - \$155. Dictor Grand loud horn speaker - \$95. 1984 novelty 9v AM-FM portable Care Bears clock radio, mint in box - \$25. Edison Mabry, 715 W. Longview, Mansfield, OH 44906. (419) 526-1175

FOR SALE: Military RT-68/GRC (mobile Jeep transceiver) 38-54.9 MHz, tunable, 9"x13"x11" - \$60. T/M manual, complete - \$12. Crystal radio kit, instructions, parts included, nice!, quan. avail. - \$14 ea. **WANTED:** Slide scanner Sylvania TV chassis #H01-2, see Photofact 1021. Mil. tube tester #TV-7 B/U instructions and tube data, reasonable. D. Testa, PO Box 9064-ARC, Newark, NJ 07104

WANTED: Three-band Philco dial glass #27-5508 for 39-38 or similar set. Coyne Electrical & Radio Troubleshooting Manual. Ghirardi's Radio Troubleshooter's Handbook. RCA Victor Service Notes (Red Books) for 1923-28, 31-32, 33, 34, 35, 36, 37, 38. Will pay most any price. Dennis Osborne, PO Box 5064, Raleigh, NC 27650. (919) 828-1074, recorder on

FOR SALE: 1921 Duck catalog #16 - \$50 plus shipping. Michael Payne, 609 N. Fairview Cr., Alvin, TX 77511. (713) 331-9217

CLASSIFIED ADVERTISEMENTS

WANTED: Good set of 8 bakelite push buttons for RCA Victor 96T7 radio. Gilbert Smith, 248 South 36th St., San Diego, CA 92113-1613. (619) 233-8646

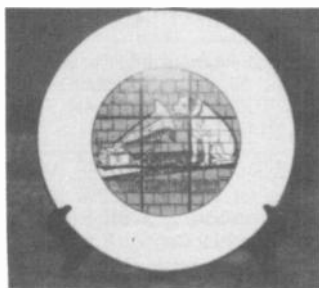

FOR SALE: A very special collectible for RCA Nipper fans. It's a commemorative china plate, one of only 1000 made. It depicts the stained glass Nipper in the RCA headquarters at Camden, New Jersey. New in box, issued in late 1970's. A truly rare item! Charles Harper, 2081 Harmony Ct., Lexington, KY 40502. (606) 268-8549

WANTED: Zenith parts chassis 5634 with good coils for 6S152. Dial & transformer optional. Alexandria Nelson, 9225 Evangeline NE, Albuquerque, NM 87111. (505) 291-9468

FOR SALE: Two Catalins, Emerson & Bendix. Lamp radio (Collins, p. 92), ivory & pale green, large stock table models, wood bakelite & plastic. All rebuilt w/1 yr. guarantee. George Kay, 429A Park Ave., Worcester, MA 01610. (508) 755-4880

Radio & TV - The Past & The Future (As Reported 40+ Years Ago)

- Codel, M., *Radio and Its Future, 1930.*** A 1930's look into the future. A collection of articles by 29 experts of the day including DeForest, Grunow, Kolster, Sarnoff, Maxim, Colpitts, Paley, Durstine and Codel. 375 pages with photos..... \$28.00
- Dunlap, O.E., *Radio's 100 Men of Science, 1944.*** Biographical Narratives of pathfinders in electronics & television. A few of those included: Gilbert, Galvani, Faraday, Loomis, Hughes, Dolbear, Tesla, Hertz, Popoff, Nipkow, Branly, Jenkins, Conrad, Weagant, Kolster, DuMont, Olson. 300 pages with photos..... \$25.00
- McNicol, D., *Radio's Conquest of Space, 1946.*** A chronological treatment of the early days of radio, the scientists and their inventions. A few of the chapters: Spark Gaps & Oscillators, Wireless Spans the Atlantic, Regenerative Receivers, The Advent of Commercial Radio. 388 pages with photos & illustrations..... \$29.00
- Dunlap, O.E., *The Outlook for Television, 1932.*** "The purpose of this book is to reveal the romance of television and its commercial possibilities; to record historically the evolution of a new era in radio science; and to explain its magic." 310 pages with photos. Includes 22-page chronology of Radio/TV from 640 B.C. \$24.50

The above are quality reprints. Send for free list of over 50 other book reprints on early radio, television, broadcasting and telegraph also available from A.R.C.

Send payment with order. Mass. residents add 5% tax. Allow 4 to 6 weeks to receive books.
Mail to: Antique Radio Classified, P.O. Box 2, Carlisle, MA 01741

CLASSIFIED ADVERTISEMENTS

FOR SALE: Knight 136M stereo FM-AM tuner 10-tube with IM plus Knight KN-740 10-tube multi-input stereo amp, 4-6L6 output; 4, 8, 16 ohm - \$110 plus UPS. RV695 Splitdorf chassis, working or will buy junker or box. Gene Claus, 2305 W. Rice, Sioux Falls, SD 57104

WANTED: Heathkit linear amplifier SB 200, 1 KW, with manual, all in good condition. Michael Durand, KA2KUG, 21 Le Grande Ave., Tarrytown, NY 10591. (914) 631-0493

WANTED: Wireless Set No. 19, ca. WWII. Especially looking for power amplifier and pocket watch. Chris Bisailion, VE3CBK, RR#1, Old Carp Rd., Kanata, Ontario, Canada K2K 1X7

FOR SALE: Sold my radio collection. Have some battery radios and misc. items. Amateur receivers transmitters. Books, magazines, tubes, teletype, military surplus, test equipment. SASE list. Russ Olmsted, K4UJZ, 608 W. Thompson Ln., Murfreesboro, TN 37129. (615) 893-5344

WANTED: Literature about or ads picturing Emerson 34C. Carl Shirley, 824 Fairwood Rd., Columbia, SC 29209. (803) 776-6850

FOR SALE: FADA 5F60 Catalin, beautiful case, needs louver cover over speaker and knobs - \$95. Ampex 860 reel-to-reel dual Capstan, SS, stereo w/speakers - \$50. Farnsworth portable radio GP350, unique, works - \$30. Bendix auto radio manuals - \$20. FADA 659 N.O.S. dial glass - \$35. Wilford Wilkes, Box 103, Brisbin, PA 16620. (814) 378-8526



The Famous Logo
 "Zenith Long Distance Radio"
 on an all-cotton T-Shirt.

Ivory on Black.
 Sizes: M-L-XL.

\$11.95 PPD.

(Quantity Discounts Available)

Alan Jesperson
 P.O. Box 17338
 Minneapolis, MN 55417
 (612) 727-2489

CLASSIFIED ADVERTISEMENTS

FOR SALE: Radiola 20 - \$160. Radiola AR-812 Superheterodyne "Portable" - \$225. Radiola 33 w/speaker - \$75. Atwater Kent 20 - \$75. Atwater Kent 42 - \$50. Atwater Kent 44 - \$30. Atwater Kent 49 - \$80. Crosley 51 - \$80. Kloster 6 chassis - \$95. One-tube home brew - \$45. Some pre- and postwar German sets. Send SASE for list. Military: BC348Q w/manual - \$70. Navy Heterodyne frequency meter - \$25. British Fullerphone MKII Keyes - \$35. Speakers: Radiola 100 - \$45. Radiola 100A - \$45. Atwater Kent - \$45. **WANTED:** Amperite 12-20, two pin, glass ballast tube. Brian Dunlop, 2715 Hanovertown Dr., Colorado Springs, CO 80919. (719) 531-7920

WANTED: Zenith Stratosphere console (see A Blast from the Past, p. 139). Dave Luellen, 45 South Main St., Alfred, NY 14802

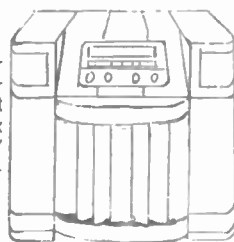

WANTED: Philco 42-1010 console radio-phonograph. Robert Wiczkowicz, PO Box 86, Craryville, NY 12521. (518) 325-5307

FOR SALE: RCA Farm radio Model 55-F, walnut, good condition - \$40. 8" lever system cathedral speaker, walnut - \$75. RCA 45 player Model 7EY1DJ with carrying case - \$40. Aircastle walnut TM radio, works good - \$40. add UPS charges. Clark Trissell, 3530 Pawnee, Lincoln, NE 68506. (402) 488-5263

WANTED: For cash, small SW table radios. Levy, 8 Waterloo Dr., Morris Plains, NJ 07950. (201) 285-0233, home; (201) 455-4312, busi.

FOR SALE: Philco Model 60 cathedral, refinished & chassis all repaired, plays good - \$95 + shipping. Russell Schoen, E7340 Nietzsche, Rd., Clintonville, WI 54929. (715) 823-6744

WANTED: Turntable for AK Model 75. Eldridge Thomas, Grundy, VA 24614. (703) 935-7429

WANTED

**1939 - R.C.A. Model 9TX-1
 "Little Nipper"**

1st plug-in portable by R.C.A.

Larry La Patka
 4411 Navajo
 Pasadena, TX 77504
 (713) 487-4268

CLASSIFIED ADVERTISEMENTS

WANTED: Manuals for RBL5, RBL4, and RBH series of National Navy rcvrs. WE215A socket and acorn tube socket adaptor for Precision 910 tube tester. I have plenty of VT120 N.I.B. acorns at \$1 apiece, minimum of 5 pcs. Would also like to buy some Edison lamps and Geisler tubes in working condition. Will pay top dollar for Philco Model 90 in excellent condition, restored is fine. I work weird hours so please use the phonemail service. Call or write: Bruce Ashcraft, 1300 Burrows Rd., Campbell, CA 95008. (408) 432-4678.

FOR SALE: Weston VTVM Model 669 Type 2, 1930's. Superior Model 650 signal generator. Bakelite, wooden, metal & plastic radios from the 30's thru the 60's, mostly very good to excellent condition. Pre-1935 parts and literature, parts are mostly N.O.S. & mint! Send SASE. Neil O'Donnell, 1809 Sampson St., Butte, MT 59701. (406) 494-8162

FOR SALE: Old flyback transformers: Triad D43, D68, D109, D213, D606; all are new - \$30/ea. Andy Czymbor, 3799 East Burt Rd., Burt, MI 48417. (517) 624-5185

FOR SALE: Zenith Trans-Oceanic R7000, exc. - \$195. Zenith Inter-Oceanic, vg - \$65! Many novelty transistors, SASE for list. Harald Herp, 6615 Michele Ct., Huntingtown, MD 20639. (301) 855-7071

WANTED: Keys, bugs and telegraph instruments. Also related parts and publications. Will purchase or trade like kind. I am a collector not a dealer. This is an affair of the heart, not the wallet. Warren Berbit, K2UVV, 46A Mile Road, Suffern, NY 10901

COLLECTING NATIONAL SW3 SW5 RECEIVERS. Glad to correspond with "Thrill Box" enthusiasts. Dean Showalter, WA6PJR, 36308 Panorama Dr., Yucaipa, CA 92399. (714) 797-1782

WANTED: Early SONY radios. Jay Lewin, 400 E. 54th St., New York, NY 10022. (212) 935-5656

INDIVIDUAL PHOTOFAC FOLDERS. From sets under #1400 - \$4. Over #1400 - \$6. Pre-paid First Class postage included. Also full stock Sams specialized books. Allen J. Loeb, 414 Chestnut Lane, East Meadow, NY 11554. (516) 481-4380

WANTED: For General Electric Models GD52 & GD60. The (6) or not less than (2) push buttons. Send price, will pay shipping and cost. Russell Sound Systems, 720 College Dr., San Jose, CA 95128. (408) 295-7110

FOR SALE: Reproduction dial glasses for Catalins. FADA 652 and Sentinel 284 - \$35 ea. plus \$2 postage. Radioart, Box 102, Centerbrook, CT 06409

CLASSIFIED ADVERTISEMENTS

**THE GOOD,
THE BAD
& THE UGLY**

NEW TUBES
IN ORIGINAL GOOD, FADED,
SCUFFED or TORN CARTONS
YOUR CHOICE only \$1.00 ea.
- WHILE THEY LAST -

*Round out your stock NOW
at this low price . . .*

1X2, 2AF4, 2BN4, 2CY5, 2EN5, 2ER5,
2FH5, 2FS5, 3A2, 3AL5, 3AU6, 3BA6,
3BC5, 3BE6, 3BN4, 3CB6, 3CE5,
3CF6, 3CS6, 3C45, 3DK6, 3DT6,
3EA5, 3EH7, 3Q4, 3S4, 4BC8, 4BL8,
4BN6, 4BZ6, 4BZ7, 4CY5, 4HS8,
5AM8, 5AN8, 5AS8, 5AT8, 5AV8, 5B8,
5BE8, 5BK7, 5BQ7, 5BR8, 5BT8,
5BW8, 5CL8, 5CM8, 5CQ8, 5CZ5,
5DH8, 5ES8, 5EU8, 5J6, 5T8, 5U8,
5X8, 6AH4, 6AH6, 6AK6, 6AM8, 6AN4,
6AN5, 6AN6, 6AQ6, 6AS6, 6AS8,
6AT8, 6AX5, 6BC7, 6BC8, 6BD6, 6BJ7,
6BK5, 6BK7, 6BN4, 6BQ7, 6BR8,
6BS8, 6BU8, 6BV8, 6BW4, 6BW8,
6BX6, 6BY5, 6BY6, 6BY8, 6BZ6, 6BZ7,
6CH8, 6CL8, 6CM6, 6CM7, 6CN7,
6CQ8, 6CU8, 6CY7, 6CZ5, 6DB5,
6DE6, 6DG6, 6DK6, 6DS5, 6DT5,
6DT8, 6EB8, 6EH7, 6EW8, 6EQ7,
6ER5, 6ES5, 6ES8, 6EU8, 6EV7,
6FH5, 6FM8, 6FY6, 6HG8, 6HJ8,
6JC8, 6S4, 6T4, 6T8, 6X8, 7AU7,
8AU8, 8BQ5, 9BR7, 12AE6, 12AL5,
12AV7, 12AY7, 12B4, 12BA7, 12BF6,
12BZ7, 12ED5, 12EG6, 25BQ6, 25W4

LIMIT: (5-of-a-type) PER ORDER
List Alternates in case of sell-outs
\$2.40 SHIPPING & HANDLING ANY ORDER
(Wisconsinites Add 5%)
ALL TUBES GUARANTEED
GOOD ON RECEIPT

SEND \$1.00 (Refundable) FOR EXTENSIVE
LISTS OF MORE TUBES & STUFF

DON DIERS
4276-AD5 North 50 St.
Milwaukee, WI 53216-1313

CLASSIFIED ADVERTISEMENTS

FOR SALE: Rider's 12, 13; seedy covers, jim pages - \$8 ea. Two Majestic 90 chassis w/most tubes - \$10 ea. Items plus UPS. Dennis Osborne, PO Box 5064, Raleigh, NC 27650. (919) 828-1074, recorder on

WANTED: Radio Troubleshooters Hand Book by Ghirardi, later edition. Old head sets & battery sets. **FOR SALE/TRADE:** Rider's #4 & 12 - will trade for other Rider's or head sets. Schematics 1930-1950 - \$2. SASE. Tony DeMara, 40231 Day, Clinton Township, MI 48044

WANTED: Schematics for Musicaire radios. Jim Moffett, 218 Shannon Lee, San Antonio, TX 78216

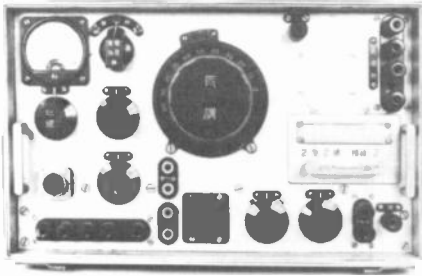

WANTED: Japanese WW2 radios, accessories, manuals. Japanese electronics/audio magazines, new/old, any quantity. Alan Douglas, Box 225, Pocasset, MA 02559

CLASSIFIED ADVERTISEMENTS

FOR SALE: Western Electric sound system "Inspectors Handbook Check List," dated 1937, over 1000 pages; contains description, installation, modification, operation, maintenance, and merchandising information on entire sound system. Equipment Bulletins include amplifiers, control units, loudspeaker networks, baffles, horns, speaker systems, and much more. Quality photo copy includes binder and shipping - \$100. For table of contents send SASE. Brian Dunlop, 2715 Hanovertown Dr., Colorado Springs, CO 80919. (719) 531-7920

WANTED: Motorola Catalin Model 51X16, black with bright red front. FADA Catalin 1000 Bullet, color green-blue-black, fine or better. Edison Mabry, 715 W. Longview, Mansfield, OH 44906. (419) 526-1175

FOR SALE: Cathedrals: Crosley, Philcos, Jax; Bendix Catalin, Westinghouse refrigerator. Lots more. SASE. Ripley, Box 9374, North St. Paul, MN 55109

WANTED: McMurdo-Silver and Lincoln chrome or brass-plated radios in any condition including junk! Also chassis, power supplies, cabinets, speakers, literature and anything for parts. I will trade generously for Lincoln radios! Please call or write me! Craig Korpak, 2542 Tuson Dr., Apt. 2C, Drayton Plains, MI 48020. (313) 673-0039

FOR SALE: Transistor radios, send SASE for list. Serge L. Krauss, 141 Homan Ave., Elkhart, IN 46515-5027

A Preliminary Bibliography of Frank Conrad

A 30-page listing of Conrad's American and British patents, and articles and books referring to him or written by him.

During the half century that radio pioneer Frank Conrad (1874-1941) worked for the Westinghouse Electric and Manufacturing Company, he acquired over 200 patents for radio transmitters and receivers, televisions, refrigerators, hand grenades, carburetors, gear shifts, air conditioners, electric meters, and vacuum tubes.

Also listed here are his professional memberships and the major honors and prizes he was awarded. About 350 references.



Published by the Pittsburgh Antique Radio Society, Inc.

All sales benefit the Society.

Send \$5 to:

PARS
506 E. Wheeling Street
Washington, PA 15301

CLASSIFIED ADVERTISEMENTS

WANTED: 1920's Indiana-made AC, battery, and crystal radios such as Amacodyne, American, Aladyne, Allison Pickett, Cardinola, Case/Hyperdyne, Diamond-T, Elmco, Guerrier, Hammond, Hancock, Hatfield, Huntington, Imperial, King Cole/Everyhome, Lyradion, Melody, Oakley Grand, Okay, Queen Quality, Sinclair, Showers/Future, Skylark, Slagle, Tidmarsh, Tilman/Challenger, Vizo, and Washburn Burner. 1930's radios such as Arvin, Capehart, Case, Code, Davis, Fairbanks Morse, Jesse French, Kennedy, Kingston, Lark, Slagle, Star Raider, Victory, Wilson & Wren. Also looking for McMurdo-Silver radios. All models in any condition. From excellent to total junk. Michael Feldt, 12035 Somerset Way E, Carmel, IN 46032. (317) 844-0635

FOR SALE: Thordarson spark transformer – \$150. Magnavox AC3C amp – \$250. Early QST. Rider's Vol. 1 – \$40. DeForest crystal detector – \$85. Scott 800 chassis, working – \$100. SASE for new list. Jim Collings, 12005 Victoria Pl., Oklahoma City, OK 73120. (405) 755-4139

FOR SALE: Farm table sets, clean, vg, w/schematic, works, xtra tubes – Silvertone 6220 (101-801) – \$40. Wards 93BR-460A – \$35 or \$70/both. GE 543 AC/DC 1953 ivory plastic clock radio, xint, works w/schematic – \$30. John Eng, PO Box 130, Cypress, CA 90630. (714) 220-1965

WANTED: Set of Alden or Octo plug-in coils for SW receiver. Bob Rathbone, RD#1 Box 127, Ossipee, NH 03864. (603) 539-2762

FOR SALE: Store leftovers. Can radios, 9v, work; Coke, Pepsi, Dr. Pepper, 7 Up. Trade for GE Mickey Mouse. Uncle Don record with radio club pin. Coke can radio, best offer. Otto W. Nill, 192 Grant Ave., Islip, L.I., NY 11751

FOR SALE: Snow White & Seven Dwarfs radio – \$950. R. J. Turner, 2400 Lorien, Minnetonka, MN 55343. (612) 545-5791

WANTED: 1, 2, 3 dial home brew battery sets. Philco 37-60 chassis. Audel's Radioman Guide. Please send description and price to: P. Currie, PO Box 738, Chuluota, FL 32766-0738

WANTED: Prewar Scott radio chassis with the original factory-issued wooden front panels, any condition, (F.O.S., p. 166). Michael Feldt, 12035 Somerset Way E, Carmel, IN 46032. (317) 844-0635

FOR SALE: Old Popular Electronics magazines, plug-in coils, WW2 Japanese headphone, Allied catalog. Art Collatz, 2127 Market, Blue Island, IL 60406

WANTED: Copy of AWA Review, Vol. 1, or Xerox copy of Telegraph Key article by Lou Moreau, W3WRE. David I. Combs, W5VJW, 2000 Victory Ave., Wichita Falls, TX 76301. (817) 767-0077

CLASSIFIED ADVERTISEMENTS

FOR SALE: New tubes – from \$2 ea.; good used – \$1 ea. SASE for list. Henry Nessler, 136-26 61 Rd., Flushing, NY 11367

FOR SALE: Western Electric items: "Candlestick" W/297G oak ringer box, no dial – \$325. WE-201 desk set w/metal ringer box, 1920's – \$225. WE-211 "Spacesaver" desk set w/metal ringer box, 1920's – \$200. WE portable "District Test Set" w/dial, relays, etc. – \$65. All plus UPS. Have few phone booklets. Also have Weeden toy steam engines and light bulbs for sale. Call or write. Doug Heinmuller, 115 West St., Bar Harbor, ME 04609. (207) 288-4332

WANTED: Cabinet parts and manual for Zenith 7G605 Trans-Oceanic, 1941. Also Zenith Royal 500H, 500L, 130, and 990. Any Zenith signs, ads, literature, etc. Also need junk HRO-5 for parts. **FOR SALE/TRADE:** General Radio 1211-B – \$75; 916-A – \$225; 1232-A – \$45; 1390-B – \$50; 546-C – \$25; 1142-A – \$30. Also RCA 7-BX-10 Strato-World – \$35; RCA 1-T-5J portable – \$15. Scott D. Prather, KB9Y, 2776 S. Monroe St., Denver, CO 80210. (303) 758-9381

WANTED: For Simpson 270 series 3 VOM, case and meter movement. Thomas Bisel, 2266 Halyard, St. Louis, MO 63129

FOR SALE: Hallicrafters R-46 speaker, clean and original – \$35. SX-62, works – \$60. R. Miller, 5217 43rd Ave. Ct. NW, Gig Harbor, WA 98335. (206) 858-9240

WANTED: Meter (P/N 461 064) for TV-7B/U tube tester. We are still looking for a dot-bar generator. E. H. Melvin, 5050 New Market Rd., Hillsboro, OH 45133

WANTED: Telegraph collection now at 170 pieces, looking for more keys, etc. Chuck Brydges, W4WXZ, 4901 Tiffany Ave., Winston-Salem, NC 27104

WANTED: Pre-1942 TV's, TV magazines, TV service literature. **FOR SALE/TRADE:** AK 21. Zenith 52. Catalins, TV's. Transistors. More. LSASE for list #2. Don Hauff, 9988 107th Ave. N, Maple Grove, MN 55369

ATTENTION!
Collectors, Antique Dealers

Patent Dating Guide determines the dates of your favorite antiques and collectibles.

Convenient pocket guide is great for Flea Markets, Auctions, Tag Sales and wherever Attic Treasures may be found.
From 1836 to Present.

Send \$2.50 postpaid to:
J.A.G.
P.O. Box 81
Shelton, CT 06484

CLASSIFIED ADVERTISEMENTS

FOR SALE: AK breadboard Model 10 - \$475. AK lamp base - \$150. Zenith Trans-Oceanic 7G605 - \$60. Lee Bruton, 1202 S. Pratt, Longmont, CO 80501. (303) 651-0254

FOR SALE: Geiger counters, scintillators, new & used; all work. Also, spare units for parts, \$3000 value, all for - \$500 plus UPS. Quitting business. John Martin, 817 Cook Ave., Billings, MT 59101. (406) 252-4287

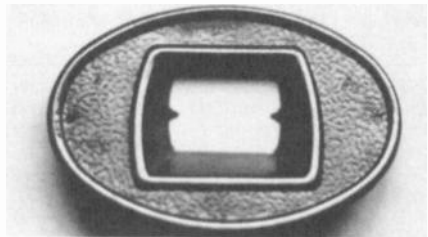

WANTED: Bezel for Remler drum dial. Will pay \$10. Duane Bylund, 5153 W. 5400 S, Salt Lake City, UT 84118. (801) 251-4949

WANTED: Chassis/parts/information for General Motors Radio Corporation Model 219, chassis S7A; I have the cabinet. Need manual for Navy RBM receiver and rectifier. Will buy BC-659 or BC-620 and accessories for them. **FOR SALE:** Have some military TM's/manuals on radios (GRC/VRC) test equipment, teletype. Send card for what you need. If I have it, I'll quote price; no list yet. Henry Engstrom, PO Box 5846, Santa Rosa, CA 95402. (707) 579-2070

WANTED: Operating instructions for Johnson Viking Ranger radio and tube layout. All correspondence acknowledged. George Moritz, 31 Hart St., Woburn, MA 01801

FOR SALE: Novelty transistor radios. SASE for sale list. Will trade or buy ones I do not have. Lee Bruton, 1202 S. Pratt, Longmont, CO 80501. (303) 651-0254

FOR SALE: Used tubes, tested good. Low prices. Send SASE for list. E&E Enterprises, 954 Johnston Dr., Aurora, IL 60506

WANTED: FADA, DEWALD, SONORA, and Mirror Sets. Bill Cress, 28 Worcester Dr., Wayne, NJ 07470. (201) 694-5154

WANTED: 1931 Pilot Allwave 11-tube Super Wasp in Radio, A Blast from the Past, p. 73. Andrew Mooradian, 5 Priscilla Lane, Winchester, MA 01890

FOR SALE: FADA reproduction Bullets, AM/FM, 4 colors - \$200. SASE or call. David Brenner, 71 Burdette Rd., Atlanta, GA 30327. (404) 257-1665

CLASSIFIED ADVERTISEMENTS

WANTED: Meissner 9-1091A/B AM/FM tuner. John Peterson, 4333 9th NE #D, Seattle, WA 98105

FOR SALE: Philco radio chassis Model 76, no tubes, appears complete, untested. Make offer, include UPS. Dennis Hilberg, 804 Ravine St., Decorah, IA 52101

WANTED: Urgently, chassis, knobs, dial plate for Philco 42-1008. Nora Brown, 515 Meyer Ln. #31, Redondo Beach, CA 90278. (213) 373-3208

WANTED: BC-403 scope. BC-404 receiver. BC-405 transmitter. BC-402 keyer. RA-39 rectifier, (p/o SCR-270). Don Helegeson, POB 3087, Skokie, IL 60076-3087

FOR SALE: Tabletop bar radio, plastic, Stewart-Warner Model #R-35825 Porto-Baradio, excellent - \$150. R. Yerke, PO Box 392, Moscow, PA 18444. (717) 842-4857

WANTED: Radio novelties such as radio board games, banks, toys, radio promotional items, other radio-related novelties. Also need Heath brand 3-tube resistance coupled amplifier from 1927/28. Gary B. Schneider, 9511 Sunrise Blvd., #J-23, North Royalton, OH 44133

WANTED: Any info on small wood cabinet 5-tube AC/DC radio. Dial has picture of 2 motor airplane and word "Clipper." Who, where, when made? Schematic, tubes used, etc. Circa 1938. Gene Warner, 522 Weiman, Ridgecrest, CA 93555. (619) 446-2617

FOR SALE: Emerson Aristocrat Catalin radio, bad crack, chassis real clean, works good, no knobs or handle. Make offer. Motorola auto radio, about year 1946 - \$20. I need Rider's manuals. Will buy or trade other small radios. Chuck, PO Box 598, New Haven, WV 25265. (304) 882-2220

WE'RE STILL HERE! Tubes: "Oldest," "Latest." Schematics. SASE for lists to Steinmetz Electronics, 7519 Maplewood Ave., Hammond, IN 46324

FOR SALE: Phono Needles & Cartridges (ceramic - magnetic). What do you need? Send SASE. J.J. Papovich, 53 Magnolia Ave., Pitman, NJ 08071. (609) 582-8279.

FOR SALE: Tubes old new old flybacks yokes transformers power audio coils condensers controls, etc. Pan American Electronics, 814 Houston St., Laredo, TX 78040

WANTED: Early tube hi-fi components and studio equipment by Acrosound, Brook, Brociner, Fairchild, Hadley, Marantz. Also want Western Electric amplifiers, speakers, tubes, microphones. Richard Shafrisky, PO Box 521, Belmont, MA 02178. (617) 484-5784

CLASSIFIED ADVERTISEMENTS

FOR SALE: N.O.S.: CRT's: Sylvania 12VP4A, GE & (3) RCA 5FP7. Radio tubes: No. 484 - \$12 ea. 24 phono cartridges. Vibrators - \$7-10 ea: Delco 8621, 5041125, 5041376, 5033181, 7268575; Mallory 4-4, 12-3, G826, Δ7239124Δ, VB-0001; C-D 6722, 43697M; Motorola 3333; Philco 83-0026, 38-5036-P; Radiart 5314, 5320; Zenith A190-19-A. Surplus dynamotors - \$15 ea.: Pioneer Gen-E-Motor 12v 3.5a/480v .042a, 28v 1.6a/230v .100a, two gv/450v, Westinghouse 27v 1.4a/285v .060a; these work well also at 1/2 input/output voltage. 16 TV selenium rectifiers. Misc. TV coils, horiz., etc. Untested radio: Grundig Majestic 4006 stereo, cond. g - \$25. Paajanen Radio Service, Goen Rd., New Ipswich, NH 03071. (603) 878-2376

FOR SALE: Many types of antique radio and jukebox tubes. DH Distributors, PO Box 48623, Wichita, KS 67201. (316) 684-0050

WANTED: Chassis, knobs and dial escutcheon for 1934 Philco 39 or 39A cathedral. Carl Reinke, 2724 N. 27th St., Sheboygan, WI 53083

FOR SALE: Green plastic Zeniths. 1989 calendars. Few small "as is" table models. 450v and 600v new Sprague capacitors. New 8-inch spkrs. - \$6 ea. New and used tubes - 25¢ and up. Plus other components to restore AC and AC/DC sets. List available. Sue Coulter, 4200 Prince St., Bakersfield, CA 93301

WANTED: Set of Hands On Electronics magazine from first issue. Quote price. James Ryan, 1997 Whittier St., Rahway, NJ 07065. (201) 382-4526

CLASSIFIED ADVERTISEMENTS

WANTED: Cases for Crosley #148 cathedral. Radiola 20. Mayflower cathedral. Thorola Isodyne #55. Grebe Equaphase. Chassis for Clarion Jr. AC 60. Zenith 5R-216. Grebe MU-1. **FOR SALE:** Woolaroc, nice #3-9A - \$55. Regal #135-104X, nice - \$35. Majestic console speaker - \$25. Majestic 90-13 [or 90-B] chassis - \$40. All sold "as is"; buyer assumes all responsibility. All plus UPS. Darrell Combs, 6587 Pacheco Way, Citrus Heights, CA 95610. (916) 969-0635, after 5 pm PST

FOR SALE: Rider's X, XI, XII, XIII - \$20 plus shipping; VII, VIII and IX - \$24 plus shipping. **WANTED:** Zenith 500. John W. Richardt Jr., W2WIY, 94 Bald Eagle, Hackettstown, NJ 07840. (201) 852-7278

CLASSIFIED AD DEADLINES

Jan. 10 for Feb. 1989 Issue

Feb. 10 for Mar. 1989 Issue

Mar. 10 for Apr. 1989 Issue

FOR SALE: Two interesting bibliographies published in 1935 by National Bureau of Standards. "Current Radio Publications of NBS" and "Sources of Radio Information." Thirty-two 8.5x11 pages total. Photo copies of both - \$5 ppd. Rainy Day Books, 44 Bertwell Rd., Lexington, MA 02173. (617) 861-8656

WANTED: Working speaker for an Atwater Kent 46. Also tubular caps .1 & .2 mfd @1600 WVDC. Larry Parker, 3647 Bahama Rd., Palm Beach Gardens, FL 33410-2368

WANTED FOR CASH

Jennings Coin-Operated Radio

Ozarka Model 93

Clarion Model 70

Emerson Patriot or Aristocrat Model 400

Philip Collins

10965 Rochester Ave, Apt. 201

Los Angeles, CA 90024. (213) 479-0167

CLASSIFIED ADVERTISEMENTS

FOR SALE: Wurlitzer Lyric SA-130, nice cabinet, complete with all 13 tubes, doesn't play, you pick up - \$60. Hallcrafters WR-100 4-band SW, wood case, plays good - \$27. Unbuilt N.I.B. Heathkits, GW-52 1-watt walkie-talkie, AJ-31 FM tuner, FM-4 FM tuner - \$20 ea. Madison-Fielding Model 360 stereo amp, works good - \$30. Scott 312 FM-MPX tuner, works great, w/wood case - \$40. Lafayette HB200 base CB, works good - \$25. Regency Imperial SSB-DSB base CB, not working - \$20. Following base CB's not working: Lafayette Comstat 35 (have 2), Courier 23 - \$10 ea. Heathkit 6-volt vibrator tester, works - \$12. Navy TV-7D/U tube tester with charts, mutual conductance, tests all oldies and newer types, works good - \$45. Brach Controlit B battery eliminator, untested - \$5. 6 N.I.B. HY 1269 Hytron trans. tubes - \$28/all. 17 N.I.B. Amperite assorted ballast tubes - \$40/all. 1 N.I.B., 1 used good 50A1 - \$30/both. 4 high test used 01-A's - \$20/all. 16 Radio Electronics mags, '51-55 - \$9/all. 10 Electronics mags, '44-'48 - \$6/all. Rider's Vol. 9, 10, 12 - \$12 ea. 5 The Radio Service Man mags, 1930 - \$12/all. Zenith T-600 Trans-Oceanic operators guide w/all original store tags, nice - \$12. Radio Trouble Finder, 1930 - \$4. Radio and Electronic Parts Corp. catalog, nice - \$6. Zenith Color TV Service Manual, 1969 - \$4. Sylvania Technical Tube Manual, like new, 1959 - \$8. The Star Amateur Electrician, 1907, has plans for building a radio receiver - \$7. Rider's High Fidelity Simplified, 1952 - \$3. Allied's Radio Builder's Handbook - \$3. Third Radio Make It - Fix It Annual 1942 - \$4. Sam's Auto Radio Removal Manuals, 1955 & 1957 - \$3 ea. Rider's TV Index Vol. 1-22 - \$9. Radio Amateur's Handbook, 1953 - \$6. All plus shipping, please. Dan Farnham, PO Box 505, Sherman, NY 14781. (716) 761-6752

WANTED: Help! Would appreciate photo or drawing of Philco 91 Code 126 console cabinet. Singo Kamiya, 516 Arbor Rd., Yeadon, PA 19050

FOR SALE: AK Model 32 batt. radio, vg condition - \$65. AK Model 43 elect. - \$45. Brunswick Model 15 floor model elect. - \$75. Crosley Show Box, no lid or tubes. Crosley Trirdyn Newport Model 3R3 - \$85. Crosley Trirdyn Special - \$85. Crosley floor model cabinet only, 76A774 repwood & walnut. Crosley Gem Box. RCA Model R32 floor radio, vg cond. - \$100. Amrad Model 81 floor model on legs - \$95. Zenith 10569 floor model radio-phonograph - \$55. Freed-Eisemann NR7 battery - \$85. Radiola III. Radiola Senior chassis. DeForest Type F5 - \$90. Wayne Heise, 3965 Princeton Ave., St. Louis Park, MN 55416. (612) 922-7944, evenings

FOR SALE: After Xmas sale: AK 40 AC radio (V.R., p. 77), 1928 yr., 7 tubes, looks and works good - \$60. Zenith Trans-Oceanic 5H-40, good shape - \$60. RCA 56X3 5-tube AC, walnut case (F.O.S., p. 156 similar) - \$25. Wm. J. Key, W1DWD, 58 Sycamore Dr., Halifax, MA 02338. (617) 294-1831

CLASSIFIED ADVERTISEMENTS

WANTED: Astatac D104 microphone for the Johnson Viking Ranger, 1954 vintage; I would like the microphone wired for the Viking Ranger. Call Jim Foskin, Groton, MA 01450. (617) 981-2047. (508) 448-2817

FOR SALE: Packet of old reprint electrical medical device data - Tesla, etc. - \$35. H. Andreoni, 250-E S. Lyon Ave., Hemet, CA 92343

FOR SALE: Audio: Garrard Type A changer, mint - \$125. Harmon Kardon A-224 stereo amp/preamp, exc. - \$90. Harmon Kardon TA-260 tube stereo rec. - \$150. Eico HF 85 preamp w/mahogany case, very nice - \$100. Pr. Electro Voice 12 TRXB coax. spkrs., exc. - \$150. RCA L C-1-A open tweeter - offer. Pair AR-2A's, exc. - \$150. Teac TD1052TK 4 head tube reel-to-reel with AR9-D electronics, mint, Baby Ampex - offer. Ampex 602 1/2 TK mono in leather case - \$100. Scott 410-C sound level meter tubes; RCA Silverama tube caddy full of TV tubes color-b/w series - make offer. 201A's, tested in set - \$6; UX199's - \$10; 171A's, 112's - \$7.50. Set 5 BB-TT 201's - \$150. Van Home detector in box - \$20. Horn & cone speakers: Magnavox R3's, WE 10-D, Dictogrand, AKE-E2, RCA 100-A, Silvertone. Radios; Freshman 3-dial chassis home brew, Browning Drake 4-tube. Heath color bar gen. 1G - \$62. Altec 230-B mixing console with manual near mint. **WANTED:** RCA & WE ribbons, Altec cond. & ribbons, Altec & Dultec tube EQ's & limiters. Happy New Year! Ward Kremer, 301 SW 16 St., Ft. Lauderdale, FL 33315. (305) 524-5652

FOR SALE: Fascinating radios cheap! GE 220 AC-DC 2-band plastic, 6-tube sophisticated circuitry, wonderful performance, excellent, but cardboard back missing - \$45. Bosch 240 2-band wood table model superhet, ca. 1932, exc., works, very scarce - \$38. Visa/MC OK. Better phone; they'll sell quickly. **WANTED:** Bosch 595, Scott Phantom, chassis or console, pay well. Ed Romney, N4DFX, Box 386, Drayton, SC 29333. (803) 583-3081

FOR SALE: Trans-Oceanic R7000-1, 11 band, U.S. made, very nice - \$225 + UPS. Sonora WAU-243 plastic w/push buttons - \$25 + UPS. Daryl Jorud, R#1 Box 180, Battle Lake, MN 56515. (218) 864-5725

FOR SALE: Radiola IIIA, NT - \$60. 2 ea. 1-tube home brews - \$35/both. Crosley F speaker - \$25. Sylvania older tube tester - \$25. Early & late test equipment. **WANTED:** Supply chassis and tweeters for Crosley WLW. Merrill Bancroft, 169 S. Row Rd., Townsend, MA 01469. (508) 597-6623

WANTED: Dial glass for Philco 42-322 (sim. to 42-323, F.O.S., p. 132). Instr. manuals for Heathkit Model T-3 sig. tracer & SG-8 sig. gen., copies OK. Also celluloid dial cover & pointer for Belmont 6D (Radios, p. 69). Thanks! Terry Bakowski, 1240 W. Arthur, Chicago IL 60626. (312) 262-7747

CLASSIFIED ADVERTISEMENTS

WANTED: Big Jon and Sparky's birthday song, early 50's children's radio program from Cincinnati. C. W. Cole, 34811 Seavey Loop Rd., Eugene, OR 97405. (503) 747-7158

FOR SALE: Good Bosch 107 chassis - make offer. New tubes in cartons, 1AX2 - \$1, 2B7 - \$2, 6A3 - \$5.50, 6K5 - \$2, 6SZ7 - \$1.50, 6ZY5 - \$1.50, '38 - \$1.50, 45Z3 - \$1.50, '77 - \$2. Send SASE for many other types. **WANTED:** Chassis for Model 60-B Philco. Bev Ritchie, 5 E. Garland, Fresno, CA 93704. (209) 229-1212

WANTED: Dial glass, bezel, for Delco R-1141 AM/SW. Anyone collecting this? Value? Gene Heyler, 6102 Forestvale Ct., Columbia, MD 21044. (301) 992-7015

WANTED: Philco 90 in mint, original and working condition - will pay accordingly. Philco 52, GE J100 and RCA 121. Complete working chassis for Philco 37-84. Joe Yanul, 9606 Troy Ct., Mentor, OH 44060. (216) 255-1952

FOR SALE: Trans-Oceanic R600, brown cowhide, beautiful set, used little since new - \$200 + UPS. Daryl Jorud, R#1 Box 180, Battle Lake, MN 56515. (218) 864-5725

FOR SALE: 1920-30's original newspaper ads featuring Atwater Kent, Sparton, etc. etc. James P. Roggentine, 8280 Janes Ave. #204, Woodridge, IL 60517

WANTED: Premium radios before 1950: woods, bakelites, Catalins, chrome, mirrored; damaged goods OK, need not work. Also want Scott consoles. Stephen Despres, PO Box 020775, Brooklyn, NY 11202-0017. (718) 625-7254

WANTED: Early 1920's Ace sets made by Precision Equipment. Craig Ball, 204 N. 5th St., Marshalltown, IA 50158. (515) 752-0406

FOR SALE: 1954 RCA CT-100 15" color set. Set has been completely restored and plays beautifully. I will be taking offers until 1/15/88. Tommy Joyner, Rt. 1, Box 434, Walters, VA 23481. (804) 569-8615

FOR SALE/TRADE: Not just parts! A dozen complete sets in list 1.1: Philco, RCA, Stromberg-Carlson, others. Plenty more to trade for prewar German, Zenith. Send your list, SASE. See me in Nashua. Anthony Matt, PO Box 584, Chelmsford, MA 01824. (508) 937-5900, weekdays

FOR SALE: AK Model 44 with Type E2 speaker in desk cabinet by Pooley of Philadelphia, exc. cond - \$225 + ship. Sidney Allen, Jr., 1908 Rosecrest Dr., Greensboro, NC 27408. (919) 288-4115

WANTED: Sparton 506 Bluebird and 1933 Majestic 886 Park Avenue. Tom Roesch, 9613 Kelly Ct., Indianapolis, IN 46231. (317) 839-5983, evenings

CLASSIFIED ADVERTISEMENTS

FOR SALE: B&K sweep marker generator Model 415, like new in original box, with manual - \$75 plus UPS. Ed Povraznik, 9606 Biddulph Rd., Brooklyn, OH 44144

FOR TRADE: Grebe items for Grebe, Federal or others in my wanted ads. I would consider trading the following extras: RKAB, RORH, RORD late, CR-3 Special. **FOR SALE/TRADE:** Boston Scale Model 101/105 needing a little work - \$800. John V. Terrey, 498 Cross St., Carlisle, MA 01741. (508) 369-9770

FOR SALE: Green Bulova bakelite Model 100 with tubes, plays OK - \$25 plus postage. James S. Looney, Rt. 1 Box 54, Grundy, VA 24614. (703) 531-8677

WANTED: High school electronics teacher needs help obtaining examples of early tube types for a classroom display. Need not be working tubes. Clean out your junk box for a good cause. Reply c/o Bob Crawford, PO Box 685, Troy, MI 48099

FOR SALE: Delco console R1144 - \$50. Airline console 04BR-903A - \$50. Mantola console 480-7H - \$50. Philco console on legs - \$50. RCA console 6K - \$50. RCA console C7-6 console - \$50. Philco 48-1264 with RP - \$40. Ozarka console - \$30. Majestic 70-B console HB - \$40 less power unit. Silvertone tombstone 1907 - \$50. Silvertone tombstone 7033 - \$60. Airline table model 8A47 Art Deco - \$60. **WANTED:** Speaker for AK 55 console. Speaker for Philco metal box 65 power unit for AK 42. Philco 14 chairside 1933. Gene Fout, 4760 Columbus St., Zanesfield, OH 43360. (513) 592-7524

FOR SALE: RCA X551, AM, phono plug, brown bakelite, mint, plays. Emerson FM, TM, white, nice, plays - best offer. Harry W. Overholzer, KA3BDN, 1480 Farmington Ave., Pottstown, PA 19464. (215) 323-7640

WANTED: Gates receivers, early 1920's, Quinicy, Illinois manufacturer; and information about these radio sets. Curt Lutz, 1021 N. Hickory Pl., Broken Arrow, OK 74012

FOR SALE: Zenith rotor wavemagnet, tabletop, two coils, five pounds, original box - \$25 + UPS. L. Gardner, W2QBC, 458 Two Mile Creek Rd., Tonawanda, NY 14150. (716) 873-0447

MESSAGE: I want to take this opportunity to wish a happy and prosperous New Year to all my friends who I have made and met through A.R.C. Russell Schoen, E7340 Nietzke Rd., Clintonville, WI 54929

WANTED: Catalin radio knobs, handles, dial faces, etc. Also any broken Catalin sets or chassis in any condition. Cash paid. Write or call. Steven Caiati, 1030 73rd St., Brooklyn, NY 11228. (718) 921-0316



ARKANSAS - Jan. 5

**ANTIQUA RADIO COLLECTORS CLUB
OF FT. SMITH - CLUB MEETING**

Ft. Smith, AR - Red Cross Bldg.
1709 S. Greenwood - 7:30 pm
Info: Ed Stewart (501) 785-1116

COLORADO - Jan. 7

**COLORADO RADIO COLLECTORS
ORGANIZATIONAL MEETING**

Littleton, CO - 1 pm, 5722 S. Lee Court
Program: Dev. of Tubes and Dating Sets
Info: Ron Smith - (303) 972-2427

ARKANSAS - Jan. 12

**ARKANSAS ANTIQUA RADIO CLUB OF
LITTLE ROCK - CLUB MEETING**

Little Rock, AR - The Auditorium
S.W. Bell Bldg., 120 W. 8th St. - 7 pm
Info: Tom Burgess - (501) 565-1750

OREGON - Jan. 14

**NORTHWEST VINTAGE RADIO SOCIETY
MEETING - EXHIBIT - CONTEST**

Oregon City, OR - Buena Vista Clubhouse
16th and Jackson Streets - 10 am
Info: Dan Howard, 2940 SE 118th Ave.
Portland, OR 97266 - (503) 761-7799

NEW CLUBS FORMING

**COLORADO - ALABAMA
NEW JERSEY - WISCONSIN**

Colorado - Info L. Bruton, 2201 Newton St.
Denver, CO 80211. (303) 651-0254

New Jersey - TV Club - Info: Harry Poster,
PO Box 1883, Hackensack, NJ 07606

Wisconsin residents interested in forming a
radio/phonograph club:

Info: Sandy Connors, 5 Breyerwood Ct.
Hortonville, WI 54944. (414) 779-4167

Alabama - Info: Bill Moore, Fieldstone Ct.,
Huntsville, AL 35803

**Non-members welcomed at all meets!
Admission charged at some meets.
Mention A.R.C. when contacting clubs!**

WASHINGTON - Jan. 15

**PUGET SOUND ANTIQUA RADIO ASSOC.
SWAP MEET - MEETING**

North Seattle, WA - Ronald School
North 175th St., one mile west of Interstate 5
11 am - Swap Meet; 1 pm - Business Mtg.
Program: Bert Whitaker on Troubleshooting
Show and Tell: Open

Info: Max Kaplan, 14902 84th Ave. Ct. NW
Gig Harbor, WA 98336 - (206) 851-4187

TEXAS - Jan. 16

**HOUSTON VINTAGE RADIO ASSOC.
CLUB MEETING**

Houston, TX - Museum of Natural Science
Hermann Park - Classroom #1 - 7:30 pm
Program: Video Tour of AWA Museum
Auction & Flea Market

Info: Frank Cooper, 4215 Ravine Dr.
Friendswood, TX 77546 - (713) 482-6781

N. HAMPSHIRE - Jan. 22

**NEW ENGLAND RADIO CLUB
SWAP & SELL MEET**

Nashua, NH - Holiday Inn, Exit 4 off Rt. 3

8 am - Set-up & Early Admission

9 am - 1 pm - General Admission

Over 60 Tables - Contest - Auction

Advance reservation required to set-up

Info: Marty Bunis, 422 Day Street
Manchester, NH 03104 - (603) 623-8996

CALIFORNIA Feb. 18

**SO. CALIF. ANTIQUA RADIO SOCIETY
SWAP MEET - CLUB MEETING**

Burbank, CA - Lockheed Employees Rec.
Center, 2814 Empire Ave.

7 am - Swap Meet, 10 am - Equip. Contest

10:30 am - Bus. Meeting - Prog: Radio Lit.

Info: Walt Curry, 10035 Country View Rd.
La Mesa, CA 92041

S. CAROLINA - Feb. 25-26

**SOUTHEAST ANTIQUA RADIO SOCIETY
SWAP MEET**

Greenville, SC - Flea Market - Contest

Info: SEARS, PO Box 8357
Greenville, SC 29604

RADIO CLUB LISTINGS

CLUBS: Send antique radio club and meet information to A.R.C. for free listing here, as space permits. Sorry, we don't have room for Hamfests.

Antique Wireless Association (AWA). P.O. Box "E", Breesport, NY 14816. Pub: *The Old Timer's Bulletin*, quarterly. Dues: \$10.00. National and regional conventions. Museum.

Antique Radio Club of America (ARCA). William Denk, 81 Steeplechase Rd., Devon, PA 19333. Pub: *The Antique Radio Gazette*, quarterly. Dues: \$12.00. National and regional conventions. Regional chapters.

Antique Radio Club of Illinois (ARCI). Carolyn Knipfel, Route 3, Morton, IL 61550. Pub: *ARCI News*. Dues: \$12.00. Annual Radiofest and additional meets each year.

Antique Radio Collectors Club of Ft. Smith, Arkansas. Wanda Conatser, 7917 Hermitage Dr., Ft. Smith, AR 72903. Monthly Meetings.

Arkansas Antique Radio Club of Little Rock. Tom Burgess, P.O. Box 9769, Little Rock, AR 72219. Pub: None. Dues: \$5.00. Monthly meets.

Arizona Antique Radio Club (AARC). Treasurer, 8311 E. Via de Sereno, Scottsdale, AZ 85258. Pub: *Arizona Antique Radio Club News*, quarterly. Monthly meetings.

California Historical Radio Society (CHRS). Paul Bourbin, 25 Greenview Ct., San Francisco, CA 94131. Pub: *CHRS Journal*, quarterly. Dues: \$12.50. Quarterly swap meets.

Colorado Radio Collectors (CRC). New club forming. Johnny Johnson, 2201 Newton St., Denver, CO 80211. Pub: Not yet. Dues: \$10.00. Quarterly meets.

Greater Boston Antique Radio Collectors (GBARC). Richard Foster, 12 Shawmut Ave., Cohituate, MA 01778. Informal organization. Write to be put on mailing list. One Winter and one Spring meet each year.

Greater New York Vintage Wireless Association (GNYVWA). Bob Scheps, 12 Garrity Ave., Ronkonkoma, NY 11779. Pub: Meeting Notices. Dues: \$4. Six meets/year.

Houston Vintage Radio Association (HVRA). Bill Moore, 805 Valerie, Pasadena, TX 77502. Pub: *The Grid Leak*, monthly. Dues: \$10.00 (\$15.00, local). Regional meets.

Indiana Historical Radio Society (IHRS). 245 N. Oakland Ave., Indianapolis, IN 46201-3360. Pub: *IHRS Bulletin*, quarterly. Dues: \$8.00. Quarterly swap meets in various areas of state.

London Vintage Radio Club. New club forming. For information, contact: Glen S. Lee, RR #2 Mt. Brydges, Ontario, Canada N0L 1W0. (519) 264-9115.

Michigan Antique Radio Club (MARC). Larry Anderson, 3453 Balsam NE, Grand Rapids, MI 49505. Pub: *MARC Newsletter*, quarterly. Dues: \$10. Quarterly regional swap meets.

Mid-America Antique Radio Club (MAARC). Sheldon Wheaton, 1120 Virginia Ln., Apt. #1, Olathe, KS 66061. Pub: *The Broadcaster*. Dues: \$8.00. Meets and two auctions each year.

MARK YOUR CALENDAR

Jan. 5 - AR, Ft. Smith - ARCCFS \$*

Jan. 7 - CO, Littleton - CRC *

Jan. 12 - AR, Little Rock - AARCLR \$*

Jan. 14 - OR, Oregon City - NVRS \$*

Jan. 15 - WA, Seattle - PSARA \$*

Jan. 16 - TX, Houston - HVRA \$*

Jan. 21 - MI, Grand Rapids - MARC

Jan. 22 - NH, Nashua - NERC Swap Meet *

Feb. 18 - CA, Burbank - SCARS *

Feb. 25-26 - SC, Greenville - SEARS *

April 1 - PA, Harrisburg - AWA

April 2 - MA, Weston - RADIO XX

April 15 - TX, Houston - HVRA/AWA

May 20-21 - CO, Denver - CRC Meet

June 1-3 - CT, Mystic - ARCA-89

June 21-29 - London, England Trip - AWA

Oct. 4-8 - NY, Canandaigua - AWA

*See expanded listing on these pages.

\$ Monthly Meeting.

Details, if received by A.R.C., will appear in an issue of A.R.C. prior to the meet.

Mid-Atlantic Antique Radio Club (MAARC). Joe Koester, 249 Spring Gap South, Laurel, MD 2C707. Pub: *MAARC Newsletter*, monthly. Dues: \$10.00. Monthly meetings.

New England Radio Club (NERC). Marty Bunis, 422 Day St., Manchester, NH 03104. Dues: \$5.00. Pub: Newsletter. Quarterly swap meets.

Niagara Frontier Wireless Association (NFWA). Dick Schamberger, P.O. Box 68, Central Park Station, Buffalo, NY 14215. Pub: *NFWA Chronicle*, quarterly. Dues: \$6.00. Regional meets.

Northland Antique Radio Club (NARC). P.O. Box 18362, Minneapolis, MN 55418. Pub: *NARC Newsletter*, six/year. Dues: \$10.00. About six meets/year.

Northwest Vintage Radio Society (NVRS). P.O. Box 02379, Portland, OR 97202. Pub: *The Call Letter*, monthly. Dues: \$12.00 (beyond 100 miles). Monthly meetings.

Pittsburgh Antique Radio Society, Inc. (PARS). David W. Kraeuter, Secretary, 506 E. Wheeling St., Washington, PA 15301. Pub: *The Pittsburgh Oscillator*, quarterly. Dues: \$10. Quarterly meetings.

Puget Sound Antique Radio Association (PSARA). M.A. Kaplan, 14902 84th Ave. Ct. NW, Gig Harbor, WA 98335. Pub: *The Horn of Plenty*. Dues: \$15/year.

Sacramento Historical Radio Society (SHRS). William Howell, 5724 Gibbons Dr., Carmichael, CA 95608. Pub: *The Announcer*. Dues: \$10. Special meets & monthly meetings.

Southern California Antique Radio Society (SCARS). Edward Sheldon, 656 Graviola Pl., La Jolla, CA 92037. Pub: *California Antique Radio Gazette*, quarterly. Dues: \$10.00. Meets: 3rd Sat. in Feb., May, Aug. & Nov.

(S. Vintage Wireless Assoc. & Vintage Radio & Phono. Soc. will be listed in future issue.)

BUSINESS CARD ADS — \$15.00 FOR 3 MONTHS

WANTED

**RADIO — WIRELESS
Pre-1925
ELECTRICITY — TELEGRAPHY
Pre-1900**

Books, Magazines, Autographs, Catalogs, Ephemera
One Item or Entire Collection

New Wireless Pioneers
6270 Clinton, Elma, NY 14059 USA
(716) 681-3186

— **WANTED** —
Old Transmitting Tubes

Amateur or Commercial types
FOR MUSEUM

Ye Olde Transmitting Tube Museum
Post Office Box 97
Crescent City, California 95531



ANTIQUe RADIO REPAIR

Repair - Restore - Buy & Sell
Schematic Diagrams \$2.00

DAMASKE ELECTRONICS
574-W16834 Janesville Road
Muskego, WI 53150
Phone: (414) 679-0838



EMUD REKORD
Senior 60
(1957)

ERIC P. MARX

S mmler von deutschen Rundfunkger ten
(Collector of German Radios)

2460 Bandon Dr
Grand Blanc, MI 48439 7906

(313) 695-0604

50 years **CHUCKS** of service!

**Any Tube Radio Repaired and
Guaranteed to work good.
\$26.00 plus large parts & UPS**

CHUCKS
167 LYNN DRIVE — PO Box 598
NEW HAVEN, WV 25265 — PH (304) 882-2220

Blade & Cage

Electric Brass Desk
Fans Bought, Sold, Restored



M. L. YOUNG
4200 Sunshine Rd
Miami, FL 33133

(305) 661-6245

Are You Looking For Antique Radios, Parts,
Tubes, Schematics, Etc.?

For Free Flyer, a 2-Stamp LSASE is required to insure a
response to your request. Send to:

Olde Tyme Radio Company
2445 Lyttonville Road, Silver Spring, MD 20910

Wish to contact us by phone?
Our number is (301) 585-8776.

Please call 10 am to 10 pm (Local Time)

Antique Radios



David & Nancy Snow
P.O. Box 6352
Jackson, MI 49204
(517) 750-4992

We Buy, Sell, Repair
ARBE - III Battery Eliminators



The Incomparable **Cavehart**

Kenny Bunny

*Exotic Radios & Phonographs
Pasadena Antique Center*

480 SO. FAIR OAKS PASADENA, CA 91105 **RES. (213) 733-7233**
(818) 449-7706

Books by Guy Biraud

Radio and TV Collector's Guide\$49.95
European/French Sets. Copious Illus.
**Restoration and Preservation of Scientific
Apparatus**\$35.00
French/Engl. Texts, Glossary, Many Good Hints

Available from: **Richard Foster**
Antique Electronic Supply
Vestal Press

**SCHEMATICS 1920-1960
RADIO/TV/HAM/MISC.**

**FULL DESCRIPTION OF SET IN
FIRST LETTER PLEASE — \$3.50 EA.**

ALTON H. BOWMAN
RD2 (CHAPIN VLG.)
CANANDAIGUA, NY 14424

**TELEVISIONS
TYPEWRITERS
SEWING MACHINES
WANTED**

**UNUSUAL OLDIES AND
RELATED PAPER ITEMS**

**Mike Brooks, 7335 Skyline Blvd.,
Oakland, CA 94611 (415) 339-1751**

BUSINESS CARD ADS — \$15.00 FOR 3 MONTHS



**Antique Radio
Service**
**REPAIR BUY
RESTORE SELL**
Woodwork a Specialty

RICHARD FOSTER
12 SHAWMUT AVE
COCHITUATE, MA 01778

508 - 655-2056

WANTED URGENTLY
Hollywood Radio & Television Institute's

Correspondence course lessons (any number), also the Superhet Radio Kit. Past students of HRTI, please help with any items. Finder's fee will be paid.

**B. All, 710B Highpoint, Waterloo
Ontario, Canada N2V1G9 — (519) 886-0347**

Victorian Talking Machine, Company
261 Robinson Ave. Newburg, NY 12550



914-561-0132
SHOP HOURS
BY APPT



*Unique Monographs
Cylinders, Discs,
Buy, Sell, Restore & Repair*

100 Needles \$3 00
Book & Parts Catalog ..\$3 00
TELEPHONE ORDERS
MC/VISA

BOB SOLTYSIK

LINDA SOLTYSIK

AKO SERVICES

Antique Radio and Apparatus Repair

2813 EVANS CT
PLANO TEXAS 75075

PHONE 598 0078



- Radios
- 78 RPM Jukeboxes
- 78 RPM Turntables
- Radio Tubes
- Shure
Needles & Cartridges
- Astatic
Needles & Cartridges
- Parts & Accessories

(815) 229-6900

ASTATIC

**VINTAGE RADIO
And Electronics**

**SCOTT A. WEBSTER
Owner**

1414 - 17th STREET
ROCKFORD, IL 61104

SHURE



ANTIQUE JUKEBOXES, MICROPHONES

Deco & Deluxe Console & Table Radios
Broadcasting, Hi Fi & Recording equipment
16" Transcriptions & Blank recording disks

Buy, Sell & Trade.

Robert Van Dyke 516-728-1327
2 Squires Ave., East Quogue NY 11942



Sales

Service

*Radiophile
The Vintage Radio Store*

Stephen Depres P.O. Box 020775
Brooklyn, N.Y. 11202-0017 (718) 625-7254
Call For Appointment

TUBES & STUFF

EXTENSIVE STOCK OF **NEW** AND
GOOD USED TUBES ETC.
Send \$1.00 (refundable) for latest lists

DON DIERS
4276-AB1 N. 50 St.
Milwaukee, WI 53216-1313



(201) 794-9606

VINTAGE TV'S
& RADIOS

**HARRY
POSTER**

P O Box 1883 • South Hackensack, New Jersey 07606

WANTED

Radios Advertising - Signs,
Clocks, Posters, etc. Toys, Banks,
etc., Shaped Like Radios

Brenda Wilk
409 S. Fible
Kirkville, MO 63501
(816) 665-9304

WANTED
ZENITH 5S126

Bert Hansen
POB 5
Boulder City, NV 89005
702-293-1272 eve.

Andrew Mooradian

Wanted Pre-1926 Radios by

AMRAD

*Also, Radio Parts, Accessories
and Literature*

5 Priscilla Lane, Winchester, MA 01890



WANTED

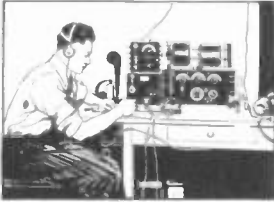

**Radio and Wireless items - pre-1925:
Books, Magazines, Catalogs, Receivers,
Transmitters, Speakers, Crystal sets,
Detectors, Tubes, and Spark Gear.**

Will buy entire collections! Qualified appraisals anytime, anywhere.
(References provided)

New Wireless Pioneers

WIRELESS

Jim Kreuzer, N2GHD, 6270 Clinton St., Elma, NY 14059 (716-681-3186)

rainy day books

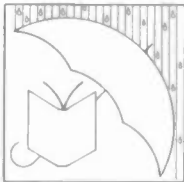

44 Bertwell Road
Lexington, MA 02173
(617) 861-8656
(Call for appointment)

frank bequaert
lucia bequaert

Technical Books Catalogs and Magazines Bought and Sold

Wireless - Radio - Telephone
Broadcasting - Telephone
Electronics - Computers
Electric Power - Electric RR
Civil Engineering - Machine Tools
Metallurgy - Mining

*New Lists Always Being Issued
Let Us Know Your Interests*



WAVES
ANTIQUES
EARLY RADIOS
&
PHONOGRAPHS
78 RECORDS
BOUGHT • SOLO
OPEN 12 6
CLOSED SUN & MON

32 EAST 13TH ST. NEW YORK, N. Y. 10003 212 989-9284

PROPRIETORS: Bruce and Charlotte Mager

THIS MONTH'S SPECIALS:

1. ACME K-3 Speaker\$85
2. AK E-Speaker 75
3. Howe Crystal Set 145
4. Heathkit Crystal Receiver.....45
5. Mitchell Lumiton Lamp Radio... 125
6. Pen Radio Retaling Magazines
1947-194880
7. G.E. Tubes Light-up Sign65

SEE NEXT MONTH'S LIST FOR MORE!





BUYING

RCA Black and Chrome Radios
 (see photo) \$1,500 to \$3,500
 RCA-Wanted unusual radios, TV's, miscellany!
 Sparton Mirror Radios \$1,000 - \$2,000
 Console over \$10,000!
 Color TV's..Early 15", 16", and 19" round CRT sets
 Transistors + early solid-state devices, radios, novelties
 Raytheon: Any radios: tube, transistor or hybrid!
 Radio/TV advertising: signs and clocks - top dollar!
 Radio/TV toys and items shaped like a radio or TV!



We also buy: Black and chrome anything; 1950's and 1960's unusually styled furniture, lamps, sculpture; old oak and mahogany furniture, books on machine design and style; stereoscopic "3D" cameras, viewers, plus View Master and similar items.

SELLING

★★ See us at the Jan. 22 Nashua, New Hampshire, show! ★★

Motorola Astronaut, rare 2nd transistor TV...as found \$185
 Motorola Astronaut...restored and working! \$295
 Sony VCR's - early reel-to-reel. AV3600 plus AV3650, both \$125
 Sony CV 2200A \$195
 Sony Micro TV, 4-203UW w/battery pack, cords, etc \$45
 Vibrator testers - Mallory 12VT1D \$20
 ElectroX Analyzer \$15
 Varistors + Thermistors + Glo-bars..50 new, assorted \$4
 Farnsworth #1846 Iconoscope tube TRADE
 UX199's and UV199's...duds \$3/each
 10BP4, 10" CRT's, tested good \$25/each
 7JP4's, tested good \$30/each
 Western Electric tube, #313CA (black) \$12/each
 French "Neotron". New, boxed metal 6L7MG's 2 for \$6
 SPECIAL - 1949/1950 Television - my choice! As found, clean and complete...
 Makes a great prop! \$25 plus shipping

TV COLLECTORS
 Now forming TV club with meets in this area.
 Please write if interested!

Member AWA - ARCA - PARS - MAARC - MARC - VRPS - NFWA - NZVRS - HRSA



DISPLAY ADVERTISEMENTS



COLLECTOR'S BOOKS

Antique Radio Restoration & Price Guide	\$12.95
Seventy Years of Radio Tubes & Valves by John W. Stockes (SC)	15.95
Radio Enters The Home, 128 pgs. 8 1/2 X 11	12.50
Radio Equipment & Supplies - 168 page reprint	12.50
1927 Radio Encyclopedia - Gernsback, 179 pgs.	11.95
Crosley Radio Catalog, circa 1923, 32 pages	4.50
Westinghouse Apparatus, circa 1920's, 8 1/2 X 11	4.00
Short Wave Radio Manual Official 1934, 260 pages	12.95
How To Repair Old-Time Radios	9.95
Vintage Radio Handbook, 263 pages, 1000 illus.	11.95
Flick Of The Switch 1930-1950, 312 pgs., 1000 illus.	11.95
Most Often Needed Diagrams 1926-1938, 600 models	11.95
1921-1932 Collector's Guide, 264 pg., 9,000 models	11.95
Atwater Kent Radio Parts Book, 24 pages, Model 9 plus 50 speakers	4.95
The William B. Duck Co. Catalog #18 (1921) - 256 Pgs.	18.95
Radio Collector's Directory & Price Guide, 321 pages.	15.95
Wireless & Electrical Encyclopedia, The Electro Importing Co.	4.95
Early Wireless by Anthony Constable, HB.	15.95
Instructions for Operating Grebe Radios, 64 pages pocket size	4.95
Radiola Super - Hetrodyne 2nd Harmonic	4.95
Atwater Kent Instruction Book Vol. II, an exact color duplication of the original	8.95
Grebe Synchrophase Instruction Manual, 70 pages, an excellent reproduction	10.95
Official Radio Service Manual, 1930 Gernsback, 8 1/2 X 11, 356 pages	19.95
The Story of Nipper and His Master's Voice, 64 pages, illustrated	6.50
Radio Collectors Pin (high metal relief and porcelain)	4.95
RASCO Radio Parts - Catalog #18, 145 pgs.	8.95
Radio Station Treasury 1900-1946 — 8 1/2 X 11 176 pgs.	12.95
The Continuous Wave-Technology and American Radio, 1900-1932, by Hugh G. J. Aiken, 588 pgs.	20.95
Syntony & Spark, by Hugh G. J. Aiken, 368 pgs.	14.95
Television, The Story of Scanning Disc Television — E. E. Taylor, 52 pgs.	4.95
Radio Speaker Encyclopedia, 8 1/2 X 11, by Floyd A. Paul.	11.90
Fifty Years of Radio, March 1938 issue of Hugo Gernsback's famous publication - 134 pgs.	14.95
Radio Manufacturers of the 1920's, Vol. 1, Very Large, by Alan Douglas	19.95
Radios — The Golden Age, 120 pgs. Full Color, by Phil Collins	14.95
David Sarnoff, biography, HB, 372 pages	14.95
Man of High Fidelity, <i>Edwin H. Armstrong</i> , PB, 272 pages	3.50
The Golden Age of Radio in the Home, HB <i>John Stokes</i>	NEW 24.95
Thomas A. Edison - A Stroke of Luck, PB, 562 pages.	NEW 13.95
Saga of the Vacuum Tube by <i>Gerald Tyne</i> , 494 pages	15.95
Tesla's Experiment, PB, 162 pages	8.95
Tesla Coil Secrets, PB	6.95
The Complete Talking Machine, 8 1/2 X 11, 183 pages	NEW 15.95

All orders under \$35.00 enclose \$1.50 postage — Orders over \$35.00 shipped free.

WE HAVE DETERMINED THAT ALL OF THESE PUBLICATIONS ARE THE VERY BEST OFFSET QUALITY.
ALLOW 3-4 WEEKS FOR DELIVERY

ORDER FROM

Antique Radio Club of America, Inc.

Charleston West Virginia Area Chapter

4204 Thorn Apple Lane

Charleston, West Virginia 25313

Revised 12/1/88

CLASSIFIED ADVERTISING POLICY

ONE FREE 20-WORD AD for subscribers in each issue; additional words are 10¢ each. See details below. All classified ads must be received (not just postmarked!) by the ad deadline. Late ads are held for the following issue. Please enclose correct payment with all ads. Stamps or cash are OK for small amounts. (Canadian and other foreign advertisers, please see "Payment" on page two for methods.) "Free words" cannot be accumulated from month to month; "free words" must be "taken" when ad is submitted.

Please write each ad on a separate sheet of paper, especially when included with other A.R.C. correspondence. A 3" x 5" card is suggested if the ad is short. Ads may be sent in advance; again, write each ad on a separate piece of paper and indicate the month (or two months) you want the ad to run.

Please write legibly and use both capital and small letters. Do not use dashes between words. Some numbers and letters can look alike, for example 1, l and I (the number one, the capital i and the small L.) Write the following characters clearly (especially in model numbers): 1, l and I; 0, O, o, Q and D; r and n; 6, b and G; V, U, u, v and Y; A and R; 5, S and s; 2, Z and z. We try to correct spelling errors, so when using an uncommon word or manufacturer which looks similar to a common word or manufacturer, note it so that we do not "correct" it. Editor's comments are in [brackets].

Advertising is accepted only for items related to antique radios, communication, electricity, etc. All items must be described fairly; reproductions, reprints and not-original items must be identified as such. Advertisers agree to respond promptly to inquiries and orders, and to resolve problems promptly if the buyer is not satisfied.

Publisher reserves the right to edit ads without notification to the advertiser and to reject ads for any reason. Publisher is not responsible for errors due to illegibly written ads or for any other reason; if requested, the ad will be run in the next available issue at no charge for errors made by A.R.C. All ad rates and details are subject to change by the publisher. See page two for additional information.

CLASSIFIED AD DETAILS

Classified ads must have a standard heading such as **WANTED, FOR SALE, FOR TRADE, FOR SALE/TRADE, SERVICES, MESSAGE, HELP**, etc. This heading is the only bold or all-capitalized words allowed in the ad. Capitalize only manufacturer names, model names, etc. Wanted and For Sale ads are mixed together to encourage the reading of all ads, including the Wanted ads. This standard ad format makes scanning the ads easier.

Before writing your ad, please look over the ads in a recent issue of A.R.C., and try to write your ad in the same style.

To encourage varied content of the ads, **multiple insertions of the same classified ad are limited to two successive months.** (To run an ad continuously, use a boxed classified or display ad.)

Classified Ad Rates per Month

Subscribers:

First 20 words: **FREE***

10¢ per word for extra words over 20 **plus**

10¢ per word for a shaded ad (count all words including free words).

* Subscribers may take 20 free words on only one ad each month.

Non-Subscribers:

20¢ per word **plus**

10¢ per word for shaded ad.

Please do not forget to send in the extra 10¢ per word when your classified ad runs over the free 20 words; your payment will be appreciated, and it will help to keep A.R.C. healthy.

BOXED CLASSIFIED AD DETAILS

Boxed classified ads can run unchanged for three months or more. No words are free. Ads may be shaded and may include bold and all-capitalized words freely. The ad need not begin with For Sale, etc. Boxed classified ads are placed with the display ads on the lower portion of the page.

Minimum run is 3 months, prepaid.

Boxed Classified Ad Rates per Month

Unshaded ads:

12¢ per word for all words,* none free, **plus**

10¢ per word for each bold word **plus**

10¢ per word for each all-caps word.

Shaded Ads:

22¢ per word for all words* **plus**

10¢ per word for each all-caps word.

Note: All words in shaded ads are bold.

Non-Subscribers:

Add 15¢ per word to above costs.

*Three of the total words can be bold-all-caps at no extra charge.

PHOTO & DRAWING DETAILS

The deadline for ads with drawings or photos is the first of the month.

Drawings and photos are encouraged as the response to your ad is much larger and the reader knows better what you want or are selling. Send in your drawing or photograph and A.R.C. will reduce it or enlarge it as **needed**.

Photo and Drawing Rates per Month

\$5.00 per month for each photo or drawing

IMPORTANT — COUNTING WORDS — IMPORTANT

The **standard headings:** WANTED, FOR SALE, etc., count as **one word** each time used in an ad. **Name, address** and (one) **telephone number**, count as **6 words**, regardless of length. Ham call letters and business name can be included in the 6 words and do not count extra. (Note: "Jim, (111) 111-1111" also counts as 6 words.) So, please include complete name and address in your ads.

Each additional word, **abbreviation**, model number or number group, extra telephone numbers, etc. count as one word. Hyphenated words count as two words.

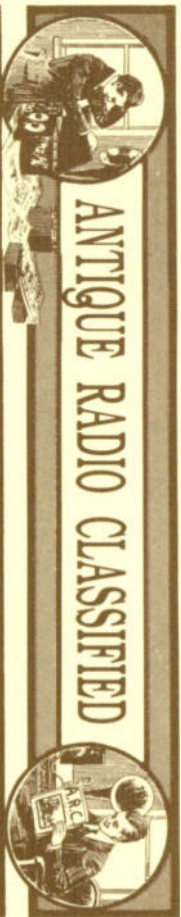

SECOND CLASS
POSTAGE PAID
at Carlisle, MA

A.R.C., P.O. Box 2, CARLISLE, MA 01741

RETURN POSTAGE GUARANTEED

TO:

CLASSIFIED AD
DEADLINE JAN. 10TH

POSTMASTER: Deliver Promptly